

ETSI TS 125 331 V7.21.0 (2012-01)



Technical Specification

**Universal Mobile Telecommunications System (UMTS);
Radio Resource Control (RRC);
Protocol specification
(3GPP TS 25.331 version 7.21.0 Release 7)**



Reference

RTS/TSGR-0225331v710

Keywords

UMTS

ETSI

650 Route des Lucioles
F-06921 Sophia Antipolis Cedex - FRANCE

Tel.: +33 4 92 94 42 00 Fax: +33 4 93 65 47 16

Siret N° 348 623 562 00017 - NAF 742 C
Association à but non lucratif enregistrée à la
Sous-Préfecture de Grasse (06) N° 7803/88

Important notice

Individual copies of the present document can be downloaded from:

<http://www.etsi.org>

The present document may be made available in more than one electronic version or in print. In any case of existing or perceived difference in contents between such versions, the reference version is the Portable Document Format (PDF). In case of dispute, the reference shall be the printing on ETSI printers of the PDF version kept on a specific network drive within ETSI Secretariat.

Users of the present document should be aware that the document may be subject to revision or change of status. Information on the current status of this and other ETSI documents is available at

<http://portal.etsi.org/tb/status/status.asp>

If you find errors in the present document, please send your comment to one of the following services:

http://portal.etsi.org/chaicor/ETSI_support.asp

Copyright Notification

No part may be reproduced except as authorized by written permission.
The copyright and the foregoing restriction extend to reproduction in all media.

© European Telecommunications Standards Institute 2012.
All rights reserved.

DECT™, PLUGTESTS™, UMTS™ and the ETSI logo are Trade Marks of ETSI registered for the benefit of its Members.
3GPP™ and LTE™ are Trade Marks of ETSI registered for the benefit of its Members and
of the 3GPP Organizational Partners.
GSM® and the GSM logo are Trade Marks registered and owned by the GSM Association.

Intellectual Property Rights

IPRs essential or potentially essential to the present document may have been declared to ETSI. The information pertaining to these essential IPRs, if any, is publicly available for **ETSI members and non-members**, and can be found in ETSI SR 000 314: *"Intellectual Property Rights (IPRs); Essential, or potentially Essential, IPRs notified to ETSI in respect of ETSI standards"*, which is available from the ETSI Secretariat. Latest updates are available on the ETSI Web server (<http://ipr.etsi.org>).

Pursuant to the ETSI IPR Policy, no investigation, including IPR searches, has been carried out by ETSI. No guarantee can be given as to the existence of other IPRs not referenced in ETSI SR 000 314 (or the updates on the ETSI Web server) which are, or may be, or may become, essential to the present document.

Foreword

This Technical Specification (TS) has been produced by ETSI 3rd Generation Partnership Project (3GPP).

The present document may refer to technical specifications or reports using their 3GPP identities, UMTS identities or GSM identities. These should be interpreted as being references to the corresponding ETSI deliverables.

The cross reference between GSM, UMTS, 3GPP and ETSI identities can be found under <http://webapp.etsi.org/key/queryform.asp>.

Contents

Intellectual Property Rights	2
Foreword.....	2
Foreword.....	32
1 Scope	33
2 References	33
3 Definitions and abbreviations.....	35
3.1 Definitions	35
3.2 Abbreviations	36
4 General	38
4.1 Overview of the specification.....	38
4.2 RRC Layer Model	39
4.3 Protocol specification principles	42
5 RRC Functions and Services provided to upper layers	42
5.1 RRC Functions	42
5.2 RRC Services provided to upper layers.....	43
5.3 Primitives between RRC and upper layers	43
6 Services expected from lower layers.....	43
6.1 Services expected from Layer 2	43
6.2 Services expected from Layer 1	43
6.3 Signalling Radio Bearers.....	43
7 Protocol states	44
7.1 Overview of RRC States and State Transitions including GSM	44
7.2 Processes in UE modes/states.....	45
7.2.1 UE Idle mode.....	45
7.2.2 UTRA RRC Connected mode.....	45
7.2.2.1 URA_PCH or CELL_PCH state	45
7.2.2.2 CELL_FACH state.....	46
7.2.2.3 CELL_DCH state.....	47
8 RRC procedures	48
8.1 RRC Connection Management Procedures	48
8.1.1 Broadcast of system information	48
8.1.1.1 General	49
8.1.1.1.1 System information structure.....	49
8.1.1.1.2 System information blocks	49
8.1.1.1.3 Segmentation and concatenation of system information blocks	55
8.1.1.1.4 Re-assembly of segments	56
8.1.1.1.5 Scheduling of system information	57
8.1.1.2 Initiation.....	57
8.1.1.3 Reception of SYSTEM INFORMATION messages by the UE.....	57
8.1.1.4 Void.....	58
8.1.1.5 Actions upon reception of the Master Information Block and Scheduling Block(s).....	58
8.1.1.6 Actions upon reception of system information blocks	61
8.1.1.6.1 System Information Block type 1	63
8.1.1.6.2 System Information Block type 2.....	63
8.1.1.6.3 System Information Block type 3.....	63
8.1.1.6.4 System Information Block type 4.....	66
8.1.1.6.5 System Information Block type 5 and 5bis.....	66
8.1.1.6.6 System Information Block type 6.....	69
8.1.1.6.7 System Information Block type 7.....	71
8.1.1.6.8 Void.....	71
8.1.1.6.9 Void.....	71

8.1.1.6.10	Void.....	71
8.1.1.6.11	System Information Block type 11.....	71
8.1.1.6.11a	System Information Block type 11bis.....	73
8.1.1.6.12	System Information Block type 12.....	73
8.1.1.6.13	System Information Block type 13.....	75
8.1.1.6.14	System Information Block type 14.....	75
8.1.1.6.15	System Information Block type 15.....	75
8.1.1.6.15.0	System Information Block type 15bis.....	75
8.1.1.6.15.1	System Information Block type 15.1.....	75
8.1.1.6.15.1a	System Information Block type 15.1bis.....	76
8.1.1.6.15.2	System Information Block type 15.2.....	76
8.1.1.6.15.2a	System Information Block type 15.2bis.....	76
8.1.1.6.15.3	System Information Block type 15.3.....	77
8.1.1.6.15.3a	System Information Block type 15.3bis.....	77
8.1.1.6.15.4	System Information Block type 15.4.....	78
8.1.1.6.15.5	System Information Block type 15.5.....	78
8.1.1.6.15.6	System Information Block type 15.6.....	78
8.1.1.6.15.7	System Information Block type 15.7.....	78
8.1.1.6.15.8	System Information Block type 15.8.....	79
8.1.1.6.16	System Information Block type 16.....	79
8.1.1.6.17	System Information Block type 17.....	79
8.1.1.6.18	System Information Block type 18.....	80
8.1.1.7	Modification of system information.....	81
8.1.1.7.1	Modification of system information blocks using a value tag.....	81
8.1.1.7.2	Synchronised modification of system information blocks.....	81
8.1.1.7.3	Actions upon system information change.....	82
8.1.1.7.4	Actions upon expiry of a system information expiry timer.....	82
8.1.2	Paging.....	83
8.1.2.1	General.....	83
8.1.2.2	Initiation.....	83
8.1.2.3	Reception of a PAGING TYPE 1 message by the UE.....	83
8.1.3	RRC connection establishment.....	85
8.1.3.1	General.....	85
8.1.3.2	Initiation.....	85
8.1.3.3	RRC CONNECTION REQUEST message contents to set.....	86
8.1.3.4	Reception of an RRC CONNECTION REQUEST message by the UTRAN.....	88
8.1.3.5	Cell re-selection, T300 or T318 timeout.....	88
8.1.3.5a	Abortion of RRC connection establishment.....	89
8.1.3.6	Reception of an RRC CONNECTION SETUP message by the UE.....	89
8.1.3.7	Physical channel failure or cell re-selection.....	92
8.1.3.8	Invalid RRC CONNECTION SETUP message, unsupported configuration or invalid configuration.....	93
8.1.3.9	Reception of an RRC CONNECTION REJECT message by the UE.....	94
8.1.3.10	Invalid RRC CONNECTION REJECT message.....	96
8.1.4	RRC connection release.....	97
8.1.4.1	General.....	98
8.1.4.2	Initiation.....	98
8.1.4.3	Reception of an RRC CONNECTION RELEASE message by the UE.....	98
8.1.4.4	Invalid RRC CONNECTION RELEASE message.....	100
8.1.4.5	Cell re-selection or radio link failure.....	100
8.1.4.6	Expiry of timer T308, unacknowledged mode transmission.....	100
8.1.4.7	Void.....	101
8.1.4.8	Reception of an RRC CONNECTION RELEASE COMPLETE message by UTRAN.....	101
8.1.4.9	Unsuccessful transmission of the RRC CONNECTION RELEASE COMPLETE message, acknowledged mode transmission.....	101
8.1.4.10	Detection of loss of dedicated physical channel by UTRAN in CELL_DCH state.....	102
8.1.4.11	Failure to receive RRC CONNECTION RELEASE COMPLETE message by UTRAN.....	102
8.1.4a	RRC connection release requested by upper layers.....	102
8.1.4a.1	General.....	102
8.1.4a.2	Initiation.....	102
8.1.5	Void.....	102
8.1.6	Transmission of UE capability information.....	103

8.1.6.1	General	103
8.1.6.2	Initiation	103
8.1.6.3	Reception of a UE CAPABILITY INFORMATION message by the UTRAN	104
8.1.6.4	Reception of the UE CAPABILITY INFORMATION CONFIRM message by the UE	104
8.1.6.5	Invalid UE CAPABILITY INFORMATION CONFIRM message	105
8.1.6.6	T304 timeout	105
8.1.7	UE capability enquiry	106
8.1.7.1	General	106
8.1.7.2	Initiation	106
8.1.7.3	Reception of a UE CAPABILITY ENQUIRY message by the UE	106
8.1.7.4	Invalid UE CAPABILITY ENQUIRY message	106
8.1.8	Initial Direct transfer	107
8.1.8.1	General	107
8.1.8.2	Initiation of Initial direct transfer procedure in the UE	107
8.1.8.2a	RLC re-establishment or inter-RAT change	109
8.1.8.2ab	Inter-RAT handover from UTRAN to GERAN <i>Iu mode</i>	109
8.1.8.2b	Abortion of signalling connection establishment	109
8.1.8.3	Reception of INITIAL DIRECT TRANSFER message by the UTRAN	110
8.1.9	Downlink Direct transfer	110
8.1.9.1	General	110
8.1.9.2	Initiation of downlink direct transfer procedure in the UTRAN	110
8.1.9.3	Reception of a DOWNLINK DIRECT TRANSFER message by the UE	110
8.1.9.3a	No signalling connection exists	111
8.1.9.4	Invalid DOWNLINK DIRECT TRANSFER message	111
8.1.10	Uplink Direct transfer	112
8.1.10.1	General	112
8.1.10.2	Initiation of uplink direct transfer procedure in the UE	112
8.1.10.2a	RLC re-establishment or inter-RAT change	113
8.1.10.2b	Inter-RAT handover from UTRAN to GERAN <i>Iu mode</i>	113
8.1.10.3	Reception of UPLINK DIRECT TRANSFER message by the UTRAN	113
8.1.11	UE dedicated paging	113
8.1.11.1	General	113
8.1.11.2	Initiation	113
8.1.11.3	Reception of a PAGING TYPE 2 message by the UE	114
8.1.11.4	Invalid PAGING TYPE 2 message	114
8.1.12	Security mode control	114
8.1.12.1	General	115
8.1.12.2	Initiation	115
8.1.12.2.1	Ciphering configuration change	115
8.1.12.2.2	Integrity protection configuration change	116
8.1.12.3	Reception of SECURITY MODE COMMAND message by the UE	118
8.1.12.3.1	New ciphering and integrity protection keys	121
8.1.12.4	Void	123
8.1.12.4a	Incompatible simultaneous security reconfiguration	123
8.1.12.4b	Cell update procedure during security reconfiguration	124
8.1.12.4c	Invalid configuration	124
8.1.12.5	Reception of SECURITY MODE COMPLETE message by the UTRAN	125
8.1.12.6	Invalid SECURITY MODE COMMAND message	127
8.1.13	Signalling connection release procedure	127
8.1.13.1	General	128
8.1.13.2	Initiation of SIGNALLING CONNECTION RELEASE by the UTRAN	128
8.1.13.3	Reception of SIGNALLING CONNECTION RELEASE by the UE	128
8.1.13.4	Invalid SIGNALLING CONNECTION RELEASE message	128
8.1.13.5	Invalid configuration	128
8.1.14	Signalling connection release indication procedure	129
8.1.14.1	General	129
8.1.14.2	Initiation	129
8.1.14.2a	RLC re-establishment or inter-RAT change	130
8.1.14.3	Reception of SIGNALLING CONNECTION RELEASE INDICATION by the UTRAN	130
8.1.15	Counter check procedure	130
8.1.15.1	General	130
8.1.15.2	Initiation	130

8.1.15.3	Reception of a COUNTER CHECK message by the UE.....	131
8.1.15.4	Reception of the COUNTER CHECK RESPONSE message by UTRAN	131
8.1.15.5	Cell re-selection	132
8.1.15.6	Invalid COUNTER CHECK message.....	132
8.1.16	Inter RAT handover information transfer	132
8.1.16.1	General	132
8.1.16.2	Initiation.....	132
8.1.16.3	INTER RAT HANDOVER INFO message contents to set	133
8.2	Radio Bearer control procedures	134
8.2.1	Radio bearer establishment	134
8.2.2	Reconfiguration procedures	134
8.2.2.1	General	136
8.2.2.2	Initiation.....	137
8.2.2.2a	Initiation of handover from GERAN <i>Iu mode</i>	138
8.2.2.3	Reception of RADIO BEARER SETUP or RADIO BEARER RECONFIGURATION or RADIO BEARER RELEASE or TRANSPORT CHANNEL RECONFIGURATION or PHYSICAL CHANNEL RECONFIGURATION message by the UE.....	139
8.2.2.3a	Reception of RADIO BEARER RECONFIGURATION message by the UE performing handover from GERAN <i>Iu mode</i>	152
8.2.2.4	Transmission of a response message by the UE, normal case.....	152
8.2.2.5	Reception of a response message by the UTRAN, normal case.....	155
8.2.2.5a	Rejection by the UE	155
8.2.2.6	Unsupported configuration in the UE	156
8.2.2.7	Physical channel failure	156
8.2.2.8	Cell re-selection	157
8.2.2.9	Transmission of a response message by the UE, failure case	158
8.2.2.10	Reception of a response message by the UTRAN, failure case	158
8.2.2.11	Invalid configuration.....	159
8.2.2.12	Incompatible simultaneous reconfiguration	159
8.2.2.12a	Incompatible simultaneous security reconfiguration.....	159
8.2.2.12b	Cell update procedure during security reconfiguration	160
8.2.2.13	Invalid received message	161
8.2.2.14	Radio link failure	161
8.2.3	Radio bearer release.....	162
8.2.4	Transport channel reconfiguration.....	162
8.2.5	Transport format combination control	162
8.2.5.1	General	163
8.2.5.2	Initiation.....	163
8.2.5.3	Reception of a TRANSPORT FORMAT COMBINATION CONTROL message by the UE	163
8.2.5.4	Invalid configuration.....	165
8.2.5.5	Invalid TRANSPORT FORMAT COMBINATION CONTROL message	165
8.2.6	Physical channel reconfiguration	166
8.2.7	Physical Shared Channel Allocation [TDD only].....	166
8.2.7.1	General	166
8.2.7.2	Initiation.....	166
8.2.7.3	Reception of a PHYSICAL SHARED CHANNEL ALLOCATION message by the UE	166
8.2.7.4	Invalid PHYSICAL SHARED CHANNEL ALLOCATION message	169
8.2.8	PUSCH capacity request [TDD only]	169
8.2.8.1	General	169
8.2.8.2	Initiation.....	169
8.2.8.3	PUSCH CAPACITY REQUEST message contents to set.....	170
8.2.8.4	Reception of a PUSCH CAPACITY REQUEST message by the UTRAN.....	171
8.2.8.5	T310 expiry	171
8.2.9	Void	171
8.2.10	Uplink Physical Channel Control [TDD only].....	171
8.2.10.1	General	171
8.2.10.2	Initiation.....	172
8.2.10.3	Reception of UPLINK PHYSICAL CHANNEL CONTROL message by the UE.....	172
8.2.10.4	Invalid UPLINK PHYSICAL CHANNEL CONTROL message	172
8.2.11	Physical channel reconfiguration failure.....	173
8.2.11.1	General	173
8.2.11.2	Runtime error due to overlapping compressed mode configurations.....	173

8.2.11.3	Void.....	173
8.3	RRC connection mobility procedures.....	174
8.3.1	Cell and URA update procedures	174
8.3.1.1	General	176
8.3.1.2	Initiation.....	177
8.3.1.3	CELL UPDATE / URA UPDATE message contents to set.....	183
8.3.1.4	T305 expiry and the UE detects "out of service area"	187
8.3.1.4.1	Re-entering "in service area"	187
8.3.1.4.2	Expiry of timer T307	188
8.3.1.5	Reception of an CELL UPDATE/URA UPDATE message by the UTRAN.....	188
8.3.1.6	Reception of the CELL UPDATE CONFIRM/URA UPDATE CONFIRM message by the UE	189
8.3.1.7	Transmission of a response message to UTRAN	196
8.3.1.7a	Physical channel failure	200
8.3.1.8	Unsupported configuration by the UE	201
8.3.1.9	Invalid configuration.....	202
8.3.1.9a	Incompatible simultaneous reconfiguration	203
8.3.1.9b	Security reconfiguration during Cell update procedure	205
8.3.1.10	Confirmation error of URA ID list.....	205
8.3.1.11	Invalid CELL UPDATE CONFIRM/URA UPDATE CONFIRM message	206
8.3.1.12	T302 expiry or cell reselection.....	207
8.3.1.13	T314 expiry	210
8.3.1.14	T315 expiry	211
8.3.1.15	Reception of the UTRAN MOBILITY INFORMATION CONFIRM message by the UTRAN	212
8.3.1.16	T320 Expiry	212
8.3.2	URA update	212
8.3.3	UTRAN mobility information	212
8.3.3.1	General	212
8.3.3.2	Initiation.....	213
8.3.3.3	Reception of UTRAN MOBILITY INFORMATION message by the UE.....	213
8.3.3.4	Reception of an UTRAN MOBILITY INFORMATION CONFIRM message by the UTRAN.....	216
8.3.3.5	Cell re-selection	216
8.3.3.5a	Incompatible simultaneous security reconfiguration.....	217
8.3.3.6	Invalid UTRAN MOBILITY INFORMATION message	217
8.3.4	Active set update.....	217
8.3.4.1	General	218
8.3.4.2	Initiation.....	218
8.3.4.3	Reception of an ACTIVE SET UPDATE message by the UE.....	219
8.3.4.4	Unsupported configuration in the UE	221
8.3.4.5	Invalid configuration.....	221
8.3.4.5a	Void.....	222
8.3.4.5b	Incompatible simultaneous reconfiguration	222
8.3.4.6	Reception of the ACTIVE SET UPDATE COMPLETE message by the UTRAN	222
8.3.4.7	Reception of the ACTIVE SET UPDATE FAILURE message by the UTRAN	222
8.3.4.8	Invalid ACTIVE SET UPDATE message.....	223
8.3.4.9	Reception of an ACTIVE SET UPDATE message in wrong state	223
8.3.5	Hard handover	223
8.3.5.1	Timing re-initialised hard handover	224
8.3.5.1.1	General	224
8.3.5.1.2	Initiation (FDD only).....	224
8.3.5.2	Timing-maintained hard handover	225
8.3.5.2.1	General	225
8.3.5.2.2	Initiation (FDD only).....	225
8.3.6	Inter-RAT handover to UTRAN.....	226
8.3.6.1	General	226
8.3.6.2	Initiation.....	226
8.3.6.3	Reception of HANDOVER TO UTRAN COMMAND message by the UE	227
8.3.6.4	Invalid Handover to UTRAN command message.....	231
8.3.6.4a	Unsupported configuration in HANDOVER TO UTRAN COMMAND message.....	231
8.3.6.5	UE fails to perform handover.....	231
8.3.6.6	Reception of message HANDOVER TO UTRAN COMPLETE by the UTRAN	232
8.3.7	Inter-RAT handover from UTRAN	232
8.3.7.1	General	232

8.3.7.2	Initiation.....	232
8.3.7.3	Reception of a HANDOVER FROM UTRAN COMMAND message by the UE.....	232
8.3.7.4	Successful completion of the inter-RAT handover	234
8.3.7.5	UE fails to complete requested handover.....	234
8.3.7.6	Invalid HANDOVER FROM UTRAN COMMAND message	235
8.3.7.7	Reception of an HANDOVER FROM UTRAN FAILURE message by UTRAN	236
8.3.7.8	Unsupported configuration in HANDOVER FROM UTRAN COMMAND message.....	236
8.3.7.8a	Reception of HANDOVER FROM UTRAN COMMAND message by UE in CELL_FACH.....	237
8.3.8	Inter-RAT cell reselection to UTRAN.....	237
8.3.8.1	General.....	237
8.3.8.2	Initiation.....	237
8.3.8.2a	Initiation of inter-RAT cell reselection from GERAN <i>Iu mode</i>	237
8.3.8.3	UE fails to complete an inter-RAT cell reselection.....	238
8.3.8.3a	UE fails to complete an inter-RAT cell reselection from GERAN <i>Iu mode</i>	238
8.3.9	Inter-RAT cell reselection from UTRAN	238
8.3.9.1	General.....	238
8.3.9.2	Initiation.....	239
8.3.9.2a	Initiation of inter-RAT cell reselection to GERAN <i>Iu mode</i>	239
8.3.9.3	Successful cell reselection.....	239
8.3.9.4	UE fails to complete an inter-RAT cell reselection.....	239
8.3.10	Inter-RAT cell change order to UTRAN	239
8.3.10.1	General.....	239
8.3.10.2	Initiation.....	239
8.3.10.3	UE fails to complete an inter-RAT cell change order	240
8.3.11	Inter-RAT cell change order from UTRAN.....	240
8.3.11.1	General.....	240
8.3.11.2	Initiation.....	240
8.3.11.3	Reception of an CELL CHANGE ORDER FROM UTRAN message by the UE	241
8.3.11.4	Successful completion of the cell change order	242
8.3.11.5	Expiry of timer T309 or UE fails to complete requested cell change order	242
8.3.11.6	Unsupported configuration in CELL CHANGE ORDER FROM UTRAN message	243
8.3.11.7	Invalid CELL CHANGE ORDER FROM UTRAN message.....	244
8.4	Measurement procedures.....	244
8.4.0	Measurement related definitions.....	244
8.4.1	Measurement control	246
8.4.1.1	General.....	246
8.4.1.2	Initiation.....	246
8.4.1.3	Reception of MEASUREMENT CONTROL by the UE	246
8.4.1.4	Unsupported measurement in the UE.....	253
8.4.1.4a	Configuration Incomplete	253
8.4.1.5	Invalid MEASUREMENT CONTROL message.....	253
8.4.1.6	Measurements after transition from CELL_DCH to CELL_FACH/CELL_PCH/URA_PCH state ...	254
8.4.1.6.1	Intra-frequency measurement	254
8.4.1.6.2	Inter-frequency measurement	254
8.4.1.6.3	Inter-RAT measurement	255
8.4.1.6.4	Quality measurement.....	255
8.4.1.6.5	UE internal measurement	255
8.4.1.6.6	Traffic volume measurement.....	255
8.4.1.6.7	UE positioning measurement.....	256
8.4.1.6a	Actions in CELL_FACH/CELL_PCH/URA_PCH state upon cell re-selection	258
8.4.1.7	Measurements after transition from CELL_FACH to CELL_DCH state	258
8.4.1.7.1	Intra-frequency measurement	258
8.4.1.7.2	Inter-frequency measurement	258
8.4.1.7.3	Inter-RAT measurement.....	258
8.4.1.7.4	Traffic volume measurement.....	259
8.4.1.7.5	UE positioning measurement.....	259
8.4.1.8	Measurements after transition from idle mode to CELL_DCH state	260
8.4.1.8.1	Intra-frequency measurement	260
8.4.1.8.2	Inter-frequency measurement	260
8.4.1.8.3	Inter-RAT measurement.....	260
8.4.1.8.4	Traffic volume measurement.....	260
8.4.1.8.5	UE positioning measurement.....	260

8.4.1.9	Measurements after transition from idle mode to CELL_FACH state.....	261
8.4.1.9.1	Intra-frequency measurement.....	261
8.4.1.9.2	Inter-frequency measurement.....	261
8.4.1.9.3	Inter-RAT measurement.....	261
8.4.1.9.4	Traffic volume measurement.....	261
8.4.1.9.5	UE positioning measurement.....	261
8.4.1.9a	Measurements after transition from connected mode to idle mode.....	262
8.4.1.9a.1	Intra-frequency measurement.....	262
8.4.1.9a.2	Inter-frequency measurement.....	262
8.4.1.9a.3	Inter-RAT measurement.....	262
8.4.1.9a.4	UE positioning measurement.....	262
8.4.1.9b	Measurements after transition from CELL_FACH to CELL_PCH/URA_PCH.....	262
8.4.1.9b.1	Traffic volume measurement.....	262
8.4.1.9b.2	UE positioning measurement.....	263
8.4.1.9c	Measurements after transition from CELL_PCH/URA_PCH to CELL_FACH.....	263
8.4.1.9c.1	Traffic volume measurement.....	263
8.4.1.9c.2	UE positioning measurement.....	263
8.4.1.10	Changes in measurement objects.....	264
8.4.1.10.1	Traffic volume measurement.....	264
8.4.1.10.2	Quality measurement.....	264
8.4.1.10.3	Intra-frequency, Inter-frequency and Inter-RAT measurements.....	265
8.4.2	Measurement report.....	265
8.4.2.1	General.....	265
8.4.2.2	Initiation.....	265
8.4.3	Assistance Data Delivery.....	267
8.4.3.1	General.....	267
8.4.3.2	Initiation.....	267
8.4.3.3	Reception of ASSISTANCE DATA DELIVERY message by the UE.....	267
8.4.3.4	Invalid ASSISTANCE DATA DELIVERY message.....	267
8.5	General procedures.....	268
8.5.1	Selection of initial UE identity.....	268
8.5.2	Actions when entering idle mode from connected mode.....	268
8.5.3	Open loop power control upon establishment of DPCCCH.....	270
8.5.4	Physical channel establishment criteria.....	270
8.5.5	Actions in "out of service area" and "in service area".....	270
8.5.5.1	Detection of "out of service" area.....	270
8.5.5.1.1	Actions following detection of "out of service" area in URA_PCH or CELL_PCH state.....	270
8.5.5.1.2	Actions following detection of "out of service" area in CELL_FACH state.....	270
8.5.5.1.3	Actions following detection of "out of service" area on transition from CELL_DCH to URA_PCH or CELL_PCH.....	271
8.5.5.1.4	Actions following detection of "out of service" area on transition from CELL_DCH to CELL_FACH.....	271
8.5.5.2	Detection of "in service" area.....	271
8.5.5.2.1	Actions following Re-entry into "in service area" in URA_PCH or CELL_PCH state.....	271
8.5.5.2.2	Actions following re-entry into "in service area" in CELL_FACH state.....	272
8.5.5.3	T316 expiry.....	272
8.5.5.4	T317 expiry.....	272
8.5.6	Radio link failure criteria and actions upon radio link failure.....	272
8.5.7	Open loop power control.....	273
8.5.8	Maintenance of Hyper Frame Numbers.....	277
8.5.9	START value calculation.....	278
8.5.10	Integrity protection.....	278
8.5.10.1	Integrity protection in downlink.....	279
8.5.10.2	Integrity protection in uplink.....	281
8.5.10.3	Calculation of message authentication code.....	281
8.5.11	FACH measurement occasion calculation.....	282
8.5.12	Establishment of Access Service Classes.....	283
8.5.13	Mapping of Access Classes to Access Service Classes.....	284
8.5.14	PLMN Type Selection.....	284
8.5.14a	Neighbour cells list narrowing for cell reselection.....	284
8.5.15	CFN calculation.....	284
8.5.15.1	Initialisation for CELL_DCH state after state transition.....	284

8.5.15.2	Initialisation in CELL_DCH state at hard handover	285
8.5.15.3	Initialisation for CELL_FACH	285
8.5.15.4	Initialisation after intersystem handover to UTRAN	285
8.5.15.5	Initialisation for MTCH and/or MSCH carried on S-CCPCH that may be soft combined	286
8.5.16	Configuration of CTCH occasions.....	286
8.5.17	PRACH selection.....	286
8.5.18	Selection of RACH TTI.....	287
8.5.18.1	FDD.....	287
8.5.18.2	1.28 Mcps TDD.....	288
8.5.19	Secondary CCPCH selection	289
8.5.19a	Secondary CCPCH and FACH selection for MCCH reception.....	289
8.5.20	Unsupported configuration	290
8.5.21	Actions related to Radio Bearer mapping	290
8.5.22	Actions when entering another RAT from connected mode.....	295
8.5.23	Measured results on RACH.....	295
8.5.24	Change of PLMN while in RRC connected mode	297
8.5.25	Actions related to HS_DSCH_RECEPTION variable.....	298
8.5.26	Service prioritisation.....	300
8.5.27	MBMS frequency selection	300
8.5.28	Actions related to E_DCH_TRANSMISSION variable	302
8.5.29	MBMS modification period identity calculation	304
8.5.30	Detecting MBMS service reception inability.....	305
8.5.31	Actions related to DEFERRED_MEASUREMENT_STATUS variable	305
8.5.32	Actions related to MIMO_PARAMS variable.....	305
8.5.33	Actions related to MIMO_STATUS variable	306
8.5.34	Actions related to DTX_DRX_STATUS variable (FDD only)	307
8.5.35	Actions related to HS_SCCH_LESS_STATUS variable (FDD only).....	308
8.5.36	Actions related to HS_DSCH_RECEPTION_CELL_FACH_STATE variable (FDD only)	309
8.5.37	Actions related to HS_DSCH_RECEPTION_OF_CCCH_ENABLED variable (FDD only).....	310
8.5.37a	Actions related to HS_DSCH_RECEPTION_GENERAL	311
8.5.38	Common H-RNTI selection (FDD only)	311
8.5.39	PICH selection for HSDPA based paging (FDD only)	311
8.5.40	HS_DSCH Reception in CELL_PCH and URA_PCH (FDD only)	312
8.5.41	HS-PDSCH channelisation codes selection for paging reception (FDD only)	313
8.5.42	Autonomous UTRAN DRX Cycle length coefficient	313
8.5.43	Reception of MBMS from a cell operating in MBSFN mode	313
8.5.44	HS-DSCH CQI reporting tables.....	313
8.6	Generic actions on receipt and absence of an information element.....	314
8.6.1	CN information elements.....	314
8.6.1.1	Void.....	314
8.6.1.2	CN information info	314
8.6.1.3	Signalling connection release indication.....	314
8.6.2	UTRAN mobility information elements	315
8.6.2.1	URA identity	315
8.6.2.2	Mapping info.....	315
8.6.2.3	RNC support for change of UE capability	316
8.6.3	UE information elements	316
8.6.3.1	Activation time.....	316
8.6.3.1a	CN domain specific DRX cycle length coefficient	317
8.6.3.1b	H-RNTI	317
8.6.3.2	UTRAN DRX Cycle length coefficient	318
8.6.3.3	Generic state transition rules depending on received information elements	318
8.6.3.4	Ciphering mode info	319
8.6.3.5	Integrity protection mode info.....	322
8.6.3.5.1	Initialisation of Integrity Protection.....	323
8.6.3.5.2	Integrity Protection Re-configuration for SRNS Relocation and handover from GERAN Iu mode	323
8.6.3.5.3	Integrity Protection modification in case of new keys or initialisation of signalling connection	324
8.6.3.6	Void.....	325
8.6.3.7	Void.....	325
8.6.3.8	Integrity check info	326
8.6.3.9	New C-RNTI.....	326

8.6.3.9a	New DSCH-RNTI.....	326
8.6.3.10	New U-RNTI.....	326
8.6.3.11	RRC transaction identifier.....	326
8.6.3.12	Capability Update Requirement.....	330
8.6.3.13	Group release information.....	331
8.6.3.14	New E-RNTI.....	332
8.6.4	Radio bearer information elements.....	332
8.6.4.1	Signalling RB information to setup list.....	332
8.6.4.2	RAB information for setup.....	333
8.6.4.2a	RAB information to reconfigure.....	334
8.6.4.3	RB information to setup.....	334
8.6.4.4	RB information to be affected.....	336
8.6.4.4a	Void.....	336
8.6.4.5	RB information to reconfigure.....	336
8.6.4.6	RB information to release.....	337
8.6.4.7	RB with PDCP information.....	337
8.6.4.8	RB mapping info.....	338
8.6.4.9	RLC Info.....	341
8.6.4.10	PDCP Info.....	344
8.6.4.11	PDCP SN Info.....	345
8.6.4.12	NAS Synchronisation Indicator.....	345
8.6.4.13	PDCP context relocation info.....	345
8.6.4.14	RLC Info MBMS.....	346
8.6.4.15	RAB information for MBMS ptp bearer.....	346
8.6.5	Transport channel information elements.....	346
8.6.5.1	Transport Format Set.....	346
8.6.5.2	Transport format combination set.....	348
8.6.5.3	Transport format combination subset.....	350
8.6.5.4	DCH quality target.....	351
8.6.5.5	Added or Reconfigured UL TrCH information.....	351
8.6.5.5a	Added or reconfigured MAC-d flow.....	352
8.6.5.6	Added or Reconfigured DL TrCH information.....	353
8.6.5.6a	Void.....	353
8.6.5.6b	HARQ Info.....	353
8.6.5.7	Deleted UL TrCH information.....	354
8.6.5.8	Deleted DL TrCH information.....	354
8.6.5.9	UL Transport channel information common for all transport channels.....	354
8.6.5.10	DL Transport channel information common for all transport channels.....	355
8.6.5.11	Void.....	356
8.6.5.12	TFCS Reconfiguration/Addition Information.....	356
8.6.5.12a	Additional RACH TFCS for CCCH.....	356
8.6.5.13	TFCS Removal Information.....	356
8.6.5.14	Void.....	357
8.6.5.15	TFCS Explicit Configuration.....	357
8.6.5.16	E-DCH Transmission Time Interval (FDD only).....	357
8.6.5.17	HARQ Info for E-DCH.....	357
8.6.5.18	Added or reconfigured E-DCH MAC-d flow.....	358
8.6.5.19	SRB1 mapping info (FDD only).....	359
8.6.5.20	HARQ System Info (FDD only).....	359
8.6.5.21	CCCH mapping info (FDD only).....	360
8.6.5.22	Common MAC-ehs reordering queue (FDD only).....	360
8.6.5.23	Added or reconfigured MAC-ehs reordering queue.....	360
8.6.6	Physical channel information elements.....	361
8.6.6.1	Frequency info.....	361
8.6.6.2	Void.....	361
8.6.6.2a	PNBSCCH allocation.....	361
8.6.6.3	Void.....	362
8.6.6.3a	Downlink information per radio link list.....	362
8.6.6.4	Downlink information for each radio link.....	363
8.6.6.5	Void.....	365
8.6.6.6	Uplink DPCH info.....	365
8.6.6.7	Void.....	366

8.6.6.8	Maximum allowed UL TX power	366
8.6.6.9	Void.....	366
8.6.6.10	Void.....	366
8.6.6.11	Uplink DPCH power control info	366
8.6.6.12	Secondary CPICH info.....	367
8.6.6.13	Primary CPICH usage for channel estimation	368
8.6.6.14	DPCH frame offset (FDD Only)	368
8.6.6.15	DPCH Compressed mode info	370
8.6.6.16	Repetition period, Repetition length, Offset (TDD only).....	373
8.6.6.16a	Repetition period, Repetition length, Offset _{sub} (1.28 Mcps TDD non-scheduled transmission only)	374
8.6.6.17	Primary CCPCH info	375
8.6.6.18	Primary CPICH info.....	375
8.6.6.19	Void.....	375
8.6.6.20	Void.....	375
8.6.6.21	Void.....	375
8.6.6.22	Secondary Scrambling Code, Code Number.....	375
8.6.6.23	PDSCH Power Control info	375
8.6.6.24	Tx Diversity Mode	376
8.6.6.25	Void.....	377
8.6.6.26	UL Timing Advance Control (TDD only)	377
8.6.6.26a	Uplink synchronisation parameters (TDD only)	378
8.6.6.27	Downlink information common for all radio links.....	378
8.6.6.28	Downlink DPCH info common for all radio links	378
8.6.6.28a	Downlink F-DPCH info common for all radio links	380
8.6.6.29	ASC setting	380
8.6.6.30	SRB delay, PC preamble (FDD only)	382
8.6.6.31	Void.....	382
8.6.6.32	Void.....	382
8.6.6.33	HS-SCCH Info	382
8.6.6.34	Measurement Feedback Info	383
8.6.6.35	DPC Mode.....	383
8.6.6.36	Downlink HS-PDSCH Information	383
8.6.6.36a	DL Multi-carrier information (1.28 Mcps TDD only)	384
8.6.6.37	E-DCH Info.....	384
8.6.6.38	DTX-DRX timing information (FDD only).....	386
8.6.6.39	DTX-DRX information (FDD only)	386
8.6.6.40	HS-SCCH less information (FDD only)	387
8.6.6.41	MIMO parameters.....	387
8.6.6.42	UL 16QAM settings.....	387
8.6.6.43	Multi-frequency Info (1.28 Mcps TDD only)	387
8.6.7	Measurement information elements.....	388
8.6.7.1	Measurement validity.....	388
8.6.7.2	Filter coefficient	388
8.6.7.3	Intra-frequency/Inter-frequency/Inter-RAT cell info list	390
8.6.7.4	Intra-frequency measurement quantity.....	397
8.6.7.5	Inter-RAT measurement quantity.....	397
8.6.7.6	Inter-RAT reporting quantity	398
8.6.7.7	Cell Reporting Quantities.....	399
8.6.7.8	Periodical Reporting Criteria	399
8.6.7.9	Reporting Cell Status	400
8.6.7.10	Traffic Volume Measurement	401
8.6.7.11	Traffic Volume Measurement Reporting Criteria	401
8.6.7.12	FACH measurement occasion info	401
8.6.7.13	Measurement Reporting Mode.....	403
8.6.7.14	Inter-frequency measurement.....	403
8.6.7.15	Inter-RAT measurement.....	404
8.6.7.16	Intra-frequency measurement.....	405
8.6.7.17	Quality measurement	405
8.6.7.18	UE internal measurement.....	405
8.6.7.18a	Void.....	406
8.6.7.19	UE positioning	406

8.6.7.19.0	UE positioning reporting criteria	406
8.6.7.19.1	UE positioning reporting quantity	406
8.6.7.19.1a	UE positioning reporting for UE assisted methods.....	407
8.6.7.19.1b	UE positioning reporting for UE based methods.....	410
8.6.7.19.2	UE positioning OTDOA assistance data for UE-assisted.....	412
8.6.7.19.2a	UE positioning OTDOA assistance data for UE-based	413
8.6.7.19.3	UE positioning GPS assistance data	415
8.6.7.19.3.1	UE positioning GPS acquisition assistance.....	415
8.6.7.19.3.2	UE positioning GPS Almanac.....	416
8.6.7.19.3.3	UE positioning D-GPS Corrections	416
8.6.7.19.3.3a	UE positioning GPS Navigation Model.....	416
8.6.7.19.3.4	UE positioning GPS Ephemeris and Clock Correction Parameters	416
8.6.7.19.3.5	UE positioning GPS ionospheric model	416
8.6.7.19.3.6	UE positioning GPS real-time integrity	417
8.6.7.19.3.7	UE positioning GPS reference time	417
8.6.7.19.3.8	UE positioning GPS reference UE position	418
8.6.7.19.3.9	UE positioning UTC model	418
8.6.7.19.4	UE positioning Ciphering info	418
8.6.7.19.5	UE positioning Error	420
8.6.7.19.6	Void.....	421
8.6.7.19.7	UE positioning GANSS assistance data	421
8.6.7.19.7.1	UE positioning GANSS reference measurement information	421
8.6.7.19.7.2	UE positioning GANSS Almanac.....	421
8.6.7.19.7.3	UE positioning D-GANSS Corrections	421
8.6.7.19.7.4	UE positioning GANSS Navigation Model	422
8.6.7.19.7.4a	UE positioning GANSS Clock Model	422
8.6.7.19.7.4b	UE positioning GANSS Orbit Model	422
8.6.7.19.7.5	UE positioning GANSS ionospheric model.....	422
8.6.7.19.7.6	UE positioning GANSS real-time integrity	423
8.6.7.19.7.7	UE positioning GANSS reference time	423
8.6.7.19.7.8	UE positioning GANSS reference UE position	424
8.6.7.19.7.9	UE positioning GANSS time model	424
8.6.7.19.7.10	UE positioning GANSS UTC model	424
8.6.7.19.7.11	UE positioning GANSS data bit assistance	424
8.6.7.20	Void.....	424
8.6.7.21	Intra-frequency reporting quantity for RACH reporting	424
8.6.7.22	Additional Measurement List.....	425
8.6.8	Void.....	426
8.6.9	MBMS specific information elements	426
8.6.9.1	Continue MCCH Reading	426
8.6.9.1a	MBMS dynamic persistence level.....	426
8.6.9.2	MBMS PL Service Restriction Information.....	426
8.6.9.3	MBMS L1 combining schedule	426
8.6.9.3a	MBMS Number of neighbour cells.....	426
8.6.9.4	MBMS Preferred frequency information	427
8.6.9.4a	Void.....	427
8.6.9.4b	MBMS p-t-m activation time	427
8.6.9.5	MBMS RB list released to change transfer mode	427
8.6.9.6	MBMS Required UE action	428
8.6.9.6a	MBMS re- acquire MCCH.....	429
8.6.9.7	MBMS Service transmissions info list.....	429
8.6.9.8	MBMS Short transmission ID.....	429
8.6.9.9	MBMS Transmission identity	430
8.6.9.9a	MBMS transmission time difference	430
8.6.9.9ab	MBSFN cluster frequency.....	430
8.6.9.9ac	MBSFN frequency list	430
8.6.9.9ad	MBSFN inter frequency neighbour list.....	431
8.6.9.9ae	MBSFN TDM Information	431
8.6.9.9b	MCCH configuration information.....	432
8.6.9.10	Next scheduling period	432
8.6.9.11	TDD MBSFN Information.....	432
8.7	MBMS specific procedures	432

8.7.1	Reception of MBMS control information.....	432
8.7.1.1	General.....	432
8.7.1.2	Initiation.....	433
8.7.1.3	UE requirements on reading of MCCH information.....	433
8.7.1.4	UE requirements on reading of MSCH information.....	434
8.7.2	MCCH acquisition.....	435
8.7.2.1	General.....	435
8.7.2.2	Initiation.....	435
8.7.2.3	MCCH information to be acquired by the UE.....	435
8.7.2.4	Reception of the MBMS MODIFIED SERVICES INFORMATION and the MBMS UNMODIFIED SERVICES INFORMATION by the UE.....	436
8.7.2.5	Reception of the other MBMS messages by the UE.....	437
8.7.3	MBMS Notification.....	437
8.7.3.1	General.....	437
8.7.3.2	Initiation.....	438
8.7.3.3	Receiving the MBMS Notification information.....	438
8.7.3.3.1	Reception via MCCH.....	438
8.7.3.3.2	Void.....	438
8.7.3.3.3	Reception via DCCH.....	439
8.7.3.4	UE action upon receiving MBMS MODIFIED SERVICES INFORMATION message.....	439
8.7.3.5	UE fails to receive MBMS Notification information.....	440
8.7.4	MBMS counting.....	440
8.7.4.1	General.....	440
8.7.4.2	Initiation.....	441
8.7.4.3	Reception of the MBMS ACCESS INFORMATION.....	441
8.7.4.4	Termination of the MBMS counting procedure.....	442
8.7.4.5	Failure of the counting response procedure.....	442
8.7.5	MBMS p-t-m radio bearer configuration.....	443
8.7.5.1	General.....	443
8.7.5.2	Initiation.....	443
8.7.5.3	Reception of the MBMS Current Cell PTM RB information.....	443
8.7.5.4	Reception of the MBMS Neighbouring Cell PTM RB information.....	443
8.7.6	MBMS modification request.....	444
8.7.6.1	General.....	444
8.7.6.2	Initiation.....	444
8.7.6.2a	MBMS MODIFICATION REQUEST message contents to set.....	445
8.7.6.3	Reception of a MBMS MODIFICATION REQUEST message by the UTRAN.....	445
8.7.7	MBMS service scheduling.....	446
8.7.7.1	General.....	446
8.7.7.2	Initiation.....	446
8.7.7.3	Reception of the MBMS scheduling information.....	446
9	Handling of unknown, unforeseen and erroneous protocol data.....	446
9.1	General.....	446
9.2	ASN.1 violation or encoding error.....	447
9.3	Unknown or unforeseen message type.....	447
9.3a	Unsolicited received message.....	447
9.3b	Unexpected critical message extension.....	448
9.4	Unknown or unforeseen information element value, mandatory information element.....	448
9.5	Conditional information element error.....	449
9.6	Unknown or unforeseen information element value, conditional information element.....	449
9.7	Unknown or unforeseen information element value, optional information element.....	450
9.8	Unexpected non-critical message extension.....	450
9.9	Handling of errors in nested information elements.....	451
10	Message and information element functional definition and content.....	452
10.1	General.....	452
10.1.1	Protocol extensions.....	453
10.1.1.1	Non-critical extensions.....	454
10.1.1.1.1	Extension of an information element with additional values or choices.....	454
10.1.1.1.2	Extension of a message with additional information elements.....	455
10.1.1.2	Critical extensions.....	455

10.1.1.2.1	Extension of an information element with additional values or choices	455
10.1.1.2.2	Extension of a message with additional information elements	455
10.2	Radio Resource Control messages	455
10.2.1	ACTIVE SET UPDATE	455
10.2.2	ACTIVE SET UPDATE COMPLETE	457
10.2.3	ACTIVE SET UPDATE FAILURE	458
10.2.4	ASSISTANCE DATA DELIVERY	458
10.2.5	CELL CHANGE ORDER FROM UTRAN	459
10.2.6	CELL CHANGE ORDER FROM UTRAN FAILURE	460
10.2.7	CELL UPDATE	460
10.2.8	CELL UPDATE CONFIRM	463
10.2.9	COUNTER CHECK	466
10.2.10	COUNTER CHECK RESPONSE	467
10.2.11	DOWNLINK DIRECT TRANSFER	467
10.2.12	Void	468
10.2.13	Void	468
10.2.14	Void	468
10.2.15	HANDOVER FROM UTRAN COMMAND	468
10.2.16	HANDOVER FROM UTRAN FAILURE	470
10.2.16a	HANDOVER TO UTRAN COMMAND	471
10.2.16b	HANDOVER TO UTRAN COMPLETE	474
10.2.16c	INITIAL DIRECT TRANSFER	475
10.2.16d	INTER RAT HANDOVER INFO	477
10.2.16e	MBMS ACCESS INFORMATION	478
10.2.16f	MBMS COMMON P-T-M RB INFORMATION	478
10.2.16g	MBMS CURRENT CELL P-T-M RB INFORMATION	481
10.2.16h	MBMS GENERAL INFORMATION	483
10.2.16i	MBMS MODIFICATION REQUEST	484
10.2.16j	MBMS MODIFIED SERVICES INFORMATION	485
10.2.16k	MBMS NEIGHBOURING CELL P-T-M RB INFORMATION	488
10.2.16L	MBMS SCHEDULING INFORMATION	491
10.2.16m	MBMS UNMODIFIED SERVICES INFORMATION	492
10.2.17	MEASUREMENT CONTROL	493
10.2.18	MEASUREMENT CONTROL FAILURE	495
10.2.19	MEASUREMENT REPORT	496
10.2.20	PAGING TYPE 1	496
10.2.21	PAGING TYPE 2	497
10.2.22	PHYSICAL CHANNEL RECONFIGURATION	497
10.2.23	PHYSICAL CHANNEL RECONFIGURATION COMPLETE	500
10.2.24	PHYSICAL CHANNEL RECONFIGURATION FAILURE	501
10.2.25	PHYSICAL SHARED CHANNEL ALLOCATION	502
10.2.26	PUSCH CAPACITY REQUEST	503
10.2.27	RADIO BEARER RECONFIGURATION	504
10.2.28	RADIO BEARER RECONFIGURATION COMPLETE	508
10.2.29	RADIO BEARER RECONFIGURATION FAILURE	509
10.2.30	RADIO BEARER RELEASE	510
10.2.31	RADIO BEARER RELEASE COMPLETE	514
10.2.32	RADIO BEARER RELEASE FAILURE	515
10.2.33	RADIO BEARER SETUP	516
10.2.34	RADIO BEARER SETUP COMPLETE	520
10.2.35	RADIO BEARER SETUP FAILURE	521
10.2.36	RRC CONNECTION REJECT	522
10.2.37	RRC CONNECTION RELEASE	523
10.2.38	RRC CONNECTION RELEASE COMPLETE	524
10.2.39	RRC CONNECTION REQUEST	524
10.2.40	RRC CONNECTION SETUP	527
10.2.41	RRC CONNECTION SETUP COMPLETE	529
10.2.41a	RRC FAILURE INFO	530
10.2.42	RRC STATUS	531
10.2.43	SECURITY MODE COMMAND	531
10.2.44	SECURITY MODE COMPLETE	532
10.2.45	SECURITY MODE FAILURE	532

10.2.46	SIGNALLING CONNECTION RELEASE.....	533
10.2.47	SIGNALLING CONNECTION RELEASE INDICATION.....	533
10.2.48	SYSTEM INFORMATION.....	534
10.2.48.1	First Segment	536
10.2.48.2	First Segment (short).....	536
10.2.48.3	Subsequent Segment	536
10.2.48.4	Last Segment.....	537
10.2.48.5	Last Segment (short)	537
10.2.48.6	Complete SIB	537
10.2.48.7	Complete SIB (short)	538
10.2.48.8	System Information Blocks.....	538
10.2.48.8.1	Master Information Block	538
10.2.48.8.2	Scheduling Block 1.....	539
10.2.48.8.3	Scheduling Block 2.....	539
10.2.48.8.4	System Information Block type 1	539
10.2.48.8.5	System Information Block type 2.....	540
10.2.48.8.6	System Information Block type 3.....	540
10.2.48.8.7	System Information Block type 4.....	542
10.2.48.8.8	System Information Block type 5 and 5bis.....	543
10.2.48.8.9	System Information Block type 6.....	546
10.2.48.8.10	System Information Block type 7	548
10.2.48.8.11	Void.....	548
10.2.48.8.12	Void.....	548
10.2.48.8.13	Void.....	548
10.2.48.8.14	System Information Block type 11	548
10.2.48.8.14a	System Information Block type 11bis	549
10.2.48.8.15	System Information Block type 12.....	549
10.2.48.8.16	System Information Block type 13.....	549
10.2.48.8.16.1	System Information Block type 13.1	550
10.2.48.8.16.2	System Information Block type 13.2	550
10.2.48.8.16.3	System Information Block type 13.3	550
10.2.48.8.16.4	System Information Block type 13.4	551
10.2.48.8.17	System Information Block type 14.....	551
10.2.48.8.18	System Information Block type 15.....	551
10.2.48.8.18.0	System Information Block type 15bis.....	552
10.2.48.8.18.1	System Information Block type 15.1	552
10.2.48.8.18.1a	System Information Block type 15.1bis.....	552
10.2.48.8.18.2	System Information Block type 15.2	553
10.2.48.8.18.2a	System Information Block type 15.2bis.....	553
10.2.48.8.18.3	System Information Block type 15.3	553
10.2.48.8.18.3a	System Information Block type 15.3bis.....	554
10.2.48.8.18.4	System Information Block type 15.4	555
10.2.48.8.18.4a	System Information Block type 15.5	555
10.2.48.8.18.5	System Information Block type 15.6	555
10.2.48.8.18.6	System Information Block type 15.7	555
10.2.48.8.18.7	System Information Block type 15.8	556
10.2.48.8.19	System Information Block type 16.....	556
10.2.48.8.20	System Information Block type 17.....	556
10.2.48.8.21	System Information Block type 18.....	557
10.2.49	SYSTEM INFORMATION CHANGE INDICATION.....	557
10.2.50	TRANSPORT CHANNEL RECONFIGURATION	558
10.2.51	TRANSPORT CHANNEL RECONFIGURATION COMPLETE	561
10.2.52	TRANSPORT CHANNEL RECONFIGURATION FAILURE.....	562
10.2.53	TRANSPORT FORMAT COMBINATION CONTROL.....	563
10.2.54	TRANSPORT FORMAT COMBINATION CONTROL FAILURE.....	564
10.2.55	UE CAPABILITY ENQUIRY	564
10.2.56	UE CAPABILITY INFORMATION.....	565
10.2.57	UE CAPABILITY INFORMATION CONFIRM	565
10.2.58	UPLINK DIRECT TRANSFER.....	566
10.2.59	UPLINK PHYSICAL CHANNEL CONTROL.....	566
10.2.60	URA UPDATE	568
10.2.61	URA UPDATE CONFIRM	569

10.2.62	UTRAN MOBILITY INFORMATION	570
10.2.63	UTRAN MOBILITY INFORMATION CONFIRM	572
10.2.64	UTRAN MOBILITY INFORMATION FAILURE	573
10.3	Information element functional definitions	573
10.3.1	CN Information elements	573
10.3.1.1	CN domain identity	573
10.3.1.2	CN Domain System Information	573
10.3.1.3	CN Information info	574
10.3.1.3a	CN Information info full	574
10.3.1.3b	Domain Specific Access Restriction	575
10.3.1.3c	Domain Specific Access Restriction Parameters	575
10.3.1.4	IMEI	575
10.3.1.5	IMSI (GSM-MAP)	575
10.3.1.6	Intra Domain NAS Node Selector	576
10.3.1.7	Location Area Identification	577
10.3.1.7a	Multiple PLMN List	578
10.3.1.8	NAS message	578
10.3.1.9	NAS system information (GSM-MAP)	578
10.3.1.10	Paging record type identifier	578
10.3.1.11	PLMN identity	579
10.3.1.11a	PLMN identity with Optional MCC	579
10.3.1.12	PLMN Type	579
10.3.1.13	P-TMSI (GSM-MAP)	579
10.3.1.14	RAB identity	580
10.3.1.15	Routing Area Code	580
10.3.1.16	Routing Area Identification	580
10.3.1.17	TMSI (GSM-MAP)	581
10.3.2	UTRAN mobility Information elements	581
10.3.2.1	Cell Access Restriction	581
10.3.2.2	Cell identity	581
10.3.2.3	Cell selection and re-selection info for SIB3/4	582
10.3.2.4	Cell selection and re-selection info for SIB11/12	586
10.3.2.5	Mapping Info	587
10.3.2.6	URA identity	588
10.3.3	UE Information elements	589
10.3.3.1	Activation time	589
10.3.3.2	Capability Update Requirement	589
10.3.3.3	Cell update cause	589
10.3.3.4	Ciphering Algorithm	590
10.3.3.5	Ciphering mode info	590
10.3.3.6	CN domain specific DRX cycle length coefficient	590
10.3.3.7	Void	591
10.3.3.8	C-RNTI	591
10.3.3.9	Void	591
10.3.3.9a	DSCH-RNTI	591
10.3.3.10	Void	591
10.3.3.10a	E-RNTI	591
10.3.3.11	Establishment cause	592
10.3.3.12	Expiration Time Factor	593
10.3.3.13	Failure cause	593
10.3.3.14	Failure cause and error information	593
10.3.3.14o	Group release information	594
10.3.3.14a	H-RNTI	594
10.3.3.15	Initial UE identity	594
10.3.3.16	Integrity check info	595
10.3.3.17	Integrity protection activation info	595
10.3.3.18	Integrity protection Algorithm	596
10.3.3.19	Integrity protection mode info	596
10.3.3.19a	Void	596
10.3.3.20	Void	597
10.3.3.21	Measurement capability	597
10.3.3.21a	Measurement capability extension	599

10.3.3.22	Paging cause.....	602
10.3.3.23	Paging record	602
10.3.3.24	PDCP capability	603
10.3.3.25	Physical channel capability	604
10.3.3.26	Protocol error cause.....	609
10.3.3.27	Protocol error indicator	610
10.3.3.28	RB timer indicator.....	610
10.3.3.29	Redirection info.....	610
10.3.3.30	Re-establishment timer.....	610
10.3.3.31	Rejection cause	611
10.3.3.32	Release cause	611
10.3.3.32a	RF Capability Compressed	612
10.3.3.33	RF capability FDD	612
10.3.3.33a	RF capability FDD extension.....	613
10.3.3.33b	RF capability TDD.....	613
10.3.3.33c	RF capability TDD 1.28 Mcps.....	613
10.3.3.34	RLC capability	614
10.3.3.35	RLC re-establish indicator	614
10.3.3.35o	RRC connection release information	614
10.3.3.35a	RRC State Indicator	614
10.3.3.36	RRC transaction identifier.....	615
10.3.3.37	Security capability.....	615
10.3.3.38	START	616
10.3.3.39	Void.....	616
10.3.3.40	Transport channel capability	616
10.3.3.41	UE multi-mode/multi-RAT capability	618
10.3.3.42	UE radio access capability	618
10.3.3.42o	UE radio access capability compressed.....	622
10.3.3.42oa	UE radio access capability comp 2	623
10.3.3.42a	UE radio access capability extension	625
10.3.3.42b	UE security information	625
10.3.3.42c	UE security information2.....	626
10.3.3.43	UE Timers and Constants in connected mode.....	626
10.3.3.44	UE Timers and Constants in idle mode.....	628
10.3.3.45	UE positioning capability.....	629
10.3.3.45a	GANSS Signal Id.....	630
10.3.3.46	URA update cause.....	630
10.3.3.47	U-RNTI.....	631
10.3.3.47a	U-RNTI group.....	631
10.3.3.48	U-RNTI Short	631
10.3.3.49	UTRAN DRX cycle length coefficient	632
10.3.3.50	Wait time.....	632
10.3.3.51	UE Specific Behaviour Information 1 idle.....	632
10.3.3.52	UE Specific Behaviour Information 1 interRAT.....	633
10.3.4	Radio Bearer Information elements	633
10.3.4.oa	Common RB mapping info	633
10.3.4.0	Default configuration identity	633
10.3.4.1	Downlink RLC STATUS info.....	634
10.3.4.1a	PDCP context relocation info.....	634
10.3.4.2	PDCP info	635
10.3.4.2a	PDCP ROHC target mode.....	637
10.3.4.3	PDCP SN info	637
10.3.4.4	Polling info.....	638
10.3.4.5	Predefined configuration identity.....	638
10.3.4.5a	Predefined configuration status information	638
10.3.4.5b	Predefined configuration status information compressed	639
10.3.4.6	Predefined configuration value tag	639
10.3.4.7	Predefined RB configuration.....	640
10.3.4.8	RAB info	640
10.3.4.9	RAB info Post.....	641
10.3.4.9a	RAB information for MBMS ptp bearers.....	641
10.3.4.10	RAB information for setup.....	641

10.3.4.11	RAB information to reconfigure	641
10.3.4.12	NAS Synchronization indicator	642
10.3.4.13	RB activation time info	642
10.3.4.14	RB COUNT-C MSB information	642
10.3.4.15	RB COUNT-C information	642
10.3.4.16	RB identity	643
10.3.4.17	RB information to be affected	643
10.3.4.18	RB information to reconfigure	643
10.3.4.19	RB information to release	643
10.3.4.20	RB information to setup	644
10.3.4.21	RB mapping info	644
10.3.4.22	RB with PDCP information	647
10.3.4.23	RLC info	648
10.3.4.23a	RLC info MBMS	650
10.3.4.24	Signalling RB information to setup	650
10.3.4.25	Transmission RLC Discard	650
10.3.4.26	UM Duplication Avoidance and Reordering info	652
10.3.4.27	UM Out of sequence delivery info	652
10.3.5	Transport CH Information elements	652
10.3.5.1	Added or Reconfigured DL TrCH information	652
10.3.5.1a	Added or reconfigured MAC-d flow	653
10.3.5.1b	Added or reconfigured E-DCH MAC-d flow	654
10.3.5.1c	Added or reconfigured MAC-ehs reordering queue	656
10.3.5.2	Added or Reconfigured UL TrCH information	657
10.3.5.2a	Additional Dynamic Transport Format Information for CCCH	657
10.3.5.2b	Additional RACH TFCS for CCCH	658
10.3.5.3	Void	658
10.3.5.3a	Common MAC-ehs reordering queue list	658
10.3.5.4	Deleted DL TrCH information	659
10.3.5.5	Deleted UL TrCH information	659
10.3.5.6	DL Transport channel information common for all transport channels	660
10.3.5.7	Void	660
10.3.5.7a	HARQ Info	661
10.3.5.7b	Void	662
10.3.5.7c	MAC-d Flow Identity	662
10.3.5.7d	HARQ Info for E-DCH	662
10.3.5.7e	E-DCH MAC-d Flow Identity	662
10.3.5.7f	MAC-ehs Queue Id	662
10.3.5.8	Power Offset Information	663
10.3.5.9	Predefined TrCH configuration	664
10.3.5.10	Quality Target	664
10.3.5.11	Semi-static Transport Format Information	664
10.3.5.12	Void	665
10.3.5.13	TFCS Explicit Configuration	665
10.3.5.14	Void	665
10.3.5.15	TFCS Reconfiguration/Addition Information	666
10.3.5.16	TFCS Removal Information	667
10.3.5.17	Void	667
10.3.5.18	Transport channel identity	667
10.3.5.19	Transport Format Combination (TFC)	667
10.3.5.20	Transport Format Combination Set	667
10.3.5.21	Transport Format Combination Set Identity	667
10.3.5.22	Transport Format Combination Subset	668
10.3.5.23	Transport Format Set	668
10.3.5.24	UL Transport channel information common for all transport channels	670
10.3.6	Physical CH Information elements	671
10.3.6.1	AC-to-ASC mapping	671
10.3.6.2	AICH Info	672
10.3.6.3	AICH Power offset	672
10.3.6.4	Allocation period info	672
10.3.6.5	Alpha	672
10.3.6.6	ASC setting	672

10.3.6.7	Void.....	674
10.3.6.8	CCTrCH power control info	675
10.3.6.8a	Cell and Channel Identity info	675
10.3.6.9	Cell parameters Id	675
10.3.6.10	Common timeslot info.....	675
10.3.6.10a	Common timeslot info MBMS.....	676
10.3.6.11	Constant value.....	676
10.3.6.11a	Constant value TDD.....	676
10.3.6.12	Void.....	677
10.3.6.13	Void.....	677
10.3.6.14	Void.....	677
10.3.6.15	Void.....	677
10.3.6.16	Default DPCH Offset Value.....	677
10.3.6.17	Downlink channelisation codes.....	677
10.3.6.17a	Downlink channelisation codes VHCR.....	678
10.3.6.18	Downlink DPCH info common for all RL	679
10.3.6.19	Downlink DPCH info common for all RL Post	681
10.3.6.20	Downlink DPCH info common for all RL Pre	681
10.3.6.21	Downlink DPCH info for each RL.....	681
10.3.6.22	Downlink DPCH info for each RL Post.....	684
10.3.6.23	Downlink DPCH power control information	685
10.3.6.23oa	Downlink F-DPCH info common for all RL.....	685
10.3.6.23ob	Downlink F-DPCH info for each RL	685
10.3.6.23a	Downlink HS-PDSCH Information	687
10.3.6.24	Downlink information common for all radio links.....	688
10.3.6.25	Downlink information common for all radio links Post.....	689
10.3.6.26	Downlink information common for all radio links Pre	689
10.3.6.27	Downlink information for each radio link.....	690
10.3.6.28	Downlink information for each radio link Post.....	690
10.3.6.28a	DL Multi-Carrier Information (1.28 Mcps TDD only)	692
10.3.6.29	Void.....	693
10.3.6.30	Void.....	693
10.3.6.31	Downlink rate matching restriction information	693
10.3.6.32	Downlink Timeslots and Codes	693
10.3.6.32a	Downlink Timeslots and Codes VHCR	694
10.3.6.33	DPCH compressed mode info	695
10.3.6.34	DPCH Compressed Mode Status Info.....	698
10.3.6.34a	DTX-DRX information	698
10.3.6.34b	DTX-DRX timing information.....	700
10.3.6.35	Dynamic persistence level.....	700
10.3.6.35a	FPACH info	700
10.3.6.35b	Frequency band indicator.....	701
10.3.6.35c	Frequency band indicator 2	701
10.3.6.36	Frequency info	701
10.3.6.36oo	HS-PDSCH Midamble Configuration.....	701
10.3.6.36o	HS-PDSCH Timeslot Configuration.....	702
10.3.6.36oa	HS-PDSCH Timeslot Configuration VHCR.....	703
10.3.6.36a	HS-SCCH Info	704
10.3.6.36ab	HS-SCCH less information	708
10.3.6.36b	HS-SICH Power Control Info	708
10.3.6.36c	HS-DSCH common system information.....	709
10.3.6.36d	HS-DSCH paging system information	709
10.3.6.36e	HS-SCCH system info	710
10.3.6.37	Individual timeslot info	710
10.3.6.38	Individual Timeslot interference	711
10.3.6.39	Maximum allowed UL TX power.....	711
10.3.6.39a	Multi-frequency Info (1.28 Mcps TDD only)	712
10.3.6.40	Void.....	712
10.3.6.40a	Measurement Feedback Info	712
10.3.6.41	Midamble shift and burst type.....	712
10.3.6.41a	MIMO parameters.....	714
10.3.6.41b	MIMO pilot configuration.....	714

10.3.6.41c	Non-scheduled transmission grant info (TDD only)	716
10.3.6.42	PDSCH Capacity Allocation info	718
10.3.6.43	Void.....	718
10.3.6.44	PDSCH info	718
10.3.6.45	PDSCH Power Control info	719
10.3.6.46	PDSCH system information	719
10.3.6.47	Void.....	720
10.3.6.48	Persistence scaling factors.....	720
10.3.6.49	PICH Info.....	720
10.3.6.50	PICH Power offset	721
10.3.6.50a	PLCCH Info	721
10.3.6.51	PRACH Channelisation Code List.....	721
10.3.6.51a	PRACH Channelisation Code 1.28 Mcps TDD	722
10.3.6.51b	PRACH Channelisation Code List VHCR.....	722
10.3.6.52	PRACH info (for RACH).....	723
10.3.6.53	PRACH partitioning.....	725
10.3.6.54	PRACH power offset	725
10.3.6.55	PRACH system information list.....	725
10.3.6.56	Predefined PhyCH configuration	727
10.3.6.57	Primary CCPCH info	727
10.3.6.58	Primary CCPCH info post.....	728
10.3.6.59	Primary CCPCH TX Power	728
10.3.6.60	Primary CPICH info.....	728
10.3.6.61	Primary CPICH Tx power.....	728
10.3.6.62	Primary CPICH usage for channel estimation	729
10.3.6.63	PUSCH info	729
10.3.6.63a	PUSCH info VHCR	729
10.3.6.64	PUSCH Capacity Allocation info	730
10.3.6.65	PUSCH power control info	730
10.3.6.66	PUSCH system information	731
10.3.6.66a	PUSCH system information VHCR	731
10.3.6.67	RACH transmission parameters	732
10.3.6.68	Radio link addition information	732
10.3.6.69	Radio link removal information	733
10.3.6.69a	E-DCH reconfiguration information	733
10.3.6.69b	E-DCH reconfiguration information same serving cell.....	735
10.3.6.70	Void.....	735
10.3.6.70a	SCTD indicator	735
10.3.6.71	Secondary CCPCH info	736
10.3.6.71a	Secondary CCPCH info MBMS	738
10.3.6.71b	Secondary CCPCH info MBMS Diff.....	739
10.3.6.72	Secondary CCPCH system information.....	740
10.3.6.72a	Secondary CCPCH system information MBMS	741
10.3.6.73	Secondary CPICH info.....	741
10.3.6.74	Secondary scrambling code.....	741
10.3.6.74a	Serving HS-DSCH cell information.....	742
10.3.6.75	SFN Time info	742
10.3.6.75a	Special Burst Scheduling	742
10.3.6.76	Void.....	742
10.3.6.77	Void.....	742
10.3.6.78	STTD indicator	742
10.3.6.78o	SYNC_UL codes bitmap.....	743
10.3.6.78a	SYNC_UL info	743
10.3.6.78b	TDD MBSFN Information.....	744
10.3.6.78c	LCR TDD MBSFN Information	744
10.3.6.78d	SYNC_UL info for E-RUCCH	744
10.3.6.79	TDD open loop power control	745
10.3.6.80	TFC Control duration.....	746
10.3.6.81	Void.....	746
10.3.6.82	TGPSI	746
10.3.6.83	Time info.....	746
10.3.6.83a	Time Slot LCR Extension	747

10.3.6.84	Timeslot number	747
10.3.6.85	TPC combination index.....	747
10.3.6.85a	TSTD indicator	747
10.3.6.86	TX Diversity Mode	747
10.3.6.86a	UL 16QAM configuration.....	748
10.3.6.86a	UL 16QAM settings	748
10.3.6.87	UL interference	749
10.3.6.87a	UL interference TDD	749
10.3.6.88	Uplink DPCH info	750
10.3.6.89	Uplink DPCH info Post.....	752
10.3.6.90	Uplink DPCH info Pre	753
10.3.6.91	Uplink DPCH power control info	753
10.3.6.92	Uplink DPCH power control info Post	755
10.3.6.93	Uplink DPCH power control info Pre	755
10.3.6.94	Uplink Timeslots and Codes	756
10.3.6.94a	Uplink Timeslots and Codes LCR	757
10.3.6.94b	Uplink Timeslots and Codes VHCR	759
10.3.6.95	Uplink Timing Advance.....	761
10.3.6.95a	Extended Uplink Timing Advance.....	761
10.3.6.96	Uplink Timing Advance Control.....	761
10.3.6.97	E-DCH Info	764
10.3.6.98	E-DPCCH Info	765
10.3.6.99	E-DPDCH Info	766
10.3.6.100	E-AGCH Info	767
10.3.6.101	E-HICH Info	769
10.3.6.102	E-RGCH Info (FDD only)	771
10.3.6.103	E-RUCCH Info (TDD only).....	772
10.3.6.104	E-PUCH Info (TDD only).....	775
10.3.6.105	E-TFCS info (TDD only)	778
10.3.6.106	E-TFC Boost Info.....	778
10.3.7	Measurement Information elements.....	778
10.3.7.1	Additional measurements list	778
10.3.7.2	Cell info	778
10.3.7.3	Cell measured results	780
10.3.7.4	Cell measurement event results.....	781
10.3.7.5	Cell reporting quantities	782
10.3.7.6	Cell synchronisation information	782
10.3.7.7	Event results	783
10.3.7.8	FACH measurement occasion info	784
10.3.7.9	Filter coefficient	784
10.3.7.10	HCS Cell re-selection information	785
10.3.7.11	HCS neighbouring cell information	785
10.3.7.12	HCS Serving cell information	785
10.3.7.13	Inter-frequency cell info list	786
10.3.7.14	Inter-frequency event identity	787
10.3.7.15	Inter-frequency measured results list	787
10.3.7.16	Inter-frequency measurement.....	787
10.3.7.17	Inter-frequency measurement event results.....	788
10.3.7.18	Inter-frequency measurement quantity.....	788
10.3.7.19	Inter-frequency measurement reporting criteria	789
10.3.7.20	Inter-frequency measurement system information	792
10.3.7.20a	Inter-frequency RACH reporting information	792
10.3.7.21	Inter-frequency reporting quantity	792
10.3.7.22	Inter-frequency SET UPDATE	793
10.3.7.23	Inter-RAT cell info list.....	793
10.3.7.24	Inter-RAT event identity	794
10.3.7.25	Inter-RAT info	794
10.3.7.26	Inter-RAT measured results list	795
10.3.7.27	Inter-RAT measurement.....	796
10.3.7.28	Inter-RAT measurement event results.....	796
10.3.7.29	Inter-RAT measurement quantity.....	797
10.3.7.30	Inter-RAT measurement reporting criteria.....	797

10.3.7.31	Inter-RAT measurement system information	798
10.3.7.32	Inter-RAT reporting quantity	798
10.3.7.33	Intra-frequency cell info list	798
10.3.7.34	Intra-frequency event identity	799
10.3.7.35	Intra-frequency measured results list	800
10.3.7.36	Intra-frequency measurement	800
10.3.7.37	Intra-frequency measurement event results	801
10.3.7.38	Intra-frequency measurement quantity	801
10.3.7.39	Intra-frequency measurement reporting criteria	801
10.3.7.40	Intra-frequency measurement system information	805
10.3.7.41	Intra-frequency reporting quantity	805
10.3.7.42	Intra-frequency reporting quantity for RACH reporting	806
10.3.7.43	Maximum number of reported cells on RACH	806
10.3.7.43a	MBMS preferred frequency information	807
10.3.7.43b	MBSFN inter frequency neighbour list	807
10.3.7.44	Measured results	807
10.3.7.45	Measured results on RACH	808
10.3.7.46	Measurement Command	810
10.3.7.47	Measurement control system information	811
10.3.7.47a	Measurement control system information extension	812
10.3.7.48	Measurement Identity	813
10.3.7.49	Measurement reporting mode	813
10.3.7.50	Measurement Type	813
10.3.7.51	Measurement validity	814
10.3.7.52	Void	814
10.3.7.53	Periodical reporting criteria	814
10.3.7.53aa	Periodical reporting info-1b	814
10.3.7.53a	PLMN identities of neighbour cells	814
10.3.7.54	Primary CCPCH RSCP info	815
10.3.7.54a	Qhcs	815
10.3.7.55	Quality measured results list	817
10.3.7.56	Quality measurement	818
10.3.7.57	Quality measurement event results	818
10.3.7.58	Quality measurement reporting criteria	818
10.3.7.59	Quality reporting quantity	819
10.3.7.60	Reference time difference to cell	819
10.3.7.61	Reporting Cell Status	819
10.3.7.62	Reporting information for state CELL_DCH	822
10.3.7.63	SFN-SFN observed time difference	822
10.3.7.64	Time to trigger	822
10.3.7.65	Timeslot ISCP info	822
10.3.7.66	Traffic volume event identity	823
10.3.7.67	Traffic volume measured results list	823
10.3.7.68	Traffic volume measurement	824
10.3.7.69	Traffic volume measurement event results	824
10.3.7.70	Traffic volume measurement object	825
10.3.7.71	Traffic volume measurement quantity	825
10.3.7.72	Traffic volume measurement reporting criteria	826
10.3.7.73	Traffic volume measurement system information	827
10.3.7.74	Traffic volume reporting quantity	827
10.3.7.75	UE internal event identity	828
10.3.7.76	UE internal measured results	828
10.3.7.77	UE internal measurement	829
10.3.7.78	UE internal measurement event results	829
10.3.7.79	UE internal measurement quantity	829
10.3.7.80	UE internal measurement reporting criteria	830
10.3.7.81	Void	831
10.3.7.82	UE Internal reporting quantity	831
10.3.7.83	UE Rx-Tx time difference type 1	831
10.3.7.84	UE Rx-Tx time difference type 2	832
10.3.7.85	UE Transmitted Power info	832
10.3.7.86	UE positioning Cipherring info	832

10.3.7.87	UE positioning Error	833
10.3.7.88	UE positioning GPS acquisition assistance	834
10.3.7.88a	UE positioning GPS Additional Assistance Data Request	835
10.3.7.88b	UE positioning GANSS reference measurement information	837
10.3.7.88c	UE positioning GANSS additional assistance data request	839
10.3.7.88d	DGANSS Signal Id	840
10.3.7.89	UE positioning GPS almanac	841
10.3.7.89a	UE positioning GANSS almanac	842
10.3.7.90	UE positioning GPS assistance data	842
10.3.7.90a	Void	843
10.3.7.90b	UE positioning GANSS assistance data	843
10.3.7.91	UE positioning GPS DGPS corrections	845
10.3.7.91a	UE positioning GPS Ephemeris and Clock Correction parameters	846
10.3.7.91b	UE positioning DGANSS corrections	847
10.3.7.91c	UE positioning GANSS orbit model	848
10.3.7.91d	UE positioning GANSS clock model	850
10.3.7.92	UE positioning GPS ionospheric model	850
10.3.7.92a	UE positioning GANSS ionospheric model	851
10.3.7.93	UE positioning GPS measured results	851
10.3.7.93a	UE positioning GANSS measured results	853
10.3.7.94	UE positioning GPS navigation model	856
10.3.7.94a	UE positioning GANSS navigation model	856
10.3.7.95	UE positioning GPS real-time integrity	857
10.3.7.95a	Void	857
10.3.7.95b	UE positioning GANSS real-time integrity	857
10.3.7.96	UE positioning GPS reference time	858
10.3.7.96a	UE positioning GANSS reference time	859
10.3.7.96b	UE positioning GPS reference time uncertainty	860
10.3.7.97	UE positioning GPS UTC model	860
10.3.7.97a	UE positioning GANSS time model	860
10.3.7.97b	UE positioning GANSS data bit assistance	861
10.3.7.97c	UE positioning GANSS UTC model	861
10.3.7.98	UE positioning IPDL parameters	862
10.3.7.99	UE positioning measured results	863
10.3.7.100	UE positioning measurement	863
10.3.7.101	UE positioning measurement event results	864
10.3.7.102	Void	864
10.3.7.103	UE positioning OTDOA assistance data for UE-assisted	865
10.3.7.103a	UE positioning OTDOA assistance data for UE-based	865
10.3.7.104	Void	865
10.3.7.105	UE positioning OTDOA measured results	865
10.3.7.106	UE positioning OTDOA neighbour cell info	866
10.3.7.106a	UE positioning OTDOA neighbour cell info for UE-based	868
10.3.7.107	UE positioning OTDOA quality	868
10.3.7.108	UE positioning OTDOA reference cell info	870
10.3.7.108a	UE positioning OTDOA reference cell info for UE-based	871
10.3.7.109	UE positioning position estimate info	871
10.3.7.109a	UE positioning Relative Time Difference quality	874
10.3.7.110	UE positioning reporting criteria	874
10.3.7.111	UE positioning reporting quantity	875
10.3.7.112	TADV info	877
10.3.8	Other Information elements	878
10.3.8.1	BCCH modification info	878
10.3.8.2	BSIC	878
10.3.8.3	CBS DRX Level 1 information	878
10.3.8.4	Cell Value tag	878
10.3.8.4a	Ellipsoid point	879
10.3.8.4b	Ellipsoid point with Altitude	879
10.3.8.4c	Ellipsoid point with Altitude and uncertainty ellipsoid	879
10.3.8.4d	Ellipsoid point with uncertainty Circle	880
10.3.8.4e	Ellipsoid point with uncertainty Ellipse	881

10.3.8.4f	GERAN system information	881
10.3.8.4g	GSM Target Cell Info	881
10.3.8.4h	Horizontal Velocity	882
10.3.8.4i	Horizontal with Vertical Velocity	882
10.3.8.4j	Horizontal Velocity with Uncertainty	883
10.3.8.4k	Horizontal with Vertical Velocity and Uncertainty	883
10.3.8.5	Inter-RAT change failure	884
10.3.8.6	Inter-RAT handover failure	884
10.3.8.7	Inter-RAT UE radio access capability	885
10.3.8.8	Void	886
10.3.8.8a	Inter-RAT UE security capability	886
10.3.8.9	MIB Value tag	886
10.3.8.10	PLMN Value tag	886
10.3.8.10a	PNBSCCH allocation	886
10.3.8.11	Predefined configuration identity and value tag	887
10.3.8.12	Protocol error information	887
10.3.8.13	References to other system information blocks	887
10.3.8.14	References to other system information blocks and scheduling blocks	888
10.3.8.15	Rplmn information	888
10.3.8.16	Scheduling information	889
10.3.8.17	SEG COUNT	890
10.3.8.18	Segment index	890
10.3.8.18a	SIB and SB type	890
10.3.8.18b	SIB type extension	891
10.3.8.19	SIB data fixed	891
10.3.8.20	SIB data variable	892
10.3.8.20a	SIB occurrence identity	892
10.3.8.20b	SIB occurrence identity and value tag	892
10.3.8.20c	SIB occurrence value tag	892
10.3.8.21	SIB type	892
10.3.8.22	SIB type SIBs only	893
10.3.9	ANSI-41 Information elements	894
10.3.9.1	ANSI-41 Core Network Information	894
10.3.9.2	ANSI-41 Global Service Redirection information	894
10.3.9.3	ANSI-41 NAS parameter	894
10.3.9.4	ANSI-41 NAS system information	895
10.3.9.5	ANSI-41 Private Neighbour List information	895
10.3.9.6	ANSI-41 RAND information	895
10.3.9.7	ANSI-41 User Zone Identification information	895
10.3.9.8	MIN_P_REV	895
10.3.9.9	NID	896
10.3.9.10	P_REV	896
10.3.9.11	SID	896
10.3.9a	MBMS Information elements	896
10.3.9a.1	MBMS Common CCTrCH identity	896
10.3.9a.2	MBMS Common PhyCh identity	897
10.3.9a.3	MBMS Common RB identity	897
10.3.9a.4	MBMS Common TrCh identity	897
10.3.9a.5	MBMS Current cell S-CCPCH identity	897
10.3.9a.6	Void	897
10.3.9a.7	MBMS L1 combining schedule	898
10.3.9a.7o	MBMS p-t-m activation time	898
10.3.9a.7a	MBMS p-t-m RB information	899
10.3.9a.7b	MBMS Selected Service Info	899
10.3.9a.7c	MBMS Selected Services Full	900
10.3.9a.7d	MBMS Selected Services Short	900
10.3.9a.8	MBMS Service identity	900
10.3.9a.8a	MBMS Service ID	901
10.3.9a.9	MBMS Session identity	901
10.3.9a.10	MBMS Short transmission identity	901
10.3.9a.10a	MBMS Soft Combining Timing Offset	901
10.3.9a.11	MBMS specific timers and counters	902

10.3.9a.12	MBMS Transmission identity	902
10.3.9a.12a	MBSFN frequency list	902
10.3.9a.12b	MBSFN TDM Information List	903
10.3.9a.13	MCCH configuration information	903
10.3.9a.14	MICH configuration information	904
10.3.9a.15	MICH Power offset	905
10.3.9a.16	MSCH configuration information	906
10.3.10	Multiplicity values and type constraint values	906
11	Message and Information element abstract syntax (with ASN.1)	910
11.0	General	910
11.1	General message structure	911
11.2	PDU definitions	915
11.3	Information element definitions	1010
11.4	Constant definitions	1216
11.5	RRC information between network nodes	1218
12	Message transfer syntax	1237
12.1	Structure of encoded RRC messages	1237
12.1.1	Basic production	1237
12.1.2	Extension	1237
12.1.3	Padding	1237
12.2	ECN link module for RRC	1240
12.3	ECN modules for RRC	1240
12.4	RRC messages encoded otherwise	1241
12.4.1	Messages using tabular encoding specification	1241
12.4.1.1	TRANSPORT FORMAT COMBINATION CONTROL using transparent DCCH	1241
12.4.1.1.1	TRANSPORT FORMAT COMBINATION CONTROL, 3 bit format	1241
12.4.1.1.2	Void	1242
12.4.1.1.3	Void	1242
13	Protocol timers, counters, other parameters and default configurations	1243
13.1	Timers for UE	1243
13.2	Counters for UE	1244
13.3	UE constants and parameters	1245
13.4	UE variables	1245
13.4.ob	AM_RLC_ERROR_PENDING_RB234	1245
13.4.oc	AM_RLC_ERROR_PENDING_RB5_AND_UP	1245
13.4.0	CELL_INFO_LIST	1245
13.4.00	Void	1246
13.4.0a	CELL_UPDATE_STARTED	1246
13.4.1	CIPHERING_STATUS	1247
13.4.2	Void	1247
13.4.2a	CONFIGURATION_INCOMPLETE	1247
13.4.3	C_RNTI	1247
13.4.3a	DEFERRED_MEASUREMENT_STATUS	1248
13.4.3b	DTX_DRX_PARAMS	1248
13.4.3c	DTX_DRX_STATUS	1248
13.4.3d	DSAC_PARAM	1248
13.4.3e	DSCH_RNTI	1249
13.4.4	Void	1249
13.4.4o	E_DCH_TRANSMISSION	1249
13.4.4a	E_RNTI	1250
13.4.5	ESTABLISHED_RABS	1250
13.4.5a	ESTABLISHED_SIGNALLING_CONNECTIONS	1250
13.4.6	ESTABLISHMENT_CAUSE	1251
13.4.7	FAILURE_CAUSE	1251
13.4.8	FAILURE_INDICATOR	1251
13.4.8o	H_RNTI	1251
13.4.8oo	HS_DSCH_RECEPTION	1252
13.4.8oa	HS_DSCH_RECEPTION_CELL_FACH_STATE	1252
13.4.8ob	HS_DSCH_RECEPTION_OF_CCCH_ENABLED	1253
13.4.8oc	HS_DSCH_RECEPTION_GENERAL	1253

13.4.8000	HS_SCCH_LESS_PARAMS	1253
13.4.80000	HS_SCCH_LESS_STATUS	1254
13.4.8a	INCOMPATIBLE_SECURITY_RECONFIGURATION.....	1254
13.4.8b	Void.....	1254
13.4.8c	Void.....	1254
13.4.9	INITIAL_UE_IDENTITY.....	1254
13.4.9a	INTEGRITY_PROTECTION_ACTIVATION_INFO.....	1255
13.4.10	INTEGRITY_PROTECTION_INFO	1255
13.4.10a	INTER_RAT_HANDOVER_INFO_TRANSFERRED.....	1255
13.4.11	INVALID_CONFIGURATION	1257
13.4.11a	LATEST_CONFIGURED_CN_DOMAIN.....	1257
13.4.11b	LATEST_CONFIGURED_SRB_DELAY_AND_PC_PREAMBLE	1257
13.4.11c	MBMS_ACTIVATED_SERVICES.....	1257
13.4.11d	MBMS_PREV_FREQUENCY_INFO	1258
13.4.11e	MBMS_PL_SERVICE_RESTRICTION_INFO_DEDICATED	1258
13.4.12	MEASUREMENT_IDENTITY	1259
13.4.13	Void.....	1259
13.4.13a	MIMO_PARAMS.....	1259
13.4.13b	MIMO_STATUS.....	1259
13.4.14	ORDERED_RECONFIGURATION.....	1260
13.4.14a	PDCP_ROHC_TARGET_MODE.....	1260
13.4.15	PDCP_SN_INFO.....	1260
13.4.15a	PHYSICAL_SHARED_CHANNEL_CONFIGURATION	1260
13.4.16	PROTOCOL_ERROR_INDICATOR	1261
13.4.17	PROTOCOL_ERROR_INFORMATION	1261
13.4.18	PROTOCOL_ERROR_REJECT	1261
13.4.19	RB_TIMER_INDICATOR.....	1262
13.4.20	RB_UPLINK_CIPHERING_ACTIVATION_TIME_INFO.....	1262
13.4.20o	RNC_CAPABILITY_CHANGE_SUPPORT	1262
13.4.20a	SECURITY_MODIFICATION.....	1262
13.4.21	Void.....	1263
13.4.22	START_THRESHOLD	1263
13.4.23	START_VALUE_TO_TRANSMIT.....	1263
13.4.24	TFC_SUBSET	1263
13.4.25	TGPS_IDENTITY	1265
13.4.26	TGSN_REPORTED	1265
13.4.26a	TIMERS_AND_CONSTANTS.....	1265
13.4.27	TRANSACTIONS.....	1266
13.4.27o	TRIGGERED_MEASUREMENT_REPORT	1266
13.4.27a	TRIGGERED_1A_EVENT.....	1267
13.4.27b	TRIGGERED_1B_EVENT	1267
13.4.27c	TRIGGERED_1C_EVENT	1268
13.4.27d	BEST_CELL_1D_EVENT.....	1268
13.4.27e	TRIGGERED_1E_EVENT	1268
13.4.27f	TRIGGERED_1F_EVENT	1269
13.4.27f1	TRIGGERED_1G_EVENT.....	1269
13.4.27f2	TRIGGERED_1H_EVENT.....	1269
13.4.27f3	TRIGGERED_1I_EVENT	1269
13.4.27f4	BEST_FREQUENCY_2A_EVENT.....	1270
13.4.27f5	TRIGGERED_2B_EVENT	1270
13.4.27f6	TRIGGERED_2C_EVENT	1270
13.4.27f7	TRIGGERED_2D_EVENT.....	1270
13.4.27f8	TRIGGERED_2E_EVENT	1271
13.4.27f9	TRIGGERED_2F_EVENT	1271
13.4.27f10	TRIGGERED_3A_EVENT.....	1271
13.4.27f11	TRIGGERED_3B_EVENT	1272
13.4.27f12	TRIGGERED_3C_EVENT	1272
13.4.27f13	BEST_CELL_3D_EVENT.....	1272
13.4.27f14	TRIGGERED_6A_EVENT.....	1273
13.4.27f15	TRIGGERED_6B_EVENT	1273
13.4.27f16	TRIGGERED_6C_EVENT	1273
13.4.27f17	TRIGGERED_6D_EVENT.....	1273

13.4.27f18	TRIGGERED_6E_EVENT	1273
13.4.27f19	TRIGGERED_6F_EVENT	1273
13.4.27f20	TRIGGERED_6G_EVENT	1274
13.4.27f21	TRIGGERED_1J_EVENT	1274
13.4.27g	UE_CAPABILITY_REQUESTED	1274
13.4.28	UE_CAPABILITY_TRANSFERRED	1275
13.4.28a	UE_POSITIONING_GPS_DATA	1276
13.4.28b	UE_POSITIONING_OTDOA_DATA_UE_ASSISTED	1277
13.4.28c	UE_POSITIONING_OTDOA_DATA_UE_BASED	1278
13.4.29	UNSUPPORTED_CONFIGURATION	1279
13.4.30	URA_IDENTITY	1280
13.4.31	U_RNTI	1280
13.4.32	VALUE_TAG	1280
13.5	UE RRC Procedure Performance	1284
13.5.1	Definitions	1284
13.5.2	RRC procedure performance values	1284
13.6	RB information parameters for signalling radio bearer RB 0	1290
13.6a	RB information parameters for SHCCH	1290
13.6b	RB information parameters for BCCH mapped to FACH	1290
13.6c	RB information parameters for PCCH mapped to PCH	1291
13.6d	Parameters for BCCH mapped to BCH	1291
13.6e	RB information parameters for signalling radio bearer RB 0 mapped on HS-DSCH and RACH	1291
13.6f	RB information parameters for BCCH mapped to HS-DSCH	1291
13.6g	RB information parameters for PCCH mapped to HS-DSCH	1292
13.7	Parameter values for default radio configurations	1292
14	Specific functions	1360
14.1	Intra-frequency measurements	1360
14.1.1	Intra-frequency measurement quantities	1360
14.1.2	Intra-frequency reporting events for FDD	1360
14.1.2.1	Reporting event 1A: A Primary CPICH enters the reporting range	1360
14.1.2.2	Reporting event 1B: A primary CPICH leaves the reporting range	1363
14.1.2.3	Reporting event 1C: A non-active primary CPICH becomes better than an active primary CPICH	1365
14.1.2.4	Reporting event 1D: Change of best cell	1368
14.1.2.5	Reporting event 1E: A Primary CPICH becomes better than an absolute threshold	1370
14.1.2.6	Reporting event 1F: A Primary CPICH becomes worse than an absolute threshold	1371
14.1.2.7	Reporting event 1J: A non-active E-DCH but active DCH primary CPICH becomes better than an active E-DCH primary CPICH	1373
14.1.3	Intra-frequency reporting events for TDD	1376
14.1.3.1	Reporting event 1G: Change of best cell (TDD)	1376
14.1.3.2	Reporting event 1H: Timeslot ISCP below a certain threshold (TDD)	1377
14.1.3.3	Reporting event 1I: Timeslot ISCP above a certain threshold (TDD)	1378
14.1.4	Event-triggered periodic intra-frequency measurement reports (informative)	1380
14.1.4.1	Cell addition failure (FDD only)	1380
14.1.4.1a	Cell removal failure (FDD only)	1381
14.1.4.2	Cell replacement failure (FDD only)	1382
14.1.5	Mechanisms available for modifying intra-frequency measurement reporting behaviour (informative)	1382
14.1.5.1	Hysteresis	1382
14.1.5.2	Time-to-trigger	1383
14.1.5.3	Cell individual offsets	1384
14.1.5.4	Forbid a Primary CPICH to affect the reporting range (FDD only)	1385
14.1.6	Report quantities in intra-frequency measurements	1386
14.2	Inter-frequency measurements	1387
14.2.0a	Inter-frequency measurement quantities	1387
14.2.0b	Frequency quality estimate	1387
14.2.0b.1	FDD cells	1387
14.2.0b.2	TDD cells	1388
14.2.0c	Inter-frequency reporting quantities	1388
14.2.1	Inter-frequency reporting events	1389
14.2.1.1	Event 2a: Change of best frequency	1389

14.2.1.2	Event 2b: The estimated quality of the currently used frequency is below a certain threshold and the estimated quality of a non-used frequency is above a certain threshold.....	1390
14.2.1.3	Event 2c: The estimated quality of a non-used frequency is above a certain threshold	1391
14.2.1.4	Event 2d: The estimated quality of the currently used frequency is below a certain threshold.....	1392
14.2.1.5	Event 2e: The estimated quality of a non-used frequency is below a certain threshold.....	1393
14.2.1.6	Event 2 f: The estimated quality of the currently used frequency is above a certain threshold	1394
14.3	Inter-RAT measurements	1395
14.3.0a	Inter-RAT measurement quantities.....	1395
14.3.0b	Frequency quality estimate of the UTRAN frequency	1396
14.3.0c	Inter-RAT reporting quantities	1396
14.3.1	Inter-RAT reporting events.....	1396
14.3.1.1	Event 3a: The estimated quality of the currently used UTRAN frequency is below a certain threshold and the estimated quality of the other system is above a certain threshold.....	1397
14.3.1.2	Event 3b: The estimated quality of other system is below a certain threshold.....	1398
14.3.1.3	Event 3c: The estimated quality of other system is above a certain threshold	1400
14.3.1.4	Event 3d: Change of best cell in other system	1401
14.3.2	GSM measurements in compressed mode	1403
14.3.2.1	GSM RSSI measurements	1403
14.3.2.2	Initial BSIC identification	1403
14.3.2.3	BSIC re-confirmation.....	1403
14.4	Traffic Volume Measurements.....	1403
14.4.1	Traffic Volume Measurement Quantity	1403
14.4.2	Traffic Volume reporting triggers.....	1403
14.4.2.1	Reporting event 4 A: Transport Channel Traffic Volume becomes larger than an absolute threshold.....	1408
14.4.2.2	Reporting event 4 B: Transport Channel Traffic Volume becomes smaller than an absolute threshold.....	1408
14.4.3	Traffic volume reporting mechanisms	1409
14.4.3.1	Pending time after trigger.....	1409
14.4.3.2	Time-to-trigger	1409
14.4.4	Interruption of user data transmission.....	1410
14.5	Quality Measurements.....	1410
14.5.1	Quality reporting measurement quantities	1410
14.5.2	Quality reporting events.....	1410
14.5.2.1	Reporting event 5A: A predefined number of bad CRCs is exceeded	1410
14.6	UE internal measurements.....	1411
14.6.1	UE internal measurement quantities	1411
14.6.2	UE internal measurement reporting events.....	1411
14.6.2.1	Reporting event 6A: The UE Tx power becomes larger than an absolute threshold.....	1411
14.6.2.2	Reporting event 6B: The UE Tx power becomes less than an absolute threshold	1412
14.6.2.3	Reporting event 6C: The UE Tx power reaches its minimum value	1413
14.6.2.4	Reporting event 6D: The UE Tx power reaches its maximum value	1414
14.6.2.5	Reporting event 6E: The UE RSSI reaches the UE's dynamic receiver range	1415
14.6.2.6	Reporting event 6F (FDD): The UE Rx-Tx time difference for a RL included in the active set becomes larger than an absolute threshold.....	1415
14.6.2.6a	Reporting event 6F (1.28 Mcps TDD): The time difference indicated by T _{ADV} becomes larger than an absolute threshold	1416
14.6.2.7	Reporting event 6G: The UE Rx-Tx time difference for a RL included in the active set becomes less than an absolute threshold	1416
14.7	UE positioning measurements.....	1417
14.7.1	UE positioning measurement quantities	1417
14.7.2	Void	1417
14.7.3	UE positioning reporting events	1417
14.7.3.1	Reporting Event 7a: The UE position changes more than an absolute threshold.....	1417
14.7.3.2	Reporting Event 7b: SFN-SFN measurement changes more than an absolute threshold.....	1418
14.7.3.3	Reporting Event 7c: GPS time and SFN time have drifted apart more than an absolute threshold ..	1418
14.7.3.4	Reporting Event 7d: GANSS time and SFN time have drifted apart more than an absolute threshold.....	1419
14.8	Void.....	1419
14.9	Downlink power control.....	1419
14.9.1	Generalities	1419
14.9.2	Downlink power control in compressed mode	1419

14.10	Calculated Transport Format Combination	1420
14.10.1	Default TFCS for MBMS	1421
14.10.1.1	S-CCPCH configuration including a FACH carrying MSCH.....	1421
14.10.1.2	S-CCPCH configuration not including a FACH carrying MSCH.....	1421
14.11	UE autonomous update of virtual active set on non-used frequency (FDD only).....	1421
14.11.1	Initial virtual active set	1422
14.11.2	Virtual active set update during an inter-frequency measurement.....	1423
14.12	Provision and reception of RRC information between network nodes.....	1424
14.12.0	General.....	1424
14.12.0a	General error handling for RRC messages exchanged between network nodes	1425
14.12.1	RRC Information to target RNC	1425
14.12.2	RRC information, target RNC to source RNC.....	1426
14.12.3	Void	1427
14.12.4	RRC messages exchanged between network nodes.....	1427
14.12.4.0	HANDOVER TO UTRAN COMMAND	1427
14.12.4.0a	INTER RAT HANDOVER INFO	1427
14.12.4.1	INTER RAT HANDOVER INFO WITH INTER RAT CAPABILITIES.....	1427
14.12.4.2	SRNS RELOCATION INFO	1429
14.12.4.3	Void.....	1441
14.12.4.4	RFC 3095 CONTEXT INFO	1441
14.13	Void.....	1444
14.14	Void.....	1444
Annex A (informative): USIM parameters		1445
A.1	Introduction	1445
A.2	Cipherring information	1445
A.3	Frequency information	1445
A.4	Multiplicity values and type constraint values	1446
Annex B (informative): Description of RRC state transitions.....		1447
B.1	RRC states and state transitions including GSM.....	1447
B.2	Transition from Idle Mode to UTRA RRC Connected Mode	1447
B.2.1	Transitions for Emergency Calls	1447
B.3	UTRA RRC Connected Mode States and Transitions.....	1447
B.3.1	CELL_DCH state.....	1447
B.3.1.1	Transition from CELL_DCH to Idle Mode.....	1448
B.3.1.2	Transition from CELL_DCH to CELL_FACH state	1448
B.3.1.3	Transition from CELL_DCH to CELL_PCH state	1448
B.3.1.4	Transition from CELL_DCH to URA_PCH state.....	1448
B.3.1.5	Radio Resource Allocation tasks (CELL_DCH).....	1448
B.3.1.6	RRC Connection mobility tasks (CELL_DCH).....	1449
B.3.1.7	UE Measurements (CELL_DCH)	1449
B.3.1.8	Acquisition of system information (CELL_DCH)	1449
B.3.2	CELL_FACH state	1449
B.3.2.1	Transition from CELL_FACH to CELL_DCH state	1450
B.3.2.2	Transition from CELL_FACH to CELL_PCH state	1450
B.3.2.3	Transition from CELL_FACH to Idle Mode	1450
B.3.2.4	Transition from CELL_FACH to URA_PCH State.....	1450
B.3.2.5	Radio Resource Allocation Tasks (CELL_FACH)	1450
B.3.2.6	RRC Connection mobility tasks (CELL_FACH).....	1450
B.3.2.7	UE Measurements (CELL_FACH).....	1451
B.3.2.8	Transfer and update of system information (CELL_FACH).....	1451
B.3.3	CELL_PCH state	1451
B.3.3.1	Transition from CELL_PCH to CELL_FACH state	1451
B.3.3.2	Radio Resource Allocation Tasks (CELL_PCH).....	1452
B.3.3.3	RRC Connection mobility tasks (CELL_PCH).....	1452
B.3.3.4	UE Measurements (CELL_PCH).....	1452
B.3.3.5	Transfer and update of system information (CELL_PCH)	1452
B.3.4	URA_PCH State	1452
B.3.4.1	Transition from URA_PCH State to CELL_FACH State (URA_PCH)	1453
B.3.4.2	Radio Resource Allocation Tasks (URA_PCH).....	1453
B.3.4.3	RRC Connection mobility tasks (URA_PCH)	1453

B.3.4.4	UE Measurements (URA_PCH)	1453
B.3.4.5	Transfer and update of system information (URA_PCH)	1453
B.3.5	States and Transitions for Cell Reselection in URA_PCH, CELL_PCH, and CELL_FACH	1454
B.4	Inter-RAT handover with CS domain services.....	1454
B.5	Inter-RAT handover with PS domain services	1455
B.6	Inter-RAT handover with simultaneous PS and CS domain services.....	1455
B.6.1	Inter-RAT handover UTRAN to GSM / BSS	1455
B.6.2	Inter-RAT handover GSM / BSS to UTRAN	1455
Annex C (informative):	Description for the Compressed Coding of Pre-defined configurations included in the INTER RAT HANDOVER INFO message	1456
C.1	Definitions	1456
C.2	Examples of the methodology	1456
Annex D (Normative):	Implementation of Domain Specific Access Control (DSAC) in UEs of 3GPP Release 5.....	1459
Annex E (informative):	Change history	1460
History		1497

Foreword

This Technical Specification has been produced by the 3rd Generation Partnership Project (3GPP).

The contents of the present document are subject to continuing work within the TSG and may change following formal TSG approval. Should the TSG modify the contents of the present document, it will be re-released by the TSG with an identifying change of release date and an increase in version number as follows:

Version x.y.z

where:

- x the first digit:
 - 1 presented to TSG for information;
 - 2 presented to TSG for approval;
 - 3 or greater indicates TSG approved document under change control.
- y the second digit is incremented for all changes of substance, i.e. technical enhancements, corrections, updates, etc.
- z the third digit is incremented when editorial only changes have been incorporated in the document.

1 Scope

The present document specifies the Radio Resource Control protocol for the UE-UTRAN radio interface.

The scope of the present document also includes:

- the information to be transported in a transparent container between source RNC and target RNC in connection with SRNC relocation;
- the information to be transported in a transparent container between a target RNC and another system.

2 References

The following documents contain provisions which, through reference in this text, constitute provisions of the present document.

- References are either specific (identified by date of publication, edition number, version number, etc.) or non-specific.
- For a specific reference, subsequent revisions do not apply.
- For a non-specific reference, the latest version applies. In the case of a reference to a 3GPP document (including a GSM document), a non-specific reference implicitly refers to the latest version of that document *in the same Release as the present document*.

- [1] 3GPP TR 21.905: "Vocabulary for 3GPP Specifications".
- [2] 3GPP TS 25.301: "Radio Interface Protocol Architecture".
- [3] 3GPP TS 25.303: "Interlayer Procedures in Connected Mode".
- [4] 3GPP TS 25.304: "UE Procedures in Idle Mode and Procedures for Cell Reselection in Connected Mode".
- [5] 3GPP TS 24.008: "Mobile radio interface layer 3 specification; Core Network Protocols; Stage 3".
- [6] 3GPP TS 25.103: "RF parameters in support of RRM".
- [7] 3GPP TS 25.215: "Physical layer – Measurements (FDD)".
- [8] 3GPP TS 25.225: "Physical layer – Measurements (TDD)".
- [9] 3GPP TS 25.401: "UTRAN overall description".
- [10] 3GPP TS 25.402: "Synchronization in UTRAN; Stage 2".
- [11] 3GPP TS 23.003: "Numbering, addressing and identification".
- [12] ICD-GPS-200: "Navstar GPS Space Segment/Navigation User Interface".
- [13] RTCM-SC104: "RTCM Recommended Standards for Differential GNSS Service (v.2.2)".
- [14] 3GPP TR 25.921: "Guidelines and principles for protocol description and error handling".
- [15] 3GPP TS 25.321: "Medium Access Control (MAC) protocol specification".
- [16] 3GPP TS 25.322: "Radio Link Control (RLC) protocol specification".
- [17] 3GPP TS 24.007: "Mobile radio interface signalling layer 3; General aspects".
- [18] 3GPP TS 25.305: "Stage 2 Functional Specification of UE Positioning in UTRAN".
- [19] 3GPP TS 25.133: "Requirements for Support of Radio Resource Management (FDD)".

- [20] 3GPP TS 25.123: "Requirements for Support of Radio Resource Management (TDD)".
- [21] 3GPP TS 25.101: "UE Radio Transmission and Reception (FDD)".
- [22] 3GPP TS 25.102: "UE Radio Transmission and Reception (TDD)".
- [23] 3GPP TS 23.060: "General Packet Radio Service (GPRS); Service description; Stage 2".
- [24] 3GPP TS 23.032: "Universal Geographical Area Description (GAD)".
- [25] 3GPP TS 23.122: "Non-Access-Stratum functions related to Mobile Station (MS) in idle mode".
- [26] 3GPP TS 25.211: "Physical channels and mapping of transport channels onto physical channels (FDD)".
- [27] 3GPP TS 25.212: "Multiplexing and channel coding (FDD)".
- [28] 3GPP TS 25.213: "Spreading and modulation (FDD)".
- [29] 3GPP TS 25.214: "Physical layer procedures (FDD)".
- [30] 3GPP TS 25.221: "Physical channels and mapping of transport channels onto physical channels (TDD)".
- [31] 3GPP TS 25.222: "Multiplexing and channel coding (TDD)".
- [32] 3GPP TS 25.223: "Spreading and modulation (TDD)".
- [33] 3GPP TS 25.224: "Physical Layer Procedures (TDD)".
- [34] 3GPP TS 25.302: "Services provided by the physical layer".
- [35] 3GPP TS 25.306 "UE Radio Access Capabilities".
- [36] 3GPP TS 25.323: "Packet Data Convergence Protocol (PDCP) Specification".
- [37] 3GPP TS 25.324: "Broadcast/Multicast Control BMC".
- [38] 3GPP TR 25.922: "Radio resource management strategies".
- [39] 3GPP TR 25.925: "Radio interface for broadcast/multicast services".
- [40] 3GPP TS 33.102: "3G Security; Security Architecture".
- [41] 3GPP TS 34.108: "Common Test Environments for User Equipment (UE) Conformance Testing".
- [42] 3GPP TS 34.123-2: "User Equipment (UE) conformance specification; Part 2: Implementation Conformance Statement (ICS) proforma specification".
- [43] 3GPP TS 44.018: "Mobile radio interface layer 3 specification; Radio Resource Control Protocol".
- [44] 3GPP TS 44.060: "General Packet Radio Service (GPRS); Mobile Station (MS) - Base Station System (BSS) interface; Radio Link Control/Medium Access Control (RLC/MAC) protocol".
- [45] 3GPP TS 45.005: "Radio transmission and reception".
- [46] 3GPP TS 45.008: "Radio subsystem link control".
- [47] ITU-T Recommendation X.680 (07/2002) "Information Technology - Abstract Syntax Notation One (ASN.1): Specification of basic notation".
- [48] ITU-T Recommendation X.681 (07/2002) "Information Technology - Abstract Syntax Notation One (ASN.1): Information object specification".
- [49] ITU-T Recommendation X.691 (07/2002) "Information technology - ASN.1 encoding rules: Specification of Packed Encoding Rules (PER)".
- [50] 3GPP TS 31.102: "Characteristics of the USIM Application".

- [51] 3GPP TS 25.308: "High Speed Downlink Packet Access (HSDPA): Overall Description; Stage 2".
- [52] IANA ROHC profile identifier definition (<http://www.iana.org/assignments/rohc-pro-ids>).
- [53] 3GPP TS 44.118: "Mobile radio interface layer 3 specification; Radio Resource Control Protocol, Iu Mode".
- [54] 3GPP TS 23.246: "Multimedia Broadcast Multicast Service; Architecture and Functional Description".
- [55] 3GPP TS 25.346: " Introduction of the Multimedia Broadcast Multicast Service (MBMS) in the Radio Access Network (Stage-2)".
- [56] 3GPP TR 25.992: "Multimedia Broadcast Multicast Service (MBMS); UTRAN/GERAN Requirements".
- [57] 3GPP TS 25.413: "UTRAN Iu Interface RANAP Signalling".
- [58] 3GPP TS 25.309: "FDD Enhanced Uplink; Overall Description; Stage 2".
- [59] 3GPP TS 25.319: "Enhanced Uplink; Overall Description; Stage 2".
- [60] 3GPP TR 25.827: "1.28Mcps TDD Enhanced Uplink; Physical Layer Aspects".
- [61] Galileo OS Signal in Space ICD (OS SIS ICD), Draft 0, Galileo Joint Undertaking, May 23rd, 2006.

3 Definitions and abbreviations

3.1 Definitions

For the purposes of the present document, the terms and definitions given in [1] apply, together as:

Data Description Indicator (DDI): MAC-e header field used to identify the logical channel, MAC-d flow and the size of the MAC-d PDUs concatenated into a MAC-es PDU.

E-DCH active set (FDD only): The set of cells which carry the E-DCH for one UE. Only radio links for which an E-HICH configuration is stored are considered part of the E-DCH active set.

HARQ profile: One HARQ profile consists of a power offset attribute and maximum number of transmissions.

MBMS activated services: the MBMS multicast services the UE has joined as well as the broadcast services the UE is interested in.

MCCH acquisition: the procedure for acquiring all MCCH information relevant for the UE ie. includes reception of the RB information for the UE's MBMS activated services.

MBMS controlling cell: the cell from which the UE receives MCCH.

MBMS notification: a notification provided by UTRAN indicating a change in the provision of one or more MBMS services.

MBMS Selected Services: a subset of the MBMS activated services of the Broadcast type for which the UE applies RRC procedures to inform UTRAN that the service has been selected (by upper layers).

MBMS transmission: a possibly repeated session of an MBMS service. An MBMS transmission is uniquely identified by the combination of the MBMS service identity and the MBMS session identity.

MBSFN cluster: Set of cells operating in MBSFN mode providing only MBMS service in PtM mode and seen as one cell by a UE.

MBSFN mode: Transmission mode where a set of synchronized cells transmit exactly the same data for provision of MBMS service.

Primary Absolute Grant (FDD only): Absolute Grant received with the primary E-RNTI.

Secondary Absolute Grant (FDD only): Absolute Grant received with the secondary E-RNTI.

Serving E-DCH cell: Cell from which the UE receives Absolute Grants from the Node-B scheduler. A UE has one Serving E-DCH cell.

Serving E-DCH RLS or Serving RLS (FDD only): Set of cells which contains at least the Serving E-DCH cell and from which the UE can receive and combine one Relative Grant. The UE has only one Serving E-DCH RLS.

Non-serving E-DCH RL or Non-serving RL (FDD only): Cell which belongs to the E-DCH active set but does not belong to the Serving E-DCH RLS and from which the UE can receive one Relative Grant. The UE can have zero, one or several Non-serving E-DCH RL(s).

3.2 Abbreviations

For the purposes of the present document, the following abbreviations apply:

ACK	Acknowledgement
AG	Absolute Grant
AICH	Acquisition Indicator CHannel
AM	Acknowledged Mode
AS	Access Stratum
ASC	Access Service Class
ASN.1	Abstract Syntax Notation.1
BCCH	Broadcast Control Channel
BCFE	Broadcast Control Functional Entity
BER	Bit Error Rate
BLER	BLOCK Error Rate
BSS	Base Station Sub-system
CCCH	Common Control Channel
CCPCH	Common Control Physical CHannel
CH	Conditional on history
CM	Connection Management
CN	Core Network
C-RNTI	Cell RNTI
CTCH	Common Traffic CHannel
CTFC	Calculated Transport Format Combination
CV	Conditional on value
DCA	Dynamic Channel Allocation
DCCH	Dedicated Control Channel
DCFE	Dedicated Control Functional Entity
DCH	Dedicated Channel
DC-SAP	Dedicated Control SAP
DDI	Data Description Indicator
DGPS	Differential Global Positioning System
DL	Downlink
DSCH	Downlink Shared Channel
DTCH	Dedicated Traffic Channel
DTM	Dual Transfer Mode
E-AGCH	E-DCH Absolute Grant Channel
E-DCH	Enhanced uplink DCH
E-DPCCH	E-DCH Dedicated Physical Control Channel (FDD Only)
E-DPDCH	E-DCH Dedicated Physical Data Channel (FDD Only)
E-HICH	E-DCH HARQ Acknowledgement Indicator Channel
E-PUCH	Enhanced Uplink Physical Channel (TDD only)
E-RGCH	E-DCH Relative Grant Channel (FDD only)
E-RNTI	E-DCH RNTI
E-RUCCH	E-DCH Random Access Uplink Control Channel (TDD only)
E-TFCI	E-DCH Transport Format Combination Indicator
E-UCCH	E-DCH Uplink Control Channel (TDD only)
FACH	Forward Access Channel

FDD	Frequency Division Duplex
F-DPCH	Fractional DPCH
GANSS	Galileo and Additional Navigation Satellite Systems
GC-SAP	General Control SAP
GERAN	GSM/EDGE Radio Access Network
GNSS	Global Navigation Satellite System
GRA	GERAN Registration Area
G-RNTI	GERAN Radio Network Temporary Identity
HARQ	Hybrid Automatic Repeat Request
HCS	Hierarchical Cell Structure
HFN	Hyper Frame Number
H-RNTI	HS-DSCH RNTI
HS-DSCH	High Speed Downlink Shared Channel
ID	Identifier
IDNNS	Intra Domain NAS Node Selector
IE	Information element
IETF	Internet Engineering Task Force
IMEI	International Mobile Equipment Identity
IMSI	International Mobile Subscriber Identity
IP	Internet Protocol
ISCP	Interference on Signal Code Power
L1	Layer 1
L2	Layer 2
L3	Layer 3
LAI	Location Area Identity
MAC	Media Access Control
MBMS	Multimedia Broadcast Multicast Service
MBSFN	MBMS over a Single Frequency Network
MCC	Mobile Country Code
MCCH	MBMS point-to-multipoint Control Channel
MD	Mandatory default
MICH	MBMS notification Indicator Channel
MM	Mobility Management
MNC	Mobile Network Code
MP	Mandatory present
MTCH	MBMS point-to-multipoint Traffic Channel
MSCH	MBMS point-to-multipoint Scheduling Channel
NACC	Network Assisted Cell Change
NAS	Non Access Stratum
Nt-SAP	Notification SAP
NW	Network
OP	Optional
PCCH	Paging Control Channel
PCH	Paging Channel
PDCP	Packet Data Convergence Protocol
PDSCH	Physical Downlink Shared Channel
PDU	Protocol Data Unit
PLMN	Public Land Mobile Network
PNFE	Paging and Notification Control Functional Entity
PRACH	Physical Random Access CHannel
PSI	Packet System Information
p-t-m	Point-to-Multipoint
P-TMSI	Packet Temporary Mobile Subscriber Identity
p-t-p	Point-to-Point
PUSCH	Physical Uplink Shared Channel
QoS	Quality of Service
RAB	Radio access bearer
RACH	Random Access CHannel
RAI	Routing Area Identity
RAT	Radio Access Technology
RB	Radio Bearer
RFE	Routing Functional Entity

RG	Relative Grant
RL	Radio Link
RLC	Radio Link Control
RLS	Radio Link Set
RNC	Radio Network Controller
RNTI	Radio Network Temporary Identifier
RRC	Radio Resource Control
RSCP	Received Signal Code Power
RSN	Retransmission Sequence Number
RSSI	Received Signal Strength Indicator
SAP	Service Access Point
SCFE	Shared Control Function Entity
SCTD	Space Code Transmit Diversity
SCTO	Soft Combining Timing Offset (MBMS)
SF	Spreading Factor
SG	Serving grant
SHCCH	Shared Control Channel
SI	System Information
SIR	Signal to Interference Ratio
S-RNTI	SRNC - RNTI
TDD	Time Division Duplex
TF	Transport Format
TFCS	Transport Format Combination Set
TFS	Transport Format Set
TM	Transparent Mode
TME	Transfer Mode Entity
TMSI	Temporary Mobile Subscriber Identity
Tr	Transparent
TSN	Transmission Sequence Number
Tx	Transmission
UE	User Equipment
UL	Uplink
UM	Unacknowledged Mode
URA	UTRAN Registration Area
U-RNTI	UTRAN-RNTI
USCH	Uplink Shared Channel
UTRAN	Universal Terrestrial Radio Access Network

4 General

If not specified differently, descriptions are relevant for both FDD and TDD. Descriptions for TDD only are relevant for both 1.28 Mcps TDD and 3.84 Mcps TDD and 7.68 Mcps TDD if not specified differently.

4.1 Overview of the specification

This specification is organised as follows:

- subclause 4.2 contains the description of the model of the RRC protocol layer;
- clause 5 lists the RRC functions and the services provided to upper layers;
- clause 6 lists the services expected from the lower layers and specifies the radio bearers available for usage by the RRC messages;
- clause 7 specifies the UE states for the Access Stratum, and also specifies the processes running in the UE in the respective states;
- clause 8 specifies RRC procedures, including UE state transitions;

- clause 9 specifies the procedures for the handling of unknown, unforeseen, and erroneous protocol data by the receiving entity;
- clause 10 describes the message in a Tabular format; these messages descriptions are referenced in clause 8;
- clause 11 specifies the encoding of the messages of the RRC protocol. This is based on the Tabular description in clause 10.
- clause 12 specifies the transfer syntax for RRC PDUs derived from the encoding definition;
- clause 13 lists the protocol timers, counters, constants and variables to be used by the UE;
- clause 14 specifies some of the processes applicable in UTRA RRC connected mode e.g. measurement processes, and also the RRC information to be transferred between network nodes. Note that not all the processes applicable in UTRA RRC connected mode are specified here i.e. some UTRA RRC connected mode processes are described in [4] e.g. cell re-selection;
- Annex A contains recommendations about the network parameters to be stored on the USIM;
- Annex B contains informative Stage 2 description of the RRC protocol states and state transitions.

The following figure summarises the mapping of UE states, including states in GSM, to the appropriate UTRA and GSM specifications that specify the UE behaviour.

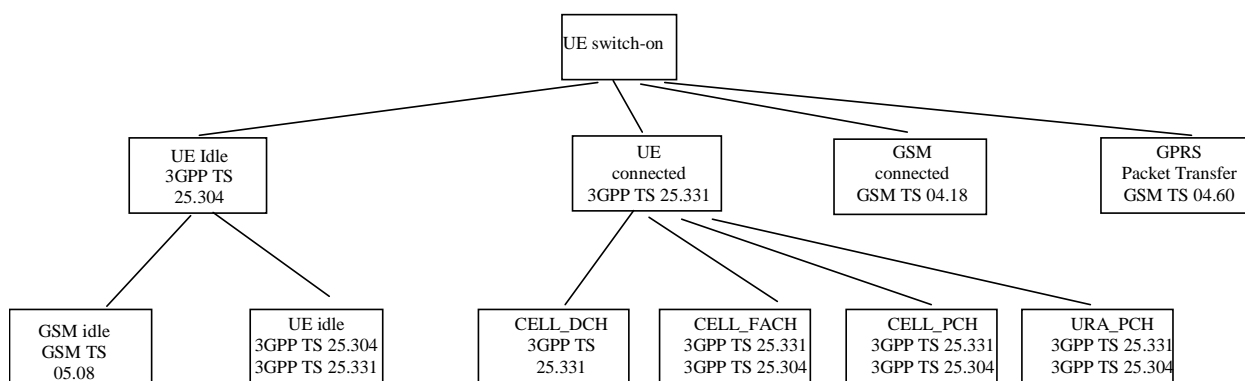

Figure 4.1-1: Mapping of UE state to 3GPP Specifications

4.2 RRC Layer Model

The functional entities of the RRC layer are described below:

- Routing of higher layer messages to different MM/CM entities (UE side) or different core network domains (UTRAN side) is handled by the Routing Function Entity (**RFE**).
- Broadcast functions are handled in the broadcast control function entity (**BCFE**). The BCFE is used to deliver the RRC services, which are required at the GC-SAP. The BCFE can use the lower layer services provided by the Tr-SAP and UM-SAP.
- Paging of UEs that do not have an RRC connection is controlled by the paging and notification control function entity (**PNFE**). The PNFE is used to deliver the RRC services that are required at the Nt-SAP. The PNFE can use the lower layer services provided by the Tr-SAP and UM-SAP.
- The Dedicated Control Function Entity (**DCFE**) handles all functions specific to one UE. The DCFE is used to deliver the RRC services that are required at the DC-SAP and can use lower layer services of UM/AM-SAP and Tr-SAP depending on the message to be sent and on the current UE service state.
- In TDD mode, the DCFE is assisted by the Shared Control Function Entity (SCFE) location in the C-RNC, which controls the allocation of the PDSCH and PUSCH using lower layers services of UM-SAP and Tr-SAP.
- The Transfer Mode Entity (TME) handles the mapping between the different entities inside the RRC layer and the SAPs provided by RLC.

NOTE 1: Logical information exchange is necessary also between the RRC sublayer functional entities. Most of that is implementation dependent and not necessary to present in detail in a specification.

Figure 4.2-1 shows the RRC model for the UE and Figure 4.2-2 and Figure 4.2-3 show the RRC model for the UTRAN.

NOTE 2: The figure shows only the types of SAPs that are used. Multiple instances of Tr-SAP, UM-SAP and AM-SAP are possible. Especially, different functional entities usually use different instances of SAP types.

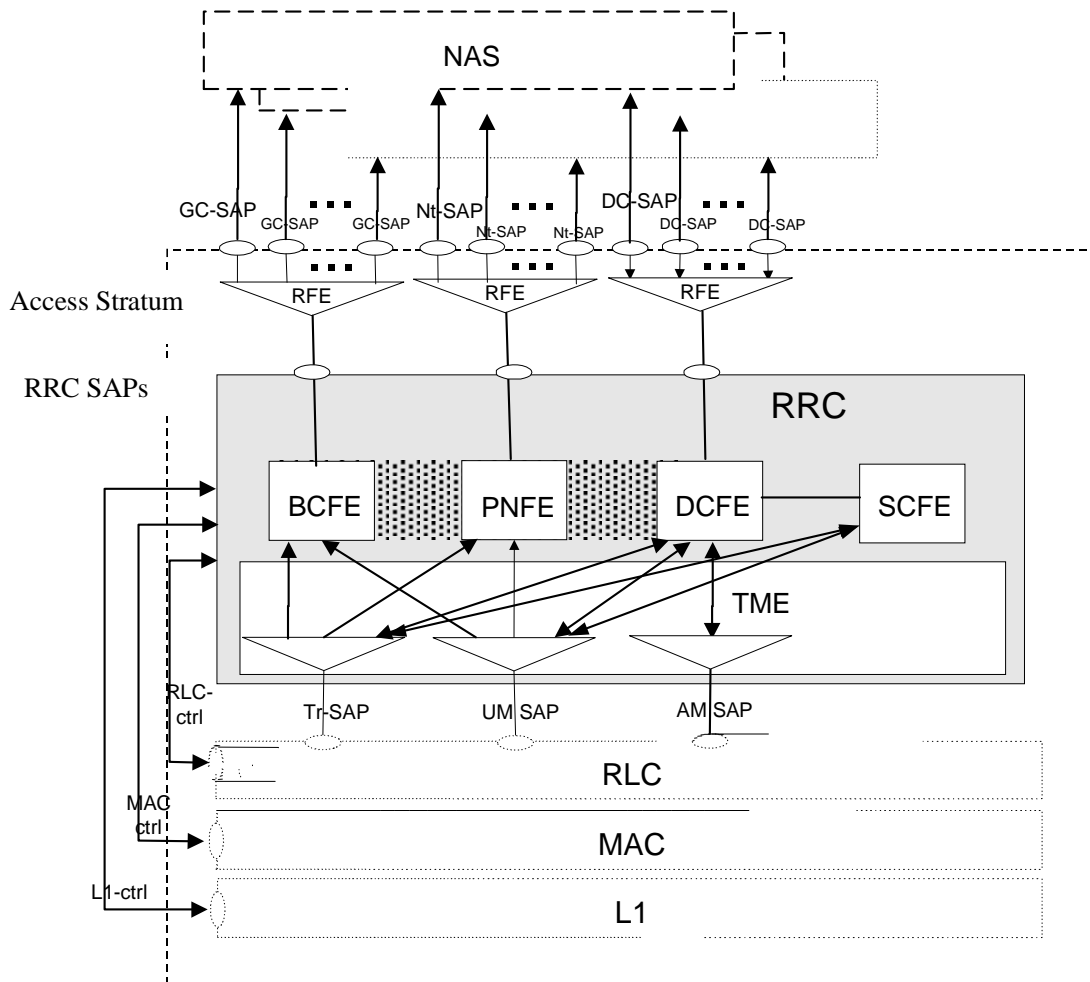

Figure 4.2-1: UE side model of RRC

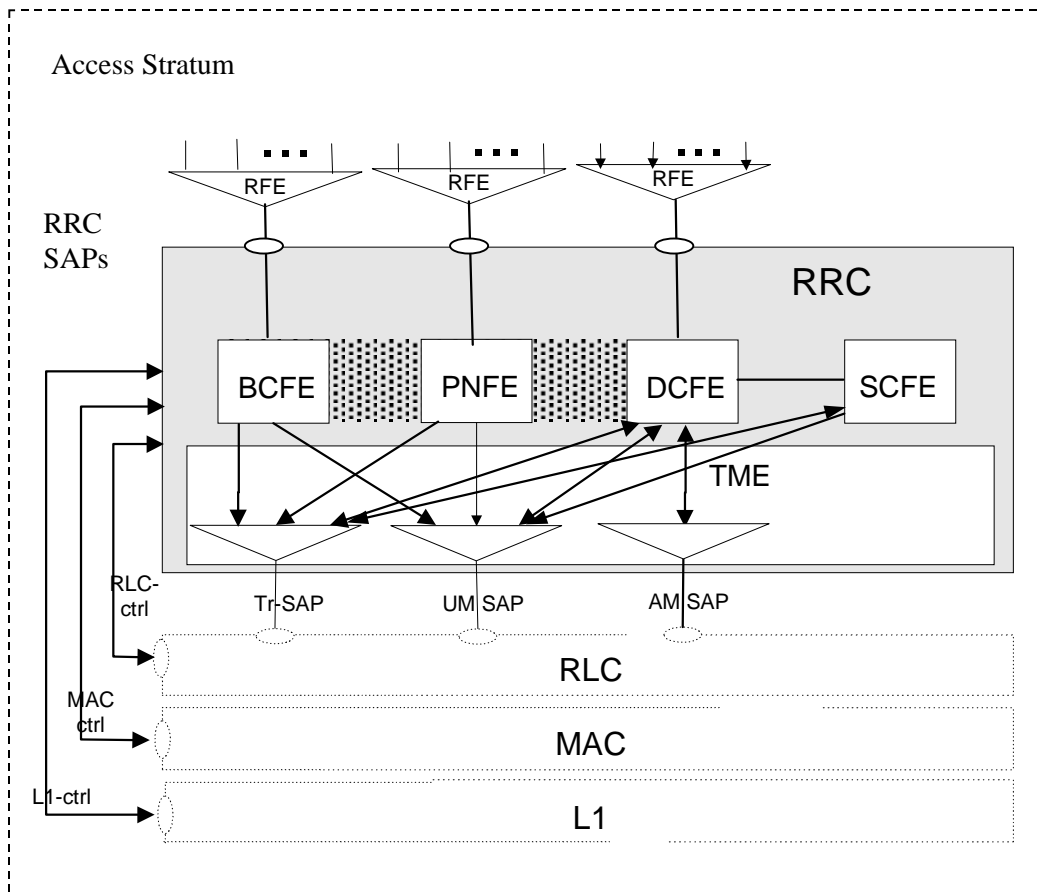

Figure 4.2-2: UTRAN side RRC model (DS-MAP system)

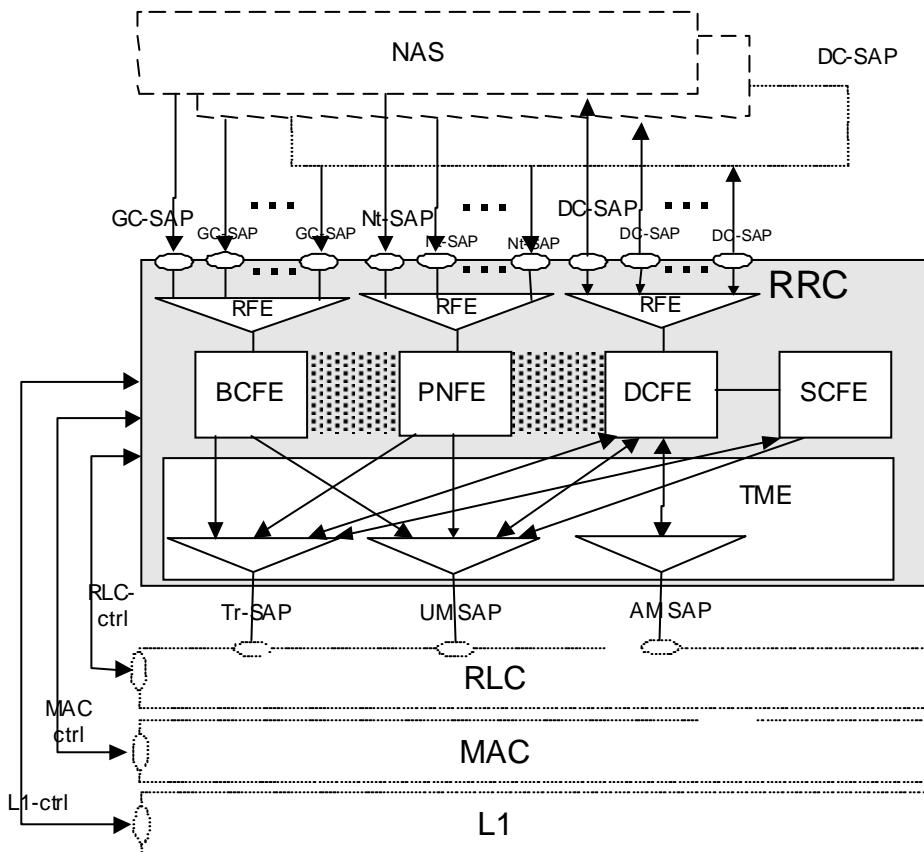

Figure 4.2-3: UTRAN side RRC model (DS-41 System)

4.3 Protocol specification principles

This protocol specification is based on the applicable general guidelines given in [14].

In this specification, a notation of variables is used. The variables are defined in subclause 13.4. Variables are typically used to represent a status or a result of an action, such as reception of an information element in a message, which is used to specify a behaviour somewhere else in the specification, such as when setting the value of an information element in a transmitted message. The variables only serve the purpose of specifying the protocol, and do not therefore impose any particular implementation.

When specifying the UE behaviour at reception of messages, the behaviour that is tied to reception or non-reception of individual information elements, and in some cases combinations of information elements, is specified in one location (subclause 8.6).

5 RRC Functions and Services provided to upper layers

5.1 RRC Functions

The RRC performs the functions listed below. A more detailed description of these functions is provided in [2]:

- Broadcast of information related to the non-access stratum (Core Network);
- Broadcast of information related to the access stratum;
- Establishment, maintenance and release of an RRC connection between the UE and UTRAN;
- Establishment, reconfiguration and release p-t-p of Radio Bearers;
- Establishment, reconfiguration and release of p-t-m Radio Bearers;
- Assignment, reconfiguration and release of radio resources for the RRC connection;
- RRC connection mobility functions;
- Control of requested QoS;
- UE measurement reporting and control of the reporting;
- Outer loop power control;
- Control of ciphering;
- Slow DCA (TDD mode);
- Paging;
- Initial cell selection and cell re-selection;
- Arbitration of radio resources on uplink DCH;
- RRC message integrity protection;
- Timing advance (TDD mode);
- CBS control;
- MBMS control.

5.2 RRC Services provided to upper layers

The RRC offers the following services to upper layers, a description and primitives of these services are provided in [2] and [17].

- General Control;
- Notification;
- Dedicated control.

The RRC layer provides the UE-UTRAN portion of signalling connections to the upper layers to support the exchange of upper layer's information flow. The signalling connection is used between the user equipment and the core network to transfer upper layer information. For each core network domain, at most one signalling connection may exist at the same time. The RRC layer maps the signalling connections for one UE on a single RRC connection. For the upper layer data transfer on signalling connections, the RRC layer supports the discrimination between two different classes, named "High priority" (corresponding to "SAPI 0" for a GSM-MAP based core network) and "Low priority" (corresponding to "SAPI 3" for a GSM-MAP based core network).

5.3 Primitives between RRC and upper layers

The primitives between RRC and the upper layers are described in [17].

6 Services expected from lower layers

6.1 Services expected from Layer 2

The services provided by layer 2 are described in [2], [15] and [16].

6.2 Services expected from Layer 1

The services provided by layer 1 are described in [2].

6.3 Signalling Radio Bearers

The Radio Bearers (RB) available for transmission of RRC messages are defined as "signalling radio bearers" and are specified in the following. The UE and UTRAN shall select the signalling radio bearers for RRC messages using RLC-TM, RLC-UM or RLC-AM on the DCCH and CCCH, according to the following:

- Signalling radio bearer RB0 shall be used for all messages sent on the CCCH (UL: RLC-TM, DL: RLC-UM).
- Signalling radio bearer RB1 shall be used for all messages sent on the DCCH, when using RLC unacknowledged mode (RLC-UM).
- Signalling radio bearer RB2 shall be used for all messages sent on the DCCH, when using RLC acknowledged mode (RLC-AM), except for the RRC messages carrying higher layer (NAS) signalling.
- Signalling radio bearer RB3 and optionally Signalling radio bearer RB4 shall be used for the RRC messages carrying higher layer (NAS) signalling and sent on the DCCH in RLC acknowledged mode (RLC-AM), as specified in subclauses 8.1.8., 8.1.9 and 8.1.10.
- Additionally, RBs whose identities shall be set between 5 and 32 may be used as signalling radio bearer for the RRC messages on the DCCH sent in RLC transparent mode (RLC-TM).
- RRC messages on the SHCCH are mapped either on RACH or on the USCH in the uplink using TM and either on FACH or on the DSCH using RLC-UM. These messages are only specified for TDD mode.

- RRC messages on the MCCH are mapped on FACH using RLC-UM. The transport channel configuration for MCCH is indicated on BCCH. For this signalling radio bearer no identity is applied.
- RRC messages on the MSCH are mapped on FACH using RLC-UM. The transport channel configuration for MSCH is indicated on MCCH. For this signalling radio bearer no identity is applied.

The Radio Bearer configuration for signalling radio bearer RB0, SHCCH, BCCH on FACH, PCCH on PCH, BCCH mapped to BCH, RB0 mapped on HS-DSCH (FDD only), BCCH mapped on HS-DSCH (FDD only) and PCCH mapped to HS-DSCH (FDD only) are specified in subclauses 13.6, 13.6a, 13.6b, 13.6c, 13.6e, 13.6f and 13.6g.

Ciphering is never applied to signalling radio bearer RB0 or signalling radio bearers using RLC TM.

7 Protocol states

7.1 Overview of RRC States and State Transitions including GSM

Figure 7.1-1 shows the RRC states in UTRA RRC Connected Mode, including transitions between UTRA RRC connected mode and GSM connected mode for CS domain services, and between UTRA RRC connected mode and GSM/GPRS packet modes for PS domain services. It also shows the transitions between Idle Mode and UTRA RRC Connected Mode and furthermore the transitions within UTRA RRC connected mode.

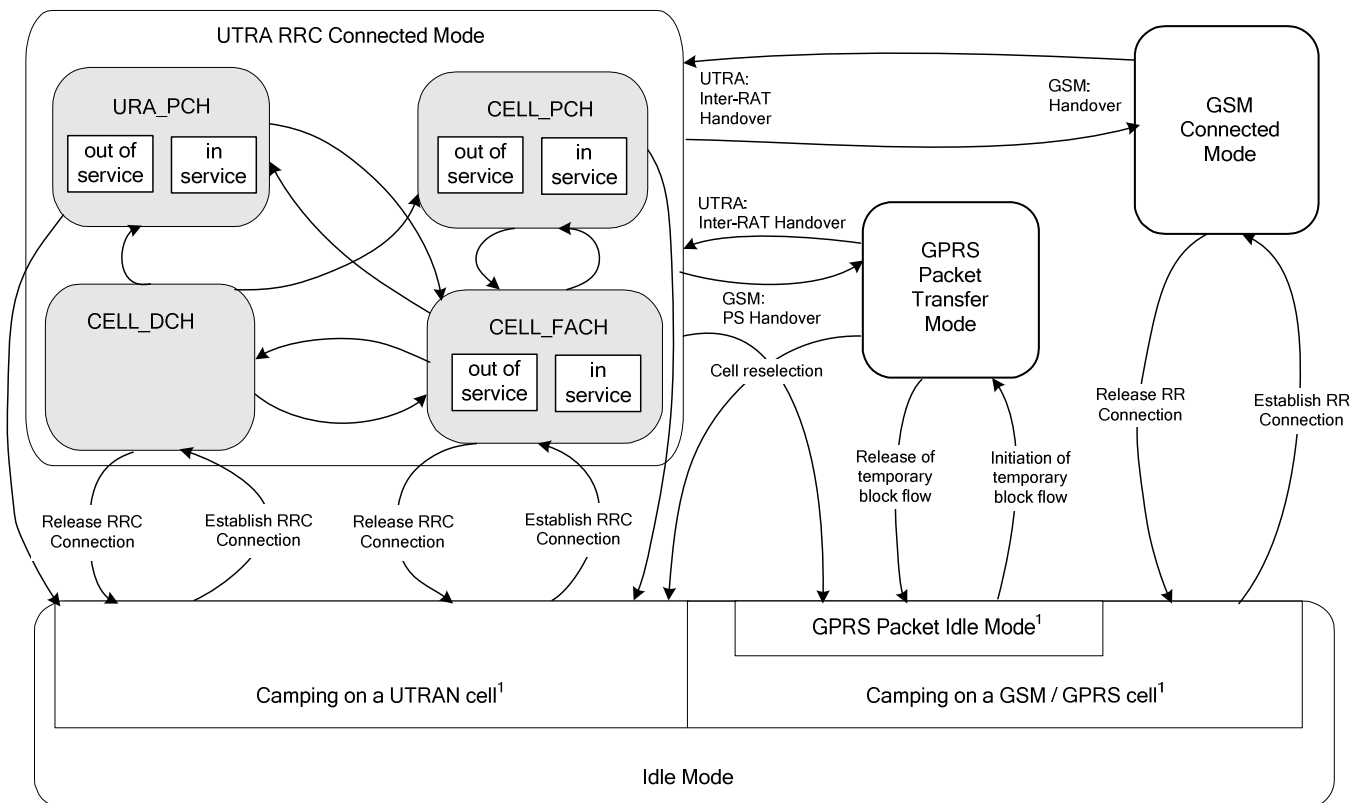

NOTE: ¹: The indicated division within Idle Mode is only included for clarification and shall not be interpreted as states.

Figure 7.1-1: RRC States and State Transitions including GSM

The RRC connection is defined as a point-to-point bi-directional connection between RRC peer entities in the UE and the UTRAN characterised by the allocation of a U-RNTI. A UE has either zero or one RRC connection.

If NAS informs AS about a new selected PLMN, registered PLMN or equivalent PLMN list while being in connected mode, the UE shall perform the actions according to subclause 8.5.24.

NOTE: The state transitions are specified in clause 8.

7.2 Processes in UE modes/states

NOTE: This subclause specifies what processes shall be active in the UE in the different RRC modes/states. The related procedures and the conditions on which they are triggered are specified either in clause 8 or elsewhere in the relevant process definition.

7.2.1 UE Idle mode

UE processes that are active in UE Idle mode are specified in [4].

The UE shall perform a periodic search for higher priority PLMNs as specified in [25], unless the UE is receiving MBMS services via p-t-m radio bearers.

A UE that is capable of receiving MBMS services on cells operating in MBSFN mode as specified in subclause 8.1.1.6.3 is operating in idle mode and acts on RRC messages and system information received from this cell operating in MBSFN mode independently from messages received from cells not operating in MBSFN mode. This implies that procedures executed based on messages and system information received from a cell operating in MBSFN mode shall not interact with messages and system information received from a cell not operating in MBSFN mode unless explicitly specified otherwise.

NOTE 1: This implies that the UE is operating an independent stack for the reception of MBMS services on cells operating in MBSFN mode as specified in subclause 8.1.1.6.3.

NOTE 2: For 1.28 Mcps TDD, if the cell is operating in MBSFN mode, system information and MCCH messages are transmitted on the MBSFN Special Timeslot [30].

7.2.2 UTRA RRC Connected mode

In this specification unless otherwise mentioned "connected mode" shall refer to "UTRA RRC connected mode".

7.2.2.1 URA_PCH or CELL_PCH state

In the URA_PCH or CELL_PCH state the UE shall perform the following actions:

NOTE: For TDD, neither DCCH nor DTCH are available in these states.
For FDD, DCCH and DTCH reception on HS-DSCH may be configured in CELL_PCH state, if the UE supports HS-DSCH reception in CELL_PCH and URA_PCH state. Otherwise, neither DCCH nor DTCH are available in CELL_PCH state. In URA_PCH, neither DCCH nor DTCH are available.

1> if the UE is "in service area":

- 2> maintain up-to-date system information as broadcast by the serving cell as specified in the subclause 8.1.1;
- 2> perform cell reselection process as specified in [4];
- 2> perform a periodic search for higher priority PLMNs as specified in [25], unless the UE is receiving MBMS services via p-t-m radio bearers;

NOTE: If the DRX cycle length is 80ms, then a search for higher priority PLMNs may not identify all the available PLMNs due to the paging occasion on the current serving cell coinciding with the MIB of the cell of interest.

- 2> for TDD; or
- 2> for FDD, if the UE does not support HS-DSCH reception in CELL_PCH and URA_PCH state; or
- 2> if the IE "HS-DSCH paging system information" is not included in System Information Block type 5 or System Information Block type 5bis:

- 3> monitor the paging occasions and PICH monitoring occasions determined according to subclauses 8.6.3.1a, 8.6.3.2 and 8.5.42 and receive paging information on the PCH mapped on the S-CCPCH selected by the UE according to the procedure in subclause 8.5.19;
- 2> else:
 - 3> monitor the paging occasions and PICH monitoring occasions determined according to subclauses 8.6.3.1a, 8.6.3.2 and 8.5.39 and receive PCCH on the HS-DSCH mapped on the HS-PDSCH, or DCCH and DTCH on the HS-DSCH mapped on the HS-PDSCH and the associated HS-SCCH selected by the UE according to the procedure in subclause 8.5.40.
- 2> act on RRC messages received on PCCH, BCCH, and DCCH (FDD only);
- 2> perform measurements process according to measurement control information as specified in subclause 8.4 and in subclause 14.4;
- 2> maintain up-to-date BMC data if it supports Cell Broadcast Service (CBS) as specified in [37];
- 2> act on RRC messages received on MCCH if it supports MBMS and has activated an MBMS service as specified in subclause 8.7;
- 2> run timer T305 for periodical URA update if the UE is in URA_PCH or for periodical cell update if the UE is in CELL_PCH.
- 1> if the UE is "out of service area":
 - 2> perform cell selection process as specified in [4];
 - 2> run timer T316;
 - 2> run timer T305 or T307;
 - 2> if the cell selection process fails to find a suitable cell after a complete scan of all RATs and all frequency bands supported by the UE, the UE shall after a minimum of TimerOutOfService time (default value 30 s) of being "out of service area":
 - 3> indicate all available PLMNs to NAS to enable the selection of a new PLMN;
 - 3> if an acceptable cell is found then the UE shall camp on that cell to obtain limited service as defined in [4] and, perform actions according to subclause 8.5.24;
 - 3> else if no acceptable cell is found, the UE shall continue looking for an acceptable cell as defined in [4].

7.2.2.2 CELL_FACH state

In the CELL_FACH state the UE shall perform the following actions:

NOTE: DCCH and, if configured, DTCH are available in this state.

- 1> if the UE is "in service area":
 - 2> maintain up-to-date system information as broadcast by the serving cell as specified in subclause 8.1.1;
 - 2> perform cell reselection process as specified in [4];
 - 2> perform measurements process according to measurement control information as specified in subclause 8.4 and in subclause 14.4;
 - 2> run timer T305 (periodical cell update);
 - 2> select and configure the RB multiplexing options applicable for the transport channels to be used in this RRC state;
 - 2> for TDD; or
 - 2> for FDD, if the UE does not support HS-DSCH reception in CELL_FACH state; or

- 2> if the IE "HS-DSCH common system information" is not included in System Information Block type 5 or System Information Block type 5bis:
 - 3> listen to all FACH transport channels mapped on the S-CCPCH selected by the UE according to the procedure in subclause 8.5.19.
- 2> else:
 - 3> if variable H_RNTI is set:
 - 4> receive physical channels HS-SCCH(s) using the value of the variable H_RNTI as UE identity and parameters given by the IE(s) "HS-DSCH common system information" according to the procedure in subclause 8.5.36.
 - 3> else:
 - 4> if variable HS_DSCH_RECEPTION_OF_CCCH_ENABLED is set to TRUE:
 - 5> receive physical channel(s) of type HS-SCCH with selected common H-RNTI using parameters given by the IE(s) "HS-DSCH common system information" according to the procedure in subclause 8.5.37.
- 2> act on RRC messages received on BCCH, CCCH and DCCH;
- 2> act on RRC messages received on MCCH if it supports MBMS and has activated an MBMS service as specified in subclause 8.7;
- 2> act on RRC messages received on, if available, SHCCH (TDD only).
- 1> if the UE is "out of service area":
 - 2> perform cell selection process as specified in [4];
 - 2> run timers T305 (periodical cell update), and T317 (cell update when re-entering "in service") or T307 (transition to Idle mode), if started;
 - 2> run timers T314 and/or T315, if started;
 - 2> if the cell selection process fails to find a suitable cell after a complete scan of all RATs and all frequency bands supported by the UE, the UE shall after a minimum of TimerOutOfService time (default value 30 seconds) of being "out of service area":
 - 3> indicate all available PLMNs to NAS to enable the selection of a new PLMN;
 - 3> if an acceptable cell is found then the UE shall camp on that cell to obtain limited service as defined in [4] and perform actions according to subclause 8.5.24;
 - 3> else if no acceptable cell is found, the UE shall continue looking for an acceptable cell as defined in [4].

7.2.2.3 CELL_DCH state

In the CELL_DCH state the UE shall perform the following actions:

NOTE: DCCH and, if configured, DTCH are available in this state.

- 1> read the system information as specified in subclause 8.1.1 (for UEs in TDD mode);
- 1> perform measurements process according to measurement control information as specified in subclause 8.4 and in clause 14;
- 1> select and configure the RB multiplexing options applicable for the transport channels to be used in this RRC state;
- 1> act on RRC messages received on DCCH;
- 1> act on RRC messages received on BCCH (applicable only to UEs with certain capabilities and in FDD mode);

1> act on RRC messages received on MCCH if it supports MBMS and has activated an MBMS service as specified in subclause 8.7 (applicable only to UEs supporting MBMS with certain capabilities);

1> act on RRC messages received on BCCH (TDD only) and, if available, SHCCH (TDD only).

NOTE: If any of the above procedures results in different HS-DSCH and E-DCH serving cells, the UE behaviour is unspecified.

8 RRC procedures

The UE shall be able to process several simultaneous RRC procedures. After the reception of a message which invoked a procedure, the UE shall be prepared to receive and act on another message which may invoke a second procedure. Whether this second invocation of a procedure (transaction) is accepted or rejected by the UE is specified in the subclauses of this clause, and in particular in subclause 8.6.3.11 (RRC transaction identifier).

On receiving a message the UE shall:

1> check that the message is addressed to the UE (e.g. by checking the IE "Initial UE identity" or the IE "U-RNTI" for messages on CCCH);

1> discard the messages addressed to other UEs.

and then the UE shall:

1> apply integrity check as appropriate;

1> proceed with error handling as specified in clause 9;

1> act upon the IE "RRC transaction identifier";

1> continue with the procedure as specified in the relevant subclause.

NOTE: Due to an error in the Release '99 ASN.1, a Release '99 UE is unable to determine which UE is addressed by a downlink CCCH message corresponding to a protocol version later than Release '99. As a result, the Release '99 UE will not be able to return a protocol error according to subclause 9.3a. Therefore, the UTRAN should only send a Release '99 message version towards UEs that have indicated conformance to Release '99 in the IE "Access stratum release indicator".

The RRC entity in the UE shall consider PDUs to have been transmitted when they are submitted to the lower layers. If the RRC entity in the UE submits a message for transmission using AM RLC, it shall consider the message successfully transmitted when UTRAN reception of all relevant PDUs is acknowledged by RLC. In the UE, timers are started when the PDUs are sent on the radio interface in the case of the transmission using the CCCH.

8.1 RRC Connection Management Procedures

8.1.1 Broadcast of system information

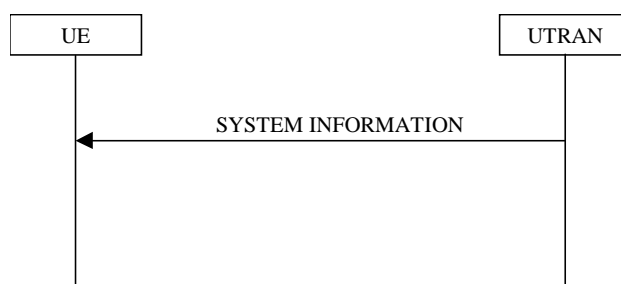

Figure 8.1.1-1: Broadcast of system information

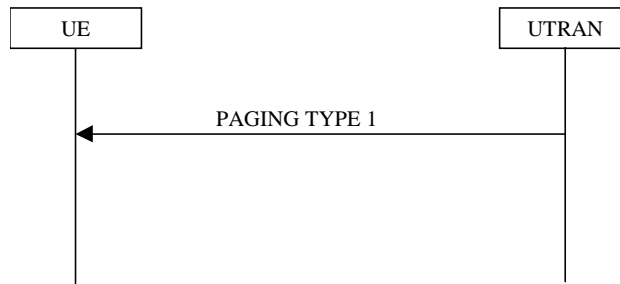

Figure 8.1.1-2: Notification of system information modification for UEs in idle mode, CELL_PCH state and URA_PCH state

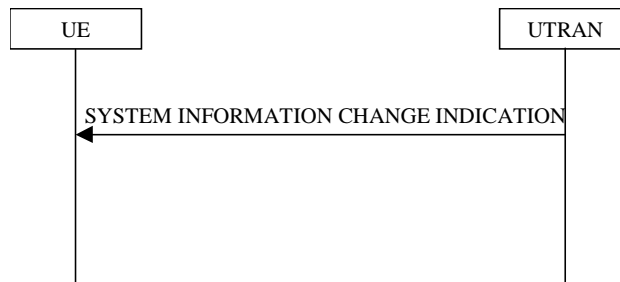

Figure 8.1.1-3: Notification of system information modification for UEs in CELL_FACH and CELL_DCH(TDD only) state

8.1.1.1 General

The purpose of this procedure is to broadcast system information from the UTRAN to UEs in a cell.

8.1.1.1.1 System information structure

The system information elements are broadcast in *system information blocks*. A system information block groups together system information elements of the same nature. Different system information blocks may have different characteristics, e.g. regarding their repetition rate and the requirements on UEs to re-read the system information blocks.

The system information is organised as a tree. A *master information block* gives references and scheduling information to a number of system information blocks in a cell. The system information blocks contain the actual system information. The master information block may optionally also contain reference and scheduling information to one or two *scheduling blocks*, which give references and scheduling information for additional system information blocks. Scheduling information for a system information block may only be included in either the master information block or one of the scheduling blocks.

For all system information blocks except System Information Block types 15.2, 15.3 and 16, the content is the same in each occurrence for system information blocks using value tag. System Information Block types 15.2, 15.3 and 16 may occur more than once with different content. In this case scheduling information is provided for each such occurrence of the system information block. System information blocks that do not use value tag may have different content for each occurrence.

8.1.1.1.2 System information blocks

Table 8.1.1 specifies all system information blocks and their characteristics.

The *area scope column* in table 8.1.1 specifies the area where a system information block's value tag is valid. If the area scope is *cell*, the UE shall consider the system information block to be valid only in the cell in which it was read. If system information blocks have been previously stored for this cell, the UE shall check whether the value tag for the system information block in the entered cell is different compared to the stored value tag. If the area scope is *PLMN* or *Equivalent PLMN*, the UE shall check the value tag for the system information block when a new cell is selected. If the value tag for the system information block in the new cell is different compared to the value tag for the system information block stored in the UE, the UE shall re-read the system information block. If the area scope is *PLMN*, the

UE shall consider the system information block to be valid only within the PLMN in which it was read. If the area scope is *Equivalent PLMN*, the UE shall consider the system information block to be valid within the PLMN in which it was received and all PLMNs which are indicated by higher layers to be equivalent.

For System information block types 15.2, 15.3 and 16, which may have multiple occurrences, each occurrence has its own independent value tag. The UE shall re-read a particular occurrence if the value tag of this occurrence has changed compared to that stored in the UE.

The *UE mode/state column when block is valid* in Table 8.1.1 specifies in which UE mode or UE state the IEs in a system information block shall be regarded as valid by the UE. In other words, the indicated system information block becomes invalid upon change to a mode/state that is not included in this column. System Information Block Type 16 remains also valid upon transition to or from GSM/GPRS. In some cases, the states are inserted in brackets to indicate that the validity is dependent on the broadcast of the associated System Information Blocks by the network as explained in the relevant procedure subclause.

The *UE mode/state column when block is read* in Table 8.1.1 specifies in which UE mode or UE state the IEs in a system information block may be read by the UE. The UE shall have the necessary information prior to execution of any procedure requiring information to be obtained from the appropriate system information block. The requirements on the UE in terms of when to read the system information may therefore be derived from the procedure specifications that specify which IEs are required in the different UE modes/states in conjunction with the different performance requirements that are specified.

The UE shall:

- 1> if variable DEFERRED_MEASUREMENT_STATUS is set to FALSE:
 - 2> if System Information Block type 11 is referenced in the master information block or in the scheduling blocks:
 - 3> if System Information Block type 12 is not referenced in the master information block or in the scheduling blocks, or broadcast of System Information Block type 12 is not indicated in System Information Block type 11:
 - 4> have read and acted upon System Information Block type 11 and System Information Block type 11bis, if scheduled on BCH, in a cell when the UE transmits an RRC message on RACH.
 - 3> else:
 - 4> have read and acted upon System Information Block type 11 and System Information Block type 11bis, if scheduled on BCH, in a cell before the UE transmits the RRC CONNECTION REQUEST message.
 - 4> have read and acted upon both System Information Block type 11 and System Information Block type 11bis, if scheduled on BCH, and System Information Block type 12 in a cell when:
 - 5> the UE transmits an RRC message on RACH in RRC connected mode; or
 - 5> the UE receives a message commanding to enter Cell_DCH state.
 - 1> else:
 - 2> the UE may transmit an RRC message on RACH before having read and acted upon System Information Block type 11, System Information Block type 11bis and System Information Block type 12, if scheduled on BCH.

NOTE 1: There are a number of system information blocks that include the same IEs while the UE mode/state in which the information is valid differs. This approach is intended to allow the use of different IE values in different UE mode/states.

NOTE 2: System Information Block Type 16 is also obtained by a UE while in GSM/GPRS. The details of this are not within the scope of this specification.

The *Scheduling information* column in table 8.1.1 specifies the position and repetition period for the System Information Block.

The *modification of system information* column in table 8.1.1 specifies the update mechanisms applicable for a certain system information block. For system information blocks with a value tag, the UE shall update the information according to subclause 8.1.1.7.1 or 8.1.1.7.2. For system information blocks with an expiration timer, the UE shall, when the timer expires, perform an update of the information according to subclause 8.1.1.7.4.

Table 8.1.1: Specification of system information block characteristics

System information block	Area scope	UE mode/state when block is valid	UE mode/state when block is read	Scheduling information	Modification of system information	Additional comment
Master information block	Cell	Idle mode, CELL_FACH, CELL_PCH, URA_PCH, CELL_DCH (TDD only)	Idle mode, CELL_FACH, CELL_PCH, URA_PCH, CELL_DCH (TDD only)	SIB_POS = 0 SIB_REP = 8 (FDD) SIB_REP = 8, 16, 32 (TDD) SIB_OFF=2	Value tag	
Scheduling block 1	Cell	Idle mode, CELL_FACH, CELL_PCH, URA_PCH, CELL_DCH (TDD only)	Idle mode, CELL_FACH, CELL_PCH, URA_PCH, CELL_DCH (TDD only)	Specified by the IE "Scheduling information" in MIB	Value tag	See Note 3
Scheduling block 2	Cell	Idle mode, CELL_FACH, CELL_PCH, URA_PCH, CELL_DCH (TDD only)	Idle mode, CELL_FACH, CELL_PCH, URA_PCH, CELL_DCH (TDD only)	Specified by the IE "Scheduling information" in MIB	Value tag	See Note 3
System information block type 1	Cell	Idle mode, CELL_FACH, CELL_PCH, URA_PCH, CELL_DCH	Idle, CELL_FACH, CELL_PCH, URA_PCH	Specified by the IE "Scheduling information"	Value tag	Note: The area scope of SIB1 is Cell but for compliance to earlier versions of the specification the coding of the scheduling information for SIB1 contains the 'PLMN value tag' information element. See Note 3
System information block type 2	Cell	URA_PCH	URA_PCH	Specified by the IE "Scheduling information"	Value tag	See Note 3
System information block type 3	Cell	Idle mode, (CELL_FACH, CELL_PCH, URA_PCH)	Idle mode, (CELL_FACH, CELL_PCH, URA_PCH)	Specified by the IE "Scheduling information"	Value tag	
System information block type 4	Cell	CELL_FACH, CELL_PCH, URA_PCH	CELL_FACH, CELL_PCH, URA_PCH	Specified by the IE "Scheduling information"	Value tag	If System information block type 4 is not broadcast in a cell, the connected mode UE shall apply information in System information block type 3 in connected mode. See Note 3
System information block type 5 and 5bis	Cell	Idle mode, (CELL_FACH, CELL_PCH, URA_PCH, CELL_DCH (TDD only))	Idle mode, (CELL_FACH, CELL_PCH, URA_PCH, CELL_DCH (TDD only))	Specified by the IE "Scheduling information"	Value tag	System information block type 5bis is sent instead of system information block type 5 in cells that use Band IV or Band IX or Band X.

System information block	Area scope	UE mode/state when block is valid	UE mode/state when block is read	Scheduling information	Modification of system information	Additional comment
System information block type 6	Cell	CELL_FACH, CELL_PCH, URA_PCH, CELL_DCH (TDD only)	CELL_FACH, CELL_PCH, URA_PCH, CELL_DCH (TDD only)	Specified by the IE "Scheduling information"	Value tag	<p>If system information block type 6 is not broadcast in a cell, the connected mode UE shall read System information block type 5 or System information block type 5bis.</p> <p>If some of the optional IEs are not included in System information block type 6, the UE shall read the corresponding IEs in System information block type 5 or System information block type 5bis.</p> <p>In TDD mode system information block 6 shall only be read in CELL_DCH if required for open loop power control as specified in subclause 8.5.7 and/or if shared transport channels are assigned to the UE. If in these cases system information block type 6 is not broadcast the UE shall read system information block type 5. See Note 3</p>
System information block type 7	Cell	Idle mode, CELL_FACH, CELL_PCH, URA_PCH, CELL_DCH (TDD only)	Idle mode, CELL_FACH, CELL_PCH, URA_PCH, CELL_DCH (TDD only)	Specified by the IE "Scheduling information"	Expiration timer = MAX(32 , SIB_REP * ExpirationTimeFactor)	In TDD mode system information block type 7 shall only be read in CELL_DCH if shared transport channels are assigned to the UE. See Note 3
System information block type 11	Cell	Idle mode (CELL_FACH, CELL_PCH, URA_PCH, CELL_DCH)	Idle mode (CELL_FACH, CELL_PCH, URA_PCH)	Specified by the IE "Scheduling information"	Value tag	
System information block type 11bis	Cell	Idle mode (CELL_FACH, CELL_PCH, URA_PCH, CELL_DCH)	Idle mode (CELL_FACH, CELL_PCH, URA_PCH)	Specified by the IE "Scheduling information"	Value tag	See Note 3

System information block	Area scope	UE mode/state when block is valid	UE mode/state when block is read	Scheduling information	Modification of system information	Additional comment
System information block type 12	Cell	CELL_FACH, CELL_PCH, URA_PCH, CELL_DCH	Idle mode, CELL_FACH, CELL_PCH, URA_PCH	Specified by the IE "Scheduling information"	Value tag	If system information block type 12 is not broadcast in a cell, the connected mode UE shall read System information block type 11. If some of the optional IEs are not included in System information block type 12, the UE shall read the corresponding IEs in System information block type 11. See Note 3
System information block type 13	Cell	Idle Mode, CELL_FACH, CELL_PCH, URA_PCH	Idle Mode, CELL_FACH, CELL_PCH, URA_PCH	Specified by the IE "Scheduling information"	Value tag	See Note 3
System information block type 13.1	Cell	Idle Mode, CELL_FACH, CELL_PCH, URA_PCH	Idle Mode, CELL_FACH, CELL_PCH, URA_PCH	Specified by the IE "Scheduling information"	Value tag	See Note 3
System information block type 13.2	Cell	Idle Mode, CELL_FACH, CELL_PCH, URA_PCH	Idle Mode, CELL_FACH, CELL_PCH, URA_PCH	Specified by the IE "Scheduling information"	Value tag	See Note 3
System information block type 13.3	Cell	Idle Mode, CELL_FACH, CELL_PCH, URA_PCH	Idle Mode, CELL_FACH, CELL_PCH, URA_PCH	Specified by the IE "Scheduling information"	Value tag	See Note 3
System information block type 13.4	Cell	Idle Mode, CELL_FACH, CELL_PCH, URA_PCH	Idle Mode, CELL_FACH, CELL_PCH, URA_PCH	Specified by the IE "Scheduling information"	Value tag	See Note 3
System information block type 14	Cell	Idle Mode, CELL_FACH, CELL_PCH, URA_PCH, CELL_DCH	Idle Mode, CELL_FACH, CELL_PCH, URA_PCH, CELL_DCH	Specified by the IE "Scheduling information"	Expiration timer = MAX(32, SIB_REP * ExpirationTimeFactor)	This system information block is used in 3.84 Mcps TDD and 7.68 Mcps TDD mode only. System information block type 14 shall only be read in CELL_DCH if required for open loop power control as specified in subclause 8.5.7. See Note 3
System information block type 15	Cell	Idle Mode, CELL_FACH, CELL_PCH, URA_PCH	Idle Mode, CELL_FACH, CELL_PCH, URA_PCH	Specified by the IE "Scheduling information"	Value tag	See Note 3
System information block type 15bis		Idle Mode, CELL_FACH, CELL_PCH, URA_PCH	Idle Mode, CELL_FACH, CELL_PCH, URA_PCH	Specified by the IE "Scheduling information"	Value tag	See Note 3
System information block type 15.1	Cell	Idle Mode, CELL_FACH, CELL_PCH, URA_PCH	Idle Mode, CELL_FACH, CELL_PCH, URA_PCH	Specified by the IE "Scheduling information"	Value tag	See Note 3

System information block	Area scope	UE mode/state when block is valid	UE mode/state when block is read	Scheduling information	Modification of system information	Additional comment
System information block type 15.1bis		Idle Mode, CELL_FACH, CELL_PCH, URA_PCH	Idle Mode, CELL_FACH, CELL_PCH, URA_PCH	Specified by the IE "Scheduling information"	Value tag	See Note 3
System information block type 15.2	Cell	Idle Mode, CELL_FACH, CELL_PCH, URA_PCH	Idle Mode, CELL_FACH, CELL_PCH, URA_PCH	Specified by the IE "Scheduling information"	Value tag	For this system information block there may be multiple occurrences See Note 3
System information block type 15.2bis	Cell	Idle Mode, CELL_FACH, CELL_PCH, URA_PCH	Idle Mode, CELL_FACH, CELL_PCH, URA_PCH	Specified by the IE "Scheduling information"	Value tag	For this system information block there may be multiple occurrences See Note 3
System information block type 15.3	PLMN	Idle Mode, CELL_FACH, CELL_PCH, URA_PCH	Idle Mode, CELL_FACH, CELL_PCH, URA_PCH	Specified by the IE "Scheduling information"	Value tag	For this system information block there may be multiple occurrences See Note 3
System information block type 15.3bis	PLMN	Idle Mode, CELL_FACH, CELL_PCH, URA_PCH	Idle Mode, CELL_FACH, CELL_PCH, URA_PCH	Specified by the IE "Scheduling information"	Value tag	For this system information block there may be multiple occurrences See Note 3
System information block type 15.4	Cell	Idle Mode, CELL_FACH, CELL_PCH, URA_PCH	Idle Mode, CELL_FACH, CELL_PCH, URA_PCH	Specified by the IE "Scheduling information"	Value tag	See Note 3
System information block type 15.5	Cell	Idle Mode, CELL_FACH, CELL_PCH, URA_PCH	Idle Mode, CELL_FACH, CELL_PCH, URA_PCH	Specified by the IE "Scheduling information"	Value tag	See Note 3
System information block type 15.6	Cell	Idle Mode, CELL_FACH, CELL_PCH, URA_PCH	Idle Mode, CELL_FACH, CELL_PCH, URA_PCH	Specified by the IE "Scheduling information"	Value tag	See Note 3
System information block type 15.7	Cell	Idle Mode, CELL_FACH, CELL_PCH, URA_PCH	Idle Mode, CELL_FACH, CELL_PCH, URA_PCH	Specified by the IE "Scheduling information"	Value tag	See Note 3
System information block type 15.8	Cell	Idle Mode, CELL_FACH, CELL_PCH, URA_PCH	Idle Mode, CELL_FACH, CELL_PCH, URA_PCH	Specified by the IE "Scheduling information"	Value tag	See Note 3
System information block type 16	Equivalent PLMN	Idle Mode, CELL_FACH, CELL_PCH, URA_PCH, CELL_DCH	Idle Mode, CELL_FACH, CELL_PCH, URA_PCH	Specified by the IE "Scheduling information"	Value tag	For this system information block there may be multiple occurrences. This system information block is also valid while in GSM/GPRS. See Note 3
System information block type 17	Cell	CELL_FACH, CELL_PCH, URA_PCH, CELL_DCH	CELL_FACH, CELL_PCH, URA_PCH, CELL_DCH	Specified by the IE "Scheduling information"	Expiration timer = SIB_REP	This system information block is used in TDD mode only. System information block type 17 shall only be read if shared transport channels are assigned to the UE. See Note 3

System information block	Area scope	UE mode/state when block is valid	UE mode/state when block is read	Scheduling information	Modification of system information	Additional comment
System Information Block type 18	Cell	Idle mode, CELL_FACH, CELL_PCH, URA_PCH, CELL_DCH	Idle mode, CELL_FACH, CELL_PCH, URA_PCH	Specified by the IE "Scheduling information"	Value tag	See Note 3

NOTE 3: The UE behaviour is unspecified if this system information block is received on a cell operating in MBSFN mode as indicated in subclause 8.1.1.6.3. A network should not send these system information blocks on a cell operating in MBSFN mode.

NOTE 4: For 1.28 Mcps TDD, if a cell is operating in MBSFN mode, system information blocks are transmitted on the MBSFN Special Timeslot [30].

8.1.1.1.3 Segmentation and concatenation of system information blocks

A generic SYSTEM INFORMATION message is used to convey the system information blocks on the BCCH. A given BCCH may be mapped onto either a BCH or a FACH transport channel according to subclause 8.1.1.1.2. The size of the SYSTEM INFORMATION message shall fit the size of a BCH or a FACH transport block.

The RRC layer in UTRAN performs segmentation and concatenation of encoded system information blocks. If the encoded system information block is larger than the size of a SYSTEM INFORMATION message, it will be segmented and transmitted in several messages. If the encoded system information block is smaller than a SYSTEM INFORMATION message, UTRAN may concatenate several system information blocks, or the first segment or the last segment into the same message as specified in the remainder of this clause.

Four different segment types are defined:

- First segment;
- Subsequent segment;
- Last segment;
- Complete.

Each of the types - *First*, *Subsequent* and *Last segment* - is used to transfer segments of a master information block, scheduling block or a system information block. The segment type, *Complete*, is used to transfer a complete master information block, complete scheduling block or a complete system information block.

Each segment consists of a header and a data field. The data field carries the encoded system information elements. The header contains the following parameters:

- The number of segments in the system information block (SEG_COUNT). This parameter is only included in the header if the segment type is "First segment".
- SIB type. The SIB type uniquely identifies the master information block, scheduling block or a system information block.
- Segment index. This parameter is only included in the header if the segment type is "Subsequent segment" or "Last segment".

UTRAN may combine one or several segments of variable length in the same SYSTEM INFORMATION message. The following combinations are allowed:

1. No segment;
2. First segment;
3. Subsequent segment;
4. Last segment;

5. Last segment + First segment;
6. Last segment + one or several Complete;
7. Last segment + one or several Complete + First segment;
8. One or several Complete;
9. One or several Complete + First segment;
10. One Complete of size 215 to 226;
11. Last segment of size 215 to 222.

The "No segment" combination is used when there is no master information block, scheduling block or system information block scheduled for a specific BCH transport block.

UEs are not required to support the reception of multiple occurrences of the same system information block type within one SYSTEM INFORMATION message.

NOTE: Since the SIB type is the same for each occurrence of the system information block, the UE does not know the order in which the occurrences, scheduled for this SYSTEM INFORMATION message, appear. Therefore, the UE is unable to determine which scheduling information, e.g., value tag relates to which occurrence of the system information block.

8.1.1.1.4 Re-assembly of segments

The RRC layer in the UE shall perform re-assembly of segments. All segments belonging to the same master information block, scheduling block or system information block shall be assembled in ascending order with respect to the segment index. When all segments of the master information block, scheduling block or a system information block have been received, the UE shall perform decoding of the complete master information block, scheduling block or system information block. For System Information Block types 15.2, 15.3 and 16, which may have multiple occurrences, each occurrence shall be re-assembled independently.

The UE shall discard system information blocks of which segments were missing, of which segments were received out of sequence and/or for which duplicate segments were received. The only valid sequence is an ascending one with the sequence starting with the First Segment of the associated System Information Block.

If the UE receives a Subsequent segment or Last segment where the index in IE "Segment index" is equal to or larger than the number of segments stated in IE "SEG_COUNT" in the scheduling information for that scheduling block or system information block:

- 1> the UE may:
 - 2> read all the segments to create a system information block as defined by the scheduling information read by the UE;
 - 2> store the content of the system information block with a value tag set to the value NULL; and
 - 2> consider the content of the scheduling block or system information block as valid:
 - 3> until it receives the same type of scheduling block or system information block in a position according to its scheduling information; or
 - 3> at most for 6 hours after reception.
- 1> and the UE shall:
 - 2> re-read scheduling information for that scheduling block or system information block.

If the UE receives a Subsequent segment or Last segment where the index in IE "Segment index" is equal to or larger than the number of segments stated in IE "SEG_COUNT" in the First segment, the UE shall

- 1> discard all segments for that master information block, scheduling block or system information block; and
- 1> re-read the scheduling information for that system information block;

1> then re-read all segments for that system information block.

8.1.1.1.5 Scheduling of system information

Scheduling of system information blocks is performed by the RRC layer in UTRAN. If segmentation is used, it should be possible to schedule each segment separately.

To allow the mixing of system information blocks with short repetition period and system information blocks with segmentation over many frames, UTRAN may multiplex segments from different system information blocks. Multiplexing and de-multiplexing is performed by the RRC layer.

The scheduling of each system information block broadcast on a BCH transport channel is defined by the following parameters:

- the number of segments (SEG_COUNT);
- the repetition period (SIB_REP). The same value applies to all segments;
- the position (phase) of the first segment within one cycle of the Cell System Frame Number (SIB_POS(0)). Since system information blocks are repeated with period SIB_REP, the value of SIB_POS(i), $i = 0, 1, 2, \dots, \text{SEG_COUNT}-1$ must be less than SIB_REP for all segments;
- the offset of the subsequent segments in ascending index order (SIB_OFF(i), $i = 1, 2, \dots, \text{SEG_COUNT}-1$). The position of the subsequent segments is calculated using the following: $\text{SIB_POS}(i) = \text{SIB_POS}(i-1) + \text{SIB_OFF}(i)$.

The scheduling is based on the Cell System Frame Number (SFN). The SFN of a frame at which a particular segment, i , with $i = 0, 1, 2, \dots, \text{SEG_COUNT}-1$ of a system information block occurs, fulfils the following relation:

$$\text{SFN mod SIB_REP} = \text{SIB_POS}(i)$$

In FDD and TDD the scheduling of the master information block is fixed as defined in table 8.1.1. For TDD, UTRAN may apply one of the values allowed for the master information block's repetition period. The value that UTRAN is using in TDD is not signalled; UEs have to determine it by trial and error.

8.1.1.2 Initiation

The system information is continuously broadcast on a regular basis in accordance with the scheduling defined for each system information block.

8.1.1.3 Reception of SYSTEM INFORMATION messages by the UE

The UE shall read SYSTEM INFORMATION messages broadcast on a BCH transport channel in idle mode and in the connected mode in states CELL_FACH, CELL_PCH, URA_PCH and CELL_DCH (TDD only).

In idle mode and connected mode different combinations of system information blocks are valid. The UE shall acquire the system information blocks that are needed according to table 8.1.1.

The UE may store system information blocks with *cell*, *PLMN* or *Equivalent PLMN* area scope (including their value tag if applicable) for different cells and different PLMNs, to be used if the UE returns to these cells.

The UE shall consider all stored system information blocks as invalid after it has been switched off. Some information obtained from system information may be stored by the UE or in the USIM for use in a stored information cell selection.

When selecting a new cell the UE shall consider all current system information blocks with area scope cell to be invalid. If the UE has stored valid system information blocks for the newly selected cell, the UE may set those as current system information blocks.

After selecting a new cell and this cell broadcasts an IE "PLMN Identity" in the MIB which is different from the IE "PLMN Identity" broadcast in the MIB in the previously selected cell, the UE shall consider all current system information blocks with area scope *PLMN* to be invalid. If the UE has previously stored valid system information blocks for the selected cell of the new PLMN, the UE may set those as current system information blocks.

When NAS informs AS about a new selected PLMN, the UE shall consider all stored system information blocks with area scope *Equivalent PLMN* to be invalid.

8.1.1.4 Void

8.1.1.5 Actions upon reception of the Master Information Block and Scheduling Block(s)

When selecting a new cell, the UE shall read the master information block. The UE may use the pre-defined scheduling information to locate the master information block in the cell.

Upon reception of the master information block, the UE shall:

1> if the IE "Multiple PLMN List" is not present in the Master Information Block:

2> consider the IE "PLMN identity" in the Master Information Block as the PLMN identity of the cell.

1> else:

2> consider the PLMN identities in the IE "Multiple PLMN List" as the PLMN identities of the cell;

2> when reading the "Multiple PLMN List", read all the PLMN identities in the list as follows:

3> if the IE "MIB PLMN Identity" is set to TRUE:

4> read the "PLMN identity" IE in the MIB and consider it as a part of the "Multiple PLMN List".

3> if the IE "MIB PLMN Identity" is set to FALSE:

4> not consider the "PLMN identity" IE in the MIB as a part of the "Multiple PLMN List";

4> not consider the IE "PLMN identity" in the MIB as a PLMN identity of the cell;

4> not forward the PLMN in the IE "PLMN identity" of the MIB to upper layers.

3> if the MCC is not present when reading a IE "PLMN identity with Optional MCC" in the IE "Multiple PLMN List":

4> set the MCC of this PLMN identity equal to the MCC of the closest preceding "PLMN identity with Optional MCC" in the "Multiple PLMN List" that includes an MCC;

4> or, if no such "PLMN identity with Optional MCC" exists, the UE shall set the MCC of this PLMN identity to the MCC of the "PLMN identity" IE in the Master Information Block irrespective of the value of the IE "MIB PLMN Identity".

1> if the UE is operating in "ANSI-41 mode" and the IE "PLMN Type" has the value "ANSI-41" or "GSM-MAP and ANSI-41":

2> store the ANSI-41 Information elements contained in the master information block and perform initial process for ANSI-41.

1> compare the value tag in the master information block with the value tag stored for this cell and this PLMN in the variable VALUE_TAG;

1> if the value tags differ, or if no IEs for the master information block are stored:

2> store the value tag into the variable VALUE_TAG for the master information block;

2> read and store scheduling information included in the master information block.

1> if the value tags are the same the UE may use stored system information blocks and scheduling blocks using value tag that were stored for this cell and this PLMN as valid system information.

For all system information blocks or scheduling blocks that are supported by the UE referenced in the master information block or the scheduling blocks, the UE shall perform the following actions:

- 1> for all system information blocks with area scope "PLMN" or "Equivalent PLMN" that use value tags:
 - 2> compare the value tag read in scheduling information for that system information block with the value stored within the variable VALUE_TAG for that system information block;
 - 2> if the value tags differ, or if no IEs for the corresponding system information block are stored:
 - 3> store the value tag read in scheduling information for that system information block into the variable VALUE_TAG;
 - 3> read and store the IEs of that system information block.
 - 2> if the value tags are the same the UE may use stored system information blocks using value tag that were stored in this PLMN as valid system information.
- 1> for all system information blocks or scheduling blocks with area scope cell that use value tags:
 - 2> compare the value tag read in scheduling information for that system information block or scheduling block with the value stored within the variable VALUE_TAG for that system information block or scheduling block;
 - 2> if the value tags differ, or if no IEs for the corresponding system information block or scheduling block are stored:
 - 3> store the value tag read in scheduling information for that system information block or scheduling block into the variable VALUE_TAG;
 - 3> read and store the IEs of that system information block or scheduling block.
 - 2> if the value tags are the same the UE may use stored system information blocks using value tags that were stored for this cell and this PLMN as valid system information.
- 1> for system information blocks which may have multiple occurrences:
 - 2> compare the value tag and the configuration or multiple occurrence identity for the occurrence of the system information blocks read in scheduling information with the value tag and configuration or multiple occurrence identity stored within the variable VALUE_TAG:
 - 3> if the value tags differ, or if no IEs from the occurrence with that configuration or multiple occurrence identity of the system information block are stored:
 - 4> store the value tag read in scheduling information for that system information block and the occurrence with that configuration or multiple occurrence identity into the variable VALUE_TAG;
 - 4> read and store the IEs of that system information block.
 - 3> if the value tags and the configuration or multiple occurrence identity are identical to those stored, the UE may use stored occurrences of system information blocks that were stored for this cell and this PLMN as valid system information.

For system information blocks, not supported by the UE, but referenced either in the master information block or in the scheduling blocks, the UE may:

- 1> skip reading this system information block;
- 1> skip monitoring changes to this system information block.

If the UE:

- 1> receives a scheduling block at a position different from its position according to the scheduling information for the scheduling block; or
- 1> receives a scheduling block for which scheduling information has not been received:

the UE may:

- 1> store the content of the scheduling block with a value tag set to the value NULL; and
- 1> consider the content of the scheduling block as valid until it receives the same type of scheduling block in a position according to its scheduling information or at most for 6 hours after reception.

If the UE does not find a scheduling block in a position where it should be according to its scheduling information, but a transport block with correct CRC was found at that position, the UE shall:

- 1> read the scheduling information for this scheduling block.

If the UE does not find the master information block in a position fulfilling:

$$\text{SFN mod } 32 = 0$$

but a transport block with correct CRC was found at that position), the UE shall:

- 1> consider the master information block as not found; and
- 1> consider the cell to be barred according to [4]; and
- 1> consider the barred cell as using the value "allowed" in the IE "Intra-frequency cell re-selection indicator", and the maximum value in the IE " T_{barred} ".

NOTE: This permits a different repetition for the MIB in later versions for FDD. In TDD it allows for a variable SIB_REP in this and future releases.

If the cell is not operating in MBSFN mode (according to Section 8.1.1.6.3) then:

- 1> If system information block type 1 is not scheduled on BCH, and system information block type 13 is not scheduled on BCH, the UE shall:
 - 2> consider the cell to be barred according to [4]; and
 - 2> consider the barred cell as using the value "allowed" in the IE "Intra-frequency cell re-selection indicator", and the maximum value in the IE " T_{barred} ".
- 1> If the UE only supports GSM-MAP but finds a cell that broadcasts System Information Block type 13 but not System Information Block type 1, the UE shall:
 - 2> consider the cell barred.
- 1> system information block type 1 is not scheduled on BCH; and
- 1> the UE is operating in "GSM-MAP mode"; and
- 1> the IE "PLMN type" in the Master Information Block has the value "GSM-MAP" or "GSM-MAP and ANSI-41", the UE shall:
 - 2> indicate to upper layers that no CN system information is available.
- 1> If in idle mode and System Information Block type 3 is not scheduled on BCH, the UE shall:
 - 2> consider the cell to be barred according to [4]; and
 - 2> consider the barred cell as using the value "allowed" in the IE "Intra-frequency cell re-selection indicator", and the maximum value in the IE " T_{barred} ".
- 1> If in connected mode and System Information Block type 3 is not scheduled on BCH, and System Information Block type 4 is not scheduled on BCH, the UE shall:
 - 2> consider the cell to be barred according to [4]; and
 - 2> consider the barred cell as using the value "allowed" in the IE "Intra-frequency cell re-selection indicator", and the maximum value in the IE " T_{barred} ".

- 1> If in idle mode and neither System Information Block type 5 nor type 5bis is scheduled on BCH, or System Information Block type 5 or type 5bis is scheduled but IE "AICH info" (FDD) or IE "PICH info" is not present, the UE shall:
 - 2> consider the cell to be barred according to [4]; and
 - 2> consider the barred cell as using the value "allowed" in the IE "Intra-frequency cell re-selection indicator", and the maximum value in the IE " T_{barred} ".
- 1> If in connected mode and neither System Information Block type 5 nor type 5bis is scheduled on BCH, and System Information Block type 6 is not scheduled on BCH, or any of System Information Block type 5, type 5bis or type 6 is scheduled but IE "AICH info" (FDD) or IE "PICH info" is not present, the UE shall:
 - 2> consider the cell to be barred according to [4]; and
 - 2> consider the barred cell as using the value "allowed" in the IE "Intra-frequency cell re-selection indicator", and the maximum value in the IE " T_{barred} ".
- 1> If System Information Block type 7 is not scheduled on BCH, the UE shall:
 - 2> consider the cell to be barred according to [4]; and
 - 2> consider the barred cell as using the value "allowed" in the IE "Intra-frequency cell re-selection indicator", and the maximum value in the IE " T_{barred} ".
- 1> In 3.84 Mcps TDD and 7.68 Mcps TDD, if System Information Block type 14 is not scheduled on BCH, the UE shall:
 - 2> consider the cell to be barred according to [4]; and
 - 2> consider the barred cell as using the value "allowed" in the IE "Intra-frequency cell re-selection indicator", and the maximum value in the IE " T_{barred} ".

If the cell is operating in MBSFN mode (according to section 8.1.1.6.3) then:

- 1> If neither System Information block type 5 nor System Information Block type 5bis is scheduled on the BCH the UE shall:
 - 2> not consider this MBSFN cluster as candidate during the MBSFN cluster selection and MBSFN cluster re-selection procedures [4]. The UE may choose to not recheck the status of this MBSFN cluster during the time corresponding to the maximum value for T_{barred} .
- 1> If System Information Block type 11 is not scheduled on the BCH the UE shall:
 - 2> not consider this MBSFN cluster as candidate during the MBSFN cluster selection and MBSFN cluster re-selection procedures [4]. The UE may choose to not recheck the status of this MBSFN cluster during the time corresponding to the maximum value for T_{barred} .

If System Information Block type 5 and System Information Block type 5bis are both scheduled on BCH:

- 1> the UE behaviour is unspecified.

8.1.1.6 Actions upon reception of system information blocks

The UE may use the scheduling information included within the master information block and the scheduling blocks to locate each system information block to be acquired. For System Information Block type 15.1bis, 15.2bis, 15.3bis, 15.6, 15.7 and 15.8 the scheduling information shall be used to associate a system information block with a GNSS.

The UE should only expect one occurrence of the scheduling information for a system information block in the master information block and any of the scheduling blocks except for System Information Block type 16, System Information Block type 15.2 and System Information Block type 15.3, which may have multiple occurrences. System Information Blocks 15.1bis, 15.6, 15.7 and 15.8 have one occurrence for each GNSS supported while System Information Blocks 15.2bis and 15.3bis may have multiple occurrences for each GNSS. However, to enable future introduction of new system information blocks, the UE shall also be able to receive system information blocks other than the ones indicated within the scheduling information. The UE may ignore contents of such system information block.

If the UE:

- 1> receives a system information block in a position according to the scheduling information for the system information block; and
- 1> this system information block uses a value tag; or
- 1> this system information block uses a value tag and configuration or multiple occurrence identity:

the UE shall:

- 1> store the content of the system information block together with the value of its value tag or the values of configuration and multiple occurrence identity and the associated value tag in the scheduling information for the system information block; and
- 1> consider the content of the system information block valid until, if used, the value tag in the scheduling information for the system information block is changed or at most for 6 hours after reception.

If the UE:

- 1> receives a system information block in a position according to the scheduling information for the system information block; and
- 1> this system information block does not use a value tag according to the system information block type:

the UE shall:

- 1> store the content of the system information block; and
- 1> start an expiration timer using a value as defined in Table 8.1.1 for that system information block type; and
- 1> consider the content of the system information block valid until, the expiration timer expires.

If the UE:

- 1> receives a system information block at a position different from its position according to the scheduling information for the system information block; or
- 1> receives a system information block for which scheduling information has not been received; and
- 1> this system information block uses a value tag:

the UE may:

- 1> store the content of the system information block with a value tag set to the value NULL; and
- 1> consider the content of the system information block as valid until it receives the same type of system information block in a position according to its scheduling information or at most for 6 hours after reception.

If the UE:

- 1> receives a system information block with multiple occurrences at a position different from its position according to the scheduling information for the system information block; or
- 1> receives a system information block with multiple occurrences for which scheduling information has not been received; and
- 1> this system information block uses a value tag and configuration or multiple occurrence identity:

the UE shall:

- 1> ignore this information.

If the UE does not find a system information block in a position where it should be according to its scheduling information, but a transport block with correct CRC was found at that position, the UE shall read the scheduling information for this system information block.

The UE shall act upon all received information elements as specified in subclause 8.6 unless specified otherwise in the following subclauses.

8.1.1.6.1 System Information Block type 1

The UE should store all relevant IEs included in this system information block if the UE is operating in "GSM-MAP mode" and the IE "PLMN type" in the Master Information Block has the value "GSM-MAP" or "GSM-MAP and ANSI-41". The UE shall also:

- 1> check that the cell, according to information included in IE "CN common GSM-MAP NAS system information", is suitable [4];
- 1> if in connected mode:
 - 2> not forward the content of the IE "CN common GSM-MAP NAS system information" to upper layers.
- 1> if in idle mode:
 - 2> forward the content of the IE "CN common GSM-MAP NAS system information" to upper layers.
- 1> for the IE "CN domain system information list":
 - 2> for each IE "CN domain system information" that is present:
 - 3> check that the cell, according to information included in IE "CN domain specific NAS system information", is suitable [4];
 - 3> if in connected mode:
 - 4> not forward the content of the IE "CN domain specific NAS system information" to upper layers.
 - 3> if in idle mode:
 - 4> forward the content of the IE "CN domain specific NAS system information" and the IE "CN domain identity" to upper layers;
 - 4> use the IE "CN domain specific DRX cycle length coefficient" to calculate frame number for the Paging Occasions as specified in [4];
 - 4> store the value of the IE "CN domain specific DRX cycle length coefficient" for use in connected mode.
 - 2> if an IE "CN domain system information" is not present for a particular CN domain:
 - 3> if in idle mode:
 - 4> indicate to upper layers that no CN system information is available for that CN domain.
- 1> if the UE has not yet entered UTRA RRC connected mode:
 - 2> store the values of the IE "UE Timers and constants in connected mode" in the variable TIMERS_AND_CONSTANTS.
- 1> use the values stored in the variable TIMERS_AND_CONSTANTS for the relevant timers and constants.

8.1.1.6.2 System Information Block type 2

If in connected mode the UE should store all relevant IEs included in this system information block. The UE shall:

- 1> if in state URA_PCH, start to perform URA updates using the information in the IE "URA identity".

If in idle mode, the UE shall not use the values of the IEs in this system information block.

8.1.1.6.3 System Information Block type 3

The UE should store all relevant IEs included in this system information block. The UE shall:

- 1> if in connected mode, and System Information Block 4 is indicated as used in the cell:
 - 2> read and act on information sent in that block.
- 1> if IE "Deferred measurement control UTRAN support" is present:
 - 2> set variable DEFERRED_MEASUREMENT_STATUS to TRUE.
- 1> else:
 - 2> set variable DEFERRED_MEASUREMENT_STATUS to FALSE.

With respect to Domain Specific Access Control, the UE shall:

- 1> if the IE "Multiple PLMN List" is not included in the Master Information Block:
 - 2> apply the domain specific access restrictions as indicated by the IE "Domain Specific Access Restriction Parameters For PLMN Of MIB".
- 1> else:
 - 2> if the PLMN specified by the IE "PLMN Identity" of the Master Information Block is chosen by the UE:
 - 3> apply the domain specific access restrictions as indicated by the IE "Domain Specific Access Restriction Parameters For PLMN Of MIB".
 - 2> else, if N-th (N=1..5) PLMN in the IE "Multiple PLMNs" contained in the IE "Multiple PLMN List" is chosen by the UE:
 - 3> if the IE "Domain Specific Access Restriction List" of the IE "Domain Specific Access Restriction For Shared Network" is indicated:
 - 4> if the IE "Domain Specific Access Restriction Parameters For OperatorN" is indicated:
 - 5> apply the domain specific access restrictions as indicated by the IE "Domain Specific Access Restriction Parameters For OperatorN".
 - 3> else, if the IE "Domain Specific Access Restriction Parameters For All" of the IE "Domain Specific Access Restriction For Shared Network" is indicated:
 - 4> apply the domain specific access restrictions as indicated by the IE "Domain Specific Access Restriction Parameters For All".

The UE shall apply the following handling with respect to any Access Class Barring information:

- 1> if in idle mode:
 - 2> if the IE "Domain Specific Access Restriction Parameters For PLMN Of MIB", the IE "Domain Specific Access Restriction Parameters For OperatorN" or the IE "Domain Specific Access Restriction Parameters For All" to be applied according to the requirements above is included in System Information Block Type 3, the UE shall:
 - 3> act on the IE "Domain Specific Access Class Barred List" if indicated in the IE "CS Domain Specific Access Restriction" when initiating RRC Connection establishment to send an INITIAL DIRECT TRANSFER message to the CS domain, as specified in [4]. If "no restriction" was indicated in restriction status, the UE shall act as if no Access Class is barred in the IE "Domain Specific Access Class Barred List", and ignore the IE "Access Class Barred List" in the IE "Cell Access Restriction";
 - 3> act on the IE "Domain Specific Access Class Barred List" if indicated in the IE "PS Domain Specific Access Restriction" when initiating RRC Connection establishment to send an INITIAL DIRECT TRANSFER message to the PS domain, as specified in [4]. If "no restriction" was indicated in restriction status, the UE shall act as if no Access Class is barred in the IE "Domain Specific Access Class Barred List", and ignore the IE "Access Class Barred List" in the IE "Cell Access Restriction";
 - 3> upon transition to UTRA RRC connected, the UE shall:

- 4> store that Domain Specific Access Restriction Parameters to the variable "DSAC_PARAM" and maintain the variable until it is cleared, the PLMN chosen by the UE is changed or the RRC connection is released;
- 4> act on the stored IE "Domain Specific Access Class Barred List" if indicated in the IE "CS Domain Specific Access Restriction" when initiating an INITIAL DIRECT TRANSFER message to the CS domain, as specified in [4];
- 4> act on the stored IE "Domain Specific Access Class Barred List" if indicated in the IE "PS Domain Specific Access Restriction" when initiating an INITIAL DIRECT TRANSFER message to the PS domain, as specified in [4];

2> else:

- 3> act on the IE "Access Class Barred list" when initiating RRC Connection establishment as specified in [4].

1> if in connected mode:

- 2> else if the IE "Domain Specific Access Restriction Parameters For PLMN Of MIB", the IE "Domain Specific Access Restriction Parameters For OperatorN" or the IE "Domain Specific Access Restriction Parameters For All" to be applied according to the requirements above is included in the System Information Block Type 3:

3> if the variable "DSAC_PARAM" is not set, the UE shall:

- 4> store that Domain Specific Access Restriction Parameters to the variable "DSAC_PARAM" and maintain the variable until it is cleared, the PLMN chosen by the UE is changed or the RRC connection is released;
- 4> act on the stored IE "Domain Specific Access Class Barred List" if indicated in the IE "CS Domain Specific Access Restriction" when initiating an INITIAL DIRECT TRANSFER message to the CS, as specified in [4];
- 4> act on the stored IE "Domain Specific Access Class Barred List" if indicated in the IE "PS Domain Specific Access Restriction" when initiating an INITIAL DIRECT TRANSFER message to the PS domain, as specified in [4].

3> else (the access class barring information is stored) UE shall:

- 4> update the variable "DSAC_PARAM" with that Domain Specific Access Restriction Parameters;
- 4> act on the updated IE "Domain Specific Access Class Barred List" if indicated in the IE "CS Domain Specific Access Restriction" when initiating an INITIAL DIRECT TRANSFER message to the CS domain, as specified in [4];
- 4> act on the updated IE "Domain Specific Access Class Barred List" if indicated in the IE "PS Domain Specific Access Restriction" when initiating an INITIAL DIRECT TRANSFER message to the PS domain, as specified in [4].

2> else:

3> if the variable "DSAC_PARAM" is set, the UE shall:

- 4> clear the variable "DSAC_PARAM";
- 4> act as if no Access Class is barred.

If the IE "MBSFN only service" is set to TRUE the UE shall:

- 1> consider this cell to operate in MBSFN mode;
- 1> for TDD consider that all slots operate in MBSFN mode;
- 1> for FDD and 3.84/7.68 Mcps TDD if the UE capabilities allow the reception of MBSFN in addition to the normal UE operation the UE may receive MBMS services from this cell in accordance with requirements for

selection of a cell providing only MBSFN as specified in [4]. For 1.28 Mcps TDD, if the UE capabilities allow the reception of MBSFN in addition to the normal UE operation the UE may get synchronized to the MBSFN cluster as specified in [4].

8.1.1.6.4 System Information Block type 4

If in connected mode, the UE should store all relevant IEs included in this system information block. The UE shall:

- 1> if in connected mode:
 - 2> read and act on information sent in this block;
 - 2> read the System Information Block Type 3 for any Access Class Barring information and act on that information as described in subclause 8.1.1.6.3.

If in idle mode, the UE shall not use the values of the IEs included in this system information block.

8.1.1.6.5 System Information Block type 5 and 5bis

The UE should store all relevant IEs included in this system information block. The UE shall:

- 1> if the IE "Frequency band indicator" is included and if the frequency band indicated in the IE is not part of the frequency bands supported in the UE radio access capability; or
- 1> if the IE "Frequency band indicator 2" is included and if the frequency band indicated in the IE is not part of the frequency bands supported in the UE radio access capability; or
- 1> if the IE "Frequency band indicator" is included and set to "extension indicator", and the UE does not support any of the frequency bands that can be indicated by the IE "Frequency band indicator 2" (i.e., Band VIII or beyond); or
- 1> if the IE "Frequency band indicator" is not included in System Information Block type 5, the DL frequency is in between 2110MHz-2170MHz, and Band I is not part of the frequency bands supported by the UE in the UE radio access capability, or
- 1> if the IE "Frequency band indicator" is not included in System Information Block type 5, the DL frequency is in between 1805MHz-1880MHz, and Band III is not part of the frequency bands supported by the UE in the UE radio access capability:
 - 2> consider the cell to be barred according to [4]; and
 - 2> consider the barred cell as using the value "not allowed" in the IE "Intra-frequency cell re-selection indicator", and the maximum value in the IE " T_{barred} ".
- 1> if the cell belongs to any frequency band equal to Band IV or greater and neither the IE "Frequency band indicator" nor the IE "Frequency band indicator 2" are included in System Information Block type 5 or in System Information Block type 5bis:
 - 2> the UE behaviour is not specified.
- 1> if in connected mode, and System Information Block type 6 is indicated as used in the cell:
 - 2> read and act on information sent in System Information Block type 6.
- 1> replace the TFS of the RACH with the one stored in the UE if any;
- 1> let the physical channel(s) of type PRACH given by the IE(s) "PRACH info" be the default in uplink for the PRACH if UE is in CELL_FACH state;
- 1> start to receive the physical channel of type AICH using the parameters given by the IE "AICH info" (FDD only) when given allocated PRACH is used;
- 1> if the IE "Additional Dynamic Transport Format Information for CCCH" is included for the selected PRACH:
 - 2> use this transport format for transmission of the CCCH.

1> else:

2> use the first instance of the list of transport formats as in the IE "RACH TFS" for the used RACH received in the IE "PRACH system information list" when using the CCCH.

1> for TDD; or

1> for FDD, if the UE does not support HS-DSCH reception in CELL_FACH state; or

1> if the IE "HS-DSCH common system information" is not included:

2> replace the TFS of the FACH/PCH with the one stored in the UE if any;

2> select a Secondary CCPCH as specified in [4] and in subclause 8.5.19, and start to receive the physical channel of type PICH associated with the PCH carried by the selected Secondary CCPCH using the parameters given by the IE "PICH info" if UE is in Idle mode or in CELL_PCH or URA_PCH state;

2> start to monitor its paging occasions on the selected PICH if UE is in Idle mode or in CELL_PCH or URA_PCH state;

2> start to receive the selected physical channel of type Secondary CCPCH using the parameters given by the IE(s) "Secondary CCPCH info" if UE is in CELL_FACH state;

2> in 3.84 Mcps TDD and 7.68 Mcps TDD:

3> use the IE "TDD open loop power control" as defined in subclause 8.5.7 when allocated PRACH is used.

2> in TDD:

3> if the IE "PDSCH system information" and/or the IE "PUSCH system information" is included:

4> store each of the configurations given there with the associated identity given in the IE "PDSCH Identity" and/or "PUSCH Identity" respectively. For every configuration, for which the IE "SFN Time info" is included, the information shall be stored for the duration given there.

2> take the actions related to the HS_DSCH_RECEPTION_GENERAL variable as described in subclause 8.5.37a.

1> else:

2> if the UE is in Idle mode:

3> if variable HS_DSCH_RECEPTION_OF_CCCH_ENABLED is set to TRUE:

4> start to receive HS-DSCH according to the procedure in subclause 8.5.37.

3> else:

4> replace the TFS of the FACH/PCH with the one stored in the UE if any;

4> select a Secondary CCPCH as specified in [4] and in subclause 8.5.19, and start to receive the physical channel of type PICH associated with the PCH carried by the selected Secondary CCPCH using the parameters given by the IE "PICH info";

4> start to monitor its paging occasions on the selected PICH.

3> take the actions related to the HS_DSCH_RECEPTION_GENERAL variable as described in subclause 8.5.37a.

2> if the UE is in CELL_FACH:

3> if variable H_RNTI is set:

4> start to receive HS-DSCH according to the procedure in subclause 8.5.36.

3> else:

4> if variable HS_DSCH_RECEPTION_OF_CCCH_ENABLED is set to TRUE:

- 5> start to receive HS-DSCH according to the procedure in subclause 8.5.37.
- 2> if the UE is in CELL_PCH or URA_PCH state:
 - 3> for FDD, if the UE supports HS-DSCH reception in CELL_PCH and URA_PCH state; and
 - 3> if IE "HS-DSCH paging system information" is included:
 - 4> if this IE is not currently stored; and
 - 4> if the value of the IE "SRNC identity" in the variable U_RNTI is not equal to the 12 MSBs of the received IE "Cell identity" in System Information Block type 3; and
 - 4> if the UE is in URA_PCH state:
 - 5> initiate the URA update procedure as specified in subclause 8.3.1, using the cause "periodic URA update".
 - 4> start to monitor the paging occasions and PICH monitoring occasions determined according to subclauses 8.6.3.1a, 8.6.3.2 and 8.5.39 and receive PCCH on the HS-DSCH mapped on the HS-PDSCH, or DCCH and DTCH and BCCH on the HS-DSCH mapped on the HS-PDSCH and the associated HS-PDSCH selected by the UE according to the procedure in subclause 8.5.40.
 - 3> else:
 - 4> replace the TFS of the FACH/PCH with the one stored in the UE if any;
 - 4> select a Secondary CCPCH as specified in [4] and in subclause 8.5.19, and start to receive the physical channel of type PICH associated with the PCH carried by the selected Secondary CCPCH using the parameters given by the IE "PICH info";
 - 4> start to monitor its paging occasions on the selected PICH;
 - 4> take the actions related to the HS_DSCH_RECEPTION_GENERAL variable as described in subclause 8.5.37a.

If a UE is a 12 kbps class UE according to [35] and the UE has a lower capability than required to support all transport channel configurations mapped on a specific Secondary CCPCH, the UE shall at a certain time instant still be able to decode those transport channels mapped on this Secondary CCPCH that do match the capability supported by the UE. The UE shall use the TFCI bits for that Secondary CCPCH, to distinguish a transport channel configuration that is supported by the UE from a transport channel configuration that is not supported by the UE.

In particular if the UE is a 12 kbps class UE according to [35] and it does not support the processing requirement at a given point in time for a Secondary CCPCH, it shall still be able to decode the same Secondary CCPCH when the processing requirement is consistent with the UE capability. Or if the UE does not support the number of TFs or the coding of a certain transport channel on a Secondary CCPCH, it shall still be able to decode other transport channels mapped on the same Secondary CCPCH that is consistent with what is supported by the UE.

The UE shall:

- 1> if the IE "Secondary CCPCH system information MBMS" is included:
 - 2> apply the Secondary CCPCH and FACH indicated by the IE "FACH carrying MCCH" for receiving MCCH.
- 1> otherwise, if the IE "Secondary CCPCH system information" includes the IE "MCCH configuration information":
 - 2> apply the Secondary CCPCH and FACH indicated by the IE "MCCH configuration information" for receiving MCCH.
- 1> for TDD, if the IE "TDD MBSFN Information" is included:
 - 2> apply the scrambling codes (as referenced by the "Cell parameters ID") to each timeslot indicated by "TDD MBSFN Information".

8.1.1.6.6 System Information Block type 6

If in connected mode, the UE should store all relevant IEs included in this system information block. The UE shall:

- 1> if the IE "Frequency band indicator" is included:
 - 2> if the frequency band indicated in the IE is not part of the frequency bands supported in the UE radio access capability; or
 - 2> if the IE "Frequency band indicator 2" is included and if the frequency band indicated in the IE is not part of the frequency bands supported in the UE radio access capability; or
 - 2> if the IE "Frequency band indicator" is included and set to "extension indicator", and the UE does not support any of the frequency bands that can be indicated by the IE "Frequency band indicator 2" (i.e., Band VIII or beyond):
 - 3> consider the cell to be barred according to [4]; and
 - 3> consider the barred cell as using the value "not allowed" in the IE "Intra-frequency cell re-selection indicator", and the maximum value in the IE " T_{barred} ".
- 1> replace the TFS of the RACH with the one stored in the UE if any;
- 1> let the physical channel(s) of type PRACH given by the IE(s) "PRACH info" be the default in uplink if UE is in CELL_FACH state. If the IE "PRACH info" is not included, the UE shall read the corresponding IE(s) in System Information Block type 5 or System Information Block type 5bis and use that information to configure the PRACH;
- 1> start to receive the physical channel of type AICH using the parameters given by the IE "AICH info" when associated PRACH is used. If the IE "AICH info" is not included, the UE shall read the corresponding IE in System Information Block type 5 or System Information Block type 5bis and use that information (FDD only);
- 1> if the IE "Additional Dynamic Transport Format Information for CCCH" is included for the selected PRACH:
 - 2> use this transport format for transmission of the CCCH (FDD only).
- 1> else:
 - 2> use the first instance of the list of transport formats as in the IE "RACH TFS" for the used RACH received in the IE "PRACH system information list" when using the CCCH (FDD only).
- 1> for TDD; or
- 1> for FDD, if the UE does not support HS-DSCH reception in CELL_FACH state; or
- 1> if the IE "HS-DSCH common system information" is not included in System Information Block type 5 or System Information Block type 5bis:
 - 2> replace the TFS of the FACH/PCH with the one stored in the UE if any;
 - 2> select a Secondary CCPCH as specified in [4] and in subclause 8.5.19, and start to receive the physical channel of type PICH associated with the PCH carried by the selected Secondary CCPCH using the parameters given by the IE "PICH info" if the UE is in CELL_PCH or URA_PCH state. If the IE "PICH info" is not included, the UE shall read the corresponding IE in System Information Block type 5 or System Information Block type 5bis and use that information;
 - 2> start to monitor its paging occasions on the selected PICH if the UE is in CELL_PCH or URA_PCH state;
 - 2> start to receive the selected physical channel of type Secondary CCPCH using the parameters given by the IE(s) "Secondary CCPCH info" if the UE is in CELL_FACH state. If the IE "Secondary CCPCH info" is not included, the UE shall read the corresponding IE(s) in System Information Block type 5 or System Information Block type 5bis and use that information;
 - 2> in 3.84 Mcps TDD and 7.68 Mcps TDD: use the IE "TDD open loop power control" as defined in subclause 8.5.7;

- 2> in TDD: if the IE "PDSCH system information" and/or the IE "PUSCH system information" is included, store each of the configurations given there with the associated identity given in the IE "PDSCH Identity" and/or "PUSCH Identity" respectively. For every configuration, for which the IE "SFN Time info" is included, the information shall be stored for the duration given there;
 - 2> take the corresponding actions as described in subclause 8.5.37a.
- 1> else:
- 2> if the UE is in CELL_FACH:
 - 3> read and use the IE "HS-DSCH common system information" in System Information Block type 5 or System Information Block type 5bis;
 - 3> if variable H_RNTI is set:
 - 4> start to receive HS-DSCH according to the procedure in subclause 8.5.36.
 - 3> else:
 - 4> if variable HS_DSCH_RECEPTION_OF_CCCH_ENABLED is set to TRUE:
 - 5> start to receive HS-DSCH according to the procedure in subclause 8.5.37.
 - 2> if the UE is in CELL_PCH or URA_PCH state:
 - 3> for FDD, if the UE supports HS-DSCH reception in CELL_PCH and URA_PCH state; and
 - 3> if IE "HS-DSCH paging system information" is included in System Information Block type 5 or System Information Block type 5bis:
 - 4> read and use the IE "HS-DSCH paging system information" in System Information Block type 5 or System Information Block type 5bis;
 - 4> start to monitor the paging occasions and PICH monitoring occasions determined according to subclauses 8.6.3.1a, 8.6.3.2 and 8.5.39 and receive PCCH or DCCH and DTCH according to the procedure in subclause 8.5.40.
 - 3> else:
 - 4> replace the TFS of the FACH/PCH with the one stored in the UE if any;
 - 4> select a Secondary CCPCH as specified in [4] and in subclause 8.5.19, and start to receive the physical channel of type PICH associated with the PCH carried by the selected Secondary CCPCH using the parameters given by the IE "PICH info". If the IE "PICH info" is not included, the UE shall read the corresponding IE in System Information Block type 5 or System Information Block type 5bis and use that information;
 - 4> start to monitor its paging occasions on the selected PICH;
 - 4> take the actions related to the HS_DSCH_RECEPTION_GENERAL variable as described in subclause 8.5.37a.

If in idle mode, the UE shall not use the values of the IEs in this system information block.

If a UE is a 12 kbps class UE according to [35] and the UE has a lower capability than required to support all transport channel configurations mapped on a specific Secondary CCPCH, the UE shall at a certain time instant still be able to decode those transport channels mapped on this Secondary CCPCH that do match the capability supported by the UE. The UE shall use the TFCI bits for that Secondary CCPCH, to distinguish a transport channel configuration that is supported by the UE from a transport channel configuration that is not supported by the UE.

In particular if the UE is a 12 kbps class UE according to [35] and it does not support the processing requirement at a given point in time for a Secondary CCPCH, it shall still be able to decode the same Secondary CCPCH when the processing requirement is consistent with the UE capability. Or if the UE does not support the number of TFs or the coding of a certain transport channel on a Secondary CCPCH, it shall still be able to decode other transport channels mapped on the same Secondary CCPCH that is consistent with what is supported by the UE.

8.1.1.6.7 System Information Block type 7

The UE should store all relevant IEs included in this system information block.

8.1.1.6.8 Void

8.1.1.6.9 Void

8.1.1.6.10 Void

8.1.1.6.11 System Information Block type 11

If the cell is not operating in MBSFN mode according to subclause 8.1.1.6.3 the UE should store all relevant IEs included in this system information block. If the cell is not operating in MBSFN mode according to subclause 8.1.1.6.3 the UE shall:

1> if in idle mode:

2> clear the variable MEASUREMENT_IDENTITY.

1> if IE "FACH measurement occasion info" is included:

2> act as specified in subclause 8.6.7.

1> else:

2> may perform inter-frequency/inter-RAT measurements or inter-frequency/inter-RAT cell re-selection evaluation, if the UE capabilities permit such measurements while simultaneously receiving the S-CCPCH of the serving cell.

1> clear the variable CELL_INFO_LIST;

1> act upon the received IE "Intra-frequency cell info list"/"Inter-frequency cell info list"/"Inter-RAT cell info list" as described in subclause 8.6.7.3;

1> if the IE "Inter-frequency RACH reporting information" is included in the system information block:

2> read the IE and use that information for the inter-frequency measurements as specified in subclause 8.5.23.

1> if in idle mode; or

1> if in connected mode and if System Information Block type 12 is not broadcast in the cell:

2> if no intra-frequency measurement stored in the variable MEASUREMENT_IDENTITY was set up or modified through a MEASUREMENT CONTROL message:

3> if included, store the IE "Intra-frequency reporting quantity" and the IE "Intra-frequency measurement reporting criteria" or "Periodical reporting criteria" in order to activate reporting when state CELL_DCH is entered in the variable MEASUREMENT_IDENTITY. The IE "Cells for measurement" is absent for this measurement. The IE "Measurement Validity" is absent for this measurement after a state transition to CELL_DCH;

1> if in connected mode and if System Information Block type 12 is not broadcast in the cell:

2> read the IE "Traffic volume measurement information";

2> if no traffic volume measurement with the measurement identity indicated in the IE "Traffic volume measurement system information" was set up or modified through a MEASUREMENT CONTROL message:

- 3> update the variable MEASUREMENT_IDENTITY with the measurement information received in that IE.
- 1> if the IE "Cell selection and reselection info" is not included for a new neighbouring cell in the IE "intra-frequency cell info list", the IE "inter-frequency cell info list" or the IE "inter-RAT cell info list" in System Information Block type 11:
 - 2> use the default values specified for the IE "Cell selection and reselection info" for that cell except for the IE "HCS neighbouring cell information".
- 1> if the IE "Use of HCS" is set to "used", indicating that HCS is used, do the following:
 - 2> if IE "HCS neighbouring cell information" is not included for the first new cell in the IE "Intra-frequency cell info list", the IE "Inter-frequency cell info list" or the IE "Inter-RAT cell info list" in System Information Block type 11:
 - 3> use the default values specified for the IE "HCS neighbouring cell information" for that cell.
 - 2> if IE "HCS neighbouring cell information" is not included for any other new cell in the IE "Intra-frequency cell info list", the IE "Inter-frequency cell info list" or the IE "Inter-RAT cell info list" in System Information Block type 11:
 - 3> for that cell use the same parameter values as used for the preceding cell in the same cell info list in System Information Block type 11.
- 1> if the value of the IE "Cell selection and reselection quality measure" is different from the value of the IE "Cell selection and reselection quality measure" obtained from System Information Block type 3 or System Information Block type 4:
 - 2> use the value of the IE from this System Information Block and ignore the value obtained from System Information Block type 3 or System Information Block type 4.
- 1> if in connected mode, and System Information Block type 12 is indicated as used in the cell:
 - 2> read and act on information sent in System Information Block type 12 as indicated in subclause 8.1.1.6.12.

For 1.28 Mcps TDD if the cell is operating in MBSFN only mode according to subclause 8.1.1.6.3 the UE shall:

- 1> store the frequencies and their corresponding "cell parameter ID" indicated in the IE "MBSFN LCR TDD frequency list" included in the IE "MBSFN frequency list".

If the cell is operating in MBSFN mode according to subclause 8.1.1.6.3 the UE may:

- 1> for FDD and 3.84/7.68 Mcps TDD consider the cells indicated in the IE "Intra-frequency cell info list" in the IE "Intra-frequency measurement system information" as candidates for the selection of the MBSFN cluster;
- 1> for 1.28 Mcps TDD consider there exist MBSFN clusters deployed with the frequencies and their corresponding "cell parameter ID" stored.

For 1.28 Mcps TDD if the cell is not operating in MBSFN only mode but associated with one or more MBSFN clusters the UE shall:

- 1> store the frequencies and their corresponding "cell parameter ID" indicated in the IE "MBSFN LCR TDD frequency list" included in the IE "MBSFN frequency list";
- 1> consider there exist MBSFN clusters deployed with the frequencies and their corresponding "cell parameter ID" stored;
- 1> search an MBSFN cluster in MBSFN only mode with its frequency and corresponding "cell parameter ID" for monitoring the MBMS services delivered in dedicated MBSFN frequency layer.

NOTE: The IE "Intra-frequency cell info list" may not include information about all neighbouring MBSFN clusters

8.1.1.6.11a System Information Block type 11bis

The UE should store all relevant IEs included in this system information block. The UE shall:

- 1> after reception of SIB 11 act upon the received IEs "Intra-frequency cell info list", "Inter-frequency cell info list" and "Inter-RAT cell info list" as described in subclause 8.6.7.3;
- 1> if the IE "Cell selection and reselection info" is not included for a new neighbouring cell in the IEs "New Intra-frequency cells", "New Inter-frequency cells" or "New Inter-RAT cells" in System Information Block type 11bis:
 - 2> use the default values specified for the IE "Cell selection and reselection info" for that cell except for the IE "HCS neighbouring cell information".
- 1> if the IE "Use of HCS" is set to "used", indicating that HCS is used, do the following:
 - 2> if IE "HCS neighbouring cell information" is not included for the first new cell in the IEs "New Intra-frequency cells", "New Inter-frequency cells" or "New Inter-RAT cells" in System Information Block type 11bis:
 - 3> use the default values specified for the IE "HCS neighbouring cell information" for that cell.
 - 2> if IE "HCS neighbouring cell information" is not included for any other new cell in the IEs "New Intra-frequency cells", "New Inter-frequency cells" or "New Inter-RAT cells" in System Information Block type 11bis:
 - 3> for that cell use the same parameter values as used for the preceding cell in the same cell info list in System Information Block type 11bis.

8.1.1.6.12 System Information Block type 12

If in connected mode, the UE should store all relevant IEs included in this system information block. The UE shall:

- 1> after reception of System Information Block type 11; and
- 1> after reception of System Information Block type 11bis, if broadcast in the cell:
 - 2> update the variable MEASUREMENT_IDENTITY with the measurement information in the received IEs unless specified otherwise.
- 1> if IE "FACH measurement occasion info" is included:
 - 2> act as specified in subclause 8.6.7.
- 1> else:
 - 2> may perform inter-frequency/inter-RAT measurements or inter-frequency/inter-RAT cell re-selection evaluation, if the UE capabilities permit such measurements while simultaneously receiving the S-CCPCH of the serving cell.
- 1> act upon the received IE "Intra-frequency cell info list"/"Inter-frequency cell info list"/"Inter-RAT cell info list" as described in subclause 8.6.7.3;
- 1> if any of the IEs "Intra-frequency measurement quantity", "Intra-frequency reporting quantity for RACH reporting", "Maximum number of reported cells on RACH" or "Reporting information for state CELL_DCH" are not included in the system information block:
 - 2> read the corresponding IE(s) in system information block type 11 and use that information for the intra-frequency measurement.
- 1> if the IE "Inter-frequency RACH reporting information" is included in this system information block or in System Information Block type 11:
 - 2> if the IE is not included in the system information block, read the corresponding IE(s) in System Information Block type 11;

- 2> use the received information for the inter-frequency measurements as specified in subclause 8.5.23.
- 1> if included in this system information block or in System Information Block type 11:
 - 2> if no intra-frequency measurement in the variable MEASUREMENT_IDENTITY was set up or modified through a MEASUREMENT CONTROL message:
 - 3> store the IE "Intra-frequency reporting quantity" and the IE "Intra-frequency measurement reporting criteria" or "Periodical reporting criteria" in order to activate reporting when state CELL_DCH is entered in the variable MEASUREMENT_IDENTITY. The IE "Cells for measurement" is absent for this measurement. The IE "Measurement Validity" is absent for this measurement after a state transition to CELL_DCH;
- 1> if the IE "Traffic volume measurement system information" is not included in this system information block:
 - 2> read the corresponding IE in System Information Block type 11.
- 1> if the IE "Traffic volume measurement system information" was received either in this system information block or in System Information Block type 11:
 - 2> if no traffic volume measurement with the measurement identity indicated in the IE "Traffic volume measurement system information" was set up or modified through a MEASUREMENT CONTROL message:
 - 3> update the variable MEASUREMENT_IDENTITY with the measurement information received in that IE.
- 1> if in CELL_FACH state:
 - 2> start or continue the traffic volume measurements stored in the variable MEASUREMENT_IDENTITY that are valid in CELL_FACH state.
- 1> if the IE "Cell selection and reselection info" is not included for a new neighbouring cell in the IE "Intra-frequency cell info list", the IE "Inter-frequency cell info list" or the IE "Inter-RAT cell info list" in System Information Block type 12:
 - 2> use the default values specified for the IE "Cell selection and reselection info" for that cell except for the IE "HCS neighbouring cell information".
- 1> if the IE "Use of HCS" is set to "used", indicating that HCS is used, do the following:
 - 2> if IE "HCS neighbouring cell information" is not included for the first new cell in the IE "Intra-frequency cell info list", the IE "Inter-frequency cell info list" or the IE "Inter-RAT cell info list" in System Information Block type 12:
 - 3> use the default values specified for the IE "HCS neighbouring cell information" for that cell.
 - 2> if IE "HCS neighbouring cell information" is not included for any other new cell in the IE "Intra-frequency cell info list", the IE "Inter-frequency cell info list" or the IE "Inter-RAT cell info list" in System Information Block type 12:
 - 3> for that cell use the same parameter values as used for the preceding cell in the same cell info list in System Information Block type 12.
- 1> if the value of the IE "Cell selection and reselection quality measure" is different from the value of the IE "Cell selection and reselection quality measure" obtained from System Information Block type 3 or System Information Block type 4:
 - 2> use the value of the IE from this System Information Block and ignore the value obtained from System Information Block type 3 or System Information Block type 4.

If in idle mode, the UE shall not use the values of the IEs in this system information block.

8.1.1.6.13 System Information Block type 13

If in idle or connected mode, the UE should store all relevant IEs included in this system information block except for the IEs "CN domain specific DRX cycle length coefficient", "UE timers and constants in idle mode" and "Capability update requirement" which shall be stored only in the idle mode case. The UE shall read System Information Block type 13 and the associated System Information Block types 13.1, 13.2, 13.3 and 13.4 only when the UE is operating in "ANSI-41 mode" and the IE "PLMN type" in the Master Information Block has the value "ANSI-41" or "GSM-MAP and ANSI-41". The UE shall also:

- 1> forward the content of the IE "CN domain specific NAS system information" to the non-access stratum entity indicated by the IE "CN domain identity";
- 1> use the IE "CN domain specific DRX cycle length coefficient" to calculate frame number for the Paging Occasions and Page indicator as specified in [4].

Refer to TIA/EIA/IS-2000.5-A for actions on information contained in System Information Block types 13.1, 13.2, 13.3 and 13.4.

8.1.1.6.14 System Information Block type 14

This system information block type is used only in 3.84 Mcps TDD and 7.68 Mcps TDD.

The UE should store all relevant IEs included in this system information block. The UE shall:

- 1> use the IE "UL Timeslot Interference" to calculate PRACH, DPCH and PUSCH transmit power for TDD uplink open loop power control as defined in subclause 8.5.7.

8.1.1.6.15 System Information Block type 15

If the UE is in idle or connected mode, and supports GPS location services it should store all relevant IEs included in this system information block. The UE shall:

- 1> if the IE "GPS Data ciphering info" is included:
 - 1> act as specified in the subclause 8.6.7.19.4.- act upon the received IE "Reference position" as specified in subclause 8.6.7.19.3.8;
 - 1> act upon the received IE "GPS reference time" as specified in subclause 8.6.7.19.3.7;
 - 1> if IE "Satellite information" is included:
 - 2> act upon this list of bad satellites as specified in subclause 8.6.7.19.3.6.

NOTE: For efficiency purposes, the UTRAN should broadcast System Information Block type 15 if it is broadcasting System Information Block type 15.2.

8.1.1.6.15.0 System Information Block type 15bis

If the UE is in idle or connected mode, and supports GANSS location services it should store all relevant IEs included in this system information block. The UE shall:

- 1> act upon the received IE "Reference position" as specified in subclause 8.6.7.19.6.8;
- 1> act upon the received IE "GANSS reference time" as specified in subclause 8.6.7.19.6.7;
- 1> if IE "GANSS ionospheric model" is included:
 - 2> act upon the received IE "GANSS ionospheric model" as specified in subclause 8.6.7.19.6.5.

8.1.1.6.15.1 System Information Block type 15.1

The UE should store all the relevant IEs included in this system information block in variable UE_POSITIONING_GPS_DATA. The UE shall:

1> act on "DGPS information" in the IE "DGPS Corrections" in a similar manner as specified in [13] except that the scale factors for PRC and RRC are different;

1> act upon the received IE "UE Positioning GPS DGPS corrections" as specified in subclause 8.6.7.19.3.3.

In this version of the specification, the UE shall:

1> ignore the following IEs: "Delta PRC2", "Delta RRC2", "Delta PRC3" and "Delta RRC3".

8.1.1.6.15.1a System Information Block type 15.1bis

This SIB has one occurrence for each GANSS supported. To identify the different GANSSs, the scheduling information for System Information Block type 15.1bis is associated with IE "GANSS ID". The UE should store all the relevant IEs included in this system information block in variable UE_POSITIONING_GANSS_DATA. The UE shall:

1> act on "DGANSS information" in the IE "DGANSS Corrections" in a similar manner as specified in [13] except that the scale factors for PRC and RRC are different;

1> act upon the received IE "UE Positioning DGANSS corrections" as specified in subclause 8.6.7.19.6.3.

8.1.1.6.15.2 System Information Block type 15.2

For System Information Block type 15.2 multiple occurrences may be used; one occurrence for one satellite. To identify the different occurrences, the scheduling information for System Information Block type 15.2 includes IE "SIB occurrence identity and value tag". The UE should store all the relevant IEs included in this system information block in variable UE_POSITIONING_GPS_DATA. The UE shall:

1> compare for each occurrence the value tag of the stored occurrence, if any, with the occurrence value tag included in the IE "SIB occurrence identity and value tag" for the occurrence of the System Information Block with the same occurrence identity;

1> in case the UE has no SIB occurrence stored with the same identity or in case the occurrence value tag is different:

2> store the occurrence information together with its identity and value tag for later use.

1> in case an occurrence with the same identity but different value tag was stored:

2> overwrite this one with the new occurrence read via system information for later use.

1> interpret IE "Transmission TOW" as a very coarse estimate of the current time, i.e., the approximate GPS time-of-week when the message is broadcast;

1> interpret IE "SatID" as the satellite ID of the data from which this message was obtained;

1> act upon the received IEs "Sat ID" and "GPS Ephemeris and Clock Corrections Parameter" as specified in subclause 8.6.7.19.3.4.

The IE "Transmission TOW" may be different each time a particular SIB occurrence is transmitted. The UTRAN should not increment the value tag of the SIB occurrence if the IE "Transmission TOW" is the only IE that is changed.

The UE may not need to receive all occurrences before it can use the information from any one occurrence.

8.1.1.6.15.2a System Information Block type 15.2bis

For System Information Block type 15.2bis multiple occurrences may be used; one occurrence for one satellite. To identify for which GANSS the occurrence is related to, the scheduling information for System Information Block type 15.2bis is associated with IE "GANSS ID". To identify the different occurrences within each GANSS, the scheduling information for System Information Block type 15.2bis includes IE "SIB occurrence identity and value tag". The UE should store all the relevant IEs included in this system information block in variable UE_POSITIONING_GANSS_DATA. The UE shall:

1> compare for each occurrence the value tag of the stored occurrence, if any, with the occurrence value tag included in the IE "SIB occurrence identity and value tag" for the occurrence of the System Information Block with the same occurrence identity;

- 1> in case the UE has no SIB occurrence stored with the same identity or in case the occurrence value tag is different:
 - 2> store the occurrence information together with its identity and value tag for later use.
- 1> in case an occurrence with the same identity but different value tag was stored:
 - 2> overwrite this one with the new occurrence read via system information for later use.
- 1> act upon the received IEs "GANSS Navigation Model" as specified in subclause 8.6.7.19.6.4.

The UE may not need to receive all occurrences before it can use the information from any one occurrence.

8.1.1.6.15.3 System Information Block type 15.3

For System Information Block type 15.3 multiple occurrences may be used; one occurrence for each set of satellite data. To identify the different occurrences, the scheduling information for System Information Block type 15.3 includes IE "SIB occurrence identity and value tag". The UE should store all the relevant IEs included in this system information block in variable UE_POSITIONING_GPS_DATA. The UE shall:

- 1> compare for each occurrence the value tag of the stored occurrence, if any, with the occurrence value tag included in the IE "SIB occurrence identity and value tag" for the occurrence of the System Information Block with the same occurrence identity;
- 1> in case the UE has no SIB occurrence stored with the same identity or in case the occurrence value tag is different:
 - 2> store the occurrence information together with its identity and value tag for later use.
- 1> in case an occurrence with the same identity but different value tag was stored:
 - 2> overwrite this one with the new occurrence read via system information for later use.
- 1> interpret IE "Transmission TOW" as a very coarse estimate of the current time, i.e., the approximate GPS time-of-week when the message is broadcast;
- 1> if the IE "GPS Almanac and Satellite Health" is included:
 - 2> interpret IE "SatMask" as the satellites that contain the pages being broadcast in this message;
 - 2> interpret IE "LSB TOW" as the least significant 8 bits of the TOW ([12]);
 - 2> act upon the received IE "GPS Almanac and Satellite Health" as specified in subclause 8.6.7.19.3.2.
- 1> if the IE "GPS ionospheric model" is included:
 - 2> act upon the received IE "GPS ionospheric model" as specified in subclause 8.6.7.19.3.5.
- 1> if the IE "GPS UTC model" is included:
 - 2> act upon the received IE "GPS UTC model" as specified in subclause 8.6.7.19.3.9.

The IE "Transmission TOW" may be different each time a particular SIB occurrence is transmitted. The UTRAN should not increment the value tag of the SIB occurrence if the IE "Transmission TOW" is the only IE that is changed. One SIB occurrence value tag is assigned to the table of subclause 10.2.48.8.18.3.

The UE may not need to receive all occurrences before it can use the information for any one occurrence.

8.1.1.6.15.3a System Information Block type 15.3bis

For System Information Block type 15.3bis multiple occurrences may be used; one occurrence for each set of satellite data. To identify for which GANSS the occurrence is related to, the scheduling information for System Information Block type 15.3bis is associated with IE "GANSS ID". To identify the different occurrences within each GANSS, the scheduling information for System Information Block type 15.3bis includes IE "SIB occurrence identity and value tag". The UE should store all the relevant IEs included in this system information block in variable UE_POSITIONING_GANSS_DATA. The UE shall:

- 1> compare for each occurrence the value tag of the stored occurrence, if any, with the occurrence value tag included in the IE "SIB occurrence identity and value tag" for the occurrence of the System Information Block with the same occurrence identity;
- 1> in case the UE has no SIB occurrence stored with the same identity or in case the occurrence value tag is different:
 - 2> store the occurrence information together with its identity and value tag for later use.
- 1> in case an occurrence with the same identity but different value tag was stored:
 - 2> overwrite this one with the new occurrence read via system information for later use.
- 1> if the IE "GANSS Almanac " is included:
 - 2> act upon the received IE "GANSS Almanac" as specified in subclause 8.6.7.19.7.2.
- 1> if the IE "GANSS time model" is included:
 - 2> act upon the received IE "GANSS time model" as specified in subclause 8.6.7.19.6.9.
- 1> if the IE "GANSS UTC model" is included:
 - 2> act upon the received IE "GANSS UTC model" as specified in subclause 8.6.7.19.6.10.

The UE may not need to receive all occurrences before it can use the information for any one occurrence.

8.1.1.6.15.4 System Information Block type 15.4

If the UE is in idle mode or connected mode, the UE shall:

- 1> if the IE "OTDOA Data ciphering info" is included:
 - 2> act as specified in subclause 8.6.7.19.4.

If the UE is in connected mode, the UE shall:

- 1> act as specified in subclause 8.6.7.19.2.

8.1.1.6.15.5 System Information Block type 15.5

If the UE is in idle or connected mode, the UE shall:

- 1> if the UE supports UE-based OTDOA positioning:
 - 2> act as specified in subclause 8.6.7.19.2a.

8.1.1.6.15.6 System Information Block type 15.6

The UE should store all the relevant IEs included in this system information block in variable UE_POSITIONING_GANSS_DATA. The UE shall:

- 1> use IE "GANSS TOD" as a reference time for the data in IE "GANSS reference measurement information";
- 1> act upon the received IE "GANSS reference measurement information" as specified in subclause 8.6.7.19.6.1.

8.1.1.6.15.7 System Information Block type 15.7

The UE should store all the relevant IEs included in this system information block in variable UE_POSITIONING_GANSS_DATA. The UE shall:

- 1> act upon the received IE "GANSS data bit assistance" as specified in subclause 8.6.7.19.6.11.

8.1.1.6.15.8 System Information Block type 15.8

The UE should store all the relevant IEs included in this system information block in variable UE_POSITIONING_GANSS_DATA. The UE shall:

- 1> if the IE "GANSS Data ciphering info" is included:
 - 2> act as specified in the subclause 8.6.7.19.4.
- 1> if the IE "GANSS real-time integrity" is included:
 - 2> act upon the received IE " GANSS real-time integrity" as specified in subclause 8.6.7.19.6.6.

8.1.1.6.16 System Information Block type 16

If the IE "Uplink DPCH info Pre" is included in the PhyCH Information Elements for a predefined configuration the UE shall:

- 1> for FDD:
 - 2> if the IE "Number of TPC bits" is not included:
 - 3> use 2 TPC bits in the Uplink DPCH.
 - 2> else:
 - 3> if F-DPCH is not configured then the UE behaviour is unspecified.

For System Information Block type 16 multiple occurrences may be used; one occurrence for each predefined configuration. To identify the different predefined configurations, the scheduling information for System Information Block type 16 includes IE "Predefined configuration identity and value tag".

The UE should store all relevant IEs included in this system information block. The UE shall:

- 1> compare for each predefined configuration the value tag of the stored predefined configuration with the preconfiguration value tag included in the IE "Predefined configuration identity and value tag" for the occurrence of the System Information Block with the same predefined configuration identity;
- 1> in case the UE has no predefined configuration stored with the same identity:
 - 2> store the predefined configuration information together with its identity and value tag for later use e.g. during handover to UTRAN.
- 1> in case a predefined configuration with the same identity but different value tag was stored:
 - 2> overwrite this one with the new configuration read via system information for later use e.g. during handover to UTRAN.

The above handling applies regardless of whether the previously stored predefined configuration information has been obtained via UTRA or via another RAT.

The UE is not required to complete reading of all occurrences of System Information Block type 16 before initiating RRC connection establishment.

The UE is not required to store more than maxPredefConfig preconfigurations even in the case of multiple equivalent PLMNs.

8.1.1.6.17 System Information Block type 17

This system information block type is used only for TDD.

If in connected mode, the UE should store all relevant IEs included in this system information block. The UE shall:

- 1> if the IE "PDSCH system information" and/or the IE "PUSCH system information" is included, store each of the configurations given there with the associated identity given in the IE "PDSCH Identity" and/or "PUSCH

Identity" respectively. This information shall become invalid after the time specified by the repetition period (SIB_REP) for this system information block.

If in idle mode, the UE shall not use the values of the IEs in this system information block.

8.1.1.6.18 System Information Block type 18

If the System Information Block type 18 is present, a UE shall obtain knowledge of the PLMN identity of the neighbour cells to be considered for cell reselection, and shall behave as specified in this subclause and in subclause 8.5.14a.

The UE should store all the relevant IEs included in this system information block.

A UE in idle mode shall act according to the following rules:

- 1> if System Information Block type 11bis is scheduled on BCH; and the IE "Idle mode PLMN identities for SIB 11bis" is present:
 - 2> any PLMN list of a given type (IEs "PLMNs of intra-frequency cells list", "PLMNs of inter-frequency cells list", "PLMNs of inter-RAT cell lists") included in the IE "Idle mode PLMN identities for SIB 11bis" is paired with the list of cells of the same type derived from System Information Block type 11 and System Information Block type 11bis.
- 1> else:
 - 2> any PLMN list of a given type (IEs "PLMNs of intra-frequency cells list", "PLMNs of inter-frequency cells list", "PLMNs of inter-RAT cell lists") included in the IE "Idle mode PLMN identities" is paired with the list of cells of the same type derived from System Information Block type 11 and System Information Block type 11bis if scheduled on BCH.
- 1> the PLMN identity located at a given rank in the PLMN list is that of the cell with the same ranking in the paired list of cells, the cells being considered in the increasing order of their associated identities ("Intra-frequency cell id", "Inter-frequency cell id", "Inter-RAT cell id");
- 1> if no identity is indicated for the first PLMN in a list, the UE shall assume that the neighbouring cell broadcasts the same PLMN configuration (i.e. IE "PLMN Identity" and IE "Multiple PLMN List") as the current cell;
- 1> if no identity is indicated for another entry in the list, the UE shall assume that the neighbouring cell broadcasts the same PLMN configuration (i.e. IE "PLMN Identity" and IE "Multiple PLMN List") as the previous cell in the list;
- 1> if the number of identities in a PLMN list exceeds the number of neighbour cells in the paired list (if any), the extra PLMN identities are considered as unnecessary and ignored;
- 1> if the number of identities in a PLMN list (if any) is lower than the number of neighbour cells in the paired list, the missing PLMN identities are replaced by the PLMN configuration for the last cell in the list.

A UE in connected mode shall act in the same manner as a UE in idle mode with the following modifications:

- 1> if System Information Block type 11bis is scheduled on BCH:
 - 2> the PLMN lists to be considered are the ones included, when present, in the IE "Connected mode PLMN identities for SIB 11bis";
 - 2> otherwise, the UE shall use, in place of any missing list, when present, the corresponding one in the IE "Idle mode PLMN identities for SIB 11bis";
 - 2> otherwise, the UE shall use, in place of any missing list, when present, the corresponding one in the IE "Connected mode PLMN identities";
 - 2> otherwise, the UE shall use, in place of any missing list, the corresponding one in the IE "Idle mode PLMN identities".
- 1> else:
 - 2> the PLMN lists to be considered are the ones included, when present, in the IE "Connected mode PLMN identities";

2> otherwise, the UE shall use, in place of any missing list, the corresponding one in the IE "Idle mode PLMN identities".

1> the paired lists of cells are the ones derived from System Information Block type 11, and System Information Block type 11bis if scheduled on BCH, and System Information Block type 12 if present.

8.1.1.7 Modification of system information

For System Information Block type 15.2, 15.3 and 16 that may have multiple occurrences, the UE shall handle each occurrence independently as specified in the previous; that is each occurrence is handled as a separate system information block.

NOTE: It should be noted that for the proper operation of the BCCH Modification Information sent on a PCH or on an HS-DSCH (FDD only), the System Information should not be changed more frequently than can be accommodated by mobile stations operating at the maximum DRX cycle length supported by the UTRAN.

8.1.1.7.1 Modification of system information blocks using a value tag

Upon modifications of system information blocks using value tags, UTRAN should notify the new value tag for the master information block in the IE "BCCH modification info", transmitted in the following way:

- 1> to reach UEs in idle mode, and in CELL_PCH state and URA_PCH state with S-CCPCH assigned, the IE "BCCH modification info" is contained in a PAGING TYPE 1 message transmitted on the PCCH in all paging occasions in the cell;
- 1> to reach UEs in CELL_PCH state and URA_PCH state with HS-DSCH assigned and no dedicated H-RNTI assigned, the IE "BCCH modification info" is contained in a PAGING TYPE 1 message transmitted on the PCCH in all paging occasions in the cell;
- 1> to reach UEs in CELL_FACH state or TDD UEs in CELL_DCH with S-CCPCH assigned, the IE "BCCH modification info" is contained in a SYSTEM INFORMATION CHANGE INDICATION message transmitted on the BCCH mapped on at least one FACH on every Secondary CCPCH in the cell;
- 1> for FDD, to reach UEs in CELL_FACH state with HS-DSCH assigned and in CELL_PCH with HS-DSCH and dedicated H-RNTI assigned, the IE "BCCH modification info" is contained in a SYSTEM INFORMATION CHANGE INDICATION message transmitted on the BCCH mapped on the HS-PDSCH indicated with the first indexed HS-SCCH code by the BCCH specific H-RNTI.

Upon reception of a PAGING TYPE 1 message or a SYSTEM INFORMATION CHANGE INDICATION message containing the IE "BCCH modification info" containing the IE "MIB value tag" but not containing the IE "BCCH modification time", the UE shall perform actions as specified in subclause 8.1.1.7.3.

If the IE "BCCH modification time" is included the UE shall perform actions as specified in subclause 8.1.1.7.2.

8.1.1.7.2 Synchronised modification of system information blocks

For modification of some system information elements, e.g. reconfiguration of the channels, it is important for the UE to know exactly when a change occurs. In such cases, the UTRAN should notify the SFN when the change will occur as well as the new value tag for the master information block in the IE "BCCH modification info" transmitted in the following way:

- 1> To reach UEs in idle mode, CELL_PCH state and URA_PCH state, the IE "BCCH modification info" is contained in a PAGING TYPE 1 message transmitted on the PCCH in all paging occasions in the cell;
- 1> To reach UEs in CELL_FACH state or TDD UEs in CELL_DCH with SCCPCH assigned, the IE "BCCH modification info" is contained in a SYSTEM INFORMATION CHANGE INDICATION message transmitted on the BCCH mapped on at least one FACH on every Secondary CCPCH in the cell;
- 1> for FDD, to reach UEs in CELL_FACH state with HS-DSCH assigned and in CELL_PCH with HS-DSCH and dedicated H-RNTI assigned, the IE "BCCH modification info" is contained in a SYSTEM INFORMATION CHANGE INDICATION message transmitted on the BCCH mapped on the HS-PDSCH indicated with the first indexed HS-SCCH code by the BCCH specific H-RNTI.

Upon reception of a PAGING TYPE 1 message or a SYSTEM INFORMATION CHANGE INDICATION message containing the IE "BCCH modification info" containing the IE "MIB value tag" and containing the IE "BCCH modification time", the UE shall:

- 1> perform the actions as specified in subclause 8.1.1.7.3 at the time, indicated in the IE "BCCH Modification Info".

8.1.1.7.3 Actions upon system information change

The UE shall:

- 1> compare the value of IE "MIB value tag" in the IE "BCCH modification info" with the value tag stored for the master information block in variable VALUE_TAG.
 - 1> if the value tags differ:
 - 2> read the master information block on BCH;
 - 2> if the value tag of the master information block in the system information is the same as the value in IE "MIB value tag" in "BCCH modification info" but different from the value tag stored in the variable VALUE_TAG:
 - 3> perform actions as specified in subclause 8.1.1.5.
 - 2> if the value tag of the master information block in the system information is the same as the value tag stored in the variable VALUE_TAG:
 - 3> for the next occurrence of the master information block:
 - 4> perform actions as specified in subclause 8.1.1.7.3 again.
 - 2> if the value tag of the master information block in the system information is different from the value tag stored in the variable VALUE_TAG, and is different from the value in IE "MIB value tag" in "BCCH modification info":
 - 3> perform actions as specified in subclause 8.1.1.5;
 - 3> if $(VTMIB - VTCI) \bmod 8 < 4$, where VTCI is the value tag in the IE "MIB value tag" in "BCCH modification info" and VTMIB is the value tag of the master information block in the system information:
 - 4> for the next occurrence of the master information block:
 - 5> perform actions as specified in subclause 8.1.1.7.3 again.

8.1.1.7.4 Actions upon expiry of a system information expiry timer

When the expiry timer of a system information block not using a value tag expires

the UE shall:

- 1> consider the content of the system information block invalid;
- 1> re-acquire the system information block again before the content can be used;

In FDD for system information blocks other than System Information Block type 7, or in states other than CELL_FACH, or in TDD for system information blocks other than System Information Block type 14, or in states other than CELL_FACH or CELL_DCH the UE may:

- 1> postpone reading the system information block until the content is needed.

In FDD for System Information Block type 7, while in state CELL_FACH, and in TDD for System Information Block type 14, while in state CELL_FACH or CELL_DCH the UE shall always keep an up to date version of the relevant IEs, unless this is not possible because system information can not be received due to bad radio conditions.

8.1.2 Paging

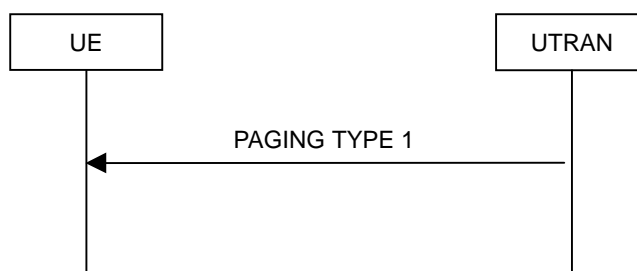

Figure 8.1.2-1: Paging

8.1.2.1 General

This procedure is used to transmit paging information to selected UEs in idle mode, CELL_PCH or URA_PCH state using the paging control channel (PCCH). Upper layers in the network may request paging, to e.g. establish a signalling connection. UTRAN may initiate paging for UEs in CELL_PCH or URA_PCH state to trigger a cell update procedure. In addition, UTRAN may initiate paging for UEs in idle mode, CELL_PCH and URA_PCH state to trigger reading of updated system information. UTRAN may also initiate paging for UEs in CELL_PCH and URA_PCH state to release the RRC connection.

8.1.2.2 Initiation

UTRAN initiates the paging procedure by transmitting a PAGING TYPE 1 message on an appropriate paging occasion on the PCCH.

UTRAN may repeat transmission of a PAGING TYPE 1 message to a UE in several paging occasions to increase the probability of proper reception of a page.

UTRAN may page several UEs in the same paging occasion by including one IE "Paging record" for each UE in the PAGING TYPE 1 message.

For CN originated paging, UTRAN should set the IE "Paging cause" to the cause for paging received from upper layers. If no cause for paging is received from upper layers, UTRAN should set the value "Terminating – cause unknown".

UTRAN may also indicate that system information has been updated, by including the value tag of the master information block in the IE "BCCH modification info" in the PAGING TYPE 1 message. In this case, UTRAN may omit the IEs "Paging record".

8.1.2.3 Reception of a PAGING TYPE 1 message by the UE

A UE in idle mode, CELL_PCH state or URA_PCH state shall receive the paging information for all its monitored paging occasions. For a UE in idle mode, the paging occasions are specified in [4] and depend on the IE "CN domain specific DRX cycle length coefficient", as specified in subclause 8.6.3.1a. For a UE in CELL_PCH state or URA_PCH state, the paging occasions depend also on the IE "UTRAN DRX cycle length coefficient" and the IE "RRC State Indicator", as specified in subclauses 8.6.3.2 and 8.6.3.3 respectively.

When the UE receives a PAGING TYPE 1 message, it shall perform the actions as specified below.

If the UE is in idle mode, for each occurrence of the IE "Paging record" included in the message the UE shall:

- 1> if the IE "Used paging identity" is a CN identity:
 - 2> compare the IE "UE identity" with all of its allocated CN UE identities:
 - 2> if one match is found:
 - 3> indicate reception of paging; and
 - 3> forward the IE "CN domain identity", the IE "UE identity" and the IE "Paging cause" to the upper layers.

1> otherwise:

2> ignore that paging record.

If the UE is in connected mode, for each occurrence of the IE "Paging record" included in the message the UE shall:

1> if the IE "Used paging identity" is a UTRAN single UE identity and if this U-RNTI is the same as the U-RNTI allocated to the UE stored in the UE variable U_RNTI:

2> if the optional IE "CN originated page to connected mode UE" is included:

3> indicate reception of paging; and

3> forward the IE "CN domain identity", the IE "Paging cause" and the IE "Paging record type identifier" to the upper layers.

2> if the IE "Release indicator" in the IE "RRC connection release information" has the value "Release":

3> release all its radio resources;

3> indicate the release of the established signalling connections (as stored in the variable ESTABLISHED_SIGNALLING_CONNECTIONS) and established radio access bearers (as stored in the variable ESTABLISHED_RABS) to the upper layers;

3> clear the variable ESTABLISHED_SIGNALLING_CONNECTIONS;

3> clear the variable ESTABLISHED_RABS;

3> pass the value of the IE "Release cause" received in the IE "Release information" to upper layers;

3> enter idle mode;

3> perform the actions specified in subclause 8.5.2 when entering idle mode;

3> and the procedure ends.

2> otherwise:

3> perform a cell update procedure with cause "paging response" as specified in subclause 8.3.1.2.

2> ignore any other remaining IE "Paging record" that may be present in the message.

1> if the IE "Used paging identity" is a UTRAN group identity and there is a group identity match according to subclause 8.6.3.13:

2> if the IE "Release indicator" in the IE "RRC connection release information" has the value "Release":

3> release all its radio resources;

3> indicate the release of the established signalling connections (as stored in the variable ESTABLISHED_SIGNALLING_CONNECTIONS) and established radio access bearers (as stored in the variable ESTABLISHED_RABS) to the upper layers;

3> clear the variable ESTABLISHED_SIGNALLING_CONNECTIONS;

3> clear the variable ESTABLISHED_RABS;

3> pass the value of the IE "Release cause" received in the IE "Release information" to upper layers;

3> enter idle mode;

3> perform the actions specified in subclause 8.5.2 when entering idle mode;

3> and the procedure ends.

2> otherwise:

3> perform a cell update procedure with cause "paging response" as specified in subclause 8.3.1.2.

2> ignore any other remaining IE "Paging record" that may be present in the message.

1> otherwise:

2> ignore that paging record.

If the IE "BCCH modification info" is included, any UE in idle mode, CELL_PCH or URA_PCH state shall perform the actions as specified in subclause 8.1.1 in addition to any actions caused by the IE "Paging record" occurrences in the message as specified above.

8.1.3 RRC connection establishment

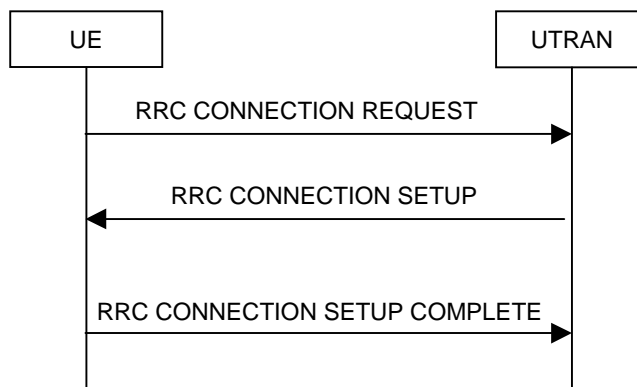

Figure 8.1.3-1: RRC Connection Establishment, network accepts RRC connection

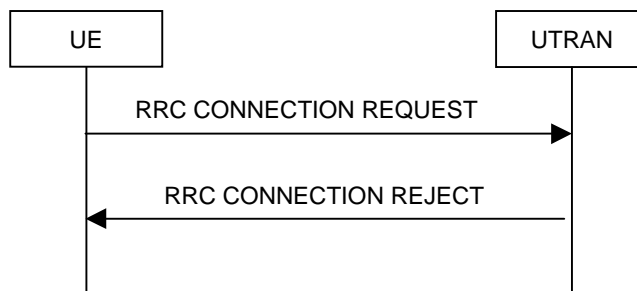

Figure 8.1.3-2: RRC Connection Establishment, network rejects RRC connection

8.1.3.1 General

The purpose of this procedure is to establish an RRC connection.

8.1.3.2 Initiation

The UE shall initiate the procedure when upper layers in the UE requests the establishment of a signalling connection and the UE is in idle mode (no RRC connection exists), as specified in subclause 8.1.8.

Upon initiation of the procedure, the UE shall:

- 1> set the variable `PROTOCOL_ERROR_INDICATOR` to `FALSE`;
- 1> if the USIM is present:
 - 2> set the value of "THRESHOLD" in the variable "START_THRESHOLD" to the 20 MSBs of the value stored in the USIM [50] for the maximum value of START for each CN Domain.
- 1> if the SIM is present:
 - 2> set the value of "THRESHOLD" in the variable "START_THRESHOLD" to the default value in [40] for each CN Domain.

- 1> set the IE "Initial UE identity" in the variable INITIAL_UE_IDENTITY according to subclause 8.5.1;
- 1> set the contents of the RRC CONNECTION REQUEST message according to subclause 8.1.3.3;
- 1> set CFN in relation to SFN of current cell according to subclause 8.5.15;
- 1> perform the mapping of the Access Class to an Access Service Class as specified in subclause 8.5.13, and apply the given Access Service Class when accessing the RACH;
- 1> submit the RRC CONNECTION REQUEST message for transmission on the uplink CCCH;
- 1> set counter V300 to 1; and
- 1> if the variable ESTABLISHMENT_CAUSE is set to "MBMS reception":
 - 2> when the MAC layer indicates success or failure to transmit the message:
 - 3> if the MAC layer indicates failure:
 - 4> enter idle mode;
 - 4> consider the procedure to be unsuccessful;
 - 4> perform other actions when entering idle mode from connected mode as specified in subclause 8.5.2;
 - 4> the procedure ends.
 - 3> else:
 - 4> start timer T318;
 - 4> apply value 0 for counter N300 regardless of the value included in IE "UE Timers and Constants in idle mode".
 - 1> otherwise:
 - 2> start timer T300 when the MAC layer indicates success or failure to transmit the message.
- 1> for TDD; or
- 1> for FDD, if the UE does not support HS-DSCH reception in CELL_FACH state; or
- 1> if the IE "HS-DSCH common system information" is not included in System Information Block type 5 or System Information Block type 5bis:
 - 2> select a Secondary CCPCH according to [4];
 - 2> start receiving all FACH transport channels mapped on the selected Secondary CCPCH.
- 1> otherwise:
 - 2> set variable HS_DSCH_RECEPTION_OF_CCCH_ENABLED to TRUE; and
 - 2> start receiving the HS-DSCH according to the procedure in subclause 8.5.37.

8.1.3.3 RRC CONNECTION REQUEST message contents to set

The UE shall, in the transmitted RRC CONNECTION REQUEST message:

- 1> set the IE "Establishment cause" to the value of the variable ESTABLISHMENT_CAUSE;
- 1> set the IE "Initial UE identity" to the value of the variable INITIAL_UE_IDENTITY;
- 1> set the IE "Protocol error indicator" to the value of the variable PROTOCOL_ERROR_INDICATOR; and
- 1> include the IE "Predefined configuration status information" and set this IE to true if the UE has all pre-configurations stored with the same value tag as broadcast in the cell in which the RRC connection establishment is initiated.

- 1> if the UE is attempting to establish the signalling connection to PS-domain:
 - 2> include the IE "Domain Indicator" and set it to "PS domain".
- 1> else if the UE is attempting to establish the signalling connection to CS domain:
 - 2> include the IE "Domain Indicator" and set it to "CS domain";
 - 2> set the value of the IE "Call type" to "speech", "video" or "other" according to the call being initiated.
- 1> if the UE only supports HS-DSCH but not E-DCH:
 - 2> include the IE "UE capability indication" and set it to the "HS-DSCH" value.
- 1> if the UE supports HS-DSCH and E-DCH:
 - 2> include the IE "UE capability indication" and set it to the "HS-DSCH+E-DCH" value.
- 1> if, according to [4], the High-mobility state is applicable and it has been detected by the UE:
 - 2> include the IE "UE Mobility State Indicator" and set it to the "High-MobilityDetected" value.
- 1> if the UE performs connection establishment for MBMS ptp radio bearer request as specified in subclause 8.6.9.6; and
- 1> if one or more of the MBMS services for which the UE initiates the ptp radio bearer request concerns an MBMS Selected Service:
 - 2> for each MBMS Selected Service that is indicated on MCCH and for which the UE initiates the ptp radio bearer request:
 - 3> order the MBMS Selected Services such that those selected with a higher priority are listed in the IE "MBMS Selected Services Short" before those selected with a lower priority;
 - 3> include the IE "MBMS Selected Service ID" within the IE "MBMS Selected Services Short" and set it to a value in accordance with subclause 8.6.9.8.
- 1> otherwise if the UE performs connection establishment for MBMS counting as specified in subclause 8.7.4; and
- 1> if one or more of the MBMS services for which the UE initiates the counting response concerns an MBMS Selected Service:
 - 2> for each MBMS Selected Service that is indicated on MCCH and for which the UE initiates the counting response:
 - 3> order the MBMS Selected Services such that those selected with a higher priority are listed in the IE "MBMS Selected Services Short" before those selected with a lower priority;
 - 3> include the IE "MBMS Selected Service ID" within the IE "MBMS Selected Services Short" and set it to a value in accordance with subclause 8.6.9.8.
- 1> if the UE included one or more "MBMS Selected Service ID" IEs:
 - 2> include the IE "MBMS Modification Period identity" and set it to a value in accordance with subclause 8.5.29.
- 1> if the UE supports MAC-ehs:
 - 2> include the IE "MAC-ehs support " and set it to TRUE.
- 1> if the UE supports HS-DSCH reception in CELL_FACH state:
 - 2> include the IE "HS-PDSCH in CELL_FACH" and set it to TRUE.

The UE shall not include the IE "UE Specific Behaviour Information 1 idle".

8.1.3.4 Reception of an RRC CONNECTION REQUEST message by the UTRAN

Upon receiving an RRC CONNECTION REQUEST message, UTRAN should either:

- 1> accept the request and use a predefined or default radio configuration, in which case it should:
 - 2> include the following information in the RRC CONNECTION SETUP message:
 - 3> the IE "Predefined configuration identity", to indicate which pre-defined configuration of RB and transport channel parameters shall be used; or
 - 3> the IE "Default configuration mode" and IE "Default configuration identity", to indicate which default configuration of RB and transport channel parameters shall be used;
 - 3> PhyCH information elements.
 - 2> submit the RRC CONNECTION SETUP message to the lower layers for transmission on the downlink CCCH.

NOTE 1: UTRAN should only apply a predefined radio configuration in case it orders the UE to enter CELL_DCH. This is because the predefined configuration information included in System Information Block 16 mandatorily includes information only required in CELL_DCH state.

- 1> accept the request without using a predefined or default radio configuration, in which case it should:
 - 2> include in the RRC CONNECTION SETUP message the complete set of RB, TrCH and PhyCH information elements to be used;
 - 2> submit the RRC CONNECTION SETUP message to the lower layers for transmission on the downlink CCCH;

NOTE 2: In R99, the RRC CONNECTION SETUP message always includes the IEs "Added or Reconfigured TrCH information list", both for uplink and downlink transport channels, even if UTRAN orders the UE to move to CELL_FACH and hence need not configure any transport channels. In these cases, UTRAN may include a configuration that adds little to the encoded message size e.g. a DCH with a single zero size transport format. At a later stage, UTRAN may either remove or reconfigure this configuration.

- 1> submit an RRC CONNECTION REJECT message on the downlink CCCH. In the RRC CONNECTION REJECT message, the UTRAN may direct the UE to another UTRA carrier or to another system. After the RRC CONNECTION REJECT message has been sent, all context information for the UE may be deleted in UTRAN.

8.1.3.5 Cell re-selection, T300 or T318 timeout

- 1> if the UE has not yet received an RRC CONNECTION SETUP message with the value of the IE "Initial UE identity" equal to the value of the variable INITIAL_UE_IDENTITY; and

- 1> if cell re-selection or expiry of timer T300 or timer T318 occurs:

the UE shall:

- 1> check the value of V300; and
 - 2> if V300 is equal to or smaller than N300:
 - 3> if cell re-selection occurred:
 - 4> set CFN in relation to SFN of current cell according to subclause 8.5.15.
 - 4> for FDD, if the UE supports HS-DSCH reception in CELL_FACH state and if IE: "HS-DSCH common system information" is included in System Information Block type 5 or System Information Block type 5bis:
 - 5> if variable HS_DSCH_RECEPTION_OF_CCCH_ENABLED is set to TRUE:
 - 6> reset the MAC-ehs entity [15].

- 5> else:
 - 6> set the variable HS_DSCH_RECEPTION_OF_CCCH_ENABLED to TRUE;
 - 6> start receiving the HS-DSCH according to the procedure in subclause 8.5.37.
- 3> set the IEs in the RRC CONNECTION REQUEST message according to subclause 8.1.3.3;
- 3> perform the mapping of the Access Class to an Access Service Class as specified in subclause 8.5.13; and
- 3> apply the given Access Service Class when accessing the RACH;
- 3> submit a new RRC CONNECTION REQUEST message to lower layers for transmission on the uplink CCCH;
- 3> increment counter V300;
- 3> restart timer T300 when the MAC layer indicates success or failure to transmit the message.
- 2> if V300 is greater than N300:
 - 3> enter idle mode.
 - 3> consider the procedure to be unsuccessful;
 - 3> Other actions the UE shall perform when entering idle mode from connected mode are specified in subclause 8.5.2;
 - 3> the procedure ends.

8.1.3.5a Abortion of RRC connection establishment

If the UE has not yet entered UTRA RRC Connected mode and the RRC connection establishment is to be aborted as specified in subclause 8.1.8, the UE shall:

- 1> consider the procedure to be unsuccessful;
- 1> perform the actions when entering idle mode as specified in subclause 8.5.2.

The procedure ends.

8.1.3.6 Reception of an RRC CONNECTION SETUP message by the UE

The UE shall compare the value of the IE "Initial UE identity" in the received RRC CONNECTION SETUP message with the value of the variable INITIAL_UE_IDENTITY.

If the values are different, the UE shall:

- 1> ignore the rest of the message.

If the values are identical, the UE shall:

- 2> if IE "Specification mode" is set to "Preconfiguration" and IE "Preconfiguration mode" is set to "Predefined configuration":
 - 3> initiate the radio bearer and transport channel configuration in accordance with the predefined parameters identified by the IE "Predefined configuration identity" with the following exception;
 - 4> ignore the IE "RB to setup list" and the IE "Re-establishment timer".

NOTE: IE above IEs are mandatory to include in IE "Predefined RB configuration" that is included in System Information Block 16 but should be ignored since it is not possible to establish a RAB during RRC connection establishment.

- 3> initiate the physical channels in accordance with the received physical channel information elements;

2> if IE "Specification mode" is set to "Preconfiguration" and IE "Preconfiguration mode" is set to "Default configuration":

3> initiate the radio bearer and transport channel configuration in accordance with the default parameters identified by the IE "Default configuration mode" and IE "Default configuration identity" with the following exception:

4> ignore the radio bearers other than signalling radio bearers.

3> initiate the physical channels in accordance with the received physical channel information elements.

NOTE: IE "Default configuration mode" specifies whether the FDD or TDD version of the default configuration shall be used.

2> if IE "Specification mode" is set to "Complete specification":

3> initiate the radio bearer, transport channel and physical channel configuration in accordance with the received radio bearer, transport channel and physical channel information elements.

1> clear the variable ESTABLISHMENT_CAUSE;

1> for FDD, if the HS_DSCH_RECEPTION_OF_CCCH_ENABLED is set to TRUE:

2> set the variable HS_DSCH_RECEPTION_OF_CCCH_ENABLED to FALSE.

1> stop timer T300 or T318, whichever one is running, and act upon all received information elements as specified in subclause 8.6, unless specified otherwise in the following:

2> if the UE, according to subclause 8.6.3.3, will be in the CELL_FACH state at the conclusion of this procedure:

3> if the IE "Frequency info" is included:

4> select a suitable UTRA cell according to [4] on that frequency.

3> enter UTRA RRC connected mode;

3> select PRACH according to subclause 8.5.17;

3> for TDD; or

3> for FDD, if the UE does not support HS-DSCH reception in CELL_FACH state; or

3> if the IE "HS-DSCH common system information" is not included in System Information Block type 5 or System Information Block type 5bis:

4> select Secondary CCPCCH according to subclause 8.5.19;

3> else:

4> set variable HS_DSCH_RECEPTION_OF_CCCH_ENABLED to FALSE;

4> if the RBs have the multiplexing option with transport channel type "HS-DSCH" for the DL and transport channel type "RACH" in the UL; and

4> if "new H-RNTI" and "new C-RNTI" are included:

5> store the "new H-RNTI" according to subclause 8.6.3.1b;

5> store the "new C-RNTI" according to subclause 8.6.3.9;

5> and start to receive HS-DSCH according to the procedure in subclause 8.5.36.

4> else:

5> clear variable C_RNTI and delete any stored C-RNTI value;

5> clear variable H_RNTI and delete any stored H-RNTI value;

- 5> clear any stored IE "HARQ Info";
- 5> set the variable INVALID_CONFIGURATION to TRUE.
- 3> ignore the IE "UTRAN DRX cycle length coefficient" and stop using DRX.
- 1> if the UE, according to subclause 8.6.3.3, will be in the CELL_DCH state at the conclusion of this procedure:
 - 2> perform the physical layer synchronisation procedure A as specified in [29] (FDD only);
 - 2> enter UTRA RRC connected mode;
 - 2> ignore the IE "UTRAN DRX cycle length coefficient" and stop using DRX.
- 1> submit an RRC CONNECTION SETUP COMPLETE message to the lower layers on the uplink DCCH after successful state transition per subclause 8.6.3.3, with the contents set as specified below:
 - 2> set the IE "RRC transaction identifier" to:
 - 3> the value of "RRC transaction identifier" in the entry for the RRC CONNECTION SETUP message in the table "Accepted transactions" in the variable TRANSACTIONS; and
 - 3> clear that entry.
 - 2> if the USIM or SIM is present:
 - 3> set the "START" for each CN domain in the IE "START list" in the RRC CONNECTION SETUP COMPLETE message with the corresponding START value that is stored in the USIM [50] if present, or as stored in the UE if the SIM is present; and then
 - 3> set the START value stored in the USIM [50] if present, and as stored in the UE if the SIM is present for any CN domain to the value "THRESHOLD" of the variable START_THRESHOLD.
 - 2> if neither the USIM nor SIM is present:
 - 3> set the "START" for each CN domain in the IE "START list" in the RRC CONNECTION SETUP COMPLETE message to zero;
 - 3> set the value of "THRESHOLD" in the variable "START_THRESHOLD" to the default value [40].
 - 2> retrieve its UTRA UE radio access capability information elements from variable UE_CAPABILITY_REQUESTED; and then
 - 2> include this in IE "UE radio access capability" and IE "UE radio access capability extension", provided this IE is included in variable UE_CAPABILITY_REQUESTED;
 - 2> retrieve its inter-RAT-specific UE radio access capability information elements from variable UE_CAPABILITY_REQUESTED; and then
 - 2> include this in IE "UE system specific capability";
 - 2> if the variable DEFERRED_MEASUREMENT_STATUS is TRUE:
 - 3> if System Information Block type 11 is scheduled on the BCCH and the UE has not read nor stored the IEs present in this System Information Block, or
 - 3> if System Information Block type 11bis is scheduled on the BCCH and the UE has not read nor stored the IEs present in this System Information Block, or
 - 3> if System Information Block type 12 is scheduled on the BCCH and the UE has not read nor stored the IEs present in this System Information Block:
 - 4> include IE "Deferred measurement control reading".

NOTE: If the "RRC State indicator" is set to the value "CELL_FACH", the UE continues to read and store the IEs in System Information Block type 11, System Information Block type 11bis, and System Information Block type 12, if transmitted, after submitting the RRC Connection Setup Complete message to lower layers (see 8.5.31).

When the RRC CONNECTION SETUP COMPLETE message has been submitted to lower layers for transmission the UE shall:

- 1> if the UE has entered CELL_DCH state:
 - 2> if the IE "Deferred measurement control reading" was included in the RRC CONNECTION SETUP COMPLETE message:
 - 3> clear variable MEASUREMENT_IDENTITY;
 - 3> clear the variable CELL_INFO_LIST.
- 1> if the UE has entered CELL_FACH state:
 - 2> start timer T305 using its initial value if periodical update has been configured by T305 in the IE "UE Timers and constants in connected mode" set to any other value than "infinity" in the variable TIMERS_AND_CONSTANTS.
- 1> store the contents of the variable UE_CAPABILITY_REQUESTED in the variable UE_CAPABILITY_TRANSFERRED;
- 1> initialise variables upon entering UTRA RRC connected mode as specified in subclause 13.4;
- 1> consider the procedure to be successful;

And the procedure ends.

8.1.3.7 Physical channel failure or cell re-selection

- 1> If the UE failed to establish, per subclause 8.5.4, the physical channel(s) indicated in the RRC CONNECTION SETUP message; or
- 1> if the UE performs cell re-selection; or
- 1> if the UE will be in the CELL_FACH state at the conclusion of this procedure; and
- 1> if the received RRC CONNECTION SETUP message included the IE "Frequency info" and the UE could not find a suitable UTRA cell on that frequency but it could find a suitable UTRA cell on another frequency; or
- 1> if the received RRC CONNECTION SETUP message included the IE "Primary CPICH info" (for FDD) or "Primary CCPCH info" (for TDD), and the UE selected another cell than indicated by this IE; or
- 1> if the contents of the variable C_RNTI is empty;
- 1> after having received an RRC CONNECTION SETUP message with the value of the IE "Initial UE identity" equal to the value of the variable INITIAL_UE_IDENTITY; and
- 1> before the RRC CONNECTION SETUP COMPLETE message is delivered to lower layers for transmission:

the UE shall:

- 1> clear the entry for the RRC CONNECTION SETUP message in the table "Accepted transactions" in the variable TRANSACTIONS;
- 1> check the value of V300, and:
 - 2> if V300 is equal to or smaller than N300:
 - 3> set CFN in relation to SFN of current cell according to subclause 8.5.15;
 - 3> set the IEs in the RRC CONNECTION REQUEST message according to subclause 8.1.3.3;

- 3> perform the mapping of the Access Class to an Access Service Class as specified in subclause 8.5.13, and apply the given Access Service Class when accessing the RACH;
 - 3> submit a new RRC CONNECTION REQUEST message to the lower layers for transmission on the uplink CCCH;
 - 3> increment counter V300; and
 - 3> restart timer T300 when the MAC layer indicates success or failure in transmitting the message.
- 2> if V300 is greater than N300:
- 3> enter idle mode;
 - 3> perform the actions specified in subclause 8.5.2 when entering idle mode from connected mode;
 - 3> consider the RRC establishment procedure to be unsuccessful;
 - 3> the procedure ends.

8.1.3.8 Invalid RRC CONNECTION SETUP message, unsupported configuration or invalid configuration

If the UTRAN instructs the UE to use a configuration, which it does not support e.g., the message includes a pre-defined configuration that the UE has not stored and/or if the received message causes the variable UNSUPPORTED_CONFIGURATION or the variable INVALID_CONFIGURATION to be set to TRUE the UE shall perform procedure specific error handling as specified in this subclause.

If the UE receives an RRC CONNECTION SETUP message which contains an IE "Initial UE identity" with a value which is identical to the value of the variable INITIAL_UE_IDENTITY, but the RRC CONNECTION SETUP message contains a protocol error causing the variable PROTOCOL_ERROR_REJECT to be set to TRUE according to clause 9, the UE shall perform procedure specific error handling as follows. The UE shall:

- 1> stop timer T300 or T318, whichever one is running; and
- 1> clear the entry for the RRC CONNECTION SETUP message in the table "Rejected transactions" in the variable TRANSACTIONS and proceed as below.

If the UE receives an RRC CONNECTION SETUP message which contains an IE "Initial UE identity" with a value which is identical to the value of the variable INITIAL_UE_IDENTITY:

- 1> if the RRC CONNECTION SETUP message contained a configuration the UE does not support; and/or
- 1> if the variable UNSUPPORTED_CONFIGURATION becomes set to TRUE due to the received RRC CONNECTION SETUP message; and/or
- 1> if the variable INVALID_CONFIGURATION becomes set to TRUE due to the received RRC CONNECTION SETUP message:

the UE shall:

- 1> stop timer T300 or T318, whichever one is running; and
- 1> clear the entry for the RRC CONNECTION SETUP message in the table "Accepted transactions" in the variable TRANSACTIONS and proceed as below.

If V300 is equal to or smaller than N300, the UE shall:

- 1> set the variable PROTOCOL_ERROR_INDICATOR to TRUE;
- 1> set the IEs in the RRC CONNECTION REQUEST message according to subclause 8.1.3.3;
- 1> perform the mapping of the Access Class to an Access Service Class as specified in subclause 8.5.13; and
- 1> apply the given Access Service Class when accessing the RACH;

- 1> submit a new RRC CONNECTION REQUEST message to the lower layers for transmission on the uplink CCCH;
- 1> increment counter V300; and
- 1> restart timer T300 when the MAC layer indicates success or failure in transmitting the message.

If V300 is greater than N300, the UE shall:

- 1> enter idle mode;
- 1> perform the actions specified in subclause 8.5.2 when entering idle mode from connected mode;
- 1> consider the RRC establishment procedure to be unsuccessful;
- 1> the procedure ends.

8.1.3.9 Reception of an RRC CONNECTION REJECT message by the UE

When the UE receives an RRC CONNECTION REJECT message on the downlink CCCH, it shall compare the value of the IE "Initial UE identity" in the received RRC CONNECTION REJECT message with the value of the variable INITIAL_UE_IDENTITY:

If the values are different, the UE shall ignore the rest of the message;

If the values are identical, the UE shall:

- 1> stop timer T300 or T318, whichever one is running; and
- 1> clear the entry for the RRC CONNECTION REJECT message in the table "Accepted transactions" in the variable TRANSACTIONS;
- 1> if the UE has disabled cell reselection to a UTRA carrier due to an earlier RRC CONNECTION REJECT message, the UE shall resume cell reselection to that UTRA carrier;
- 1> if the Rejection Cause is 'unspecified' and the IE "Counting Completion" is present, the UE shall terminate an ongoing MBMS counting procedure according to subclause 8.7.4.4;
- 1> if the IE "wait time" \neq '0'; and
- 1> if the IE "frequency info" is present and:
 - 2> if V300 is equal to or smaller than N300:
 - 3> select a suitable UTRA cell according to [4] on that frequency;
 - 3> after having selected and camped on a suitable cell on the designated UTRA carrier:
 - 4> set CFN in relation to SFN of current cell according to subclause 8.5.15;
 - 4> set the contents of the RRC CONNECTION REQUEST message according to subclause 8.1.3.3;
 - 4> perform the mapping of the Access Class to an Access Service Class as specified in subclause 8.5.13, and apply the given Access Service Class when accessing the RACH;
 - 4> transmit an RRC CONNECTION REQUEST message on the uplink CCCH;
 - 4> reset counter V300;
 - 4> start timer T300 when the MAC layer indicates success or failure in transmitting the message;
 - 4> disable cell reselection to original UTRA carrier until the time stated in the IE "wait time" has elapsed or until the RRC connection establishment procedure ends, whichever occurs first;

- 3> if no suitable cell on the designated UTRA carrier is found:
 - 4> wait for at least the time stated in the IE "wait time";
 - 4> set CFN in relation to SFN of current cell according to subclause 8.5.15;
 - 4> set the IEs in the RRC CONNECTION REQUEST message according to subclause 8.1.3.3;
 - 4> perform the mapping of the Access Class to an Access Service Class as specified in subclause 8.5.13, and apply the given Access Service Class when accessing the RACH;
 - 4> then submit a new RRC CONNECTION REQUEST message to the lower layers for transmission on the uplink CCCH of the original serving cell;
 - 4> increment counter V300;
 - 4> restart timer T300 when the MAC layer indicates success or failure to transmit the message;
- 2> if V300 is greater than N300:
 - 3> enter idle mode;
 - 3> perform the actions specified in subclause 8.5.2 when entering idle mode from connected mode;
 - 3> consider the RRC establishment procedure to be unsuccessful;
 - 3> the procedure ends.
- 1> if the IE "inter-RAT info" is present:
 - 2> if the IE "wait time" = '0':
 - 3> the UE behaviour is not specified.
 - 2> if V300 is equal to or smaller than N300:
 - 3> if the IE "GSM target cell info" is present:
 - 4> attempt to camp on a suitable cell of the list of cells indicated for that RAT;
 - 4> if the UE selects and camps on one of the cells indicated for that RAT:
 - 5> disable cell reselection to the original RAT until the time stated in the IE "wait time" has elapsed.
 - 4> if the UE cannot find any suitable cell from the indicated ones within 10s, the UE is allowed to camp on any suitable cell on that RAT.
 - 5> after having selected and camped on a suitable cell on the designated RAT:
 - 6> the UE may disable cell reselection to the original RAT until the time stated in the IE "wait time" has elapsed.
 - 3> if the IE "GSM target cell info" is not present:
 - 4> select a suitable cell in the designated RAT;
 - 4> after having selected and camped on a suitable cell on the designated RAT:
 - 5> disable cell reselection to the original RAT until the time stated in the IE "wait time" has elapsed or until the UE successfully establishes a connection on the designated RAT, whichever occurs first.
 - 3> if no suitable cell in the designated RAT is found:
 - 4> wait at least the time stated in the IE "wait time";
 - 4> set CFN in relation to SFN of current cell according to subclause 8.5.15;

- 4> set the IEs in the RRC CONNECTION REQUEST message according to subclause 8.1.3.2.
- 4> perform the mapping of the Access Class to an Access Service Class as specified in subclause 8.5.13, and apply the given Access Service Class when accessing the RACH;
- 4> then submit a new RRC CONNECTION REQUEST message to the lower layers for transmission on the uplink CCCH;
- 4> increment counter V300;
- 4> restart timer T300 when the MAC layer indicates success or failure to transmit the message;
- 2> if V300 is greater than N300:
 - 3> enter idle mode;
 - 3> perform the actions specified in subclause 8.5.2 when entering idle mode from connected mode;
 - 3> consider the RRC establishment procedure to be unsuccessful;
 - 3> the procedure ends.
- 1> if the IE "wait time" <> '0'; and
- 1> if neither the IEs "frequency info" nor "inter-RAT info" are present:
 - 2> if V300 is equal to or smaller than N300:
 - 3> wait at least the time stated in the IE "wait time";
 - 3> set the IEs in the RRC CONNECTION REQUEST message according to subclause 8.1.3.2;
 - 3> perform the mapping of the Access Class to an Access Service Class as specified in subclause 8.5.13, and apply the given Access Service Class when accessing the RACH;
 - 3> submit a new RRC CONNECTION REQUEST message to the lower layers for transmission on the uplink CCCH;
 - 3> increment counter V300;
 - 3> restart timer T300 when the MAC layer indicates success or failure to transmit the message;
 - 2> if V300 is greater than N300:
 - 3> enter idle mode;
 - 3> perform the actions specified in subclause 8.5.2 when entering idle mode from connected mode;
 - 3> consider the RRC establishment procedure to be unsuccessful;
 - 3> the procedure ends.
- 1> if the IE "wait time" = '0':
 - 2> enter idle mode;
 - 2> perform the actions specified in subclause 8.5.2 when entering idle mode from connected mode;
 - 2> consider the RRC establishment procedure to be unsuccessful;
 - 2> the procedure ends.

8.1.3.10 Invalid RRC CONNECTION REJECT message

If the UE receives an RRC CONNECTION REJECT message which contains an IE "Initial UE identity" with a value which is identical to the value of the IE "Initial UE identity" in the most recent RRC CONNECTION REQUEST message sent by the UE; but the RRC CONNECTION REJECT message contains a protocol error causing the variable

PROTOCOL_ERROR_REJECT to be set to TRUE according to clause 9, the UE shall perform procedure specific error handling as follows:

The UE shall:

- 1> stop timer T300 or T318, whichever one is running; and
- 1> clear the entry for the RRC CONNECTION REJECT message in the table "Rejected transactions" in the variable TRANSACTIONS;
- 1> if V300 is equal to or smaller than N300:
 - 2> set the variable PROTOCOL_ERROR_INDICATOR to TRUE;
 - 2> set the IEs in the RRC CONNECTION REQUEST message according to subclause 8.1.3.3;
 - 2> perform the mapping of the Access Class to an Access Service Class as specified in subclause 8.5.13, and apply the given Access Service Class when accessing the RACH;
 - 2> submit a new RRC CONNECTION REQUEST message to the lower layers for transmission on the uplink CCCH;
 - 2> increment counter V300;
 - 2> restart timer T300 when the MAC layer indicates success or failure to transmit the message.
- 1> if V300 is greater than N300:
 - 2> enter idle mode;
 - 2> perform the actions specified in subclause 8.5.2 when entering idle mode from connected mode;
 - 2> consider the procedure to be successful;
 - 2> the procedure ends.

8.1.4 RRC connection release

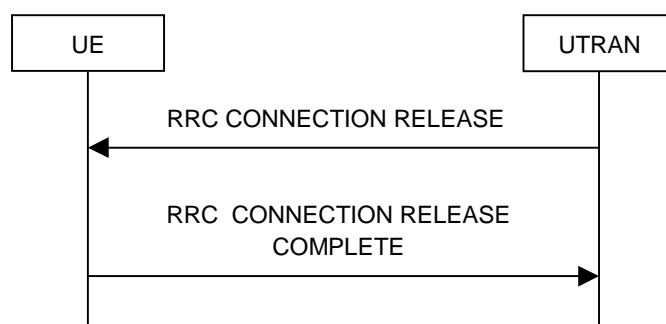

Figure 8.1.4-1: RRC Connection Release procedure on the DCCH



Figure 8.1.4-2: RRC Connection Release procedure on the CCCH

8.1.4.1 General

The purpose of this procedure is to release the RRC connection including all radio bearers and all signalling radio bearers between the UE and the UTRAN. By doing so, all established signalling connections will be released.

8.1.4.2 Initiation

When the UE is in state CELL_DCH or CELL_FACH or CELL_PCH (FDD only), the UTRAN may at anytime initiate an RRC connection release by transmitting an RRC CONNECTION RELEASE message using UM RLC.

When UTRAN transmits an RRC CONNECTION RELEASE message the downlink DCCH should be used, if available. If the downlink DCCH is not available in UTRAN and the UE is in CELL_FACH state, the downlink CCCH may be used.

UTRAN may transmit several RRC CONNECTION RELEASE messages to increase the probability of proper reception of the message by the UE. In such a case, the RRC SN for these repeated messages should be the same. The number of repeated messages and the interval between the messages is a network option.

8.1.4.3 Reception of an RRC CONNECTION RELEASE message by the UE

The UE shall receive and act on an RRC CONNECTION RELEASE message in states CELL_DCH and CELL_FACH and CELL_PCH (FDD only). Furthermore this procedure can interrupt any ongoing procedures with the UE in the above listed states.

When the UE receives the first RRC CONNECTION RELEASE message; and

- 1> if the message is received on the CCCH, and IE "U-RNTI" is present and has the same value as the variable U_RNTI; or
- 1> if the message is received on DCCH:

the UE shall perform the RRC connection release procedure as specified below.

When the UE receives the first RRC CONNECTION RELEASE message; and

- 1> if the message is received on the CCCH, the IE "UTRAN group identity" is present and there is a group identity match according to subclause 8.6.3.13:

the UE shall perform the RRC connection release procedure as specified below.

The UE shall:

- 1> in state CELL_DCH:
 - 2> initialise the counter V308 to zero;
 - 2> set the IE "RRC transaction identifier" in the RRC CONNECTION RELEASE COMPLETE message to the value of "RRC transaction identifier" in the entry for the RRC CONNECTION RELEASE message in the table "Accepted transactions" in the variable TRANSACTIONS;
 - 2> submit an RRC CONNECTION RELEASE COMPLETE message to the lower layers for transmission using UM RLC on the DCCH to the UTRAN;
 - 2> if the IE "Rplmn information" is present:
 - 3> the UE may:
 - 4> store the IE on the ME together with the PLMN id for which it applies;
 - 3> the UE may then:
 - 4> utilise this information, typically indicating where a number of BCCH frequency ranges of a RAT may be expected to be found, during subsequent Rplmn selections of the indicated PLMN.
 - 2> if the IE "UE Mobility State Indicator" is present:

- 3> consider the High-mobility state to have being detected when entering idle mode.
- 2> start timer T308 when the RRC CONNECTION RELEASE COMPLETE message is sent on the radio interface.
- 1> in state CELL_FACH:
 - 2> if the RRC CONNECTION RELEASE message was received on the DCCH:
 - 3> set the IE "RRC transaction identifier" in the RRC CONNECTION RELEASE COMPLETE message to the value of "RRC transaction identifier" in the entry for the RRC CONNECTION RELEASE message in the table "Accepted transactions" in the variable TRANSACTIONS;
 - 3> submit an RRC CONNECTION RELEASE COMPLETE message to the lower layers for transmission using AM RLC on the DCCH to the UTRAN.
 - 3> when the successful transmission of the RRC CONNECTION RELEASE COMPLETE message has been confirmed by the lower layers:
 - 4> release all its radio resources; and
 - 4> indicate the release of the established signalling connections (as stored in the variable ESTABLISHED_SIGNALLING_CONNECTIONS) and established radio access bearers (as stored in the variable ESTABLISHED_RABS) to upper layers; and
 - 4> clear any entry for the RRC CONNECTION RELEASE message in the tables "Accepted transactions" and "Rejected transactions" in the variable TRANSACTIONS;
 - 4> clear the variable ESTABLISHED_SIGNALLING_CONNECTIONS;
 - 4> clear the variable ESTABLISHED_RABS;
 - 4> pass the value of the IE "Release cause" received in the RRC CONNECTION RELEASE message to upper layers;
 - 4> enter idle mode;
 - 4> perform the actions specified in subclause 8.5.2 when entering idle mode.
 - 3> and the procedure ends.
 - 2> if the RRC CONNECTION RELEASE message was received on the CCCH:
 - 3> release all its radio resources;
 - 3> indicate the release of the established signalling connections (as stored in the variable ESTABLISHED_SIGNALLING_CONNECTIONS) and established radio access bearers (as stored in the variable ESTABLISHED_RABS) to the upper layers;
 - 3> clear any entry for the RRC CONNECTION RELEASE message in the tables "Accepted transactions" and "Rejected transactions" in the variable TRANSACTIONS;
 - 3> clear the variable ESTABLISHED_SIGNALLING_CONNECTIONS;
 - 3> clear the variable ESTABLISHED_RABS;
 - 3> pass the value of the IE "Release cause" received in the RRC CONNECTION RELEASE message to upper layers;
 - 3> enter idle mode;
 - 3> perform the actions specified in subclause 8.5.2 when entering idle mode;
 - 3> and the procedure ends.

8.1.4.4 Invalid RRC CONNECTION RELEASE message

If the RRC CONNECTION RELEASE message contains a protocol error causing the variable `PROTOCOL_ERROR_REJECT` to be set to `TRUE` according to clause 9, and if the "protocol error cause" in `PROTOCOL_ERROR_INFORMATION` is set to any cause value except "ASN.1 violation or encoding error", the UE shall perform procedure specific error handling as follows:

The UE shall:

- 1> ignore any IE(s) causing the error but treat the rest of the RRC CONNECTION RELEASE message as normal according to subclause 8.1.4.3, with an addition of the following actions:
 - 2> if the RRC CONNECTION RELEASE message was received on the DCCH:
 - 3> set the IE "RRC transaction identifier" in the RRC CONNECTION RELEASE COMPLETE message to the value of "RRC transaction identifier" in the entry for the RRC CONNECTION RELEASE message in the table "Rejected transactions" in the variable `TRANSACTIONS`;
 - 3> include the IE "Error indication" in the RRC CONNECTION RELEASE COMPLETE message with:
 - 4> the IE "Failure cause" set to the cause value "Protocol error"; and
 - 4> the IE "Protocol error information" set to the value of the variable `PROTOCOL_ERROR_INFORMATION`.

8.1.4.5 Cell re-selection or radio link failure

If the UE performs cell re-selection or the radio link failure criteria in subclause 8.5.6 are met at any time during the RRC connection release procedure and the UE has not yet entered idle mode, the UE shall:

- 1> if cell re-selection occurred (`CELL_FACH` state or `CELL_PCH` (FDD only)):
 - 2> perform a cell update procedure according to subclause 8.3.1 using the cause "Cell reselection".
- 1> if radio link failure occurred (`CELL_DCH` state):
 - 2> release all its radio resources;
 - 2> indicate the release of the established signalling connections (as stored in the variable `ESTABLISHED_SIGNALLING_CONNECTIONS`) and established radio access bearers (as stored in the variable `ESTABLISHED_RABS`) to upper layers;
 - 2> clear the variable `ESTABLISHED_SIGNALLING_CONNECTIONS`;
 - 2> clear the variable `ESTABLISHED_RABS`;
 - 2> enter idle mode;
 - 2> perform the actions specified in subclause 8.5.2 when entering idle mode;
 - 2> and the procedure ends.

8.1.4.6 Expiry of timer T308, unacknowledged mode transmission

When in state `CELL_DCH` and the timer T308 expires, the UE shall:

- 1> increment V308 by one;
- 1> if V308 is equal to or smaller than N308:
 - 2> prior to retransmitting the RRC CONNECTION RELEASE COMPLETE message:
 - 3> if the IE "Status" in the variable `INTEGRITY_PROTECTION_INFO` has the value "Started":
 - 4> include the same IEs as in the last unsuccessful attempt of this message, except for the IE "Integrity check info", which is set as specified in subclause 8.5.10.

- 3> else:
 - 4> include the same IEs as in the last unsuccessful attempt of this message.
 - 2> set the IE "RRC transaction identifier" in the RRC CONNECTION RELEASE COMPLETE message retransmitted below to the value of "RRC transaction identifier" in the entry for the RRC CONNECTION RELEASE message in the table "Accepted transactions" in the variable TRANSACTIONS;
 - 2> send the RRC CONNECTION RELEASE COMPLETE message on signalling radio bearer RB1;
 - 2> start timer T308 when the RRC CONNECTION RELEASE COMPLETE message is sent on the radio interface.
- 1> if V308 is greater than N308:
- 2> release all its radio resources;
 - 2> indicate the release of the established signalling connections (as stored in the variable ESTABLISHED_SIGNALLING_CONNECTIONS) and established radio access bearers (as stored in the variable ESTABLISHED_RABS) to upper layers;
 - 2> clear any entry for the RRC CONNECTION RELEASE message in the tables "Accepted transactions" and "Rejected transactions" in the variable TRANSACTIONS;
 - 2> clear the variable ESTABLISHED_SIGNALLING_CONNECTIONS;
 - 2> clear the variable ESTABLISHED_RABS;
 - 2> enter idle mode;
 - 2> perform the actions specified in subclause 8.5.2 when entering idle mode;
 - 2> and the procedure ends.

8.1.4.7 Void

8.1.4.8 Reception of an RRC CONNECTION RELEASE COMPLETE message by UTRAN

When UTRAN receives an RRC CONNECTION RELEASE COMPLETE message from the UE, it should:

- 1> release all UE dedicated resources and the procedure ends on the UTRAN side.

8.1.4.9 Unsuccessful transmission of the RRC CONNECTION RELEASE COMPLETE message, acknowledged mode transmission

When acknowledged mode was used and RLC does not succeed in transmitting the RRC CONNECTION RELEASE COMPLETE message, the UE shall:

- 1> release all its radio resources;
- 1> indicate the release of the established signalling connections (as stored in the variable ESTABLISHED_SIGNALLING_CONNECTIONS) and established radio access bearers (as stored in the variable ESTABLISHED_RABS) to upper layers;
- 1> clear the variable ESTABLISHED_SIGNALLING_CONNECTIONS;
- 1> clear the variable ESTABLISHED_RABS;
- 1> enter idle mode;
- 1> perform the actions specified in subclause 8.5.2 when entering idle mode;

1> and the procedure ends.

8.1.4.10 Detection of loss of dedicated physical channel by UTRAN in CELL_DCH state

If the release is performed from the state CELL_DCH, and UTRAN detects loss of the dedicated physical channel according to subclause 8.5.6, UTRAN may release all UE dedicated resources, even if no RRC CONNECTION RELEASE COMPLETE message has been received.

8.1.4.11 Failure to receive RRC CONNECTION RELEASE COMPLETE message by UTRAN

If UTRAN does not receive any RRC CONNECTION RELEASE COMPLETE message, it should release all UE dedicated resources.

8.1.4a RRC connection release requested by upper layers

8.1.4a.1 General

The purpose of this procedure is to release the RRC connection and bar the current cell or cells. The procedure is requested by upper layers when they determine that the network has failed an authentication check [5].

8.1.4a.2 Initiation

If the upper layers request the release of the RRC connection, the UE shall:

1> release all its radio resources;

1> enter idle mode;

1> perform other actions when entering idle mode from connected mode as specified in subclause 8.5.2;

1> if the UE was in CELL_DCH state prior to entering idle mode:

2> consider all cells that were in the active set prior to entering idle mode to be barred according to [4]; and

2> consider the barred cells as using the value "allowed" in the IE "Intra-frequency cell re-selection indicator", and the maximum value in the IE " T_{barred} ".

1> if the UE was in CELL_FACH or CELL_PCH or URA_PCH state prior to entering idle mode:

2> consider the cell on which the UE was camped prior to entering idle mode to be barred according to [4]; and

2> consider the barred cell as using the value "allowed" in the IE "Intra-frequency cell re-selection indicator", and the maximum value in the IE " T_{barred} ".

8.1.5 Void

8.1.6 Transmission of UE capability information

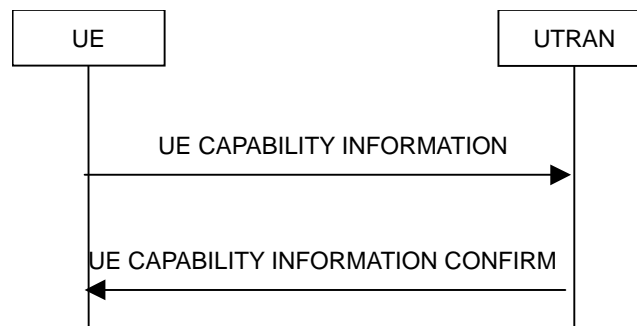

Figure 8.1.6-1: Transmission of UE capability information, normal flow

8.1.6.1 General

The UE capability update procedure is used by the UE to convey UE specific capability information to the UTRAN.

8.1.6.2 Initiation

The UE shall initiate the UE capability update procedure in the following situations:

- 1> the UE receives a UE CAPABILITY ENQUIRY message from the UTRAN;
- 1> while in CELL_DCH or CELL_FACH state, the UE capabilities change compared to those stored in the variable UE_CAPABILITY_TRANSFERRED, and the variable RNC_CAPABILITY_CHANGE_SUPPORT is set to TRUE.

If the UE CAPABILITY INFORMATION message is sent in response to a UE CAPABILITY ENQUIRY message, the UE shall:

- 1> include the IE "RRC transaction identifier"; and
- 1> set it to the value of "RRC transaction identifier" in the entry for the UE CAPABILITY ENQUIRY message in the table "Accepted transactions" in the variable TRANSACTIONS;
- 1> for the UE capabilities defined prior to REL-6:
 - 2> retrieve its UTRA UE radio access capability information elements from variable UE_CAPABILITY_REQUESTED; and
 - 2> include this in IE "UE radio access capability" and in IE "UE radio access capability extension", provided this IE is included in variable UE_CAPABILITY_REQUESTED;
 - 2> retrieve its inter-RAT-specific UE radio access capability information elements from variable UE_CAPABILITY_REQUESTED; and
 - 2> include this in IE "UE system specific capability".
- 1> for the UE capabilities defined in REL-6 or later:
 - 2> include the information elements associated with the capabilities included in the variable UE_CAPABILITY_REQUESTED and the variable UE_CAPABILITY_TRANSFERRED.

If the UE CAPABILITY INFORMATION message is sent because one or more of the UE capabilities change compared to those stored in the variable UE_CAPABILITY_TRANSFERRED while in connected state, the UE shall:

- 1> for the UE capabilities defined prior to REL-6, include the information elements associated with the capabilities that have changed in the UE CAPABILITY INFORMATION message; and
- 1> for the UE capabilities defined in REL-6 or later, include the information elements associated with the capabilities included in the variable UE_CAPABILITY_TRANSFERRED.

If the UE is in CELL_PCH or URA_PCH state, it shall:

- 1> if variable H_RNTI and variable C_RNTI are set:
 - 2> continue as below.
- 1> else:
 - 2> perform a cell update procedure using the cause "uplink data transmission", see subclause 8.3.1.

The UE RRC shall submit the UE CAPABILITY INFORMATION message to the lower layers for transmission on the uplink DCCH using AM RLC. When the message has been delivered to lower layers for transmission the UE RRC shall start timer T304 and set counter V304 to 1.

A UE in connected mode should only indicate changes of capability in the IEs "DL capability with simultaneous HS-DSCH configuration", "Transport channel capability", "Physical channel capability", "Device type", and the IE "UE power class extension" within "RF capability extension".

The UE should not request a changed capability that would render an existing CS configuration invalid.

A UE with HS-PDSCH configured should not request a changed capability that removes support for HSDPA or HSUPA entirely; it may request reduction of its capabilities to the lowest category, but not to "DCH only".

If the UE is MAC-ehs capable, the UE shall signal a value in the "HS-DSCH physical layer category extension" IE.

If the UE signals an "HS-DSCH physical layer category extension" of 13, 15 or 17, it shall signal an "HS-DSCH physical layer category" of 9.

If the UE signals an "HS-DSCH physical layer category extension" of 14, 16 or 18, it shall signal an "HS-DSCH physical layer category" of 10.

The UE shall use the "Total number of soft channel bits" (defined in Table 5.1a of [35]) for the category it has signalled, as follows:

- 1> If MAC-hs is configured, the UE uses the category it has signalled in the IE "HS-DSCH physical layer category";
- 1> If MAC-ehs is configured, the UE uses the category it has signalled in the IE "HS-DSCH physical layer category extension".

8.1.6.3 Reception of a UE CAPABILITY INFORMATION message by the UTRAN

Upon reception of a UE CAPABILITY INFORMATION message, the UTRAN should transmit a UE CAPABILITY INFORMATION CONFIRM message on the downlink DCCH using UM or AM RLC. After the UE CAPABILITY INFORMATION CONFIRM message has been submitted to the lower layers for transmission, the procedure is complete.

If the received UE CAPABILITY INFORMATION message indicates capabilities that would be insufficient for the UE to continue in an ongoing service, the UTRAN may reconfigure the bearers for the ongoing service. In such a case, if the UTRAN does not perform such a reconfiguration, it should set the IE "Acceptance of requested change of capability" to "Refused" in the UE CAPABILITY INFORMATION CONFIRM message.

8.1.6.4 Reception of the UE CAPABILITY INFORMATION CONFIRM message by the UE

Upon reception of a UE CAPABILITY INFORMATION CONFIRM message, the UE shall:

- 1> stop timer T304;
- 1> if there is an entry for the UE CAPABILITY ENQUIRY message is present in the table "Accepted transactions" in the variable TRANSACTIONS:
 - 2> clear that entry.
- 1> if the IE "Acceptance of requested change of capability" is included and set to "Accepted":

- 2> update its variable UE_CAPABILITY_TRANSFERRED with the UE capabilities it has last transmitted to the UTRAN during the current RRC connection.
- 1> if the IE "Acceptance of requested change of capability" is included and set to "Accepted with reconfiguration to follow":
 - 2> when a reconfiguration message with the flag "Reconfiguration in response to requested change of UE capability" set to TRUE, update its variable UE_CAPABILITY_TRANSFERRED with the UE capabilities it has last transmitted to the UTRAN during the current RRC connection;
 - 2> if a reconfiguration message with the flag "Reconfiguration in response to requested change of UE capability" set to TRUE it is not received by the UE within a time determined by the implementation, the UE shall consider the change of capabilities to be refused by the UTRAN.
- 1> if the IE "Acceptance of requested change of capability" is included and set to "Refused":
 - 2> consider the request for a change of capabilities to be refused;
 - 2> wait at least 300 seconds before transmitting another such request.
- 1> clear the variable UE_CAPABILITY_REQUESTED;
- 1> and the procedure ends.

8.1.6.5 Invalid UE CAPABILITY INFORMATION CONFIRM message

If the UE receives a UE CAPABILITY INFORMATION CONFIRM message, which contains a protocol error causing the variable PROTOCOL_ERROR_REJECT to be set to TRUE according to clause 9, the UE shall perform procedure specific error handling as follows:

- 1> stop timer T304;
- 1> transmit an RRC STATUS message on the uplink DCCH using AM RLC;
- 1> include the IE "Identification of received message"; and
- 1> set the IE "Received message type" to UE CAPABILITY INFORMATION CONFIRM; and
- 1> set the IE "RRC transaction identifier" to the value of "RRC transaction identifier" in the entry for the UE CAPABILITY INFORMATION CONFIRM message in the table "Rejected transactions" in the variable TRANSACTIONS; and
- 1> clear that entry;
- 1> include the IE "Protocol error information" with contents set to the value of the variable PROTOCOL_ERROR_INFORMATION;
- 1> when the RRC STATUS message has been submitted to lower layers for transmission:
 - 2> restart timer T304 and continue with any ongoing procedures or processes as if the invalid UE CAPABILITY INFORMATION CONFIRM message has not been received.

8.1.6.6 T304 timeout

Upon expiry of timer T304, the UE shall check the value of V304 and:

- 1> if V304 is smaller than or equal to N304:
 - 2> prior to retransmitting the UE CAPABILITY INFORMATION message:
 - 3> if the IE "Status" in the variable INTEGRITY_PROTECTION_INFO has the value "Started":
 - 4> include the same IEs as in the last unsuccessful attempt of this message, except for the IE "Integrity check info", which is set as specified in subclause 8.5.10.
 - 3> else:

- 4> include the same IEs as in the last unsuccessful attempt of this message.
- 2> send the UE CAPABILITY INFORMATION message on signalling radio bearer RB2;
- 2> restart timer T304;
- 2> increment counter V304.
- 1> if V304 is greater than N304:
 - 2> initiate the Cell update procedure as specified in subclause 8.3.1, using the cause "Radio link failure".

8.1.7 UE capability enquiry

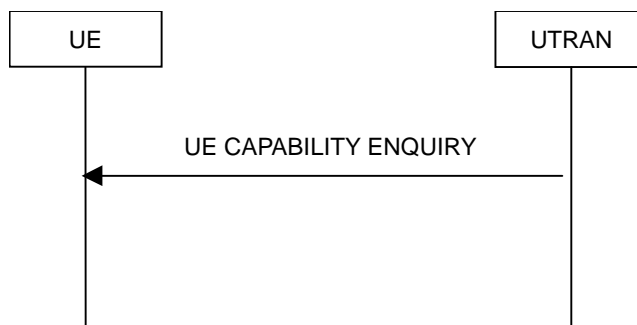

Figure 8.1.7-1: UE capability enquiry procedure, normal flow

8.1.7.1 General

The UE capability enquiry can be used to request the UE to transmit its capability information related to any radio access network that is supported by the UE.

8.1.7.2 Initiation

The UE capability enquiry procedure is initiated by the UTRAN by transmitting a UE CAPABILITY ENQUIRY message on the DCCH using UM or AM RLC.

8.1.7.3 Reception of a UE CAPABILITY ENQUIRY message by the UE

Upon reception of a UE CAPABILITY ENQUIRY message, the UE shall act on the received information elements as specified in subclause 8.6 and initiate the transmission of UE capability information procedure, which is specified in subclause 8.1.6.

8.1.7.4 Invalid UE CAPABILITY ENQUIRY message

If the UE receives a UE CAPABILITY ENQUIRY message, which contains a protocol error causing the variable `PROTOCOL_ERROR_REJECT` to be set to `TRUE` according to clause 9, the UE shall perform procedure specific error handling as follows:

- 1> transmit an RRC STATUS message on the uplink DCCH using AM RLC;
- 1> include the IE "Identification of received message"; and
- 1> set the IE "Received message type" to UE CAPABILITY ENQUIRY; and
- 1> set the IE "RRC transaction identifier" to the value of "RRC transaction identifier" in the entry for the UE CAPABILITY ENQUIRY message in the table "Rejected transactions" in the variable `TRANSACTIONS`; and
- 1> clear that entry;
- 1> include the IE "Protocol error information" with contents set to the value of the variable `PROTOCOL_ERROR_INFORMATION`;

- 1> when the RRC STATUS message has been submitted to lower layers for transmission:
- 2> continue with the ongoing processes and procedures as if the invalid UE CAPABILITY ENQUIRY message has not been received.

8.1.8 Initial Direct transfer

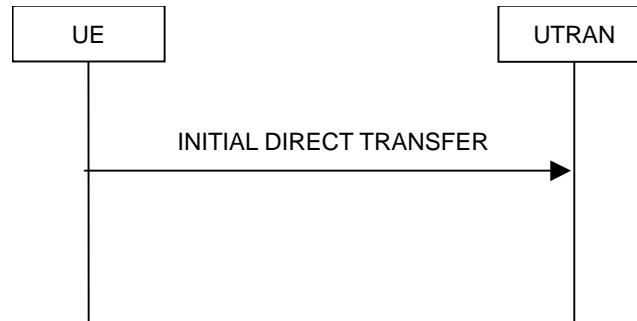

Figure 8.1.8-1: Initial Direct transfer in the uplink, normal flow

8.1.8.1 General

The initial direct transfer procedure is used in the uplink to establish a signalling connection. It is also used to carry an initial upper layer (NAS) message over the radio interface.

8.1.8.2 Initiation of Initial direct transfer procedure in the UE

In the UE, the initial direct transfer procedure shall be initiated, when the upper layers request establishment of a signalling connection. This request also includes a request for the transfer of a NAS message.

Upon initiation of the initial direct transfer procedure the UE shall:

- 1> set the variable ESTABLISHMENT_CAUSE to the cause for establishment indicated by upper layers.

Upon initiation of the initial direct transfer procedure when the UE is in idle mode, the UE shall:

- 1> perform an RRC connection establishment procedure, according to subclause 8.1.3;

NOTE: If an RRC connection establishment is ongoing, this procedure continues unchanged, i.e. it is not interrupted.

- 1> if the RRC connection establishment procedure was not successful:
 - 2> if the establishment cause for the failed RRC connection establishment was set to "MBMS reception" and a different cause value is stored in the variable "ESTABLISHMENT_CAUSE":
 - 3> UE-AS (RRC) initiates a new RRC connection establishment procedure, using the establishment cause as contained in the variable ESTABLISHMENT_CAUSE.
 - 2> otherwise:
 - 3> indicate failure to establish the signalling connection to upper layers and end the procedure.
- 1> when the RRC connection establishment procedure is completed successfully:
 - 2> continue with the initial direct transfer procedure as below.

Upon initiation of the initial direct transfer procedure when the UE is in CELL_PCH or URA_PCH state, the UE shall:

- 1> if variable H_RNTI and variable C_RNTI are set:
 - 2> continue with the initial direct transfer procedure as below.

- 1> else:

- 2> perform a cell update procedure, according to subclause 8.3.1, using the cause "uplink data transmission";
- 2> when the cell update procedure completed successfully:
 - 3> continue with the initial direct transfer procedure as below.

The UE shall, in the INITIAL DIRECT TRANSFER message:

- 1> set the IE "NAS message" as received from upper layers; and
- 1> set the IE "CN domain identity" as indicated by the upper layers; and
- 1> set the IE "Intra Domain NAS Node Selector" as follows:
 - 2> derive the IE "Intra Domain NAS Node Selector" from TMSI/PMTSI, IMSI, or IMEI; and
 - 2> provide the coding of the IE "Intra Domain NAS Node Selector" according to the following priorities:
 - 1. derive the routing parameter for IDNNS from TMSI (CS domain) or PTMSI (PS domain) whenever a valid TMSI/PTMSI is available;
 - 2. base the routing parameter for IDNNS on IMSI when no valid TMSI/PTMSI is available;
 - 3. base the routing parameter for IDNNS on IMEI only if no (U)SIM is inserted in the UE.
- 1> if the UE, on the existing RRC connection, has received a dedicated RRC message containing the IE "Primary PLMN Identity" in the IE "CN Information Info":
 - 2> set the IE "PLMN identity" in the INITIAL DIRECT TRANSFER message to the latest PLMN information received via dedicated RRC signalling. If NAS has indicated the PLMN towards which a signalling connection is requested, and this PLMN is not in agreement with the latest PLMN information received via dedicated RRC signalling, then the initial direct transfer procedure shall be aborted, and NAS shall be informed.
- 1> if the UE, on the existing RRC connection, has not received a dedicated RRC message containing the IE "CN Information Info" , and if the IE "Multiple PLMN List" was broadcast in the cell where the current RRC connection was established:
 - 2> set the IE "PLMN identity" in the INITIAL DIRECT TRANSFER message to the PLMN chosen by higher layers [5, 25] amongst the PLMNs in the IE "Multiple PLMN List" broadcast in the cell where the RRC connection was established.
- 1> if the IE "Activated service list" within variable MBMS_ACTIVATED_SERVICES includes one or more MBMS services with the IE "Service type" set to "Multicast" and;
- 1> if the IE "CN domain identity" as indicated by the upper layers is set to "CS domain" and;
- 1> if the variable ESTABLISHED_SIGNALLING_CONNECTIONS does not include the CN domain identity 'PS domain':
 - 2> include the IE "MBMS joined information";
 - 2> include the IE "P-TMSI" within the IE "MBMS joined information" if a valid PTMSI is available.
- 1> if the UE is in CELL_FACH state and the IE "CN domain identity" as indicated by the upper layers is set to "CS domain":
 - 2> if the value of the variable ESTABLISHMENT_CAUSE is set to "Originating Conversational Call" or "Emergency Call":
 - 3> set the value of the IE "Call type" to "speech", "video" or "other" according to the call being initiated.
- 1> if the variable ESTABLISHMENT_CAUSE is initialised:
 - 2> set the IE "Establishment cause" to the value of the variable ESTABLISHMENT_CAUSE;
 - 2> clear the variable ESTABLISHMENT_CAUSE.

- 1> calculate the START according to subclause 8.5.9 for the CN domain as set in the IE "CN Domain Identity"; and
- 1> include the calculated START value for that CN domain in the IE "START".

The UE shall:

- 1> transmit the INITIAL DIRECT TRANSFER message on the uplink DCCH using AM RLC on signalling radio bearer RB3;
- 1> when the INITIAL DIRECT TRANSFER message has been submitted to lower layers for transmission:
 - 2> confirm the establishment of a signalling connection to upper layers; and
 - 2> add the signalling connection with the identity indicated by the IE "CN domain identity" in the variable ESTABLISHED_SIGNALLING_CONNECTIONS.
- 1> when the successful delivery of the INITIAL DIRECT TRANSFER message has been confirmed by RLC:
 - 2> the procedure ends.

When not stated otherwise elsewhere, the UE may also initiate the initial direct transfer procedure when another procedure is ongoing, and in that case the state of the latter procedure shall not be affected.

A new signalling connection request may be received from upper layers during transition to idle mode. In those cases, from the time of the indication of release to upper layers until the UE has entered idle mode, any such upper layer request to establish a new signalling connection shall be queued. This request shall be processed after the UE has entered idle mode.

8.1.8.2a RLC re-establishment or inter-RAT change

If a re-establishment of the transmitting side of the RLC entity on signalling radio bearer RB3 occurs before the successful delivery of the INITIAL DIRECT TRANSFER message has been confirmed by RLC, the UE shall:

- 1> retransmit the INITIAL DIRECT TRANSFER message on the uplink DCCH using AM RLC on signalling radio bearer RB3.

If an Inter-RAT handover from UTRAN procedure occurs before the successful delivery of the INITIAL DIRECT TRANSFER message has been confirmed by RLC, for messages with the IE "CN domain identity" set to "CS domain", the UE shall:

- 1> retransmit the NAS message as specified in subclause 8.3.7.4.

8.1.8.2ab Inter-RAT handover from UTRAN to GERAN *Iu mode*

If an Inter-RAT handover from UTRAN to GERAN *Iu mode* occurs before the successful delivery of the INITIAL DIRECT TRANSFER message has been confirmed by RLC, for messages for all CN domains, the UE shall:

- 1> retransmit the NAS message as specified in subclause 8.3.7.4.

8.1.8.2b Abortion of signalling connection establishment

If the UE receives a request from upper layers to release (abort) the signalling connection for the CN domain for which the initial direct transfer procedure is ongoing, the UE shall:

- 1> if the UE has not yet entered UTRA RRC connected mode:
 - 2> abort the RRC connection establishment procedure as specified in subclause 8.1.3;

the procedure ends.

8.1.8.3 Reception of INITIAL DIRECT TRANSFER message by the UTRAN

On reception of the INITIAL DIRECT TRANSFER message the NAS message should be routed using the IE "CN Domain Identity". UTRAN may also use the IE "Intra Domain NAS Node Selector" and the IE "PLMN identity" for routing among the CN nodes for the addressed CN domain.

If no signalling connection exists towards the chosen node, then a signalling connection is established.

When the UTRAN receives an INITIAL DIRECT TRANSFER message, it shall not affect the state of any other ongoing RRC procedures, when not stated otherwise elsewhere.

The UTRAN should:

- 1> set the START value for the CN domain indicated in the IE "CN domain identity" to the value of the IE "START".

8.1.9 Downlink Direct transfer



Figure 8.1.9-1: Downlink Direct transfer, normal flow

8.1.9.1 General

The downlink direct transfer procedure is used in the downlink direction to carry upper layer (NAS) messages over the radio interface.

8.1.9.2 Initiation of downlink direct transfer procedure in the UTRAN

In the UTRAN, the direct transfer procedure is initiated when the upper layers request the transfer of a NAS message after the initial signalling connection is established. The UTRAN may also initiate the downlink direct transfer procedure when another RRC procedure is ongoing, and in that case the state of the latter procedure shall not be affected. The UTRAN shall transmit the DOWNLINK DIRECT TRANSFER message on the downlink DCCH using AM RLC on signalling radio bearer RB3 or signalling radio bearer RB4. The UTRAN should:

- 1> if upper layers indicate "low priority" for this message:
 - 2> select signalling radio bearer RB4, if available. Specifically, for a GSM-MAP based CN, signalling radio bearer RB4 should, if available, be selected when "SAPI 3" is requested;
 - 2> select signalling radio bearer RB3 when signalling radio bearer RB4 is not available.
- 1> if upper layers indicate "high priority" for this message:
 - 2> select signalling radio bearer RB3. Specifically, for a GSM-MAP based CN, signalling radio bearer RB3 should be selected when "SAPI 0" is requested.

The UTRAN sets the IE "CN Domain Identity" to indicate, which CN domain the NAS message is originated from.

8.1.9.3 Reception of a DOWNLINK DIRECT TRANSFER message by the UE

Upon reception of the DOWNLINK DIRECT TRANSFER message, the UE RRC shall, using the IE "CN Domain Identity", route the contents of the IE "NAS message" and the value of the IE "CN Domain Identity" to upper layers.

The UE shall clear the entry for the DOWNLINK DIRECT TRANSFER message in the table "Accepted transactions" in the variable TRANSACTIONS.

When the UE receives a DOWNLINK DIRECT TRANSFER message, it shall not affect the state of any other ongoing RRC procedures when not stated otherwise elsewhere.

8.1.9.3a No signalling connection exists

If the UE receives a DOWNLINK DIRECT TRANSFER message, and the signalling connection identified with the IE "CN domain identity" does not exist according to the variable ESTABLISHED_SIGNALLING_CONNECTIONS, the UE shall:

- 1> ignore the content of the DOWNLINK DIRECT TRANSFER message;
- 1> transmit an RRC STATUS message on the uplink DCCH using AM RLC;
- 1> include the IE "Identification of received message"; and
- 1> set the IE "Received message type" to DOWNLINK DIRECT TRANSFER; and
- 1> set the IE "RRC transaction identifier" to the value of "RRC transaction identifier" in the entry for the DOWNLINK DIRECT TRANSFER message in the table "Accepted transactions" in the variable TRANSACTIONS; and
- 1> clear that entry;
- 1> include the IE "Protocol error information" with the IE "Protocol error cause" set to "Message not compatible with receiver state".

When the RRC STATUS message has been submitted to lower layers for transmission, the UE shall:

- 1> continue with any ongoing processes and procedures as if the DOWNLINK DIRECT TRANSFER message has not been received.

8.1.9.4 Invalid DOWNLINK DIRECT TRANSFER message

If the UE receives a DOWNLINK DIRECT TRANSFER message, which contains a protocol error causing the variable PROTOCOL_ERROR_REJECT to be set to TRUE according to clause 9, the UE shall perform procedure specific error handling as follows:

- 1> transmit an RRC STATUS message on the uplink DCCH using AM RLC;
- 1> include the IE "Identification of received message"; and
- 1> set the IE "Received message type" to DOWNLINK DIRECT TRANSFER; and
- 1> set the IE "RRC transaction identifier" to the value of "RRC transaction identifier" in the entry for the DOWNLINK DIRECT TRANSFER message in the table "Rejected transactions" in the variable TRANSACTIONS; and
- 1> clear that entry;
- 1> include the IE "Protocol error information" with contents set to the value of the variable PROTOCOL_ERROR_INFORMATION.

When the RRC STATUS message has been submitted to lower layers for transmission, the UE shall:

- 1> continue with any ongoing processes and procedures as if the invalid DOWNLINK DIRECT TRANSFER message has not been received.

8.1.10 Uplink Direct transfer

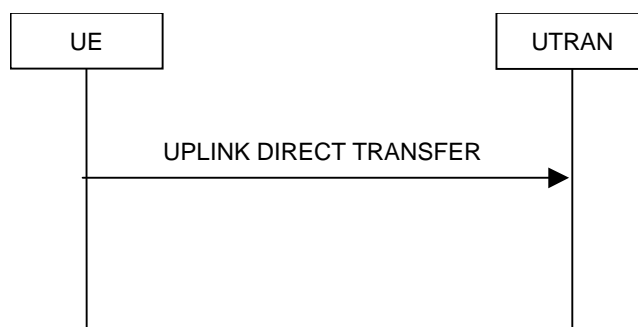

Figure 8.1.10-1: Uplink Direct transfer, normal flow

8.1.10.1 General

The uplink direct transfer procedure is used in the uplink direction to carry all subsequent upper layer (NAS) messages over the radio interface belonging to a signalling connection.

8.1.10.2 Initiation of uplink direct transfer procedure in the UE

In the UE, the uplink direct transfer procedure shall be initiated when the upper layers request a transfer of a NAS message on an existing signalling connection. When not stated otherwise elsewhere, the UE may initiate the uplink direct transfer procedure when another procedure is ongoing, and in that case the state of the latter procedure shall not be affected.

Upon initiation of the uplink direct transfer procedure in CELL_PCH or URA_PCH state, the UE shall:

- 1> if variable H_RNTI and variable C_RNTI are set:
 - 2> continue with the uplink direct transfer procedure as below.
- 1> else:
 - 2> perform a cell update procedure, according to subclause 8.3.1, using the cause "uplink data transmission";
 - 2> when the cell update procedure has been completed successfully:
 - 3> continue with the uplink direct transfer procedure as below.

The UE shall transmit the UPLINK DIRECT TRANSFER message on the uplink DCCH using AM RLC on signalling radio bearer RB3 or signalling radio bearer RB4. The UE shall:

- 1> if upper layers indicate "low priority" for this message:
 - 2> select signalling radio bearer RB4, if available. Specifically, for a GSM-MAP based CN, signalling radio bearer RB4 shall, if available, be selected when "SAPI 3" is requested;
 - 2> select signalling radio bearer RB3 when signalling radio bearer RB4 is not available;
- 1> if upper layers indicate "high priority" for this message:
 - 2> select signalling radio bearer RB3. Specifically, for a GSM-MAP based CN, signalling radio bearer RB3 shall be selected when "SAPI 0" is requested.

The UE shall set the IE "NAS message" as received from upper layers and set the IE "CN domain identity" as indicated by the upper layers.

When the successful delivery of the UPLINK DIRECT TRANSFER message has been confirmed by RLC the procedure ends.

8.1.10.2a RLC re-establishment or inter-RAT change

If signalling radio bearer RB *n* (where *n* equals to 3 or 4) was used when transmitting the UPLINK DIRECT TRANSFER message and a re-establishment of the transmitting side of the RLC entity on the same signalling radio bearer RB *n* occurs before the successful delivery of the UPLINK DIRECT TRANSFER message has been confirmed by RLC, the UE shall:

- 1> retransmit the UPLINK DIRECT TRANSFER message on the uplink DCCH using AM RLC on signalling radio bearer RB *n*.

If an Inter-RAT handover from UTRAN procedure occurs before the successful delivery of the UPLINK DIRECT TRANSFER message has been confirmed by RLC, for messages with the IE "CN domain identity" set to "CS domain", the UE shall:

- 1> retransmit the NAS message as specified in subclause 8.3.7.4.

8.1.10.2b Inter-RAT handover from UTRAN to GERAN *Iu mode*

If an Inter-RAT handover from UTRAN to GERAN *Iu mode* occurs before the successful delivery of the UPLINK DIRECT TRANSFER message has been confirmed by RLC, for messages for all CN domains, the UE shall:

- 1> retransmit the NAS message as specified in subclause 8.3.7.4.

8.1.10.3 Reception of UPLINK DIRECT TRANSFER message by the UTRAN

On reception of the UPLINK DIRECT TRANSFER message the NAS message should be routed using the value indicated in the IE "CN domain identity".

When the UTRAN receives an UPLINK DIRECT TRANSFER message, it shall not affect the state of any other ongoing RRC procedures, when not stated otherwise elsewhere.

8.1.11 UE dedicated paging

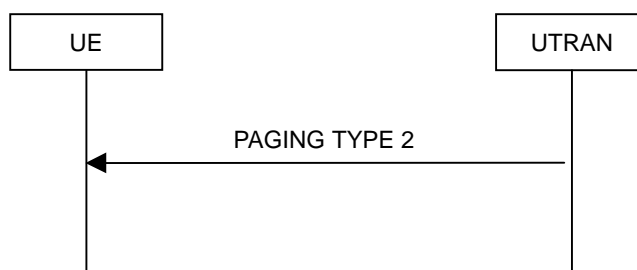

Figure 8.1.11-1: UE dedicated paging

8.1.11.1 General

This procedure is used to transmit dedicated paging information to one UE in connected mode in CELL_DCH, CELL_FACH or CELL_PCH (FDD only) state. Upper layers in the network may request initiation of paging.

8.1.11.2 Initiation

For a UE in CELL_DCH, CELL_FACH or CELL_PCH (FDD only) state, UTRAN initiates the procedure by transmitting a PAGING TYPE 2 message on the DCCH using AM RLC. When not stated otherwise elsewhere, the UTRAN may initiate the UE dedicated paging procedure also when another RRC procedure is ongoing, and in that case the state of the latter procedure shall not be affected.

UTRAN should set the IE "Paging cause" to the cause for paging received from upper layers. If no cause for paging is received from upper layers, UTRAN should set the value "Terminating – cause unknown".

8.1.11.3 Reception of a PAGING TYPE 2 message by the UE

When the UE receives a PAGING TYPE 2 message, it shall not affect the state of any other ongoing RRC procedures, when not stated otherwise elsewhere.

The UE shall:

- 1> indicate reception of paging; and
- 1> forward the IE "Paging cause" and the IE "Paging record type identifier" to upper layers.

The UE shall:

- 1> clear the entry for the PAGING TYPE 2 message in the table "Accepted transactions" in the variable TRANSACTIONS.

8.1.11.4 Invalid PAGING TYPE 2 message

If the UE receives a PAGING TYPE 2 message, which contains a protocol error causing the variable `PROTOCOL_ERROR_REJECT` to be set to `TRUE` according to clause 9, the UE shall perform procedure specific error handling as follows:

- 1> transmit an RRC STATUS message on the uplink DCCH using AM RLC;
- 1> include the IE "Identification of received message"; and
- 1> set the IE "Received message type" to PAGING TYPE 2; and
- 1> set the IE "RRC transaction identifier" to the value of "RRC transaction identifier" in the entry for the PAGING TYPE 2 message in the table "Rejected transactions" in the variable TRANSACTIONS; and
- 1> clear that entry;
- 1> include the IE "Protocol error information" with contents set to the value of the variable `PROTOCOL_ERROR_INFORMATION`;
- 1> when the RRC STATUS message has been submitted to lower layers for transmission:
 - 2> continue with any ongoing processes and procedures as if the invalid PAGING TYPE 2 message has not been received.

8.1.12 Security mode control

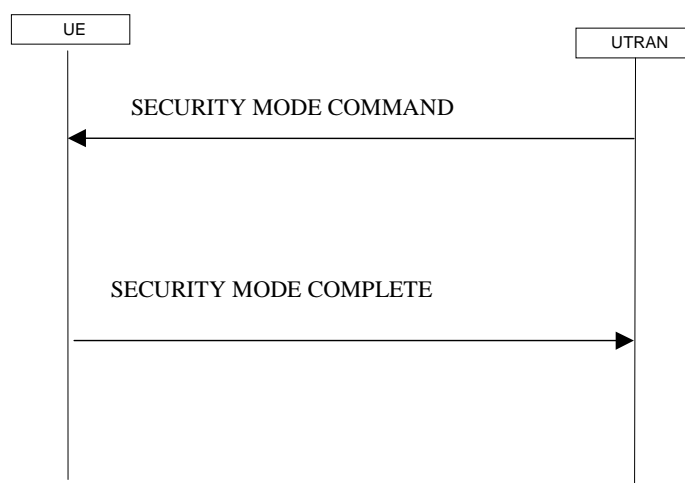

Figure 8.1.12-1: Security mode control procedure

8.1.12.1 General

The purpose of this procedure is to trigger the start of ciphering or to command the restart of the ciphering with a new ciphering configuration, for the radio bearers of one CN domain and for all signalling radio bearers.

It is also used to start integrity protection or to modify the integrity protection configuration for all signalling radio bearers.

8.1.12.2 Initiation

8.1.12.2.1 Ciphering configuration change

To start/restart ciphering, UTRAN sends a SECURITY MODE COMMAND message on the downlink DCCH in AM RLC using the most recent ciphering configuration. If no such ciphering configuration exists then the SECURITY MODE COMMAND is not ciphered. UTRAN should not transmit a SECURITY MODE COMMAND to signal a change in ciphering algorithm.

When configuring ciphering, UTRAN should ensure that the UE needs to store at most two different ciphering configurations (keyset and algorithm) per CN domain, in total over all radio bearers at any given time. For signalling radio bearers the total number of ciphering configurations that need to be stored is at most three. Prior to sending the SECURITY MODE COMMAND, for the CN domain indicated in the IE "CN domain identity" in the SECURITY MODE COMMAND, UTRAN should:

- 1> suspend all radio bearers using RLC-AM or RLC-UM and all signalling radio bearers using RLC-AM or RLC-UM, except the signalling radio bearer used to send the SECURITY MODE COMMAND message on the downlink DCCH in RLC-AM, and except signalling radio bearer RB0, according to the following:
 - 2> not transmit RLC PDUs with sequence number greater than or equal to the number in IE "Radio bearer downlink ciphering activation time info" on all suspended radio bearers and all suspended signalling radio bearers.
- 1> set, for the signalling radio bearer used to send the SECURITY MODE COMMAND, the "RLC sequence number" in IE "Radio bearer downlink ciphering activation time info" in the IE "Ciphering mode info", at which time the new ciphering configuration shall be applied;

NOTE: The UTRAN should avoid the situation that the UE is aware of more than one pending downlink ciphering activation times for SRB2. In such a case the UE behaviour is unspecified.

- 1> if a transparent mode radio bearer for this CN domain exists:
 - 2> include the IE "Ciphering activation time for DPCH" in IE "Ciphering mode info", at which time the new ciphering configuration shall be applied and specify a CFN value for this IE that is a multiple of 8 frames ($CFN \bmod 8 = 0$).

NOTE: UTRAN should chose the value for the IE "Ciphering activation time for DPCH" such that the new ciphering configuration will occur after all the pending ciphering activation times have been reached for the transparent mode radio bearers of this CN domain.

- 1> consider a ciphering activation time in downlink to be pending until the RLC sequence number of the next RLC PDU to be transmitted for the first time is equal to or larger than the selected activation time;
- 1> set, for each suspended radio bearer and signalling radio bearer that has no pending ciphering activation time set by a previous security mode control procedure, an "RLC sequence number" in IE "Radio bearer downlink ciphering activation time info" in the IE "Ciphering mode info", at which time the new ciphering configuration shall be applied;
- 1> set, for each suspended radio bearer and signalling radio bearer that has a pending ciphering activation time set by a previous security mode control procedure, the "RLC sequence number" in IE "Radio bearer downlink ciphering activation time info" in the IE "Ciphering mode info" to the value used in the previous security mode control procedure, at which time the latest ciphering configuration shall be applied;

- 1> if Integrity protection has already been started for the UE:

- 2> if for the CN domain indicated in the IE "CN domain identity" in the SECURITY MODE COMMAND, a new security key set (new ciphering and integrity protection keys) has been received from upper layers since the transmission of the last SECURITY MODE COMMAND message for that CN domain:
 - 3> include the IE "Integrity protection mode info" in the SECURITY MODE COMMAND.
- 2> if the IE "CN domain identity" in the SECURITY MODE COMMAND is different from the IE "CN domain identity" that was sent in the previous SECURITY MODE COMMAND message to the UE:
 - 3> include the IE "Integrity protection mode info" in the SECURITY MODE COMMAND.
- 1> transmit the SECURITY MODE COMMAND message on RB2.

8.1.12.2.2 Integrity protection configuration change

To start or modify integrity protection, UTRAN sends a SECURITY MODE COMMAND message on the downlink DCCH in AM RLC using the new integrity protection configuration. UTRAN should not "modify" integrity protection for a CN domain to which a SECURITY MODE COMMAND configuring integrity protection has been previously sent for an ongoing signalling connection unless the application of new integrity keys needs to be signalled to the UE. UTRAN should not transmit a SECURITY MODE COMMAND to signal a change in integrity protection algorithm.

In case of Inter-RAT handover to UTRAN, after the reception of the HANDOVER TO UTRAN COMPLETE message and a key set is received, UTRAN should transmit a SECURITY MODE COMMAND message containing IE "Integrity protection mode info" in order to initiate integrity protection with the integrity key of the key set used in the other RAT (see subclause 8.3.6.3).

When configuring Integrity protection, UTRAN should:

- 1> ensure that the UE needs to store at most three different Integrity protection configurations (keysets) at any given time. This includes the total number of Integrity protection configurations for all signalling radio bearers;
- 1> if Ciphering has already been started for the UE for the CN domain to be set in the IE "CN domain identity" in the SECURITY MODE COMMAND:
 - 2> if for the CN domain indicated in the IE "CN domain identity" in the SECURITY MODE COMMAND, a new security key set (new ciphering and integrity protection keys) has been received from upper layers since the transmission of the last SECURITY MODE COMMAND message for that CN domain:
 - 3> include the IE "Ciphering mode info" in the SECURITY MODE COMMAND.
- 1> if Ciphering has already been configured for the UE for a CN domain different from the CN domain to be set in the IE "CN domain identity" in the SECURITY MODE COMMAND:
 - 2> include the IE "Ciphering mode info" in the SECURITY MODE COMMAND.

Prior to sending the SECURITY MODE COMMAND, for the CN domain indicated in the IE "CN domain identity" in the SECURITY MODE COMMAND, UTRAN should:

- 1> if this is the first SECURITY MODE COMMAND sent for this RRC connection:
 - 2> if new keys have been received:
 - 3> initialise the hyper frame numbers as follows:
 - 4> set all bits of the hyper frame numbers of the COUNT-I values for all signalling radio bearers to zero.
 - 2> else (if new keys have not been received):
 - 3> use the value "START" in the most recently received IE "START list" or IE "START" that belongs to the CN domain indicated in the IE "CN domain identity" to initialise all hyper frame numbers of COUNT-I for all the signalling radio bearers by:
 - 4> setting the 20 most significant bits of the hyper frame numbers for all signalling radio bearers to the value "START" in the most recently received IE "START list" or IE "START" for that CN domain;
 - 4> setting the remaining bits of the hyper frame numbers equal to zero.

- 1> else (this is not the first SECURITY MODE COMMAND sent for this RRC connection):
 - 2> if new keys have been received:
 - 3> initialise the hyper frame number for COUNT-I for RB2 as follows:
 - 4> set all bits of the HFN of the COUNT-I value for RB2 to zero.
 - 2> if new keys have not been received:
 - 3> initialise the hyper frame number for COUNT-I for RB2 as follows:
 - 4> set the 20 most significant bits of the HFN of the downlink and uplink COUNT-I to the value of the most recently received IE "START" or IE "START list" for the CN domain to be set in the IE "CN Domain Identity";
 - 4> set the remaining bits of the HFN of the downlink and uplink COUNT-I to zero.
 - 1> if the IE "Integrity protection mode command" has the value "Start":
 - 2> prohibit the transmission of signalling messages with any RRC SN on all signalling radio bearers, except RB2;
 - 2> set the FRESH value in the IE "Integrity protection initialisation number", included in the IE "Integrity protection mode info".
 - 1> if the IE "Integrity protection mode command" has the value "Modify":
 - 2> for each signalling radio bearer RBn, except RB2:
 - 3> prohibit the transmission of signalling messages with RRC SN greater or equal to the RRC sequence number in entry for signalling radio bearer n in the "RRC message sequence number list" in the IE "Downlink integrity protection activation info", included in the IE "Integrity protection mode info".
 - 2> consider an integrity protection activation time in downlink to be pending until the selected activation time is equal to the next RRC sequence number to be used, which means that the last RRC message using the old integrity protection configuration has been submitted to lower layers;
 - 2> set, for each signalling radio bearer RBn, that has no pending integrity protection activation time set by a previous security mode control procedure, an RRC sequence number in entry for signalling radio bearer n in the "RRC message sequence number list" in the IE "Downlink integrity protection activation info", included in the IE "Integrity protection mode info", at which time the new integrity protection configuration shall be applied;
 - 2> set, for each signalling radio bearer RBn, that has a pending integrity protection activation time set by a previous security mode control procedure, the RRC sequence number in entry for signalling radio bearer n in the "RRC message sequence number list" in the IE "Downlink integrity protection activation info", included in the IE "Integrity protection mode info", to the value used in the previous security mode control procedure, at which time the latest integrity protection configuration shall be applied.
- 1> transmit the SECURITY MODE COMMAND message on RB2 using the new integrity protection configuration.

NOTE1: In the case of re-initialisation of Integrity Protection at HFN wrap around, the network should take into account the UE actions as described in subclauses 8.5.10.1 and 8.5.10.2.

NOTE2: After the SECURITY MODE COMMAND message is transmitted, the network should ensure that it can revert back to old integrity protection until it receives the SECURITY MODE COMPLETE message, to take into account the UE actions when security mode control procedure is unsuccessful. The network should also be aware that the UE may revert to old configuration when waiting for the acknowledgement from L2 for the SECURITY MODE COMPLETE message, and act accordingly.

NOTE3: In the case of the first SECURITY MODE COMMAND message following an SRNS relocation, the network should set the IE "Downlink integrity protection activation info" for SRB3 and SRB4 to at least "the current downlink RRC sequence number +2". As a consequence, at least the first message sent on SRB3 and SRB4 by the Target RNC will use the old integrity protection configuration.

8.1.12.3 Reception of SECURITY MODE COMMAND message by the UE

Upon reception of the SECURITY MODE COMMAND message, the UE shall:

- 1> if neither IE "Ciphering mode info" nor IE "Integrity protection mode info" is included in the SECURITY MODE COMMAND:
 - 2> set the variable INVALID_CONFIGURATION to TRUE.
- 1> if the IE "Security capability" is the same as indicated by variable UE_CAPABILITY_TRANSFERRED, and the IE "GSM security capability" (if included in the SECURITY MODE COMMAND) is the same as indicated by the variable UE_CAPABILITY_TRANSFERRED:
 - 2> set the variable LATEST_CONFIGURED_CN_DOMAIN equal to the IE "CN domain identity";
 - 2> set the IE "Status" in the variable SECURITY_MODIFICATION for the CN domain indicated in the IE "CN domain identity" in the received SECURITY MODE COMMAND to the value "Affected";
 - 2> set the IE "Status" in the variable SECURITY_MODIFICATION for all CN domains other than the CN domain indicated in the IE "CN domain identity" to "Not affected";
 - 2> set the IE "RRC transaction identifier" in the SECURITY MODE COMPLETE message to the value of "RRC transaction identifier" in the entry for the SECURITY MODE COMMAND message in the table "Accepted transactions" in the variable TRANSACTIONS; and
 - 2> clear that entry;
 - 2> if the SECURITY MODE COMMAND message contained the IE "Ciphering mode info":
 - 3> perform the actions as specified in subclause 8.6.3.4.
 - 2> if the SECURITY MODE COMMAND message contained the IE "Integrity protection mode info":
 - 3> perform the actions as specified in subclause 8.6.3.5.
- 1> prior to sending the SECURITY MODE COMPLETE message:
 - 2> use the old ciphering configuration for this message;
 - 2> if the SECURITY MODE COMMAND message contained the IE "Ciphering mode info":
 - 3> include and set the IE "Radio bearer uplink ciphering activation time info" to the value of the variable RB_UPLINK_CIPHERING_ACTIVATION_TIME_INFO;
 - 3> for each radio bearer and signalling radio bearer that belongs to the CN domain as indicated in the variable LATEST_CONFIGURED_CN_DOMAIN:
 - 4> start or continue incrementing the COUNT-C values for all RLC-AM and RLC-UM signalling radio bearers at the ciphering activation time as specified in the procedure;
 - 4> start or continue incrementing the COUNT-C values common for all transparent mode radio bearers for this CN domain at the ciphering activation time as specified in the procedure;
 - 4> continue incrementing the COUNT-C values for all RLC-AM and RLC-UM radio bearers.
 - 3> if no new security key set (new ciphering and integrity protection keys) has been received from the upper layers [40] for the CN domain as indicated in the variable LATEST_CONFIGURED_CN_DOMAIN:
 - 4> for ciphering on signalling radio bearers using RLC-AM and RLC-UM in the downlink, at the RLC sequence number indicated in IE "Radio bearer downlink ciphering activation time info" in the IE "Ciphering mode info" included in the SECURITY MODE COMMAND, for each signalling radio bearer:
 - 5> set the 20 most significant bits of the HFN component of the downlink COUNT-C to the value "START" in the most recently transmitted IE "START list" or IE "START", at the reception of the SECURITY MODE COMMAND, that belongs to the CN domain as indicated in the variable LATEST_CONFIGURED_CN_DOMAIN;

- 5> set the remaining bits of the hyper frame numbers to zero.
- 3> if new keys have been received:
 - 4> perform the actions in subclause 8.1.12.3.1.
- 2> if the SECURITY MODE COMMAND message contained the IE "Integrity protection mode info":
 - 3> include and set the IE "Uplink integrity protection activation info" to the value of the variable INTEGRITY_PROTECTION_ACTIVATION_INFO for each signalling radio bearer;
 - 3> if no new security key set (new ciphering and integrity protection keys) has been received from the upper layers [40] for the CN domain as indicated in the variable LATEST_CONFIGURED_CN_DOMAIN, for RB2:
 - 4> in the downlink, for the received SECURITY MODE COMMAND message:
 - 5> set the 20 most significant bits of the IE "Downlink RRC HFN" in the variable INTEGRITY_PROTECTION_INFO of the downlink COUNT-I to the value "START" in the most recently transmitted IE "START list" or IE "START", at the reception of the SECURITY MODE COMMAND, that belongs to the CN domain as indicated in the variable LATEST_CONFIGURED_CN_DOMAIN;
 - 5> set the remaining bits of the IE "Downlink RRC HFN" to zero.
 - 4> in the uplink, for the transmitted response message, SECURITY MODE COMPLETE:
 - 5> set the 20 most significant bits of the IE "Uplink RRC HFN" in the variable INTEGRITY_PROTECTION_INFO of the uplink COUNT-I to the value "START" in the most recently transmitted IE "START list" or IE "START", at the reception of the SECURITY MODE COMMAND, that belongs to the CN domain as indicated in the variable LATEST_CONFIGURED_CN_DOMAIN;
 - 5> set the remaining bits of the IE "Uplink RRC HFN" to zero.
 - 3> if no new security key set (new ciphering and integrity protection keys) has been received from the upper layers [40] for the CN domain indicated in the variable LATEST_CONFIGURED_CN_DOMAIN, for each signalling radio bearer other than RB2:
 - 4> if the IE "Integrity protection mode command" has the value "start":
 - 5> in the downlink, for this signalling radio bearer:
 - 6> set the 20 most significant bits of IE "Downlink RRC HFN" in the variable INTEGRITY_PROTECTION_INFO of the downlink COUNT-I to the value START transmitted in the most recently transmitted IE "START list" or IE "START", at the reception of the SECURITY MODE COMMAND, that belongs to the CN domain as indicated in the variable LATEST_CONFIGURED_CN_DOMAIN;
 - 6> set the remaining bits of the IE "Downlink RRC HFN" in the variable INTEGRITY_PROTECTION_INFO of the downlink COUNT-I to zero;
 - 4> else:
 - 5> in the downlink, for the first message for which the RRC sequence number in a received RRC message for this signalling radio bearer is equal to or greater than the activation time as indicated in IE "Downlink integrity protection activation info" as included in the IE "Integrity protection mode info", for this signalling radio bearer:
 - 6> set the 20 most significant bits of the IE "Downlink RRC HFN" in the variable INTEGRITY_PROTECTION_INFO of the downlink COUNT-I to the value "START" in the most recently transmitted IE "START list" or IE "START", at the reception of the SECURITY MODE COMMAND, that belongs to the CN domain as indicated in the variable LATEST_CONFIGURED_CN_DOMAIN;
 - 6> set the remaining bits of the IE "Downlink RRC HFN" to zero.

3> if new keys have been received:

4> perform the actions in subclause 8.1.12.3.1.

2> start applying the new integrity protection configuration in the uplink for signalling radio bearer RB2 from and including the transmitted SECURITY MODE COMPLETE message;

2> transmit the SECURITY MODE COMPLETE message on RB2.

NOTE: After submission of the SECURITY MODE COMPLETE message to the lower layers, the UE should accept messages received in the DL which require the new security configuration to be applied on them. If the received message is successfully integrity checked, the UE should not discard the message due to lack of completion of the security procedure, caused by the successful delivery of the SECURITY MODE COMPLETE not having yet been confirmed by lower layers, unless the security configuration to be applied has been aborted and the message received requires integrity protection [5].

1> when the successful delivery of the SECURITY MODE COMPLETE message has been confirmed by RLC:

2> if the SECURITY MODE COMMAND message contained the IE "Ciphering mode info":

3> if no new security key set (new ciphering and integrity protection keys) has been received from the upper layers [40] for the CN domain as indicated in the variable LATEST_CONFIGURED_CN_DOMAIN:

4> for ciphering on signalling radio bearers using RLC-AM and RLC-UM in the uplink, at the RLC sequence number indicated in IE "Radio bearer uplink ciphering activation time info" included in the SECURITY MODE COMPLETE, for each signalling radio bearer:

5> set the 20 most significant bits of the HFN component of the uplink COUNT-C to the value "START" in the most recently transmitted IE "START list" or IE "START", at the reception of the SECURITY MODE COMMAND, that belongs to the CN domain as indicated in the variable LATEST_CONFIGURED_CN_DOMAIN;

5> set the remaining bits of the hyper frame numbers to zero.

3> if new keys have been received:

4> perform the actions in subclause 8.1.12.3.1.

3> resume data transmission on any suspended radio bearer and signalling radio bearer mapped on RLC-AM or RLC-UM;

3> set the IE "Reconfiguration" in the variable CIPHERING_STATUS to FALSE; and

3> clear the variable RB_UPLINK_CIPHERING_ACTIVATION_TIME_INFO.

2> if the SECURITY MODE COMMAND message contained the IE "Integrity protection mode info":

3> if no new security key set (new ciphering and integrity protection keys) has been received from the upper layers [40] for the CN domain indicated in the variable LATEST_CONFIGURED_CN_DOMAIN, for each signalling radio bearer other than RB2:

4> if the IE "Integrity protection mode command" has the value "start":

5> in the uplink, for this signalling radio bearer:

6> set the 20 most significant bits of IE "Uplink RRC HFN" in the variable INTEGRITY_PROTECTION_INFO of the uplink COUNT-I to the value START transmitted in the most recently transmitted IE "START list" or IE "START", at the reception of the SECURITY MODE COMMAND, that belongs to the CN domain as indicated in the variable LATEST_CONFIGURED_CN_DOMAIN;

6> set the remaining bits of the IE "Uplink RRC HFN" in the variable INTEGRITY_PROTECTION_INFO of the uplink COUNT-I to zero.

4> else:

- 5> in the uplink, for the first transmitted RRC message for this signalling radio bearer with RRC sequence number equal to the activation time as indicated in IE "Uplink integrity protection activation info" included in the transmitted SECURITY MODE COMPLETE, for this signalling radio bearer:
 - 6> set the 20 most significant bits of the IE "Uplink RRC HFN" in the variable INTEGRITY_PROTECTION_INFO of the uplink COUNT-I to the value "START" in the most recently transmitted IE "START list" or IE "START", at the reception of the SECURITY MODE COMMAND, that belongs to the CN domain as indicated in the variable LATEST_CONFIGURED_CN_DOMAIN;
 - 6> set the remaining bits of the IE "Uplink RRC HFN" to zero.
- 3> if new keys have been received:
 - 4> perform the actions in subclause 8.1.12.3.1.
- 3> allow the transmission of RRC messages on all signalling radio bearers with any RRC SN;
- 3> set "Uplink RRC Message sequence number" for signalling radio bearer RB0 in the variable INTEGRITY_PROTECTION_INFO to a value such that next RRC message to be sent on uplink RB0 will use the new integrity protection configuration and the "RRC Message sequence number" in the IE "Integrity check info" in the next RRC message will equal to the activation time for RB0 as indicated in IE "Uplink integrity protection activation info" included in the transmitted SECURITY MODE COMPLETE;
- 3> set the IE "Reconfiguration" in the variable INTEGRITY_PROTECTION_INFO to FALSE; and
- 3> clear the variable INTEGRITY_PROTECTION_ACTIVATION_INFO.
- 2> clear the variable SECURITY_MODIFICATION;
- 2> notify upper layers upon change of the security configuration;
- 2> and the procedure ends.
- 1> if the IE "Security capability" is not the same as indicated by the variable UE_CAPABILITY_TRANSFERRED, or the IE "GSM security capability" (if included in the SECURITY MODE COMMAND) is not the same as indicated by the variable UE_CAPABILITY_TRANSFERRED, or if the IE "GSM security capability" is not included in the SECURITY MODE COMMAND and is included in the variable UE_CAPABILITY_TRANSFERRED:
 - 2> release all its radio resources;
 - 2> indicate the release of the established signalling connections (as stored in the variable ESTABLISHED_SIGNALLING_CONNECTIONS) and established radio access bearers (as stored in the variable ESTABLISHED_RABS) to upper layers;
 - 2> clear the variable ESTABLISHED_SIGNALLING_CONNECTIONS;
 - 2> clear the variable ESTABLISHED_RABS;
 - 2> clear the variable SECURITY_MODIFICATION;
 - 2> enter idle mode;
 - 2> perform actions when entering idle mode as specified in subclause 8.5.2;
 - 2> and the procedure ends.

8.1.12.3.1 New ciphering and integrity protection keys

NOTE: The actions in this subclause are to be performed only if the new keys were received for an ongoing RRC connection while in UTRA.

If a new security key set (new ciphering and integrity protection keys) has been received from the upper layers [40] for the CN domain as indicated in the variable LATEST_CONFIGURED_CN_DOMAIN, the UE shall:

- 1> set the START value for the CN domain indicated in the variable LATEST_CONFIGURED_CN_DOMAIN to zero;
- 1> if the SECURITY MODE COMMAND message contained the IE "Integrity protection mode info":
 - 2> for integrity protection in the downlink on each signalling radio bearer except RB2:
 - 3> if IE "Integrity protection mode command" has the value "start":
 - 4> for the first received message on this signalling radio bearer:
 - 5> start using the new integrity key;
 - 5> for this signalling radio bearer:
 - 6> set the IE "Downlink RRC HFN" in the variable INTEGRITY_PROTECTION_INFO of the downlink COUNT-I to zero.
 - 3> else:
 - 4> for the first message for which the RRC sequence number in a received RRC message for this signalling radio bearer is equal to or greater than the activation time as indicated in IE "Downlink integrity protection activation info" as included in the IE "Integrity protection mode info":
 - 5> start using the new integrity key;
 - 5> for this signalling radio bearer:
 - 6> set the IE "Downlink RRC HFN" in the variable INTEGRITY_PROTECTION_INFO of the downlink COUNT-I to zero.
 - 2> for integrity protection in the uplink on each signalling radio bearer except RB2:
 - 3> for the first message for which the RRC sequence number in a to be transmitted RRC message for this signalling radio bearer is equal to the activation time as indicated in IE "Uplink integrity protection activation info" included in the transmitted SECURITY MODE COMPLETE message:
 - 4> start using the new integrity key;
 - 4> for this signalling radio bearer:
 - 5> set the IE "Uplink RRC HFN" in the variable INTEGRITY_PROTECTION_INFO of the uplink COUNT-I to zero.
 - 2> for integrity protection in the downlink on signalling radio bearer RB2:
 - 3> at the received SECURITY MODECOMMAND:
 - 4> start using the new integrity key;
 - 4> set the IE "Downlink RRC HFN" in the variable INTEGRITY_PROTECTION_INFO of the downlink COUNT-I to zero.
 - 2> for integrity protection in the uplink on signalling radio bearer RB2 :
 - 3> at the transmitted SECURITY MODE COMPLETE:
 - 4> start using the new integrity key;
 - 4> set the IE "Uplink RRC HFN" in the variable INTEGRITY_PROTECTION_INFO of the uplink COUNT-I to zero.
 - 1> if the SECURITY MODE COMMAND message contained the IE "Ciphering mode info":

- 2> for each signalling radio bearer and for each radio bearer for the CN domain indicated in the variable LATEST_CONFIGURED_CN_DOMAIN:
 - 3> if the IE "Status" in the variable CIPHERING_STATUS has the value "Started" for this CN domain, then for ciphering on radio bearers using RLC-TM:
 - 4> at the CFN as indicated in the IE "Ciphering activation time for DPCH" in the IE "Ciphering mode info":
 - 5> start using the new key in uplink and downlink;
 - 5> set the HFN component of the COUNT-C to zero.
 - 3> if the IE "Status" in the variable CIPHERING_STATUS has the value "Started" for this CN domain, then for ciphering on radio bearers and signalling radio bearers using RLC-AM and RLC-UM:
 - 4> in the downlink, at the RLC sequence number indicated in IE "Radio bearer downlink ciphering activation time info" in the IE "Ciphering mode info":
 - 5> start using the new key;
 - 5> set the HFN component of the downlink COUNT-C to zero.
 - 4> in the uplink, at the RLC sequence number indicated in IE "Radio bearer uplink ciphering activation time info":
 - 5> start using the new key;
 - 5> set the HFN component of the uplink COUNT-C to zero.
- 1> consider the value of the latest transmitted START value to be zero.

8.1.12.4 Void

8.1.12.4a Incompatible simultaneous security reconfiguration

If the variable INCOMPATIBLE_SECURITY_RECONFIGURATION becomes set to TRUE of the received SECURITY MODE COMMAND message, the UE shall:

- 1> transmit a SECURITY MODE FAILURE message on the uplink DCCH using AM RLC, using the ciphering and integrity protection configurations prior to the reception of this SECURITY MODE COMMAND;
- 1> set the IE "RRC transaction identifier" in the SECURITY MODE FAILURE message to the value of "RRC transaction identifier" in the entry for the SECURITY MODE COMMAND message in the table "Accepted transactions" in the variable TRANSACTIONS; and
- 1> clear that entry;
- 1> set the IE "failure cause" to the cause value "incompatible simultaneous reconfiguration";
- 1> when the response message has been submitted to lower layers for transmission:
 - 2> set the variable INCOMPATIBLE_SECURITY_RECONFIGURATION to FALSE;
 - 2> continue with any ongoing processes and procedures as if the invalid SECURITY MODE COMMAND message has not been received;
 - 2> only accept a message on SRB 2, with a COUNT-I that:
 - 3> is higher than the COUNT-I used prior to receiving the SECURITY MODE COMMAND message incremented by one; and
 - 3> does not take into account the HFN from the received SECURITY MODE COMMAND message.

2> and the procedure ends.

8.1.12.4b Cell update procedure during security reconfiguration

If:

- a cell update procedure according to subclause 8.3.1 is initiated; and
- the received SECURITY MODE COMMAND message causes either,
 - the IE "Reconfiguration" in the variable CIPHERING_STATUS to be set to TRUE; and/or
 - the IE "Reconfiguration" in the variable INTEGRITY_PROTECTION_INFO to be set to TRUE:

the UE shall:

- 1> abort the ongoing integrity and/or ciphering reconfiguration;
- 1> resume data transmission on any suspended radio bearer and signalling radio bearer mapped on RLC-AM or RLC-UM;
- 1> allow the transmission of RRC messages on all signalling radio bearers with any RRC SN;
- 1> when the CELL UPDATE message has been submitted to lower layers for transmission:
 - 2> if the SECURITY MODE COMMAND message contained the IE "Ciphering mode info":
 - 3> set the IE "Reconfiguration" in the variable CIPHERING_STATUS to FALSE; and
 - 3> clear the variable RB_UPLINK_CIPHERING_ACTIVATION_TIME_INFO;
 - 2> if the SECURITY MODE COMMAND message contained the IE "Integrity protection mode info":
 - 3> set the IE "Reconfiguration" in the variable INTEGRITY_PROTECTION_INFO to FALSE; and
 - 3> clear the variable INTEGRITY_PROTECTION_ACTIVATION_INFO.
 - 2> continue with any ongoing processes and procedures as if the SECURITY MODE COMMAND message has not been received;
 - 2> only accept a message on SRB 2, with a COUNT-I that:
 - 3> is higher than the COUNT-I used prior to receiving the SECURITY MODE COMMAND message incremented by one; and
 - 3> does not take into account the HFN from the received SECURITY MODE COMMAND message.
 - 2> if the UE has already submitted the SECURITY MODE COMPLETE message, use a COUNT-I value for transmission of the next message on SRB2 as stated below:
 - 3> take the COUNT-I used prior to the transmission of the SECURITY MODE COMPLETE message;
 - 3> increment that COUNT-I with 2;
 - 3> apply that COUNT-I on the next message to transmit.
 - 2> clear the variable SECURITY_MODIFICATION;
 - 2> the procedure ends.

8.1.12.4c Invalid configuration

If the variable INVALID_CONFIGURATION is set to TRUE due to the received SECURITY MODE COMMAND message, the UE shall:

- 1> transmit a SECURITY MODE FAILURE message on the DCCH using AM RLC after setting the IEs as specified below:

- 2> set the IE "RRC transaction identifier" in the SECURITY MODE FAILURE message to the value of "RRC transaction identifier" in the entry for the SECURITY MODE COMMAND message in the table "Accepted transactions" in the variable TRANSACTIONS; and
 - 2> clear that entry;
 - 2> set the IE "failure cause" to the cause value "invalid configuration".
- 1> when the response message has been submitted to lower layers for transmission:
 - 2> set the variable INVALID_CONFIGURATION to FALSE;
 - 2> set the IE "Reconfiguration" in the variable CIPHERING_STATUS to FALSE;
 - 2> continue with any ongoing processes and procedures as if the invalid SECURITY MODE COMMAND message has not been received;
 - 2> only accept a message on SRB 2, with a COUNT-I that:
 - 3> is higher than the COUNT-I used prior to receiving the SECURITY MODE COMMAND message incremented by one; and
 - 3> does not take into account the HFN from the received SECURITY MODE COMMAND message.
 - 2> and the procedure ends.

8.1.12.5 Reception of SECURITY MODE COMPLETE message by the UTRAN

UTRAN should apply integrity protection on the received SECURITY MODE COMPLETE message and all subsequent messages with the new integrity protection configuration, if changed. When UTRAN has received a SECURITY MODE COMPLETE message and the integrity protection has successfully been applied, UTRAN should:

- 1> if the IE "Ciphering mode info" was included in the SECURITY MODE COMMAND message:
 - 2> if new keys were received for the CN domain set in the IE "CN Domain Identity" in the SECURITY MODE COMMAND:
 - 3> set, at the downlink and uplink activation time, all the bits of the hyper frame numbers of the downlink and uplink COUNT-C values respectively for all radio bearers for this CN domain and all signalling radio bearers to zero.
 - 2> else (if new keys were not received):
 - 3> use, at the downlink and uplink activation time, the value "START" in the most recently received IE "START list" or IE "START" that belongs to the CN domain as indicated in the IE "CN domain identity" to initialise all hyper frame numbers of the downlink and uplink COUNT-C values respectively for all the signalling radio bearers as follows:
 - 4> set the 20 most significant bits of the hyper frame numbers of the COUNT-C for all signalling radio bearers to the value "START" in the most recently received IE "START list" or IE "START" for that CN domain;
 - 4> set the remaining bits of the hyper frame numbers equal to zero.
- 1> if the IE "Integrity protection mode info" was included in the SECURITY MODE COMMAND message:
 - 2> if this was not the first SECURITY MODE COMMAND message for this RRC connection:
 - 3> if new keys have been received for the CN domain set in the IE "CN Domain Identity" included in the transmitted SECURITY MODE COMMAND message:
 - 4> initialise, at the downlink and uplink activation time, all hyper frame numbers of the downlink and uplink COUNT-I values respectively for all the signalling radio bearers other than RB2 as follows:
 - 5> set all bits of the hyper frame numbers of the uplink and downlink COUNT-I to zero.

- 3> if no new keys have been received for the CN domain set in the IE "CN Domain Identity" included in the transmitted SECURITY MODE COMMAND message:
 - 4> use, at the downlink and uplink activation time, the value "START" in the most recently received IE "START list" or IE "START" that belongs to the CN domain as indicated in the IE "CN domain identity" to initialise all hyper frame numbers of the downlink and uplink COUNT-I values respectively for all the signalling radio bearers other than RB2 as follows:
 - 5> set the 20 most significant bits of the hyper frame numbers of the downlink and uplink COUNT-I respectively for all signalling radio bearers to the value "START" in the most recently received IE "START list" or IE "START" for that CN domain;
 - 5> set the remaining bits of the hyper frame numbers equal to zero.
- 1> send an indication to upper layers that the new security configuration has been activated;
- 1> resume, in the downlink, all suspended radio bearers and all signalling radio bearers;
- 1> allow the transmission of RRC messages on all signalling radio bearers with any RRC SN;
- 1> if the IE "Integrity protection mode command" included in the SECURITY MODE COMMAND had the value "Start":
 - 2> start applying integrity protection in the downlink for all signalling radio bearers.
- 1> if the IE "Integrity protection mode command" included in the SECURITY MODE COMMAND had the value "Modify":
 - 2> start applying the new integrity protection configuration in the downlink at the RRC sequence number, for each signalling radio bearers RBn, except for signalling radio bearer RB2, indicated by the entry for signalling radio bearer n in the "RRC message sequence number list" in the IE "Downlink integrity protection activation info";
 - 2> continue applying the new integrity configuration for signalling radio bearer RB2;
 - 2> apply the new integrity protection configuration on the received signalling messages with RRC SN greater than or equal to the number associated with the signalling radio bearer in IE "Uplink integrity protection activation info".
- 1> apply the old ciphering configuration for the transmission of RLC PDUs with RLC sequence number less than the number indicated in the IE "Radio bearer downlink ciphering activation time info" included in the IE "Ciphering mode info";
- 1> apply the new ciphering configuration for the transmission of RLC PDUs with RLC sequence number greater than or equal to the number indicated in IE "Radio bearer downlink ciphering activation time info" included in the IE "Ciphering mode info";
- 1> apply the old integrity protection configuration on the received signalling messages with RRC SN smaller than the number associated with the signalling radio bearer in IE "Uplink integrity protection activation info";
- 1> for radio bearers using RLC-AM or RLC-UM:
 - 2> use the old ciphering configuration for received RLC PDUs with RLC sequence number less than the RLC sequence number indicated in the IE "Radio bearer uplink ciphering activation time info" sent by the UE;
 - 2> use the new ciphering configuration for received RLC PDUs with RLC sequence number greater than or equal to the RLC sequence number indicated in the IE "Radio bearer uplink ciphering activation time info" sent by the UE;
 - 2> if an RLC reset or re-establishment of the transmitting side of an RLC entity occurs after the SECURITY MODE COMPLETE message has been received by UTRAN before the downlink activation time for the new ciphering configuration has been reached, ignore the activation time and apply the new ciphering configuration in downlink immediately after the RLC reset or RLC re-establishment;
 - 2> if an RLC reset or re-establishment of the receiving side of an RLC entity occurs after the SECURITY MODE COMPLETE message has been received by UTRAN before the uplink activation time for the new

ciphering configuration has been reached, ignore the activation time and apply the new ciphering configuration in uplink immediately after the RLC reset or RLC re-establishment.

1> for radio bearers using RLC-TM:

2> use the old ciphering configuration for the received RLC PDUs before the CFN as indicated in the IE "Ciphering activation time for DPCH" in the IE "Ciphering mode info" as included in the SECURITY MODE COMMAND;

2> use the new ciphering configuration for the received RLC PDUs at the CFN as indicated in the IE "Ciphering activation time for DPCH" in the IE "Ciphering mode info" as included in the SECURITY MODE COMMAND.

1> and the procedure ends.

8.1.12.6 Invalid SECURITY MODE COMMAND message

If the SECURITY MODE COMMAND message contains a protocol error causing the variable `PROTOCOL_ERROR_REJECT` to be set to TRUE according to clause 9, the UE shall perform procedure specific error handling as follows:

1> transmit a SECURITY MODE FAILURE message on the uplink DCCH using AM RLC;

1> set the IE "RRC transaction identifier" in the SECURITY MODE FAILURE message to the value of "RRC transaction identifier" in the entry for the SECURITY MODE COMMAND message in the table "Rejected transactions" in the variable `TRANSACTIONS`; and

1> clear that entry;

1> set the IE "failure cause" to the cause value "protocol error";

1> include the IE "Protocol error information" with contents set to the value of the variable `PROTOCOL_ERROR_INFORMATION`;

1> when the response message has been submitted to lower layers for transmission:

2> continue with any ongoing processes and procedures as if the invalid SECURITY MODE COMMAND message has not been received;

2> only accept a message on SRB 2, with a COUNT-I that:

3> is higher than the COUNT-I used prior to receiving the SECURITY MODE COMMAND message incremented by one; and

3> does not take into account the HFN from the received SECURITY MODE COMMAND message.

2> and the procedure ends.

8.1.13 Signalling connection release procedure



Figure 8.1.13-1: Signalling connection release procedure, normal case

8.1.13.1 General

The signalling connection release procedure is used to notify to the UE that one of its ongoing signalling connections has been released. The procedure does not initiate the release of the RRC connection.

8.1.13.2 Initiation of SIGNALLING CONNECTION RELEASE by the UTRAN

To initiate the procedure, the UTRAN transmits a SIGNALLING CONNECTION RELEASE message on DCCH using AM RLC.

8.1.13.3 Reception of SIGNALLING CONNECTION RELEASE by the UE

Upon reception of a SIGNALLING CONNECTION RELEASE message, the UE shall:

- 1> indicate the release of the signalling connection and pass the value of the IE "CN domain identity" to upper layers;
- 1> remove the signalling connection with the identity indicated by the IE "CN domain identity" from the variable ESTABLISHED_SIGNALLING_CONNECTIONS;
- 1> clear the entry for the SIGNALLING CONNECTION RELEASE message in the table "Accepted transactions" in the variable TRANSACTIONS;
- 1> the procedure ends.

8.1.13.4 Invalid SIGNALLING CONNECTION RELEASE message

If the UE receives a SIGNALLING CONNECTION RELEASE message, which contains a protocol error causing the variable PROTOCOL_ERROR_REJECT to be set to TRUE according to clause 9, the UE shall perform procedure specific error handling as follows:

- 1> include the IE "Identification of received message"; and
 - 2> set the IE "Received message type" to SIGNALLING CONNECTION RELEASE;
 - 2> set the IE "RRC transaction identifier" to the value of "RRC transaction identifier" in the entry for the SIGNALLING CONNECTION RELEASE message in the table "Rejected transactions" in the variable TRANSACTIONS; and
 - 2> clear that entry.
- 1> include the IE "Protocol error information" with contents set to the value of the variable PROTOCOL_ERROR_INFORMATION;
- 1> transmit an RRC STATUS message on the uplink DCCH using AM RLC
- 1> when the RRC STATUS message has been submitted to lower layers for transmission:
 - 2> continue with any ongoing processes and procedures as if the invalid SIGNALLING CONNECTION RELEASE message has not been received.

8.1.13.5 Invalid configuration

If radio access bearers for the CN domain indicated by the IE "CN domain identity" exist in the variable ESTABLISHED_RABS, the UE shall:

- 1> transmit an RRC STATUS message on the uplink DCCH using AM RLC;
- 1> include the IE "Identification of received message"; and
- 1> set the IE "Received message type" to SIGNALLING CONNECTION RELEASE; and

- 1> set the IE "RRC transaction identifier" to the value of "RRC transaction identifier" in the entry for the SIGNALLING CONNECTION RELEASE message in the table "Accepted transactions" in the variable TRANSACTIONS and clear that entry;
- 1> include the IE "Protocol error information" with contents set to the value "Message not compatible with receiver state";
- 1> when the RRC STATUS message has been submitted to lower layers for transmission:
 - 2> continue with any ongoing processes and procedures as if the invalid SIGNALLING CONNECTION RELEASE message has not been received.

8.1.14 Signalling connection release indication procedure

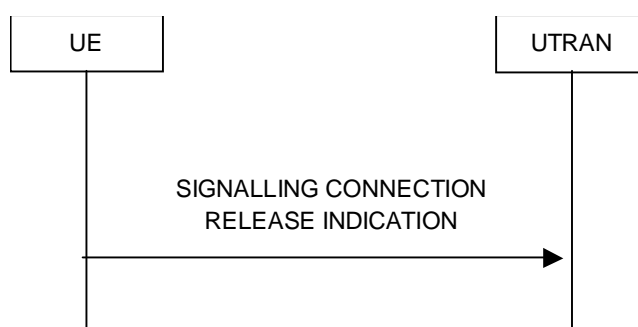

Figure 8.1.14-1: Signalling connection release indication procedure, normal case

8.1.14.1 General

The signalling connection release indication procedure is used by the UE to indicate to the UTRAN that one of its signalling connections has been released. The procedure may in turn initiate the RRC connection release procedure.

8.1.14.2 Initiation

The UE shall, on receiving a request to release (abort) the signalling connection from upper layers for a specific CN domain:

- 1> if a signalling connection in the variable ESTABLISHED_SIGNALLING_CONNECTIONS for the specific CN domain identified with the IE "CN domain identity" exists:
 - 2> initiate the signalling connection release indication procedure.
- 1> otherwise:
 - 2> abort any ongoing establishment of signalling connection for that specific CN domain as specified in 8.1.3.5a.

Upon initiation of the signalling connection release indication procedure in CELL_PCH or URA_PCH state, the UE shall:

- 1> if variable H_RNTI and variable C_RNTI are set:
 - 2> continue with the signalling connection release indication procedure as below.
- 1> else:
 - 2> perform a cell update procedure, according to subclause 8.3.1, using the cause "uplink data transmission";
 - 2> when the cell update procedure completed successfully:
 - 3> continue with the signalling connection release indication procedure as below.

The UE shall:

- 1> set the IE "CN Domain Identity" to the value indicated by the upper layers. The value of the IE indicates the CN domain whose associated signalling connection the upper layers are indicating to be released;
- 1> remove the signalling connection with the identity indicated by upper layers from the variable ESTABLISHED_SIGNALLING_CONNECTIONS;
- 1> transmit a SIGNALLING CONNECTION RELEASE INDICATION message on DCCH using AM RLC.

When the successful delivery of the SIGNALLING CONNECTION RELEASE INDICATION message has been confirmed by RLC the procedure ends.

8.1.14.2a RLC re-establishment or inter-RAT change

If a re-establishment of the transmitting side of the RLC entity on signalling radio bearer RB2 occurs before the successful delivery of the SIGNALLING CONNECTION RELEASE INDICATION message has been confirmed by RLC, the UE shall:

- 1> retransmit the SIGNALLING CONNECTION RELEASE INDICATION message on the uplink DCCH using AM RLC on signalling radio bearer RB2.

If an Inter-RAT handover from UTRAN procedure occurs before the successful delivery of the SIGNALLING CONNECTION RELEASE INDICATION message has been confirmed by RLC, the UE shall:

- 1> abort the signalling connection while in the new RAT.

8.1.14.3 Reception of SIGNALLING CONNECTION RELEASE INDICATION by the UTRAN

Upon reception of a SIGNALLING CONNECTION RELEASE INDICATION message, the UTRAN requests the release of the signalling connection from upper layers. Upper layers may then initiate the release of the signalling connection.

8.1.15 Counter check procedure

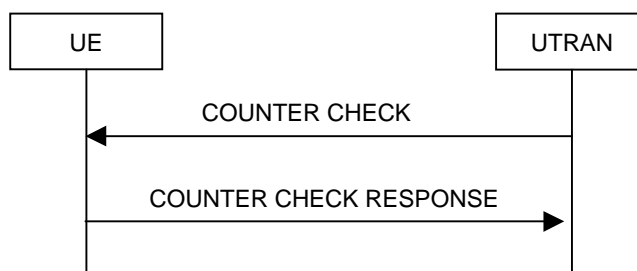

Figure 8.1.15-1: Counter check procedure

8.1.15.1 General

The counter check procedure is used by the UTRAN to perform a local authentication. The purpose of the procedure is to check that the amount of data sent in both directions (uplink and downlink) over the duration of the RRC connection is identical at the UTRAN and at the UE (to detect a possible intruder – a 'man-in-the-middle' – from operating).

This procedure is only applicable to radio bearers, and only to radio bearers using RLC-AM or RLC-UM. It should be noted that this requires that the COUNT-C values for each UL and DL radio bearers using RLC-AM or RLC-UM continue to be incremented even if ciphering is not used. This procedure is not applicable to signalling radio bearers.

8.1.15.2 Initiation

The UTRAN monitors the COUNT-C value associated with each radio bearer using UM or AM RLC. The procedure is triggered whenever any of these values reaches a critical checking value. The granularity of these checking values and

the values themselves are defined to the UTRAN by the visited network. The UTRAN initiates the procedure by sending a COUNTER CHECK message on the downlink DCCH.

8.1.15.3 Reception of a COUNTER CHECK message by the UE

When the UE receives a COUNTER CHECK message it shall compare the COUNT-C MSB values received in the IE "RB COUNT-C MSB information" in the COUNTER CHECK message to the COUNT-C MSB values of the corresponding radio bearers.

The UE shall:

- 1> set the IE "RRC transaction identifier" in the COUNTER CHECK RESPONSE message to the value of "RRC transaction identifier" in the entry for the COUNTER CHECK message in the table "Accepted transactions" in the variable TRANSACTIONS; and
- 1> clear that entry.

If:

- there is one or more radio bearer(s) using UM or AM RLC mode stored in the variable ESTABLISHED_RABS, which is (are) not included in the IE "RB COUNT-C MSB information"; or
- there is one or more radio bearer(s) included in the IE "RB COUNT-C MSB information", which is (are) not stored in the variable ESTABLISHED_RABS; or
- for any radio bearer (excluding signalling radio bearers) using UM or AM RLC mode stored in the variable ESTABLISHED_RABS and included in the IE "RB COUNT-C MSB information" with COUNT-C MSB values different from the MSB part of the COUNT-C values in the UE:

the UE shall:

- 1> include these radio bearers in the IE "RB COUNT-C information" in the COUNTER CHECK RESPONSE message. For any RB which is included in the IE "RB COUNT-C MSB information" in the COUNTER CHECK message but not stored in the variable ESTABLISHED_RABS in the UE, the MSB part of COUNT-C values in the COUNTER CHECK RESPONSE message shall be set identical to COUNT-C-MSB values in the COUNTER CHECK message. The LSB part shall be filled with zeroes.

The UE shall:

- 1> if no COUNT-C exists for a radio bearer for a given direction (uplink or downlink) because:
 - 2> it is a uni-directional radio bearer configured only for the other direction (downlink or uplink respectively); or
 - 2> it has been configured to RLC-TM mode in one direction (uplink or downlink) and RLC-UM in the other (downlink or uplink respectively):
 - 3> set the COUNT-C in the IE "RB COUNT-C information" in the COUNTER CHECK RESPONSE message, to any value.
- 1> submit a COUNTER CHECK RESPONSE message to lower layers for transmission on the uplink DCCH using AM RLC.

When the COUNTER CHECK RESPONSE message has been submitted to lower layers for transmission the procedure ends.

8.1.15.4 Reception of the COUNTER CHECK RESPONSE message by UTRAN

If the UTRAN receives a COUNTER CHECK RESPONSE message that does not contain any COUNT-C values, the procedure ends.

If the UTRAN receives a COUNTER CHECK RESPONSE message that contains one or several COUNT-C values the UTRAN may release the RRC connection.

8.1.15.5 Cell re-selection

If the UE performs cell re-selection anytime during this procedure it shall, without interrupting the procedure:

- 1> initiate the cell update procedure according to subclause 8.3.1.

8.1.15.6 Invalid COUNTER CHECK message

If the UE receives a COUNTER CHECK message, which contains a protocol error causing the variable `PROTOCOL_ERROR_REJECT` to be set to `TRUE` according to clause 9, the UE shall perform procedure specific error handling as follows. The UE shall:

- 1> transmit an RRC STATUS message on the uplink DCCH using AM RLC;
- 1> include the IE "Identification of received message"; and
- 1> set the IE "Received message type" to COUNTER CHECK; and
- 1> set the IE "RRC transaction identifier" to the value of "RRC transaction identifier" in the entry for the UE COUNTER CHECK message in the table "Rejected transactions" in the variable `TRANSACTIONS`; and
- 1> clear that entry;
- 1> include the IE "Protocol error information" with contents set to the value of the variable `PROTOCOL_ERROR_INFORMATION`;
- 1> when the RRC STATUS message has been submitted to lower layers for transmission:
 - 2> continue with any ongoing processes and procedures as if the invalid COUNTER CHECK message has not been received.

8.1.16 Inter RAT handover information transfer



Figure 8.1.16-1: Inter RAT handover information transfer, normal flow

8.1.16.1 General

The inter RAT handover information transfer procedure is used by the UE to convey RRC information needed for inter RAT handover to UTRAN.

8.1.16.2 Initiation

If:

- a radio access technology other than UTRA, e.g. GSM, using radio access technology-specific procedures, orders the UE to provide the INTER RAT HANDOVER INFO message; or
- a radio access technology other than UTRA, e.g. GSM, using radio access technology-specific procedures, configures the UE to send the INTER RAT HANDOVER INFO message upon system specific conditions not involving an explicit order e.g. early classmark sending upon entering connected mode; or

- while in connected mode using another radio access technology, the inter RAT handover info changes compared to what has previously been sent via the other radio access technology:

the UE shall:

- 1> initiate the inter RAT handover information transfer procedure.

To determine if the inter RAT handover info has changed compared to what has previously been sent, the UE shall:

- 1> store the information last sent in the variable INTER_RAT_HANDBOVER_INFO_TRANSFERRED;
- 1> if this variable has not yet been set:
 - 2> not initiate the inter RAT handover information transfer procedure due to change of inter RAT handover info.

NOTE: Currently neither the UE security information nor the predefined configuration status information change while in connected mode using GSM radio access technology.

8.1.16.3 INTER RAT HANDBOVER INFO message contents to set

The UE shall:

- 1> include the IE "UE security information", and the IE "UE security information2" if supported by the UE; and
- 1> not include the IE "UE Specific Behaviour Information 1 interRAT".
- 1> in case support for the compressed version of the inter RAT handover info is indicated via the other radio access technology:
 - 2> include of the following IEs the IE that after encoding has the smallest size: IE "Predefined configuration status information compressed" or the IE "Predefined configuration status information";
 - 2> include the IE "UE radio access capability compressed".
- 1> else:
 - 2> include the IE "Predefined configuration status information";
 - 2> include the IE "UE capability container", containing the IE "UE radio access capability" and the IE "UE radio access capability extension", in accordance with the following:
 - 3> if the UE supports multiple UTRA FDD Frequency Bands; or
 - 3> if the UE supports a single UTRA FDD Frequency Band different from Band I [21]:
 - 4> include the IE "UE radio access capability", excluding IEs "RF capability FDD" and "Measurement capability";
 - 4> include the IE "UE radio access capability extension", including the IEs "RF capability FDD extension" and the "Measurement capability extension" associated with each supported UTRA FDD frequency band indicated in the IE "Frequency band".
 - 3> else:
 - 4> include the IE "UE radio access capability", including the IEs "RF capability FDD" and "Measurement capability" associated with the Band I [21];
 - 4> include the IE "UE radio access capability extension", including the IEs "RF capability FDD extension" and the "Measurement capability extension" associated with each supported UTRA FDD frequency band indicated in the IE "Frequency band".
- 1> For FDD, include the IE "UE radio access capability comp 2";
- 1> initiate the transfer of the INTER RAT HANDBOVER INFO message via the other radio access technology, using radio access technology-specific procedures;

- 1> store the following in the variable INTER_RAT_HANDOVER_INFO_TRANSFERRED if they were included in the INTER RAT HANDOVER INFO message:
 - 2> the IE "Predefined configuration status information";
 - 2> the IE "Predefined configuration status information compressed";
 - 2> the IE "UE security information";
 - 2> the IE "UE security information2";
 - 2> the IE "UE radio access capability";
 - 2> the IE "UE radio access capability extension"; and
 - 2> the IE "UE radio access capability compressed";
 - 2> if the IE "UE radio access capability compressed" were included in the INTER RAT HANDOVER INFO message:
- 3> set the IE "Security Capability" to the mandatory R99 algorithms.
- 1> and the procedure ends.

8.2 Radio Bearer control procedures

8.2.1 Radio bearer establishment

See subclause 8.2.2 Reconfiguration procedures.

8.2.2 Reconfiguration procedures

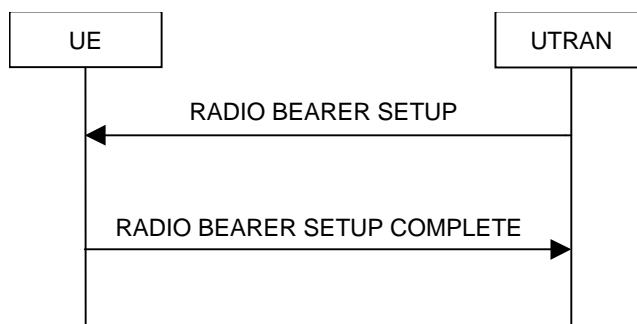

Figure 8.2.2-1: Radio Bearer Establishment, normal case

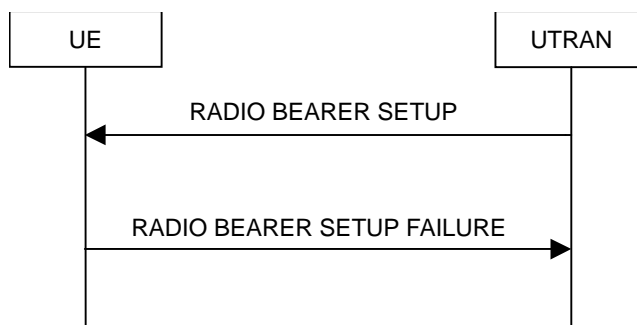

Figure 8.2.2-2: Radio Bearer Establishment, failure case

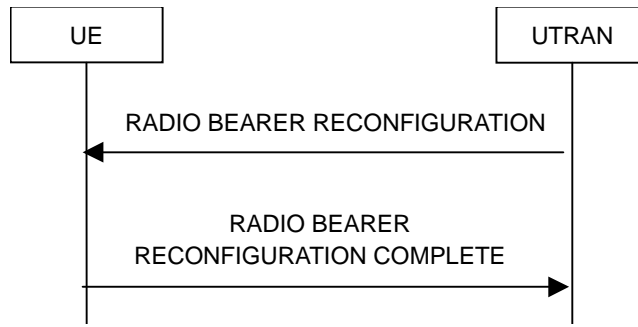

Figure 8.2.2-3: Radio bearer reconfiguration, normal flow

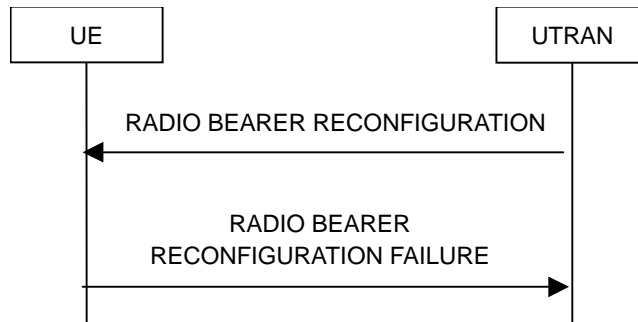

Figure 8.2.2-4: Radio bearer reconfiguration, failure case

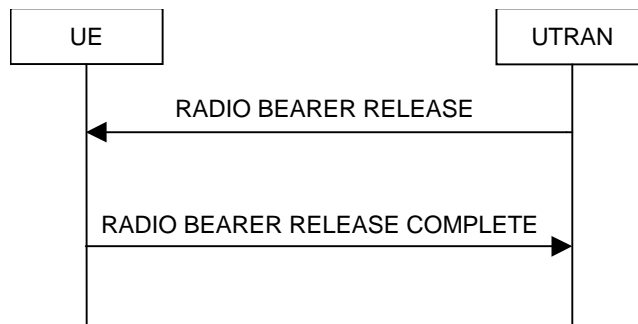

Figure 8.2.2-5: Radio Bearer Release, normal case

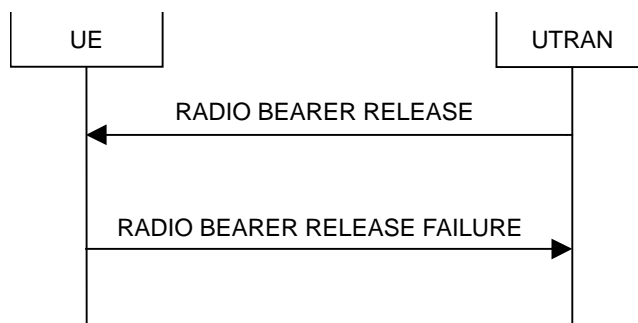

Figure 8.2.2-6: Radio Bearer Release, failure case

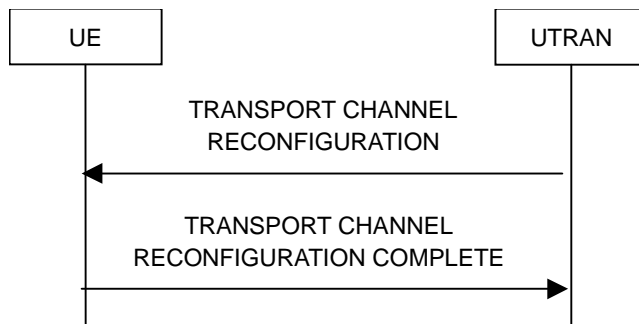

Figure 8.2.2-7: Transport channel reconfiguration, normal flow

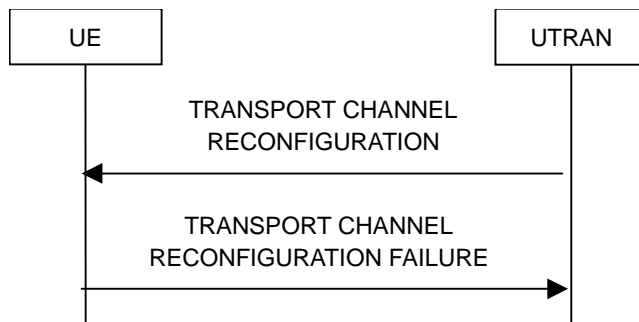

Figure 8.2.2-8: Transport channel reconfiguration, failure case

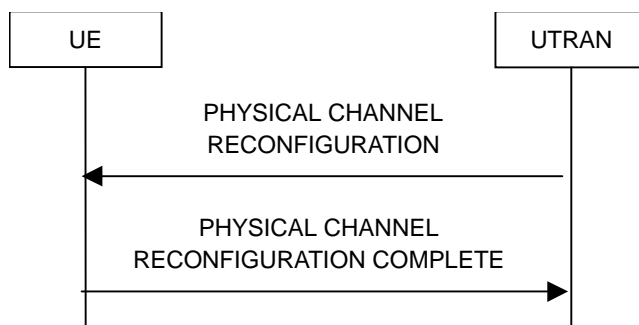

Figure 8.2.2-9: Physical channel reconfiguration, normal flow

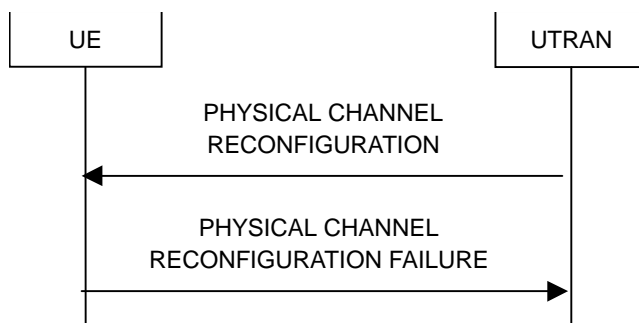

Figure 8.2.2-10: Physical channel reconfiguration, failure case

8.2.2.1 General

Reconfiguration procedures include the following procedures:

- the radio bearer establishment procedure;
- radio bearer reconfiguration procedure;

- the radio bearer release procedure;
- the transport channel reconfiguration procedure; and
- the physical channel reconfiguration procedure.

The radio bearer establishment procedure is used to establish new radio bearer(s).

The radio bearer reconfiguration procedure is used to reconfigure parameters for a radio bearer.

The radio bearer release procedure is used to release radio bearer(s).

The transport channel reconfiguration procedure is used to reconfigure transport channel parameters.

The physical channel reconfiguration procedure is used to establish, reconfigure and release physical channels.

While performing any of the above procedures, these procedures may perform a hard handover (subclause 8.3.5) and/or an HS-DSCH cell change and/or a serving E-DCH cell change. The reconfiguration procedures are also used to change the feedback configuration for HS-DSCH.

8.2.2.2 Initiation

To initiate any one of the reconfiguration procedures, UTRAN should:

- 1> configure new radio links in any new physical channel configuration;
- 1> start transmission and reception on the new radio links;
- 1> for a radio bearer establishment procedure:
 - 2> transmit a RADIO BEARER SETUP message on the downlink DCCH using AM or UM RLC;
 - 2> if signalling radio bearer RB4 is setup with this procedure and signalling radio bearers RB1-RB3 were already established prior to the procedure:
 - 3> if the variable "LATEST_CONFIGURED_CN_DOMAIN" has been initialised:
 - 4> connect any radio bearers setup by the same message as signalling radio bearer RB4 to the CN domain indicated in the variable "LATEST_CONFIGURED_CN_DOMAIN".
- 1> for a radio bearer reconfiguration procedure:
 - 2> transmit a RADIO BEARER RECONFIGURATION message on the downlink DCCH using AM or UM RLC.
- 1> for a radio bearer release procedure:
 - 2> transmit a RADIO BEARER RELEASE message on the downlink DCCH using AM or UM RLC.
- 1> for a transport channel reconfiguration procedure:
 - 2> transmit a TRANSPORT CHANNEL RECONFIGURATION message on the downlink DCCH using AM or UM RLC.
- 1> for a physical channel reconfiguration procedure:
 - 2> transmit a PHYSICAL CHANNEL RECONFIGURATION message on the downlink DCCH using AM or UM RLC.
- 1> if the reconfiguration procedure is simultaneous with SRNS relocation procedure:
 - 2> if the transmitted message is a RADIO BEARER RECONFIGURATION:
 - 3> include the IE "New U-RNTI".
 - 2> else:

- 3> include the IE "Downlink counter synchronisation info".
- 2> if ciphering and/or integrity protection are activated:
 - 3> include new ciphering and/or integrity protection configuration information to be used after reconfiguration.
- 2> use the downlink DCCH using AM RLC.
- 1> if transport channels are added, reconfigured or deleted in uplink and/or downlink:
 - 2> set TFCS according to the new transport channel(s).
- 1> if transport channels are added or deleted in uplink and/or downlink, and RB Mapping Info applicable to the new configuration has not been previously provided to the UE, the UTRAN should:
 - 2> send the RB Mapping Info for the new configuration.

In the Radio Bearer Reconfiguration procedure UTRAN may indicate that uplink transmission shall be stopped or continued on certain radio bearers. Uplink transmission on a signalling radio bearer used by the RRC signalling (signalling radio bearer RB1 or signalling radio bearer RB2) should not be stopped.

NOTE 1: The Release '99 RADIO BEARER RECONFIGURATION message always includes the IE "RB information to reconfigure", even if UTRAN does not require the reconfiguration of any RB. In these cases, UTRAN may include only the IE "RB identity" within the IE "RB information to reconfigure".

NOTE 2: The Release '99 RADIO BEARER RECONFIGURATION message always includes the IE "Downlink information per radio link list", even if UTRAN does not require the reconfiguration of any RL. In these cases, UTRAN may re-send the currently assigned values for the mandatory IEs included within the IE "Downlink information per radio link list".

NOTE 3: The Release '99 RADIO BEARER RECONFIGURATION message always includes the IE "Primary CPICH Info" (FDD) or IE "Primary CCPCH Info" (TDD) within IE "Downlink information per radio link list". This implies that in case UTRAN applies the RADIO BEARER RECONFIGURATION message to move the UE to CELL_FACH state, it has to indicate a cell. However, UTRAN may indicate any cell; the UE anyhow performs cell selection and notifies UTRAN if it selects another cell than indicated by UTRAN.

If the IE "Activation Time" is included, UTRAN should set it to a value taking the UE performance requirements into account.

UTRAN should take the UE capabilities into account when setting the new configuration.

If the message is used to initiate a transition from CELL_DCH to CELL_FACH state, the UTRAN may assign a C-RNTI to be used in that cell by the UE. In FDD, if a C-RNTI is assigned, then UTRAN may additionally assign an H-RNTI to be used in that cell by the UE.

For FDD, if the message is used to initiate a transition to CELL_PCH state, the UTRAN may assign a C-RNTI and an H-RNTI to be used in that cell by the UE.

8.2.2.2a Initiation of handover from GERAN *Iu mode*

To initiate the handover from GERAN *Iu mode*, UTRAN should:

- 1> provide a RADIO BEARER RECONFIGURATION message to be encapsulated in INTERSYSTEM HANDOVER TO UTRAN COMMAND message, sent on the downlink SRB2 in GERAN *Iu mode*, as specified in [53].
- 1> in case UTRAN decides to use a predefined or default radio configuration that is stored in the UE, it should include the following information in the RADIO BEARER RECONFIGURATION message:
 - PhyCH information elements; and
 - either:

- the IE "Predefined configuration identity", to indicate which pre-defined configuration of RB, transport channel and physical channel parameters shall be used; or
- the IE "Default configuration mode" and IE "Default configuration identity", to indicate which default configuration of RB, transport channel and physical channel parameters shall be used.

8.2.2.3 Reception of RADIO BEARER SETUP or RADIO BEARER RECONFIGURATION or RADIO BEARER RELEASE or TRANSPORT CHANNEL RECONFIGURATION or PHYSICAL CHANNEL RECONFIGURATION message by the UE

The UE shall:

- 1> be able to receive any of the following messages:
 - 2> RADIO BEARER SETUP message; or
 - 2> RADIO BEARER RECONFIGURATION message; or
 - 2> RADIO BEARER RELEASE message; or
 - 2> TRANSPORT CHANNEL RECONFIGURATION message; or
 - 2> PHYSICAL CHANNEL RECONFIGURATION message;
- 1> be able to perform a hard handover and apply physical layer synchronisation procedure A as specified in [29], even if no prior UE measurements have been performed on the target cell and/or frequency.

In case the reconfiguration procedure is used to remove all existing RL(s) in the active set while new RL(s) are established the UE shall:

- 1> For FDD:
 - 2> if the UE has a pending "TGPS reconfiguration CFN" at the activation time received in the reconfiguration message and the reconfiguration requests a timing re-initialised hard handover (see subclause 8.3.5.1), the UE may:
 - 3> abort the pending CM activation;
 - 3> set the CM_PATTERN_ACTIVATION_ABORTED to TRUE.
 - 2> otherwise:
 - 3> set the CM_PATTERN_ACTIVATION_ABORTED to FALSE.

If the UE receives:

- a RADIO BEARER SETUP message; or
- a RADIO BEARER RECONFIGURATION message; or
- a RADIO BEARER RELEASE message; or
- a TRANSPORT CHANNEL RECONFIGURATION message; or
- a PHYSICAL CHANNEL RECONFIGURATION message:

it shall:

- 1> set the variable ORDERED_RECONFIGURATION to TRUE;
- 1> if the UE will enter the CELL_DCH state from any state other than CELL_DCH state at the conclusion of this procedure:
 - 2> perform the physical layer synchronisation procedure A as specified in [29] (FDD only).

- 1> act upon all received information elements as specified in subclause 8.6, unless specified in the following and perform the actions below.

The UE may:

- 1> maintain a list of the set of cells to which the UE has Radio Links if the IE "Cell ID" is present.

The UE may first release the physical channel configuration used at reception of the reconfiguration message. The UE shall then:

- 1> enter a state according to subclause 8.6.3.3.

In case the UE receives a RADIO BEARER RECONFIGURATION message including the IE "RB information to reconfigure" that only includes the IE "RB identity", the UE shall:

- 1> handle the message as if IE "RB information to reconfigure" was absent.

NOTE: The ASN.1 "r3" version of the RADIO BEARER RECONFIGURATION message always includes the IE "RB information to reconfigure". UTRAN has to include it even if it does not require the reconfiguration of any RB.

In case the UE receives a RADIO BEARER RECONFIGURATION message with the IE "Specification mode" set to "Preconfiguration" while the message is not sent through GERAN *Iu mode*, the UE behaviour is unspecified.

In case the UE receives a RADIO BEARER SETUP message with the IE "Specification mode" not set to "Complete Specification", the UE behaviour is unspecified.

If after state transition the UE enters CELL_DCH state, the UE shall, after the state transition:

- 1> in FDD; or
- 1> in TDD when "Primary CCPCH Info" is included indicating a new target cell and "New C-RNTI" is not specified:
 - 2> remove any C-RNTI from MAC;
 - 2> clear the variable C_RNTI.

If after state transition the UE leaves CELL_DCH state, the UE shall, after the state transition:

- 1> if any IEs related to HS-DSCH are stored in the UE:
 - 2> clear any stored IE "Downlink HS-PDSCH information";
 - 2> for 1.28Mcps TDD, clear the IE "HS-PDSCH Midamble Configuration" and the IE "HS-SCCH Set Configuration" in the IE "DL Multi Carrier Information";
 - 2> determine the value for the HS_DSCH_RECEPTION variable and take the corresponding actions as described in subclause 8.5.25.
- 1> if any IEs related to E-DCH are stored in the UE:
 - 2> clear any stored IE "E-DCH info";
 - 2> determine the value for the E_DCH_TRANSMISSION variable and take the corresponding actions as described in subclause 8.5.28.
- 1> if any of the IEs "DTX-DRX timing information" or "DTX-DRX information" are stored in the UE:
 - 2> determine the value for the DTX_DRX_STATUS variable and take the corresponding actions as described in subclause 8.5.34.
- 1> if the IE "HS-SCCH less information" is stored in the UE:
 - 2> determine the value for the HS_SCCH_LESS_STATUS variable and take the corresponding actions as described in subclause 8.5.35.

- 1> if any IEs related to MIMO are stored in the UE:
 - 2> determine the value for the MIMO_STATUS variable and take the corresponding actions as described in subclause 8.5.33.
- 1> if the IE "UE Mobility State Indicator" was present in the reconfiguration message:
 - 2> consider the High-mobility state to have being detected.

If the UE was in CELL_DCH state upon reception of the reconfiguration message and remains in CELL_DCH state, the UE shall:

- 1> if the IE "Uplink DPCH Info" is absent, not change its current UL Physical channel configuration;
- 1> in TDD:
 - 2> if "Primary CCPCH Info" is included indicating a new target cell and "New C-RNTI" is not specified:
 - 3> remove any C-RNTI from MAC;
 - 3> clear the variable C_RNTI.
 - 2> if "Primary CCPCH Info" is included indicating a new target cell and "New H-RNTI" is not specified:
 - 3> remove any H-RNTI from MAC;
 - 3> clear the variable H_RNTI;
 - 3> determine the value for the HS_DSCH_RECEPTION variable and take the corresponding actions as described in subclause 8.5.25.
 - 2> if the reconfiguration message caused a change from FDD mode to 3.84/7.68 Mcps TDD mode and provides for E-DCH/HS-DSCH operation without an uplink DPCH:
 - 3> the UE shall obtain timing advance for the 3.84/7.68 Mcps TDD cell according to [15].
- 1> if "DPCH frame offset" is included for one or more RLS in the active set, and the reconfiguration procedure does not request a timing reinitialized hard handover (see subclause 8.3.5.1):
 - 2> use its value to determine the beginning of the DPCH or F-DPCH frame in accordance with the following:
 - 3> if the received IE "DPCH frame offset" is across the value range border compared to the DPCH or F-DPCH frame offset currently used by the UE:
 - 4> consider it to be a request to adjust the timing with 256 chips across the frame border (e.g. if the UE receives value 0 while the value currently used is 38144 consider this as a request to adjust the timing with +256 chips).
 - 3> if after taking into account value range borders, the received IE "DPCH frame offset" corresponds to a request to adjust the timing with a step exceeding 256 chips:
 - 4> set the variable INVALID_CONFIGURATION to TRUE.
 - 3> and the procedure ends.
- 2> adjust the radio link timing accordingly.

If after state transition the UE enters CELL_FACH state, the UE shall, after the state transition:

- 1> if the IE "Frequency info" is included in the received reconfiguration message:
 - 2> select a suitable UTRA cell according to [4] on that frequency;
 - 2> if the UE finds a suitable UTRA cell on that frequency:
 - 3> if the received reconfiguration message included the IE "Primary CPICH info" (for FDD) or "Primary CCPCH info" (for TDD), and the UE selects another cell than indicated by this IE or the received

reconfiguration message did not include the IE "Primary CPICH info" (for FDD) or "Primary CCPCH info" (for TDD):

4> initiate a cell update procedure according to subclause 8.3.1 using the cause "Cell reselection";

4> when the cell update procedure completed successfully:

5> if the UE is in CELL_PCH or URA_PCH state:

6> if variable H_RNTI and variable C_RNTI are set:

7> proceed as below.

6> else:

7> initiate a cell update procedure according to subclause 8.3.1 using the cause "Uplink data transmission" and proceed as below.

2> else, if the UE can not find a suitable UTRA cell on that frequency but it finds a suitable UTRA cell on another frequency:

3> initiate a cell update procedure according to subclause 8.3.1 using the cause "Cell reselection";

3> when the cell update procedure completed successfully:

4> if the UE is in CELL_PCH or URA_PCH state:

5> if variable H_RNTI and variable C_RNTI are set:

6> proceed as below.

5> else:

6> initiate a cell update procedure according to subclause 8.3.1 using the cause "Uplink data transmission" and proceed as below.

1> if the IE "Frequency info" is not included in the received reconfiguration message:

2> select a suitable UTRA cell according to [4];

2> if the UE finds a suitable UTRA cell on the current frequency:

3> if the received reconfiguration message included the IE "Primary CPICH info" (for FDD) or "Primary CCPCH info" (for TDD), and the UE selects another cell than indicated by this IE or the received reconfiguration message did not include the IE "Primary CPICH info" (for FDD) or "Primary CCPCH info" (for TDD):

4> initiate a cell update procedure according to subclause 8.3.1 using the cause "Cell reselection";

4> when the cell update procedure completed successfully:

5> if the UE is in CELL_PCH or URA_PCH state:

6> if variable H_RNTI and variable C_RNTI are set:

7> proceed as below.

6> else:

7> initiate a cell update procedure according to subclause 8.3.1 using the cause "Uplink data transmission" and proceed as below.

2> else, if the UE can not find a suitable UTRA cell on the current frequency but it finds a suitable UTRA cell on another frequency:

3> initiate a cell update procedure according to subclause 8.3.1 using the cause "Cell reselection";

3> when the cell update procedure completed successfully:

- 4> if the UE is in CELL_PCH or URA_PCH state:
 - 5> if variable H_RNTI and variable C_RNTI are set:
 - 6> proceed as below.
 - 5> else:
 - 6> initiate a cell update procedure according to subclause 8.3.1 using the cause "Uplink data transmission" and proceed as below.
- 1> start timer T305 using its initial value if timer T305 is not running and if periodical update has been configured by T305 in the IE "UE Timers and constants in connected mode" set to any other value than "infinity" in the variable TIMERS_AND_CONSTANTS;
- 1> select PRACH according to subclause 8.5.17;
- 1> for TDD; or
- 1> for FDD, if the UE does not support HS-DSCH reception in CELL_FACH state; or
- 1> if the IE "HS-DSCH common system information" is not included in System Information Block type 5 or System Information Block type 5bis:
 - 2> select Secondary CCPCH according to subclause 8.5.19;
 - 2> use the transport format set given in system information;
 - 2> take the actions related to the HS_DSCH_RECEPTION_GENERAL variable as described in subclause 8.5.37a.
- 1> else:
 - 2> if the RBs have the multiplexing option with transport channel type "HS-DSCH" for the DL and transport channel type "RACH" in the UL; and
 - 2> if variable H_RNTI and variable C_RNTI are set:
 - 3> start to receive HS-DSCH according to the procedure in subclause 8.5.36.
 - 2> else:
 - 3> clear variable C_RNTI and delete any stored C-RNTI value;
 - 3> clear variable H_RNTI and delete any stored H-RNTI value;
 - 3> clear any stored IE "HARQ Info".
- 1> if the IE "UTRAN DRX cycle length coefficient" is included in the same message:
 - 2> ignore that IE and stop using DRX.
- 1> if the contents of the variable C_RNTI is empty:
 - 2> perform a cell update procedure according to subclause 8.3.1 using the cause "Cell reselection";
 - 2> when the cell update procedure completed successfully:
 - 3> if the UE is in CELL_PCH or URA_PCH state:
 - 4> if variable H_RNTI and variable C_RNTI are set:
 - 5> proceed as below.
 - 4> else:
 - 5> initiate a cell update procedure according to subclause 8.3.1 using the cause "Uplink data transmission";

4> proceed as below.

If the UE was in CELL_FACH state upon reception of the reconfiguration message and remains in CELL_FACH state, the UE shall:

- 1> if the IE "Frequency info" is included in the received reconfiguration message:
 - 2> select a suitable UTRA cell according to [4] on that frequency;
 - 2> if the UE finds a suitable UTRA cell on that frequency:
 - 3> if the received reconfiguration message included the IE "Primary CPICH info" (for FDD) or "Primary CCPCH info" (for TDD), and the UE selected another cell than indicated by this IE or the received reconfiguration message did not include the IE "Primary CPICH info" (for FDD) or "Primary CCPCH info" (for TDD):
 - 4> initiate a cell update procedure according to subclause 8.3.1 using the cause "cell reselection";
 - 4> when the cell update procedure completed successfully:
 - 5> if the UE is in CELL_PCH or URA_PCH state:
 - 6> if variable H_RNTI and variable C_RNTI are set:
 - 7> proceed as below.
 - 6> else:
 - 7> initiate a cell update procedure according to subclause 8.3.1 using the cause "Uplink data transmission" and proceed as below.
 - 2> else, if the UE can not find a suitable UTRA cell on that frequency but it finds a suitable UTRA cell on another frequency:
 - 3> initiate a cell update procedure according to subclause 8.3.1 using the cause "Cell reselection";
 - 3> when the cell update procedure completed successfully:
 - 4> if the UE is in CELL_PCH or URA_PCH state:
 - 5> if variable H_RNTI and variable C_RNTI are set:
 - 6> proceed as below.
 - 5> else:
 - 6> initiate a cell update procedure according to subclause 8.3.1 using the cause "Uplink data transmission" and proceed as below.
 - 1> if the IE "Frequency info" is not included in the received reconfiguration message:
 - 2> if the IE "Primary CPICH info" (for FDD) or "Primary CCPCH info" (for TDD) is included the UE shall either:
 - 3> ignore the content of the IE "Primary CPICH info" (for FDD) or "Primary CCPCH info" (for TDD) and proceed as below;
 - 2> or:
 - 3> if the received reconfiguration message included the IE "Primary CPICH info" (for FDD) or "Primary CPCH info" (for TDD), and it is different from the current cell:
 - 4> initiate a cell update procedure according to subclause 8.3.1 using the cause "Cell reselection";
 - 4> when the cell update procedure completed successfully:
 - 5> if the UE is in CELL_PCH or URA_PCH state:

- 6> if variable H_RNTI and variable C_RNTI are set:
 - 7> proceed as below.
- 6> else:
 - 7> initiate a cell update procedure according to subclause 8.3.1 using the cause "Uplink data transmission" and proceed as below.

If after state transition the UE leaves CELL_FACH state, the UE shall:

- 1> stop timer T305.

If after state transition the UE enters CELL_PCH or URA_PCH state, the UE shall:

- 1> if the IE "UTRAN DRX cycle length coefficient" is not included in the same message:
 - 2> set the variable INVALID_CONFIGURATION to TRUE.

The UE shall transmit a response message as specified in subclause 8.2.2.4, setting the information elements as specified below. The UE shall:

- 1> if the received reconfiguration message included the IE "Downlink counter synchronisation info"; or
- 1> if the received reconfiguration message is a RADIO BEARER RECONFIGURATION and the IE "New U-RNTI" is included:
 - 2> if the variable PDCP_SN_INFO is empty:
 - 3> configure the corresponding RLC entity for all AM and UM radio bearers and AM and UM signalling radio bearers except RB2 to "stop".
 - 2> else:
 - 3> configure the RLC entity for signalling radio bearers RB1, RB3 and RB4 to "stop";
 - 3> configure the RLC entity for UM and AM radio bearers for which the IE "PDCP SN Info" is not included to "stop".
 - 2> re-establish the RLC entity for RB2;
 - 2> for the downlink and the uplink, apply the ciphering configuration as follows:
 - 3> if the received re-configuration message included the IE "Ciphering Mode Info":
 - 4> use the ciphering configuration in the received message when transmitting the response message.
 - 3> if the ciphering configuration for RB2 from a previously received SECURITY MODE COMMAND has not yet been applied because the activation times not having been reached:
 - 4> if the previous SECURITY MODE COMMAND was received due to new keys being received:
 - 5> consider the new ciphering configuration to include the received new keys;
 - 5> initialise the HFN component of the uplink COUNT-C and downlink COUNT-C of SRB2 as indicated in subclause 8.1.12.3.1.
 - 4> else if the ciphering configuration for RB2 from a previously received SECURITY MODE COMMAND has not yet been applied because of the corresponding activation times not having been reached and the previous SECURITY MODE COMMAND caused a change in LATEST_CONFIGURED_CN_DOMAIN:
 - 5> consider the new ciphering configuration to include the keys associated with the LATEST_CONFIGURED_CN_DOMAIN;
 - 5> initialise the HFN component of the uplink COUNT-C and downlink COUNT-C of SRB2 to the most recently transmitted IE "START list" or IE "START" for the

LATEST_CONFIGURED_CN_DOMAIN at the reception of the previous SECURITY MODE COMMAND.

- 4> apply the new ciphering configuration immediately following RLC re-establishment.
- 3> else:
 - 4> continue using the current ciphering configuration.
- 2> set the new uplink and downlink HFN component of COUNT-C of RB2 to MAX(uplink HFN component of COUNT-C of RB2, downlink HFN component of COUNT-C of RB2);
- 2> increment by one the downlink and uplink values of the HFN of COUNT-C for RB2;
- 2> calculate the START value according to subclause 8.5.9;
- 2> include the calculated START values for each CN domain in the IE "START list" in the IE "Uplink counter synchronisation info".
- 1> if the received reconfiguration message did not include the IE "Downlink counter synchronisation info":
 - 2> if the variable START_VALUE_TO_TRANSMIT is set:
 - 3> include and set the IE "START" to the value of that variable.
 - 2> if the variable START_VALUE_TO_TRANSMIT is not set and the IE "New U-RNTI" is included:
 - 3> calculate the START value according to subclause 8.5.9;
 - 3> include the calculated START values for each CN domain in the IE "START list" in the IE "Uplink counter synchronisation info".
 - 2> if the received reconfiguration message caused a change in the RLC PDU size, a change from flexible to fixed DL RLC PDU size or a change from fixed to flexible DL RLC PDU size with RLC length indicator set to 15 bits or a change of the RLC LI size for any RB using RLC-AM:
 - 3> calculate the START value according to subclause 8.5.9;
 - 3> include the calculated START values for the CN domain associated with the corresponding RB identity in the IE "START list" in the IE "Uplink counter synchronisation info".
- 1> if the received reconfiguration message contained the IE "Ciphering mode info" or contained the IE "Integrity protection mode info":
 - 2> set the IE "Status" in the variable SECURITY_MODIFICATION for all the CN domains in the variable SECURITY_MODIFICATION to "Affected".
- 1> if the received reconfiguration message contained the IE "Ciphering mode info":
 - 2> if the reconfiguration message is not used to perform SRNS relocation or a handover from GERAN *Iu mode* with change of ciphering algorithm:
 - 3> the UE behaviour is not specified.
 - 2> if the message is used to perform a timing re-initialised hard handover:
 - 3> if IE "Ciphering activation time for DPCH" is included:
 - 4> the UE behaviour is not specified.
 - 2> else:
 - 3> if the reconfiguration message is used to setup radio bearer(s) using RLC-TM; or
 - 3> if radio bearer(s) using RLC-TM already exist:
 - 4> if IE "Ciphering activation time for DPCH" is not included:

5> the UE behaviour is not specified.

1> if the received reconfiguration message contained the IE "Integrity Protection mode info":

2> if the reconfiguration message is not used to perform SRNS relocation or a handover from GERAN *Iu mode*:

3> the UE behaviour is not specified.

1> if the received reconfiguration message did not contain the IE "Ciphering activation time for DPCH" in IE "Ciphering mode info":

2> if prior to this procedure there exist no transparent mode RLC radio bearers:

3> if, at the conclusion of this procedure, the UE will be in CELL_DCH state; and

3> if, at the conclusion of this procedure, at least one transparent mode RLC radio bearer exists:

4> include the IE "COUNT-C activation time" and specify a CFN value for this IE that is a multiple of 8 frames ($CFN \bmod 8 = 0$) and lies at least 200 frames ahead of the CFN in which the response message is first transmitted.

NOTE: UTRAN should not include the IE "Ciphering mode info" in any reconfiguration message unless it is also used to perform an SRNS relocation with change of ciphering algorithm.

1> set the IE "RRC transaction identifier" to the value of "RRC transaction identifier" in the entry for the received message in the table "Accepted transactions" in the variable TRANSACTIONS; and

1> clear that entry;

1> if the variable PDCP_SN_INFO is not empty:

2> include the IE "RB with PDCP information list" and set it to the value of the variable PDCP_SN_INFO.

1> in TDD, if the procedure is used to perform a handover to a cell where timing advance is enabled, and the UE can calculate the timing advance value in the new cell (i.e. in a synchronous TDD network):

2> set the IE "Uplink Timing Advance" according or the IE "Extended UL Timing Advance" to subclause 8.6.6.26.

1> if the IE "Integrity protection mode info" was present in the received reconfiguration message:

2> start applying the new integrity protection configuration in the uplink for signalling radio bearer RB2 from and including the transmitted response message.

1> if IE "RRC state indicator" is set to "CELL_DCH":

2> if the variable DEFERRED_MEASUREMENT_STATUS is set to TRUE:

3> if System Information Block type 11 is scheduled on the BCCH and the UE has not read nor stored the IEs present in this System Information Block, or

3> if System Information Block type 11bis is scheduled on the BCCH and the UE has not read nor stored the IEs present in this System Information Block, or

3> if System Information Block type 12 is scheduled on the BCCH and the UE has not read nor stored the IEs present in this System Information Block:

4> include IE "Deferred measurement control reading".

If after state transition the UE enters CELL_DCH state, the UE shall, after the state transition:

1> if the IE "Deferred measurement control reading" was included in the response message:

2> clear the variable CELL_INFO_LIST.

If after state transition the UE enters URA_PCH state, the UE shall, after the state transition and transmission of the response message:

- 1> if the IE "Frequency info" is included in the received reconfiguration message:
 - 2> select a suitable UTRA cell according to [4] on that frequency.
 - 2> if the UE can not find a suitable UTRA cell on that frequency but it finds a suitable UTRA cell on another frequency:
 - 3> proceed as below.
- 1> if the IE "Frequency info" is not included in the received reconfiguration message:
 - 2> select a suitable UTRA cell according to [4].
- 1> prohibit periodical status transmission in RLC;
- 1> for TDD; or
- 1> for FDD, if the UE does not support HS-DSCH reception in CELL_PCH and URA_PCH state; or
- 1> if the IE "HS-DSCH paging system information" is not included in System Information Block type 5 or System Information Block type 5bis:
 - 2> remove any C-RNTI from MAC;
 - 2> clear the variable C_RNTI;
- 1> start timer T305 using its initial value if timer T305 is not running and if periodical update has been configured by T305 in the IE "UE Timers and constants in connected mode" set to any other value than "infinity" in the variable TIMERS_AND_CONSTANTS;
- 1> for TDD; or
- 1> for FDD, if the UE does not support HS-DSCH reception in CELL_PCH and URA_PCH state; or
- 1> if the IE "HS-DSCH paging system information" is not included:
 - 2> select Secondary CCPCH according to subclause 8.5.19;
 - 2> take the actions related to the HS_DSCH_RECEPTION_GENERAL variable as described in subclause 8.5.37a.
- 1> else:
 - 2> clear variable C_RNTI and delete any stored C-RNTI value;
 - 2> clear variable H_RNTI and delete any stored H-RNTI value;
 - 2> clear any stored IE "HARQ Info";
 - 2> reset the MAC-ehs entity [15];
 - 2> monitor its paging occasions on the selected PICH determined according to subclauses 8.6.3.1a, 8.6.3.2 and 8.5.39 and receive paging on the HS-DSCH mapped on the HS-PDSCH selected by the UE according to the procedures in subclause 8.5.40.
- 1> if the IE "UTRAN DRX cycle length coefficient" is included in the same message:
 - 2> use the values in the IE "UTRAN DRX Cycle length coefficient" for calculating Paging occasion and PICH Monitoring Occasion as specified in subclause 8.6.3.2.
- 1> if the criteria for URA update caused by "URA reselection" according to subclause 8.3.1 are fulfilled after cell selection:
 - 2> initiate a URA update procedure according to subclause 8.3.1 using the cause "URA reselection";

- 2> when the URA update procedure is successfully completed:
- 3> the procedure ends.

If after state transition the UE enters CELL_PCH state from CELL_DCH state, the UE shall, after the state transition and transmission of the response message:

- 1> if the IE "Frequency info" is included in the received reconfiguration message:
 - 2> select a suitable UTRA cell according to [4] on that frequency.
 - 2> if the UE finds a suitable UTRA cell on that frequency:
 - 3> if the received reconfiguration message included the IE "Primary CPICH info" (for FDD) or "Primary CCPCH info" (for TDD), and the UE selects another cell than indicated by this IE or the received reconfiguration message did not include the IE "Primary CPICH info" (for FDD) or "Primary CCPCH info" (for TDD):
 - 4> initiate a cell update procedure according to subclause 8.3.1 using the cause "Cell reselection";
 - 4> proceed as below.
 - 2> else, if the UE can not find a suitable UTRA cell on that frequency but it finds a suitable UTRA cell on another frequency:
 - 3> initiate a cell update procedure according to subclause 8.3.1 using the cause "Cell reselection";
 - 3> proceed as below.
 - 1> if the IE "Frequency info" is not included in the received reconfiguration message:
 - 2> select a suitable UTRA cell according to [4].
 - 2> if the UE finds a suitable UTRA cell on the current frequency:
 - 3> if the received reconfiguration message included the IE "Primary CPICH info" (for FDD) or "Primary CCPCH info" (for TDD), and the UE selects another cell than indicated by this IE or the received reconfiguration message did not include the IE "Primary CPICH info" (for FDD) or "Primary CCPCH info" (for TDD):
 - 4> initiate a cell update procedure according to subclause 8.3.1 using the cause "Cell reselection";
 - 4> proceed as below.
 - 2> else, if the UE can not find a suitable UTRA cell on the current frequency but it finds a suitable UTRA cell on another frequency:
 - 3> initiate a cell update procedure according to subclause 8.3.1 using the cause "Cell reselection";
 - 3> proceed as below.
 - 1> prohibit periodical status transmission in RLC;
 - 1> for TDD; or
 - 1> for FDD, if the UE does not support HS-DSCH reception in CELL_PCH and URA_PCH state; or
 - 1> if the IE "HS-DSCH paging system information" is not included in System Information Block type 5 or System Information Block type 5bis:
 - 2> remove any C-RNTI from MAC;
 - 2> clear the variable C_RNTI.
 - 1> start timer T305 using its initial value if timer T305 is not running and if periodical update has been configured by T305 in the IE "UE Timers and constants in connected mode" set to any other value than "infinity" in the variable TIMERS_AND_CONSTANTS;

- 1> for TDD; or
- 1> for FDD, if the UE does not support HS-DSCH reception in CELL_PCH and URA_PCH state; or
- 1> if the IE "HS-DSCH paging system information" is not included in System Information Block type 5 or System Information Block type 5bis:
 - 2> select Secondary CCPCH according to subclause 8.5.19;
 - 2> take the actions related to the HS_DSCH_RECEPTION_GENERAL variable as described in subclause 8.5.37a.
- 1> else:
 - 2> if IE "New C-RNTI" is not included:
 - 3> clear variable H_RNTI and delete any stored H-RNTI value;
 - 3> clear any stored IE "HARQ Info";
 - 3> reset the MAC-ehs entity [15].
 - 2> monitor its paging occasions on the selected PICH determined according to subclauses 8.6.3.1a, 8.6.3.2 and 8.5.39 and receive PCCH or DCCH and DTCH on the HS-DSCH according to the procedures in subclause 8.5.40.
- 1> if the IE "UTRAN DRX cycle length coefficient" is included in the same message:
 - 2> use the values in the IE "UTRAN DRX Cycle length coefficient" for calculating Paging occasion and PICH Monitoring Occasion as specified in subclause 8.6.3.2.
- 1> the procedure ends.

If after state transition the UE enters CELL_DCH state from CELL_FACH or from CELL_PCH state:

- 1> if the IE "Default DPCH Offset Value" is not included:
 - 2> the UE behaviour is not specified.

If after state transition the UE enters CELL_PCH state from CELL_FACH state, the UE shall, after the state transition and transmission of the response message:

- 1> if the IE "Frequency info" is included in the received reconfiguration message:
 - 2> select a suitable UTRA cell according to [4] on that frequency.
 - 2> if the UE finds a suitable UTRA cell on that frequency:
 - 3> if the received reconfiguration message included the IE "Primary CPICH info" (for FDD) or "Primary CCPCH info" (for TDD), and the UE selected another cell than indicated by this IE or the received reconfiguration message did not include the IE "Primary CPICH info" (for FDD) or "Primary CCPCH info" (for TDD):
 - 4> initiate a cell update procedure according to subclause 8.3.1 using the cause "cell reselection";
 - 4> proceed as below.
 - 2> else, if the UE can not find a suitable UTRA cell on that frequency but it finds a suitable UTRA cell on another frequency:
 - 3> initiate a cell update procedure according to subclause 8.3.1 using the cause "Cell reselection";
 - 3> proceed as below.
- 1> if the IE "Frequency info" is not included in the received reconfiguration message:
 - 2> if the IE "Primary CPICH info" (for FDD) or "Primary CCPCH info" (for TDD) is included the UE shall either:

- 3> ignore the content of the IE "Primary CPICH info" (for FDD) or "Primary CCPCH info" (for TDD) and proceed as below;
- 2> or:
 - 3> if the received reconfiguration message included the IE "Primary CPICH info" (for FDD) or "Primary CPCH info" (for TDD), and it is different from the current cell:
 - 4> initiate a cell update procedure according to subclause 8.3.1 using the cause "Cell reselection";
 - 4> proceed as below.
- 1> prohibit periodical status transmission in RLC;
- 1> for TDD; or
- 1> for FDD, if the UE does not support HS-DSCH reception in CELL_PCH and URA_PCH state; or
- 1> if the IE "HS-DSCH paging system information" is not included in System Information Block type 5 or System Information Block type 5bis:
 - 2> remove any C-RNTI from MAC;
 - 2> clear the variable C_RNTI.
- 1> start timer T305 using its initial value if timer T305 is not running and if periodical update has been configured by T305 in the IE "UE Timers and constants in connected mode" set to any other value than "infinity" in the variable TIMERS_AND_CONSTANTS;
- 1> for TDD; or
- 1> for FDD, if the UE does not support HS-DSCH reception in CELL_PCH and URA_PCH state; or
- 1> if the IE "HS-DSCH paging system information" is not included in System Information Block type 5 or System Information Block type 5bis:
 - 2> select Secondary CCPCH according to subclause 8.5.19;
 - 2> take the actions related to the HS_DSCH_RECEPTION_GENERAL variable as described in subclause 8.5.37a.
- 1> else:
 - 2> if IE "New C-RNTI" is not included:
 - 3> clear variable C_RNTI and delete any stored C-RNTI value;
 - 3> clear variable H_RNTI and delete any stored H-RNTI value;
 - 3> clear any stored IE "HARQ Info";
 - 3> reset the MAC-ehs entity [15].
 - 2> monitor its paging occasions on the selected PICH determined according to subclauses 8.6.3.1a, 8.6.3.2 and 8.5.39 and receive PCCH or DCCH and DTCH on the HS-DSCH according to the procedures in subclause 8.5.40.
- 1> if the IE "UTRAN DRX cycle length coefficient" is included in the same message:
 - 2> use the values in the IE "UTRAN DRX Cycle length coefficient" for calculating Paging occasion and PICH Monitoring Occasion as specified in subclause 8.6.3.2.
- 1> the procedure ends.

8.2.2.3a Reception of RADIO BEARER RECONFIGURATION message by the UE performing handover from GERAN *Iu mode*

If the UE is performing handover from GERAN *Iu mode*, the UE shall, in addition to the actions in 8.2.2.3:

- 1> if the IE "Specification mode" is set to "Preconfiguration" and the IE "Preconfiguration mode" is set to "Predefined configuration":
 - 2> initiate the radio bearer and transport channel configuration in accordance with the predefined parameters identified by the IE "Predefined configuration identity";
 - 2> initiate the physical channels in accordance with the predefined parameters identified by the IE "Predefined radio configuration identity" and the received physical channel information elements;
 - 2> store information about the established radio access bearers and radio bearers according to the IE "Predefined configuration identity"; and
- 1> if the IE "Specification mode" is set to "Preconfiguration" and the IE "Preconfiguration mode" is set to "Default configuration":
 - 2> initiate the radio bearer and transport channel configuration in accordance with the default parameters identified by the IE "Default configuration mode" and the IE "Default configuration identity";
 - 2> initiate the physical channels in accordance with the default parameters identified by the IE "Default configuration mode" and IE "Default configuration identity" and the received physical channel information elements;

NOTE: The IE "Default configuration mode" specifies whether the FDD or TDD version of the default configuration shall be used.

- 1> if IE "Specification mode" is set to "Complete specification":
 - 2> initiate the radio bearer, transport channel and physical channel configuration in accordance with the received radio bearer, transport channel and physical channel information elements.
- 1> perform an open loop estimation to determine the UL transmission power according to subclause 8.5.3;
- 1> set the following variables equal to the corresponding variables in GERAN *Iu mode*:

CIPHERING_STATUS

ESTABLISHED_RABS

ESTABLISHED_SIGNALLING_CONNECTIONS

INTEGRITY_PROTECTION_INFO

INTER_RAT_HANDOVER_INFO_TRANSFERRED

LATEST_CONFIGURED_CN_DOMAIN

START_THRESHOLD

UE_CAPABILITY_TRANSFERRED.

- 1> set the new uplink and downlink HFN of RB2 to $MSB_{20}(\text{MAX}(\text{uplink HFN of RB2}, \text{downlink HFN of RB2}))$;

NOTE: $MSB_{20}()$ operation provides the HFN mapping from GERAN *Iu mode* to UTRAN. In GERAN *Iu mode* the length of HFN component of the COUNT-C of RB2 is longer than 20 bits.

- 1> initialise the variable TIMERS_AND_CONSTANTS to the default values and start to use those timer and constants values.

8.2.2.4 Transmission of a response message by the UE, normal case

In case the procedure was triggered by reception of a RADIO BEARER SETUP message, the UE shall:

1> transmit a RADIO BEARER SETUP COMPLETE as response message on the uplink DCCH using AM RLC.

In case the procedure was triggered by reception of a RADIO BEARER RECONFIGURATION message, the UE shall:

1> transmit a RADIO BEARER RECONFIGURATION COMPLETE as response message on the uplink DCCH using AM RLC.

In case the procedure was triggered by reception of a RADIO BEARER RELEASE message, the UE shall:

1> transmit a RADIO BEARER RELEASE COMPLETE as response message on the uplink DCCH using AM RLC.

In case the procedure was triggered by reception of a TRANSPORT CHANNEL RECONFIGURATION message, the UE shall:

1> transmit a TRANSPORT CHANNEL RECONFIGURATION COMPLETE as response message on the uplink DCCH using AM RLC.

In case the procedure was triggered by reception of a PHYSICAL CHANNEL RECONFIGURATION message, the UE shall:

1> transmit a PHYSICAL CHANNEL RECONFIGURATION COMPLETE as response message on the uplink DCCH using AM RLC.

If the new state is CELL_DCH or CELL_FACH, the response message shall be transmitted using the new configuration after the state transition, and the UE shall:

1> if the IE "Downlink counter synchronisation info" was included in the reconfiguration message; or

1> if the received reconfiguration message is a RADIO BEARER RECONFIGURATION and the IE "New U-RNTI" is included:

2> when RLC has confirmed the successful transmission of the response message:

3> if the variable PDCP_SN_INFO is empty:

4> configure the RLC entity for all AM and UM radio bearers and AM and UM signalling radio bearers except RB2 to "continue".

3> else:

4> configure the RLC entity for signalling radio bearers RB1, RB3 and RB4 to "continue";

4> configure the RLC entity for UM and AM radio bearers for which the IE "PDCP SN Info" is not included to "continue".

3> re-establish all AM and UM RLC entities with RB identities larger than 4 and set the first 20 bits of all the HFN component of the respective COUNT-C values to the START value included in the response message for the corresponding CN domain;

3> re-establish the RLC entities with RB identities 1, 3 and 4 and set the first 20 bits of all the HFN component of the respective COUNT-C values to the START value included in the response message for the CN domain stored in the variable LATEST_CONFIGURED_CN_DOMAIN;

3> set the remaining bits of the HFN component of COUNT-C values of all UM RLC entities to zero;

3> if the IE "PDCP context relocation info" is not present:

4> re-initialise the PDCP header compression entities of each radio bearer in the variable ESTABLISHED_RABS as specified in [36].

3> if the IE "PDCP context relocation info" is present:

4> perform the actions as specified in subclause 8.6.4.13.

1> if the variable PDCP_SN_INFO is empty:

- 2> if the received reconfiguration message contained the IE "Ciphering mode info":
 - 3> when RLC has confirmed the successful transmission of the response message:
 - 4> notify upper layers upon change of the security configuration;
 - 4> perform the actions below.
 - 2> if the received reconfiguration message did not contain the IE "Ciphering mode info":
 - 3> when RLC has been requested to transmit the response message:
 - 4> perform the actions below.
- 1> if the variable PDCP_SN_INFO is non-empty:
 - 2> when RLC has confirmed the successful transmission of the response message:
 - 3> for each radio bearer in the variable PDCP_SN_INFO:
 - 4> if the IE "RB started" in the variable ESTABLISHED_RABS is set to "started":
 - 5> configure the RLC entity for that radio bearer to "continue".
 - 3> perform the actions below.

If the new state is CELL_PCH or URA_PCH, the response message shall be transmitted using the old configuration before the state transition, but the new C-RNTI shall be used if the IE "New C-RNTI" was included in the received reconfiguration message, and the UE shall:

- 1> when RLC has confirmed the successful transmission of the response message:
 - 2> for each radio bearer in the variable PDCP_SN_INFO:
 - 3> if the IE "RB started" in the variable ESTABLISHED_RABS is set to "started":
 - 4> configure the RLC entity for that radio bearer to "continue".
 - 2> enter the new state (CELL_PCH or URA_PCH, respectively);
 - 2> perform the actions below.

The UE shall:

- 1> set the variable ORDERED_RECONFIGURATION to FALSE;
- 1> if the received reconfiguration message contained the IE "Ciphering mode info":
 - 2> resume data transmission on any suspended radio bearer and signalling radio bearer mapped on RLC-AM or RLC-UM;
 - 2> set the IE "Reconfiguration" in the variable CIPHERING_STATUS to FALSE; and
 - 2> clear the variable RB_UPLINK_CIPHERING_ACTIVATION_TIME_INFO.
- 1> if the received reconfiguration message contained the IE "Integrity protection mode info":
 - 2> allow the transmission of RRC messages on all signalling radio bearers with any RRC SN;
 - 2> set "Uplink RRC Message sequence number" for signalling radio bearer RB0 in the variable INTEGRITY_PROTECTION_INFO to a value such that next RRC message to be sent on uplink RB0 will use the new integrity protection configuration;
 - 2> set the IE "Reconfiguration" in the variable INTEGRITY_PROTECTION_INFO to FALSE; and
 - 2> clear the variable INTEGRITY_PROTECTION_ACTIVATION_INFO.
- 1> clear the variable PDCP_SN_INFO;

- 1> clear the variable START_VALUE_TO_TRANSMIT;
- 1> clear the variable SECURITY_MODIFICATION.

8.2.2.5 Reception of a response message by the UTRAN, normal case

When UTRAN has received

- the RADIO BEARER SETUP COMPLETE message; or
- the RADIO BEARER RECONFIGURATION COMPLETE message; or
- the RADIO BEARER RELEASE COMPLETE message; or
- the TRANSPORT CHANNEL RECONFIGURATION COMPLETE message; or
- the PHYSICAL CHANNEL RECONFIGURATION COMPLETE message.

UTRAN may:

- 1> delete the old configuration.

If the procedure caused the UE to leave the CELL_FACH state, UTRAN may:

- 1> delete the C-RNTI of the UE.

If the IE "UL Timing Advance" or the IE "Extended UL Timing Advance" is included in TDD, UTRAN should:

- 1> evaluate the timing advance value that the UE has to use in the new cell after handover.

If the IE "START" or the IE "START list" is included, UTRAN should:

- 1> set the START value for each CN domain with the corresponding values as received in this response message;
- 1> consequently, then use the START values to initialise the hyper frame numbers, in the same way as specified for the UE in subclause 8.2.2.3, for any new radio bearers that are established.

If UTRAN has ordered a ciphering reconfiguration by including the IE "Ciphering mode info", UTRAN should:

- 1> for radio bearers using RLC-AM or RLC-UM:
 - 2> on the receiving side of an RLC entity apply the new ciphering configuration in uplink immediately;
 - 2> on the transmitting side of an RLC entity apply the new ciphering configuration in downlink immediately.
- 1> for radio bearers using RLC-TM:
 - 2> begin incrementing the COUNT-C at the CFN only as indicated in:
 - 3> the IE "Ciphering activation time for DPCH" in the IE "Ciphering mode info", if included in the message that triggered the radio bearer control procedure; or
 - 3> the IE "COUNT-C activation time", if included in the response message for this procedure.
- 1> and the procedure ends on the UTRAN side.

8.2.2.5a Rejection by the UE

If the UTRAN establishes one or more p-t-p radio bearer(s) for the transmission of a session of an MBMS service, identified by the IE "MBMS Session identity", for which upper layers indicate that it has already been received correctly, the UE shall:

- 1> transmit a failure response as specified in subclause 8.2.2.9, setting the information elements as specified below:
 - 2> include the IE "RRC transaction identifier";

- 2> set it to the value of "RRC transaction identifier" in the entry for the received message in the table "Accepted transactions" in the variable TRANSACTIONS;
- 2> clear that entry; and
- 2> set the IE "failure cause" to "MBMS session already received correctly".
- 1> set the variable UNSUPPORTED_CONFIGURATION to FALSE;
- 1> continue with any ongoing processes and procedures as if the reconfiguration message was not received.
- 1> the procedure ends.

If the UTRAN establishes one or more p-t-p radio bearer(s) for the transmission of a session of an MBMS service, which will inhibit reception of one or more MBMS services which according to upper layers are of higher priority, the UE may:

- 1> transmit a failure response as specified in subclause 8.2.2.9, setting the information elements as specified below:
 - 2> include the IE "RRC transaction identifier";
 - 2> set it to the value of "RRC transaction identifier" in the entry for the received message in the table "Accepted transactions" in the variable TRANSACTIONS;
 - 2> clear that entry; and
 - 2> set the IE "failure cause" to "Lower priority MBMS service".
- 1> set the variable UNSUPPORTED_CONFIGURATION to FALSE;
- 1> continue with any ongoing processes and procedures as if the reconfiguration message was not received.
- 1> the procedure ends.

8.2.2.6 Unsupported configuration in the UE

If the UTRAN instructs the UE to use a configuration, which it does not support and/or if the received message causes the variable UNSUPPORTED_CONFIGURATION to be set to TRUE, the UE shall:

- 1> transmit a failure response as specified in subclause 8.2.2.9, setting the information elements as specified below:
 - 2> include the IE "RRC transaction identifier"; and
 - 2> set it to the value of "RRC transaction identifier" in the entry for the received message in the table "Accepted transactions" in the variable TRANSACTIONS; and
 - 2> clear that entry;
 - 2> set the IE "failure cause" to "configuration unsupported".
- 1> set the variable UNSUPPORTED_CONFIGURATION to FALSE;
- 1> continue with any ongoing processes and procedures as if the reconfiguration message was not received.

The procedure ends.

8.2.2.7 Physical channel failure

If the received message caused the UE to be in CELL_DCH state and the UE according to subclause 8.5.4 failed to establish the dedicated physical channel(s) indicated in the received message or for 3.84 Mcps TDD or 7.68 Mcps TDD failed to establish the physical channel(s) indicated in the received message to which DCCH(s) are mapped the UE shall:

- 1> For TDD or for FDD if the CM_PATTERN_ACTIVATION_ABORTED flag is not set to TRUE:

- 2> revert to the configuration prior to the reception of the message (old configuration), including any HS-DSCH E-DCH, DTX, and DRX configuration if existing. If there exists any DTX or DRX configuration, the UE shall instruct the physical layer to consider only the HS-SCCH orders which were acknowledged prior to the activation time of the received message;
- 2> For FDD: if the UE was in Cell DCH state prior to the reconfiguration:
 - 3> if the variable DTX_DRX_STATUS is set to TRUE, re-configure the physical layer to perform discontinuous uplink DPCCCH transmission and enable or disable discontinuous downlink reception operations according to the variable DTX_DRX_PARAMS at the CFN corresponding to the frame boundary that is offset by the stored value of the IE "Enabling Delay" from the frame boundary where uplink transmission resumes with the old configuration;
 - 3> perform the physical layer synchronisation procedure A as specified in [29];
 - 3> apply power control preamble according to [26] during the number of frames indicated in the IE "PC preamble" in the variable LATEST_CONFIGURED_SRB_DELAY_AND_PC_PREAMBLE; and
 - 3> then not send any data on signalling radio bearers RB0 to RB4 during the number of frames indicated in the IE "SRB delay" in the variable LATEST_CONFIGURED_SRB_DELAY_AND_PC_PREAMBLE or while the physical channel is not considered established;
- 1> if the old configuration includes dedicated physical channels (CELL_DCH state) and the UE is unable to revert to the old configuration or for FDD if the CM_PATTERN_ACTIVATION_ABORTED flag is set to TRUE:
 - 2> initiate a cell update procedure according to subclause 8.3.1, using the cause "radio link failure";
 - 2> after the cell update procedure has completed successfully:
 - 3> proceed as below.
- 1> if the old configuration does not include dedicated physical channels (CELL_FACH state):
 - 2> select a suitable UTRA cell according to [4];
 - 2> if the UE selects another cell than the cell the UE camped on upon reception of the reconfiguration message:
 - 3> initiate a cell update procedure according to subclause 8.3.1, using the cause "Cell reselection";
 - 3> after the cell update procedure has completed successfully:
 - 4> proceed as below.
- 1> transmit a failure response message as specified in subclause 8.2.2.9, setting the information elements as specified below:
 - 2> include the IE "RRC transaction identifier"; and
 - 2> set it to the value of "RRC transaction identifier" in the entry for the received message in the table "Accepted transactions" in the variable TRANSACTIONS; and
 - 2> clear that entry;
 - 2> set the IE "failure cause" to "physical channel failure".
- 1> set the variable ORDERED_RECONFIGURATION to FALSE;
- 1> continue with any ongoing processes and procedures as if the reconfiguration message was not received.

The procedure ends.

8.2.2.8 Cell re-selection

If the UE performs cell re-selection during the reconfiguration procedure, the UE shall:

- 1> initiate a cell update procedure, as specified in subclause 8.3.1;

1> continue with the reconfiguration procedure.

NOTE: After the completion of the cell update procedure and completion of the reconfiguration procedure within the UE, the UE will move to the RRC state as indicated in the reconfiguration message.

8.2.2.9 Transmission of a response message by the UE, failure case

The UE shall:

1> in case of reception of a RADIO BEARER SETUP message:

2> if the radio bearer establishment procedure affects several radio bearers:

3> (may) include the identities of the radio bearers for which the procedure would have been successful into the RADIO BEARER SETUP FAILURE message.

2> transmit a RADIO BEARER SETUP FAILURE as response message on the DCCH using AM RLC.

1> in case of reception of a RADIO BEARER RECONFIGURATION message:

2> if the radio bearer reconfiguration procedure affects several radio bearers:

3> (may) include the identities of the radio bearers for which the procedure would have been successful into the RADIO BEARER RECONFIGURATION FAILURE message.

2> transmit a RADIO BEARER RECONFIGURATION FAILURE as response message on the DCCH using AM RLC.

1> in case of reception of a RADIO BEARER RECONFIGURATION message encapsulated in INTERSYSTEM HANDOVER TO UTRAN COMMAND message in GERAN *Iu mode*:

2> perform the actions as specified in [53].

1> in case of reception of a RADIO BEARER RELEASE message:

2> if the radio bearer release procedure affects several radio bearers:

3> (may) include the identities of the radio bearers for which the procedure would have been successful into the RADIO BEARER RELEASE FAILURE message.

2> transmit a RADIO BEARER RELEASE FAILURE as response message on the DCCH using AM RLC.

1> in case of reception of a TRANSPORT CHANNEL RECONFIGURATION message:

2> transmit a TRANSPORT CHANNEL RECONFIGURATION FAILURE as response message on the DCCH using AM RLC.

1> in case of reception of a PHYSICAL CHANNEL RECONFIGURATION message:

2> transmit a PHYSICAL CHANNEL RECONFIGURATION FAILURE as response message on the DCCH using AM RLC.

1> when the response message has been submitted to lower layers for transmission:

2> continue with any ongoing processes and procedures as if no reconfiguration attempt had occurred.

8.2.2.10 Reception of a response message by the UTRAN, failure case

When the UTRAN has received:

- the RADIO BEARER SETUP FAILURE message; or
- the RADIO BEARER RECONFIGURATION FAILURE message; or
- the RADIO BEARER RELEASE FAILURE message; or

- the TRANSPORT CHANNEL RECONFIGURATION FAILURE message; or
- the PHYSICAL CHANNEL RECONFIGURATION FAILURE message:

the UTRAN may restore the old and delete the new configuration. Upper layers should be notified of the failure.

The procedure ends on the UTRAN side.

8.2.2.11 Invalid configuration

If the variable INVALID_CONFIGURATION is set to TRUE the UE shall:

- 1> keep the configuration existing before the reception of the message;
- 1> transmit a failure response message as specified in subclause 8.2.2.9, setting the information elements as specified below:
 - 2> include the IE "RRC transaction identifier"; and
 - 3> set it to the value of "RRC transaction identifier" in the entry for the received message in the table "Accepted transactions" in the variable TRANSACTIONS; and
 - 3> clear that entry.
 - 2> set the IE "failure cause" to "invalid configuration".
- 1> set the variable INVALID_CONFIGURATION to FALSE;
- 1> continue with any ongoing processes and procedures as if the reconfiguration message was not received.

The procedure ends.

8.2.2.12 Incompatible simultaneous reconfiguration

If the table "Rejected transactions" in the variable TRANSACTIONS is set due to the received message and the variable PROTOCOL_ERROR_REJECT is set to FALSE, the UE shall:

- 1> not apply the configuration contained in the received reconfiguration message;
- 1> transmit a failure response message as specified in subclause 8.2.2.9, setting the information elements as specified below:
 - 2> include the IE "RRC transaction identifier"; and
 - 2> set it to the value of "RRC transaction identifier" in the entry for the received message in the table "Rejected transactions" in the variable TRANSACTIONS; and
 - 2> clear that entry;
 - 2> set the IE "failure cause" to "incompatible simultaneous reconfiguration".
- 1> continue with any ongoing processes and procedures as if the reconfiguration message was not received.

The procedure ends.

8.2.2.12a Incompatible simultaneous security reconfiguration

If the variable INCOMPATIBLE_SECURITY_RECONFIGURATION is set to TRUE due to the received reconfiguration message, the UE shall:

- 1> transmit a failure response message as specified in subclause 8.2.2.9, setting the information elements as specified below:
 - 2> include the IE "RRC transaction identifier"; and

- 2> set it to the value of "RRC transaction identifier" in the entry for the received message in the table "Accepted transactions" in the variable TRANSACTIONS; and
- 2> clear that entry;
- 2> set the IE "failure cause" to the cause value "incompatible simultaneous reconfiguration".
- 1> set the variable INCOMPATIBLE_SECURITY_RECONFIGURATION to FALSE;
- 1> continue with any ongoing processes and procedures as if the reconfiguration message was not received.

The procedure ends.

8.2.2.12b Cell update procedure during security reconfiguration

If:

- a cell update procedure according to subclause 8.3.1 is initiated; and
- the received reconfiguration message causes either:
 - the IE "Reconfiguration" in the variable CIPHERING_STATUS to be set to TRUE; and/or
 - the IE "Reconfiguration" in the variable INTEGRITY_PROTECTION_INFO to be set to TRUE:

the UE shall:

- 1> release all radio resources;
- 1> indicate the release of the established signalling connections (as stored in the variable ESTABLISHED_SIGNALLING_CONNECTIONS) and established radio access bearers (as stored in the variable ESTABLISHED_RABS) to upper layers; and
- 1> clear any entry for the RRC CONNECTION RELEASE message in the tables "Accepted transactions" and "Rejected transactions" in the variable TRANSACTIONS;
- 1> clear the variable ESTABLISHED_SIGNALLING_CONNECTIONS;
- 1> clear the variable ESTABLISHED_RABS;
- 1> if the received reconfiguration message contained the IE "Ciphering mode info":
 - 2> set the IE "Reconfiguration" in the variable CIPHERING_STATUS to FALSE; and
 - 2> clear the variable RB_UPLINK_CIPHERING_ACTIVATION_TIME_INFO;
 - 2> clear the variable SECURITY_MODIFICATION.
- 1> if the received reconfiguration message contained the IE "Integrity protection mode info":
 - 2> set the IE "Reconfiguration" in the variable INTEGRITY_PROTECTION_INFO to FALSE; and
 - 2> clear the variable INTEGRITY_PROTECTION_ACTIVATION_INFO.
- 1> enter idle mode;
- 1> perform the actions specified in subclause 8.5.2 when entering idle mode;
- 1> and the procedure ends.

NOTE: UTRAN should use RB Control messages to perform an SRNS relocation only in case of state transitions from CELL_DCH to CELL_DCH.

8.2.2.13 Invalid received message

If the received reconfiguration message contains a protocol error causing the variable `PROTOCOL_ERROR_REJECT` to be set to `TRUE` according to clause 9, the UE shall perform procedure specific error handling as follows. The UE shall:

- 1> transmit a failure response message as specified in subclause 8.2.2.9, setting the information elements as specified below:
 - 2> include the IE "RRC transaction identifier"; and
 - 2> set it to the value of "RRC transaction identifier" in the entry for the received message in the table "Rejected transactions" in the variable `TRANSACTIONS`; and
 - 2> clear that entry;
 - 2> set the IE "failure cause" to the cause value "protocol error";
 - 2> include the IE "Protocol error information" with contents set to the value of the variable `PROTOCOL_ERROR_INFORMATION`.

The procedure ends.

8.2.2.14 Radio link failure

If the criteria for radio link failure are met in the old configuration during the reconfiguration procedure as specified in subclause 8.5.6, the UE shall:

- 1> if UE would have entered `CELL_PCH` or `URA_PCH` as a result of this reconfiguration procedure and UE has already submitted a response message to lower layers:
 - 2> act as if the reconfiguration message was not received;
 - 2> initiate a cell update procedure according to subclause 8.3.1, using the cause "radio link failure";
 - 2> the procedure ends.

NOTE: UTRAN should consider the reconfiguration procedure as unsuccessful in this case even if a success response message had been received.

- 1> if the UE would have remained in `CELL_DCH` state as a result of this reconfiguration procedure:
 - 2> initiate a cell update procedure according to subclause 8.3.1, using the cause "radio link failure";
 - 2> after the cell update procedure has completed successfully:
 - 3> transmit a failure response message as specified in subclause 8.2.2.9, setting the information elements as specified below:
 - 4> include the IE "RRC transaction identifier"; and
 - 4> set it to the value of "RRC transaction identifier" in the entry for the received message in the table "Accepted transactions" in the variable `TRANSACTIONS`; and
 - 4> clear that entry;
 - 4> set the IE "failure cause" to "physical channel failure".
 - 3> act as if the reconfiguration message was not received;
 - 3> the procedure ends.

If the criteria for radio link failure are met in the new configuration during the reconfiguration procedure (i.e. while UE is waiting for RLC acknowledgement for a response message.) as specified in subclause 8.5.6, the UE shall:

- 1> if the received reconfiguration causes either:

- the IE "Reconfiguration" in the variable CIPHERING_STATUS to be set to TRUE; and/or
 - the IE "Reconfiguration" in the variable INTEGRITY_PROTECTION_INFO to be set to TRUE:
- 2> perform the actions specified in subclause 8.2.2.12b.
- 1> else, the UE should:
- 2> release all its radio resources;
 - 2> indicate the release of the established signalling connections (as stored in the variable ESTABLISHED_SIGNALLING_CONNECTIONS) and established radio access bearers (as stored in the variable ESTABLISHED_RABS) to upper layers;
 - 2> clear any entry for the RRC CONNECTION RELEASE message in the tables "Accepted transactions" and "Rejected transactions" in the variable TRANSACTIONS;
 - 2> clear the variable ESTABLISHED_SIGNALLING_CONNECTIONS;
 - 2> clear the variable ESTABLISHED_RABS;
 - 2> enter idle mode;
 - 2> perform the actions specified in subclause 8.5.2 when entering idle mode; and
 - 2> the procedure ends.

8.2.3 Radio bearer release

See subclause 8.2.2 (Reconfiguration procedures).

8.2.4 Transport channel reconfiguration

See subclause 8.2.2 (Reconfiguration procedures).

8.2.5 Transport format combination control

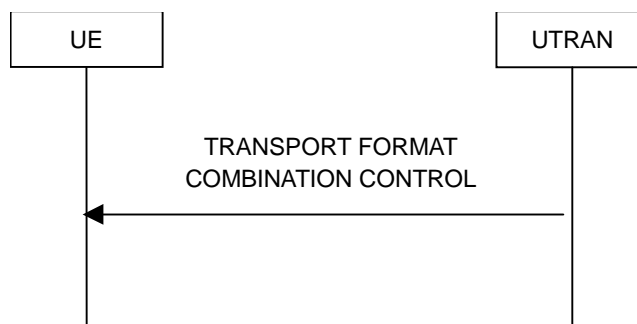

Figure 8.2.5-1: Transport format combination control, normal flow

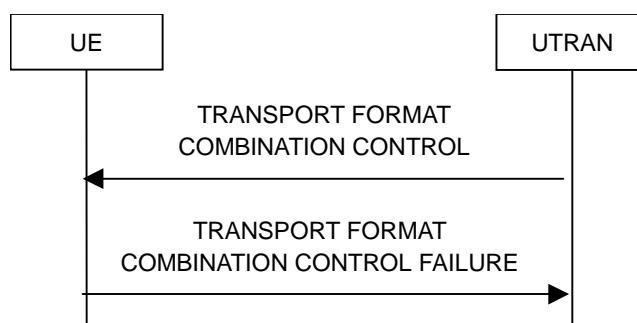

Figure 8.2.5-2: Transport format combination control, failure case

8.2.5.1 General

The transport format combination control procedure is used to control the allowed uplink transport format combinations within the transport format combination set.

8.2.5.2 Initiation

To initiate the transport format combination control procedure, the UTRAN transmits the TRANSPORT FORMAT COMBINATION CONTROL message on the downlink DCCH using AM, UM or TM RLC. When not stated otherwise elsewhere, the UTRAN may initiate the transport format combination control procedure also when another procedure is ongoing, and in that case the state of the latter procedure shall not be affected.

To change the sub-set of allowed transport format combinations, the UTRAN should:

- 1> set the allowed TFCs in the IE "Transport Format Combination subset" ("TFC subset"). The UTRAN may specify the duration for which a new TFC sub-set applies by using the IE "TFC Control duration" and independently may specify the time at which a new TFC sub-set shall be applied using the IE "Activation time for TFC subset".

To remove completely the previous restrictions of allowed transport format combinations, the UTRAN should:

- 1> set the IE "full transport format combination set " in the IE "TFC subset".

8.2.5.3 Reception of a TRANSPORT FORMAT COMBINATION CONTROL message by the UE

If the TRANSPORT FORMAT COMBINATION CONTROL message was received on AM RLC or UM RLC, the UE shall:

- 1> act upon all received information elements as specified in 8.6, unless specified otherwise in the following;
- 1> perform the actions for the transport format combination subset specified in the IE "DPCH/PUSCH TFCS in uplink" according to subclause 8.6.5.3;
- 1> if the message is received in CELL_FACH state, and the IE "TFC Control duration" or the IE "Activation time for TFC subset" is present in the message:
 - 2> set the variable INVALID_CONFIGURATION to TRUE.
- 1> if the variable INVALID_CONFIGURATION is set to FALSE:
 - 2> if the IE "TFC Control duration" is included in the message:
 - 3> store the value of the IE "TFC Control duration" in the IE "Duration" in the variable TFC_SUBSET;
 - 3> set the IE "Current TFC subset" (for the CCTrCH indicated by the IE "TFCS Id" in case of TDD) in the variable TFC_SUBSET to the value of the IE "Transport format combination subset";
 - 3> at the CFN indicated by IE "Activation time for TFC subset" apply the transport format combination subset in the IE "Current TFC subset" stored in the variable TFC_SUBSET for the number of (10 ms) frames specified in the IE "Duration";
 - 3> at the end of the time period defined by the IE "Duration" in the variable TFC_SUBSET:
 - 4> if the IE "Current TFC subset" (for the CCTrCH indicated by the IE "TFCS Id" in case of TDD) in the variable TFC_SUBSET has not subsequently been changed by another message:
 - 5> set the value of the IE "Current TFC subset" to the value of the IE "Default TFC subset" in the variable TFC_SUBSET;
 - 5> clear the IE "Duration" in the variable TFC_SUBSET;
 - 5> apply the transport format combination subset in the IE "Current TFC subset" stored in the variable TFC_SUBSET;

- 2> if the IE "TFC Control duration" is not included in the message:
 - 3> clear the value of the IE "Duration" in the variable TFC_SUBSET;
 - 3> set both the IE "Current TFC subset" and the IE "Default TFC subset" (for the CCTrCH indicated by the IE "TFCS Id" in case of TDD) in the variable TFC_SUBSET to the value of the IE "Transport format combination subset";
 - 3> at the CFN indicated by the IE "Activation time for TFC subset" apply the transport format combination subset in the IE "Current TFC subset" stored in the variable TFC_SUBSET.
- 2> when the UE enters a state other than CELL_DCH state after the reception of the message:
 - 3> if the CFN indicated by IE "Activation time for TFC subset" has been reached and the time period defined by the IE "Duration" in the variable TFC_SUBSET has not been reached:
 - 4> if the IE "Current TFC subset" (for the CCTrCH indicated by the IE "TFCS Id" in case of TDD) in the variable TFC_SUBSET has not subsequently been changed by another message:
 - 5> set the value of the IE "Current TFC subset" to the value of the IE "Default TFC subset" in the variable TFC_SUBSET;
 - 5> clear the IE "Duration" in the variable TFC_SUBSET;
 - 5> apply the transport format combination subset in the IE "Current TFC subset" stored in the variable TFC_SUBSET.
 - 3> if the CFN indicated by IE "Activation time for TFC subset" has not been reached:
 - 4> if the IE "TFC Control duration" is not included in the message:
 - 5> apply the transport format combination subset in the IE "Current TFC subset" stored in the variable TFC_SUBSET.
 - 4> if the IE "TFC Control duration" is included in the message, and if the IE "Current TFC subset" (for the CCTrCH indicated by the IE "TFCS Id" in case of TDD) in the variable TFC_SUBSET has not subsequently been changed by another message:
 - 5> set the value of the IE "Current TFC subset" to the value of the IE "Default TFC subset" in the variable TFC_SUBSET;
 - 5> clear the IE "Duration" in the variable TFC_SUBSET;
 - 5> apply the transport format combination subset in the IE "Current TFC subset" stored in the variable TFC_SUBSET.

If the TRANSPORT FORMAT COMBINATION CONTROL message was received on TM RLC, the UE shall:

- 1> if the IE "TFC subset identity" identifies one of the TFC subsets stored in the IE "TFC subset list" in the variable TFC_SUBSET:
 - 2> perform the actions as specified in subclause 8.6.5.3;
 - 2> if the variable INVALID_CONFIGURATION is set to FALSE:
 - 3> in the variable TFC_SUBSET, set the IE "Current TFC subset" and the IE "default TFC subset" to the value of the IE "TFC subset" in "TFC subset list" which is identified by the IE "TFC subset identity";
 - 3> clear the IE "Duration" in the variable TFC_SUBSET;
 - 3> apply the transport format combination subset in the IE "Current TFC subset" stored in the variable TFC_SUBSET.
- 1> if the IE "TFC subset identity" is greater than the maximum number of TFC subsets stored in the IE "TFC subset list" in the variable TFC_SUBSET:
 - 2> set the variable INVALID_CONFIGURATION to TRUE.

NOTE: The UTRAN should only send the TRANSPORT FORMAT COMBINATION CONTROL message on TM RLC in order to control the rate of TM RBs (for example, carrying multi-rate AMR or WB-AMR) otherwise the UE behaviour is not specified.

The UE shall:

- 1> clear the entry for the TRANSPORT FORMAT COMBINATION CONTROL message in the table "Accepted transactions" in the variable TRANSACTIONS;
- 1> and the procedure ends.

8.2.5.4 Invalid configuration

If the variable INVALID_CONFIGURATION is set to TRUE due to the received TRANSPORT FORMAT COMBINATION CONTROL message the UE shall:

- 1> if the TRANSPORT FORMAT COMBINATION CONTROL message was received on AM RLC:
 - 2> keep the TFC subset existing before the TRANSPORT FORMAT COMBINATION CONTROL message was received;
 - 2> transmit a TRANSPORT FORMAT COMBINATION CONTROL FAILURE message on the DCCH using AM RLC;
 - 2> set the IE "RRC transaction identifier" in the TRANSPORT FORMAT COMBINATION CONTROL FAILURE message to the value of "RRC transaction identifier" in the entry for the TRANSPORT FORMAT COMBINATION CONTROL message in the table "Accepted transactions" in the variable TRANSACTIONS; and
 - 2> clear that entry;
 - 2> set the IE "failure cause" to "invalid configuration";
 - 2> when the TRANSPORT FORMAT COMBINATION CONTROL FAILURE message has been submitted to lower layers for transmission the procedure ends.
- 1> if the TRANSPORT FORMAT COMBINATION CONTROL message was received on UM RLC or TM RLC:
 - 2> ignore the TRANSPORT FORMAT COMBINATION CONTROL message;
 - 2> clear the entry for the TRANSPORT FORMAT COMBINATION CONTROL message in the table "Accepted transactions" in the variable TRANSACTIONS.

8.2.5.5 Invalid TRANSPORT FORMAT COMBINATION CONTROL message

If the TRANSPORT FORMAT COMBINATION CONTROL message was received on AM RLC or UM RLC and contains a protocol error causing the variable PROTOCOL_ERROR_REJECT to be set to TRUE according to clause 9, the UE shall perform procedure specific error handling as follows. The UE shall:

- 1> transmit a TRANSPORT FORMAT COMBINATION CONTROL FAILURE message on the uplink DCCH using AM RLC setting the information elements as specified below:
 - 2> set the IE "RRC transaction identifier" in the TRANSPORT FORMAT COMBINATION CONTROL FAILURE message to the value of "RRC transaction identifier" in the entry for the TRANSPORT FORMAT COMBINATION CONTROL message in the table "Rejected transactions" in the variable TRANSACTIONS; and
 - 2> clear that entry;
 - 2> set the IE "failure cause" to the cause value "protocol error";
 - 2> include the IE "Protocol error information" with contents set to the value of the variable PROTOCOL_ERROR_INFORMATION.

- 1> when the TRANSPORT FORMAT COMBINATION CONTROL FAILURE message has been submitted to lower layers for transmission:
 - 2> continue with any ongoing processes and procedures as if the invalid TRANSPORT FORMAT COMBINATION CONTROL message has not been received;
 - 2> and the procedure ends.

If the TRANSPORT FORMAT COMBINATION CONTROL message was received on TM RLC and contains a protocol error causing the variable `PROTOCOL_ERROR_REJECT` to be set to `TRUE` according to clause 9, the UE shall perform procedure specific error handling as follows. The UE shall:

- 1> ignore the invalid TRANSPORT FORMAT COMBINATION CONTROL message as if it has not been received;
- 1> the procedure ends.

8.2.6 Physical channel reconfiguration

See subclause 8.2.2 Reconfiguration procedures.

8.2.7 Physical Shared Channel Allocation [TDD only]



Figure 8.2.7-1: Physical Shared Channel Allocation

8.2.7.1 General

The purpose of this procedure is to allocate radio resources to USCH and/or DSCH transport channels in TDD mode, for use by a UE. This procedure can also be used to indicate to the UE, that a PUSCH allocation is pending, in order to prevent further capacity requests from the UE.

UEs are not required to receive FACH and DSCH simultaneously, i.e. if resources are allocated to DSCH the FACH reception may be suspended.

8.2.7.2 Initiation

To initiate the Physical Shared Channel Allocation procedure, the UTRAN sends the "PHYSICAL SHARED CHANNEL ALLOCATION" message on the downlink SHCCH or on the downlink DCCH using UM RLC. The DSCH-RNTI shall be included for UE identification, if the message is sent on the SHCCH.

8.2.7.3 Reception of a PHYSICAL SHARED CHANNEL ALLOCATION message by the UE

Upon reception of a "PHYSICAL SHARED CHANNEL ALLOCATION" message, if the message is received on the downlink SHCCH the UE shall:

- 1> check the DSCH-RNTI to see if the UE is addressed by the message;
- 1> if the UE is addressed by the message, or if the message is received on the downlink DCCH:
 - 2> perform the following actions.
- 1> otherwise:

- 2> ignore the message.
- 1> act upon all received information elements as specified in subclause 8.6, unless specified otherwise in the following:
 - 1> if the IE "ISCP Timeslot list" is included:
 - 2> store the timeslot numbers given there for future Timeslot ISCP measurements and reports in the variable PHYSICAL_SHARED_CHANNEL_CONFIGURATION.
 - 1> if the IE "PDSCH capacity allocation info" is included:
 - 2> configure the physical resources used for the downlink CCTrCH given by the IE "TFCS ID" according to the following:
 - 3> if the CHOICE "Configuration" has the value "Old configuration":
 - 4> if the UE has stored a PDSCH configuration in the variable PHYSICAL_SHARED_CHANNEL_CONFIGURATION with the identity given by the IE "PDSCH Identity":
 - 5> configure the physical resources according to that configuration.
 - 4> otherwise:
 - 5> ignore the IE "PDSCH capacity allocation info".
 - 3> if the CHOICE "Configuration" has the value "New configuration":
 - 4> configure the physical resources according to the information given in IE "PDSCH Info". If IE "Common timeslot info" or IE "PDSCH timeslots and codes" IE are not present in IE "PDSCH Info":
 - 5> reuse the configuration stored in the variable PHYSICAL_SHARED_CHANNEL_CONFIGURATION for this CCTrCH.
 - 4> if the IE "PDSCH Identity" is included:
 - 5> store the new configuration in the variable PHYSICAL_SHARED_CHANNEL_CONFIGURATION using that identity.
 - 2> start using the new configuration at the CFN specified by the IE "Allocation activation time", and use that for the duration given by the IE "Allocation duration";
 - 2> if the IE "Confirm request" has the value "Confirm PDSCH" and IE "PDSCH Identity" is included in IE "PDSCH capacity allocation info":
 - 3> initiate the PUSCH CAPACITY REQUEST procedure as described in subclause 8.2.8.
 - 1> if the IE "PUSCH capacity allocation info" is included:
 - 2> stop the timer T310, if running;
 - 2> if the CHOICE "PUSCH allocation" has the value "PUSCH allocation pending":
 - 3> start the timer T311.
 - 2> if the CHOICE "PUSCH allocation" has the value "PUSCH allocation assignment":
 - 3> stop the timer T311, if running;
 - 3> configure the physical resources used for the uplink CCTrCH given by the IE "TFCS ID" according to the following:
 - 4> if the CHOICE "Configuration" has the value "Old configuration":
 - 5> if the UE has stored a PUSCH configuration with the identity given by the IE "PUSCH Identity" in the variable PHYSICAL_SHARED_CHANNEL_CONFIGURATION:

- 6> configure the physical resources according to that configuration.
- 5> otherwise:
 - 6> ignore the IE "PUSCH capacity allocation info".
- 4> if the CHOICE "Configuration" has the value "New configuration", the UE shall:
 - 5> configure the physical resources according to the information given in IE "PUSCH Info". If IE "Common timeslot info" or IE "PUSCH timeslots and codes" is not present in IE "PUSCH Info":
 - 6> reuse the configuration stored in the variable PHYSICAL_SHARED_CHANNEL_CONFIGURATION for this CCTrCH.
 - 5> if the IE "PUSCH Identity" is included:
 - 6> store the new configuration in the variable PHYSICAL_SHARED_CHANNEL_CONFIGURATION using that identity.
- 3> if the IE "PUSCH power control info" is present in this message and includes the parameter "UL target SIR" for 3.84 Mcps TDD or 7.68 Mcps TDD, or the parameters "PRX_{PUSCHdes}" and "Beacon PL Est. " and "TPC Step Size" for 1.28 Mcps TDD, or the parameters are stored in the variable PHYSICAL SHARED CHANNEL CONFIGURATION for this CCTrCH:
 - 4> start using the new configuration at the CFN specified by the IE "Allocation activation time", and use that for the duration given by the IE "Allocation duration".
- 3> otherwise:
 - 4> ignore the IE "PUSCH capacity allocation info".
- 3> if the IE "PUSCH power control info" is present in this message and includes the parameter "UL target SIR" for 3.84 Mcps TDD or 7.68 Mcps TDD, or the parameters "PRX_{PUSCHdes}" and/or "Beacon PL Est. " and/or "TPC Step Size" for 1.28 Mcps TDD:
 - 4> replace the parameters "UL target SIR" or "PRX_{PUSCHdes}" or "TPC Step Size" stored in the variable PHYSICAL SHARED CHANNEL CONFIGURATION for this CCTrCH with the signalled values.
- 3> if the IE "Traffic volume report request " is included:
 - 4> initiate the PUSCH CAPACITY REQUEST procedure as described in subclause 8.2.8 at the time indicated by the IE "Traffic volume report request".
- 3> if the IE "Confirm request" has the value "Confirm PUSCH" and IE "PUSCH Identity" is included in IE "PUSCH capacity allocation info":
 - 4> initiate the PUSCH CAPACITY REQUEST procedure as described in subclause 8.2.8.
- 3> determine the TFCS subset and hence the TFCI values which are possible given the PUSCH allocation for that CCTrCH;
- 3> configure the MAC-c/sh in the UE with this TFCS restriction if necessary;
- 3> transmit USCH Transport Block Sets as required, within the TFCS limits given by the PUSCH allocation.

NOTE: If the UE has just entered a new cell and System Information Block Type 6 has not yet been scheduled, PUSCH/PDSCH information should be specified in the allocation message.

The UE shall:

- 1> clear the entry for the PHYSICAL SHARED CHANNEL ALLOCATION message in the table "Accepted transactions" in the variable TRANSACTIONS;
- 1> and the procedure ends.

8.2.7.4 Invalid PHYSICAL SHARED CHANNEL ALLOCATION message

If the UE receives a PHYSICAL SHARED CHANNEL ALLOCATION message, which contains a protocol error causing the variable `PROTOCOL_ERROR_REJECT` to be set to `TRUE` according to clause 9, the UE shall perform procedure specific error handling as follows. The UE shall:

- 1> ignore the invalid PHYSICAL SHARED CHANNEL ALLOCATION message;
- 1> submit the PUSCH CAPACITY REQUEST message for transmission on the uplink SHCCH, setting the information elements in the message as specified in subclause 8.2.8.3;
- 1> reset counter V310;
- 1> start timer T310;
- 1> proceed as described in subclause 8.2.8.

8.2.8 PUSCH capacity request [TDD only]

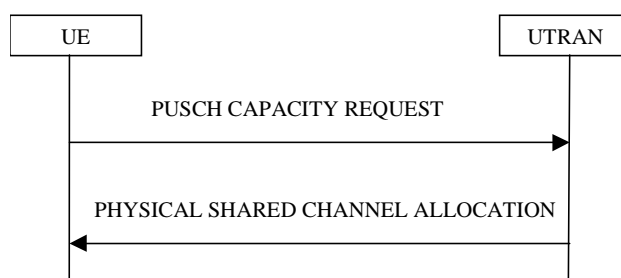

Figure 8.2.8-1: PUSCH Capacity request procedure

8.2.8.1 General

With this procedure, the UE transmits its request for PUSCH resources to the UTRAN. In the normal case, the UTRAN responds with a PHYSICAL SHARED CHANNEL ALLOCATION message, which either allocates the requested PUSCH resources, and/or allocates a PDSCH resource, or may just serve as an acknowledgement, indicating that PUSCH allocation is pending.

This procedure can also be used to acknowledge the reception of a PHYSICAL SHARED CHANNEL ALLOCATION message, or to indicate a protocol error in that message.

With the PUSCH CAPACITY REQUEST message, the UE can request capacity for one or more USCH.

8.2.8.2 Initiation

This procedure is initiated:

- 1> in the `CELL_FACH` or `CELL_DCH` state;
- 1> and when at least one RB using USCH has been established;
- 1> and when the UE sees the requirement to request physical resources (PUSCH) for an USCH channel or there is the need to reply to a PHYSICAL SHARED CHANNEL ALLOCATION message as described in clause 8.2.7 (i.e. to confirm the reception of a message, if requested to do so, or to indicate a protocol error).

The procedure can be initiated if:

- Timer T311 is not running.
- The timer T310 (capacity request repetition timer) is not running.

The UE shall:

- 1> set the IEs in the PUSCH CAPACITY REQUEST message according to subclause 8.2.8.3;

- 1> if the procedure is triggered to reply to a previous PHYSICAL SHARED CHANNEL ALLOCATION message by the IE "Confirm request" set to "Confirm PUSCH" and the IE "PUSCH capacity allocation info" is not present:
 - 2> transmit the PUSCH CAPACITY REQUEST message on RACH.
- 1> else:
 - 2> transmit the PUSCH CAPACITY REQUEST message on the uplink SHCCH.
- 1> set counter V310 to 1;
- 1> start timer T310.

8.2.8.3 PUSCH CAPACITY REQUEST message contents to set

With one PUSCH CAPACITY REQUEST message, capacity for one or more USCH can be requested. It shall include these information elements:

- 1> DSCH-RNTI to be used as UE identity if the message is sent on RACH;
- 1> Traffic volume measured results for each radio bearer satisfying the reporting criteria as specified in the MEASUREMENT CONTROL procedure (if no radio bearer satisfies the reporting criteria, traffic volume measured results shall not be included). These results shall include:
 - 2> Radio Bearer ID of the Radio Bearer being reported;
 - 2> RLC buffer payload for these radio bearers, as specified by the MEASUREMENT CONTROL procedure.

The UE shall:

- 1> if the initiation of the procedure is triggered by the IE "Traffic volume report request" in a previously received PHYSICAL SHARED CHANNEL ALLOCATION message:
 - 2> report the traffic volume measurement result for the radio bearer mapped on USCH transport channel specified in the received message. These results shall include:
 - 3> Radio Bearer ID of the Radio Bearer being reported;
 - 3> RLC buffer payload for this radio bearer.
- 1> if the initiation of the procedure is triggered by the IE "Confirm request" set to "Confirm PDSCH" in a previously received PHYSICAL SHARED CHANNEL ALLOCATION message and the IE "PUSCH capacity allocation info" is present in this message:
 - 2> set the CHOICE "Allocation confirmation" to "PDSCH Confirmation" with the value given in the IE "PDSCH Identity" stored in the variable PHYSICAL_SHARED_CHANNEL_CONFIGURATION.
- 1> if the initiation of the procedure is triggered by the IE "Confirm request" set to "Confirm PUSCH" in a previously received PHYSICAL SHARED CHANNEL ALLOCATION message:
 - 2> set the CHOICE "Allocation confirmation" to "PUSCH Confirmation" with the value given in the IE "PUSCH Identity" stored in the variable PHYSICAL_SHARED_CHANNEL_CONFIGURATION.
- 1> if the variable PROTOCOL_ERROR_REJECT is set to TRUE:
 - 2> include the IE "RRC transaction identifier" in the response message transmitted below; and
 - 2> set it to the value of "RRC transaction identifier" in the entry for the PHYSICAL SHARED CHANNEL ALLOCATION message in the table "Rejected transactions" in the variable TRANSACTIONS; and
 - 2> clear that entry;
 - 2> set the IE "protocol error indicator" to TRUE;
 - 2> include the IE "Protocol error information" with contents set to the value of the variable PROTOCOL_ERROR_INFORMATION.

1> if the value of the variable `PROTOCOL_ERROR_REJECT` is FALSE:

2> set the IE "Protocol error indicator" to FALSE.

As an option, the message may include IE "Timeslot ISCP" and IE "Primary CCPCH RSCP".

The timeslots for which "Timeslot ISCP" may be reported shall have been configured with a previous `PHYSICAL SHARED CHANNEL ALLOCATION` message and stored in the variable `PHYSICAL_SHARED_CHANNEL_CONFIGURATION`.

"Primary CCPCH RSCP" is reported when requested with a previous `PHYSICAL SHARED CHANNEL ALLOCATION` message.

8.2.8.4 Reception of a PUSCH CAPACITY REQUEST message by the UTRAN

Upon receiving a `PUSCH CAPACITY REQUEST` message with traffic volume measurement included for at least one radio bearer, the UTRAN should initiate the `PHYSICAL SHARED CHANNEL ALLOCATION` procedure, either for allocating PUSCH or PDSCH resources as required, or just as an acknowledgement, indicating a pending PUSCH allocation, as described in subclause 8.2.7.

8.2.8.5 T310 expiry

Upon expiry of timer T310, the UE shall:

1> if V310 is smaller than N310:

2> transmit a new `PUSCH CAPACITY REQUEST` message on the Uplink SHCCH;

2> restart timer T310;

2> increment counter V310;

2> set the IEs in the `PUSCH CAPACITY REQUEST` message as specified in subclause 8.2.8.3.

1> if V310 is greater than or equal to N310:

2> the procedure ends.

8.2.9 Void

8.2.10 Uplink Physical Channel Control [TDD only]

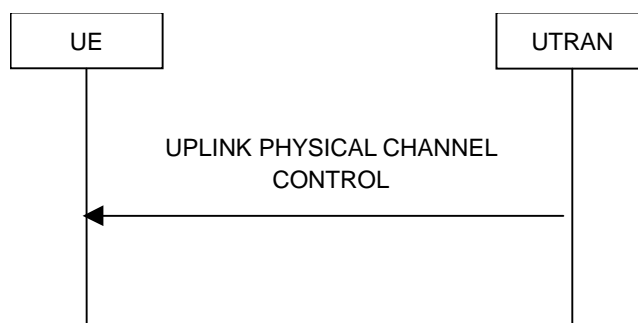

Figure 8.2.10-1: Uplink Physical Channel Control

8.2.10.1 General

The uplink physical channel control procedure is used in TDD to control the uplink outer loop power control and timing advance running in the UE.

8.2.10.2 Initiation

The UTRAN initiates the procedure by transmitting the UPLINK PHYSICAL CHANNEL CONTROL message on the downlink DCCH using AM or UM RLC in order to update parameters for uplink open loop power control in the UE for one CCTrCH or to inform the UE about a new timing advance value to be applied. Especially, uplink interference information measured by the UTRAN can be included for the uplink timeslots used for the CCTrCH.

8.2.10.3 Reception of UPLINK PHYSICAL CHANNEL CONTROL message by the UE

Upon reception of the UPLINK PHYSICAL CHANNEL CONTROL message, the UE shall:

- 1> act upon all received information elements as specified in subclause 8.6.

In 1.28 Mcps TDD, if the IE "Uplink DPCH Power Control Info" and IE "PRX_{HS-SICH}" and IE "TPC step size" are transmitted, this information shall be taken into account by the UE for uplink open loop power control and for uplink closed loop power control as described in subclause 8.6.6.11, and the "PRX_{HS-SICH}" shall be taken into account by the UE for open loop power control as described in subclause 8.5.7 and the "TPC step size" for closed loop power control on HS-SICH.

In 3.84 Mcps TDD or 7.68 Mcps TDD, if the IEs "Uplink DPCH Power Control Info", "PRACH Constant Value", "PUSCH Constant Value", "HS-SICH Power Control Info", "Alpha" or IE group "list of UL Timeslot Interference" are transmitted, this information shall be taken into account by the UE for uplink open loop power control as specified in subclause 8.5.7. If the UE is capable of using IPDLs for UE positioning, the IE "IPDL-Alpha" shall be used instead of the IE "Alpha". If the IE "IPDL-Alpha" parameter is not present, the UE shall use IE "Alpha".

If the IE Special Burst Scheduling is transmitted the UE shall:

- 1> use the new value for the "Special Burst Generation Period".

The UE shall:

- 1> clear the entry for the UPLINK PHYSICAL CHANNEL CONTROL message in the table "Accepted transactions" in the variable TRANSACTIONS;
- 1> and the procedure ends.

8.2.10.4 Invalid UPLINK PHYSICAL CHANNEL CONTROL message

If the UE receives a UPLINK PHYSICAL CHANNEL CONTROL message, which contains a protocol error causing the variable PROTOCOL_ERROR_REJECT to be set to TRUE according to clause 9, the UE shall perform procedure specific error handling as follows. The UE shall:

- 1> transmit an RRC STATUS message on the uplink DCCH using AM RLC, setting the information elements as specified below:
 - 2> include the IE "Identification of received message"; and
 - 2> set the IE "Received message type" to UPLINK PHYSICAL CHANNEL CONTROL; and
 - 2> set the IE "RRC transaction identifier" to the value of "RRC transaction identifier" in the entry for the UPLINK PHYSICAL CHANNEL CONTROL message in the table "Rejected transactions" in the variable TRANSACTIONS; and
 - 2> clear that entry;
 - 2> include the IE "Protocol error information" with contents set to the value of the variable PROTOCOL_ERROR_INFORMATION.
- 1> when the RRC STATUS message has been submitted to lower layers for transmission:
 - 2> continue with any ongoing processes and procedures as if the invalid UPLINK PHYSICAL CHANNEL CONTROL message has not been received.

8.2.11 Physical channel reconfiguration failure

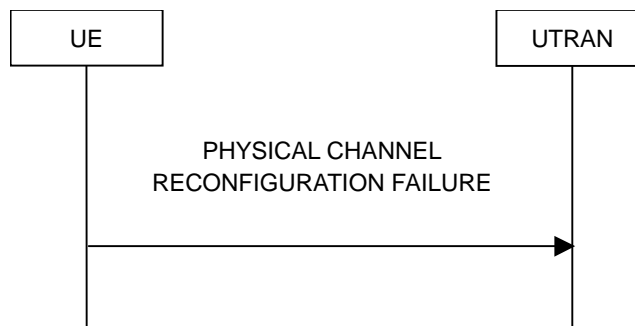

Figure 8.2.11-1: Physical channel reconfiguration failure in case of runtime configuration error

8.2.11.1 General

The physical channel reconfiguration failure procedure is used to indicate to the network a runtime configuration error in the UE.

8.2.11.2 Runtime error due to overlapping compressed mode configurations

When the UE has received from the UTRAN the configurations of several compressed mode transmission gap pattern sequences, and if several of these patterns are to be simultaneously active, the UE shall check to see if these simultaneously active transmission gap pattern sequences create transmission gaps in the same frame. An illegal overlap is created if two or more transmission gap pattern sequences create transmission gaps in the same frame, irrespective of the gaps are created in uplink or downlink.

If the parallel transmission gap pattern sequences create an illegal overlap, the UE shall:

- 1> delete the overlapping transmission gap pattern sequence configuration stored in the variable TGPS_IDENTITY, which is associated with the highest value of IE "TGPSI";
- 1> transmit a PHYSICAL CHANNEL RECONFIGURATION FAILURE message on the DCCH using AM RLC, setting the information elements as specified below:
 - 2> not include the IE "RRC transaction identifier";
 - 2> set the cause value in IE "failure cause" to value "compressed mode runtime error".
- 1> terminate the inter-frequency and/or inter-RAT measurements corresponding to the deleted transmission gap pattern sequence;
- 1> when the PHYSICAL CHANNEL RECONFIGURATION FAILURE message has been submitted to lower layers for transmission:
 - 2> the procedure ends.

8.2.11.3 Void

8.3 RRC connection mobility procedures

8.3.1 Cell and URA update procedures

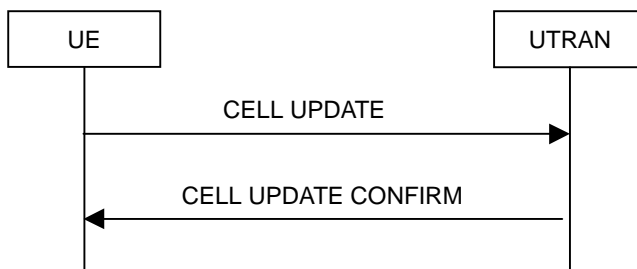

Figure 8.3.1-1: Cell update procedure, basic flow

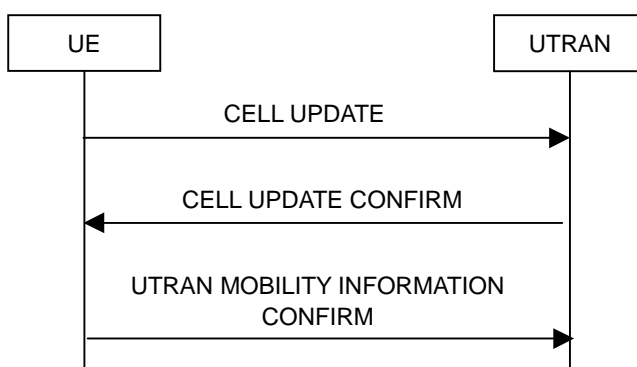

Figure 8.3.1-2: Cell update procedure with update of UTRAN mobility information

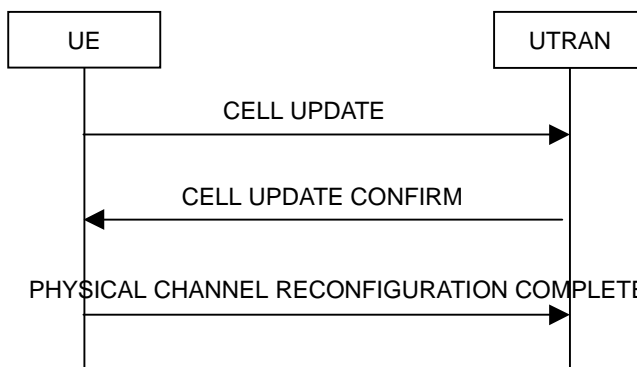

Figure 8.3.1-3: Cell update procedure with physical channel reconfiguration

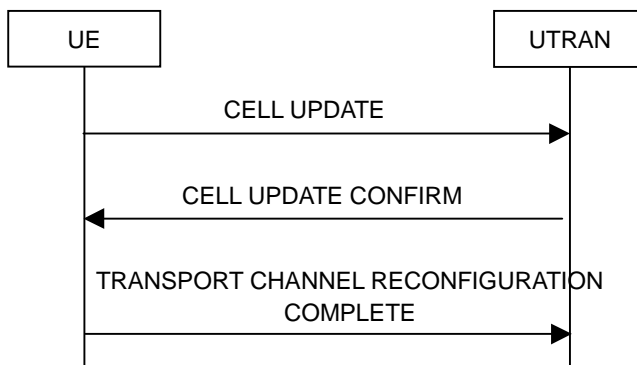

Figure 8.3.1-4: Cell update procedure with transport channel reconfiguration

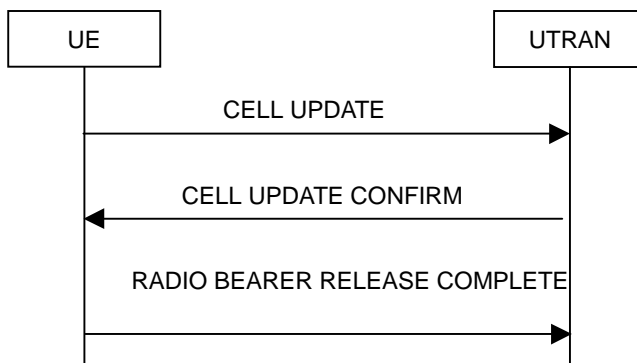

Figure 8.3.1-5: Cell update procedure with radio bearer release

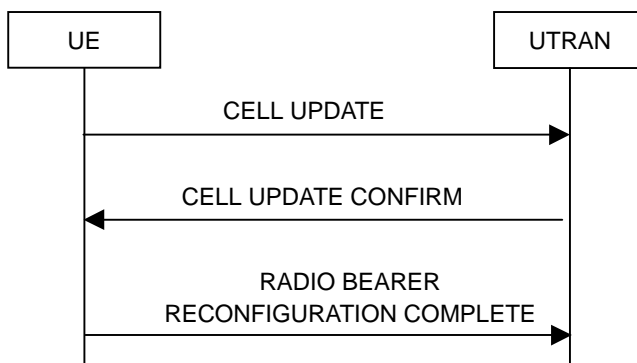

Figure 8.3.1-6: Cell update procedure with radio bearer reconfiguration

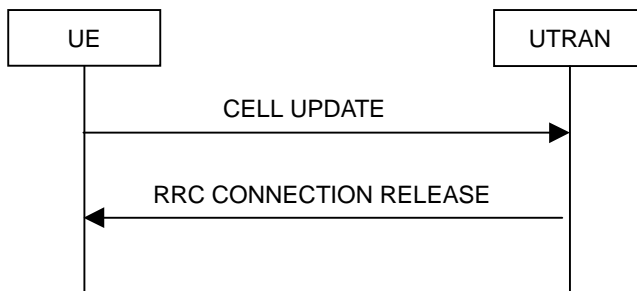

Figure 8.3.1-7: Cell update procedure, failure case

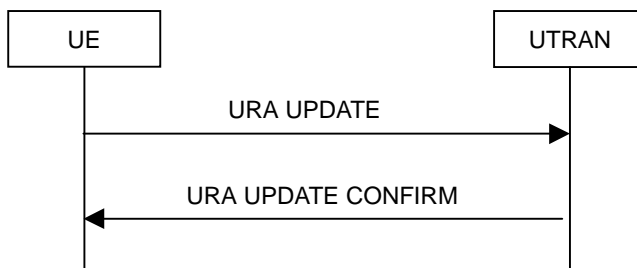

Figure 8.3.1-8: URA update procedure, basic flow

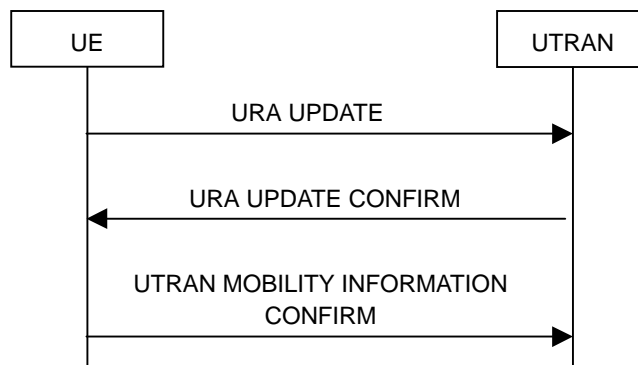

Figure 8.3.1-9: URA update procedure with update of UTRAN mobility information

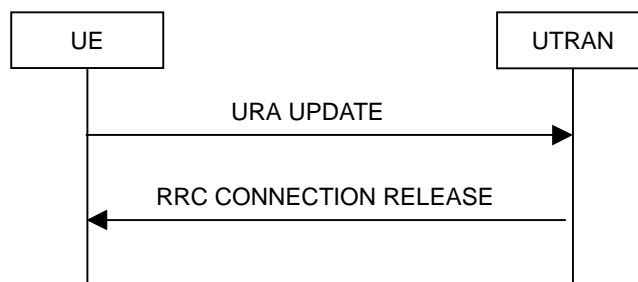

Figure 8.3.1-10: URA update procedure, failure case

8.3.1.1 General

The URA update and cell update procedures serve several main purposes:

- to notify UTRAN after re-entering service area in the URA_PCH or CELL_PCH state;
- to notify UTRAN of an RLC unrecoverable error [16] on an AM RLC entity;
- to be used as a supervision mechanism in the CELL_FACH, CELL_PCH, or URA_PCH state by means of periodical update.

In addition, the URA update procedure also serves the following purpose:

- to retrieve a new URA identity after cell re-selection to a cell not belonging to the current URA assigned to the UE in URA_PCH state.

In addition, the cell update procedure also serves the following purposes:

- to update UTRAN with the current cell the UE is camping on after cell reselection;
- to act on a radio link failure in the CELL_DCH state;
- to act on the transmission failure of the UE CAPABILITY INFORMATION message;
- for FDD, if the variable H_RNTI is not set, and for TDD:
when triggered in the URA_PCH or CELL_PCH state, to notify UTRAN of a transition to the CELL_FACH state due to the reception of UTRAN originated paging or due to a request to transmit uplink data;
- to count the number of UEs in URA_PCH, CELL_PCH and CELL_FACH that are interested to receive an MBMS transmission;
- when triggered in the URA_PCH, CELL_PCH and CELL_FACH state, to notify UTRAN of the UEs interest to receive an MBMS service;
- to request the MBMS P-T-P RB setup by the UE in CELL_PCH, URA_PCH and CELL_FACH state.

The URA update and cell update procedures may:

1> include an update of mobility related information in the UE;

1> cause a state transition from the CELL_FACH state to the CELL_DCH, CELL_PCH or URA_PCH states or idle mode.

The cell update procedure may also include:

- a re-establish of AM RLC entities;
- a radio bearer release, radio bearer reconfiguration, transport channel reconfiguration or physical channel reconfiguration.

8.3.1.2 Initiation

A UE shall initiate the cell update procedure in the following cases:

1> Uplink data transmission:

2> for FDD, if the variable H_RNTI is not set, and for TDD:

3> if the UE is in URA_PCH or CELL_PCH state; and

3> if timer T320 is not running:

4> if the UE has uplink RLC data PDU or uplink RLC control PDU on RB1 or upwards to transmit:

5> perform cell update using the cause "uplink data transmission".

3> else:

4> if the variable ESTABLISHMENT_CAUSE is set:

5> perform cell update using the cause "uplink data transmission".

1> Paging response:

2> if the criteria for performing cell update with the cause specified above in the current subclause are not met; and

2> if the UE in URA_PCH or CELL_PCH state, receives a PAGING TYPE 1 message fulfilling the conditions for initiating a cell update procedure specified in subclause 8.1.2.3:

3> perform cell update using the cause "paging response".

1> Radio link failure:

2> if none of the criteria for performing cell update with the causes specified above in the current subclause is met:

3> if the UE is in CELL_DCH state and the criteria for radio link failure are met as specified in subclause 8.5.6; or

3> if the transmission of the UE CAPABILITY INFORMATION message fails as specified in subclause 8.1.6.6:

4> perform cell update using the cause "radio link failure".

1> MBMS ptp RB request:

2> if none of the criteria for performing cell update with the causes specified above in the current subclause is met; and

2> if the UE is in URA_PCH, Cell_PCH or Cell_FACH state; and

2> if timer T320 is not running; and

2> if the UE should perform cell update for MBMS ptp radio bearer request as specified in subclause 8.6.9.6:

3> perform cell update using the cause "MBMS ptp RB request".

1> Re-entering service area:

2> if none of the criteria for performing cell update with the causes specified above in the current subclause is met; and

2> if the UE is in CELL_FACH or CELL_PCH state; and

2> if the UE has been out of service area and re-enters service area before T307 or T317 expires:

3> perform cell update using the cause "re-entering service area".

1> RLC unrecoverable error:

2> if none of the criteria for performing cell update with the causes specified above in the current subclause is met; and

2> if the UE detects RLC unrecoverable error [16] in an AM RLC entity:

3> perform cell update using the cause "RLC unrecoverable error".

1> Cell reselection:

2> if none of the criteria for performing cell update with the causes specified above in the current subclause is met:

3> if the UE is in CELL_FACH or CELL_PCH state and the UE performs cell re-selection; or

3> if the UE is in CELL_FACH state and the variable C_RNTI is empty:

4> perform cell update using the cause "cell reselection".

1> Periodical cell update:

2> if none of the criteria for performing cell update with the causes specified above in the current subclause is met; and

2> if the UE is in CELL_FACH or CELL_PCH state; and

2> if the timer T305 expires; and

2> if the criteria for "in service area" as specified in subclause 8.5.5.2 are fulfilled; and

2> if periodic updating has been configured by T305 in the IE "UE Timers and constants in connected mode" set to any other value than "infinity":

3> perform cell update using the cause "periodical cell update".

1> MBMS reception:

2> if none of the criteria for performing cell update with the causes specified above in the current subclause is met; and

2> if the UE is in URA_PCH, Cell_PCH or Cell_FACH state; and

2> if the UE should perform cell update for MBMS counting as specified in subclause 8.7.4:

3> perform cell update using the cause "MBMS reception".

A UE in URA_PCH state shall initiate the URA update procedure in the following cases:

1> URA reselection:

2> if the UE detects that the current URA assigned to the UE, stored in the variable URA_IDENTITY, is not present in the list of URA identities in system information block type 2; or

2> if the list of URA identities in system information block type 2 is empty; or

2> if the system information block type 2 can not be found:

3> perform URA update using the cause "change of URA".

1> Periodic URA update:

2> if the criteria for performing URA update with the causes as specified above in the current subclause are not met:

3> if the timer T305 expires and if periodic updating has been configured by T305 in the IE "UE Timers and constants in connected mode" set to any other value than "infinity"; or

3> if the conditions for initiating an URA update procedure specified in subclause 8.1.1.6.5 are fulfilled:

4> perform URA update using the cause "periodic URA update".

When initiating the URA update or cell update procedure, the UE shall:

1> if timer T320 is running:

2> stop timer T320;

2> if the UE has uplink RLC data PDU or uplink RLC control PDU on RB1 or upwards to transmit:

3> perform cell update using the cause "uplink data transmission".

2> else:

3> if the cell update procedure is not triggered due to Paging response or Radio link failure; and

3> if the UE should perform cell update for MBMS ptp radio bearer request as specified in subclause 8.6.9.6:

4> perform cell update using the cause "MBMS ptp RB request".

1> stop timer T319 if it is running;

1> stop timer T305;

1> for FDD:

2> if the UE is in CELL_FACH state; and

2> if the IE "HS-DSCH common system information" is included in System Information Block type 5 or System Information Block type 5bis; and

2> if the UE does support HS-DSCH reception in CELL_FACH state:

3> if variable H_RNTI is not set or variable C_RNTI is not set; or

3> an unrecoverable error [16] in any of the AM RLC entities for the signalling radio bearers RB2, RB3 or RB4 is detected:

4> clear variable H_RNTI;

4> clear variable C_RNTI;

4> clear any stored IEs "HARQ info";

4> set variable HS_DSCH_RECEPTION_OF_CCCH_ENABLED to TRUE;

4> and start receiving the HS-DSCH transport channels mapped physical channel(s) of type HS-SCCH and HS-PDSCH, by using parameters given by the IE(s) "HS-DSCH common system information" according to the procedure in subclause 8.5.37.

3> else:

- 4> receive the HS-DSCH transport channels mapped physical channel(s) of type HS-SCCH and HS-PDSCH, by using parameters given by the IE(s) "HS-DSCH common system information" according to the procedure in subclause 8.5.36.
- 1> if the UE is in CELL_DCH state:
 - 2> in the variable RB_TIMER_INDICATOR, set the IE "T314 expired" and the IE "T315 expired" to FALSE;
 - 2> if the stored values of the timer T314 and timer T315 are both equal to zero; or
 - 2> if the stored value of the timer T314 is equal to zero and there are no radio bearers associated with any radio access bearers for which in the variable ESTABLISHED_RABS the value of the IE "Re-establishment timer" is set to "useT315" and signalling connection exists only to the CS domain:
 - 3> release all its radio resources;
 - 3> indicate release (abort) of the established signalling connections (as stored in the variable ESTABLISHED_SIGNALLING_CONNECTIONS) and established radio access bearers (as stored in the variable ESTABLISHED_RABS) to upper layers;
 - 3> clear the variable ESTABLISHED_SIGNALLING_CONNECTIONS;
 - 3> clear the variable ESTABLISHED_RABS;
 - 3> enter idle mode;
 - 3> perform other actions when entering idle mode from connected mode as specified in subclause 8.5.2;
 - 3> and the procedure ends.
 - 2> if the stored value of the timer T314 is equal to zero:
 - 3> release all radio bearers, associated with any radio access bearers for which in the variable ESTABLISHED_RABS the value of the IE "Re-establishment timer" is set to "useT314";
 - 3> in the variable RB_TIMER_INDICATOR set the IE "T314 expired" to TRUE;
 - 3> if all radio access bearers associated with a CN domain are released:
 - 4> release the signalling connection for that CN domain;
 - 4> remove the signalling connection for that CN domain from the variable ESTABLISHED_SIGNALLING_CONNECTIONS;
 - 4> indicate release (abort) of the signalling connection to upper layers;
 - 2> if the stored value of the timer T315 is equal to zero:
 - 3> release all radio bearers associated with any radio access bearers for which in the variable ESTABLISHED_RABS the value of the IE "Re-establishment timer" is set to "useT315";
 - 3> in the variable RB_TIMER_INDICATOR set the IE "T315 expired" to TRUE.
 - 3> if all radio access bearers associated with a CN domain are released:
 - 4> release the signalling connection for that CN domain;
 - 4> remove the signalling connection for that CN domain from the variable ESTABLISHED_SIGNALLING_CONNECTIONS;
 - 4> indicate release (abort) of the signalling connection to upper layers;
 - 2> if the stored value of the timer T314 is greater than zero:
 - 3> if there are radio bearers associated with any radio access bearers for which in the variable ESTABLISHED_RABS the value of the IE "Re-establishment timer" is set to "useT314":
 - 4> start timer T314.

- 3> if there are no radio bearers associated with any radio access bearers for which in the variable ESTABLISHED_RABS the value of the IE "Re-establishment timer" is set to "useT314" or "useT315" and the signalling connection exists to the CS domain:
 - 4> start timer T314.
- 2> if the stored value of the timer T315 is greater than zero:
 - 3> if there are radio bearers associated with any radio access bearers for which in the variable ESTABLISHED_RABS the value of the IE "Re-establishment timer" is set to "useT315"; or
 - 3> if the signalling connection exists to the PS domain:
 - 4> start timer T315.
- 2> for the released radio bearer(s):
 - 3> delete the information about the radio bearer from the variable ESTABLISHED_RABS;
 - 3> when all radio bearers belonging to the same radio access bearer have been released:
 - 4> indicate local end release of the radio access bearer to upper layers using the CN domain identity together with the RAB identity stored in the variable ESTABLISHED_RABS;
 - 4> delete all information about the radio access bearer from the variable ESTABLISHED_RABS.
- 2> move to CELL_FACH state;
- 2> select a suitable UTRA cell on the current frequency according to [4];
- 2> for TDD; or
- 2> for FDD, if the UE does not support HS-DSCH reception in CELL_FACH state; or
- 2> if the IE "HS-DSCH common system information" is not included in System Information Block type 5 or System Information Block type 5bis:
 - 3> select PRACH according to subclause 8.5.17;
 - 3> select Secondary CCPCH according to subclause 8.5.19;
 - 3> use the transport format set given in system information as specified in subclause 8.6.5.1;
 - 3> take the actions related to the HS_DSCH_RECEPTION_GENERAL variable as described in subclause 8.5.37a.
- 2> else:
 - 3> select PRACH according to subclause 8.5.17 and:
 - 4> use for the PRACH the transport format set given in system information as specified in subclause 8.6.5.1.
 - 3> clear variable H_RNTI;
 - 3> clear any stored IEs "HARQ info";
 - 3> reset the MAC-ehs entity [15];
 - 3> set variable HS_DSCH_RECEPTION_OF_CCCH_ENABLED to TRUE;
 - 3> and start receiving the HS-DSCH according to the procedure in subclause 8.5.37.
- 2> set the variable ORDERED_RECONFIGURATION to FALSE.
- 1> set the variables PROTOCOL_ERROR_INDICATOR, FAILURE_INDICATOR, UNSUPPORTED_CONFIGURATION and INVALID_CONFIGURATION to FALSE;

- 1> set the variable CELL_UPDATE_STARTED to TRUE;
- 1> if any IEs related to HS-DSCH are stored in the UE:
 - 2> clear any stored IE "Downlink HS-PDSCH information";
 - 2> for 1.28Mcps TDD, clear the IE "HS-PDSCH Midamble Configuration" and the IE "HS-SCCH Set Configuration" in the IE "DL Multi Carrier Information";
 - 2> determine the value for the HS_DSCH_RECEPTION variable and take the corresponding actions as described in subclause 8.5.25.
- 1> if any IEs related to E-DCH are stored in the UE:
 - 2> clear any stored IE "E-DCH info";
 - 2> determine the value for the E_DCH_TRANSMISSION variable and take the corresponding actions as described in subclause 8.5.28.
- 1> if any of the IEs "DTX-DRX timing information" or "DTX-DRX information" are stored in the UE:
 - 2> determine the value for the DTX_DRX_STATUS variable and take the corresponding actions as described in subclause 8.5.34.
- 1> if the IE "HS-SCCH less information" is stored in the UE:
 - 2> determine the value for the HS_SCCH_LESS_STATUS variable and take the corresponding actions as described in subclause 8.5.35.
- 1> if any IEs related to MIMO are stored in the UE:
 - 2> determine the value for the MIMO_STATUS variable and take the corresponding actions as described in subclause 8.5.33.
- 1> if the UE is not already in CELL_FACH state:
 - 2> move to CELL_FACH state;
 - 2> for TDD; or
 - 2> for FDD, if the UE does not support HS-DSCH reception in CELL_FACH state; or
 - 2> if the IE "HS-DSCH common system information" is not included in System Information Block type 5 or System Information Block type 5bis:
 - 3> select PRACH according to subclause 8.5.17;
 - 3> select Secondary CCPCH according to subclause 8.5.19;
 - 3> use the transport format set given in system information as specified in subclause 8.6.5.1;
 - 3> take the actions related to the HS_DSCH_RECEPTION_GENERAL variable as described in subclause 8.5.37a.
- 2> else:
 - 3> select PRACH according to subclause 8.5.17 and:
 - 4> use for the PRACH the transport format set given in system information as specified in subclause 8.6.5.1.
 - 3> if variable H_RNTI is not set or variable C_RNTI is not set:
 - 4> clear variable C_RNTI;
 - 4> clear variable H_RNTI;
 - 4> clear any stored IEs "HARQ info";

- 4> set variable HS_DSCH_RECEPTION_OF_CCCH_ENABLED to TRUE;
- 4> and start receiving the HS-DSCH according to the procedure in subclause 8.5.37.
- 3> else:
 - 4> receive the HS-DSCH according to the procedure in subclause 8.5.36.
- 1> if the UE performs cell re-selection:
 - 2> clear the variable C_RNTI; and
 - 2> stop using that C_RNTI just cleared from the variable C_RNTI in MAC;
 - 2> for FDD, if the variable H_RNTI is set:
 - 3> clear the variable H_RNTI; and
 - 3> stop using that H_RNTI just cleared from the variable H_RNTI in MAC;
 - 3> clear any stored IEs "HARQ info";
 - 2> for FDD, if the UE does support HS-DSCH reception in CELL_FACH state and IE "HS-DSCH common system information" is included in System Information Block type 5 or System Information Block type 5bis:
 - 3> reset the MAC-ehs entity [15].
 - 3> set variable HS_DSCH_RECEPTION_OF_CCCH_ENABLED to TRUE;
 - 3> and start receiving the HS-DSCH according to the procedure in subclause 8.5.37.
 - 2> else:
 - 3> take the actions related to the HS_DSCH_RECEPTION_GENERAL variable as described in subclause 8.5.37a.
- 1> set CFN in relation to SFN of current cell according to subclause 8.5.15;
- 1> in case of a cell update procedure:
 - 2> set the contents of the CELL UPDATE message according to subclause 8.3.1.3;
 - 2> submit the CELL UPDATE message for transmission on the uplink CCCH.
- 1> in case of a URA update procedure:
 - 2> set the contents of the URA UPDATE message according to subclause 8.3.1.3;
 - 2> submit the URA UPDATE message for transmission on the uplink CCCH.
- 1> set counter V302 to 1;
- 1> start timer T302 when the MAC layer indicates success or failure in transmitting the message.

8.3.1.3 CELL UPDATE / URA UPDATE message contents to set

In case of cell update procedure the UE shall transmit a CELL UPDATE message.

In case of URA update procedure the UE shall transmit a URA UPDATE message.

The UE shall set the IEs in the CELL UPDATE message as follows:

- 1> set the IE "Cell update cause" corresponding to the cause specified in subclause 8.3.1.2 that is valid when the CELL UPDATE message is submitted to lower layers for transmission;

NOTE: During the time period starting from when a cell update procedure is initiated by the UE until when the procedure ends, additional CELL UPDATE messages may be transmitted by the UE with different causes.

- 1> if the IE "Cell update cause" is set to "uplink data transmission" and if an event triggered traffic volume measurement has been configured:
 - 2> if the TCTV is larger than the threshold in the IE "Reporting threshold" for a traffic volume measurement stored in the MEASUREMENT_IDENTITY variable and that traffic volume measurement has "measurement identity" equal to 4, "Traffic volume event identity" equal to "4a", "Measurement validity" equal to "all states" or "all states except CELL_DCH":
 - 3> set the IE "Traffic volume indicator" to TRUE.
 - 2> else:
 - 3> set the IE "Traffic volume indicator" to FALSE.
- 1> set the IE "U-RNTI" to the value of the variable U_RNTI;
- 1> if the value of the variable PROTOCOL_ERROR_INDICATOR is TRUE:
 - 2> include the IE "RRC transaction identifier"; and
 - 3> set it to the value of "RRC transaction identifier" in the entry for the CELL UPDATE CONFIRM message in the table "Rejected transactions" in the variable TRANSACTIONS.
 - 2> include and set the IE "failure cause" to the cause value "protocol error";
 - 2> set the IE "Protocol error information" set to the value of the variable PROTOCOL_ERROR_INFORMATION.
- 1> if the value of the variable FAILURE_INDICATOR is TRUE:
 - 2> include the IE "RRC transaction identifier"; and
 - 3> set it to the value of "RRC transaction identifier" in the entry for the CELL UPDATE CONFIRM message in the table "Accepted transactions" in the variable TRANSACTIONS.
 - 2> include and set the IE "failure cause" to the value of the variable FAILURE_CAUSE.
- 1> if the variable "LATEST_CONFIGURED_CN_DOMAIN" has been initialised:
 - 2> for each CN domain for which an entry exists in the variable ESTABLISHED_RABS or which is indicated in the variable LATEST_CONFIGURED_CN_DOMAIN:
 - 3> include the START value calculated according to subclause 8.5.9.
- 1> else:
 - 2> include the START value for either the CS domain or the PS domain, calculated according to subclause 8.5.9.
- 1> if an unrecoverable error [16] in any of the AM RLC entities for the signalling radio bearers RB2, RB3 or RB4 is detected:
 - 2> set the IE "AM_RLC error indication (RB2, RB3 or RB4)" to TRUE;
 - 2> set the variable AM_RLC_ERROR_PENDING_RB234 to TRUE.
- 1> otherwise:
 - 2> if the value of the variable AM_RLC_ERROR_PENDING_RB234 is TRUE:
 - 3> set the IE "AM_RLC error indication (RB2, RB3 or RB4)" to TRUE.
 - 2> otherwise:
 - 3> set the IE "AM_RLC error indication (RB2, RB3 or RB4)" to FALSE.
- 1> if an unrecoverable error [16] in any of the AM RLC entities for the RB5 or upward is detected:

- 2> set the IE "AM_RLC error indication (RB>4)" to TRUE;
- 2> set the variable AM_RLC_ERROR_PENDING_RB5_AND_UP to TRUE.
- 1> otherwise:
 - 2> if the value of the variable AM_RLC_ERROR_PENDING_RB5_AND_UP is TRUE:
 - 3> set the IE "AM_RLC error indication (RB>4)" to TRUE.
 - 2> otherwise:
 - 3> set the IE "AM_RLC error indication (RB>4)" to FALSE.
- 1> set the IE "RB Timer indicator" to the value of the variable RB_TIMER_INDICATOR;
- 1> if the variable ESTABLISHMENT_CAUSE is initialised:
 - 2> include the IE "Establishment cause" and set it to the value of the variable ESTABLISHMENT_CAUSE;
 - 2> if the value of the variable ESTABLISHMENT_CAUSE is set to "Originating Conversational Call" or "Emergency Call" and a CS call is being initiated:
 - 3> set the value of the IE "Call type" to "speech", "video" or "other" according to the call being initiated.
- 1> if the variable ORDERED_RECONFIGURATION is set to TRUE:
 - 2> include the IE "Reconfiguration Status Indicator" and set it to TRUE.
- 1> if the IE "Cell update cause" is set to "radio link failure" and the UE has submitted a reconfiguration response message to RLC and the UE has not received the RLC acknowledgement for the response message:
 - 2> include the IE "Reconfiguration Status Indicator" and set it to TRUE.
- 1> if the UE supports HS-DSCH reception in CELL_FACH state:
 - 2> include the IE "HS-PDSCH in CELL_FACH" and set it to TRUE.
- 1> if the UE performs cell update for MBMS ptp radio bearer request as specified in subclause 8.6.9.6; and
- 1> if one or more of the MBMS services for which the UE initiates the ptp radio bearer request concerns an MBMS Selected Service:
 - 2> for each MBMS Selected Service that is indicated on MCCH and for which the UE initiates ptp radio bearer request:
 - 3> order the MBMS Selected Services such that those selected with a higher priority are listed in the IE "MBMS Selected Services Short" before those selected with a lower priority;
 - 3> include the IE "MBMS Selected Service ID" within the IE "MBMS Selected Services Short" and set it to a value in accordance with subclause 8.6.9.8.
- 1> otherwise, if the UE performs cell update for MBMS counting as specified in subclause 8.7.4; and
- 1> if one or more of the MBMS services for which the UE initiates the counting response concerns an MBMS Selected Service:
 - 2> for each MBMS Selected Service that is indicated on MCCH and for which the UE initiates the counting response:
 - 3> order the MBMS Selected Services such that those selected with a higher priority are listed in the IE "MBMS Selected Services Short" before those selected with a lower priority;
 - 3> include the IE "MBMS Selected Service ID" within the IE "MBMS Selected Services Short" and set it to a value in accordance with subclause 8.6.9.8.
- 1> if the UE included one or more "MBMS Selected Service ID" IEs:

2> include the IE "MBMS Modification Period identity" and set it to a value in accordance with subclause 8.5.29.

1> if, according to [4], the High-mobility state is applicable and it has been detected by the UE:

2> include the IE "UE Mobility State Indicator" and set it to the "High-MobilityDetected" value.

The UE shall:

1> if the UE capability has changed compared to the value stored in the variable UE_CAPABILITY_TRANSFERRED and the variable RNC_CAPABILITY_CHANGE_SUPPORT is set to TRUE:

2> include the IE "Capability change indicator".

NOTE: Transmitting the IE "Capability change indicator" does not trigger any actual changed behaviour on the part of the UE. It serves only to inform the network that the UE is requesting an opportunity to send a UE CAPABILITY INFORMATION message.

The UE shall set the IEs in the URA UPDATE message as follows:

1> set the IE "U-RNTI" to the value of the variable U_RNTI;

1> set the IE "URA update cause" corresponding to which cause as specified in subclause 8.3.1.2 that is valid when the URA UPDATE message is submitted to lower layers for transmission;

NOTE: During the time period starting from when a URA update procedure is initiated by the UE until when the procedure ends, additional URA UPDATE messages may be transmitted by the UE with different causes, depending on which causes are valid for the respective URA UPDATE message.

1> if the value of the variable PROTOCOL_ERROR_INDICATOR is TRUE:

2 > include the IE "RRC transaction identifier"; and

3> set it to the value of "RRC transaction identifier" in the entry for the URA UPDATE CONFIRM message in the table "Rejected transactions" in the variable TRANSACTIONS.

2> set the IE "Protocol error indicator" to TRUE;

2> include the IE "Protocol error information" set to the value of the variable PROTOCOL_ERROR_INFORMATION.

1> if the value of the variable PROTOCOL_ERROR_INDICATOR is FALSE:

2> if the value of the variable INVALID_CONFIGURATION is TRUE:

3> include the IE "RRC transaction identifier"; and

3> set it to the value of "RRC transaction identifier" in the entry for the URA UPDATE CONFIRM message in the table "Accepted transactions" in the variable TRANSACTIONS;

3> set the IE "Protocol error indicator" to TRUE;

3> include the IE "Protocol error information" set to "Information element value not comprehended".

2> if the value of the variable INVALID_CONFIGURATION is FALSE:

3> set the IE "Protocol error indicator" to FALSE.

1> if the UE supports HS-DSCH reception in CELL_FACH state:

2> include the IE "HS-PDSCH in CELL_FACH" and set it to TRUE.

1> if the UE supports HS-DSCH reception CELL_PCH and URA_PCH state:

2> include the IE "HS-PDSCH in CELL_PCH and URA_PCH " and set it to TRUE.

1> if the UE supports Two DRX schemes in URA_PCH and CELL_PCH

2> include the IE "Support for Two DRX schemes in URA_PCH and CELL_PCH" and set it to TRUE.

8.3.1.4 T305 expiry and the UE detects "out of service area"

When the T305 expires and the UE detects that it is "out of service area" as specified in subclause 8.5.5.1, the UE shall

1> start timer T307;

1> act according to subclause 7.2.2.

8.3.1.4.1 Re-entering "in service area"

If the UE detects "in service area" according to subclause 8.5.5.2 and timer T307 or T317 is running, the UE shall:

1> check the value of V302; and

1> if V302 is equal to or smaller than N302:

2> in case of a cell update procedure:

3> set the contents of the CELL UPDATE message according to subclause 8.3.1.3;

3> submit the CELL UPDATE message for transmission on the uplink CCCH.

2> in case of a URA update procedure:

3> set the contents of the URA UPDATE message according to subclause 8.3.1.3;

3> submit the URA UPDATE message for transmission on the uplink CCCH.

2> increment counter V302;

2> restart timer T302 when the MAC layer indicates success or failure to transmit the message.

1> if V302 is greater than N302:

2> clear the variable RB_UPLINK_CIPHERING_ACTIVATION_TIME_INFO;

2> clear the variable INTEGRITY_PROTECTION_ACTIVATION_INFO;

2> in case of a cell update procedure:

3> clear the entry for the CELL UPDATE CONFIRM message in the table "Rejected transactions" in the variable TRANSACTIONS.

2> in case of a URA update procedure:

3> clear the entry for the URA UPDATE CONFIRM message in the table "Rejected transactions" in the variable TRANSACTIONS.

2> release all its radio resources;

2> indicate release (abort) of the established signalling connections (as stored in the variable ESTABLISHED_SIGNALLING_CONNECTIONS) and established radio access bearers (as stored in the variable ESTABLISHED_RABS) to upper layers;

2> clear the variable ESTABLISHED_SIGNALLING_CONNECTIONS;

2> clear the variable ESTABLISHED_RABS;

2> enter idle mode;

2> perform other actions when entering idle mode from connected mode as specified in subclause 8.5.2;

2> and the procedure ends.

8.3.1.4.2 Expiry of timer T307

When the T307 expires, the UE shall:

- 1> move to idle mode;
- 1> release all dedicated resources;
- 1> indicate release (abort) of the established signalling connections (as stored in the variable ESTABLISHED_SIGNALLING_CONNECTIONS) and established radio access bearers (as stored in the variable ESTABLISHED_RABS) to upper layers;
- 1> clear the variable ESTABLISHED_SIGNALLING_CONNECTIONS;
- 1> clear the variable ESTABLISHED_RABS;
- 1> perform other actions when entering idle mode from connected mode as specified in subclause 8.5.2;
- 1> and the procedure ends.

8.3.1.5 Reception of an CELL UPDATE/URA UPDATE message by the UTRAN

When the UTRAN receives a CELL UPDATE/URA UPDATE message, the UTRAN should:

- 1> in case the procedure was triggered by reception of a CELL UPDATE:
 - 2> if SRNS relocation was performed:
 - 3> transmit a CELL UPDATE CONFIRM message on the downlink DCCH.
 - 2> otherwise:
 - 3> update the START value for each CN domain as maintained in UTRAN (refer to subclause 8.5.9) with "START" in the IE "START list" for the CN domain as indicated by "CN domain identity" in the IE "START list";
 - 3> transmit a CELL UPDATE CONFIRM message on the downlink DCCH or optionally on the CCCH but only if ciphering is not required; and
 - 3> optionally set the IE "RLC re-establish indicator (RB2, RB3 and RB4)" and/or the IE "RLC re-establish indicator (RB5 and upwards)" to TRUE to request a RLC re-establishment in the UE, in which case the corresponding RLC entities should also be re-established in UTRAN; or
- 1> in case the procedure was triggered by reception of a URA UPDATE:
 - 2> if SRNS relocation was performed:
 - 3> transmit a URA UPDATE CONFIRM message on the downlink DCCH.
 - 2> otherwise:
 - 3> transmit a URA UPDATE CONFIRM message on the downlink CCCH or DCCH.
 - 2> include the IE "URA identity" in the URA UPDATE CONFIRM message in a cell where multiple URA identifiers are broadcast; or
- 1> initiate an RRC connection release procedure (see subclause 8.1.4) by transmitting an RRC CONNECTION RELEASE message on the downlink CCCH. In particular UTRAN should:
 - 2> if the CELL UPDATE message was sent because of an unrecoverable error in RB2, RB3 or RB4:
 - 3> initiate an RRC connection release procedure (subclause 8.1.4) by transmitting an RRC CONNECTION RELEASE message on the downlink CCCH.

UTRAN may transmit several CELL UPDATE CONFIRM/URA UPDATE CONFIRM messages to increase the probability of proper reception of the message by the UE. In such a case, the RRC SN for these repeated messages should be the same.

8.3.1.6 Reception of the CELL UPDATE CONFIRM/URA UPDATE CONFIRM message by the UE

When the UE receives a CELL UPDATE CONFIRM/URA UPDATE CONFIRM message; and

- if the message is received on the CCCH, and IE "U-RNTI" is present and has the same value as the variable U_RNTI; or
- if the message is received on DCCH:

the UE may:

- 1> maintain a list of the set of cells to which the UE has Radio Links if the IE "Cell ID" is present.

the UE shall:

- 1> stop timer T302;
- 1> set variable HS_DSCH_RECEPTION_OF_CCCH_ENABLED to FALSE;
- 1> in case of a cell update procedure and the CELL UPDATE CONFIRM message:
 - 2> includes "RB information elements"; and/or
 - 2> includes "Transport channel information elements"; and/or
 - 2> includes "Physical channel information elements"; and
 - 2> if the variable ORDERED_RECONFIGURATION is set to FALSE:
 - 3> set the variable ORDERED_RECONFIGURATION to TRUE.
- 1> act upon all received information elements as specified in subclause 8.6, unless specified otherwise in the following:
 - 2> if the IE "Frequency info" is included in the message:
 - 3> if the IE "RRC State Indicator" is set to the value "CELL_FACH":
 - 4> select a suitable UTRA cell according to [4] on that frequency;
 - 4> if the UE finds a suitable UTRA cell on that frequency:
 - 5> if the received CELL UPDATE CONFIRM message included the IE "Primary CPICH info" (for FDD) or "Primary CCPCH info" (for TDD), and the UE selects another cell than indicated by this IE or the received CELL UPDATE CONFIRM message did not include the IE "Primary CPICH info" (for FDD) or "Primary CCPCH info" (for TDD):
 - 6> act as specified in subclause 8.3.1.12.
 - 4> else, if the UE can not find a suitable UTRA cell on the indicated frequency but it finds a suitable UTRA cell on another frequency:
 - 5> act as specified in subclause 8.3.1.12.
 - 3> if the IE "RRC State Indicator" is set to the value "CELL_PCH" or "URA_PCH":
 - 4> select a suitable UTRA cell according to [4] on that frequency;
 - 4> if the UE finds a suitable UTRA cell on that frequency:
 - 5> if the received CELL UPDATE CONFIRM message included the IE "Primary CPICH info" (for FDD) or "Primary CCPCH info" (for TDD), and the UE in CELL_PCH state selects another cell than indicated by this IE or the received CELL UPDATE CONFIRM message did not include the IE "Primary CPICH info" (for FDD) or "Primary CCPCH info" (for TDD); or

- 5> if the received CELL UPDATE CONFIRM message included the IE "URA identity", and the UE in URA_PCH state selects cell being part of another URA than indicated by this IE or the received CELL UPDATE CONFIRM message did not include the IE "URA identity":
 - 6> act as specified in subclause 8.3.1.12.
 - 4> else, if the UE can not find a suitable UTRA cell on the indicated frequency but it finds a suitable UTRA cell on another frequency:
 - 5> act as specified in subclause 8.3.1.12.
 - 3> if the IE "RRC State Indicator" is set to the value "CELL_DCH":
 - 4> act on the IE "Frequency info" as specified in subclause 8.6.6.1.
 - 2> if the IE "RRC State Indicator" is set to the value "CELL_PCH" or "URA_PCH":
 - 3> if the IE "Wait time" <> 0 is included in the message and the UE supports timer T320:
 - 4> start timer T320 with value set to the time stated in the IE "wait time".
 - 2> use the transport channel(s) applicable for the physical channel types that is used; and
 - 2> if the IE "TFS" is neither included nor previously stored in the UE for that transport channel(s):
 - 3> use the TFS given in system information.
 - 2> if none of the TFS stored is compatible with the physical channel:
 - 3> delete the stored TFS;
 - 3> use the TFS given in system information.
 - 2> if the IE "RLC re-establish indicator (RB2, RB3 and RB4)" in the CELL UPDATE CONFIRM message is set to TRUE:
 - 3> re-establish the RLC entities for signalling radio bearer RB2, signalling radio bearer RB3 and signalling radio bearer RB4 (if established);
 - 3> if the value of the IE "Status" in the variable CIPHERING_STATUS of the CN domain stored in the variable LATEST_CONFIGURED_CN_DOMAIN is set to "Started":
 - 4> set the HFN component of the respective COUNT-C values for AM RLC entities with RB identity 2, RB identity 3 and RB identity 4 (if established) equal to the START value included in the latest transmitted CELL UPDATE message for the CN domain stored in the variable LATEST_CONFIGURED_CN_DOMAIN.
- NOTE: UTRAN should not send a CELL UPDATE CONFIRM message with a target state CELL_PCH or URA_PCH, and including C-RNTI, and setting the IE "RLC re-establish indicator (RB2, RB3 and RB4)" to TRUE, otherwise the UE behaviour is not specified.
- 2> if the IE "RLC re-establish indicator (RB5 and upwards)" in the CELL UPDATE CONFIRM message is set to TRUE:
 - 3> for radio bearers with RB identity 5 and upwards:
 - 4> re-establish the AM RLC entities;
 - 4> if the value of the IE "Status" in the variable CIPHERING_STATUS of the CN domain as indicated in the IE "CN domain identity" in the IE "RAB info" in the variable ESTABLISHED_RABS is set to "Started":
 - 5> set the HFN component of the respective COUNT-C values for AM RLC entities equal to the START value included in this CELL UPDATE message for the CN domain as indicated in the IE "CN domain identity" in the IE "RAB info" in the variable ESTABLISHED_RABS.

NOTE: UE actions, in case IE "Downlink counter synchronisation info" is included and either IE "RLC re-establish indicator (RB2, RB3 and RB4)" or IE "RLC re-establish indicator (RB5 and upwards)" are set to TRUE, are not defined.

- 1> if the CELL UPDATE CONFIRM / URA UPDATE CONFIRM message contained the IE "Ciphering mode info" or contained the IE "Integrity protection mode info":
 - 2> set the IE "Status" in the variable SECURITY_MODIFICATION for all the CN domains in the variable SECURITY_MODIFICATION to "Affected".
- 1> if the variable ESTABLISHMENT_CAUSE is set:
 - 2> clear the variable ESTABLISHMENT_CAUSE.
- 1> enter a state according to subclause 8.6.3.3 applied on the CELL UPDATE CONFIRM / URA UPDATE CONFIRM message.

If the UE after state transition enters CELL_DCH state, it shall:

- 1> perform the physical layer synchronisation procedure A as specified in [29] (FDD only);
- 1> not prohibit periodical status transmission in RLC.
- 1> if the IE "Default DPCH Offset Value" is not included:
 - 2> the UE behaviour is not specified.

If the UE after state transition remains in CELL_FACH state, it shall

- 1> start the timer T305 using its initial value if timer T305 is not running and periodical cell update has been configured by T305 in the IE "UE Timers and constants in connected mode" set to any other value than "infinity";
- 1> select PRACH according to subclause 8.5.17;
- 1> for TDD; or
- 1> for FDD, if the UE does not support HS-DSCH reception in CELL_FACH state; or
- 1> if the IE "HS-DSCH common system information" is not included in System Information Block type 5 or System Information Block type 5bis:
 - 2> select Secondary CCPCH according to subclause 8.5.19;
 - 2> take the actions related to the HS_DSCH_RECEPTION_GENERAL variable as described in subclause 8.5.37a.
- 1> else:
 - 2> if the RBs have the multiplexing option with transport channel type "HS-DSCH" for the DL and transport channel type "RACH" in the UL; and
 - 2> if variable H_RNTI and variable C_RNTI are set:
 - 3> start to receive HS-DSCH according to the procedure in subclause 8.5.36.
 - 2> else:
 - 3> clear variable C_RNTI and delete any stored C-RNTI value;
 - 3> clear variable H_RNTI and delete any stored H-RNTI value;
 - 3> clear any stored IEs "HARQ info";
 - 3> set the variable INVALID_CONFIGURATION to TRUE.
- 1> not prohibit periodical status transmission in RLC;

- 1> if the IE "UTRAN DRX cycle length coefficient" is included in the same message:
 - 2> ignore that IE and stop using DRX.

If the UE after state transition enters URA_PCH or CELL_PCH state, it shall:

- 1> prohibit periodical status transmission in RLC;
- 1> for TDD; or
- 1> for FDD, if the UE does not support HS-DSCH reception in CELL_PCH and URA_PCH state; or
- 1> if the IE "HS-DSCH paging system information" is not included in System Information Block type 5 or System Information Block type 5bis:
 - 2> clear the variable C_RNTI;
 - 2> stop using that C_RNTI just cleared from the variable C_RNTI in MAC.
- 1> start the timer T305 using its initial value if timer T305 is not running and periodical update has been configured by T305 in the IE "UE Timers and constants in connected mode" set to any other value than "infinity";
- 1> for TDD; or
- 1> for FDD, if the UE does not support HS-DSCH reception in CELL_PCH and URA_PCH state; or
- 1> if the IE "HS-DSCH paging system information" is not included in System Information Block type 5 or System Information Block type 5bis:
 - 2> select Secondary CCPCH according to subclause 8.5.19;
 - 2> take the actions related to the HS_DSCH_RECEPTION_GENERAL variable as described in subclause 8.5.37a.
- 1> else:
 - 2> if the UE is in CELL_PCH:
 - 3> if IE "New C-RNTI" is not included:
 - 4> clear the variable C_RNTI;
 - 4> clear the variable H_RNTI;
 - 4> clear any stored IEs "HARQ info".
 - 2> monitor its paging occasions on the selected PICH determined according to subclauses 8.6.3.1a, 8.6.3.2 and 8.5.39 and receive PCCH on the HS-DSCH mapped on the HS-PDSCH, or DCCH and DTCH mapped on the HS-PDSCH and the associated HS-SCCH selected by the UE according to the procedures in subclause 8.5.40.
- 1> if the IE "UTRAN DRX cycle length coefficient" is included in the same message:
 - 2> use the values in the IE "UTRAN DRX Cycle length coefficient" for calculating Paging Occasion and PICH Monitoring Occasion as specified in subclause 8.6.3.2.

NOTE: In the case of a cell update procedure during an ongoing reconfiguration procedure moving the UE into CELL_PCH/URA_PCH then the value of the IE "UTRAN DRX Cycle length coefficient" sent in the CELL UPDATE CONFIRM message should be the same as the value sent in the reconfiguration message.

- 1> if the IE "UTRAN DRX cycle length coefficient" is not included in the same message:
 - 2> set the variable INVALID_CONFIGURATION to TRUE.

If the UE after the state transition remains in CELL_FACH state; and

- 1> the contents of the variable C_RNTI are empty:

it shall check the value of V302; and:

- 1> if V302 is equal to or smaller than N302:
 - 2> if, caused by the received CELL UPDATE CONFIRM or URA UPDATE CONFIRM message:
 - 3> the IE "Reconfiguration" in the variable CIPHERING_STATUS is set to TRUE; and/or
 - 3> the IE "Reconfiguration" in the variable INTEGRITY_PROTECTION_INFO is set to TRUE:
 - 4> abort the ongoing integrity and/or ciphering reconfiguration;
 - 4> if the received CELL UPDATE CONFIRM or URA UPDATE CONFIRM message contained the IE "Ciphering mode info":
 - 5> set the IE "Reconfiguration" in the variable CIPHERING_STATUS to FALSE; and
 - 5> clear the variable RB_UPLINK_CIPHERING_ACTIVATION_TIME_INFO.
 - 4> if the received CELL UPDATE CONFIRM or URA UPDATE CONFIRM message contained the IE "Integrity protection mode info":
 - 5> set the IE "Reconfiguration" in the variable INTEGRITY_PROTECTION_INFO to FALSE; and
 - 5> clear the variable INTEGRITY_PROTECTION_ACTIVATION_INFO.
 - 2> in case of a URA update procedure:
 - 3> stop the URA update procedure;
 - 3> clear any entry for the URA UPDATE CONFIRM message in the table "Accepted transactions" in the variable TRANSACTIONS; and
 - 3> continue with a cell update procedure.
 - 2> set the contents of the CELL UPDATE message according to subclause 8.3.1.3, except for the IE "Cell update cause" which shall be set to "cell reselection";
 - 2> submit the CELL UPDATE message for transmission on the uplink CCCH;
 - 2> increment counter V302;
 - 2> restart timer T302 when the MAC layer indicates success or failure to transmit the message.
 - 1> if V302 is greater than N302:
 - 2> clear the variable RB_UPLINK_CIPHERING_ACTIVATION_TIME_INFO;
 - 2> clear the variable INTEGRITY_PROTECTION_ACTIVATION_INFO;
 - 2> in case of a cell update procedure:
 - 3> clear the entry for the CELL UPDATE CONFIRM message in the table "Rejected transactions" in the variable TRANSACTIONS.
 - 2> in case of a URA update procedure:
 - 3> clear the entry for the URA UPDATE CONFIRM message in the table "Rejected transactions" in the variable TRANSACTIONS.
 - 2> release all its radio resources;
 - 2> indicate release (abort) of the established signalling connections (as stored in the variable ESTABLISHED_SIGNALLING_CONNECTIONS) and established radio access bearers (as stored in the variable ESTABLISHED_RABS) to upper layers;
 - 2> clear the variable ESTABLISHED_SIGNALLING_CONNECTIONS;

- 2> clear the variable ESTABLISHED_RABS;
- 2> enter idle mode;
- 2> other actions the UE shall perform when entering idle mode from connected mode are specified in subclause 8.5.2;
- 2> and the procedure ends.

If the UE after the state transition remains in CELL_FACH state; and

- a C-RNTI is stored in the variable C_RNTI;
- or
- the UE after the state transition moves to another state than the CELL_FACH state:

the UE shall:

- 1> in case cell reselection interrupted an ongoing cell update procedure and a CELL UPDATE CONFIRM/URA UPDATE CONFIRM was received with the IE "Downlink counter synchronisation info" present and the response to which was not submitted to the lower layers due to the cell re-selection:
 - 2> include the IE "START list" in the response message transmitted according to subclause 8.3.1.7;
 - 2> if the CELL UPDATE CONFIRM/URA UPDATE CONFIRM, the response to which was not delivered to the lower layers, due to the cell re-selection, included the IE "RB with PDCP information list":
 - 3> include the IE "RB with PDCP information list" in the response message transmitted according to subclause 8.3.1.7.
- 1> in case of a cell update procedure:
 - 2> set the IE "RRC transaction identifier" in any response message transmitted below to the value of "RRC transaction identifier" in the entry for the CELL UPDATE CONFIRM message in the table "Accepted transactions" in the variable TRANSACTIONS; and
 - 2> clear that entry.
- 1> in case of a URA update procedure:
 - 2> set the IE "RRC transaction identifier" in any response message transmitted below to the value of "RRC transaction identifier" in the entry for the URA UPDATE CONFIRM message in the table "Accepted transactions" in the variable TRANSACTIONS; and
 - 2> clear that entry;
- 1> if the variable PDCP_SN_INFO is non-empty:
 - 2> include the IE "RB with PDCP information list" in any response message transmitted below and set it to the value of the variable PDCP_SN_INFO.
- 1> if the received CELL UPDATE CONFIRM or URA UPDATE CONFIRM message included the IE "Downlink counter synchronisation info":
 - 2> if the variable PDCP_SN_INFO is empty:
 - 3> configure the corresponding RLC entity for all AM and UM radio bearers and AM and UM signalling radio bearers except RB2 to "stop".
 - 2> else:
 - 3> configure the RLC entity for signalling radio bearers RB1, RB3 and RB4 to "stop";
 - 3> configure the RLC entity for UM and AM radio bearers for which the IE "PDCP SN Info" is not included to "stop".

- 2> re-establish the RLC entity for RB2;
- 2> for the downlink and the uplink, apply the ciphering configuration as follows:
 - 3> if the received re-configuration message included the IE "Ciphering Mode Info":
 - 4> use the ciphering configuration in the received message when transmitting the response message.
 - 3> if the ciphering configuration for RB2 from a previously received SECURITY MODE COMMAND has not yet been applied because the activation times not having been reached:
 - 4> if the previous SECURITY MODE COMMAND was received due to new keys being received:
 - 5> consider the new ciphering configuration to include the received new keys;
 - 5> initialise the HFN component of the uplink COUNT-C and downlink COUNT-C of SRB2 as indicated in subclause 8.1.12.3.1.
 - 4> else if the ciphering configuration for RB2 from a previously received SECURITY MODE COMMAND has not yet been applied because of the corresponding activation times not having been reached and the previous SECURITY MODE COMMAND caused a change in LATEST_CONFIGURED_CN_DOMAIN:
 - 5> consider the new ciphering configuration to include the keys associated with the LATEST_CONFIGURED_CN_DOMAIN;
 - 5> initialise the HFN component of the uplink COUNT-C and downlink COUNT-C of SRB2 to the most recently transmitted IE "START list" or IE "START" for the LATEST_CONFIGURED_CN_DOMAIN at the reception of the previous SECURITY MODE COMMAND.
 - 4> apply the new ciphering configuration immediately following RLC re-establishment.
 - 3> else:
 - 4> continue using the current ciphering configuration.
- 2> set the new uplink and downlink HFN component of the COUNT-C of RB2 to MAX(uplink HFN component of the COUNT-C of RB2, downlink HFN component of the COUNT-C of RB2);
- 2> increment by one the downlink and uplink values of the HFN component of the COUNT-C for RB2;
- 2> calculate the START value according to subclause 8.5.9;
- 2> include the calculated START values for each CN domain in the IE "START list" in the IE "Uplink counter synchronisation info" in any response message transmitted below.
- 1> if System Information Block type 11 is scheduled on the BCCH and the UE has not read nor stored the IEs present in this System Information Block; or
- 1> if System Information Block type 11bis is scheduled on the BCCH and the UE has not read nor stored the IEs present in this System Information Block; or
- 1> if System Information Block type 12 is scheduled on the BCCH and the UE has not read nor stored the IEs present in this System Information Block:
 - 2> include the IE "Deferred measurement control reading" in any response message transmitted.
- 1> transmit a response message as specified in subclause 8.3.1.7;
- 1> if the IE "Integrity protection mode info" was present in the CELL UPDATE CONFIRM or URA UPDATE CONFIRM message:
 - 2> start applying the new integrity protection configuration in the uplink for signalling radio bearer RB2 from and including the transmitted response message.

- 1> if the variable ORDERED_RECONFIGURATION is set to TRUE caused by the received CELL UPDATE CONFIRM message in case of a cell update procedure:
 - 2> set the variable ORDERED_RECONFIGURATION to FALSE.
- 1> clear the variable PDCP_SN_INFO;
- 1> when the response message transmitted per subclause 8.3.1.7 to the UTRAN has been confirmed by RLC:
 - 2> if the CELL UPDATE CONFIRM / URA UPDATE CONFIRM message contained the IE "Ciphering mode info":
 - 3> resume data transmission on any suspended radio bearer and signalling radio bearer mapped on RLC-AM or RLC-UM;
 - 3> set the IE "Reconfiguration" in the variable CIPHERING_STATUS to FALSE; and
 - 3> clear the variable RB_UPLINK_CIPHERING_ACTIVATION_TIME_INFO.
 - 2> if the CELL UPDATE CONFIRM / URA UPDATE CONFIRM message contained the IE "Integrity protection mode info":
 - 3> set "Uplink RRC Message sequence number" for signalling radio bearer RB0 in the variable INTEGRITY_PROTECTION_INFO to a value such that next RRC message to be sent on uplink RB0 will use the new integrity protection configuration;
 - 3> allow the transmission of RRC messages on all signalling radio bearers with any RRC SN;
 - 3> set the IE "Reconfiguration" in the variable INTEGRITY_PROTECTION_INFO to FALSE.
 - 2> clear the variable INTEGRITY_PROTECTION_ACTIVATION_INFO.
- 1> in case of a cell update procedure:
 - 2> clear the entry for the CELL UPDATE CONFIRM message in the table "Rejected transactions" in the variable TRANSACTIONS.
- 1> in case of a URA update procedure:
 - 2> clear the entry for the URA UPDATE CONFIRM message in the table "Rejected transactions" in the variable TRANSACTIONS.
- 1> set the variable CELL_UPDATE_STARTED to FALSE;
- 1> if the variable AM_RLC_ERROR_PENDING_RB234 is set to TRUE:
 - 2> set the variable AM_RLC_ERROR_PENDING_RB234 to FALSE.
- 1> if the variable AM_RLC_ERROR_PENDING_RB5_AND_UP is set to TRUE:
 - 2> set the variable AM_RLC_ERROR_PENDING_RB5_AND_UP to FALSE.
- 1> clear the variable SECURITY_MODIFICATION.
- 1> stop timers T314 and/or T315 if they are running.

The procedure ends.

8.3.1.7 Transmission of a response message to UTRAN

If the CELL UPDATE CONFIRM message:

- includes the IE "RB information to release list":

the UE shall:

- 1> transmit a RADIO BEARER RELEASE COMPLETE as response message using AM RLC.

If the CELL UPDATE CONFIRM message:

- does not include the IE "RB information to release list"; and
- includes the IE "RB information to reconfigure list"; or
- includes the IE "RB information to be affected list":

the UE shall:

- 1> transmit a RADIO BEARER RECONFIGURATION COMPLETE as response message using AM RLC.

If the CELL UPDATE CONFIRM message:

- does not include the IE "RB information to release list", nor the IE "RB information to reconfigure list", nor the IE "RB information to be affected list"; and
- includes "Transport channel information elements":

the UE shall:

- 1> transmit a TRANSPORT CHANNEL RECONFIGURATION COMPLETE as response message using AM RLC.

If the CELL UPDATE CONFIRM message:

- does not include the IE "RB information to release list", nor the IE "RB information to reconfigure list", nor the IE "RB information to be affected list"; and
- does not include "Transport channel information elements"; and
- includes "Physical channel information elements":

the UE shall:

- 1> transmit a PHYSICAL CHANNEL RECONFIGURATION COMPLETE as response message using AM RLC.

If the CELL UPDATE CONFIRM message:

- does not include the IE "RB information to release list", nor the IE "RB information to reconfigure list", nor the IE "RB information to be affected list"; and
- does not include "Transport channel information elements"; and
- does not include "Physical channel information elements"; and
- includes "CN information elements"; or
- includes the IE "Ciphering mode info"; or
- includes the IE "Integrity protection mode info"; or
- includes the IE "New C-RNTI"; or
- includes the IE "New U-RNTI"; or
- includes the IE "Downlink counter synchronisation info" and the IE "New U-RNTI":

NOTE: In the case of a cell update procedure during an ongoing reconfiguration procedure moving the UE into CELL_PCH/URA_PCH the CELL UPDATE CONFIRM message should include the IE "New C-RNTI".

the UE shall:

- 1> transmit a UTRAN MOBILITY INFORMATION CONFIRM as response message using AM RLC.

If the CELL UPDATE CONFIRM message:

- does not include "RB information elements"; and

- does not include "Transport channel information elements"; and
- does not include "Physical channel information elements"; and
- does not include "CN information elements"; and
- does not include the IE "Ciphering mode info"; and
- does not include the IE "Integrity protection mode info"; and
- does not include the IE "New C-RNTI"; and
- does not include the IE "New U-RNTI";

the UE shall:

- 1> transmit no response message.

If the URA UPDATE CONFIRM message:

- includes "CN information elements"; or
- includes the IE "Ciphering mode info"; or
- includes the IE "Integrity protection mode info"; or
- includes any one or both of the IEs "New C-RNTI" and "New U-RNTI"; or
- includes the IE "Downlink counter synchronisation info" and the IE "New U-RNTI";

the UE shall:

- 1> transmit a UTRAN MOBILITY INFORMATION CONFIRM as response message using AM RLC.

If the URA UPDATE CONFIRM message:

- does not include "CN information elements"; and
- does not include the IE "Ciphering mode info"; and
- does not include the IE "Integrity protection mode info"; and
- does not include the IE "New U-RNTI"; and
- does not include the IE "New C-RNTI";

the UE shall:

- 1> transmit no response message.

If the new state is CELL_DCH state, the UE shall, after the state transition:

- 1> if the IE "Deferred measurement control reading" was included in the response message:
 - 2> clear the variable CELL_INFO_LIST.

If the new state is CELL_DCH or CELL_FACH, the response message shall be transmitted using the new configuration after the state transition., and the UE shall:

- 1> if the IE "Downlink counter synchronisation info" was included in the received CELL UPDATE CONFIRM or URA UPDATE CONFIRM message:
 - 2> when RLC has confirmed the successful transmission of the response message:
 - 3> if the variable PDCP_SN_INFO is empty:
 - 4> configure the RLC entity for all AM and UM radio bearers and AM and UM signalling radio bearers except RB2 to "continue".

- 3> else:
 - 4> configure the RLC entity for signalling radio bearers RB1, RB3 and RB4 to "continue";
 - 4> configure the RLC entity for UM and AM radio bearers for which the IE "PDCP SN Info" is not included to "continue".
- 3> re-establish all AM and UM RLC entities with RB identities larger than 4 and set the first 20 bits of all the HFN component of the respective COUNT-C values to the START value included in the response message for the corresponding CN domain;
- 3> re-establish the RLC entities with RB identities 1, 3 and 4 and set the first 20 bits of all the HFN component of the respective COUNT-C values to the START value included in the response message for the CN domain stored in the variable LATEST_CONFIGURED_CN_DOMAIN;
- 3> set the remaining bits of the HFN component of the COUNT-C values of all UM RLC entities to zero;
- 3> if the IE "PDCP context relocation info" is not present:
 - > re-initialise the PDCP header compression entities of each radio bearer in the variable ESTABLISHED_RABS as specified in [36].
- 3> if the IE "PDCP context relocation info" is present:
 - 4> perform the actions as specified in subclause 8.6.4.13.
- 1> if the variable PDCP_SN_INFO is empty:
 - 2> if the CELL UPDATE CONFIRM or URA UPDATE CONFIRM message contained the IE "Ciphering mode info":
 - 3> when RLC has confirmed the successful transmission of the response message:
 - 4> continue with the remainder of the procedure.
 - 2> if the CELL UPDATE CONFIRM or URA UPDATE CONFIRM message did not contain the IE "Ciphering mode info":
 - 3> when RLC has been requested to transmit the response message,
 - 4> continue with the remainder of the procedure.
- 1> if the variable PDCP_SN_INFO is non-empty:
 - 2> when RLC has confirmed the successful transmission of the response message:
 - 3> for each radio bearer in the variable PDCP_SN_INFO:
 - 4> if the IE "RB started" in the variable ESTABLISHED_RABS is set to "started":
 - 5> configure the RLC entity for that radio bearer to "continue".
 - 3> continue with the remainder of the procedure.

If the new state is CELL_PCH or URA_PCH, the response message shall be transmitted in CELL_FACH state, and the UE shall:

- 1> when RLC has confirmed the successful transmission of the response message:
 - 2> if the IE "Downlink counter synchronisation info" was included in the received CELL UPDATE CONFIRM or URA UPDATE CONFIRM message:
 - 3> re-establish all AM and UM RLC entities with RB identities larger than 4 and set the first 20 bits of all the HFN component of the respective COUNT-C values to the START value included in the response message for the corresponding CN domain;

- 3> re-establish the RLC entities with RB identities 1, 3 and 4 and set the first 20 bits of all the HFN component of the respective COUNT-C values to the START value included in the response message for the CN domain stored in the variable LATEST_CONFIGURED_CN_DOMAIN;
- 3> set the remaining bits of the HFN component of the COUNT-C values of all UM RLC entities to zero;
- 3> re-initialise the PDCP header compression entities of each radio bearer in the variable ESTABLISHED_RABS as specified in [36].
- 2> for each radio bearer in the variable PDCP_SN_INFO:
 - 3> if the IE "RB started" in the variable ESTABLISHED_RABS is set to "started":
 - 4> configure the RLC entity for that radio bearer to "continue".
 - 2> enter the new state (CELL_PCH or URA_PCH, respectively).
- 1> continue with the remainder of the procedure.

8.3.1.7a Physical channel failure

If the received CELL UPDATE CONFIRM message would cause the UE to transit to CELL_DCH state:

- 1> if the UE failed to establish the physical channel(s) indicated in the received CELL UPDATE CONFIRM message according to the criteria defined in subclause 8.5.4 are not fulfilled;
- 1> if the received CELL UPDATE CONFIRM message does not contain dedicated physical channels; or
- 1> for 3.84 Mcps TDD or 7.68 Mcps TDD, if the received CELL UPDATE CONFIRM does not contain physical channels to which DCCH(s) are mapped:

the UE shall:

- 1> if, caused by the received CELL UPDATE CONFIRM message
 - 2> the IE "Reconfiguration" in the variable CIPHERING_STATUS is set to TRUE; and/or
 - 2> the IE "Reconfiguration" in the variable INTEGRITY_PROTECTION_INFO is set to TRUE:
 - 3> abort the ongoing integrity and/or ciphering reconfiguration;
 - 3> if the received CELL UPDATE CONFIRM message contained the IE "Ciphering mode info":
 - 4> set the IE "Reconfiguration" in the variable CIPHERING_STATUS to FALSE; and
 - 4> clear the variable RB_UPLINK_CIPHERING_ACTIVATION_TIME_INFO.
 - 3> if the received CELL UPDATE CONFIRM message contained the IE "Integrity protection mode info":
 - 4> set the IE "Reconfiguration" in the variable INTEGRITY_PROTECTION_INFO to FALSE; and
 - 4> clear the variable INTEGRITY_PROTECTION_ACTIVATION_INFO.
- 1> if the variable ORDERED_RECONFIGURATION is set to TRUE caused by the received CELL UPDATE CONFIRM message:
 - 2> set the IE "failure cause" to "physical channel failure";
 - 2> set the variable ORDERED_RECONFIGURATION to FALSE.
- 1> if V302 is equal to or smaller than N302:
 - 2> select a suitable UTRA cell according to [4];
 - 2> set the contents of the CELL UPDATE message according to subclause 8.3.1.3, except for the IE "Cell update cause" which shall be set to "Radio link failure";

- 2> submit the CELL UPDATE message for transmission on the uplink CCCH;
 - 2> increment counter V302;
 - 2> restart timer T302 when the MAC layer indicates success or failure to transmit the message.
- 1> if V302 is greater than N302:
- 2> clear the variable RB_UPLINK_CIPHERING_ACTIVATION_TIME_INFO;
 - 2> clear the variable INTEGRITY_PROTECTION_ACTIVATION_INFO;
 - 2> in case of a cell update procedure:
 - 3> clear the entry for the CELL UPDATE CONFIRM message in the table "Rejected transactions" in the variable TRANSACTIONS.
 - 2> release all its radio resources;
 - 2> indicate release (abort) of the established signalling connections (as stored in the variable ESTABLISHED_SIGNALLING_CONNECTIONS) and established radio access bearers (as stored in the variable ESTABLISHED_RABS) to upper layers;
 - 2> clear the variable ESTABLISHED_SIGNALLING_CONNECTIONS;
 - 2> clear the variable ESTABLISHED_RABS;
 - 2> set the variable CELL_UPDATE_STARTED to FALSE;
 - 2> enter idle mode.

8.3.1.8 Unsupported configuration by the UE

If the UE does not support the configuration in the CELL UPDATE CONFIRM message and/or the variable UNSUPPORTED_CONFIGURATION is set to TRUE, the UE shall:

- 1> if V302 is equal to or smaller than N302, the UE shall:
- 2> if, caused by the received CELL UPDATE CONFIRM message
 - 3> the IE "Reconfiguration" in the variable CIPHERING_STATUS is set to TRUE; and/or
 - 3> the IE "Reconfiguration" in the variable INTEGRITY_PROTECTION_INFO is set to TRUE:
 - 4> abort the ongoing integrity and/or ciphering reconfiguration;
 - 4> if the received CELL UPDATE CONFIRM message contained the IE "Ciphering mode info":
 - 5> set the IE "Reconfiguration" in the variable CIPHERING_STATUS to FALSE; and
 - 5> clear the variable RB_UPLINK_CIPHERING_ACTIVATION_TIME_INFO.
 - 4> if the received CELL UPDATE CONFIRM message contained the IE "Integrity protection mode info":
 - 5> set the IE "Reconfiguration" in the variable INTEGRITY_PROTECTION_INFO to FALSE; and
 - 5> clear the variable INTEGRITY_PROTECTION_ACTIVATION_INFO.
 - 2> if the variable ORDERED_RECONFIGURATION is set to TRUE due to the received CELL UPDATE CONFIRM message in case of a cell update procedure:
 - 3> set the variable ORDERED_RECONFIGURATION to FALSE.
 - 2> set the variable FAILURE_INDICATOR to TRUE;
 - 2> set the variable FAILURE_CAUSE to "Unsupported configuration";

- 2> set the content of the CELL UPDATE message according to subclause 8.3.1.3;
 - 2> submit the CELL UPDATE message for transmission on the uplink CCCH;
 - 2> increment counter V302;
 - 2> restart timer T302 when the MAC layer indicates success or failure to transmit the message.
- 1> if V302 is greater than N302, the UE shall:
- 2> clear the variable RB_UPLINK_CIPHERING_ACTIVATION_TIME_INFO;
 - 2> clear the variable INTEGRITY_PROTECTION_ACTIVATION_INFO;
 - 2> clear the variable PDCP_SN_INFO;
 - 2> clear the entry for the CELL UPDATE CONFIRM message in the table "Rejected transactions" in the variable TRANSACTIONS;
 - 2> release all its radio resources;
 - 2> indicate release (abort) of the established signalling connections (as stored in the variable ESTABLISHED_SIGNALLING_CONNECTIONS) and established radio access bearers (as stored in the variable ESTABLISHED_RABS) to upper layers;
 - 2> clear the variable ESTABLISHED_SIGNALLING_CONNECTIONS;
 - 2> clear the variable ESTABLISHED_RABS;
 - 2> set the variable CELL_UPDATE_STARTED to FALSE;
 - 2> enter idle mode;
 - 2> Other actions the UE shall perform when entering idle mode from connected mode are specified in subclause 8.5.2;
 - 2> and the procedure ends.

8.3.1.9 Invalid configuration

If the variable INVALID_CONFIGURATION is set to TRUE, the UE shall:

- 1> if V302 is equal to or smaller than N302:
 - 2> if, caused by the received CELL UPDATE CONFIRM or URA UPDATE CONFIRM message
 - 3> the IE "Reconfiguration" in the variable CIPHERING_STATUS is set to TRUE; and/or
 - 3> the IE "Reconfiguration" in the variable INTEGRITY_PROTECTION_INFO is set to TRUE:
 - 4> abort the ongoing integrity and/or ciphering reconfiguration;
 - 4> if the received CELL UPDATE CONFIRM or URA UPDATE CONFIRM message contained the IE "Ciphering mode info":
 - 5> set the IE "Reconfiguration" in the variable CIPHERING_STATUS to FALSE; and
 - 5> clear the variable RB_UPLINK_CIPHERING_ACTIVATION_TIME_INFO.
 - 4> if the received CELL UPDATE CONFIRM or URA UPDATE CONFIRM message contained the IE "Integrity protection mode info":
 - 5> set the IE "Reconfiguration" in the variable INTEGRITY_PROTECTION_INFO to FALSE; and
 - 5> clear the variable INTEGRITY_PROTECTION_ACTIVATION_INFO.

- 2> if the variable ORDERED_RECONFIGURATION is set to TRUE caused by the received CELL UPDATE CONFIRM message in case of a cell update procedure:
 - 3> set the variable ORDERED_RECONFIGURATION to FALSE.
 - 2> in case of a cell update procedure:
 - 3> set the variable FAILURE_INDICATOR to TRUE;
 - 3> set the variable FAILURE_CAUSE to "Invalid configuration";
 - 3> set the contents of the CELL UPDATE message according to subclause 8.3.1.3;
 - 3> submit the CELL UPDATE message for transmission on the uplink CCCH.
 - 2> in case of a URA update procedure:
 - 3> set the contents of the URA UPDATE message according to subclause 8.3.1.3;
 - 3> submit the URA UPDATE message for transmission on the uplink CCCH.
 - 2> increment counter V302;
 - 2> restart timer T302 when the MAC layer indicates success or failure to transmit the message.
- 1> if V302 is greater than N302:
- 2> clear the variable RB_UPLINK_CIPHERING_ACTIVATION_TIME_INFO;
 - 2> clear the variable INTEGRITY_PROTECTION_ACTIVATION_INFO;
 - 2> clear the variable PDCP_SN_INFO;
 - 2> clear the entry for the CELL UPDATE CONFIRM message in the table "Rejected transactions" in the variable TRANSACTIONS;
 - 2> release all its radio resources;
 - 2> indicate release (abort) of the established signalling connections (as stored in the variable ESTABLISHED_SIGNALLING_CONNECTIONS) and established radio access bearers (as stored in the variable ESTABLISHED_RABS) to upper layers;
 - 2> clear the variable ESTABLISHED_SIGNALLING_CONNECTIONS;
 - 2> clear the variable ESTABLISHED_RABS;
 - 2> set the variable CELL_UPDATE_STARTED to FALSE;
 - 2> enter idle mode;
 - 2> Other actions the UE shall perform when entering idle mode from connected mode are specified in subclause 8.5.2;
 - 2> the procedure ends.

8.3.1.9a Incompatible simultaneous reconfiguration

In case of a cell update procedure and if the received CELL UPDATE CONFIRM message

- includes the IE "RB information to release list", and/or the IE "RB information to reconfigure list", and/or the IE "RB information to be affected list", and/or
- includes "Transport channel information elements"; and/or
- includes "Physical channel information elements"; and

- the variable ORDERED_RECONFIGURATION is set to TRUE because of an ongoing Reconfiguration procedure;

or

If the variable INCOMPATIBLE_SECURITY_RECONFIGURATION is set to TRUE due to the received CELL UPDATE CONFIRM or URA UPDATE CONFIRM message:

the UE shall:

- 1> if V302 is equal to or smaller than N302:
 - 2> if, caused by the received CELL UPDATE CONFIRM or URA UPDATE CONFIRM message
 - 3> the IE "Reconfiguration" in the variable CIPHERING_STATUS is set to TRUE; and/or
 - 3> the IE "Reconfiguration" in the variable INTEGRITY_PROTECTION_INFO is set to TRUE:
 - 4> abort the ongoing integrity and/or ciphering reconfiguration;
 - 4> if the received CELL UPDATE CONFIRM or URA UPDATE CONFIRM message contained the IE "Ciphering mode info":
 - 5> set the IE "Reconfiguration" in the variable CIPHERING_STATUS to FALSE; and
 - 5> clear the variable RB_UPLINK_CIPHERING_ACTIVATION_TIME_INFO.
 - 4> if the received CELL UPDATE CONFIRM or URA UPDATE CONFIRM message contained the IE "Integrity protection mode info":
 - 5> set the IE "Reconfiguration" in the variable INTEGRITY_PROTECTION_INFO to FALSE; and
 - 5> clear the variable INTEGRITY_PROTECTION_ACTIVATION_INFO.
 - 2> if the variable ORDERED_RECONFIGURATION is set to TRUE due to the received CELL UPDATE CONFIRM message in case of a cell update procedure:
 - 3> set the variable ORDERED_RECONFIGURATION to FALSE.
 - 2> set the variable FAILURE_INDICATOR to TRUE;
 - 2> set the variable FAILURE_CAUSE to "Incompatible simultaneous reconfiguration";
 - 2> set the content of the CELL UPDATE message according to subclause 8.3.1.3;
 - 2> submit the CELL UPDATE message for transmission on the uplink CCCH;
 - 2> increment counter V302;
 - 2> restart timer T302 when the MAC layer indicates success or failure to transmit the message.
 - 1> if V302 is greater than N302:
 - 2> clear the variable RB_UPLINK_CIPHERING_ACTIVATION_TIME_INFO;
 - 2> clear the variable INTEGRITY_PROTECTION_ACTIVATION_INFO;
 - 2> clear the variable PDCP_SN_INFO;
 - 2> set the variable INCOMPATIBLE_SECURITY_RECONFIGURATION to FALSE;
 - 2> clear the entry for the CELL UPDATE CONFIRM message in the table "Rejected transactions" in the variable TRANSACTIONS;
 - 2> release all its radio resources;

- 2> indicate release (abort) of the established signalling connections (as stored in the variable ESTABLISHED_SIGNALLING_CONNECTIONS) and established radio access bearers (as stored in the variable ESTABLISHED_RABS) to upper layers;
- 2> clear the variable ESTABLISHED_SIGNALLING_CONNECTIONS;
- 2> clear the variable ESTABLISHED_RABS;
- 2> set the variable CELL_UPDATE_STARTED to FALSE;
- 2> enter idle mode;
- 2> Other actions the UE shall perform when entering idle mode from connected mode are specified in subclause 8.5.2;
- 2> the procedure ends.

8.3.1.9b Security reconfiguration during Cell update procedure

If:

- the variable CELL_UPDATE_STARTED is set to TRUE; and
- the UE receives a SECURITY MODE COMMAND message:

the UE shall

- 1> ignore the received SECURITY MODE COMMAND and continue with any ongoing processes and procedures as if the SECURITY MODE COMMAND message has not been received.

8.3.1.10 Confirmation error of URA ID list

If the URA UPDATE CONFIRM message causes a confirmation error of URA identity list as specified in subclause 8.6.2.1 the UE shall:

- 1> check the value of V302; and
- 1> if V302 is smaller or equal than N302:
 - 2> if, caused by the received URA UPDATE CONFIRM message
 - 3> the IE "Reconfiguration" in the variable CIPHERING_STATUS is set to TRUE; and/or
 - 3> the IE "Reconfiguration" in the variable INTEGRITY_PROTECTION_INFO is set to TRUE:
 - 4> abort the ongoing integrity and/or ciphering reconfiguration;
 - 4> if the received URA UPDATE CONFIRM message contained the IE "Ciphering mode info":
 - 5> set the IE "Reconfiguration" in the variable CIPHERING_STATUS to FALSE; and
 - 5> clear the variable RB_UPLINK_CIPHERING_ACTIVATION_TIME_INFO.
 - 4> if the received URA UPDATE CONFIRM message contained the IE "Integrity protection mode info"
 - 5> set the IE "Reconfiguration" in the variable INTEGRITY_PROTECTION_INFO to FALSE; and
 - 5> clear the variable INTEGRITY_PROTECTION_ACTIVATION_INFO.
 - 2> set the IEs in the URA UPDATE message according to subclause 8.3.1.3;
 - 2> submit the URA UPDATE message for transmission on the uplink CCCH;
 - 2> increment counter V302;
 - 2> restart timer T302 when the MAC layer indicates success or failure to transmit the message.

- 1> if V302 is greater than N302:
 - 2> release all its radio resources;
 - 2> clear the variable RB_UPLINK_CIPHERING_ACTIVATION_TIME_INFO;
 - 2> clear the variable INTEGRITY_PROTECTION_ACTIVATION_INFO;
 - 2> clear the variable PDCP_SN_INFO;
 - 2> indicate release (abort) of the established signalling connections (as stored in the variable ESTABLISHED_SIGNALLING_CONNECTIONS) and established radio access bearers (as stored in the variable ESTABLISHED_RABS) to upper layers;
 - 2> clear the variable ESTABLISHED_SIGNALLING_CONNECTIONS;
 - 2> clear the variable ESTABLISHED_RABS;
 - 2> set the variable CELL_UPDATE_STARTED to FALSE;
 - 2> enter idle mode;
 - 2> perform the actions specified in subclause 8.5.2 when entering idle mode from connected mode;
 - 2> the procedure ends.

8.3.1.11 Invalid CELL UPDATE CONFIRM/URA UPDATE CONFIRM message

If the UE receives an CELL UPDATE CONFIRM/URA UPDATE CONFIRM message, which contains a protocol error causing the variable PROTOCOL_ERROR_REJECT to be set to TRUE according to clause 9, the UE shall perform procedure specific error handling as follows:

- 1> If V302 is equal to or smaller than N302, the UE shall:
 - 2> set the variable PROTOCOL_ERROR_INDICATOR to TRUE;
 - 2> in case of a cell update procedure:
 - 3> set the contents of the CELL UPDATE message according to subclause 8.3.1.3;
 - 3> submit the CELL UPDATE message for transmission on the uplink CCCH.
 - 2> in case of a URA update procedure:
 - 3> set the contents of the URA UPDATE message according to subclause 8.3.1.3;
 - 3> submit the URA UPDATE message for transmission on the uplink CCCH.
 - 2> increment counter V302;
 - 2> restart timer T302 when the MAC layer indicates success or failure to transmit the message.
- 1> if V302 is greater than N302, the UE shall:
 - 2> clear the variable RB_UPLINK_CIPHERING_ACTIVATION_TIME_INFO;
 - 2> in case of a cell update procedure:
 - 3> clear the entry for the CELL UPDATE CONFIRM message in the table "Rejected transactions" in the variable TRANSACTIONS.
 - 2> in case of a URA update procedure:
 - 3> clear the entry for the URA UPDATE CONFIRM message in the table "Rejected transactions" in the variable TRANSACTIONS.

- 2> indicate release (abort) of the established signalling connections (as stored in the variable ESTABLISHED_SIGNALLING_CONNECTIONS) and established radio access bearers (as stored in the variable ESTABLISHED_RABS) to upper layers;
- 2> clear the variable ESTABLISHED_SIGNALLING_CONNECTIONS;
- 2> clear the variable ESTABLISHED_RABS;
- 2> set the variable CELL_UPDATE_STARTED to FALSE;
- 2> release all its radio resources;
- 2> enter idle mode;
- 2> Other actions the UE shall perform when entering idle mode from connected mode are specified in subclause 8.5.2;
- 2> the procedure ends.

8.3.1.12 T302 expiry or cell reselection

If any or several of the following conditions are true:

- expiry of timer T302;
- reselection to another UTRA cell (including the previously serving cell) before completion of the cell update or URA update procedure;

the UE shall:

- 1> stop T302 if it is running;
- 1> if the UE was in CELL_DCH state prior to the initiation of the procedure; and
 - 2> if timers T314 and T315 have elapsed while T302 was running:
 - 3> enter idle mode.
 - 3> indicate release (abort) of the established signalling connections (as stored in the variable ESTABLISHED_SIGNALLING_CONNECTIONS) and established radio access bearers (as stored in the variable ESTABLISHED_RABS) to upper layers. Other actions the UE shall perform when entering idle mode from connected mode are specified in subclause 8.5.2.
 - 3> and the procedure ends.
 - 2> if timer T314 has elapsed while T302 was running and,
 - 3> if "T314 expired" in the variable RB_TIMER_INDICATOR is set to FALSE and
 - 3> if T315 is still running:
 - 4> release locally all radio bearers which are associated with any radio access bearers for which in the variable ESTABLISHED_RABS the value of the IE "Re-establishment timer" is set to "useT314";
 - 4> indicate release of those radio access bearers to upper layers;
 - 4> delete all information about those radio access bearers from the variable ESTABLISHED_RABS;
 - 4> set "T314 expired" in the variable RB_TIMER_INDICATOR to TRUE;
 - 4> if all radio access bearers associated with a CN domain are released:
 - 5> release the signalling connection for that CN domain;
 - 5> remove the signalling connection for that CN domain from the variable ESTABLISHED_SIGNALLING_CONNECTIONS;

- 5> indicate release (abort) of the signalling connection to upper layers.
- 2> if timer T315 has elapsed while T302 was running and,
 - 3> if "T315 expired" in the variable RB_TIMER_INDICATOR is set to FALSE and,
 - 3> if T314 is still running:
 - 4> release locally all radio bearers which are associated with any radio access bearers for which in the variable ESTABLISHED_RABS the value of the IE "Re-establishment timer" is set to "useT315";
 - 4> indicate release of those radio access bearers to upper layers;
 - 4> delete all information about those radio access bearers from the variable ESTABLISHED_RABS;
 - 4> set "T315 expired" in the variable RB_TIMER_INDICATOR to TRUE;
 - 4> if all radio access bearers associated with a CN domain are released:
 - 5> release the signalling connection for that CN domain;
 - 5> remove the signalling connection for that CN domain from the variable ESTABLISHED_SIGNALLING_CONNECTIONS;
 - 5> indicate release (abort) of the signalling connection to upper layers.
 - 2> if timers T314 and T315 are not running:
 - 3> enter idle mode;
 - 3> indicate release (abort) of the established signalling connections (as stored in the variable ESTABLISHED_SIGNALLING_CONNECTIONS) and established radio access bearers (as stored in the variable ESTABLISHED_RABS) to upper layers. Other actions the UE shall perform when entering idle mode from connected mode are specified in subclause 8.5.2;
 - 3> and the procedure ends.
 - 1> check whether it is still in "in service area" (see subclause 8.5.5.2);
 - 1> if the variable ORDERED_RECONFIGURATION is set to TRUE caused by the received CELL UPDATE CONFIRM message in case of a cell update procedure:
 - 2> set the variable ORDERED_RECONFIGURATION to FALSE.
 - 1> in case of a cell update procedure:
 - 2> clear any entry for the CELL UPDATE CONFIRM message in the table "Accepted transactions" in the variable TRANSACTIONS.
 - 1> in case of a URA update procedure:
 - 2> clear any entry for the URA UPDATE CONFIRM message in the table "Accepted transactions" in the variable TRANSACTIONS.

If the UE detects "in service area" if it has not entered idle mode, and:

- 1> if V302 is equal to or smaller than N302, the UE shall:
 - 2> if the UE performed cell re-selection:
 - 3> delete its C-RNTI;
 - 3> for FDD, if the variable H-RNTI is set:
 - 4> clear the variable H_RNTI;
 - 4> stop using that H_RNTI just cleared from the variable H_RNTI in MAC;

- 4> clear any stored IEs "HARQ info".
- 3> for FDD, if the UE does support HS-DSCH reception in CELL_FACH state and the IE "HS-DSCH common system information" is included in System Information Block type 5 or System Information Block type 5bis:
 - 4> reset the MAC-ehs entity [15];
 - 4> set variable HS_DSCH_RECEPTION_OF_CCCH_ENABLED to TRUE;
 - 4> and start receiving the HS-DSCH according to the procedure in subclause 8.5.37.
- 3> else:
 - 4> take the actions related to the HS_DSCH_RECEPTION_GENERAL variable as described in subclause 8.5.37a.
- 2> in case of a cell update procedure:
 - 3> set the contents of the CELL UPDATE message according to subclauses 8.3.1.3 and 8.5.10;
 - 3> if a CELL UPDATE CONFIRM message was received and caused the IE "Reconfiguration" in the variable CIPHERING_STATUS to be set to TRUE and/or the IE "Reconfiguration" in the variable INTEGRITY_PROTECTION_INFO to be set to TRUE:
 - 4> if the IE "Downlink counter synchronisation info" was included in the received CELL UPDATE CONFIRM message:
 - 5> apply the new security (integrity protection) configuration received in the CELL UPDATE CONFIRM on the CELL UPDATE message.
 - 3> submit the CELL UPDATE message for transmission on the uplink CCCH.
- 2> in case of a URA update procedure:
 - 3> set the contents of the URA UPDATE message according to subclauses 8.3.1.3 and 8.5.10;
 - 3> if a URA UPDATE CONFIRM message was received and caused the IE "Reconfiguration" in the variable CIPHERING_STATUS to be set to TRUE and/or the IE "Reconfiguration" in the variable INTEGRITY_PROTECTION_INFO is set to TRUE:
 - 4> if the IE "Downlink counter synchronisation info" was included in the received URA UPDATE CONFIRM message:
 - 5> apply the new security (integrity protection) configuration received in the URA UPDATE CONFIRM on the URA UPDATE message.
 - 3> submit the URA UPDATE message for transmission on the uplink CCCH.
- 2> increment counter V302;
- 2> restart timer T302 when the MAC layer indicates success or failure to transmit the message.
- 1> if V302 is greater than N302, the UE shall:
 - 2> clear the variable RB_UPLINK_CIPHERING_ACTIVATION_TIME_INFO;
 - 2> clear the variable INTEGRITY_PROTECTION_ACTIVATION_INFO;
 - 2> clear the variable PDCP_SN_INFO;
 - 2> in case of a cell update procedure:
 - 3> clear the entry for the CELL UPDATE CONFIRM message in the table "Rejected transactions" in the variable TRANSACTIONS.
 - 2> in case of a URA update procedure:

- 3> clear the entry for the URA UPDATE CONFIRM message in the table "Rejected transactions" in the variable TRANSACTIONS.
- 2> release all its radio resources;
- 2> indicate release (abort) of the established signalling connections (as stored in the variable ESTABLISHED_SIGNALLING_CONNECTIONS) and established radio access bearers (as stored in the variable ESTABLISHED_RABS) to upper layers;
- 2> clear the variable ESTABLISHED_SIGNALLING_CONNECTIONS;
- 2> clear the variable ESTABLISHED_RABS;
- 2> set the variable CELL_UPDATE_STARTED to FALSE;
- 2> enter idle mode;
- 2> other actions the UE shall perform when entering idle mode from connected mode are specified in subclause 8.5.2;
- 2> and the procedure ends.

If the UE detects "out of service area", it shall:

- 1> act according to subclause 7.2.2.

8.3.1.13 T314 expiry

Upon expiry of timer T314 the UE shall:

- 1> if timer T302 is running:
 - 2> continue awaiting response message from UTRAN.
- 1> if timer T302 is not running and timer T315 is running:
 - 2> set IE "T314 expired" in variable RB_TIMER_INDICATOR to TRUE;
 - 2> release locally all radio bearers which are associated with any radio access bearers for which in the variable ESTABLISHED_RABS the value of the IE "Re-establishment timer" is set to "useT314";
 - 2> indicate release of those radio access bearers to upper layers;
 - 2> delete all information about those radio access bearers from the variable ESTABLISHED_RABS;
 - 2> if all radio access bearers associated with a CN domain are released:
 - 3> release the signalling connection for that CN domain;
 - 3> remove the signalling connection for that CN domain from the variable ESTABLISHED_SIGNALLING_CONNECTIONS;
 - 3> indicate release (abort) of the signalling connection to upper layers.
- 1> if timers T302 and T315 are not running:
 - 2> clear the variable RB_UPLINK_CIPHERING_ACTIVATION_TIME_INFO;
 - 2> clear the variable INTEGRITY_PROTECTION_ACTIVATION_INFO;
 - 2> clear the variable PDCP_SN_INFO;
 - 2> clear the entry for the CELL UPDATE CONFIRM message in the table "Rejected transactions" in the variable TRANSACTIONS;
 - 2> release all its radio resources;

- 2> indicate release (abort) of the established signalling connections (as stored in the variable ESTABLISHED_SIGNALLING_CONNECTIONS) and established radio access bearers (as stored in the variable ESTABLISHED_RABS) to upper layers;
- 2> clear the variable ESTABLISHED_SIGNALLING_CONNECTIONS;
- 2> clear the variable ESTABLISHED_RABS;
- 2> set the variable CELL_UPDATE_STARTED to FALSE;
- 2> enter idle mode;
- 2> other actions the UE shall perform when entering idle mode from connected mode are specified in subclause 8.5.2;
- 2> and the procedure ends.

8.3.1.14 T315 expiry

Upon expiry of timer T315 the UE shall:

- 1> if timer T302 is running:
 - 2> continue awaiting response message from UTRAN.
- 1> if timer T302 is not running and timer T314 is running:
 - 2> set IE "T315 expired" in variable RB_TIMER_INDICATOR to TRUE;
 - 2> release locally all radio bearers which are associated with any radio access bearers for which in the variable ESTABLISHED_RABS the value of the IE "Re-establishment timer" is set to "use T315";
 - 2> indicate release of those radio access bearers to upper layers;
 - 2> delete all information about those radio access bearers from the variable ESTABLISHED_RABS;
 - 2> if all radio access bearers associated with a CN domain are released:
 - 3> release the signalling connection for that CN domain;
 - 3> remove the signalling connection for that CN domain from the variable ESTABLISHED_SIGNALLING_CONNECTIONS;
 - 3> indicate release (abort) of the signalling connection to upper layers.
- 1> if timers T302 and T314 are not running:
 - 2> clear the variable RB_UPLINK_CIPHERING_ACTIVATION_TIME_INFO;
 - 2> clear the variable INTEGRITY_PROTECTION_ACTIVATION_INFO;
 - 2> clear the variable PDCP_SN_INFO;
 - 2> clear the entry for the CELL UPDATE CONFIRM message in the table "Rejected transactions" in the variable TRANSACTIONS;
 - 2> release all its radio resources;
 - 2> indicate release (abort) of the established signalling connections (as stored in the variable ESTABLISHED_SIGNALLING_CONNECTIONS) and established radio access bearers (as stored in the variable ESTABLISHED_RABS) to upper layers;
 - 2> clear the variable ESTABLISHED_SIGNALLING_CONNECTIONS;
 - 2> clear the variable ESTABLISHED_RABS;
 - 2> set the variable CELL_UPDATE_STARTED to FALSE;

2> enter idle mode;

2> other actions the UE shall perform when entering idle mode from connected mode are specified in subclause 8.5.2;

2> and the procedure ends.

8.3.1.15 Reception of the UTRAN MOBILITY INFORMATION CONFIRM message by the UTRAN

See subclause 8.3.3.4.

8.3.1.16 T320 Expiry

Upon expiry of timer T320, the UE shall:

1> if the UE has uplink RLC data PDU or uplink RLC control PDU on RB1 or upwards to transmit:

2> perform a cell update procedure according to subclause 8.3.1 using the cause corresponding to "uplink data transmission".

1> else:

2> if the UE should perform cell update for MBMS ptp radio bearer request as specified in subclause 8.6.9.6:

3> perform a cell update procedure according to subclause 8.3.1 using the cause corresponding to "MBMS ptp RB request".

8.3.2 URA update

See subclause 8.3.1.

8.3.3 UTRAN mobility information

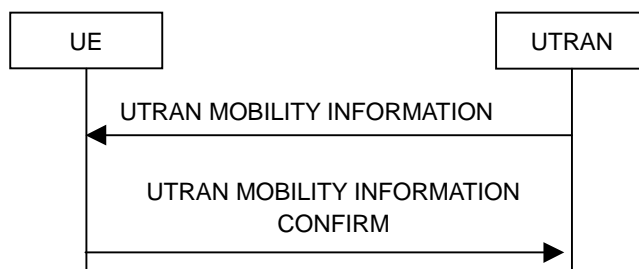

Figure 8.3.3-1: UTRAN mobility information procedure, normal flow

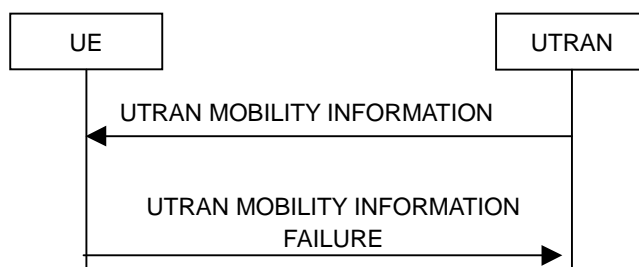

Figure 8.3.3-2: UTRAN mobility information procedure, failure case

8.3.3.1 General

The purpose of this procedure is to allocate any one or a combination of the following to a UE in connected mode:

- a new C-RNTI;
- a new U-RNTI;
- a new H-RNTI (FDD and CELL_FACH state only);
- other mobility related information.

8.3.3.2 Initiation

To initiate the procedure UTRAN transmits a UTRAN MOBILITY INFORMATION message to the UE on the downlink DCCH using AM or UM RLC. In case of SRNS relocation, the message is sent using UM RLC only.

8.3.3.3 Reception of UTRAN MOBILITY INFORMATION message by the UE

When the UE receives a UTRAN MOBILITY INFORMATION message, it shall:

- 1> act on received information elements as specified in subclause 8.6;
- 1> if the IE "UE Timers and constants in connected mode" is present:
 - 2> store the values of the IE "UE Timers and constants in connected mode" in the variable TIMERS_AND_CONSTANTS, replacing any previously stored value for each timer and constant; and
 - 2> for each updated timer value:
 - 3> start using the new value next time the timer is started;

NOTE: If a new value of timer T305 is included in the IE "UE Timers and constants in connected mode", and the old value of timer T305 is "infinity", the new value may not be used immediately.

- 2> for each updated constant value:
 - 3> start using the new value directly;
- 1> if the IE "CN domain specific DRX cycle length coefficient" is present:
 - 2> store the value of the IE "CN domain specific DRX cycle length coefficient" for that CN domain, replacing any previously stored value; and
 - 2> use the value to determine the connected mode paging occasions according to [4].
- 1> set the IE "RRC transaction identifier" in the UTRAN MOBILITY INFORMATION CONFIRM message to the value of "RRC transaction identifier" in the entry for the UTRAN MOBILITY INFORMATION message in the table "Accepted transactions" in the variable TRANSACTIONS; and
- 1> clear that entry;
- 1> if the UTRAN MOBILITY INFORMATION message contained the IE "Ciphering mode info" or contained the IE "Integrity protection mode info":
 - 2> set the IE "Status" in the variable SECURITY_MODIFICATION for all the CN domains in the variable SECURITY_MODIFICATION to "Affected".
- 1> if the variable PDCP_SN_INFO is non-empty:
 - 2> include the IE "RB with PDCP information list" in the UTRAN MOBILITY INFORMATION CONFIRM message and set it to the value of the variable PDCP_SN_INFO.
- 1> if the received UTRAN MOBILITY INFORMATION message included the IE "Downlink counter synchronisation info":
 - 2> if the variable PDCP_SN_INFO is empty:
 - 3> configure the corresponding RLC entity for all AM and UM radio bearers and AM and UM signalling radio bearers except RB2 to "stop".

- 2> else:
 - 3> configure the RLC entity for signalling radio bearers RB1, RB3 and RB4 to "stop";
 - 3> configure the RLC entity for UM and AM radio bearers for which the IE "PDCP SN Info" is not included to "stop".
- 2> re-establish the RLC entity for RB2;
- 2> for the downlink and the uplink, apply the ciphering configuration as follows:
 - 3> if the received re-configuration message included the IE "Ciphering Mode Info":
 - 4> use the ciphering configuration in the received message when transmitting the response message.
 - 3> if the ciphering configuration for RB2 from a previously received SECURITY MODE COMMAND has not yet been applied because the activation times not having been reached:
 - 4> if the previous SECURITY MODE COMMAND was received due to new keys being received:
 - 5> consider the new ciphering configuration to include the received new keys;
 - 5> initialise the HFN component of the uplink COUNT-C and downlink COUNT-C of SRB2 as indicated in subclause 8.1.12.3.1.
 - 4> else if the ciphering configuration for RB2 from a previously received SECURITY MODE COMMAND has not yet been applied because of the corresponding activation times not having been reached and the previous SECURITY MODE COMMAND caused a change in LATEST_CONFIGURED_CN_DOMAIN:
 - 5> consider the new ciphering configuration to include the keys associated with the LATEST_CONFIGURED_CN_DOMAIN;
 - 5> initialise the HFN component of the uplink COUNT-C and downlink COUNT-C of SRB2 to the most recently transmitted IE "START list" or IE "START" for the LATEST_CONFIGURED_CN_DOMAIN at the reception of the previous SECURITY MODE COMMAND.
 - 4> apply the new ciphering configuration immediately following RLC re-establishment.
 - 3> else:
 - 4> continue using the current ciphering configuration.
- 2> set the new uplink and downlink HFN component of COUNT-C of RB2 to MAX(uplink HFN component of COUNT-C of RB2, downlink HFN component of COUNT-C of RB2);
- 2> increment by one the downlink and uplink values of the HFN component of COUNT-C for RB2;
- 2> calculate the START value according to subclause 8.5.9;
- 2> include the calculated START values for each CN domain in the IE "START list" in the IE "Uplink counter synchronisation info" in the UTRAN MOBILITY INFORMATION CONFIRM message.
- 1> transmit a UTRAN MOBILITY INFORMATION CONFIRM message on the uplink DCCH using AM RLC;
- 1> if the IE "Integrity protection mode info" was present in the UTRAN MOBILITY INFORMATION message:
 - 2> start applying the new integrity protection configuration in the uplink for signalling radio bearer RB2 from and including the transmitted UTRAN MOBILITY INFORMATION CONFIRM message.
- 1> if the IE "Downlink counter synchronisation info" was included in the received UTRAN MOBILITY INFORMATION message:
 - 2> when RLC has confirmed the successful transmission of the response message:
 - 3> if the variable PDCP_SN_INFO is empty:

- 4> configure the RLC entity for all AM and UM radio bearers and AM and UM signalling radio bearers except RB2 to "continue".
- 3> else:
 - 4> configure the RLC entity for signalling radio bearers RB1, RB3 and RB4 to "continue";
 - 4> configure the RLC entity for UM and AM radio bearers for which the IE "PDCP SN Info" is not included to "continue".
- 3> re-establish all AM and UM RLC entities with RB identities larger than 4 and set the first 20 bits of all the HFN component of the respective COUNT-C values to the START value included in the response message for the corresponding CN domain;
- 3> re-establish the RLC entities with RB identities 1, 3 and 4 and set the first 20 bits of all the HFN component of the respective COUNT-C values to the START value included in the response message for the CN domain stored in the variable LATEST_CONFIGURED_CN_DOMAIN;
- 3> set the remaining bits of the HFN component of the COUNT-C values of all UM RLC entities to zero;
- 3> if the IE "PDCP context relocation info" is not present:
 - 4> re-initialise the PDCP header compression entities of each radio bearer in the variable ESTABLISHED_RABS as specified in [36].
- 3> if the IE "PDCP context relocation info" is present:
 - 4> perform the actions as specified in subclause 8.6.4.13.
- 1> if the variable PDCP_SN_INFO is empty; and
 - 2> if the UTRAN MOBILITY INFORMATION message contained the IE "Ciphering mode info":
 - 3> when RLC has confirmed the successful transmission of the UTRAN MOBILITY INFORMATION CONFIRM message:
 - 4> perform the actions below:
 - 2> if the UTRAN MOBILITY INFORMATION message did not contain the IE "Ciphering mode info":
 - 3> when RLC has been requested to transmit the UTRAN MOBILITY INFORMATION CONFIRM message:
 - 4> perform the actions below.
- 1> if the variable PDCP_SN_INFO is non-empty:
 - 2> when RLC has confirmed the successful transmission of the UTRAN MOBILITY INFORMATION CONFIRM message:
 - 3> for each radio bearer in the variable PDCP_SN_INFO:
 - 4> if the IE "RB started" in the variable ESTABLISHED_RABS is set to "started":
 - 5> configure the RLC entity for that radio bearer to "continue".
 - 3> clear the variable PDCP_SN_INFO; and
 - 3> perform the actions below.

The UE shall:

- 1> if the UTRAN MOBILITY INFORMATION message contained the IE "Ciphering mode info":
 - 2> resume data transmission on any suspended radio bearer and signalling radio bearer mapped on RLC-AM or RLC-UM;
 - 2> set the IE "Reconfiguration" in the variable CIPHERING_STATUS to FALSE; and

- 2> clear the variable RB_UPLINK_CIPHERING_ACTIVATION_TIME_INFO.
- 1> if the UTRAN MOBILITY INFORMATION message contained the IE "Integrity protection mode info":
 - 2> allow the transmission of RRC messages on all signalling radio bearers with any RRC SN;
 - 2> set the IE "Reconfiguration" in the variable INTEGRITY_PROTECTION_INFO to FALSE; and
 - 2> clear the variable INTEGRITY_PROTECTION_ACTIVATION_INFO.
- 1> clear the variable SECURITY_MODIFICATION.

The procedure ends.

8.3.3.4 Reception of an UTRAN MOBILITY INFORMATION CONFIRM message by the UTRAN

When the network receives UTRAN MOBILITY INFORMATION CONFIRM message, UTRAN may delete any old U-RNTI. The procedure ends.

8.3.3.5 Cell re-selection

If the UE performs cell re-selection, the UE shall:

- 1> initiate a cell update procedure according to subclause 8.3.1;
- 1> if the UTRAN MOBILITY INFORMATION message contains the IE "New C-RNTI"; and
- 1> if the UE has not yet submitted the UTRAN MOBILITY INFORMATION CONFIRM message to lower layers for transmission; and
- 1> if the IE "Downlink counter synchronisation info" was not included in the received UTRAN MOBILITY INFORMATION message:
 - 2> transmit a UTRAN MOBILITY INFORMATION FAILURE message on the uplink DCCH using AM RLC;
 - 2> set the IE "RRC transaction identifier" in the UTRAN MOBILITY INFORMATION FAILURE message to the value of "RRC transaction identifier" in the entry for the UTRAN MOBILITY INFORMATION message in the table "Accepted transactions" in the variable TRANSACTIONS; and
 - 2> clear that entry.
 - 2> set the IE "failure cause" to the cause value "cell update occurred";
 - 2> when the UTRAN MOBILITY INFORMATION FAILURE message has been submitted to lower layers for transmission:
 - 3> continue with any ongoing processes and procedures as if the invalid UTRAN MOBILITY INFORMATION message has not been received and the procedure ends.
- 1> otherwise:
 - 2> if a UTRAN MOBILITY INFORMATION message was received and caused the IE "Reconfiguration" in the variable CIPHERING_STATUS to be set to TRUE and/or the IE "Reconfiguration" in the variable INTEGRITY_PROTECTION_INFO to be set to TRUE; and
 - 2> if the IE "Downlink counter synchronisation info" was included in the received UTRAN MOBILITY INFORMATION message:
 - 3> apply the new security (integrity protection) configuration received in the UTRAN MOBILITY INFORMATION message on the CELL UPDATE message to be transmitted.
 - 2> continue the procedure normally.

8.3.3.5a Incompatible simultaneous security reconfiguration

If the variable `INCOMPATIBLE_SECURITY_RECONFIGURATION` becomes set to `TRUE` of the received `UTRAN MOBILITY INFORMATION` message, the UE shall:

- 1> transmit a `UTRAN MOBILITY INFORMATION FAILURE` message on the uplink DCCH using AM RLC;
- 1> set the IE "RRC transaction identifier" in the `UTRAN MOBILITY INFORMATION FAILURE` message to the value of "RRC transaction identifier" in the entry for the `UTRAN MOBILITY INFORMATION` message in the table "Accepted transactions" in the variable `TRANSACTIONS`; and
- 1> clear that entry;
- 1> set the IE "failure cause" to the cause value "incompatible simultaneous reconfiguration";
- 1> when the `UTRAN MOBILITY INFORMATION FAILURE` message has been delivered to lower layers for transmission:
 - 2> set the variable `INCOMPATIBLE_SECURITY_RECONFIGURATION` to `FALSE`;
 - 2> continue with any ongoing processes and procedures as if the `UTRAN MOBILITY INFORMATION` message has not been received;
 - 2> and the procedure ends.

8.3.3.6 Invalid UTRAN MOBILITY INFORMATION message

If the `UTRAN MOBILITY INFORMATION` message contains a protocol error causing the variable `PROTOCOL_ERROR_REJECT` to be set to `TRUE` according to clause 9, the UE shall perform procedure specific error handling as follows. The UE shall:

- 1> transmit a `UTRAN MOBILITY INFORMATION FAILURE` message on the uplink DCCH using AM RLC;
- 1> set the IE "RRC transaction identifier" in the `UTRAN MOBILITY INFORMATION FAILURE` message to the value of "RRC transaction identifier" in the entry for the `UTRAN MOBILITY INFORMATION` message in the table "Rejected transactions" in the variable `TRANSACTIONS`, and;
- 1> clear that entry.
- 1> set the IE "failure cause" to the cause value "protocol error";
- 1> include the IE "Protocol error information" with contents set to the value of the variable `PROTOCOL_ERROR_INFORMATION`;
- 1> when the `UTRAN MOBILITY INFORMATION FAILURE` message has been submitted to lower layers for transmission:
 - 2> continue with any ongoing processes and procedures as if the invalid `UTRAN MOBILITY INFORMATION` message has not been received;
 - 2> and the procedure ends.

8.3.4 Active set update

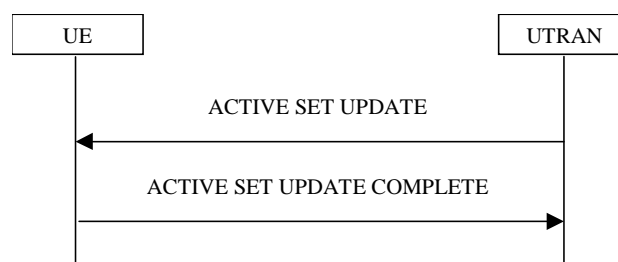

Figure 8.3.4-1: Active Set Update procedure, successful case

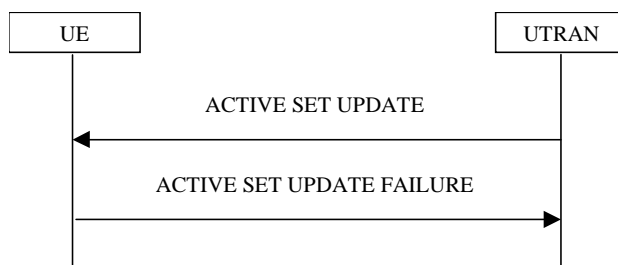

Figure 8.3.4-2: Active Set Update procedure, failure case

8.3.4.1 General

The purpose of the active set update procedure is to update the active set of the connection between the UE and UTRAN. This procedure shall be used in CELL_DCH state. The UE should keep on using the old RLs while configuring the new RLs. Also the UE should keep the transmitter turned on during the procedure. This procedure is only used in FDD mode.

8.3.4.2 Initiation

The procedure is initiated when UTRAN orders a UE in CELL_DCH state, to make the following modifications of the active set of the connection:

- a) Radio link addition;
- b) Radio link removal;
- c) Combined radio link addition and removal;
- d) Addition of a radio link to the E-DCH active set;
- e) Removal of a radio link from the E-DCH active set.

In case a) and c), UTRAN should:

- 1> prepare new additional radio link(s) in the UTRAN prior to the command to the UE.

In all cases, UTRAN should:

- 1> send an ACTIVE SET UPDATE message on downlink DCCH using AM or UM RLC;
- 1> create active sets that contain at least one common radio link across a DPCH or F-DPCH frame boundary as the result of one or multiple (parallel) active set update procedures.

UTRAN should include the following information:

- 1> IE "Radio Link Addition Information": Downlink DPCH information and other optional parameters relevant for the radio links to be added along with the IE "Primary CPICH info" used for the reference ID to indicate which radio link to add. This IE is needed in cases a) and c) listed above;
- 1> IE "Radio Link Removal Information": IE "Primary CPICH info" used for the reference ID to indicate which radio link to remove. This IE is needed in cases b) and c) listed above;
- 1> IE "E-DCH reconfiguration information": IE "Primary CPICH info" used for the reference ID along with the IE "E-HICH information" to indicate which radio link to add to the E-DCH active set. This IE is needed in case d) above, when the RL added to the E-DCH active set is already in the DCH active set;
- 1> IE "E-DCH reconfiguration information": IE "Primary CPICH info" used for the reference ID along with the IE "E-HICH release indicator" to indicate which radio link to remove from the E-DCH active set. This IE is needed in case e) above, when the RL removed from the E-DCH active set remains in the DCH active set.

NOTE: The UE behaviour is unspecified if SRBs are mapped on E-DCH and the value for the E_DCH_TRANSMISSION variable is changed to FALSE via the Active Set Update procedure; or if SRBs are mapped on HS-DSCH and the value for the HS_DSCH_RECEPTION variable is changed to FALSE via the Active Set Update procedure.

8.3.4.3 Reception of an ACTIVE SET UPDATE message by the UE

Upon reception of an ACTIVE SET UPDATE message the UE shall act upon all received information elements as specified in 8.6, unless specified otherwise in the following.

The UE may:

- 1> maintain a list of the set of cells to which the UE has Radio Links if the IE "Cell ID" is present.

The UE shall:

- 1> first add the RLS indicated in the IE "Radio Link Addition Information";
- 1> remove the RLS indicated in the IE "Radio Link Removal Information". If the UE active set is full or becomes full, an RL, which is included in the IE "Radio Link Removal Information" for removal, shall be removed before adding RL, which is included in the IE "Radio Link Addition Information" for addition;
- 1> perform the physical layer synchronisation procedure B as specified in [29];
- 1> if the IE "E-HICH information" is included:
 - 2> store this E-HICH configuration for the concerning radio link.
- 1> if the IE "E-HICH information" is included:
 - 2> store this E-RGCH configuration for the concerning radio link, if included.
- 1> determine the value for the E_DCH_TRANSMISSION variable and take the corresponding actions as described in subclause 8.5.28;
- 1> if the IE "MAC-es/e reset indicator" is included in the IE "UL 16QAM configuration":
 - 2> reset the MAC-es/e entity [15].

NOTE 1: If the IE "MAC-es/e reset indicator" is not included in the IE "UL 16QAM configuration" and 16QAM operations starts or stops, the UE behaviour is unspecified.

- 1> if the IE "UL 16QAM settings" is not included in the IE "16QAM configuration":
 - 2> indicate to lower layers to stop any operation in 16QAM mode.

NOTE 2: If the IE "UL 16QAM configuration" is not included and 16QAM mode operation is currently ongoing, the UE behaviour is unspecified.

- 1> if the IEs "E-TFCI Boost Info" and/or "E-DPDCH power interpolation" are present, act on the received information elements;
- 1> if the IEs "E-DPCCH/DPCCH power offset" and/or "Reference E-TFCI PO" are included in the IE "E-DCH reconfiguration information same serving cell", act on the received information elements;

NOTE 3: If E-TFCI boost is signalled to the UE and a reference E-TFCI \leq E-TFCI Boost is signalled to the UE with a Reference E-TFCI PO of value 30 or 31, the UE behaviour is unspecified.

- 1> if the radio link currently considered to be the serving HS-DSCH radio link is indicated in the IE "Radio Link Removal Information":
 - 2> no longer consider any radio link as the serving HS-DSCH radio link;
 - 2> determine the value for the HS_DSCH_RECEPTION variable and take the corresponding actions as described in subclause 8.5.25.

- 1> if "Serving HS-DSCH cell information" IE is present, act on received information elements as specified in subclause 8.6:
 - 2> if the IEs " Δ_{ACK} ", " Δ_{NACK} ", and "HARQ_preamble_mode" are present, act on the received information elements;
 - 2> if the new H-RNTI and "Primary CPICH info" are included:
 - 3> consider the cell indicated in Primary CPICH as serving HS-DSCH cell and no longer consider any other radio link as serving HS-DSCH cell.
 - 2> if the IE "MAC-hs reset indicator" is included:
 - 3> reset the MAC-hs/ehs entity [15].
 - 2> determine the value for the HS_DSCH_RECEPTION variable and take the corresponding actions as described in subclause 8.5.25.
- 1> if the IE "E-DCH reconfiguration information" is included:
 - 2> if the IE "E-DCH RL Info other cells" is present:
 - 3> if the IE "E-HICH Information" is present:
 - 4> store the E-HICH and E-RGCH information (if present), contained therein, for the indicated radio link.
 - 3> if the IE "E-HICH release indicator" is present:
 - 4> delete the stored E-HICH, E-AGCH and E-RGCH (if any) configurations.
 - 3> if the IE "E-RGCH release indicator" is set present:
 - 4> delete the stored E-RGCH configuration for this RL.
 - 2> if the IE "E-DCH RL Info new serving cell" is present:
 - 3> consider the cell indicated in "Primary CPICH info" as serving E-DCH radio link and no longer consider any other radio link as serving E-DCH radio link;
 - 3> store the E-HICH and E-RGCH information (if present), contained therein, for the new serving E-DCH radio link;
 - 3> if the IE "E-RGCH release indicator" is present:
 - 4> delete the stored E-RGCH configuration for this RL.
 - 3> store the newly received E-AGCH configuration;
 - 3> if the IE "Serving Grant" is included, and if the IE "Serving Grant Value" is not included:
 - 4> the UE behaviour is not specified.
 - 2> if the IEs "E-DPCCH/DPCCH power offset" and/or "Reference E-TFCI PO" and/or "Power offset for scheduling info" are present, act on the received information elements.
 - 2> if the serving E-DCH radio link was another radio link than this radio link prior to reception of the message:
 - 3> if the IE "New Primary E-RNTI" is not included:
 - 4> clear the Primary E-RNTI stored in the variable E_RNTI.
 - 3> if the IE "New Secondary E-RNTI" is not included:
 - 4> clear the Secondary E-RNTI stored in the variable E_RNTI.
- 1> if the radio link currently considered to be the serving E-DCH radio link is indicated in the IE "Radio Link Removal Information":

- 2> no longer consider any radio link as the serving E-DCH radio link.
- 1> determine the value for the E_DCH_TRANSMISSION variable and take the corresponding actions as described in subclause 8.5.28.
- 1> set the IE "RRC transaction identifier" in the ACTIVE SET UPDATE COMPLETE message to the value of "RRC transaction identifier" in the entry for the ACTIVE SET UPDATE message in the table "Accepted transactions" in the variable TRANSACTIONS; and
- 1> clear that entry;
- 1> transmit an ACTIVE SET UPDATE COMPLETE message on the uplink DCCH using AM RLC without waiting for the completion of the Physical Layer synchronisation B, as specified in [29];
- 1> the procedure ends on the UE side.

8.3.4.4 Unsupported configuration in the UE

If UTRAN instructs the UE to use a configuration that it does not support, the UE shall:

- 1> keep the active set as it was before the ACTIVE SET UPDATE message was received;
- 1> transmit an ACTIVE SET UPDATE FAILURE message on the DCCH using AM RLC;
- 1> set the IE "RRC transaction identifier" in the ACTIVE SET UPDATE FAILURE message to the value of "RRC transaction identifier" in the entry for the ACTIVE SET UPDATE message in the table "Accepted transactions" in the variable TRANSACTIONS; and
- 1> clear that entry;
- 1> set the IE "failure cause" to "configuration unsupported";
- 1> when the ACTIVE SET UPDATE FAILURE message has been submitted to lower layers for transmission:
 - 2> the procedure ends on the UE side.

8.3.4.5 Invalid configuration

If any of the following conditions are valid:

- a radio link indicated by the IE "Downlink DPCH info for each RL" in the IE "Radio link addition information" has a different spreading factor than the spreading factor for the radio links in the active set that will be established at the time indicated by the IE "Activation time"; and/or
- a radio link in the IE "Radio link addition information" is also present in the IE "Radio Link Removal Information"; and/or
- the IE "Radio Link Removal Information" contains all the radio links which are part of or will be part of the active set at the time indicated by the IE "Activation time"; and/or
- the IE "TX Diversity Mode" is not set to "none" and it indicates a diversity mode that is different from the one currently used (<STTD> or <closed loop mode1>) in all or part of the active set; and/or
- a radio link indicated by the IE "Radio Link Removal Information" does not exist in the active set; and/or
- after the removal of all radio links indicated by the IE "Radio Link Removal Information" and the addition of all radio links indicated by the IE "Radio Link Addition Information" the active set would contain more than the maximum allowed number of radio links; and/or
- after the addition of all radio links indicated by the IE "Radio Link Addition Information" the active set would contain radio links indicated by the IE "Downlink DPCH info for each RL" and radio links indicated by the IE "Downlink F-DPCH info for each RL"; and/or
- the variable INVALID_CONFIGURATION is set to TRUE:

the UE shall:

- 1> keep the active set as it was before the ACTIVE SET UPDATE message was received;
- 1> transmit an ACTIVE SET UPDATE FAILURE message on the DCCH using AM RLC;
- 1> set the IE "RRC transaction identifier" in the ACTIVE SET UPDATE FAILURE message to the value of "RRC transaction identifier" in the entry for the ACTIVE SET UPDATE message in the table "Accepted transactions" in the variable TRANSACTIONS; and
- 1> clear that entry;
- 1> set the IE "failure cause" to "Invalid configuration";
- 1> When the ACTIVE SET UPDATE FAILURE message has been submitted to lower layers for transmission:
 - 2> the procedure ends on the UE side.

If the following condition is valid:

- the active set update procedure results in active sets that do not contain at least one common radio link before and after a DPCH or F-DPCH frame boundary:

the UE behaviour is not specified.

8.3.4.5a Void

8.3.4.5b Incompatible simultaneous reconfiguration

If the variable ORDERED_RECONFIGURATION is set to TRUE, the UE may:

- 1> if the activation time for the procedure that has set variable ORDERED_RECONFIGURATION and the activation time for the Active Set Update procedure are within a time window of 5 frames:
 - 2> transmit an ACTIVE SET UPDATE FAILURE message on the uplink DCCH using AM RLC;
 - 2> set the IE "RRC transaction identifier" in the ACTIVE SET UPDATE FAILURE message to the value of "RRC transaction identifier" in the entry for the ACTIVE SET UPDATE message in the table "Accepted transactions" in the variable TRANSACTIONS; and
 - 2> clear that entry;
 - 2> set the IE "failure cause" to the cause value "incompatible simultaneous reconfiguration";
 - 2> when the ACTIVE SET UPDATE FAILURE message has been delivered to lower layers for transmission:
 - 3> continue with any ongoing processes and procedures as if the ACTIVE SET UPDATE message has not been received.
 - 3> and the procedure ends.

8.3.4.6 Reception of the ACTIVE SET UPDATE COMPLETE message by the UTRAN

When the UTRAN has received the ACTIVE SET UPDATE COMPLETE message,

- 1> the UTRAN may remove radio link(s) that are indicated to remove to the UE in case b) and c); and
- 1> the procedure ends on the UTRAN side.

8.3.4.7 Reception of the ACTIVE SET UPDATE FAILURE message by the UTRAN

When the UTRAN has received the ACTIVE SET UPDATE FAILURE message, the UTRAN may delete radio links that were included in the IE "Radio Link Addition Information" for addition. The procedure ends on the UTRAN side.

8.3.4.8 Invalid ACTIVE SET UPDATE message

If the ACTIVE SET UPDATE message contains a protocol error causing the variable `PROTOCOL_ERROR_REJECT` to be set to TRUE according to clause 9, the UE shall perform procedure specific error handling as follows. The UE shall:

- 1> transmit a ACTIVE SET UPDATE FAILURE message on the uplink DCCH using AM RLC;
- 1> set the IE "RRC transaction identifier" in the ACTIVE SET UPDATE FAILURE message to the value of "RRC transaction identifier" in the entry for the ACTIVE SET UPDATE message in the table "Rejected transactions" in the variable `TRANSACTIONS`; and
- 1> clear that entry;
- 1> set the IE "failure cause" to the cause value "protocol error";
- 1> include the IE "Protocol error information" with contents set to the value of the variable `PROTOCOL_ERROR_INFORMATION`;
- 1> when the ACTIVE SET UPDATE FAILURE message has been delivered to lower layers for transmission:
 - 2> continue with any ongoing processes and procedures as if the invalid ACTIVE SET UPDATE message has not been received;
 - 2> and the procedure ends.

8.3.4.9 Reception of an ACTIVE SET UPDATE message in wrong state

If the UE is in another state than `CELL_DCH` state upon reception of the ACTIVE SET UPDATE message, the UE shall perform procedure specific error handling as follows. The UE shall:

- 1> transmit a ACTIVE SET UPDATE FAILURE message on the uplink DCCH using AM RLC;
- 1> set the IE "RRC transaction identifier" in the ACTIVE SET UPDATE FAILURE message to the value of "RRC transaction identifier" in the entry for the ACTIVE SET UPDATE message in the table "Accepted transactions" in the variable `TRANSACTIONS`; and
- 1> clear that entry;
- 1> set the IE "failure cause" to the cause value "protocol error";
- 1> include the IE "Protocol error information" with the IE "Protocol error cause" set to "Message not compatible with receiver state";
- 1> when the ACTIVE SET UPDATE FAILURE message has been delivered to lower layers for transmission:
 - 2> continue with any ongoing processes and procedures as if the ACTIVE SET UPDATE message has not been received;
 - 2> and the procedure ends.

8.3.5 Hard handover

When performing hard handover with change of frequency, the UE shall:

- 1> stop all intra-frequency and inter-frequency measurement reporting on the cells listed in the variable `CELL_INFO_LIST`. Each stopped measurement is restarted when a MEASUREMENT CONTROL message is received with the corresponding measurement identity.

8.3.5.1 Timing re-initialised hard handover

8.3.5.1.1 General

The purpose of the timing re-initialised hard handover procedure is to remove all the RL(s) in the active set and establish new RL(s) along with a change in the CFN in the UE according to the SFN of the target cell.(see subclause 8.5.15).

For TDD timing re-initialised hard handover is realised via CFN calculation (see subclause 8.5.15.2).

NOTE: For FDD, during the hard-handover procedure, the UE will align the timing of the uplink transmission as specified in [26].

This procedure is initiated when UTRAN does not know the target SFN timing before hard handover.

8.3.5.1.2 Initiation (FDD only)

Timing re-initialised hard handover initiated by the UTRAN is normally performed by using the procedure "Physical channel reconfiguration" (subclause 8.2.6), but may also be performed by using either one of the following procedures:

- "radio bearer establishment" (subclause 8.2.1);
- "Radio bearer reconfiguration" (subclause 8.2.2);
- "Radio bearer release" (subclause 8.2.3); or
- "Transport channel reconfiguration" (subclause 8.2.4).

In this case of a timing re-initialised hard handover, UTRAN should include the IE "Default DPCH Offset Value" and:

1> in FDD mode:

2> if the UE is configured for DPCH:

3> set "Default DPCH Offset Value" and "DPCH frame offset" respecting the following relation

$$(\text{Default DPCH Offset Value}) \bmod 38400 = \text{DPCH frame offset}_j$$

- where j indicates the first radio link listed in the message and the IE values used are the Actual Values of the IEs as defined in clause 11.

2> if the UE is configured for F-DPCH:

3> set "Default DPCH Offset Value" and "DPCH frame offset _{j} " respecting one of the following relations:

4> $(\text{Default DPCH Offset Value}) \bmod 38400 = \text{DPCH frame offset}_j$; or

4> $(\text{Default DPCH Offset Value}+256) \bmod 38400 = \text{DPCH frame offset}_j$,

- where j indicates the first radio link listed in the message and the IE values used are the Actual Values of the IEs as defined in clause 11.

If the IE "Default DPCH Offset Value" is included, the UE shall:

1> in FDD mode:

2> if the UE is configured for DPCH:

3> if $(\text{Default DPCH Offset Value}) \bmod 38400 = \text{DPCH frame offset}_j$,

- where j indicates the first radio link listed in the message:

4> set DOFF (see subclause 8.5.15.1) to Default DPCH Offset Value.

3> else:

4> set the variable INVALID_CONFIGURATION to TRUE.

2> if the UE is configured for F-DPCH:

3> if $(\text{Default DPCH Offset Value}) \bmod 38400 = \text{DPCH frame offset}_j$,

- where j indicates the first radio link listed in the message:

4> set DOFF (see subclause 8.5.15.1) to Default DPCH Offset Value.

3> else if $(\text{Default DPCH Offset Value}+256) \bmod 38400 = \text{DPCH frame offset}_j$,

- where j indicates the first radio link listed in the message:

4> set DOFF (see subclause 8.5.15.1) to Default DPCH Offset Value + 256.

3> else:

4> set the variable INVALID_CONFIGURATION to true.

If the IE "Default DPCH Offset Value" is not included, the UE shall:

1> set the variable INVALID_CONFIGURATION to true.

8.3.5.2 Timing-maintained hard handover

8.3.5.2.1 General

The purpose of the Timing-maintained hard handover procedure is to remove all the RL(s) in the active set and establish new RL(s) while maintaining the CFN in the UE.

For TDD timing re-initialised hard handover is realised via CFN calculation (see subclause 8.5.15.2).

NOTE: For FDD, during the hard-handover procedure, the UE will align the timing of the uplink transmission as specified in [26].

This procedure can be initiated only if UTRAN knows the target SFN timing before hard handover. The target SFN timing can be known by UTRAN in the following 2 cases:

- UE reads SFN when measuring "Cell synchronisation information" and sends it to the UTRAN in MEASUREMENT REPORT message.
- UTRAN internally knows the time difference between the cells.

8.3.5.2.2 Initiation (FDD only)

Timing-maintained hard handover initiated by the network is normally performed by using the procedure "Physical channel reconfiguration" (subclause 8.2.6), but may also be performed by using either one of the following procedures:

- "radio bearer establishment" (subclause 8.2.1);
- "Radio bearer reconfiguration" (subclause 8.2.2);
- "Radio bearer release" (subclause 8.2.3); or
- "Transport channel reconfiguration" (subclause 8.2.4).

In this case of a timing maintained hard handover procedure the UTRAN should not include the IE "Default DPCH Offset Value".

If the IE "Default DPCH Offset Value" is included, the UE shall:

1> ignore the IE "Default DPCH Offset Value".

8.3.6 Inter-RAT handover to UTRAN

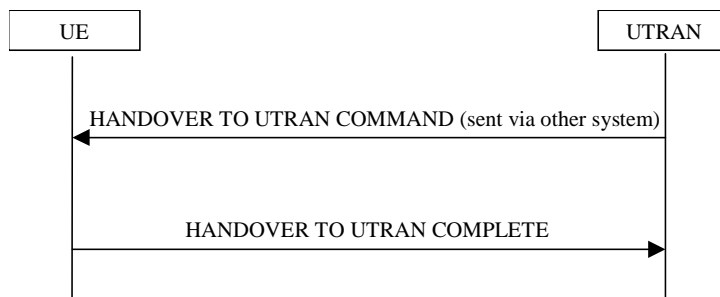

Figure 8.3.6-1: Inter-RAT handover to UTRAN, successful case

8.3.6.1 General

The purpose of the inter-RAT handover procedure is to, under the control of the network, transfer a connection between the UE and another radio access technology (e.g. GSM) to UTRAN.

This procedure may be used to perform CS handover which applies when there is a signalling connection to the CS domain.

When the UE supports Inter Rat PS handover, this procedure may be used to perform PS handover which applies when there is only a signalling connection to the PS domain.

This procedure may be used to perform simultaneous CS and PS handover (i.e. DTM Handover) which applies when there are signalling connections to both CS and PS domains.

8.3.6.2 Initiation

The procedure is initiated when a radio access technology other than UTRAN, e.g. GSM, using radio access technology-specific procedures, orders the UE to make a handover to UTRAN.

A HANDOVER TO UTRAN COMMAND message is sent to the UE via the radio access technology from which inter-RAT handover is performed.

In case UTRAN decides to use a predefined or default radio configuration that is stored in the UE, it should include the following information in the HANDOVER TO UTRAN COMMAND message.

- the IE "New U-RNTI" to be assigned;
- the IE "Predefined configuration identity", to indicate which pre-defined configuration of RB, transport channel and physical channel parameters shall be used; or
- the IE "Default configuration mode" and IE "Default configuration identity", to indicate which default configuration of RB, transport channel and physical channel parameters shall be used;
- PhyCH information elements.

NOTE 1: When using a predefined or default configuration during handover to UTRAN, UTRAN can only assign values of IEs "New U-RNTI" and "scrambling code" that are within the special subranges defined exclusively for this procedure. UTRAN may re-assign other values after completion of the handover procedure.

NOTE 2: When using a predefined or default configuration during handover to UTRAN, fewer IEs are signalled; when using this signalling option some parameters e.g. concerning compressed mode, DSCH can not be configured. In this case, the corresponding functionality can not be activated immediately.

NOTE 3: When using a predefined or default configuration, the HANDOVER TO UTRAN COMMAND should not include more than one radio link. If UTRAN includes more than one radio link in the HANDOVER TO UTRAN COMMAND using a predefined or default configuration, the UE behaviour is unspecified.

In case UTRAN does not use a predefined radio configuration that is stored in the UE, it should include the following information in the HANDOVER TO UTRAN COMMAND message.

- the IE "New U-RNTI" to be assigned;
- the complete set of RB, TrCH and PhyCH information elements to be used.

8.3.6.3 Reception of HANDOVER TO UTRAN COMMAND message by the UE

The UE shall be able to receive a HANDOVER TO UTRAN COMMAND message and perform an inter-RAT handover, even if no prior UE measurements have been performed on the target UTRAN cell and/or frequency.

The UE shall act upon all received information elements as specified in subclause 8.6, unless specified otherwise in the following.

The UE may:

- 1> maintain a list of the set of cells to which the UE has Radio Links if the IE "Cell ID" is present.

The UE shall:

- 1> store a U-RNTI value (32 bits), which is derived by the IEs "SRNC identity" and "S-RNTI 2" included in IE "U-RNTI-short". In order to produce a full size U-RNTI value, a full size "S-RNTI" (20 bits) shall be derived by padding the IE "S-RNTI 2" with 10 zero bits in the most significant positions; and
- 1> initialise the variable ESTABLISHED_SIGNALLING_CONNECTIONS with the signalling connections that remains after the handover according to the specifications of the source RAT;
- 1> initialise the variable UE_CAPABILITIES_TRANSFERRED with the UE capabilities that have been transferred to the network up to the point prior to the handover, if any;
- 1> initialise the variable TIMERS_AND_CONSTANTS to the default values and start to use those timer and constants values;
- 1> if IE "Specification mode" is set to "Preconfiguration" and IE "Preconfiguration mode" is set to "Predefined configuration":
 - 2> initiate the radio bearer and transport channel configuration in accordance with the predefined parameters identified by the IE "Predefined configuration identity";
 - 2> initiate the physical channels in accordance with the predefined parameters identified by the IE "Predefined radio configuration identity" and the received physical channel information elements;
 - 2> store information about the established radio access bearers and radio bearers according to the IE "Predefined configuration identity"; and
 - 2> set the IE "RAB Info Post" in the variable ESTABLISHED_RABS and the IE "Re-establishment timer" in the IE "RAB Info" in the variable ESTABLISHED_RABS to "useT314".
- 1> if IE "Specification mode" is set to "Preconfiguration" and IE "Preconfiguration mode" is set to "Default configuration":
 - 2> initiate the radio bearer and transport channel configuration in accordance with the default parameters identified by the IE "Default configuration mode" and IE "Default configuration identity";
 - 2> initiate the physical channels in accordance with the default parameters identified by the IE "Default configuration mode" and IE "Default configuration identity" and the received physical channel information elements;

NOTE 1: IE "Default configuration mode" specifies whether the FDD or TDD version of the default configuration shall be used.

- 2> set the IE "RAB Info Post" in the variable ESTABLISHED_RABS and the IE "Re-establishment timer" in the IE "RAB Info" in the variable ESTABLISHED_RABS to "useT314".
- 1> if IE "Specification mode" is set to "Preconfiguration":

2> use the following values for parameters that are neither signalled within the HANOVER TO UTRAN COMMAND message nor included within pre-defined or default configuration:

3> 0 dB for the power offset $P_{\text{Pilot-DPDCH}}$ bearer in FDD;

3> calculate the Default DPCH Offset Value using the following formula:

3> in FDD:

$$\text{Default DPCH Offset Value} = (\text{SRNTI} \cdot 2 \bmod 600) \cdot 512$$

3> in TDD:

$$\text{Default DPCH Offset Value} = (\text{SRNTI} \cdot 2 \bmod 7)$$

3> handle the above Default DPCH Offset Value as if an IE with that value was included in the message, as specified in subclause 8.6.6.21.

1> if IE "Specification mode" is set to "Complete specification":

2> initiate the radio bearer, transport channel and physical channel configuration in accordance with the received radio bearer, transport channel and physical channel information elements.

1> perform an open loop estimation to determine the UL transmission power according to subclause 8.5.3;

1> set the IE "START" for each CN domain, in the IE "START list" in the HANOVER TO UTRAN COMPLETE message equal to the START value for each CN domain stored in the USIM if the USIM is present, or as stored in the UE for each CN domain if the SIM is present;

NOTE 2: Keys received while in another RAT are not regarded as "new" (i.e. do not trigger the actions in subclause 8.1.12.3.1) in a subsequent security mode control procedure in UTRAN, irrespective of whether the keys are already being used in the other RAT or not. If the UE has received new keys in the other RAT before handover, then the START values in the USIM (sent in the HANOVER TO UTRAN COMPLETE message and in the INTER_RAT_HANOVER_INFO sent to the BSS while in the other RAT) will not reflect the receipt of these new keys

If ciphering has been active for the CS domain in the other RAT, then during the first security mode control procedure following the Inter-RAT handover to UTRAN procedure, UE activates integrity protection using the integrity key of the key set used. The term "key set used" denotes the key set that was used in the last successfully completed RRC Security Mode Control (UTRAN), RR Cipher Mode Control procedure or GMM Authentication and Ciphering procedure (GERAN) after entering connected mode in UTRAN or GERAN. The term "if ciphering has been active for the CS domain" is defined by a successfully completed RRC Security Mode Control procedure with "Ciphering Mode Info" (UTRAN) or RR Cipher Mode Control procedure (GERAN) for the CS domain. More specifically the state of ciphering refers to the establishment of a security context where the key is loaded from the (U)SIM to the ME even if the security command indicates NULL ciphering ("no ciphering" in GERAN or UEA0 in UTRAN).

1> set the value of "THRESHOLD" in the variable "START_THRESHOLD" to the 20 MSBs of the value stored in the USIM [50] for the maximum value of START for each CN Domain, or to the default value in [40] if the SIM is present;

1> if ciphering is indicated in the HANOVER TO UTRAN COMMAND by the presence of the IE "Ciphering Algorithm":

2> for the handover of CS domain, indicated by the IE "CN domain identity" of the IE "RAB info" of the IE "RAB information to setup" set to "CS domain" or absence of this IE, if ciphering was not active in the radio access technology from which inter-RAT handover is performed:

3> the UE behaviour is unspecified.

NOTE 2a: The distinction between CS and PS domains is that CS ciphering must be maintained across an inter-RAT handover procedure, whereas PS ciphering in UTRAN is not dependent on previous ciphering status in the source radio access technology.

2> set the variable LATEST_CONFIGURED_CN_DOMAIN to the value indicated in the IE "CN domain identity" of the IE "RAB info" of the IE "RAB information to setup" if all instances of the IE indicate the

same CN domain, or to the CS domain when this IE is either not present or different instances indicate different CN domains;

- 2> for the CN domain in variable LATEST_CONFIGURED_CN_DOMAIN set the IE "Status" in the variable CIPHERING_STATUS to "Started";
- 2> if the variable LATEST_CONFIGURED_CN_DOMAIN is set to "CS domain":
 - 3> set the 20 MSB of the HFN component of the COUNT-C variable for all signalling radio bearers to the "START" value from the IE "UE security information" in the variable INTER_RAT_HANDOVER_INFO_TRANSFERRED.
- 2> else if the variable LATEST_CONFIGURED_CN_DOMAIN is set to "PS domain":
 - 3> set the 20 MSB of the HFN component of the COUNT-C variable for all signalling radio bearers to the "START" value from the IE "UE security information2" in the variable INTER_RAT_HANDOVER_INFO_TRANSFERRED.
- 2> if the CN domain indicated in the IE "CN domain identity" of any instance of the IE "RAB info" in the IE "RAB information to setup" is "CS domain":
 - 3> set the 20 MSB of the HFN component of the COUNT-C variable for all CS domain radio bearers to the "START" value included in the IE "UE security information" in the variable INTER_RAT_HANDOVER_INFO_TRANSFERRED;
 - 3> set the IE "Status" in the variable CIPHERING_STATUS to "Started".
- 2> if the CN domain indicated in the IE "CN domain identity" of any instance of the IE "RAB info" in the IE "RAB information to setup" is "PS domain":
 - 3> set the 20 MSB of the HFN component of the COUNT-C variable for all PS domain radio bearers to the "START" value included in the IE "UE security information2" in the variable INTER_RAT_HANDOVER_INFO_TRANSFERRED;
 - 3> set the IE "Status" in the variable CIPHERING_STATUS to "Started".
- 2> set the remaining LSBs of the HFN component of COUNT-C for all radio bearers to zero;
- 2> not increment the HFN component of COUNT-C for radio bearers using RLC-TM, i.e. keep the HFN value fixed without incrementing every CFN cycle;
- 2> set the CFN component of the COUNT-C variable for radio bearers using RLC-TM to the value of the CFN as calculated in subclause 8.5.15;
- 2> for all user radio bearers belonging to the "CS domain" and for signalling radio bearers when the variable LATEST_CONFIGURED_CN_DOMAIN is set to "CS domain":
 - 3> apply the algorithm according to IE "Ciphering Algorithm" with the ciphering key of the key set used and apply ciphering immediately upon reception of the HANDOVER TO UTRAN COMMAND.
- 2> for all user radio bearers belonging to the "PS domain" and for signalling radio bearers when the variable LATEST_CONFIGURED_CN_DOMAIN is set to "PS domain":
 - 3> apply the algorithm according to IE "Ciphering Algorithm" with the ciphering key stored in the USIM/SIM and apply ciphering immediately upon reception of the HANDOVER TO UTRAN COMMAND.

NOTE 3: If ciphering is indicated in the HANDOVER TO UTRAN COMMAND, UTRAN should not include the IE "Ciphering mode info" in the SECURITY MODE COMMAND message that starts Integrity protection.

NOTE 4: DTM Handover is not possible if the IE "specification mode" is set to "Preconfiguration" due to the existence of a single IE "RAB Info".

- 1> if ciphering is not indicated in the HANDOVER TO UTRAN COMMAND:

- 2> for the CN domain(s) included in the IE "CN domain identity" which is included in the IE "RAB info" of the IE "RAB information to setup", or the CS domain when these IEs are not present:
- 3> set the IE "Status" in the variable CIPHERING_STATUS to "Not Started".

If the UE succeeds in establishing the connection to UTRAN, it shall:

- 1> if "RAB Info" list contained only one CN domain identity in IE "CN domain identity":
 - 2> if CN domain is set to CS domain only indicate to upper layers that no CN system information is available for any domain other than the CS domain (see NOTE 5);
 - 2> if CN domain is set to PS domain only indicate to upper layers that no CN system information is available for any domain other than the PS domain (see NOTE 6).

- 1> if "RAB Info" list contained RABs for the PS and CS domain:

- 2> indicate to upper layers that CN system information is available for the PS and CS domain (see NOTE 7).

NOTE 5: After CS handover has been completed, the UTRAN should provide the UE with the CN system information of the PS domain as soon as possible, in order not to delay access to the PS domain.

NOTE 6: After PS handover has been completed, the UTRAN should provide the UE with the CN system information of the CS and PS domain as soon as possible in order not to delay access to the CS domain and trigger a NAS procedure for the PS domain.

NOTE 7: After DTM handover has been completed, the UTRAN should provide the UE with the CN system information of the PS domain as soon as possible in order to trigger a NAS procedure for the PS domain.

- 1> if the USIM or SIM is present:

- 2> set the START value stored in the USIM [50] if present, and as stored in the UE if the SIM is present for any CN domain to the value "THRESHOLD" of the variable START_THRESHOLD.

- 1> if the IE "Status" in the variable CIPHERING_STATUS of a CN domain is set to "Started" and transparent mode radio bearers have been established by this procedure for that CN domain:

- 2> include the IE "COUNT-C activation time" in the response message and specify a CFN value for this IE other than the default, "Now", that is a multiple of 8 frames ($CFN \bmod 8 = 0$) and lies at least 200 frames ahead of the CFN in which the response message is first transmitted;
- 2> at the CFN value as indicated in the response message in the IE "COUNT-C activation time" for radio bearers using RLC-TM:
 - 3> set the 20 MSB of the HFN component of the COUNT-C variable common for all transparent mode radio bearers of this CN domain to the START value as indicated in the IE "START list" of the response message for the relevant CN domain; and
 - 3> set the remaining LSBs of the HFN component of COUNT-C to zero;
 - 3> increment the HFN component of the COUNT-C variable by one even if the "COUNT-C activation time" is equal to zero;
 - 3> set the CFN component of the COUNT-C to the value of the IE "COUNT-C activation time" of the response message. The HFN component and the CFN component completely initialise the COUNT-C variable;
 - 3> step the COUNT-C variable, as normal, at each CFN value. The HFN component is no longer fixed in value but incremented at each CFN cycle.

- 1> if the IE "Status" in the variable CIPHERING_STATUS of a CN domain is set to "Not Started" and transparent mode radio bearers have been established by this procedure for that CN domain:

- 2> initialise the 20 MSB of the HFN component of COUNT-C common for all transparent mode radio bearers of this CN domain with the START value as indicated in the IE "START list" of the response message for the relevant CN domain;

- 2> set the remaining LSBs of the HFN component of COUNT-C to zero;
- 2> do not increment the COUNT-C value common for all transparent mode radio bearers for this CN domain.
- 1> for 3.84/7.68 Mcps TDD, if the HANOVER TO UTRAN COMMAND provides for E-DCH/HS-DSCH operation without an uplink DPCH:
 - 2> the UE shall obtain timing advance for the 3.84/7.68 Mcps TDD cell according to [15] before transmitting on the uplink DCCH.
- 1> transmit a HANOVER TO UTRAN COMPLETE message on the uplink DCCH, using, if ciphering has been started, the new ciphering configuration;
- 1> when the HANOVER TO UTRAN COMPLETE message has been submitted to lower layers for transmission:
 - 2> enter UTRA RRC connected mode in state CELL_DCH;
 - 2> initialise variables upon entering UTRA RRC connected mode as specified in subclause 13.4;
 - 2> update the variable UE_CAPABILITY_TRANSFERRED with the UE capabilities stored in the variable INTER_RAT_HANOVER_INFO_TRANSFERRED.
- 1> and the procedure ends.

8.3.6.4 Invalid Handover to UTRAN command message

If the UE receives a HANOVER TO UTRAN COMMAND message, which contains a protocol error causing the variable `PROTOCOL_ERROR_REJECT` to be set to TRUE according to clause 9, the UE shall perform procedure specific error handling according to the source radio access technology. The UE shall:

- 1> if allowed by the source RAT:
 - 2> transmit an RRC FAILURE INFO message to the source radio access technology; and
 - 2> include the IE "Protocol error information" with contents set to the value of the variable `PROTOCOL_ERROR_INFORMATION`;
- 1> Other details may be provided in the specifications related to the source radio access technology.

NOTE: The other RAT may include the above diagnostics information in a subsequent handover request towards the same RNC.

8.3.6.4a Unsupported configuration in HANOVER TO UTRAN COMMAND message

If the UE does not support the configuration included in the HANOVER TO UTRAN COMMAND message, e.g., the message includes a pre-defined configuration that the UE has not stored, the UE shall:

- 1> continue the connection using the other radio access technology; and
- 1> indicate the failure to the other radio access technology.

8.3.6.5 UE fails to perform handover

If the UE does not succeed in establishing the connection to UTRAN, it shall:

- 1> terminate the procedure including release of the associated resources;
- 1> resume the connection used before the handover; and
- 1> indicate the failure to the other radio access technology.

Upon receiving an indication about the failure from the other radio access technology, UTRAN should release the associated resources and the context information concerning this UE.

8.3.6.6 Reception of message HANDOVER TO UTRAN COMPLETE by the UTRAN

Upon receiving a HANDOVER TO UTRAN COMPLETE message, UTRAN should consider the inter-RAT handover procedure as having been completed successfully and indicate this to the Core Network.

8.3.7 Inter-RAT handover from UTRAN

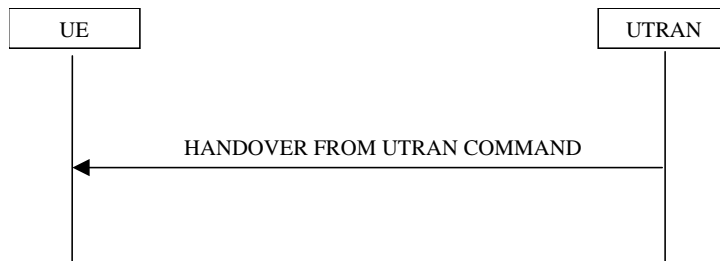

Figure 8.3.7-1: Inter-RAT handover from UTRAN, successful case

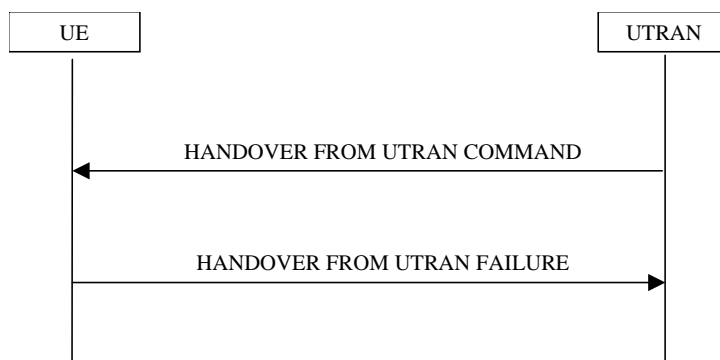

Figure 8.3.7-2: Inter-RAT handover from UTRAN, failure case

8.3.7.1 General

The purpose of the inter-RAT handover procedure is to, under the control of the network, transfer a connection between the UE and UTRAN to another radio access technology (e.g. GSM). This procedure may be used in CELL_DCH state.

This procedure may be used to perform CS handover which applies when the variable ESTABLISHED_SIGNALLING_CONNECTIONS includes at least the CN domain identity "CS Domain".

When the UE supports Inter Rat PS handover, this procedure may be used to perform PS handover which applies when the variable ESTABLISHED_SIGNALLING_CONNECTIONS includes at least the CN domain identity "PS Domain".

This procedure may be used to perform simultaneous CS and PS handover which applies when the variable ESTABLISHED_SIGNALLING_CONNECTIONS includes CN domain identities for both "CS Domain" and "PS Domain".

8.3.7.2 Initiation

The procedure is initiated when UTRAN orders a UE in CELL_DCH state, to make a handover to a radio access technology other than UTRAN, e.g. GSM.

To initiate the procedure, UTRAN sends a HANDOVER FROM UTRAN COMMAND message.

8.3.7.3 Reception of a HANDOVER FROM UTRAN COMMAND message by the UE

The UE shall be able to receive a HANDOVER FROM UTRAN COMMAND message and perform an inter-RAT handover, even if no prior UE measurements have been performed on the target cell.

The UE shall:

- 1> For FDD:
- 2> if the UE has a pending "TGPS reconfiguration CFN" at the activation time received in the HANDOVER FROM UTRAN COMMAND the UE may:
- 3> abort the pending CM activation;
- 3> set the CM_PATTERN_ACTIVATION_ABORTED to TRUE.
- 2> otherwise:
- 3> set the CM_PATTERN_ACTIVATION_ABORTED to FALSE.
- 1> establish the connection to the target radio access technology, by using the contents of the IE "Inter-RAT message". This IE contains a message specified in another standard, as indicated by the IE "System type", and carries information about the candidate/ target cell identifier(s) and radio parameters relevant for the target radio access technology. The correspondence between the value of the IE "System type", the standard to apply and the message contained within IE "Inter RAT message" is shown in the following:

Value of the IE "System type"	Standard to apply	Inter RAT Message
GSM	GSM TS 04.18, version 8.5.0 or later, or 3GPP TS 44.018 3GPP TS 44.060, version 6.13.0 or later 3GPP TS 44.018, version 7.6.0 or later and 3GPP TS 44.060, version 7.6.0 or later	HANDOVER COMMAND PS HANDOVER COMMAND DTM HANDOVER COMMAND
GERAN Iu	3GPP TS 44.118	RADIO BEARER RECONFIGURATION
cdma2000	TIA/EIA/IS-2000 or later, TIA/EIA/IS-833 or later, TIA/EIQ/IS-834 or later	

- 1> if the IE "System type" has the value "GSM" or "GERAN Iu":
- 2> if the IE "Frequency band" has the value "GSM /DCS 1800 band used":
- 3> set the BAND_INDICATOR [45] to "ARFCN indicates 1800 band".
- 2> if the IE "Frequency band" has the value " GSM /PCS 1900 band used":
- 3> set the BAND_INDICATOR [45] to "ARFCN indicates 1900 band".
- 1> apply the "Inter RAT Message" according to the "standard to apply" in the table above.
- 1> if the IE "RAB information List" is included in the HANDOVER FROM UTRAN COMMAND message:
- 2> if the IE "RAB information List" includes one IE "RAB Info" with the IE "CN domain Identity" set to "CS domain":
- 3> connect upper layer entities corresponding to the indicated CS domain RAB to the radio resources indicated in the inter-RAT message.
- 2> if the IE "RAB information List" includes one IE "RAB Info" with the IE "CN domain Identity" set to "PS domain":
- 3> connect upper layer entities corresponding to the indicated PS domain RAB to the radio resources indicated in the inter-RAT message.
- 3> if the "System type" is "GSM":
- 4> use the contents of the IE "GERAN system information" as the system information to begin access on the target GERAN cell.

- NOTE1: In this version of the specification the maximum number of CS domain RABs which may be included in the IE "RAB information List" is limited to 1.
- NOTE2: In handover to GERAN *Iu mode*, the RAB information is included in the RADIO BEARER RECONFIGURATION message specified in [53].
- NOTE3: Requirements concerning the establishment of the radio connection towards the other radio access technology and the signalling procedure are outside the scope of this specification.
- NOTE4: The UE may ignore the IE "NAS synchronisation indicator" if included in the HANDOVER FROM UTRAN COMMAND message;
- NOTE5: The UE behaviour is undefined if the IE "Re-establishment timer" in the IE "RAB info" indicates a timer different from the timer currently configured for this RAB.
- NOTE6: The IE "GERAN System Information" is constructed in the same way as in 2G to 2G PS Handover in [44].

8.3.7.4 Successful completion of the inter-RAT handover

Upon successfully completing the handover, UTRAN should:

- 1> release the radio connection; and
- 1> remove all context information for the concerned UE.

Upon successfully completing the handover, the UE shall:

- 1> if inter-RAT handover to GERAN *Iu mode* is performed:
 - 2> perform the actions on reception of the RADIO BEARER RECONFIGURATION message as specified in [53].
- 1> if inter-RAT handover to GERAN *Iu mode* is performed and if there are any NAS messages for which the successful delivery of the INITIAL DIRECT TRANSFER message or UPLINK DIRECT TRANSFER message on signalling radio bearer RB3 or signalling radio bearer RB4 has not yet been confirmed by RLC; or
- 1> if inter-RAT handover to other RAT than GERAN *Iu mode* is performed and if there are any NAS messages with the IE "CN domain identity" set to "CS domain" for which the successful delivery of the INITIAL DIRECT TRANSFER message or UPLINK DIRECT TRANSFER message on signalling radio bearer RB3 or signalling radio bearer RB4 that have not yet been confirmed by RLC:
 - 2> retransmit those NAS messages to the network on the newly established radio connection to the target radio access technology.
- 1> clear or set variables upon leaving UTRA RRC connected mode as specified in subclause 13.4.

NOTE: The release of the UMTS radio resources is initiated from the target RAT.

8.3.7.5 UE fails to complete requested handover

If the UE does not succeed in establishing the connection to the target radio access technology, it shall:

- 1> revert back to the UTRA configuration;
- 1> For FDD:
 - 2> if the CM_PATTERN_ACTIVATION_ABORTED flag is not set to TRUE:
 - 3> establish the UTRA physical channel(s) (including HS-DSCH and E-DCH related channels. If there exists any DTX or DRX configuration, the UE shall instruct the physical layer to consider only the HS-SCCH orders which were acknowledged prior to the activation time of the received message) used at the time for reception of HANDOVER FROM UTRAN COMMAND;

- 3> if the variable DTX_DRX_STATUS is set to TRUE, re-configure the physical layer to perform discontinuous uplink DPCH transmission and enable or disable discontinuous downlink reception operations according to the variable DTX_DRX_PARAMS at the CFN corresponding to the frame boundary that is offset by the stored value of the IE "Enabling Delay" from the frame boundary where uplink transmission resumes with the old configuration;
 - 3> perform the physical layer synchronisation procedure A as specified in [29] (FDD only);
 - 3> apply power control preamble according to [26] during the number of frames indicated in the IE "PC preamble" in the variable LATEST_CONFIGURED_SRB_DELAY_AND_PC_PREAMBLE; and
 - 3> then not send any data on signalling radio bearers RB0 to RB4 during the number of frames indicated in the IE "SRB delay" in the variable LATEST_CONFIGURED_SRB_DELAY_AND_PC_PREAMBLE or while the physical channel is not considered established.
- 1> if the UE does not succeed to establish the UTRA physical channel(s) or for FDD if the CM_PATTERN_ACTIVATION_ABORTED flag is set to TRUE:
 - 2> perform a cell update procedure according to subclause 8.3.1 with cause "Radio link failure";
 - 2> when the cell update procedure has completed successfully:
 - 3> proceed as below.
 - 1> transmit the HANDOVER FROM UTRAN FAILURE message setting the information elements as specified below:
 - 2> include the IE "RRC transaction identifier"; and
 - 2> set it to the value of "RRC transaction identifier" in the entry for the HANDOVER FROM UTRAN COMMAND message in the table "Accepted transactions" in the variable TRANSACTIONS; and
 - 2> clear that entry;
 - 2> set the IE "Inter-RAT handover failure" to "physical channel failure".
 - 1> When the HANDOVER FROM UTRAN FAILURE message has been submitted to lower layer for transmission:
 - 2> the procedure ends.

8.3.7.6 Invalid HANDOVER FROM UTRAN COMMAND message

If the IE "Inter-RAT message" received within the HANDOVER FROM UTRAN COMMAND message does not include a valid inter RAT handover message in accordance with the protocol specifications for the target RAT, the UE shall perform procedure specific error handling as follows. The UE shall:

- 1> set the IE "failure cause" to the cause value "Inter-RAT protocol error";
- 1> include the IE "Inter-RAT message" in accordance with the specifications applicable to the other RAT;
- 1> transmit a HANDOVER FROM UTRAN FAILURE message on the uplink DCCH using AM RLC;
- 1> when the transmission of the HANDOVER FROM UTRAN FAILURE message has been confirmed by RLC:
 - 2> continue with any ongoing processes and procedures as if the invalid HANDOVER FROM UTRAN COMMAND message has not been received;
 - 2> and the procedure ends.

If the HANDOVER FROM UTRAN COMMAND message contains a protocol error causing the variable PROTOCOL_ERROR_REJECT to be set to TRUE according to clause 9, the UE shall perform procedure specific error handling as follows. The UE shall:

- 1> set the IE "RRC transaction identifier" in the HANDOVER FROM UTRAN FAILURE message to the value of "RRC transaction identifier" in the entry for the HANDOVER FROM UTRAN COMMAND message in the table "Rejected transactions" in the variable TRANSACTIONS; and

- 1> clear that entry;
- 1> set the IE "failure cause" to the cause value "protocol error";
- 1> include the IE "Protocol error information" with contents set to the value of the variable PROTOCOL_ERROR_INFORMATION;
- 1> transmit a HANDOVER FROM UTRAN FAILURE message on the uplink DCCH using AM RLC;
- 1> when the HANDOVER FROM UTRAN FAILURE message has been submitted to lower layers for transmission:
 - 2> continue with any ongoing processes and procedures as if the invalid HANDOVER FROM UTRAN COMMAND message has not been received;
 - 2> and the procedure ends.

8.3.7.7 Reception of an HANDOVER FROM UTRAN FAILURE message by UTRAN

Upon receiving an HANDOVER FROM UTRAN FAILURE message, UTRAN may initiate the release the resources in the target radio access technology.

8.3.7.8 Unsupported configuration in HANDOVER FROM UTRAN COMMAND message

If:

- the UTRAN instructs the UE to perform a non-supported handover scenario; or
- the UTRAN instructs the UE to use a non-supported configuration; or
- the UE does not support PS Handover to GERAN, and the inter-RAT handover to other RAT than GERAN *Iu mode* is performed and the IE "RAB information List" is included in the HANDOVER FROM UTRAN COMMAND message and this IE does not include any IE "RAB Info" with the IE "CN domain Identity" set to "CS domain"; or
- the HANDOVER FROM UTRAN COMMAND message includes the IE "RAB information List" and includes at least one IE "RAB Info" with the IE "CN domain Identity" set to "PS domain", and the IE "GERAN System Information" is not present:

the UE shall:

- 1> transmit a HANDOVER FROM UTRAN FAILURE message, setting the information elements as specified below:
 - 2> include the IE "RRC transaction identifier"; and
 - 2> set it to the value of "RRC transaction identifier" in the entry for the HANDOVER FROM UTRAN COMMAND message in the table "Accepted transactions" in the variable TRANSACTIONS; and
 - 2> clear that entry;
 - 2> set the IE "Inter-RAT handover failure" to "configuration unacceptable";
 - 2> when the HANDOVER FROM UTRAN FAILURE message has been submitted to lower layers for transmission:
 - 3> resume normal operation as if the invalid HANDOVER FROM UTRAN COMMAND message has not been received;
 - 3> and the procedure ends.

8.3.7.8a Reception of HANDOVER FROM UTRAN COMMAND message by UE in CELL_FACH

If the UE receives HANDOVER FROM UTRAN COMMAND while in CELL_FACH, the UE shall:

- 1> transmit a HANDOVER FROM UTRAN FAILURE message, setting the information elements as specified below:
 - 2> include the IE "RRC transaction identifier"; and
 - 2> set it to the value of "RRC transaction identifier" in the entry for the HANDOVER FROM UTRAN COMMAND message in the table "Accepted transactions" in the variable TRANSACTIONS; and
 - 2> clear that entry;
 - 2> set the IE "Inter-RAT handover failure" to "protocol error", include IE "Protocol error information"; and
 - 2> set the value of IE "Protocol error cause" to "Message not compatible with receiver state";
 - 2> when the HANDOVER FROM UTRAN FAILURE message has been submitted to lower layers for transmission:
 - 3> resume normal operation as if the invalid HANDOVER FROM UTRAN COMMAND message has not been received;
 - 3> and the procedure ends.

8.3.8 Inter-RAT cell reselection to UTRAN

8.3.8.1 General

The purpose of the inter-RAT cell reselection procedure to UTRAN is to transfer, under the control of the UE and to some extent the source radio access technology, a connection between the UE and another radio access technology (e.g. GSM/GPRS, but not UTRAN) to UTRAN.

8.3.8.2 Initiation

When the UE makes an inter-RAT cell reselection to UTRAN according to the criteria specified in [4], it shall initiate this procedure. The inter-RAT cell reselection made by the UE may use system information broadcast from the source radio access technology or UE dedicated information.

If the NAS procedures associated with inter-system change specified in [5] require the establishment of an RRC connection, the UE shall:

- 1> set the variable ESTABLISHMENT_CAUSE to "Inter-RAT cell reselection";
- NOTE: This value of ESTABLISHMENT_CAUSE has priority over the cause requested by upper layers.
- 1> initiate an RRC connection establishment procedure as specified in subclause 8.1.3;
 - 1> after initiating an RRC connection establishment:
 - 2> release all resources specific to the other radio access technology.

If the NAS procedures associated with inter-system change specified in [5] do not require the establishment of an RRC connection, the UE shall:

- 1> enter idle mode in the target cell without accessing the cell; and
- 1> release all resources specific to the other radio access technology.

8.3.8.2a Initiation of inter-RAT cell reselection from GERAN *Iu mode*

When the UE performs an inter-RAT cell reselection from GERAN *Iu mode* Cell_Shared state, the UE shall:

- 1> initiate the cell update procedure as specified for the cell reselection case in CELL_FACH and CELL_PCH states, using the cause "cell reselection" and setting the G-RNTI in the IE "U-RNTI".

When the UE performs an inter-RAT cell reselection from GERAN *Iu mode* GRA_PCH state, the UE shall:

- 1> compare the GRA identity which the MS had been assigned to in GERAN against the URA identities which are broadcast in the UTRAN cell.
- 1> If the assigned GRA identity is not present in the list of URA identities that are broadcast in the UTRAN cell:
 - 2> initiate the URA update procedure as specified for the URA reselection case in URA_PCH state, using the cause "change of URA" and setting the G-RNTI in the IE "U-RNTI".

The UE shall:

- 1> set the following variables equal to the corresponding variables in GERAN *Iu mode*:

CIPHERING_STATUS
 ESTABLISHED_RABS
 ESTABLISHED_SIGNALLING_CONNECTIONS
 INTEGRITY_PROTECTION_INFO
 INTER_RAT_HANDOVER_INFO_TRANSFERRED
 LATEST_CONFIGURED_CN_DOMAIN
 START_THRESHOLD
 UE_CAPABILITY_TRANSFERRED.

- 1> set the new uplink and downlink HFN of RB2 to $MSB_{20}(\text{MAX}(\text{uplink HFN of RB2}, \text{downlink HFN of RB2}))$.

NOTE: $MSB_{20}()$ operation provides the HFN mapping from GERAN *Iu mode* to UTRAN. In GERAN *Iu mode* the length of HFN component of the COUNT-C of RB2 is longer than 20 bits.

- 1> initialise the variable TIMERS_AND_CONSTANTS to the default values and start to use those timer and constants values.

8.3.8.3 UE fails to complete an inter-RAT cell reselection

If the inter-RAT cell reselection fails before the UE has initiated the RRC connection establishment the UE may return back to the other radio access technology.

If the RRC connection establishment fails, the UE shall enter idle mode.

8.3.8.3a UE fails to complete an inter-RAT cell reselection from GERAN *Iu mode*

When the UE performs an inter-RAT cell reselection from GERAN *Iu mode* to UTRAN, and the cell reselection fails:

- 1> the UE may return back to the GERAN *Iu mode* state from which it initiated the inter-RAT cell reselection.

8.3.9 Inter-RAT cell reselection from UTRAN

8.3.9.1 General

The purpose of the inter-RAT cell reselection procedure from UTRAN is to transfer, under the control of the UE and to some extent the UTRAN, a connection between the UE and UTRAN to another radio access technology (e.g. GSM/GPRS).

8.3.9.2 Initiation

This procedure is applicable in states CELL_FACH, CELL_PCH or URA_PCH.

When the UE based on received system information makes a cell reselection to a radio access technology other than UTRAN, e.g. GSM/GPRS, according to the criteria specified in [4], the UE shall:

- 1> If the NAS procedures associated with inter-system change specified in [5] require the establishment of a connection:
- 2> initiate the establishment of a connection to the target radio access technology according to its specifications.

8.3.9.2a Initiation of inter-RAT cell reselection to GERAN *Iu mode*

When the UE in CELL_PCH or CELL_FACH state performs an inter-RAT cell reselection to GERAN *Iu mode*, according to the criteria specified in [4], the UE shall:

- 1> initiate the cell update procedure according to 3GPP TS 44.118 [53], setting the U-RNTI in the IE "G-RNTI".

When the UE in URA_PCH state performs an inter-RAT cell reselection to GERAN *Iu mode*, according to the criteria specified in [4], the UE shall:

- 1> compare the URA identity which the UE had been assigned to in UTRAN against the GRA identities which are broadcast in the GERAN cell;
- 1> If the assigned URA identity is not present in the list of GRA identities that are broadcast in the GERAN cell:
 - 2> initiate the GRA update procedure as specified in 3GPP TS 44.118 [53], setting the U-RNTI in the IE "G-RNTI".

8.3.9.3 Successful cell reselection

When the UE has succeeded in reselecting a cell in the target radio access technology, the UE shall:

- 1> release all UTRAN specific resources.

UTRAN should:

- 1> release all UE dedicated resources upon indication that the UE has completed a connection establishment to the other radio access technology.

8.3.9.4 UE fails to complete an inter-RAT cell reselection

If the inter-RAT cell reselection fails, the UE shall:

- 1> resume the connection to UTRAN using the resources used before initiating the inter-RAT cell reselection procedure.

8.3.10 Inter-RAT cell change order to UTRAN

8.3.10.1 General

The purpose of the inter-RAT cell change order to UTRAN procedure is to transfer, under the control of the source radio access technology, a connection between the UE and another radio access technology (e.g. GSM/GPRS) to UTRAN.

8.3.10.2 Initiation

The procedure is initiated when a radio access technology other than UTRAN, e.g. GSM/GPRS, using procedures specific for that RAT, orders the UE to change to a UTRAN cell.

NOTE: Within the message used to order the UE to change to a UTRAN cell, the source RAT should specify the identity of the target UTRAN cell as specified in the specifications for that RAT.

The UE shall:

1> set the variable ESTABLISHMENT_CAUSE to "Inter-RAT cell change order";

NOTE: This value of ESTABLISHMENT_CAUSE has priority over the cause requested by upper layers.

1> initiate an RRC connection establishment procedure as specified in subclause 8.1.3.

8.3.10.3 UE fails to complete an inter-RAT cell change order

If the inter-RAT cell reselection fails the UE shall return to the other radio access technology and proceed as specified in the appropriate specifications for that RAT.

NOTE 3: The cell change was network ordered. Therefore, failure to change to the target cell should not cause the UE to move to UE- controlled cell selection.

8.3.11 Inter-RAT cell change order from UTRAN

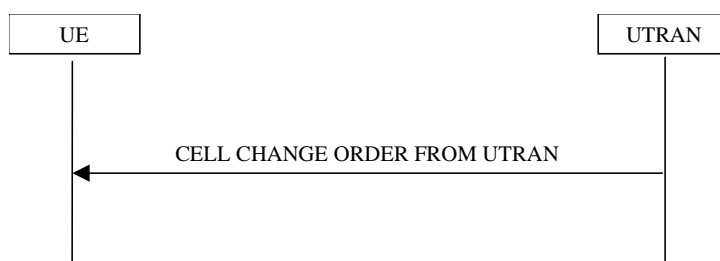

Figure 8.3.11-1: Inter-RAT cell change order from UTRAN

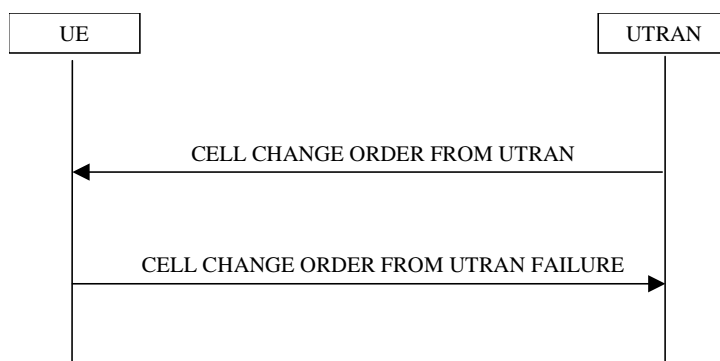

Figure 8.3.11-2: Inter-RAT cell change order from UTRAN, failure case

8.3.11.1 General

The purpose of the inter-RAT cell change order procedure is to transfer, under the control of the network, a connection between the UE and UTRAN to another radio access technology (e.g. GSM). This procedure may be used in CELL_DCH and CELL_FACH state. This procedure may be used when no RABs are established or when the established RABs are only from PS domain. This procedure may not be used when there is no PS signalling connection.

8.3.11.2 Initiation

The procedure is initiated when UTRAN orders a UE in CELL_DCH or CELL_FACH state, to make a cell change to a radio access technology other than UTRAN, e.g. GSM.

To initiate the procedure, UTRAN sends a CELL CHANGE ORDER FROM UTRAN message.

8.3.11.3 Reception of an CELL CHANGE ORDER FROM UTRAN message by the UE

The UE shall be able to receive a CELL CHANGE ORDER FROM UTRAN message and perform a cell change order to another RAT, even if no prior UE measurements have been performed on the target cell.

If the variable ESTABLISHED_SIGNALLING_CONNECTIONS does not include the CN domain identity "PS domain", or if the variable ESTABLISHED_SIGNALLING_CONNECTIONS includes the CN domain identity "CS domain":

- 1> the UE shall act as if the message was never received.

The UE shall:

- 1> For FDD:

- 2> if the UE has a pending "TGPS reconfiguration CFN" at the activation time received in the CELL CHANGE ORDER FROM UTRAN message the UE may:

- 3> abort the pending CM activation;

- 3> set the CM_PATTERN_ACTIVATION_ABORTED to TRUE.

- 2> otherwise:

- 3> set the CM_PATTERN_ACTIVATION_ABORTED to FALSE.

- 1> start timer T309; and

- 1> establish the connection to the other radio access technology, as specified within IE "Target cell description". This IE specifies the target cell identity, in accordance with the specifications for that other RAT. In case the target cell is a GSM/ GPRS cell, IE "Target cell description" may also include IE "NC mode", which specifies the cell selection mode to be applied in the target cell; and

- 1> if IE "NC mode" is not included in the CELL CHANGE ORDER FROM UTRAN:

- 2> retrieve it from the target cell as specified in [43];

- 2> act upon IE "NC mode" as specified in [43].

- 1> if the IE "RAB Information List" is included in the CELL CHANGE ORDER FROM UTRAN message:

- 2> ignore the contents of the IE "RAB Information List".

NOTE: Requirements concerning the establishment of the radio connection towards the other radio access technology and the signalling procedure are outside the scope of this specification. In case of GSM/GPRS proceed according to the procedure Network control cell reselection procedure as specified in [44].

- 1> if the UE supports UTRAN to GERAN Network Assisted Cell Change, the IE "Geran System Information" is present and the UE is in CELL_DCH state:

- 2> if according to [44] the IE "GERAN System Information" includes a correct and consistent set of SI or PSI messages:

- 3> use this information as the system information to begin access on the target GERAN cell.

- 2> otherwise:

- 3> ignore the IE "GERAN System Information" and continue the Cell Change Order procedure.

NOTE: The IE "GERAN System Information" is constructed in the same way as in 2G to 2G NACC, i.e. the PSI messages are encoded as such, whereas the SI messages exclude 2 octets of headers, see [44].

8.3.11.4 Successful completion of the cell change order

The UE regards the procedure as completed when it has received a successful response from the target RAT, e.g. in case of GSM when it received the response to a (PACKET) CHANNEL REQUEST in the new cell.

Upon successful completion of the cell change order, the UE shall:

- 1> stop timer T309;
- 1> clear or set variables upon leaving UTRA RRC connected mode as specified in subclause 13.4.

Upon indication of the UE having successfully completed the cell change order, UTRAN should:

- 1> release the radio connection; and
- 1> remove all context information for the concerned UE.

NOTE: The release of the UMTS radio resources is initiated from another RAT.

8.3.11.5 Expiry of timer T309 or UE fails to complete requested cell change order

If:

- timer T309 expires prior to the successful establishment of a connection to the target RAT; or
- if the establishment of the connection to the other RAT failed due to other reasons e.g. (random) access failure, rejection due to lack of resources:

the UE shall:

- 1> if it received the CELL CHANGE ORDER FROM UTRAN message in state CELL_DCH:
 - 2> For TDD or for FDD if the CM_PATTERN_ACTIVATION_ABORTED flag is not set to TRUE:
 - 3> revert back to the UTRA configuration;
 - 3> establish the UTRA physical channel(s) (including HS-DSCH and E-DCH related channels) used at the time for reception of CELL CHANGE ORDER FROM UTRAN.
 - 2> For FDD:
 - 3> perform the physical layer synchronisation procedure A as specified in [29];
 - 3> if there exists any DTX or DRX configuration prior to the reception of the CELL CHANGE ORDER FROM UTRAN COMMAND, instruct the physical layer to consider only the HS-SCCH orders which were acknowledged prior to the activation time of the received message;
 - 3> if the variable DTX_DRX_STATUS is set to TRUE, re-configure the physical layer to perform discontinuous uplink DPCCCH transmission and enable or disable discontinuous downlink reception operations according to the variable DTX_DRX_PARAMS at the CFN corresponding to the frame boundary that is offset by the stored value of the IE "Enabling Delay" from the frame boundary where uplink transmission resumes with the old configuration;
 - 3> apply power control preamble according to [26] during the number of frames indicated in the IE "PC preamble" in the variable LATEST_CONFIGURED_SRB_DELAY_AND_PC_PREAMBLE; and
 - 3> then not send any data on signalling radio bearers RB0 to RB4 during the number of frames indicated in the IE "SRB delay" in the variable LATEST_CONFIGURED_SRB_DELAY_AND_PC_PREAMBLE or while the physical channel is not considered established;
 - 3> if the CM_PATTERN_ACTIVATION_ABORTED flag is set to TRUE or if the UE does not succeed in establishing the UTRA physical channel(s):
 - 4> perform a cell update procedure according to subclause 8.3.1 with cause "Radio link failure";
 - 4> when the cell update procedure has completed successfully:

- 5> proceed as below.
 - 3> transmit the CELL CHANGE ORDER FROM UTRAN FAILURE message setting the information elements as specified below:
 - 4> include the IE "RRC transaction identifier"; and
 - 4> set it to the value of "RRC transaction identifier" in the entry for the received message in the table "Accepted transactions" in the variable TRANSACTIONS; and
 - 4> clear that entry;
 - 4> set the IE "Inter-RAT change failure" to "physical channel failure".
 - 3> When the CELL CHANGE ORDER FROM UTRAN FAILURE message has been submitted to lower layer for transmission, the procedure ends.
- 1> if the UE receives the CELL CHANGE ORDER FROM UTRAN message in CELL_FACH state:
- 2> revert to the cell it was camped on at the reception of the CELL CHANGE ORDER FROM UTRAN message;
 - 2> if the UE is unable to return to this cell:
 - 3> select a suitable UTRA cell according to [4];
 - 3> initiate the cell update procedure according to subclause 8.3.1 using the cause "cell re-selection";
 - 3> when the cell update procedure completed successfully:
 - 4> proceed as below.
 - 2> transmit the CELL CHANGE ORDER FROM UTRAN FAILURE message setting the information elements as specified below:
 - 3> include the IE "RRC transaction identifier"; and
 - 3> set it to the value of "RRC transaction identifier" in the entry for the CELL CHANGE ORDER FROM UTRAN message in the table "Accepted transactions" in the variable TRANSACTIONS; and
 - 3> clear that entry;
 - 3> set the IE "Inter-RAT change failure" to "physical channel failure".
 - 2> When the CELL CHANGE ORDER FROM UTRAN FAILURE message has been submitted to lower layer for transmission:
 - 3> the procedure ends.

8.3.11.6 Unsupported configuration in CELL CHANGE ORDER FROM UTRAN message

If the UTRAN instructs the UE to perform a non-supported cell change order scenario or to use a non-supported configuration, the UE shall:

- 1> transmit a CELL CHANGE ORDER FROM UTRAN FAILURE message, setting the information elements as specified below:
 - 2> include the IE "RRC transaction identifier"; and
 - 2> set it to the value of "RRC transaction identifier" in the entry for the received message in the table "Accepted transactions" in the variable TRANSACTIONS; and
 - 2> clear that entry;
 - 2> set the IE "Inter-RAT change failure" to "configuration unacceptable";

- 2> when the CELL CHANGE ORDER FROM UTRAN FAILURE message has been submitted to lower layers for transmission:
- 3> resume normal operation as if the CELL CHANGE ORDER FROM UTRAN message has not been received;
- 3> and the procedure ends.

8.3.11.7 Invalid CELL CHANGE ORDER FROM UTRAN message

If the CELL CHANGE ORDER FROM UTRAN message contains a protocol error causing the variable `PROTOCOL_ERROR_REJECT` to be set to `TRUE` according to clause 9, the UE shall perform procedure specific error handling as follows. The UE shall:

- 1> set the IE "RRC transaction identifier" in the CELL CHANGE ORDER FROM UTRAN FAILURE message to the value of "RRC transaction identifier" in the entry for the CELL CHANGE ORDER FROM UTRAN message in the table "Rejected transactions" in the variable `TRANSACTIONS`; and
- 1> clear that entry;
- 1> set the IE "Inter-RAT change failure" to the cause value "protocol error";
- 1> include the IE "Protocol error information" with contents set to the value of the variable `PROTOCOL_ERROR_INFORMATION`;
- 1> transmit a CELL CHANGE ORDER FROM UTRAN FAILURE message on the uplink DCCH using AM RLC;
- 1> when the CELL CHANGE ORDER FROM UTRAN FAILURE message has been submitted to lower layers for transmission:
 - 2> resume normal operation as if the invalid CELL CHANGE ORDER FROM UTRAN message has not been received;
 - 2> and the procedure ends.

8.4 Measurement procedures

8.4.0 Measurement related definitions

UTRAN may control a measurement in the UE either by broadcast of `SYSTEM INFORMATION` and/or by transmitting a `MEASUREMENT CONTROL` message.

The following information is used to control the UE measurements and the measurement results reporting:

1. **Measurement identity:** A reference number that should be used by the UTRAN when setting up, modifying or releasing the measurement and by the UE in the measurement report.
2. **Measurement command:** One out of three different measurement commands.
 - Setup: Setup a new measurement.
 - Modify: Modify a previously defined measurement, e.g. to change the reporting criteria.
 - Release: Stop a measurement and clear all information in the UE that are related to that measurement.
3. **Measurement type:** One of the types listed below describing what the UE shall measure.

Presence or absence of the following control information depends on the measurement type

4. **Measurement objects:** The objects on which the UE shall measure measurement quantities, and corresponding object information.
5. **Measurement quantity:** The quantity the UE shall measure on the measurement object. This also includes the filtering of the measurements.

6. **Reporting quantities:** The quantities the UE shall include in the report in addition to the quantities that are mandatory to report for the specific event.
7. **Measurement reporting criteria:** The triggering of the measurement report, e.g. periodical or event-triggered reporting.
8. **Measurement Validity:** Defines in which UE states the measurement is valid.
9. **Measurement reporting mode:** This specifies whether the UE shall transmit the measurement report using AM or UM RLC.
10. **Additional measurement identities:** A list of references to other measurements. When this measurement triggers a measurement report, the UE shall also include the reporting quantities for the measurements referenced by the additional measurement identities.

All these measurement parameters depend on the measurement type and are described in more detail in clause 14.

The different types of measurements are:

- **Intra-frequency measurements:** measurements on downlink physical channels at the same frequency as the active set. A measurement object corresponds to one cell. Detailed description is found in subclause 14.1.
- **Inter-frequency measurements:** measurements on downlink physical channels at frequencies that differ from the frequency of the active set and on downlink physical channels in the active set. A measurement object corresponds to one cell. Detailed description is found in subclause 14.2.
- **Inter-RAT measurements:** measurements on downlink physical channels belonging to another radio access technology than UTRAN, e.g. GSM. A measurement object corresponds to one cell. Detailed description is found in subclause 14.3.
- **Traffic volume measurements:** measurements on uplink traffic volume. A measurement object corresponds to one cell. Detailed description is found in subclause 14.4.
- **Quality measurements:** Measurements of downlink quality parameters, e.g. downlink transport block error rate. A measurement object corresponds to one transport channel in case of BLER. A measurement object corresponds to one timeslot in case of SIR (TDD only). Detailed description is found in subclause 14.5.
- **UE-internal measurements:** Measurements of UE transmission power and UE received signal level. Detailed description is found in subclause 14.6.
- **UE positioning measurements:** Measurements of UE position. Detailed description is found in subclause 14.7.

The UE shall support a number of measurements running in parallel as specified in [19] and [20]. The UE shall also support that each measurement is controlled and reported independently of every other measurement.

Cells that the UE is monitoring are grouped in the UE into three mutually exclusive categories:

1. Cells, which belong to the **active set**. User information is sent from all these cells. In FDD, the cells in the active set are involved in soft handover. In TDD the active set always comprises one cell only. The UE shall only consider active set cells included in the variable CELL_INFO_LIST for measurement; i.e. active set cells not included in the CELL_INFO_LIST shall not be considered in any event evaluation and measurement reporting.
2. Cells, which are not included in the active set, but are included in the CELL_INFO_LIST belong to the **monitored set**.
3. Cells detected by the UE, which are neither in the CELL_INFO_LIST nor in the active set belong to the **detected set**. Reporting of measurements of the detected set is only applicable to intra-frequency measurements made by UEs in CELL_DCH state.

If the IE "Cells for measurement" has been included in a MEASUREMENT CONTROL message, only monitored set cells explicitly indicated for a given intra-frequency (resp. inter-frequency, interRAT) measurement by the IE "Cells for measurement" shall be considered for measurement. If the IE "Cells for measurement" has not been included in a MEASUREMENT CONTROL message, all of the intra-frequency (resp. inter-frequency, inter RAT) cells stored in the variable CELL_INFO_LIST shall be considered for measurement. The IE "Cells for measurement" is not applicable to active set cells e.g. when the triggering condition refers to active set cells, the UE shall consider all active set cells in the

CELL_INFO_LIST for measurement irrespective if these cells are explicitly indicated by the IE "Cells for measurement".

8.4.1 Measurement control



Figure 8.4.1-1: Measurement Control, normal case

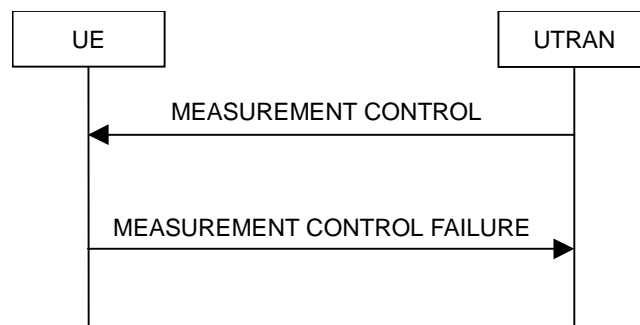

Figure 8.4.1-2: Measurement Control, failure case

8.4.1.1 General

The purpose of the measurement control procedure is to setup, modify or release a measurement in the UE.

In subclause 8.4.1 and its subclauses references to System Information Block type 11 mean the merge of System Information Block Type 11 and System Information Block type 11bis, if scheduled on BCH.

8.4.1.2 Initiation

The UTRAN may request a measurement by the UE to be setup, modified or released with a MEASUREMENT CONTROL message, which is transmitted on the downlink DCCH using AM RLC.

The UTRAN should take the UE capabilities into account when a measurement is requested from the UE.

When a new measurement is created, UTRAN should set the IE "Measurement identity" to a value, which is not used for other measurements. UTRAN may use several "Measurement identity" for the same "Measurement type". In case of setting several "Measurement identity" within a same "Measurement type", the measurement object or the list of measurement objects can be set differently for each measurement with different "Measurement identity".

When a current measurement is modified or released, UTRAN should set the IE "Measurement identity" to the value, which is used for the measurement being modified or released. In case of modifying IEs within a "Measurement identity", it is not needed for UTRAN to indicate the IEs other than modified IEs, and the UE continues to use the current values of the IEs that are not modified. UTRAN should not use "modify" to change the type of measurement stored in the variable MEASUREMENT_IDENTITY for a given measurement identity.

8.4.1.3 Reception of MEASUREMENT CONTROL by the UE

Upon reception of a MEASUREMENT CONTROL message the UE shall perform actions specified in subclause 8.6 unless otherwise specified below.

The UE shall:

- 1> read the IE "Measurement command";

- 1> if the IE "Measurement command" has the value "setup":
 - 2> store this measurement in the variable MEASUREMENT_IDENTITY according to the IE "measurement identity", first releasing any previously stored measurement with that identity if that exists;
 - 2> if the measurement type is quality, UE internal, intra-frequency, inter-frequency or inter-RAT:
 - 3> if the UE is in CELL_FACH state:
 - 4> the UE behaviour is not specified.
 - 2> for measurement types "inter-RAT measurement" or "inter-frequency measurement" that require measurements on a frequency other than the actually used frequency:
 - 3> if, according to its measurement capabilities, the UE requires compressed mode to perform that measurement type and after reception of this message a compressed mode pattern sequence with an appropriate measurement purpose is active according to the IE "Current TGPS Status Flag" in UE variable TGPS_IDENTITY; or
 - 3> if, according to its measurement capabilities, the UE does not require compressed mode to perform the measurements on at least one supported band of that measurement type:
 - 4> if the measurement is valid in the current RRC state of the UE:
 - 5> begin measurements according to the stored control information for this measurement identity.

NOTE: The UE is not required to perform measurements on cells for which it needs compressed mode but a suitable compressed mode pattern is not activated.

- 2> for measurement type "inter-frequency measurement" that requires measurements only on the same frequency as the actually used frequency:
 - 3> if the measurement is valid in the current RRC state of the UE:
 - 4> begin measurements according to the stored control information for this measurement identity.
- 2> for measurement type "UE positioning measurement":
 - 3> if the UE is in CELL_FACH state:
 - 4> if IE "Positioning Method" is set to "OTDOA":
 - 5> if IE "Method Type" is set to "UE assisted":
 - 6> if IE "UE positioning OTDOA assistance data for UE assisted" is not included:
 - 7> if System Information Block type 15.4 is broadcast:
 - 8> read System Information Block type 15.4.
 - 7> act as specified in subclause 8.6.7.19.2.
 - 5> if IE "Method Type" is set to "UE based":
 - 6> if IE "UE positioning OTDOA assistance data for UE based" is not included:
 - 7> if System Information Block type 15.5 is broadcast:
 - 8> read System Information Block type 15.5.
 - 7> act as specified in subclause 8.6.7.19.2a.
- 2> for any other measurement type:
 - 3> if the measurement is valid in the current RRC state of the UE:
 - 4> begin measurements according to the stored control information for this measurement identity.

- 1> if the IE "Measurement command" has the value "modify":
 - 2> for all IEs present in the MEASUREMENT CONTROL message:
 - 3> if a measurement was stored in the variable MEASUREMENT_IDENTITY associated to the identity by the IE "measurement identity":
 - 4> if the measurement type is quality, UE internal, intra-frequency, inter-frequency or inter-RAT:
 - 5> if the UE is in CELL_FACH state:
 - 6> the UE behaviour is not specified.
 - 4> if measurement type is set to "intra-frequency measurement", for any of the optional IEs "Intra-frequency measurement objects list", "Intra-frequency measurement quantity", "Intra-frequency reporting quantity", "Measurement Validity", "report criteria" and "parameters required for each event" (given "report criteria" is set to "intra-frequency measurement reporting criteria") that are present in the MEASUREMENT CONTROL message:
 - 4> if measurement type is set to "inter-frequency measurement", for any of the optional IEs "Inter-frequency measurement quantity", "Inter-frequency reporting quantity", "Measurement Validity", "Inter-frequency set update" and "parameters required for each event" (given "report criteria" is set to either "inter-frequency measurement reporting criteria" or "intra-frequency measurement reporting criteria") that are present in the MEASUREMENT CONTROL message:
 - 4> if measurement type is set to "inter-RAT measurement", for any of the optional IEs "Inter-RAT measurement objects list", "Inter-RAT measurement quantity", and "Inter-RAT reporting quantity" that are present in the MEASUREMENT CONTROL message:
 - 4> if measurement type is set to "UE positioning measurement" and the IE "UE positioning OTDOA assistance data" is present, for any of the optional IEs "UE positioning OTDOA neighbour cell info for UE-assisted", "UE positioning OTDOA reference cell info for UE-assisted", "UE positioning OTDOA reference cell info for UE-based", "UE positioning OTDOA neighbour cell info for UE-based" and "UE positioning" that are present in the MEASUREMENT CONTROL message:
 - 4> if measurement type is set to "UE positioning measurement" and the IE "UE positioning GPS assistance data" is present, for any of the optional IEs "UE positioning GPS reference time", "UE positioning GPS reference UE position", "UE positioning GPS DGPS corrections", "UE positioning GPS ionospheric model", "UE positioning GPS UTC model", "UE positioning GPS acquisition assistance", "UE positioning GPS real-time integrity" that are present in the MEASUREMENT CONTROL message:
 - 4> if measurement type is set to "UE positioning measurement" and the IE "UE positioning GANSS assistance data" is present, for any of the optional IEs "UE positioning GANSS reference time", "UE positioning GANSS reference UE position", "UE positioning DGANSS corrections", "UE positioning GANSS ionospheric model", "UE positioning GANSS UTC model", "UE positioning GANSS reference measurement information", "UE positioning GANSS data bit assistance", "UE positioning GANSS Time model", "UE positioning GANSS real-time integrity" that are present in the MEASUREMENT CONTROL message:
 - 4> if measurement type is set to "traffic volume measurement", for any of the optional IEs "Traffic volume measurement Object", "Traffic volume measurement quantity", "Traffic volume reporting quantity", and "Measurement Validity" that are present in the MEASUREMENT CONTROL message:
 - 4> if measurement type is set to "quality measurement", for the optional IE "Quality reporting quantity" if it is present in the MEASUREMENT CONTROL message:
 - 4> if measurement type is set to "UE internal measurement", for any of the optional IEs "UE internal measurement quantity", and "UE internal reporting quantity" that are present in the MEASUREMENT CONTROL message:
 - 5> replace all instances of the IEs listed above (and all their children) stored in variable MEASUREMENT_IDENTITY associated to the identity indicated by the IE "measurement identity" with the IEs received in the MEASUREMENT CONTROL message;

- 5> leave all other stored information elements unchanged in the variable MEASUREMENT_IDENTITY.
- 3> otherwise:
 - 4> set the variable CONFIGURATION_INCOMPLETE to TRUE.
- 2> if measurement type is set to "inter-frequency measurement":
 - 3> if "report criteria" is set to "intra-frequency measurement reporting criteria" and "reporting criteria" in "inter-frequency measurement quantity" is set to "intra-frequency reporting criteria":
 - 4> for FDD, 3.84 Mcps TDD and 7.68 Mcps TDD; or
 - 4> for 1.28 Mcps TDD, if the UE only uses one frequency:
 - 5> leave the currently stored "inter-frequency measurement reporting criteria" within "report criteria" and "inter-frequency reporting criteria" within "inter-frequency measurement quantity" unchanged, and continue to act on the information stored in these variables.
- NOTE: If the UTRAN wants to modify the inter-frequency cell info list for an inter-frequency measurement configured with event based reporting without repeating any IEs related to the configured events, one possibility is to set the IE "report criteria" to "intra-frequency measurement reporting criteria", not include the IE "parameters required for each event", and set the IE "reporting criteria" in the IE "inter-frequency measurement quantity" to "intra-frequency reporting criteria".
 - 4> for 1.28 Mcps TDD, if the UE uses multiple frequencies:
 - 5> use the content of MEASUREMENT CONTROL to replace the IEs related to MEASUREMENT_IDENTITY which have stored;
 - 5> not delete the unchanged values.
- 2> for measurement types "inter-frequency measurement" that require measurements on a frequency other than the actually used frequency, or that require measurements on another RAT:
 - 3> if, according to its measurement capabilities, the UE requires compressed mode to perform that measurement type and after reception of this message a compressed mode pattern sequence with an appropriate measurement purpose is active according to the IE "Current TGPS Status Flag" in UE variable TGPS_IDENTITY; or
 - 3> if, according to its measurement capabilities, the UE does not require compressed mode, on at least one supported band of that measurement type, to perform the measurements:
 - 4> resume the measurements according to the new stored measurement control information.
- 2> for measurement type "inter-frequency measurement" that requires measurements only on the same frequency as the actually used frequency:
 - 3> if the measurement is valid in the current RRC state of the UE:
 - 4> resume measurements according to the new stored control information for this measurement identity.
- 2> for any other measurement type:
 - 3> resume the measurements according to the new stored measurement control information.
- 2> for measurement type "inter-RAT measurement":
 - 3> if "report criteria" is set to "inter-RAT measurement reporting criteria":
 - 4> if the value of "report criteria" stored in the variable MEASUREMENT_IDENTITY associated to the identity indicated by the IE "measurement identity" is not "inter-RAT measurement reporting criteria"; or

- 4> if the value of "report criteria" stored in the variable MEASUREMENT_IDENTITY associated to the identity indicated by the IE "measurement identity" is "inter-RAT measurement reporting criteria" and if the IE "Parameters required for each event" is present:
 - 5> replace the IE "report criteria" (and all its children) stored in variable MEASUREMENT_IDENTITY associated to the identity indicated by the IE "measurement identity" with the IE "reporting criteria" received in the MEASUREMENT CONTROL message.
- 3> if "report criteria" is not set to "inter-RAT measurement reporting criteria":
 - 4> replace the IE "reporting criteria" (and all its children) stored in variable MEASUREMENT_IDENTITY associated to the identity indicated by the IE "measurement identity" with the IE "reporting criteria" received in the MEASUREMENT CONTROL message.
- 2> for measurement type "UE positioning measurement":
 - 3> if "reporting criteria" is set to "UE positioning reporting criteria":
 - 4> if the value of "reporting criteria" stored in the variable MEASUREMENT_IDENTITY associated to the identity indicated by the IE "measurement identity" is not "UE positioning reporting criteria", or;
 - 4> if the value of "reporting criteria" stored in the variable MEASUREMENT_IDENTITY associated to the identity indicated by the IE "measurement identity" is "UE positioning reporting criteria" and if the IE "Parameters required for each event" is present:
 - 5> replace the IE "reporting criteria" (and all its children) stored in variable MEASUREMENT_IDENTITY associated to the identity indicated by the IE "measurement identity" with the IE "report criteria" received in the MEASUREMENT CONTROL message.
 - 3> if "reporting criteria" is not set to "UE positioning reporting criteria":
 - 4> replace the IE "report criteria" (and all its children) stored in variable MEASUREMENT_IDENTITY associated to the identity indicated by the IE "measurement identity" with the IE "report criteria" received in the MEASUREMENT CONTROL message.
- 2> for measurement type "traffic volume measurement":
 - 3> replace the IE "report criteria" (and all its children) stored in variable MEASUREMENT_IDENTITY associated to the identity indicated by the IE "measurement identity" with the IE "report criteria" received in the MEASUREMENT CONTROL message.
- 2> for measurement type "quality measurement":
 - 3> replace the IE "report criteria" (and all its children) stored in variable MEASUREMENT_IDENTITY associated to the identity indicated by the IE "measurement identity" with the IE "report criteria" received in the MEASUREMENT CONTROL message;
 - 3> if "report criteria" is set to "quality measurement reporting criteria":
 - 4> if the value of "BLER reporting" in any instance of the IE "Quality reporting quantity" stored in the variable MEASUREMENT_IDENTITY associated to the identity indicated by the IE "measurement identity" with the IE "report criteria" received in the MEASUREMENT CONTROL message is set to TRUE:
 - 5> the UE behaviour is unspecified.
- 2> for measurement type "UE internal measurement":
 - 3> if "report criteria" is set to "UE internal measurement reporting criteria":
 - 4> if the value of "report criteria" stored in the variable MEASUREMENT_IDENTITY associated to the identity indicated by the IE "measurement identity" is not "UE internal measurement reporting criteria"; or

- 4> if the value of "report criteria" stored in the variable MEASUREMENT_IDENTITY associated to the identity indicated by the IE "measurement identity" is "UE internal measurement reporting criteria" and if the IE "Parameters sent for each UE internal measurement event" is present:
 - 5> replace the IE "report criteria" (and all its children) stored in variable MEASUREMENT_IDENTITY associated to the identity indicated by the IE "measurement identity" with the IE "report criteria" received in the MEASUREMENT CONTROL message.
 - 3> if "report criteria" is not set to "UE internal measurement reporting criteria":
 - 4> replace the IE "report criteria" (and all its children) stored in variable MEASUREMENT_IDENTITY associated to the identity indicated by the IE "measurement identity" with the IE "report criteria" received in the MEASUREMENT CONTROL message.
 - 1> if the IE "measurement command" has the value "release":
 - 2> terminate the measurement associated with the identity given in the IE "measurement identity";
 - 2> clear all stored measurement control information related associated to this measurement identity in variable MEASUREMENT_IDENTITY.
 - 1> if the IE "DPCH Compressed Mode Status Info" is present:
 - 2> if, as the result of this message, UE will have more than one transmission gap pattern sequence with the same measurement purpose active (according to IEs "TGMP" and "Current TGPS Status Flag" in variable TGPS_IDENTITY):
 - 3> set the variable CONFIGURATION_INCOMPLETE to TRUE.
 - 2> if there is any pending "TGPS reconfiguration CFN" or any pending "TGCFN":
 - 3> the UE behaviour is unspecified.
 - 2> if there is a pending "activation time" for a reconfiguration procedure that included the IE "DPCH Compressed mode info":
 - 3> the UE behaviour is unspecified.
 - 2> if pattern sequence corresponding to IE "TGPSI" is already active (according to "Current TGPS Status Flag") in the variable TGPS_IDENTITY):
 - 3> if the "TGPS Status Flag" in this message is set to "deactivate" for the corresponding pattern sequence:
 - 4> deactivate this pattern sequence at the beginning of the frame indicated by IE "TGPS reconfiguration CFN" received in the message;
 - 4> set the "Current TGPS Status Flag" for this pattern sequence in the variable TGPS_IDENTITY to "inactive" at the frame indicated by IE "TGPS reconfiguration CFN" received in the message.
 - 3> if the "TGPS Status Flag" in this message is set to "activate" for the corresponding pattern sequence:
 - 4> deactivate this pattern sequence at the beginning of the frame indicated by IE "TGPS reconfiguration CFN" received in the message.
- NOTE1: The temporary deactivation of pattern sequences for which the status flag is set to "activate" can be used by the network to align the timing of already active patterns with newly activated patterns.
- NOTE2: The deactivation of pattern sequences only occurs as a result of RRC messages received by the UE, i.e. the UE does not set the "Current TGPS Status Flag" to "inactive" after the final gap of a finite length pattern sequence.
- 2> after the time indicated by IE "TGPS reconfiguration CFN" has elapsed:
 - 3> activate the pattern sequence corresponding to each IE "TGPSI" for which the "TGPS status flag" in this message is set to "activate" at the time indicated by IE "TGCFN"; and

- 3> set the corresponding "Current TGPS status flag" for this pattern sequence in the variable TGPS_IDENTITY to "active"; and
- 3> begin the inter-frequency and/or inter-RAT measurements corresponding to the pattern sequence measurement purpose of each activated pattern sequence;
- 3> if the values of IE "TGPS reconfiguration CFN" and IE "TGCFN" are equal:
 - 4> start the concerned pattern sequence immediately at that CFN.
- 2> not alter pattern sequences stored in variable TGPS_IDENTITY, if the pattern sequence is not identified in IE "TGPSI" in the received message.
- 1> if the UE in CELL_FACH state receives a MEASUREMENT CONTROL message, which indicates the same measurement identity as that stored in the variable MEASUREMENT_IDENTITY:
 - 2> update the stored information with the traffic volume measurement control information in variable MEASUREMENT_IDENTITY; and
 - 2> refrain from updating the traffic volume measurement control information associated with this measurement identity in the variable MEASUREMENT_IDENTITY with the information received in System Information Block type 12 (or System Information Block type 11, according to subclause 8.1.1.6.11) until this measurement is explicitly released with another MEASUREMENT CONTROL message.
- 1> if the IE "Read SFN indicator" included in the IE "Cell info" of an inter-frequency cell is set to TRUE and the variable UE_CAPABILITY_TRANSFERRED has the DL "Measurement capability" for "FDD measurements" set to TRUE (the UE requires DL compressed mode in order to perform measurements on FDD):
 - 2> set the variable CONFIGURATION_INCOMPLETE to TRUE.
- 1> clear the entry for the MEASUREMENT CONTROL message in the table "Accepted transactions" in the variable TRANSACTIONS.

The UE may:

- 1> if the IE "Measurement command" has the value "setup":
 - 2> for measurement type "UE positioning measurement":
 - 3> if the UE is CELL_FACH state:
 - 4> if IE "Positioning Method" is set to "GPS":
 - 5> if IE "UE positioning GPS assistance data" is not included and variable UE_POSITIONING_GPS_DATA is empty:
 - 6> if System Information Block types 15, 15.1, 15.2 and 15.3 are broadcast:
 - 7> read System Information Block types 15, 15.1, 15.2 and 15.3.
 - 6> act as specified in subclause 8.6.7.19.3.
 - 5> if IE "GANSS Positioning Methods" is present:
 - 6> for each GNSS indicated in IE "GANSS Positioning Methods" and supported by UE:
 - 7> if IE "UE positioning GANSS assistance data" is not included and variable UE_POSITIONING_GANSS_DATA does not contain data for that GNSS:
 - 8> if System Information Block types 15bis, 15.1bis, 15.2bis, 15.3bis, 15.6, 15.7 and 15.8 are broadcast:
 - 9> read System Information Block types 15bis, 15.1bis, 15.2bis, 15.3bis, 15.6, 15.7 and 15.8.
 - 8> act as specified in subclause 8.6.7.19.6.

1> and the procedure ends.

8.4.1.4 Unsupported measurement in the UE

If UTRAN instructs the UE to perform a measurement that is not supported by the UE, or would cause the maximum number of reporting criteria supported by the UE [19] to be exceeded, the UE shall:

- 1> retain the measurement configuration that was valid before the MEASUREMENT CONTROL message was received;
- 1> set the IE "RRC transaction identifier" in the MEASUREMENT CONTROL FAILURE message to the value of "RRC transaction identifier" in the entry for the MEASUREMENT CONTROL message in the table "Accepted transactions" in the variable TRANSACTIONS; and
- 1> clear that entry.
- 1> set the cause value in IE "failure cause" to "unsupported measurement";
- 1> submit the MEASUREMENT CONTROL FAILURE message to lower layers for transmission on the DCCH using AM RLC;
- 1> continue with any ongoing processes and procedures as if the invalid MEASUREMENT CONTROL message has not been received;
- 1> and the procedure ends.

8.4.1.4a Configuration Incomplete

If the variable CONFIGURATION_INCOMPLETE is set to TRUE, the UE shall:

- 1> retain the measurement configuration that was valid before the MEASUREMENT CONTROL message was received;
- 1> set the IE "RRC transaction identifier" in the MEASUREMENT CONTROL FAILURE message to the value of "RRC transaction identifier" in the entry for the MEASUREMENT CONTROL message in the table "Accepted transactions" in the variable TRANSACTIONS and clear that entry;
- 1> clear the variable CONFIGURATION_INCOMPLETE;
- 1> set the cause value in IE "failure cause" to "Configuration incomplete";
- 1> submit the MEASUREMENT CONTROL FAILURE message to lower layers for transmission on the DCCH using AM RLC;
- 1> continue with any ongoing processes and procedures as if the invalid MEASUREMENT CONTROL message has not been received;
- 1> and the procedure ends.

8.4.1.5 Invalid MEASUREMENT CONTROL message

If the MEASUREMENT CONTROL message contains a protocol error causing the variable PROTOCOL_ERROR_REJECT to be set to TRUE according to clause 9, the UE shall perform procedure specific error handling as follows. The UE shall:

- 1> set the IE "RRC transaction identifier" in the MEASUREMENT CONTROL FAILURE message to the value of "RRC transaction identifier" in the entry for the MEASUREMENT CONTROL message in the table "Rejected transactions" in the variable TRANSACTIONS; and
- 1> clear that entry.
- 1> set the IE "failure cause" to the cause value "protocol error";
- 1> include the IE "Protocol error information" with contents set to the value of the variable PROTOCOL_ERROR_INFORMATION;

- 1> submit the MEASUREMENT CONTROL FAILURE message to lower layers for transmission on the DCCH using AM RLC;
- 1> continue with any ongoing processes and procedures as if the invalid MEASUREMENT CONTROL message has not been received;
- 1> and the procedure ends.

8.4.1.6 Measurements after transition from CELL_DCH to CELL_FACH/CELL_PCH/URA_PCH state

The UE shall apply the following rules for different measurement types after transiting from CELL_DCH to CELL_FACH/CELL_PCH/URA_PCH state:

8.4.1.6.1 Intra-frequency measurement

Upon transition from CELL_DCH to CELL_FACH/CELL_PCH/URA_PCH state, the UE shall:

- 1> stop intra-frequency type measurement reporting;
- 1> if the transition is due to a reconfiguration message which included the IE "Primary CPICH info" (for FDD) or "Primary CCPCH info" (for TDD), and the UE selects a cell other than that indicated by this IE on the current frequency (in case the IE "Frequency info" is not received) or other than that indicated by this IE on the frequency indicated by the IE "Frequency info" (when the IE "Frequency info" is included); or
- 1> if the transition is due to a reconfiguration message which does not include the IE "Primary CPICH info" (for FDD) or "Primary CCPCH info" (for TDD); or
- 1> if the transition is not due to a reconfiguration message:
 - 2> delete the measurements of type intra-frequency associated with the variable MEASUREMENT_IDENTITY.
- 1> begin monitoring cells listed in the IE "intra-frequency cell info list" received in System Information Block type 12 (or System Information Block type 11, according to subclause 8.1.1.6.11).

8.4.1.6.2 Inter-frequency measurement

Upon transition from CELL_DCH to CELL_FACH/ CELL_PCH/URA_PCH state, the UE shall:

- 1> stop the inter-frequency type measurement reporting assigned in a MEASUREMENT CONTROL message;
- 1> if the transition is due to a reconfiguration message which included the IE "Primary CPICH info" (for FDD) or "Primary CCPCH info" (for TDD), and the UE selects a cell other than that indicated by this IE on the current frequency (in case the IE "Frequency info" is not received) or other than that indicated by this IE on the frequency indicated by the IE "Frequency info" (when the IE "Frequency info" is included); or
- 1> if the transition is due to a reconfiguration message which does not include the IE "Primary CPICH info" (for FDD) or "Primary CCPCH info" (for TDD); or
- 1> if the transition is not due to a reconfiguration message:
 - 2> delete the measurements of type inter-frequency associated with the variable MEASUREMENT_IDENTITY and delete the corresponding compressed mode pattern stored in the variable TGPS_IDENTITY.
- 1> for remaining compressed mode patterns, set the IE "TGPS Status Flag" to "deactivate" and the IE "Current TGPS Status Flag" to "inactive" in the variable TGPS_IDENTITY.
- 1> begin monitoring cells listed in the IE "inter-frequency cell info list" received in System Information Block type 12 (or System Information Block type 11, according to subclause 8.1.1.6.11);
- 1> in CELL_FACH state:
 - 2> perform measurements on other frequencies according to the IE "FACH measurement occasion info".

8.4.1.6.3 Inter-RAT measurement

Upon transition from CELL_DCH to CELL_FACH/CELL_PCH/URA_PCH state, the UE shall:

- 1> stop the inter-RAT type measurement reporting assigned in a MEASUREMENT CONTROL message;
- 1> delete the measurements of type inter-RAT associated with the variable MEASUREMENT_IDENTITY and delete the corresponding compressed mode pattern stored in the variable TGPS_IDENTITY;
- 1> begin monitoring cells listed in the IE "inter-RAT cell info list" received in System Information Block type 12 (or System Information Block type 11, according to subclause 8.1.1.6.11);
- 1> in CELL_FACH state:
 - 2> perform measurements on other systems according to the IE "FACH measurement occasion info".

8.4.1.6.4 Quality measurement

Upon transition from CELL_DCH to CELL_FACH/CELL_PCH/URA_PCH state, the UE shall:

- 1> stop quality type measurement reporting;
- 1> delete all measurement control information of measurement type "quality" stored in the variable MEASUREMENT_IDENTITY.

8.4.1.6.5 UE internal measurement

Upon transition from CELL_DCH to CELL_FACH/CELL_PCH/URA_PCH state, the UE shall:

- 1> stop UE internal measurement type measurement reporting;
- 1> delete all measurement control information of measurement type "UE internal" stored in the variable MEASUREMENT_IDENTITY.

8.4.1.6.6 Traffic volume measurement

Upon transition from CELL_DCH to CELL_FACH or CELL_PCH or URA_PCH state, the UE shall:

- 1> retrieve each set of measurement control information of measurement type "traffic volume" stored in the variable MEASUREMENT_IDENTITY; and
 - 2> if the optional IE "measurement validity" for this measurement has not been included:
 - 3> delete the measurement associated with the variable MEASUREMENT_IDENTITY.
 - 2> if the IE "measurement validity" for the measurement has been included, and the IE "UE state" has been assigned to value "CELL_DCH":
 - 3> stop measurement reporting;
 - 3> store the measurement associated with the variable MEASUREMENT_IDENTITY to be used after the next transition to CELL_DCH state.
 - 2> if the IE "measurement validity" for the measurement has been included, and the IE "UE state" has been assigned to value "all states" or "all states except CELL_DCH", and if the state transition is from CELL_DCH to CELL_PCH or URA_PCH state:
 - 3> stop measurement reporting;
 - 3> store the measurement associated with the variable MEASUREMENT_IDENTITY to be used after the next transition to CELL_FACH state.
 - 2> if the IE "measurement validity" for the measurement has been included, and the IE "UE state" has been assigned to value "all states", and if the state transition is from CELL_DCH to CELL_FACH state:
 - 3> continue measurement reporting.

- 2> if the IE "measurement validity" has been included and the IE "UE state" has been assigned to value "all states except CELL_DCH", and if the state transition is from CELL_DCH to CELL_FACH state:
 - 3> resume this measurement and associated reporting.
- 1> if no traffic volume type measurement has been assigned to the UE with a MEASUREMENT CONTROL message that is valid in CELL_FACH or CELL_PCH or URA_PCH states (stored in the variable MEASUREMENT_IDENTITY), which has the same identity as the one indicated in the IE "Traffic volume measurement system information":
 - 2> store the measurement control information from the IE "Traffic volume measurement system information" received in System Information Block type 12 (or System Information Block type 11, according to subclause 8.1.1.6.11) in the variable MEASUREMENT_IDENTITY;
 - 2> perform traffic volume measurement reporting according to the assigned information, when in CELL_FACH state.

8.4.1.6.7 UE positioning measurement

Upon transition from CELL_DCH to CELL_FACH and upon transition from CELL_DCH to CELL_PCH or URA_PCH for UE assisted GPS measurements, the UE shall:

- 1> retrieve each set of measurement control information of measurement type "UE positioning" stored in the variable MEASUREMENT_IDENTITY; and
 - 2> if the optional IE "measurement validity" for this measurement has not been included:
 - 3> delete the measurement associated with the variable MEASUREMENT_IDENTITY.
 - 2> if the IE "measurement validity" for the measurement has been included, and the IE "UE state" has been assigned to value "CELL_DCH":
 - 3> stop measurement reporting;
 - 3> store the measurement associated with the variable MEASUREMENT_IDENTITY to be used after the next transition to CELL_DCH state.
 - 2> if the IE "measurement validity" for the measurement has been included, and the IE "UE state" has been assigned to value "all states":
 - 3> upon transition from CELL_DCH to CELL_PCH or URA_PCH:
 - 4> if the choice in the IE "Reporting Criteria" included the IE "UE Positioning measurement" stored in the variable MEASUREMENT_IDENTITY is set to "UE positioning reporting criteria" and the value of the IE "Measurement interval" included in this IE is less than 64 seconds:
 - 5> use a value of 64 seconds for the measurement interval associated with this measurement while the UE remains in CELL_PCH/URA_PCH.
 - 4> if the choice in the IE "Reporting Criteria" included the IE "UE Positioning measurement" stored in the variable MEASUREMENT_IDENTITY is set to "Periodical Reporting Criteria" and the value of the IE "Reporting interval" included in this IE is less than 64 seconds:
 - 5> use a value of 64 seconds for the reporting interval associated with this measurement while the UE remains in CELL_PCH/URA_PCH.
 - 3> continue measurement reporting according to its UE positioning measurement reporting capability.
 - 2> if the IE "measurement validity" has been included and the IE "UE state" has been assigned to value "all states except CELL_DCH":
 - 3> upon transition from CELL_DCH to CELL_PCH or URA_PCH:
 - 4> if the choice in the IE "Reporting Criteria" included the IE "UE Positioning measurement" stored in the variable MEASUREMENT_IDENTITY is set to "UE positioning reporting criteria" and the value of the IE "Measurement interval" included in this IE is less than 64 seconds:

- 5> use a value of 64 seconds for the measurement interval associated with this measurement while the UE remains in CELL_PCH/URA_PCH.
- 4> if the choice in the IE "Reporting Criteria" included the IE "UE Positioning measurement" stored in the variable MEASUREMENT_IDENTITY is set to "Periodical Reporting Criteria" and the value of the IE "Reporting interval" included in this IE is less than 64 seconds:
 - 5> use a value of 64 seconds for the reporting interval associated with this measurement while the UE remains in CELL_PCH/URA_PCH.
- 3> resume this measurement and associated reporting according to its UE Positioning measurement reporting capability.
- 1> if the transition is due to a reconfiguration message which included the IE "Primary CPICH info" (for FDD) or "Primary CCPCH info" (for TDD), and the UE selects a cell other than that indicated by this IE; or
- 1> if the transition is due to a reconfiguration message which does not include the IE "Primary CPICH info" (for FDD) or "Primary CCPCH info" (for TDD); or
- 1> if the transition is due to a reconfiguration message which included the IE "Frequency info", and the UE selects a cell on another frequency than that indicated by this IE; or
- 1> if the transition is due to a reconfiguration message which does not include the IE "Frequency info", and the UE can not find a cell on the current frequency, but it selects a cell on another frequency; or
- 1> if the transition is not due to a reconfiguration message:
 - 2> delete the assistance data included in the variable UE_POSITIONING_OTDOA_DATA_UE_BASED and UE_POSITIONING_OTDOA_DATA_UE_ASSISTED.
- 1> if the IE "Positioning Methods" stored in the variable MEASUREMENT_IDENTITY is set to "OTDOA" or "OTDOA or GPS":
 - 2> if the IE "Method type" stored in the variable MEASUREMENT_IDENTITY is set to "UE-based" or "UE assisted preferred but UE-based allowed" or "UE-based preferred but UE-assisted allowed":
 - 3> begin monitoring assistance data received in System Information Block type 15.4 and System Information Block type 15.5 according to subclause 8.1.1.6.15.
 - 2> if the IE "Method type" stored in the variable MEASUREMENT_IDENTITY is set to "UE-assisted":
 - 3> begin monitoring assistance data received in System Information Block type 15.4 according to subclause 8.1.1.6.15.
- 1> if the UE is in CELL_FACH state:
 - 2> if the IE "UE positioning OTDOA neighbour cell list for UE assisted" stored in the variable UE_POSITIONING_OTDOA_DATA_UE_ASSISTED or UE_POSITIONING_OTDOA_DATA_UE_BASED contains neighbour cells on other frequencies than the current frequency:
 - 3> perform measurements on other frequencies according to the IE "FACH measurement occasion info".

The UE may:

- 1> if the IE "Positioning Methods" stored in the variable MEASUREMENT_IDENTITY is set to "GPS" or "OTDOA or GPS":
 - 2> begin monitoring assistance data received in System Information Block type 15 and/or System Information Block type 15.1 and/or System Information Block type 15.2 and/or System Information Block type 15.3 according to subclause 8.1.1.6.15.
- 2> if the IE "GANSS Positioning Methods" is present:
 - 3> begin monitoring assistance data received in System Information Block type 15bis and/or System Information Block type 15.1bis and/or System Information Block type 15.2bis and/or System Information

Block type 15.3bis and/or System Information Block type 15.6 and/or System Information Block type 15.7 and/or System Information Block type 15.8 according to subclause 8.1.1.6.15.

NOTE: In the case that the measurement or reporting intervals are modified to 64 seconds during a transition to CELL_PCH/URA_PCH as described above, the UE retains the previously used values of "Measurement interval" and "Reporting interval" for use after transition out of CELL_PCH/URA_PCH.

8.4.1.6a Actions in CELL_FACH/CELL_PCH/URA/PCH state upon cell re-selection

Upon cell reselection while in CELL_FACH/CELL_PCH/URA/PCH state and the cell reselection has occurred after the measurement control information was stored, the UE shall:

- 1> delete all measurements of type intra-frequency, inter-frequency, and inter-RAT associated with the variable MEASUREMENT_IDENTITY;
- 1> delete all compressed mode patterns associated with inter-frequency and inter-RAT measurements stored in the variable TGPS_IDENTITY;
- 1> delete the traffic volume measurements that have not been set up or modified through a MEASUREMENT CONTROL message.

8.4.1.7 Measurements after transition from CELL_FACH to CELL_DCH state

The UE shall apply the following rules for different measurement types after transiting from CELL_FACH to CELL_DCH state:

8.4.1.7.1 Intra-frequency measurement

Upon transition from CELL_FACH to CELL_DCH state:

- 1> if intra-frequency measurements applicable to CELL_DCH state are stored in the variable MEASUREMENT_IDENTITY:
 - 2> if the cell in which the UE transited from CELL_FACH state is included in the active set for the CELL_DCH state, the UE shall:
 - 3> resume the measurement reporting.
 - 2> otherwise, the UE shall:
 - 3> not resume the measurement reporting. The measurement shall be restarted when a MEASUREMENT CONTROL message is received with the corresponding measurement identity.

8.4.1.7.2 Inter-frequency measurement

Upon transition from CELL_FACH to CELL_DCH state:

- 1> if inter-frequency measurements applicable to CELL_DCH state are stored in the variable MEASUREMENT_IDENTITY:
 - 2> if the cell in which the UE transited from CELL_FACH state is included in the active set for the CELL_DCH state, the UE shall:
 - 3> resume the measurement reporting.
 - 2> otherwise, the UE shall:
 - 3> not resume the measurement reporting. The measurement shall be restarted when a MEASUREMENT CONTROL message is received with the corresponding measurement identity.

8.4.1.7.3 Inter-RAT measurement

Upon transition from CELL_FACH to CELL_DCH state, the UE shall:

- 1> stop monitoring the list of cells assigned in the IE "inter-RAT cell info list" in System Information Block type 12 (or System Information Block type 11, according to subclause 8.1.1.6.11).

8.4.1.7.4 Traffic volume measurement

Upon transition from CELL_FACH to CELL_DCH state, the UE shall:

- 1> retrieve each set of measurement control information of measurement type "traffic volume" stored in the variable MEASUREMENT_IDENTITY;
 - 2> if the optional IE "measurement validity" for this measurement has not been included:
 - 3> delete the measurement associated with the variable MEASUREMENT_IDENTITY.
 - 2> if the IE "measurement validity" for the measurement has been included, and the IE "UE state" has been assigned to value "all states except CELL_DCH":
 - 3> stop measurement reporting; and
 - 3> save the measurement associated with the variable MEASUREMENT_IDENTITY to be used after the next transition to CELL_FACH/CELL_PCH/URA_PCH state.
 - 2> if the IE "measurement validity" for the measurement has been included, and the IE "UE state" has been assigned to value "all states":
 - 3> continue measurement reporting.
 - 2> if the IE "measurement validity" has been included and the IE "UE state" has been assigned to value "CELL_DCH":
 - 3> resume this measurement and associated reporting.
- 1> if no traffic volume type measurement has been assigned to the UE with a MEASUREMENT CONTROL message that is valid in CELL_DCH and has the same identity as the one indicated in the IE "Traffic volume measurement system information":
 - 2> store the measurement control information from the IE "Traffic volume measurement system information" received in System Information Block type 12 (or System Information Block type 11, according to subclause 8.1.1.6.11) in the variable MEASUREMENT_IDENTITY;
 - 2> begin traffic volume measurement reporting according to the assigned information.

8.4.1.7.5 UE positioning measurement

Upon transition from CELL_FACH to CELL_DCH state, the UE shall:

- 1> retrieve each set of measurement control information of measurement type "UE positioning" stored in the variable MEASUREMENT_IDENTITY; and
 - 2> if the optional IE "Measurement validity" for this measurement has not been included:
 - 3> delete the measurement associated with the variable MEASUREMENT_IDENTITY.
 - 2> if the IE "measurement validity" for the measurement has been included, and the IE "UE state" has been assigned to value "all states except CELL_DCH":
 - 3> stop measurement reporting; and
 - 3> save the measurement associated with the variable MEASUREMENT_IDENTITY to be used after the next transition to CELL_FACH/CELL_PCH/URA_PCH state.
 - 2> if the IE "measurement validity" for the measurement has been included, and the IE "UE state" has been assigned to value "all states":
 - 3> continue measurement reporting.

2> if the IE "measurement validity" has been included and the IE "UE state" has been assigned to value "CELL_DCH":

3> resume this measurement and associated reporting.

1> stop monitoring assistance data received in System Information Block type 15 or System Information Block type 15.1 or System Information Block type 15.2 or System Information Block type 15.3 or System Information Block type 15.4 or System Information Block 15.5 or System Information Block type 15bis or System Information Block type 15.1bis or System Information Block type 15.2bis or System Information Block type 15.3bis or System Information Block type 15.6 or System Information Block type 15.7 or System Information Block type 15.8.

8.4.1.8 Measurements after transition from idle mode to CELL_DCH state

The UE shall obey the following rules for different measurement types after transiting from idle mode to CELL_DCH state:

8.4.1.8.1 Intra-frequency measurement

Upon transition from idle mode to CELL_DCH state:

1> if intra-frequency measurements applicable to CELL_DCH state are stored in the variable MEASUREMENT_IDENTITY:

2> if the cell in which the UE transited from idle mode is included in the active set for the CELL_DCH state, the UE shall:

3> begin measurement reporting.

2> otherwise, the UE shall:

3> not begin the measurement reporting. The measurement shall be restarted when a MEASUREMENT CONTROL message is received with the corresponding measurement identity.

8.4.1.8.2 Inter-frequency measurement

Upon transition from idle mode to CELL_DCH state, the UE shall:

1> stop monitoring the list of cells assigned in the IE "inter-frequency cell info list" in System Information Block type 12 (or System Information Block type 11, according to subclause 8.1.1.6.11).

8.4.1.8.3 Inter-RAT measurement

Upon transition from idle mode to CELL_DCH state, the UE shall:

1> stop monitoring the list of cells assigned in the IE "inter-RAT cell info list" in System Information Block type 12 (or System Information Block type 11, according to subclause 8.1.1.6.11).

8.4.1.8.4 Traffic volume measurement

Upon transition from idle mode to CELL_DCH state, the UE shall:

1> begin a traffic volume type measurement, assigned in System Information Block type 11 (or System Information Block type 12, according to subclause 8.1.1.6.11).

8.4.1.8.5 UE positioning measurement

Upon transition from idle mode to CELL_DCH state, the UE shall:

1> stop monitoring assistance data received in System Information Block type 15 or System Information Block type 15.1 or System Information Block type 15.2 or System Information Block type 15.3 or System Information Block type 15.4 or System Information Block type 15.5 or System Information Block type 15bis or System Information Block type 15.1bis or System Information Block type 15.2bis or System Information Block type

15.3bis or System Information Block type 15.6 or System Information Block type 15.7 or System Information Block type 15.8.

8.4.1.9 Measurements after transition from idle mode to CELL_FACH state

The UE shall obey the follow rules for different measurement types after transiting from idle mode to CELL_FACH state:

8.4.1.9.1 Intra-frequency measurement

Upon transition from idle mode to CELL_FACH state, the UE shall:

- 1> begin or continue monitoring cells listed in the IE "intra-frequency cell info list" received in System Information Block type 12 (or System Information Block type 11, according to subclause 8.1.1.6.11).

8.4.1.9.2 Inter-frequency measurement

Upon transition from idle mode to CELL_FACH state, the UE shall:

- 1> begin or continue monitoring cells listed in the IE "inter-frequency cell info list" received in System Information Block type 12 (or System Information Block type 11, according to subclause 8.1.1.6.11);
- 1> perform measurements on other frequencies according to the IE "FACH measurement occasion info".

8.4.1.9.3 Inter-RAT measurement

Upon transition from idle mode to CELL_FACH state, the UE shall:

- 1> begin or continue monitoring cells listed in the IE "inter-RAT cell info list" received in System Information Block type 12 (or System Information Block type 11, according to subclause 8.1.1.6.11);
- 1> perform measurements on other systems according to the IE "FACH measurement occasion info".

8.4.1.9.4 Traffic volume measurement

Upon transition from idle mode to CELL_FACH state, the UE shall:

- 1> store the measurement control information from the IE "Traffic volume measurement system information" received in System Information Block type 12 (or System Information Block type 11, according to subclause 8.1.1.6.11) in the variable MEASUREMENT_IDENTITY;
- 1> begin traffic volume measurement reporting according to the assigned information.

8.4.1.9.5 UE positioning measurement

Upon transition from idle mode to CELL_FACH state, the UE may:

- 1> begin or continue monitoring assistance data received in System Information Block type 15 or System Information Block type 15.1 or System Information Block type 15.2 or System Information Block type 15.3 or System Information Block type 15.4 or System Information Block type 15.5 or System Information Block type 15bis or System Information Block type 15.1bis or System Information Block type 15.2bis or System Information Block type 15.3bis or System Information Block type 15.6 or System Information Block type 15.7 or System Information Block type 15.8 according to subclause 8.1.1.6.15;
- 1> if the IE "UE positioning OTDOA neighbour cell list for UE assisted" stored in the variable UE_POSITIONING_OTDOA_DATA_UE_ASSISTED; or
- 1> if the IE "UE positioning OTDOA neighbour cell list for UE based" stored in the variable UE_POSITIONING_OTDOA_DATA_UE_BASED contains neighbour cells on other frequencies than the current frequency:
 - 2> perform measurements on other frequencies according to the IE "FACH measurement occasion info".

8.4.1.9a Measurements after transition from connected mode to idle mode

Upon transition from connected mode to idle mode the UE shall:

- 1> stop measurement reporting for all measurements stored in the variable MEASUREMENT_IDENTITY;
- 1> clear the variable MEASUREMENT_IDENTITY;
- 1> apply the following rules for different measurement types.

8.4.1.9a.1 Intra-frequency measurement

Upon transition from connected mode to idle mode, the UE shall:

- 1> stop monitoring intra-frequency cells listed in the IE "intra-frequency cell info list" received in System Information Block type 12 (if System Information Block type 12 is transmitted in the cell, according to subclause 8.1.1.6.11);
- 1> begin monitoring intra-frequency cells listed in the IE "intra-frequency cell info list" received in System Information Block type 11.

8.4.1.9a.2 Inter-frequency measurement

Upon transition from connected mode to idle mode, the UE shall:

- 1> stop monitoring inter-frequency cells listed in the IE "inter-frequency cell info list" received in System Information Block type 12 (if System Information Block type 12 is transmitted in the cell, according to subclause 8.1.1.6.11);
- 1> begin monitoring inter-frequency cells listed in the IE "inter-frequency cell info list" received in System Information Block type 11.

8.4.1.9a.3 Inter-RAT measurement

Upon transition from connected mode to idle mode, the UE shall:

- 1> stop monitoring inter-RAT cells listed in the IE "inter-RAT cell info list" received in System Information Block type 12 (if System Information Block type 12 is transmitted in the cell, according to 8.1.1.6.11);
- 1> begin monitoring inter-RAT cells listed in the IE "inter-RAT cell info list" received in System Information Block type 11.

8.4.1.9a.4 UE positioning measurement

Upon transition from connected mode to idle mode, the UE may:

- 1> begin or continue monitoring assistance data received in System Information Block type 15 or System Information Block type 15.1 or System Information Block type 15.2 or System Information Block type 15.3 or System Information Block type 15.4 or System Information Block type 15.5 or System Information Block type 15.5bis or System Information Block type 15.1bis or System Information Block type 15.2bis or System Information Block type 15.3bis or System Information Block type 15.6 or System Information Block type 15.7 or System Information Block type 15.8.

8.4.1.9b Measurements after transition from CELL_FACH to CELL_PCH/URA_PCH

8.4.1.9b.1 Traffic volume measurement

Upon transition from CELL_FACH to CELL_PCH or URA_PCH, the UE shall:

- 1> stop any ongoing traffic volume measurement, and associated traffic volume measurement reporting.
- 1> store the measurement associated with the variable MEASUREMENT_IDENTITY to be used after the next transition to CELL_FACH state;

- 1> if no traffic volume type measurement has been assigned to the UE with a MEASUREMENT CONTROL message that is valid in CELL_FACH or CELL_PCH or URA_PCH states (stored in the variable MEASUREMENT_IDENTITY), which has the same identity as the one indicated in the IE "Traffic volume measurement system information":
 - 2> store the measurement control information from the IE "Traffic volume measurement system information" received in System Information Block type 12 (or System Information Block type 11, according to subclause 8.1.1.6.11) in the variable MEASUREMENT_IDENTITY.

8.4.1.9b.2 UE positioning measurement

Upon transition from CELL_FACH to CELL_PCH or URA_PCH, the UE shall:

- 1> retrieve each set of measurement control information of measurement type "UE positioning" stored in the variable MEASUREMENT_IDENTITY; and
 - 2> if the optional IE "measurement validity" for this measurement has not been included:
 - 3> delete the measurement associated with the variable MEASUREMENT_IDENTITY.
 - 2> if the IE "measurement validity" for the measurement has been included, and the IE "UE state" has been assigned to value "all states" or "all states except CELL_DCH":
 - 3> if the choice in the IE "Reporting Criteria" included in the IE "UE Positioning measurement" stored in the variable MEASUREMENT_IDENTITY is set to "UE positioning reporting criteria" and the value of the IE "Measurement interval" included in this IE is less than 64 seconds:
 - 4> use a value of 64 seconds for the measurement interval associated with this measurement while the UE remains in CELL_PCH/URA_PCH.
 - 3> if the choice in the IE "Reporting Criteria" included in the IE "UE Positioning measurement" stored in the variable MEASUREMENT_IDENTITY is set to "Periodical Reporting Criteria" and the value of the IE "Reporting interval" included in this IE is less than 64 seconds:
 - 4> use a value of 64 seconds for the reporting interval associated with this measurement while the UE remains in CELL_PCH/URA_PCH.

NOTE: In the case that the measurement or reporting intervals are modified to 64 seconds as described above, the UE retains the previously used values of "Measurement interval" and "Reporting interval" for use after transition out of CELL_PCH/URA_PCH.

8.4.1.9c Measurements after transition from CELL_PCH/URA_PCH to CELL_FACH

8.4.1.9c.1 Traffic volume measurement

Upon transition from CELL_PCH or URA_PCH to CELL_FACH, the UE shall resume any traffic volume measurement stored in the variable MEASUREMENT_IDENTITY with measurement validity "all states" or "all states except CELL_DCH", and start the associated traffic volume measurement reporting.

8.4.1.9c.2 UE positioning measurement

Upon transition from CELL_PCH or URA_PCH to CELL_FACH, the UE shall continue any UE positioning measurement stored in the variable MEASUREMENT_IDENTITY with measurement validity "all states" or "all states except CELL_DCH", and continue the associated UE positioning measurement reporting.

NOTE: The UE's values of "Measurement interval" in the IE "UE positioning reporting criteria" and "Reporting interval" in the IE "Periodical Reporting Criteria" after this state transition revert to the values stored during the transition to CELL_PCH/URA_PCH (i.e., the 64-second interval specified in subclause 8.4.1.9b.2 is not retained).

8.4.1.10 Changes in measurement objects

8.4.1.10.1 Traffic volume measurement

When performing traffic volume event evaluation or reporting related to a certain transport channel, the UE shall consider all RBs which are mapped to the concerning transport channel e.g. if an additional RB is established on a transport channel used for event triggering or reporting, the new RB shall be taken into account.

NOTE: In this subclause, an "existing" uplink transport channel refers to a configured uplink transport channel applicable in the current RRC state.

The UE shall:

- 1> if the IE "Traffic volume measurement object" is included for this measurement:
 - 2> while a transport channel that is referenced in the IE "Traffic volume measurement object" does not exist:
 - 3> not perform any reporting related to this transport channel.
- 1> else:
 - 2> report on all existing uplink transport channels; e.g. if an additional transport channel is established while the measurement is ongoing, this new transport channel shall be taken into account in the traffic volume measurement reporting.

For every traffic volume event, the UE shall:

- 1> if the IE "Uplink transport channel type" is not included in the IE "Traffic volume measurement reporting criteria", or the "Uplink transport channel type" has the value "DCH" or "USCH" and the IE "UL transport channel id" is not included in the IE "Traffic volume measurement reporting criteria":
 - 2> if the IE "Traffic volume measurement object" is not included:
 - 3> take all existing UL transport channels into account for event triggering; e.g. if an additional transport channel is established while the measurement is ongoing, this new transport channel shall be taken into account in the traffic volume event triggering.
 - 2> else:
 - 3> while a transport channel that is referenced in the IE "Traffic Volume Measurement object" does not exist:
 - 4> not take this transport channel identity into account in the traffic volume measurement triggering.
- 1> else:
 - 2> while a transport channel that is referenced in the IE "Traffic Volume Measurement Reporting Criteria" does not exist:
 - 3> not take this transport channel identity into account in the traffic volume event triggering.

8.4.1.10.2 Quality measurement

While a transport channel that is explicitly referenced with a transport channel identity in the IE "Quality Reporting Quantity" does not exist, the UE shall:

- 1> not perform any reporting related to this transport channel identity.

If the IE "Quality Reporting Quantity" does not contain any explicit transport channel identities, the UE shall:

- 1> report the quality of all existing downlink dedicated transport channels;
- 1> if an additional transport channel is established while the measurement is ongoing:
 - 2> take into account this new transport channel in the quality measurement reporting.

While a transport channel that is explicitly referenced with a transport channel id in the IE "Quality Measurement Reporting Criteria" does not exist, the UE shall:

- 1> not take this transport channel identity into account in the quality measurement event triggering.

8.4.1.10.3 Intra-frequency, Inter-frequency and Inter-RAT measurements

For measurements which include the IE "Cells for measurement" the UE shall:

- 1> while an IE "Intra-frequency cell id" or IE "Inter-frequency cell id" or IE "Inter-RAT cell id" in the IE "Cells for measurement" points to a position in the variable CELL_INFO_LIST which is marked as "vacant":
- 2> not take this position into account for event triggering and reporting.

8.4.2 Measurement report



Figure 8.4.2-1: Measurement report, normal case

8.4.2.1 General

The purpose of the measurement reporting procedure is to transfer measurement results from the UE to UTRAN.

8.4.2.2 Initiation

In CELL_DCH state, the UE shall:

- 1> transmit a MEASUREMENT REPORT message on the uplink DCCH when the reporting criteria stored in variable MEASUREMENT_IDENTITY are met for any ongoing measurements that are being performed in the UE.

In CELL_FACH state, the UE shall:

- 1> transmit a MEASUREMENT REPORT message on the uplink DCCH when the reporting criteria stored in variable MEASUREMENT_IDENTITY are met for any ongoing traffic volume measurement or UE positioning measurement that is being performed in the UE.

In TDD, if the Radio Bearer associated with the MEASUREMENT_IDENTITY fulfilling the reporting criteria for an ongoing traffic volume measurement is mapped on transport channel of type USCH, the UE shall:

- 1> initiate the "PUSCH CAPACITY REQUEST" procedure instead of transmitting a MEASUREMENT REPORT (TDD Only).

In CELL_PCH or URA_PCH state, the UE shall:

- 1> if the measurement reporting is not initiated according to subclause 8.5.40:
 - 2> first perform the cell update procedure according to subclause 8.3.1, using the cause "uplink data transmission", in order to transit to CELL_FACH state; and then
 - 2> transmit a MEASUREMENT REPORT message on the uplink DCCH when the reporting criteria stored in variable MEASUREMENT_IDENTITY are fulfilled for any ongoing UE positioning measurement which is being performed in the UE.

For FDD, the UE in CELL_PCH state shall:

1> if variable H_RNTI is set:

2> if the measurement reporting is initiated according to subclause 8.5.40:

3> set the IE "measurement identity" to "16";

3> not set the IE "measured results";

3> include the IE "measured results on RACH";

3> if an event triggered traffic volume measurement has been configured:

4> if the TCTV is larger than the threshold in the IE "Reporting threshold" for a traffic volume measurement stored in the MEASUREMENT_IDENTITY variable and that traffic volume measurement has "measurement identity" equal to 4, "Traffic volume event identity" equal to "4a", "Measurement validity" equal to "all states" or "all states except CELL_DCH":

5> set the IE "Traffic volume event identity" to "4a".

3> and then transmit the MEASUREMENT REPORT message on the uplink DCCH using AM RLC; when the MEASUREMENT REPORT message has been submitted to lower layers for transmission the procedure ends.

The reporting criteria are fulfilled if either:

- a periodic MEASUREMENT REPORT message shall be sent according to the IE "Periodical Reporting Criteria"; or
- an event in stored IE "Measurement reporting criteria" was triggered. Events and triggering of reports for different measurement types are described in detail in clause 14.

For the measurement, which triggered the MEASUREMENT REPORT message, the UE shall:

1> set the IE "measurement identity" to the measurement identity, which is associated with that measurement in variable MEASUREMENT_IDENTITY;

1> set the IE "measured results" to include measurements according to the IE "reporting quantity" of that measurement stored in variable MEASUREMENT_IDENTITY; and

2> if all the reporting quantities are set to FALSE:

3> not set the IE "measured results".

1> set the IE "Measured results" in the IE "Additional measured results" according to the IE "reporting quantity" for all measurements associated with the measurement identities included in the "Additional measurements list" stored in variable MEASUREMENT_IDENTITY of the measurement that triggered the measurement report; and

2> if one or more additional measured results are to be included:

3> include only the available additional measured results, and sort them in ascending order according to their IE "measurement identity" in the MEASUREMENT REPORT message.

1> if the MEASUREMENT REPORT message was triggered by an event (i.e. not a periodical report):

2> set the IE "Event results" according to the event that triggered the report.

1> if the IE Inter-RAT measured results list or the IE Inter-RAT measurement event results is included in the measurement report:

2> if the indication status of the IE "Inter-RAT cell info indication" in the variable CELL_INFO_LIST is marked "present" , include the stored value of the IE "Inter-RAT cell info indication" in the MEASUREMENT REPORT message.

The UE shall:

- 1> transmit the MEASUREMENT REPORT message on the uplink DCCH using either AM or UM RLC according to the stored IE "measurement reporting mode" associated with the measurement identity that triggered the report.

When the MEASUREMENT REPORT message has been submitted to lower layers for transmission:

- 1> the procedure ends.

8.4.3 Assistance Data Delivery

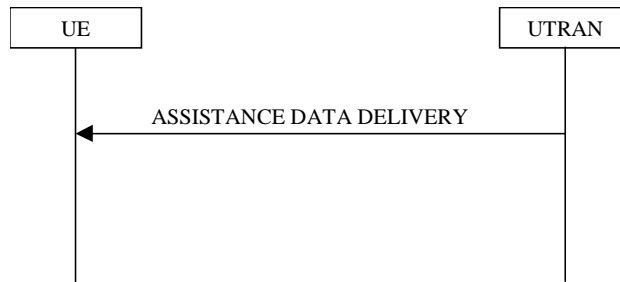

Figure 8.4.3-1 Assistance Data Delivery

8.4.3.1 General

The purpose of the assistance data delivery procedure is to transfer UE positioning related assistance data from the UTRAN to the UE.

8.4.3.2 Initiation

When requested by the Core Network, the UTRAN may deliver UE positioning related assistance data with a ASSISTANCE DATA DELIVERY message, which is transmitted on the downlink DCCH using AM RLC

8.4.3.3 Reception of ASSISTANCE DATA DELIVERY message by the UE

Upon reception of a ASSISTANCE DATA DELIVERY message the UE shall:

- 1> if IE "UE positioning OTDOA assistance data for UE-based" is included:
 - 2> act as specified in subclause 8.6.7.19.2a.
- 1> if IE "UE positioning GPS assistance data" is included:
 - 2> act as specified in subclause 8.6.7.19.3.
- 1> if IE "UE positioning GANSS assistance data" is included:
 - 2> act as specified in subclause 8.6.7.19.6.

8.4.3.4 Invalid ASSISTANCE DATA DELIVERY message

If the UE receives a ASSISTANCE DATA DELIVERY message, which contains a protocol error causing the variable `PROTOCOL_ERROR_REJECT` to be set to `TRUE` according to clause 9, the UE shall perform procedure specific error handling as follows. The UE shall:

- 1> transmit an RRC STATUS message on the uplink DCCH using AM RLC;
- 1> include the IE "Identification of received message"; and
- 1> set the IE "Received message type" to ASSISTANCE DATA DELIVERY; and

- 1> set the IE "RRC transaction identifier" to the value of "RRC transaction identifier" in the entry for the ASSISTANCE DATA DELIVERY message in the table "Rejected transactions" in the variable TRANSACTIONS; and
- 1> clear that entry;
- 1> include the IE "Protocol error information" with contents set to the value of the variable PROTOCOL_ERROR_INFORMATION.
- 1> when the RRC STATUS message has been submitted to lower layers for transmission:
 - 2> continue with any ongoing processes and procedures as if the invalid ASSISTANCE DATA DELIVERY message has not been received.

8.5 General procedures

8.5.1 Selection of initial UE identity

The purpose of the IE "Initial UE identity" is to provide a unique UE identification at the establishment of an RRC connection. The type of identity shall be selected by the UE according to the following.

If the UE is operating in "GSM-MAP mode", the UE shall choose "UE id type" in the IE "Initial UE identity" with the following priority:

1. TMSI (GSM-MAP): The TMSI (GSM-MAP) shall be chosen if available. The IE "LAI" in the IE "Initial UE identity" shall also be present when TMSI (GSM-MAP) is used, for making it unique.
2. P-TMSI (GSM-MAP): The P-TMSI (GSM-MAP) shall be chosen if available and no TMSI (GSM-MAP) is available. The IE "RAI" in the IE "Initial UE identity" shall in this case also be present when P-TMSI (GSM-MAP) is used, for making it unique.
3. IMSI (GSM-MAP): The IMSI (GSM-MAP) shall be chosen if available and no TMSI (GSM-MAP) or P-TMSI is available.
4. IMEI: The IMEI shall be chosen when none of the above three conditions are fulfilled.

When being used, the IEs "TMSI (GSM-MAP)", "P-TMSI (GSM-MAP)", "IMSI (GSM-MAP)", "LAI" and "RAI" shall be set equal to the values of the corresponding identities stored in the USIM or SIM.

If the UE is operating in "ANSI-41 mode", the UE shall choose "UE id type" in the IE "Initial UE identity" according to the procedure specified in the 3GPP2 document "3GPP2 C.P0004-A".

8.5.2 Actions when entering idle mode from connected mode

When entering idle mode from connected mode, the UE shall:

- 1> clear or set variables upon leaving UTRA RRC connected mode as specified in subclause 13.4;
- 1> if the RRC CONNECTION RELEASE message was received and the IE "Redirection info" was present therein:
 - 2> attempt to camp on a suitable cell on the indicated UTRA carrier included in the RRC CONNECTION RELEASE message;
 - 2> attempt to camp on a suitable cell of the list of cells for the indicated RAT included in the RRC CONNECTION RELEASE message. If no cells were indicated for that RAT or no suitable cell of the indicated cells for that RAT is found within 10s, attempt to camp on any suitable cell of that RAT; or
 - 2> if no suitable cell is found on the indicated UTRA carrier or RAT camp on any suitable cell.
- 1> attempt to select a suitable cell to camp on.

When leaving connected mode according to [4], the UE shall:

- 1> perform cell selection.

While camping on a cell, the UE shall:

- 1> acquire system information according to the system information procedure in subclause 8.1;
- 1> perform measurements according to the measurement control procedure specified in subclause 8.4; and
- 1> if the UE is registered:
 - 2> be prepared to receive paging messages according to the paging procedure in subclause 8.2.

If the UE is operating in "GSM-MAP mode", the UE shall:

- 1> delete any NAS system information received in connected mode;
- 1> acquire the NAS system information in system information block type 1; and
- 1> proceed according to subclause 8.6.1.2.

When entering idle mode, the UE shall:

- 1> if the USIM is present, for each CN domain:
 - 2> if a new security key set was received for this CN domain but was not used either for integrity protection or ciphering during this RRC connection:
 - 3> set the START value for this domain to zero; and
 - 3> store this START value for this domain in the USIM.
 - 2> else:
 - 3> if the current "START" value, according to subclause 8.5.9 for a CN domain, is greater than or equal to the value "THRESHOLD" of the variable START_THRESHOLD:
 - 4> delete the ciphering and integrity keys that are stored in the USIM for that CN domain;
 - 4> inform the deletion of these keys to upper layers.
 - 3> else:
 - 4> store the current "START" value for this CN domain on the USIM.

NOTE: Prior to storing the "START" value, the UE should calculate this "START" value according to subclause 8.5.9.

- 1> else:
 - 2> if the SIM is present, for each CN domain:
 - 3> if a new security key set was received for this CN domain but was not used either for integrity protection or ciphering during this RRC connection:
 - 4> set the START value for this domain to zero; and
 - 4> store this START value for this domain in the UE
 - 3> else:
 - 4> if the current "START" value, according to subclause 8.5.9 for this CN domain, is greater than or equal to the value "THRESHOLD" of the variable START_THRESHOLD:
 - 5> delete the Kc key for this CN domain;
 - 5> delete the ciphering and integrity keys that are stored in the UE for that CN domain;
 - 5> set the "START" values for this CN domain to zero and store it the UE;
 - 5> inform the deletion of the key to upper layers.

4> else:

5> store the current "START" value for this CN domain in the UE.

NOTE: Prior to storing the "START" value, the UE should calculate this "START" value according to subclause 8.5.9.

8.5.3 Open loop power control upon establishment of DPCCH

This procedure is used in FDD mode only.

When establishing the first DPCCH the UE shall start the UL inner loop power control at a power level according to:

1> $DPCCH_Initial_power = DPCCH_Power_offset - CPICH_RSCP$

Where

DPCCH_Power_offset shall have the value of IE "DPCCH Power offset" in IE "Uplink DPCH power control info"

The value for the CPICH_RSCP shall be measured by the UE.

8.5.4 Physical channel establishment criteria

When a physical dedicated channel establishment is initiated by the UE, the UE shall start a timer T312 and wait for layer 1 to indicate N312 "in sync" indications. On receiving N312 "in sync" indications, the physical channel is considered established and the timer T312 is stopped and reset.

If the timer T312 expires before the physical channel is established, the UE shall consider this as a "physical channel failure".

NOTE: The criteria defined in this subclause only apply in case the UE performs synchronisation procedure A (FDD only).

8.5.5 Actions in "out of service area" and "in service area"

This subclause specifies the general actions the UE shall perform when it detects "out of service" or "in service" area. The specific UE behaviour when it detects "out of service" or "in service area" and periodical update has been configured by T305 in the IE "UE Timers and constants in connected mode" set to any other value than "infinity" is specified in subclause 8.3.1.

8.5.5.1 Detection of "out of service" area

The UE shall detect "out of service" area as defined in [19].

8.5.5.1.1 Actions following detection of "out of service" area in URA_PCH or CELL_PCH state

If the UE detects the "out of service area" and the UE is in URA_PCH or CELL_PCH state it shall perform the following actions:

1> start timer T316;

1> perform processes described in subclause 7.2.2.

8.5.5.1.2 Actions following detection of "out of service" area in CELL_FACH state

If the UE detects the "out of service area" and the UE is in CELL_FACH state it shall perform the following actions. The UE shall:

1> start timer T317 if not already running;

1> perform processes described in subclause 7.2.2.

8.5.5.1.3 Actions following detection of "out of service" area on transition from CELL_DCH to URA_PCH or CELL_PCH

If the UE detects the "out of service area" on transition from CELL_DCH to URA_PCH or CELL_PCH, it shall perform the following actions:

1> start timer T316;

1> start the timer T305 using its initial value if timer T305 is not running and periodical cell update has been configured by T305 in the IE "UE Timers and constants in connected mode" set to any other value than "infinity";

1> perform processes described in subclause 7.2.2.

8.5.5.1.4 Actions following detection of "out of service" area on transition from CELL_DCH to CELL_FACH

If the UE detects the "out of service area" on transition from CELL_DCH to CELL_FACH, it shall perform the following actions:

1> if the transition is triggered by a reconfiguration procedure:

2> start timer T317;

2> start the timer T305 using its initial value if timer T305 is not running and periodical cell update has been configured by T305 in the IE "UE Timers and constants in connected mode" set to any other value than "infinity";

2> perform processes described in subclause 7.2.2.

1> otherwise:

2> perform processes described in subclause 7.2.2.

8.5.5.2 Detection of "in service" area

When a suitable cell is found based on the description in [4], the UE considers it as having detected "in service area".

8.5.5.2.1 Actions following Re-entry into "in service area" in URA_PCH or CELL_PCH state

If the UE re-enters "in service area" before T316 expiry the UE shall perform the following actions. The UE shall:

1> stop T316;

1> if T307 is active:

2> stop T307.

1> if the UE is in CELL_PCH state and the UE is camped on a cell different from the one where service was lost:

2> for FDD:

3> clear the variable C_RNTI and H_RNTI;

3> stop using that C-RNTI and H-RNTI just cleared from variables C_RNTI and H_RNTI in MAC.

2> initiate the cell update procedure using the cause "cell-reselection" as specified in subclause 8.3.1.

1> perform processes described in subclause 7.2.2.

8.5.5.2.2 Actions following re-entry into "in service area" in CELL_FACH state

If the UE detects "in service area" before T317 expiry the UE shall perform the following actions. If no cell update procedure or URA update procedure is ongoing, the UE shall:

- 1> stop T317;
- 1> if T307 is active:
 - 2> stop T307.
- 1> initiate the cell update procedure using as cause "Re-entering service area" as specified in subclause 8.3.1;
- 1> perform processes described in subclause 7.2.2.

If a cell update procedure or URA update procedure is ongoing, the UE shall:

- 1> stop T317;
- 1> perform the actions as specified in 8.3.1.

8.5.5.3 T316 expiry

On T316 expiry the UE shall perform the following actions. The UE shall:

- 1> if "out of service area" is detected:
 - 2> start timer T317;
 - 2> move to CELL_FACH state;
 - 2> perform processes described in subclause 7.2.2.
- 1> if "in service area" is detected:
 - 2> initiate the cell update procedure using as cause "Re-entering service area" as specified in subclause 8.3.1;
 - 2> perform processes described in subclause 7.2.2.

8.5.5.4 T317 expiry

T317 shall never expire, i.e. all its values shall be assumed to be "infinity".

If T317 is running:

- 1> the UE behaviour shall be as specified in subclause 7.2.2.2.

8.5.6 Radio link failure criteria and actions upon radio link failure

In CELL_DCH State, after receiving N313 consecutive "out of sync" indications from layer 1 for the established DPCCH or F-DPCH physical channel in FDD, and the physical channels associated with mapped DCCHs in TDD, the UE shall:

- 1> start timer T313;
- 1> upon receiving N315 successive "in sync" indications from layer 1 and upon change of UE state:
 - 2> stop and reset timer T313.
- 1> if T313 expires:
 - 2> consider it as a "Radio link failure".

Periods in time where neither "in sync" nor "out of sync" is reported by layer 1 do not affect the evaluation of the number of consecutive (resp. successive) "in sync" or "out of sync" indications.

For 1.28 Mcps TDD, when the variable E_DCH_TRANSMISSION is set to TRUE (see subclause 8.5.28) and the UE has stored the IE "E-RUCCH info", a "Radio link failure" shall be triggered as below:

- 1> if the E-RUCCH transmission counter is added greater than N_RUCCH, another hysteresis Timer with the value of N-RUCCH times of T-RUCCH period shall be started:
 - 2> upon the hysteresis Timer expires and still no Grant has been received for the whole time duration since the last E-RUCCH transmission:
 - 3> consider it as a "Radio link failure", refer to [59].

When a radio link failure occurs, the UE shall:

- 1> clear the dedicated physical channel configuration;
- 1> perform actions as specified for the ongoing procedure;
- 1> if no procedure is ongoing or no actions are specified for the ongoing procedure:
 - 2> perform a cell update procedure according to subclause 8.3.1 using the cause "radio link failure".

8.5.7 Open loop power control

For FDD and prior to PRACH transmission the UE shall:

- 1> acquire valid versions of the necessary System Information IEs as follows:
 - 2> if the UE has stored valid versions of the IEs "Primary CPICH Tx power" and "Constant value":
 - 3> use the stored content of the IEs.
 - 2> otherwise:
 - 3> read and store the IE "Primary CPICH Tx power" and "Constant value" in System Information Block type 6 (or System Information Block type 5 or System Information Block type 5bis, if System Information Block type 6 is not being broadcast).
 - 2> if the UE has a valid version of the IE "UL interference" stored:
 - 3> use the stored content of the IE "UL interference".
 - 2> otherwise:
 - 3> read and store the IE "UL interference" in System Information Block type 7;
 - 3> if the UE fails to read the IE "UL interference" in System Information Block type 7 due to bad radio conditions, the UE shall use the last stored IE "UL interference".
- 1> measure the value for the CPICH_RSCP;
- 1> calculate the power for the first preamble as:

$$\text{Preamble_Initial_Power} = \text{Primary CPICH TX power} - \text{CPICH_RSCP} + \text{UL interference} + \text{Constant Value}$$

Where,

Primary CPICH TX power shall have the value of IE "Primary CPICH Tx power",

UL interference shall have the value of IE "UL interference"; and

Constant Value shall have the value of IE "Constant value".

- 1> as long as the physical layer is configured for PRACH transmission:
 - 2> continuously recalculate the Preamble_Initial_Power when any of the broadcast parameters used in the above formula changes; and

2> resubmit to the physical layer the new calculated Preamble_Initial_Power.

For 3.84 Mcps TDD or 7.68 Mcps TDD the UE shall:

1> if in the IE "Uplink DPCH Power Control info" the "CHOICE UL OL PC info" has the value "Broadcast UL OL PC info":

2> prior to DPCH transmission the UE shall:

3> acquire valid versions of the necessary System Information IEs as follows:

4> if the UE has stored valid versions of the IEs "Primary CCPCH Tx power" and "DPCH Constant value":

5> use the stored content of the IEs.

4> otherwise:

5> read and store the IE "Primary CCPCH Tx power" and "DPCH Constant value" in System Information Block type 6 (or System Information Block type 5, if System Information Block type 6 is not being broadcast).

3> if the UE has a valid version of the IE "UL interference" for each active UL timeslot stored:

4> use the stored content of the IE "UL interference" for each active UL timeslot.

3> otherwise:

4> read and store the IE "UL Timeslot Interference" for each active UL timeslot in System Information Block type 14;

4> if the UE fails to read the IE "UL Timeslot Interference" for each active UL time slot in System Information Block type 14 due to bad radio conditions, the UE shall use the last stored IE "UL Timeslot interference" for each active UL timeslot.

1> otherwise:

2> acquire Reference Power, Constant Values and I_{BTS} for all active UL timeslots from the IE "Uplink DPCH Power Control info".

1> for PUSCH, PRACH and HS-SICH power control:

2> prior to PUSCH or PRACH transmission the UE shall:

3> acquire valid versions of the necessary System Information IEs as follows:

4> if the UE has stored valid versions of the IEs "Primary CCPCH Tx power" and "PUSCH Constant value" for PUSCH transmissions or "PRACH Constant value" for PRACH transmissions:

5> use the stored content of the IEs.

4> otherwise:

5> read and store the IE "Primary CCPCH Tx power" and "PUSCH Constant value" for PUSCH transmissions or "PRACH Constant value" for PRACH transmissions in System Information Block type 6 (or System Information Block type 5, if System Information Block type 6 is not being broadcast).

3> if the UE has a valid version of the IE "UL interference" for each active UL timeslot stored:

4> use the stored content of the IE "UL interference" for each active UL timeslot.

3> otherwise:

4> read and store the IE "UL Timeslot Interference" for each active UL timeslot in System Information Block type 14;

- 4> if the UE fails to read the IE "UL Timeslot Interference" for each active UL time slot in System Information Block type 14 due to bad radio conditions, the UE shall use the last stored IE "UL Timeslot interference" for each active UL timeslot.

calculate the UL transmit power according to the following formula for the PRACH continuously while the physical channel is active:

$$P_{\text{PRACH}} = L_{\text{PCCPCH}} + I_{\text{BTS}} + \text{PRACH Constant value},$$

- 2> 3dB shall be added to RACH Constant Value in the above equation for the case where RACH Spreading Factor = 8;

- 2> for 7.68 Mcps TDD, 3dB shall be added to RACH Constant Value in the above equation for the case where RACH Spreading Factor = 16.

- 1> calculate the UL transmit power according to the following formula for the DPCH continuously while the physical channel is active:

$$P_{\text{DPCH}} = \alpha L_{\text{PCCPCH}} + (1-\alpha)L_0 + I_{\text{BTS}} + \text{SIR}_{\text{TARGET}} + \text{DPCH Constant value}$$

- 1> calculate the UL transmit power according to the following formula for the PUSCH continuously while the physical channel is active:

$$P_{\text{PUSCH}} = \alpha L_{\text{PCCPCH}} + (1-\alpha)L_0 + I_{\text{BTS}} + \text{SIR}_{\text{TARGET}} + \text{PUSCH Constant value}$$

- 1> calculate the initial UL transmit power for HS-SICH according to the following formula:

$$P_{\text{HS-SICH}} = \alpha L_{\text{PCCPCH}} + (1-\alpha)L_0 + I_{\text{BTS}} + \text{SIR}_{\text{TARGET}} + \text{HS-SICH Constant value}$$

Where, for all the above equations for 3.84 Mcps TDD or 7.68 Mcps TDD the following apply:

- $P_{\text{PRACH}}, P_{\text{DPCH}}, P_{\text{PUSCH}}$ and $P_{\text{HS-SICH}}$: Transmitter power level in dBm;
- Pathloss values:
 - L_{PCCPCH} : Measurement representing path loss in dB based on beacon channels (the reference transmit power is signalled as the value of the IE "Primary CCPCH Tx Power" on BCH in System Information Block type 6 (or System Information Block type 5, according to subclause 8.1.1.6.5), or individually signalled in the IE "Uplink DPCH Power Control info").
 - L_0 : Long term average of path loss in dB;
 - If the midamble is used in the evaluation of L_{PCCPCH} and L_0 , and the Tx diversity scheme used for the P-CCPCH involves the transmission of different midambles from the diversity antennas, the received power of the different midambles from the different antennas shall be combined prior to evaluation of the variables.
- I_{BTS} : Interference signal power level at cell's receiver in dBm. I_{BTS} shall have the value of the IE "UL Timeslot Interference" (IE "UL Timeslot Interference" is broadcast on BCH in System Information Block type 14 or individually signalled to each UE in the IE "Uplink DPCH Power Control info" for each active uplink timeslot).
- α : α is a weighting parameter, which represents the quality of path loss measurements. α may be a function of the time delay between the uplink time slot and the most recent down link PCCPCH time slot. α is calculated at the UE. α shall be smaller or equal to the value of the IE "Alpha". If the IE "Alpha" is not explicitly signalled to the UE α shall be set to 1. If UE is capable of estimating its position by using the OTDOA IPDL method, the UE shall use the IPDL- α parameter.
- $\text{SIR}_{\text{TARGET}}$: Target SNR in dB. This value is individually signalled to UEs in IE "UL target SIR" in IE "Uplink DPCH Power Control Info" or in IE "PUSCH Power Control Info" or in IE "HS-SICH Power Control Info".
- PRACH Constant value: PRACH Constant value shall have the value of the IE "PRACH Constant value".
- DPCH Constant value: DPCH Constant value shall have the value of the IE "DPCH Constant value".

- PUSCH Constant value: PUSCH Constant value shall have the value of the IE "PUSCH Constant value".
- HS-SICH Constant value: HS-SICH Constant value shall have the value of the IE "HS-SICH Constant value".
- Values received by dedicated signalling shall take precedence over broadcast values.
- If IPDLs are applied, the UE may increase UL Tx power by the value given in the IE "Max power increase". This power increase is only allowed in the slots between an idle slot and the next beacon slot.

For 1.28 Mcps TDD the UE shall:

1> acquire valid versions of the necessary System Information IEs as follows:

2> if the UE has stored a valid version of the IE "Primary CCPCH Tx Power":

3> use the stored content of the IE.

2> otherwise:

3> read and store the IE "Primary CCPCH Tx Power" from System Information Block type 6 (or System Information Block type 5, if System Information Block type 6 is not being broadcast).

1> calculate the UL transmit power according to the following formula for each UpPCH code transmission:

$$P_{\text{UpPCH}} = L_{\text{PCCPCH}} + \text{PRX}_{\text{UpPCHdes}} + (i-1) * P_{\text{Wramp}}$$

NOTE: When i equals 1, the initial signature power "Signature_Initial_Power" defined in [33] corresponds to P_{UpPCH} with i set to 1.

1> calculate the UL transmit power according to the following formula for each PRACH transmission:

$$P_{\text{PRACH}} = L_{\text{PCCPCH}} + \text{PRX}_{\text{PRACHdes}} + (i_{\text{UpPCH}}-1) * P_{\text{Wramp}}$$

1> calculate the initial UL transmit power according to the following formula for the PUSCH. Once the UE receives TPC bits relating to the PUSCH then it transitions to closed loop power control. If successive PUSCH resource allocations are contiguous then no return is made to open loop power control at the beginning of the succeeding resource allocation.

$$P_{\text{USCH}} = \text{PRX}_{\text{PUSCHdes}} + L_{\text{PCCPCH}}$$

1> calculate the initial UL transmit power for HS-SICH according to the following formula:

$$P_{\text{HS-SICH}} = \text{PRX}_{\text{HS-SICH}} + L_{\text{PCCPCH}}$$

1> calculate the initial UL transmit power according to the following formula for the DPCH. Once the UE receives TPC bits relating to the uplink DPCH then it transitions to closed loop power control.

$$P_{\text{DPCH}} = \text{PRX}_{\text{DPCHdes}} + L_{\text{PCCPCH}}$$

1> calculate the initial UL transmit power for E-PUCH according to the following formula:

$$P_{\text{E-PUCH}} = \text{PRX}_{\text{des_base}} + L_{\text{PCCPCH}} + \beta_e$$

Where:

- P_{UpPCH} , P_{PRACH} , P_{DPCH} , $P_{\text{HS-SICH}}$, P_{USCH} , & $P_{\text{E-PUCH}}$: Transmitter power level in dBm.
- L_{PCCPCH} : Measurement representing path loss in dB (reference transmit power "Primary CCPCH Tx Power" is broadcast on BCH in System Information Block type 5 and System Information Block type 6, or individually signalled to each UE in the IE "Uplink DPCH Power Control info").
- i is the number of transmission attempts on UpPCH, $i=1 \dots \text{Max SYNC_UL Transmissions}$.
- i_{UpPCH} is the final value of i .

- $PRX_{PRACHdes}$: Desired PRACH RX power at the cell's receiver in dBm signalled to the UE by the network in the FPACH response to the UE's successful SYNC_UL transmission.
- $PRX_{UpPCHdes}$: Desired UpPCH RX power at the cell's receiver in dBm. The value is broadcast in " $PRX_{UpPCHdes}$ " in IE "SYNC_UL info" on BCH and shall be read on System Information Block type 5 and System Information Block type 6. It can also be signalled directly to the UE in IE "Uplink Timing Advance Control" contained in a protocol message triggering a hard handover or a transition from cell FACH to cell DCH state.
- $PRX_{PUSCHdes}$: Desired PUSCH RX power at the cell's receiver in dBm signalled to the UE in IE "PUSCH Power Control Info".
- $PRX_{DPCHdes}$: Desired DPCH RX power at the cell's receiver in dBm signalled to the UE in IE "Uplink DPCH Info" and IE "Uplink DPCH Power Control Info".
- Pwr_{ramp} : The UE shall increase its transmission power by the value of the IE "Power Ramp step" by every UpPCH transmission. Its value is signalled in the IE "SYNC UL info" in System Information Block type 5 and System Information Block type 6 or is signalled to the UE in the IE "Uplink Timing Advance Control" contained in a protocol message triggering a hard handover or a transition from cell FACH state to cell DCH state.
- $PRX_{HS-SICH}$: Desired HS-SICH RX power at the cell's receiver in dBm signalled to the UE in IE "Downlink HS-PDSCH Information".
- Ack-Nack Power Offset: Difference in the desired RX power between HS-SICH transmissions conveying an acknowledgement and transmissions conveying a negative acknowledgement signalled to the UE in IE "HS-SCCH Info".
- PRX_{des_base} : Reference Desired E-PUCH RX power at the cell's receiver in dBm signalled to the UE in IE "E-PUCH Info".
- β_e : Gain factor for the selected E-TFC transport block size, the allocated E-PUCH physical resources, and the Modulation type and the HARQ power offset (see [33]).

8.5.8 Maintenance of Hyper Frame Numbers

The MSBs of both the ciphering sequence numbers (COUNT-C) and integrity sequence numbers (COUNT-I), for the ciphering and integrity protection algorithms, respectively [40], are called the Hyper Frame Numbers (HFN).

For integrity protection, the UE shall:

- 1> maintain COUNT-I as specified in subclause 8.5.10.

The following hyper frame numbers types are defined:

MAC-d HFN:
24 MSB of COUNT-C for data sent over RLC TM

RLC UM HFN:
25 MSB of COUNT-C for data sent over RLC UM

RLC AM HFN:
20 MSB of COUNT-C for data sent over RLC AM

RRC HFN:
28 MSB of COUNT-I

For non-transparent mode RLC signalling radio bearers and radio bearers, the UE shall:

- 1> maintain one uplink and one downlink COUNT-C per signalling radio bearer and per radio bearer and one uplink and one downlink COUNT-I per signalling radio bearer;
- 1> increment the RLC UM HFN and RLC AM HFN in uplink and downlink by one each time the RLC sequence number wraps around in uplink and downlink respectively;

- 1> if the activation time for a new ciphering configuration set by an RRC procedure is equal to zero:
 - 2> apply the configured RLC UM HFN or RLC AM HFN at this activation time, i.e. the configured HFN is not incremented.

NOTE: On the receiver side it may happen that the RLC PDU with sequence number equal to the activation time is lost and the first received PDU after the activation time implies a wrap around of the sequence number compared to the activation time. In this case the configured HFN is incremented by one. This action is taken only when the activation time is set to a RLC PDU sequence number value other than zero.

For all transparent mode RLC signalling radio bearers and radio bearers of each CN domain, the UE shall:

- 1> maintain one COUNT-C, common for all radio bearers in uplink and downlink;
- 1> increment the MAC-d HFN by one each time the CFN wraps around;
- 1> if the activation time for a new ciphering configuration set by an RRC procedure is equal to zero:
 - 2> apply the configured MAC-d HFN at this activation time, i.e. the configured HFN is not incremented.
- 1> maintain one uplink and one downlink COUNT-I per signalling radio bearer.

NOTE: In this release of the specification there is only an uplink transparent mode COUNT-I, which is used for signalling radio bearer RB0.

COUNT-C and COUNT-I are defined in [40], with the following supplement for COUNT-C: for transparent mode RLC radio bearers with a transmission time interval of x radio frames ($x = 2, 4, 8$), the MAC PDU is carried by L1 in x consecutive radio frames due to radio frame segmentation. In this case, the CFN of the first radio frame in the TTI shall be used as the CFN component of COUNT-C for ciphering of all data in the TTI [15].

8.5.9 START value calculation

In connected mode, if a security mode command procedure has been successfully completed for a CN domain during the current RRC connection, the START value for that CN domain is calculated as:

Let $START_X$ = the START value for CN domain 'X' prior to the calculation below:

$START_X' = MSB_{20} (MAX \{ COUNT-C, COUNT-I \mid \text{radio bearers and signalling radio bearers using the most recently configured } CK_X \text{ and } IK_X \}) + 2$.

- if $START_X' = \text{the maximum value} = 1048575$ then $START_X = START_X'$;
- if the current $START_X < START_X'$ then $START_X = START_X'$, otherwise $START_X$ is unchanged.

NOTE: Here, "most recently configured" means that if there is more than one key in use for a CN domain, due to non-expiry of the ciphering and/or integrity protection activation time for any signalling radio bearers and/or radio bearers, do not include the COUNT-I/COUNT-C for these signalling radio bearers and/or radio bearers in the calculation of the $START_X'$.

COUNT-C corresponding to non-ciphered radio bearers (i.e. RBs with ciphering status set to "not started") shall not be included in the calculation of the $START_X'$. If a radio bearer is released and the radio bearer was ciphered, the values of the COUNT-C at the time the radio bearer is released shall be taken into account in the calculation of the $START_X'$.

If a security mode command procedure has not been successfully completed for a CN domain during the current RRC connection, the UE shall use the latest transmitted START value for this CN domain.

8.5.10 Integrity protection

If the "Status" in the variable INTEGRITY_PROTECTION_INFO has the value "Started" then the UE shall:

- 1> perform integrity protection (and integrity checking) on all RRC messages, with the following exceptions:

HANDOVER TO UTRAN COMPLETE

MBMS ACCESS INFORMATION

MBMS COMMON P-T-M RB INFORMATION
MBMS CURRENT CELL P-T-M RB INFORMATION
MBMS GENERAL INFORMATION
MBMS MODIFIED SERVICES INFORMATION (MCCH only)
MBMS NEIGHBOURING CELL P-T-M RB INFORMATION
MBMS SCHEDULING INFORMATION
MBMS UNMODIFIED SERVICES INFORMATION
PAGING TYPE 1
PUSCH CAPACITY REQUEST
PHYSICAL SHARED CHANNEL ALLOCATION
RRC CONNECTION REQUEST
RRC CONNECTION SETUP
RRC CONNECTION SETUP COMPLETE
RRC CONNECTION REJECT
RRC CONNECTION RELEASE (CCCH only)
SYSTEM INFORMATION
SYSTEM INFORMATION CHANGE INDICATION
TRANSPORT FORMAT COMBINATION CONTROL (TM DCCH only)

If the "Status" in the variable INTEGRITY_PROTECTION_INFO has the value "Not started" then integrity protection (and integrity checking) shall not be performed on any RRC message.

For each signalling radio bearer, the UE shall use two RRC hyper frame numbers:

- "Uplink RRC HFN";
- "Downlink RRC HFN".

and two message sequence numbers:

- "Uplink RRC Message sequence number";
- "Downlink RRC Message sequence number".

The above information is stored in the variable INTEGRITY_PROTECTION_INFO per signalling radio bearer (RB0-RB4).

Upon the first activation of integrity protection for an RRC connection, UE and UTRAN initialise the "Uplink RRC Message sequence number" and "Downlink RRC Message sequence number" for all signalling radio bearers as specified in subclauses 8.6.3.5 and 8.5.10.1.

The RRC message sequence number (RRC SN) is incremented for every integrity protected RRC message.

If the IE "Integrity Protection Mode Info" is present in a received message, the UE shall:

- 1> perform the actions in subclause 8.6.3.5 before proceeding with the integrity check of the received message.

8.5.10.1 Integrity protection in downlink

If the UE receives an RRC message on signalling radio bearer with RB identity n, the "Status" in the variable INTEGRITY_PROTECTION_INFO has the value "Started" and the IE 'Integrity check info' is present the UE shall:

- 1> check the value of the IE "RRC message sequence number" included in the IE "Integrity check info";
- 2> if the "Downlink RRC Message sequence number" is not present in the variable INTEGRITY_PROTECTION_INFO:
 - 3> initialise the "Downlink RRC Message sequence number" for signalling radio bearer RBn in the variable INTEGRITY_PROTECTION_INFO with the value of the IE "RRC message sequence number" included in the IE "Integrity check info" of the received message.
- 2> if the "Downlink RRC Message sequence number" is present in the variable INTEGRITY_PROTECTION_INFO:
 - 3> if the RRC message sequence number is lower than the "Downlink RRC Message sequence number" for signalling radio bearer RBn in the variable INTEGRITY_PROTECTION_INFO:
 - 4> increment "Downlink RRC HFN" for signalling radio bearer RBn in the variable INTEGRITY_PROTECTION_INFO with one.

NOTE: The actions above imply that also for the case the "Downlink RRC HFN" is re-initialised by a security mode control procedure, this "Downlink RRC HFN" value is incremented by one before it is applied for the integrity protection of any received message if the conditions above are fulfilled.

- 3> if the RRC message sequence number is equal to the "Downlink RRC Message sequence number" for signalling radio bearer RBn in the variable INTEGRITY_PROTECTION_INFO:
 - 4> discard the message.
- 1> calculate an expected message authentication code in accordance with subclause 8.5.10.3;
- 1> compare the expected message authentication code with the value of the received IE "message authentication code" contained in the IE "Integrity check info";
- 2> if the expected message authentication code and the received message authentication code are the same, the integrity check is successful:
 - 3> update the "Downlink RRC Message sequence number" for signalling radio bearer RBn in the variable INTEGRITY_PROTECTION_INFO with the value of the IE "RRC message sequence number" included in the IE "Integrity check info" of the received RRC message.
- 2> if the calculated expected message authentication code and the received message authentication code differ:
 - 3> act as if the message was not received.

If the UE receives an RRC message on signalling radio bearer with identity 0, 1, or 2, the "Status" in the variable INTEGRITY_PROTECTION_INFO has the value "Started" and the IE 'Integrity check info' is not present the UE shall:

- 1> discard the message.

If the UE receives an RRC message on signalling radio bearer with identity 3 or 4, the "Status" in the variable INTEGRITY_PROTECTION_INFO has the value "Started" and the IE 'Integrity check info' is not present:

- 1> if a security mode command procedure has not been successfully completed during the current RRC connection for the CN domain indicated by IE "CN Domain Identity" in the received message:
 - 2> the UE shall forward the message to upper layer.
- 1> else:
 - 2> the UE shall discard the message.

UTRAN may transmit several copies of the same message in the downlink to increase the probability of proper reception of the message by the UE. In such a case, the RRC SN for these repeated messages should be the same.

8.5.10.2 Integrity protection in uplink

Prior to sending an RRC message using the signalling radio bearer with radio bearer identity *n*, and the "Status" in the variable INTEGRITY_PROTECTION_INFO has the value "Started" the UE shall:

- 1> increment "Uplink RRC Message sequence number" for signalling radio bearer RB*n* in the variable INTEGRITY_PROTECTION_INFO with 1, even if the message is a retransmission of a previously transmitted message.
- 1> if the "Uplink RRC Message sequence number" for signalling radio bearer RB*n* in the variable INTEGRITY_PROTECTION_INFO equals zero:
 - 2> increment "Uplink RRC HFN" for signalling radio bearer RB*n* in the variable INTEGRITY_PROTECTION_INFO by one.

NOTE 1: The actions above imply that also for the case the "Uplink RRC HFN" is re-initialised by a security mode control procedure, this "Uplink RRC HFN" is incremented before it is applied in the integrity protection of any transmitted message if the conditions above are fulfilled.

NOTE 2: For SRB0, this is also valid in case the Message Sequence Number has been increased by N302 +2 resulting in an MSN which equals 0 (i.e.: SRB0 UL activation time equals 0). Then the uplink RRC HFN is incremented by 1 after it is re-initialized and before it is applied in the integrity protection of any transmitted message.

- 1> calculate the message authentication code in accordance with subclause 8.5.10.3;
- 1> replace the "Message authentication code" in the IE "Integrity check info" in the message with the calculated message authentication code;
- 1> replace the "RRC Message sequence number" in the IE "Integrity check info" in the message with contents set to the new value of the "Uplink RRC Message sequence number" for signalling radio bearer RB*n* in the variable INTEGRITY_PROTECTION_INFO.

In the response message for the procedure ordering the security reconfiguration, the UE indicates the activation time, for each signalling radio bearer. When the new integrity configuration is to be applied in uplink, UTRAN should start to apply the new integrity protection configuration according to the activation time for each signalling radio bearer (except for the signalling radio bearer which is used to send the message that is reconfiguring the security configuration where the new configuration is to be applied starting from and including reception of the response message).

8.5.10.3 Calculation of message authentication code

The UE shall calculate the message authentication code in accordance with [40]. The input parameter MESSAGE [40] for the integrity algorithm shall be constructed by:

- 1> setting the "Message authentication code" in the IE "Integrity check info" in the message to the value of the IE "RB identity" for the signalling radio bearer;
- 1> setting the "RRC Message sequence number" in the IE "Integrity check info" in the message to zero;
- 1> encoding the message;
- 1> appending RRC padding (if any) as a bit string to the encoded bit string as the least significant bits.

For usage on an RRC message transmitted or received on the radio bearer with identity *n*, the UE shall:

- 1> construct the input parameter COUNT-I [40] by appending the following IEs from the IE "Signalling radio bearer specific integrity protection information" for radio bearer *n* in the variable INTEGRITY_PROTECTION_INFO:
 - 2> for uplink:
 - 3> "Uplink RRC HFN", as the MSB, and "Uplink RRC Message sequence number", as LSB.
 - 2> for downlink:

- 3> "Downlink RRC HFN", as the MSB, and the IE "RRC message sequence number" included in the IE "Integrity check info", as LSB.

8.5.11 FACH measurement occasion calculation

For TDD, when in CELL_FACH state and when the variable C_RNTI is non-empty, or for FDD, when in CELL_FACH state, when the variable C_RNTI is non-empty and when variable HS_DSCH_RECEPTION_CELL_FACH_STATE is set to FALSE, then the UE shall perform measurements as specified in subclauses 8.4.1.6 and 8.4.1.9 during the frame(s) with the SFN value fulfilling the following equation:

$$\text{SFN div } N = \text{C_RNTI mod } M_REP + n * M_REP$$

where

- N is the TTI (in number of 10ms frames) of the FACH having the largest TTI on the SCCPCH selected by the UE according to the procedure in subclause 8.5.19. FACHs that only carry MBMS logical channels (MTCH, MSCH, or MCCH) are excluded from measurement occasion calculations.
- C_RNTI is the C-RNTI value of the UE stored in the variable C_RNTI
- M_REP is the Measurement Occasion cycle length. According to the equation above, a FACH Measurement Occasion of N frames will be repeated every N * M_REP frame, and $M_REP = 2^k$.

where,

- k is the FACH Measurement occasion cycle length coefficient.
The value of the FACH Measurement occasion cycle length coefficient is read in system information in "System Information Block type 11" or "System Information Block type 12" in the IE "FACH measurement occasion info".
- n = 0,1,2... as long as SFN is below its maximum value

The UE is allowed to measure on other occasions in case the UE moves "out of service" area or in case it can simultaneously perform the ordered measurements.

A UE in TDD mode shall use the frame(s) with the SFN value fulfilling the above equation for neighbour cells measurements.

For FDD when in CELL_FACH state, when the variable C_RNTI is non-empty and when variable HS_DSCH_RECEPTION_CELL_FACH_STATE is set to TRUE, then the UE in FDD mode shall perform measurements as specified in subclauses 8.4.1.6 and 8.4.1.9 during the frame(s) with the SFN value fulfilling the following equation:

$$\text{SFN} = \text{H-RNTI mod } M_REP + n * M_REP$$

where

- H-RNTI is the value stored in the variable H_RNTI.
- M_REP is the Measurement Occasion cycle length. According to the equation above, a FACH Measurement Occasion of 10ms-frame will be repeated every M_REP frame, and $M_REP = 2^k$.

where,

- k is the FACH Measurement occasion cycle length coefficient.
The value of the FACH Measurement occasion cycle length coefficient is read in system information in "System Information Block type 11" or "System Information Block type 12" in the IE "FACH measurement occasion info".
- n = 0,1,2... as long as SFN is below its maximum value.

The UE is allowed to measure on other occasions in case the UE moves "out of service" area or in case it can simultaneously perform the ordered measurements.

NOTE: For FDD, in order to meet the MBMS demodulation performance requirements [21], a UE receiving MBMS PTM may not be able use the entire measurement occasion.

8.5.12 Establishment of Access Service Classes

The PRACH resources (i.e. access slots and preamble signatures for FDD), timeslot (with specific frame allocation and channelisation code for 3.84 Mcps TDD and 7.68 Mcps TDD, and SYNC_UL codes (with specific frame allocation) for 1.28 Mcps TDD) may be divided between different Access Service Classes in order to provide different priorities of RACH usage. It is possible for more than one ASC or for all ASCs to be assigned to the same access slot/signature space in FDD or frame allocation/channelisation codes in 3.84 Mcps TDD or 7.68 Mcps TDD, or frame allocation/SYNC_UL codes in 1.28 Mcps TDD.

Access Service Classes shall be numbered in the range $0 \leq i \leq \text{NumASC} \leq 7$ (i.e. the maximum number of ASCs is 8). An ASC is defined by an identifier, i , that defines a certain partition of the PRACH resources (SYNC_UL resources in 1.28 Mcps TDD) and an associated persistence value P_i . A set of ASC parameters consists of "NumASC+1" such parameters (i, P_i), $i = 0, \dots, \text{NumASC}$.

PRACH partitions shall be established using the information element "PRACH partitioning". The persistence values P_i to be associated with each ASC shall be derived from the dynamic persistence level $N = 1, \dots, 8$ which is broadcast in System Information Block 7, and the persistence scaling factors s_i , broadcast in System Information Block Type 5 or System Information Block type 5bis and possibly also in System Information Block Type 6, as follows:

$$P(N) = 2^{-(N-1)}$$

ASC # i	0	1	2	3	4	5	6	7
P_i	1	$P(N)$	$s_2 P(N)$	$s_3 P(N)$	$s_4 P(N)$	$s_5 P(N)$	$s_6 P(N)$	$s_7 P(N)$

In addition, MBMS specific persistence values may be provided within the MBMS MODIFIED SERVICES INFORMATION message. The UE behaviour upon receiving upon receiving an MBMS dynamic persistence value is specified in subclause 8.6.9.1a.

Scaling factors s_i are provided optionally for $i = 2, \dots, \text{NumASC}$, where NumASC+1 is the number of ASCs as defined by PRACH partitioning. If no scaling factors are broadcast, default value 1 shall be used if NumASC ≥ 2 .

If $k \geq 1$ scaling factors are broadcast and NumASC $\geq k+2$ then the last scaling factor s_{k+1} shall be used as default for the ASCs where $i > k+1$.

In the case of E-RUCCH operation (3.84/7.68 Mcps TDD only) a separate set of persistence values will be used. For E-RUCCH a single scaling factor S_r is signalled. If the E-RUCCH shares resource with a PRACH then dynamic persistence levels of the PRACH are used and persistence values are determined using the table below:

ASC # i	0	1	2-7
$P_{i(\text{E-RUCCH})}$	1	$P(N)$	$S_r P(N)$

Else if the E-RUCCH does not share resource with a PRACH then persistence values are determined using the table below:

ASC # i	0	1	2-7
$P_{i(\text{E-RUCCH})}$	1	1	S_r

The establishment of Access Service Classes for E-RUCCH (1.28 Mcps TDD only) is similar as PRACH, differently Access Service Classes parameters and persistence scaling factors of E-RUCCH may be acquired from the information element "E-RUCCH info", e.g. in the case of E-DCH serving cell change. Only in the case that the UEs with E-DCH and E-RUCCH configured on the Primary Frequency of the multi-frequency cell, the E-DCH serving cell unchanged and the UEs can obtain the dynamic persistence level N from SIB7 according to the configuration of information element "E-RUCCH info", the dynamic persistence value N shall be used. Otherwise, dynamic persistence level $N=1$ shall always be used. The persistence values are determined using the table below:

ASC # i	0	1	2	3	4	5	6	7
$P_{i(\text{E-RUCCH})}$	1	$P(N)$	$s_2 P(N)$	$s_3 P(N)$	$s_4 P(N)$	$s_5 P(N)$	$s_6 P(N)$	$s_7 P(N)$

The set of ASC parameters is provided to MAC with the CMAC-Config-REQ primitive (see [15]), the PRACH partitioning is provided to PHY using the CPHY-RL-Setup-REQ primitive (see [34]). For 3.84/7.68 Mcps TDD E-DCH operation the E-RUCCH persistence values will also be provided to MAC with the CMAC-Config-REQ primitive.

The ASC enumeration shall be such that it corresponds to the order of priority (ASC 0 = highest priority, ASC 7 = lowest priority). ASC 0 shall be used in case of Emergency Call or for reasons with equivalent priority.

ASCs are numbered according to the order in which the IEs "ASC Setting" appear in the IE "PRACH partitioning", where the first IE "ASC Setting" describes ASC 0, the second IE "ASC Setting" describes ASC 1, etc.

At radio bearer setup/reconfiguration each involved logical channel is assigned a MAC Logical channel Priority (MLP) in the range 1,...,8. When the MAC sublayer is configured for RACH transmission in the UE, these MLP levels shall be employed for ASC selection on MAC.

8.5.13 Mapping of Access Classes to Access Service Classes

Access Classes shall only be applied at initial access, i.e. when sending an RRC CONNECTION REQUEST message. A mapping between Access Class (AC) and Access Service Class (ASC) shall be indicated by the information element "AC-to-ASC mapping" in System Information Block type 5 or System Information Block type 5bis. The correspondence between AC and ASC shall be indicated as follows.

AC	0 - 9	10	11	12	13	14	15
ASC	1 st IE	2 nd IE	3 rd IE	4 th IE	5 th IE	6 th IE	7 th IE

In the table, "nth IE" designates an ASC number *i* in the range 0 - 7 to AC. If the ASC indicated by the "nth IE" is undefined, the UE behaviour is unspecified.

For the random access, the parameters implied by the respective ASC shall be employed. In case the UE is member of several ACs it shall select the ASC for the highest AC number. In connected mode, AC shall not be applied.

8.5.14 PLMN Type Selection

Depending on UE configuration, the UE is operating in "ANSI-41 mode" or "GSM-MAP mode".

8.5.14a Neighbour cells list narrowing for cell reselection

While a UE is camping on a suitable cell, a UE having performed the PLMN identification of the neighbour cells as specified in subclause 8.1.1.6.18 shall narrow the cell list to be used for cell reselection ([4]) to those neighbour cells for which:

The PLMN identity is part of the PLMNs that can make a cell suitable as defined in [4].

8.5.15 CFN calculation

The DOFF used in the formulas in this clause concerns the value of IE "Default DPCH Offset Value" received in the message that instructs the UE to enter CELL_DCH state or to perform timing re-initialised hard handover.

Subclause 8.5.15.5 is used in FDD to initialise the CFN for MTCH and/or MSCH if the IE "MBMS Soft Combining Timing Offset" is included for an S-CCPCH in MBMS CURRENT CELL P-T-M RB INFORMATION or MBMS NEIGHBOURING CELL P-T-M RB INFORMATION, and if only MTCH and/or MSCH are on the S-CCPCH. Otherwise, subclauses 8.5.15.1 through 8.5.15.4 are used to initialise the CFN.

8.5.15.1 Initialisation for CELL_DCH state after state transition

When the UE receives any of the messages causing the UE to perform a state transition to CELL_DCH, the UE shall set the CFN in relation to the SFN of the first radio link listed in the IE "Downlink information per radio link list" included in that message according to the following formula:

- for FDD:

$$\text{CFN} = (\text{SFN} - (\text{DOFF} \text{ div } 38400)) \text{ mod } 256$$

where the formula gives the CFN of the downlink DPCH or F-DPCH frame which starts at the same time as or which starts during the PCCPCH frame with the given SFN. DOFF is determined according to subclause 8.6.6.14.

- for TDD:

$$\text{CFN} = (\text{SFN} - \text{DOFF}) \bmod 256.$$

8.5.15.2 Initialisation in CELL_DCH state at hard handover

When the UE is in CELL_DCH state and receives any of the messages causing the UE to perform a hard handover, the UE shall check the IE "Timing indication" in that message and:

- 1> if IE "Timing indication" has the value "initialise" (i.e. timing re-initialised hard handover):
 - 2> read SFN on target cell identified by the first radio link listed in the IE "Downlink information per radio link list" included in that message;
 - 2> set the CFN according to the following formula:

- 3> for FDD:

$$\text{CFN} = (\text{SFN} - (\text{DOFF} \text{ div } 38400)) \bmod 256$$

where the formula gives the CFN of the downlink DPCH or F-DPCH frame which starts at the same time as or which starts during the PCCPCH frame with the given SFN.

- 3> for TDD:

$$\text{CFN} = (\text{SFN} - \text{DOFF}) \bmod 256.$$

- 1> if IE "Timing indication" has the value "maintain" (i.e. timing-maintained hard handover), the UE shall keep CFN with no change due to the hard handover, and only increase CFN (mod 256) by 1 every frame.

8.5.15.3 Initialisation for CELL_FACH

Unless the conditions of subclause 8.5.15.5 are met, when the UE performs cell selection, re-selection or changes to CELL_FACH state the UE shall set CFN for all common or shared channels according to:

$$\text{CFN} = \text{SFN} \bmod 256$$

where the formula gives the CFN of the downlink common or shared channel frame which starts at the same time as or which starts during the PCCPCH frame with the given SFN.

After the initialisation, the CFN in the UE is increased (mod 256) by 1 every frame.

8.5.15.4 Initialisation after intersystem handover to UTRAN

Upon inter RAT handover to UTRAN the UE shall, regardless of the value received within IE "Timing indication" (if received):

- 1> read SFN on target cell and set the CFN according to the following formula:

- 2> for FDD:

$$\text{CFN} = (\text{SFN} - (\text{DOFF} \text{ div } 38400)) \bmod 256$$

where the formula gives the CFN of the downlink DPCH frame which starts at the same time as or which starts during the PCCPCH frame with the given SFN.

- 2> for TDD:

$$\text{CFN} = (\text{SFN} - \text{DOFF}) \bmod 256.$$

8.5.15.5 Initialisation for MTCH and/or MSCH carried on S-CCPCH that may be soft combined

For FDD, if the IE "MBMS Soft Combining Timing Offset" is included for an S-CCPCH in MBMS CURRENT CELL P-T-M RB INFORMATION or MBMS NEIGHBOURING CELL P-T-M RB INFORMATION, and if only MTCH and/or MSCH are on the S-CCPCH, the UE shall set CFN for the S-CCPCH according to:

$$\text{CFN} = (\text{SFN} - (\text{SCTO} \div 10\text{ms})) \bmod 256$$

where the formula gives the CFN of the downlink S-CCPCH frame which starts at the same time as or which starts during the PCCPCH frame with the given SFN.

the SCTO used in the formula is the IE "MBMS Soft Combining Timing Offset".

After the initialisation, the CFN in the UE is increased (mod 256) by 1 every frame.

8.5.16 Configuration of CTCH occasions

The CTCH, carrying CBS data is mapped onto only one S-CCPCH. If more than one CTCH is defined, the first CTCH that is configured in the list of S-CCPCHs is the one that is used for CBS data. If the UE is in connected mode it shall ignore any CTCH configuration contained in System Information Block type 6 and use the CTCH configuration contained in System Information Block 5.

The CTCH occasions are identified by the first radio frame of the TTI that can contain CTCH data. The CTCH occasions are fixed on the system frame number cycle 0 .. 4095 (i.e. no modulo calculation) and thus repeated cyclically.

The CTCH occasions are determined by a set of parameters.

M_{TTI} : number of radio frames within the TTI of the FACH used for CTCH

N: period of CTCH allocation on S-CCPCH, integer number of radio frames,
 $M_{\text{TTI}} \leq N \leq 256$, where N is a multiple of M_{TTI} (see [27] and [31]).

MaxSFN: maximum system frame number = 4095 (see [10]).

K: CBS frame offset, integer number of radio frames $0 \leq K \leq N-1$ where K is a multiple of M_{TTI} .

The CTCH occasions are calculated as follows:

$$\text{SFN} = (K + m N), m = 0, 1, \dots, M, \text{ with } M \text{ chosen that } K + MN \leq \text{MaxSFN}.$$

The parameters N and K are broadcast as system information.

If the IE "Period of BMC scheduling messages (P)" is included in System Information Block type 5 or System Information Block type 5bis then BMC Schedule Messages are transmitted periodically every P CTCH occasions. One BMC Schedule Message may be segmented across more than one CTCH occasion. The CTCH occasions that contain the start of the BMC Schedule Messages are calculated as follows:

$$\text{SFN} = (K + m P N), \text{ where } m \text{ is an integer and } 0 \leq \text{SFN} \leq \text{MaxSFN}$$

If the IE "Period of BMC scheduling messages (P)" is not included in system information block type 5 then BMC Schedule Messages could be transmitted in any CTCH occasion.

8.5.17 PRACH selection

For this version of the specification, when a UE selects a cell, the uplink frequency to be used for the initial PRACH transmission shall have a default duplex frequency spacing offset from the downlink frequency that the cell was selected on. The default duplex frequency separation to be used by the UE is specified in [21] for each frequency band (for FDD only).

NOTE: The PRACH selection scheme assumes that all PRACHs configured in System Information Block type 5, System Information Block type 5bis and System Information Block type 6 support all (implicitly or explicitly) configurable RLC sizes of the cell, i.e. at least the transport formats corresponding to a single transport block of each applicable RLC size of the cell must be defined for each PRACH.

The UE shall select a "PRACH system information" according to the following rule. The UE shall:

- 1> select a "PRACH system information" from the ones indicated in the IE "PRACH system information list" in System Information Block type 5 or in System Information Block type 5bis (applicable in Idle Mode and Connected Mode) or System Information Block type 6 (applicable in Connected Mode only), as follows:
 - 2> if in connected mode and System Information Block type 6 is defined and includes PRACH info:
 - 3> compile a list of candidate PRACHs that consists of the PRACH system information listed in System Information Block 6, in the order of appearance as in System Information Block 6.
 - 2> otherwise:
 - 3> compile a list of candidate PRACHs that consists of the PRACH system information listed in System Information Block 5 or in System Information Block 5bis, in the order of appearance as in System Information Block 5 or in System Information Block 5bis, respectively.
 - 2> in FDD:
 - 3> perform RACH TTI selection as specified in subclause 8.5.18.1.
 - 2> in 1.28 Mcps TDD:
 - 3> perform RACH TTI selection according to subclause 8.5.18.2.
 - 2> remove from the list of candidate PRACHs those PRACHs that have a TTI length different from the selected value;
 - 2> select a PRACH randomly from the list of candidate PRACHs as follows:

$$\text{"Index of selected PRACH"} = \text{floor}(\text{rand} * K)$$

where K is equal to the number of candidate PRACH system informations, "rand" is a random number uniformly distributed in the range $0 \leq \text{rand} < 1$ and "floor" refers to rounding down to nearest integer. The candidate PRACH system informations shall be indexed from 0 to K-1. The random number generator is left to implementation. The scheme shall be implemented such that one of the available PRACH system informations is randomly selected with uniform probability. At start-up of the random number generator in the UE the seed shall be dependent on the IMSI of the UE or time, thereby avoiding that all UEs select the same RACH;
 - 2> use the TFCS of the selected PRACH when performing TFC selection (see [15]);
 - 2> reselect the PRACH system information when a new cell is selected. RACH reselection may also be performed after each transmission of a Transport Block Set on RACH.
- 1> for emergency call, the UE is allowed to select any of the available PRACH system informations.

After selecting a PRACH system information, the RRC in the UE shall configure the MAC and the physical layer for the RACH access according to the parameters included in the selected "PRACH system information" IE.

8.5.18 Selection of RACH TTI

8.5.18.1 FDD

In FDD mode, a RACH may employ either 10 or 20 ms TTI. The supported TTI is indicated as a semi-static parameter of the RACH Transport Format in system information. The UE shall select an appropriate TTI length from the RACHs included in the list of candidate PRACH(s) according to the following rule.

The UE shall:

- 1> if only RACHs with one particular TTI length are included in the list of candidate PRACH(s):
 - 2> select this TTI length and proceed as specified in subclause 8.5.17.
- 1> if both PRACHs with 10ms and 20ms TTI lengths are included in the list of candidate PRACH(s):
 - 2> perform TTI selection as follows:
 - 3> when the UE calculates the initial preamble transmit power ("Preamble_Initial_Power") as specified in subclause 8.5.7:
 - 4> select a TF to be employed for calculation of a transmit power margin as follows:
 - 5> from the TFs supported by all candidate PRACHs keep those which correspond to a single transport block of all configured RLC sizes (i.e., in idle mode, the RLC size applicable for RB0, in connected mode, the RLC sizes configured with explicit "RB mapping info"). If more than a single TF remain applicable, the UE may select any of these. Preferably the UE should select the TF which is intended to be used at the next transmission or, if such information is not available, the TF corresponding to the largest configured RLC size.

- 4> calculate a transmit power margin,

$$\text{Margin} = \{ \min(\text{Maximum allowed UL tx power, P_MAX}) - \max(\text{Preamble_Initial_Power, Preamble_Initial_Power} + \Delta P_{p-m} + 10 \cdot \log_{10}(1 + (\beta_d / \beta_c)^2)) \}$$

where "Maximum allowed UL tx power" is the maximum allowed uplink transmit power indicated in system information (in dBm), and P_MAX is the maximum RF output power of the UE (dBm). The margin shall be calculated for the gain factors β_d and β_c of the TF selected in the step above, using 10ms TTI length.

NOTE 1: the expression $\text{Preamble_Initial_Power} + \Delta P_{p-m} + 10 \cdot \log_{10}(1 + (\beta_d / \beta_c)^2)$ represents the total RACH message power if the message would be sent after the initial preamble.

NOTE 2: For all PRACHs with the same TTI the UTRAN should set each of the IEs "Primary CPICH TX power", "Constant value" to the same value, and within these PRACH configurations, the UTRAN should, for all TFs including a single TB, set each of the IEs "Gain Factor β_c ", "Gain Factor β_d " and "Power offset P_p-m" to the same value. If these guidelines are not followed, the UE behaviour is unspecified.

- 3> if the resulting "Margin" value is less than 6 dB:
 - 4> select RACH with 20 ms TTI, and proceed as specified in subclause 8.5.17.
 - 3> otherwise, if the last L1 message transmission on PRACH failed (see [15]):
 - 4> the UE may select RACH with 20ms TTI length and proceed as specified in subclause 8.5.17.
 - 3> otherwise:
 - 4> select RACH with 10ms TTI length and proceed as specified in subclause 8.5.17.

8.5.18.2 1.28 Mcps TDD

In 1.28 Mcps TDD, a RACH may be assigned a 5, 10 or 20 ms TTI. If, in one cell, more than one RACH is defined a UE shall select the RACH that is to be used for each transmission according to the following rule:

- 1> if only RACHs with one particular TTI length are assigned a transport format that is suitable for the transmission of the transport block set:
 - 2> select this RACH's TTI length.
- 1> if more than one RACHs are assigned a transport format that is suitable for the transmission of the transport block set:
 - 2> select the longest of the TTI lengths of these RACHs.

8.5.19 Secondary CCPCH selection

In UTRAN Connected mode, the UE shall select the Secondary CCPCH according to the following rules:

1> in Cell_DCH state:

2> select Secondary CCPCH according to subclause 8.6.6.4.

1> in Cell_FACH state:

2> if System Information Block type 6 is defined and includes one or more SCCPCH that carry a FACH, compile a list of candidate SCCPCH that consists of these SCCPCH, in the order of appearance in System Information Block type 6.

NOTE 1: An SCCPCH carries a FACH if the size of the "FACH/PCH information" list within the IE "Secondary CCPCH system information" exceeds 1 or if the size of this list equals 1 while IE "Secondary CCPCH system information" does not contain an IE "PICH info".

2> otherwise:

3> compile a list of candidate SCCPCH that consists of the SCCPCH(s) included in System Information Block type 5 or System Information Block type 5bis that carry a FACH, in the order of appearance in System Information Block type 5 or System Information Block type 5bis.

2> select an SCCPCH from the list of candidate SCCPCHs based on U-RNTI as follows:

$$\text{"Index of selected SCCPCH"} = \text{U-RNTI mod K,}$$

where K is equal to the number of candidate SCCPCHs.

1> in Cell_PCH and URA_PCH states:

2> if System Information Block type 6 is defined and includes one or more SCCPCH that carry a PCH, compile a list of candidate SCCPCH that consists of these SCCPCH, in the order of appearance in System Information Block type 6

NOTE 2: An SCCPCH carries a PCH if the IE "Secondary CCPCH system information" contains IE "PICH info"

2> otherwise compile a list of candidate SCCPCH that consists of the SCCPCH(s) included in System Information Block type 5 or System Information Block type 5bis that that carry a PCH, in the order of appearance in System Information Block type 5 or System Information Block type 5bis;

2> select an SCCPCH from the list of candidate SCCPCHs based on U-RNTI as follows:

$$\text{"Index of selected SCCPCH"} = \text{U-RNTI mod K,}$$

where K is equal to the number of candidate SCCPCHs.

The UE shall set the CFN in relation to the SFN of the current cell according to subclause 8.5.15.

The UE shall decode all transport formats on all FACHs multiplexed on the selected S-CCPCH according to its UE capability, as defined in subclauses 8.1.1.6.5 and 8.1.1.6.6, to find blocks addressed to the UE.

8.5.19a Secondary CCPCH and FACH selection for MCCH reception

The UE shall select the Secondary CCPCH for acquiring MCCH information according to the following rules:

1> if System Information Block type 5 or System Information Block type 5bis is defined and includes an S-CCPCH within the IE "Secondary CCPCH system information" including a FACH for which the IE "MCCH configuration information" is included:

2> select that S-CCPCH and FACH for receiving MCCH.

1> otherwise if System Information Block type 5 or System Information Block type 5bis is defined and includes an SCCPCH within the IE "Secondary CCPCH system information MBMS" for which the IE "FACH carrying MCCH" is included:

- 2> select that S-CCPCH and FACH for receiving MCCH.

8.5.20 Unsupported configuration

The UE should set the variable UNSUPPORTED_CONFIGURATION to TRUE if the received message is not according to the UE capabilities.

8.5.21 Actions related to Radio Bearer mapping

When the UE receives the IEs "RB mapping info", "CCCH mapping info", "SRB1 mapping info" and/or the IE "Transport format set", when transport channels, MAC-d flows, MAC-ehs reordering queues or E-DCH MAC-d flows are added or deleted, when the UE performs a cell reselection or a state transition, or when the UE releases a RB, the UE shall for each of the configured Radio Bearers:

- 1> upon moving to CELL_FACH state from CELL_DCH state to initiate a cell update procedure and upon subsequent cell reselections until the first successfully completed cell update procedure, only perform the actions defined in the remainder of this subclause after reception of the CELL UPDATE CONFIRM message;
- 1> for FDD, select the multiplexing option according to the following:
 - 2> if the UE is in CELL_PCH state:
 - 3> for FDD, if the UE does support HS-DSCH reception in CELL_PCH and URA_PCH state and IE "HS-DSCH paging system information" is included in System Information Block type 5 or System Information Block type 5bis:
 - 4> if the RB has a multiplexing option with transport channel type "HS-DSCH" for the DL, and the corresponding MAC-ehs reordering queue is configured, and transport channel type "RACH" for the UL:
 - 5> select this multiplexing option.
 - 2> if the UE is in CELL_FACH state:
 - 3> for FDD, if the UE does not support HS-DSCH reception in CELL_FACH state; or
 - 3> if the IE "HS-DSCH common system information" is not included in System Information Block type 5 or System Information Block type 5bis:
 - 4> if the RB has a multiplexing option with transport channel type "FACH" for the DL and transport channel type "RACH" for the UL:
 - 5> select this multiplexing option.
 - 3> else:
 - 4> if the RB has a multiplexing option with transport channel type "HS-DSCH" for the DL, and the corresponding MAC-ehs reordering queue is configured, and transport channel type "RACH" for the UL:
 - 5> select this multiplexing option.
 - 2> if the UE is in CELL_DCH state:
 - 3> if the RB has a multiplexing option with transport channel type "DCH + HS-DSCH" for the DL, and both the corresponding DCH transport channel and the corresponding MAC-d flow or MAC-ehs reordering queue are configured, and with transport channel type "E-DCH" for the UL, and the corresponding E-DCH MAC-d flow is configured:
 - 4> select this multiplexing option; else
 - 3> if the RB has a multiplexing option with transport channel type "DCH + HS-DSCH" for the DL, and both the corresponding DCH transport channel and the corresponding MAC-d flow or MAC-ehs reordering queue are configured, and with transport channel type "DCH" for the UL, and the corresponding DCH transport channel is configured:

- 4> select this multiplexing option; else
 - 3> if the RB has a multiplexing option with transport channel type "DCH + DSCH" for the DL:
 - 4> the UE behaviour is unspecified; else
 - 3> if the RB has a multiplexing option with transport channel type "HS-DSCH" for the DL, and the corresponding MAC-d flow or MAC-ehs reordering queue is configured, and with transport channel type "E-DCH" for the UL, and the corresponding E-DCH MAC-d flow is configured:
 - 4> select this multiplexing option; else
 - 3> if the RB has a multiplexing option with transport channel type "HS-DSCH" for the DL, and the corresponding MAC-d flow or MAC-ehs reordering queue is configured, and with transport channel type "DCH" for the UL, and the corresponding DCH transport channel is configured:
 - 4> select this multiplexing option; else
 - 3> if the RB has a multiplexing option with transport channel type "DSCH" for the DL:
 - 4> the UE behaviour is unspecified; else
 - 3> if the RB has a multiplexing option with transport channel type "DCH" for the DL, and the corresponding DCH transport channel is configured, and with transport channel type "E-DCH" for the UL, and the corresponding E-DCH MAC-d flow is configured:
 - 4> select this multiplexing option; else
 - 3> if the RB has a multiplexing option with transport channel type "DCH" for the DL, and the corresponding DCH transport channel is configured, and with transport channel type "DCH" for the UL, and the corresponding DCH transport channel is configured:
 - 4> select this multiplexing option.
- 1> for TDD, select the multiplexing option according to the following:
- 2> if the UE is in CELL_FACH state:
 - 3> if the RB has the multiplexing options with the transport channel types "FACH" and "DSCH" for the DL, and the corresponding FACH and DSCH transport channels are configured, and with the transport channel types "RACH" and "USCH" for the UL, and the corresponding RACH and USCH transport channels are configured:
 - 4> if both PUSCH and PDSCH are allocated:
 - 5> select the multiplexing option "DSCH" for DL and "USCH" for UL; else
 - 4> if only PUSCH is allocated:
 - 5> select the multiplexing option "FACH" for DL and "USCH" for UL; else
 - 4> if only PDSCH is allocated:
 - 5> select the multiplexing option "DSCH" for DL and "RACH" for UL; else
 - 4> if neither PUSCH nor PDSCH is allocated:
 - 5> select the multiplexing option "FACH" for DL and "RACH" for UL.
 - 3> if the RB has a single multiplexing option with the transport channel type "FACH" for the DL and the transport channel type "RACH" for the UL:
 - 4> select this multiplexing option; else
 - 3> if the RB has a single multiplexing option with the transport channel type "DSCH" for the DL, and the corresponding DSCH transport channel is configured, and with the transport channel type "USCH" for the UL, and the corresponding USCH transport channel is configured:

- 4> select this multiplexing option; else
- 2> if the UE is in CELL_DCH state:
 - 3> if the RB has a multiplexing option with transport channel type "DCH + HS-DSCH" for the DL, and both the corresponding DCH transport channel and the corresponding MAC-d flow or MAC-ehs reordering queue are configured, and with transport channel type "E-DCH" for the UL, and the corresponding E-DCH MAC-d flow is configured:
 - 4> select this multiplexing option; else
 - 3> if the RB has a multiplexing option with transport channel type "DCH + HS-DSCH" for the DL, and both the corresponding DCH transport channel and the corresponding MAC-d flow or MAC-ehs reordering queue are configured, and with transport channel type "DCH" for the UL, and the corresponding DCH transport channel is configured:
 - 4> select this multiplexing option; else
 - 3> if the RB has a multiplexing option with transport channel type "DCH + DSCH" for the DL, and both the corresponding DCH and DSCH transport channels are configured, and with transport channel type "DCH" for the UL, and the corresponding DCH transport channel is configured:
 - 4> select this multiplexing option; else
 - 3> if the RB has a multiplexing option with transport channel type "HS-DSCH" for the DL, and the corresponding MAC-d flow or MAC-ehs reordering queue is configured, and with transport channel type "E-DCH" for the UL, and the corresponding E-DCH MAC-d flow is configured:
 - 4> select this multiplexing option; else
 - 3> if the RB has a multiplexing option with transport channel type "HS-DSCH" for the DL, and the corresponding MAC-d flow or MAC-ehs reordering queue is configured, and with transport channel type "DCH" for the UL, and the corresponding DCH transport channel is configured:
 - 4> select this multiplexing option; else
 - 3> if the RB has a multiplexing option with transport channel type "DCH" for the DL, and the corresponding DCH transport channel is configured, and with transport channel type "E-DCH" for the UL, and the corresponding E-DCH MAC-d flow is configured:
 - 4> select this multiplexing option; else
 - 3> if the RB has a multiplexing option with transport channel type "DCH" for the DL, and the corresponding DCH transport channel is configured, and with transport channel type "DCH" for the UL, and the corresponding DCH transport channel is configured:
 - 4> select this multiplexing option; else
 - 3> if the RB has a multiplexing option with transport channel type "DSCH" for the DL, and the corresponding DSCH transport channel is configured, and with transport channel "USCH" for the UL, and the corresponding USCH transport channel is configured:
 - 4> select this multiplexing option.
- 1> configure the MAC with the appropriate transport format set (with computed transport block sizes) for the transport channel used by that RB; or
- 1> configure the MAC with the appropriate MAC-d flow or MAC-ehs reordering queue used by that RB;
- 1> in case the selected multiplexing option is a multiplexing option on E-DCH:
 - 2> the set of RLC sizes that apply to the logical channel used by that RB consists of all RLC PDU sizes listed in the IE "RLC PDU size list" in the RB mapping info for E-DCH.
- 1> else:

2> determine the sets of RLC sizes that apply to the logical channels used by that RB, based on the IEs "RLC size list" and/or the IEs "Logical Channel List" included in the applicable "Transport format set" (either the ones received in the same message or the ones stored if none were received);

1> in case the selected multiplexing option is a multiplexing option on RACH:

2> ignore the RLC size indexes that do not correspond to any RLC size within the Transport Format Set stored for RACH.

2> if there is no remaining RLC size index corresponding to an RLC size within the Transport Format Set stored for RACH:

3> set the variable INVALID_CONFIGURATION to TRUE.

1> if RACH is the transport channel to be used on the uplink, if that RB has a multiplexing option on RACH and if it is using AM:

2> apply the largest size amongst the ones derived according to the previous bullet for the RLC size (or RLC sizes in case the RB is realised using two logical channels) for the corresponding RLC entity.

NOTE: The IE "RB mapping info" is only included in the IE "Predefined RB configurations" in system information when used for Inter-RAT handover to UTRAN and there is no AM RLC size change involved in this case.

1> if that RB is using AM and the RLC size applicable to the uplink logical channel transporting data PDUs is different from the one derived from the previously stored configuration; and

1> none of the following conditions is met:

- the RLC size change is caused by a CELL UPDATE CONFIRM and the CELL UPDATE CONFIRM message includes the IE "Downlink counter synchronisation info".
- the RLC size change is caused by a reconfiguration message, and a cell update procedure occurs during the reconfiguration procedure and the CELL UPDATE CONFIRM message includes the IE "Downlink counter synchronisation info".
- the RLC size change is caused by a reconfiguration message, and a cell update procedure occurs during this reconfiguration procedure and the CELL UPDATE CONFIRM message includes the IE "RLC re-establish indicator" being set to TRUE for the corresponding radio bearer.

2> if the RLC size change is caused by a reconfiguration message or a CELL UPDATE CONFIRM; and

2> the IE "one sided RLC re-establishment" is included in that message and is set to TRUE:

3> re-establish the transmitting side of the corresponding RLC entity.

2> else:

3> re-establish the corresponding RLC entity.

2> configure the corresponding RLC entity with the new uplink RLC size;

2> for each AM RLC radio bearer in the CN domain as indicated in the IE "CN domain identity" in the IE "RAB info" in the variable ESTABLISHED_RABS whose RLC size is changed; and

2> for each AM RLC signalling radio bearer in the CN domain as indicated in the IE "CN domain identity" in the variable LATEST_CONFIGURED_CN_DOMAIN whose RLC size is changed:

3> if the IE "Status" in the variable CIPHERING_STATUS of this CN domain is set to "Started":

4> if the information causing the RLC re-establishment was included in system information:

5> set the HFN values for the corresponding RLC entity equal to the value of the IE "START" for this CN domain that will be included in the CELL UPDATE message following cell reselection.

NOTE: Since the UE cannot predict the START value at the time of the next CELL UPDATE transmission in the future, UTRAN should desist from changing the RLC size for a signalling radio bearer within a cell. Other than this case the change in RLC size for a signalling radio bearer is known to the UE when reading system information following cell reselection.

4> if the RLC re-establishment is caused by a CELL UPDATE CONFIRM:

5> if the whole RLC entity was re-established:

6> set the HFN values for the corresponding RLC entity in uplink and downlink equal to the value of the IE "START" included in the latest transmitted CELL UPDATE message for this CN domain.

5> if only the transmitting side of the RLC entity was re-established:

6> set the HFN value for the corresponding RLC entity in the uplink equal to the value of the IE "START" included in the latest transmitted CELL UPDATE message for this CN domain.

4> if the RLC re-establishment is caused by a reconfiguration message:

5> if the whole RLC entity was re-established:

6> set the HFN values for the corresponding RLC entity in uplink and downlink equal to the value of the IE "START" that will be included in the reconfiguration complete message for this CN domain.

5> if only the transmitting side of the RLC entity was re-established:

6> set the HFN value for the corresponding RLC entity in the direction uplink equal to the value of the IE "START" that will be included in the reconfiguration complete message for this CN domain.

NOTE1: If the UTRAN modifies the RLC size for RB2 on any reconfiguration message or Cell Update Confirm message, the UE behaviour is unspecified in this version of the specification.

NOTE2: The UE cannot rely on the configured Transport Formats to determine the RLC sizes to be used in downlink for a particular logical channel. This size can be signalled explicitly in the RLC Info IE.

1> if that RB is using UM:

2> indicate the largest RLC size applicable for uplink to the corresponding RLC entity.

1> configure MAC multiplexing according to the selected multiplexing option (MAC multiplexing shall only be configured for a logical channel if the transport channel it is mapped on according to the selected multiplexing option is the same as the transport channel another logical channel is mapped on according to the multiplexing option selected for it);

1> configure the MAC with the logical channel priorities according to selected multiplexing option;

1> configure the MAC with the set of applicable RLC Sizes for each of the logical channels used for that RB;

1> if there is no multiplexing option applicable for the transport channels, MAC-d flows and MAC-ehs reordering queues to be used:

2> set the variable INVALID_CONFIGURATION to TRUE.

1> if there is more than one multiplexing option applicable for the transport channels, MAC-d flows or MAC-ehs reordering queues to be used:

2> set the variable INVALID_CONFIGURATION to TRUE.

If upon cell re-selection or upon moving to CELL_FACH state from CELL_DCH state to initiate cell update procedure the UE sets variable INVALID_CONFIGURATION to TRUE as a result of the actions defined in this subclause, the UE should:

- 1> move to idle mode;
- 1> release (locally) the established signalling connections (as stored in the variable ESTABLISHED_SIGNALLING_CONNECTIONS) and the established radio access bearers (as stored in the variable ESTABLISHED_RABS) and indicate this to upper layers;
- 1> perform other actions when entering idle mode from connected mode as specified in subclause 8.5.2.

8.5.22 Actions when entering another RAT from connected mode

NOTE: This section does not apply when entering GERAN Iu mode from UTRAN connected mode.

When entering another RAT from connected mode (due to Inter-RAT handover from UTRAN, Inter-RAT cell change order from UTRAN or Inter-RAT cell reselection from UTRAN), after successful completion of the procedure causing the transition to the other RAT, the UE shall:

- 1> if the USIM is present, for each CN domain:
 - 2> if a new security key set was received for this CN domain but was not used either for integrity protection or ciphering during this RRC connection:
 - 3> set the START value for this domain to zero and;
 - 3> store this START value for this domain in the USIM;
 - 2> else:
 - 3> store the current START value for every CN domain in the USIM [50].

NOTE: Prior to storing the START value, the UE should calculate this START value according to subclause 8.5.9.

- 1> if the SIM is present, for each CN domain:
 - 2> if a new security key was received for this CN domain but was not used either for integrity protection or ciphering during this RRC connection:
 - 3> set the START value for this domain to zero and;
 - 3> store this START value for this domain in the UE.
 - 2> else:
 - 3> store the current START value for this CN domain in the UE.

NOTE: Prior to storing the START value, the UE should calculate this START value according to subclause 8.5.9.

8.5.23 Measured results on RACH

When transmitting an uplink RRC message and System Information Block type 11, System Information Block type 11bis and System Information Block type 12, if transmitted, have been received, the UE shall:

- 1> if the uplink RRC message is an RRC CONNECTION REQUEST message:
 - 2> if the IE "Intra-frequency reporting quantity for RACH reporting" and the IE "Maximum number of reported cells on RACH" are included in System Information Block type 11:
 - 3> include a measurement report in the IE "Measured results on RACH", as specified in the IE "Intra-frequency reporting quantity for RACH reporting" and the IE "Maximum number of reported cells on RACH" in System Information Block type 11.
 - 2> if the IE "Inter-frequency RACH reporting information" is included in System Information Block type 11:
 - 3> if, at the time the message is to be sent, valid measurements are available; and

- 3> there is one or more cells for which the quantity, indicated by the IE "Reporting quantity" in the IE "Inter-frequency RACH reporting information", exceeds the threshold specified by the IE "Inter-frequency RACH reporting threshold":
 - 4> include a measurement report in the IE "Measured results on RACH";
 - 4> include the cells for which the quantity, indicated by the IE "Reporting quantity" in the IE "Inter-frequency RACH reporting information", exceeds the threshold specified by the IE "Inter-frequency RACH reporting threshold";
 - 4> set the IE "Inter-frequency cell indication- SIB11" to the following value: Value_Tag MOD 2, with Value_Tag corresponding to the value tag of System Information Block Type 11;
 - 4> set the IE "Inter-frequency cell indication- SIB12" to any value.
 - 1> for any other uplink RRC message which optionally includes the IE "Measured results on RACH":
 - 2> if the IE "Intra-frequency reporting quantity for RACH reporting" and the IE "Maximum number of reported cells on RACH" are included in System Information Block type 12 (or "System Information Block Type 11", if these IEs are not included in the broadcast "System Information Block Type 12" or "System Information Block Type 12" is not being broadcast).
 - 3> include a measurement report in the IE "Measured results on RACH", as specified in the IE "Intra-frequency reporting quantity for RACH reporting" and the IE "Maximum number of reported cells on RACH" in System Information Block type 12 (or "System Information Block Type 11" if these IEs are not included in the broadcast "System Information Block Type 12" or "System Information Block Type 12" is not being broadcast).
 - 2> if the IE "Inter-frequency RACH reporting information" is included in "System Information Block type 12" (or "System Information Block Type 11" if this IE is not included in the "System Information Block Type 12" or if "System Information Block Type 12" is not being broadcast):
 - 3> if, at the time the message is to be sent, valid measurements are available; and
 - 3> there is one or more cells for which the quantity, indicated by the IE "Reporting quantity" in the IE "Inter-frequency RACH reporting information", exceeds the threshold specified by the IE "Inter-frequency RACH reporting threshold":
 - 4> include a measurement report in the IE "Measured results on RACH";
 - 4> include the cells for which the quantity, indicated by the IE "Reporting quantity" in the IE "Inter-frequency RACH reporting information", exceeds the threshold specified by the IE "Inter-frequency RACH reporting threshold";
 - 4> set the IE "Inter-frequency cell indication- SIB11" to the following value: Value_Tag MOD 2, with Value_Tag corresponding to the value tag of System Information Block Type 11;
 - 4> if "System Information Block Type 12" is being broadcast:
 - 5> set the IE "Inter-frequency cell indication- SIB12" to the following value: Value_Tag MOD 2, with Value_Tag corresponding to the value tag of System Information Block Type 12.
 - 4> else:
 - 5> set the IE "Inter-frequency cell indication- SIB12" to any value.
 - 1> include in the IE "Measured results on RACH" all requested reporting quantities for cells for which measurements are reported.
- NOTE: The UE only includes measurement results for neighbour cells for which valid measurements are available at the time the message is sent. At cell access following selection or reselection to a cell, the UE may not have had sufficient time to obtain valid measurement results for neighbour cells.
- 1> for messages transmitted on CCCH, take care that the maximum allowed message size is not exceeded when forming the IE "Measured results on RACH", i.e. limit the number of included neighbour cells or if required omit the IE "Measured results on RACH" altogether. When limiting the number of included neighbouring cells,

the number of inter-frequency cells should be limited first i.e. inter-frequency cells should be omitted before limiting the number of intra-frequency cells.

When transmitting an uplink RRC message and the System Information Block type 11, System Information Block type 11bis and System Information Block type 12, if transmitted, have not been received, the UE shall:

- 1> for any uplink RRC message which optionally includes the IE "Measured results on RACH", include a measurement report in the IE "Measured results on RACH" according to the following rules:
 - 2> if the IE "Intra-frequency reporting quantity" was not present in System Information Block type 3:
 - 3> include a measurement report for the serving cell using CPICH RSCP as a measurement quantity;
 - 3> include measurement reports for cells on the used frequency for which measured results are available, using CPICH RSCP as measurement quantity for each cell;
 - 3> omit the IE "Measurement results for monitored cells on non-used frequencies".
 - 2> if the IE "Intra-frequency reporting quantity" was present in System Information Block type 3:
 - 3> include a measurement report for the serving cell using as a measurement quantity given in IE "Intra-frequency reporting quantity";
 - 3> include measurement reports for cells on the used frequency for which measured results are available, using as a measurement quantity given in IE "Intra-frequency reporting quantity" for each cell;
 - 3> omit the IE "Measurement results for monitored cells on non-used frequencies".
- 2> for TDD, include measurement reports using the measurement quantities specified in the IE "Reporting quantity list".

If the IE "Measured results on RACH" is present in the message, the UTRAN should extract the contents to be used for radio resource control.

8.5.24 Change of PLMN while in RRC connected mode

If the UE camps on an acceptable cell to obtain limited service while in RRC connected mode the UE shall:

- 1> keep the RRC connection and its behaviour, while camping on an acceptable cell as if in Idle mode in that PLMN;
- 1> if the UE re-enters "in service area" in a suitable cell, or cannot maintain limited service (i.e. cannot find any acceptable cell of any PLMN), the UE shall resume its RRC Connected mode behaviour as if it had not camped on any cell whilst being in "out of service area".

The UE shall:

- 1> if the NAS indicates the selection of a new PLMN resulting from manual- or automatic mode PLMN selection [25] while the UE is in RRC connected mode; or
- 1> if the UE attempts transmission on an acceptable cell while the UE is in RRC connected mode (i.e. to initiate emergency call), the UE shall:
 - 2> move to idle mode;
 - 2> release all dedicated resources;
 - 2> indicate release (abort) of the established signalling connections (as stored in the variable ESTABLISHED_SIGNALLING_CONNECTIONS) and established radio access bearers (as stored in the variable ESTABLISHED_RABS) to upper layers;
 - 2> clear the variable ESTABLISHED_SIGNALLING_CONNECTIONS;
 - 2> clear the variable ESTABLISHED_RABS; and
 - 2> perform actions specified in subclause 8.5.2 when entering idle mode from connected mode.

NOTE: NAS can inform AS about a new selected PLMN as a result of a PLMN selection (manual- or automatic mode PLMN selection (see [25])), or as a result of network signalling (after inter-RAT handover or inter-PLMN SRNS relocation). Only in the first case (manual- or automatic mode PLMN selection), this will result in an immediate RRC connection release.

8.5.25 Actions related to HS_DSCH_RECEPTION variable

The variable HS_DSCH_RECEPTION shall be set to TRUE only when all the following conditions are met:

- 1> for FDD and 1.28 Mcps TDD:
 - 2> the UE is in CELL_DCH state.
- 1> for 3.84 Mcps TDD or 7.68 Mcps TDD:
 - 2> a dedicated physical channel is allocated to the UE in the uplink.
- 1> the variable H_RNTI is set;
- 1> the UE has a stored IE "HS-SCCH info";
- 1> the UE has a stored IE "HARQ info";
- 1> for FDD:
 - 2> one of the radio links in the active set is configured as the serving HS-DSCH radio link;
 - 2> the UE has stored the following IEs:
 - IE "Measurement Feedback Info";
 - IE "Uplink DPCH Power Control Info" including stored Δ_{ACK} , Δ_{NACK} and Ack-NACK Repetition factor.
- 1> for 3.84 Mcps TDD or 7.68 Mcps TDD, the UE has stored the IE "HS-PDSCH Timeslot Configuration" and either of the following conditions are met:
 - 2> a dedicated physical channel is allocated to the UE in the downlink;
 - 2> the UE has stored $D_{hs-sync}$.
- 1> for 1.28 Mcps TDD, the UE has stored the IE "HS-PDSCH Midamble Configuration" and either of the following conditions are met:
 - 2> a dedicated physical channel is allocated to the UE in the downlink;
 - 2> the UE has stored "PLCCH Info".
- 1> there is at least one RB mapped to HS-DSCH;
- 1> at least for one of the RBs mapped to HS-DSCH, there is either:
 - 2> at least one MAC-hs queue (including the IE "MAC-d PDU size Info") configured for the concerning MAC-d flow; or
 - 2> at least one MAC-ehs reordering queue configured for the associated logical channel.

NOTE 1: For TDD and for FDD in CELL_DCH, to enable or disable HS-DSCH reception, the UTRAN has the possibility to add/remove the concerning HS-DSCH related RB mapping options, add/remove the concerning MAC-d flows or, for FDD, add/remove the concerning MAC-ehs reordering queue, add/remove the serving HS-DSCH radio link or, for TDD add/remove H-RNTI upon hard handover.

NOTE 2: For TDD and for FDD in CELL_DCH, if HS_DSCH_RECEPTION is set to TRUE and a reconfiguration, an inter-RAT handover from UTRAN, or a cell change order procedure is initiated, the UE checks the conditions only when the reconfiguration, inter-RAT handover from UTRAN, or cell change order procedure is successfully completed. Doing so ensures that, in case of failure in the reconfiguration, inter-RAT handover from UTRAN, or cell change order procedure, the UE can return to the old configuration as if the message was not received, e.g. without performing a MAC-HS reset.

If any of the above conditions is not met and the variable HS_DSCH_RECEPTION is set to TRUE, the UE shall:

- 1> set the variable HS_DSCH_RECEPTION to FALSE;
- 1> for TDD and for FDD in CELL_DCH:
 - 2> set the variable HS_DSCH_RECEPTION_GENERAL to FALSE;
 - 2> stop any HS_SCCH reception procedures;
 - 2> stop any HS-DSCH reception procedures;
 - 2> clear the variable H_RNTI and remove any stored H-RNTI;
 - 2> reset the MAC-hs/ehs entity [15];
 - 2> release all HARQ resources;
 - 2> no long consider any radio link to be the HS-DSCH serving radio link.

- 1> for 3.84 Mcps TDD or 7.68 Mcps TDD, if no downlink DPCH is assigned the UE shall clear the uplink DPCH configuration and initiate the Cell Update procedure according to subclause 8.3.1, cause "radio link failure".

NOTE 3: If configured for HS-DSCH and not explicitly indicated as being cleared, the UE will have still stored the IEs "HARQ info", "Added or Reconfigured MAC-d flow", "Added or Reconfigured MAC-ehs reordering queue", "RB mapping Info" and "Downlink HS-PDSCH information".

Whenever the variable HS_DSCH_RECEPTION is set to TRUE, the UE shall:

- 1> set the variable HS_DSCH_RECEPTION_GENERAL to TRUE;
- 1> perform HS_SCCH reception procedures according to the stored HS-SCCH configuration as stated in:
 - 2> subclause 8.6.6.33 for the IE "HS-SCCH Info".
 - 2> for 1.28 Mcps TDD, when performing reception on signalling radio bearer before RAB has been established, the UE shall use the lowest HSDPA capability category, as specified in [35], to read the DL control information on HS-SCCH.

NOTE 4: For 1.28 Mcps TDD, when performing transmission on signalling radio bearer before RAB has been established, UTRAN should use the lowest HSDPA capability category, as specified in [35], when performing scheduling and signalling the control information on HS-SCCH, as it is not possible for Node B to be aware of the UE's HSDPA capability category during this period.

- 1> perform HS-DSCH reception procedures according to the stored HS-PDSCH configuration as stated in:
 - 2> subclause 8.6.3.1b for the IE "H-RNTI";
 - 2> subclause 8.6.5.6b for the IE "HARQ info";
 - 2> subclause 8.6.6.34 for the IE "Measurement Feedback Info".
- 1> use the relevant CQI reporting table as stated in subclause 8.5.44.

For TDD and for FDD in CELL_DCH, whenever the variable HS_DSCH_RECEPTION is set to FALSE, the UE shall:

- 1> not perform HS_SCCH reception procedures;
- 1> not perform HS-DSCH reception procedures.

8.5.26 Service prioritisation

If the UE detects an MBMS service reception inability as specified in subclause 8.5.30, the UE may:

- 1> request upper layers to prioritise the services and to initiate release of non- prioritised services that may cause interruption in the reception of the prioritised services;
- 1> if reception of the prioritised MBMS service is inhibited by one or more MBMS service(s) provided via a p-t-p radio bearer:
 - 2> request UTRAN to terminate these MBMS service(s) using the MBMS MODIFICATION REQUEST message as specified in subclause 8.7.6.

NOTE: The termination of MBMS services is performed by RRC procedures, while clearing of non- MBMS services is performed by upper layers.

8.5.27 MBMS frequency selection

The UE shall perform the MBMS frequency layer selection procedure upon receiving the IE "MBMS Preferred frequency information", when specified explicitly e.g. as in subclause 8.6.9.2, or when the priority for an MBMS service as indicated by upper layers changes.

The UE shall:

- 1> if there exist two or more preferred frequencies for services included in variable MBMS_ACTIVATED_SERVICES:
 - 2> request from upper layers the priorities of the different MBMS services included in variable MBMS_ACTIVATED_SERVICES for which a preferred frequency has been received.
- 1> if the UE is in idle mode:
 - 2> if a preferred frequency layer applies for a service included in variable MBMS_ACTIVATED_SERVICES:
 - 3> select the preferred frequency indicated for the MBMS service(s) prioritised most by upper layers for which a preferred frequency exists as the preferred frequency.
- 1> if the UE is in CELL_FACH, CELL_PCH or URA_PCH state; and
- 1> if there exists one or more preferred frequencies for services included in variable MBMS_ACTIVATED_SERVICES and the variable MBMS_PL_SERVICE_RESTRICTION_INFO_DEDICATED is set to FALSE:
 - 2> if the IE "RAB information" in the variable ESTABLISHED_RABS is not empty:
 - 3> if the current frequency is the frequency corresponding with the preferred frequency indicated for the MBMS service(s) prioritised most by upper layers for which a preferred frequency exists:
 - 4> select the current frequency as the preferred frequency.
 - 3> else:
 - 4> if there exists one or more preferred frequencies for services included in variable MBMS_ACTIVATED_SERVICES for which the IE "MBMS PL Service Restriction Information" has not been received in the MBMS GENERAL INFORMATION message:
 - 5> select the preferred frequency indicated for the MBMS service(s) prioritised most by upper layers for which a preferred frequency exists for which the IE "MBMS PL Service Restriction Information" has not been received in the MBMS GENERAL INFORMATION message as the preferred frequency.
 - 2> else:
 - 3> select the preferred frequency indicated for the MBMS service(s) prioritised most by upper layers for which a preferred frequency exists as the preferred frequency.

- 1> if the UE is in CELL_DCH:
 - 2> if there exists one or more preferred frequencies for services included in variable MBMS_ACTIVATED_SERVICES and the variable MBMS_PL_SERVICE_RESTRICTION_INFO_DEDICATED is set to FALSE:
 - 3> if the current frequency does not correspond to the preferred frequency indicated for the MBMS service(s) prioritised most by upper layers for which a preferred frequency exists:
 - 4> select as preferred frequency the preferred frequency indicated for the MBMS service(s) prioritised most by upper layers for which a preferred frequency exists for which the IE "MBMS PL Service Restriction Information" is not included in the MBMS GENERAL INFORMATION message;
 - 4> if a preferred frequency has been selected and the current frequency is different from the selected frequency:
 - 5> request UTRAN to be moved to the preferred frequency by means of the MBMS MODIFICATION REQUEST message as specified in subclause 8.7.6;
 - 5> if the variable MBMS_PREV_FREQUENCY_INFO is empty:
 - 6> upon receiving a request to move to the requested preferred frequency, store the frequency information of the frequency on which the UE was operating prior to the hard-handover to the preferred frequency in the variable MBMS_PREV_FREQUENCY_INFO.
 - 1> if a preferred frequency has been selected:
 - 2> if the UE is not in CELL_DCH state:
 - 3> apply the cell-reselection procedure as described in [4], using the received "MBMS Preferred frequency information" applicable to the selected frequency;
 - 3> if the UE re-selects to a cell on the indicated preferred frequency:
 - 4> if HCS is not used, and the IE "Qoffmbms" is not present for the MBMS preferred frequency:
 - 5> consider the cells on the MBMS preferred frequency having a Qoffmbms equal to "infinity".
 - 4> if HCS is used, and the IE "HCS_OFFmbms" is not present for the MBMS preferred frequency:
 - 5> consider the cells on the MBMS preferred frequency having the highest HCS priority level.
 - 4> if the UE is in CELL_FACH, CELL_PCH or URA_PCH:
 - 5> act according to subclause 8.3.1.2.
 - 4> if the selected frequency is different to the frequency on which the UE was previously operating; and
 - 4> if the variable MBMS_PREV_FREQUENCY_INFO is empty:
 - 5> store the frequency information of the frequency on which the UE was operating prior to cell-reselection to the preferred frequency in the variable MBMS_PREV_FREQUENCY_INFO.
 - 4> apply the MCCH acquisition procedure, as specified in subclause 8.7.2.
 - 1> else:
 - 2> if the UE is not in CELL_DCH state:
 - 3> stop applying any "MBMS Preferred frequency information".
 - 3> if the UE is not redirected to another frequency; and
 - 3> if the UE does not decide to receive an MBMS service; and
 - 3> if the variable MBMS_PREV_FREQUENCY_INFO is not empty:

- 4> if any frequency in SIB11 or SIB12 has the same frequency stored in the variable MBMS_PREV_FREQUENCY_INFO:
 - 5> select a suitable UTRA cell in that frequency;
 - 5> if no suitable UTRA cell in that frequency is found:
 - 6> select a suitable UTRA cell in another frequency.
- 4> if no frequency in SIB11 or SIB12 has the same frequency stored in the variable MBMS_PREV_FREQUENCY_INFO:
 - 5> select a frequency randomly among the inter-frequencies indicated in SIB11 or SIB12:
 - 6> select a suitable UTRA cell in the selected frequency;
 - 6> if no suitable UTRA cell in the selected frequency is found:
 - 7> select a suitable UTRA cell in another frequency.
- 4> clear the variable MBMS_PREV_FREQUENCY_INFO.

NOTE: The UE is only required to acquire the relevant SIB11 or SIB12, according to what is specified in subclauses 8.1.1.6.11 and 8.1.1.6.12.

8.5.28 Actions related to E_DCH_TRANSMISSION variable

The variable E_DCH_TRANSMISSION shall be set to TRUE only when all the following conditions are met:

- 1> the UE is in CELL_DCH state;
- 1> the variable E_RNTI includes either the Primary E-RNTI or the Secondary E-RNTI or both the Primary and the Secondary E-RNTI;
- 1> For FDD:
 - 2> the UE has stored the following IEs:
 - IE "E-DCH Transmission Time Interval";
 - IE "HARQ info for E-DCH";
 - IE "E-DCH info", including the IE "E-DPCCH info" and the IE "E-DPDCH info";
 - one of the radio links in the active set is configured as the serving E-DCH radio link, and for this radio link the UTRAN has configured the IE "E-HICH configuration" and the IE "E-AGCH info".
- 1> For TDD:
 - 2> for non-scheduled transmission, the UE has stored the following IEs:
 - IE "HARQ info for E-DCH";
 - IE "E-DCH information", including the IE "E-PUCH info";
 - IE "Non-scheduled transmission grant info".
 - 2> for scheduled transmission, the UE has stored the following IEs:
 - IE "HARQ info for E-DCH";
 - IE "E-DCH information", including the IE "E-RUCCH info" and the IE "E-PUCH info";
 - IE "E-HICH info";
 - IE "E-AGCH info".

- 1> there is at least one logical channel mapped to E-DCH for which:
 - 2> the corresponding E-DCH MAC-d flow is configured, i.e. the IEs "E-DCH MAC-d flow power offset" and "E-DCH MAC-d flow maximum number of retransmissions", and the transmission grant type are configured.

If any of the above conditions is not met and the variable E_DCH_TRANSMISSION is set to TRUE, the UE shall:

- 1> set the variable E_DCH_TRANSMISSION to FALSE;
- 1> stop any E-AGCH and E-HICH reception procedures;
- 1> For FDD:
 - 2> stop any E-RGCH reception procedures.
- 1> For FDD:
 - 2> stop any E-DPCCH and E-DPDCH transmission procedures.
- 1> For TDD:
 - 2> stop any E-RUCCH and E-PUCH transmission procedures.
- 1> clear the variable E_RNTI;
- 1> act as if the IE "MAC-es/e reset indicator" was received and set to TRUE;
- 1> release all E-DCH HARQ resources;
- 1> no longer consider any radio link to be the serving E-DCH radio link.

Whenever the variable E_DCH_TRANSMISSION is set to TRUE, the UE shall:

- 1>For FDD:
 - 2> perform E-AGCH reception procedures according to the stored E-AGCH configuration as stated in:
 - 3> subclause 8.6.3.14 for the IE "New Primary E-RNTI" and the IE "New Secondary E-RNTI".
 - 2> perform E-HICH reception procedures for all radio links in the E-DCH active set;
 - 2> perform E-RGCH reception procedures for all radio links in the active set for which an E-RGCH configuration has been provided;
 - 2> perform E-DPCCH transmission procedures according to the stored E-DPCCH configuration as stated in:
 - 3> subclause 8.6.6.37 for the IE "E-DPCCH Info".
 - 2> perform E-DPDCH transmission procedures according to the stored E-DPDCH configuration as stated in:
 - 3> subclause 8.6.5.16 for the IE "E-DCH Transmission Time Interval";
 - 3> subclause 8.6.5.17 for the IE "HARQ info for E-DCH";
 - 3> subclause 8.6.6.37 for the IE "E-DPDCH Info".
 - 2> inclusion of MAC-d PDU's in a MAC-e PDU for logical channels belonging to a MAC-d flow for which the IE "Non-scheduled transmission grant info" is configured shall:
 - 3> obey the scheduling and size restrictions as specified for that MAC-d flow (see subclause 8.6.5.18).
 - 2> inclusion of MAC-d PDU's in a MAC-e PDU for logical channels belonging to a MAC-d flow for which the IE "Scheduled transmission grant info" is configured shall:
 - 3> be performed in accordance with the received scheduling grant on E-AGCH/E-RGCH (see [15]); and
 - 3> obey the scheduling restrictions as specified for scheduled transmissions (see subclause 8.6.6.37).
- 1>For TDD:

- 2> if scheduled transmission is configured, perform E-AGCH reception procedures according to the stored E-AGCH configuration as stated in:
 - 3> subclause 8.6.3.14 for the IE "New Primary E-RNTI".
- 2> Perform E-HICH reception;
- 2> for 3.84/7.68 Mcps TDD, perform E-RUCCH transmission procedures according to the stored E-RUCCH configuration as stated in:
 - 3> subclause 8.6.6.37 for the IE "E-RUCCH Info".
- 2> for 1.28 Mcps TDD, if scheduled transmission is configured, perform E-RUCCH transmission procedure according to the stored PRACH configuration (see [60]) and the stored E-RUCCH configuration as stated in:
 - 3> subclause 8.6.6.37 for the IE "E-RUCCH Info".

NOTE 1: The PRACH configuration is signalled directly to the UE in "E-RUCCH Info" IE in case of E-DCH serving cell change.

- 2> Perform E-PUCH transmission procedures according to the stored E-PUCH configuration as stated in:
 - 3> subclause 8.6.6.37 for the IE "E-PUCH Info".
- 2> inclusion of MAC-d PDU's in a MAC-e PDU for logical channels belonging to a MAC-d flow for which the IE "Non-scheduled transmission grant info" is configured shall:
 - 3> obey the scheduling and size restrictions as specified for that MAC-d flow (see subclause 8.6.5.18).
- 2> inclusion of MAC-d PDU's in a MAC-e PDU for logical channels belonging to a MAC-d flow for which the IE "Scheduled transmission grant info" is configured shall:
 - 3> be performed in accordance with the received scheduling grant on E-AGCH (see [15]); and
 - 3> obey the scheduling restrictions as specified for scheduled transmissions (see subclause 8.6.6.37).
- 2> obtain and format the appropriate information on E-UCCH (see [15]). For 1.28 Mcps TDD, when performing transmission on signalling radio bearer before RAB has been established, the UE shall use the lowest E-DCH capability category, as specified in [35], to signal the UL control information on E-UCCH.

NOTE 2: For 1.28 Mcps TDD, when performing transmission on signalling radio bearer before RAB has been established, UTRAN should use the lowest E-DCH capability category when performing configuration, scheduling and reading the control information on E-UCCH, as it is not possible for Node B to be aware of the UE's E-DCH capability category during this period.

Whenever the variable E_DCH_TRANSMISSION is set to FALSE, the UE shall:

- 1> not perform E-AGCH, E-HICH and/or E-RGCH reception procedures;
- 1> not perform E-DPCCH, E-DPDCH, E-RUCCH and/or E-PUCH transmission procedures.

8.5.29 MBMS modification period identity calculation

The UE shall calculate the identity of a Modification period as follows:

$$MP_{identity} = (SFN_{MP} \div MP_{len}) \bmod 2$$

With SFN_{MP} being the SFN corresponding with the frame in which the concerned Modification Period starts
 MP_{len} being the length of the Modification Period, that is indicated by the IE "Modification period coefficient" that is included in System Information Block type 5 and 5bis.

8.5.30 Detecting MBMS service reception inability

The UE may detect that it becomes incapable of receiving all services it is interested in at any time due to implementation specific constraints as well as upon state transitions, service / session start, service / session stop, service reconfiguration e.g. transfer mode change and preferred frequency layer changes or whenever there are changes concerning the subset of services that it has selected to receive.

When evaluating its MBMS service reception abilities, the UE shall:

- 1> consider that MBMS services, for which a preferred frequency layer is specified, are available only on the concerned frequency;
- 1> consider that MBMS services, for which no preferred frequency layer is specified are available on all frequencies;
- 1> consider non- MBMS services to be available on all frequencies unless specified otherwise in the following:
 - 1> if the variable MBMS_PL_SERVICE_RESTRICTION_INFO_DEDICATED is set to TRUE:
 - 2> consider the established non-MBMS services not to be available on any MBMS preferred frequency.
 - 1> if the IE "MBMS PL Service Restriction Information" is included in the MBMS GENERAL INFORMATION message for the MBMS preferred frequency the UE is considering to select to:
 - 2> consider non-MBMS services not to be available on the concerned MBMS preferred frequency.

If the UE is unable to receive the MBMS and the non-MBMS services it is interested in, the UE shall:

- 1> detect an MBMS service reception inability.

8.5.31 Actions related to DEFERRED_MEASUREMENT_STATUS variable

If after state transition the UE remains in a state other than CELL_DCH state, the UE shall:

- 1> if variable DEFERRED_MEASUREMENT_STATUS is set to TRUE:
 - 2> if System Information Block type 11 is referenced in the master information block or in the scheduling blocks:
 - 3> if the UE has not read and stored System Information Block type 11:
 - 4> read and store System Information Block type 11.
 - 3> if System Information Block type 11bis is referenced in the master information block or in the scheduling blocks:
 - 4> if the UE has not read and stored System Information Block type 11:
 - 5> read and store System Information Block type 11.
 - 2> if System Information Block type 12 is referenced in the master information block or in the scheduling blocks, or broadcast of System Information Block type 12 is indicated in System Information Block type 11:
 - 3> if the UE has not read and stored System Information Block type 12:
 - 4> read and store System Information Block type 12.

8.5.32 Actions related to MIMO_PARAMS variable

If the UE receives an ACTIVE SET UPDATE, CELL UPDATE CONFIRM, or any reconfiguration message:

- 1> if the IE "MIMO parameters" is not included:
 - 2> clear the MIMO_PARAMS variable;

2> trigger lower layers to stop operation in MIMO mode.

1> otherwise:

2> if the IE "MIMO N_cqi_typeA/M_cqi ratio" is included:

3> store the value of the IE "MIMO N_cqi_typeA/M_cqi ratio" in the MIMO_PARAMS variable.

2> if the IE "MIMO pilot configuration" is included:

3> store the value of the IE "MIMO pilot configuration" in the MIMO_PARAMS variable.

2> if the IE "MIMO operation" is set to "start":

3> if the IE "Precoding weight set restriction" is included:

4> store the value of the IE "Precoding weight set restriction" in the MIMO_PARAMS variable. In addition, it shall be indicated to lower layers that precoding weight set restriction is configured.

3> else:

4> clear the value of the IE "Precoding weight set restriction" in the MIMO_PARAMS variable. In addition, it shall be indicated to lower layers that precoding weight set restriction is not configured.

2> else if the IE "MIMO operation" is set to "continue":

3> if the IE "Precoding weight set restriction" is included:

4> if the IE "Precoding weight set restriction" is already stored in the variable MIMO_PARAMS before receiving this message:

5> continue using "Precoding weight set restriction" for MIMO operation.

4> else:

5> UE behaviour is undefined.

3> else:

4> if the IE "Precoding weight set restriction" is already stored in the variable MIMO_PARAMS before receiving this message:

5> continue using "Precoding weight set restriction" for MIMO operation.

4> else:

5> continue MIMO operation without using "Precoding weight set restriction".

NOTE: This subclause applies to FDD only.

8.5.33 Actions related to MIMO_STATUS variable

If the UE receives an ACTIVE SET UPDATE, CELL UPDATE CONFIRM, or any reconfiguration message, the UE shall:

1> take actions related to the MIMO_PARAMS variable as specified in subclause 8.5.32;

1> determine the value of the MIMO_STATUS variable.

The MIMO_STATUS variable shall be set to TRUE only when all the following conditions are met:

1> The UE is in CELL_DCH state;

1> the variable HS_DSCH_RECEPTION is set to TRUE;

1> the variable MIMO_PARAMS contains a value for the IE "MIMO N_cqi_typeA/M_cqi ratio"; and

1> the variable MIMO_PARAMS contains a value for the IE "MIMO pilot configuration".

If any of the above conditions is not met and the MIMO_STATUS variable is set to TRUE, the UE shall:

- 1> set the MIMO_STATUS variable to FALSE;
- 1> clear the MIMO_PARAMS variable;
- 1> trigger lower layers to stop operation in MIMO mode.

If the MIMO_STATUS variable is set to FALSE:

- 1> if prior to receiving an ACTIVE SET UPDATE, CELL UPDATE CONFIRM, or any reconfiguration message, the MIMO_STATUS variable was set to TRUE:
 - 2> if the IE "HARQ info" is not included in the received message:
 - 3> the UE behaviour is unspecified.

If the MIMO_STATUS variable is set to TRUE:

- 1> if prior to receiving an ACTIVE SET UPDATE, CELL UPDATE CONFIRM, or any reconfiguration message, the MIMO_STATUS variable was set to FALSE:
 - 2> if the IE "HARQ info" is not included in the received message:
 - 3> the UE behaviour is unspecified.

NOTE: This subclause applies to FDD only.

8.5.34 Actions related to DTX_DRX_STATUS variable (FDD only)

If the UE receives RRC CONNECTION SETUP, ACTIVE SET UPDATE, CELL UPDATE CONFIRM, or any reconfiguration message:

- 1> the UE shall determine the value for the DTX_DRX_STATUS variable.

The variable DTX_DRX_STATUS shall be set to TRUE only when all the following conditions are met:

- 1> the UE is in CELL_DCH state;
- 1> both variables HS_DSCH RECEPTION and E_DCH_TRANSMISSION are set to TRUE;
- 1> no DPDCH is present in uplink and F-DPCH is configured in downlink;
- 1> the variable DTX_DRX_PARAMS is set;
- 1> the IE "DTX-DRX timing information" is included in the received message.

If any of the above conditions is not met and the variable DTX_DRX_STATUS is set to TRUE, the UE shall:

- 1> set the variable DTX_DRX_STATUS to FALSE;
- 1> clear the variable DTX_DRX_PARAMS;
- 1> stop DTX-DRX mode related activities.

NOTE: If the uplink slot format is not changed by the received RRC message, the UE keeps using the same uplink slot format currently configured.

If the variable DTX_DRX_STATUS is set to true and the serving HS-DSCH cell was changed as a result of the received message the UE shall instruct the physical layer to consider that the HS-SCCH orders were never received.

If the variable DTX_DRX_STATUS is set to TRUE, the value of IE "DTX-DRX timing information" included in the message is "Continue" and the serving HS-DSCH cell was not changed as a result of the received message, the UE shall instruct the physical layer to consider that the DTX, DRX related HS-SCCH orders were received.

Whenever the variable DTX_DRX_STATUS is set to TRUE after receiving this message and the value of IE "DTX-DRX timing information" included in this message is not "Continue", the UE shall:

- 1> if the variable DTX_DRX_STATUS was set to TRUE before receiving this message:
 - 2> re-configure the physical layer to perform discontinuous uplink DPCCH transmission and enable or disable discontinuous downlink reception operations according to the variable DTX_DRX_PARAMS at the CFN corresponding to the frame boundary that is offset by the value of the IE "Enabling Delay" from the frame boundary where uplink transmission starts with the new configuration;
 - 2> let the MAC layer continue any current restriction on E-DCH transmission and monitoring of absolute and relative grant channels from the frame boundary where the uplink transmission starts with the new configuration and for the duration of the IE "Enabling Delay".

NOTE: Whenever the variable DTX_DRX_STATUS is set to TRUE before and after receiving the message, the value of IE "DTX-DRX timing information" included in the message is not "Continue" and the serving HS-DSCH cell was not changed as a result of this message, the UE may or may not instruct the physical layer to consider that the DTX, DRX related HS-SCCH orders were never received.

1> else:

- 2> perform discontinuous uplink DPCCH transmission and enable discontinuous downlink reception operations by configuring the physical layer according to the variable DTX_DRX_PARAMS at the CFN corresponding to the frame boundary that is offset by the value of the IE "Enabling Delay" from the frame boundary where the uplink transmission starts with the new configuration.
- 1> configure the MAC layer to start restricting E-DCH transmissions and monitor absolute and relative grant channels at the CFN corresponding to the frame boundary that is offset by the value of IE "Enabling Delay" from the frame boundary where the uplink transmission starts with the new configuration taking into account the IEs "UE DTX DRX Offset", "MAC DTX Cycle", "MAC Inactivity Threshold" and "Inactivity Threshold for UE Grant Monitoring".

NOTE: If a post-verification period is configured [29], then the uplink transmission starts when the physical channel establishment is initiated by the UE. If a post-verification period is configured and the post-verification procedure fails then uplink transmission (re)starts when the downlink physical channel is established and the enabling delay timer is (re)started. If a post-verification period is not configured, the uplink transmission starts when the downlink physical channel is established.

8.5.35 Actions related to HS_SCCH_LESS_STATUS variable (FDD only)

If the UE receives RRC CONNECTION SETUP, ACTIVE SET UPDATE, CELL UPDATE CONFIRM, or any reconfiguration message;

- 1> the UE shall determine the value for the HS_SCCH_LESS_STATUS variable.

The variable HS_SCCH_LESS_STATUS shall be set to TRUE only when all the following conditions are met:

- 1> the UE is in CELL_DCH state;
- 1> the variable HS_DSCH_RECEPTION is set to TRUE;
- 1> no DPDCH is present in uplink and F-DPCH is configured in downlink;
- 1> the UE is not configured in MIMO mode;
- 1> the variable HS_SCCH_LESS_PARAMS is set;
- 1> the IE "HS-SCCH less information" is included in the received message.

If any of the above conditions is not met and the variable HS_SCCH_LESS_STATUS is set to TRUE the UE shall:

- 1> set the variable HS_SCCH_LESS_STATUS to FALSE;
- 1> clear the variable HS_SCCH_LESS_PARAMS;

1> stop all HS-SCCH less related activities.

Whenever the variable HS_SCCH_LESS_STATUS is set to TRUE, the UE shall:

- 1> configure the physical and MAC layers to operate according to the HS_SCCH_LESS_PARAMS;
- 1> configure the physical layer to use a virtual IR buffer size of at least 4536 bits for HS-SCCH less HS-DSCH transmissions.

8.5.36 Actions related to HS_DSCH_RECEPTION_CELL_FACH_STATE variable (FDD only)

The variable HS_DSCH_RECEPTION_CELL_FACH_STATE shall be set to TRUE only when all the following conditions are met:

- 1> the UE is in CELL_FACH;
- 1> the variable H_RNTI is set;
- 1> the variable C_RNTI is set;
- 1> the UE has stored the IE "Added or reconfigured MAC-ehs reordering queue";
- 1> System Information Block type 5 or System Information Block type 5bis includes IE "HS-DSCH common system information".

If any of the above conditions is not met and the variable HS_DSCH_RECEPTION_CELL_FACH_STATE is set to TRUE, the UE shall:

- 1> set the variable HS_DSCH_RECEPTION_CELL_FACH_STATE to FALSE;
- 1> if the UE is in CELL_FACH and variable HS_DSCH_RECEPTION_OF_CCCH_ENABLED is set to FALSE:
 - 2> set the variable HS_DSCH_RECEPTION_GENERAL to FALSE;
 - 2> stop any HS-SCCH reception procedures;
 - 2> stop any HS-DSCH reception procedures;
 - 2> clear the variable H_RNTI and remove any stored H-RNTI;
 - 2> reset the MAC-ehs entity [15];
 - 2> release all HARQ resources;
 - 2> clear any stored IEs "HARQ info";

Whenever the variable HS_DSCH_RECEPTION_CELL_FACH_STATE is set to TRUE, the UE shall:

- 1> set the variable HS_DSCH_RECEPTION_GENERAL to TRUE;
- 1> use the IE "HS-DSCH common system information" in System Information Block type 5 or System Information Block type 5bis;
- 1> receive the HS-SCCH(s) according to the IE "HS-SCCH channelisation code" on the serving cell applying the scrambling code as received in the IE "DL Scrambling code" as received in IE "HS-DSCH common system information";
- 1> determine the "Total number of soft channel bits" (defined in Table 5.1a of [35]) according to subclause 8.1.6.2 and use it in the physical layer;
- 1> use the octet aligned HS-DSCH transport block table [15] in the MAC-ehs entity;
- 1> perform HS-DSCH reception procedures for DCCH or DTCH:
 - 2> if the UE has a stored IE "HARQ info":

- 3> act on subclause 8.6.5.6b for the stored IE "HARQ info".
- 2> else:
 - 3> act on subclause 8.6.5.20 for the IE "HARQ System info" as received in IE "HS-DSCH common system information".
 - 2> and use the value of the variable H_RNTI as UE identity in the HS-SCCH reception procedure in the physical layer;
 - 2> configure the MAC-ehs reordering queues according to IE "Added or reconfigured MAC-ehs reordering queue" as defined in subclauses 8.6.5.23;
- 1> and for BCCH reception perform HS-DSCH reception procedures by listening to the first indexed HS-SCCH code listed in the IE "HS-SCCH channelisation code" with "BCCH specific H-RNTI" as received in IE "HS-DSCH common system information".

Whenever the variable HS_DSCH_RECEPTION_CELL_FACH_STATE is set to FALSE, the UE shall:

- 1> if the UE is in CELL_FACH and variable HS_DSCH_RECEPTION_OF_CCCH_ENABLED is set to FALSE:
 - 2> not perform HS_SCCH reception procedures;
 - 2> not perform HS-DSCH reception procedures.

8.5.37 Actions related to HS_DSCH_RECEPTION_OF_CCCH_ENABLED variable (FDD only)

When UE does not support HS-DSCH reception in CELL_FACH state or when the IE "HS-DSCH common system information" is not included in System Information Block type 5 or System Information Block type 5bis, the UE shall:

- 1> set HS_DSCH_RECEPTION_OF_CCCH_ENABLED to FALSE;
- 1> set the variable HS_DSCH_RECEPTION_GENERAL to FALSE.

When HS_DSCH_RECEPTION_OF_CCCH_ENABLED is set to TRUE, the UE shall:

- 1> set the variable HS_DSCH_RECEPTION_GENERAL to TRUE;
- 1> use the IE "HS-DSCH common system information" in System Information Block type 5 or System Information Block type 5bis;
- 1> configure the physical layer to use the "Total number of soft channel bits" (defined in Table 5.1a of [35]) for category 12 for HS-DSCH reception;
- 1> use the octet aligned HS-DSCH transport block table [15] in the MAC-ehs entity;
- 1> configure the HARQ according to IE "HARQ System info" as defined in subclause 8.6.5.20;
- 1> configure the common MAC-ehs reordering queues according to IE "Common MAC-ehs reordering queues" as defined in subclauses 8.6.5.22; and then
- 1> receive the CCCH according to IE "CCCH mapping info" as defined in subclause 8.6.5.21;
- 1> if the UE is RRC Connected mode:
 - 2> select a common H-RNTI as specified in 8.5.38;
 - 2> receive the SRB1 according to IE "SRB1 mapping info" as defined in subclause 8.6.5.19.
- 1> else:
 - 2> select a common H-RNTI as specified in [4].
- 1> and start to receive the HS-SCCH(s) with selected H-RNTI according to the IE "HS-SCCH channelisation code" on the selected cell applying the scrambling code as received in the IE "DL Scrambling code";

- 1> configure the MAC flow for BCCH reception as specified in [15];
- 1> and start to receive the first indexed HS-SCCH code listed in the IE "HS-SCCH channelisation code" with "BCCH specific H-RNTI" as received in IE "HS-DSCH common system information".

8.5.37a Actions related to HS_DSCH_RECEPTION_GENERAL

For CELL_FACH state, when UE does not support HS-DSCH reception in CELL_FACH state or when the IE "HS-DSCH common system information" or for CELL_PCH, URA_PCH when the UE does not support HS-DSCH reception in CELL_PCH and URA_PCH state or the IE "HS-DSCH paging system information" is not included in System Information Block type 5 or System Information Block type 5bis, the UE shall:

- 1> if the variable HS_DSCH_RECEPTION_GENERAL is set to TRUE:
 - 2> set the variable HS_DSCH_RECEPTION_GENERAL to FALSE;
 - 2> stop any HS_SCCH reception procedures;
 - 2> stop any HS-DSCH reception procedures;
 - 2> clear the variable H_RNTI and remove any stored H-RNTI;
 - 2> reset the MAC-ehs entity [15];
 - 2> release all HARQ resources;
 - 2> clear any stored IEs "HARQ info".

8.5.38 Common H-RNTI selection (FDD only)

When the IE "Common H-RNTI Information" is included in System Information Block type 5 or System Information Block type 5bis and if the UE is in CELL_FACH state, the UE shall select the Common H-RNTI according to the following rules:

- 1> compile a list of candidate Common H-RNTI IE(s) "Common H-RNTI" in the order of appearance in System Information Block type 5 or System Information Block type 5bis;
- 1> select a Common H-RNTI from the list of candidate Common H-RNTIs based on U-RNTI as follows:

$$\text{"Index of selected Common H-RNTI"} = \text{U-RNTI mod K},$$

where K is equal to the number of candidate Common H-RNTIs.

The UE shall set the CFN in relation to the SFN of the current cell according to subclause 8.5.15.

8.5.39 PICH selection for HSDPA based paging (FDD only)

When the IE "HS-DSCH paging system information" is included in System Information Block type 5 or System Information Block type 5bis and the UE is in UTRAN in CELL_PCH or URA_PCH state, the UE shall select the PICH according to the following rules:

- 1> compile a list of candidate PICH for HSDPA from IE(s) "HSDPA associated PICH info" in the order of appearance in System Information Block type 5 or System Information Block type 5bis;
- 1> select a PICH from the list of candidate PICHs based on U-RNTI as follows:

$$\text{"Index of selected HSDPA associated PICH"} = \text{U_RNTI value mod K},$$

where K is equal to the number of candidate PICHs for HSDPA.

8.5.40 HS_DSCH Reception in CELL_PCH and URA_PCH (FDD only)

When the IE "HS-DSCH paging system information" is included in System Information Block type 5 or System Information Block type 5bis and the UE supports HS-DSCH reception in CELL_PCH and URA_PCH state and the UE is in CELL_PCH or URA_PCH state, the UE shall:

- 1> set the variable HS_DSCH_RECEPTION_GENERAL to TRUE;
- 1> use the octet aligned HS-DSCH transport block table [15] in the MAC-ehs entity;
- 1> if variable H_RNTI and variable C_RNTI are set and the UE is in CELL_PCH state:
 - 2> determine the "Total number of soft channel bits" (defined in Table 5.1a of [35]) according to subclause 8.1.6.2 and use it in the physical layer;
 - 2> for DCCH or DTCH reception:
 - 3> use the value of the variable H_RNTI as UE identity in the HS-SCCH reception procedure in the physical layer.
 - 2> for BCCH reception:
 - 3> perform HS-DSCH reception procedures by listening to the first indexed HS-SCCH code listed in the IE "HS-SCCH channelisation code" with "BCCH specific H-RNTI" as received in IE "HS-DSCH common system information" from System Information Block type 5 or System Information Block type 5bis.
 - 2> if the UE detects the value of the variable H_RNTI in the HS-SCCH reception procedure:
 - 3> initiate the measurement report procedure as specified in subclause 8.4.2;
 - 3> move to CELL_FACH;
 - 3> start to receive HS-DSCH according to the procedure in subclause 8.5.36;
 - 3> stop timer T319 if it is running;
 - 3> restart the timer T305 if it is set to any value other than "infinity".
 - 2> if the UE has uplink RLC data PDU or uplink RLC control PDU on RB1 or upwards to transmit:
 - 3> initiate the measurement report procedure as specified in subclause 8.4.2;
 - 3> move to CELL_FACH state;
 - 3> start to receive HS-DSCH according to the procedure in subclause 8.5.36;
 - 3> stop timer T319 if it is running;
 - 3> restart the timer T305 if it is set to any value other than "infinity".
- 1> else:
 - 2> if variable H_RNTI or variable C_RNTI are set, or if the UE is in URA_PCH state:
 - 3> clear the variable H_RNTI;
 - 3> clear the variable C_RNTI;
 - 3> clear any stored IE "HARQ Info";
 - 3> reset the MAC-ehs entity [15].
 - 2> perform the HS-DSCH reception procedure according to IE "HS-DSCH paging system information" as received in System Information Block type 5 or System Information Block type 5bis, receive the HS-PDSCH applying:
 - 3> a scrambling code as received in the IE "DL Scrambling code";

- 3> a channelisation code selected according to 8.5.41 in "Number of PCCH transmissions" consecutive TTIs;
- 3> the Transport block sizes indexed in the IE "Transport Block Size List" for demultiplexing of upper layer PDUs from transport blocks delivered from the physical layer on HS-DSCH, as described in [29]; and
- 3> configure the physical layer to use the "Total number of soft channel bits" (defined in Table 5.1a of [35]) for category 12 for HS-DSCH reception.

8.5.41 HS-PDSCH channelisation codes selection for paging reception (FDD only)

When the IE "HS-DSCH paging system information" is included in System Information Block type 5 or System Information Block type 5bis and the UE is in UTRAN in CELL_PCH or URA_PCH state with variable H_RNTI not set, the UE shall select the channelisation code for HS-PDSCH reception according to the following rules:

- 1> compile a list of candidate HS-PDSCH channelisation codes from the IE(s) "HS-PDSCH Channelisation Code" in the order of appearance in System Information Block type 5 or System Information Block type 5bis;
- 1> select a HS-PDSCH channelisation codes from the list of candidate HS-PDSCH channelisation codes based on U-RNTI as follows:

$$\text{"Index of selected HS-PDSCH channelisation codes"} = U_RNTI \text{ value mod } K,$$

where K is equal to the number of candidate HS-PDSCH channelisation codes.

8.5.42 Autonomous UTRAN DRX Cycle length coefficient change

If timer T319 expires:

- 1> set k to the value of the stored IE "DRX cycle length coefficient";
- 1> store the result of $\text{MAX}(2^k, \text{PBP})$, where PBP is the Paging Block Periodicity, as the DRX cycle length; and
- 1> determine its connected mode paging occasions and PICH monitoring occasions in the same way as for idle mode, according to [4].

NOTE: The DRX cycle length to use in connected mode is defined in [4].

8.5.43 Reception of MBMS from a cell operating in MBSFN mode

A cell provides MBMS service in MBSFN mode if it is indicated so in system information, see subclause 8.1.1.6.3. A UE that supports MBSFN operation may receive MBMS services via a cell operating in MBSFN mode. For FDD and 3.84/7.68 Mcps TDD in order to receive an MBMS service via a MBSFN cluster the UE shall select the MBSFN cluster as specified in [4] in addition to selecting a cell for normal camping as specified in [4]. For 1.28 Mcps TDD in order to receive an MBMS service via an MBSFN cluster the UE shall at the first step camp on a unicast cell and get the frequency and "cell parameter ID" from the system information, and then get synchronized to the MBSFN cluster operating with that frequency and "cell parameter ID". For 3.84/7.68 Mcps TDD a cell shall be considered to be operating in MBSFN mode when individual scrambling codes are assigned to all timeslots (via the IE "TDD MBSFN Information").

8.5.44 HS-DSCH CQI reporting tables

If the variable HS_DSCH_RECEPTION is set to "TRUE", the UE shall:

- 1> if the UE has been configured with at least one MAC-ehs reordering queue:
 - 2> use the relevant CQI tables, as defined in [29], for the HS-DSCH category indicated by the IE "HS-DSCH physical layer category extension" stored in the variable UE_CAPABILITY_TRANSFERRED. For 1.28 Mcps TDD, use the table of transport block size, as defined in [15], for the HS-DSCH category indicated by the IE "HS-DSCH physical layer category extension" stored in the variable UE_CAPABILITY_TRANSFERRED

1> otherwise:

- 2> use the relevant CQI tables, as defined in [29], for the HS-DSCH category indicated by the IE "HS-DSCH physical layer category" stored in the variable UE_CAPABILITY_TRANSFERRED. For 1.28 Mcps TDD, use the table of transport block size, as defined in [15], for the HS-DSCH category indicated by the IE "HS-DSCH physical layer category" stored in the variable UE_CAPABILITY_TRANSFERRED

8.6 Generic actions on receipt and absence of an information element

8.6.1 CN information elements

8.6.1.1 Void

8.6.1.2 CN information info

If the IE "CN information info" is present in a message, the UE shall:

1> if the IE "Primary PLMN Identity" is present:

- 2> forward the content of the IE "Primary PLMN identity" to upper layers.

1> else:

2> if the IE "PLMN Identity" is present:

- 3> forward the content of the IE "PLMN identity" to upper layers.

1> if present, forward the content of the IE "CN common GSM-MAP NAS system information" to upper layers;

1> if the IE "CN domain related information" is present:

- 2> forward each occurrence of the IE "CN domain specific GSM-MAP NAS system info" together with the IE "CN domain identity" to upper layers.

2> if an IE "CN domain specific GSM-MAP NAS system info" is not present for a particular CN domain:

- 3> indicate to upper layers that no CN system information is available for that CN domain.

NOTE: If UTRAN at SRNS relocation includes and sets the IE "Primary PLMN identity" to the PLMN identity signalled in RANAP RELOCATION REQUEST [57], the UTRAN should also set the IE "PLMN identity" to the PLMN identity in the IE "PLMN Identity" of the Master Information Block transmitted in the cell(s) used by the UE after completed SRNS relocation.

8.6.1.3 Signalling connection release indication

If the IE "Signalling Connection release indication" is present in a message, the UE shall:

1> if all radio access bearers for the CN domain identified with the value of the IE "Signalling Connection release indication" would have been released in the variable ESTABLISHED_RABS after processing of the received message:

- 2> indicate release of the signalling connection identified with the value of the IE "Signalling Connection release indication" to the upper layers;

2> remove the signalling connection identified with the value of the IE "Signalling Connection release indication" from the variable ESTABLISHED_SIGNALLING_CONNECTIONS.

1> if radio access bearers for the CN domain identified with the value of the IE "Signalling Connection release indication" would remain in the variable ESTABLISHED_RABS after processing of the received message:

2> set the variable INVALID_CONFIGURATION to TRUE.

8.6.2 UTRAN mobility information elements

8.6.2.1 URA identity

The UE shall:

- 1> if the IE "URA identity" is included in a received message:
 - 2> if the IE "RRC State Indicator" is included and set to "URA_PCH":
 - 3> store this URA identity in the variable URA_IDENTITY;
 - 3> after sending a possible message to UTRAN and entering URA_PCH state as specified elsewhere, read system information block type 2 in the selected cell;
 - 3> if the stored URA identity in the variable URA_IDENTITY is not included in the list of URA identities in System Information Block type 2 in the selected cell, the list of URA identities in system information block type 2 is empty or if the system information block type 2 can not be found, a confirmation error of URA identity list has occurred:
 - 4> if no URA update procedure is ongoing:
 - 5> initiate a URA update procedure after entering URA_PCH state; see subclause 8.3.1.2.
 - 4> if a URA update procedure is ongoing:
 - 5> take actions as specified in subclause 8.3.1.10.
 - 1> if the IE "URA identity" is not included in a received message:
 - 2> if the IE "RRC State Indicator" is included and set to " URA_PCH":
 - 3> after sending a possible message to UTRAN and entering URA_PCH state as specified elsewhere, read System Information Block type 2 in the selected cell;
 - 3> if System Information Block type 2 in the selected cell contains a single URA identity:
 - 4> store this URA identity in the variable URA_IDENTITY.
 - 3> if System Information Block type 2 of the selected cell contains more than one URA identity, the list of URA identities in system information block type 2 is empty or if the system information block type 2 can not be found, a confirmation error of URA identity list has occurred:
 - 4> if no URA update procedure is ongoing:
 - 5> initiate a URA update procedure after entering URA_PCH state, see subclause 8.3.1.2.
 - 4> if a URA update procedure is ongoing:
 - 5> take actions as specified in subclause 8.3.1.10.

8.6.2.2 Mapping info

For FDD, 3.84 Mcps TDD and 7.68 Mcps TDD, if the IE "Mapping info" is received, the UE shall in this version of the specification:

- 1> ignore the contents of this IE.

For 1.28 Mcps TDD, if the IE "Mapping info" is received, the UE shall:

- 1> if the IE "Map parameter 1" is included, interpret the IE "Map parameter 1" as IE "UpPCH Position Info":

- 2> store and use the UpPCH position indicated by the IE "UpPCH Positon Info". The calculation of the uplink access position is described in [33].
- 1> if the IE "Map parameter 1" is not included:
 - 2> use the UpPTS as the default UpPCH position.
- 1> ignore other contents of the IE "Mapping info".

8.6.2.3 RNC support for change of UE capability

The UE shall:

- 1> if the IE "RNC support for change of UE capability" is included in a received message:
 - 2> set the variable RNC_CAPABILITY_CHANGE_SUPPORT to the value of the IE "RNC support for change of UE capability".

8.6.3 UE information elements

8.6.3.1 Activation time

If the UE receives a message in which presence is needed for the IE "Activation time", and the value is other than the default value "Now", the UE shall:

- 1> let the "reference CCTrCH" be defined as the CCTrCh that includes any transport channel or is associated with any physical channel which is being added, re-configured or removed, or, in the case of HS-DSCH, the CCTrCh including the associated DCH;
- 1> if the frame boundary immediately before the frame with the CFN (Connection Frame Number) value indicated by the IE "Activation Time" is at the TTI boundary common to all the transport channels that are multiplexed onto the reference CCTrCh:
 - 2> select that frame boundary as the activation time T.
- 1> else:
 - 2> select the next TTI boundary, which is common to all the transport channels that are multiplexed onto the reference CCTrCh, after the frame with the CFN (Connection Frame Number) value indicated by the IE "Activation Time", as the activation time T.
- 1> if the IE "Delay restriction flag" is received and activation time T is more than 128 frames from the CFN at which the message was received:
 - 2> choose an activation time T as soon as possible after reception of the message, respecting the performance requirements in subclause 13.5, which is common to all the transport channels that are multiplexed onto the reference CCTrCh.

NOTE: If the UE receives a message containing the IE "Delay restriction flag" and that message causes a transport channel or physical channel reconfiguration of the reference CCTrCH then the UE behaviour is not specified.

- 1> at the activation time T:
 - 2> for a physical channel reconfiguration other than an HS-DSCH related reconfiguration, caused by the received message:
 - 3> release the physical channel configuration, which was present before T;
 - 3> initiate the establishment of the physical channel configuration as specified for the physical channel information elements in the received message as specified elsewhere.
 - 2> for an HS-DSCH related reconfiguration in FDD or 1.28 Mcps TDD caused by the received message:

- 3> select the HS-SCCH subframe boundary immediately before the first HS-SCCH subframe, which entirely falls within the 10 ms frame following T;
- 3> start using, at that HS-SCCH subframe boundary, the new HS-DSCH configuration in the received message, replacing any old HS-DSCH configuration.
- 2> for an HS-DSCH related reconfiguration in 3.84 Mcps TDD or 7.68 Mcps TDD caused by the received message:
 - 3> start using, at activation time T, the new HS-DSCH configuration in the received message, replacing any old HS-DSCH configuration.
- 2> for actions, other than a physical channel reconfiguration, caused by the received message:
 - 3> perform the actions for the information elements in the received message as specified elsewhere.

NOTE: In FDD an "HS-DSCH related reconfiguration" includes, in particular, reconfigurations that need to be time-aligned with the 2ms subframe of the HS-SCCH, HS-PDSCH and/or HS-DPCCH. For example, start and stop of HS-SCCH reception and serving HS-DSCH cell change.

If the UE receives a message in which presence is needed for the IE "Activation time", and the value is the default value "Now", the UE shall:

- 1> choose an activation time T as soon as possible after the reception of the message, respecting the performance requirements in subclause 13.5;
- 1> at the activation time T:
 - 2> perform the actions for the information elements in the received message as specified elsewhere.

NOTE: In FDD, if the UE was in idle mode or CELL_FACH or CELL_PCH state upon reception of the message, regardless of the state the UE enters after reception of the message, and the value of the IE "Activation time" in the received message is different from "Now", the UE behaviour is unspecified. In TDD, if the UE was in idle mode or CELL_FACH state upon reception of the message, the value of the IE "Activation time" in the received message is relative to the CFN associated with the cell from which the message was received.

8.6.3.1a CN domain specific DRX cycle length coefficient

The UE updates CN domain specific DRX cycle length coefficient as specified in [4]. The UE shall use it to calculate the CN domain specific DRX cycle length, according to the following:

- 1> set k to the value of the IE "CN domain specific DRX cycle length coefficient".
- 1> store the result of $\text{MAX}(2^k, \text{PBP})$, where PBP is the Paging Block Periodicity, as the CN domain specific DRX cycle length for the CN domain indicated by the IE "CN domain identity". For FDD PBP=1.

The UE shall determine its idle mode paging occasions and PICH monitoring occasions for that CN domain, according to [4], based on the stored CN domain specific DRX cycle length, when using DRX in idle mode.

8.6.3.1b H-RNTI

If the IE "New H-RNTI" is included and the UE will be in CELL_DCH state after completion of this procedure, the UE shall:

- 1> if the IE "New H-RNTI" is received in a UTRAN MOBILITY INFORMATION message
 - 2> the UE behaviour is unspecified.
- 1> store the value in the variable H_RNTI;
- 1> determine the value for the HS_DSCH_RECEPTION variable and take the corresponding actions as described in subclause 8.5.25.

If the message that triggers the HS_DSCH_RECEPTION variable to change value from FALSE to TRUE does not contain the IE "New H-RNTI"; and

if, before receiving that message, the UE is not in CELL_FACH or CELL_PCH state or the variable H_RNTI is not set:

- 1> the UE behaviour is not defined.

When the variable HS_DSCH_RECEPTION is set to TRUE the UE shall:

- 1> use the value of the variable H_RNTI as UE identity in the HS-SCCH reception procedure in the physical layer.

In FDD, if the IE "New H-RNTI" is included and the UE will be in CELL_FACH state after completion of this procedure, the UE shall:

- 1> store the value in the variable H_RNTI;
- 1> determine the value for the HS_DSCH_RECEPTION_CELL_FACH_STATE variable and take the corresponding actions as described in subclause 8.5.36.

When the variable HS_DSCH_RECEPTION_CELL_FACH_STATE is set to TRUE the UE shall:

- 1> use the value of the variable H_RNTI as UE identity in the HS-SCCH reception procedure in the physical layer.

In FDD, if the IE "New H-RNTI" is included and the UE will be in CELL_PCH state after completion of this procedure, the UE shall:

- 1> store the value in the variable H_RNTI.

8.6.3.2 UTRAN DRX Cycle length coefficient

If the IE "UTRAN DRX cycle length coefficient" is present, the UE shall use it to calculate the UTRAN DRX cycle length, according to the following:

- 1> start timer T319 using the IE "Time for DRX cycle 2" value;
- 1> store IE "DRX cycle length coefficient";
- 1> set k to the value of the IE "DRX cycle length coefficient 2";
- 1> store the result of $\text{MAX}(2^k \text{PBP})$, where PBP is the Paging Block Periodicity, as the DRX cycle length.

The UE shall determine its connected mode paging occasions and PICH monitoring occasions in the same way as for idle mode, according to [4].

The DRX cycle length to use in connected mode is defined in [4].

8.6.3.3 Generic state transition rules depending on received information elements

The IE "RRC State Indicator" indicates the state the UE shall enter. The UE shall enter the state indicated by the IE "RRC State Indicator" even if the received message includes other IEs relevant only for states other than indicated by the IE "RRC State Indicator". E.g. if the RRC state indicator is set to CELL_FACH while other IEs provide information about a configuration including dedicated channels, the UE shall enter CELL_FACH state. If however the UE has no information about the configuration corresponding to the state indicated by the IE "RRC State Indicator", it shall consider the requested configuration as invalid.

The UE shall, if the IE "RRC State Indicator" in the received message has the value:

- 1> "CELL_FACH":
 - 2> enter CELL_FACH state as dictated by the procedure governing the message received.
- 1> "CELL_DCH":
 - 2> if neither DPCH is assigned in the message nor is the UE in CELL_DCH:
 - 3> set the variable INVALID_CONFIGURATION to TRUE.

2> else:

3> enter CELL_DCH state as dictated by the procedure governing the message received.

1> "CELL_PCH":

2> if the received message is RRC CONNECTION SETUP and IE "RRC State Indicator" is set to CELL_PCH:

3> set the variable INVALID_CONFIGURATION to TRUE.

2> else:

3> enter CELL_PCH state as dictated by the procedure governing the message received.

1> "URA_PCH":

2> if the received message is RRC CONNECTION SETUP and IE "RRC State Indicator" is set to URA_PCH:

3> set the variable INVALID_CONFIGURATION to TRUE.

2> else:

3> enter URA_PCH state as dictated by the procedure governing the message received.

8.6.3.4 Cipherng mode info

The IE "Cipherng mode info" defines the new cipherng configuration. At any given time, the UE needs to store at most two different cipherng configurations (keyset and algorithm) per CN domain at any given time in total for all radio bearers and three configurations in total for all signalling radio bearers.

If the IE "Cipherng mode info" is present and if the IE "Reconfiguration" in the variable CIPHERING_STATUS is set to TRUE, the UE shall:

1> ignore this second attempt to change the cipherng configuration; and

1> set the variable INCOMPATIBLE_SECURITY_RECONFIGURATION to TRUE.

If the IE "Cipherng mode info" is present and if the IE "Reconfiguration" in the variable CIPHERING_STATUS is set to FALSE, the UE shall:

1> if none of the IE "Status" in the variable CIPHERING STATUS has the value "Started", and this IE "Cipherng mode info" was included in a message that is not the message SECURITY MODE COMMAND; or

1> if the IE "Cipherng Mode Info" was received in the message SECURITY MODE COMMAND and there does not exist exactly one cipherng activation time in the IE "Radio bearer downlink cipherng activation time info" for each established RLC-AM and RLC-UM radio bearers included in the IE "RB information" in the IE "ESTABLISHED_RABS" for the CN domain as indicated in the variable LATEST_CONFIGURED_CN_DOMAIN; or

1> if the IE "Cipherng Mode Info" was received in the message SECURITY MODE COMMAND and the IE "Cipherng activation time for DPCH" is not included in the message, and there exist radio bearers using RLC-TM according to the IE "RB information" in the IE "ESTABLISHED_RABS" for the CN domain as indicated in the variable LATEST_CONFIGURED_CN_DOMAIN; or

1> if the IE "Cipherng Mode Info" was received in the message SECURITY MODE COMMAND and there does not exist exactly one cipherng activation time in the IE "Radio bearer downlink cipherng activation time info" for each established signalling radio bearer included in the IE "Signalling radio bearer information" in the IE "ESTABLISHED_RABS":

2> ignore this attempt to change the cipherng configuration;

2> set the variable INVALID_CONFIGURATION to TRUE;

2> perform the actions as specified in subclause 8.1.12.4c.

1> set the IE "Reconfiguration" in the variable CIPHERING_STATUS to TRUE;

- 1> set the IE "Status" in the variable CIPHERING_STATUS of the CN domains for which the IE "Status" of the variable SECURITY_MODIFICATION is set to "Affected" to "Started";
- 1> apply the new ciphering configuration in the lower layers for all RBs that belong to a CN domain for which the IE "Status" of the variable SECURITY_MODIFICATION is set to "Affected" and all signalling radio bearers:
 - 2> using the ciphering algorithm (UEA [40]) indicated by the IE "Ciphering algorithm" as part of the new ciphering configuration;
 - 2> for each radio bearer that belongs to a CN domain for which the IE "Status" of the variable SECURITY_MODIFICATION is set to "Affected" and all signalling radio bearers:
 - 3> using the value of the IE "RB identity" in the variable ESTABLISHED_RABS minus one as the value of BEARER [40] in the ciphering algorithm.
- 1> for the downlink and the uplink, apply the new ciphering configuration as follows:
 - 2> if the ciphering configuration for a AM or UM radio bearer or signalling radio bearer from a previously received SECURITY MODE COMMAND has not yet been applied because of the corresponding activation times not having been reached and the current received message includes the IE "DL Counter Synch Info" or the current received message is a RADIO BEARER RECONFIGURATION message and includes the IE "New U-RNTI":
 - 3> if the previous SECURITY MODE COMMAND was received due to new keys being received:
 - 4> consider the new ciphering configuration to include the received new keys.
 - 3> else if the previous SECURITY MODE COMMAND caused a change in LATEST_CONFIGURED_CN_DOMAIN:
 - 4> consider the new ciphering configuration to include the keys associated with the LATEST_CONFIGURED_CN_DOMAIN.
 - 3> apply the new ciphering configuration in uplink and downlink immediately following RLC re-establishment.
- 2> if the IE "Ciphering activation time for DPCH" is present in the IE "Ciphering mode info" and the UE was in CELL_DCH state prior to this procedure:
 - 3> for radio bearers using RLC-TM:
 - 4> apply the old ciphering configuration for CFN less than the number indicated in the IE "Ciphering activation time for DPCH";
 - 4> apply the new ciphering configuration for CFN greater than or equal to the number indicated in IE "Ciphering activation time for DPCH".
- 2> if the IE "Radio bearer downlink ciphering activation time info" is present:
 - 3> apply the following procedure for each radio bearer and signalling radio bearers using RLC-AM or RLC-UM indicated by the IE "RB identity":
 - 4> suspend uplink transmission on the radio bearer or the signalling radio bearer (except for the SRB where the response message is transmitted) according to the following:
 - 5> do not transmit RLC PDUs with sequence number greater than or equal to the uplink activation time, where the uplink activation time is selected according to the rules below.
 - 4> select an "RLC sequence number" at which (activation) time the new ciphering configuration shall be applied in uplink for that radio bearer according to the following:
 - 5> consider a ciphering activation time in uplink to be pending until the RLC sequence number of the next RLC PDU to be transmitted for the first time is equal to or larger than the selected activation time;

- 5> for each radio bearer and signalling radio bearer that has no pending ciphering activation time in uplink as set by a previous procedure changing the security configuration:
 - 6> set a suitable value that would ensure a minimised delay in the change to the latest ciphering configuration.
- 5> for each radio bearer and signalling radio bearer that has a pending ciphering activation time in uplink as set by a previous procedure changing the security configuration:
 - 6> for radio bearers and signalling radio bearers except SRB2:
 - 7> set the same value as the pending ciphering activation time.
 - 6> for signalling radio bearer SRB2:
 - 7> set a suitable value that would ensure a minimised delay in the change to the latest ciphering configuration.
- 4> store the selected "RLC sequence number" for that radio bearer in the entry for the radio bearer in the variable RB_UPLINK_CIPHERING_ACTIVATION_TIME_INFO;
- 4> switch to the new ciphering configuration according to the following:
 - 5> use the old ciphering configuration for the transmitted and received RLC PDUs with RLC sequence numbers smaller than the corresponding RLC sequence numbers indicated in the IE "Radio bearer uplink ciphering activation time info" sent to UTRAN and in the received IE "Radio bearer downlink ciphering activation time info" received from UTRAN, respectively;
 - 5> use the new ciphering configuration for the transmitted and received RLC PDUs with RLC sequence numbers greater than or equal to the corresponding RLC sequence numbers indicated in the IE "Radio bearer uplink ciphering activation time info" sent to UTRAN and in the received IE "Radio bearer downlink ciphering activation time info" received from UTRAN, respectively;
 - 5> for a radio bearer using RLC-AM, when the RLC sequence number indicated in the IE "Radio bearer downlink ciphering activation time info" falls below the RLC receiving window and the RLC sequence number indicated in the IE "Radio bearer uplink ciphering activation time info" falls below the RLC transmission window, the UE may release the old ciphering configuration for that radio bearer;
 - 5> if an RLC reset or re-establishment of the transmitting side of an RLC entity occurs before the activation time for the new ciphering configuration has been reached in uplink, ignore the activation time and apply the new ciphering configuration in uplink immediately after the RLC reset or RLC re-establishment;
 - 5> if an RLC reset or re-establishment of the receiving side of an RLC entity occurs before the activation time for the new ciphering configuration has been reached in downlink, ignore the activation time and apply the new ciphering configuration in downlink immediately after the RLC reset or RLC re-establishment.
- 2> if the current received message includes the IE "Downlink counter synchronisation info" or the current received message is a RADIO BEARER RECONFIGURATION message and includes the IE "New U-RNTI":
 - 3> apply the new ciphering configuration in uplink and downlink immediately following RLC re-establishment.

If the IE "Radio bearer downlink ciphering activation time info" was received in another message than SECURITY MODE COMMAND:

- 1> the UE behaviour is unspecified.

If the IE "Ciphering mode info" is not present, the UE shall:

- 1> for the downlink and the uplink, apply the ciphering configuration as follows:

- 2> if the ciphering configuration for a AM or UM radio bearer or signalling radio bearer from a previously received SECURITY MODE COMMAND has not yet been applied because of the corresponding activation times not having been reached and the current received message includes the IE "Downlink counter synchronisation info" or the current received message is a RADIO BEARER RECONFIGURATION message and includes the IE "New U-RNTI":
 - 3> if the previous SECURITY MODE COMMAND was received due to new keys being received:
 - 4> consider the ciphering configuration to include the received new keys.
 - 3> else if the previous SECURITY MODE COMMAND caused a change in LATEST_CONFIGURED_CN_DOMAIN:
 - 4> consider the ciphering configuration to include the keys associated with the LATEST_CONFIGURED_CN_DOMAIN.
 - 3> apply the ciphering configuration in uplink and downlink immediately following RLC re-establishment.
- 2> else:
 - 3> not change the ciphering configuration.

8.6.3.5 Integrity protection mode info

The IE "Integrity protection mode info" defines the new integrity protection configuration. At any given time, the UE needs to store at most three different integrity protection configurations (keysets) in total for all signalling radio bearers for all CN domains.

If the IE "Integrity protection mode info" is present and if the IE "Reconfiguration" in the variable INTEGRITY_PROTECTION_INFO is set to TRUE, the UE shall:

- 1> ignore this second attempt to change the integrity protection configuration; and
- 1> set the variable INCOMPATIBLE_SECURITY_RECONFIGURATION to TRUE.

If the IE "Integrity protection mode command" has the value "Start", the IE "Status" in the variable INTEGRITY_PROTECTION_INFO has the value "Not started" and the IE "Integrity protection mode info" was not included in the message SECURITY MODE COMMAND; or

If the IE "Integrity protection mode command" has the value "Start", the IE "Status" in the variable INTEGRITY_PROTECTION_INFO has the value "Not started", the IE "Integrity protection mode info" was included in the message SECURITY MODE COMMAND and the IE "Integrity protection algorithm" is not included; or

If the IE "Integrity protection mode command" has the value "Modify" and the IE "Status" in the variable INTEGRITY_PROTECTION_INFO has the value "Not Started"; or

If the IE "Integrity protection mode command" has the value "Start", the IE "Status" in the variable INTEGRITY_PROTECTION_INFO has the value "Started" and the IE "Integrity protection mode command info" was included in the message SECURITY MODE COMMAND; or

If the IE "Integrity protection mode command" has the value "Modify" and there does not exist exactly one integrity protection activation time in the IE "Downlink integrity protection activation info" for each established signalling radio bearer included in the IE "Signalling radio bearer information" in the IE "ESTABLISHED_RABS"; or

If the IE "Integrity protection mode command" has the value "Modify", the IE "Status" in the variable INTEGRITY_PROTECTION_INFO has the value "Started" and the IE "Integrity protection mode info" was not included in the message SECURITY MODE COMMAND:

the UE shall:

- 1> ignore this attempt to change the integrity protection configuration; and
- 1> set the variable INVALID_CONFIGURATION to TRUE.

If the IE "Integrity protection mode info" is not present, the UE shall:

1> not change the integrity protection configuration.

If the IE "Integrity protection mode info" is present and if the IE "Reconfiguration" in the variable INTEGRITY_PROTECTION_INFO is set to FALSE, the UE shall:

- 1> set the IE "Reconfiguration" in the variable INTEGRITY_PROTECTION_INFO to TRUE;
- 1> perform the actions in accordance with subclauses 8.6.3.5.1, 8.6.3.5.2 and 8.6.3.5.3.

8.6.3.5.1 Initialisation of Integrity Protection

The UE shall:

- 1> if the IE "Integrity protection mode command" has the value "start" and the IE "Status" in the variable INTEGRITY_PROTECTION_INFO has the value "Not started", and this IE was included in the message SECURITY MODE COMMAND:
 - 2> initialise the information for all signalling radio bearers in the variable INTEGRITY_PROTECTION_INFO according to the following:
 - 3> set the IE "Uplink RRC Message sequence number" in the variable INTEGRITY_PROTECTION_INFO to zero;
 - 3> do not set the IE "Downlink RRC Message sequence number" in the variable INTEGRITY_PROTECTION_INFO;
 - 3> set the variable INTEGRITY_PROTECTION_ACTIVATION_INFO to zero for each signalling radio bearer in the IE "ESTABLISHED_RABS".

NOTE: The IEs "Integrity protection activation info" and "RRC Message sequence number" included in the IE "Integrity Check Info" in the transmitted message do not have identical values, but integrity protection is applied from the first transmitted message.

- 2> set the IE "Status" in the variable INTEGRITY_PROTECTION_INFO to the value "Started";
- 2> perform integrity protection on the received message, applying the new integrity protection configuration, as described in subclause 8.5.10.1 by:
 - 3> using the algorithm (UIA [40]) indicated by the IE "Integrity protection algorithm" contained in the IE "Integrity protection mode info";
 - 3> using the IE "Integrity protection initialisation number", contained in the IE "Integrity protection mode info" as the value of FRESH [40].
- 2> start applying the new integrity protection configuration in the downlink for each signalling radio bearer in the IE "ESTABLISHED_RABS" except RB2 at the next received RRC message;
- 2> start applying the new integrity protection configuration in the downlink for signalling radio bearer RB2 from and including the received SECURITY MODE COMMAND message;
- 2> start applying the new integrity protection configuration in the uplink for signalling radio bearer RB2 from and including the transmitted SECURITY MODE COMPLETE message;
- 2> start applying the new integrity protection configuration in the uplink for signalling radio bearers other than RB2 at the uplink activation time included in the IE "Uplink integrity protection activation info".

NOTE: After Inter-RAT handover to UTRAN, and ciphering was activated in the other RAT, then during the first security mode control procedure following the handover, UE activates integrity protection using the integrity key of the same key set as used in the other RAT (see.subclause 8.3.6.3).

8.6.3.5.2 Integrity Protection Re-configuration for SRNS Relocation and handover from GERAN Iu mode

The UE shall:

- 1> if IE "Integrity protection mode command" has the value "start" and the IE "Status" in the variable INTEGRITY_PROTECTION_INFO has the value "Started" and this IE was not included SECURITY MODE COMMAND:

NOTE: This case is used in SRNS relocation and in handover from GERAN *Iu mode*.

- 2> perform integrity protection on the received message, applying the new integrity protection configuration, as described in subclause 8.5.10.1 by:
- 3> using the algorithm (UIA [40]) indicated by the IE "Integrity protection algorithm" contained in the IE "Integrity protection mode info";

NOTE: If the algorithm indicated by the IE "Integrity protection algorithm" is different from the one currently used by the UE, then this leads to a change of the integrity protection algorithm.

- 3> using the IE "Integrity protection initialisation number", contained in the IE "Integrity protection mode info" as the value of FRESH [40].
- 2> let RB_m be the signalling radio bearer where the reconfiguration message was received and let RB_n be the signalling radio bearer where the response message is transmitted;
- 2> prohibit transmission of RRC messages on all signalling radio bearers in the IE "ESTABLISHED_RABS" except on RB₀ and the radio bearer where the response message is transmitted;
- 2> for the downlink, for each signalling radio bearer, if for the signalling radio bearer, a security configuration triggered by a previous SECURITY MODE COMMAND has not yet been applied, due to the activation time for the signalling radio bearer not having been reached:
- 3> set "Down link RRC Message sequence number" for this signalling radio bearer in the variable INTEGRITY_PROTECTION_INFO to (activation time -1), where the activation time is the corresponding activation time for this signalling radio bearer;
- 3> if the previous SECURITY MODE COMMAND was received due to new keys being received:
- 4> consider the new integrity protection configuration to include the received new keys.
- 3> else if the previous SECURITY MODE COMMAND caused a change in LATEST_CONFIGURED_CN_DOMAIN:
- 4> consider the new Integrity Protection configuration to include the keys associated with the LATEST_CONFIGURED_CN_DOMAIN associated with the previously received SECURITY MODE COMMAND.
- 2> start applying the new integrity protection configuration in the downlink for each signalling radio bearer in the IE "ESTABLISHED_RABS" except RB_m at the next received RRC message for the corresponding signalling radio bearer;
- 2> start applying the new integrity protection configuration in the downlink for signalling radio bearer RB_m from and including the received configuration message;
- 2> start applying the new integrity protection configuration in the uplink for signalling radio bearer RB_n from and including the transmitted response message;
- 2> start applying the new integrity protection configuration in the uplink for signalling radio bearers other than RB_n from the first message onwards.

8.6.3.5.3 Integrity Protection modification in case of new keys or initialisation of signalling connection

The UE shall:

- 1> if the IE "Integrity protection mode command" has the value "modify" and the IE "Status" in the variable INTEGRITY_PROTECTION_INFO has the value "Started" and this IE was included in SECURITY MODE COMMAND:

- 2> store the (oldest currently used) integrity protection configuration until activation times have elapsed for the new integrity protection configuration to be applied on all signalling radio bearers;
 - 2> start applying the new integrity protection configuration in the downlink for each signalling radio bearer *n*, at the first received message with RRC Sequence number greater than or equal to the RRC sequence number indicated by the entry for signalling radio bearer *n* in the "RRC message sequence number list" in the IE "Downlink integrity protection activation info", included in the IE "Integrity protection mode info";
 - 2> perform integrity protection on the received message, applying the new integrity protection configuration, as described in subclause 8.5.10.1;
 - 3> if present, use the algorithm indicated by the IE "Integrity protection algorithm" (UIA [40]);
 - 2> set the content of the variable INTEGRITY_PROTECTION_ACTIVATION_INFO according to the following:
 - 3> for each established signalling radio bearer, stored in the variable ESTABLISHED_RABS:
 - 4> select a value of the RRC sequence number at which (activation) time the new integrity protection configuration shall be applied in uplink for that signalling radio bearer according to the following:
 - 5> for each signalling radio bearer except RB0:
 - 6> set the activation time for the new integrity protection configuration to the next RRC SN.
 - 4> for signalling radio bearer RB0:
 - 5> set the value of the included RRC sequence number to greater than or equal to the current value of the RRC sequence number for signalling radio bearer RB0 in the variable INTEGRITY_PROTECTION_ACTIVATION_INFO, plus the value of the constant N302 plus two.
 - 4> prohibit the transmission of RRC messages on all signalling radio bearers, except for RB2, with RRC SN greater than or equal to the value in the "RRC message sequence number list" for the signalling radio bearer in the IE "Uplink integrity protection activation info" of the variable INTEGRITY_PROTECTION_ACTIVATION_INFO.
 - 2> start applying the new integrity protection configuration in the uplink at the RRC sequence number, for each RB*n*, except for signalling radio bearer RB2, indicated by the entry for signalling radio bearer *n* in the "RRC message sequence number list" in the IE "Uplink integrity protection activation info", included in the variable INTEGRITY_PROTECTION_ACTIVATION_INFO;
 - 2> start applying the new integrity protection configuration in the uplink at the RRC sequence number for signalling radio bearer RB2, as specified for the procedure initiating the integrity protection reconfiguration;
 - 2> start applying the new integrity protection configuration in the downlink at the RRC sequence number, for each RB*n*, except for signalling radio bearer RB2, indicated by the entry for signalling radio bearer *n* in the "RRC message sequence number list" in the IE "Downlink integrity protection activation info";
- NOTE: For signalling radio bearers that have a pending activation time as set for integrity protection by a previous procedure changing the integrity protection configuration, UTRAN should set this value in IE "Downlink integrity protection activation info".
- 2> start applying the new integrity protection configuration in the downlink at the RRC sequence number for signalling radio bearer RB2, as specified for the procedure initiating the integrity protection reconfiguration.

8.6.3.6 Void

8.6.3.7 Void

8.6.3.8 Integrity check info

If the IE "Integrity check info" is present the UE shall:

- 1> act as described in subclause 8.5.10.1.

8.6.3.9 New C-RNTI

If the IE "New C-RNTI" is included, the UE shall:

- 1> store the value in the variable C_RNTI, replacing any old stored value;
- 1> use that C-RNTI when using common transport channels of type RACH and FACH in the current cell;
- 1> for FDD:
 - 2> if the UE is in CELL_FACH and CELL_PCH:
 - 3> use that C-RNTI when using the transport channel of type HS-DSCH.

8.6.3.9a New DSCH-RNTI

In TDD if the IE "New DSCH-RNTI" is included, the UE shall:

- 1> if the UE will be in CELL_DCH or CELL_FACH at the end of the procedure where the received message included this IE:
 - 2> if the UE supports DSCH or USCH as indicated in the IE "Physical Channel Capability" included in the IE "UE Radio Access Capability":
 - 3> store the value in the variable DSCH_RNTI, replacing any old stored value;
 - 3> use that DSCH-RNTI when using SHCCH signalling in the current cell.

8.6.3.10 New U-RNTI

If the IE "New U-RNTI" is included in a received message, the UE shall:

- 1> store the value in the variable U_RNTI, replacing any old stored value.

8.6.3.11 RRC transaction identifier

The IE "RRC transaction identifier" may be used, together with the message type, for identification of an invocation of a downlink procedure (transaction). The UE behaviour for accepting or rejecting transactions based on the message type and the IE "RRC transaction identifier" is specified below.

If the IE "RRC transaction identifier" is included in a received message, the UE shall perform the actions below. The UE shall:

If the received message is any of the messages:

- RADIO BEARER SETUP; or
- RADIO BEARER RECONFIGURATION; or
- RADIO BEARER RELEASE; or
- TRANSPORT CHANNEL RECONFIGURATION; or
- PHYSICAL CHANNEL RECONFIGURATION:

the UE shall:

- 1> if the variable ORDERED_RECONFIGURATION is set to FALSE; and

- 1> if the variable CELL_UPDATE_STARTED is set to FALSE; and
- 1> if the received message does not contain a protocol error according to clause 9 and the variable PROTOCOL_ERROR_REJECT is set to FALSE; and
- 1> if the table "Accepted transactions" in the variable TRANSACTIONS does not contain an entry with an IE "Message Type" set to ACTIVE SET UPDATE:
 - 2> accept the transaction; and
 - 2> store the IE "Message type" and the IE "RRC transaction identifier" of the received message in the table "Accepted transactions" in the variable TRANSACTIONS.
- 1> else:
 - 2> if the variable ORDERED_RECONFIGURATION is set to TRUE; or
 - 2> if the variable CELL_UPDATE_STARTED is set to TRUE; or
 - 2> if the table "Accepted transactions" in the variable TRANSACTIONS contains an entry with an IE "Message Type" set to ACTIVE SET UPDATE; or
 - 2> if the received message contains a protocol error according to clause 9 causing the variable PROTOCOL_ERROR_REJECT to be set to TRUE:
 - 3> if the IE "RRC transaction identifier" of the received message is identical to the "RRC transaction identifier" stored for the same "Message Type" as the received message in the table "Accepted transactions" in the variable TRANSACTIONS:
 - 4> ignore the transaction; and
 - 4> continue with any ongoing processes and procedures as the message was not received;
 - 4> and end the procedure.
 - 3> else:
 - 4> reject the transaction; and
 - 4> if the IE "Message Type" of the received message is not present in the table "Rejected transactions" in the variable TRANSACTIONS:
 - 5> store the IE "Message type" and the IE "RRC transaction identifier" of the received message in the table "Rejected transactions" in the variable TRANSACTIONS.

Else:

If the received message is any of the messages:

- RRC CONNECTION SETUP; or
- CELL UPDATE CONFIRM; or
- URA UPDATE CONFIRM; or
- UE CAPABILITY ENQUIRY:

the UE shall:

- 1> if the IE "Message Type" of the received message is not present in the table "Accepted transactions" in the variable TRANSACTIONS:
- 2> if the received message does not contain a protocol error according to clause 9 and the variable PROTOCOL_ERROR_REJECT is set to FALSE:
- 3> accept the transaction; and

- 3> store the IE "Message type" and the IE "RRC transaction identifier" of the received message in the table "Accepted transactions" in the variable TRANSACTIONS.
- 2> else:
 - 2> if the received message contains a protocol error according to clause 9 causing the variable PROTOCOL_ERROR_REJECT to be set to TRUE:
 - 3> reject the transaction; and
 - 3> if the IE "Message Type" of the received message is not present in the table "Rejected transactions" in the variable TRANSACTIONS:
 - 4> store the IE "Message type" and the IE "RRC transaction identifier" of the received message in the table "Rejected transactions" in the variable TRANSACTIONS.
 - 1> else:
 - 1> if the IE "Message Type" of the received message is present in the table "Accepted transactions" in the variable TRANSACTIONS:
 - 2> if the IE "RRC transaction identifier" of the received message is identical to the "RRC transaction identifier" stored for the "Message Type" in the table "Accepted transactions" in the variable TRANSACTIONS:
 - 3> ignore the transaction; and
 - 3> continue with any ongoing processes and procedures as the message was not received; and
 - 3> end the procedure.
 - 2> else:
 - 2> if the IE "RRC transaction identifier" of the received message is different from the "RRC transaction identifier" stored for the "Message Type" in the table "Accepted transactions" in the variable TRANSACTIONS:
 - 3> if the received message does not contain a protocol error according to clause 9 and the variable PROTOCOL_ERROR_REJECT is set to FALSE:
 - 4> ignore the once accepted transaction and instead accept the new transaction; and
 - 4> store the IE "Message type" and the IE "RRC transaction identifier" of the received message in the table "Accepted transactions" in the variable TRANSACTIONS, replacing the previous entry.

NOTE 1: The UE is expected to process the first RRC CONNECTION SETUP/CELL UPDATE CONFIRM/URA UPDATE CONFIRM message that it receives after transmitting an RRC CONNECTION REQUEST/CELL_UPDATE/URA_UPDATE message. If the UE receives further RRC CONNECTION SETUP/CELL UPDATE CONFIRM/URA UPDATE CONFIRM messages without having transmitted another RRC CONNECTION REQUEST/CELL_UPDATE/URA_UPDATE message, the UE is not required to process these messages.

NOTE 2: If the previously accepted transaction was a CELL UPDATE CONFIRM/URA UPDATE CONFIRM that included the IE "Dowlink counter synchronisation info", rather than ignore the first accepted transaction the UE may continue with the first transaction in the case where a cell re-selection interrupted the on-going procedure causing a cell update procedure to be triggered. In this case the response message acts as an explicit acknowledgement of both the CELL UPDATE CONFIRM/URA UPDATE CONFIRM message signalling an SRNS relocation and the subsequent CELL UPDATE CONFIRM/URA UPDATE CONFIRM.

- 3> else:
 - 3> if the received message contains a protocol error according to clause 9 causing the variable PROTOCOL_ERROR_REJECT to be set to TRUE:
 - 4> reject the transaction; and

4> if the IE "Message Type" of the received message is not present in the table "Rejected transactions" in the variable TRANSACTIONS:

5> store the IE "Message type" and the IE "RRC transaction identifier" of the received message in the table "Rejected transactions" in the variable TRANSACTIONS.

Else:

If the received message is any of the messages:

- HANDOVER FROM UTRAN COMMAND; or
- CELL CHANGE ORDER FROM UTRAN:

the UE shall:

1> if the variable ORDERED_RECONFIGURATION is set to TRUE;

2> reject the transaction; and

2> if the IE "Message Type" of the received message is not present in the table "Rejected transactions" in the variable TRANSACTIONS:

3> store the IE "Message type" and the IE "RRC transaction identifier" of the received message in the table "Rejected transactions" in the variable TRANSACTIONS.

Else:

If the received message is any other message, the UE shall:

1> if the IE "Message Type" of the received message is not present in the table "Accepted transactions" in the variable TRANSACTIONS:

2> if the received message does not contain a protocol error according to clause 9 and the variable PROTOCOL_ERROR_REJECT is set to FALSE:

3> accept the transaction; and

3> store the IE "Message type" and the IE "RRC transaction identifier" of the received message in the table "Accepted transactions" in the variable TRANSACTIONS.

2> else:

2> if the received message contains a protocol error according to clause 9 causing the variable PROTOCOL_ERROR_REJECT to be set to TRUE:

3> reject the transaction; and

3> store the IE "Message type" and the IE "RRC transaction identifier" of the received message in the table "Rejected transactions" in the variable TRANSACTIONS.

1> else:

1> if the IE "Message Type" of the received message is present in the table "Accepted transactions" in the variable TRANSACTIONS:

2> if the IE "RRC transaction identifier" of the received message is identical to the "RRC transaction identifier" stored in any entry for the "Message Type" in the table "Accepted transactions" in the variable TRANSACTIONS:

3> ignore the transaction; and

3> continue with any ongoing processes and procedures as the message was not received; and

3> end the procedure.

2> else:

- 2> if the IE "RRC transaction identifier" of the received message is different from the "RRC transaction identifier" stored in all entries for the "Message Type" in the table "Accepted transactions" in the variable TRANSACTIONS:
 - 3> if the received message does not contain a protocol error according to clause 9 and the variable PROTOCOL_ERROR_REJECT is set to FALSE:
 - 4> accept the additional transaction; and
 - 4> store the IE "Message type" and the IE "RRC transaction identifier" of the received message in the table "Accepted transactions" in the variable TRANSACTIONS, in addition to the already existing entries.
 - 3> else:
 - 3> if the received message contains a protocol error according to clause 9 causing the variable PROTOCOL_ERROR_REJECT to be set to TRUE:
 - 4> reject the transaction; and
 - 4> store the IE "Message type" and the IE "RRC transaction identifier" of the received message in the table "Rejected transactions" in the variable TRANSACTIONS.

8.6.3.12 Capability Update Requirement

If the IE "Capability Update Requirement" is included the UE shall:

- 1> if the IE "UE radio access FDD capability update requirement" has the value TRUE:
 - 2> if the UE supports FDD mode:
 - 3> store its UTRA FDD capabilities and its UTRA capabilities common to FDD and TDD in the IE "UE radio access capability" and the IE "UE radio access capability extension" in variable UE_CAPABILITY_REQUESTED as specified below:
 - 4> if the UE supports any radio access capability included in IE "UE radio access capability extension" that is not included in IE "UE radio access capability":

NOTE: This is valid e.g. for UE that supports multiple UTRA FDD Bands and UE that supports a single UTRA FDD Band different from Band I [21].

- 5> store the IE "UE radio access capability", excluding IEs "RF capability FDD" and "Measurement capability";
 - 5> store the IE "UE radio access capability extension", including the IEs "RF capability FDD extension" and the "Measurement capability extension" associated with each supported UTRA FDD frequency band indicated in the IE "Frequency band".
 - 4> else:
 - 5> store the IE "UE radio access capability", including the IEs "RF capability FDD" and "Measurement capability" associated with the Band I [21].
- 1> if the IE "UE radio access 3.84 Mcps TDD capability update requirement" has the value TRUE:
 - 2> if the UE supports 3.84 Mcps TDD mode:
 - 3> store its UTRAN-specific 3.84 Mcps TDD capabilities and its UTRAN-specific capabilities common to FDD and TDD in the variable UE_CAPABILITY_REQUESTED.
- 1> if the IE "UE radio access 7.68 Mcps TDD capability update requirement" has the value TRUE:
 - 2> if the UE supports 7.68 Mcps TDD mode:
 - 3> store its UTRAN-specific 7.68 Mcps TDD capabilities and its UTRAN-specific capabilities common to FDD and TDD in the variable UE_CAPABILITY_REQUESTED.

- 1> if the IE "UE radio access 1.28 Mcps TDD capability update requirement" has the value TRUE:
 - 2> if the UE supports 1.28 Mcps TDD mode:
 - 3> store its UTRAN-specific 1.28 Mcps TDD capabilities and its UTRAN-specific capabilities common to FDD and TDD in the variable UE_CAPABILITY_REQUESTED.
- 1> if the IE "System specific capability update requirement list" is present:
 - 2> for each of the RAT requested in the IE "UE system specific capability"
 - 3> if the UE supports the listed RAT:
 - 4> include its inter-RAT radio access capabilities for the listed RAT in the IE "UE system specific capability" from the variable UE_CAPABILITY_REQUESTED.
 - 4> if the listed RAT is GSM and PS Handover to GPRS is supported:
 - 5> include the IE "MS Radio Access Capability" in the variable UE_CAPABILITY_REQUESTED;

If the IE " Capability update requirement " is not present, the UE shall:

- 1> assume the default values as specified in subclause 10.3.3.2 and act in accordance with the above.

8.6.3.13 Group release information

The UE shall apply the following procedure to compare the IE "U-RNTI group" with the U-RNTI allocated to the UE stored in the variable U_RNTI.

If the IE "group discriminator" is equal to "All":

- 1> consider this as a group identity match.

If the IE "group discriminator" is equal to "U-RNTI mask":

- 1> let N be the value of the IE "U-RNTI bit mask index";
 - 1> if N is equal to b20, b21, ... or b31:
 - 2> compare pairs of bits, starting from bit b31 downto, and including, bit N of the "SRNC identity" of the IE "U-RNTI" with the corresponding bits stored in the variable U_RNTI;
 - 2> if all pairs of bits are equal:
 - 3> consider this as a group identity match.
 - 1> if N is equal to b1, b2, ... or b19:
 - 2> compare pairs of bits, starting from bit b31 downto, and including, bit b20 of the "SRNC identity" in the IE "U-RNTI" with the corresponding bits of the "SRNC identity" stored in the variable U_RNTI;
 - 2> if all pairs of bits are equal:
 - 3> then compare pairs of bits, starting from bit b19 downto, and including, bit N of the "S-RNTI" in the IE "U-RNTI" with the corresponding bits of the "S-RNTI" stored in the variable U_RNTI;
 - 3> if all pairs of bits are equal:
 - 4> consider this as a group identity match.

NOTE 1: The most significant bits of the U-RNTI, which indicate the "SRNC identity" must be unique among all RNC's, which support all the UEs in the group to be released, in order to obtain correct behaviour of group release.

8.6.3.14 New E-RNTI

If the IE "New Primary E-RNTI" and/or the IE "New Secondary E-RNTI" (FDD only) are/is included and the UE will be in CELL_DCH state after completion of this procedure, the UE shall:

- 1> store the new value(s) in the variable E_RNTI;
- 1> determine the value for the E_DCH_TRANSMISSION variable and take the corresponding actions as described in subclause 8.5.28.

If, after the completion of this procedure, the variable E_DCH_TRANSMISSION is set to FALSE, the UE shall:

- 1> clear the variable E_RNTI.

When the variable E_DCH_TRANSMISSION is set to TRUE the UE shall:

- 1> for FDD:
 - 2> use the value of the Primary E-RNTI and/or Secondary E-RNTI stored in the variable E_RNTI as UE identities in the E-AGCH reception procedure in the physical layer.
- 1> for TDD:
 - 2> use the value of New Primary E-RNTI stored in the variable E_RNTI as the UE identity in the E-AGCH reception procedure and the E-RUCCH transmission procedure in the physical layer.

8.6.4 Radio bearer information elements

8.6.4.1 Signalling RB information to setup list

If the IE "Signalling RB information to setup list" is included the UE shall:

- 1> use the same START value to initialise the COUNT-C and COUNT-I variables for all the signalling radio bearers in the list;
- 1> if the IE "Signalling RB information to setup list" was included in the RADIO BEARER SETUP message:
 - 2> if the variable LATEST_CONFIGURED_CN_DOMAIN has been initialised:
 - 3> calculate the START value only once during this procedure according to subclause 8.5.9 for the CN domain indicated in the variable LATEST_CONFIGURED_CN_DOMAIN;
 - 3> store the calculated START value in the variable START_VALUE_TO_TRANSMIT.
- 1> for each occurrence of the IE "Signalling RB information to setup":
 - 2> use the value of the IE "RB identity" as the identity of the signalling radio bearer to setup;
 - 2> if the signalling radio bearer identified with the IE "RB identity" does not exist in the variable ESTABLISHED_RABS:
 - 3> create a new entry for the signalling radio bearer in the variable ESTABLISHED_RABS.
 - 2> if the IE "Signalling RB information to setup list" was received in a message other than HANDOVER TO UTRAN COMMAND; and
 - 2> if the variable LATEST_CONFIGURED_CN_DOMAIN has been initialised and the value "STATUS" of the variable CIPHERING_STATUS of the CN domain stored in this variable is "Started":
 - 3> if the IE "Uplink RLC mode" or the IE "Downlink RLC mode" either in the IE "RLC info" or referenced by the RB identity in the IE "Same as RB" is set to "AM RLC" or "UM RLC":
 - 4> initialise the 20 MSB of the hyper frame number component of COUNT-C for this signalling radio bearer with the START value in the variable START_VALUE_TO_TRANSMIT;

- 4> set the remaining LSB of the hyper frame number component of COUNT-C for this signalling radio bearer to zero;
- 4> start to perform ciphering on this signalling radio bearer, using the value of the IE "RB identity" minus one as the value of BEARER in the ciphering algorithm.
- 2> if the IE "Signalling RB information to setup list" was received in a message other than HANDOVER TO UTRAN COMMAND; and
- 2> if the variable LATEST_CONFIGURED_CN_DOMAIN has been initialised and the value "Status" of the variable "INTEGRITY_PROTECTION_INFO" of the CN domain stored in this variable is "Started":
 - 3> initialise the 20 MSB of the hyper frame number component of COUNT-I for this signalling radio bearer with the START value in the variable START_VALUE_TO_TRANSMIT;
 - 3> set the remaining LSB of the hyper frame number component of COUNT-I for this signalling radio bearer to zero;
 - 3> for this signalling radio bearer, set the IE "Uplink RRC Message sequence number" in the variable INTEGRITY_PROTECTION_INFO to zero;
 - 3> start performing integrity protection according to subclauses 8.5.10.1 and 8.5.10.2.
- 2> perform the actions for the IE "RLC info" as specified in subclause 8.6.4.9, applied for that signalling radio bearer;
- 2> perform the actions for the IE "RB mapping info" as specified in subclause 8.6.4.8, applied for that signalling radio bearer.
- 1> apply a default value of the IE "RB identity" equal to 1 for the first IE "Signalling RB information to setup"; and
- 1> increase the default value by 1 for each occurrence.

NOTE: The UTRAN should only use the default value of the IE "RB identity" within the RRC Connection Setup and Handover to UTRAN Command messages. If the default value of the IE "RB identity" is used in any other message then the UE behaviour is not specified.

8.6.4.2 RAB information for setup

If the IE "RAB information for setup" is included, the procedure is used to establish radio bearers belonging to a radio access bearer, and the UE shall:

- 1> if several IEs "RAB information for setup" are included in a message other than HANDOVER TO UTRAN COMMAND and the included IEs "CN domain identity" in the IE "RAB info" does not all have the same value:
 - 2> set the variable INVALID_CONFIGURATION to TRUE.
- 1> if the radio access bearer identified with the IE "RAB info" does not exist in the variable ESTABLISHED_RABS:
 - 2> create a new entry for the radio access bearer in the variable ESTABLISHED_RABS;
 - 2> store the content of the IE "RAB info" in the entry for the radio access bearer in the variable ESTABLISHED_RABS;
 - 2> indicate the establishment of each radio access bearer to the upper layer entity using the IE "CN domain identity", forwarding the content of the IE "RAB identity" and the IEs NAS Synchronization Indicator as well as the following IEs if included in the IE "RAB info": "MBMS Session identity" and/ or "MBMS Service Identity";
 - 2> if prior to this procedure there exists no transparent mode radio bearer for the CN domain included in the IE "CN domain identity" and at least one transparent mode radio bearer is included in the IE "RB information to setup"; or
 - 2> if at least one RLC-AM or RLC-UM radio bearer is included in the IE "RB information to setup":

- 3> calculate the START value only once during this procedure (the same START value shall be used on all new radio bearers created for this radio access bearer) according to subclause 8.5.9 for the CN domain as indicated in the IE "CN domain identity" in the IE "RAB info" part of the IE "RAB information to setup";
 - 3> store the calculated START value in the variable START_VALUE_TO_TRANSMIT.
- 1> for each radio bearer in the IE "RB information to setup":
- 2> if the radio bearer identified with the IE "RB identity" does not exist in the variable ESTABLISHED_RABS:
 - 3> perform the actions specified in subclause 8.6.4.3;
 - 3> store information about the new radio bearer in the entry for the radio access bearer identified by "RAB info" in the variable ESTABLISHED_RABS;
 - 3> create a new RAB subflow for the radio access bearer;
 - 3> number the RAB subflow in ascending order, assigning the smallest number to the RAB subflow corresponding to the first radio bearer in the list;
 - 3> if the IE "CN domain identity" in the IE "RAB info" is set to "PS domain" and the number of RAB subflows for the radio access bearer is greater than 1:
 - 4> set the variable INVALID_CONFIGURATION to TRUE.
 - 2> if the radio bearer identified with the IE "RB identity" already exists in the variable ESTABLISHED_RABS:
 - 3> set the variable INVALID_CONFIGURATION to TRUE.

8.6.4.2a RAB information to reconfigure

If the IE "RAB information to reconfigure" is included then the UE shall:

- 1> if the entry for the radio access bearer identified by the IE "CN domain identity" together with the IE "RAB Identity" in the variable ESTABLISHED_RABS already exists:
 - 2> perform the action for the IE "NAS Synchronization Indicator", according to subclause 8.6.4.12.
- 1> else:
 - 2> set the variable INVALID_CONFIGURATION to TRUE.

8.6.4.3 RB information to setup

If the IE "RB information to setup" is included, the UE shall apply the following actions on the radio bearer identified with the value of the IE "RB identity". The UE shall:

- 1> use the same START value to initialise the hyper frame number components of COUNT-C variables for all the new radio bearers to setup;
- 1> perform the actions for the IE "PDCP info", if present, according to subclause 8.6.4.10, applied for the radio bearer;
- 1> perform the actions for the IE "RLC info", according to subclause 8.6.4.9, applied for the radio bearer;
- 1> perform the actions for the IE "RB mapping info", according to subclause 8.6.4.8, applied for the radio bearer;
- 1> if the IE "Downlink RLC mode" either in the IE "RLC info" or referenced by the RB identity in the IE "Same as RB" is set to "TM RLC":
 - 2> configure delivery of erroneous SDUs in lower layers according to indication from upper layer [5].
- 1> if the IE "RB information to setup" was received in a message other than HANDOVER TO UTRAN COMMAND; and

- 1> if the IE "Uplink RLC mode" or the IE "Downlink RLC mode" either in the IE "RLC info" or referenced by the RB identity in the IE "Same as RB" is set to "AM RLC" or "UM RLC":
 - 2> initialise the 20 MSB of the hyper frame number component of COUNT-C for this radio bearer with the START value in the variable START_VALUE_TO_TRANSMIT;
 - 2> set the remaining LSB of the hyper frame number component of COUNT-C for this radio bearer to zero;
 - 2> start incrementing the COUNT-C values.
- 1> if the IE "RB information to setup" was received in a message other than HANDOVER TO UTRAN COMMAND; and
- 1> if the IE "Uplink RLC mode" and the IE "Downlink RLC mode" either in the IE "RLC info" or referenced by the RB identity in the IE "Same as RB" is set to "TM RLC":
 - 2> if prior to this procedure there exists no transparent mode radio bearer for the CN domain included in the IE "CN domain identity" in the IE "RAB info" in the variable ESTABLISHED_RABS and at least one transparent mode radio bearer is included in the IE "RB information to setup":
 - 3> if the IE "Status" in the variable CIPHERING_STATUS of the CN domain as indicated in the IE "CN domain identity" in the IE "RAB info" in the variable ESTABLISHED_RABS is set to "Not Started":
 - 4> at the activation time as specified in the IE "Ciphering activation time for DPCH" if included in the IE "Ciphering mode info" in the command message or, if this IE is not included, as specified in the IE "COUNT-C activation time" included in the response message:
 - 5> initialise the 20 most significant bits of the hyper frame number component of COUNT-C common for all transparent mode radio bearers of this CN domain with the START value in the variable START_VALUE_TO_TRANSMIT;
 - 5> set the remaining LSB of the hyper frame number component of COUNT-C to zero;
 - 5> do not increment the COUNT-C value common for all transparent mode radio bearers for this CN domain.
 - 3> if the IE "Status" in the variable CIPHERING_STATUS of the CN domain as indicated in the IE "CN domain identity" in the IE "RAB info" in the variable ESTABLISHED_RABS is set to " Started":
 - 4> at the activation time as specified in the IE "Activation Time" in the RADIO BEARER SETUP message:
 - 5> initialise the 20 most significant bits of the HFN component of COUNT-C common for all transparent mode RLC radio bearer to the value of the latest transmitted START for this CN domain, while not incrementing the value of the HFN component of COUNT-C at each CFN cycle; and
 - 5> set the remaining LSB of the HFN component of COUNT-C to zero;
 - 5> start to perform ciphering on the radio bearer in lower layers while not incrementing the HFN.
 - 4> at the activation time as specified in the IE "Ciphering activation time for DPCH" if included in the IE "Ciphering mode info" in the command message or, if this IE is not included, as specified in the IE "COUNT-C activation time" included in the response message:
 - 5> initialise the 20 most significant bits of the HFN component of COUNT-C common for all transparent mode radio bearers of this CN domain with the START value in the variable START_VALUE_TO_TRANSMIT;
 - 5> set the remaining LSB of the HFN component of COUNT-C to zero;
 - 5> if the received message is used to perform a Timing re-initialised hard handover:
 - 6> increment the HFN component of the COUNT-C variable by one even if the "COUNT-C activation time" is set to zero.

- 5> start incrementing the COUNT-C value common for all transparent mode radio bearers of this CN domain as normal, at each CFN value, i.e. the HFN component is no longer fixed in value but incremented at each CFN cycle.
- 2> if prior to this procedure there exists at least one transparent mode radio bearer for the CN domain included in the IE "CN domain identity" in the IE "RAB info" in the variable ESTABLISHED_RABS:
 - 3> if the IE "Status" in the variable CIPHERING_STATUS of the CN domain as indicated in the IE "CN domain identity" in the IE "RAB info" in the variable ESTABLISHED_RABS is set to "Not Started":
 - 4> do not increment the COUNT-C value common for all transparent mode radio bearers for this CN domain.
 - 3> if the IE "Status" in the variable CIPHERING_STATUS of the CN domain as indicated in the IE "CN domain identity" in the IE "RAB info" in the variable ESTABLISHED_RABS is set to "Started":
 - 4> use the COUNT-C value common for all transparent mode radio bearers of this CN domain.
- 1> if the IE "Status" in the variable CIPHERING_STATUS of the CN domain as indicated in the IE "CN domain identity" in the IE "RAB info" in the variable ESTABLISHED_RABS is set to "Started":
 - 2> start to perform ciphering on the radio bearer in lower layers, using the value of the IE "RB identity" minus one as the value of BEARER in the ciphering algorithm.

NOTE: UTRAN should not use the IE "RB information to setup" to setup radio bearers with RB identity in the range 1-4.

8.6.4.4 RB information to be affected

If the IE "RB information to be affected" is included, the UE shall apply the following actions on the radio bearer identified with the value of the IE "RB identity". The UE shall:

- 1> perform the actions for the IE "RB mapping info", according to subclause 8.6.4.8, applied for the radio bearer.

8.6.4.4a Void

8.6.4.5 RB information to reconfigure

If the IE "RB information to reconfigure" is included, the UE shall apply the following actions on the radio bearer identified with the value of the IE "RB identity". The UE shall:

- 1> perform the actions for the IE "PDCP info", if present, according to subclause 8.6.4.10, applied for the radio bearer;

- 1> if the IE "RLC info" is present:

- 2> perform the actions for the IE "RLC info", according to subclause 8.6.4.9, applied for the radio bearer.

- 1> else:

- 2> continue using the current RLC configuration for the radio bearer.

- 1> perform the actions for the IE "RB mapping info", according to subclause 8.6.4.8, applied for the radio bearer;

- 1> if the IE "Downlink RLC mode" in the IE "RLC info" is set to "TM RLC":

- 2> configure delivery of erroneous SDUs in lower layers according to indication from upper layer [5].

- 1> if the IE "PDCP SN info" is included:

- 2> perform the actions as specified in subclause 8.6.4.11 applied for the radio bearer.

- 1> if the IE "RB stop/continue" is included; and

- 2> if the "RB identity" has a value greater than 2; and
 - 3> if the value of the IE "RB stop/continue" is "stop":
 - 4> configure the RLC entity for the radio bearer to stop;
 - 4> set the IE "RB started" in the variable ESTABLISHED_RABS to "stopped" for that radio bearer.
 - 3> if the value of the IE "RB stop/continue" is "continue":
 - 4> configure the RLC entity for the radio bearer to continue;
 - 4> set the IE "RB started" in the variable ESTABLISHED_RABS to "started" for that radio bearer.
- 2> if the IE "RB identity" is set to a value less than or equal to 2:
 - 3> set the variable INVALID_CONFIGURATION to TRUE.

8.6.4.6 RB information to release

If the IE "RB information to release" is included, the UE shall apply the following actions on the radio bearer identified with the value of the IE "RB identity". The UE shall:

- 1> if the IE "RB identity" is set to a value less than 4:
 - 2> set the variable INVALID_CONFIGURATION to TRUE.
- 1> if the IE "RB identity" refers to a signalling radio bearer:
 - 2> release the RLC entity for the signalling radio bearer;
 - 2> delete the information about the signalling radio bearer from the variable ESTABLISHED_RABS.
- 1> if the IE "RB identity" refers to a radio bearer:
 - 2> release the PDCP and RLC entities for that radio bearer;
 - 2> indicate release of the RAB subflow associated with the radio bearer to upper layers;
 - 2> delete the information about the radio bearer from the variable ESTABLISHED_RABS;
 - 2> when all radio bearers belonging to the same radio access bearer have been released:
 - 3> indicate release of the radio access bearer to upper layers providing the "CN domain identity" together with the "RAB identity" and the "MBMS Service Identity" if stored in the variable ESTABLISHED_RABS;
 - 3> delete all information about the radio access bearer from the variable ESTABLISHED_RABS.

The UE shall:

- 1> determine the value for the HS_DSCH_RECEPTION variable and take the corresponding actions as described in subclause 8.5.25;
- 1> determine the value for the E_DCH_TRANSMISSION variable and take the corresponding actions as described in subclause 8.5.28.

8.6.4.7 RB with PDCP information

If the IE "RB with PDCP information" is included, the UE shall apply the following actions on the radio bearer identified with the value of the IE "RB identity". The UE shall:

- 1> for the IE "PDCP SN info":
 - 2> perform the actions as specified in subclause 8.6.4.11.

8.6.4.8 RB mapping info

If the IE "RB mapping info" is included, the UE shall:

- 1> for each multiplexing option of the RB:
 - 2> if a multiplexing option that maps a logical channel corresponding to a TM-RLC entity onto RACH, FACH, USCH, DSCH (only for TDD), HS-DSCH or E-DCH is included:
 - 3> set the variable INVALID_CONFIGURATION to TRUE.
 - 2> if the multiplexing option realises the radio bearer on the uplink (resp. on the downlink) using two logical channels with different values of the IE "Uplink transport channel type" (resp. of the IE "Downlink transport channel type"):
 - 3> set the variable INVALID_CONFIGURATION to TRUE.
 - 2> if that RB is using TM and the IE "Segmentation indication" is set to TRUE and, based on the multiplexing configuration resulting from this message, the logical channel corresponding to it is mapped onto the same transport channel as another logical channel:
 - 3> set the variable INVALID_CONFIGURATION to TRUE.
 - 2> if the transport channel considered in that multiplexing option is different from RACH and if that RB is using AM and the set of RLC sizes applicable to the uplink logical channel transferring data PDUs has more than one element not equal to zero:
 - 3> set the variable INVALID_CONFIGURATION to TRUE.
 - 2> if that RB is using UM or TM and the multiplexing option realises it using two logical channels:
 - 3> set the variable INVALID_CONFIGURATION to TRUE.
- 2> for each logical channel in that multiplexing option:
 - 3> if the value of the IE "RLC size list" is set to "Explicit list":
 - 4> if a "Transport format set" for the transport channel this logical channel is mapped on in this multiplexing option is included in the same message, and the value (index) of any IE "RLC size index" in the IE "Explicit list" does not correspond to an "RLC size" in the IE transport format set of that transport channel given in the message; or
 - 4> if the transport channel this logical channel is mapped on in this multiplexing option is different from RACH, and if a "Transport format set" for that transport channel is not included in the same message, and the value (index) of any IE "RLC size index" in the IE "Explicit list" does not correspond to an "RLC size" in the stored transport format set of that transport channel; or
 - 4> if a "Transport format set" for the transport channel this logical channel is mapped on in this multiplexing option is included in the same message, and the value of any IE "Logical channel list" in the transport format set is not set to "Configured"; or
 - 4> if a "Transport format set" for the transport channel this logical channel is mapped on in this multiplexing option is not included in the same message, and the value of any IE "Logical channel list" in the stored transport format set of that transport channel is not set to "Configured":
 - 5> set the variable INVALID_CONFIGURATION to TRUE.
 - 3> if the value of the IE "RLC size list" is set to "All":
 - 4> if the transport channel this logical channel is mapped on is RACH; or
 - 4> if a "Transport format set" for the transport channel this logical channel is mapped on in this multiplexing option is included in the same message, and the value of any IE "Logical channel list" in the transport format set is not set to "Configured"; or

- 4> if a "Transport format set" for the transport channel this logical channel is mapped on in this multiplexing option is not included in the same message, and the value of any IE "Logical channel list" in the stored transport format set of that transport channel is not set to "Configured":
 - 5> set the variable INVALID_CONFIGURATION to TRUE.
- 3> if the value of the IE "RLC size list" is set to "Configured":
 - 4> if the transport channel this logical channel is mapped on is RACH; or
 - 4> if a "Transport format set" for the transport channel this logical channel is mapped on in this multiplexing option is included in the same message, and for none of the RLC sizes defined for that transport channel in the "Transport format set", the "Logical Channel List" is set to "All" or given as an "Explicit List" which contains this logical channel; or
 - 4> if a "Transport format set" for the transport channel this logical channel is mapped on in this multiplexing option is not included in the same message, and for none of the RLC sizes defined in the transport format set stored for that transport channel, the "Logical Channel List" is set to "All" or given as an "Explicit List" which contains this logical channel:
 - 5> set the variable INVALID_CONFIGURATION to TRUE.
- 1> if, for the HS-DSCH transport channel, when MAC-hs is configured and as a result of the message this IE is included in, several radio bearers can be mapped onto the same MAC-d flow, and the IE "Logical Channel Identity" was not included in the RB mapping info of any of those radio bearers for a multiplexing option on that MAC-d flow or the same "Logical Channel Identity" was used more than once in the RB mapping info of those radio bearers for the multiplexing options on that MAC-d flow:
 - 2> the UE behaviour is not specified.
- 1> if, for the HS-DSCH transport channel, when MAC-ehs is configured and as a result of the message this IE is included in, several radio bearers can be mapped onto the reordering queue(s), and the IE "Logical Channel Identity" was not included in the RB mapping info of any of those radio bearers for a multiplexing option on at least one reordering queue or the same "Logical Channel Identity" was used more than once in the RB mapping info of those radio bearers for the multiplexing options on any reordering queue:
 - 2> the UE behaviour is not specified.
- 1> if, as a result of the message this IE is included in, several radio bearers can be mapped onto the E-DCH MAC-d flows(s), and the IE "Logical Channel Identity" was not included in the RB mapping info of any of those radio bearers for a multiplexing option on at least one E-DCH MAC-d flow or the same "Logical Channel Identity" was used more than once in the RB mapping info of those radio bearers for the multiplexing options on any MAC-d flow:
 - 2> the UE behaviour is not specified.
- 1> if, for transport channels other than HS-DSCH and E-DCH, as a result of the message this IE is included in, several radio bearers can be mapped onto the same transport channel, and the IE "Logical Channel Identity" was not included in the RB mapping info of any of those radio bearers for a multiplexing option on that transport channel or the same "Logical Channel Identity" was used more than once in the RB mapping info of those radio bearers for the multiplexing options on that transport channel:
 - 2> set the variable INVALID_CONFIGURATION to TRUE.
- 1> if, as a result of the message this IE is included in, there are several radio bearers configured with a multiplexing option mapped on "HS-DSCH", i.e., a downlink transport channel of type "HS-DSCH" or "DCH + HS-DSCH", and there is at least one radio bearer with a multiplexing option configured with the DL MAC header type set to "MAC-hs" and at least one radio bearer with a multiplexing option configured with the DL MAC header type set to "MAC-ehs":
 - 2> set the variable INVALID_CONFIGURATION to TRUE.
- 1> if the "RB mapping info" is considered as valid according to the rules above:
 - 2> delete all previously stored multiplexing options for that radio bearer;

- 2> store each new multiplexing option for that radio bearer;
 - 2> perform the actions as specified in subclause 8.5.21;
 - 2> determine the value for the HS_DSCH_RECEPTION variable and take the corresponding actions as described in subclause 8.5.25;
 - 2> determine the value for the E_DCH_TRANSMISSION variable and take the corresponding actions as described in subclause 8.5.28.
- 1> if the IE "Uplink transport channel type" is set to the value "RACH":
- 2> in FDD:
 - 3> refer the IE "RLC size index" to the RACH Transport Format Set of the first PRACH received in the IE "PRACH system information list" received in System Information Block 5, System Information Block 5bis or System Information Block 6.
 - 2> in TDD:
 - 3> use the first Transport Format of the PRACH of the IE "PRACH system information list" at the position equal to the value in the IE "RLC size index".
- 1> if the IE "Downlink transport channel type" is set to the value "HS-DSCH" and the DL MAC header type is set to "MAC-ehs":
- 2> if the IE "Logical channel identity" is present:
 - 3> configure the receiving MAC-ehs entity with the value of the IE "Logical channel identity" to be used in the "LCH-ID" field of the MAC-ehs header [15] associated with the MAC-ehs reordering queue identified by the value of the IE "DL HS-DSCH MAC-ehs Queue Id".
 - 2> else:
 - 3> set the variable INVALID_CONFIGURATION to TRUE.

If case IE "RLC info" includes IE "Downlink RLC mode" ("DL RLC logical channel info" is mandatory present) but IE "Number of downlink RLC logical channels" is absent in the corresponding IE "RB mapping info", the parameter values are exactly the same as for the corresponding UL logical channels. In case two multiplexing options are specified for the UL, the first options shall be used as default for the DL. As regards the IE "Channel type", the following rule should be applied to derive the DL channel type from the UL channel included in the IE:

Channel used in UL	DL channel type implied by "same as"
DCH	DCH
RACH	FACH
USCH	DSCH

If ciphering is applied, UTRAN should not map Transparent Mode RBs of different CN domains on the same transport channel and it should not map transparent mode SRBs and RBs onto the same transport channel. In such cases the UE behaviour is not specified.

For FDD the list of multiplexing options configured in the UE for each RB and SRB should comply with the following rules otherwise the UE behaviour is not specified:

- at most one multiplexing option can contain the combination "FACH" for the DL and "RACH" for the UL;
- for FDD, at most one multiplexing option can contain the combination "HS-DSCH" mapped on MAC-ehs for the DL and "RACH" for the UL;
- at most one multiplexing option can contain the combination "DCH" or "DCH + HS-DSCH" for the DL together with "DCH" for the UL;
- at most one multiplexing option can contain the combination "HS-DSCH" or "DCH + HS-DSCH" for the DL together with "DCH" for the UL;

- at most one multiplexing option can contain the combination "DCH" or "DCH + HS-DSCH" for the DL together with "E-DCH" for the UL; and
- at most one multiplexing option can contain the combination "HS-DSCH" or "DCH + HS-DSCH" for the DL together with "E-DCH" for the UL.

8.6.4.9 RLC Info

Upon reception of the IE "RLC Info", the UE shall:

- 1> if both the IE "Uplink RLC mode" and the IE "Downlink RLC mode" are present in the IE "RLC info":
 - 2> configure the transmitting and receiving RLC entities in the UE for that radio bearer accordingly.
- 1> else, if the IE "Uplink RLC mode" is present and the IE "Downlink RLC mode" is not present in the IE "RLC info":
 - 2> configure the transmitting RLC entity in the UE for that radio bearer accordingly and keep the configuration existing before the reception of the message for the receiving RLC entity.
- 1> else, if the IE "Uplink RLC mode" is not present and the IE "Downlink RLC mode" is present in the IE "RLC info":
 - 2> configure the receiving RLC entity in the UE for that radio bearer accordingly and keep the configuration existing before the reception of the message for the transmitting RLC entity.
- 1> if the IE "Polling info" is present in the IE "RLC info":
 - 2> for each present IE in the IE "Polling info":
 - 3> configure RLC to use the corresponding function according to the value of the IE.
 - 2> for each absent IE in the IE "Polling info":
 - 3> configure RLC to not use the corresponding function.
- 1> if the IE "Polling info" is absent:
 - 2> configure RLC to not use the polling functionality.
- 1> if the IE "Downlink RLC STATUS info" is present in the IE "RLC info" (this IE is present for AM RLC):
 - 2> for each present IE in the IE "Downlink RLC STATUS info":
 - 3> configure RLC to use the corresponding function according to value of the IE.
 - 2> for each absent IE in the IE "Downlink RLC STATUS info":
 - 3> configure RLC to not use the corresponding function.
- 1> if the IE "Transmission RLC discard" is present:
 - 2> configure the discard procedure in RLC according to the IE "Transmission RLC discard"
- 1> if the IE "Transmission RLC discard" is absent (only possible for TM RLC and UM RLC):
 - 2> do not configure SDU discard in RLC.
- 1> if the IE "Uplink RLC mode" is present and is set to "AM RLC":
 - 2> if the IE "Use special value of HE field" is present:
 - 3> configure the uplink RLC entity to use the special value of the HE field to indicate the end of an SDU.
 - 2> if the IE "Use special value of HE field" is not present:
 - 3> configure the uplink RLC entity to not use the special value of the HE field to indicate the end of an SDU.

- 1> if the IE "Uplink RLC mode" is present and is set to "UM RLC":
 - 2> if the IE "Alternative E-bit interpretation" is present:
 - 3> configure the uplink RLC entity to use the alternative E-bit interpretation and corresponding LI's.
 - 2> if the IE "Alternative E-bit interpretation" is not present:
 - 3> configure the uplink RLC entity to use the normal E-bit interpretation and corresponding LI's.
- 1> if the IE "Downlink RLC mode" is present and is set to "AM RLC":
 - 2> if IE "DL RLC PDU size" is not present:
 - 3> determining the downlink RLC PDU size will be handled at RLC level as described in [16], without any configuration from RRC.

NOTE: The case where this mandatory IE is not present is meant to handle the interaction with a network using an earlier release of the specification.

- 2> else, if the IE "DL RLC PDU size" is present, the DL RLC PDU size is set to "fixed size" and no downlink RLC PDU size is currently set in the RLC entity:
 - 3> configure the corresponding RLC entity with the downlink RLC PDU size.
- 2> else, if the DL RLC PDU size is set to "flexible size" and no downlink RLC PDU size is currently set in the RLC entity:
 - 3> if this radio bearer is a signalling radio bearer:
 - 4> the UE behaviour is unspecified.
 - 3> else, configure the corresponding RLC entity with the RLC length indicator size indicated in the IE "Length indicator size".
- 2> else, if the DL RLC PDU size is changed to "flexible size" from "fixed size" and the the indicated RLC length indicator size is 7 bits:
 - 3> if this radio bearer is a signalling radio bearer:
 - 4> the UE behaviour is unspecified.
 - 3> else, configure the corresponding RLC entity with flexible RLC PDU size and the RLC length indicator size indicated in the IE "Length indicator size".
- 2> else, if the IE "DL RLC PDU size" is present, the DL RLC PDU size is set to "fixed size" and DL RLC PDU size value is different from the one currently set in the RLC entity; or
- 2> the DL RLC PDU size is set to "flexible size" and the indicated RLC length indicator size is different from the one currently set in the RLC entity; or
- 2> the DL RLC PDU size is changed to "fixed size" from "flexible size"; or
- 2> the DL RLC PDU size is changed to "flexible size" from "fixed size" and the indicated RLC length indicator size is 15 bits:

NOTE: The downlink RLC PDU size set in the RLC entity should be explicitly configured in this release of the specification.

- 3> if the DL RLC PDU size is set to "flexible size":
 - 4> if this radio bearer is a signalling radio bearer:
 - 5> the UE behaviour is unspecified.
- 3> if the IE "one sided RLC re-establishment" is set to TRUE:
 - 4> re-establish the receiving side of the corresponding RLC entity.

- 3> else:
 - 4> re-establish the corresponding RLC entity.
- 3> if the DL RLC PDU size is set to "fixed size":
 - 4> configure the corresponding RLC entity with the new downlink RLC PDU size.
- 3> if the DL RLC PDU size is set to "flexible size":
 - 4> configure the corresponding RLC entity with the RLC length indicator size indicated in the IE "Length indicator size".
- 3> if the UE supports the lossless DL RLC PDU size change and PDCP was configured for that radio bearer with the IE "Support for lossless SRNS relocation or for lossless DL RLC PDU size change" set to TRUE:
 - 4> include the current DL PDCP receive sequence number and the radio bearer identity for that radio bearer in the variable PDCP_SN_INFO.
- 3> if the IE "Status" in the variable CIPHERING_STATUS of the CN domain as indicated in the IE "CN domain identity" in the IE "RAB info" for this radio bearer is set to "Started":
 - 4> if the RLC re-establishment is caused by a CELL UPDATE CONFIRM:
 - 5> if only the receiving side of the RLC entity was re-established:
 - 6> set the HFN values for the corresponding RLC entity in downlink equal to the value of the IE "START" included in the latest transmitted CELL UPDATE message for this CN domain.
 - 5> if the whole RLC entity was re-established:
 - 6> set the HFN values for the corresponding RLC entity in uplink and downlink equal to the value of the IE "START" included in the latest transmitted CELL UPDATE message for this CN domain.
 - 4> if the RLC re-establishment is caused by a reconfiguration message:
 - 5> if only the receiving side of the RLC entity was re-established:
 - 6> set the HFN values for the corresponding RLC entity in downlink equal to the value of the IE "START" that will be included in the reconfiguration complete message for this CN domain.
 - 5> if the whole RLC entity was re-established:
 - 6> set the HFN values for the corresponding RLC entity in uplink and downlink equal to the value of the IE "START" that will be included in the reconfiguration complete message for this CN domain.
- 2> if the IE "Use special value of HE field" is present:
 - 3> configure the downlink RLC entity to use the special value of the HE field to indicate the end of an SDU.
- 2> if the IE "Use special value of HE field" is not present:
 - 3> configure the downlink RLC entity to not use the special value of the HE field to indicate the end of an SDU.
- 1> if the IE "Downlink RLC mode" is present and is set to "UM RLC":
 - 2> if the IE "DL UM RLC LI size" is not present:
 - 3> configure the corresponding RLC entity with an LI size of 7 bits;

NOTE: The case where this mandatory IE is not present is meant to handle the interaction with a network using an earlier release of the specification.

2> else:

3> configure the corresponding RLC entity with the LI size indicated in the IE "DL UM RLC LI size".

2> if the IE "DL Reception Window Size" is present:

3> if the variable UE_CAPABILITY_TRANSFERRED indicates "Support of HS-PDSCH" as "Supported":

4> configure the corresponding RLC entity to support out-of-sequence reception with the receive window size indicated in the IE.

3> if the variable UE_CAPABILITY_TRANSFERRED indicates "Support of HS-PDSCH" as "Unsupported":

4> the UE behaviour is not specified.

2> else:

3> configure the corresponding RLC entity without out-of-sequence reception.

NOTE: If the "Uplink RLC mode" or the "Downlink RLC mode" of an existing radio bearer is modified by a reconfiguration message, the UE behaviour is unspecified.

2> if the IE "Alternative E-bit interpretation" is present:

3> configure the downlink RLC entity to use the alternative E-bit interpretation and corresponding LI's.

2> if the IE "Alternative E-bit interpretation" is not present:

3> configure the downlink RLC entity to use the normal E-bit interpretation and corresponding LI's.

8.6.4.10 PDCP Info

For RFC 3095:

1> the chosen MAX_CID shall be less than the value "Maximum number of ROHC context sessions" as indicated in the IE "PDCP Capability".

If IE "PDCP info" is included, the UE shall:

1> if the radio bearer is connected to a CS domain radio access bearer:

2> set the variable INVALID_CONFIGURATION to TRUE.

1> if the IE "PDCP PDU header" is set to the value "absent":

2> if the IE "Support for lossless SRNS relocation or for lossless DL RLC PDU size change" is true:

3> set the variable INVALID_CONFIGURATION to TRUE.

1> if the IE "PDCP PDU header" is set to the value "present":

2> include PDCP headers in both uplink and downlink PDCP PDUs;

2> if the IE "Support for lossless SRNS relocation or for lossless DL RLC PDU size change" is false:

3> if the IE "Header compression information" is absent:

4> set the variable INVALID_CONFIGURATION to TRUE.

1> if the IE "Header compression information" is absent:

2> not use Header compression after the successful completion of this procedure;

2> remove any stored configuration for the IE "Header compression information".

- 1> if the IE "Header compression information" is present:
 - 2> if the IE "Algorithm Type" is set to "RFC 2507":
 - 3> if the UE capability "Maximum header compression context space", as specified in [35], is exceeded with this configuration:
 - 4> set the variable INVALID_CONFIGURATION to TRUE.
 - 3> if the IE "PDCP PDU header" is set to the value "absent":
 - 4> the behaviour of the UE is unspecified.
 - 2> if the IE "Algorithm Type" is set to "RFC 3095":
 - 3> if the uplink RLC mode for this radio bearer is RLC-TM:
 - 4> the behaviour of the UE is unspecified.
- 1> configure the PDCP entity for that radio bearer accordingly;
- 1> configure the RLC entity for that radio bearer according to the value of the IE "Support for lossless SRNS relocation or for lossless DL RLC PDU size change";
- 1> set the PROFILES parameter, used by inband ROHC profile negotiation, for this PDCP entity for both UL and DL equal to the list of ROHC profiles received in the IE "PDCP info". A UE complying to this version of the protocol shall support ROHC profiles 0x0000 (ROHC uncompressed), 0x0001 (ROHC RTP), 0x0002 (ROHC UDP) and 0x0003 (ROHC ESP) (see [52]).
- 1> if the IE "PDCP ROHC target mode" is received:
 - 2> set the variable " PDCP_ROHC_TARGET_MODE " to the received value.
- 1> if the IE "PDCP ROHC target mode" is not received in either of the CELL UPDATE CONFIRM, the RADIO BEARER RECONFIGURATION or the RADIO BEARER SETUP message:
 - 2> delete the variable "PDCD_ROHC_TARGET_MODE" and act according to actions specified in [36].

8.6.4.11 PDCP SN Info

If the IE "PDCP SN Info" is included, the UE shall:

- 1> transfer the sequence number to the PDCP entity for the radio bearer;
- 1> configure the RLC entity for the radio bearer to stop;
- 1> include the current PDCP receive sequence number and the radio bearer identity for the radio bearer in the variable PDCP_SN_INFO.

8.6.4.12 NAS Synchronisation Indicator

If the IE "NAS Synchronisation Indicator" is present in a message, the UE shall:

- 1> forward the content to upper layers along with the IE "CN domain identity" of the associated RAB stored in the variable ESTABLISHED_RABS at the CFN indicated in the IE "Activation time" in order to synchronise actions in NAS and AS.

8.6.4.13 PDCP context relocation info

If the IE "PDCP context relocation info" is included, the UE shall, for each radio bearer included in this IE:

- 1> If the IE "Downlink RFC 3095 context relocation indication" is set to TRUE:
 - 2> perform the actions as specified in [36] for all RFC 3095 contexts associated with that radio bearer in the downlink.

- 1> If the IE "Uplink RFC 3095 context relocation indication" is set to TRUE:
 - 2> perform the actions as specified in [36] for all RFC 3095 contexts associated with that radio bearer in the uplink.

8.6.4.14 RLC Info MBMS

Upon reception of the IE "RLC Info MBMS", the UE shall:

- 1> configure the receiving RLC entity in the UE for that radio bearer accordingly;
- 1> configure the corresponding RLC entity with the LI size indicated in the IE "DL UM RLC LI size".
- 1> if the IE "DL Duplication Avoidance and Reordering info" is present:
 - 2> configure the corresponding RLC entity to use the UM duplication avoidance and reordering functionality.
- 1> if the IE "DL Out of sequence delivery info" is present:
 - 2> configure the corresponding RLC entity to use the UM out of sequence delivery functionality.

8.6.4.15 RAB information for MBMS ptp bearer

If the IE "RAB information for MBMS ptp bearer" is included then the UE shall:

- 1> if an entry for the radio access bearer identified by the IE "RB Identity" already exists in the variable ESTABLISHED_RABS and a value of the IE "MBMS Service Identity" is stored in this entry of the variable ESTABLISHED_RABS:
 - 2> notify upper layers that the radio access bearer characterised by the parameters currently stored in this entry of the variable ESTABLISHED_RABS is released;
 - 2> reuse this entry of the variable ESTABLISHED_RABS and update it with the received value of IE "MBMS Service Identity" and, if included, with the received value of IE "MBMS Session Identity";
 - 2> notify upper layers that the radio access bearer characterised by the updated parameters in this entry is established.
- 1> else:
 - 2> set the variable INVALID_CONFIGURATION to TRUE.

8.6.5 Transport channel information elements

8.6.5.1 Transport Format Set

If the IE "Transport format set" is included, the UE shall:

- 1> if the transport format set is a RACH TFS received in System Information Block type 5 or System Information Block type 5bis or System Information Block type 6, and CHOICE "Logical Channel List" has a value different from "Configured":
 - 2> ignore that System Information Block.

NOTE: The TFS added by the IE "Additional Dynamic Transport Format Information for CCCH" has no CHOICE "Logical Channel List" and can thus never be considered as different from "Configured".

- 1> if the transport format set for a downlink transport channel is received in a System Information Block, and CHOICE "Logical Channel List" has a value different from 'ALL':
 - 2> ignore that System Information Block.
- 1> if the transport format set for a downlink transport channel is received in a message on a DCCH, and CHOICE "Logical Channel List" has a value different from 'ALL':

- 2> keep the transport format set if this exists for that transport channel;
- 2> set the variable INVALID_CONFIGURATION to TRUE.
- 1> if the value of any IE "RB identity" (and "Logical Channel" for RBs using two UL logical channels) in the IE "Logical channel list" does not correspond to a logical channel indicated to be mapped onto this transport channel in any RB multiplexing option (either included in the same message or previously stored and not changed by this message); or
- 1> if the "Logical Channel List" for any of the RLC sizes defined for that transport channel is set to "Configured" while it is set to "All" or given as an "Explicit List" for any other RLC size; or
- 1> if the "Logical Channel List" for any of the RLC sizes defined for that transport channel is set to "All" and for any logical channel mapped to this transport channel, the value of the "RLC size list" (either provided in the IE "RB mapping info" if included in the same message, or stored) is not set to "Configured"; or
- 1> if the "Logical Channel List" for any of the RLC sizes defined for that transport channel is given as an "Explicit List" that contains a logical channel for which the value of the "RLC size list" (either provided in the IE "RB mapping info" if included in the same message, or stored) is not set to "Configured"; or
- 1> if the "Logical Channel List" for all the RLC sizes defined for that transport channel are given as "Explicit List" and if one of the logical channels mapped onto this transport channel is not included in any of those lists; or
- 1> if the "Logical Channel List" for the RLC sizes defined for that transport channel is set to "Configured" and for any logical channel mapped onto that transport channel, the value of the "RLC size list" (either provided in the IE "RB mapping info" if included in the same message, or stored) is also set to "Configured"; or
- 1> if the IE "Transport Format Set" was not received within the IE "PRACH system information list" and if the "Logical Channel List" for the RLC sizes defined for that transport channel is set to "Configured" and for any logical channel mapped onto that transport channel, the "RLC size list" (either provided in the IE "RB mapping info" if included in the same message, or stored) is given as an "Explicit List" that includes an "RLC size index" that does not correspond to any RLC size in this "Transport Format Set"; or
- 1> if the IE "Transport Format Set" was not received within the IE "PRACH system information list", and if that RB is using AM and the set of RLC sizes applicable to the logical channel transferring data PDUs has more than one element not equal to zero:
 - 2> keep the transport format set if this exists for that transport channel;
 - 2> set the variable INVALID_CONFIGURATION to TRUE.
- 1> if the total number of configured transport formats for the transport channel exceeds maxTF:
 - 2> keep the transport format set if this exists for that transport channel;
 - 2> set the variable INVALID_CONFIGURATION to TRUE.
- 1> if the IE "Transport format set" is considered as valid according to the rules above:
 - 2> remove a previously stored transport format set if this exists for that transport channel;
 - 2> store the transport format set for that transport channel;
 - 2> consider the first instance of the parameter *Number of TBs and TTI List* within the *Dynamic transport format information* to correspond to transport format 0 for this transport channel, the second to transport format 1 and so on;
 - 2> if the IE "Transport format Set" has the choice "Transport channel type" set to "Dedicated transport channel":
 - 3> calculate the transport block size for all transport formats in the TFS using the following

$$\begin{array}{ll}
 \text{TB size} = \text{RLC size} + \text{MAC header size} & \text{if "RLC size"} \neq 0, \\
 \text{TB size} = 0 & \text{if "RLC size"} = 0,
 \end{array}$$

where:

- MAC header size is calculated according to [15] if MAC multiplexing is used. Otherwise it is 0 bits;

- 'RLC size' reflects the RLC PDU size.
- 2> if the IE "Transport format Set" has the choice "Transport channel type" set to "Common transport channel":
 - 3> calculate the transport block size for all transport formats in the TFS using the following:

$$\text{TB size} = \text{RLC size.}$$
- 2> if the IE "Number of Transport blocks" $\neq 0$ and IE "RLC size" = 0, no RLC PDU data exists but only parity bits exist for that transport format;
- 2> if the IE "Number of Transport blocks" = 0, neither RLC PDU neither data nor parity bits exist for that transport format;
- 2> perform the actions as specified in subclause 8.5.21.

For configuration restrictions on Blind Transport Format Detection, see [27].

8.6.5.2 Transport format combination set

If the IE "Transport format combination set" is included for the uplink, the UE shall for that direction:

- 1> store the new transport format combination set, or (if this exists) modify a previously stored transport format combination set according to IEs included in IE "Transport format combination set";
- 1> start to respect those transport format combinations;
- 1> if IE "Transport format combination subset" is received in this message:
 - 2> perform the actions as specified in subclause 8.6.5.3.
- 1> if IE "Transport format combination subset" is not received in this message:
 - 2> clear the IE "Duration" in the variable TFC_SUBSET;
 - 2> set both the IE "Current TFC subset" and the IE "Default TFC subset" in the variable TFC_SUBSET to the value indicating "full transport format combination set".

If the IE "Transport format combination set" is included for the downlink, the UE shall for that direction:

- 1> store the new transport format combination set, or (if this exists) modify a previously stored transport format combination set according to IEs included in IE "Transport format combination set";
- 1> start to respect those transport format combinations.

If the IE "Transport format combination set" is not included for the uplink and if there is no addition, removal or reconfiguration of transport channels, the UE shall for that direction:

- 1> use a previously stored transport format combination set if this exists.

If the IE "Transport format combination set" is not included for the downlink and if there is no addition, removal or reconfiguration of transport channels, the UE shall for that direction:

- 1> use a previously stored transport format combination set if this exists.

If the IE "Transport format combination set" is not included for either the uplink or the downlink and for that direction after the reconfiguration there is one or more stored DCH configuration; and

- 1> if no transport format combination set is stored in the UE; or
- 1> if transport channels are added or removed in the message; or
- 1> if any transport channel is reconfigured in the message such that the size of the transport format set is changed:

the UE shall:

- 1> set the variable INVALID_CONFIGURATION to TRUE.

If the IE "Transport format combination set" is not included for either the uplink or the downlink and for that direction after the reconfiguration there is no stored DCH configuration, the UE shall:

- 1> remove any stored transport format combination set for dedicated channels for that direction.

In the uplink TFCS the minimum set of TFCs is the set of TFCs that is needed for the TFC selection algorithm defined in [15] to give a predictable result. Any configured TFCS or TFC subset shall satisfy the requirements as specified by the minimum set. In the definition of the minimum set of TFCs below, only logical channels for which the TFCS or the TFC subset include at least one TFC with non-empty TF for the corresponding transport channel should be considered.

The minimum set of TFCs consists of the following:

- 1> for each UM logical channel:

- 2> a TFC with one transport block for this transport channel and empty TFs (see [34]) for all the others. If more than one TFC fulfils these criteria, only the TFC with the lowest number of bits should be included in the minimum set of TFCs.

- 1> for each AM logical channel:

- 2> a TFC with a non-empty TF for the corresponding transport channel and empty TFs for all other transport channels, where the non-empty TF includes one transport block with "Configured RLC Size" equal to the RLC PDU size.

- 1> for each set of "synchronous" TM logical channels (see the definition below) and for each set of SDU sizes associated with it:

- 2> a TFC with TFs corresponding to any combination of SDU sizes that can be received in a TTI from higher layers on the corresponding transport channels and empty TFs for all other transport channels.

NOTE: In case an adaptive rate codec is used and the TFCS has been restricted by the IE "TFC subset", the minimum set consists of the set of TFCs with TFs corresponding to any combination of SDU sizes that can be received in a TTI respecting the restricted TFCS.

- 1> for each TM logical channel that is not part of a set of "synchronous" TM logical channels (see the definition below):

- 2> a TFC with non-empty TFs for the corresponding transport channel, and empty TFs for all other transport channels, where

- 3> for non-segmented mode TM-RLC logical channels the non-empty TFs include, for the smallest SDU size that can be received in a single TTI from higher layer:

- 4> a TF with non-zero number of transport blocks with "Configured RLC Size" equal to the corresponding SDU size. If more than one TFC fulfils these criteria, only the TFC with the lowest number of bits in the TFC is included in the minimum set of TFCs.

- 3> for segmented mode TM-RLC, the non-empty TFs include any TF such that the number of transport blocks multiplied by the "Configured RLC Size" is equal to the smallest SDU size that can be received in a single TTI from higher layer.

- 1> an "empty" TFC (see [34]).

Furthermore, the UTRAN should ensure that the uplink TFCS and any configured TFC Subset satisfies the following rules:

- 1> for each TTI length with which at least one transport channel is configured:

- 2> for each combination of TFs for the transport channels configured with this TTI length included in the TFCS:

- 3> a TFC with these TFs for the transport channels configured with this TTI length and empty TFs on all transport channels configured with shorter TTI lengths is also included in the TFCS.

For TDD, the TFCS of a CCTrCH should include those of the above combinations, which include a TF with one transport block for a transport channel used in that CCTrCH, and the "empty" TFC should be included in the TFCS of every CCTrCH.

Synchronous TM logical channels are logical channels on which higher layer traffic is generated in a perfectly correlated fashion (e.g. AMR RAB).

NOTE: The "Configured RLC Size" is defined as the transport block size minus the MAC header size.

8.6.5.3 Transport format combination subset

When configuring a TFC Subset, the UTRAN should follow the guidelines defined in subclause 8.6.5.2.

If the IE "Transport format combination subset" ("TFC subset") is included, the UE shall:

- 1> if the IE "Minimum allowed Transport format combination index" is included; and
 - 2> if the value of the IE "Minimum allowed Transport format combination index" is greater than the highest TFCI value in the current transport format combination set:
 - 3> consider the TFC subset to be incompatible with the current transport format combination set.
- 1> if the IE "Allowed transport format combination list" is included; and
 - 2> if the value of any of the IEs "Allowed transport format combination" included in the IE "Allowed transport format combination list" does not match a TFCI value in the current transport format combination set:
 - 3> consider the TFC subset to be incompatible with the current transport format combination set.
- 1> if the IE "Non-allowed transport format combination list" is included; and
 - 2> if the value of any of the IEs "Non-allowed transport format combination" included in the IE "Non-allowed transport format combination list" does not match a TFCI value in the current transport format combination set:
 - 3> consider the TFC subset to be incompatible with the current transport format combination set.
- 1> if the IE "Restricted TrCH information" is included:
 - 2> if the value of any of the IEs "Uplink transport channel type" and "Restricted UL TrCH identity" included in the IE "Restricted TrCH information" do not correspond to any of the transport channels for which the current transport format combination set is valid:
 - 3> consider the TFC subset to be incompatible with the current transport format combination set.
- 2> if the IE "Allowed TFIs" is included; and
 - 3> if the value of each of the IEs "Allowed TFI" included in the IE "Allowed TFIs" corresponds to a transport format for that transport channel within the current transport format combination set:
 - 4> allow all transport format combinations that include these transport formats for the transport channel;
 - 4> restrict all other transport format combinations.
 - 3> else:
 - 4> consider the TFC subset to be incompatible with the current transport format combination set.
- 2> if the IE "Allowed TFIs" is not included:
 - 3> restrict all transport format combinations where the transport channel has a transport format of non-zero rate.
- 1> if the UE considers the TFC subset to be incompatible with the current Transport format combination set according to the above:
 - 2> keep any previous restriction of the transport format combination set;
 - 2> set the variable INVALID_CONFIGURATION to TRUE.

- 1> if the UE does not consider the TFC subset to be incompatible with the current Transport format combination set according to the above:
 - 2> if the IE "Transport format combination subset" is received in a message other than a TRANSPORT FORMAT COMBINATION CONTROL message:
 - 3> set both the IE "Current TFC subset" and the IE "Default TFC subset" in the variable TFC_SUBSET to the IE "Transport format combination subset" (in case of TDD for the uplink CCTrCH specified by the IE "TFCS Id");
 - 3> clear the IE "Duration" in the variable TFC_SUBSET;
 - 3> apply the transport format combination subset in the IE "Current TFC subset" stored in the variable TFC_SUBSET.
- 1> if the IE "transport format combination subset" indicates the "full transport format combination set":
 - 2> set both the IE "Current TFC subset" and the IE "Default TFC subset" in the variable TFC_SUBSET to the value indicating "full transport format combination set";
 - 2> clear the IE "Duration" in the variable TFC_SUBSET;
 - 2> if the IE "Transport format combination subset" is received in a TRANSPORT FORMAT COMBINATION CONTROL message, then at the CFN indicated by the IE "Activation time for TFC subset" any restriction on transport format combination set is released and the UE may use the full transport format combination set;
 - 2> else:
 - 3> any restriction on transport format combination set is released and the UE may use the full transport format combination set.

8.6.5.4 DCH quality target

If the IE "DCH quality target" is included, the UE shall:

- 1> set, at physical channel establishment, the initial downlink target SIR value based on the received IE "DCH quality target" for the transport channel with respect to all transport formats;
- 1> adjust the target SIR for the downlink power control to meet the quality target received in the IE "DCH quality target" for the transport channel. The UE shall not compensate for the fact that the required SIR to achieve a target BLER for a particular transport format may be different from the required SIR to achieve the target BLER for another transport format..

NOTE 1: Adjusting the target SIR is possible to do continuously by the UE if a CRC exists in all transport formats in the downlink TFS for a DCH. If a CRC does not exist in all transport formats, the UE can only adjust the target SIR when receiving transport formats containing a CRC and the UE has knowledge about the transport format according to [27].

NOTE 2: If the UTRAN configures a UE to use blind transport format detection and configures a transport channel such that single transport format detection [27] must be used to detect the TF, then it is not possible for the UE to maintain a quality target for that transport channel.

8.6.5.5 Added or Reconfigured UL TrCH information

If the IE "Added or Reconfigured UL TrCH information" is included then the UE shall:

- 1> for the transport channel identified by the IE "UL Transport Channel Identity" and IE "Uplink transport channel type":
 - 2> perform the actions for the IE "Transport Format Set" as specified in subclause 8.6.5.1.

NOTE: The UE stores the UL transport channel configuration until it is explicitly deleted by a message containing the IE "Deleted UL TrCH information" or the UE leaves RRC Connected mode.

- 1> if the choice "UL parameters" is set to 'E-DCH':

- 2> for FDD:
 - 3> apply the values of the IE "E-DCH Transmission Time Interval" and the IE "HARQ info for E-DCH" to all E-DCH MAC-d flows.
- 2> for TDD:
 - 3> apply the value of the IE "HARQ info for E-DCH" to all E-DCH MAC-d flows.
- 2> for the IE "HARQ Info for E-DCH":
 - 3> perform the actions specified in subclause 8.6.5.17.
- 2> if the IE "Added or Reconfigured E-DCH MAC-d Flow list " is included:
 - 3> for each MAC-d flow identified by the IE "Mac-d flow identity":
 - 4> perform the actions as specified in subclause 8.6.5.18.
- 2> determine the value for the E_DCH_TRANSMISSION variable and take the corresponding actions as described in subclause 8.5.28.

NOTE: In case of multiple E-DCH MAC-d flows, IE "Added or Reconfigured UL TrCH information" is only included once. If the IE "Added or Reconfigured UL TrCH information" is included more than once with the IE "Uplink transport channel type" set to 'E-DCH', the UE behaviour is unspecified.

8.6.5.5a Added or reconfigured MAC-d flow

If the IE "Added or reconfigured MAC-d flow" is included, the UE shall:

- 1> if a MAC-hs queue (identified by the IE "MAC-hs queue Id") is included in both the IE "MAC-hs queue to add or reconfigure list" and the IE "MAC-hs queue to delete list":
 - 2> set the variable INVALID_CONFIGURATION to TRUE.
- 1> for each MAC-hs queue included in the IE "MAC-hs queue to add or reconfigure" list:
 - 2> if the UE has previously stored a mapping between this MAC-hs queue and a MAC-d flow:
 - 3> delete the old mapping.
 - 2> map the MAC-d flow indicated in the current message to this MAC-hs queue;
 - 2> set the release timer for each of the MAC-hs queues in the MAC-hs entity to the value in the corresponding IE "T1";
 - 2> set the MAC-hs receiver window size for each of the MAC-hs queues in the MAC-hs entity to the value in the corresponding IE "MAC-hs window size"; and
 - 2> configure MAC-hs with the mapping between MAC-d PDU sizes index and allowed MAC-d PDU sizes as follows:
 - 3> if a MAC-d PDU size has been stored for a MAC-d PDU size index for the corresponding MAC-hs queue and no mapping is provided in the current message for this MAC-d PDU index:
 - 4> continue to use this mapping.
 - 3> if a MAC-d PDU size has been stored for a MAC-d PDU size index for the corresponding MAC-hs queue and a mapping is provided in the current message for this MAC-d PDU index:
 - 4> configure the MAC-hs entity with the mapping indicated in the current message.
- 1> for each MAC-hs queue included in the IE "MAC-hs queue to delete" list:
 - 2> delete any information about the MAC-hs queue identified by the IE "MAC-hs queue Id".
- 1> if the IE "Added or reconfigured MAC-d flow" is considered valid according to the rules above:

2> perform the actions as specified in subclause 8.5.21.

8.6.5.6 Added or Reconfigured DL TrCH information

If the IE "Added or Reconfigured DL TrCH information" is included the UE shall:

- 1> for the transport channel identified by the IE "DL Transport Channel Identity":
 - 2> if the choice "DL parameters" is set to 'explicit':
 - 3> perform the actions for the IE "Transport Format Set" as specified in subclause 8.6.5.1.
 - 2> if the choice "DL parameters" is set to 'same as uplink':
 - 3> if the IE "UL Transport Channel Identity" indicates an existing or a new UL Transport Channel:
 - 4> store as transport format for this transport channel the transport format associated with the transport channel identified by the IE "UL Transport Channel Identity".
 - 3> else:
 - 4> set the variable INVALID_CONFIGURATION to TRUE.
 - 2> if the IE "DCH quality target" is included:
 - 3> perform the actions specified in subclause 8.6.5.4.
- 1> if the choice "DL parameters" is set to "HSDSCH":
 - 2> if the IE "HARQ Info" is included:
 - 3> perform the actions specified in subclause 8.6.5.6b.
 - 2> if the IE "Added or Reconfigured MAC-d Flow" is included:
 - 3> perform the actions as specified in subclause 8.6.5.5a.
 - 2> if the IE "Added or Reconfigured MAC-ehs reordering queue" is included:
 - 3> perform the actions as specified in subclause 8.6.5.23.
 - 2> determine the value for the HS_DSCH_RECEPTION variable and take the corresponding actions as described in subclause 8.5.25.

NOTE: The UE stores the DL transport channel configuration until it is explicitly deleted by a message containing the IE "Deleted DL TrCH information" or the UE leaves RRC connected mode.

8.6.5.6a Void

8.6.5.6b HARQ Info

If the IE "HARQ Info" is included, the UE shall:

- 1> store the received configuration;
- 1> determine the value for the HS_DSCH_RECEPTION variable and take the corresponding actions as described in subclause 8.5.25;
- 1> determine the value for the HS_DSCH_RECEPTION_CELL_FACH_STATE variable and take the corresponding actions as described in subclause 8.5.36.

When the variable HS_DSCH_RECEPTION or variable HS_DSCH_RECEPTION_CELL_FACH_STATE is set to TRUE the UE shall:

- 1> configure the MAC-hs/ehs entity with the number of HARQ processes indicated in IE "Number of Processes";

- 1> assign to each of these HARQ processes IDs going from 0 to "Number of Processes" – 1;
- 1> if the IE "Memory Partitioning" is set to 'Implicit':
 - 2> partition the soft memory buffer in the MAC-hs/ehs entity equally among the processes configured above. In the event that the division of the soft memory buffer results in a non-Integer value the partition memory size is rounded down to the nearest Integer value.
- 1> if the IE "Memory Partitioning" is set to 'Explicit':
 - 2> if the UE capability "Total number of soft channel bits in HS-DSCH", as specified in [35], is exceeded with this configuration:
 - 3> set the variable INVALID_CONFIGURATION to TRUE.
 - 2> else:
 - 3> partition the soft memory buffer in the MAC-hs/ehs entity according to the IE "Process memory size" assuming that the order in the list follows the order in the HARQ process IDs.

8.6.5.7 Deleted UL TrCH information

If the IE "Deleted UL TrCH information" is included the UE shall:

- 1> if an Uplink transport channel is requested to be deleted:
 - 2> delete any information about the transport channel identified by the IE "UL TrCH identity" and the IE "Uplink transport channel type".
- 1> if an E-DCH MAC-d flow is requested to be deleted:
 - 2> delete any information about the E-DCH MAC-d flow identified by the IE "E-DCH MAC-d flow identity";
 - 2> determine the value for the E_DCH_TRANSMISSION variable and take the corresponding actions as described in subclause 8.5.28.

8.6.5.8 Deleted DL TrCH information

If the IE "Deleted DL TrCH information" is included the UE shall:

- 1> if a Downlink transport channel is requested to be deleted:
 - 2> delete any information about the transport channel identified by the IE "DL TrCH identity".
- 1> if a DL MAC-d flow is requested to be deleted:
 - 2> delete any information about the DL HS-DSCH MAC-d flow identified by the IE "MAC-d Flow Identity", i.e. delete any information about MAC-hs queue(s) mapped onto this MAC-d flow.
 - 2> determine the value for the HS_DSCH_RECEPTION variable and take the corresponding actions as described in subclause 8.5.25.
- 1> if a DL MAC-ehs reordering queue is requested to be deleted:
 - 2> delete any information about the DL HS-DSCH DL MAC-ehs reordering queue identified by the IE "DL HS-DSCH MAC-ehs queue Id";
 - 2> determine the value for the HS_DSCH_RECEPTION variable and take the corresponding actions as described in subclause 8.5.25.

8.6.5.9 UL Transport channel information common for all transport channels

If the IE "UL Transport channel information common for all transport channels" is included the UE shall:

- 1> perform actions for the IE "TFC subset" as specified in subclause 8.6.5.3;

- 1> if the IE "PRACH TFCS" is included:
 - 2> set the variable INVALID_CONFIGURATION to TRUE.
- 1> if the IE has the choice "mode" set to FDD:
 - 2> perform actions for the IE "UL DCH TFCS" as specified in subclause 8.6.5.2.
- 1> if the IE has the choice "mode" set to TDD:
 - 2> if the IE "Individual UL CCTrCH information" is included:
 - 3> for each TFCS identified by IE "UL TFCS id":
 - 4> perform actions for the IE "UL TFCS" as specified in subclause 8.6.5.2.
- 1> if the IE "TFC subset list" is included:
 - 2> remove a previously stored TFC subset list if this exists in the IE "TFC subset list" in the variable TFC_SUBSET;
 - 2> store the IE "TFC subset list" in the IE "TFC subset list" in the variable TFC_SUBSET;
 - 2> consider the first instance of the IE "TFC subset" in the IE "TFC subset list" as Transport Format Combination Subset 0 (TFC subset identity = 0), the second instance as Transport Format Combination Subset 1 (TFC subset identity = 1) and so on;
 - 2> if the IE "TFC subset list" contains greater than 8 elements then the UE behaviour is not specified.

NOTE: The UTRAN should not modify the TFC subset list when a temporary restriction of the TFC set is being applied, due to the reception of the IE "TFC Control Duration" in a TRANSPORT FORMAT COMBINATION CONTROL message is still being applied.

8.6.5.10 DL Transport channel information common for all transport channels

If the IE "DL Transport channel information common for all transport channels" is included the UE shall:

- 1> if the IE "SCCPCH TFCS" is included:
 - 2> set the variable INVALID_CONFIGURATION to TRUE.
- 1> if the IE choice "mode" is set to FDD:
 - 2> if the choice "DL parameters" is set to 'explicit':
 - 3> if the IE "DL DCH TFCS" is included:
 - 4> if the IE "SCCPCH TFCS" is included and the state the UE enters after handling the received information is other than CELL_DCH:
 - 5> ignore the received IE "DL DCH TFCS".

NOTE: the IE "DL Transport channel information common for all transport channels" always includes a DL DCH TFCS configuration, either by including the IE "DL DCH TFCS" or by specifying that the TFCS is the same as in UL. If UTRAN does not require the reconfiguration of the concerned parameters, UTRAN may replace one TFC with the value that is already assigned for this IE.

- 4> else:
 - 5> perform actions as specified in subclause 8.6.5.2.
- 1> if the IE choice "mode" is set to TDD:
 - 2> if the IE "Individual DL CCTrCH information" is included:
 - 3> for each DL TFCS identified by the IE "DL TFCS identity":

- 4> if the IE choice "DL parameters" is set to 'independent':
 - 5> perform actions for the IE "DL TFCS" as specified in subclause 8.6.5.2.
- 4> if the IE choice "DL parameters" is set to 'same as UL':
 - 5> if the IE "UL DCH TFCS identity" indicates an existing or a new UL TFCS:
 - 6> store for that DL TFCS the TFCS identified by the IE "UL DCH TFCS identity".
 - 5> else:
 - 6> set the variable INVALID_CONFIGURATION to TRUE.

8.6.5.11 Void

8.6.5.12 TFCS Reconfiguration/Addition Information

If the IE "TFCS Reconfiguration/Addition Information" is included the UE shall:

- 1> store the TFCs to be reconfigured/added indicated in the IE "CTFC information" as specified below;
 - 1> if the IE "Power offset information" is included:
 - 2> perform actions as specified in [29].

In order to identify the TFCs included in this IE the UE shall calculate the CTFC as specified in subclause 14.10.

- 1> if the IE "Additional Dynamic Transport Format Information for CCCH" was included in the IE "RACH TFS":
 - 2> ignore for the CTFC calculation any TF added by the IE "Additional Dynamic Transport Format Information for CCCH".

If the IE "TFCS Reconfiguration/Addition Information" is used in case of TFCS "Complete reconfiguration" the UE shall:

- 1> remove a previously stored transport format combination set if this exists;
 - 1> consider the first instance of the IE "CTFC information" as Transport Format Combination 0 in FDD (TFCI=0) and 1 in TDD (TFCI=1), the second instance as Transport Format Combination 1 in FDD (TFCI=1) and 2 in TDD (TFCI=2) and so on. In TDD the TFCI value = 0 is reserved for physical layer use.

If the IE "TFCS Reconfiguration/Addition Information" is used in case of TFCS "Addition" the UE shall insert the new additional(s) TFC into the first available position(s) in ascending TFCI order in the TFCS.

8.6.5.12a Additional RACH TFCS for CCCH

If the IE "Additional RACH TFCS for CCCH" is included the UE shall:

- 1> if the IE "Power offset information" is included:
 - 2> perform actions as specified in [29].
- 1> add to the TFCS as calculated in 8.6.5.12 for the corresponding PRACH the TFC which consists of the TF added by the IE "Additional Dynamic Transport Format Information for CCCH" into the next position in ascending order after the highest TFCI value already used.

NOTE: On PRACH only one transport channel can be multiplexed.

8.6.5.13 TFCS Removal Information

If the IE "TFCS Removal Information" is included the UE shall:

- 1> remove the TFC indicated by the IE "TFCI" from the current TFCS, and regard this position (TFCI) in the TFCS as vacant.

8.6.5.14 Void

8.6.5.15 TFCS Explicit Configuration

If the IE "TFCS Explicit Configuration" is included the UE shall:

- 1> if the IE choice "TFCS representation" is set to 'complete reconfiguration':
 - 2> perform the actions for the IE "TFCS Reconfiguration/Addition Information" as specified in subclause 8.6.5.12.
- 1> if the IE choice "TFCS representation" is set to 'addition':
 - 2> perform the actions for the IE "TFCS Reconfiguration/Addition Information" as specified in subclause 8.6.5.12.
- 1> if the IE choice "TFCS representation" is set to 'removal':
 - 2> perform the actions for the IE "TFCS Removal Information" as specified in subclause 8.6.5.13.
- 1> if the IE choice "TFCS representation" is set to 'replace':
 - 2> perform first the actions for the IE "TFCS Removal Information" as specified in subclause 8.6.5.13; and then
 - 2> perform the actions for the IE "TFCS Reconfiguration/Addition Information" as specified in subclause 8.6.5.12.

8.6.5.16 E-DCH Transmission Time Interval (FDD only)

If the IE "E-DCH Transmission Time Interval" is included, the UE shall:

- 1> store the received TTI;
- 1> determine the value for the E_DCH_TRANSMISSION variable and take the corresponding actions as described in subclause 8.5.28.

When the variable E_DCH_TRANSMISSION is set to TRUE the UE shall:

- 1> apply the TTI as signalled in the IE "E-DCH Transmission Time Interval" on the E-DPDCH.

If the received "E-DCH Transmission Time Interval" is 2 ms and the previously stored TTI was 10 ms:

- 1> not send any data on E-DPDCH in first 8 TTIs after activation time of new TTI.

8.6.5.17 HARQ Info for E-DCH

If the IE "HARQ Info for E-DCH" is included, the UE shall:

- 1> store the received configuration;
- 1> determine the value for the E_DCH_TRANSMISSION variable and take the corresponding actions as described in subclause 8.5.28.

When the variable E_DCH_TRANSMISSION is set to TRUE the UE shall:

- 1> use a redundancy version for each HARQ transmission as configured by the IE "HARQ RV Configuration".

8.6.5.18 Added or reconfigured E-DCH MAC-d flow

If the IE "Added or reconfigured E-DCH MAC-d flow" is included, the UE shall:

- 1> if the IE "E-DCH MAC-d flow power offset" is included:
 - 2> configure the power offset indicated in the IE "E-DCH MAC-d flow power offset" for the E-DCH MAC-d flow identified by the IE "E-DCH MAC-d flow identity".
- 1> if the IE "E-DCH MAC-d flow maximum number of retransmissions" is included:
 - 2> configure the maximum number of retransmissions indicated in the IE "E-DCH MAC-d flow maximum number of retransmissions" for the E-DCH MAC-d flow identified by the IE "E-DCH MAC-d flow identity".
- 1> for 1.28 Mcps TDD, if the IE "E-DCH MAC-d flow retransmission timer" is included:
 - 2> configure the retransmission timer for the E-DCH MAC-d flow identified by the IE "E-DCH MAC-d flow identity".
- 1> if the IE "E-DCH MAC-d flow multiplexing list" is included:
 - 2> only multiplex MAC-d PDU's from the E-DCH MAC-d flow indicated in the IE "E-DCH MAC-d flow identity" with MAC-d PDU's from E-DCH MAC-d flows with which multiplexing in the same MAC-e PDU is allowed in accordance to the IE "E-DCH MAC-d flow multiplexing list".
- 1> else:
 - 2> if previously the IE "E-DCH MAC-d flow multiplexing list" was already received for this E-DCH MAC-d flow:
 - 3> continue to only multiplex E-DCH PDU's from the E-DCH MAC-d flow indicated in the IE "E-DCH MAC-d flow identity" with MAC-d PDU's from E-DCH MAC-d flows with which multiplexing in the same MAC-e PDU is allowed according to the previously received IE "E-DCH MAC-d flow multiplexing list".
 - 2> else (never received the IE "E-DCH MAC-d flow multiplexing list" for this E-DCH MAC-d flow):
 - 3> allow multiplexing of MAC-d PDU's from the E-DCH MAC-d flow indicated in the IE "E-DCH MAC-d flow identity" with MAC-d PDU's from any other E-DCH MAC-d flow in the same MAC-e PDU.
- 1> for FDD:
 - 2> if the IE "Non-scheduled transmission grant info" is included:
 - 3> if the TTI configured on the E-DCH equals 2ms, and the IE "2ms non-scheduled transmission grant HARQ process allocation" is configured for this MAC-d flow:
 - 4> MAC-d PDU's for logical channels belonging to this MAC-d flow shall only be included in a MAC-e PDU transmitted by HARQ processes allowed by the IE "2ms non-scheduled transmission grant HARQ process allocation", with a total contribution from this MAC-d flow (i.e. including MAC-e/es headers) not exceeding the size as signalled by the IE "Max MAC-e PDU contents size".
 - 3> else:
 - 4> MAC-d PDU's for logical channels belonging to this MAC-d flow shall be included in a MAC-e PDU transmitted by any HARQ process, with a total contribution from this MAC-d flow (i.e. including MAC-e/es headers) not exceeding the size as signalled by the IE "Max MAC-e PDU contents size".
 - 2> if the IE "Scheduled transmission grant info" is included:
 - 3> transmission of MAC-d PDU's for logical channels belonging to this MAC-d flow shall be in accordance with the received scheduled grant on E-AGCH/E-RGCH (see [15]).
- 1> for TDD:
 - 2> if the IE "Non-scheduled transmission grant info" is included:

- 3> MAC-d PDU's for logical channels belonging to this MAC-d flow shall only be included in a MAC-e PDU transmitted by HARQ processes designated as non scheduled (Ids 4 – 7) in the TTIs indicated (for 3.84 Mcps TDD and 7.68 Mcps TDD, as determined from the IEs "Activation Time", "Resource Duration" and "Resource Periodicity"; for 1.28 Mcps TDD, as determined from the IEs "Activation Time", "Subframe number", "Resource Duration" and "Resource Periodicity", and the calculation of assigned non-scheduled transmission grant is specified in subclause 8.6.6.16a).
- 2> if the IE "Scheduled transmission grant info" is included:
 - 3> transmission of MAC-d PDUs for logical channels belonging to this MAC-d flow shall be in accordance with the received scheduled grant on E-AGCH (see [15]).
- 1> perform the actions as specified in subclause 8.5.21;
- 1> determine the value for the E_DCH_TRANSMISSION variable and take the corresponding actions as described in subclause 8.5.28.

8.6.5.19 SRB1 mapping info (FDD only)

When variable HS_DSCH_RECEPTION_CELL_FACH_STATE or variable HS_DSCH_RECEPTION_OF_CCCH_ENABLED are set to TRUE and the UE is in CELL_FACH state, the UE shall:

- 1> if no MAC-ehs queue with identified by the "MAC-ehs queue identity" value as received in IE "SRB1 mapping info" of System Information Block type 5 or System Information Block type 5bis is configured:
 - 2> the UE behaviour is unspecified.
- 1> else:
 - 2> map the logical channel identified by the IE "Logical channel identity" to the MAC-ehs queue identified by the IE "MAC-ehs queue identity" as received in IE "SRB1 mapping info" of System Information Block type 5 or System Information Block type 5bis.
- 1> if there is more than one multiplexing option applicable for logical channels to be used:
 - 2> the UE behaviour is unspecified.

8.6.5.20 HARQ System Info (FDD only)

When the UE is not in RRC Connected state and variable HS_DSCH_RECEPTION_OF_CCCH_ENABLED is set to TRUE, or when the UE is in CELL_FACH state or will be in CELL_FACH state at the completion of this procedure, the UE shall:

- 1> if IE "HS-DSCH common system information" is included in System Information Block type 5 or System Information Block type 5bis:
 - 2> configure the MAC-ehs entity with the number of HARQ processes indicated in IE "Number of Processes";
 - 2> assign to each of these HARQ processes IDs going from 0 to "Number of Processes" – 1;
- 2> if the IE "Memory Partitioning" is set to 'Implicit':
 - 3> partition the soft memory buffer in the MAC-ehs entity equally among the processes configured above. In the event that the division of the soft memory buffer results in a non-Integer value the partition memory size is rounded down to the nearest Integer value.
- 2> if the IE "Memory Partitioning" is set to 'Explicit':
 - 3> if the UE capability "Total number of soft channel bits in HS-DSCH", as specified in [35], is exceeded with this configuration:
 - 4> the UE behaviour is unspecified.
- 3> else:

- 4> partition the soft memory buffer in the MAC-ehs entity according to the IE "Process memory size" assuming that the order in the list follows the order in the HARQ process IDs.

8.6.5.21 CCCH mapping info (FDD only)

When variable HS_DSCH_RECEPTION_OF_CCCH_ENABLED is set to TRUE, the UE shall:

- 1> if no MAC-ehs queue with identified by the "MAC-ehs queue identity" value as received in IE "CCCH mapping info" of System Information Block type 5 or System Information Block type 5bis is configured:
 - 2> set the variable INVALID_CONFIGURATION to TRUE.
- 1> else:
 - 2> map the logical channel identified by the IE "Logical channel identity" to the MAC-ehs queue identified by the IE "MAC-ehs queue identity" as received in IE "CCCH mapping info" of System Information Block type 5 or System Information Block type 5bis.
- 1> if there is more than one multiplexing option applicable for logical channels to be used:
 - 2> the UE behaviour is not specified.

8.6.5.22 Common MAC-ehs reordering queue (FDD only)

When variable HS_DSCH_RECEPTION_OF_CCCH_ENABLED is set to TRUE, the UE shall:

- 1> set the release timer for the MAC-ehs queue in the MAC-ehs entity to the value in the corresponding IE "T1";
- 1> set the reset timer for the MAC-ehs queue in the MAC-ehs entity to the value in te corresponding IE "Treset";
- 1> set the MAC-ehs receiver window size for the MAC-ehs queues in the MAC-ehs entity to the value in the corresponding IE "MAC-ehs window size".

8.6.5.23 Added or reconfigured MAC-ehs reordering queue

If the IE "Added or reconfigured MAC-ehs reordering queue" is included, the UE shall:

- 1> if the IE "Deleted DL TrCH information" is included in the received message; and
 - 1> if a MAC-ehs queue (identified by the IE "MAC-ehs queue Id") is included in both the IE "MAC-ehs queue to add or reconfigure list" and the IE "DL HS-DSCH MAC-ehs reordering queue" within the IE "Deleted DL TrCH information":
 - 2> the UE behaviour is unspecified.
- 1> for each MAC-ehs queue included in the IE "MAC-ehs queue to add or reconfigure" list:
 - 2> set the release timer for each of the MAC-ehs queues in the MAC-ehs entity to the value in the corresponding IE "T1";
 - 2> set the reset timer for the MAC-ehs queue in the MAC-ehs entity to the value in te corresponding IE "Treset";

NOTE: A UE that does not support reception of HS-DSCH in CELL_FACH state may ignore the IE "Treset".

- 2> set the MAC-ehs receiver window size for each of the MAC-ehs queues in the MAC-ehs entity to the value in the corresponding IE "MAC-ehs window size".
- 1> if the IE "Added or reconfigured MAC-ehs reordering queue" is considered valid according to the rules above:
 - 2> perform the actions as specified in subclause 8.5.21.

8.6.6 Physical channel information elements

This subclause specifies the actions upon reception and/or non-reception of the physical channel information elements. The combination of the values of those information elements included in a given message shall follow the compatibility rules that are specified in the physical layer specifications. In case those rules are not followed, the UE shall set the variable `INVALID_CONFIGURATION` to `TRUE`.

8.6.6.1 Frequency info

If, after completion of the procedure, the UE will be in `CELL_DCH` state, the UE shall:

- 1> for FDD, 3.84 Mcps TDD and 7.68 Mcps TDD, if the IE "Frequency info" is included; or
- 1> for 1.28 Mcps TDD, if the IE "Frequency info" is included and the "Second Frequency info" is not included:
 - 2> if the frequency is different from the currently used frequency:
 - 3> store and use the frequency indicated by the IE "Frequency Info";
 - 3> if the received message is used to perform a Timing-maintained hard handover (see subclause 8.3.5.2), and IE "Timing maintained Synchronization indicator" is included:
 - 4> not perform any physical layer synchronisation procedure (FDD only);
 - 3> else:
 - 4> perform the physical layer synchronisation procedure A as specified in [29] (FDD only).
 - 2> if the frequency is the same as the currently used frequency:
 - 3> continue to use the currently used frequency;
 - 3> perform the physical layer synchronisation procedure A as specified in [29] (FDD only).
- 1> for 1.28 Mcps TDD, if both the IE "Frequency info" and the IE "Second Frequency info" are included:
 - 2> the frequency in IE "Frequency info" is used as the primary frequency, and the frequency in IE "Second Frequency info" is used as the secondary frequency;
 - 2> store the primary frequency;
 - 2> if the secondary frequency is different with the currently used frequency:
 - 3> store and use the secondary frequency.
 - 2> if the secondary frequency is the same as the currently used frequency:
 - 3> continue to use the currently used frequency.
- 1> if the IE "Frequency info" is not included and the UE has a currently used frequency:
 - 2> continue to use the currently used frequency;

NOTE If the received message is used to perform a Timing-reinitialised hard handover, and the IE "Frequency Info" is not included, the UE may perform the physical layer synchronisation procedure A as specified in [29] (FDD only).

8.6.6.2 Void

8.6.6.2a PNBSCH allocation

The UE shall consider the frame numbers fulfilling the following equation as "PRACH blocked frames" as specified in [33].

$$\text{SFN} = \lfloor k * \text{Repetition period} \rfloor$$

for an integer k with $k \in \{0, 1, 2, 3, 4, \dots, \text{value of IE "Number of repetitions per SFN period"} - 1\}$, where:

Repetition period is: $4096 / \text{value of IE "Number of repetitions per SFN period"}$.

The UE shall configure the physical layer for the physical random access procedure accordingly.

8.6.6.3 Void

8.6.6.3a Downlink information per radio link list

If the IE "Downlink information per radio link list" is included in a received message, the UE shall:

- 1> if the active set resulting after the reception of the IE "Downlink information per radio link list" would contain radio links indicated by the IE "Downlink DPCH info for each RL" and radio links indicated by the IE "Downlink F-DPCH info for each RL":
 - 2> set the variable INVALID_CONFIGURATION to TRUE.
- 1> if the message was received in CELL_DCH state and the UE remains in CELL_DCH state according to subclause 8.6.3.3 applied on the received message:
 - 2> for FDD, check whether the radio links included in the IE "Downlink information per radio link list" are part of the current active set considering that a radio link is uniquely identified by the downlink UARFCN and the primary scrambling code;
 - 2> for TDD, check whether the radio links included in the IE "Downlink information per radio link list" are part of the current active set considering that a radio link is uniquely identified by the UARFCN and the primary CCPCH;
- 2> if all radio links included in the IE "Downlink information per radio link list" are part of the current active set:
 - 3> for radio links part of the current active set, and present in the IE "Downlink information per radio link list":
 - 4> update the downlink physical channel configuration according to the IE "Downlink information for each radio link" as specified in subclause 8.6.6.4.
 - 3> for radio links part of the current active set, and absent in the IE "Downlink information per radio link list":
 - 4> not change its current downlink physical channel configuration;
 - 4> For FDD, in case the IE "Serving HS-DSCH radio link indicator" is set to 'TRUE' for another radio link, no longer consider any of these absent radio links as serving HS-DSCH radio link;
 - 4> For FDD, in case the IE "Serving E-DCH radio link indicator" is set to 'TRUE' for another radio link, no longer consider any of these absent radio links as serving E-DCH radio link.
- 2> if all radio links included in the IE "Downlink information per radio link list" are not part of the current active set:
 - 3> perform a hard handover by replacing all the radio links in the current active set with the radio links in the IE "Downlink information per radio link list", each with a downlink physical channel configuration according to the IE "Downlink information for each radio link" as specified in subclause 8.6.6.4;
 - 3> perform the checks on the value of the IE "Default DPCH Offset Value" as specified in subclause 8.3.5.1.2 or 8.3.5.2.2;
 - 3> act on the IE "Timing indication" and the IE "Default DPCH Offset Value", if included, as specified in subclause 8.5.15.2;

NOTE: UTRAN should not mix radio links which are part of the current active set and radio links which are not part of the current active set in the same IE "Downlink information per radio link list". In such cases the UE behaviour is unspecified.

1> otherwise:

2> if the message was received in CELL_FACH state and the UE would transit to CELL_DCH state according to subclause 8.6.3.3 applied on the received message:

3> establish a downlink physical channel configuration for each of the included radio links according to the IE "Downlink information for each radio link" as specified in subclause 8.6.6.4.

8.6.6.4 Downlink information for each radio link

If the IE "Downlink information for each radio link" is included in a received message, the UE shall:

1> if the UE would enter CELL_DCH state according to subclause 8.6.3.3 applied on the received message:

2> if the UE is in TDD mode and shared transport channels are assigned to the UE:

3> start to receive the indicated Secondary CCPCH.

2> if the UE is in TDD mode and no shared transport channels are assigned to the UE:

3> set the variable UNSUPPORTED_CONFIGURATION to TRUE.

2> For FDD:

3> if the IE "Serving HS-DSCH radio link indicator" is set to 'TRUE':

4> consider this radio link as the serving HS-DSCH radio link and no longer consider any other radio link as serving HS-DSCH radio link.

2> For FDD:

3> if the IE "Serving E-DCH radio link indicator" is set to 'TRUE':

4> consider this radio link as the serving E-DCH radio link and no longer consider any other radio link as serving E-DCH radio link.

3> if the IE "E-AGCH Info" is included for the serving E-DCH radio link:

4> store the newly received E-AGCH configuration.

NOTE: The UTRAN should always include the IE "E-AGCH info" if the serving E-DCH radio link indicated in the message is another radio link than the serving E-DCH radio link prior to the procedure.

3> if the IE "E-HICH information" is included:

4> store this E-HICH configuration for the concerning radio link.

3> if the IE "E-HICH information" is included or previously stored:

4> store this E-RGCH configuration for the concerning radio link, if included.

3> determine the value for the E_DCH_TRANSMISSION variable and take the corresponding actions as described in subclause 8.5.28.

2> for TDD:

3> if the IE "E-AGCH Info" is included:

4> store the newly received E-AGCH configuration.

3> if the IE "E-HICH information" is included:

- 4> store the E-HICH configuration.
- 3> determine the value for the E_DCH_TRANSMISSION variable and take the corresponding actions as described in subclause 8.5.28.
- 2> act on the other IEs contained in the IE "Downlink information for each radio link" as specified in subclause 8.6 applied on this radio link.
- 1> in addition, if the message was received in CELL_DCH state and the UE remains in CELL_DCH state according to subclause 8.6.3.3 applied on the received message:
 - 2> For FDD:
 - 3> if the IE "Serving HS-DSCH radio link indicator" is set to 'TRUE':
 - 4> consider this radio link as the serving HS-DSCH radio link;
 - 4> if the serving HS-DSCH radio link was another radio link than this radio link prior to reception of the message and the IE "H-RNTI" is not included:
 - 5> clear the variable H_RNTI.
 - 3> if the IE "Serving HS-DSCH radio link indicator" is set to 'FALSE' and this radio link was considered the serving HS-DSCH radio link prior to reception of this message:
 - 4> no longer consider this radio link as the serving HS-DSCH radio link.
 - 3> determine the value for the HS_DSCH_RECEPTION variable and take the corresponding actions as described in subclause 8.5.25;
 - 3> if the IE "Serving E-DCH radio link indicator" is set to 'TRUE':
 - 4> consider this radio link as the serving E-DCH radio link;
 - 4> if the serving E-DCH radio link was another radio link than this radio link prior to reception of the message:
 - 5> if the IE "New Primary E-RNTI" is not included:
 - 6> clear the Primary E-RNTI stored in the variable E_RNTI.
 - 5> if the IE "New Secondary E-RNTI" is not included:
 - 6> clear the Secondary E-RNTI stored in the variable E_RNTI.
 - 3> if the IE "Serving E-DCH radio link indicator" is set to 'FALSE' and this radio link was considered the serving E-DCH radio link prior to reception of this message:
 - 4> no longer consider this radio link as the serving E-DCH radio link.
 - 3> if the IE "E-HICH release indicator" is present:
 - 4> delete the stored E-HICH, E-AGCH and E-RGCH (if any) configurations.
 - 3> if the IE "E-RGCH release indicator" is present:
 - 4> delete the stored E-RGCH configuration for this RL.
 - 3> determine the value for the E_DCH_TRANSMISSION variable and take the corresponding actions as described in subclause 8.5.28.
 - 2> For TDD:
 - 3> if the IE "H-RNTI" is not included and the primary CCPCH has changed:
 - 4> clear the variable H_RNTI.

3> determine the value for the HS-DSCH_RECEPTION variable and take the corresponding actions as described in subclause 8.5.25.

2> for TDD:

3> if the IE "New Primary E-RNTI" is not included:

4> clear the variable E_RNTI.

3> determine the value for the E_DCH_TRANSMISSION variable and take the corresponding actions as described in subclause 8.5.28.

2> for each optional IE part of the IE "Downlink information for each radio link" that is not present:

3> do not change its current downlink physical channel configuration corresponding to the IE, which is absent, if not stated otherwise elsewhere.

NOTE: The Release '99 RADIO BEARER RECONFIGURATION message always includes at least one IE "Downlink information for each radio link" containing the mandatory IEs, even if UTRAN does not require the reconfiguration of any radio link.

1> if the UE would enter either the CELL_FACH, CELL_PCH or URA_PCH state according to subclause 8.6.3.3 applied on the received message:

2> if IEs other than the IE "Primary CPICH info" (for FDD) or the IE "Primary CCPCH info" (for TDD) are included in the IE "Downlink information for each radio link":

3> ignore these IEs.

2> act on the other IEs contained in the IE "Downlink information for each radio link" as specified in subclause 8.6 applied on this radio link.

8.6.6.5 Void

8.6.6.6 Uplink DPCH info

If the IE "Uplink DPCH info" is included, the UE shall:

For FDD:

1> release any active uplink physical channels and activate the given physical channels;

1> if the IE "Number of FBI bits" is not included:

2> use 0 FBI bits in the Uplink DPCH.

1> if the IE "Number of TPC bits" is not included:

2> use 2 TPC bits in the Uplink DPCH.

1> else:

2> if F-DPCH is not configured then the UE behaviour is unspecified.

1> use an SF equal to or greater than the minimum SF indicated in the IE "Spreading Factor" during uncompressed frames or compressed frames by HL scheduling;

1> use an SF equal to or greater than the minimum SF divided by 2 during compressed frames by SF reduction.

For TDD:

1> release the uplink physical channels associated with any CCTrCH that is removed or reconfigured and activate the physical channels assigned to any CCTrCH that is added or reconfigured;

1> for 3.84 Mcps TDD or 7.68 Mcps TDD use the IE "UL target SIR" specified for each added or reconfigured CCTrCH as described in subclause 8.5.7. For 1.28 Mcps TDD use the value of IE "UL target SIR" specified for each added or reconfigured CCTrCH for parameter $PRX_{DPCHdes}$ as described in subclause 8.5.7;

1> for 1.28 Mcps TDD:

2> if "PLCCH Info" is included then store PLCCH Info parameters with respect to this uplink DPCH (overwriting parameter values previously stored);

2> if "PLCCH Info" is not included then delete the PLCCH Info stored with respect to this uplink DPCH.

1> use the parameters of the IE "Time info" for each added or reconfigured CCTrCH;

1> if present, use the IE "Uplink Timing Advance Control" as specified in subclause 8.6.6.26.

8.6.6.7 Void

8.6.6.8 Maximum allowed UL TX power

If the IE "Maximum allowed UL TX power" is included in the Handover to UTRAN Command, in any other dedicated message or in System Information Block type 3 or in System Information Block 4, the UE shall:

1> store and use the value until it is updated.

If the IE "Maximum allowed UL TX power" was not included in any dedicated message, the UE shall:

1> use the value previously stored, when received in an earlier dedicated message, Handover to UTRAN Command message or received in System Information Block type 3 or in System Information Block 4.

For all cases, the UE shall:

1> keep the UE uplink transmit power at or below the indicated power value;

1> if the current UE uplink transmit power is above the indicated power value:

2> decrease the power to a level at or below the power value.

The maximum UE TX power is defined as the lower of the maximum output power of the UE power class and the maximum allowed UL TX power indicated in this IE. The maximum UE TX power shall not be exceeded.

8.6.6.9 Void

8.6.6.10 Void

8.6.6.11 Uplink DPCH power control info

The UE shall:

1> in FDD:

2> if the IE "Uplink DPCH power control info" is included:

3> if a synchronisation procedure A is performed according to [29]:

4> calculate and set an initial uplink transmission power;

4> start inner loop power control as specified in subclause 8.5.3;

- 4> for the UL inner loop power control:
 - 5> use the parameters specified in the IE.
 - 3> else:
 - 4> ignore the IEs "DPCCH Power offset", "PC Preamble" and "SRB delay";
 - 4> act on the IE "Power control algorithm" and the IE "TPC step size", if included.
 - 3> act on the IEs " Δ_{ACK} ", " Δ_{NACK} " and "Ack-Nack repetition factor", if included;
 - 3> use the procedure for transmitting HS-DPCCH preamble and postamble according to [29], if the IE "HARQ_preamble_mode" is set to 1.
- 1> in 3.84 Mcps TDD or 7.68 Mcps TDD:
- 2> if the IE "Uplink DPCH power control info" is included:
 - 3> use the parameters specified in the IE for open loop power control as defined in subclause 8.5.7.
 - 2> else:
 - 3> use the current uplink transmission power.
- 1> in 1.28 Mcps TDD:
- 2> if the CHOICE UL OL PC info is set to 'Broadcast UL OL PC info':
 - 3> set the variable INVALID_CONFIGURATION to true.
 - 2> if the IE "Uplink DPCH power control info" is included in the UPLINK PHYSICAL CHANNEL CONTROL message:
 - 3> use "Beacon PL Est. " and the TPC step size for the closed loop power control of the CCTrCH identified in the message, replacing the existing value used for the CCTrCH.
 - 3> if the IE " UL target SIR " is included:
 - 4> use this value for parameter $PRX_{DPCHdes}$ for open loop power control of the CCTrCH identified in the message in the case of a transition from closed loop to open loop power control as specified in [33].
 - 2> if the IE "Uplink DPCH power control info" is included in the IE "Uplink DPCH info":
 - 3> use the "Beacon PL Est. " and TPC step size for the closed loop power control of all CCTrCH added or reconfigured by the IE replacing any existing values used for the CCTrCHs;
 - 3> if the IE " UL target SIR " is included ignore the parameter.
- 1> both in FDD and TDD;
- 2> if the IE "Uplink DPCH power control info" is not included in a message used to enter CELL_DCH:
 - 3> set the variable INVALID_CONFIGURATION to true.
- 1> determine the value for the HS_DSCH_RECEPTION variable and take the corresponding actions as described in subclause 8.5.25.

8.6.6.12 Secondary CPICH info

If the IE Secondary CPICH info is included, the UE may:

- 1> use the channelisation code according to IE "channelisation code", with scrambling code according to IE "DL scrambling code" in the IE "Secondary CPICH info", for channel estimation of that radio link;
- 1> use the pilot bits on DPCCH for channel estimation.

If the IE Secondary CPICH info is not included, the UE shall:

- 1> not use any previously stored configuration corresponding to the usage of the Secondary CPICH info.

8.6.6.13 Primary CPICH usage for channel estimation

If the IE "Primary CPICH usage for channel estimation" is included and has the value "Primary CPICH may be used" the UE:

- 1> may use the Primary CPICH for channel estimation;
- 1> may use the pilot bits on DPCCH for channel estimation.

NOTE: If the IE "Primary CPICH usage for channel estimation" has the value "Primary CPICH shall not be used" and the IE "Secondary CPICH info" is not included for that radio link then the UE behaviour is not specified.

If the IE "Primary CPICH usage for channel estimation" is included and has the value "Primary CPICH shall not be used" the UE:

- 1> shall not use the Primary CPICH for channel estimation;
- 1> may use the Secondary CPICH for channel estimation;
- 1> may use the pilot bits on DPCCH for channel estimation.

8.6.6.14 DPCH frame offset (FDD Only)

If "DPCH frame offset" is included in a message that instructs the UE to enter CELL_DCH state:

1> UTRAN should:

2> if only one Radio Link is included in the message:

3> if the UE is configured for DPCH:

4> set "Default DPCH Offset Value" and "DPCH frame offset" respecting the following relation:

$$(\text{Default DPCH Offset Value}) \bmod 38400 = \text{DPCH frame offset}$$

- where the IE values used are the Actual Values of the IEs as defined in clause 11.

3> if the UE is configured for F-DPCH:

4> set "Default DPCH Offset Value" and "DPCH frame offset" respecting one of the following relations:

5> $(\text{Default DPCH Offset Value}) \bmod 38400 = \text{DPCH frame offset}$; or

5> $(\text{Default DPCH Offset Value} + 256) \bmod 38400 = \text{DPCH frame offset}$,

- where the IE values used are the Actual Values of the IEs as defined in clause 11.

2> if more than one Radio Link are included in the message:

3> if the UE is configured for DPCH:

4> set "Default DPCH Offset Value" and "DPCH frame offset" respecting the following relation:

$$(\text{Default DPCH Offset Value}) \bmod 38400 = \text{DPCH frame offset}_j$$

- where j indicates the first radio link listed in the message and the IE values used are the Actual Values of the IEs as defined in clause 11.

3> if the UE is configured for F-DPCH:

4> set "Default DPCH Offset Value" and "DPCH frame offset _{j} " respecting one of the following relations:

5> (Default DPCH Offset Value) mod 38400 = DPCH frame offset_j; or

5> (Default DPCH Offset Value+256) mod 38400 = DPCH frame offset_j,

- where *j* indicates the first radio link listed in the message and the IE values used are the Actual Values of the IEs as defined in clause 11.

1> The UE shall:

2> if only one Radio Link is included in the message:

3> if the UE is configured for DPCH:

4> if (Default DPCH Offset Value) mod 38400 = DPCH frame offset:

5> set DOFF (see subclause 8.5.15.1) to Default DPCH Offset Value.

4> else:

5> set the variable INVALID_CONFIGURATION to true.

3> if the UE is configured for F-DPCH:

4> if (Default DPCH Offset Value) mod 38400 = DPCH frame offset:

5> set DOFF (see subclause 8.5.15.1) to Default DPCH Offset Value.

4> else if (Default DPCH Offset Value+256) mod 38400 = DPCH frame offset:

5> set DOFF (see subclause 8.5.15.1) to Default DPCH Offset Value + 256.

4> else:

5> set the variable INVALID_CONFIGURATION to true.

2> if more than one Radio Links are included in the message:

3> if the UE is configured for DPCH:

4> if (Default DPCH Offset Value) mod 38400 = DPCH frame offset_j,

- where *j* indicates the first radio link listed in the message:

5> set DOFF (see subclause 8.5.15.1) to Default DPCH Offset Value.

4> else:

5> set the variable INVALID_CONFIGURATION to true.

3> if the UE is configured for F-DPCH:

4> if (Default DPCH Offset Value) mod 38400 = DPCH frame offset_j,

- where *j* indicates the first radio link listed in the message:

5> set DOFF (see subclause 8.5.15.1) to Default DPCH Offset Value.

4> else if (Default DPCH Offset Value+256) mod 38400 = DPCH frame offset_j,

- where *j* indicates the first radio link listed in the message:

5> set DOFF (see subclause 8.5.15.1) to Default DPCH Offset Value + 256.

4> else:

5> set the variable INVALID_CONFIGURATION to true.

If the IE "DPCH frame offset" is included the UE shall:

- 1> use its value to determine the beginning of the DPCH or F-DPCH frame.

8.6.6.15 DPCH Compressed mode info

If the IE "DPCH compressed mode info" is included, and if the IE group "transmission gap pattern sequence configuration parameters" is included, the UE shall for each transmission gap pattern sequence perform the following consistency checks:

- 1> if the UE, according to its measurement capabilities, and for all supported bands of the UTRA mode or RAT associated with the measurement purpose indicated by IE "TGMP", requires UL compressed mode, and CHOICE 'UL/DL mode' indicates 'DL only':
 - 2> set the variable INVALID_CONFIGURATION to TRUE.
- 1> if the UE, according to its measurement capabilities, and for all supported bands of the UTRA mode or RAT associated with the measurement purpose indicated by IE "TGMP", requires DL compressed mode, and CHOICE 'UL/DL mode' indicates 'UL only':
 - 2> set the variable INVALID_CONFIGURATION to TRUE.
- 1> if the UE, according to its measurement capabilities, does not require UL compressed mode for any of supported band of the UTRA mode or RAT associated with the measurement purpose indicated by the IE "TGMP", and CHOICE 'UL/DL mode' indicates 'UL only' or 'UL and DL':
 - 2> set the variable INVALID_CONFIGURATION to TRUE.
- 1> if the UE, according to its measurement capabilities, does not require DL compressed mode for any supported band of the UTRA mode or RAT associated with the measurement purpose indicated by the IE "TGMP", and CHOICE 'UL/DL mode' indicates 'DL only' or 'UL and DL':
 - 2> set the variable INVALID_CONFIGURATION to TRUE.
- 1> if UE already has an active transmission gap pattern sequence that, according to IE "TGMP", has the same measurement purpose, and both patterns will be active (according to the IE "Current TGPS Status Flag" in variable TGPS_IDENTITY) after the new configuration has been taken into use:
 - 2> set the variable INVALID_CONFIGURATION to TRUE.
- 1> if there is any pending "TGPS reconfiguration CFN" or any pending "TGCFN":
 - 2> the UE behaviour is unspecified.

If variable INVALID_CONFIGURATION has value FALSE after UE has performed the checks above, the UE shall:

- 1> if pattern sequence corresponding to IE "TGPSI" is already active (according to "Current TGPS Status Flag") in the variable TGPS_IDENTITY):
 - 2> if the "TGPS Status Flag" in this message is set to "deactivate" for the corresponding pattern sequence:
 - 3> deactivate this pattern sequence at the beginning of the frame, indicated by IE "Activation time" (see subclause 8.6.3.1) received in this message, when the new configuration received in this message is taken into use.
 - 3> set the "Current TGPS Status Flag" for this pattern sequence in the variable TGPS_IDENTITY to "inactive" at the frame, indicated by IE "Activation time" (see subclause 8.6.3.1) received in this message, when the new configuration received in this message is taken into use.
 - 2> if the "TGPS Status Flag" in this message is set to "activate" for the corresponding pattern sequence:
 - 3> deactivate this pattern sequence at the beginning of the frame, indicated by IE "Activation time" (see subclause 8.6.3.1) received in this message, when the new configuration received in this message is taken into use.

NOTE1: The temporary deactivation of pattern sequences for which the status flag is set to "activate" can be used by the network to align the timing of already active patterns with newly activated patterns.

NOTE2: The deactivation of pattern sequences only occurs as a result of RRC messages received by the UE, i.e. the UE does not set the "Current TGPS Status Flag" to "inactive" after the final gap of a finite length pattern sequence.

- 1> update each pattern sequence to the variable TGPS_IDENTITY according to the IE "TGPSI";
- 1> update into the variable TGPS_IDENTITY the configuration information defined by IE group "transmission gap pattern sequence configuration parameters";
- 1> if an F-DPCH is configured:
 - 2> not use the IEs "Downlink compressed mode method", "Downlink frame type", "DeltaSIR1", "DeltaSIRafter1", and if included, the IEs "DeltaSIR2", "DeltaSIRafter2".
- 1> after the instant in which the message is to be executed, as specified in subclause 8.6.3.1:
 - 2> activate the stored pattern sequence corresponding to each IE "TGPSI" for which the "TGPS status flag" in the variable TGPS_IDENTITY is set to "activate" at the time indicated by IE "TGCFN"; and
 - 2> set the "Current TGPS Status Flag" for this pattern sequence in the variable TGPS_IDENTITY to "active".

NOTE1: If the pattern is activated with a message that includes the IE "Activation time", and if the CFN value indicated by the IE "Activation Time" and the CFN value indicated by the TGCFN are included in the same TTI (but not at the TTI boundary) common to all the transport channels that are multiplexed onto the reference CCTrCh (as defined in subclause 8.6.3.1), and if the CFN value indicated by the TGCFN is equal or higher than the CFN value indicated by the IE "Activation Time" (as defined in subclause 8.6.3.1) value, the UE behaviour is not specified.

NOTE2: If the pattern is activated with a message used to perform timing re-initialised hard handover, the UE can start evaluating the activation of the pattern (i.e. compare the value of the CFN in the new configuration with the value of the TGCFN) at any time between the message activation time and the completion of the synchronisation procedure A.

- 2> if the IE "DPCH compressed mode info" is included in a message used to perform a Hard Handover with change of frequency (see subclause 8.3.5); or
- 2> if the IE "DPCH compressed mode info" is included in a message used to transfer the UE from Cell_FACH to Cell_DCH, and the cell in which the UE transited from CELL_FACH state is not included in the active set for the CELL_DCH state (see subclause 8.4.1.7.2):
 - 3> not begin the inter-frequency measurement reporting corresponding to the pattern sequence measurement purpose of each activated pattern sequence.
- 2> else:
 - 3> begin the inter-frequency measurement reporting corresponding to the pattern sequence measurement purpose of each activated pattern sequence.
- 2> begin the inter-RAT measurement reporting corresponding to the pattern sequence measurement purpose of each activated pattern sequence;
- 2> if the new configuration is taken into use at the same CFN as indicated by IE "TGCFN":
 - 3> start the concerned pattern sequence immediately at that CFN.
- 1> monitor if the parallel transmission gap pattern sequences create an illegal overlap, and in case of overlap, take actions as specified in subclause 8.2.11.2.

If the IE "DPCH compressed mode info" is included, and if the IE group "transmission gap pattern sequence configuration parameters" is not included, the UE shall:

- 1> if, as the result of this message, UE will have more than one transmission gap pattern sequence with the same measurement purpose active (according to IEs "TGMP" and "Current TGPS Status Flag" in variable TGPS_IDENTITY):
 - 2> set the variable CONFIGURATION_INCOMPLETE to TRUE.

- 1> if there is any pending "TGPS reconfiguration CFN" or any pending "TGCFN":
 - 2> the UE behaviour is unspecified.
- 1> if pattern sequence corresponding to IE "TGPSI" is already active (according to "Current TGPS Status Flag" in the variable TGPS_IDENTITY):
 - 2> if the "TGPS Status Flag" in this message is set to "deactivate" for the corresponding pattern sequence:
 - 3> deactivate this pattern sequence at the beginning of the frame, indicated by IE "Activation time"(see subclause 8.6.3.1) received in this message, when the new configuration received in this message is taken into use;
 - 3> set the "Current TGPS Status Flag" for this pattern sequence in the variable TGPS_IDENTITY to "inactive" at the frame, indicated by IE "Activation time"(see subclause 8.6.3.1) received in this message, when the new configuration received in this message is taken into use.
 - 2> if the "TGPS Status Flag" in this message is set to "activate" for the corresponding pattern sequence:
 - 3> deactivate this pattern sequence at the beginning of the frame, indicated by IE "Activation time"(see subclause 8.6.3.1) received in this message, when the new configuration received in this message is taken into use.

NOTE1: The temporary deactivation of pattern sequences for which the status flag is set to "activate" can be used by the network to align the timing of already active patterns with newly activated patterns.

NOTE2: The deactivation of pattern sequences only occurs as a result of RRC messages received by the UE, i.e. the UE does not set the "Current TGPS Status Flag" to "inactive" after the final gap of a finite length pattern sequence.

- 1> after the instant in which the message is to be executed, as specified in subclause 8.6.3.1:
 - 2> activate the stored pattern sequence corresponding to each IE "TGPSI" for which the "TGPS status flag" is set to "activate" at the time indicated by IE "TGCFN"; and

NOTE1: If the pattern is activated with a message that includes the IE "Activation time", and if the CFN value indicated by the IE "Activation Time" and the CFN value indicated by the TGCFN are included in the same TTI (but not at the TTI boundary) common to all the transport channels that are multiplexed onto the reference CCTrCh (as defined in subclause 8.6.3.1), and if the CFN value indicated by the TGCFN is equal or higher than the CFN value indicated by the IE "Activation Time" (as defined in subclause 8.6.3.1) value, the UE behaviour is not specified.

NOTE2: If the pattern is activated with a message used to perform timing re-initialised hard handover, the UE can start evaluating the activation of the pattern (i.e. compare the value of the CFN in the new configuration with the value of the TGCFN) at any time between the message activation time and the completion of the synchronisation procedure A.

- 2> set the "Current TGPS Status Flag" for this pattern sequence in the variable TGPS_IDENTITY to "active";
- 2> if the IE "DPCH compressed mode info" is included in a message used to perform a Hard Handover with change of frequency (see subclause 8.3.5); or
- 2> if the IE "DPCH compressed mode info" is included in a message used to transfer the UE from Cell_FACH to Cell_DCH, and the cell in which the UE transited from CELL_FACH state is not included in the active set for the CELL_DCH state (see subclause 8.4.1.7.2):
 - 3> not begin the inter-frequency measurement reporting corresponding to the pattern sequence measurement purpose of each activated pattern sequence.
- 2> else:
 - 3> begin the inter-frequency measurement reporting corresponding to the pattern sequence measurement purpose of each activated pattern sequence.
- 2> begin the inter-RAT measurement reporting corresponding to the pattern sequence measurement purpose of each activated pattern sequence;

2> if the new configuration is taken into use at the same CFN as indicated by IE "TGCFN":

3> start the concerned pattern sequence immediately at that CFN.

For transmission gap pattern sequences stored in variable TGPS_IDENTITY, but not identified in IE "TGPSI" (either due to the absence of the IE "DPCH compressed mode info" in the received message or due to not receiving the corresponding TGPSI value in the IE "DPCH compressed mode info"), the UE shall:

1> if the received message implies a timing re-initialised hard handover (see subclause 8.3.5.1):

2> deactivate such transmission gap pattern sequences at the beginning of the frame, indicated by IE "Activation time" (see subclause 8.6.3.1) received in this message; and

2> set IE "Current TGPS Status Flag" in corresponding UE variable TGPS_IDENTITY to 'inactive'.

1> if the received message not implies a timing re-initialised hard handover (see subclause 8.3.5.1):

2> continue such transmission gap pattern sequence according to IE "Current TGPS Status Flag" in the corresponding UE variable TGPS_IDENTITY.

Uplink and downlink compressed mode methods are described in [27]. For UL "higher layer scheduling" compressed mode method and transport format combination selection, see [15].

8.6.6.16 Repetition period, Repetition length, Offset (TDD only)

In case the physical allocations of different channels overlap the following priority rules shall apply for common channels and shall be taken into account by the UE:

1> PICH takes precedence over Primary CCPCH;

1> PICH takes precedence over Secondary CCPCH;

1> MICH takes precedence over Primary CCPCH;

1> MICH takes precedence over Secondary CCPCH;

1> Secondary CCPCH takes precedence over Primary CCPCH.

The frame allocation can be derived by following rules:

If no IE "Offset" is explicitly given, the parameter "Offset" to be used is calculated by the following equation:

$$\text{Activation time mod Repetition period} = \text{Offset.}$$

Frames from CFN CFN_{off} to $CFN_{\text{off}} + \text{Repetition length} - 1$ belong to the allocation with CFN_{off} fulfilling the following equation:

$$CFN_{\text{off}} \text{ mod Repetition period} = \text{Offset.}$$

Repetition length is always a multiple of the largest TTI within the CCTrCH fulfilling the following equation:

$$(\text{largest TTI within CCTrCH}) * X = \text{Repetition Length}$$

Example of usage:

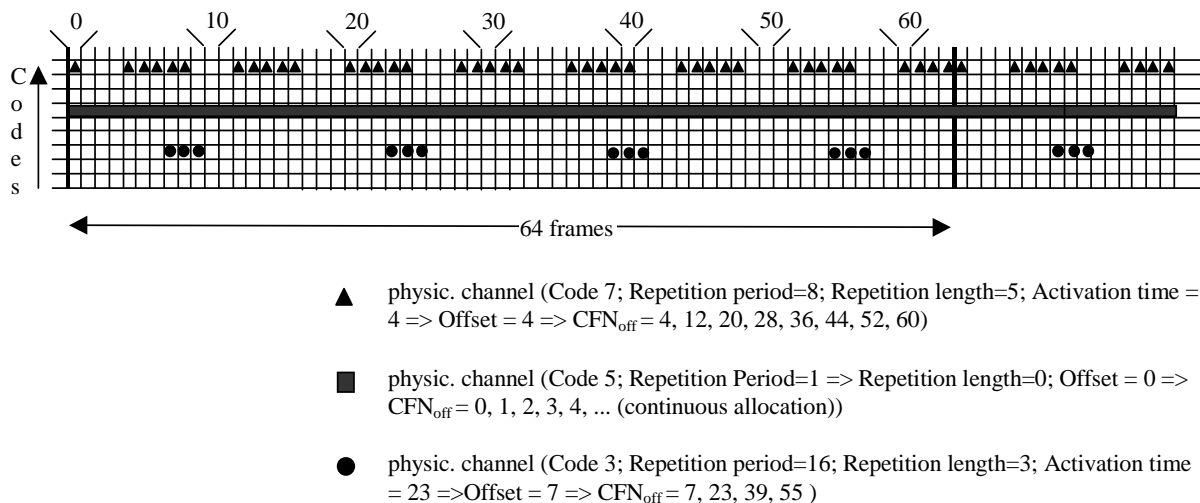

Figure 8.6.6.16-1: Examples for frame allocations in TDD

8.6.6.16a Repetition period, Repetition length, Offset_{sub} (1.28 Mcps TDD non-scheduled transmission only)

The subframes, i.e. TTI in 5ms, of non-scheduled E-PUCH allocated can be determined from "Activation Time", "Subframe number", "Resource Duration" and "Resource Periodicity" as below:

The parameter "Offset_{sub}" is defined to denote the offset of assigned E-PUCH physical resource within each Repetition period and numerated in subframe number.

"Offset_{sub}" to be used is calculated by the following equation:

$$(Activation\ time * 2 + Subframe\ number) \bmod Repetition\ period = Offset_{sub}$$

Here, a new term subCFN is defined to represent the Subframe within a specified CFN, and subCFN within a specified CFN is counted as below:

$$CFN * 2 + Subframe\ number = subCFN$$

SubFrames from subCFN_{off} to subCFN_{off} + Repetition length - 1 belong to the allocation with subCFN_{off} fulfilling the following equation:

$$subCFN_{off} \bmod Repetition\ period = Offset_{sub}$$

Example of usage:

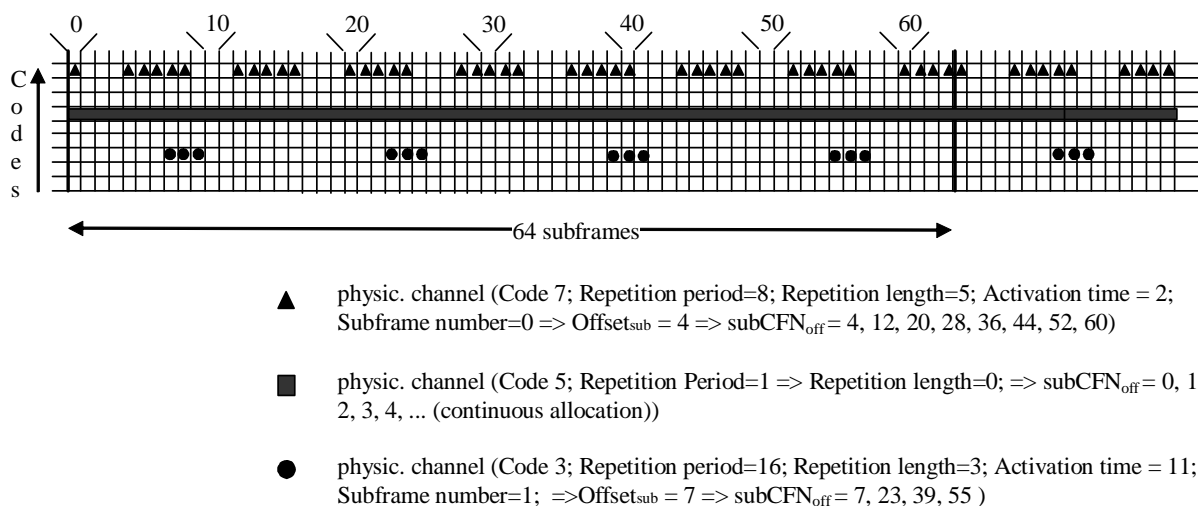

Figure 8.6.6.16a-1: Examples for subframe allocations in TDD

8.6.6.17 Primary CCPCH info

If the IE "Primary CCPCH info" is included, the UE shall:

- 1> use the information elements in this IE.

8.6.6.18 Primary CPICH info

If the IE "Primary CPICH info" in FDD is included, the UE shall:

- 1> use the value of this IE as the primary scrambling code for the downlink radio link.

8.6.6.19 Void

8.6.6.20 Void

8.6.6.21 Void

8.6.6.22 Secondary Scrambling Code, Code Number

The following description applies to FDD.

Code Number can be assigned by following rules:

- 1> When more than one DL DPDCH is assigned per RL, the segmented physical channel shall be mapped on to DL DPDCHs according to [27]. When p number of DL DPDCHs are assigned to each RL, the first pair of Secondary Scrambling Code and Code Number corresponds to "PhCH number 1", the second to "PhCH number 2", and so on until the p th to "PhCH number p ".

8.6.6.23 PDSCH Power Control info

The UE shall:

- 1> if the IE "PDSCH Power Control info" is included:

- 2> configure PDSCH power control with the received values.
- 1> if the IE "PDSCH Power Control info" is not included:
 - 2> continue to use the stored values.

8.6.6.24 Tx Diversity Mode

If the IE "Tx Diversity Mode" is included the UE shall:

- 1> if the value of the IE "Tx Diversity Mode" is STTD:
 - 2> configure the Layer 1 to use the Tx diversity mode indicated in the IE "Tx Diversity Mode" for the radio links for which the IE "Closed loop timing adjustment mode" is included, ignoring the actual value of IE "Closed loop timing adjustment mode".
- 1> if the value of the IE "Tx Diversity Mode" is closed loop mode 1:
 - 2> configure the Layer 1 to use the Tx diversity mode indicated in the IE "Tx Diversity Mode" for the radio links for which the IE "Closed loop timing adjustment mode" is included, using the actual value of the IE "Closed loop timing adjustment mode".
- 1> if the value of the IE "Tx Diversity Mode" is "none":
 - 2> configure the Layer 1 not to use Tx diversity for all radio links in the active set.

If the IE "Tx Diversity Mode" is not included, the UE shall:

- 1> continue to use the already configured Tx diversity mode;
- 1> in case no Tx diversity mode has been configured:
 - 2> do not apply Tx diversity.

For F-DPCH the UE shall:

- 1> if the IE "STTD indication" is included in the IE "Downlink F-DPCH info for each RL":
 - 2> use STTD for F-DPCH on the radio links for which the IE "STTD indication" is set to TRUE.

For HS-SCCH, the UE shall:

- 1> if the DPCH associated with a HS-SCCH is using either open or closed loop transmit diversity on the radio link transmitted from the HS-DSCH serving cell:
 - 2> use STTD for this HS-SCCH;
- 1> if the F-DPCH associated with an HS-SCCH is using open loop transmit diversity on the radio link transmitted from the HS-DSCH serving cell:
 - 2> use STTD for this HS-SCCH.
- 1> otherwise:
 - 2> not use Tx diversity for this HS-SCCH.

For E-AGCH, E-RGCH, and E-HICH from the same cell, the UE shall:

- 1> for each radio link:
 - 2> if the DPCH associated with E-AGCH, E-RGCH, and E-HICH from the same cell is using either open or closed loop transmit diversity:
 - 3> use STTD for these E-AGCH, E-RGCH, and E-HICH.
 - 2> if the F-DPCH associated with E-AGCH, E-RGCH, and E-HICH from the same cell is using open loop transmit diversity:

- 3> use STTD for these E-AGCH, E-RGCH, and E-HICH.
- 2> otherwise:
 - 3> not use Tx diversity for these E-AGCH, E-RGCH, and E-HICH.

8.6.6.25 Void

8.6.6.26 UL Timing Advance Control (TDD only)

If the IE "UL Timing Advance Control" is present, the UE shall:

- 1> if the IE "Uplink Timing Advance Control" has the value "disabled":
 - 2> reset timing advance to 0;
 - 2> disable calculated timing advance following handover;
 - 2> in case of handover:
 - 3> start uplink transmissions in the target cell without applying timing advance.
- 1> if the IE "Uplink Timing Advance Control" has the value "enabled":
 - 2> in 3.84 Mcps TDD or 7.68 Mcps TDD:
 - 3> in case of no cell change:
 - 4> evaluate and apply the timing advance value for uplink transmission as indicated in the IE "Uplink Timing Advance" or the IE "Extended Uplink Timing Advance" at the CFN indicated in the IE "Activation Time".
 - 3> in case of cell change:
 - 4> use the IE "Uplink Timing Advance" or the IE "Extended UL Timing Advance" as TA_{old} and apply TA_{new} for uplink transmission in the target cell at the CFN indicated in the IE "Activation Time" as specified in [33];
 - 4> include the value of the applied timing advance in the IE "Timing Advance" or the IE "Extended UL Timing Advance" in the COMPLETE message.
 - 2> in 1.28 Mcps TDD:
 - 3> if the IE "Synchronisation parameters" is included:
 - 4> initiate a sequence of UpPCH SYNC_UL code transmissions using a code selected from the set specified and continue until a timing correction is received in the specified FPACH (received for WT sub-frames following the sub-frame in which the transmission was made) or until Max SYNC_UL transmissions have been completed. The power used for each SYNC_UL transmission is as specified in subclause 8.5.7. Each transmission is made in the first sub-frame possible following the end of each FPACH reception interval using the timing specified in [33]. A new code is selected for each transmission. The detection that the FPACH relates to the transmitted SYNC_UL code is described in [33];
 - 4> if a timing correction is received within Max SYNC_UL transmissions the procedure is completed. The assigned uplink resources may then be used, commencing at the first possible TTI boundary or the SFN in which the assignment commences, whichever is the later. The timing of the uplink transmission is described in [33];
 - 4> if no timing correction has been received within Max SYNC_UL transmissions, the synchronisation procedure has failed. If the assigned resources are DCH, the UE should not transmit using these resources and should respond as if a physical channel failure has occurred as specified in subclauses

8.1.3.7 or 8.2.2.7 or 8.3.1.7, or 8.3.6.5. If the assigned resources are USCH then the UE should ignore the USCH allocation.

3> if the IE "Synchronisation parameters" is not included:

4> in case of no cell change:

5> continue to use the current uplink timing.

4> in case of cell change:

5> evaluate and apply the timing correction TA_{new} for uplink transmissions using the procedure as specified in [33].

8.6.6.26a Uplink synchronisation parameters (TDD only)

The UE shall apply uplink synchronisation using the values of the IEs "Uplink synchronisation step size" and "Uplink synchronisation frequency" as specified in [33].

8.6.6.27 Downlink information common for all radio links

If the IE "Downlink information common for all radio links" is included the UE shall:

1> if the IE "Downlink DPCH info common for all RL" is included:

2> perform actions as specified in subclause 8.6.6.28.

1> if the IE "Downlink F-DPCH info common for all RL" is included:

2> perform actions as specified in subclause 8.6.6.28a.

1> if the IE choice "mode" is set to 'FDD':

2> perform actions for the IE "DPCH compressed mode info" as specified in subclause 8.6.6.15;

2> perform actions for the IE "Tx Diversity mode" as specified in subclause 8.6.6.24.

1> if the IE "MAC-hs reset indicator" is included:

2> if the serving HS-DSCH radio link is the same radio link as prior to the reception of the message; and

2> if, as a result of the reconfiguration message where this IE is received, the MAC header type (i.e., either MAC-hs or MAC-ehs) is unchanged:

3> the UE behaviour is unspecified.

2> reset the MAC-hs/ehs entity [15].

NOTE: If the MAC header type is changed, either from MAC-hs to MAC-ehs or from MAC-ehs to MAC-hs, UTRAN should include the IE "MAC-hs reset indicator" in order to ensure a reset of the MAC-hs/ehs entity in the UE prior to MAC-hs/ehs reconfiguration, otherwise the UE behaviour is unspecified.

8.6.6.28 Downlink DPCH info common for all radio links

If the IE "Downlink DPCH info common for all RL" is included the UE shall:

1> if:

2> the IE "Downlink DPCH info common for all RL" is included in a reconfiguration message; and

2> the UE was in CELL_DCH state upon reception of the message and remains in CELL_DCH state; and

2> the message is not used to perform a hard handover (as specified in subclause 8.6.6.3a) and the IE "Timing indication" is set to "initialise":

3> the UE behaviour is not specified.

- 1> if the IE "Downlink DPCH power control information" is included:
 - 2> in the case of FDD:
 - 3> perform actions for the IE "DPC Mode" according to [29].
 - 2> in the case of TDD:
 - 3> perform actions for the IE "TPC Step Size" according to [33].
- 1> if the IE choice "mode" is set to 'FDD':
 - 2> if the IE "Downlink rate matching restriction information" is included:
 - 3> set the variable INVALID_CONFIGURATION to TRUE.
 - 2> perform actions for the IE "spreading factor";
 - 2> perform actions for the IE "Fixed or Flexible position";
 - 2> perform actions for the IE "TFCI existence";
 - 2> if the IE choice "SF" is set to 256:
 - 3> store the value of the IE "Number of bits for pilot bits".
 - 2> if the IE choice "SF" is set to 128:
 - 3> store the value of the IE "Number of bits for pilot bits".

If the IE "Downlink DPCH info common for all RL" is included in a message used to perform a Timing re-initialised hard handover or the IE "Downlink DPCH info common for all RL" is included in a message other than RB SETUP used to transfer the UE from a state different from Cell_DCH to Cell_DCH, and ciphering is active for any radio bearer using RLC-TM, the UE shall, after having activated the dedicated physical channels indicated by that IE:

- 1> if any ciphering configuration for a radio bearer using RLC-TM has not been applied, due to that the activation time from a previous procedure has not elapsed:
 - 2> apply the ciphering configuration immediately and consider the activation time from the previous procedure to be elapsed.
- 1> if the IE "MAC-d HFN initial value" is included in the IE "Downlink DPCH info common for all RL":
 - 2> set the HFN component of COUNT-C for TM-RLC to the value of the IE "MAC-d HFN initial value", while not incrementing the value of the HFN component of COUNT-C at each CFN cycle.

NOTE: The UTRAN should choose a value for the IE "MAC-d HFN initial value" using the COUNT-C value of the RBs using RLC-TM indicated by the Source RNC to the Target RNC in the IE "SRNS Relocation Info" and include some margin in such a way that no values of COUNT-C are repeated after the handover.

- 1> else:
 - 2> set the 20 MSB of the HFN component of COUNT-C for TM-RLC to the value of the latest transmitted IE "START" or "START List" for this CN domain, while not incrementing the value of the HFN component of COUNT-C at each CFN cycle; and
 - 2> set the remaining LSBs of the HFN component of COUNT-C to zero.
- 1> start to perform ciphering on the radio bearer in lower layers while not incrementing the HFN;
- 1> include the IE "COUNT-C activation time" in the response message and specify a CFN value for this IE other than the default, "Now", that is a multiple of 8 frames ($CFN \bmod 8 = 0$) and lies at least 200 frames ahead of the CFN in which the response message is first transmitted;
- 1> calculate the START value according to subclause 8.5.9;

- 1> include the calculated START values for each CN domain in the IE "START list" in the IE "Uplink counter synchronisation info" in the response message;
- 1> at the CFN value as indicated in the response message in the IE "COUNT-C activation time":
 - 2> set the 20 MSB of the HFN component of the COUNT-C variable common for all transparent mode radio bearers of this CN domain to the START value as indicated in the IE "START list" of the response message for the relevant CN domain; and
 - 2> set the remaining LSBs of the HFN component of COUNT-C to zero;
 - 2> increment the HFN component of the COUNT-C variable by one even if the "COUNT-C activation time" is equal to zero;
 - 2> set the CFN component of the COUNT-C to the value of the IE "COUNT-C activation time" of the response message. The HFN component and the CFN component completely initialise the COUNT-C variable;
 - 2> step the COUNT-C variable, as normal, at each CFN value, i.e. the HFN component is no longer fixed in value but incremented at each CFN cycle.

8.6.6.28a Downlink F-DPCH info common for all radio links

If the IE "Downlink F-DPCH info common for all RL" is included the UE shall:

- 1> if the IE "Downlink F-DPCH info common for all RL" is included in a message used to perform a hard handover:
 - 2> perform actions for the IE "Timing indication" as specified in subclause 8.5.15.2, and subclause 8.3.5.1 or 8.3.5.2.
- 1> if the IE "Downlink DPCH power control information" is included:
 - 2> perform actions for the IE "DPC Mode" according to [29].

8.6.6.29 ASC setting

If the IE "ASC setting" is included, the UE shall:

- 1> establish the available signatures for this ASC as specified in the following:
 - 2> renumber the list of available signatures specified in the IE "Available signature" included in the IE "PRACH info" from signature index 0 to signature index N-1, where N is the number of available signatures, starting with the lowest available signature number and continuing in sequence, in the order of increasing signature numbers;
 - 2> consider as available signatures for this ASC the signatures included in this renumbered list from the index specified by the IE "Available signature Start Index" to the index specified by the IE "Available signature End Index".
- 1> establish the available access slot sub-channels for this ASC as specified in the following:
 - 2> if the IE "AICH transmission timing" included in the IE "AICH Info" is set to '0':
 - 3> ignore the leftmost (most significant) bit (bit b3) of the bit string specified by the IE "Assigned Sub-Channel Number";
 - 3> repeat 4 times the 3 rightmost (least significant) bits (bits b2-b0) of the bit string specified by the IE "Assigned Sub-Channel Number" to form a resulting bit string 'b2 b1 b0 b2 b1 b0 b2 b1 b0 b2 b1 b0' of length 12 bits, where the leftmost bit is the most significant.
 - 2> if the IE "AICH transmission timing" included in the IE "AICH Info" is set to '1':
 - 3> repeat 3 times the bit string (bits b3-b0) specified by the IE "Assigned Sub-Channel Number" to form a bit string 'b3 b2 b1 b0 b3 b2 b1 b0 b3 b2 b1 b0' of length 12 bits, where the leftmost bit is the most significant.

- 2> perform in both cases, for the resulting bit string (that includes the repetitions) bit-wise logical AND operation with the IE "Available Sub Channel number" included in IE "PRACH info (for RACH)";
- 2> consider as available sub-channels for this ASC the available sub-channels indicated in the resulting bit string, after logical AND operation i.e. each bit set to 1 or 0 indicates availability or non-availability, respectively, of sub-channel number x , with x from 0 to 11, for the respective ASC.

NOTE 1: In FDD, the list of available signatures is renumbered from signature index 0 to signature index N-1, where N is the number of available signatures, starting with the lowest available signature number and continuing in sequence, in the order of increasing signature numbers.

- List of available signatures: 16 or fewer signatures are available.
- Example: only signatures 0, 5, 10 and 15 are available, then :
 - Signature 0 is: available signature index 0
 - Signature 5 is: available signature index 1
 - Signature 10 is: available signature index 2
 - Signature 15 is: available signature index 3

NOTE 2: In 3.84 Mcps TDD, the list of available channelisation codes (defined in PRACH info) is renumbered from channelisation code index 0 to channelisation code index N-1, where N is the number of available channelisation codes, starting with the lowest available channelisation code number and continuing in sequence, in the order of increasing channelisation code numbers

List of available channelisation codes : 8 or less channelisation codes are available.

The i -th bit of the bitmap defined in the IE "Available Channelisation Code indices" defines whether the channelisation code with the available channelisation code index i is to be used for this ASC (bit set means used, bit unset means not used). Only the low N bits shall be used in the bitmap, where N is the number of available channelisation codes defined in PRACH info.

Ex : spreading factor 16, channelisation codes 16/1, 16/2, 16/5, 16/8 are available :

- Channelisation code 16/1 is: available channelisation code index 0
- Channelisation code 16/2 is: available channelisation code index 1
- Channelisation code 16/5 is: available channelisation code index 2
- Channelisation code 16/8 is: available channelisation code index 3

Available Channelisation Code indices has the value '00001100' means: Channelisation Codes 16/5 and 16/8 are available for this ASC.

NOTE 2a: In 7.68 Mcps TDD, the list of available channelisation codes (defined in PRACH info) is renumbered from channelisation code index 0 to channelisation code index N-1, where N is the number of available channelisation codes, starting with the lowest available channelisation code number and continuing in sequence, in the order of increasing channelisation code numbers

List of available channelisation codes : 16 or less channelisation codes are available.

The i -th bit of the bitmap defined in the IE "Available Channelisation Code indices" defines whether the channelisation code with the available channelisation code index i is to be used for this ASC (bit set means used, bit unset means not used). Only the low N bits shall be used in the bitmap, where N is the number of available channelisation codes defined in PRACH info.

Ex : spreading factor 32, channelisation codes 32/1, 32/2, 32/5, 32/8 are available :

- Channelisation code 32/1 is: available channelisation code index 0
- Channelisation code 32/2 is: available channelisation code index 1
- Channelisation code 32/5 is: available channelisation code index 2
- Channelisation code 32/8 is: available channelisation code index 3

Available Channelisation Code indices has the value '000000000001100' means: Channelisation Codes 32/5 and 32/8 are available for this ASC.

NOTE 3: In TDD, the subchannel description is found in [33].

NOTE 4: In 1.28 Mcps TDD, the list of available SYNC_UL codes (defined in PRACH info) is numbered from SYNC_UL code index 0 to SYNC_UL code index N-1, where N is the number of available SYNC_UL codes, starting with the lowest available SYNC_UL code number and continuing in sequence, in the order of increasing SYNC_UL code numbers

The i-th bit of the bitmap defined in the IE "Available SYNC_UL codes indices" defines whether the SYNC_UL code with the available SYNC_UL code index i is to be used for this ASC (bit set means used, bit unset means not used). Only the low N bits shall be used in the bitmap, where N is the number of available SYNC_UL codes defined in PRACH info.

- List of available SYNC_UL codes: 8 or fewer SYNC_UL codes are available.

Example: only signatures 0, 5, 6 and 7 are available, then:

- SYNC_UL codes 0 is: available SYNC_UL codes index 0
- SYNC_UL codes 5 is: available SYNC_UL codes index 1
- SYNC_UL codes 6 is: available SYNC_UL codes index 2
- SYNC_UL codes 7 is: available SYNC_UL codes index 3

Available SYNC_UL codes indices has the value '00001100' means: SYNC_UL codes 6 and 7 are available for this ASC.

8.6.6.30 SRB delay, PC preamble (FDD only)

When the IE "SRB delay" and IE "PC preamble" is received in a message that results in a configuration of uplink DPCH or E-DPCH, and synchronisation procedure A is being used as specified in [29], the UE shall:

- 1> store the received IE "SRB delay" and IE "PC preamble" in the variable LATEST_CONFIGURED_SRB_DELAY_AND_PC_PREAMBLE;
- 1> apply power control preamble according to [26] during the number of frames indicated in the IE "PC preamble"; and
- 1> then not send any data on signalling radio bearers RB0 to RB4 during the number of frames indicated in the IE "SRB delay" or while the physical channel is not considered established.

8.6.6.31 Void

8.6.6.32 Void

8.6.6.33 HS-SCCH Info

If the IE "HS-SCCH Info" is included and the UE will be in CELL_DCH state after completion of this procedure, the UE shall:

- 1> store the received configuration.
- 1> determine the value for the HS_DSCH_RECEPTION variable and take the corresponding actions as described in subclause 8.5.25.

When the variable HS_DSCH_RECEPTION is set to TRUE the UE shall:

- 1> in the case of FDD:
 - 2> receive the HS-SCCH(s) according to the IE "HS-SCCH channelisation code" on the serving HS-DSCH radio link applying the scrambling code as received in the IE "DL Scrambling code".
- 1> in the case of TDD:

- 2> receive the HS-SCCH(s) according to the IEs "Timeslot Number", "Channelisation Code" and Midamble configuration IEs.
- 2> transmit the HS-SICH according to the IEs "Timeslot Number", "Channelisation Code" and Midamble configuration IEs.
- 2> for HS-SCCH power control the UE shall use the "BLER target" signalled in the first occurrence of the "HS-SCCH Set Configuration", and the UE shall also use the IE "Power Control GAP" for 1.28 Mcps TDD.
- 2> in 3.84 Mcps TDD and 7.68 Mcps TDD:
 - 3> use the parameters specified in the IE "HS-SICH power control info" for open loop power control as defined in subclause 8.5.7.
- 2> in 1.28 Mcps TDD:
 - 3> use the IE "PRX_{HS-SICH}" to calculate and set an initial uplink transmission power;
 - 3> use the IE "TPC step size" upon reception of TPC commands for closed loop power control;
 - 3> perform closed loop power control on HS-SICH within the interval indicated in the IE "Power Control GAP";
 - 3> use the IE "Pathloss compensation switch" to determine if the pathloss compensation from the beacon channel estimation should be taken into account for closed loop power control on HS-SICH;
 - 3> use default value of "Uplink synchronisation frequency" and same value of "Uplink synchronisation step size" in "Uplink DPCH info" for HS-SICH upon reception of SS commands for closed loop uplink synchronisation on HS-SICH.

8.6.6.34 Measurement Feedback Info

If the IE "Measurement Feedback Info" is included and the UE will be in CELL_DCH state after completion of this procedure, the UE shall:

- 1> store the received configuration;
- 1> determine the value for the HS_DSCH_RECEPTION variable and take the corresponding actions as described in subclause 8.5.25.

When the variable HS_DSCH_RECEPTION is set to TRUE the UE shall:

- 1> use the information for the channel quality indication (CQI) procedure in the physical layer on the serving HS-DSCH radio link.

8.6.6.35 DPC Mode

If the IE "DPC Mode" is included, the UE shall:

- 1> apply the indicated DPC mode according to [29].

If the IE "DPC Mode" is not included, the UE shall:

- 1> continue with the currently used DPC mode.

8.6.6.36 Downlink HS-PDSCH Information

If the IE "Downlink HS-PDSCH Information" is included and the UE would be in CELL_DCH state after completion of this procedure, the UE shall:

- 1> for 1.28 Mcps TDD, if the HS-PDSCH has been configured by the IE "DL Multi-carrier information":
 - 2> clear other stored carriers configuration in the IE "DL Multi-carrier information".
- 1> if the IE "HS-SCCH Info" is included:

- 2> act as specified in subclause 8.6.6.33.
- 1> if the IE "Measurement Feedback Info" is included:
 - 2> act as specified in subclause 8.6.6.34.
- 1> if the IE "HS-DSCH Timeslot Configuration" or "HS-PDSCH Midamble Configuration" is included:
 - 2> store the received configuration;
 - 2> determine the value for the HS_DSCH_RECEPTION variable and take actions as described in subclause 8.5.25.

8.6.6.36a DL Multi-carrier information (1.28 Mcps TDD only)

The IE "DL Multi-carrier information" is used in multiple carriers system.

NOTE: When only one frequency is configured to the UE, either the IE "DL Multi-carrier information" or the IE "Downlink HS-PDSCH Information" may be used but should use only one of them and the DPCH frequency shall be aligned with the IE "DL Multi-carrier information".

If the IE "DL Multi-carrier information" is included, the UE shall:

- 1> if the IE "TSN-Length" is included:
 - 2> store the new TSN length indicated by the IE "TSN-Length".
- 1> if the IE "TSN-Length" is not included:
 - 2> if the UE has stored TSN length:
 - 3> use the stored content of the IE.
 - 2> else:
 - 3> set the TSN length to 6bits.
- 1> if the IE "Multi-Carrier number" is included:
 - 2> store the new multiple carriers number indicated by the IE "Multi-Carrier number";
 - 2> start reception procedure on the HS-SCCHs (refer to [33]).
- 1> if the IE "DL-HSPDSCH-MultiCarrier-Information" is included:
 - 2> if the IE "HS-SCCH Set Configuration" is included:
 - 3> perform processes described in subclause 8.6.6.33.
 - 2> if the IE "HARQ-Info" is included:
 - 3> perform processes described in subclause 8.6.5.6b.
 - 2> if the IE "HS-PDSCH Midamble Configuration" is included:
 - 3> store the HS-PDSCH midamble configuration indicated by the IE "HS-PDSCH Midamble Configuration";
 - 3> perform processes described in subclause 8.5.25.
- 1> if the carrier which has been stored by the UE is not included in the the IE "DL-HSPDSCH-MultiCarrier-Information", the UE should delete all the configurations related to this carrier.

8.6.6.37 E-DCH Info

If the IE "E-DCH Info" is included and the UE will be in CELL_DCH state after completion of this procedure, the UE shall:

1> for FDD:

2> if the IE "E-DPCCH Info" is included:

3> store the newly received E-DPCCH configuration.

2> if the IE "E-DPDCH Info" is included:

3> store the newly received E-DPDCH configuration.

2> if the IE "UL 16QAM settings" is not included:

3> indicate to lower layers to stop any operation in 16QAM mode.

1> for 3.84/7.68 Mcps TDD:

2> if the IE "E-RUCCH Info" is included:

3> store the newly received E-RUCCH configuration.

2> if the IE "E-PUCH Info" is included:

NOTE 1: The UTRAN should ensure the ordering of the E-TFCI table strictly in increasing order of transmission power prior to quantization, by correct setting of the reference E-TFCI power offsets otherwise the UE behaviour is unspecified.

NOTE 2: If a reference E-TFCI signalled to the UE is outside the UE physical channel capability, the UE behaviour is unspecified.

NOTE 2a: If E-TFCI boost is signalled to the UE and a reference E-TFCI \leq E-TFCI Boost is signalled to the UE with a Reference E-TFCI PO of value 30 or 31, the UE behaviour is unspecified.

NOTE 2b: If the UE is configured with E-TFCI table 0 and 2ms TTI, and a reference E-TFCI =120 has been configured, the UE behavior is unspecified.

NOTE 2c: If the UE is configured with E-TFCI table 1 and 2ms TTI, and a reference E-TFCI =115 has been configured, the UE behavior is unspecified.

NOTE 2d: If the UE is configured with E-TFCI table 2 and 2ms TTI, and a reference E-TFCI =121 has been configured, the UE behavior is unspecified.

NOTE 2e: If the UE is configured with E-TFCI table 3 and 2ms TTI, and a reference E-TFCI =101 or a reference E-TFCI = 102 has been configured, the UE behavior is unspecified.

1> if the IE "MAC-es/e reset indicator" is included:

2> reset the MAC-es/e entity [15].

NOTE 3: If the IE "MAC-es/e reset indicator" is not set to TRUE in case the IE "E-DCH Transmission Time Interval" is reconfigured, the UE behaviour is unspecified.

NOTE 4: If the IE "MAC-es/e reset indicator" is not included in the IE "E-DCH Info" and 16QAM operation starts or stops, the UE behaviour is unspecified.

1> determine the value for the E_DCH_TRANSMISSION variable and take the corresponding actions as described in subclause 8.5.28.

When the variable E_DCH_TRANSMISSION is set to TRUE the UE shall:

1> for FDD:

2> configure the UL E-DPCCH in accordance with the stored IE "E-DPCCH" configuration;

2> configure the MAC with the stored IE "E-DPDCH" configuration and/or the information contained in IE "Scheduled Transmission configuration".

1> for TDD:

- 2> configure the E-RUCCH with the stored E-RUCCH configuration;
- 2> configure the MAC with the stored E-PUCH configuration.

8.6.6.38 DTX-DRX timing information (FDD only)

If the IE "DTX-DRX timing information" is included and the UE will be in CELL_DCH state after completion of this procedure, the UE shall:

- 1> if the CHOICE "timing" is set to "New timing":
 - 2> use the newly received DTX-DRX timing configuration.
- 1> if the CHOICE "timing" is set to "Continue", and the message is used to perform a hard handover (as specified in subclause 8.6.6.3a); or
- 1> if the received message does not include the IE "DTX-DRX information" and this message will perform E-DCH TTI reconfiguration:
 - 2> the UE behaviour is unspecified.
- 1> determine the value for the DTX_DRX_STATUS variable and take the corresponding actions as described in subclause 8.5.34.

8.6.6.39 DTX-DRX information (FDD only)

If the IE "DTX-DRX information" is included and the UE will be in CELL_DCH state after completion of this procedure, the UE shall:

- 1> store the contents of the IE in the variable DTX_DRX_PARAMS, replacing or clearing any previously stored "DTX Information" or "DRX Information";
- 1> determine the value for the DTX_DRX_STATUS variable and take the corresponding actions as described in subclause 8.5.34;
- 1> if the value of the IE "UE DTX cycle 2" is not an integer multiple of the value of the IE "UE DTX cycle 1"; or
- 1> if the value of the IE "UE DTX cycle 2" is not an integer multiple or a divisor of the value of the IE "CQI Feedback cycle, k" divided by 2; or
- 1> if the value of the IE "UE DPCCH burst 1" is greater than the value of the IE "UE DTX cycle 1"; or
- 1> if the value of the IE "UE DPCCH burst 2" is greater than the value of the IE "UE DTX cycle 2"; or
- 1> if the IE "UE DTX long preamble length" is set to 4 or 15 slots and the value of the IE "Inactivity Threshold for UE DTX cycle 2" is less than 4 TTIs (for 10ms E-DCH TTI) or 8 TTIs (for 2ms E-DCH TTI); or
- 1> if the IE "UE DRX cycle" is not an integer multiple or a divisor of the value of the IE "UE DTX cycle 1"; or
- 1> if the value of the IE "UE DTX cycle 1" is not an integer multiple or a divisor of the value of the IE "MAC DTX cycle"; or
- 1> if the IE "DTX-DRX timing information" is included in this message and if the CHOICE "timing" is set to "continue"; or
- 1> if the IE "Uplink DPCCH slot format information" is received in an ACTIVE SET UPDATE message and indicates different uplink DPCCH slot format from the one currently configured, and neither the indicated uplink DPCCH slot format nor the currently configured uplink DPCCH slot format are uplink DPCCH slot format 4; or
- 1> if the IE "DTX Information" is not included in this message:
 - 2> the UE behaviour is unspecified.

NOTE: If the IE "Uplink DPCH info" is included in this message, the UTRAN should ensure that the configuration of the uplink DPCH does not contradict the uplink DPCH configuration indicated in the IE "Uplink DPCCH slot format information".

8.6.6.40 HS-SCCH less information (FDD only)

If the IE "HS-SCCH less information" is included and the UE will be in CELL_DCH state after completion of this procedure, the UE shall:

- 1> if the CHOICE "HS-SCCH less operation" is set to "New HS-SCCH less operation":
 - 2> store the contents of the IE in the variable HS_SCCH_LESS_PARAMS.
- 1> determine the value for the HS_SCCH_LESS_STATUS variable and take the corresponding actions as described in subclause 8.5.35.

8.6.6.41 MIMO parameters

If the IE "MIMO parameters" is included, the UE shall:

- 1> act as specified in clauses 8.5.32 and 8.5.33;
- 1> If the IE "MIMO operation" is set to "start":
 - 2> If the MIMO_STATUS variable is set to FALSE:
 - 3> the UE behaviour is undefined.
 - 2> otherwise:
 - 3> indicate to lower layers to start operation in MIMO mode, using the parameter values stored in the variable MIMO_PARAMS.
- 1> If the IE "MIMO operation" is set to "continue":
 - 2> If the MIMO_STATUS variable is set to FALSE:
 - 3> the UE behaviour is undefined.
- 1> If the IE "Primary CPICH usage for Channel Estimation" is set to "Primary CPICH shall not be used":
 - 2> the UE behavior is undefined.
- 1> If the IE "Secondary CPICH Info" is included and if the IE "Channelisation code" in MIMO pilot configuration is different from the IE "Channelisation Code" in Secondary CPICH info:
 - 2> the UE behavior is undefined.
- 1> for FDD, if the IE "Secondary CPICH Info" is included and if the IE "Power Offset for S-CPICH for MIMO" is provided, then pass the offset value received in the IE "Power Offset for S-CPICH for MIMO" to the lower layers.

NOTE: This subclause applies to FDD only.

8.6.6.42 UL 16QAM settings

If the IE "UL 16QAM settings" is included, the UE shall:

- 1> indicate to lower layers to operate in 16QAM mode, using the parameters contained in the IE.

8.6.6.43 Multi-frequency Info (1.28 Mcps TDD only)

Upon reception of the IE "Multi-frequency info", the UE shall:

- 1> If the IE "Second Frequency info" is included, the UE shall:
 - 2> act as specified in section 8.6.6.1.
- 1> If the IE "FPACH Frequency info" is included::

- 2> store the FPACH frequency indicated in the IE "FPACH Frequency info".
- 1> else:
 - 2> use the primary frequency as FPACH frequency.
- 1> If the IE "UpPCH Position Info" is included:
 - 2> store and use the UpPCH position indicated by the IE "UpPCH Positon Info ". The calculation of the uplink access position is described in [33].
- 1> else
 - 2> use the UpPTS as the default UpPCH position.

8.6.7 Measurement information elements

On reception of measurement information elements the UE shall:

- 1> store the received information in the variable MEASUREMENT_IDENTITY and CELL_INFO_LIST as specified;
- 1> perform further actions as specified in subclause 8.6.7 and subclause 8.4, based on the content of the variable MEASUREMENT_IDENTITY.

If a configuration is considered to be invalid the UE may:

- 1> set the variable CONFIGURATION_INCOMPLETE to TRUE.

8.6.7.1 Measurement validity

If the IE "measurement validity" for a given measurement has not been included in measurement control information, the UE shall delete the measurement associated with the variable MEASUREMENT_IDENTITY after the UE makes a transition to a new state.

If the IE "measurement validity" for this measurement has been included in measurement control information, the UE shall save the measurement associated with the variable MEASUREMENT_IDENTITY. The IE "UE state" defines the scope of resuming the measurement.

If the "UE state" is defined as "all states", the UE shall continue the measurement after making a transition to a new state. This scope is assigned for traffic volume measurement type and UE positioning measurement type. For traffic volume measurement type this scope can only be applied by the UE if the IE " traffic volume measurement object" has been included in measurement control information. If the IE " traffic volume measurement object" has not been included in measurement control information, the UE shall not save the measurement control information in variable MEASUREMENT_IDENTITY, but shall send a MEASUREMENT CONTROL FAILURE message to the UTRAN with failure cause "Configuration incomplete".

If the "UE state" is defined as "all states except CELL_DCH", the UE shall store the measurement to be resumed after a subsequent transition from CELL_DCH state to any of the other states in connected mode. This scope is assigned for traffic volume measurement type or UE positioning measurement type.

If the "UE state" is defined as "CELL_DCH", the UE shall store the measurement to be resumed after a subsequent transition to CELL_DCH state.

If the IE "measurement type" received in a MEASUREMENT CONTROL message is set to "inter-frequency measurement" or "intra-frequency measurement" and the IE "measurement validity" is present and is set to a value other than "CELL_DCH", the UE behaviour is unspecified.

8.6.7.2 Filter coefficient

If the IE "Filter coefficient" is received the UE shall, depending on the measurement quantity (see Table 8.6.7.2), apply filtering of the measurements for that measurement quantity according to the formula below. This filtering shall be performed by the UE before UE event evaluation. The UE shall depending on the reporting quantity (see Table 8.6.7.2),

also filter the measurements reported in the IE "Measured results". The filtering shall not be performed for the measurements reported in the IE "Measured results on RACH" and for cell-reselection in connected or idle mode.

The filtering shall be performed according to the following formula.

$$F_n = (1 - a) \cdot F_{n-1} + a \cdot M_n$$

The variables in the formula are defined as follows:

F_n is the updated filtered measurement result

F_{n-1} is the old filtered measurement result

M_n is the latest received measurement result from physical layer measurements, the unit used for M_n is the same unit as the reported unit in the MEASUREMENT REPORT message or the unit used in the event evaluation.

$a = 1/2^{(k/2)}$, where k is the parameter received in the IE "Filter coefficient".

NOTE: if k is set to 0 that will mean no layer 3 filtering.

In order to initialise the averaging filter, F_0 is set to M_1 when the first measurement result from the physical layer measurement is received.

The physical layer measurement results are sampled once every measurement period. The measurement period and the accuracy for a certain measurement is defined in [19] and [20].

Table 8.6.7.2 lists for all measurement quantities and reporting quantities if L3-filtering is applicable or not and used L3-filtering type for each measurement quantity.

Table 8.6.7.2: L3 filtering applicable for each measurement quantity and reporting quantity

Measurement- / Reporting quantity	L3-filtering applicable	Linear or logarithmic filtering	Comment
Pathloss	Yes	Log	
Cell synchronisation information	No	-	
Cell Identity	No	-	
Frequency quality estimate	No	-	Although the frequency quality estimate itself is not filtered, the inputs to the frequency quality estimate calculation (CPICH Ec/N0 or CPICH RSCP or P-CCPCH RSCP) are filtered
UTRA carrier RSSI	Yes	Log	
GSM carrier RSSI	Yes	Log	
UE transmitted power	Yes	Log	
FDD			
> UE Rx-Tx time difference	No	-	
> CPICH Ec/N0	Yes	Log	
> CPICH RSCP	Yes	Log	
TDD			
> Primary CCPCH RSCP	Yes	Log	

> Proposed TGSN	No	-	
> Timeslot ISCP	Yes	Log	
> TADV (1.28 Mcps TDD)	No	-	
> Applied TA (3.84 Mcps TDD)	No	-	
> Applied TA (7.68 Mcps TDD)	No	-	

The UE shall support 2 different layer 3 filters per measurement type defined in subclause 8.4.0 (i.e. the UE shall be capable to apply at least 2 different L3 filters to intra-frequency measurement results – see NOTE, at least 2 different L3 filters to inter-frequency measurement results, etc.). If a MEASUREMENT CONTROL message is received that would require the UE to configure more than 2 different layer 3 filters, the UE may:

- 1> set the variable CONFIGURATION_INCOMPLETE to TRUE.

NOTE: Any L3 filter applied to a measurement configured with measurement quantity and/or reporting quantity that evaluates or reports measurement results for the current used frequency, is counted as one intra-frequency L3 filter, and is therefore included in the count of used intra-frequency filters.

8.6.7.3 Intra-frequency/Inter-frequency/Inter-RAT cell info list

If the IE "Intra-frequency cell info list" is received in System Information Block Type 11, the UE shall update the variable CELL_INFO_LIST accordingly and in the following order. The UE shall:

- 1> if the IE "Intra-frequency cell removal" is received:
 - 2> ignore the IE.
- 1> if the IE "New Intra-frequency cells" is received, for each cell, and in the same order as the cells appear in the IE:
 - 2> update the variable CELL_INFO_LIST as follows:
 - 3> if the IE "Intra-frequency cell id" is received:
 - 4> store received cell information at this position in the Intra-frequency cell info list in the variable CELL_INFO_LIST, possibly overwriting any existing information in this position; and
 - 4> mark the position "occupied".
 - 3> if the IE "Intra-frequency cell id" is not received:
 - 4> store the received cell information at the first vacant position in ascending order in the Intra-frequency cell info list in the variable CELL_INFO_LIST; and
 - 4> mark the position as "occupied".

If the IE "Intra-frequency cell info list" is received in System Information Block Type 11bis, the UE shall update the variable CELL_INFO_LIST accordingly and in the following order. The UE shall:

- 1> for each cell, and in the same order as the cells appear in the IE:
 - 2> update the variable CELL_INFO_LIST as follows:
 - 3> if the IE "Intra-frequency cell id" is received:
 - 4> store received cell information at this position in the Intra-frequency cell info list in the variable CELL_INFO_LIST, possibly overwriting any existing information in this position; and
 - 4> mark the position "occupied".

- 3> if the IE "Intra-frequency cell id" is not received:
 - 4> store the received cell information at the first vacant position in ascending order in the Intra-frequency cell info list in the variable CELL_INFO_LIST; and
 - 4> mark the position as "occupied".

If the IE "Intra-frequency cell info list" is received in System Information Block Type 12, the UE shall update the variable CELL_INFO_LIST accordingly and in the following order. The UE shall:

- 1> if the IE "Intra-frequency cell removal" is received:
 - 2> if it has the value "Remove some intra-frequency cells", at the position indicated by the IE "Intra-frequency cell id":
 - 3> clear the cell information stored in the variable CELL_INFO_LIST; and
 - 3> mark the position "vacant".
 - 2> if it has the value "Remove all intra-frequency cells":
 - 3> for each position referring to an intra-frequency cell in the variable CELL_INFO_LIST:
 - 4> clear the cell information stored in the variable CELL_INFO_LIST; and
 - 4> mark the position "vacant".
 - 2> if it has the value "Remove no intra-frequency cells":
 - 3> leave the variable CELL_INFO_LIST unchanged.
- 1> if the IE "New Intra-frequency cells" is received, for each cell, and in the same order as the cells appear in the IE:
 - 2> update the variable CELL_INFO_LIST as follows:
 - 3> if the IE "Intra-frequency cell id" is received:
 - 4> store received cell information at this position in the Intra-frequency cell info list in the variable CELL_INFO_LIST, possibly overwriting any existing information in this position; and
 - 4> mark the position "occupied".
 - 3> if the IE "Intra-frequency cell id" is not received:
 - 4> store the received cell information at the first vacant position in ascending order in the Intra-frequency cell info list in the variable CELL_INFO_LIST; and
 - 4> mark the position as "occupied".

If the IE "Intra-frequency cell info list" is received in a MEASUREMENT CONTROL message, the UE shall update the variable CELL_INFO_LIST accordingly and in the following order. The UE shall:

- 1> if the CHOICE "Intra-frequency cell removal" is received:
 - 2> if it has the value "Remove some intra-frequency cells", at the position indicated by the IE "Intra-frequency cell id":
 - 3> clear the cell information stored in the variable CELL_INFO_LIST; and
 - 3> mark the position "vacant".
 - 2> if it has the value "Remove all intra-frequency cells":
 - 3> for each position referring to an intra-frequency cell in the variable CELL_INFO_LIST:
 - 4> clear the cell information stored in the variable CELL_INFO_LIST; and

- 4> mark the position "vacant".
- 2> if it has the value "Remove no intra-frequency cells":
 - 3> leave the variable CELL_INFO_LIST unchanged.
- 1> if the IE "New Intra-frequency cells" is received, for each cell, and in the same order as the cells appear in the IE:
 - 2> update the variable CELL_INFO_LIST as follows:
 - 3> if the IE "Intra-frequency cell id" is received:
 - 4> store received cell information at this position in the Intra-frequency cell info list in the variable CELL_INFO_LIST, possibly overwriting any existing information in this position; and
 - 4> mark the position "occupied".
 - 3> if the IE "Intra-frequency cell id" is not received:
 - 4> store the received cell information at the first vacant position in ascending order in the Intra-frequency cell info list in the variable CELL_INFO_LIST; and
 - 4> mark the position as "occupied".
 - 1> if the IE "Cells for measurement" is received, in the measurement configured by this message only:
 - 2> consider Intra-frequency cells whose cell information is stored at the position indicated by the IE "Intra-frequency cell id" in the variable CELL_INFO_LIST.
 - 1> if the IE "Cells for measurement" is not received, in the measurement configured by this message:
 - 2> consider all Intra-frequency cells whose cell information is stored in CELL_INFO_LIST.

If the IE "Inter-frequency cell info list" is received in System Information Block Type 11 update the variable CELL_INFO_LIST accordingly and in the following order. The UE shall:

- 1> if the IE "Inter-frequency cell removal" is received:
 - 2> ignore the IE.
- 1> if the IE "New Inter-frequency cells" is received, for each cell, and in the same order as the cells appear in the IE:
 - 2> update the variable CELL_INFO_LIST as follows:
 - 3> if the IE "Inter-frequency cell id" is received:
 - 4> store received cell information at this position in the Inter-frequency cell info list in the variable CELL_INFO_LIST, possibly overwriting any existing information in this position; and
 - 4> mark the position "occupied".
 - 3> if the IE "Inter-frequency cell id" is not received:
 - 4> store the received cell information at the first vacant position in ascending order in the Inter-frequency cell info list in the variable CELL_INFO_LIST; and
 - 4> mark the position as "occupied".

If the IE "Inter-frequency cell info list" is received in System Information Block Type 11bis, the UE shall update the variable CELL_INFO_LIST accordingly and in the following order. The UE shall:

- 1> for each cell, and in the same order as the cells appear in the IE:
 - 2> update the variable CELL_INFO_LIST as follows:
 - 3> if the IE "Inter-frequency cell id" is received:

- 4> store received cell information at this position in the Inter-frequency cell info list in the variable CELL_INFO_LIST, possibly overwriting any existing information in this position; and
 - 4> mark the position "occupied".
- 3> if the IE "Inter-frequency cell id" is not received:
- 4> store the received cell information at the first vacant position in ascending order in the Inter-frequency cell info list in the variable CELL_INFO_LIST; and
 - 4> mark the position as "occupied".

If the IE "Inter-frequency cell info list" is received in System Information Block Type 12, the UE shall update the variable CELL_INFO_LIST accordingly and in the following order. The UE shall:

- 1> if the CHOICE "Inter-frequency cell removal" is received:
 - 2> if it has the value "Remove some inter-frequency cells", at the position indicated by the IE "Inter-frequency cell id":
 - 3> clear the cell information stored in the variable CELL_INFO_LIST; and
 - 3> mark the position "vacant".
 - 2> if it has the value "Remove all inter-frequency cells":
 - 3> for each position referring to an inter-frequency cell in the variable CELL_INFO_LIST:
 - 4> clear the cell information stored in the variable CELL_INFO_LIST; and
 - 4> mark the position "vacant".
 - 2> if it has the value "Remove no inter-frequency cells":
 - 3> leave the variable CELL_INFO_LIST unchanged.
- 1> if the IE "New Inter-frequency cells" is received, for each cell, and in the same order as the cells appear in the IE:
 - 2> update the variable CELL_INFO_LIST as follows:
 - 3> if the IE "Inter-frequency cell id" is received:
 - 4> store received cell information at this position in the Inter-frequency cell info list in the variable CELL_INFO_LIST, possibly overwriting any existing information in this position; and
 - 4> mark the position "occupied".
 - 3> if the IE "Inter-frequency cell id" is not received:
 - 4> store the received cell information at the first vacant position in ascending order in the Inter-frequency cell info list in the variable CELL_INFO_LIST; and
 - 4> mark the position as "occupied".

If the IE "Inter-frequency cell info list" is received in a MEASUREMENT CONTROL message, the UE shall update the variable CELL_INFO_LIST accordingly and in the following order:

- 1> if the CHOICE "Inter-frequency cell removal" is received:
 - 2> if it has the value "Remove some inter-frequency cells", at the position indicated by the IE "Inter-frequency cell id":
 - 3> clear the cell information stored in the variable CELL_INFO_LIST; and
 - 3> mark the position "vacant".
 - 2> if it has the value "Remove all inter-frequency cells":

- 3> for each position referring to an inter-frequency cell in the variable CELL_INFO_LIST:
 - 4> clear the cell information stored in the variable CELL_INFO_LIST; and
 - 4> mark the position "vacant".
- 2> if it has the value "Remove no inter-frequency cells":
 - 3> leave the variable CELL_INFO_LIST unchanged.
- 1> if the IE "New Inter-frequency cells" is received, for each cell, and in the same order as the cells appear in the IE:
 - 2> update the variable CELL_INFO_LIST as follows:
 - 3> if the IE "Inter-frequency cell id" is received:
 - 4> store received cell information at this position in the Inter-frequency cell info list in the variable CELL_INFO_LIST, possibly overwriting any existing information in this position; and
 - 4> mark the position "occupied".
 - 3> if the IE "Inter-frequency cell id" is not received:
 - 4> store the received cell information at the first vacant position in ascending order in the Inter-frequency cell info list in the variable CELL_INFO_LIST; and
 - 4> mark the position as "occupied".
- 1> if the IE "Cells for measurement" is received, in the measurement configured by this message only:
 - 2> consider Inter-frequency cells whose cell information is stored at the position indicated by the IE "Inter-frequency cell id" in the variable CELL_INFO_LIST.
- 1> if the IE "Cells for measurement" is not received, in the measurement configured by this message:
 - 2> consider all Inter-frequency cells whose cell information is stored in CELL_INFO_LIST.

If the IE "Inter-RAT cell info list" is received in System Information Block Type 11, the UE shall update the variable CELL_INFO_LIST accordingly and in the following order. The UE shall:

- 1> ignore the IE "Inter-RAT cell removal".
- 1> if the IE "New Inter-RAT cells" is received, for each cell, and in the same order as the cells appear in the IE:
 - 2> if the IE "Radio Access Technology" is set to "None":
 - 3> ignore the cell.
 - 2> otherwise:
 - 3> update the variable CELL_INFO_LIST as follows:
 - 4> if the IE "Inter-RAT cell id" is received:
 - 5> store received cell information at this position in the Inter-RAT cell info list in the variable CELL_INFO_LIST, possibly overwriting any existing information in this position; and
 - 5> mark the position "occupied".
 - 4> if the IE "Inter-RAT cell id" is not received:
 - 5> store the received cell information at the first vacant position in ascending order in the Inter-RAT cell info list in the variable CELL_INFO_LIST; and
 - 5> mark the position as "occupied".
- 1> if the IE "Cells for measurement" is received:

2> ignore the IE.

1> set the "Inter-RAT cell info indication" to the value "0" and mark the indication status "present" in the variable CELL_INFO_LIST.

If the IE "Inter-RAT cell info list" is received in System Information Block Type 11bis, the UE shall update the variable CELL_INFO_LIST accordingly and in the following order. The UE shall:

1> for each cell, and in the same order as the cells appear in the IE:

2> update the variable CELL_INFO_LIST as follows:

3> if the IE "Inter-RAT cell id" is received:

4> store received cell information at this position in the Inter-RAT cell info list in the variable CELL_INFO_LIST, possibly overwriting any existing information in this position; and

4> mark the position "occupied".

3> if the IE "Inter-RAT cell id" is not received:

4> store the received cell information at the first vacant position in ascending order in the Inter-RAT cell info list in the variable CELL_INFO_LIST; and

4> mark the position as "occupied".

If the IE "Inter-RAT cell info list" is received in System Information Block Type 12, the UE shall update the variable CELL_INFO_LIST accordingly and in the following order. The UE shall:

1> if the IE "Inter-RAT cell removal" is received:

2> if it has the value "Remove some inter-RAT cells", at the position indicated by the IE "Inter-RAT cell id":

3> clear the cell information stored in the variable CELL_INFO_LIST; and

3> mark the position "vacant".

2> if it has the value "Remove all inter-RAT cells":

3> for each position referring to an inter-RAT cell in the variable CELL_INFO_LIST:

4> clear the cell information stored in the variable CELL_INFO_LIST; and

4> mark the position "vacant".

2> if it has the value "Remove no inter-RAT cells":

3> leave the variable CELL_INFO_LIST unchanged.

1> if the IE "New Inter-RAT cells" is received, for each cell, and in the same order as the cells appear in the IE:

2> if the IE "Radio Access Technology" is set to "None":

3> ignore the cell.

2> otherwise:

3> update the variable CELL_INFO_LIST as follows:

4> if the IE "Inter-RAT cell id" is received:

5> store received cell information at this position in the Inter-RAT cell info list in the variable CELL_INFO_LIST, possibly overwriting any existing information in this position; and

5> mark the position "occupied".

4> if the IE "Inter-RAT cell id" is not received:

- 5> store the received cell information at the first vacant position in ascending order in the Inter-RAT cell info list in the variable CELL_INFO_LIST; and
- 5> mark the position as "occupied".

1> if the IE "Cells for measurement" is received:

- 2> ignore the IE;

1> set the "Inter-RAT cell info indication" to the value "0" and mark the indication status "present" in the variable CELL_INFO_LIST.

If the IE "Inter-RAT cell info list" is received in a MEASUREMENT CONTROL message, the UE shall update the variable CELL_INFO_LIST accordingly and in the following order. The UE shall:

1> if the IE "Inter-RAT cell removal" is received:

- 2> if it has the value "Remove some inter-RAT cells", at the position indicated by the IE "Inter-RAT cell id":

- 3> clear the cell information stored in the variable CELL_INFO_LIST; and

- 3> mark the position "vacant".

- 2> if it has the value "Remove all inter-RAT cells":

- 3> for each position referring to an inter RAT cell in the variable CELL_INFO_LIST:

- 4> clear the cell information stored in the variable CELL_INFO_LIST; and

- 4> mark the position "vacant".

- 2> if it has the value "Remove no inter-RAT cells":

- 3> leave the variable CELL_INFO_LIST unchanged.

1> if the IE "New Inter-RAT cells" is received, for each cell, and in the same order as the cells appear in the IE:

- 2> if the IE "Radio Access Technology" is set to "None":

- 3> ignore the cell.

- 2> otherwise:

- 3> update the variable CELL_INFO_LIST as follows:

- 4> if the IE "Inter-RAT cell id" is received:

- 5> store received cell information at this position in the Inter-RAT cell info list in the variable CELL_INFO_LIST, possibly overwriting any existing information in this position; and

- 5> mark the position "occupied".

- 4> if the IE "Inter-RAT cell id" is not received:

- 5> store the received cell information at the first vacant position in ascending order in the Inter-RAT cell info list in the variable CELL_INFO_LIST; and

- 5> mark the position as "occupied".

1> if the IE "Cells for measurement" is received, in the measurement configured by this message only:

- 2> consider Inter-RAT cells whose cell information is stored at the position indicated by the IE "Inter-RAT cell id" in the variable CELL_INFO_LIST.

1> if the IE "Cells for measurement" is not received, in the measurement configured by this message:

- 2> consider all Inter-RAT cells whose cell information is stored in CELL_INFO_LIST.

1> if the IE "Cell selection and re-selection info for SIB11/12" is present:

2> ignore the IE.

1> if the IE "Inter-RAT cell info indication" is present:

2> store the received value of the IE "Inter-RAT cell info indication" and mark the indication status "present" in the variable CELL_INFO_LIST.

1> if the IE "Inter-RAT cell info indication" is not present:

2> clear the "Inter-RAT cell info indication" and mark the indication status "not present" in the variable CELL_INFO_LIST.

NOTE: If UTRAN signalling would result in more than "maxCellMeas" cells for the Intra-frequency, Inter-frequency or Inter-RAT cell information list the UE behaviour is unspecified.

8.6.7.4 Intra-frequency measurement quantity

If the IE "Intra-frequency measurement quantity" is received in a MEASUREMENT CONTROL message, the UE shall:

1> if the IE "Measurement quantity" is set to "pathloss"; and

1> for any intra-frequency cell indicated by the IE "Cells for measurement", the IE "Primary CPICH Tx power" in FDD or the IE "Primary CCPCH TX Power" in TDD in the intra frequency cell info list in the variable CELL_INFO_LIST is not present:

2> set the variable CONFIGURATION_INCOMPLETE to TRUE.

1> else:

2> configure the measurement quantity accordingly.

8.6.7.5 Inter-RAT measurement quantity

If the IE "Inter-RAT measurement quantity" is received in a MEASUREMENT CONTROL message and CHOICE system is GSM, the UE shall:

1> if IE "BSIC verification required" is set to "required", for cells that match any of the BCCH ARFCN and BSIC combinations in the list of inter-RAT cells that the UE has received in IE "Inter-RAT cell info list", and that has a "verified" BSIC:

2> report measurement quantities according to IE "inter-RAT reporting quantity" taking into account the restrictions defined in subclause 8.6.7.6;

2> trigger inter-RAT events according to IE "inter-RAT measurement reporting criteria"; and

2> perform event evaluation for event-triggered reporting after BSIC has been verified for a GSM cell as defined in [19]; and

2> trigger periodical reports according to the given "Reporting interval"; and

2> when a periodical measurement report is triggered, include only BSIC verified GSM cells in the IE "Inter-RAT measured results list"; and

3> indicate verified BSIC for a GSM cell in the IE "Inter-RAT measured results list" as defined in subclause 8.6.7.6.

2> when an event triggered measurement report is triggered, include only BSIC verified GSM cells in the IE "Inter-RAT measured results list"; and

3> indicate verified BSIC for a GSM cell in the IE "Inter-RAT measured results list" as defined in subclause 8.6.7.6.

- 1> if IE "BSIC verification required" is set to "not required", for cells that match any of the BCCH ARFCN in the list of inter-RAT cells that the UE has received in IE "Inter-RAT cell info list", regardless if the BSIC is "verified" or "non-verified":
 - 2> report measurement quantities according to IE "inter-RAT reporting quantity";
 - 2> trigger inter-RAT events according to IE "inter-RAT measurement reporting criteria";
 - 2> when an event triggered or periodical measurement report is triggered, include GSM cells in the IE "Inter-RAT measured results list" regardless of whether the BSIC of the GSM cell has been verified or not; and
 - 3> for any GSM cell that has not been verified, indicate non-verified BSIC for a GSM cell in the "Inter-RAT measured results list" IE as defined in subclause 8.6.7.6.
 - 3> for any GSM cell that has been verified, indicate verified BSIC for a GSM cell in the "Inter-RAT measured results list" IE as defined in subclause 8.6.7.6.
- 1> if the IE "Measurement quantity" is set to "pathloss":
 - 2> set the variable CONFIGURATION_INCOMPLETE to TRUE.

NOTE: The requirements for a cell to be considered "verified" or "non-verified" can be found in [19].

8.6.7.6 Inter-RAT reporting quantity

If the IE "Inter-RAT reporting quantity" is received by the UE, the UE shall:

- 1> store the content of the IE to the variable MEASUREMENT_IDENTITY.

If the IE "Inter-RAT measurement quantity" is received and CHOICE system is GSM, the UE shall check each quantity in the GSM choice. The UE shall include measured results in MEASUREMENT REPORT as specified in the IE "Inter-RAT reporting quantity" with the following restrictions:

- 1> if the UE has not confirmed the BSIC of the measured cell:
 - 2> if no compressed mode pattern sequence specified with measurement purpose "Initial BSIC identification" is active and according to its capabilities the UE requires compressed mode to measure this, the UE is not required to include the "inter-RAT cell id" in the IE "Inter-RAT measured results list", when a MEASUREMENT REPORT is triggered.
- 1> if the UE has confirmed the BSIC of the measured cell, then:
 - 2> if no compressed mode pattern sequence specified with measurement purpose "Initial BSIC identification" nor "BSIC re-confirmation" is active and according to its capabilities the UE requires compressed mode to measure this, the UE is not required to include the "inter-RAT cell id" in the IE "Inter-RAT measured results list", when a MEASUREMENT REPORT is triggered. If no compressed mode pattern sequence with measurement purpose "GSM carrier RSSI measurements" is active and according to its capabilities the UE requires compressed mode to measure this, the UE may include "inter-RAT cell id" in MEASUREMENT REPORT without "GSM carrier RSSI" even if it is defined in the IE "Inter-RAT reporting quantity".
- 1> if the IE "UTRAN estimated quality" is set to TRUE:
 - 2> ignore that IE.
- 1> if IE "GSM Carrier RSSI" is set to TRUE:
 - 2> include optional IE "GSM Carrier RSSI" with a value set to the measured RXLEV to that GSM cell in IE "Inter-RAT measured results list". If no compressed mode pattern sequence specified with measurement purpose "GSM carrier RSSI measurements" is active and according to its capabilities the UE requires compressed mode to measure this, the UE is not required to include the "GSM carrier RSSI" in the IE "Inter-RAT measured results list", when a MEASUREMENT REPORT is triggered.
- 1> if the BSIC of reported GSM cell is "verified":
 - 2> set the CHOICE BSIC to "Verified BSIC" and IE "inter-RAT cell id" to the value that GSM cell had in the IE "Inter-RAT cell info list".

- 1> if the BSIC of reported GSM cell is "non-verified":
 - 2> set the CHOICE BSIC to "Non verified BSIC" and the IE "BCCH ARFCN" to the value of that GSM cells ARFCN.

The requirements for a cell to be considered "verified" or "non-verified" can be found in [19].

8.6.7.7 Cell Reporting Quantities

If the IE "Cell Reporting Quantities" is received by the UE, the UE shall store the content of the IE "Cell Reporting Quantities" to the variable MEASUREMENT_IDENTITY.

The UE shall include measured results in MEASUREMENT REPORT as specified in the IE "Cell Reporting Quantities", except for the following cases:

If the IE "Cell Identity" is set to TRUE, the UE shall in this version of the specification:

- 1> treat the IE as if the IE "Cell Identity" is set to FALSE.

If the IE "Cell synchronisation information reporting indicator" is set to TRUE, the UE shall:

- 1> include the IE "Cell synchronisation information" in MEASUREMENT REPORT as specified in the IE "Cell Reporting Quantities":
 - 2> if the measurement is performed on another frequency; or
 - 2> if the IE "Read SFN indicator" included in the IE "Cell info" of the measured cell is set to FALSE:
 - 3> the UE may omit the information group "COUNT-C-SFN frame difference" in the IE "Cell synchronisation information".
 - 2> if the measurement is performed on the same frequency and no RLC Transparent Mode COUNT-C exists in the UE:
 - 3> set the IE "COUNT-C-SFN high" to 0.
 - 2> otherwise:
 - 3> include the information group "COUNT-C-SFN frame difference" with IE "COUNT-C-SFN high" set to:

$$\text{COUNT-C-SFN high} = (((\text{SFN} - (\text{COUNT-C} \bmod 4096)) \bmod 4096) \text{ div } 256) * 256;$$
 - 3> if RLC Transparent Mode COUNT-Cs exist in both CN domains:
 - 4> use the COUNT-C of CS domain in this measurement.

If the IE "Proposed TGSN Reporting required" is set to TRUE, the UE shall:

- 1> if compressed mode was used to monitor a TDD cell and the variable TGSN_REPORTED is set to FALSE:
 - 2> report the IE "Proposed TGSN" indicating the TGSN that suits best to the measured cell;
 - 2> set the variable TGSN_REPORTED to TRUE.
- 1> otherwise
 - 2> omit the IE "Proposed TGSN".

8.6.7.8 Periodical Reporting Criteria

If the IE "Periodical Reporting Criteria" is received by the UE, the UE shall:

- 1> store the contents of the IE "Amount of Reporting" and IE "Reporting interval" in the variable MEASUREMENT_IDENTITY.

For the first MEASUREMENT REPORT message, the UE shall:

- 1> send the MEASUREMENT REPORT as soon as all requested reporting quantities are available according to the requirements and the measurement capabilities set in [19] and [20] for at least one measurement object stored in the variable MEASUREMENT_IDENTITY, but never later than one reporting interval after measurement initiation.

Following the first MEASUREMENT REPORT message, the UE shall:

- 1> send a MEASUREMENT REPORT message one reporting interval after the previous MEASUREMENT REPORT message;

The first and subsequent periodic MEASUREMENT REPORT messages shall only include measured results for reporting quantities that are available according to the requirements and the measurement capabilities set in [19] and [20] i.e. if no measured results are available and the measurement type is not UE positioning, the IE "Measured Results" shall not be included in the MEASUREMENT REPORT message. If no measured results are available and the measurement type is UE positioning, the UE shall include the IE "Measured Results" in the MEASUREMENT REPORT message in order to include the IE "UE positioning error" as specified in 8.6.7.19a and 8.6.7.19b.

After the UE has sent a total number of MEASUREMENT REPORT messages, which equal the value indicated in the IE "Amount of reporting", the UE shall:

- 1> terminate measurement reporting; and
- 1> delete all measurement information linked with the "Measurement identity" of the ongoing measurement from the variable MEASUREMENT_IDENTITY.

If according to subclause 8.6.7.19.1a or 8.6.7.19.1b, a UE configured with a UE positioning measurement is unable to report the requested measurement results due to missing GPS or GANSS assistance data and sends a MEASUREMENT REPORT containing the IE "UE positioning error" and the IE "Error reason" is set to "Assistance Data Missing", then this is not counted in the total number of MEASUREMENT REPORT messages sent.

8.6.7.9 Reporting Cell Status

If the IE "Reporting Cell Status" is received, the UE shall set the IE "Measured Results" in MEASUREMENT REPORT as follows. The UE shall:

- 1> for intra-frequency measurement and inter-frequency measurement:
 - 2> include the IE "Cell Measured Results" for cells (excluding cells of another RAT) that satisfy the condition (such as "Report cells within active set") specified in the IE "Reporting Cell Status", in descending order by the measurement quantity.
 - 2> the maximum number of the IE "Cell Measured Results" to be included in the IE "Measured Results" per reported frequency is the number specified in the IE "Reporting Cell Status".
- 1> for periodic inter-frequency measurement:
 - 2> include in the IE "Inter-frequency measured results list" the measured results for all non-used frequencies.
- 1> for inter-RAT measurement:
 - 2> include the measurement results for cells of other RAT (e.g., GSM) that satisfy the condition specified in the IE "Reporting Cell Status", in descending order by the measurement quantity.
 - 2> the maximum number of the IE "Measured GSM Cells" to be included in the IE "Measured Results" is the number specified in the IE "Reporting Cell Status".

If the IE "Reporting Cell Status" is not received for intra-frequency, inter-frequency measurement, or inter-RAT measurement, the UE shall:

- 1> for intra-frequency measurement, inter-frequency measurement and inter-RAT measurement:
 - 2> exclude the IE "Measured Results" in MEASUREMENT REPORT.

NOTE: The IE "Reporting Cell Status" within "Event Criteria List" defines whether "Cell Measured Results" is present for event-based reporting.

The IE "Reporting Cell Status" is not included in System Information Block 11/12 for periodic intra-frequency measurements. In this case the UE shall assume the default values "Report cells within active set and/or monitored set on used frequency " and "6".

8.6.7.10 Traffic Volume Measurement

If the IE "Traffic Volume Measurement" is received by the UE, the UE shall:

- 1> store the content of the IE to the variable MEASUREMENT_IDENTITY.

If IE "Traffic volume measurement" is received by the UE in a MEASUREMENT CONTROL message, where IE "measurement command" has the value "setup", and if the IE "traffic volume reporting quantity" is included, the UE shall:

- 1> if the parameter "Average of RLC Buffer Payload for each RB" or the parameter "Variance of RLC Buffer payload for each RB" is set to TRUE:
 - 2> if the IE "Traffic volume measurement quantity" is not included:
 - 3> set the variable CONFIGURATION_INCOMPLETE to TRUE.
 - 2> if the IE "Traffic volume measurement quantity" is included:
 - 3> if the parameter "time interval to take an average or a variance" is not included:
 - 4> set the variable CONFIGURATION_INCOMPLETE to TRUE.

If IE "Traffic volume measurement" is received by the UE in a MEASUREMENT CONTROL message, where IE "measurement command" has the value "setup", but IE "Traffic volume reporting quantity" or is not received, the UE shall:

- 1> set the variable CONFIGURATION_INCOMPLETE to TRUE.

8.6.7.11 Traffic Volume Measurement Reporting Criteria

If the IE "Traffic Volume Measurement Reporting Criteria" is received by the UE, the UE shall:

- 1> if the IE "Parameters sent for each transport channel" is absent:
 - 2> set the variable PROTOCOL_ERROR_REJECT to TRUE;
 - 2> set the IE "Protocol error cause" in the variable PROTOCOL_ERROR_INFORMATION to "Information element missing".
- 1> for each IE "Parameters sent for each transport channel":
 - 2> if the IE "Parameters required for each Event" is absent:
 - 3> set the variable CONFIGURATION_INCOMPLETE to TRUE.

8.6.7.12 FACH measurement occasion info

IE "FACH measurement occasion info" is used to control UE measurement activities in inter-frequency and inter-RAT cells in CELL_FACH state.

For FDD when variable HS_DSCH_RECEPTION_CELL_FACH_STATE is set to FALSE, or for TDD: if IE "FACH measurement occasion info" is received, UE shall, when in CELL_FACH state:

- 1> if IE "FACH Measurement occasion cycle length coefficient" is included:
 - 2> if, according to its measurement capabilities, UE is not able to perform some of the indicated measurements in this IE simultaneously as receiving the SCCPCH of serving cell:
 - 3> perform those measurements during FACH measurement occasions, see subclause 8.5.11.

- 2> if, according to its measurement capabilities, UE is able to perform some of the indicated measurements in this IE simultaneously as receiving the SCCPCH of serving cell:
 - 3> UE may perform measurements also on other occasions.
- 2> if, according to its measurement capabilities, UE is able to perform the measurements and indicated in this IE simultaneously as receiving the SCCPCH of serving cell:
 - 3> perform the measurements simultaneously as receiving the SCCPCH of serving cell.
- 1> if IE "FACH Measurement occasion cycle length coefficient" is not included:
 - 2> perform those indicated measurements indicated in this IE that UE, according to its measurement capabilities, is able to perform simultaneously as receiving the SCCPCH of serving cell.
- 1> if IE "Inter-frequency FDD measurement indicator" is set to TRUE:
 - 2> perform measurements and evaluate cell re-selection criteria according to [4] on inter-frequency FDD cells listed in "System Information Block type 11", "System Information Block type 11bis", if scheduled on BCH, and "System Information Block type 12", if scheduled on BCH.
- 1> if IE "Inter-frequency FDD measurement indicator" is set to FALSE:
 - 2> neither perform measurements nor evaluate cell re-selection criteria on inter-frequency FDD cells.
- 1> if IE "Inter-frequency TDD measurement indicator" is set to TRUE:
 - 2> perform measurements and evaluate cell re-selection criteria according to [4] on inter-frequency TDD cells listed in "System Information Block type 11", "System Information Block type 11bis", if scheduled on BCH, and "System Information Block type 12", if scheduled on BCH.
- 1> if IE "Inter-frequency TDD measurement indicator" is set to FALSE:
 - 2> neither perform measurements nor evaluate cell re-selection criteria on inter-frequency TDD cells.
- 1> if IE "Inter-RAT measurement indicators" is included:
 - 2> perform measurements and evaluate cell re-selection criteria according to [4] on those cells of listed Inter-RAT types that are present in "System Information Block type 11", "System Information Block type 11bis", if scheduled on BCH, and "System Information Block type 12", if scheduled on BCH.

For FDD when variable HS_DSCH_RECEPTION_CELL_FACH_STATE is set to TRUE: if IE "FACH measurement occasion info" is received, UE shall:

- 1> if IE "FACH Measurement occasion cycle length coefficient" is included:
 - 2> if, according to its measurement capabilities, the UE is not able to perform some of the indicated measurements in this IE simultaneously as receiving the HS-DSCH and its associated physical channels of serving cell:
 - 3> perform those measurements during FACH measurement occasions, see subclause 8.5.11.
 - 2> if, according to its measurement capabilities, the UE is able to perform some of the indicated measurements in this IE simultaneously as receiving the HS-DSCH and its associated physical channels of serving cell:
 - 3> the UE may perform measurements also on other occasions.
 - 2> if, according to its measurement capabilities, the UE is able to perform the measurements and indicated in this IE simultaneously as receiving the HS-DSCH and its associated physical channels of serving cell:
 - 3> perform the measurements simultaneously as receiving the HS-DSCH and its associated physical channels of serving cell.
- 1> if IE "FACH Measurement occasion cycle length coefficient" is not included:

- 2> perform those indicated measurements indicated in this IE that UE, according to its measurement capabilities, is able to perform simultaneously as receiving the HS-DSCH and its associated physical channels of serving cell.
- 1> if IE "Inter-frequency FDD measurement indicator" is set to TRUE:
 - 2> perform measurements and evaluate cell re-selection criteria according to [4] on inter-frequency FDD cells listed in "System Information Block type 11", "System Information Block type 11bis", if scheduled on BCH, and "System Information Block type 12", if scheduled on BCH.
- 1> if IE "Inter-frequency FDD measurement indicator" is set to FALSE:
 - 2> neither perform measurements nor evaluate cell re-selection criteria on inter-frequency FDD cells.
- 1> if IE "Inter-RAT measurement indicators" is included:
 - 2> perform measurements and evaluate cell re-selection criteria according to [4] on those cells of listed Inter-RAT types that are present in "System Information Block type 11", "System Information Block type 11bis", if scheduled on BCH, and "System Information Block type 12", if scheduled on BCH.

8.6.7.13 Measurement Reporting Mode

If IE "Measurement Reporting Mode" is received by the UE, the UE shall:

- 1> store the contents of the IE "Measurement Report Transfer Mode" in the variable MEASUREMENT_IDENTITY;
- 1> use the indicated RLC mode when sending MEASUREMENT REPORT message(s) related to this measurement;
- 1> ignore IE "Periodical Reporting / Event Trigger Reporting Mode".

If IE "Measurement Reporting Mode" is not received by the UE in MEASUREMENT CONTROL message, where IE "measurement command" has the value "setup", the UE shall:

- 1> clear all stored measurement control information related associated to this measurement identity in variable MEASUREMENT_IDENTITY;
- 1> set the variable CONFIGURATION_INCOMPLETE to TRUE.

8.6.7.14 Inter-frequency measurement

If the Inter-frequency cell info list, included in the variable CELL_INFO_LIST, includes a number (M) of frequencies that is larger than the number (N) considered in a UE performance requirement defined in [19] and [20]:

- 1> the UE shall:
 - 2> meet this performance requirement on the first relevant (N) frequencies, according to the order defined by the position of the frequencies in the Inter-frequency cell info list, included in the variable CELL_INFO_LIST.
- 1> the UE may:
 - 2> ignore the remaining (M-N) frequencies.

If IE "Inter-frequency measurement" is received by the UE in a MEASUREMENT CONTROL message, where IE "measurement command" has the value "setup", but IE "Inter-frequency measurement quantity", IE "Inter-frequency reporting quantity" or IE "parameters required for each event" (given "CHOICE Report criteria" is set to "inter-frequency measurement reporting criteria") is not received, the UE shall:

- 1> clear all stored measurement control information related associated to this measurement identity in variable MEASUREMENT_IDENTITY;
- 1> set the variable CONFIGURATION_INCOMPLETE to TRUE.

If IE "Inter-frequency measurement" is received by the UE in a MEASUREMENT CONTROL message, where IE "measurement command" has the value "modify":

- 1> if CHOICE "Report criteria" in IE "Inter-frequency measurement" is set to "intra-frequency measurement reporting criteria" and IE "parameters required for each event" is present:
 - 2> for FDD, 3.84 Mcps TDD and 7.68 Mcps TDD; or
 - 2> for 1.28 Mcps TDD, if the UE uses only one frequency:
 - 3> the UE behaviour is unspecified.

If IE "Inter-frequency measurement" is received by the UE in a MEASUREMENT CONTROL message, where IE "measurement command" has the value "setup" and CHOICE "Report criteria" in IE "Inter-frequency measurement" is set to "intra-frequency measurement reporting criteria":

- 1> for FDD, 3.84 Mcps TDD and 7.68 Mcps TDD; or
- 1> for 1.28 Mcps TDD, if the UE uses only one frequency:
 - 2> the UE behaviour is unspecified.

In the case of an inter-frequency measurement for FDD, the UE shall:

- 1> if IE "Inter-frequency measurement" is received by the UE in a MEASUREMENT CONTROL message, where IE "measurement command" has the value "setup", if an inter-frequency event is configured that is different from event 2d or 2f, and if the IE "Inter-frequency SET UPDATE" is not received in that same message:
 - 2> set the variable CONFIGURATION_INCOMPLETE to TRUE.

NOTE: The UTRAN should include the IE "Inter-frequency SET UPDATE" in the MEASUREMENT CONTROL message with the IE "measurement command" set to "modify" when event 2a, 2b, 2c or 2e is first configured, and when the UE is requested to measure a frequency that has not been previously measured. Otherwise the UE behaviour is unspecified.

If IE "Inter-frequency measurement" is received by the UE in a MEASUREMENT CONTROL message:

- 1> if CHOICE "Report criteria" is set to "inter-frequency measurement reporting criteria" and CHOICE "reporting criteria" in "inter-frequency measurement quantity" is not set to "inter-frequency reporting criteria"; or
- 1> if CHOICE "Report criteria" is set to "intra-frequency measurement reporting criteria" and CHOICE "reporting criteria" in "inter-frequency measurement quantity" is not set to "intra-frequency reporting criteria":
 - 2> for FDD, 3.84 Mcps TDD and 7.68 Mcps TDD; or
 - 2> for 1.28 Mcps TDD, if the UE uses only one frequency:
 - 3> the UE behaviour is not specified.

If the variable CONFIGURATION_INCOMPLETE is set to TRUE, the UE shall:

- 1> act as described in subclause 8.4.1.4a.

8.6.7.15 Inter-RAT measurement

If the Inter-RAT cell info list, included in the variable CELL_INFO_LIST, includes a number (M) of frequencies that is larger than the number (N) considered in a UE performance requirement defined in [19] and [20]:

- 1> the UE shall:
 - 2> meet this performance requirement on the first relevant (N) frequencies, according to the order defined by the position of the frequencies in the Inter-RAT cell info list, included in the variable CELL_INFO_LIST.
- 1> the UE may:
 - 2> ignore the remaining (M-N) frequencies.

If IE "Inter-RAT measurement" is received by the UE in a MEASUREMENT CONTROL message, where IE "measurement command" has the value "setup", but IE "Inter-RAT measurement quantity", IE "Inter-RAT reporting

quantity" or "parameters required for each event" (given "CHOICE Report criteria" is set to "inter-RAT measurement reporting criteria") is not received, the UE shall:

- 1> clear all stored measurement control information related associated to this measurement identity in variable MEASUREMENT_IDENTITY;
- 1> set the variable CONFIGURATION_INCOMPLETE to TRUE.

8.6.7.16 Intra-frequency measurement

If IE "Intra-frequency measurement" is received by the UE in a MEASUREMENT CONTROL message, where IE "measurement command" has the value "setup", but IE "Intra-frequency measurement quantity", IE "Intra-frequency reporting quantity", "CHOICE Report criteria" or "parameters required for each event" (given "CHOICE report criteria" is set to "intra-frequency measurement reporting criteria") is not received, the UE shall:

- 1> clear all stored measurement control information related associated to this measurement identity in variable MEASUREMENT_IDENTITY;
- 1> set the variable CONFIGURATION_INCOMPLETE to TRUE.

In case of 1a or 1e event-triggered reporting:

- 1> if the IE "Intra-frequency measurement quantity" is set to "pathloss", the UE shall:
 - 2> if detected set cells are indicated as possibly triggering the event within the IEs "Triggering condition 2" :
 - 3> set the variable CONFIGURATION_INCOMPLETE to TRUE.

8.6.7.17 Quality measurement

If IE "Quality measurement" is received by the UE in a MEASUREMENT CONTROL message, where IE "measurement command" has the value "setup", but IE "Quality reporting quantity" is not received, the UE shall:

- 1> clear all stored measurement control information related associated to this measurement identity in variable MEASUREMENT_IDENTITY;
- 1> set the variable CONFIGURATION_INCOMPLETE to TRUE.

If Transport Channel BLER reporting is requested in IE "Quality Reporting Quantity", but no transport channels are explicitly referenced with transport channel identities, the UE shall

- 1> report BLER for all downlink transport channels, for which Transport Channel BLER is defined and can be requested [7, 8].

If a transport channel, for which Transport Channel BLER is not defined and can not be requested [7, 8], is referenced with a transport channel identity in IE "Quality Reporting Quantity" and/or IE "Quality Measurement Reporting Criteria":

- 1> the UE behaviour is not specified.

8.6.7.18 UE internal measurement

If IE "UE internal measurement" is received by the UE in a MEASUREMENT CONTROL message, where IE "measurement command" has the value "setup", but IE "UE internal measurement quantity", IE "UE internal reporting quantity" or "parameters sent for each UE internal measurement event" (given "CHOICE report criteria" is set to "UE internal measurement reporting criteria") is not received, the UE shall:

- 1> clear all stored measurement control information related associated to this measurement identity in variable MEASUREMENT_IDENTITY;
- 1> set the variable CONFIGURATION_INCOMPLETE to TRUE.

8.6.7.18a Void

8.6.7.19 UE positioning

8.6.7.19.0 UE positioning reporting criteria

If IE "UE positioning reporting criteria" is included, the UE shall:

- 1> perform the necessary measurements and evaluate the event in the interval indicated in IE "Measurement Interval";
- 1> if IE "Event ID" is set to "7a" and if IE "Report first fix" is set to TRUE:
 - 2> if the IE "Method Type" included in the variable MEASUREMENT_IDENTITY is set to "UE based":
 - 3> act as specified in subclause 8.6.7.19.1b.

8.6.7.19.1 UE positioning reporting quantity

The UE shall:

- 1> ignore IE "Multiple Sets";
- 1> ignore IE "Response Time";
- 1> if IE "Horizontal Accuracy" and/or IE "Vertical Accuracy" is included:
 - 2> should try to achieve the requested level(s) of positioning accuracy with 67% confidence.
- 1> if IE "Positioning Methods" is set to "Cell ID":
 - 2> act as specified in subclause 8.6.7.19.1a.
- 1> if the IE "Method Type" is set to "UE based":
 - 2> if the IE "Positioning Methods" is set to "GPS"; and
 - 2> if the IE "Additional Assistance Data Request" is set to FALSE; and
 - 2> if the IE "UE positioning GPS assistance data" is not received in the MEASUREMENT CONTROL message; and
 - 2> if, according to its UE positioning capabilities, the UE supports a standalone positioning method:
 - 3> use the standalone positioning method.
 - 2> act as specified in subclause 8.6.7.19.1b.
- 1> if the IE "Method Type" is set to "UE assisted":
 - 2> act as specified in subclause 8.6.7.19.1a.
- 1> if the IE "Method Type" is set to "UE-assisted preferred but UE-based allowed" or "UE-based preferred but UE-assisted allowed":
 - 2> act either according to subclause 8.6.7.19.1a or 8.6.7.19.1b depending on the method type chosen by the UE.

If UE according to its capabilities supports Rx-Tx time difference type 2 measurement and if IE "Positioning Methods" is set to "Cell ID" and the IE "Method Type" is set to "UE-based", the UE shall:

- 1> set the variable CONFIGURATION_INCOMPLETE to TRUE.

If UE according to its capabilities supports Rx-Tx time difference type 2 measurement and if IE "Positioning Methods" is set to "Cell ID" and the IE "Measurement validity" stored in the variable MEASUREMENT_IDENTITY is other than "CELL_DCH", the UE shall:

1> set the variable CONFIGURATION_INCOMPLETE to TRUE.

The UE shall perform the following consistency check:

1> if UE, according to its capabilities, does not support UE-based OTDOA and if IE "Positioning Methods" is set to "OTDOA" and if IE "Method Type" is set to "UE-based":

2> set the variable CONFIGURATION_INCOMPLETE to TRUE.

1> if UE, according to its capabilities, does not support UE-assisted OTDOA and if IE "Positioning Methods" is set to "OTDOA" and if IE "Method Type" is set to "UE-assisted":

2> set the variable CONFIGURATION_INCOMPLETE to TRUE.

1> if UE, according to its capabilities, does not support UE-based GPS and does not support a standalone positioning method and if IE "Positioning Methods" is set to "GPS" and if the IE "GANSS Positioning Methods" is not present and if IE "Method Type" is set to "UE-based":

2> set the variable CONFIGURATION_INCOMPLETE to TRUE.

1> if UE, according to its capabilities, does not support UE-assisted GPS and if the IE "GANSS Positioning Methods" is not present and if IE "Positioning Methods" is set to "GPS" and if IE "Method Type" is set to "UE-assisted":

2> set the variable CONFIGURATION_INCOMPLETE to TRUE.

1> if UE, according to its capabilities, does not support UE-based positioning and if IE "Positioning Methods" is set to "OTDOAorGPS" and if IE "Method Type" is set to "UE-based":

2> set the variable CONFIGURATION_INCOMPLETE to TRUE.

1> if UE, according to its capabilities, does not support UE-based GANSS and if IE "Positioning Methods" is set to "GPS" and if IE "GANSS Positioning Methods" is present and if IE "Method Type" is set to "UE-based":

2> set the variable CONFIGURATION_INCOMPLETE to TRUE.

1> if UE, according to its capabilities, does not support UE-assisted GANSS and if IE "Positioning Methods" is set to "GPS" and if IE "GANSS Positioning Methods" is present and if IE "Method Type" is set to "UE-assisted":

2> set the variable CONFIGURATION_INCOMPLETE to TRUE.

1> if IE "Positioning Methods" is set to "GPS" and if IE "GANSS Positioning Methods" is present and if UE, according to its capabilities, does not support any GNSS indicated in IE "GANSS Positioning Methods":

2> set the variable CONFIGURATION_INCOMPLETE to TRUE.

1> if UE, according to its capabilities, does not support Rx-Tx time difference type 2 measurement and if IE "Positioning Methods" is set to "Cell ID":

2> set the variable CONFIGURATION_INCOMPLETE to TRUE.

1> if UE, according to its capabilities, does not support UE GPS timing of cell frames measurement and if IE "GPS timing of Cell wanted" is set to TRUE:

2> set the variable CONFIGURATION_INCOMPLETE to TRUE.

8.6.7.19.1a UE positioning reporting for UE assisted methods

The UE shall:

1> when a measurement report is triggered:

- 2> if the UE was able to perform measurements on at least one neighbour cell included in the variable UE_POSITIONING_OTDOA_DATA_UE_ASSISTED in case of OTDOA or one satellite included in the variable UE_POSITIONING_GPS_DATA in case of GPS positioning or one satellite included in the variable UE_POSITIONING_GANSS_DATA in case of GANSS positioning or one cell from the active set in case of CELL ID:
 - 3> if the IE "Vertical Accuracy" is included:
 - 4> interpret the presence of this IE to indicate that the UTRAN desires to compute a 3-dimensional position estimate.
 - 3> if the IE "Positioning Methods" is set to "GPS" and if the IE "GANSS Positioning Methods" is not present or if the IE "GANSS Positioning Methods" is present indicating GPS allowed:
 - 4> include the IE "UE positioning GPS measured results" in the measurement report and set the contents of the IE as follows:
 - 5> if the UE supports the capability to provide the GPS timing of the cell frames measurement:
 - 6> if the IE "GPS timing of Cell wanted" is set to TRUE:
 - 7> perform the UE GPS timing of cell frames measurement on the serving cell or on one cell of the active set.
 - 7> include the IE "Primary CPICH Info" for FDD or the IE "cell parameters id" for TDD; and
 - 7> include the IE "Reference SFN", the IE "UE GPS timing of cell frames" and the IE "UE Positioning GPS Reference Time Uncertainty".
 - 6> if the IE "GPS timing of Cell wanted" is set to FALSE:
 - 7> include the IE "GPS TOW msec" and set it to the GPS TOW when the measurements included in the MEASUREMENT REPORT were valid;
 - 7> include the IE "UE Positioning GPS Reference Time Uncertainty" and set it to the uncertainty of the GPS TOW when the measurements included in the MEASUREMENT REPORT were valid.
 - 5> if the UE does not support the capability to provide the GPS timing of the cell:
 - 6> include the IE "GPS TOW msec" and set it to the GPS TOW when the measurements included in the MEASUREMENT REPORT were valid;
 - 6> include the IE "UE Positioning GPS Reference Time Uncertainty" and set it to the uncertainty of the GPS TOW when the measurements included in the MEASUREMENT REPORT were valid.
 - 3> if the IE "Positioning Methods" is set to "GPS" and the IE "GANSS Positioning Methods" is present indicating other GNSS than GPS allowed and if any of these other GNSSs is measured:
 - 4> include the IE "UE positioning GANSS measured results" in the measurement report and set the contents of the IE as follows:
 - 5> if the UE supports the capability to provide the GANSS timing of the cell frames measurement:
 - 6> if the IE "GANSS timing of Cell wanted" is set to TRUE and if IE "UE GPS timing of cell frames" is not present:
 - 7> perform the UE GANSS timing of cell frames measurement on the serving cell or on one cell of the active set;
 - 7> include the IE "Primary CPICH Info" for FDD or the IE "cell parameters id" for TDD; and
 - 7> include the IE "Reference SFN" and the IE "UE GANSS timing of cell frames".
 - 6> if the IE "GANSS timing of Cell wanted" is set to FALSE and if IE "UE positioning GPS measured results" is not present:

- 7> include the IE "GANSS TOD msec" and set it to the GANSS TOD when the measurements included in the MEASUREMENT REPORT were valid.
- 5> if the UE does not support the capability to provide the GANSS timing of the cell and if IE "UE positioning GPS measured results" is not present:
 - 6> include the IE "GANSS TOD msec" and set it to the GANSS TOD when the measurements included in the MEASUREMENT REPORT were valid.
- 5> if the UE supports the capability to provide the GANSS carrier-phase measurements:
 - 6> if the IE "GANSS Carrier-Phase Measurement Requested" is set to TRUE:
 - 7> include the IE "Carrier Quality Indication" and include the IE "ADR".
- 3> if the IE "Positioning Methods" is set to "OTDOA":
 - 4> include the IE "UE positioning OTDOA measured results " in the measurement report and set the contents of the IE as follows:
 - 5> set IE "SFN" to the SFN when the last measurement was performed;
 - 5> if the UE supports the capability to perform the Rx-Tx time difference type 2 measurement:
 - 6> if the UE is in CELL_DCH state:
 - 7> if the measured value is equal to "1279.9375":
 - 8> set the IE "Rx-Tx time difference type 2" in IE "UE positioning OTDOA measured results" for the reference cell to "1279.8750".
 - 7> otherwise:
 - 8> set the IE "Rx-Tx time difference type 2" in IE "UE positioning OTDOA measured results" for the reference cell to the measured value.
 - 7> include the IE group "Rx-Tx time difference type 2 info" for the reference cell and for each neighbour cell listed in variable UE_POSITIONING_OTDOA_DATA_UE_ASSISTED that belongs to the active set.
 - 5> if the UE does not support the capability to perform the Rx-Tx time difference type 2 measurement:
 - 6> set the IE "Rx-Tx time difference type 2" in IE "UE positioning OTDOA measured results" for the reference cell to value "1279.9375" to indicate that the measurement is not supported.
 - 4> include IE group "Neighbour" for all neighbour cells listed in variable UE_POSITIONING_OTDOA_DATA_UE_ASSISTED on which the SFN-SFN observed time difference type 2 measurement could be performed.
 - 3> if IE "Positioning Methods" in the MEASUREMENT CONTROL message has been assigned to value "OTDOA or GPS":
 - 4> the UE may choose to either act as if IE "Positioning Methods" is set to "GPS" or "OTDOA" depending on the method chosen by the UE.
 - 3> if the IE "Positioning Methods" is set to "CELL ID":
 - 4> if the UE supports the capability to perform the Rx-Tx time difference type 2 measurement; and
 - 4> if the UE is in CELL_DCH state:
 - 5> perform the Rx-Tx time difference type 2 measurement on the cells in the active set; and
 - 5> report the measurement results back to the network in the MEASUREMENT REPORT by using IE "UE positioning OTDOA measured results" including measurements on the cells in the active set; and

- 5> report Rx-Tx time difference type 2 measurement of the reference cell (as designated by the UE);
and
- 5> for all reported neighbour cells:
 - 6> report Rx-Tx time difference type 2 measurement; and
 - 6> set the IE "SFN-SFN observed time difference type 2" and all IEs within the corresponding IE "UE positioning OTDOA quality" in IE "UE positioning OTDOA measured results" to value "0".
- 2> if the UE is not able to report the requested measurement results:
 - 3> include IE "UE positioning error" in the MEASUREMENT REPORT and set the contents of this IE as specified in subclause 8.6.7.19.5.
- 1> if the UE is unable to report the requested measurement results due to missing GPS assistance data:
 - 2> the UE may at anytime send a measurement report containing the IE "UE positioning error" and set the contents of this IE as specified in subclause 8.6.7.19.5.
 - 2> after sending the measurement report, the UE shall not send another measurement report to request the same GPS assistance data for at least 20s. This requirement does not apply after release of the current RRC connection.
- 1> if the UE is unable to report the requested measurement results due to missing GANSS assistance data:
 - 2> the UE may at anytime send a measurement report containing the IE "UE positioning error" and set the contents of this IE as specified in subclause 8.6.7.19.5;
 - 2> after sending the measurement report, the UE shall not send another measurement report to request the same GANSS assistance data for at least 20s. This requirement does not apply after release of the current RRC connection.

8.6.7.19.1b UE positioning reporting for UE based methods

The UE shall:

- 1> when a measurement report is triggered:
 - 2> if the UE has been able to calculate a position after performing measurements on the cells included in the variable UE_POSITIONING_OTDOA_DATA_UE_BASED in case of OTDOA or the UE has been able to calculate a position in case of GPS or GANSS positioning or the UE has been able to calculate a position using a standalone positioning method:
 - 3> include IE "UE positioning Position Estimate Info" in the MEASUREMENT REPORT and set the contents of the IE as follows:
 - 4> if the UE supports the capability to perform the UE GPS timing of cell frames measurement:
 - 5> if the IE "GPS timing of Cell wanted" is set to TRUE:
 - 6> perform the UE GPS timing of cell frames measurement on the serving cell or on one cell of the active set.
 - 6> include the IE "Primary CPICH Info" for FDD or the IE "cell parameters id" for TDD;
 - 6> include the SFN when the position was determined;
 - 6> include the IE "UE GPS timing of cell frames";
 - 6> include the IE "UE Positioning GPS Reference Time Uncertainty".
 - 5> if the IE "GPS timing of Cell wanted" is set to FALSE:
 - 6> include the IE "GPS TOW msec" and set it to the GPS TOW when the position estimate was valid.

- 4> if the position was calculated with GPS; and
- 4> the UE does not support the capability to provide the GPS timing of the cell:
 - 5> include the IE "GPS TOW msec" and set it to the GPS TOW when the position estimate was valid.
- 4> if the UE supports the capability to provide the GANSS timing of the cell frames measurement:
 - 5> if the IE "GANSS timing of Cell wanted" is set to TRUE:
 - 6> perform the UE GANSS timing of cell frames measurement on the serving cell or on one cell of the active set;
 - 6> include the IE "GANSS Time ID" to identify the GNSS system time;
 - 6> include the IE "Primary CPICH Info" for FDD or the IE "cell parameters id" for TDD; and
 - 6> include the IE "Reference SFN" and the IE "UE GANSS timing of cell frames".
 - 5> if the IE "GANSS timing of Cell wanted" is set to FALSE:
 - 6> include the IE "GANSS TOD msec" and set it to the GANSS TOD when the position estimate was valid.
- 4> if the UE does not support the capability to provide the GANSS timing of the cell:
 - 5> include the IE "GANSS TOD msec" and set it to the GANSS TOD when the position estimate was valid;
 - 5> include the IE "GANSS Time ID" to identify the GNSS system time.
- 4> if IE "Vertical Accuracy" has been included in IE "UE positioning reporting quantity":
 - 5> if the IE "Vertical Accuracy" has been assigned to value "0":
 - 6> if the IE "Horizontal Accuracy" has been assigned a value "0":
 - 7> may include IE "Ellipsoid point with altitude".
 - 6> if the IE "Horizontal Accuracy" has been assigned a value unequal to "0"; and
 - 6> if the UE has been able to calculate a 3-dimensional position
 - 7> include IE "Ellipsoid point with altitude" or IE "Ellipsoid point with altitude and uncertainty ellipsoid" as the position estimate.
 - 6> if the UE has not been able to calculate a 3-dimensional position:
 - 7> may act as if IE "Vertical Accuracy" was not included in IE "UE positioning reporting quantity".
 - 5> if the IE "Vertical Accuracy" has been assigned to a value unequal to "0":
 - 6> if the UE has been able to calculate a 3-dimensional position:
 - 7> include IE "Ellipsoid point with altitude and uncertainty ellipsoid" as the position estimate.
 - 6> if the UE has not been able to calculate a 3-dimensional position:
 - 7> act as if IE "Vertical Accuracy" has not been included in IE "UE positioning reporting quantity".
- 4> if IE "Vertical Accuracy" has not been included in IE "UE positioning reporting quantity":
 - 5> if IE "Horizontal Accuracy" in IE "UE positioning reporting quantity" has been assigned to value "0":
 - 6> may include IE "Ellipsoid point".

- 5> if IE "Horizontal Accuracy" in IE "UE positioning reporting quantity" has been assigned to a value unequal to 0:
 - 6> include either IE "Ellipsoid point with uncertainty circle" or IE "Ellipsoid point with uncertainty ellipse" or IE "Ellipsoid point with altitude and uncertainty ellipsoid" as the position estimate.
 - 4> if any of the IEs "Ellipsoid point with uncertainty ellipse" or "Ellipsoid point with altitude and uncertainty ellipsoid" is reported:
 - 5> should calculate a value of the IE "Confidence", different from "0", as the probability that the UE is located within the uncertainty region of the one of the IEs "Ellipsoid point with uncertainty ellipse" or "Ellipsoid point with altitude and uncertainty ellipsoid" that is reported.
- NOTE: The value "0" of the IE "Confidence" is interpreted as "no information" by the UTRAN [57].
- 4> if IE "Velocity Requested" has been included in IE "UE positioning reporting quantity":
 - 5> include IE "Velocity estimate" if supported and available.
 - 2> if the UE was not able to calculate a position:
 - 3> include IE "UE positioning error" in the MEASUREMENT REPORT and set the contents of this IE as specified in subclause 8.6.7.19.5.
 - 1> if the UE is unable to calculate a position due to missing GPS assistance data:
 - 2> the UE may at any time send a measurement report containing the IE "UE positioning error" and set the contents of this IE as specified in subclause 8.6.7.19.5;
 - 2> after sending the measurement report, the UE shall not send another measurement report to request the same GPS assistance data for at least 20s. This requirement does not apply after release of the current RRC connection.
 - 1> if the UE is unable to report the requested measurement results due to missing GANSS assistance data:
 - 2> the UE may at anytime send a measurement report containing the IE "UE positioning error" and set the contents of this IE as specified in subclause 8.6.7.19.5;
 - 2> after sending the measurement report, the UE shall not send another measurement report to request the same GANSS assistance data for at least 20s. This requirement does not apply after release of the current RRC connection.

8.6.7.19.2 UE positioning OTDOA assistance data for UE-assisted

If IE "UE positioning OTDOA reference cell info for UE-assisted" is received in System Information Block type 15.4 or in the MEASUREMENT CONTROL message, the UE shall update the variable UE_POSITIONING_OTDOA_DATA_UE_ASSISTED accordingly. The UE shall:

- 1> store received cell information in the UE positioning reference cell info in the variable UE_POSITIONING_OTDOA_DATA_UE_ASSISTED, overwriting any existing information.

If IE "UE positioning OTDOA neighbour cell list for UE-assisted" is received in System Information Block type 15.4 or in the MEASUREMENT CONTROL message, the UE shall update the variable UE_POSITIONING_OTDOA_DATA_UE_ASSISTED accordingly. The UE shall:

- 1> store received cell information in the neighbour cell info list in the variable UE_POSITIONING_OTDOA_DATA_UE_ASSISTED, overwriting any existing information.

If, according to its capabilities, UE does not support IPDLs and if IE "IPDL parameters" is received for the reference or any of the neighbour cells, the UE shall:

- 1> ignore this IE.

In 1.28 Mcps TDD, if the IE "IPDL parameters" is received and the UE supports IPDLs, the UE shall:

- 1> ignore the IE IP_Slot;
- 1> if the IE "IP_PCCPCH" is set to FALSE:
 - 2> configure the physical layer with IP_Sub to be first subframe according to [33].
- 1> if the IE "IP_PCCPCH" is set to TRUE:
 - 2> configure the physical layer with IP_Sub to be second subframe according to [33].
- 1> if the IE "IP_PCCPCH" is absent:
 - 2> configure the physical layer with IP_Sub to use both subframes according to [33].

If IE "SFN offset validity" is set to FALSE, the UE shall:

- 1> ignore the IE "SFN offset".

If IE "UE positioning measurement" is received in the MEASUREMENT CONTROL message, the UE shall also perform the following consistency checks:

- 1> if IE "Positioning Methods" is set to "OTDOA":
 - 2> if IE "UE positioning OTDOA reference cell info for UE-assisted" is not included and if UE positioning OTDOA reference cell info for UE-assisted in variable UE_POSITIONING_OTDOA_DATA_UE_ASSISTED is empty:
 - 3> set the variable CONFIGURATION_INCOMPLETE to TRUE.
- 1> if IE "Positioning Methods" is set to "OTDOA":
 - 2> if IE "UE positioning OTDOA neighbour cell list for UE-assisted" is not included and if less than two neighbour cells are stored in UE positioning OTDOA neighbour cell info list for UE-assisted in variable UE_POSITIONING_OTDOA_DATA_UE_ASSISTED:
 - 3> set the variable CONFIGURATION_INCOMPLETE to TRUE.

8.6.7.19.2a UE positioning OTDOA assistance data for UE-based

The UE shall:

- 1> if IE "UE positioning OTDOA reference cell info for UE-based" is received in System Information Block type 15.5 or in the MEASUREMENT CONTROL message or in the ASSISTANCE DATA DELIVERY:
 - 2> update the variable UE_POSITIONING_OTDOA_DATA_UE_BASED accordingly;
 - 2> store received cell information in the UE positioning reference cell info for UE-based in the variable UE_POSITIONING_OTDOA_DATA_UE_BASED, overwriting any existing information.
- 1> if IE "UE positioning OTDOA neighbour cell list for UE-based" is received in System Information Block type 15.5 or in the MEASUREMENT CONTROL message or in the ASSISTANCE DATA DELIVERY:
 - 2> update the variable UE_POSITIONING_OTDOA_DATA_UE_BASED accordingly;
 - 2> store received cell information in the neighbour cell info list for UE-based in the variable UE_POSITIONING_OTDOA_DATA_UE_BASED, overwriting any existing information.
- 1> if, according to its capabilities, UE does not support IPDLs and if IE "IPDL parameters" is received for the reference or any of the neighbour cells:
 - 2> ignore this IE.
- 1> in 1.28 Mcps TDD:
 - 2> if the IE "IPDL parameters" is received and the UE supports IPDLs:
 - 3> ignore the IE IP_Slot;

- 3> if the IE "IP_PCCPCH" is set to FALSE:
 - 4> configure the physical layer with IP_Sub to be first subframe according to [33].
- 3> if the IE "IP_PCCPCH" is set to TRUE:
 - 4> configure the physical layer with IP_Sub to be second subframe according to [33].
- 3> if the IE "IP_PCCPCH" is absent:
 - 4> configure the physical layer with IP_Sub to use both subframes according to [33].
- 1> if IE "SFN offset validity" is set to FALSE:
 - 2> ignore the IE "SFN offset".
- 1> if IE "UE positioning measurement" is received in the MEASUREMENT CONTROL message:
 - 2> also perform the following consistency checks:
 - 3> if IE "Positioning Methods" is set to "OTDOA":
 - 4> if IE "UE positioning OTDOA reference cell info for UE-based" is not included and if UE positioning OTDOA reference cell info for UE-based in variable UE_POSITIONING_OTDOA_DATA_UE_BASED is empty:
 - 5> set the variable CONFIGURATION_INCOMPLETE to TRUE.
 - 3> if IE "Positioning Methods" is set to "OTDOA":
 - 4> if IE "UE positioning OTDOA neighbour cell list for UE-based" is not included and if less than two neighbour cells are stored in UE positioning OTDOA neighbour cell info list for UE-based in variable UE_POSITIONING_OTDOA_DATA_UE_BASED:
 - 5> set the variable CONFIGURATION_INCOMPLETE to TRUE.
 - 4> if IE "Method Type" is set to "UE based":
 - 5> if IE "UE positioning OTDOA reference cell info for UE-based" is included and if IE "Cell Position" for the reference cell is not included:
 - 6> set the variable CONFIGURATION_INCOMPLETE to TRUE.
 - 5> if the IE "UE positioning OTDOA neighbour cell list for UE-based" is included and if cell position of less than two neighbour cells of the cells included in this IE and stored in variable UE_POSITIONING_OTDOA_DATA_UE_BASED are different; or
 - 5> if the IE "UE positioning OTDOA neighbour cell list for UE-based" is included and if cell position of only two neighbour cells of the cells included in this IE and stored in variable UE_POSITIONING_OTDOA_DATA_UE_BASED are different and if those cell positions are not different to the one of the reference cell stored in variable UE_POSITIONING_OTDOA_DATA_UE_BASED:
 - 6> set the variable CONFIGURATION_INCOMPLETE to TRUE.
 - 5> if the IE "Round Trip Time" is neither included for the neighbour cells nor for the reference cell info; and
 - 6> if the IE "UE positioning OTDOA neighbour cell list for UE-based" is included and if cell position of only two neighbour cells of the cells included in this IE and stored in variable UE_POSITIONING_OTDOA_DATA_UE_BASED are different; or
 - 6> if the IE "UE positioning OTDOA neighbour cell list for UE-based" is included and if cell position of only three neighbour cells of the cells included in this IE and stored in variable UE_POSITIONING_OTDOA_DATA_UE_BASED are different and if those cell positions are not different to the one of the reference cell stored in variable UE_POSITIONING_OTDOA_DATA_UE_BASED:

7> set the variable CONFIGURATION_INCOMPLETE to TRUE.

8.6.7.19.3 UE positioning GPS assistance data

The UE may receive GPS assistance data in System Information Block types 15, 15.1, 15.2, or 15.3, or in the ASSISTANCE DATA DELIVERY message, or in the MEASUREMENT CONTROL message.

8.6.7.19.3.1 UE positioning GPS acquisition assistance

If the IE "UE positioning GPS acquisition assistance" is included, the UE shall:

- 1> update the variable UE_POSITIONING_GPS_DATA as follows:
 - 2> delete all information currently stored in the IE "UE positioning GPS acquisition assistance" in the variable UE_POSITIONING_GPS_DATA;
 - 2> store the received acquisition assistance information in the IE "UE positioning GPS acquisition assistance" in the variable UE_POSITIONING_GPS_DATA;
 - 2> store the IE "GPS TOW msec" in the IE "UE positioning GPS acquisition assistance" in variable UE_POSITIONING_GPS_DATA and use it as an estimate of the GPS Time-of-Week at the time of reception of the complete message containing the IE "GPS TOW msec";

NOTE: The UE does not need to apply any compensation on the GPS Time-of-Week.

- 1> if the IEs "SFN" and "UTRAN GPS timing of cell frames" are included:
 - 2> if the UE is able to utilise these IEs:
 - 3> store these IEs in the IE "UE positioning GPS acquisition assistance" in variable UE_POSITIONING_GPS_DATA;
 - 3> if the IE "Primary CPICH Info" for FDD or IE "cell parameters id" for TDD is not included:
 - 4> if the UE is not in CELL_DCH state:
 - 5> use IEs "SFN" and "UTRAN GPS timing of cell frames" to estimate the relationship between GPS time and radio interface timing of the NODE B transmission in the serving cell.
 - 5> if the IE "UE Positioning GPS ReferenceTime Uncertainty" is included:
 - 6> store this IE in the IE "UE Positioning GPS acquisition assistance" in variable UE_POSITIONING_GPS_DATA and use it to determine the relationship between GPS time and air-interface timing of the NODE B transmission.
 - 4> if the UE is in CELL_DCH state:
 - 5> ignore IEs "SFN" and "UTRAN GPS timing of cell frames".
 - 3> if the IE "Primary CPICH Info" for FDD or IE "cell parameters id" for TDD is also included:
 - 4> store this IE in the IE "UE positioning acquisition assistance" in variable UE_POSITIONING_GPS_DATA;
 - 4> use IEs "SFN" and "UTRAN GPS timing of cell frames" to estimate the relationship between GPS time and air-interface timing of the NODE B transmission in the cell indicated by "Primary CPICH info" or "cell parameters id".
 - 4> if the IE "UE Positioning GPS ReferenceTime Uncertainty" is included:
 - 5> store this IE in the IE "UE Positioning GPS acquisition assistance" in variable UE_POSITIONING_GPS_DATA and use it to determine the relationship between GPS time and air-interface timing of the NODE B transmission.

8.6.7.19.3.2 UE positioning GPS Almanac

If the IE "UE positioning GPS Almanac" is included, the UE shall:

- 1> if the IE "SV Global Health" is included:
 - 1> store this IE in the IE in the IE "SV Global Health" in the IE "UE positioning GPS Almanac" in variable UE_POSITIONING_GPS_DATA.
- 1> for each satellite:
 - 2> store received GPS almanac information at the position indicated by the IE "Sat ID" in the IE "UE positioning GPS Almanac" in the variable UE_POSITIONING_GPS_DATA, possibly overwriting any existing information in this position.
 - 2> interpret IE "Data ID" as the Data ID field contained in the indicated subframe, word 3, most significant 2 bits, as defined by [12];
 - 2> act on the rest of the IEs in a similar manner as specified in [12].

8.6.7.19.3.3 UE positioning D-GPS Corrections

If the IE "UE positioning GPS DGPS corrections" is included, the UE shall:

- 1> update the variable UE_POSITIONING_GPS_DATA as follows:
 - 2> delete all information currently stored in the IE "UE positioning GPS DGPS corrections" in the variable UE_POSITIONING_GPS_DATA;
 - 2> store the received DGPS corrections in the IE "UE positioning GPS DGPS corrections" in the variable UE_POSITIONING_GPS_DATA.
- 1> use IE "GPS TOW sec" to determine when the differential corrections were calculated;
- 1> use IE "Status/Health" to determine the status of the differential corrections.

8.6.7.19.3.3a UE positioning GPS Navigation Model

If the IE "UE positioning GPS Navigation Model" is included, for each satellite, the UE shall:

- 1> use IE "Satellite Status" to determine if an update of IE "UE positioning GPS Ephemeris and Clock Correction parameters" has been provided for the satellite indicated by the IE "SatID";
- 1> if an update has been provided for this satellite:
 - 2> act as specified in subclause 8.6.7.19.3.4.

8.6.7.19.3.4 UE positioning GPS Ephemeris and Clock Correction Parameters

If the IE "UE positioning GPS Ephemeris and Clock Correction parameters" is included, for each satellite, the UE shall:

- 1> update the variable UE_POSITIONING_GPS_DATA as follows:
 - 2> store this IE at the position indicated by the IE "Sat ID" in the IE "UE positioning GPS Navigation Model" in the variable UE_POSITIONING_GPS_DATA, possibly overwriting any existing information in this position.
- 1> act on these GPS ephemeris and clock correction parameters in a manner similar to that specified in [12].

8.6.7.19.3.5 UE positioning GPS ionospheric model

If IE "UE positioning GPS ionospheric model" is included, the UE shall:

- 1> store this IE in the IE "UE positioning GPS ionospheric model" in variable UE_POSITIONING_GPS_DATA;
- 1> act on these GPS ionospheric model parameters in a manner similar to that specified in [12].

8.6.7.19.3.6 UE positioning GPS real-time integrity

If this list of bad satellites is included, the UE shall:

- 1> update the variable UE_POSITIONING_GPS_DATA as follows:
 - 2> add the Sat IDs that are not yet included in the list of satellites in the IE "UE positioning GPS real time integrity" in the variable UE_POSITIONING_GPS_DATA;
 - 2> remove all Sat IDs in the list of satellites in the IE "UE positioning GPS real time integrity" in the variable UE_POSITIONING_GPS_DATA that are not included in IE UE positioning GPS real time integrity.
- 1> consider the data associated with the satellites identified in the variable UE_POSITIONING_GPS_DATA as invalid.

8.6.7.19.3.7 UE positioning GPS reference time

If the IE "UE positioning GPS reference time" is included, the UE shall:

- 1> store the IE "GPS Week" in "UE positioning GPS reference time" in variable UE_POSITIONING_GPS_DATA and use it as the current GPS week;
- 1> store the IE "GPS TOW msec" in the IE "UE positioning GPS reference time" in variable UE_POSITIONING_GPS_DATA and use it as an estimate of the GPS Time-of-Week at the time of reception of the complete message containing the IE "GPS TOW msec";

NOTE: The UE does not need to apply any compensation on the GPS Time-of-Week.

- 1> if the IE "SFN" and IE "UTRAN GPS timing of cell frames" are included:
 - 2> if the UE is able to utilise the IEs:
 - 3> store these IEs in the IE "UE positioning GPS reference time" in variable UE_POSITIONING_GPS_DATA;
 - 3> if the IE "Primary CPICH Info" for FDD or IE "cell parameters id" for TDD is not included:
 - 4> if the UE is not in CELL_DCH state:
 - 5> use IEs "SFN" and "UTRAN GPS timing of cell frames" to estimate the relationship between GPS time and air-interface timing of the NODE B transmission in the serving cell.
 - 5> if the IE "UE Positioning GPS ReferenceTime Uncertainty" is included:
 - 6> store this IE in the IE "UE positioning GPS reference time" in variable UE_POSITIONING_GPS_DATA and use it to determine the relationship between GPS time and air-interface timing of the NODE B transmission.
 - 4> if the UE is in CELL_DCH state:
 - 5> ignore IEs "SFN" and "UTRAN GPS timing of cell frames".
 - 3> if the IE "Primary CPICH Info" for FDD or IE "cell parameters id" for TDD is also included:
 - 4> store this IE in the IE "UE positioning GPS reference time" in variable UE_POSITIONING_GPS_DATA;
 - 4> use IEs "SFN" and "UTRAN GPS timing of cell frames" to estimate the relationship between GPS time and air-interface timing of the NODE B transmission in the cell indicated by "Primary CPICH info" or "cell parameters id".
 - 4> if the IE "UE Positioning GPS ReferenceTime Uncertainty" is included:
 - 5> store this IE in the IE "UE positioning GPS reference time" in variable UE_POSITIONING_GPS_DATA and use it to determine the relationship between GPS time and air-interface timing of the NODE B transmission.

- 1> if the IE "UE Positioning GPS ReferenceTime Uncertainty" is not included; and
- 1> if the IE "SFN-TOW Uncertainty" is included:
 - 2> store this IE in the IE "UE positioning GPS reference time" in variable UE_POSITIONING_GPS_DATA and use it to determine if the relationship between GPS time and air-interface timing of the NODE B transmission is known to within at least 10ms.
- 1> if the IE "T_{UTRAN-GPS} drift rate" is included:
 - 2> store this IE in the IE "UE positioning GPS reference time" in variable UE_POSITIONING_GPS_DATA; and
 - 2> may use it as an estimate of the drift rate of the NODE B clock relative to GPS time.
- 1> if the IE "GPS TOW Assist" is included:
 - 2> for each satellite:
 - 3> delete all information currently stored in the IE "GPS TOW Assist" in the IE "UE positioning GPS reference time" in the variable UE_POSITIONING_GPS_DATA;
 - 3> store the received GPS TOW Assist information in the IE "UE positioning GPS reference time" in the variable UE_POSITIONING_GPS_DATA.

8.6.7.19.3.8 UE positioning GPS reference UE position

If the IE "UE positioning GPS reference UE position" is included, the UE shall:

- 1> store this IE in the IE "UE positioning GPS reference UE position" in variable UE_POSITIONING_GPS_DATA; and
- 1> use it as a priori knowledge of the approximate location of the UE.

8.6.7.19.3.9 UE positioning UTC model

If the IE "UE positioning GPS UTC model" is included, the UE shall:

- 1> store this IE in the IE "UE positioning GPS UTC model" in variable UE_POSITIONING_GPS_DATA.

8.6.7.19.4 UE positioning Ciphering info

The UE shall:

- 1> if deciphering information is received from higher layers for deciphering of GPS assistance data broadcast on system information:
 - 2> store the current key in IE "Current deciphering key" in variable UE_POSITIONING_GPS_DATA;
 - 2> store the next key in IE "Next deciphering key" in variable UE_POSITIONING_GPS_DATA;
 - 2> store the ciphering key flag in UE_POSITIONING_GPS_DATA.
- 1> if deciphering information is received from higher layers for deciphering of GANSS assistance data broadcast on system information:
 - 2> store the current key in IE "Current deciphering key" in variable UE_POSITIONING_GANSS_DATA;
 - 2> store the next key in IE "Next deciphering key" in variable UE_POSITIONING_GANSS_DATA;
 - 2> store the ciphering key flag in UE_POSITIONING_GANSS_DATA.
- 1> if deciphering information is received from higher layers for deciphering of OTDOA assistance data broadcast on system information:

- 2> store the current key in IE "Current deciphering key" in variable UE_POSITIONING_OTDOA_DATA_UE_BASED;
 - 2> store the next key in IE "Next deciphering key" in variable UE_POSITIONING_OTDOA_DATA_UE_BASED;
 - 2> store the ciphering key flag in UE_POSITIONING_OTDOA_DATA_UE_BASED.
- 1> if the IE "GPS Data ciphering info" is included in System Information Block type 15:
- 2> select one of the two deciphering keys received and stored it in UE_POSITIONING_GPS_DATA according to the following:
 - 3> if the value of the received IE "Ciphering Key Flag" is the same as the value of the IE "Ciphering Key Flag" stored in the variable UE_POSITIONING_GPS_DATA:
 - 4> select the current deciphering key.
 - 3> if the value of the received IE "Ciphering Key Flag" is different from the value of the IE "Ciphering Key Flag" stored in the variable UE_POSITIONING_GPS_DATA:
 - 4> select the next deciphering key.
 - 2> store the received IE in the variable UE_POSITIONING_GPS_DATA;
 - 2> use the selected deciphering key to decipher the broadcast UE positioning GPS information contained within the System Information Block types 15.1, 15.2 and 15.3.
- 1> if the IE "GANSS Data ciphering info" is included in System Information Block type 15.8:
- 2> select one of the two deciphering keys received and stored it in UE_POSITIONING_GANSS_DATA according to the following:
 - 3> if the value of the received IE "Ciphering Key Flag" is the same as the value of the IE "Ciphering Key Flag" stored in the variable UE_POSITIONING_GANSS_DATA:
 - 4> select the current deciphering key.
 - 3> if the value of the received IE "Ciphering Key Flag" is different from the value of the IE "Ciphering Key Flag" stored in the variable UE_POSITIONING_GANSS_DATA:
 - 4> select the next deciphering key.
 - 2> store the received IE in the variable UE_POSITIONING_GANSS_DATA;
 - 2> use the selected deciphering key to decipher the broadcast UE positioning GANSS information contained within the System Information Block types 15.1bis, 15.2bis, 15.3bis, 15.6 and 15.7.
- 1> if the IE "OTDOA positioning ciphering info" is included in System Information Block type 15.4:
- 2> select one of the two deciphering keys and stored it in UE_POSITIONING_OTDOA_DATA_UE_BASED according to the following:
 - 3> if the value of the received IE "Ciphering Key Flag" is the same as the value of the IE "Ciphering Key Flag" stored in the variable UE_POSITIONING_OTDOA_DATA_UE_BASED:
 - 4> select the current deciphering key.
 - 3> if the value of the received IE "Ciphering Key Flag" is different from the value of the IE "Ciphering Key Flag" stored in the variable UE_POSITIONING_OTDOA_DATA_UE_BASED:
 - 4> select the next deciphering key.
 - 2> store the received IE in the variable UE_POSITIONING_OTDOA_DATA_UE_BASED;
 - 2> use the selected deciphering key to decipher the IE "OTDOA assistance data" included in the System Information Block types 15.4.

8.6.7.19.5 UE positioning Error

The UE shall set the contents of the IE "UE positioning Error" as follows:

- 1> if the IE "Positioning Methods" in IE "UE positioning reporting quantity" has been assigned to value "OTDOA" and no neighbour cells could be received,
 - 2> set IE "Error reason" to "Not Enough OTDOA Cells";
- 1> if the IE "Positioning Methods" in IE "UE positioning reporting quantity" has been assigned to value "GPS":
 - 2> if there were not enough GPS satellites to be received:
 - 3> set IE "Error reason" to "Not Enough GPS Satellites".
 - 2> if some GPS assistance data was missing:
 - 3> set IE "Error reason" to "Assistance Data Missing"; and
 - 3> if the IE "Additional Assistance Data Request" included in the IE "UE positioning reporting quantity" stored in the variable MEASUREMENT_IDENTITY is set to TRUE:
 - 4> include the IE "GPS Additional Assistance Data Request".
 - 3> if the IE "Additional Assistance Data Request" included in the IE "UE positioning reporting quantity" stored in the variable MEASUREMENT_IDENTITY is set to FALSE:
 - 4> not include the IE "GPS Additional Assistance Data Request", and use the assistance data available for doing a positioning estimate.
 - 2> if the UE was not able to read the SFN of the reference cell included in the IE "UE positioning GPS reference time" or in the IE "UE positioning acquisition assistance":
 - 3> set IE "Error reason" to "Reference Cell Not Serving Cell".
 - 2> if the UE was not able to measure the requested GPS timing of cell frames measurement:
 - 3> set IE "Error reason" to "Not Accomplished GPS Timing Of Cell Frames".
 - 1> if the IE "Positioning Methods" in IE "UE positioning reporting quantity" has been assigned to value "GPS" and the IE "GANSS Positioning Methods" is present:
 - 2> if there were not enough GANSS satellites to be received:
 - 3> set IE "Error reason" to "Not Enough GANSS Satellites".
 - 2> if some GANSS assistance data was missing:
 - 3> set IE "Error reason" to "Assistance Data Missing"; and
 - 3> if the IE "Additional Assistance Data Request" included in the IE "UE positioning reporting quantity" stored in the variable MEASUREMENT_IDENTITY is set to TRUE:
 - 4> include the IE "GANSS Additional Assistance Data Request".
 - 3> if the IE "Additional Assistance Data Request" included in the IE "UE positioning reporting quantity" stored in the variable MEASUREMENT_IDENTITY is set to FALSE:
 - 4> not include the IE "GANSS Additional Assistance Data Request", and use the assistance data available for doing a positioning estimate.
 - 2> if the UE was not able to read the SFN of the reference cell included in the IE "UE positioning GANSS reference time":
 - 3> set IE "Error reason" to "Reference Cell Not Serving Cell".
 - 2> if the UE was not able to measure the requested GANSS timing of cell frames measurement:

3> set IE "Error reason" to "Not Accomplished GANSS Timing Of Cell Frames".

1> if none of the conditions above are fulfilled:

2> set IE "Error reason" to "Undefined Error".

The UE shall not set the IE "Error reason" to "Request Denied By User" or "Not Processed and Timeout".

8.6.7.19.6 Void

8.6.7.19.7 UE positioning GANSS assistance data

The UE may receive GANSS assistance data in System Information Block types 15bis, 15.1bis, 15.2bis, 15.3bis, 15.6, 15.7 or 15.8 or in the ASSISTANCE DATA DELIVERY message, or in the MEASUREMENT CONTROL message. IE "UE positioning GANSS assistance data" is divided into a common part which is applicable to any GNSS and a generic part which contains assistance data separately for each supported GNSS.

8.6.7.19.7.1 UE positioning GANSS reference measurement information

If the IE "UE positioning GANSS reference measurement information" is included, the UE shall:

1> update the variable UE_POSITIONING_GANSS_DATA as follows:

2> for each GANSS the IE "UE positioning GANSS reference measurement information" is included:

3> delete all information currently stored in the IE "UE positioning GANSS reference measurement information" in the variable UE_POSITIONING_GANSS_DATA;

3> store the received information in the IE "UE positioning GANSS reference measurement information" in the variable UE_POSITIONING_GANSS_DATA.

1> perform the following consistency check:

2> if the IE "UE positioning GANSS reference time" is included and the IE "UE positioning GPS acquisition assistance" is not included, the UE shall interpret the IE "Satellite information" to be valid at the time provided in IE "UE positioning GANSS reference time";

2> if the IE "UE positioning GPS acquisition assistance" is included, the UE shall interpret the IE "Satellite information" to be valid at the time provided in the IE "UE positioning GPS acquisition assistance";

2> if neither the IE "UE positioning GANSS reference time" nor the IE "UE positioning GPS acquisition assistance" is included:

3> set the variable CONFIGURATION_INCOMPLETE to TRUE.

8.6.7.19.7.2 UE positioning GANSS Almanac

If the IE "UE positioning GANSS Almanac" is included, the UE shall:

1> for each GANSS:

2> for each satellite:

3> store received GANSS almanac information at the position indicated by the IE "SV ID" in the IE "UE positioning GANSS Almanac" in the variable UE_POSITIONING_GANSS_DATA, possibly overwriting any existing information in this position;

3> act on the information in a similar manner as specified in e.g. [59].

8.6.7.19.7.3 UE positioning D-GANSS Corrections

If the IE "UE positioning DGANSS corrections" is included, the UE shall:

1> for each GANSS:

- 2> update the variable UE_POSITIONING_GANSS_DATA as follows:
 - 3> delete all information currently stored in the IE "UE positioning DGANSS corrections" in the variable UE_POSITIONING_GANSS_DATA;
 - 3> store the received DGANSS corrections in the IE "UE positioning DGANSS corrections" in the variable UE_POSITIONING_GANSS_DATA.
- 2> use IE "DGANSS Reference Time" to determine when the differential corrections were calculated;
- 2> use IE "Status/Health" to determine the status of the differential corrections.

8.6.7.19.7.4 UE positioning GANSS Navigation Model

If the IE "UE positioning GANSS Navigation Model" is included, the UE shall:

for each GANSS:

- 2> if Orbit Model is "Keplerian Parameters":
 - 3> store the three MSB parameters and use them in combination with LSB parameters provided in IEs "UE positioning GANSS clock model" and "UE positioning GANSS orbit model" to get the complete parameters.
- 2> for each satellite, the UE shall:
 - 3> for IE "UE positioning GANSS clock model":
 - 4> act as specified in subclause 8.6.7.19.6.4a.
 - 3> for IE "UE positioning GANSS orbit model":
 - 4> act as specified in subclause 8.6.7.19.6.4b.

8.6.7.19.7.4a UE positioning GANSS Clock Model

If the IE "UE positioning GANSS clock model" is included, the UE shall:

- 1> for each GANSS:
 - 2> update the variable UE_POSITIONING_GANSS_DATA as follows:
 - 3> store this IE at the position indicated by the IE "Sat ID" in the IE "UE positioning GANSS Navigation Model" in the variable UE_POSITIONING_GANSS_DATA, possibly overwriting any existing information in this position.
 - 2> act on these GANSS clock models in a manner similar to that specified in a relevant ICD.

8.6.7.19.7.4b UE positioning GANSS Orbit Model

If the IE "UE positioning GANSS orbit model" is included, for each satellite of each supported GNSS, the UE shall:

- 1> update the variable UE_POSITIONING_GANSS_DATA as follows:
 - 2> store this IE at the position indicated by the IE "Sat ID" in the IE "UE positioning GANSS Navigation Model" in the variable UE_POSITIONING_GANSS_DATA, possibly overwriting any existing information in this position..
- 1> act on these GANSS orbit models in a manner similar to that specified in a relevant ICD.

8.6.7.19.7.5 UE positioning GANSS ionospheric model

If IE "UE positioning GANSS ionospheric model" is included, the UE shall:

- 1> store this IE in the IE "UE positioning GANSS ionospheric model" in variable UE_POSITIONING_GANSS_DATA;

1> act on these GANSS ionospheric model parameters in a manner similar to that specified in [61].

8.6.7.19.7.6 UE positioning GANSS real-time integrity

If this list of bad satellites is included, the UE shall for each GANSS:

1> update the variable UE_POSITIONING_GANSS_DATA as follows:

2> for each satellite included in the list:

3> add the Sat IDs that are not yet included in the list of satellites in the IE "UE positioning GANSS real time integrity" in the variable UE_POSITIONING_GANSS_DATA;

3> if the IE "Bad GNSS Signal ID" is included in the satellite information:

4> store this IE at the position indicated by the IE "Bad GNSS SatID" in the variable UE_POSITIONING_GANSS_DATA, possibly overwriting any existing information in this position.

3> remove all Sat IDs in the list of satellites in the IE "UE positioning GANSS real time integrity" in the variable UE_POSITIONING_GANSS_DATA that are not included in IE UE positioning GANSS real time integrity.

1> consider the data associated with the satellites or signals identified in the variable UE_POSITIONING_GANSS_DATA as invalid.

8.6.7.19.7.7 UE positioning GANSS reference time

If the IE "UE positioning GANSS reference time" is included, the UE shall:

1> if the IE "GANSS Day" is included:

2> store this IE in "UE positioning GANSS reference time" in variable UE_POSITIONING_GANSS_DATA and use it as the current GANSS day.

1> store the IE "GANSS TOD" in the IE "UE positioning GANSS reference time" in variable UE_POSITIONING_GANSS_DATA and use it as an estimate of the GANSS Time-of-Day at the time of reception of the complete message containing the IE "GANSS TOD";

NOTE: The UE does not need to apply any compensation on the GANSS Time-of-Day.

1> if the IE "GANSS TOD Uncertainty" is included:

2> store this IE in the IE "UE positioning GANSS reference time" in variable UE_POSITIONING_GANSS_DATA and use it to determine the uncertainty of the relationship between GANSS time and air-interface timing of the NODE B transmission.

1> if the IE "GANSS Time ID" is not included:

2> use Galileo system time as a reference for GANSS-Time-of-Day.

1> if the IE "GANSS Time ID" is included:

2> use the system time indicated by this IE as a reference for GANSS-Time-of-Day.

1> if the IE "SFN" and IE "UTRAN GANSS timing of cell frames" are included:

2> if the UE is able to utilise the IEs:

3> store these IEs in the IE "UE positioning GANSS reference time" in variable UE_POSITIONING_GANSS_DATA;

3> if the IE "Primary CPICH Info" for FDD or IE "cell parameters id" for TDD is not included:

4> if the UE is not in CELL_DCH state:

5> use IEs "SFN" and "UTRAN GANSS timing of cell frames" to estimate the relationship between GANSS time and air-interface timing of the NODE B transmission in the serving cell.

4> if the UE is in CELL_DCH state:

5> ignore IEs "SFN" and "UTRAN GANSS timing of cell frames".

3> if the IE "Primary CPICH Info" for FDD or IE "cell parameters id" for TDD is also included:

4> store this IE in the IE "UE positioning GANSS reference time" in variable UE_POSITIONING_GANSS_DATA;

4> use IEs "SFN" and "UTRAN GANSS timing of cell frames" to estimate the relationship between GANSS time and air-interface timing of the NODE B transmission in the cell indicated by "Primary CPICH info" or "cell parameters id".

1> if the IE "T_{UTRAN-GANSS} drift rate" is included:

2> store this IE in the IE "UE positioning GANSS reference time" in variable UE_POSITIONING_GANSS_DATA; and

2> may use it as an estimate of the drift rate of the NODE B clock relative to GANSS time.

8.6.7.19.7.8 UE positioning GANSS reference UE position

If the IE "UE positioning GANSS reference UE position" is included, the UE shall:

1> store this IE in the IE "UE positioning GANSS reference UE position" in variable UE_POSITIONING_GANSS_DATA; and

1> use it as a priori knowledge of the approximate location of the UE.

8.6.7.19.7.9 UE positioning GANSS time model

If the IE "UE positioning GANSS time model" is included, the UE shall for each GANSS:

1> store the information in "UE positioning GANSS time model" in variable UE_POSITIONING_GANSS_DATA;

1> use the stored parameters to relate GANSS time to time reference indicated by IE "GNSS_TO_ID".

8.6.7.19.7.10 UE positioning GANSS UTC model

If the IE "UE positioning GANSS UTC model" is included, the UE shall for each GANSS:

1> store this IE in the IE "UE positioning GANSS UTC model" in variable UE_POSITIONING_GANSS_DATA.

8.6.7.19.7.11 UE positioning GANSS data bit assistance

If the IE "UE positioning GANSS data bit assistance" is included, the UE shall for each GANSS:

1> store this IE in the IE "UE positioning GANSS data bit assistance" in variable UE_POSITIONING_GANSS_DATA;

1> use the data in IE "Data Bits" for data wipe-off of satellite signal indicated by IEs "SV_ID" and "GNSS Data Type ID".

8.6.7.20 Void

8.6.7.21 Intra-frequency reporting quantity for RACH reporting

If the IE "Intra-frequency reporting quantity for RACH reporting" is included, the UE shall:

1> if the IE "SFN-SFN observed time difference reporting indicator" has the value "type 2":

- 2> act as if the value of the IE "SFN-SFN observed time difference reporting indicator" is "no reporting".
- 1> if the IE "Reporting quantity" (FDD) or all IEs "Reporting quantity" (TDD) have the value "no report":
 - 2> the UE behaviour is unspecified.

8.6.7.22 Additional Measurement List

If the IE "Additional Measurement List" is received in a MEASUREMENT CONTROL message, the UE shall:

- 1> if the received measurement configuration in this MEASUREMENT CONTROL message, or any measurement referenced in the "Additional Measurement List" do not all have the same validity (for this consistency check the UE shall assume "CELL_DCH" as the measurement validity for measurements of type "inter-RAT", "UE internal", and "quality"):
 - 2> set the variable CONFIGURATION_INCOMPLETE to TRUE.
- 1> if any of the measurements referenced in the "Additional Measurement List" is an intra-frequency, inter-frequency or inter-RAT measurement, and this measurement is configured with event based reporting:
 - 2> the UE behaviour is not specified.
- 1> if any of the "intra-frequency", "inter-frequency", "traffic volume" or "UE positioning" measurements referenced in the "Additional Measurement List" has been setup without including the IE "measurement validity":
 - 2> the UE behaviour is not specified.
- 1> if the result of this MEASUREMENT CONTROL message is such that more than one additional measurement of the same type will be referenced in the IE "Additional Measurement List" in the MEASUREMENT_IDENTITY variable:
 - 2> the UE behaviour is not specified.
- 1> if the UE has no IE "Additional Measurement List" stored in the variable MEASUREMENT_IDENTITY associated with the identity indicated by the IE "measurement identity":
 - 2> store the received IE "Additional Measurement List" in the variable MEASUREMENT_IDENTITY.

If the IE "Additional Measurement List" is received in a MEASUREMENT CONTROL message with the IE "Measurement command" value set to "modify", and the UE has an IE "Additional Measurement List" stored in the variable MEASUREMENT_IDENTITY associated with the identity indicated by the IE "measurement identity", the UE shall:

- 1> replace the information stored in "Additional Measurement List" in variable MEASUREMENT_IDENTITY associated to the identity indicated by the IE "measurement identity" with the one received in the MEASUREMENT CONTROL message.

If the IE "Additional Measurement List" is not received in a MEASUREMENT CONTROL message and the IE "Measurement command" has the value "modify" and the UE has an IE "Additional Measurement List" stored in the variable MEASUREMENT_IDENTITY associated with the identity indicated by the IE "measurement identity", the UE shall:

- 1> leave the IE "Additional Measurement List" stored in the variable MEASUREMENT_IDENTITY associated with the identity indicated by the IE "measurement identity" unchanged.

If, at any time during the life-time of a measurement, any measurement referenced in the Additional Measurement List does not exist, the UE shall:

- 1> remove this measurement identity from the Additional Measurement List.

NOTE: A measurement referenced in the Additional Measurement List which is updated with a measurement command set to "modify", or replaced with a measurement command set to "setup", continues to exist.

If the measurement configured with the MEASUREMENT CONTROL message triggers a measurement report, the UE shall:

- 1> also include the reporting quantities for the measurements referenced by the additional measurement identities. The contents of the IE "Additional Measured results" are completely determined by the measurement configuration of the referenced additional measurement.

8.6.8 Void

8.6.9 MBMS specific information elements

The UE shall perform the generic actions defined in this subclause only for the information elements corresponding with services that are included in variable MBMS_ACTIVATED_SERVICES.

8.6.9.1 Continue MCCH Reading

If the "Continue MCCH Reading " is included the UE shall:

- 1> if the IE "Continue MCCH reading " is set to 'TRUE':
 - 2> continue receiving the MBMS MODIFIED SERVICES INFORMATION from MCCH in the next modification period and act upon it as specified in subclause 8.7.3.4.

8.6.9.1a MBMS dynamic persistence level

If the IE "MBMS dynamic persistence level" is included the UE shall:

- 1> Apply the dynamic persistence level in place of that broadcast in SIB 7 for MBMS related PRACH transmissions that are made within the modification period in which this IE was received.

8.6.9.2 MBMS PL Service Restriction Information

The UE shall:

- 1> if the UE receives a Radio Bearer Control message or a CELL UPDATE CONFIRM message:
 - 2> if the IE "MBMS PL Service Restriction Information" is included:
 - 3> set the variable MBMS_PL_SERVICE_RESTRICTION_INFO_DEDICATED to TRUE.
 - 2> else:
 - 3> set the variable MBMS_PL_SERVICE_RESTRICTION_INFO_DEDICATED to FALSE.
- 1> if the UE receives a Radio Bearer Control message or a CELL UPDATE CONFIRM message or an MBMS GENERAL INFORMATION message:
 - 2> perform the MBMS frequency selection procedure as specified in subclause 8.5.27.

8.6.9.3 MBMS L1 combining schedule

If the IE "MBMS L1 combining schedule" is included the UE may:

- 1> apply L1 combining between the concerned neighbouring cell' S-CCPCH and the corresponding current cell's S-CCPCH for the periods indicated by this IE.

8.6.9.3a MBMS Number of neighbour cells

The UE may:

- 1> apply the number of neighbour cells to identify if all MBMS NEIGHBOURING CELL P-T-M RB INFORMATION messages have been received from MCCH.

8.6.9.4 MBMS Preferred frequency information

If the IE "MBMS Preferred frequency information" is included the UE shall:

- 1> if HCS is not used, and the IE "Qoffmbms" is not present for the MBMS preferred frequency:
 - 2> consider the cells on the MBMS preferred frequency having a Qoffmbms equal to "infinity".
- 1> if HCS is used, and the IE "HCS_OFFmbms" is not present for the MBMS preferred frequency:
 - 2> consider the cells on the MBMS preferred frequency having the highest HCS priority level.
- 1> perform the MBMS frequency selection procedure as specified in subclause 8.5.27.

8.6.9.4a Void

8.6.9.4b MBMS p-t-m activation time

Upon reception of the IE "MBMS p-t-m activation time", for the services included in the IE "Modified service list" in the MBMS MODIFIED SERVICES INFORMATION message, and, if the IE "MBMS all unmodified p-t-m services" is included in the MBMS MODIFIED SERVICES INFORMATION message, for the services included in the IE "Unmodified services list" included in the MBMS UNMODIFIED SERVICES INFORMATION message, the UE shall:

- 1> if the IE "MBMS required UE action" for this service is set to "Acquire PTM RB info":
 - 2> for the current cell:
 - 3> stop using any old configuration on TTIs that are after or contain the time instant as indicated by the IE "MBMS p-t-m activation time";
 - 3> start using the configuration for the S-CCPCH received for that p-t-m bearer in the same modification period as the IE "MBMS p-t-m activation time" on TTIs that are after or that contain the time instant as indicated by the IE "MBMS p-t-m activation time".
 - 2> for neighbouring cells:
 - 3> for the neighbouring cells for which the IE "MBMS transmission time difference" is included:
 - 4> stop using any old configuration on TTIs corresponding to the TTIs of the cell wherein the UE is reading the MCCH from and where the new p-t-m radio bearer information is valid according to the above;
 - 4>> start using the configuration for the S-CCPCH received for that p-t-m bearer in the same modification period as the IE "MBMS p-t-m activation time" on TTIs corresponding to the TTIs of the cell wherein the UE is reading the MCCH from and where the new p-t-m radio bearer information is valid according to the above.
 - 3> for the neighbouring cells for which the IE "MBMS transmission time difference" is not included:
 - 4> stop using any old configuration on TTIs that are after or contain the time instant as indicated by the IE "MBMS p-t-m activation time".
 - 4> start using the configuration for the S-CCPCH received for that p-t-m bearer in the same modification period as the IE "MBMS p-t-m activation time" on TTIs that are after the time instant as indicated by the IE "MBMS p-t-m activation time".

8.6.9.5 MBMS RB list released to change transfer mode

If the IE "MBMS RB list released to change transfer mode" is included the UE shall:

- 1> perform the service prioritisation procedure as specified in subclause 8.5.26, taking into account that the MBMS service(s) for which the radio bearers are released will be provided via p-t-m radio bearer(s).

8.6.9.6 MBMS Required UE action

If the IE "MBMS required UE action" is included and concerns an MBMS activated service the UE shall:

- 1> if the "MBMS required UE action" is set to 'None':
 - 2> take no action with respect to this IE.
- 1> if the IE "MBMS required UE action" is set to 'Acquire counting info' or set to 'Acquire counting info– PTM RBs unmodified':
 - 2> perform the MBMS counting procedure as specified in subclause 8.7.4;

NOTE: If upper layers indicate that an MBMS transmission has already been received correctly, the UE will continue as if the information about the concerned MBMS transmission was not included in the message. This implies that the UE does not respond to counting for a transmission already received correctly.

- 1> if the IE "MBMS required UE action" is set to 'Acquire PTM RB info'; or
- 1> if the IE "MBMS required UE action" is set to 'Acquire counting info– PTM RBs unmodified' and the UE is not receiving a p-t-m RB for the concerned service:
 - 2> continue acquiring the MBMS COMMON P-T-M RB INFORMATION, MBMS CURRENT CELL P-T-M RB INFORMATION and the MBMS NEIGHBOURING CELL P-T-M RB INFORMATION messages without delaying reading of MCCH until the next modification period and without stopping at the end of the modification period, in accordance with subclause 8.7.1.3
 - 2> act upon the MBMS COMMON P-T-M RB INFORMATION, MBMS CURRENT CELL P-T-M RB INFORMATION and the MBMS NEIGHBOURING CELL P-T-M RB INFORMATION message, if received, in accordance with subclause 8.7.5;
- 1> if the IE "MBMS required UE action" is set to 'Request PTP RB':
 - 2> if the UE is in idle mode:
 - 3> indicate to upper layers that establishment of a PS signalling connection is required to receive the concerned MBMS [5], unless the UE has already requested p-t-p RB establishment in the current modification period, and use the establishment cause set to 'MBMS ptp RB request' in the RRC connection establishment procedure.
 - 2> if the UE is in URA_PCH, Cell_PCH or CELL_FACH states:
 - 3> indicate to upper layers to initiate a service request procedure [5] to receive the concerned MBMS service;
 - 3> perform the cell update procedure with cause "MBMS ptp RB request", as specified in subclause 8.3.1.2, unless the UE has already requested p-t-p RB establishment in the current modification period.
 - 2> if the UE is in CELL_DCH:
 - 3> indicate to upper layers to initiate a service request procedure [5] to receive the concerned MBMS service.
- 1> if the IE "MBMS required UE action" is set to 'Release PTM RB':
 - 2> stop receiving the concerned MBMS service;
 - 2> for 1.28 Mcps TDD, if the IE "MBMS PTM RB Release Cause" is present to indicate the actual MBMS PTM RB release cause to UE:
 - 3> pass the value of the IE "MBMS PTM RB Release Cause" to upper layers.

- 2> if the UE is in a state other than CELL_DCH (for FDD) or if the UE is in Idle mode, URA_PCH or CELL_PCH state (for TDD); and
- 2> if the UE decides not to receive an MBMS service indicated on the MCCH; and
- 2> if the variable MBMS_PREV_FREQUENCY_INFO is not empty:
 - 3> if any frequency in SIB11 or SIB12 has the same frequency stored in the variable MBMS_PREV_FREQUENCY_INFO:
 - 4> select a suitable UTRA cell in that frequency.
 - 4> if no suitable UTRA cell in that frequency is found:
 - 5> select a suitable UTRA cell in another frequency.
 - 3> if no frequency in SIB11 or SIB12 has the same frequency stored in the variable MBMS_PREV_FREQUENCY_INFO.
 - 4> select a frequency randomly among the inter-frequencies indicated in SIB11 or SIB12.
 - 5> select a suitable UTRA cell in the selected frequency
 - 5> if no suitable UTRA cell in the selected frequency is found:
 - 6> select a suitable UTRA cell in another frequency.
 - 3> clear the variable MBMS_PREV_FREQUENCY_INFO.
 - 2> clear all service specific information applicable for the concerned service.

NOTE: The UE is only required to acquire the relevant SIB11 or SIB12, according to what is specified in subclauses 8.1.1.6.11 and 8.1.1.6.12.

8.6.9.6a MBMS re- acquire MCCH

If the UE receives the IE "MBMS re- acquire MCCH", the UE shall:

- 1> perform the MCCH acquisition procedure as specified in subclause 8.7.2.

8.6.9.7 MBMS Service transmissions info list

If the UE receives the IE "MBMS Service transmissions info list", the UE may:

- 1> discontinue reception of the S-CCPCH on which the IE was received, except for the service transmissions indicated by this IE for the concerned scheduling period.

8.6.9.8 MBMS Short transmission ID

If the IE "MBMS short transmission ID" is included the UE shall:

- 1> if the value of the "MBMS short transmission ID" is less than or equal to the number of services identified by the IE "Modified services list" included in the MBMS MODIFIED SERVICES INFORMATION message acquired in the same modification period as the one in which the "MBMS short transmission ID" is received:
 - 2> consider the "MBMS short transmission ID" to be an index to the list of services contained in the IE "Modified services list" and apply the MBMS transmission identity specified for this entry.
- 1> otherwise:
 - 2> compile a list of available MBMS services, as included in the MBMS MODIFIED SERVICES INFORMATION and the MBMS UNMODIFIED SERVICES INFORMATION messages acquired in the same modification period as the one in which the "MBMS short transmission ID" is received:

- 3> concatenate the services contained in IE "Modified services list" included in the MBMS MODIFIED SERVICES INFORMATION and the services contained in IE "Unmodified services list" included in the MBMS UNMODIFIED SERVICES INFORMATION.
- 2> consider the 'MBMS short transmission ID' to be the index of the entry in the list of available services and apply the MBMS transmission identity specified for this entry.

8.6.9.9 MBMS Transmission identity

If the IE "MBMS transmission identity" is included the UE shall:

- 1> if upper layers indicate that the MBMS transmission has already been received correctly:
 - 2> ignore the information about this MBMS transmission i.e. continue as if the information about the concerned MBMS transmission was not included in the message.
- 1> otherwise:
 - 2> act upon the information about the concerned MBMS transmission as specified elsewhere.

The UE behaviour is unspecified if an MBMS transmission identity appears more than once in the combined list of transmissions i.e. the IE is included more than once in the MBMS MODIFIED SERVICES INFORMATION or in the MBMS UNMODIFIED SERVICES INFORMATION, or once in both message.

8.6.9.9a MBMS transmission time difference

The IE "MBMS transmission time difference" indicates the time difference between the transmissions on the current and the neighbour cell i.e. indicating the TTIs that can be L1- combined. The UE shall:

- 1> derive the parameter Neighbor_Start from the IE MBMS transmission time difference as follows:

$$\text{MBMS transmission time difference} = (\text{Neighbor_Start} / \text{Max_TTI_Size}) \bmod 4$$

where Neighbor_Start is the CFN of the first radio frame in a TTI on the neighbour cell that may be combined with the TTI on the current cell of which the CFN of the first radio frame equals 0 while Max_TTI_Size is the largest TTI size on the S-CCPCHs to be soft combined;

- 1> in case of partial soft combining, derive the CFN of the first radio frame in a TTI on the neighbour cell that may be combined assuming the same time difference applies.

The maximum delay between S-CCPCH clusters that the UE may combine is set by UE performance requirements.

- NOTE: The MBMS transmission time difference is semi-static; it does not vary within or between L1 combining periods nor when full combining is used.

8.6.9.9ab MBSFN cluster frequency

If the cell is operating in MBSFN mode according to subclause 8.1.1.6.3 the UE shall:

- 1> if for two or more services included in variable MBMS_ACTIVATED_SERVICES the IE "MBSFN cluster frequency" is available:
 - 2> request from upper layers the priorities of the different MBMS services included in variable MBMS_ACTIVATED_SERVICES for which the IE "MBSFN cluster frequency" is available;
 - 2> if the IE "MBSFN cluster frequency" is available for the service with the highest priority included in variable MBMS_ACTIVATED_SERVICES:
 - 3> tune to the frequency indicated in the IE "MBSFN cluster frequency" of that service.

8.6.9.9ac MBSFN frequency list

For FDD and 3.84/7.68 Mcps TDD this IE may be included in system information block 11 in a cell which is not providing MBMS service in MBSFN mode in order to provide information about frequencies providing MBMS service

in MBSFN mode. For 1.28 Mcps TDD this IE shall be included in system information block 11 in a cell which is not providing MBMS service in MBSFN only mode but is associated with one or more cells in MBSFN only mode, in order to provide information about frequencies providing MBMS service in MBSFN only mode, and this IE also provides information about the secondary frequencies providing MBMS service in non-MBSFN only mode of current multi-frequency cell.

If the IE "MBSFN frequency list" is included in system information block 11 a UE may consider that all frequencies on which cells providing MBMS service in MBSFN mode are listed in the IE "MBSFN frequency list".

If the IE "MBSFN frequency list" is included in system information block 11 and no frequency is included in the IE "MBSFN frequency list" a UE may consider that no cell operating in MBSFN mode is available.

For FDD and 3.84/7.68 Mcps TDD if the IE "MBSFN frequency list" is not included in system information block 11 and if services are listed in the variable MBMS_ACTIVATED_SERVICES a UE supporting reception of MBMS service in MBSFN mode shall search for cells providing MBMS service in MBSFN mode.

For 1.28 Mcps TDD the IE "Cell parameter ID" in the IE "MBSFN frequency list" included in system information block 11 indicates the cell which is providing MBMS service in MBSFN only mode on the corresponding frequency; if the IE "Cell parameter ID" is not included in the IE "MBSFN frequency list", a UE may consider that the corresponding frequency is the secondary frequency providing MBMS service in non-MBSFN only mode of current multi-frequency cell.

8.6.9.9ad MBSFN inter frequency neighbour list

For FDD and 3.84/7.68 Mcps TDD if the IE "MBSFN inter frequency neighbour list" is included and the UE does not receive a service from this MBSFN cluster, the UE shall:

- 1> consider that MBMS services transmitted in MBSFN mode are available on these frequencies;
 - 1> if "MBSFN services notified" is indicated for a frequency listed in the IE "MBSFN inter frequency neighbour list":
 - 2> consider that available services provided on this frequency are notified on the current frequency.
 - 1> if at least one frequency is listed for which "MBSFN services not notified" is indicated in the IE "MBSFN inter frequency neighbour list":
 - 2> if the IE "All MBSFN services notified" is included for one frequency as defined in [21] for FDD and [22] for TDD on which the UE supports reception in MBSFN mode:
 - 3> attempt to receive notifications on one of the frequencies for which the IE "All MBSFN services notified" is included according to subclause 8.7.3.
 - 2> else:
 - 3> attempt to receive notifications on all frequencies for which the IE "MBSFN services not notified" is indicated as specified in subclause 8.7.3 on that band.

NOTE 1: The UE may not be able to receive frequencies listed in the IE "MBSFN inter frequency neighbour list" on a different band compared to the band on which the information is sent (this depends on UE capabilities).

NOTE 2: The indications for different frequencies (i.e. "MBSFN services notified", "MBSFN services not notified", "All MBSFN services notified") in the MBMS GENERAL INFORMATION message can be different depending on the frequency in which the MBMS GENERAL INFORMATION message has been received.

8.6.9.9ae MBSFN TDM Information

If the IE "MBSFN TDM Information List" is included, the UE shall:

- 1> assume that the MBMS service identified in IE "MBMS short transmission ID" can be received only in frame(s) with the CFN fulfilling the following equation:

$$(CFN \text{ div } N) \bmod TDM_Rep = TDM_Offset + i, i = 0 \text{ to } TDM_Length - 1$$

where

- N is the TTI (in number of 10ms frames) of the FACH
- TDM_Rep is the repetition period
- TDM_Offset is the offset
- TDM_Length is the number of TTIs the MBMS Service is transmitted, starting from TDM_Offset
- CFN is set according to subclause 8.5.15.3 (Initialisation for Cell_FACH).

8.6.9.9b MCCH configuration information

If the IE "MCCH configuration information" is included the UE shall:

- 1> Consider an access information period to start from the frame with the SFN value fulfilling the following equation (where m is the modification period coefficient and a is the access info period coefficient):

$$\text{SFN mod } 2^{(m-a)} = 0$$

- 1> Consider a repetition period to start from the frame with the SFN value fulfilling the following equation (where m is the modification period coefficient and r is the repetition period coefficient):

$$\text{SFN mod } 2^{(m-r)} = 0$$

- 1> Consider a modification period to start from the frame with the SFN value fulfilling the following equation (where m is the modification period coefficient):

$$\text{SFN mod } 2^m = 0$$

- 1> configure the RLC entity in the UE used for receiving MCCH in accordance with 8.6.4.9;

- 1> configure the MAC entity in the UE, used for receiving MCCH, for receiving TCTF field unless the IE 'TCTF presence' is received;

8.6.9.10 Next scheduling period

If the IE "Next scheduling period" is included for an MBMS service the UE may:

- 1> discontinue reception of the given MBMS service for the number of scheduling periods indicated by this IE.

8.6.9.11 TDD MBSFN Information

For TDD if the UE receives "TDD MBSFN Information" (via System Information Block type 5) then the UE shall assume that any CCTrCH configured to use the timeslots indicated by this IE shall use MBSFN Burst Type.

8.7 MBMS specific procedures

8.7.1 Reception of MBMS control information

8.7.1.1 General

The procedure for receiving MBMS control information is used by a UE to receive information from UTRAN concerning the way it provides MBMS services the UE has activated. The procedure applies to all UEs supporting MBMS, irrespective of its state (idle, URA_PCH, CELL_PCH, CELL_FACH and CELL_DCH).

Most MBMS control information is provided on the MCCH. The information on MCCH is transmitted using a fixed schedule, which is common for all services. MCCH information other than MBMS ACCESS INFORMATION message is transmitted periodically based on a repetition period. This MCCH information is repeated a configurable number of times with exactly the same content; the period in which the content of MCCH information other than MBMS ACCESS INFORMATION message remains unchanged is called the modification period. MBMS ACCESS INFORMATION

message may be transmitted more frequently, based on the Access Info period. The transmissions of MBMS ACCESS INFORMATION message within a modification period need not have exactly the same content (the value of some parameters eg. IE 'Access probability factor – Idle' may change). Nevertheless, the transmissions of MBMS ACCESS INFORMATION message within a modification period should concern the same MBMS service(s), although information for a service may be removed eg. upon completion of the counting for that service.

The general principles are illustrated in figure 8.7.1-1, in which different colours indicate potentially different content of the MCCH information.

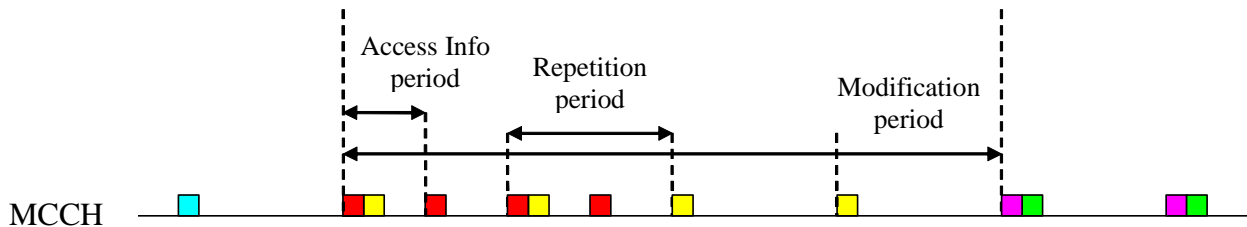

Figure 8.7.1-1: Scheduling of MCCH Information

For services provided via a p-t-m radio bearer scheduling information may be provided on an MSCH mapped on the same S-CCPCH as the p-t-m radio bearer(s). For some of the services provided p-t-m this scheduling information may be provided by signalling an MBMS SCHEDULING INFORMATION message at every scheduling period, while for others the MBMS SCHEDULING INFORMATION message may be signalled less frequently i.e. after a multiple of the scheduling period. In general, the UE is neither required to acquire MSCH information nor to act on it.

In case the UE shall acquire MCCH information that is scheduled at the same time as MSCH information, the reception of the MCCH information shall take precedence.

In order to minimise the time the UE needs to read MCCH upon notification as specified in 8.7.3 to acquire the required information, UTRAN should schedule the MCCH messages in a specific order i.e. any message that needs to be read by any UE due to the reception of the MBMS MODIFIED SERVICES INFORMATION message should be scheduled prior to the remaining messages. More specifically, the UE may assume that UTRAN schedules the MCCH messages in the following order:

MBMS MODIFIED SERVICES INFORMATION,

followed by messages that needs to be read by any UE due to the content of the MBMS MODIFIED SERVICES INFORMATION message in the following order: MBMS GENERAL INFORMATION, MBMS COMMON P-T-M RB INFORMATION, MBMS CURRENT CELL P-T-M RB INFORMATION, one or more MBMS NEIGHBOURING CELL P-T-M RB INFORMATION,

MBMS UNMODIFIED SERVICES INFORMATION,

followed by messages that do not need to be read by any UE due to the content of the MBMS MODIFIED SERVICES INFORMATION message in the following order: MBMS GENERAL INFORMATION, MBMS COMMON P-T-M RB INFORMATION, MBMS CURRENT CELL P-T-M RB INFORMATION, one or more MBMS NEIGHBOURING CELL P-T-M RB INFORMATION

8.7.1.2 Initiation

The requirements concerning which MBMS control information the UE shall acquire in the different cases is specified in other subclauses. This section specifies common requirements concerning the reception of MCCH information and MSCH information.

8.7.1.3 UE requirements on reading of MCCH information

When requested to acquire MBMS control information other than the MBMS ACCESS INFORMATION message, the UE shall:

- 1> if requested to start reading MCCH at the next modification period:
- 2> start reading MCCH at the beginning of the next modification period.

- 1> otherwise
 - 2> start reading MCCH at the beginning of the next repetition period.
- 1> if requested to stop reading MCCH at the end of the modification period:
 - 2> continue reading MCCH until the required MBMS control information is received or until the UE detects a TTI in which no MCCH information is transmitted, whichever is first;
 - 2> continue reading MCCH in this manner at every subsequent repetition period, until the information is received correctly or until the end of the modification period.
- 1> otherwise:
 - 2> continue reading MCCH until the required MBMS control information is received or until the UE detects a TTI in which no MCCH information is transmitted, whichever is first;
 - 2> continue reading MCCH in this manner at every subsequent repetition period, until the information is received correctly.

NOTE 1: The UE may combine information received at different repetition periods within a modification period.

When requested to acquire the MBMS ACCESS INFORMATION message, the UE shall:

- 1> if requested to start reading MCCH at the next modification period:
 - 2> start reading MCCH at the beginning of the next modification period.
- 1> otherwise:
 - 2> start reading MCCH at the beginning of the next access info period.
- 1> continue reading MCCH in this manner at every subsequent access info period, until the message is received correctly or until the end of the modification period.

If the UE is CELL_DCH and has a compressed mode pattern that overlaps with the period in which it needs to read MCCH, the UE may temporarily refrain from receiving MCCH unless it is capable of simultaneous operation. If the UE is CELL_FACH and has a measurement occasion that overlaps with the period in which it needs to read MCCH, the UE may temporarily refrain from receiving MCCH unless it is capable of simultaneous operation. A UE in CELL_FACH may omit performing measurements during a measurement occasion in order to receive MCCH provided that this does not prevent it from fulfilling the measurement performance requirements as specified in [19]. In Idle mode as well as in CELL_PCH and URA_PCH states the UE may temporarily refrain from receiving MCCH if needed to fulfil the measurements performance requirements as specified in [19].

NOTE 2: The UTRAN should endeavour to ensure that for each UE in CELL_FACH the assigned measurement occasions do not overlap constantly with the periodic MCCH transmissions.

If the UE selects to another cell, the UE shall re-establish the RLC entity used for MCCH reception.

8.7.1.4 UE requirements on reading of MSCH information

If the UE supports reception of MSCH, UE shall:

- 1> if the UE needs to acquire MCCH information that is transmitted at the same time as the MSCH information and the UE does not support simultaneous reception:
 - 2> refrain from reading MSCH.

If the UE supports reception of MSCH, UE should:

- 1> start reading MSCH at the beginning of the next scheduling period;
- 1> continue reading MSCH until the required MBMS control information is received or until the UE detects a TTI in which no MSCH information is transmitted, whichever is first.

8.7.2 MCCH acquisition

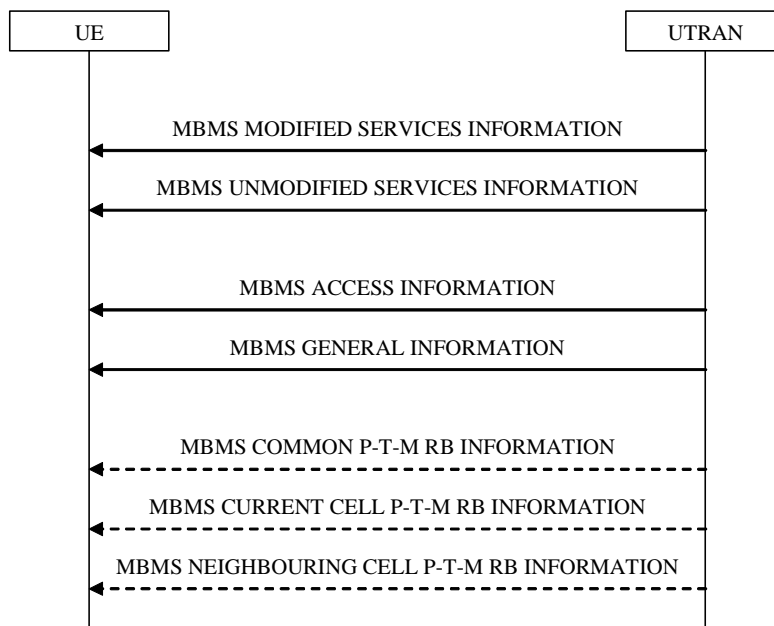

Figure 8.7.2-1: MCCH acquisition, normal

8.7.2.1 General

The UE applies the MCCH acquisition procedure to determine the MBMS services available in the cell and to initiate reception of the services that the UE has activated. The procedure applies to all UEs supporting MBMS, irrespective of their state (idle, URA_PCH, CELL_PCH, CELL_FACH and CELL_DCH). The UE may also apply the MCCH acquisition procedure to inform NAS of other available services that are not activated.

For 1.28 Mcps TDD, if the cell is operating in MBSFN mode, the MCCH will be deployed on the MBSFN Special Timeslot [30].

8.7.2.2 Initiation

If the variable MBMS_ACTIVATED_SERVICES is not empty, the UE shall apply the MCCH acquisition procedure upon selecting (eg. upon power on) or re-selecting a cell supporting MBMS or an MBSFN cluster, upon change of MBMS controlling cell (eg. due to an active set update or hard handover), upon entering UTRA from another RAT, upon release of a MBMS PTP RB for the purpose of changing transfer mode, upon return from loss of coverage and upon receiving an indication from upper layers that the set of activated services has changed.

8.7.2.3 MCCH information to be acquired by the UE

The UE shall detect the available MBMS services by acquiring the MBMS MODIFIED SERVICES INFORMATION and the MBMS UNMODIFIED SERVICES INFORMATION messages without delaying reading of MCCH until the next modification period and without stopping at the end of the modification period, in accordance with subclause 8.7.1.3.

For cells not operating in MBSFN mode as indicated in subclause 8.1.1.6.3 the UE shall immediately acquire the MBMS ACCESS INFORMATION and the MBMS GENERAL INFORMATION messages ie. it shall not delay reception of these messages until it has completed the acquisition of the MBMS MODIFIED SERVICES INFORMATION and the MBMS UNMODIFIED SERVICES INFORMATION messages. Likewise for cells not operating in MBSFN mode as indicated in subclause 8.1.1.6.3, the UE should immediately acquire the MBMS CURRENT CELL P-T-M RB INFORMATION and MBMS NEIGHBOURING CELL P-T-M RB INFORMATION messages.

For cells operating in MBSFN mode as indicated in subclause 8.1.1.6.3 the UE shall immediately acquire the MBMS GENERAL INFORMATION messages ie. it shall not delay reception of these messages until it has completed the acquisition of the MBMS MODIFIED SERVICES INFORMATION and the MBMS UNMODIFIED SERVICES

INFORMATION messages. Likewise for cells operating in MBSFN mode as indicated in subclause 8.1.1.6.3, the UE should immediately acquire the MBMS CURRENT CELL P-T-M RB INFORMATION.

The UE shall continue acquiring the above messages until it has received a consistent set of MCCH information eg. both the MBMS MODIFIED SERVICES INFORMATION and the MBMS UNMODIFIED SERVICES INFORMATION message should be acquired in the same modification period.

8.7.2.4 Reception of the MBMS MODIFIED SERVICES INFORMATION and the MBMS UNMODIFIED SERVICES INFORMATION by the UE

If the UE is receiving an MBMS service that is not included in variable MBMS_ACTIVATED_SERVICES and that is using a p-t-m radio bearer, the UE shall:

- 1> stop receiving the concerned MBMS service and clear all service specific information applicable for the concerned service.
- 1> if the UE is in a state other than CELL_DCH (for FDD) or if the UE is in Idle mode, URA_PCH or CELL_PCH state (for TDD); and
- 1> if the UE does not decide to receive an MBMS service; and
- 1> if the variable MBMS_PREV_FREQUENCY_INFO is not empty:
 - 2> if any frequency in SIB11 or SIB12 has the same frequency stored in the variable MBMS_PREV_FREQUENCY_INFO:
 - 3> select a suitable UTRA cell in that frequency;
 - 3> if no suitable UTRA cell in that frequency is found:
 - 4> select a suitable UTRA cell in another frequency.
 - 2> if no frequency in SIB11 or SIB12 has the same frequency stored in the variable MBMS_PREV_FREQUENCY_INFO:
 - 3> select a frequency randomly among the inter-frequencies indicated in SIB11 or SIB12:
 - 4> select a suitable UTRA cell in the selected frequency;
 - 4> if no suitable UTRA cell in the selected frequency is found:
 - 5> select a suitable UTRA cell in another frequency.
- 2> clear the variable MBMS_PREV_FREQUENCY_INFO.

NOTE: The UE is only required to acquire the relevant SIB11 or SIB12, according to what is specified in subclauses 8.1.1.6.11 and 8.1.1.6.12.

Upon completing the reception of the MBMS MODIFIED SERVICES INFORMATION and the MBMS UNMODIFIED SERVICES INFORMATION messages, the UE shall

- 1> act as follows for each of the services included in these messages provided that the service is included in variable MBMS_ACTIVATED_SERVICES and upper layers indicate that the session has not yet been received correctly (referred to as 'applicable services');
- 1> act upon all received information elements as specified in subclause 8.6, unless specified otherwise in the following;
- 1> if one or more preferred frequency applies for the applicable services:
 - 2> delay acting upon the "MBMS Preferred frequency information" until receiving the relevant MCCH information i.e. the MBMS GENERAL INFORMATION message;
 - 2> act upon the "MBMS Preferred frequency information" as specified in subclause 8.6.9.4 for the service(s) that upper layers indicate to have highest priority.

- 1> perform the MBMS frequency selection procedure as specified in subclause 8.5.27;
- 1> if the UE receives an MBMS service using a p-t-m radio bearer and the received messages do not contain an IE "MBMS required UE action" set to "Acquire PTM RB info" or set to "Acquire counting info– PTM RBs unmodified" for that service then the UE shall:
 - 2> stop receiving the concerned MBMS service and clear all service specific information applicable for the concerned service.

8.7.2.5 Reception of the other MBMS messages by the UE

For cells not operating in MBSFN mode as indicated in subclause 8.1.1.6.3, upon receiving the MBMS ACCESS INFORMATION message, the UE shall act as specified in subclause 8.7.4.3.

Upon receiving the MBMS GENERAL INFORMATION message, the UE should store all relevant IEs included in this message. The UE shall also:

- 1> act upon all received information elements as specified in subclause 8.6, unless specified otherwise in the following.

For cells not operating in MBSFN mode as indicated in subclause 8.1.1.6.3, upon receiving the MBMS CURRENT CELL P-T-M RB INFORMATION and MBMS NEIGHBOURING CELL P-T-M RB INFORMATION messages, the UE shall act as specified in subclauses 8.7.5.3 and subclause 8.7.5.4 respectively.

For cells operating in MBSFN mode as indicated in subclause 8.1.1.6.3 upon receiving the MBMS CURRENT CELL P-T-M RB INFORMATION message, the UE shall act as specified in subclauses 8.7.5.3.

The procedure ends.

8.7.3 MBMS Notification

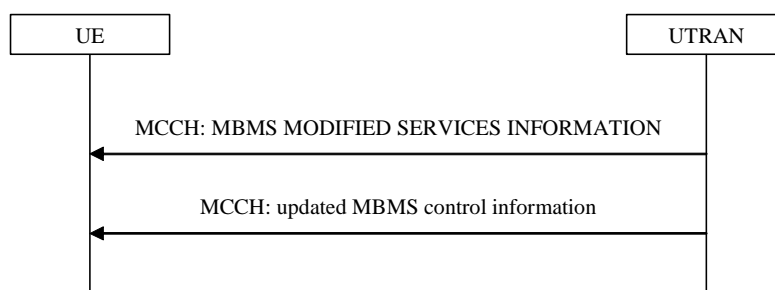

Figure 8.7.3-1: MBMS notification on MCCH

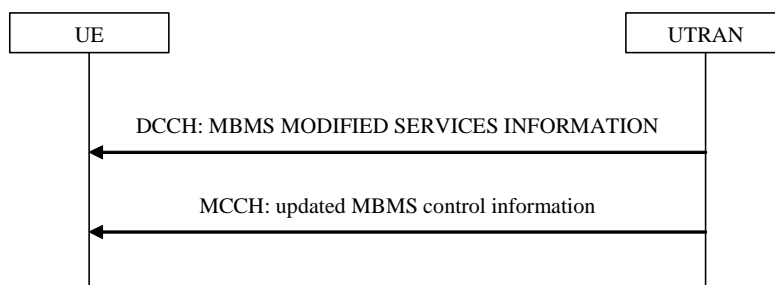

Figure 8.7.3-2: MBMS notification on DCCH

8.7.3.1 General

The MBMS notification procedure is used by the UE to respond to a notification provided by UTRAN, indicating a change applicable for one or more MBMS services the UE has activated. The procedure applies to all UEs supporting

MBMS, irrespective of their state (idle and connected mode: URA_PCH, CELL_PCH, CELL_FACH and CELL_DCH). The actual notification mechanism to be used depends on the UE state.

Reception of the MBMS MODIFIED SERVICES INFORMATION message on DCCH is optional for a UE capable of reading MCCH in CELL_DCH.

8.7.3.2 Initiation

UTRAN initiates the notification procedure to inform UEs about a change applicable for one or more MBMS services available in a cell. Some types of MBMS service changes e.g. the establishment of a p-t-m radio bearer, involve a modification of MCCH messages other than the MBMS MODIFIED SERVICES INFORMATION message.

NOTE 1: On MCCH, the MBMS MODIFIED SERVICES INFORMATION as well as the MBMS UNMODIFIED SERVICES INFORMATION messages are signalled even if no services are contained in the message.

NOTE 2: A service remains in the MBMS MODIFIED SERVICES INFORMATION message until it enters a 'steady state', upon which it moves to the MBMS UNMODIFIED SERVICES INFORMATION message. In case counting is used, the service remains in the MBMS MODIFIED SERVICES INFORMATION message through the moment UTRAN has decided the transfer mode.

8.7.3.3 Receiving the MBMS Notification information

8.7.3.3.1 Reception via MCCH

The UE may:

- 1> monitor the MBMS notification Indicator Channel (MICH);
- 1> if a notification on the MICH for one or more of the MBMS services included in the variable MBMS_ACTIVATED_SERVICES is detected:
 - 2> acquire the MBMS MODIFIED SERVICES INFORMATION message with delaying the reading of MCCH until the next modification period and with stopping at the end of the modification period, in accordance with subclause 8.7.1.3;
 - 2> handle the MBMS MODIFIED SERVICES INFORMATION message as specified in subclause 8.7.3.4.

The UE shall:

- 1> if in idle mode, URA_PCH, CELL_PCH or CELL_FACH state:
 - 2> if not monitoring MICH during the current or the previous modification period:
 - 3> acquire the MBMS MODIFIED SERVICES INFORMATION message from MCCH at the start of every modification period, in accordance with subclause 8.7.1.3;
 - 3> handle the MBMS MODIFIED SERVICES INFORMATION message as specified in subclause 8.7.3.4.
- 1> if in CELL_DCH state:
 - 2> if receiving an MBMS service that is provided via a p-t-m radio bearer and not monitoring MICH:
 - 3> acquire the MBMS MODIFIED SERVICES INFORMATION message from MCCH at the start of every modification period, in accordance with subclause 8.7.1.3;
 - 3> handle the MBMS MODIFIED SERVICES INFORMATION message as specified in subclause 8.7.3.4.

8.7.3.3.2 Void

8.7.3.3.3 Reception via DCCH

Notification via DCCH is used to notify the UE about the start of a session for which a PL applies, to notify the UE about the establishment of a p-t-m radio bearer and to request a UE in PMM_idle state to establish a PMM connection to enable reception of a service provided via a p-t-p radio bearer.

Upon receiving the MBMS MODIFIED SERVICES INFORMATION message via DCCH, a UE in CELL_DCH shall:

- 1> handle the MBMS MODIFIED SERVICES INFORMATION message as specified in subclause 8.7.3.4.

8.7.3.4 UE action upon receiving MBMS MODIFIED SERVICES INFORMATION message

Upon receiving the MBMS MODIFIED SERVICES INFORMATION message, if the IE "MIB Value tag" is present, the UE should check it to ensure that the stored system information blocks are up to date. If the received IE "MIB Value tag" does not match the value tag stored in the variable VALUE_TAG for the master information block the UE should not consider any MBMS configuration stored or received to be valid, until the stored system information blocks are up to date.

Upon receiving the MBMS MODIFIED SERVICES INFORMATION message, the UE shall act as follows for each of the services included in this messages provided that the service is included in variable MBMS_ACTIVATED_SERVICES and upper layers indicate that the session has not yet been received correctly (referred to as 'applicable services'):

- 1> if the IE "MBMS all unmodified p-t-m services" is included in the MBMS MODIFIED SERVICES INFORMATION messages:
 - 2> for all services listed in the message UNMODIFIED SERVICES INFORMATION, provided that the service is included in variable MBMS_ACTIVATED_SERVICES, upper layers indicate that the session has not yet been received correctly (referred to as 'applicable services') and the IE "MBMS required UE action" in the message MBMS UNMODIFIED SERVICES INFORMATION is set to "Acquire PTM RB info":
 - 3> continue acquiring the MBMS UNMODIFIED SERVICES INFORMATION, MBMS COMMON P-T-M RB INFORMATION, MBMS CURRENT CELL P-T-M RB INFORMATION, and for FDD and 3.84/7.68 Mcps TDD cells not operating in MBSFN mode as indicated in subclause 8.1.1.6.3 the MBMS NEIGHBOURING CELL P-T-M RB INFORMATION messages without delaying reading of MCCH until the next modification period and without stopping at the end of the modification period, in accordance with subclause 8.7.1.3;
 - 3> act upon the MBMS UNMODIFIED SERVICES INFORMATION MBMS COMMON P-T-M RB INFORMATION, MBMS CURRENT CELL P-T-M RB INFORMATION and for FDD and 3.84/7.68 Mcps TDD cells not operating in MBSFN mode as indicated in subclause 8.1.1.6.3 the MBMS NEIGHBOURING CELL P-T-M RB INFORMATION message, if received, in accordance with subclause 8.7.5, and assuming the p-t-m configuration indicated in these messages is valid immediately, unless the IE "MBMS p-t-m activation time" is included in the MBMS MODIFIED SERVICES INFORMATION message.
- 2> if the UE receives an MBMS service using a p-t-m radio bearer and the messages MBMS UNMODIFIED SERVICES INFORMATION and MBMS MODIFIED SERVICES INFORMATION do not contain an IE "MBMS required action" set to "Acquire PTM RB info" or set to "Acquire counting info – PTM RBs unmodified" for that service then the UE shall:
 - 3> stop receiving the concerned MBMS service and clear all service specific information applicable for the concerned service.
 - 3> if the UE is in a state other than CELL_DCH (for FDD) or if the UE is in Idle mode, URA_PCH or CELL_PCH state (for TDD); and
 - 3> if the UE does not decide to receive an MBMS service; and
 - 3> if the variable MBMS_PREV_FREQUENCY_INFO is not empty:
 - 4> if any frequency in SIB11 or SIB12 has the same frequency stored in the variable MBMS_PREV_FREQUENCY_INFO:

- 5> select a suitable UTRA cell in that frequency;
- 5> if no suitable UTRA cell in that frequency is found:
 - 6> select a suitable UTRA cell in another frequency.
- 4> if no frequency in SIB11 or SIB12 has the same frequency stored in the variable MBMS_PREV_FREQUENCY_INFO:
 - 5> select a frequency randomly among the inter-frequencies indicated in SIB11 or SIB12:
 - 6> select a suitable UTRA cell in the selected frequency;
 - 6> if no suitable UTRA cell in the selected frequency is found:
 - 7> select a suitable UTRA cell in another frequency.
 - 4> clear the variable MBMS_PREV_FREQUENCY_INFO.

NOTE: The UE is only required to acquire the relevant SIB11 or SIB12, according to what is specified in subclauses 8.1.1.6.11 and 8.1.1.6.12.

- 1> act upon all received information elements as specified in subclause 8.6, unless specified otherwise in the following
 - 1> if one or more preferred frequency applies for the applicable services:
 - 2> acquire the MBMS GENERAL INFORMATION message.
 - 1> perform the MBMS frequency selection procedure as specified in subclause 8.5.27;
 - 1> the procedure ends.

8.7.3.5 UE fails to receive MBMS Notification information

If the UE fails to receive the MBMS MODIFIED SERVICES INFORMATION message within the current modification period, the UE shall:

- 1> Acquire the MBMS MODIFIED SERVICES INFORMATION and the MBMS UNMODIFIED SERVICES INFORMATION messages without delaying reading of MCCH until the next modification period and with stopping at the end of that modification period, in accordance with subclause 8.7.1.3;
- 1> act upon the received MBMS MODIFIED SERVICES INFORMATION and the MBMS UNMODIFIED SERVICES INFORMATION messages as specified in subclause 8.7.2.4.

8.7.4 MBMS counting

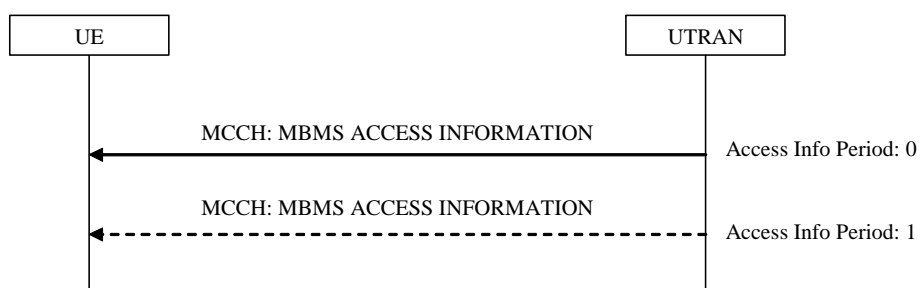

Figure 8.7.4-1: MBMS counting, normal

8.7.4.1 General

The MBMS counting procedure is used by the UE to inform UTRAN about its interest to receive an MBMS transmission. The procedure applies to UEs supporting MBMS that are in idle mode or in connected mode for cells not operating in MBSFN mode as indicated in subclause 8.1.1.6.3. In connected mode the procedure applies to the

URA_PCH, Cell_PCH and/ or Cell_FACH states dependent upon the value of the IE "Connected mode counting scope".

8.7.4.2 Initiation

The UE initiates the MBMS counting procedure for an MBMS transmission upon receiving an MBMS MODIFIED SERVICES message including IE "MBMS required UE action" with the value set to 'Acquire counting info' or set to 'Acquire counting info- PTM RBs unmodified'.

8.7.4.3 Reception of the MBMS ACCESS INFORMATION

For cells not operating in MBSFN mode as indicated in subclause 8.1.1.6.3 the UE shall acquire the MBMS ACCESS INFORMATION message without delaying reading of MCCH until the next modification period in accordance with subclause 8.7.1.3. If the procedure the UE would apply to respond to counting (Idle mode: RRC connection establishment, connected mode: Cell update) is ongoing, the UE may defer acquiring the MBMS ACCESS INFORMATION message until this procedure has completed.

The UE behaviour upon receiving an MBMS ACCESS INFORMATION message that is contained in more than one TTI is not specified.

Upon receiving the MBMS ACCESS INFORMATION message for cells not operating in MBSFN mode as indicated in subclause 8.1.1.6.3 including one or more MBMS service(s) it has joined and/or including one or more MBMS Selected Services, the UE shall for each joined and/or selected service:

- 1> if the UE is in idle mode:
 - 2> draw a random number, "rand", uniformly distributed in the range: $0 \leq \text{rand} < 1$
 - 2> if 'rand' is lower than the value indicated by the IE 'Access probability factor-Idle' for the concerned service:
 - 3> indicate to upper layers that establishment of an RRC connection is required to receive the concerned MBMS service, with the establishment cause set to 'MBMS reception';
 - 3> if the above condition applies for more than one service, initiate a single indication to upper layers;
 - 3> if the RRC connection establishment succeeds, the procedure ends.
 - 2> otherwise:
 - 3> if the message triggering the MBMS counting procedure included the IE "Continue MCCH reading" with a value set to TRUE:
 - 4> continue acquiring further MBMS ACCESS INFORMATION messages without delaying reading of MCCH until the next modification period and without stopping at the end of the modification period, in accordance with subclause 8.7.1.3.
 - 3> otherwise:
 - 4> continue acquiring further MBMS ACCESS INFORMATION messages without delaying reading of MCCH until the next modification period and with stopping at the end of the modification period, in accordance with subclause 8.7.1.3.
- 1> if the UE is in URA_PCH state, Cell_PCH or Cell_FACH state and the IE "Connected mode counting scope" indicates that counting is applicable for this UE state:
 - 2> draw a random number, "rand", uniformly distributed in the range: $0 \leq \text{rand} < 1$.
 - 2> if 'rand' is lower than the value indicated by the IE 'Access probability factor-connected' for the concerned service:
 - 3> if a cell update has not been successfully transmitted for this service in the current modification period:
 - 4> initiate the cell update procedure with 'Cell update cause' set to "MBMS reception", in accordance with subclause 8.3.1;

- 4> if the above condition applies for more than one service, initiate a single cell update;
- 4> if the cell update procedure succeeds,
 - 5> the procedure ends.

2> otherwise:

3> if the message triggering the MBMS counting procedure included the IE "Continue MCCH reading" with a value set to TRUE:

- 4> continue acquiring further MBMS ACCESS INFORMATION messages without delaying reading of MCCH until the next modification period and without stopping at the end of the modification period, in accordance with subclause 8.7.1.3.

3> otherwise:

- 4> continue acquiring further MBMS ACCESS INFORMATION messages without delaying reading of MCCH until the next modification period and with stopping at the end of the modification period, in accordance with subclause 8.7.1.3.

1> otherwise:

- 2> the procedure ends;

Upon receiving the MBMS ACCESS INFORMATION message not including an MBMS service(s) the UE has joined or selected:

- 1> the procedure ends;

8.7.4.4 Termination of the MBMS counting procedure

If the UE detects that the MBMS ACCESS INFORMATION message is not provided at an access info period; OR

If the UE receives an MBMS ACCESS INFORMATION message not including an MBMS service the UE has joined or selected, the UE shall:

- 1> terminate the MBMS counting procedure.

If the UE receives an RRC CONNECTION REJECT message with Rejection Cause 'unspecified' and including the MBMS "Counting completion" IE, the UE shall:

- 1> consider the MBMS counting procedure ended for the MBMS service(s) for which the UE has initiated the MBMS counting response;
- 1> indicate to upper layers that the establishment of an RRC connection with the establishment cause set to 'MBMS reception' shall be aborted.

8.7.4.5 Failure of the counting response procedure

If the counting response procedure (RRC connection establishment or Cell update) fails, the UE shall:

- 1> if the failure occurs in the same modification period as the one in which the UE initiated the counting response procedure; or
- 1> if the message triggering the MBMS counting procedure included the IE "Continue MCCH reading" with a value set to TRUE that is applicable in the modification period in which the UE detects the failure:
 - 2> continue acquiring further MBMS ACCESS INFORMATION messages without delaying reading of MCCH until the next modification period and without stopping at the end of the modification period, in accordance with subclause 8.7.1.3.

1> otherwise:

- 2> the procedure ends.

8.7.5 MBMS p-t-m radio bearer configuration

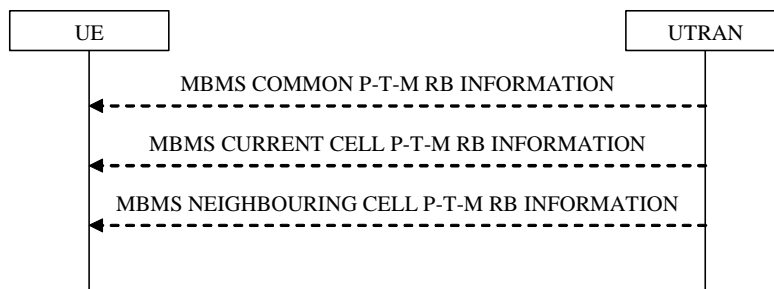

Figure 8.7.5-1: MBMS p-t-m radio bearer modification, normal

8.7.5.1 General

The MBMS p-t-m radio bearer configuration procedure is used by the UE to acquire the (modified) radio bearer configuration for one or more activated MBMS services. The procedure applies to all UEs supporting MBMS, irrespective of their state (idle and connected mode: URA_PCH, CELL_PCH, CELL_FACH and CELL_DCH).

8.7.5.2 Initiation

The UE applies the MBMS p-t-m radio bearer configuration procedure whenever it detects that one of the activated services is provided by means of a p-t-m radio bearer. This may occur as part of the MCCH acquisition or the MBMS Notification procedure.

8.7.5.3 Reception of the MBMS Current Cell PTM RB information

Upon completing the reception of the MBMS COMMON P-T-M RB INFORMATION and the MBMS CURRENT CELL P-T-M RB INFORMATION messages for an activated MBMS service, the UE shall:

- 1> if the UE is already receiving an MTCH and does not have the capability to receive the new service in addition:
 - 2> the UE behaviour is undefined.

NOTE: In this case, the UE may request upper layers to prioritise the services and only receive the service(s) prioritised by upper layers.

- 1> act upon all received information elements as specified in subclause 8.6, unless specified otherwise in the following:
 - 1> if the UE previously received the service by means of a p-t-m radio bearer from a cell belonging to another MBMS cell group:
 - 2> re-establish RLC;
 - 2> re-initialise PDCP.
 - 1> start immediately to use the indicated configuration unless specified otherwise;
 - 1> start or continue receiving the indicated p-t-m radio bearers depending on its UE capabilities.

The UE shall continue acquiring the above messages until it has received a consistent set of MCCH information i.e. the MBMS MODIFIED SERVICES INFORMATION message, MBMS UNMODIFIED SERVICES INFORMATION message, MBMS COMMON P-T-M RB INFORMATION and the MBMS CURRENT CELL P-T-M RB INFORMATION message should be acquired in the same modification period.

8.7.5.4 Reception of the MBMS Neighbouring Cell PTM RB information

Upon receiving the MBMS NEIGHBOURING CELL P-T-M RB INFORMATION message for an activated MBMS service for a cell not operating in MBSFN mode as indicated in subclause 8.1.1.6.3, the UE shall:

- 1> start immediately to use the indicated neighbouring cells and configuration, or a subset of them, for L1- or L2 combining or Chip combining (1.28Mcps TDD only) unless specified otherwise;
- 1> start or continue receiving the indicated p-t-m radio bearers from the selected neighbouring cells depending on its UE capabilities.

The UE shall apply MBMS NEIGHBOURING CELL P-T-M RB INFORMATION only in combination with an MBMS MODIFIED SERVICES INFORMATION message, MBMS UNMODIFIED SERVICES INFORMATION message, MBMS COMMON P-T-M RB INFORMATION and MBMS CURRENT CELL P-T-M RB INFORMATION message acquired in the same modification period.

8.7.6 MBMS modification request

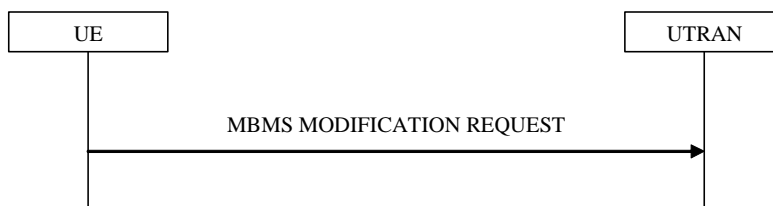

Figure 8.7.6-1: MBMS modification request, normal

8.7.6.1 General

The MBMS modification request procedure is used by the UE to request UTRAN to release the p-t-p radio bearers of one or more MBMS services the UE is receiving. The procedure is also used to request to be moved to a preferred frequency applicable for one or more (prioritised) activated MBMS services the UE, and to indicate the UE MBMS Selected Services. The procedure applies to all UEs supporting MBMS, that are in CELL_DCH, CELL_PCH, URA_PCH or CELL_FACH state.

8.7.6.2 Initiation

A UE entering CELL_DCH shall initiate the MBMS modification request procedure in the following cases:

- 1> if the UE has any MBMS Selected Service; and
- 1> if the IE "MCCH configuration information" was received in System Information Block Type 5 or System Information Block Type 5bis prior to entering CELL_DCH.

A UE completing an RRC Connection Setup procedure shall initiate the MBMS modification request procedure in the following cases:

- 1> if the UE has any MBMS Selected Service; and
- 1> if the IE "MCCH configuration information" was received in System Information Block Type 5 or System Information Block Type 5bis prior to completing the RRC Connection Setup procedure.

A UE in CELL_DCH shall initiate the MBMS modification request procedure in the following cases:

- 1> the preferred frequency applicable for the MBMS service prioritised by upper layers is different from the currently used frequency;
- 1> upper layers request to discontinue reception of an MBMS service provided via a p-t-p radio bearer e.g. because this inhibits reception of a higher priority service;
- 1> upon a change in selection of the MBMS Selected Services.

NOTE: The above case may occur upon receiving a dedicated notification or in other cases eg. a change of transfer mode from p-t-p to p-t-m for the UE's highest priority MBMS service.

A UE in CELL_FACH, CELL_PCH or URA_PCH state shall initiate the MBMS modification request procedure in the following cases:

1> upon a change in selection of the MBMS Selected Services that are indicated on MCCH; and

1> if the IE "Indicate changes in MBMS Selected Services" that is included in the MBMS GENERAL INFORMATION message is set to TRUE.

If the UE is required to initiate the MBMS modification request procedure as specified in the conditions above, the UE shall:

1> transmit an MBMS MODIFICATION REQUEST message with the contents as specified in subclause 8.7.6.2a.

If applicable, the UE shall use a single MBMS MODIFICATION REQUEST message to request a move to the preferred frequency and/or to request release of radio bearers corresponding with lower priority MBMS services provided p-t-p and/or to report the MBMS Selected Services.

8.7.6.2a MBMS MODIFICATION REQUEST message contents to set

The UE shall set the contents of the MBMS MODIFICATION REQUEST message as follows:

1> if the preferred frequency applicable for the MBMS service prioritised by upper layers is different from the currently used frequency:

2> include the IE "MBMS preferred frequency request" and set it to the prioritised MBMS service identity;

1> if upper layers request to discontinue reception of an MBMS service provided via a p-t-p radio bearer:

2> include the p-t-p radio bearers used for the corresponding MBMS services within the IE "MBMS RB list requested to be released".

1> if the UE enters CELL_DCH; or

1> if the UE completes the RRC connection establishment procedure; or

1> if there is a change in selection of one or more of the MBMS Selected Services:

2> if the UE has not selected any MBMS Selected Service:

3> include the IE "MBMS Selected Service Info" and set the Status to 'None'.

2> otherwise:

3> include the IE "MBMS Selected Service Info" and set the Status to 'Some';

3> include the IE "Support of MBMS service change for a ptp RB";

3> for each MBMS Selected Service:

4> order the MBMS Selected Services such that those selected with a higher priority are listed in the IE "MBMS Selected Services Full" before those selected with a lower priority;

4> include the IE "MBMS Selected Service ID" within the IE "MBMS Selected Services Full".

8.7.6.3 Reception of a MBMS MODIFICATION REQUEST message by the UTRAN

Upon reception of a MBMS MODIFICATION REQUEST message, the UTRAN may take further action depending on the contents of the received message.

The procedure ends.

8.7.7 MBMS service scheduling

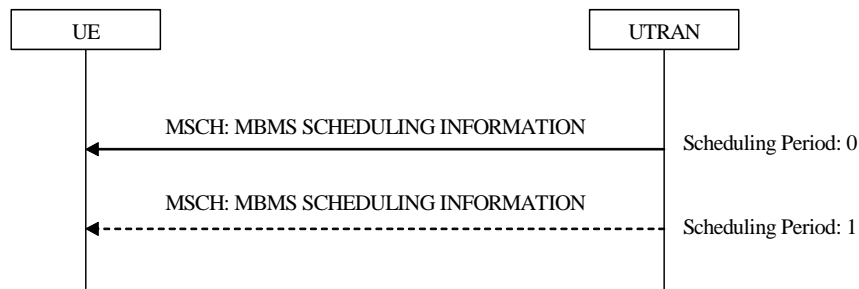

Figure 8.7.7-1: MBMS service scheduling, normal

8.7.7.1 General

The MBMS service scheduling procedure is used by the UE that is receiving one or more activated MBMS services to acquire the MBMS scheduling information for the MBMS services. The procedure applies to all UEs that are receiving an MBMS service provided via a p-t-m radio bearer, irrespective of their state (idle and connected mode: URA_PCH, CELL_PCH, CELL_FACH and CELL_DCH).

8.7.7.2 Initiation

The UE may initiate the MBMS service scheduling procedure for any scheduling period of the concerned MBMS service while receiving an SCCPCH carrying an MBMS service.

8.7.7.3 Reception of the MBMS scheduling information

Upon receiving the MBMS SCHEDULING INFORMATION message, the UE should:

- 1> act as follows for each of the services included in these messages provided that the service is included in variable MBMS_ACTIVATED_SERVICES;
- 1> act upon all received information elements as specified in subclause 8.6, unless specified otherwise in the following.

The procedure ends.

9 Handling of unknown, unforeseen and erroneous protocol data

9.1 General

This subclause specifies procedures for the handling of unknown, unforeseen, and erroneous protocol data by the receiving entity. These procedures are called "error handling procedures", but in addition to provide recovery mechanisms for error situations they define a compatibility mechanism for future extensions of the protocol.

The error handling procedures specified in this subclause shall apply to all RRC messages. When there is a specific handling for messages received on different logical channels this is specified.

For system information received on the BCCH, the error handling procedures are applied on the BCCH message SYSTEM INFORMATION, the re-assembled system information segments as well as the system information blocks (including the master information block and the scheduling blocks), with specific error handling as specified below.

When the UE receives an RRC message, it shall set the variable PROTOCOL_ERROR_REJECT to FALSE and then perform the checks in the order as defined below.

The error cases specified in the following include the handling upon reception of spare values. This behaviour also applies in case the actual value of the IE results from mapping the originally sent IE value. Moreover, in certain error cases, as specified in the following, default values apply. In this case, the default values specified within the ASN.1, the tabular and the procedure specifications apply.

9.2 ASN.1 violation or encoding error

If the UE receives an RRC message on the DCCH for which the encoded message does not result in any valid abstract syntax value [49] (or "encoding error"), it shall perform the following. The UE shall:

- 1> set the variable `PROTOCOL_ERROR_REJECT` to `TRUE`;
- 1> transmit an RRC STATUS message on the uplink DCCH. The IE "Protocol error information" shall contain an IE "Protocol error cause" set to "ASN.1 violation or encoding error";
- 1> when RRC STATUS message has been submitted to lower layers for transmission:
 - 2> continue with any ongoing processes and procedures as if the invalid message had not been received.

NOTE In this case, the UE does not perform procedure specific error handling according to clause 8.

If the UE receives an RRC message sent via a radio access technology other than UTRAN, for which the encoded message does not result in any valid abstract syntax, the UE shall:

- 1> set the variable `PROTOCOL_ERROR_REJECT` to `TRUE`;
- 1> set the IE "Protocol error cause" in the variable `PROTOCOL_ERROR_INFORMATION` to "ASN.1 violation or encoding error";
- 1> perform procedure specific error handling according to clause 8.

If a reassembled set of system information segments received in messages on the BCCH does not result in any valid abstract syntax value, the UE shall:

- 1> ignore the reassembled set of system information segments;
- 1> treat the rest of each message containing the ignored system information segments as if those segments were not present.

If the UE receives an RRC message on the BCCH, PCCH, CCCH, MCCH, MSCH or SHCCH for which the encoded message does not result in any valid abstract syntax value, it shall ignore the message.

9.3 Unknown or unforeseen message type

If a UE receives an RRC message on the DCCH with a message type not defined for the DCCH it shall:

- 1> set the variable `PROTOCOL_ERROR_REJECT` to `TRUE`;
- 1> transmit an RRC STATUS message on the uplink DCCH. The IE "Protocol error information" shall contain an IE "Protocol error cause" set to "Message type non-existent or not implemented";
- 1> when the RRC STATUS message has been submitted to lower layers for transmission:
 - 2> continue with any ongoing processes and procedures as if the invalid message had not been received.

If the UE receives an RRC message on the BCCH, PCCH, CCCH, MCCH, MSCH or SHCCH with a message type not defined for the logical channel type the message was received on, it shall ignore the message.

9.3a Unsolicited received message

If the UE receives any of the following messages:

- an RRC CONNECTION SETUP message addressed to the UE on the CCCH; or

- an RRC CONNECTION REJECT message addressed to the UE on the CCCH; or
- a UE CAPABILITY INFORMATION CONFIRM message on the DCCH; or
- a CELL UPDATE CONFIRM message addressed to the UE on the CCCH or on the DCCH; or
- a URA UPDATE CONFIRM message addressed to the UE on the CCCH or on the DCCH

and no procedure is ongoing according to clause 8 which expects the message to be received:

the UE shall:

- 1> ignore the received message.

9.3b Unexpected critical message extension

If the UE receives an RRC message on the DCCH, or addressed to the UE on the CCCH or on the SHCCH, or sent via a radio access technology other than UTRAN, containing an undefined critical message extension, the UE shall:

- 1> set the variable `PROTOCOL_ERROR_REJECT` to TRUE;
- 1> set the IE "Protocol error cause" in the variable `PROTOCOL_ERROR_INFORMATION` to "Message extension not comprehended";
- 1> if the IE "Message Type" of the received message is not present in the table "Rejected transactions" in the variable `TRANSACTIONS`:
 - 2> store the IE "Message type" of the received message in the table "Rejected transactions" in the variable `TRANSACTIONS`; and
 - 2> set the IE "RRC transaction identifier" to zero in that table entry.
- 1> perform procedure specific error handling according to clause 8.

If the UE receives an RRC message on the BCCH, MCCH, MSCH or PCCH, containing an undefined critical message extension, the UE shall:

- 1> ignore the message.

9.4 Unknown or unforeseen information element value, mandatory information element

If the UE receives an RRC message on the DCCH, or addressed to the UE on the CCCH or on the SHCCH, or sent via a radio access technology other than UTRAN, with a mandatory IE having a value, including choice, reserved for future extension (spare) or a value not used in this version of the specification (e.g. a dummy value), the UE shall:

- 1> if a default value of the IE is defined:
 - 2> treat the rest of the message using the default value of the IE.
- 1> if no default value of the IE is defined:
 - 2> set the variable `PROTOCOL_ERROR_REJECT` to TRUE;
 - 2> set the IE "Protocol error cause" in the variable `PROTOCOL_ERROR_INFORMATION` to "Information element value not comprehended";
 - 2> perform procedure specific error handling according to clause 8.

If the UE receives a system information block on the BCCH with a mandatory IE having a value reserved for future extension (spare) or a value not used in this version of the specification (e.g. a dummy value), the UE shall:

- 1> if a default value of the IE is defined:

2> treat the rest of the system information block using the default value of the IE.

1> if no default value of the IE is defined:

2> ignore the system information block.

If the UE receives an RRC message on the BCCH, MCCH, MSCH or PCCH with a mandatory IE having a value reserved for future extension (spare) or a value not used in this version of the specification (e.g. a dummy value), the UE shall:

1> if a default value of the IE is defined:

2> treat the rest of the message using the default value of the IE.

1> if no default value of the IE is defined:

2> ignore the message.

9.5 Conditional information element error

If the UE receives an RRC message on the DCCH, BCCH, PCCH, MCCH, MSCH or addressed to the UE on the CCCH or on the SHCCH, or sent via a radio access technology other than UTRAN, for which the specified conditions for absence of a conditional IE are met and that IE is present, the UE shall:

1> ignore the IE;

1> treat the rest of the message as if the IE was not present.

If the UE receives an RRC message on the DCCH, or addressed to the UE on the CCCH or on the SHCCH, or sent via a radio access technology other than UTRAN, for which the specified conditions for presence of a conditional IE are met and that IE is absent, the UE shall:

1> set the variable `PROTOCOL_ERROR_REJECT` to `TRUE`;

1> set the IE "Protocol error cause" in the variable `PROTOCOL_ERROR_INFORMATION` to "Information element missing";

1> perform procedure specific error handling according to clause 8.

If the UE receives a system information block on the BCCH for which the specified conditions for presence of a conditional IE are met and that IE is absent, the UE shall:

1> ignore the system information block.

If the UE receives an RRC message on the BCCH, MCCH, MSCH or PCCH for which the specified conditions for presence of a conditional IE are met and that IE is absent, the UE shall:

1> ignore the message.

9.6 Unknown or unforeseen information element value, conditional information element

If the UE receives an RRC message on the DCCH, or addressed to the UE on the CCCH or on the SHCCH, or sent via a radio access technology other than UTRAN, for which the specified conditions for presence of a conditional IE are met, that IE is present, and that IE has a value, including choice, reserved for future extension (spare) or a value not used in this version of the specification (e.g. a dummy value), the UE shall:

1> if a default value of the IE is defined:

2> treat the rest of the message using the default value of the IE.

1> if no default value of the IE is defined:

2> set the variable `PROTOCOL_ERROR_REJECT` to `TRUE`;

- 2> set the IE "Protocol error cause" in the variable PROTOCOL_ERROR_INFORMATION to "Information element value not comprehended";
- 2> perform procedure specific error handling according to clause 8.

If the UE receives a system information block on the BCCH for which the specified conditions for presence of a conditional IE are met, that IE is present, and that IE has a value, including choice, reserved for future extension (spare) or a value not used in this version of the specification (e.g. a dummy value), the UE shall:

- 1> if a default value of the IE is defined:
 - 2> treat the rest of the system information block using the default value of the IE.
- 1> if no default value of the IE is defined:
 - 2> ignore the system information block.

If the UE receives an RRC message on the BCCH, MCCH, MSCH or PCCH for which the specified conditions for presence of a conditional IE are met, that IE is present, and that IE has a value, including choice, reserved for future extension (spare) or a value not used in this version of the specification (e.g. a dummy value), the UE shall:

- 1> if a default value of the IE is defined:
 - 2> treat the rest of the message using the default value of the IE.
- 1> if no default value of the IE is defined:
 - 2> ignore the message.

9.7 Unknown or unforeseen information element value, optional information element

If the UE receives an RRC message on the DCCH, or addressed to the UE on the CCCH or on the SHCCH, or sent via a radio access technology other than UTRAN, with an optional IE having a value, including choice, reserved for future extension (spare) or a value not used in this version of the specification (e.g. a dummy value), it shall:

- 1> ignore the value of the IE;
- 1> treat the rest of the message as if the IE was not present.

If the UE receives a system information block on the BCCH with an optional IE having a value, including choice, reserved for future extension (spare) or a value not used in this version of the specification (e.g. a dummy value), it shall:

- 1> ignore the value of the IE;
- 1> treat the rest of the system information block as if the IE was not present.

If the UE receives an RRC message on the BCCH, MCCH or MSCH or PCCH with an optional IE having a value, including choice, reserved for future extension (spare) or a value not used in this version of the specification (e.g. a dummy value), it shall:

- 1> ignore the value of the IE;
- 1> treat the rest of the message as if the IE was not present.

9.8 Unexpected non-critical message extension

If the UE receives an RRC message on the DCCH, or addressed to the UE on the CCCH or on the SHCCH, or sent via a radio access technology other than UTRAN, containing an undefined non-critical message extension, the UE shall:

- 1> if the non critical extension is included in the "Variable Length Extension Container":

2> ignore the content of the extension and the contents of this container after the not comprehended extension, and continue decoding the rest of the message.

1> otherwise:

2> ignore the content of the extension and the message contents after the extension, but treat the parts of the message up to the extension normally.

If the UE receives a system information block on the BCCH containing an undefined non-critical message extension, the UE shall:

1> ignore the content of the extension and the system information block contents after the extension, but treat the parts of the system information block up to the extension normally.

If the UE receives an RRC message on the BCCH, MCCH or MSCH or PCCH, containing an undefined non-critical message extension, the UE shall:

1> ignore the content of the extension and the message contents after the extension, but treat the parts of the message up to the extension normally.

9.9 Handling of errors in nested information elements

An erroneous IE may be included in another IE, which may be included in another IE and so on. This subclause specifies the handling of errors in mandatory IEs as well as for conditional IEs for which the specified conditions for presence are met, that are nested in another IE.

In case the UE receives an IE (IE1) that includes a mandatory IE (IE1-1) having a value, including choice, reserved for future extension (spare) or a value not used in this version of the specification (e.g. a dummy value), the UE shall:

1> consider IE1 to have an undefined value; and

1> apply the corresponding generic error handling to IE1.

In case there are many IE nesting levels, in all of which the IE is mandatory while no default value is defined, this treatment may need to be repeated several times. The following example illustrates the general principle.

ExampleMessage ::=	SEQUENCE {	
ie1	IE1	OPTIONAL,
ie2	IE2	
}		
IE1 ::=	SEQUENCE {	
ie1-1	INTEGER (1..16),	
-- ie1-1 values 13..16 are spare and should not be used in this version of the protocol		
ie1-2	IE1-2	OPTIONAL,
ie1-3	IE1-3	
}		

If in the above example, UTRAN would include ie1 and set ie1-1 to value 13, the UE experiences an error in a mandatory IE. The guideline outlined in the previous then means that the UE shall not discard the entire message but instead consider "ie1" to have an unknown value. Since IE1 is optional, the generic error handling would be to ignore "ie1".

In case the UE receives an IE (IE1) that includes a list of another IE (IE1-1) for which one or more entries in the list have a value, including choice, reserved for future extension (spare) or a value not used in this version of the specification (e.g. a dummy value), the UE shall:

1> consider the list as if these entries were not included.

NOTE: In case the above generic error handling procedures do not result in the desired behaviour, the introduction of spares may need to be reconsidered.

10 Message and information element functional definition and content

10.1 General

The function of each Radio Resource Control message together with message contents in the form of a list of information elements is defined in subclause 10.2.

Functional definitions of the information elements are then described in subclause 10.3.

Information elements are marked as either MP - Mandatory present, MD - Mandatory with default value, OP - Optional, CV - Conditional on value or CH - Conditional on history (see Table 10.1 with information extracted from [14]).

Table 10.1: Meaning of abbreviations used in RRC messages and information elements

Abbreviation	Meaning
MP	<p>Mandatory present</p> <p>A value for that information is always needed, and no information is provided about a particular default value. If ever the transfer syntax allows absence (e.g., due to extension), then absence leads to an error diagnosis.</p>
MD	<p>Mandatory with default value</p> <p>A value for that information is always needed, and a particular default value is mentioned (in the 'Semantical information' column). This opens the possibility for the transfer syntax to use absence or a special pattern to encode the default value.</p>
CV	<p>Conditional on value</p> <p>The need for a value for that information depends on the value of some other IE or IEs, and/or on the message flow (e.g., channel, SAP). The need is specified by means of a condition, the result of which may be that the information is mandatory present, mandatory with default value, not needed or optional.</p> <p>If one of the results of the condition is that the information is mandatory present, the transfer syntax must allow for the presence of the information. If in this case the information is absent an error is diagnosed.</p> <p>If one of the results of the condition is that the information is mandatory with default value, and a particular default value is mentioned (in the 'Semantical information' column), the transfer syntax may use absence or a special pattern to encode the default value.</p> <p>If one of the results of the condition is that the information is not needed, the transfer syntax must allow encoding the absence. If in this case the information is present, it will be ignored. In specific cases however, an error may be diagnosed instead.</p> <p>If one of the results of the condition is that the information is optional, the transfer syntax must allow for the presence of the information. In this case, neither absence nor presence of the information leads to an error diagnosis.</p>
CH	<p>Conditional on history</p> <p>The need for a value for that information depends on information obtained in the past (e.g., from messages received in the past from the peer). The need is specified by means of a condition, the result of which may be that the information is mandatory present, mandatory with default value, not needed or optional.</p> <p>The handling of the conditions is the same as described for CV.</p>
OP	<p>Optional</p> <p>The presence or absence is significant and modifies the behaviour of the receiver. However whether the</p>

Abbreviation	Meaning
	information is present or not does not lead to an error diagnosis.

10.1.1 Protocol extensions

RRC messages may be extended in future versions of this protocol, either by adding values for choices, enumerated and size constrained types or by adding information elements. An important aspect concerns the behaviour of a UE, conforming to this revision of the standard, upon receiving a not comprehended future extension. The details of this error handling behaviour are provided in clause 9.

NOTE 1: By avoiding the need for partial decoding (skipping uncomprehended IEs to continue decoding the remainder of the message), the RRC protocol extension mechanism also avoids the overhead of length determinants for extensions. "Variable length extension containers" (i.e. non critical extension containers that have their abstract syntax defined using the ASN.1 type "BIT STRING") have been defined to support the introduction of extensions to a release after the subsequent release is frozen (and UEs based on that subsequent release may appear). For this container a length determinant is used, which facilitates partial decoding of the container as well as the decoding of the extensions included after the container.

Two kinds of protocol extensions are distinguished: non-critical and critical extensions. In general, a receiver shall process a message including not comprehended non-critical extensions as if the extensions were absent. However, a receiver shall entirely reject a message including not comprehended critical extensions (there is no partial rejection) and notify the sender, as specified in clause 9.

The general mechanism for adding critical extensions is by defining a new version of the message, which is indicated at the beginning of the message.

The UE shall always comprehend the complete transfer syntax specified for the protocol version it supports; if the UE comprehends the transfer syntax defined within protocol version A for message 1, it shall also comprehend the transfer syntax defined within protocol version A for message 2.

The following table shows for which messages only non-critical extensions may be added while for others both critical and non-critical extensions may be added.

NOTE 2: Critical extensions can only be added to certain downlink messages.

Extensions	Message
Critical and non-critical extensions	ACTIVE SET UPDATE 10.2.1 ASSISTANCE DATA DELIVERY 10.2.4 CELL CHANGE ORDER FROM UTRAN 10.2.5 CELL UPDATE CONFIRM 10.2.8 COUNTER CHECK 10.2.9 DOWNLINK DIRECT TRANSFER 10.2.11 HANDOVER TO UTRAN COMMAND 10.2.16a HANDOVER FROM UTRAN COMMAND 10.2.15 MEASUREMENT CONTROL 10.2.17 PHYSICAL CHANNEL RECONFIGURATION 10.2.22 PHYSICAL SHARED CHANNEL ALLOCATION 10.2.27 RADIO BEARER RECONFIGURATION 10.2.27 RADIO BEARER RELEASE 10.2.30 RADIO BEARER SETUP 10.2.33 RRC CONNECTION REJECT 10.2.36 RRC CONNECTION RELEASE 10.2.37 RRC CONNECTION SETUP 10.2.40 SECURITY MODE COMMAND 10.2.43 SIGNALLING CONNECTION RELEASE 10.2.46 TRANSPORT CHANNEL RECONFIGURATION 10.2.50 UE CAPABILITY ENQUIRY 10.2.55 UE CAPABILITY INFORMATION CONFIRM 10.2.57 UPLINK PHYSICAL CHANNEL CONTROL 10.2.59 URA UPDATE CONFIRM 10.2.61 UTRAN MOBILITY INFORMATION 10.2.62
Non-critical extensions only	ACTIVE SET UPDATE COMPLETE 10.2.2 ACTIVE SET UPDATE FAILURE 10.2.3 CELL CHANGE ORDER FROM UTRAN FAILURE 10.2.6

Extensions	Message
	CELL UPDATE 10.2.7 COUNTER CHECK RESPONSE 10.2.10 HANDOVER TO UTRAN COMPLETE 10.2.16b INITIAL DIRECT TRANSFER 10.2.16c HANDOVER FROM UTRAN FAILURE 10.2.16 MBMS ACCESS INFORMATION 10.2.16e MBMS COMMON P-T-M RB INFORMATION 10.2.16f MBMS CURRENT CELL P-T-M RB INFORMATION 10.2.16g MBMS GENERAL INFORMATION 10.2.16h MBMS MODIFICATION REQUEST 10.2.16i MBMS MODIFIED SERVICES INFORMATION 10.2.16j MBMS NEIGHBOURING CELL P-T-M RB INFORMATION 10.2.16k MBMS SCHEDULING INFORMATION 10.2.16L MBMS UNMODIFIED SERVICES INFORMATION 10.2.16m MEASUREMENT CONTROL FAILURE 10.2.18 MEASUREMENT REPORT 10.2.19 PAGING TYPE 1 10.2.20 PAGING TYPE 2 10.2.21 PHYSICAL CHANNEL RECONFIGURATION COMPLETE 10.2.23 PHYSICAL CHANNEL RECONFIGURATION FAILURE 10.2.24 PUSCH CAPACITY REQUEST 10.2.26 RADIO BEARER RECONFIGURATION COMPLETE 10.2.28 RADIO BEARER RECONFIGURATION FAILURE 10.2.29 RADIO BEARER RELEASE COMPLETE 10.2.31 RADIO BEARER RELEASE FAILURE 10.2.32 RADIO BEARER SETUP COMPLETE 10.2.34 RADIO BEARER SETUP FAILURE 10.2.35 RRC CONNECTION RELEASE COMPLETE 10.2.38 RRC CONNECTION REQUEST 10.2.39 RRC CONNECTION SETUP COMPLETE 10.2.41 RRC STATUS 10.2.42 SECURITY MODE COMPLETE 10.2.44 SECURITY MODE FAILURE 10.2.45 SIGNALLING CONNECTION RELEASE INDICATION 10.2.47 Master Information Block 10.2.48.8.1 System Information Block type 1 to System Information Block type 18 10.2.48.8.4 to 10.2.48.8.21 SYSTEM INFORMATION CHANGE INDICATION 10.2.49 TRANSPORT CHANNEL RECONFIGURATION COMPLETE 10.2.51 TRANSPORT CHANNEL RECONFIGURATION FAILURE 10.2.52 TRANSPORT FORMAT COMBINATION CONTROL 10.2.53 TRANSPORT FORMAT COMBINATION CONTROL FAILURE 10.2.54 UE CAPABILITY INFORMATION 10.2.56 UPLINK DIRECT TRANSFER 10.2.58 URA UPDATE 10.2.60 UTRAN MOBILITY INFORMATION CONFIRM 10.2.63 UTRAN MOBILITY INFORMATION FAILURE 10.2.64
No extensions	SYSTEM INFORMATION 10.2.48 First Segment 10.2.48.1 Subsequent or last Segment 10.2.48.3 Complete SIB 10.2.48.5 SIB content 10.2.48.8.1

NOTE 3: For the SYSTEM INFORMATION message protocol extensions are only possible at the level of system information blocks.

10.1.1.1 Non-critical extensions

10.1.1.1.1 Extension of an information element with additional values or choices

In future versions of this protocol, non-critical values may be added to choices, enumerated and size constrained types.

For choices, enumerated and size constrained types it is possible to indicate how many non-critical spare values need to be reserved for future extension. In this case, the tabular format should indicate the number of spare values that are

needed. The value range defined in ASN.1 for the extensible IE should include the number of spares that are needed, since a value outside the range defined for this IE will result in a general ASN.1 violation error.

For downlink messages, spare values may be defined for non-critical information elements for which the need is specified to be MD or OP (or CV case leading to MD or OP). In this case, a receiver not comprehending the received spare value shall consider the information element to have the default value or consider it to be absent respectively.

For uplink messages spare values may be defined for all information elements, including those for which the need is specified to be MP (or CV case leading to MP).

In all cases at most one spare should be defined for choices. In this case, information elements applicable to the spare choices shall be added to the end of the message.

10.1.1.1.2 Extension of a message with additional information elements

In future versions of this protocol, non-critical information elements may be added to RRC messages. These additional information elements shall be normally appended at the end of the message; the transfer syntax specified in this revision of the standard facilitates this. A receiver conformant to this revision of the standard shall accept such extension, and proceed as if it was not included.

A transmitter conformant to this version of the standard shall not include an extension reserved for introducing non critical extensions in later versions of the standard; i.e. the corresponding parameter defined in the ASN.1 shall be absent.

NOTE: If an extension, reserved for future non-critical extensions, is included (even if it is empty), this may result in transfer syntax errors when received by an implementation conforming to a later version of the standard.

Extensions to a release that are introduced after the subsequent release is frozen may however be inserted prior to the end of the message. To facilitate this, "variable length extension containers" have been introduced in most messages.

10.1.1.2 Critical extensions

10.1.1.2.1 Extension of an information element with additional values or choices

In versions of this protocol, choices, enumerated and size constrained types may be extended with critical values. For extension with critical values the general critical extension mechanism is used, i.e. for this no spare values are reserved since backward compatibility is not required.

10.1.1.2.2 Extension of a message with additional information elements

In future versions of this protocol, RRC messages may be extended with new information elements. Since messages including critical extensions are rejected by receivers not comprehending them, these messages may be modified completely, e.g. IEs may be inserted at any place and IEs may be removed or redefined.

10.2 Radio Resource Control messages

10.2.1 ACTIVE SET UPDATE

NOTE: Only for FDD.

This message is used by UTRAN to add, replace or delete radio links in the active set of the UE.

RLC-SAP: AM or UM

Logical channel: DCCH

Direction: UTRAN → UE

Information Element/Group name	Need	Multi	Type and reference	Semantics description	Version
Message Type	MP		Message		

Information Element/Group name	Need	Multi	Type and reference	Semantics description	Version
			Type		
UE information elements					
RRC transaction identifier	MP		RRC transaction identifier 10.3.3.36		
Integrity check info	CH		Integrity check info 10.3.3.16		
Activation time	MD		Activation time 10.3.3.1	Default value is "now".	
New U-RNTI	OP		U-RNTI 10.3.3.47		
New H-RNTI	OP		H-RNTI 10.3.3.14a		REL-6
New Primary E-RNTI	OP		E-RNTI 10.3.3.10a		REL-6
New Secondary E-RNTI	OP		E-RNTI 10.3.3.10a		REL-6
CN information elements					
CN Information info	OP		CN Information info 10.3.1.3		
Phy CH information elements					
DTX-DRX timing information	OP		DTX-DRX timing information 10.3.6.34b		REL-7
DTX-DRX Information	OP		DTX-DRX Information 10.3.6.34a		REL-7
HS-SCCH less Information	OP		HS-SCCH less Information 10.3.6.36a b		REL-7
MIMO parameters	OP		MIMO parameters 10.3.6.41a		REL-7
Uplink radio resources					
Maximum allowed UL TX power	MD		Maximum allowed UL TX power 10.3.6.39	Default value is the existing "maximum UL TX power."	
Downlink radio resources					
Radio link addition information	OP	1 to <maxRL-1>		Radio link addition information required for each RL to add	
>Radio link addition information	MP		Radio link addition information 10.3.6.68		
Radio link removal information	OP	1 to <maxRL>		Radio link removal information required for each RL to remove	
>Radio link removal information	MP		Radio link removal information		

Information Element/Group name	Need	Multi	Type and reference	Semantics description	Version
			10.3.6.69		
TX Diversity Mode	MD		TX Diversity Mode 10.3.6.86	Default value is the TX diversity mode currently used in all or part of the active set.	
DPC Mode	OP		Enumerated (Single TPC, TPC triplet in soft)	"Single TPC" is DPC_Mode=0 and "TPC triplet in soft" is DPC_mode=1 in [29].	REL-5
Serving HS-DSCH cell information	OP		Serving HS-DSCH cell information 10.3.6.74a		REL-6
E-DCH reconfiguration information	OP		E-DCH reconfiguration information 10.3.6.69a		REL-6
UL 16QAM configuration	OP		UL 16QAM configuration 10.3.6.86o		REL-7
E-DCH reconfiguration information same serving cell	OP		E-DCH reconfiguration information same serving cell 10.3.6.69b	This IE is not present if the serving E-DCH cell is changed with this message.	REL-7
E-TFC Boost Info	OP		E-TFC Boost Info 10.3.6.106	Absence of this IE means that boosting of E-DPCCH is disabled	REL-7
E-DPDCH power interpolation	OP		Boolean	True means E-DPDCH power interpolation formula is used, False means E-DPDCH power extrapolation formula is used for the computation of the gain factor β_{ed} according to [29]	REL-7

10.2.2 ACTIVE SET UPDATE COMPLETE

NOTE: For FDD only.

This message is sent by UE when active set update has been completed.

RLC-SAP: AM

Logical channel: DCCH

Direction: UE→UTRAN

Information Element/Group name	Need	Multi	Type and reference	Semantics description
Message Type	MP		Message Type	
UE information elements				
RRC transaction identifier	MP		RRC transaction identifier	

Information Element/Group name	Need	Multi	Type and reference	Semantics description
			10.3.3.36	
Integrity check info	CH		Integrity check info 10.3.3.16	

10.2.3 ACTIVE SET UPDATE FAILURE

NOTE: Only for FDD.

This message is sent by UE if the update of the active set has failed, e.g. because the radio link is not a part of the active set.

RLC-SAP: AM

Logical channel: DCCH

Direction: UE→UTRAN

Information Element/Group name	Need	Multi	Type and reference	Semantics description
Message Type	MP		Message Type	
UE information elements				
RRC transaction identifier	MP		RRC transaction identifier 10.3.3.36	
Integrity check info	CH		Integrity check info 10.3.3.16	
Failure cause	MP		Failure cause and error information 10.3.3.14	

10.2.4 ASSISTANCE DATA DELIVERY

This message is sent by UTRAN to convey UE positioning assistance data to the UE.

RLC-SAP: AM

Logical channel: DCCH

Direction: UTRAN→UE

Information Element/Group name	Need	Multi	Type and reference	Semantics description	Version
Message Type	MP		Message Type		
UE information elements					
RRC transaction identifier	MP		RRC transaction identifier 10.3.3.36		
Integrity check info	CH		Integrity check info 10.3.3.16		
Measurement Information elements					

Information Element/Group name	Need	Multi	Type and reference	Semantics description	Version
UE positioning OTDOA assistance data for UE-based	OP		UE positioning OTDOA assistance data for UE-based 10.3.7.103a		
UE positioning GPS assistance data	OP		UE positioning GPS assistance data 10.3.7.90		
UE positioning GANSS assistance data	OP		UE positioning GANSS assistance data 10.3.7.90b		REL-7

10.2.5 CELL CHANGE ORDER FROM UTRAN

This message is used to order a cell change from UTRA to another radio access technology, e.g., GSM.

RLC-SAP: AM

Logical channel: DCCH

Direction: UTRAN→UE

Information Element/Group name	Need	Multi	Type and reference	Semantics description	Version
Message Type	MP		Message Type		
UE information elements					
RRC transaction identifier	MP		RRC transaction identifier 10.3.3.36		
Integrity check info	CH		Integrity check info 10.3.3.16		
Activation time	MD		Activation time 10.3.3.1	Default value is "now"	
RB Information elements					
RAB information list	OP	1 to <maxRA Bsetup>		This IE should not be included in this version of the protocol.	
>RAB info	MP		RAB info 10.3.4.8		
Other information elements					
Target cell description	MP				
>CHOICE <i>Radio Access Technology</i>	MP			Two spare values are needed.	
>>GSM					
>>>BSIC	MP		BSIC 10.3.8.2		
>>>Band Indicator	MP		Enumerated (DCS 1800 band used, PCS 1900 band used)	Indicates how to interpret the BCCH ARFCN	
>>>BCCH ARFCN	MP		Integer	[45]	

Information Element/Group name	Need	Multi	Type and reference	Semantics description	Version
			(0..1023)		
>>>NC mode	OP		Bit string(3)	Includes bits b1-b3 of the NC mode IE specified in [43]. b1 is the least significant bit. NOTE: The Bit string should be extended to 4 bits in a later version of the message.	
>>>CHOICE GERAN System Info type	OP				REL-5
>>>>SI			GERAN system information 10.3.8.4f	See [44]	REL-5
>>>>PSI			GERAN system information 10.3.8.4f	See [44]	REL-5
>>IS-2000					

10.2.6 CELL CHANGE ORDER FROM UTRAN FAILURE

This message is sent on the RRC connection used before the Cell change order from UTRAN was executed. The message indicates that the UE has failed to seize the new channel in the other radio access technology.

RLC-SAP: AM

Logical channel: DCCH

Direction: UE→UTRAN

Information Element/Group name	Need	Multi	Type and reference	Semantics description
Message Type	MP		Message Type	
UE information elements				
RRC transaction identifier	MP		RRC transaction identifier 10.3.3.36	
Integrity check info	CH		Integrity check info 10.3.3.16	
Other information elements				
Inter-RAT change failure	MP		Inter-RAT change failure 10.3.8.5	

10.2.7 CELL UPDATE

This message is used by the UE to initiate a cell update procedure.

RLC-SAP: TM

Logical channel: CCCH

Direction: UE→UTRAN

Information Element/Group name	Need	Multi	Type and reference	Semantics description	Version
Message Type	MP		Message Type		
UE information elements					
U-RNTI	MP		U-RNTI 10.3.3.47		
RRC transaction identifier	CV- <i>Failure</i>		RRC transaction identifier 10.3.3.36		
Integrity check info	CH		Integrity check info 10.3.3.16		
START list	MP	1 to <maxCN domains >		START [40] values for all CN domains.	
>CN domain identity	MP		CN domain identity 10.3.1.1		
>START	MP		START 10.3.3.38	START value to be used in this CN domain.	
AM_RLC error indication(RB2, RB3 or RB4)	MP		Boolean	TRUE indicates AM_RLC unrecoverable error [16] occurred on RB2, RB3 or RB4 in the UE	
AM_RLC error indication(RB>4)	MP		Boolean	TRUE indicates AM_RLC unrecoverable error [16] occurred on RB>4 in the UE	
Cell update cause	MP		Cell update cause 10.3.3.3		
Traffic volume indicator	OP		Enumerated (true)	This IE shall be set to TRUE when the criteria for event based traffic volume measurement reporting is fulfilled. Absence of this element means not fulfilled.	REL-6
Failure cause	OP		Failure cause and error information 10.3.3.14		
RB timer indicator	MP		RB timer indicator 10.3.3.28		

Information Element/Group name	Need	Multi	Type and reference	Semantics description	Version
Establishment cause	OP		Establishment cause 10.3.3.11		REL-5
CS Call Type	CV- ConversationalCS		Enumerated (speech, video, other)	One spare value is needed	REL-7
HS-PDSCH in CELL_FACH	OP		Enumerated (TRUE)	The absence of this IE indicates that the UE does not support HS-PDSCH reception in CELL_FACH state.	REL-7
UE Mobility State Indicator	MD		Enumerated (High-mobilityDetected)	Absence of this IE implies that, according to [4] either the High mobility state is not applicable or it has not been detected by the UE	REL-7
Capability change indicator	OP		Enumerated (TRUE)	TRUE indicates that the UE capability has changed compared to the value stored in the variable UE_CAPABILITY_TRANSFERRED	REL-7
Reconfiguration Status Indicator	OP		Enumerated (true)	TRUE indicates a reconfiguration procedure is ongoing within the UE or a response message has been submitted to RLC and the UE is waiting for the layer 2 ACK.	REL-6
MBMS Selected Services	OP		MBMS Selected Services Short 10.3.9a.7d		REL-6
Support for Two DRX schemes in URA_PCH and CELL_PCH	OP		Enumerated (TRUE)	The absence of this IE indicates that the UE does not support Two DRX schemes in URA_PCH and CELL_PCH	REL-7
Measurement information elements					
Measured results on RACH	OP		Measured results on RACH 10.3.7.45		

Condition	Explanation
<i>Failure</i>	This IE is mandatory present if the IE "Failure cause" is present and not needed otherwise.
<i>ConversationalCS</i>	This IE is mandatory present if the IE "Establishment cause" has the value "Originating Conversational Call" or "EmergencyCall" and a CS call is being initiated. Otherwise it is not needed.

10.2.8 CELL UPDATE CONFIRM

This message confirms the cell update procedure and can be used to reallocate new RNTI information for the UE valid in the new cell.

RLC-SAP: UM

Logical channel: CCCH or DCCH

Direction: UTRAN→UE

Information Element/Group name	Need	Multi	Type and reference	Semantics description	Version
Message Type	MP		Message Type		
UE Information Elements					
U-RNTI	CV-CCCH		U-RNTI 10.3.3.47		
RRC transaction identifier	MP		RRC transaction identifier 10.3.3.36		
Integrity check info	CH		Integrity check info 10.3.3.16		
Integrity protection mode info	OP		Integrity protection mode info 10.3.3.19	The UTRAN should not include this IE unless it is performing an SRNS relocation or a cell reselection from GERAN <i>lu mode</i>	
Ciphering mode info	OP		Ciphering mode info 10.3.3.5	The UTRAN should not include this IE unless it is performing either an SRNS relocation or a cell reselection from GERAN <i>lu mode</i> , and a change in ciphering algorithm.	
Activation time	MD		Activation time 10.3.3.1	Default value is "now"	
New U-RNTI	OP		U-RNTI 10.3.3.47		
New C-RNTI	OP		C-RNTI 10.3.3.8		
New DSCH-RNTI	OP		DSCH-RNTI 10.3.3.9a	Should not be set in FDD. If received, the UE should ignore it	
New H-RNTI	OP		H-RNTI 10.3.3.14a		REL-5
New Primary E-RNTI	OP		E-RNTI 10.3.3.10a		REL-6
New Secondary E-RNTI	OP		E-RNTI 10.3.3.10a	FDD only	REL-6
RRC State Indicator	MP		RRC State Indicator 10.3.3.35a		
UTRAN DRX cycle length coefficient	OP		UTRAN DRX cycle length coefficient 10.3.3.49		

Information Element/Group name	Need	Multi	Type and reference	Semantics description	Version
Wait time	OP		Wait time 10.3.3.50		
RLC re-establish indicator (RB2, RB3 and RB4)	MP		RLC re-establish indicator 10.3.3.35	Should not be set to TRUE if IE "Downlink counter synchronisation info" is included in message.	
RLC re-establish indicator (RB5 and upwards)	MP		RLC re-establish indicator 10.3.3.35	Should not be set to TRUE if IE "Downlink counter synchronisation info" is included in message.	
CN Information Elements					
CN Information info	OP		CN Information info 10.3.1.3		
UTRAN Information Elements					
URA identity	OP		URA identity 10.3.2.6		
RNC support for change of UE capability	OP		Boolean	Should be included if the message is used to perform an SRNS relocation	REL-7
RB information elements					
RB information to release list	OP	1 to <maxRB>			
>RB information to release	MP		RB information to release 10.3.4.19		
RB information to reconfigure list	OP	1 to <maxRB>			
>RB information to reconfigure	MP		RB information to reconfigure 10.3.4.18		
RB information to be affected list	OP	1 to <maxRB>			
>RB information to be affected	MP		RB information to be affected 10.3.4.17		
Downlink counter synchronisation info	OP				
>RB with PDCP information list	OP	1 to <maxRBall RABs>			
>>RB with PDCP information	MP		RB with PDCP information 10.3.4.22	This IE is needed for each RB having PDCP in the case of lossless SRNS relocation	
	OP				REL-5
>>PDCP context relocation info	OP		PDCP context relocation info 10.3.4.1a	This IE is needed for each RB having PDCP and performing PDCP context relocation	REL-5
PDCP ROHC target mode	OP		PDCP		REL-5

Information Element/Group name	Need	Multi	Type and reference	Semantics description	Version
			ROHC target mode 10.3.4.2a		
TrCH Information Elements					
Uplink transport channels					
UL Transport channel information common for all transport channels	OP		UL Transport channel information common for all transport channels 10.3.5.24		
Deleted TrCH information list	OP	1 to <maxTrCH >			
>Deleted UL TrCH information	MP		Deleted UL TrCH information 10.3.5.5		
Added or Reconfigured TrCH information list	OP	1 to <maxTrCH >			
>Added or Reconfigured UL TrCH information	MP		Added or Reconfigured UL TrCH information 10.3.5.2		
Downlink transport channels					
DL Transport channel information common for all transport channels	OP		DL Transport channel information common for all transport channels 10.3.5.6		
Deleted TrCH information list	OP	1 to <maxTrCH >			
>Deleted DL TrCH information	MP		Deleted DL TrCH information 10.3.5.4		
Added or Reconfigured TrCH information list	OP	1 to <maxTrCH >			
>Added or Reconfigured DL TrCH information	MP		Added or Reconfigured DL TrCH information 10.3.5.1		
PhyCH information elements					
Frequency info	OP		Frequency info 10.3.6.36		
Multi-frequency Info	OP		Multi-frequency Info 10.3.6.39a	This IE is used for 1.28 Mcps TDD only	REL-7

Information Element/Group name	Need	Multi	Type and reference	Semantics description	Version
DTX-DRX timing information	OP		DTX-DRX timing information 10.3.6.34b		REL-7
DTX-DRX Information	OP		DTX-DRX Information 10.3.6.34a		REL-7
HS-SCCH less Information	OP		HS-SCCH less Information 10.3.6.36ab		REL-7
MIMO parameters	OP		MIMO parameters 10.3.6.41a		REL-7
Uplink radio resources					
Maximum allowed UL TX power	MD		Maximum allowed UL TX power 10.3.6.39	Default value is the existing maximum UL TX power	
Uplink DPCH info	OP		Uplink DPCH info 10.3.6.88		
E-DCH Info	OP		E-DCH Info 10.3.6.97		REL-6
Downlink radio resources					
Downlink HS-PDSCH Information	OP		Downlink HS_PDSCH Information 10.3.6.23a		REL-5
Downlink information common for all radio links	OP		Downlink information common for all radio links 10.3.6.24		
Downlink information per radio link list	OP	1 to <maxRL>		Send downlink information for each radio link to be set-up	
>Downlink information for each radio link	MP		Downlink information for each radio link 10.3.6.27		
MBMS PL Service Restriction Information	OP		Enumerated (TRUE)		REL-6

Condition	Explanation
CCCH	This IE is mandatory present when CCCH is used and ciphering is not required and not needed otherwise.

10.2.9 COUNTER CHECK

This message is used by the UTRAN to indicate the current COUNT-C MSB values associated to each radio bearer utilising UM or AM RLC mode and to request the UE to compare these to its COUNT-C MSB values and to report the comparison results to UTRAN.

RLC-SAP: AM

Logical channel: DCCH

Direction: UTRAN→UE

Information Element/Group name	Presence	Multi	IE type and reference	Semantics description
Message Type	MP			
UE information elements				
RRC transaction identifier	MP		RRC transaction identifier 10.3.3.36	
Integrity check info	CH		Integrity check info 10.3.3.16	
RB information elements				
RB COUNT-C MSB information	MP	1 to < maxRBallR ABs >		For each RB (excluding signalling radio bearers) using UM or AM RLC.
>RB COUNT-C MSB information	MP		RB COUNT-C MSB information 10.3.4.14	

10.2.10 COUNTER CHECK RESPONSE

This message is used by the UE to respond to a COUNTER CHECK message.

RLC-SAP: AM

Logical channel: DCCH

Direction: UE→UTRAN

Information Element/Group name	Presence	Multi	IE type and reference	Semantics description
Message Type	MP			
UE information elements				
RRC transaction identifier	MP		RRC transaction identifier 10.3.3.36	
Integrity check info	CH		Integrity check info 10.3.3.16	
RB information elements				
RB COUNT-C information	OP	1 to < maxRBallR ABs >		
>RB COUNT-C information	MP		RB COUNT-C information 10.3.4.15	

10.2.11 DOWNLINK DIRECT TRANSFER

This message is sent by UTRAN to transfer higher layer messages.

RLC-SAP: AM

Logical channel: DCCH

Direction: UTRAN -> UE

Information Element/Group name	Need	Multi	Type and reference	Semantics description
Message Type	MP		Message Type	

Information Element/Group name	Need	Multi	Type and reference	Semantics description
UE information elements				
RRC transaction identifier	MP		RRC transaction identifier 10.3.3.36	
Integrity check info	CH		Integrity check info 10.3.3.16	
CN information elements				
CN Domain Identity	MP		Core Network Domain Identity 10.3.1.1	
NAS message	MP		NAS message 10.3.1.8	

10.2.12 Void

10.2.13 Void

10.2.14 Void

10.2.15 HANDOVER FROM UTRAN COMMAND

This message is used for handover from UMTS to another system e.g. GSM. One or several messages from the other system can be included in the Inter-RAT message information element in this message. These messages are structured and coded according to that systems specification.

RLC-SAP: AM

Logical channel: DCCH

Direction: UTRAN→UE

Information Element/Group name	Need	Multi	Type and reference	Semantics description	Version
Message Type	MP		Message Type		
UE information elements					
RRC transaction identifier	MP		RRC transaction identifier 10.3.3.36		
Integrity check info	CH		Integrity check info 10.3.3.16		
Activation time	MD		Activation time 10.3.3.1	Default value is "now"	
RB information elements					

Information Element/Group name	Need	Multi	Type and reference	Semantics description	Version
RAB information list	OP	1 to <maxRABsetup>		For each RAB to be handed over. In handover to GERAN <i>lu mode</i> the RAB information is included in the GERAN lu message below.	
>RAB info	MP		RAB info 10.3.4.8		
Other information elements					
CHOICE <i>System type</i>	MP			This IE indicates which specification to apply, to decode the transported messages	
>GSM					
>>Frequency band	MP		Enumerated (GSM/DSS 1800 band used), GSM/DSS 1900 band used)		
>>>GSM message					
>>>Single GSM message	MP		Bit string (no explicit size constraint)	Formatted and coded according to GSM specifications The first/leftmost/most significant bit of the bit string contains bit 8 of the first octet of the GSM message.	
>>>GSM message List	MP	1.to.<maxInterSystemMessages>	Bit string (1..512)	Formatted and coded according to GSM specifications. The first/leftmost/most significant bit of the bit string contains bit 8 of the first octet of the GSM message.	
>>>CHOICE <i>GERAN System Info type</i>	OP				REL-6
>>>SI			GERAN system information 10.3.8.4f	See [44]	REL-6
>>>PSI			GERAN system information 10.3.8.4f	See [44]	REL-6

Information Element/Group name	Need	Multi	Type and reference	Semantics description	Version
>GERAN lu					REL-5
>>Frequency band	MP		Enumerated (GSM/DCS 1800 band used), GSM/PCSS 1900 band used)		REL-5
>>>GERAN lu message					REL-5
>>>>Single GERAN lu message	MP		Bit string (no explicit size constraint)	Formatted and coded according to [53]. The first/leftmost/most significant bit of the bit string contains bit 8 of the first octet of the message.	REL-5
>>>>GERAN lu message List	MP	1 to <maxInterSysMessages>	Bit string (1..32768)	Formatted and coded according to [53]. The first/leftmost/most significant bit of the bit string contains bit 8 of the first octet of the message.	REL-5
>cdma2000					
>>cdma2000MessageList	MP	1.to.<maxInterSysMessages>			
>>>>MSG_TYPE(s)	MP		Bit string (8)	Formatted and coded according to cdma2000 specifications. The MSG_TYPE bits are numbered b0 to b7. The first/leftmost/most significant bit of the bit string contains bit 7 of the MSG_TYPE.	
>>>>cdma2000MessagePayload(s)	MP		Bit string (1..512)	Formatted and coded according to cdma2000 specifications. The first/leftmost/most significant bit of the bit string contains the bit 7 of the first octet of the cdma2000 message.	

10.2.16 HANDOVER FROM UTRAN FAILURE

This message is sent on the RRC connection used before the Inter-RAT Handover was executed. The message indicates that the UE has failed to seize the new channel in the other system.

RLC-SAP: AM

Logical channel: DCCH

Direction: UE→UTRAN

Information Element/Group name	Need	Multi	Type and reference	Semantics description	Version
Message Type	MP		Message Type		

Information Element/Group name	Need	Multi	Type and reference	Semantics description	Version
UE information elements					
RRC transaction identifier	MP		RRC transaction identifier 10.3.3.36		
Integrity check info	CH		Integrity check info 10.3.3.16		
Other information elements					
Inter-RAT handover failure	OP		Inter-RAT handover failure 10.3.8.6		
CHOICE <i>System type</i>	OP			This IE indicates which specification to apply to decode the transported messages	
>GSM					
>>GSM message List	MP	1.to.<maxInterSysMessages>	Bit string (1..512)	Formatted and coded according to GSM specifications. The first/leftmost/most significant bit of the bit string contains bit 8 of the first octet of the GSM message.	
>GERAN lu					REL-5
>>GERAN lu message List	MP	1 to <maxInterSysMessages>	Bit string (1..32768)	Formatted and coded according to [53]. The first/leftmost/most significant bit of the bit string contains bit 8 of the first octet of the message.	REL-5
>cdma2000					
>>cdma2000MessageList	MP	1.to.<maxInterSysMessages>			
>>>MSG_TYPE(s)	MP		Bit string (8)	Formatted and coded according to cdma2000 specifications. The MSG_TYPE bits are numbered b0 to b7. The first/leftmost/most significant bit of the bit string contains bit 7 of the MSG_TYPE.	
>>>cdma2000Messagepayload(s)	MP		Bit string (1..512)	Formatted and coded according to cdma2000 specifications. The first/leftmost/most significant bit of the bit string contains bit 7 of the first octet of the cdma2000 message.	

10.2.16a HANDOVER TO UTRAN COMMAND

This message is sent to the UE via other system to make a handover to UTRAN.

RLC-SAP: N/A (Sent through a different RAT)

Logical channel: N/A (Sent through a different RAT)

Direction: UTRAN → UE

Information Element/Group name	Need	Multi	Type and reference	Semantics description	Version
New U-RNTI	MP		U-RNTI Short 10.3.3.48		
Ciphering algorithm	OP		Ciphering algorithm 10.3.3.4		
RNC support for change of UE capability	MP		Boolean		REL-7
New H-RNTI	OP		H-RNTI 10.3.3.14a		REL-6
New Primary E-RNTI	OP		E-RNTI 10.3.3.10a		REL-6
New Secondary E-RNTI	OP		E-RNTI 10.3.3.10a	FDD only	REL-6
CHOICE <i>specification mode</i>	MP				
>Complete specification					
RB information elements					
>>Signalling RB information to setup list	MP	1 to <maxSRBsetup>		For each signalling radio bearer established	
>>>Signalling RB information to setup	MP		Signalling RB information to setup 10.3.4.24		
>>RAB information to setup list	OP	1 to <maxRABsetup>		For each RAB established	
>>>RAB information for setup	MP		RAB information for setup 10.3.4.10		
Uplink transport channels					
>>UL Transport channel information common for all transport channels	MP		UL Transport channel information common for all transport channels 10.3.5.24		
>>Added or Reconfigured TrCH information	MP	1 to <maxTrCH>			
>>>Added or Reconfigured UL TrCH information	MP		Added or Reconfigured UL TrCH information 10.3.5.2		
Downlink transport channels					
>>DL Transport channel information common for all transport channels	MP		DL Transport channel information common for all transport channels 10.3.5.6		

Information Element/Group name	Need	Multi	Type and reference	Semantics description	Version
>>Added or Reconfigured TrCH information	MP	1 to <maxTrCH>			
>>>Added or Reconfigured DL TrCH information	MP		Added or Reconfigured DL TrCH information 10.3.5.1		
Uplink radio resources					
>>Uplink DPCH info	MP		Uplink DPCH info 10.3.6.88		
>>E-DCH Info	OP		E-DCH Info 10.3.6.97		REL-6
Downlink radio resources					
>>Downlink HS-PDSCH Information	OP		Downlink HS-PDSCH Information 10.3.6.23a		REL-6
>>Downlink information common for all radio links	MP		Downlink information common for all radio links 10.3.6.24		
>>Downlink information per radio link	MP	1 to <maxRL>			
>>>Downlink information for each radio link	MP		Downlink information for each radio link 10.3.6.27		
>Preconfiguration					
>>CHOICE <i>Preconfiguration mode</i>	MP				
>>>Predefined configuration	MP		Predefined configuration identity 10.3.4.5		
>>>Default configuration					
>>>>Default configuration mode	MP		Enumerated (FDD, TDD)	Indicates whether the FDD or TDD version of the default configuration shall be used	
>>>>Default configuration identity	MP		Default configuration identity 10.3.4.0		
>>RAB info	OP		RAB info Post 10.3.4.9	One RAB is established	
>>Uplink DPCH info	MP		Uplink DPCH info Post 10.3.6.89		
Downlink radio resources					
>>Downlink information common for all radio links	MP		Downlink information common for all radio links Post 10.3.6.25		
>>Downlink information per	MP	1 to <maxRL>		Send	

Information Element/Group name	Need	Multi	Type and reference	Semantics description	Version
radio link				downlink information for each radio link to be set-up. In TDD MaxRL is 1.	
>>>Downlink information for each radio link	MP		Downlink information for each radio link Post 10.3.6.28		
>>CHOICE <i>mode</i>	MP				
>>>FDD				(no data)	
>>>TDD					
>>>>Primary CCPCH Tx Power	MP		Primary CCPCH Tx Power 10.3.6.59		
Frequency info	MP		Frequency info 10.3.6.36		
Multi-frequency Info	OP		Multi-frequency Info 10.3.6.39a	This IE is used for 1.28 Mcps TDD only	REL-7
Maximum allowed UL TX power	MP		Maximum allowed UL TX power 10.3.6.39		

10.2.16b HANDOVER TO UTRAN COMPLETE

This message is sent by the UE when a handover to UTRAN has been completed.

RLC-SAP: AM

Logical channel: DCCH

Direction: UE → UTRAN

Information Element/Group name	Need	Multi	Type and reference	Semantics description
Message Type	MP		Message Type	
UE Information elements				
START list	CH	1 to <maxCNdo mains>		START [40] values for all CN domains.
>CN domain identity	MP		CN domain identity 10.3.1.1	
>START	MP		START 10.3.3.38	
RB Information elements				
COUNT-C activation time	OP		Activation time 10.3.3.1	Used for radio bearers mapped on RLC-TM.

10.2.16c INITIAL DIRECT TRANSFER

This message is used to initiate a signalling connection based on indication from the upper layers, and to transfer a NAS message.

RLC-SAP: AM

Logical channel: DCCH

Direction: UE -> UTRAN

Information Element/Group name	Need	Multi	Type and reference	Semantics description	Version
Message Type	MP		Message Type		
UE information elements					
Integrity check info	CH		Integrity check info 10.3.3.16		
PLMN identity	OP		PLMN identity 10.3.1.11	This IE indicates the PLMN to which the UE requests the signalling connection to be established.	REL-6
CN information elements					
CN domain identity	MP		CN domain identity 10.3.1.1		
Intra Domain NAS Node Selector	MP		Intra Domain NAS Node Selector 10.3.1.6		
NAS message	MP		NAS message 10.3.1.8		
START	OP		START 10.3.3.38	START value to be used in the CN domain as indicated in the IE "CN domain identity". This IE shall always be present in this version of the protocol.	
Establishment cause	OP		Establishment cause 10.3.3.11		Rel-5
CS Call Type	<i>CV- ConversationalCS</i>		Enumerated (speech, video, other)	One spare value is needed	REL-7
Measurement information elements					
Measured results on RACH	OP		Measured results on RACH 10.3.7.45		
MBMS joined information	OP				REL-6
>P-TMSI	OP		P-TMSI (GSM-MAP) 10.3.1.13		REL-6

Condition	Explanation
<i>ConversationalCS</i>	This IE is mandatory present if the IE "Establishment cause" has the value "Originating Conversational Call" or "EmergencyCall" and the IE "CN domain identity" has the value "CS domain". Otherwise it is not needed.

10.2.16d INTER RAT HANDOVER INFO

This message is sent by the UE via another radio access technology to provide information to the target RNC when preparing for a handover to UTRAN.

RLC-SAP: N/A (Sent through a different RAT)

Logical channel: N/A (Sent through a different RAT)

Direction: UE → UTRAN

Information Element/Group Name	Need	Multi	Type and reference	Semantics description	Version
Radio Bearer IEs					
Predefined configuration status information	OP		Predefined configuration status information 10.3.4.5a		
Predefined configuration status information compressed	OP		Predefined configuration status information compressed 10.3.4.5b		REL-5
UE Information elements					
UE security information	OP		UE security information 10.3.3.42b		
UE security information2	OP		UE security information2 10.3.3.42c		REL-6
UE Specific Behaviour Information 1 interRAT	OP		UE Specific Behaviour Information 1 interRAT 10.3.3.52	This IE shall not be included in this version of the protocol	
UE capability container	OP				
>UE radio access capability	MP		UE radio access capability 10.3.3.42		
>UE radio access capability extension	MP		UE radio access capability extension 10.3.3.42a	Although this IE is not always required, the need has been set to MP to align with the ASN.1	
UE radio access capability compressed	OP		UE radio access capability compressed 10.3.3.42o		REL-5
UE radio access capability comp 2	<i>CV-Fdd</i>		UE radio access capability comp 2 10.3.3.42oa		REL-6

Condition	Explanation
<i>Fdd</i>	This IE is mandatory present for FDD, otherwise it is not needed.

10.2.16e MBMS ACCESS INFORMATION

This message is transmitted periodically by UTRAN to inform UEs that have joined or selected a particular MBMS service about the need to establish an RRC connection or to perform a cell update. While the message contents may change within a modification period, all occurrences of the information within a modification period concern the same MBMS service(s). If the cell on which this message is sent is operating in MBSFN mode as indicated in subclause 8.1.1.6.3 the UE behaves as if this message would not have been received.

RLC-SAP: UM

Logical channel: MCCH

Direction: UTRAN → UE

Information Element/Group name	Need	Multi	Type and reference	Semantics description	Version
Message type	MP		Message Type		REL-6
Service list	MP	1 to <maxMBMSserv Count>			REL-6
>MBMS short transmission ID	MP		MBMS Short transmission identity 10.3.9a.10	Reference/ index to a transmission listed in the MBMS MODIFIED SERVICES INFORMATION or MBMS UNMODIFIED SERVICES INFORMATION	REL-6
>Access probability factor - Idle	MP		Integer (0 to 960 by step of 32, 1000)	Access probability factor for UEs in idle mode. The actual Access Probability (AP) is a function of the Access Probability Factor (APF): $AP (APF) = 2^{-(APF/100)}$	REL-6
>Access probability factor – connected	MD		Integer (0 to 960 by step of 32, 1000)	Access probability factor for UEs in connected mode. The actual Access Probability (AP) is a function of the Access Probability Factor (APF): $AP (APF) = 2^{-(APF/100)}$ Default value is the value included in IE "Access probability factor - Idle"	REL-6
>Connected mode counting scope	MP				REL-6
>>URA_PCH	MP		BOOLEAN	TRUE means that UEs in URA_PCH state shall participate in counting	REL-6
>>CELL_PCH	MP		BOOLEAN	TRUE means that UEs in CELL_PCH state shall participate in counting	REL-6
>> CELL_FACH	MP		BOOLEAN	TRUE means that UEs in CELL_FACH state shall participate in counting	REL-6

10.2.16f MBMS COMMON P-T-M RB INFORMATION

This message is transmitted periodically by UTRAN to inform UEs about the p-t-m RB configuration information that may be common between different services, applicable in the current and/ or in neighbouring cells. The message contents does not change within a modification period.

RLC-SAP: UM

Logical channel: MCCH

Direction: UTRAN → UE

Information Element/Group name	Need	Multi	Type and reference	Semantics description	Version
Message type	MP		Message Type		REL-6
RB information list	MP	1 to <maxMB MS-CommonRB>			REL-6
>RB identity	MP		MBMS Common RB identity 10.3.9a.3		REL-6
>PDCP info	MP		PDCP info 10.3.4.2		REL-6
>RLC info	MP		RLC info MBMS 10.3.4.23a		REL-6
TrCh information for each TrCh	MP	1 to <maxMB MS-CommonTrCh>			REL-6
>Transport channel identity	MP		MBMS Common TrCh identity 10.3.9a.4		REL-6
>TFS	MP		Transport format set 10.3.5.23		REL-6
TrCh information for each CCTrCh	OP	1 to <maxMB MS-CommonCCTrCh>		The list needs not include the CCTrCh for which the default TFCS for MBMS applies, as specified in subclause 14.10.1.	REL-6
>CCTrCH identity	MP		MBMS Common CCTrCh identity 10.3.9a.1		REL-6
>TFCS	MP		Transport format combination set 10.3.5.20		REL-6
PhyCh information	MP	1 to <maxMB MS-CommonPhyCh>			REL-6
>PhyCh identity	MP		MBMS Common PhyCh identity 10.3.9a.2		REL-6
>Secondary CCPCH info MBMS	MP		Secondary CCPCH info MBMS 10.3.6.71a		REL-6
LCR TDD MBSFN	OP		LCR TDD	1.28 Mcps TDD only: included	REL-7

Information Element/Group name	Need	Multi	Type and reference	Semantics description	Version
information			MBSFN Information 10.3.6.78 c	only if some timeslots of the secondary frequency of a multi-frequency cell are designated to MBSFN.	

10.2.16g MBMS CURRENT CELL P-T-M RB INFORMATION

This message is transmitted periodically by UTRAN to inform UEs about the PTM RB configuration used to in a cell, in case one or more MBMS service is provided using p-t-m radio bearers. The message contents does not change within a modification period.

RLC-SAP: UM

Logical channel: MCCH

Direction: UTRAN → UE

Information Element/Group name	Need	Multi	Type and reference	Semantics description	Version
Message type	MP		Message Type	Current cell PTM RB info	REL-6
S-CCPCH list	OP	1 to <maxSC CPCH>		Absent in case MTCH are only mapped to the S-CCPCH(s) included in SIB type 5 or 5bis	REL-6
>S-CCPCH identity	OP		MBMS Current cell S-CCPCH identity 10.3.9a.5	When L1- or L2 combining applies, this identity is used to refer to this S-CCPCH within the NEIGHBOURING CELL P-T-M RB INFORMATION message If the cell is operating in MBSFN mode as indicated in subclause 8.1.1.6.3 the UE behaviour upon reception of this IE is unspecified. When Chip combining (1.28Mcps TDD only) applies, this identity is used to refer to the S-CCPCH within the NEIGHBOURING CELL P-T-M RB INFORMATION message	REL-6
>Secondary CCPCH info	MP		MBMS Common PhyCh identity 10.3.9a.2	Refers to a configuration in the common RB info	REL-6
>MBMS Soft Combining Timing Offset	CV-Soft-FDD		MBMS Soft Combining Timing Offset 10.3.9a.1 0a	Timing offset applied in the CFN calculation in sub-clause 8.5.15.5. The default value is 0 ms. If the cell is operating in MBSFN mode as indicated in subclause 8.1.1.6.3 the UE behaviour upon reception of this IE is unspecified.	REL-6
>TrCh information common for all TrCh	MD		MBMS Common CCTrCh identity 10.3.9a.1	Refers to a (TFCS) configuration in the common RB info The default value of the TFCS is specified in subclause 14.10.1	REL-6
>TrCH information list	MP	1 to <maxFA CHPCH >		List of FACH transport channels carrying one or more MTCH and optionally one MSCH	REL-6
>>TrCh information	MP		MBMS Common TrCh identity 10.3.9a.4	Refers to a (TFS) configuration in the common RB info	REL-6
>>>RB information list	OP	1 to <maxRB perTrCh >		The IE is absent if temporarily no RBs are mapped to this TrCh or if the TrCH only carries MSCH	REL-6
>>>>RB information	MP		MBMS p-t-m RB information 10.3.9a.7 a		REL-6
>>>>MSCH configuration information	OP		MSCH configuration information 10.3.9a.1 6		REL-6
S-CCPCH in SIB type 5	OP	1 to <maxSC		Every S-CCPCH's included in SIB type 5 or 5bis may carry	REL-6

Information Element/Group name	Need	Multi	Type and reference	Semantics description	Version
		CPCH>		MTCH If the cell is operating in MBSFN mode as indicated in subclause 8.1.1.6.3 the UE behaviour upon reception of this IE is unspecified.	
>S-CCPCH identity			Integer (1..maxS CCPCH)	Index of the S-CCPCH within the list included in SIB type 5 or 5bis	REL-6
>TrCH information list	MP	1 to <maxFA CHPCH >		List of FACH transport channels carrying one or more MTCH and optionally one MSCH	REL-6
>>TrCh identity	MP		Integer (1..maxF ACHPCH)	Index of the FACH within the list of TrChs defined for that S-CCPCH as included in SIB type 5 or 5bis	REL-6
>>>RB information list	OP	1 to <maxRB perTrCh >		The IE is absent if this TrCh only carries MSCH	REL-6
>>>>RB information	MP		MBMS p-t-m RB information 10.3.9a.7a		REL-6
>>>>MSCH configuration information	OP		MSCH configuration information 10.3.9a.16	Included if the TrCH carries MSCH	REL-6
MBSFN TDM Info List	CV-Mbsfn		MBSFN TDM Information List 10.3.9a.12b		REL-7

Condition	Explanation
Soft-FDD	This IE is used only for FDD. It is mandatory default for FDD if the IE "L1 combining" is included in MBMS NEIGHBOURING CELL P-T-M RB INFORMATION. Otherwise it is not needed.
Mbsfn	The IE is optionally present if the cell supports MBSFN, and not needed otherwise.

10.2.16h MBMS GENERAL INFORMATION

This message is transmitted periodically by UTRAN to inform UEs about the general MBMS (configuration) information. The message contents does not change within a modification period.

RLC-SAP: UM

Logical channel: MCCH

Direction: UTRAN → UE

Information Element/Group name	Need	Multi	Type and reference	Semantics description	Version
Message type	MP		Message Type		REL-6
MBMS preferred frequency information	OP		MBMS preferred frequency information 10.3.7.43 a	If the cell is operating in MBSFN mode as indicated in subclause 8.1.1.6.3 the UE behaviour upon reception of this IE is unspecified.	REL-6
MBMS timers and counters	MP		MBMS specific timers and counters 10.3.9a.1 1		REL-6
MICH configuration information	MP		MICH configuration information 10.3.9a.1 4		REL-6
Cell group identity	MP		Bit string (12)	Identifies the group of cells for which the same common RLC and PDCP entity is used as the current cell	REL-6
Default MSCH configuration information	OP		MSCH configuration information 10.3.9a.1 6	The default MSCH configuration	REL-6
Indicate changes in MBMS Selected Services	MD		Boolean	True means the UE indicates changes in MBMS Selected Services while in URA_PCH, CELL_PCH or in CELL_FACH Default value is FALSE If the cell is operating in MBSFN mode as indicated in subclause 8.1.1.6.3 the UE behaves as if this IE has the value FALSE.	REL-6
MBSFN inter frequency neighbour list	OP		MBSFN inter frequency neighbour list 10.3.7.43 b	May be included for FDD and 3.84/7.68 Mcps TDD if the cell is operating in MBSFN mode	Rel-7

10.2.16i MBMS MODIFICATION REQUEST

The UE transmits this message to request UTRAN to take certain actions to improve the UE's ability to receive its (prioritised) activated MBMS services and/ or sessions.

RLC-SAP: AM

Logical channel: DCCH

Direction: UE → UTRAN

Information Element/Group name	Need	Multi	Type and reference	Semantics description	Version
Message type	MP		Message Type		REL-6
UE information elements					REL-6
Integrity check info	CH		Integrity check info 10.3.3.16		REL-6
MBMS information elements					REL-6
MBMS preferred frequency request	OP		MBMS service identity 10.3.9a.8	The MBMS preferred frequency the UE would like to be moved to. The MBMS preferred frequency is identified by the identity of the MBMS service the UE would like to receive.	REL-6
MBMS RB list requested to be released	OP	1 to <maxRB >		RBs of lower priority MBMS services inhibiting reception of a higher priority service	REL-6
>RB information to release	MP		RB information to release 10.3.4.19		REL-6
MBMS Selected Service Info	OP		MBMS Selected Service Info 10.3.9a.7b		REL-6
Support of MBMS service change for a ptp RB	OP		Enumerated (true)	In this version of the specification, this IE has no meaning but it shall be included upon the conditions specified in subclause 8.7.6.2a.	REL-6

10.2.16j MBMS MODIFIED SERVICES INFORMATION

This information is transmitted periodically by UTRAN to inform UEs about a change applicable for one or more MBMS services available in the current cell and possibly in neighbouring cells.

RLC-SAP: AM (DCCH only) or UM

Logical channel: MCCH, DCCH

Direction: UTRAN → UE

Information Element/Group name	Need	Multi	Type and reference	Semantics description	Version
Message type	MP		Message Type		REL-6
UE information elements					REL-6
Integrity check info	CV-DCCH H		Integrity check info 10.3.3.16	Integrity check info is included if integrity protection is applied	REL-6
MBMS information elements					REL-6
Modified service list	OP	1.. <maxMB MSserv Modif>			REL-6
>MBMS Transmission identity	MP		MBMS Transmission identity 10.3.9a.1 2		REL-6
>MBMS required UE action	MP		Enumerated (None, Acquire counting info, Acquire counting info – PTM RBs unmodified, Acquire PTM RB info, RequestPTP RB, Release PTM RB)	Indicates required UE action upon receiving the message. When sent on the DCCH, only the following values apply: None, Acquire PTM RB info, request PTP RB). If the cell is operating in MBSFN mode as indicated in subclause 8.1.1.6.3 all values except "Acquire PTM RB info" and "Release PTM RB" are handled as if "None" was received.	REL-6
>MBMS PTM RB Release Cause	CV- <i>PTM_RB_RELEASE_LC R_TDD</i>		Enumerated (NormalRelease, Out of MBMS Service Coverage in RAN, Network Abnormal Release)	Indicates the PTM RB Release cause. For 1.28 Mcps TDD only.	REL-7
>MBMS preferred frequency	OP			Indicates the frequency that UEs shall consider as the preferred frequency. If the cell is operating in MBSFN mode as indicated in subclause 8.1.1.6.3 the UE behaviour upon reception of this IE is unspecified.	REL-6
>>PFL index	CV- <i>MCCH</i>		Integer (1.. <maxMB MS- Freq>)	Index pointing to an entry in the list included in MBMS GENERAL INFORMATION. If the cell is operating in MBSFN mode as indicated in subclause 8.1.1.6.3 the UE behaviour upon reception of this IE is unspecified.	REL-6
>>PFL info	CV- <i>DCCH</i>		Frequency info 10.3.6.36		REL-6
>Continue MCCH	MP		BOOLEA	MCCH in- band notification.	REL-6

Information Element/Group name	Need	Multi	Type and reference	Semantics description	Version
reading			N	Indicates whether or not the UE should continue reading MCCH in the next modification period. Not applicable when sent on the DCCH	
>MBSFN cluster frequency	CV-MBSFN		Integer (1..<max MBSFNclusters>)	For FDD and 3.84/7.68 Mcps TDD index pointing to a frequency indicated in the IE "MBSFN inter frequency neighbour list " in MBMS General Information. Default: the current MBSFN cluster. For 1.28 Mcps TDD index pointing to a frequency indicated in the SIB 11. Default: the current MBSFN cluster.	REL-7
MBMS re- acquire MCCH	CV-MCCHOP		Enumerated (True)		REL-6
MBMS dynamic persistence level	CV-MCCHOP		Dynamic persistence level 10.3.6.35	If the cell is operating in MBSFN mode as indicated in subclause 8.1.1.6.3 the UE behaviour upon reception of this IE is unspecified	REL-6
End of modified MCCH information	CV-MCCHOP		Integer (1..16)	If present: the UE may assume that, in each repetition period, all the MCCH information preceding the MBMS UNMODIFIED SERVICES INFORMATION message is transmitted within the indicated number of TTIs.	REL-6
MBMS number of neighbour cells	MP		Integer (0..32)	Indicates the number of MBMS NEIGHBOURING CELL P-T-M RB INFORMATION messages that are contained within the MCCH transmission. Not applicable when sent on the DCCH. If the cell is operating in MBSFN mode as indicated in subclause 8.1.1.6.3 the UE behaves as if the value 0 was received.	REL-6
MBMS all unmodified p-t-m services	CV-MCCHOP		Enumerated (True)	True means that the UE should re-acquire the PtM information for all services listed in the message MBMS UNMODIFIED SERVICES INFORMATION with the IE "MBMS required UE action" set to "Acquire PTM RB info"	REL-6
MBMS p-t-m activation time	CV-MCCHOP		MBMS p-t-m activation time 10.3.9a.7o		REL-6
MIB Value tag	OP		MIB Value tag 10.3.8.9	Indicates the matching System Information.	REL-7

Condition	Explanation
<i>MCCH</i>	This IE is mandatory present if the message is sent via MCCH and not needed otherwise.
<i>DCCH</i>	This IE is mandatory present if the message is sent via DCCH and not needed otherwise.
<i>MCCHOP</i>	This IE is optionally present if the message is sent via MCCH and not needed otherwise.
<i>DCCHCH</i>	This IE is present conditionnaly on history if the message is sent via DCCH and not present otherwise.
<i>MBSFN</i>	This IE is mandatory default when the cell on which this IE is sent is operating in MBSFN mode according to subclause 8.1.1.6.3. Otherwise the IE is not needed.
<i>PTM_RB_RELEASE_LCR_TDD</i>	This IE is optionally present if the IE "MBMS required UE action" has the value "Release PTM RB". Otherwise it is not needed. For 1.28 Mcps TDD only.

10.2.16k MBMS NEIGHBOURING CELL P-T-M RB INFORMATION

This message is transmitted periodically by UTRAN to inform UEs about the p-t-m RB configuration used to in neighbouring cells, indicating the UE may perform selection and/ or soft combining. The message content does not change within a modification period. If the cell is operating in MBSFN mode as indicated in subclause 8.1.1.6.3 the UE behaviour upon reception of this message is unspecified.

RLC-SAP: UM

Logical channel: MCCH

Direction: UTRAN → UE

Information Element/Group name	Need	Multi	Type and reference	Semantics description	Version
Message type	MP		Message Type		REL-6
Neighbouring cell identity	MP		Integer (0..<max CellMeas -1>)	The intra-frequency cell id of the cell obtained from the IE 'Intra-frequency Cell Info list' in SIB 11/SIB 11bis. In case the intra-frequency cell id is omitted in the IE 'Intra-frequency Cell Info list' in SIB 11/SIB 11bis, it refers to the index (starting at zero) in the CELL_INFO_LIST as if the CELL_INFO_LIST was constructed from SIB11/SIB11bis only, see 8.6.7.3.	REL-6
Neighbouring cell's S-CCPCH list	MP	1 to <maxSC CPCH>			REL-6
>CHOICE <i>PhyCh</i>	MP				REL-7
>>By reference					REL-7
>>>Secondary CCPCH info	MP		MBMS Common PhyCh identity 10.3.9a.2	S-CCPCH configuration used in neighbouring cell. Refers to a configuration in the common RB info of the current cell	REL-6
>>Extended				FDD only	REL-7
>>>Secondary CCPCH info	OP		MBMS Common PhyCh identity 10.3.9a.2	Referenced S-CCPCH configuration used in neighbouring cell. Refers to a configuration in the common RB info of the current cell	REL-7
>>>Secondary CCPCH info MBMS Diff	MP		Secondary CCPCH info MBMS Diff 10.3.6.71 b	Differential S-CCPCH configuration. Physical configuration parameters in this IE replace the corresponding parameters in the referenced S-CCPCH configuration. If the referenced S-CCPCH configuration is absent, the full set of parameters is needed.	REL-7
>Secondary CCPCH Power Offset Difference	MD		Integer (-6, -3, 3, 6)	Difference ($P_n - O_f$) between the S-CCPCH power offset (P_n) of the neighboring cell S-CCPCH and the S-CCPCH power offset (O_f) of the serving cell that is going to be combined to this neighbour cell S-CCPCH, in dB. Default value is 0. Note 3 and 4.	REL-6
>L1 combining	OP			L2- combining applies if the IE is absent	REL-6
>>CHOICE <i>mode</i>	MP				REL-6
>>>FDD					REL-6
>>>>MBMS Soft Combining Timing Offset	MP		MBMS Soft Combining Timing Offset 10.3.9a.1 0a	Timing offset applied in the CFN calculation in subclause 8.5.15.5	REL-6
>>>>MBMS transmission time difference	MP		Integer (0..3)	Indicates the time difference between the TTIs on the current and the neighbouring cell's SCCPCH that can be L1-combined	REL-6
>>>>MBMS L1 combining schedule	OP		MBMS L1 combining	If included partial layer 1 combining applies, in which case	REL-6

Information Element/Group name	Need	Multi	Type and reference	Semantics description	Version
			schedule 10.3.9a.7	this IE indicates when L1-combining applies. If the IE is absent, L1 combining applies continuously	
>>>TDD				(no data)	REL-6
				If L1 combining is configured, for 1.28Mcps TDD UE, MBMS data reception shall be implemented by means of chip combine receiver [55].	REL-7
>CHOICE L23 configuration	MP				REL-6
>>SameAs Current cell				Apart from the physical channel configuration and the MSCH configuration information, the same configuration as for the indicated S-CCPCH used in the current cell applies. The MSCH is mapped on the same transport channel as in the current cell.	REL-6
>>>Current cell's S-CCPCH	MP		MBMS Current cell S-CCPCH identity 10.3.9a.5	Reference to the S-CCPCH in the current cell which uses exactly the same configuration (excluding MSCH configuration).	REL-6
>>>MSCH configuration information	OP		MSCH configuration information 10.3.9a.16		REL-6
>>Different					REL-6
>>>TrCh information for common for all TrCh	MD		MBMS Common CTrCh identity 10.3.9a.1	Refers to a (TFCS) configuration in the common RB info The default value of the TFCS is specified in subclause 14.10.1	REL-6
>>>TrCH information list	MP	1 to <maxFACHPCH>		List of FACH transport channels carrying one or more MTCH and optionally one MSCH	REL-6
>>>>TrCh information	MP		MBMS Common TrCh identity 10.3.9a.4	Refers to a (TFS) configuration in the common RB info	REL-6
>>>>TrCh combining status	MP		BOOLEAN	Value TRUE means that TrCh combining is used for this transport channel (TDD only). Note 2. The IE shall be ignored in FDD mode.	REL-6
>>>>RB information list	OP	1 to <maxRB perTrCh>		The IE is only present for the radio bearers for which selection (FDD) or transport channel (TDD) combining applies.	REL-6
>>>>>RB information	MP		MBMS p-t-m RB information 10.3.9a.7a		REL-6
>>>>MSCH configuration information	OP		MSCH configuration	Included if the TrCH carries MSCH	REL-6

Information Element/Group name	Need	Multi	Type and reference	Semantics description	Version
			ion informatio n 10.3.9a.1 6		

NOTE 1: The signalling supports the option that UTRAN maps one service to L1 combining slots for some neighbours and to the L2 combining slots for other neighbours ie. the use of different combining schemes for different neighbours

NOTE 2: Transport combining can only be indicated when the complete L2 configuration is provided for the neighbouring cell (i.e. using L2 configuration choice “different”). Fortunately, a scenario in which the neighbouring cell configuration is different from the current cell is regarded as the typical scenario for using transport combining.

NOTE 3: For FDD, an S-CCPCH power offset is defined as the offset between the transmitted power of the data part of one S-CCPCH and the transmitted power of the P-CPICH of a given cell ($P_{s-ccpch} - P_{p-cpich}$). For TDD, an S-CCPCH power offset is defined as the offset between one S-CCPCH and the P-CCPCH of a given cell ($P_{s-ccpch} - P_{p-ccpch}$).

NOTE 4: The Secondary CCPCH Power Offset Difference IE gives the UE an indication of the S-CCPCH power on the neighbouring cells that may be used to complete the neighbouring cell ranking based on P-CPICH power for FDD or P-CCPCH for TDD.

10.2.16L MBMS SCHEDULING INFORMATION

This message is transmitted periodically by UTRAN to inform UEs when the MBMS services, provided on the same S-CCPCH as the message is sent, are scheduled to be transmitted. The UE may use the scheduling information to discontinue receiving the concerned S-CCPCH. The message is transmitted in accordance with the MSCH configuration applicable for the corresponding S-CCPCH.

RLC-SAP: UM

Logical channel: MSCH

Direction: UTRAN → UE

Information Element/Group name	Need	Multi	Type and reference	Semantics description	Version
Message type	MP		Message Type		REL-6
Service scheduling info list	MP	1 to <maxMBMSservSched>			REL-6
>MBMS Transmission identity	MP		MBMS Transmission identity 10.3.9a.1 2		REL-6
>MBMS Service transmissions info list	OP	1 to <maxMBMSTransmis>		One or more sets of scheduling information comprising of the beginning and duration of an MBMS service transmission for one scheduling period	REL-6
>>Start	MP		Integer (0..1020) by step of 4	Indicates the start of the transmission relative to the start of the TTI in which the MBMS SCHEDULING INFORMATION message was received. In number of radio frames (i.e. the value 0 would correspond to the start of the MBMS transmission being in the same TTI as the MBMS Scheduling Information message.) See note 1.	REL-6
>>Duration	MP		Integer (4..1024) by step of 4	In number of radio frames	REL-6
>Next scheduling period	MP		Integer (0..31)	Number of scheduling periods (see 10.3.9a.16), after the current scheduling period, in which no data will be transmitted for the concerned service. If the Next scheduling period is set to 0, data may be transmitted for the concerned service in the scheduling period immediately following the current scheduling period	REL-6

NOTE: If UTRAN sets the value of the IE "Start" to a value less than or equal to 16 then the UE may not successfully receive the start of the MTCH transmission.

10.2.16m MBMS UNMODIFIED SERVICES INFORMATION

This message is transmitted periodically by UTRAN to inform UEs about the MBMS services, available in the current cell and possibly in neighbouring cells, that have not changed if the IE "MBMS all unmodified p-t-m services" is not included in the MBMS MODIFIED SERVICES INFORMATION message in this modification period. The message is repeated every repetition period while its contents does not change within a modification period.

RLC-SAP: UM

Logical channel: MCCH

Direction: UTRAN → UE

Information Element/Group name	Need	Multi	Type and reference	Semantics description	Version
Message type	MP		Message Type		REL-6
Unmodified services list	OP	1 to <maxMBMSserv Unmodif >		If the IE "MBMS all unmodified p-t-m services" is included in the MBMS MODIFIED SERVICES INFORMATION message in this modification period, the services with the IE "MBMS required UE action" set to "Acquire PTM RB info" in the message MBMS UNMODIFIED SERVICES INFORMATION should be considered as modified.	REL-6
>MBMS Transmission identity	MP		MBMS Transmission identity 10.3.9a.1 2		REL-6
>MBMS required UE action	MP		Enumerated (None, Acquire PTM RB info, Request PTP RB)	Indication of the UE action required to receive the service. If the cell is operating in MBSFN mode as indicated in subclause 8.1.1.6.3 all values except "Acquire PTM RB info" are handled as if "None" was received.	REL-6
>MBMS preferred frequency	OP		Integer (1.. <maxMBMS-Freq>)	Information about the frequency that UEs shall consider as the preferred frequency layer for cell re-selection during a session for an activated MBMS service, as specified in [25.304]. Index pointing to an entry in the list included in MBMS GENERAL INFORMATION. If the cell is operating in MBSFN mode as indicated in subclause 8.1.1.6.3 the UE behaviour upon reception of this IE is unspecified.	REL-6
>MBSFN cluster frequency	CV- MBSFN		Integer (1..<max MBSFNclusters>)	For FDD and 3.84/7.68 Mcps TDD index pointing to a frequency indicated in the IE "MBSFN inter frequency neighbour list " in MBSFN General Information. Default: the current MBSFN cluster. For 1.28 Mcps TDD index pointing to a frequency indicated in the SIB 11. Default: the current MBSFN cluster.	REL-7

Condition	Explanation
<i>MBSFN</i>	This IE is mandatory present when the cell on which this IE is sent is operating in MBSFN mode according to subclause 8.1.1.6.3. Otherwise the IE is not needed.

10.2.17 MEASUREMENT CONTROL

This message is sent by UTRAN to setup, modify or release a measurement in the UE.

RLC-SAP: AM

Logical channel: DCCH

Direction: UTRAN→UE

Information Element/Group name	Need	Multi	Type and reference	Semantics description
Message Type	MP		Message Type	
UE information elements				
RRC transaction identifier	MP		RRC transaction identifier 10.3.3.36	
Integrity check info	CH		Integrity check info 10.3.3.16	
Measurement Information elements				
Measurement Identity	MP		Measurement Identity 10.3.7.48	
Measurement Command	MP		Measurement Command 10.3.7.46	
Measurement Reporting Mode	OP		Measurement Reporting Mode 10.3.7.49	
Additional measurements list	OP		Additional measurements list 10.3.7.1	
CHOICE <i>Measurement type</i>	<i>CV-command</i>			
>Intra-frequency measurement			Intra-frequency measurement 10.3.7.36	
>Inter-frequency measurement			Inter-frequency measurement 10.3.7.16	
>Inter-RAT measurement			Inter-RAT measurement 10.3.7.27	
>UE positioning measurement			UE positioning measurement 10.3.7.100	
>Traffic Volume measurement			Traffic Volume measurement 10.3.7.68	
>Quality measurement			Quality measurement 10.3.7.56	
>UE internal measurement			UE internal measurement 10.3.7.77	
Physical channel information elements				
DPCH compressed mode status info	OP		DPCH compressed mode status info 10.3.6.34	

Condition	Explanation
<i>Command</i>	The IE is mandatory present if the IE "Measurement command" is set to "Setup", optional if the IE "Measurement command" is set to "modify", otherwise the IE is not needed.

10.2.18 MEASUREMENT CONTROL FAILURE

This message is sent by UE, if it cannot initiate a measurement as instructed by UTRAN.

RLC-SAP: AM

Logical channel: DCCH

Direction: UE→UTRAN

Information Element/Group name	Need	Multi	Type and reference	Semantics description
Message Type	MP		Message Type	
UE information elements				
RRC transaction identifier	MP		RRC transaction identifier 10.3.3.36	
Integrity check info	CH		Integrity check info 10.3.3.16	
Failure cause	MP		Failure cause and error information 10.3.3.14	

10.2.19 MEASUREMENT REPORT

This message is used by UE to transfer measurement results to the UTRAN.

RLC-SAP: AM or UM

Logical channel: DCCH

Direction: UE→UTRAN

Information Element/Group name	Need	Multi	Type and reference	Semantics description	Version
Message Type	MP		Message Type		
UE information elements					
Integrity check info	CH		Integrity check info 10.3.3.16		
Measurement Information Elements					
Measurement identity	MP		Measurement identity 10.3.7.48		
Measured Results	OP		Measured Results 10.3.7.44		
Measured Results on RACH	OP		Measured Results on RACH 10.3.7.45		
Additional Measured results	OP	1 to <maxAdditional Meas>			
>Measured Results	MP		Measured Results 10.3.7.44		
Event results	OP		Event results 10.3.7.7		
Inter-RAT cell info indication	CV- <i>IRAT</i>		Integer (0..3)		REL-5

Condition	Explanation
<i>IRAT</i>	The IE is optionally present if at least one of the IE "Inter-RAT measured results list" and the IE "Inter-RAT measurement event results" is included in the message. Otherwise, the IE is not needed.

10.2.20 PAGING TYPE 1

This message is used to send information on the paging channel. One or several UEs, in idle or connected mode, can be paged in one message, which also can contain other information.

RLC-SAP: TM

Logical channel: PCCH

Direction: UTRAN → UE

Information Element/Group name	Need	Multi	Type and reference	Semantics description
--------------------------------	------	-------	--------------------	-----------------------

Message Type	MP		Message Type	
UE Information elements				
Paging record list	OP	1 to <maxPage 1>		
>Paging record	MP		Paging record 10.3.3.23	
Other information elements				
BCCH modification info	OP		BCCH modification info 10.3.8.1	

If the encoded message does not fill a transport block, the RRC layer shall add padding according to subclause 12.1.

10.2.21 PAGING TYPE 2

This message is used to page a UE in connected mode, when using the DCCH for CN originated paging.

RLC-SAP: AM

Logical channel: DCCH

Direction: UTRAN → UE

Information Element/Group name	Need	Multi	Type and reference	Semantics description
Message Type	MP		Message Type	
UE information elements				
RRC transaction identifier	MP		RRC transaction identifier 10.3.3.36	
Integrity check info	CH		Integrity check info 10.3.3.16	
Paging cause	MP		Paging cause 10.3.3.22	
CN Information elements				
CN domain identity	MP		CN domain identity 10.3.1.1	
Paging Record Type Identifier	MP		Paging Record Type Identifier 10.3.1.10	

10.2.22 PHYSICAL CHANNEL RECONFIGURATION

This message is used by UTRAN to assign, replace or release a set of physical channels used by a UE.

RLC-SAP: AM or UM

Logical channel: DCCH

Direction: UTRAN → UE

Information Element/Group name	Need	Multi	Type and reference	Semantics description	Version
Message Type	MP		Message Type		

Information Element/Group name	Need	Multi	Type and reference	Semantics description	Version
UE Information Elements					
RRC transaction identifier	MP		RRC transaction identifier 10.3.3.36		
Integrity check info	CH		Integrity check info 10.3.3.16		
Integrity protection mode info	OP		Integrity protection mode info 10.3.3.19	The UTRAN should not include this IE unless it is performing an SRNS relocation	
Ciphering mode info	OP		Ciphering mode info 10.3.3.5	The UTRAN should not include this IE unless it is performing an SRNS relocation and a change in ciphering algorithm	
Activation time	MD		Activation time 10.3.3.1	Default value is "now"	
Delay restriction flag	OP		Enumerated (TRUE)	This IE is always set to TRUE and included if the activation time is restricted according to subclause 8.6.3.1	REL-6
New U-RNTI	OP		U-RNTI 10.3.3.47		
New C-RNTI	OP		C-RNTI 10.3.3.8		
New DSCH-RNTI	OP		DSCH-RNTI 10.3.3.9a	Should not be set in FDD. If received the UE should ignore it	
New H-RNTI	OP		H-RNTI 10.3.3.14a		REL-5
New Primary E-RNTI	OP		E-RNTI 10.3.3.10a		REL-6
New Secondary E-RNTI	OP		E-RNTI 10.3.3.10a	FDD only	REL-6
RRC State Indicator	MP		RRC State Indicator 10.3.3.35a		
UE Mobility State Indicator	CV-FACH_PCH		Enumerated (High-mobilityDetected)	Absence of this IE implies that, according to [4], the UE shall consider itself being in the mobility state the UE has maintained in CELL_DCH state or being not in high mobility state after the state transition, if applicable.	REL-7
UTRAN DRX cycle length coefficient	OP		UTRAN DRX cycle length coefficient 10.3.3.49		

Information Element/Group name	Need	Multi	Type and reference	Semantics description	Version
CN Information Elements					
CN Information info	OP		CN Information info 10.3.1.3		
UTRAN mobility information elements					
URA identity	OP		URA identity 10.3.2.6		
RNC support for change of UE capability	OP		Boolean	Should be included if the message is used to perform an SRNS relocation	REL-7
Reconfiguration in response to requested change of UE capability	OP		Enumerated (TRUE)		REL-7
RB information elements					
Downlink counter synchronisation info	OP				
>RB with PDCP information list	OP	1 to <maxRBall RABs>			
>>RB with PDCP information	MP		RB with PDCP information 10.3.4.22	This IE is needed for each RB having PDCP in the case of lossless SRNS relocation	
	OP				REL-5
>>>PDCP context relocation info	OP		PDCP context relocation info 10.3.4.1a	This IE is needed for each RB having PDCP and performing PDCP context relocation	REL-5
PhyCH information elements					
Frequency info	OP		Frequency info 10.3.6.36		
Multi-frequency Info	OP		Multi-frequency Info 10.3.6.39a	This IE is used for 1.28 Mcps TDD only	REL-7
DTX-DRX timing information	OP		DTX-DRX timing information 10.3.6.34b		REL-7
DTX-DRX Information	OP		DTX-DRX Information 10.3.6.34a		REL-7
HS-SCCH less Information	OP		HS-SCCH less Information 10.3.6.36ab		REL-7
MIMO parameters	OP		MIMO parameters 10.3.6.41a		REL-7
HARQ Info	OP		HARQ info 10.3.5.7a		REL-7
Uplink radio resources					
Maximum allowed UL TX power	MD		Maximum allowed UL TX power 10.3.6.39	Default value is the existing value of the maximum allowed UL TX power	
Uplink DPCH info	OP		Uplink		

Information Element/Group name	Need	Multi	Type and reference	Semantics description	Version
			DPCH info 10.3.6.88		
E-DCH Info	OP		E-DCH Info 10.3.6.97		REL-6
Downlink radio resources					
Downlink HS-PDSCH Information	OP		Downlink HS_PDSCH Information 10.3.6.23a		REL-5
Downlink information common for all radio links	OP		Downlink information common for all radio links 10.3.6.24		
Downlink information per radio link list	OP	1 to <maxRL>		Send downlink information for each radio link	
>Downlink information for each radio link	MP		Downlink information for each radio link 10.3.6.27		
MBMS PL Service Restriction Information	OP		Enumerated (TRUE)		REL-6

Condition	Explanation
<i>FACH_PCH</i>	This IE is mandatory default when a transition from CELL_DCH to CELL_FACH, URA_PCH or CELL_PCH is requested by the message and is not needed otherwise.

10.2.23 PHYSICAL CHANNEL RECONFIGURATION COMPLETE

This message is sent from the UE when a physical channel reconfiguration has been done.

RLC-SAP: AM

Logical channel: DCCH

Direction: UE → UTRAN

Information Element/Group name	Need	Multi	Type and reference	Semantics description	Version
Message Type	MP		Message Type		
UE information elements					
RRC transaction identifier	MP		RRC transaction identifier 10.3.3.36		
Integrity check info	CH		Integrity check info 10.3.3.16		
Uplink integrity protection activation info	OP		Integrity protection activation info 10.3.3.17		
CHOICE <i>mode</i>	MP				
>FDD				(no data)	
>TDD					
>>CHOICE <i>TDD option</i>	MP				REL-4

Information Element/Group name	Need	Multi	Type and reference	Semantics description	Version
>>>3.84 Mcps TDD					REL-4
>>>>Uplink Timing Advance	OP		Uplink Timing Advance 10.3.6.95		
>>>>Extended Uplink Timing Advance	OP		Extended Uplink Timing Advance 10.3.6.95a		REL-7
>>>7.68 Mcps TDD					REL-7
>>>>Extended Uplink Timing Advance	OP		Extended Uplink Timing Advance 10.3.6.95a		REL-7
>>>1.28 Mcps TDD				(no data)	REL-4
Other Information elements					REL-7
Deferred measurement control reading	MD		Enumerated (TRUE)	Indicates the UE has not read SIB11, SIB11bis and SIB12, if available. Default value is FALSE	REL-7
RB Information elements					
COUNT-C activation time	OP		Activation time 10.3.3.1	Used for radio bearers mapped on RLC-TM.	
Uplink counter synchronisation info	OP				
>RB with PDCP information list	OP	1 to <maxRBall RABs>			
>>RB with PDCP information	MP		RB with PDCP information 10.3.4.22		
>START list	MP	1 to <maxCNdo mains>		START [40] values for all CN domains.	
>>CN domain identity	MP		CN domain identity 10.3.1.1		
>>START	MP		START 10.3.3.38	START value to be used in this CN domain.	

10.2.24 PHYSICAL CHANNEL RECONFIGURATION FAILURE

This message is sent by UE if the configuration given by UTRAN is unacceptable or if the UE failed to assign, replace or release a set of physical channel(s).

RLC-SAP: AM

Logical channel: DCCH

Direction: UE→UTRAN

Information Element/Group name	Need	Multi	Type and reference	Semantics description
Message type	MP		Message type	
UE information elements				
RRC transaction identifier	OP		RRC transaction identifier 10.3.3.36	
Integrity check info	CH		Integrity check info 10.3.3.16	
Failure cause	MP		Failure cause and error information 10.3.3.14	

10.2.25 PHYSICAL SHARED CHANNEL ALLOCATION

NOTE: Only for TDD.

This message is used by UTRAN to assign physical resources to USCH/DSCH transport channels in TDD, for temporary usage by the UE.

RLC-SAP: UM on SHCCH, UM on DCCH

Logical channel: SHCCH or DCCH

Direction: UTRAN → UE

Information Element/Group name	Need	Multi	Type and reference	Semantics description
Message Type	MP		Message type	
DSCH-RNTI	OP		DSCH-RNTI 10.3.3.9a	
RRC transaction identifier	MP		RRC transaction identifier 10.3.3.36	
Uplink timing advance Control	MD		Uplink Timing Advance Control 10.3.6.96	Default value is the existing value for uplink timing advance
PUSCH capacity allocation info	OP		PUSCH Capacity Allocation info 10.3.6.64	
PDSCH capacity allocation info	OP		PDSCH Capacity Allocation info 10.3.6.42	
Confirm request	MD		Enumerated(No Confirm, Confirm PDSCH, Confirm PUSCH)	Default value is No Confirm
Traffic volume report request	OP		Integer (0 .. 255)	Indicates the number of frames between start of the allocation period and sending measurement report. The

Information Element/Group name	Need	Multi	Type and reference	Semantics description
				value should be less than the value for Allocation Duration.
ISCP Timeslot list	OP	1 to maxTS		
>Timeslot number	MP		Timeslot number 10.3.6.84	Timeslot numbers, for which the UE shall report the timeslot ISCP in PUSCH CAPACITY REQUEST message.
Request P-CCPCH RSCP	MP		Boolean	TRUE indicates that a Primary CCPCH RSCP measurement shall be reported by the UE in PUSCH CAPACITY REQUEST message.

10.2.26 PUSCH CAPACITY REQUEST

NOTE: Only for TDD.

This message is used by the UE for request of PUSCH resources to the UTRAN.

RLC-SAP: TM

Logical channel: SHCCH

Direction: UE → UTRAN

Information Element/Group name	Need	Multi	Type and reference	Semantics description
Message Type	MP		Message Type	
DSCH-RNTI	OP		DSCH-RNTI 10.3.3.9a	
RRC transaction identifier	CV-ProtErr		RRC transaction identifier 10.3.3.36	
Traffic Volume	OP		Traffic Volume, measured results list 10.3.7.67	
Timeslot list	OP	1 to maxTS		
>Timeslot number	MP		Timeslot number 10.3.6.84	
>Timeslot ISCP	MP		Timeslot ISCP info 10.3.7.65	
Primary CCPCH RSCP	OP		Primary CCPCH RSCP info 10.3.7.54	
<i>CHOICE Allocation confirmation</i>	OP			
>PDSCH Confirmation			Integer(1..hi PDSCHidentities)	
>PUSCH Confirmation			Integer(1..hi PUSCHidentities)	
Protocol error indicator	MD		Protocol error indicator 10.3.3.27	Default value is FALSE

Information Element/Group name	Need	Multi	Type and reference	Semantics description
Protocol error information	CV-ProtErr		Protocol error information 10.3.8.12	

Condition	Explanation
<i>ProtErr</i>	This IE is mandatory present if the IE "Protocol error indicator" has the value TRUE. Otherwise it is not needed.

10.2.27 RADIO BEARER RECONFIGURATION

This message is sent from UTRAN to reconfigure parameters related to a change of QoS or to release and setup a radio bearer used for ptp transmission of MBMS services of the broadcast type. This procedure can also change the multiplexing of MAC, reconfigure transport channels and physical channels. This message is also used to perform a handover from GERAN *Iu mode* to UTRAN.

RLC-SAP: AM or UM or sent through GERAN *Iu mode*

Logical channel: DCCH or sent through GERAN *Iu mode*

Direction: UTRAN → UE

Information Element/Group name	Need	Multi	Type and reference	Semantics description	Version
Message Type	MP		Message Type		
UE Information elements					
RRC transaction identifier	MP		RRC transaction identifier 10.3.3.36		
Integrity check info	CH		Integrity check info 10.3.3.16		
Integrity protection mode info	OP		Integrity protection mode info 10.3.3.19	The UTRAN should not include this IE unless it is performing an SRNS relocation or a handover from GERAN <i>Iu mode</i>	
Ciphering mode info	OP		Ciphering mode info 10.3.3.5	The UTRAN should not include this IE unless it is performing either an SRNS relocation or a handover from GERAN <i>Iu mode</i> and a change in ciphering algorithm	
Activation time	MD		Activation time 10.3.3.1	Default value is "now"	
Delay restriction flag	OP		Enumerated (TRUE)	This IE is always set to TRUE and included if the activation time is restricted according to	REL-6

Information Element/Group name	Need	Multi	Type and reference	Semantics description	Version
				subclause 8.6.3.1	
New U-RNTI	OP		U-RNTI 10.3.3.47		
New C-RNTI	OP		C-RNTI 10.3.3.8		
New DSCH-RNTI	OP		DSCH-RNTI 10.3.3.9a	Should not be set in FDD. If received The UE should ignore it	
New H-RNTI	OP		H-RNTI 10.3.3.14a		REL-5
New Primary E-RNTI	OP		E-RNTI 10.3.3.10a		REL-6
New Secondary E-RNTI	OP		E-RNTI 10.3.3.10a	FDD only	REL-6
RRC State Indicator	MP		RRC State Indicator 10.3.3.35a		
UE Mobility State Indicator	CV- FACH_PC H		Enumerated (High-mobilityDetected)	Absence of this IE implies that, according to [4], the UE shall consider itself being in the mobility state the UE has maintained in CELL_DCH state or being not in high mobility state after the state transition, if applicable.	REL-7
UTRAN DRX cycle length coefficient	OP		UTRAN DRX cycle length coefficient 10.3.3.49		
CN information elements					
CN Information info	OP		CN Information info 10.3.1.3		
UTRAN mobility information elements					
URA identity	OP		URA identity 10.3.2.6		
RNC support for change of UE capability	OP		Boolean	Should be included if the message is used to perform an SRNS relocation	REL-7
Reconfiguration in response to requested change of UE capability	OP		Enumerated (TRUE)		REL-7
CHOICE specification mode	MP				REL-5
>Complete specification					
RB information elements					
>>RAB information to reconfigure list	OP	1 to <maxRABsetup >			
>>>RAB information to reconfigure	MP		RAB information to reconfigure 10.3.4.11		

Information Element/Group name	Need	Multi	Type and reference	Semantics description	Version
>>RAB information for MBMS ptp bearer list	OP	1 to <maxMBMS servSelect >			REL-6
>>>RAB information for MBMS ptp bearer	MP		RAB information for MBMS ptp bearer 10.3.4.9a		REL-6
>>RB information to reconfigure list	MP	1 to <maxRB>		Although this IE is not always required, need is MP to align with ASN.1	
	OP				REL-4
>>>RB information to reconfigure	MP		RB information to reconfigure 10.3.4.18		
>>RB information to be affected list	OP	1 to <maxRB>			
>>>RB information to be affected	MP		RB information to be affected 10.3.4.17		
>>RB with PDCP context relocation info list	OP	1 to <maxRBall RABs>		This IE is needed for each RB having PDCP and performing PDCP context relocation	REL-5
>>>PDCP context relocation info	MP		PDCP context relocation info 10.3.4.1a		REL-5
>>PDCP ROHC target mode	OP		PDCP ROHC target mode 10.3.4.2a		REL-5
TrCH Information Elements					
Uplink transport channels					
>>UL Transport channel information common for all transport channels	OP		UL Transport channel information common for all transport channels 10.3.5.24		
>>Deleted TrCH information list	OP	1 to <maxTrCH >			
>>>Deleted UL TrCH information	MP		Deleted UL TrCH information 10.3.5.5		
>>Added or Reconfigured TrCH information list	OP	1 to <maxTrCH >			
>>>Added or Reconfigured UL TrCH information	MP		Added or Reconfigured UL TrCH information 10.3.5.2		
Downlink transport channels					

Information Element/Group name	Need	Multi	Type and reference	Semantics description	Version
>>DL Transport channel information common for all transport channels	OP		DL Transport channel information common for all transport channels 10.3.5.6		
>>Deleted TrCH information list	OP	1 to <maxTrCH >			
>>>Deleted DL TrCH information	MP		Deleted DL TrCH information 10.3.5.4		
>>Added or Reconfigured TrCH information list	OP	1 to <maxTrCH >			
>>>Added or Reconfigured DL TrCH information	MP		Added or Reconfigured DL TrCH information 10.3.5.1		
>Preconfiguration					REL-5
>>CHOICE <i>Preconfiguration mode</i>	MP			This value only applies in case the message is sent through GERAN <i>lu mode</i>	
>>>Predefined configuration identity	MP		Predefined configuration identity 10.3.4.5		
>>>Default configuration					
>>>>Default configuration mode	MP		Enumerated (FDD, TDD)	Indicates whether the FDD or TDD version of the default configuration shall be used	
>>>>Default configuration identity	MP		Default configuration identity 10.3.4.0		
PhyCH information elements					
Frequency info	OP		Frequency info 10.3.6.36		
Multi-frequency Info	OP		Multi-frequency Info 10.3.6.39a	This IE is used for 1.28 Mcps TDD only	REL-7
DTX-DRX timing information	OP		DTX-DRX timing information 10.3.6.34b		REL-7
DTX-DRX Information	OP		DTX-DRX Information 10.3.6.34a		REL-7
HS-SCCH less Information	OP		HS-SCCH less Information 10.3.6.36ab		REL-7
MIMO parameters	OP		MIMO parameters 10.3.6.41a		REL-7
Uplink radio resources					

Information Element/Group name	Need	Multi	Type and reference	Semantics description	Version
Maximum allowed UL TX power	MD		Maximum allowed UL TX power 10.3.6.39	Default value is the existing maximum UL TX power	
Uplink DPCH info	OP		Uplink DPCH info 10.3.6.88		
E-DCH Info	OP		E-DCH Info 10.3.6.97		REL-6
Downlink radio resources					
Downlink HS-PDSCH Information	OP		Downlink HS-PDSCH Information 10.3.6.23a		REL-5
Downlink information common for all radio links	OP		Downlink information common for all radio links 10.3.6.24		
Downlink information per radio link list	MP	1 to <maxRL>		Although this IE is not always required, need is MP to align with ASN.1	
	OP				REL-4
>Downlink information for each radio link	MP		Downlink information for each radio link 10.3.6.27		
MBMS PL Service Restriction Information	OP		Enumerated (TRUE)		REL-6

Condition	Explanation
<i>FACH_PCH</i>	This IE is mandatory default when a transition from CELL_DCH to CELL_FACH, URA_PCH or CELL_PCH is requested by the message and is not needed otherwise.

10.2.28 RADIO BEARER RECONFIGURATION COMPLETE

This message is sent from the UE when a RB and signalling link reconfiguration has been done.

RLC-SAP: AM

Logical channel: DCCH

Direction: UE → UTRAN

Information Element/Group name	Need	Multi	Type and reference	Semantics description	Version
Message Type	MP		Message Type		
UE information elements					
RRC transaction identifier	MP		RRC transaction identifier 10.3.3.36		
Integrity check info	CH		Integrity check info 10.3.3.16		
Uplink integrity protection activation info	OP		Integrity protection		

Information Element/Group name	Need	Multi	Type and reference	Semantics description	Version
			activation info 10.3.3.17		
CHOICE <i>mode</i>	MP			(no data)	
>FDD					
>TDD					
>>CHOICE <i>TDD option</i>	MP				REL-4
>>>3.84 Mcps TDD					REL-4
>>>>Uplink Timing Advance	OP		Uplink Timing Advance 10.3.6.95		
>>>>Extended Uplink Timing Advance	OP		Extended Uplink Timing Advance 10.3.6.95a		REL-7
>>>7.68 Mcps TDD					REL-7
>>>>Extended Uplink Timing Advance	OP		Extended Uplink Timing Advance 10.3.6.95a		REL-7
>>>1.28 Mcps TDD				(no data)	REL-4
Other Information elements					REL-7
Deferred measurement control reading	MD		Enumerated (TRUE)	Indicates the UE has not read SIB11, SIB11bis and SIB12, if available. Default value is FALSE	REL-7
RB Information elements					
COUNT-C activation time	OP		Activation time 10.3.3.1	Used for radio bearers mapped on RLC-TM.	
Uplink counter synchronisation info	OP				
>RB with PDCP information list	OP	1 to <maxRBall RABs>			
>>RB with PDCP information	MP		RB with PDCP information 10.3.4.22		
>START list	MP	1 to <maxCNdo mains>		START [40] values for all CN domains.	
>>CN domain identity	MP		CN domain identity 10.3.1.1		
>>>START	MP		START 10.3.3.38	START value to be used in this CN domain.	

10.2.29 RADIO BEARER RECONFIGURATION FAILURE

This message is sent by UE if the configuration given by UTRAN is unacceptable or if the UE failed to establish the physical channel(s).

RLC-SAP: AM

Logical channel: DCCH

Direction: UE→UTRAN

Information Element/Group name	Need	Multi	Type and reference	Semantics description
Message Type	MP		Message Type	
UE information elements				
RRC transaction identifier	MP		RRC transaction identifier 10.3.3.36	
Integrity check info	CH		Integrity check info 10.3.3.16	
Failure cause	MP		Failure cause and error information 10.3.3.14	
RB information elements				
Radio bearers for which reconfiguration would have succeeded List	OP	1 to <maxRB>		
>Radio bearer for which reconfiguration would have succeeded	MP		RB identity, 10.3.4.16	

10.2.30 RADIO BEARER RELEASE

This message is used by UTRAN to release a radio bearer. It can also include modifications to the configurations of transport channels and/or physical channels. It can simultaneously indicate release of a signalling connection when UE is connected to more than one CN domain.

RLC-SAP: AM or UM

Logical channel: DCCH

Direction: UTRAN → UE

Information Element/Group name	Need	Multi	Type and reference	Semantics description	Version
Message Type	MP		Message Type		
UE Information Elements					
RRC transaction identifier	MP		RRC transaction identifier 10.3.3.36		
Integrity check info	CH		Integrity check info 10.3.3.16		
Integrity protection mode info	OP		Integrity protection mode info 10.3.3.19	The UTRAN should not include this IE unless it is performing an SRNS relocation.	
Ciphering mode info	OP		Ciphering mode info 10.3.3.5	The UTRAN should not include this IE unless it is performing an SRNS relocation and a change in ciphering algorithm.	
Activation time	MD		Activation time 10.3.3.1	Default value is "now"	
New U-RNTI	OP		U-RNTI 10.3.3.47		
New C-RNTI	OP		C-RNTI		

Information Element/Group name	Need	Multi	Type and reference	Semantics description	Version
			10.3.3.8		
New DSCH-RNTI	OP		DSCH-RNTI 10.3.3.9a	Should not be set in FDD. If received the UE should ignore it	
New H-RNTI	OP		H-RNTI 10.3.3.14a		REL-5
New Primary E-RNTI	OP		E-RNTI 10.3.3.10a		REL-6
New Secondary E-RNTI	OP		E-RNTI 10.3.3.10a	FDD only	REL-6
RRC State Indicator	MP		RRC State Indicator 10.3.3.35a		
UE Mobility State Indicator	CV-FACH_PCH		Enumerated (High-mobilityDetected)	Absence of this IE implies that, according to [4], the UE shall consider itself being in the mobility state the UE has maintained in CELL_DCH state or being not in high mobility state after the state transition, if applicable.	REL-7
UTRAN DRX cycle length coefficient	OP		UTRAN DRX cycle length coefficient 10.3.3.49		
CN Information Elements					
CN Information info	OP		CN Information info 10.3.1.3		
Signalling Connection release indication	OP		CN domain identity 10.3.1.1		
UTRAN mobility information elements					
URA identity	OP		URA identity 10.3.2.6		
RNC support for change of UE capability	OP		Boolean	Should be included if the message is used to perform an SRNS relocation	REL-7
RB Information Elements					
RAB information to reconfigure list	OP	1 to <maxRABsetup >			
>RAB information to reconfigure	MP		RAB information to reconfigure 10.3.4.11		
RB information to release list	MP	1 to <maxRB>			
>RB information to release	MP		RB information to release 10.3.4.19		
RB information to reconfigure list	OP	1to <maxRB>			REL-6
>RB information to reconfigure	MP		RB information to reconfigure 10.3.4.18		REL-6
RB information to be affected list	OP	1 to <maxRB>			
>RB information to be affected	MP		RB information		

Information Element/Group name	Need	Multi	Type and reference	Semantics description	Version
			to be affected 10.3.4.17		
Downlink counter synchronisation info	OP				
>RB with PDCP information list	OP	1 to <maxRBall RABs>			
>>RB with PDCP information	MP		RB with PDCP information 10.3.4.22	This IE is needed for each RB having PDCP in the case of lossless SRNS relocation	
	OP				REL-5
>RB with PDCP context relocation info list	OP	1 to <maxRBall RABs>			REL-5
>>PDCP context relocation info	MP		PDCP context relocation info 10.3.4.1a	This IE is needed for each RB having PDCP and performing PDCP context relocation	REL-5
TrCH Information Elements					
Uplink transport channels					
UL Transport channel information common for all transport channels	OP		UL Transport channel information common for all transport channels 10.3.5.24		
Deleted TrCH information list	OP	1 to <maxTrCH >			
>Deleted UL TrCH information	MP		Deleted UL TrCH information 10.3.5.5		
Added or Reconfigured TrCH information list	OP	1 to <maxTrCH >			
>Added or Reconfigured UL TrCH information	MP		Added or Reconfigured UL TrCH information 10.3.5.2		
Downlink transport channels					
DL Transport channel information common for all transport channels	OP		DL Transport channel information common for all transport channels 10.3.5.6		
Deleted TrCH information list	OP	1 to <maxTrCH >			
>Deleted DL TrCH information	MP		Deleted DL TrCH information 10.3.5.4		
Added or Reconfigured TrCH information list	OP	1 to <maxTrCH >			
>Added or Reconfigured DL TrCH information	MP		Added or Reconfigure		

Information Element/Group name	Need	Multi	Type and reference	Semantics description	Version
			d DL TrCH information 10.3.5.1		
PhyCH information elements					
Frequency info	OP		Frequency info 10.3.6.36		
Multi-frequency Info	OP		Multi-frequency Info 10.3.6.39a	This IE is used for 1.28 Mcps TDD only	REL-7
DTX-DRX timing information	OP		DTX-DRX timing information 10.3.6.34b		REL-7
DTX-DRX Information	OP		DTX-DRX Information 10.3.6.34a		REL-7
HS-SCCH less Information	OP		HS-SCCH less Information 10.3.6.36ab		REL-7
MIMO parameters	OP		MIMO parameters 10.3.6.41a		REL-7
Uplink radio resources					
Maximum allowed UL TX power	MD		Maximum allowed UL TX power 10.3.6.39	Default value is the existing maximum UL TX power	
Uplink DPCH info	OP		Uplink DPCH info 10.3.6.88		
E-DCH Info	OP		E-DCH Info 10.3.6.97		REL-6
Downlink radio resources					
Downlink HS-PDSCH Information	OP		Downlink HS-PDSCH Information 10.3.6.23a		REL-5
Downlink information common for all radio links	OP		Downlink information common for all radio links 10.3.6.24		
Downlink information per radio link list	OP	1 to <maxRL>		Send downlink information for each radio link to be set-up	
>Downlink information for each radio link	MP		Downlink information for each radio link 10.3.6.27		
MBMS PL Service Restriction Information	OP		Enumerated (TRUE)		REL-6
MBMS RB list released to change transfer mode	OP	1 to <maxRB>			REL-6
>RB information to release	MP		RB information to release 10.3.4.19		REL-6

Condition	Explanation
FACH_PCH	This IE is mandatory default when a transition from CELL_DCH to CELL_FACH, URA_PCH or CELL_PCH is requested by the message and is not needed otherwise.

10.2.31 RADIO BEARER RELEASE COMPLETE

This message is sent from the UE when radio bearer release has been completed.

RLC-SAP: AM

Logical channel: DCCH

Direction: UE → UTRAN

Information Element/Group name	Need	Multi	Type and reference	Semantics description	Version
Message Type	MP		Message Type		
UE information elements					
RRC transaction identifier	MP		RRC transaction identifier 10.3.3.36		
Integrity check info	CH		Integrity check info 10.3.3.16	Integrity check info is included if integrity protection is applied	
Uplink integrity protection activation info	OP		Integrity protection activation info 10.3.3.17		
CHOICE <i>mode</i>	MP				
>FDD				(no data)	
>TDD					
>>CHOICE <i>TDD option</i>	MP				REL-4
>>>3.84 Mcps TDD					REL-4
>>>>Uplink Timing Advance	OP		Uplink Timing Advance 10.3.6.95	This information element shall be present in case of handover procedure if timing advance is enabled. Calculated timing advance value for the new cell after handover in a synchronous TDD network	
>>>>Extended Uplink Timing Advance	OP		Extended Uplink Timing Advance 10.3.6.95a		REL-7
>>>>7.68 Mcps TDD					REL-7
>>>>Extended Uplink Timing Advance	OP		Extended Uplink Timing Advance 10.3.6.95a	This information element shall be present in case of handover procedure if timing advance is enabled. Calculated timing	REL-7

Information Element/Group name	Need	Multi	Type and reference	Semantics description	Version
				advance value for the new cell after handover in a synchronous TDD network	
>>>1.28 Mcps TDD				(no data)	REL-4
Other Information elements					REL-7
Deferred measurement control reading	MD		Enumerated (TRUE)	Indicates the UE has not read SIB11, SIB11bis and SIB12, if available. Default value is FALSE	REL-7
RB Information elements					
COUNT-C activation time	OP		Activation time 10.3.3.1	Used for radio bearers mapped on RLC-TM.	
Uplink counter synchronisation info	OP				
>RB with PDCP information list	OP	1 to <maxRBall RABs>		This IE is needed for each RB having PDCP in the case of lossless SRNS relocation	
>>RB with PDCP information	MP		RB with PDCP information 10.3.4.22		
>START list	MP	1 to <maxCNdo mains>		START [40] values for all CN domains.	
>>CN domain identity	MP		CN domain identity 10.3.1.1		
>>START	MP		START 10.3.3.38	START value to be used in this CN domain.	

10.2.32 RADIO BEARER RELEASE FAILURE

This message is sent by UE if the configuration given by UTRAN is unacceptable or if radio bearer cannot be released.

RLC-SAP: AM

Logical channel: DCCH

Direction: UE→UTRAN

Information Element/Group name	Need	Multi	Type and reference	Semantics description
Message Type	MP		Message Type	
UE information elements				
RRC transaction identifier	MP		RRC transaction identifier 10.3.3.36	
Integrity check info	CH		Integrity check info 10.3.3.16	
Failure cause	MP		Failure cause and error information 10.3.3.14	
RB information elements				
Radio bearers for which reconfiguration would have succeeded	OP	1 to <maxRB>		
>Radio bearer for which reconfiguration would have been succeeded	MP		RB identity, 10.3.4.16	

10.2.33 RADIO BEARER SETUP

This message is sent by UTRAN to the UE to establish new radio bearer(s). It can also include modifications to the configurations of transport channels and/or physical channels.

RLC-SAP: AM or UM

Logical channel: DCCH

Direction: UTRAN → UE

Information Element/Group name	Need	Multi	Type and reference	Semantics description	Version
Message Type	MP		Message Type		
UE Information Elements					
RRC transaction identifier	MP		RRC transaction identifier 10.3.3.36		
Integrity check info	CH		Integrity check info 10.3.3.16		
Integrity protection mode info	OP		Integrity protection mode info 10.3.3.19	The UTRAN should not include this IE unless it is performing an SRNS relocation	
Ciphering mode info	OP		Ciphering mode info 10.3.3.5	The UTRAN should not include this IE unless it is performing an SRNS relocation and a change in ciphering algorithm	
Activation time	MD		Activation time 10.3.3.1	Default value is "now"	
New U-RNTI	OP		U-RNTI 10.3.3.47		

Information Element/Group name	Need	Multi	Type and reference	Semantics description	Version
New C-RNTI	OP		C-RNTI 10.3.3.8		
New DSCH-RNTI	OP		DSCH-RNTI 10.3.3.9a	Should not be set in FDD. If received the UE should ignore it	
New H-RNTI	OP		H-RNTI 10.3.3.14a		REL-5
New Primary E-RNTI	OP		E-RNTI 10.3.3.10a		REL-6
New Secondary E-RNTI	OP		E-RNTI 10.3.3.10a	FDD only	REL-6
RRC State Indicator	MP		RRC State Indicator 10.3.3.35a		
UTRAN DRX cycle length coefficient	OP		UTRAN DRX cycle length coefficient 10.3.3.49		
CN Information Elements					
CN Information info	OP		CN Information info 10.3.1.3		
UTRAN mobility information elements					
URA identity	OP		URA identity 10.3.2.6		
RNC support for change of UE capability	OP		Boolean	Should be included if the message is used to perform an SRNS relocation	REL-7
RB Information Elements					
CHOICE specification mode	MP				REL-6
>Complete specification				In this version of the specification, only this value is specified	REL-6
>>Signalling RB information to setup list	OP	1 to <maxSRBs etup>		For each signalling radio bearer established	
>>>Signalling RB information to setup	MP		Signalling RB information to setup 10.3.4.24		
>>RAB information to setup list	OP	1 to <maxRABs etup>		For each RAB established	
>>>RAB information for setup	MP		RAB information for setup 10.3.4.10		
>>RAB information to reconfigure list	OP	1 to <maxRABse tup >			REL-6
>>>RAB information to reconfigure	MP		RAB information to reconfigure 10.3.4.11		REL-6
>>RB information to reconfigure list	OP	1to <maxRB>			REL-6
>>>RB information to reconfigure	MP		RB information		REL-6

Information Element/Group name	Need	Multi	Type and reference	Semantics description	Version
			to reconfigure 10.3.4.18		
>>RB information to be affected list	OP	1 to <maxRB>			
>>>RB information to be affected	MP		RB information to be affected 10.3.4.17		
>>Downlink counter synchronisation info	OP				
>>>RB with PDCP information list	OP	1 to <maxRBall RABs>			
>>>>RB with PDCP information	MP		RB with PDCP information 10.3.4.22	This IE is needed for each RB having PDCP in the case of lossless SRNS relocation	
	OP				REL-5
>>>>PDCP context relocation info	OP		PDCP context relocation info 10.3.4.1a	This IE is needed for each RB having PDCP and performing PDCP context relocation	REL-5
>>PDCP ROHC target mode	OP		PDCP ROHC target mode 10.3.4.2a		REL-5
TrCH Information Elements					
Uplink transport channels					
>>UL Transport channel information common for all transport channels	OP		UL Transport channel information common for all transport channels 10.3.5.24		
>>Deleted TrCH information list	OP	1 to <maxTrCH >			
>>>Deleted UL TrCH information	MP		Deleted UL TrCH information 10.3.5.5		
>>Added or Reconfigured TrCH information list	OP	1 to <maxTrCH >			
>>>Added or Reconfigured UL TrCH information	MP		Added or Reconfigured UL TrCH information 10.3.5.2		
Downlink transport channels					
>>DL Transport channel information common for all transport channels	OP		DL Transport channel information common for all transport channels 10.3.5.6		
>>Deleted TrCH information list	OP	1 to <maxTrCH >			

Information Element/Group name	Need	Multi	Type and reference	Semantics description	Version
>>>Deleted DL TrCH information	MP		Deleted DL TrCH information 10.3.5.4		
>>Added or Reconfigured TrCH information list	OP	1 to <maxTrCH>			
>>>Added or Reconfigured DL TrCH information	MP		Added or Reconfigured DL TrCH information 10.3.5.1		
PhyCH information elements					
Frequency info	OP		Frequency info 10.3.6.36		
Multi-frequency Info	OP		Multi-frequency Info 10.3.6.39a	This IE is used for 1.28 Mcps TDD only	REL-7
DTX-DRX timing information	OP		DTX-DRX timing information 10.3.6.34b		REL-7
DTX-DRX Information	OP		DTX-DRX Information 10.3.6.34a		REL-7
HS-SCCH less Information	OP		HS-SCCH less Information 10.3.6.36ab		REL-7
MIMO parameters	OP		MIMO parameters 10.3.6.41a		REL-7
Uplink radio resources					
Maximum allowed UL TX power	MD		Maximum allowed UL TX power 10.3.6.39	Default value is the existing maximum UL TX power	
Uplink DPCH info	OP		Uplink DPCH info 10.3.6.88		
E-DCH Info	OP		E-DCH Info 10.3.6.97		REL-6
Downlink radio resources					
Downlink HS-PDSCH Information	OP		Downlink HS-PDSCH Information 10.3.6.23a		REL-5
Downlink information common for all radio links	OP		Downlink information common for all radio links 10.3.6.24		
Downlink information per radio link list	OP	1 to <maxRL>		Send downlink information for each radio link	
>Downlink information for each radio link	MP		Downlink information for each radio link 10.3.6.27		
MBMS PL Service Restriction Information	OP		Enumerated (TRUE)		REL-6

10.2.34 RADIO BEARER SETUP COMPLETE

This message is sent by the UE to confirm the establishment of the radio bearer.

RLC-SAP: AM

Logical channel: DCCH

Direction: UE → UTRAN

Information Element/Group name	Need	Multi	Type and reference	Semantics description	Version
Message Type	MP		Message Type		
UE information elements					
RRC transaction identifier	MP		RRC transaction identifier 10.3.3.36		
Integrity check info	CH		Integrity check info 10.3.3.16		
Uplink integrity protection activation info	OP		Integrity protection activation info 10.3.3.17		
CHOICE <i>mode</i>	OP				
>FDD				(no data)	
>TDD					
>>CHOICE <i>TDD option</i>	MP				REL-4
>>>3.84 Mcps TDD					REL-4
>>>>Uplink Timing Advance	OP		Uplink Timing Advance 10.3.6.95	This information element shall be present in case of handover procedure if timing advance is enabled. Calculated timing advance value for the new cell after handover in a synchronous TDD network	
>>>>Extended Uplink Timing Advance	OP		Extended Uplink Timing Advance 10.3.6.95a		REL-7
>>>7.68 Mcps TDD					REL-7
>>>>Extended Uplink Timing Advance	OP		Extended Uplink Timing Advance 10.3.6.95a	This information element shall be present in case of handover procedure if timing advance is enabled. Calculated timing advance value for the new cell after handover in a synchronous TDD network	REL-7
>>>1.28 Mcps TDD				(No data)	REL-4
START	OP		START 10.3.3.38	This information element is not	

Information Element/Group name	Need	Multi	Type and reference	Semantics description	Version
				needed for transparent mode RBs if prior to this procedure there exists one RB using RLC-TM.	
Other information elements					
Deferred measurement control reading	MD		Enumerated (TRUE)	Indicates the UE has not read SIB11, SIB11bis and SIB12, if available. Default value is FALSE	REL-7
RB Information elements					
COUNT-C activation time	OP		Activation time 10.3.3.1	Used for radio bearers mapped on RLC-TM.	
Uplink counter synchronisation info	OP				
>RB with PDCP information list	OP	1 to <maxRBall RABs>		This IE is needed for each RB having PDCP in the case of lossless SRNS relocation	
>>RB with PDCP information	MP		RB with PDCP information 10.3.4.22		
>START list	MP	1 to <maxCNdo mains>		START [40] values for all CN domains.	
>>CN domain identity	MP		CN domain identity 10.3.1.1		
>>START	MP		START 10.3.3.38	START value to be used in this CN domain.	

10.2.35 RADIO BEARER SETUP FAILURE

This message is sent by UE, if it does not support the configuration given by UTRAN.

RLC-SAP: AM

Logical channel: DCCH

Direction: UE→UTRAN

Information Element/Group name	Need	Multi	Type and reference	Semantics description
Message Type	MP		Message Type	
UE information elements				
RRC transaction identifier	MP		RRC transaction identifier 10.3.3.36	
Integrity check info	CH		Integrity check info 10.3.3.16	
Failure cause	MP		Failure cause and error information 10.3.3.14	
RB information elements				
Radio bearers for which reconfiguration would have succeeded	OP	1 to <maxRB>		
>Radio bearer for which reconfiguration would have succeeded	MP		RB identity, 10.3.4.16	

10.2.36 RRC CONNECTION REJECT

The network transmits this message when the requested RRC connection cannot be accepted.

RLC-SAP: UM

Logical channel: CCCH

Direction: UTRAN → UE

Information Element/Group name	Need	Multi	Type and reference	Semantics description	Version
Message Type	MP		Message Type		
UE information elements					
RRC transaction identifier	MP		RRC transaction identifier 10.3.3.36		
Initial UE identity	MP		Initial UE identity 10.3.3.15		
Rejection cause	MP		Rejection cause 10.3.3.31		
Wait time	MP		Wait time 10.3.3.50		
Redirection info	OP		Redirection info 10.3.3.29		
Counting completion	OP		Enumerated (TRUE)	This field may be present if the Rejection Cause is set to "unspecified" otherwise it shall be ignored.	REL-6

10.2.37 RRC CONNECTION RELEASE

This message is sent by UTRAN to release the RRC connection. The message also releases the signalling connection and all radio bearers between the UE and UTRAN.

RLC-SAP: UM

Logical channel: CCCH or DCCH

Direction: UTRAN→UE

Information Element/Group name	Need	Multi	Type and reference	Semantics description	Version
Message Type	MP		Message Type		
UE information elements					
CHOICE identity type	CV- CCCH				REL-5
>U-RNTI			U-RNTI 10.3.3.47		
> Group identity		1 to <maxUR NTIgroup >			REL-5
>>Group release information	MP		Group release information 10.3.3.140		REL-5
RRC transaction identifier	MP		RRC transaction identifier 10.3.3.36		
Integrity check info	CV- DCCH		Integrity check info 10.3.3.16	Integrity check info is included if integrity protection is applied	
N308	CH- Cell_DCH		Integer(1..8)		
Release cause	MP		Release cause 10.3.3.32		
UE Mobility State Indicator	CV- DCCH_ MD		Enumerated (High-mobilityDetected)	Absence of this IE implies that, according to [4] the UE shall consider itself being in the mobility state the UE has maintained in CELL_DCH state or being not in high-mobility state when entering in Idle Mode, if applicable.	REL-7
Other information elements					
Rplmn information	OP		Rplmn information 10.3.8.15		
Redirection info	OP		Redirection info 10.3.3.29		REL-6

Condition	Explanation
<i>CCCH</i>	This IE is mandatory present when CCCH is used and not needed otherwise.
<i>DCCH</i>	This IE is mandatory present when DCCH is used and not needed otherwise.
<i>DCCH_MD</i>	This IE is mandatory default when DCCH is used and not needed otherwise.
<i>Cell_DCH</i>	This IE is mandatory present when UE is in CELL_DCH state and not needed otherwise.

10.2.38 RRC CONNECTION RELEASE COMPLETE

This message is sent by UE to confirm that the RRC connection has been released.

RLC-SAP: AM or UM

Logical channel: DCCH

Direction: UE → UTRAN

Information Element/Group name	Need	Multi	Type and reference	Semantics description
Message Type	MP		Message Type	
UE information elements				
RRC transaction identifier	MP		RRC transaction identifier 10.3.3.36	
Integrity check info	CH		Integrity check info 10.3.3.16	
Error indication	OP		Failure cause and error information 10.3.3.14	

10.2.39 RRC CONNECTION REQUEST

RRC Connection Request is the first message transmitted by the UE when setting up an RRC Connection to the network.

RLC-SAP: TM

Logical channel: CCCH

Direction: UE → UTRAN

Information Element/Group name	Need	Multi	Type and reference	Semantics description	Version
Message Type	MP		Message Type		
Radio Bearer IEs					
Predefined configuration status information	MP		Boolean	True indicates the UE has all pre-configurations stored with the same value tag as broadcast in the cell in which the RRC connection establishment is initiated	REL-5
UE information elements					
Initial UE identity	MP		Initial UE identity 10.3.3.15		
Establishment cause	MP		Establishment cause 10.3.3.11		
Protocol error indicator	MD		Protocol error indicator 10.3.3.27	Default value is FALSE	
>UE Specific Behaviour Information 1 idle	OP		UE Specific Behaviour Information 1 idle 10.3.3.51	This IE shall not be included in this version of the protocol	
Domain indicator	MP		CN domain identity 10.3.1.1		REL-6
Call type	CV-CS- Domain		Enumerated (speech, video, other)	One spare value is needed	REL-6
UE capability indication	OP		Enumerated (HS-DSCH, HS-DSCH+E-DCH)	Absence of this IE implies that neither HS-DSCH nor E-DCH are supported by the UE	REL-6
MBMS Selected Services	OP		MBMS Selected Services Short 10.3.9a.7d		REL-6
UE Mobility State Indicator	MD		Enumerated (High-mobilityDetected)	Absence of this IE implies that, according to [4] either the High mobility state is not applicable or it has not been detected by the UE.	REL-7
Support for F-DPCH	OP		Enumerated (True)	The IE shall be set to TRUE when F-DPCH is fully supported by the UE. Absence of this information element indicates that F-DPCH is not fully supported	REL-6
Support for Enhanced F-DPCH	OP		Enumerated	The absence of	REL-7

			(True)	this IE indicates that the UE does not support enhanced F-DPCH	
HS-PDSCH in CELL_FACH	OP		Enumerated (TRUE)	The absence of this IE indicates that the UE does not support HS-PDSCH reception in CELL_FACH state.	REL-7
MAC-ehs support	OP		Enumerated (TRUE)	The presence of this IE indicates that UE supports MAC-ehs, octet aligned transport block table and the use of special value of HE field to indicate end of an SDU for RLC AM. The absence of this IE indicates that the UE does not support either MAC-ehs, octet aligned transport block table or the use of special value of HE field to indicate end of an SDU for RLC AM.	REL-7
DPCCH Discontinuous Transmission support	OP		Enumerated (TRUE)	The absence of this IE indicates that the UE does not support DPCCH Discontinuous Transmission	REL-7
Measurement information elements					
Measured results on RACH	OP		Measured results on RACH 10.3.7.45		
Access stratum release indicator	MP		Enumerated(REL-4,	Absence of the IE implies R99. The IE also indicates the release of the RRC transfer syntax supported by the UE 12 spare values are needed	REL-4
			REL-5,		REL-5
			REL-6,		REL-6
			REL-7)		REL-7

Condition	Explanation
CS-Domain	This IE is mandatory present if the IE "Domain indicator" has the value "CS domain". Otherwise it is not needed.

If the encoded message does not fill a transport block, the RRC layer shall insert padding according to subclause 12.1.

10.2.40 RRC CONNECTION SETUP

This message is used by the network to accept the establishment of an RRC connection for a UE, including assignment of signalling link information, transport channel information and optionally physical channel information.

RLC-SAP: UM

Logical channel: CCCH

Direction: UTRAN → UE

Information Element/Group name	Need	Multi	Type and reference	Semantics description	Version
Message Type	MP		Message Type		
UE Information Elements					
Initial UE identity	MP		Initial UE identity 10.3.3.15		
RRC transaction identifier	MP		RRC transaction identifier 10.3.3.36		
Activation time	MD		Activation time 10.3.3.1	Default value is "now"	
New U-RNTI	MP		U-RNTI 10.3.3.47		
New C-RNTI	OP		C-RNTI 10.3.3.8		
New H-RNTI	OP		H-RNTI 10.3.3.14a		REL-6
New Primary E-RNTI	OP		E-RNTI 10.3.3.10a		REL-6
New Secondary E-RNTI	OP		E-RNTI 10.3.3.10a	FDD only	REL-6
RRC State Indicator	MP		RRC State Indicator 10.3.3.35a		
UTRAN DRX cycle length coefficient	MP		UTRAN DRX cycle length coefficient 10.3.3.49		
Capability update requirement	MD		Capability update requirement 10.3.3.2	Default value is defined in subclause 10.3.3.2	
RNC support for change of UE capability	MP		Boolean		REL-7
CHOICE <i>specification mode</i>	MP				REL-5
>Complete specification					
RB Information Elements					
>>Signalling RB information to setup list	MP	3 to 4			
>>>Signalling RB information to setup	MP		Signalling RB information to setup 10.3.4.24		
TrCH Information Elements					
Uplink transport channels					
>>UL Transport channel information common for all transport channels	OP		UL Transport channel information common for all transport channels 10.3.5.24		

Information Element/Group name	Need	Multi	Type and reference	Semantics description	Version
>>Added or Reconfigured TrCH information list	MP	1 to <maxTrCH >		Although this IE is not required when the IE "RRC state indicator" is set to "CELL_FACH", need is MP to align with ASN.1	
	OP				REL-4
>>>Added or Reconfigured UL TrCH information	MP		Added or Reconfigured UL TrCH information 10.3.5.2		
Downlink transport channels					
>>DL Transport channel information common for all transport channels	OP		DL Transport channel information common for all transport channels 10.3.5.6		
>>Added or Reconfigured TrCH information list	MP	1 to <maxTrCH >		Although this IE is not required when the IE "RRC state indicator" is set to "CELL_FACH", need is MP to align with ASN.1	
	OP				REL-4
>>>Added or Reconfigured DL TrCH information	MP		Added or Reconfigured DL TrCH information 10.3.5.1		
>Preconfiguration					REL-5
>>CHOICE <i>Preconfiguration mode</i>	MP				REL-5
>>>Predefined configuration identity	MP		Predefined configuration identity 10.3.4.5		REL-5
>>>Default configuration					REL-5
>>>>Default configuration mode	MP		Enumerated (FDD, TDD)	Indicates whether the FDD or TDD version of the default configuration shall be used	REL-5
>>>>Default configuration identity	MP		Default configuration identity 10.3.4.0		REL-5
PhyCH information elements					
Frequency info	OP		Frequency info 10.3.6.36		
Multi-frequency Info	OP		Multi-frequency Info 10.3.6.39a	This IE is used for 1.28 Mcps TDD only	REL-7

Information Element/Group name	Need	Multi	Type and reference	Semantics description	Version
DTX-DRX timing information	OP		DTX-DRX timing information 10.3.6.34b		REL-7
DTX-DRX Information	OP		DTX-DRX Information 10.3.6.34a		REL-7
HS-SCCH less Information	OP		HS-SCCH less Information 10.3.6.36ab		REL-7
Uplink radio resources					
Maximum allowed UL TX power	MD		Maximum allowed UL TX power 10.3.6.39	Default value is the existing maximum UL TX power	
Uplink DPCH info	OP		Uplink DPCH info 10.3.6.88		
E-DCH Info	OP		E-DCH Info 10.3.6.97		REL-6
Downlink radio resources					
Downlink HS-PDSCH Information	OP		Downlink HS-PDSCH information 10.3.6.23a		REL-6
Downlink information common for all radio links	OP		Downlink information common for all radio links 10.3.6.24		
Downlink information per radio link list	OP	1 to <MaxRL>		Send downlink information for each radio link to be set-up	
>Downlink information for each radio link	MP		Downlink information for each radio link 10.3.6.27		

10.2.41 RRC CONNECTION SETUP COMPLETE

This message confirms the establishment of the RRC Connection by the UE.

RLC-SAP: AM

Logical channel: DCCH

Direction: UE → UTRAN

Information Element/Group name	Need	Multi	Type and reference	Semantics description	Version
Message Type	MP		Message Type		
UE Information Elements					
RRC transaction identifier	MP		RRC transaction identifier 10.3.3.36		
START list	MP	1 to <maxCNdomains>		START [40] values for all CN domains.	
>CN domain identity	MP		CN domain		

Information Element/Group name	Need	Multi	Type and reference	Semantics description	Version
			identity 10.3.1.1		
>START	MP		START 10.3.3.38	START value to be used in this CN domain.	
UE radio access capability	OP		UE radio access capability 10.3.3.42		
UE radio access capability extension	OP		UE radio access capability extension 10.3.3.42a		
Other information elements					
UE system specific capability	OP	1 to <maxInterSystemsMessages>			
>Inter-RAT UE radio access capability	MP		Inter-RAT UE radio access capability 10.3.8.7		
Deferred measurement control reading	MD		Enumerated (TRUE)	Indicates the UE has not read SIB11, SIB11bis and SIB12, if available. Default value is FALSE	REL-7

10.2.41a RRC FAILURE INFO

This message is sent by the UE via another radio access technology to provide information about the cause for failure to perform the requested operation.

RLC-SAP: N/A (Sent through a different RAT)

Logical channel: N/A (Sent through a different RAT)

Direction: UE → UTRAN

Information Element/Group Name	Need	Multi	Type and reference	Semantics description
Other Information elements				
Failure cause	MP		Failure cause 10.3.3.13	
Protocol error information	CV-ProtErr		Protocol error information 10.3.8.12	

Condition	Explanation
<i>ProtErr</i>	Presence is mandatory if the IE "Failure cause" has the value "Protocol error"; otherwise the element is not needed in the message.

10.2.42 RRC STATUS

This message is sent to indicate a protocol error.

RLC-SAP: AM

Logical channel: DCCH

Direction: UE→UTRAN

Information Element/Group name	Need	Multi	Type and reference	Semantics description
Message Type	MP		Message Type	
UE information elements				
Integrity check info	CH		Integrity check info 10.3.3.16	Integrity check info is included if integrity protection is applied
Identification of received message	CV- Message identified			
>Received message type	MP		Message Type	
>RRC transaction identifier	MP		RRC transaction identifier 10.3.3.36	
Other information elements				
Protocol error information	MP		Protocol error information 10.3.8.12	

Condition	Explanation
<i>Message identified</i>	This IE is mandatory present if the IE "Protocol error cause" in the IE "Protocol error information" has any other value than "ASN.1 violation or encoding error" or "Message type non-existent or not implemented" and not needed otherwise.

10.2.43 SECURITY MODE COMMAND

This message is sent by UTRAN to start or reconfigure ciphering and/or integrity protection parameters.

RLC-SAP: AM

Logical channel: DCCH

Direction: UTRAN to UE

Information Element/Group name	Need	Multi	Type and reference	Semantics description
Message Type	MP		Message Type	
UE information elements				
RRC transaction identifier	MP		RRC transaction identifier 10.3.3.36	
Integrity check info	MP		Integrity check info 10.3.3.16	
Security capability	MP		Security capability 10.3.3.37	

Information Element/Group name	Need	Multi	Type and reference	Semantics description
Ciphering mode info	OP		Ciphering mode info 10.3.3.5	Only present if ciphering shall be controlled
Integrity protection mode info	OP		Integrity protection mode info 10.3.3.19	Only present if integrity protection shall be controlled
CN Information elements				
CN domain identity	MP		CN domain identity 10.3.1.1	Indicates which ciphering and integrity protection keys are applicable
Other information elements				
UE system specific security capability	CH	1 to <maxInter SysMessages>		This IE is included if the IE "Inter-RAT UE radio access capability" was included in RRC CONNECTION SETUP COMPLETE message
>Inter-RAT UE security capability	MP		Inter-RAT UE security capability 10.3.8.8a	

10.2.44 SECURITY MODE COMPLETE

This message is sent by UE to confirm the reconfiguration of ciphering and/or integrity protection.

RLC-SAP: AM

Logical channel: DCCH

Direction: UE to UTRAN

Information Element/Group name	Need	Multi	Type and reference	Semantics description
Message Type	MP		Message Type	
UE information elements				
RRC transaction identifier	MP		RRC transaction identifier 10.3.3.36	
Integrity check info	MP		Integrity check info 10.3.3.16	
Uplink integrity protection activation info	OP		Integrity protection activation info 10.3.3.17	
RB Information elements				
Radio bearer uplink ciphering activation time info	OP		RB activation time info 10.3.4.13	

10.2.45 SECURITY MODE FAILURE

This message is sent to indicate a failure to act on a received SECURITY MODE COMMAND message.

RLC-SAP: AM

Logical channel: DCCH

Direction: UE→UTRAN

Information Element/Group name	Need	Multi	Type and reference	Semantics description
Message Type	MP		Message Type	
UE information elements				
RRC transaction identifier	MP		RRC transaction identifier 10.3.3.36	
Integrity check info	CH		Integrity check info 10.3.3.16	
Failure cause	MP		Failure cause and error information 10.3.3.14	

10.2.46 SIGNALLING CONNECTION RELEASE

This message is used to notify the UE that its ongoing signalling connection to a CN domain has been released.

RLC-SAP: AM

Logical channel: DCCH

Direction: UTRAN→UE

Information Element/Group name	Need	Multi	Type and reference	Semantics description
Message Type	MP		Message Type	
UE information elements				
RRC transaction identifier	MP		RRC transaction identifier 10.3.3.36	
Integrity check info	CH		Integrity check info 10.3.3.16	Integrity check info is included if integrity protection is applied
CN information elements				
CN domain identity	MP		CN domain identity 10.3.1.1	

10.2.47 SIGNALLING CONNECTION RELEASE INDICATION

This message is used by the UE to indicate to UTRAN the release of an existing signalling connection.

RLC-SAP: AM

Logical channel: DCCH

Direction: UE→UTRAN

Information Element/Group name	Need	Multi	IE type and reference	Semantics description
Message Type	MP		Message type	
UE Information Elements				
Integrity check info	CH		Integrity check info 10.3.3.16	
CN information elements				
CN domain identity	MP		CN domain identity 10.3.1.1	

10.2.48 SYSTEM INFORMATION

This message is used by the UTRAN to convey system information blocks to the UE.

RLC-SAP: TM

Logical channel: BCCH

Direction: UTRAN→UE

Information Element/Group name	Need	Multi	Type and reference	Semantics description
Message type	CV- <i>channel1</i>		Message type	
SFNprime	CV- <i>channel2</i>		Integer(0..40 94 by step of 2)	SFN=SFNprime (for first 10ms frame of 20ms TTI), SFN=SFNprime+1 (for last 10ms frame of 20ms TTI)
CHOICE <i>Segment combination</i>	MP			Five spares are needed
>Combination 1				(no data)
>Combination 2				
>>First Segment	MP		First Segment, 10.2.48.1	
>Combination 3				
>>Subsequent Segment	MP		Subsequent Segment, 10.2.48.3	
>Combination 4				
>>Last segment	MP		Last segment (short),10.2. 48.5	
>Combination 5				NOTE 2
>>Last segment	MP		Last Segment (short)10.2.4 8.5	
>>First Segment	MP		First Segment (short), 10.2.48.2	
>Combination 6				NOTE 2
>>Last Segment	MP		Last Segment (short), 10.2.48.5	
>>Complete list	MP	1 to maxSIBper Msg		NOTE 1
>>>Complete	MP		Complete SIB	

Information Element/Group name	Need	Multi	Type and reference	Semantics description
			(short),10.2.48.7	
>Combination 7				NOTE 2
>>Last Segment	MP		Last Segment (short), 10.2.48.5	
>>>Complete list	MP	1..<maxSIBperMsg>		NOTE 1
>>>>Complete	MP		Complete SIB (short),10.2.48.7	
>>>First Segment	MP		First Segment (short), 10.2.48.2	
>Combination 8				NOTE 2
>>>Complete list	MP	1 to maxSIBperMsg		NOTE 1
>>>>Complete	MP		Complete SIB (short),10.2.48.7	
>Combination 9				NOTE 2
>>>Complete list	MP	1..MaxSIBperMsg		NOTE 1
>>>>Complete	MP		Complete SIB (short),10.2.48.7	
>>>First Segment	MP		First Segment (short), 10.2.48.2	
>Combination 10				
>>>>Complete SIB of size 215 to 226	MP		Complete SIB,10.2.48.6	
>Combination 11				
>>>>Last segment of size 215 to 222	MP		Last segment,10.2.48.4	
NOTE 1: If Combination 6 - 9 contains a Master information block, the Master information block shall be located as the first IE in the list.				
NOTE 2: If one of the combinations 5 to 9 is used, the IE "SIB type" = "Extension Type" should not occur more than once in that message, otherwise the UE behaviour is unspecified.				

Condition	Explanation
<i>channel1</i>	The IE is mandatory present if the message is sent on the FACH and not needed otherwise.
<i>channel2</i>	This IE is mandatory present if the channel is BCH, otherwise it is not needed.

If the encoded message does not fill a transport block, the RRC layer shall insert padding according to subclause 12.1. Padding is needed e.g. if the remaining space is insufficient to start a new First Segment (which requires several bits for SIB type, SEG_COUNT and SIB data).

10.2.48.1 First Segment

This segment type is used to transfer the first segment of a segmented system information block. The IE is used when the first segment fills the entire transport block (Combination 2).

Information Element/Group name	Need	Multi	Type and reference	Semantics description
Other information elements				
SIB type	MP		SIB Type, 10.3.8.21	
SEG_COUNT	MP		SEG COUNT, 10.3.8.17	
SIB data fixed	MP		SIB data fixed, 10.3.8.19	

10.2.48.2 First Segment (short)

This segment type is used to transfer the first segment of a segmented system information block. The IE is used when the first segment is concatenated after other segments in a transport block (Combination 5, 7 and 9).

Information Element/Group name	Need	Multi	Type and reference	Semantics description
Other information elements				
SIB type	MP		SIB Type, 10.3.8.21	
SEG_COUNT	MP		SEG COUNT, 10.3.8.17	
SIB data variable	MP		SIB data variable, 10.3.8.20	

10.2.48.3 Subsequent Segment

This segment type is used to transfer a subsequent segment of a segmented system information block.

Information Element/Group name	Need	Multi	Type and reference	Semantics description
Other information elements				
SIB type	MP		SIB Type, 10.3.8.21	
Segment index	MP		Segment Index, 10.3.8.18	
SIB data fixed	MP		SIB data fixed, 10.3.8.19	

10.2.48.4 Last Segment

This segment type is used to transfer the last segment of a segmented system information block. The IE is used when the last segment has a length, excluding length denominator, from 215 through 222 (Combination 11).

Information Element/Group name	Need	Multi	Type and reference	Semantics description
Other information elements				
SIB type	MP		SIB Type, 10.3.8.21	
Segment index	MP		Segment Index, 10.3.8.18	
SIB data fixed	MP		SIB data fixed, 10.3.8.19	In case the SIB data is less than 222 bits, padding shall be used. The same padding bits shall be used as defined in clause 12.1

10.2.48.5 Last Segment (short)

This segment type is used to transfer the last segment of a segmented system information block. The IE is used when the last segment has a length, excluding length denominator, of upto 214 bits (Combination 4, 5, 6 and 7).

Information Element/Group name	Need	Multi	Type and reference	Semantics description
Other information elements				
SIB type	MP		SIB Type, 10.3.8.21	
Segment index	MP		Segment Index, 10.3.8.18	
SIB data variable	MP		SIB data variable, 10.3.8.20	

10.2.48.6 Complete SIB

This segment type is used to transfer a non-segmented system information block. The IE is used when the complete SIB has a length, excluding length denominator, from 215 through 226 (Combination 10).

Information Element/Group name	Need	Multi	Type and reference	Semantics description
Other information elements				
SIB type	MP		SIB Type, 10.3.8.21	
SIB data fixed	MP		Bit string (226)	The first/leftmost/most significant bit of the bit string contains the first bit of the segment. In case the SIB data is less than 226 bits, padding shall be used. The same padding bits shall be used as defined in clause 12.1

10.2.48.7 Complete SIB (short)

This segment type is used to transfer a non-segmented system information block. The IE is used when the complete SIB has a length, excluding length denominator, of upto 214 bits (Combination 6, 7, 8 and 9).

Information Element/Group name	Need	Multi	Type and reference	Semantics description
Other information elements				
SIB type	MP		SIB Type, 10.3.8.21	
SIB data variable	MP		SIB data variable, 10.3.8.20	

10.2.48.8 System Information Blocks

The IE "SIB data" within the IEs, "First Segment", "Subsequent or last Segment" and "Complete SIB" contains either complete system information block or a segment of a system information block. The actual system information blocks are defined in the following clauses.

10.2.48.8.1 Master Information Block

Information Element/Group name	Need	Multi	Type and reference	Semantics description	Version
Other information elements					
MIB Value tag	MP		MIB Value tag 10.3.8.9		
CN information elements					
Supported PLMN types	MP		PLMN Type 10.3.1.12		
PLMN Identity	CV-GSM		PLMN Identity 10.3.1.11		
Multiple PLMN List	OP		Multiple PLMN List 10.3.1.7a	If present, this IE specifies the PLMNs of the cell. If absent, the IE "PLMN Identity" specifies the PLMN of the cell.	REL-6
ANSI-41 information elements					
ANSI-41 Core Network Information	CV-ANSI-41		ANSI-41 Core Network Information 10.3.9.1		
References to other system information blocks and scheduling blocks	MP		References to other system information blocks and scheduling blocks 10.3.8.14		

Condition	Explanation
GSM	The IE is mandatory present if the IE "Supported PLMN Types" is set to 'GSM-MAP' or 'GSM-MAP AND ANSI-41', and not needed otherwise
ANSI-41	The IE is mandatory present if the IE "Supported PLMN Types" is set to 'ANSI-41' or 'GSM-MAP AND ANSI-41', and not needed otherwise

10.2.48.8.2 Scheduling Block 1

Information Element/Group name	Need	Multi	Type and reference	Semantics description
References to other system information blocks	MP		References to other system information blocks 10.3.8.13	

10.2.48.8.3 Scheduling Block 2

Information Element/Group name	Need	Multi	Type and reference	Semantics description
References to other system information blocks	MP		References to other system information blocks 10.3.8.13	

10.2.48.8.4 System Information Block type 1

The system information block type 1 contains NAS system information as well as UE timers and counters to be used in idle mode and in connected mode.

Information Element/Group name	Need	Multi	Type and reference	Semantics description
CN information elements				
CN common GSM-MAP NAS system information	MP		NAS system information (GSM-MAP) 10.3.1.9	
CN domain system information list	MP	1 to <maxCNdo mains>		Send CN information for each CN domain.
>CN domain system information	MP		CN domain system information 10.3.1.2	
UE information				
UE Timers and constants in idle mode	MD		UE Timers and constants in idle mode 10.3.3.44	The UE behaviour is unspecified if this IE is absent.
UE Timers and constants in connected mode	MD		UE Timers and constants in connected mode 10.3.3.43	Default value means that for all timers and constants - For parameters with need MD, the defaults specified in 10.3.3.43 apply and - For parameters with need OP, the parameters are absent

10.2.48.8.5 System Information Block type 2

The system information block type 2 contains the URA identity.

Information Element/Group name	Need	Multi	Type and reference	Semantics description
UTRAN mobility information elements				
URA identity list	MP	1 ..<maxURA>		
>URA identity	MP		URA identity 10.3.2.6	

10.2.48.8.6 System Information Block type 3

The system information block type 3 contains parameters for cell selection and re-selection.

Information Element/Group name	Need	Multi	Type and reference	Semantics description	Version
SIB4 Indicator	MP		Boolean	TRUE indicates that SIB4 is broadcast in the cell.	
UTRAN mobility information elements					
Cell identity	MP		Cell identity 10.3.2.2		
Cell selection and re-selection info	MP		Cell selection and re-selection info for SIB3/4 10.3.2.3		
Cell Access Restriction	MP		Cell Access Restriction 10.3.2.1		
Domain Specific Access Restriction Parameters For PLMN Of MIB	OP		Domain Specific Access Restriction Parameters 10.3.1.3c	This IE specifies the Domain Specific Access Restriction Parameters for UEs which has chosen the PLMN in the IE "PLMN identity" of the Master Information Block. If the cell is operating in MBSFN mode as indicated in subclause 8.1.1.6.3 the UE behaviour upon reception of this IE is unspecified.	REL-6
Domain Specific Access Restriction For Shared Network	OP			If the cell is operating in MBSFN mode as indicated in subclause 8.1.1.6.3 the UE behaviour upon reception of this IE is unspecified.	REL-6
>CHOICE <i>barring representation</i>	MP				REL-6
>>Domain Specific Access Restriction List					REL-6
>>>Domain Specific Access Restriction Parameters For Operator1	OP		Domain Specific Access Restriction Parameters 10.3.1.3c	This IE specifies the Domain Specific Access Restriction Parameters for UEs which has chosen the first PLMN in the IE "multiplePLMNs" in the IE "Multiple PLMN List" of the Master Information Block.	REL-6
>>>Domain Specific Access Restriction Parameters For Operator2	OP		Domain Specific Access Restriction Parameters 10.3.1.3c	This IE specifies the Domain Specific Access Restriction Parameters for UEs which has chosen the second PLMN in the IE "multiplePLMNs" in the IE "Multiple PLMN List" of the Master Information Block.	REL-6
>>>Domain Specific Access Restriction Parameters For Operator3	OP		Domain Specific Access Restriction Parameters 10.3.1.3c	This IE specifies the Domain Specific Access Restriction Parameters for UEs which has chosen the third PLMN in the IE "multiplePLMNs" in the IE "Multiple PLMN List" of the Master Information Block.	REL-6
>>>Domain Specific Access Restriction Parameters For Operator4	OP		Domain Specific Access Restriction Parameters 10.3.1.3c	This IE specifies the Domain Specific Access Restriction Parameters for UEs which has chosen the fourth PLMN in the IE "multiplePLMNs" in the IE "Multiple PLMN List" of the Master Information Block.	REL-6
>>>Domain Specific Access Restriction Parameters For Operator5	OP		Domain Specific Access Restriction	This IE specifies the Domain Specific Access Restriction Parameters for UEs which has chosen the fifth PLMN in the	REL-6

			Parameters 10.3.1.3c	IE "multiplePLMNs" in the IE "Multiple PLMN List" of the Master Information Block.	
>>Domain Specific Access Restriction Parameters For All					REL-6
>>>Domain Specific Access Restriction Parameters			Domain Specific Access Restriction Parameters 10.3.1.3c	This IE specifies the common Domain Specific Access Restriction Parameters applied to all PLMNs in the IE "multiplePLMNs" in the IE "Multiple PLMN List" of the Master Information Block.	REL-6
Deferred measurement control reading	OP		Enumerated (TRUE)	If present, the UE may apply deferred reading of SIB11, SIB11bis and SIB12. If not present, deferred reading may not be applied.	REL-7
>CHOICE <i>mode</i>	OP			If absent, the default reporting quantities are: "CPICH RSCP" (FDD) and "Primary CCPCH RSCP" (TDD).	REL-7
>>FDD					REL-7
>>>Intra-frequency reporting quantity SIB3	MP		Enumerated (CPICH Ec/N0, CPICH RSCP)		REL-7
>>TDD					REL-7
>>>Reporting quantity list	MP	1 to 2			REL-7
>>>>Intra-frequency reporting quantity SIB3	MP		Enumerated (Primary CCPCH RSCP, Timeslot ISCP)		REL-7
MBSFN only service	OP		Enumerated (true)	Indicates if the cell provides only MBMS services in MBSFN mode	REL-7

10.2.48.8.7 System Information Block type 4

The system information block type 4 contains parameters for cell selection and re-selection to be used in connected mode.

Information Element/Group name	Need	Multi	Type and reference	Semantics description
UTRAN mobility information elements				
Cell identity	MP		Cell identity 10.3.2.2	
Cell selection and re-selection info	MP		Cell selection and re-selection info for SIB3/4 10.3.2.3	
Cell Access Restriction	MP		Cell Access Restriction 10.3.2.1	

10.2.48.8.8 System Information Block type 5 and 5bis

The system information block type 5 contains parameters for the configuration of the common physical channels in the cell. System information block type 5bis uses the same structure as System information block type 5. System information block type 5bis is sent instead of system information block type 5 in cells that use Band IV or Band IX or Band X.

Information Element/Group name	Need	Multi	Type and reference	Semantics description	Version
SIB6 Indicator	MP		Boolean	TRUE indicates that SIB6 is broadcast in the cell.	
PhyCH information elements					
PICH Power offset	MP		PICH Power offset 10.3.6.50	If the cell is operating in MBSFN mode as indicated in subclause 8.1.1.6.3 the UE behaves as if this IE would not have been received.	
<i>CHOICE mode</i>	MP				
>FDD					
>>AICH Power offset	MP		AICH Power offset 10.3.6.3	If the cell is operating in MBSFN mode as indicated in subclause 8.1.1.6.3 the UE behaves as if this IE would not have been received.	
>TDD					
>>PUSCH system information	OP		PUSCH system information 10.3.6.66	If the cell is operating in MBSFN mode as indicated in subclause 8.1.1.6.3 the UE behaviour upon reception of this IE is unspecified.	
>>PUSCH system information VHCR	OP		PUSCH system information VHCR 10.3.6.66a	Only for 7.68 Mcps TDD If the cell is operating in MBSFN mode as indicated in subclause 8.1.1.6.3 the UE behaviour upon reception of this IE is unspecified.	REL-7
>>PDSCH system information	OP		PDSCH system information 10.3.6.46	If the cell is operating in MBSFN mode as indicated in subclause 8.1.1.6.3 the UE behaviour upon reception of this IE is unspecified.	
>>TDD open loop power control	MP		TDD open loop power control 10.3.6.79	If the cell is operating in MBSFN mode as indicated in subclause 8.1.1.6.3 the UE behaves as if this IE would not have been received.	
Primary CCPCH info	OP		Primary CCPCH info 10.3.6.57	Note 1	
PRACH system information list	MP		PRACH system information	If the cell is operating in MBSFN mode as indicated in subclause	

Information Element/Group name	Need	Multi	Type and reference	Semantics description	Version
			n list 10.3.6.55	8.1.1.6.3 the UE behaves as if this IE would not have been received.	
Secondary CCPCH system information	MP		Secondary CCPCH system information 10.3.6.72	Note 2 If the cell is operating in MBSFN mode as indicated in subclause 8.1.1.6.3 the UE behaves as if this IE would not have been received.	
CBS DRX Level 1 information	CV- <i>CTCH</i>		CBS DRX Level 1 information 10.3.8.3		

Information Element/Group name	Need	Multi	Type and reference	Semantics description	Version
Frequency band indicator	OP		Frequency band indicator 10.3.6.35 b		REL-6
Frequency band indicator 2	OP		Frequency band indicator 2 10.3.6.35 c		REL-6
HSDPA cell Indicator	MD		Enumerated (HSDPA Capable Cell)	Default is 'HSDPA capability not indicated'. 'HSDPA Capable Cell' means that the UE may consider this cell as part of the HSDPA coverage area for display indication only. This indication shall not be used for any other purpose. If the cell is operating in MBSFN mode as indicated in subclause 8.1.1.6.3 the UE behaves as if this IE would not have been received.	REL-6
E-DCH cell Indicator	MD		Enumerated (E-DCH Capable Cell)	Default is 'E-DCH capability not indicated'. 'E-DCH Capable Cell' means that the UE may consider this cell as part of the E-DCH coverage area for display indication only. This indication shall not be used for any other purpose. If the cell is operating in MBSFN mode as indicated in subclause 8.1.1.6.3 the UE behaves as if this IE would not have been received.	REL-6
Secondary CCPCH system information MBMS	OP		Secondary CCPCH system information MBMS 10.3.6.72 a	Included if MCCH is on an S-CCPCH used only for MBMS. Note 2	REL-6
CHOICE <i>mode</i>	OP				REL-7
>FDD					REL-7
>>HS-DSCH common system information	MP		HS-DSCH common system information 10.3.6.36 c	Included if cell supports HS-DSCH reception in CELL_FACH and during IDLE to RRC Connection state transition.	REL-7
>>HS-DSCH paging	OP		HS-DSCH	Included if cell supports	REL-7

Information Element/Group name	Need	Multi	Type and reference	Semantics description	Version
system information			paging system information 10.3.6.36d	for UEs in RRC Connected state paging message reception on HS-DSCH.	
>TDD				(no data)	REL-7
TDD MBSFN information	OP		TDD MBSFN Information 10.3.6.78b	TDD only: included only if some timeslots are designated to MBSFN.	REL-7

NOTE 1: DL scrambling code of the Primary CCPCH is the same as the one for Primary CPICH (FDD only).

NOTE 2: There is only one MCCH in a cell, which may either be mapped on to an S-CCPCH also used for non-MBMS purposes or to an S-CCPCH dedicated to MBMS. In the first case the MCCH configuration is specified within the IE "Secondary CCPCH system information", in the latter case the MCCH configuration is provided within the IE "Secondary CCPCH system information MBMS".

Condition	Explanation
<i>CTCH</i>	The IE is mandatory present if the IE "CTCH indicator" is equal to TRUE for at least one FACH, otherwise the IE is not needed in the message

10.2.48.8.9 System Information Block type 6

The system information block type 6 contains parameters for the configuration of the common and shared physical channels to be used in connected mode.

Information Element/Group name	Need	Multi	Type and reference	Semantics description	Version
PhyCH information elements					
PICH Power offset	MP		PICH Power offset 10.3.6.50		
CHOICE <i>mode</i>	MP				
>FDD					
>>AICH Power offset	MP		AICH Power offset 10.3.6.3		
>TDD					
>>PUSCH system information	OP		PUSCH system information 10.3.6.66		
>>PUSCH system information VHCR	OP		PUSCH system information VHCR 10.3.6.66a	Only for 7.68 Mcps TDD	REL-7
>>PDSCH system information	OP		PDSCH system information 10.3.6.46		
>>TDD open loop power	MP		TDD open		

Information Element/Group name	Need	Multi	Type and reference	Semantics description	Version
control			loop power control 10.3.6.79		
Primary CCPCH info	OP		Primary CCPCH info 10.3.6.57	Note 1	
PRACH system information list	OP		PRACH system information list 10.3.6.55		
Secondary CCPCH system information	OP		Secondary CCPCH system information 10.3.6.72		
CBS DRX Level 1 information	CV- <i>CTCH</i>		CBS DRX Level 1 information 10.3.8.3		
Frequency band indicator	OP		Frequency band indicator 10.3.6.35 b		REL-6
Frequency band indicator 2	OP		Frequency band indicator 2 10.3.6.35 c		REL-6

NOTE 1: DL scrambling code of the Primary CCPCH is the same as the one for Primary CPICH (FDD only).

Condition	Explanation
<i>CTCH</i>	The IE is mandatory present if the IE "CTCH indicator" is equal to TRUE for at least one FACH, otherwise the IE is not needed

10.2.48.8.10 System Information Block type 7

The system information block type 7 contains the fast changing parameters UL interference and Dynamic persistence level.

Information Element/Group name	Need	Multi	Type and reference	Semantics description
CHOICE <i>mode</i>	MP			
>FDD				
>>UL interference	MP		UL interference 10.3.6.87	
>TDD				(no data)
PhyCH information elements				
PRACHs listed in system information block type 5	MP	1 to <maxPRACH>		The order of the PRACHs is the same as in system information block type 5 or 5bis.
>Dynamic persistence level	MP		Dynamic persistence level 10.3.6.35	
PRACHs listed in system information block type 6	OP	1 to <maxPRACH>		The order of the PRACHs is the same as in system information block type 6.
>Dynamic persistence level	MP		Dynamic persistence level 10.3.6.35	
Expiration Time Factor	MD		Expiration Time Factor 10.3.3.12	Default is 1.

10.2.48.8.11 Void

10.2.48.8.12 Void

10.2.48.8.13 Void

10.2.48.8.14 System Information Block type 11

The system information block type 11 contains measurement control information to be used in the cell.

Information Element/Group name	Need	Multi	Type and reference	Semantics description
SIB12 Indicator	MP		Boolean	TRUE indicates that SIB12 is broadcast in the cell.
Measurement information elements				
FACH measurement occasion info	OP		FACH measurement occasion info 10.3.7.8	If the cell is operating in MBSFN mode as indicated in subclause 8.1.1.6.3 the UE behaviour upon reception of this IE is unspecified.
Measurement control system information	MP		Measurement control system information	For 1.28 Mcps TDD if the cell is operating in MBSFN only mode the UE behaviour upon reception of this IE is

Information Element/Group name	Need	Multi	Type and reference	Semantics description
			10.3.7.47	unspecified.
MBSFN frequency list	OP		MBSFN frequency list 10.3.9a.12a	If present contains all neighbouring frequencies of MBSFN clusters operating in MBSFN mode as indicated in subclause 8.1.1.6.3.

10.2.48.8.14a System Information Block type 11bis

The system information block type 11bis contains measurement control information to be used in the cell in addition to System Information Block type 11.

Information Element/Group name	Need	Multi	Type and reference	Semantics description	Version
Measurement information elements					REL-6
Measurement control system information extension	MP		Measurement control system information extension 10.3.7.47a		REL-6

10.2.48.8.15 System Information Block type 12

The system information block type 12 contains measurement control information to be used in connected mode.

Information Element/Group name	Need	Multi	Type and reference	Semantics description
Measurement information elements				
FACH measurement occasion info	OP		FACH measurement occasion info 10.3.7.8	
Measurement control system information	MP		Measurement control system information 10.3.7.47	

10.2.48.8.16 System Information Block type 13

The system information block type 13 contains ANSI-41 system information.

Information Element/Group name	Need	Multi	Type and reference	Semantics description
Other information elements				
CN Information Elements				
CN Domain system information list	MP	1 to <maxCNdo mains>		Send CN information for each CN domain.
>CN Domain system information	MP		CN Domain system information 10.3.1.2	
UE Information				
UE timers and constants in idle mode	MD		UE timers and constants in idle mode 10.3.3.44	The UE behaviour is unspecified if this IE is absent.
Capability update requirement	MD		Capability update requirement 10.3.3.2	Default value is defined in subclause 10.3.3.2

10.2.48.8.16.1 System Information Block type 13.1

The system information block type 13.1 contains the ANSI-41 RAND information.

Information Element/Group name	Need	Multi	Type and reference	Semantics description
ANSI-41 information elements				
ANSI-41 RAND information	MP		ANSI-41 RAND information 10.3.9.6	

10.2.48.8.16.2 System Information Block type 13.2

The system information block type 13.2 contains the ANSI-41 User Zone Identification information.

Information Element/Group name	Need	Multi	Type and reference	Semantics description
ANSI-41 information elements				
ANSI-41 User Zone Identification information	MP		ANSI-41 User Zone Identification information 10.3.9.7	

10.2.48.8.16.3 System Information Block type 13.3

The system information block type 13.3 contains the ANSI-41 Private Neighbour List information.

Information Element/Group name	Need	Multi	Type and reference	Semantics description
ANSI-41 information elements				
ANSI-41 Private Neighbour List information	MP		ANSI-41 Private Neighbour List information 10.3.9.5	

10.2.48.8.16.4 System Information Block type 13.4

The system information block type 13.4 contains the ANSI-41 Global Service Redirection information.

Information Element/Group name	Need	Multi	Type and reference	Semantics description
ANSI-41 information elements				
ANSI-41 Global Service Redirection information	MP		ANSI-41 Global Service Redirection information 10.3.9.2	

10.2.48.8.17 System Information Block type 14

NOTE: Only for 3.84 Mcps TDD and 7.68 Mcps TDD.

The system information block type 14 contains parameters for common and dedicated physical channel uplink outer loop power control information to be used in both idle and connected mode.

Information Element/Group name	Need	Multi	Type and reference	Semantics description
PhyCH information elements				
Individual Timeslot interference list	MP	1 to <maxTS>		
>Individual Timeslot interference	MP		Individual Timeslot interference 10.3.6.38	
Expiration Time Factor	MD		Expiration Time Factor 10.3.3.12	Default is 1.

10.2.48.8.18 System Information Block type 15

The system information block type 15 contains information useful for UE-based or UE-assisted positioning methods.

Information Element/Group name	Need	Multi	Type and Reference	Semantics description
GPS Data ciphering info	OP		UE positioning Ciphering info 10.3.7.86	If this IE is present then the SIB types 15.1, 15.2 & 15.3 are ciphered in accordance with the Data Assistance Ciphering Algorithm specified in [18]
Reference position	MP		Ellipsoid point with altitude and uncertainty ellipsoid 10.3.8.4c	approximate position where the UE is located
GPS reference time	MP		UE positioning GPS reference time 10.3.7.96	
Satellite information	OP	1 to <maxSat>		This IE is present whenever bad (failed/failing) satellites are detected by UTRAN [18].
>BadSatID	MP		Enumerated(0..63)	

10.2.48.8.18.0 System Information Block type 15bis

The system information block type 15bis contains information useful for UE-based or UE-assisted positioning methods. The content of this SIB is common to all GANSS.

Information Element/Group name	Need	Type and Reference	Semantics description	Version
Reference position	MP	Ellipsoid point with altitude and uncertainty ellipsoid 10.3.8.4c	approximate position where the UE is located	REL-7
GANSS reference time	MP	UE positioning GANSS reference time 10.3.7.96o		REL-7
GANSS ionospheric model	OP	UE positioning GANSS ionospheric model 10.3.7.92a		REL-7

10.2.48.8.18.1 System Information Block type 15.1

The system information block type 15.1 contains information useful for UE positioning DGPS Corrections. The DGPS Corrections message contents are based on a Type-1 message of DGPS specified in [13].

Information Element/Group name	Need	Multi	Type and Reference	Semantics description
DGPS corrections	MP		UE positioning GPS DGPS corrections 10.3.7.91	

10.2.48.8.18.1a System Information Block type 15.1bis

The system information block type 15.1bis contains information useful for UE positioning DGANSS Corrections. The DGANSS Corrections message contents are based on a Type-1 message of DGANSS specified in [13]. The content of this SIB is GNSS specific.

Information Element/Group name	Need	Type and Reference	Semantics description	Version
DGANSS corrections	MP	UE positioning DGANSS corrections 10.3.7.91b		REL-7

10.2.48.8.18.2 System Information Block type 15.2

The system information block type 15.2 contains information useful for GPS Navigation Model. These IE fields are based on information extracted from the subframes 1 to 3 of the GPS navigation message [12].

Information Element/Group name	Need	Multi	Type and Reference	Semantics description
Transmission TOW	MP		Integer (0..604799)	The approximate GPS time-of-week when the message is broadcast. in seconds
SatID	MP		Integer (0..63)	Satellite ID
GPS Ephemeris and Clock Correction Parameters	MP		UE positioning GPS Ephemeris and Clock Correction parameters 10.3.7.91a	

10.2.48.8.18.2a System Information Block type 15.2bis

The system information block type 15.2bis contains information useful for GANSS Navigation Model. The content of this SIB is GNSS specific.

Information Element/Group name	Need	Type and Reference	Semantics description	Version
GANSS Navigation Model	MP	UE positioning GANSS navigation model 10.3.7.94a		REL-7

10.2.48.8.18.3 System Information Block type 15.3

The system information block type 15.3 contains information useful for ionospheric delay, UTC offset, and Almanac. These IEs contain information extracted from the subframes 4 and 5 of the GPS navigation message, [12].

Information Element/Group name	Need	Multi	Type and Reference	Semantics description
Transmission TOW	MP		Integer (0..604799)	The approximate GPS time-of-week when the message is broadcast. in seconds
GPS Almanac and Satellite Health	OP		UE positioning GPS almanac 10.3.7.89	
GPS ionospheric model	OP		UE positioning GPS ionospheric model 10.3.7.92	
GPS UTC model	OP		UE positioning GPS UTC model 10.3.7.97	
SatMask	CV- <i>Almanac</i>		Bit string(1..32)	indicates the satellites that contain the pages being broadcast in this data set
LSB TOW	CV- <i>Almanac</i>		Bit string(8)	

Condition	Explanation
<i>Almanac</i>	This IE is mandatory present if the IE "GPS Almanac and Satellite Health" is present

10.2.48.8.18.3a System Information Block type 15.3bis

The system information block type 15.3bis contains information useful for GANSS time model, UTC offset and Almanac. The content of this SIB is GNSS specific.

Information Element/Group name	Need	Multi	Type and Reference	Semantics description	Version
GANSS Almanac	OP		UE positioning GANSS almanac 10.3.7.89a		REL-7
GANSS time models	OP	1 to <maxGANSS-1>			REL-7
>GANSS time model	OP		UE positioning GANSS time model 10.3.7.97a		REL-7
GANSS UTC model	OP		UE positioning GANSS UTC model 10.3.7.97c		REL-7

10.2.48.8.18.4 System Information Block type 15.4

The system information block type 15.4 contains ciphering information for System Information Block type 15.5 and information useful for OTDOA UE-assisted Positioning method.

Information Element/Group name	Need	Multi	Type and Reference	Semantics description
OTDOA Data ciphering info	OP		UE positioning Ciphering info 10.3.7.86	If this IE is present then the for UE-based the System Information Block type 15.5 is ciphered in accordance with the Data Assistance Ciphering Algorithm specified in [18]
OTDOA assistance data for UE-assisted	MP		UE positioning OTDOA assistance data for UE-assisted 10.3.7.103	

10.2.48.8.18.4a System Information Block type 15.5

The system information block type 15.5 contains information useful for OTDOA UE-based Positioning method.

Information Element/Group name	Need	Multi	Type and Reference	Semantics description
OTDOA assistance data for UE-based	MP		UE positioning OTDOA assistance data for UE-based 10.3.7.103a	

10.2.48.8.18.5 System Information Block type 15.6

The system information block type 15.6 contains information useful for acquisition of GANSS signals. The content of this SIB is GNSS specific.

Information Element/Group name	Need	Multi	Type and Reference	Semantics description	Version
GANSS TOD	MP		Integer(0..86399)	GANSS Time of Day in seconds where GANSS reference measurement information is valid.	REL-7
GANSS reference measurement information	MP		UE positioning GANSS reference measurement information 10.3.7.88b		REL-7

10.2.48.8.18.6 System Information Block type 15.7

The system information block type 15.7 contains data bits which can be used for data wipe-off. The content of this SIB is GNSS specific.

Information Element/Group name	Need	Multi	Type and Reference	Semantics description	Version
GANSS data bit assistance	MP		UE positioning GANSS data bit assistance 10.3.7.97b		REL-7

10.2.48.8.18.7 System Information Block type 15.8

The system information block type 15.8 contains ciphering information and real-time integrity information. The content of this SIB is GNSS specific.

Information Element/Group name	Need	Multi	Type and Reference	Semantics description	Version
GANSS Data ciphering info	OP		UE positioning Ciphering info 10.3.7.86	If this IE is present then the SIB types 15.1bis, 15.2bis, 15.3bis, 15.6 and 15.7 are ciphered in accordance with the Data Assistance Ciphering Algorithm specified in [18]	REL-7
GANSS real-time integrity	OP		UE positioning GANSS real-time integrity 10.3.7.95b		REL-7

10.2.48.8.19 System Information Block type 16

The system information block type 16 contains radio bearer, transport channel and physical channel parameters to be stored by UE in idle and connected mode for use during handover to UTRAN.

Information Element/Group name	Need	Multi	Type and Reference	Semantics description
RB information elements				
Predefined RB configuration	MP		Predefined RB configuration 10.3.4.7	
TrCH Information Elements				
Predefined TrCH configuration	MP		Predefined TrCH configuration 10.3.5.9	
PhyCH Information Elements				
Predefined PhyCH configuration	MP		Predefined PhyCH configuration 10.3.6.56	

10.2.48.8.20 System Information Block type 17

NOTE: Only for TDD.

The system information block type 17 contains fast changing parameters for the configuration of the shared physical channels to be used in connected mode.

Information Element/Group name	Need	Multi	Type and reference	Semantics description	Version
PhyCH information elements					
PUSCH system information	OP		PUSCH system information 10.3.6.66		
PUSCH system information VHCR	OP		PUSCH system information VHCR 10.3.6.66a	Only for 7.68 Mcps TDD	REL-7
PDSCH system information	OP		PDSCH system information 10.3.6.46		

10.2.48.8.21 System Information Block type 18

The System Information Block type 18 contains PLMN identities of neighbouring cells to be considered in idle mode as well as in connected mode.

Information Element/Group name	Need	Multi	Type and reference	Semantics description	Version
Idle mode PLMN identities	OP		PLMN identities of neighbour cells 10.3.7.53a		
Connected mode PLMN identities	OP		PLMN identities of neighbour cells 10.3.7.53a		
Idle mode PLMN identities for SIB 11bis	OP		PLMN identities of neighbour cells 10.3.7.53a		REL-6
Connected mode PLMN identities for SIB 11bis	OP		PLMN identities of neighbour cells 10.3.7.53a		REL-6

10.2.49 SYSTEM INFORMATION CHANGE INDICATION

This message is used to send information on FACH or HS-DSCH (FDD only) to the UEs in state CELL_FACH, CELL_PCH (FDD only), or CELL_DCH(TDD only) about coming modification of the system information.

RLC-SAP: TM

Logical channel: BCCH

Direction: UTRAN → UE

Information Element/Group name	Need	Multi	Type and reference	Semantics description
Message Type	MP		Message Type	
Other information elements				
BCCH modification info	MP		BCCH modification info 10.3.8.1	

If the encoded message does not fill a transport block, the RRC layer shall insert padding according to subclause 12.1.

10.2.50 TRANSPORT CHANNEL RECONFIGURATION

This message is used by UTRAN to configure the transport channel of a UE. This also includes a possible reconfiguration of physical channels. The message can also be used to assign a TFC subset and reconfigure physical channel.

RLC-SAP: AM or UM

Logical channel: DCCH

Direction: UTRAN → UE

Information Element/Group name	Need	Multi	Type and reference	Semantics description	Version
Message Type	MP		Message Type		
UE Information Elements					
RRC transaction identifier	MP		RRC transaction identifier 10.3.3.36		
Integrity check info	CH		Integrity check info 10.3.3.16		
Integrity protection mode info	OP		Integrity protection mode info 10.3.3.19	The UTRAN should not include this IE unless it is performing an SRNS relocation	
Ciphering mode info	OP		Ciphering mode info 10.3.3.5	The UTRAN should not include this IE unless it is performing an SRNS relocation and a change in ciphering algorithm	
Activation time	MD		Activation time 10.3.3.1	Default value is "now"	
Delay restriction flag	OP		Enumerated (TRUE)	This IE is always set to TRUE and included if the activation time is restricted according to subclause 8.6.3.1	REL-6
New U-RNTI	OP		U-RNTI 10.3.3.47		
New C-RNTI	OP		C-RNTI 10.3.3.8		
New DSCH-RNTI	OP		DSCH-RNTI 10.3.3.9a	Should not be set in FDD. If received the UE should ignore it	

Information Element/Group name	Need	Multi	Type and reference	Semantics description	Version
New H-RNTI	OP		H-RNTI 10.3.3.14a		REL-5
New Primary E-RNTI	OP		E-RNTI 10.3.3.10a		REL-6
New Secondary E-RNTI	OP		E-RNTI 10.3.3.10a	FDD only	REL-6
RRC State Indicator	MP		RRC State Indicator 10.3.3.35a		
UE Mobility State Indicator	CV- FACH_PC H		Enumerated (High-mobility Detected)	Absence of this IE implies that, according to [4], the UE shall consider itself being in the mobility state the UE has maintained in CELL_DCH state or being not in high mobility state after the state transition, if applicable.	REL-7
UTRAN DRX cycle length coefficient	OP		UTRAN DRX cycle length coefficient 10.3.3.49		
CN Information Elements					
CN Information info	OP		CN Information info 10.3.1.3		
UTRAN mobility information elements					
URA identity	OP		URA identity 10.3.2.6		
RNC support for change of UE capability	OP		Boolean	Should be included if the message is used to perform an SRNS relocation	REL-7
Reconfiguration in response to requested change of UE capability	OP		Enumerated (TRUE)		REL-7
RB information elements					
Downlink counter synchronisation info	OP				
>RB with PDCP information list	OP	1 to <maxRBall RABs>			
>>RB with PDCP information	MP		RB with PDCP information 10.3.4.22	This IE is needed for each RB having PDCP in the case of lossless SRNS relocation	
	OP				REL-5
>>PDCP context relocation info	OP		PDCP context relocation info 10.3.4.1a	This IE is needed for each RB having PDCP and performing PDCP context relocation	REL-5
TrCH Information Elements					
Uplink transport channels					
UL Transport channel	OP		UL Transport		

Information Element/Group name	Need	Multi	Type and reference	Semantics description	Version
information common for all transport channels			channel information common for all transport channels 10.3.5.24		
Added or Reconfigured TrCH information list	OP	1 to <maxTrCH >			
>Added or Reconfigured UL TrCH information	MP		Added or Reconfigured UL TrCH information 10.3.5.2		
Downlink transport channels					
DL Transport channel information common for all transport channels	OP		DL Transport channel information common for all transport channels 10.3.5.6		
Added or Reconfigured TrCH information list	OP	1 to <maxTrCH >			
>Added or Reconfigured DL TrCH information	MP		Added or Reconfigured DL TrCH information 10.3.5.1		
PhyCH information elements					
Frequency info	OP		Frequency info 10.3.6.36		
Multi-frequency Info	OP		Multi-frequency Info 10.3.6.39a	This IE is used for 1.28 Mcps TDD only	REL-7
DTX-DRX timing information	OP		DTX-DRX timing information 10.3.6.34b		REL-7
DTX-DRX Information	OP		DTX-DRX Information 10.3.6.34a		REL-7
HS-SCCH less Information	OP		HS-SCCH less Information 10.3.6.36ab		REL-7
MIMO parameters	OP		MIMO parameters 10.3.6.41a		REL-7
Uplink radio resources					
Maximum allowed UL TX power	MD		Maximum allowed UL TX power 10.3.6.39	Default value is the existing maximum UL TX power	
Uplink DPCH info	OP		Uplink DPCH info 10.3.6.88		
E-DCH Info	OP		E-DCH Info 10.3.6.97		REL-6
Downlink radio resources					
Downlink HS-PDSCH Information	OP		Downlink HS-PDSCH		REL-5

Information Element/Group name	Need	Multi	Type and reference	Semantics description	Version
			Information 10.3.6.23a		
Downlink information common for all radio links	OP		Downlink information common for all radio links 10.3.6.24		
Downlink information per radio link list	OP	1 to <maxRL>		Send downlink information for each radio link	
>Downlink information for each radio link	MP		Downlink information for each radio link 10.3.6.27		
MBMS PL Service Restriction Information	OP		Enumerated (TRUE)		REL-6

Condition	Explanation
FACH_PCH	This IE is mandatory default when a transition to CELL_FACH, URA_PCH or CELL_PCH is requested by the message and is not needed otherwise.

10.2.51 TRANSPORT CHANNEL RECONFIGURATION COMPLETE

This message is sent from the UE when a transport channel reconfiguration has been done.

RLC-SAP: AM

Logical channel: DCCH

Direction: UE → UTRAN

Information Element/Group name	Need	Multi	Type and reference	Semantics description	Version
Message Type	MP		Message Type		
UE information elements					
RRC transaction identifier	MP		RRC transaction identifier 10.3.3.36		
Integrity check info	CH		Integrity check info 10.3.3.16		
Uplink integrity protection activation info	OP		Integrity protection activation info 10.3.3.17		
CHOICE <i>mode</i>	OP				
>FDD				(no data)	
>TDD					
>>CHOICE <i>TDD option</i>	MP				REL-4
>>>3.84 Mcps TDD					REL-4
>>>>Uplink Timing Advance	OP		Uplink Timing Advance 10.3.6.95		
>>>>Extended Uplink Timing Advance	OP		Extended Uplink Timing		REL-7

Information Element/Group name	Need	Multi	Type and reference	Semantics description	Version
			Advance 10.3.6.95a		
>>>7.68 Mcps TDD					REL-7
>>>>Extended Uplink Timing Advance	OP		Extended Uplink Timing Advance 10.3.6.95a		REL-7
>>>1.28 Mcps TDD				(no data)	REL-4
Other information elements					REL-7
Deferred measurement control reading	MD		Enumerated (TRUE)	Indicates the UE has not read SIB11, SIB11bis and SIB12, if available. Default value is FALSE	REL-7
RB Information elements					
COUNT-C activation time	OP		Activation time 10.3.3.1	Used for radio bearers mapped on RLC-TM. Only applicable if the UE is moving to CELL_DCH state due to this procedure	
Uplink counter synchronisation info	OP				
>RB with PDCP information list	OP	1 to <maxRBall RABs>			
>>RB with PDCP information	MP		RB with PDCP information 10.3.4.22		
>START list	MP	1 to <maxCNdo mains>		START [40] values for all CN domains.	
>>CN domain identity	MP		CN domain identity 10.3.1.1		
>>START	MP		START 10.3.3.38	START value to be used in this CN domain.	

10.2.52 TRANSPORT CHANNEL RECONFIGURATION FAILURE

This message is sent by UE if the configuration given by UTRAN is unacceptable or if the UE failed to establish the physical channel(s).

RLC-SAP: AM

Logical channel: DCCCH

Direction: UE→UTRAN

Information Element/Group name	Need	Multi	Type and reference	Semantics description
Message Type	MP		Message Type	
UE information elements				
RRC transaction identifier	MP		RRC transaction	

Information Element/Group name	Need	Multi	Type and reference	Semantics description
			identifier 10.3.3.36	
Integrity check info	CH		Integrity check info 10.3.3.16	
Failure cause	MP		Failure cause and error information 10.3.3.14	

10.2.53 TRANSPORT FORMAT COMBINATION CONTROL

This message is sent by UTRAN to control the uplink transport format combination within the allowed transport format combination set. This message has different structures depending if the message is sent on transparent (TM) or non-transparent mode (AM or UM).

RLC-SAP: AM or UM

Logical channel: DCCH

Direction: UTRAN→UE

Information Element/Group name	Need	Multi	Type and reference	Semantics description
Message Type	MP		Message Type	
UE information elements				
RRC transaction identifier	MP		RRC transaction identifier 10.3.3.36	
Integrity check info	CH		Integrity check info 10.3.3.16	
TrCH information elements				
CHOICE <i>mode</i>	MP			
>FDD				(no data)
>TDD				
>>TFCS Id	OP		Transport Format Combination Set Identity 10.3.5.21	
DPCH/PUSCH TFCS in uplink	MP		Transport Format Combination subset 10.3.5.22	
Activation time for TFC subset	MD		Activation time 10.3.3.1	Default value is "now"
TFC Control duration	OP		TFC Control duration 10.3.6.80	

In case of transparent mode signalling the following message structure shall be used:

RLC-SAP: TM

Logical channel: DCCH

Direction: UTRAN→UE

Information Element/Group name	Need	Multi	Type and reference	Semantics description
TFC subset identity	MP		INTEGER (0..7)	

The encoding of this message is specified in subclause 12.4.1.1.

10.2.54 TRANSPORT FORMAT COMBINATION CONTROL FAILURE

This message is sent to indicate that a received TRANSPORT FORMAT COMBINATION CONTROL message could not be handled by the UE.

RLC-SAP: AM

Logical channel: DCCH

Direction: UE→UTRAN

Information Element/Group name	Need	Multi	Type and reference	Semantics description
Message Type	MP		Message Type	
UE information elements				
RRC transaction identifier	MP		RRC transaction identifier 10.3.3.36	
Integrity check info	CH		Integrity check info 10.3.3.16	
Failure cause	MP		Failure cause and error information 10.3.3.14	

10.2.55 UE CAPABILITY ENQUIRY

The UE CAPABILITY ENQUIRY is used by the UTRAN to enquire inter-RAT classmarks from the UE.

RLC-SAP: AM or UM

Logical channel: DCCH

Direction: UTRAN → UE

Information Element/Group name	Need	Multi	Type and reference	Semantics description
Message Type	MP		Message Type	
UE information elements				
RRC transaction identifier	MP		RRC transaction identifier 10.3.3.36	
Integrity check info	CH		Integrity check info 10.3.3.16	Integrity check info is included if integrity protection is applied
Capability update requirement	MP		Capability update requirement 10.3.3.2	

10.2.56 UE CAPABILITY INFORMATION

This message is sent by UE to convey UE specific capability information to the UTRAN.

RLC-SAP: AM

Logical channel: DCCH

Direction: UE → UTRAN

Information Element/Group name	Need	Multi	Type and reference	Semantics description
Message Type	MP		Message Type	
UE information elements				
RRC transaction identifier	OP		RRC transaction identifier 10.3.3.36	
Integrity check info	CH		Integrity check info 10.3.3.16	Integrity check info is included if integrity protection is applied
UE radio access capability	OP		UE radio access capability 10.3.3.42	
UE radio access capability extension	OP		UE radio access capability extension 10.3.3.42a	
Other information elements				
UE system specific capability	OP	1 to <maxInter SysMessages>		
>Inter-RAT UE radio access capability	MP		Inter-RAT UE radio access capability 10.3.8.7	

10.2.57 UE CAPABILITY INFORMATION CONFIRM

This message is sent by UTRAN to confirm that UE capability information has been received.

RLC-SAP: AM or UM

Logical channel: DCCH

Direction: UTRAN → UE

Information Element/Group name	Need	Multi	Type and reference	Semantics description
Message Type	MP		Message Type	
UE information elements				
RRC transaction identifier	MP		RRC transaction identifier 10.3.3.36	
Integrity check info	CH		Integrity check info	Integrity check info is included if integrity protection is applied

Information Element/Group name	Need	Multi	Type and reference	Semantics description
			10.3.3.16	
Acceptance of requested change of capability	OP		Enumerated (Refused, Accepted, Accepted with reconfiguration to follow)	Included if the message was sent in response to a UE request for a capability change in connected mode

10.2.58 UPLINK DIRECT TRANSFER

This message is used to transfer NAS messages for an existing signalling connection.

RLC-SAP: AM

Logical channel: DCCH

Direction: UE ->UTRAN

Information Element/Group name	Need	Multi	Type and reference	Semantics description
Message Type	MP		Message Type	
UE information elements				
Integrity check info	CH		Integrity check info 10.3.3.16	Integrity check info is included if integrity protection is applied
CN information elements				
CN domain identity	MP		CN domain identity 10.3.1.1	
NAS message	MP		NAS message 10.3.1.8	
Measurement information elements				
Measured results on RACH	OP		Measured results on RACH 10.3.7.45	

10.2.59 UPLINK PHYSICAL CHANNEL CONTROL

NOTE: Only for TDD.

This message is used to transfer uplink physical channel parameters to the UE.

RLC-SAP: AM or UM

Logical channel: DCCH

Direction: UTRAN→UE

Information Element/Group name	Need	Multi	Type and Reference	Semantics description	Version
Message Type	MP		Message Type		
UE information elements					
RRC transaction identifier	MP		RRC transaction identifier 10.3.3.36		

Information Element/Group name	Need	Multi	Type and Reference	Semantics description	Version
Integrity check info	OP		Integrity check info 10.3.3.16		
PhyCH information elements					
CCTrCH power control info	OP		CCTrCH power control info 10.3.6.8	Power control information for one CCTrCH	
Special Burst Scheduling	OP		Special Burst Scheduling 10.3.6.75a	UL Special Burst generation period in radio frames	
CHOICE <i>TDD option</i>	MP				REL-4
>3.84 Mcps TDD					REL-4
>>Alpha	OP		Alpha 10.3.6.5		
>>Timing Advance Control	OP		UL Timing Advance Control 10.3.6.96		
>>PRACH Constant Value	OP		Constant value TDD 10.3.6.11a	Operator controlled PRACH Margin	
>>PUSCH Constant Value	OP		Constant value TDD 10.3.6.11a	Operator controlled PUSCH Margin	
>>UE positioning related parameters	CV-IPDLs				REL-4
>>>IPDL-Alpha	MP		Alpha 10.3.6.5		REL-4
>>>Max power increase	MP		Integer (0..3)	In dB	REL-4
>> HS-SICH power control info	OP		HS-SICH Power Control Info 10.3.6.36b	Only applies to TDD 3.84 Mcps	REL-5
>7.68 Mcps TDD					REL-7
>>Alpha	OP		Alpha 10.3.6.5		REL-7
>>Timing Advance Control	OP		UL Timing Advance Control 10.3.6.96		REL-7
>>PRACH Constant Value	OP		Constant value TDD 10.3.6.11a	Operator controlled PRACH Margin	REL-7
>>PUSCH Constant Value	OP		Constant value TDD 10.3.6.11a	Operator controlled PUSCH Margin	REL-7
>>UE positioning related parameters	CV-IPDLs				REL-4
>>>IPDL-Alpha	MP		Alpha 10.3.6.5		REL-4
>>>Max power increase	MP		Integer (0..3)	In dB	REL-4
>> HS-SICH power control info	OP		HS-SICH Power Control Info 10.3.6.36b	Only applies to TDD 7.68 Mcps	REL-5
>1.28 Mcps TDD					REL-4
>>Uplink synchronisation parameters	MD			Default: Uplink synchronisation step size 1. Uplink synchronisation frequency 1.	REL-4
>>>Uplink synchronisation step	MP		Integer(1..8)	This parameter	REL-4

Information Element/Group name	Need	Multi	Type and Reference	Semantics description	Version
size				specifies the step size to be used for the adjustment of the uplink transmission timing	
>>>Uplink synchronisation frequency	MP		Integer(1..8)	This parameter specifies the frequency of the adjustment of the uplink transmission timing	REL-4
>>PRX _{HS-SICH}	OP		Integer (-120..-58 by step of 1)	In dBm. Desired power level for HS-SICH.	REL-6
>>TPC step size	OP		Integer (1, 2, 3)	In dB. For HS-SICH	REL-6

Condition	Explanation
<i>IPDLs</i>	This IE is present only if idle periods are applied

10.2.60 URA UPDATE

This message is used by the UE to initiate a URA update procedure.

RLC-SAP: TM

Logical channel: CCCH

Direction: UE→UTRAN

Information Element/Group name	Need	Multi	Type and reference	Semantics description	Version
Message Type	MP		Message Type		
UE information elements					
U-RNTI	MP		U-RNTI 10.3.3.47		
RRC transaction identifier	CV- <i>ProtErr</i>		RRC transaction identifier 10.3.3.36		
Integrity check info	CH		Integrity check info 10.3.3.16		
URA update cause	MP		URA update cause 10.3.3.46		
Protocol error indicator	MD		Protocol error indicator 10.3.3.27	Default value is FALSE	

Information Element/Group name	Need	Multi	Type and reference	Semantics description	Version
HS-PDSCH in CELL_PCH and URA_PCH	OP		Enumerated (TRUE)	This IE indicates whether the UE supports HS-PDSCH reception in CELL_PCH and URA_PCH states. The absence of this IE indicates that the UE does not support HS-PDSCH reception in CELL_PCH or URA_PCH states.	REL-7
HS-PDSCH in CELL_FACH	OP		Enumerated (TRUE)	This IE indicates whether the UE supports HS-PDSCH reception in CELL_FACH state. The absence of this IE indicates that the UE does not support HS-PDSCH reception in CELL_FACH state.	REL-7
Support for Two DRX schemes in URA_PCH and CELL_PCH	OP		Enumerated (TRUE)	The absence of this IE indicates that the UE does not support Two DRX schemes in URA_PCH and CELL_PCH	REL-7
Other information elements					
Protocol error information	CV-ProtErr		Protocol error information 10.3.8.12		

Condition	Explanation
<i>ProtErr</i>	The IE is mandatory present if the IE "Protocol error indicator" has the value TRUE and not needed otherwise.

10.2.61 URA UPDATE CONFIRM

This message confirms the URA update procedure and can be used to reallocate new RNTI information for the UE valid after the URA update.

RLC-SAP: UM

Logical channel: CCCH or DCCH

Direction: UTRAN→UE

Information Element/Group name	Need	Multi	Type and reference	Semantics description	Version
Message Type	MP		Message Type		
UE information elements					
U-RNTI	CV-CCCH		U-RNTI 10.3.3.47		
RRC transaction identifier	MP		RRC transaction identifier 10.3.3.36		
Integrity check info	CH		Integrity check info 10.3.3.16	Integrity check info is included if integrity protection is applied	
Integrity protection mode info	OP		Integrity protection mode info 10.3.3.19	The UTRAN should not include this IE unless it is performing an SRNS relocation	

Information Element/Group name	Need	Multi	Type and reference	Semantics description	Version
Ciphering mode info	OP		Ciphering mode info 10.3.3.5	The UTRAN should not include this IE unless it is performing an SRNS relocation and a change in ciphering algorithm	
New U-RNTI	OP		U-RNTI 10.3.3.47		
New C-RNTI	OP		C-RNTI 10.3.3.8		
RRC State Indicator	MP		RRC State Indicator 10.3.3.35a		
UTRAN DRX cycle length coefficient	OP		UTRAN DRX cycle length coefficient 10.3.3.49		
CN Information Elements					
CN Information info	OP		CN Information info 10.3.1.3		
UTRAN mobility information elements					
URA identity	OP		URA identity 10.3.2.6		
RNC support for change of UE capability	OP		Boolean	Should be included if the message is used to perform an SRNS relocation	REL-7
RB information elements					
Downlink counter synchronisation info	OP				
>RB with PDCP information list	OP	1 to <maxRBall RABs>			
>>RB with PDCP information	MP		RB with PDCP information 10.3.4.22	This IE is needed for each RB having PDCP in the case of lossless SRNS relocation	
	OP				REL-5
>>>PDCP context relocation info	OP		PDCP context relocation info 10.3.4.1a	This IE is needed for each RB having PDCP and performing PDCP context relocation	REL-5

Condition	Explanation
CCCH	This IE is mandatory present when CCCH is used and not needed otherwise.

10.2.62 UTRAN MOBILITY INFORMATION

This message is used by UTRAN to allocate a new RNTI and to convey other UTRAN mobility related information to a UE.

RLC-SAP: AM or UM

Logical channel: DCCH

Direction: UTRAN→UE

Information Element/Group name	Need	Multi	Type and reference	Semantics description	Version
Message Type	MP		Message Type		
UE Information Elements					
Integrity check info	CH		Integrity check info 10.3.3.16		
RRC transaction identifier	MP		RRC transaction identifier 10.3.3.36		
Integrity protection mode info	OP		Integrity protection mode info 10.3.3.19	The UTRAN should not include this IE unless it is performing an SRNS relocation	
Ciphering mode info	OP		Ciphering mode info 10.3.3.5	The UTRAN should not include this IE unless it is performing an SRNS relocation and a change in ciphering algorithm	
New U-RNTI	OP		U-RNTI 10.3.3.47		
New C-RNTI	OP		C-RNTI 10.3.3.8		
New H-RNTI	OP		H-RNTI 10.3.3.14a		REL-7
UE Timers and constants in connected mode	OP		UE Timers and constants in connected mode 10.3.3.43		
CN Information Elements					
CN Information info	OP		CN Information info full 10.3.1.3a		
UTRAN Information Elements					
URA identity	OP		URA identity 10.3.2.6		
RNC support for change of UE capability	OP		Boolean	Should be included if the message is used to perform an SRNS relocation	REL-7
RB Information elements					
Downlink counter synchronisation info	OP				
>RB with PDCP information list	OP	1 to <maxRBall RABs>			
>>RB with PDCP information	MP		RB with PDCP information 10.3.4.22	This IE is needed for each RB having PDCP in the case of lossless SRNS relocation	
	OP				REL-5
>>>PDCP context relocation info	OP		PDCP context	This IE is needed for each RB	REL-5

Information Element/Group name	Need	Multi	Type and reference	Semantics description	Version
			relocation info 10.3.4.1a	having PDCP and performing PDCP context relocation	

10.2.63 UTRAN MOBILITY INFORMATION CONFIRM

This message is used to confirm the new UTRAN mobility information for the UE.

RLC-SAP: AM

Logical channel: DCCH

Direction: UE→UTRAN

Information Element/Group name	Need	Multi	Type and reference	Semantics description	Version
Message Type	MP		Message Type		
UE information elements					
RRC transaction identifier	MP		RRC transaction identifier 10.3.3.36		
Integrity check info	CH		Integrity check info 10.3.3.16		
Uplink integrity protection activation info	OP		Integrity protection activation info 10.3.3.17		
Other Information Elements					REL-7
Deferred measurement control reading	MD		Enumerated (TRUE)	Indicates the UE has not read SIB11 and SIB12. Default value is FALSE	REL-7
RB Information elements					
COUNT-C activation time	OP		Activation time 10.3.3.1	Used for radio bearers mapped on RLC-TM. Only applicable if the UE is moving to CELL_DCH state due to this procedure	
Uplink counter synchronisation info	OP				
>RB with PDCP information list	OP	1 to <maxRB allRABs>		This IE is needed for each RB having PDCP in the case of lossless SRNS relocation	
>>RB with PDCP information	MP		RB with PDCP information 10.3.4.22		
>START list	MP	1 to <maxCN domains >		START [40] values for all CN domains.	
>>CN domain identity	MP		CN domain identity 10.3.1.1		
>>START	MP		START 10.3.3.38	START value to be used in this CN domain.	

10.2.64 UTRAN MOBILITY INFORMATION FAILURE

This message is sent to indicate a failure to act on a received UTRAN MOBILITY INFORMATION message.

RLC-SAP: AM

Logical channel: DCCH

Direction: UE→UTRAN

Information Element/Group name	Need	Multi	Type and reference	Semantics description
Message Type	MP		Message Type	
UE information elements				
RRC transaction identifier	MP		RRC transaction identifier 10.3.3.36	
Integrity check info	CH		Integrity check info 10.3.3.16	
Failure cause	MP		Failure cause and error information 10.3.3.14	

10.3 Information element functional definitions

10.3.1 CN Information elements

10.3.1.1 CN domain identity

Identifies the type of core network domain.

Information Element/Group name	Need	Multi	Type and reference	Semantics description
CN domain identity	MP		Enumerated (CS domain, PS domain)	

10.3.1.2 CN Domain System Information

Information Element/Group name	Need	Multi	Type and reference	Semantics description
CN domain identity	MP		CN domain identity 10.3.1.1	
<i>CHOICE CN Type</i>				
>GSM-MAP	MP			
>>CN domain specific NAS system information	MP		NAS system information (GSM-MAP) 10.3.1.9	
>ANSI-41				
>>CN domain specific NAS system information	MP		ANSI-41 NAS system information, 10.3.9.4	
CN domain specific DRX cycle	MP		CN domain	

Information Element/Group name	Need	Multi	Type and reference	Semantics description
length coefficient			specific DRX cycle length coefficient, 10.3.3.6	

10.3.1.3 CN Information info

Information Element/Group name	Need	Multi	Type and reference	Semantics description	Version
PLMN identity	OP		PLMN identity 10.3.1.11		
CN common GSM-MAP NAS system information	OP		NAS system information (GSM-MAP) 10.3.1.9		
CN domain related information	OP	1 to <maxCNdo mains>			
>CN domain identity	MP		CN domain identity 10.3.1.1		
>CN domain specific GSM-MAP NAS system info	MP		NAS system information (GSM-MAP) 10.3.1.9		
Primary PLMN identity	OP		PLMN identity 10.3.1.11		REL-6

10.3.1.3a CN Information info full

Information Element/Group name	Need	Multi	Type and reference	Semantics description	Version
PLMN identity	OP		PLMN identity 10.3.1.11		
CN common GSM-MAP NAS system information	OP		NAS system information (GSM-MAP) 10.3.1.9		
CN domain related information	OP	1 to <maxCNdo mains>			
>CN domain identity	MP		CN domain identity 10.3.1.1		
>CN domain specific GSM-MAP NAS system info	MP		NAS system information (GSM-MAP) 10.3.1.9		
>CN domain specific DRX cycle length coefficient	MP		CN domain specific DRX cycle length coefficient, 10.3.3.6		
Primary PLMN identity	OP		PLMN identity 10.3.1.11		REL-6

10.3.1.3b Domain Specific Access Restriction

Information Element/Group name	Need	Multi	Type and reference	Semantics description	Version
CHOICE <i>restriction status</i>	MP				REL-6
>no restriction				(no data) This means 'no Access Class is barred'	REL-6
>restriction					REL-6
>>Domain Specific Access Class Barred List	MD	<MaxAC>		The first instance of the parameter corresponds to Access Class 0, the second to Access Class 1 and so on up to Access Class 15. UE reads this IE of its access class stored in SIM. The default value is the IE "Access Class Barred list" contained in the IE "Cell Access Restriction" of the System Information Block Type 3.	REL-6
>>>Access Class Barred	MP		Enumerated(barred, not barred)		REL-6

10.3.1.3c Domain Specific Access Restriction Parameters

This IE specifies domain specific access class restriction parameters for CS and PS domain.

Information Element/Group name	Need	Multi	Type and reference	Semantics description	Version
CS Domain Specific Access Restriction	MP		Domain Specific Access Restriction 10.3.1.3b	This IE contains Domain Specific Access Restriction Parameters for CS domain.	REL-6
PS Domain Specific Access Restriction	MP		Domain Specific Access Restriction 10.3.1.3b	This IE contains Domain Specific Access Restriction Parameters for PS domain.	REL-6

10.3.1.4 IMEI

This IE contains an International Mobile Equipment Identity. Setting specified in [11].

Information Element/Group name	Need	Multi	Type and reference	Semantics description
IMEI	MP	15		The first element contains the first IMEI digit, the second element the second IMEI digit and so on.
>IMEI digit	MP		INTEGER(0..15)	

10.3.1.5 IMSI (GSM-MAP)

This IE contains an International Mobile Subscriber Identity, used towards a GSM-MAP type of PLMN. Setting specified in [11].

Information Element/Group name	Need	Multi	Type and reference	Semantics description
IMSI	MP	6 to 21		The first element contains the first IMSI digit, the second element the second IMSI digit and so on. Although normally upto 15 digits are used for this IE, a bigger length is used to support future extension.
>IMSI digit	MP		INTEGER(0..9)	

10.3.1.6 Intra Domain NAS Node Selector

This IE carries information to be used to route the establishment of a signalling connection to a CN node within a CN domain.

Information Element/Group name	Need	Multi	Type and reference	Semantics description
CHOICE <i>version</i>	MP			
>R99				This choice shall also be used by mobiles that are compliant to this version of the protocol
>>CHOICE <i>CN type</i>	MP			
>>>GSM-MAP				
>>>>CHOICE <i>Routing basis</i>	MP			
>>>>>local (P)TMSI				TMSI allocated in the current LA or PTMSI allocated in the current RA
>>>>>>Routing parameter	MP		Bit string (10)	The TMSI/ PTMSI consists of 4 octets (32bits). This can be represented by a string of bits numbered from b0 to b31, with bit b0 being the least significant The "Routing parameter" bit string consists of bits b14 through b23 of the TMSI/ PTMSI. The first/leftmost/most significant bit of the bit string contains bit b23 of the TMSI/PTMSI.
>>>>>>(P)TMSI of same PLMN, different (RA)LA				TMSI allocated in another LA of this PLMN or PTMSI allocated in another RA this PLMN
>>>>>>>Routing parameter	MP		Bit string (10)	The TMSI/ PTMSI consists of 4 octets (32bits). This can be represented by a string of bits numbered from b0 to b31, with bit b0 being the least significant The "Routing parameter" bit string consists of bits b14 through b23 of the TMSI/ PTMSI. The first/leftmost/most significant bit of the bit string contains bit b23 of the TMSI/ PTMSI.
>>>>>>>(P)TMSI of different PLMN				TMSI or a PTMSI allocated in another PLMN

Information Element/Group name	Need	Multi	Type and reference	Semantics description
>>>>>Routing parameter	MP		Bit string (10)	The TMSI/ PTMSI consists of 4 octets (32bits). This can be represented by a string of bits numbered from b0 to b31, with bit b0 being the least significant. The "Routing parameter" bit string consists of bits b14 through b23 of the TMSI/ PTMSI. The first/leftmost/most significant bit of the bit string contains bit b23 of the TMSI/ PTMSI.
>>>>>IMSI(response to IMSI paging)				NAS identity is IMSI
>>>>>Routing parameter	MP		Bit string (10)	The "Routing parameter" bit string consists of DecimalToBinary [(IMSI div 10) mod 1000]. The first/leftmost bit of the bit string contains the most significant bit of the result.
>>>>>IMSI(cause UE initiated event)				NAS identity is IMSI
>>>>>Routing parameter	MP		Bit string (10)	The "Routing parameter" bit string consists of DecimalToBinary [(IMSI div 10) mod 1000]. The first/leftmost bit of the bit string contains the most significant bit of the result.
>>>>>IMEI				NAS parameter is IMEI
>>>>>Routing parameter	MP		Bit string (10)	The "Routing parameter" bit string consists of DecimalToBinary [(IMEI div 10) mod 1000]. The first/leftmost bit of the bit string contains the most significant bit of the result.
>>>>>Spare 1			Bit string (10)	This choice shall not be used in this version
>>>>>Spare 2			Bit string (10)	This choice shall not be used in this version
>>>ANSI-41			Bit string (14)	All bits shall be set to 0
>Later			Bit string(15)	This bit string shall not be sent by mobiles that are compliant to this version of the protocol.

10.3.1.7 Location Area Identification

Identifies uniquely a location area for a GSM-MAP type of PLMN. Setting specified in [5].

Information Element/Group name	Need	Multi	Type and reference	Semantics description
PLMN identity	MP		PLMN identity 10.3.1.11	
LAC	MP		Bit string(16)	The first/leftmost bit of the bit string contains the most significant bit of the LAC..

10.3.1.7a Multiple PLMN List

This information element identifies the multiple Public Land Mobile Networks (for a GSM-MAP type of PLMN) of a cell in a shared network.

Information Element/Group name	Need	Multi	Type and reference	Semantics description	Version
MIB PLMN Identity	MP		Boolean	The PLMN identity IE 10.3.1.11, broadcasted in the MIB, shall be included in the multiple PLMN list if and only if this IE is TRUE.	REL-6
Multiple PLMNs	MP	1 to 5			REL-6
>PLMN identity with Optional MCC			PLMN identity with Optional MCC 10.3.1.11a		REL-6

10.3.1.8 NAS message

A non-access stratum message to be transferred transparently through UTRAN.

Information Element/Group name	Need	Multi	Type and reference	Semantics description
NAS message	MP		Octet string (1..4095)	The first octet contains octet 1 [17] of the NAS message, the second octet contains octet 2 of the NAS message and so on.

10.3.1.9 NAS system information (GSM-MAP)

This information element contains system information that belongs to the non-access stratum for a GSM-MAP type of PLMN. This information is transparent to RRC. It may contain either information specific to one CN domain (CS or PS) or information common for both CN domains.

Information Element/Group name	Need	Multi	Type and reference	Semantics description
GSM-MAP NAS system information	MP		Octet string(1..8)	The first octet contains octet 1 [5] of the NAS system information element, the second octet contains octet 2 of the NAS system information element and so on.

10.3.1.10 Paging record type identifier

Information Element/Group name	Need	Multi	Type and reference	Semantics description
Paging record type identifier	MP		Enumerated (IMSI (GSM-MAP), TMSI (GSM-MAP)/ P-TMSI, IMSI (DS-41), TMSI (DS-41))	

10.3.1.11 PLMN identity

This information element identifies a Public Land Mobile Network for a GSM-MAP type of PLMN. Setting of digits is defined in [11].

Information Element/Group name	Need	Multi	Type and reference	Semantics description
MCC	MP	3		The first element contains the first MCC digit, the second element the second MCC digit and so on.
>MCC digit	MP		INTEGER(0..9)	
MNC	MP	2 to 3		The first element contains the first MNC digit, the second element the second MNC digit and so on.
>MNC digit	MP		INTEGER(0..9)	

10.3.1.11a PLMN identity with Optional MCC

This information element is a PLMN identity in subclause 10.3.1.11 where MCC is optional. It is used in a shared network and inserted in the Multiple PLMN List in subclause 10.3.1.7a.

Information Element/Group name	Need	Multi	Type and reference	Semantics description	Version
MCC	MD	3		The first element contains the first MCC digit, the second element the second MCC digit and so on.	REL-6
>MCC digit	MP		Integer (0..9)		REL-6
MNC	MP	2 to 3		The first element contains the first MNC digit, the second element the second MNC digit and so on.	REL-6
>MNC digit	MP		Integer (0..9)		REL-6

10.3.1.12 PLMN Type

Identifies the type of Public Land Mobile Network (PLMN). This IE shall be used to control the interpretation of network dependent messages and information elements in the RRC protocol.

Information Element/Group name	Need	Multi	Type and reference	Semantics description
PLMN Type	MP		Enumerated (GSM-MAP, ANSI-41, GSM-MAP and ANSI-41)	One spare value is needed.

10.3.1.13 P-TMSI (GSM-MAP)

This IE contains a Packet Temporary Mobile Subscriber Identity, used towards a GSM-MAP type of PLMN.

Information Element/Group name	Need	Multi	Type and reference	Semantics description
P-TMSI	MP		Bit string (32)	Setting specified in [11]. The first/leftmost bit of the bit string contains the most significant bit of the P-TMSI.

10.3.1.14 RAB identity

This information element uniquely identifies a radio access bearer within a CN domain.

Information Element/Group name	Need	Multi	Type and reference	Semantics description
CHOICE <i>RAB identity type</i>	MP			
>RAB identity (GSM-MAP)			Bit string (8)	Formatted according to [5]. The first/leftmost bit of the bit string contains the most significant bit of the RAB identity. In case of a radio bearer setup for an MBMS selected service, the RAB identity is set to the value reserved for 'MBMS Broadcast mode', see [5].
>RAB identity (ANSI-41)			Bit string (8)	The first/leftmost bit of the bit string contains the most significant bit of the RAB identity.

CHOICE <i>NAS binding info type</i>	Condition under which the given <i>RAB identity type</i> is chosen
RAB identity (GSM-MAP)	PLMN is of type GSM-MAP
RAB identity (ANSI-41)	PLMN is of type ANSI-41

10.3.1.15 Routing Area Code

Identifies a routing area within a location area for a GSM-MAP type of PLMN.

Information Element/Group name	Need	Multi	Type and reference	Semantics description
Routing Area Code	MP		Bit string(8)	Setting specified in [11]. The first/leftmost bit of the bit string contains the most significant bit of the Routing Area Code.

10.3.1.16 Routing Area Identification

Identifies uniquely a routing area for a GSM-MAP type of PLMN. Setting specified in [11].

Information Element/Group name	Need	Multi	Type and reference	Semantics description
LAI	MP		Location area identification 10.3.1.7	
RAC	MP		Routing area code 10.3.1.15	

10.3.1.17 TMSI (GSM-MAP)

This IE contains a Temporary Mobile Subscriber Identity, used towards a GSM-MAP type of PLMN.

Information Element/Group name	Need	Multi	Type and reference	Semantics description
TMSI (GSM-MAP)	MP		Bit string (32)	Setting specified in [11]. The first/leftmost bit of the bit string contains the most significant bit of the TMSI.

10.3.2 UTRAN mobility Information elements

10.3.2.1 Cell Access Restriction

Indicates the restrictions to cell access.

Information Element/Group name	Need	Multi	Type and reference	Semantics description
Cell Barred	MP		Enumerated(not barred, barred)	If the cell is operating in MBSFN mode as indicated in subclause 8.1.1.6.3 and the value in this IE is different from "barred" the UE behaviour is unspecified.
Intra-frequency cell re-selection indicator	<i>CV-Barred</i>		Enumerated(not allowed, allowed)	
T_{barred}	<i>CV-Barred</i>		Integer (10,20,40,80 ,160,320,640 ,1280)	[4] [s]
Cell Reserved for operator use	MP		Enumerated(reserved, not reserved)	
Cell Reservation Extension	MP		Enumerated(reserved, not reserved)	
Access Class Barred list	<i>CV-SIB3-MD</i>	maxAC		Default is no access class barred is applied. The first instance of the parameter corresponds to Access Class 0, the second to Access Class 1 and so on up to Access Class 15. UE reads this IE of its access class stored in SIM.
>Access Class Barred	MP		Enumerated (barred, not barred)	

Condition	Explanation
<i>Barred</i>	The IE is mandatory present if the IE "Cell Barred" has the value "Barred"; otherwise the element is not needed in the message.
<i>SIB3-MD</i>	The IE is mandatory and has a default value if the IE "Cell Access Restriction" is included in SIB 3. Otherwise the IE is not needed.

10.3.2.2 Cell identity

This information element identifies a cell unambiguously within a PLMN.

NOTE: This information element may carry any implementation dependent identity that unambiguously identifies a cell within a PLMN. For GAN to UTRAN HO the Cell id is encoded as required in [9].

Information Element/Group name	Need	Multi	Type and reference	Semantics description
Cell identity	MP		bit string(28)	

10.3.2.3 Cell selection and re-selection info for SIB3/4

Information Element/Group name	Need	Multi	Type and reference	Semantics description	Version
Mapping Info	OP		Mapping info 10.3.2.5	This IE should not be sent.	
Cell selection and reselection quality measure	MP		Enumerated (CPICH Ec/N0, CPICH RSCP)	Choice of measurement (CPICH Ec/N0 or CPICH RSCP) to use as quality measure Q for FDD cells. This IE is also sent to the UE in SIB11/12. Both occurrences of the IE should be set to the same value.	
CHOICE <i>mode</i>	MP				
>FDD					
>>S _{intrasearch}	OP		Integer (-32..20 by step of 2)	If a negative value is received the UE shall consider the value to be 0. [4] [dB]	
>>S _{intersearch}	OP		Integer (-32..20 by step of 2)	If a negative value is received the UE shall consider the value to be 0. [4] [dB]	
>>S _{searchHCS}	OP		Integer (-105..91 by step of 2)	If a negative value is received the UE shall consider the value to be 0. [4] [dB]	
>>RAT List	OP	1 to <maxOtherRAT>			
>>>RAT identifier	MP		Enumerated (GSM, cdma2000)		
>>>S _{search,RAT}	MP		Integer (-32..20 by step of 2)	In case the value 20 is received the UE shall consider this IE as if it was absent according to [4] If a negative value is received the UE shall consider the value to be 0. [dB]	
>>>S _{HCS,RAT}	OP		Integer (-105..91 by step of 2)	If a negative value is received the UE shall consider the value to be 0.	

Information Element/Group name	Need	Multi	Type and reference	Semantics description	Version
				[4] [dB]	
>>>S _{limit,SearchRAT}	MP		Integer (-32..20 by step of 2)	If a negative value is received the UE shall consider the value to be 0. [4] [dB]	
>>Qqualmin	CV-SIB3		Integer (-24..0)	Ec/N0, [dB]	
>>Qrxlevmin	CV-SIB3		Integer (-115..-25 by step of 2)	RSCP, [dBm]	
>> Delta _{Qrxlevmin}	CV-Delta		Integer(-4..-2 by step of 2)	If present, the actual value of Qrxlevmin = Qrxlevmin + Delta _{Qrxlevmin}	REL-5
>>Qqualmin-offset	MD		Integer (1..16)	Ec/N0, [dB] The default value is 0	REL-7
>>Qrxlevmin-offset	MD		Integer (2..16 by step of 2)	RSCP, [dB] The default value is 0	REL-7
>TDD					
>>S _{inrasearch}	OP		Integer (-105..91 by step of 2)	If a negative value is received the UE shall consider the value to be 0. [4] [dB]	
>>S _{intersearch}	OP		Integer (-105..91 by step of 2)	If a negative value is received the UE shall consider the value to be 0. [4] [dB]	
>>S _{searchHCS}	OP		Integer (-105..91 by step of 2)	If a negative value is received the UE shall consider the value to be 0. [4] [dB]	
>>>RAT List	OP	1 to <maxOtherRAT >			
>>>RAT identifier	MP		Enumerated (GSM, cdma2000)		
>>>S _{search,RAT}	MP		Integer (-105..91 by step of 2)	In case the value 91 is received the UE shall consider this IE as if it was absent according to [4] If a negative value is received the UE shall consider the value to be 0. [dB]	
>>>S _{HCS,RAT}	OP		Integer (-105..91 by step of 2)	If a negative value is received the UE shall consider the value to be 0. [4] [dB]	

Information Element/Group name	Need	Multi	Type and reference	Semantics description	Version
>>>S _{limit,SearchRAT}	MP		Integer (-105..91 by step of 2)	If a negative value is received the UE shall consider the value to be 0. [4] [dB]	
>>Qrxlevmin	MP		Integer (-115..-25 by step of 2)	RSCP, [dBm]	
>>Delta _{Qrxlevmin}	CV- <i>Delta</i>		Integer(-4..-2 by step of 2)	If present, the actual value of Qrxlevmin = Qrxlevmin + Delta _{Qrxlevmin}	REL-5
>>Qrxlevmin-offset	CV- <i>SIB3</i>		Integer (2..16 by step of 2)	RSCP, [dB] The default value is 0	REL-7
Qhyst1 _s	MP		Integer (0..40 by step of 2)	[4] [dB]	
Qhyst1 _{s,PCH}	CV- <i>SIB4</i>		Integer (0..40)	If present, it is used as Qhyst1 _s for UE in CELL_PCH or URA_PCH state [4] [dB]	REL-5
Qhyst1 _{s,FACH}	CV- <i>SIB4</i>		Integer (0..40)	If present, it is used as Qhyst1 _s for UE in CELL_FACH state [4] [dB]	REL-5
Qhyst2 _s	CV- <i>FDD-Quality-Measure</i>		Integer (0..40 by step of 2)	Default value is Qhyst1 _s [4] [dB]	
Qhyst2 _{s,PCH}	CV- <i>SIB4-FDD-Quality-Measure</i>		Integer (0..40)	If present, it is used as Qhyst2 _s for UE using CPICH Ec/No quality measure in CELL_PCH or URA_PCH state. Default value is Qhyst1 _{s,PCH} [4] [dB]	REL-5
Qhyst2 _{s,FACH}	CV- <i>SIB4-FDD-Quality-Measure</i>		Integer (0..40)	If present, it is used as Qhyst2 _s for UE using CPICH Ec/No quality measure in CELL_FACH state. Default value is Qhyst1 _{s,FACH} [4] [dB]	REL-5
Treselection _s	MP		Integer (0..31)	[s]	
Treselection _{s,PCH}	CV- <i>SIB4</i>		Integer (0..31)	If present, it is used as Treselection _s for UE in CELL_PCH or URA_PCH state [4] [s]	REL-5
Treselection _{s,FACH}	CV- <i>SIB4</i>		Real (0..6.2 by step of	If present, it is used as Treselection _s for UE in CELL_FACH state [4]	REL-5

Information Element/Group name	Need	Multi	Type and reference	Semantics description	Version
			0.2)	[s]	
Speed dependent ScalingFactor for Treselection	OP		Real (0..1 by step of 0.1)	This IE is used by the UE in high mobility state as scaling factor for Treselection _s or Treselection _{s,PCH} or Treselection _{s,FACH} [4].	REL-5
Inter-frequency ScalingFactor for Treselection	OP		Real (1..4.75 by step of 0.25)	If present, it is used by the UE as scaling factor for Treselection _s or Treselection _{s,PCH} or Treselection _{s,FACH} for inter-frequency cell reselection evaluation [4].	REL-5
Inter-RAT ScalingFactor for Treselection	OP		Real (1..4.75 by step of 0.25)	If present, it is used by the UE as scaling factor for Treselection _s or Treselection _{s,PCH} or Treselection _{s,FACH} for inter-RAT cell reselection evaluation [4].	REL-5
Non-HCS_T _{CRmax}	MD		Enumerated (not used, 30, 60, 120, 180, 240)	[s] Default value is 'not used'.	REL-5
Non-HCS_N _{CR}	CV-UE speed detector _MD		Integer (1..16)	Default value = 8	REL-5
Non-HCS_T _{CRmaxHyst}	CV-UE speed detector _MP		Enumerated (not used, 10, 20, 30, 40, 50, 60, 70)	[s]	REL-5
HCS Serving cell Information	OP		HCS Serving cell information 10.3.7.12		
Maximum allowed UL TX power	MP		Maximum allowed UL TX power 10.3.6.39	[dBm] UE_TXPWR_MAX_RACH in [4].	

Condition	Explanation
<i>FDD-Quality-Measure</i>	The IE is not needed if the IE "Cell selection and reselection quality measure" has the value CPICH RSCP, otherwise the IE is mandatory and has a default value.
<i>Delta</i>	This IE is optional if the value of Qrxlevmin is below – 115dBm. It is not needed otherwise.
<i>SIB3</i>	This IE is mandatory default if the IE "Cell selection and re-selection info for SIB3/4" is included in SIB type 3. It is not needed otherwise.
<i>SIB4</i>	This IE is optional if the IE "Cell selection and re-selection info for SIB3/4" is included in SIB type 4. It is not needed otherwise.
<i>SIB4-FDD-Quality-Measure</i>	This IE is optional if the IE "Cell selection and re-selection info for SIB3/4" is included in SIB type 4, and the IE "Cell selection and reselection quality measure" has the value CPICH Ec/N0. It is not needed otherwise.
<i>UE Speed detector_MD (non-HCS)</i>	This IE is not needed if non-HCS_TCRmax equals 'not used', else it is mandatory default.
<i>UE Speed detector_MP (non-HCS)</i>	This IE is not needed if non-HCS_TCRmax equals 'not used', else it is mandatory present.

10.3.2.4 Cell selection and re-selection info for SIB11/12

Information Element/Group name	Need	Multi	Type and reference	Semantics description	Version
Qoffset1 _{s,n}	MD		Integer(-50..50)	Default value is 0. [dB]	
Qoffset2 _{s,n}	CV-FDD-Quality-Measure		Integer(-50..50)	Default value is 0. [dB]	
Maximum allowed UL TX power	MD		Maximum allowed UL TX power 10.3.6.39	According to UE_TXPWR_MAX_RACH in [4], [dBm]. If applied to FDD or TDD cells, the default is the Maximum allowed UL TX power for the serving cell. If applied to a GSM cell, the default is the UE maximum output power applicable for this GSM cell, according to the UE's radio access capability.	
HCS neighbouring cell information	OP		HCS Neighbouring cell information 10.3.7.11		
CHOICE mode	MP				
>FDD					
>>Qqualmin	CV-FDD-Serving-Cell		Integer (-24..0)	Ec/N0, [dB] Default value is Qqualmin for the serving cell	
>>Qrxlevmin	MD		Integer (-	RSCP, [dBm]	

Information Element/Group name	Need	Multi	Type and reference	Semantics description	Version
			115..-25 by step of 2)	Default value is Qrxlevmin for the serving cell	
>>Delta _{Qrxlevmin}	CV-Delta		Integer(-4..-2 by step of 2)	If present, the actual value of Qrxlevmin = Qrxlevmin + Delta _{Qrxlevmin}	REL-5
>TDD					
>>Qrxlevmin	MD		Integer (-115..-25 by step of 2)	RSCP, [dBm] Default value is Qrxlevmin for the serving cell	
>> Delta _{Qrxlevmin}	CV-Delta		Integer(-4..-2 by step of 2)	If present, the actual value of Qrxlevmin = Qrxlevmin + Delta _{Qrxlevmin}	REL-5
>GSM					
>>Qrxlevmin	MD		Integer (-115..-25 by step of 2)	GSM RSSI, [dBm] Default value is Qrxlevmin for the serving cell	

Condition	Explanation
<i>FDD-Quality-Measure</i>	This IE is mandatory and has a default value for Intra/Inter Frequency Cells if the IE "Cell selection and reselection quality measure" has the value CPICH Ec/No. Otherwise the IE is absent.
<i>FDD-Serving-Cell</i>	This IE is mandatory and has a default value if the serving cell is an FDD cell. Otherwise the IE is mandatory present.
<i>Delta</i>	This IE is optional if Qrxlevmin is present and the value of Qrxlevmin is below -115dBm. It is not needed otherwise.

10.3.2.5 Mapping Info

Information Element/Group name	Need	Multi	Type and Reference	Semantics description	Version
Mapping List	MP	1 to <MaxRAT>			
>RAT	MP		Enumerated (UTRA FDD, UTRA TDD 3.84 Mcps, UTRA TDD 1.28 Mcps, GSM, cdma2000)		UTRA TDD 1.28 Mcps is included for REL-4.
>Mapping Function Parameter List	MP	1 to <maxMeas Intervals>			
>>Function type	MP		Enumerated (linear, function type 2, function type 3, function type 4)	Type of the function within the interval.	
>>Map_parameter_1	MD		Integer (0..99)	Parameter describing the mapping function between the quality	

Information Element/Group name	Need	Multi	Type and Reference	Semantics description	Version
				measurement and the representing quality value, see [4]. Default value is zero for the first interval or otherwise the value of Map_parameter_2 of the interval before.	
			Integer (0..127)	For 1.28 Mcps TDD, the parameter is used to indicate the uplink access location of the serving cell.	REL-7
>>Map_parameter_2	MP		Integer (0..99)	Parameter describing the mapping function between the quality measurement and the representing quality value, see [4].	
>>Upper_limit	CV- <i>MaxInt</i>		Integer (1..MaxMeas)	Upper limit of interval for which the Map_parameter_1 and Map_parameter_2 are valid. MaxMeas = 25 if RAT = UTRA FDD / CPICH Ec/N0, MaxMeas = 91 if RAT = UTRA TDD 3.84 Mcps or if RAT = UTRA TDD 1.28 Mcps or if RAT = UTRA FDD/ CPICH RSCP, MaxMeas = 63 if RAT = GSM.	UTRA TDD 1.28 Mcps is included for REL-4.

Condition	Explanation
<i>MaxInt</i>	This IE is mandatory present if Mapping Function Parameter List has not reached maxMeasIntervals and is not needed otherwise.

10.3.2.6 URA identity

Gives the identity of the UTRAN Registration Area. It can be used to indicate to the UE which URA it shall use in case of overlapping URAs.

Information Element/Group name	Need	Multi	Type and reference	Semantics description
URA identity	MP		bit string(16)	

10.3.3 UE Information elements

10.3.3.1 Activation time

Activation Time defines the frame number/time at which the operation/changes caused by the related message shall take effect. Values between 0 and 255 indicate the absolute value of CFN (Connection Frame Number) of that frame number/time.

Information Element/Group name	Need	Multi	Type and reference	Semantics description
Activation time	MP		Integer(0..255)	CFN [10]

10.3.3.2 Capability Update Requirement

This IE indicates to the UE which specific capabilities to transfer to the network.

Information Element/Group name	Need	Multi	Type and reference	Semantics description	Version
UE radio access FDD capability update requirement	MP		Boolean	TRUE indicates update required	
UE radio access 3.84 Mcps TDD capability update requirement	MP		Boolean	TRUE indicates update required	Name changed in REL-4
UE radio access 7.68 Mcps TDD capability update requirement	MP		Boolean	TRUE indicates update required	REL-7
UE radio access 1.28 Mcps TDD capability update requirement	MP		Boolean	TRUE indicates update required	REL-4
System specific capability update requirement list	OP	1 to <maxSystemCapability>		In this version, a maximum size of 4 of the list shall be applied and any items after the 4 th item in the list shall be ignored.	
>System specific capability update requirement	MP		Enumerated (GSM, GERAN Iu)		REL-5

Default value is:

"UE radio capability FDD update requirement" = false

"UE radio capability 3.84 Mcps TDD update requirement" = false

"UE radio capability 7.68 Mcps TDD update requirement" = false

"UE radio capability 1.28 Mcps TDD update requirement" = false

"System specific capability update requirement" not present.

10.3.3.3 Cell update cause

Indicates the cause for cell update.

Information Element/Group name	Need	Multi	Type and reference	Semantics description	Version
Cell update cause	MP		Enumerated (cell reselection, periodical cell update, uplink data transmission, paging response, re-entered service area, radio link failure, RLC unrecoverable error,	One spare value is needed.	REL-6
			MBMS reception, MBMS ptp RB request)		

10.3.3.4 Ciphering Algorithm

Information Element/Group name	Need	Multi	Type and reference	Semantics description	Version
Ciphering algorithm	MP		Enumerated (UEA0, UEA1		REL-7
			, UEA2)		

10.3.3.5 Ciphering mode info

This information element contains the ciphering specific security mode control information.

Information Element/Group name	Need	Multi	Type and reference	Semantics description
Ciphering mode command	MP		Enumerated (start/restart)	
Ciphering algorithm	MP		Ciphering algorithm 10.3.3.4	
Ciphering activation time for DPCH	OP		Activation time 10.3.3.1	Used for radio bearers mapped on RLC-TM. Only applicable if the UE is already in CELL_DCH state
Radio bearer downlink ciphering activation time info	OP		RB activation time info, 10.3.4.13	Used for radio bearers mapped on RLC-AM or RLC-UM The UTRAN should not include this IE in a message other than a SECURITY MODE COMMAND

10.3.3.6 CN domain specific DRX cycle length coefficient

A coefficient in the formula to count the paging occasions to be used by a specific UE (specified in [4]).

Information Element/Group name	Need	Multi	Type and reference	Semantics description
CN domain specific DRX cycle length coefficient	MP		Integer(6...9)	Refers to 'k' in the formula as specified in [4], Discontinuous reception

10.3.3.7 Void

10.3.3.8 C-RNTI

The cell RNTI (C-RNTI) identifies a UE having a RRC connection within a cell.

Information Element/Group name	Need	Multi	Type and reference	Semantics description
C-RNTI	MP		bit string(16)	

10.3.3.9 Void

10.3.3.9a DSCH-RNTI

In TDD, the DSCH-RNTI identifies a UE in CELL_DCH or CELL_FACH using a DSCH or USCH within the cell.

Information Element/Group name	Need	Multi	Type and reference	Semantics description
DSCH-RNTI	MP		bit string(16)	

10.3.3.10 Void

10.3.3.10a E-RNTI

Information Element/Group name	Need	Multi	Type and reference	Semantics description	Version
E-RNTI	MP		bit string(16)		REL-6

10.3.3.11 Establishment cause

Cause for an RRC connection establishment request.

Information Element/Group name	Need	Multi	Type and reference	Semantics description
Establishment cause	MP		Enumerated(Originating Conversational Call, Originating Streaming Call, Originating Interactive Call, Originating Background Call, Originating Subscribed traffic Call, Terminating Conversational Call, Terminating Streaming Call, Terminating Interactive Call, Terminating Background Call, Emergency Call, Inter-RAT cell re-selection, Inter-RAT cell change order, Registration, Detach, Originating High Priority Signalling, Originating Low Priority Signalling, Call re-establishment, Terminating High Priority Signalling, Terminating Low Priority Signalling, Terminating – cause unknown, MBMS reception, MBMS ptp RB request)	Eleven spare values are needed.

10.3.3.12 Expiration Time Factor

Information Element/Group name	Need	Multi	Type and reference	Semantics description
Expiration Time Factor	MP		Enumerated(2times, 4times, 8times, 16times, 32times, 64times, 128times, 256times)	

10.3.3.13 Failure cause

Cause for failure to perform the requested procedure.

Information Element/Group name	Need	Multi	Type and reference	Semantics description
Failure cause	MP		Enumerated (configuration unsupported, physical channel failure, incompatible simultaneous reconfiguration, protocol error, compressed mode runtime error, cell update occurred, invalid configuration, configuration incomplete, unsupported measurement, MBMS session already received correctly, lower priority MBMS service)	Five spare values are needed.

10.3.3.14 Failure cause and error information

Cause for failure to perform the requested procedure.

Information Element/Group name	Need	Multi	Type and reference	Semantics description
Failure cause	MP		Failure cause 10.3.3.13	

Protocol error information	<i>CV-ProtErr</i>		Protocol error information 10.3.8.12	
Deleted TGPSI	<i>CV-CompModeErr</i>		TGPSI 10.3.6.82	

Condition	Explanation
<i>ProtErr</i>	The IE is mandatory present if the IE "Failure cause" has the value "Protocol error"; otherwise it is not needed in the message.
<i>CompModeErr</i>	The IE is mandatory present if the IE "Failure cause" has the value "Compressed mode runtime error"; otherwise it is not needed in the message.

10.3.3.14o Group release information

Contains addressing information to perform a release of a group of RRC connections.

Information Element/Group name	Need	Multi	Type and reference	Semantics description	Version
U-RNTI group	MP		U-RNTI group 10.3.3.47a		REL-5

10.3.3.14a H-RNTI

The H-RNTI identifies an UE having a HS-PDSCH assignment within a cell.

Information Element/Group name	Need	Multi	Type and reference	Semantics description	Version
H-RNTI	MP		bit string(16)		REL-5

10.3.3.15 Initial UE identity

This information element identifies the UE at a request of an RRC connection.

Information Element/Group name	Need	Multi	Type and reference	Semantics description
CHOICE <i>UE id type</i>	MP			
>IMSI (GSM-MAP)			IMSI (GSM-MAP) 10.3.1.5	
>TMSI and LAI (GSM-MAP)				
>>TMSI (GSM-MAP)	MP		TMSI (GSM-MAP) 10.3.1.17	
>>LAI (GSM-MAP)	MP		Location Area Identification 10.3.1.7	
>P-TMSI and RAI (GSM-MAP)				
>>P-TMSI (GSM-MAP)	MP		P-TMSI (GSM-MAP) 10.3.1.13	
>>RAI (GSM-MAP)	MP		Routing Area Identification 10.3.1.16	
>IMEI			IMEI 10.3.1.4	

>ESN (DS-41)			Bit string (SIZE (32))	TIA/EIA/IS-2000-4
>IMSI (DS-41)			Octet string (SIZE (5..7))	TIA/EIA/IS-2000-4
>IMSI and ESN (DS-41)				TIA/EIA/IS-2000-4
>>IMSI (DS-41)	MP		Octet string (SIZE (5..7))	TIA/EIA/IS-2000-4
>>ESN (DS-41)	MP		Bit string (SIZE (32))	TIA/EIA/IS-2000-4
>TMSI (DS-41)			Octet string (SIZE (2..17))	TIA/EIA/IS-2000-4 Although normally upto 12 digits are used for this IE, a bigger length is used to support future extension.

10.3.3.16 Integrity check info

The Integrity check info contains the RRC message sequence number needed in the calculation of XMAC-I [40] and the calculated MAC-I.

Information Element/Group name	Need	Multi	Type and reference	Semantics description
Message authentication code	MP		bit string(32)	MAC-I [40]. The first/leftmost bit of the bit string contains the most significant bit of the MAC-I. The 27 MSB of the IE shall be set to zero and the 5 LSB of the IE shall be set to the value of the IE "RB identity" for the used signalling radio bearer when the encoded RRC message is used as the MESSAGE parameter in the integrity protection algorithm.
RRC Message sequence number	MP		Integer (0..15)	The local RRC hyper frame number (RRC HFN) is concatenated with the RRC message sequence number to form the input parameter COUNT-I for the integrity protection algorithm. The IE value shall be set to zero when the encoded RRC message is used as the MESSAGE parameter in the integrity protection algorithm.

10.3.3.17 Integrity protection activation info

This IE contains the time, in terms of RRC sequence numbers, when a new integrity protection configuration shall be activated for the signalling radio bearers.

Information Element/Group name	Need	Multi	Type and reference	Semantics description
RRC message sequence number list	MP	4 to 5		The RRC sequence number when a new integrity protection configuration shall be applied, for signalling radio bearers in the order RB0, RB1, RB2, RB3, RB4. The value for RB1 shall be ignored if this IE was included in a RRC message sent on RB1. The value for RB2 shall be ignored if this IE was included in a RRC message sent on RB2.
>RRC message sequence number	MP		Integer (0..15)	

10.3.3.18 Integrity protection Algorithm

Information Element/Group name	Need	Multi	Type and reference	Semantics description	Version
Integrity protection algorithm	MP		Enumerated (UIA1, UIA2)		REL-7

10.3.3.19 Integrity protection mode info

Information Element/Group name	Need	Multi	Type and reference	Semantics description
Integrity protection mode command	MP		Enumerated (start, modify)	
Downlink integrity protection activation info	<i>CV-modify</i>		Integrity protection activation info 10.3.3.17	
Integrity protection algorithm	OP		Integrity protection algorithm 10.3.3.18	
Integrity protection initialisation number	<i>CV-start</i>		Bit string(32)	FRESH [40]. The first/leftmost bit of the bit string contains the most significant bit of the FRESH.

Condition	Explanation
<i>Start</i>	The IE is mandatory present if the IE "Integrity protection mode command" has the value "start ", otherwise it is not needed in the message.
<i>Modify</i>	The IE is mandatory present if the IE "Integrity protection mode command" has the value "modify" and not needed otherwise.

10.3.3.19a Void

10.3.3.20 Void

10.3.3.21 Measurement capability

Information Element/Group name	Need	Multi	Type and reference	Semantics description	Version
Need for downlink compressed mode					
FDD measurements	MP		Boolean	TRUE means that the UE requires DL compressed mode in order to perform measurements on FDD	
3.84 Mcps TDD measurements	CV- 3.84_Mcps _tdd_sup		Boolean	TRUE means that the UE requires DL compressed mode in order to perform measurements on 3.84 Mcps TDD	Name changed in REL-4
7.68 Mcps TDD measurements	CV- 7.68_Mcps _tdd_sup		Boolean	TRUE means that the UE requires DL compressed mode in order to perform measurements on 7.68 Mcps TDD	REL-7
1.28 Mcps TDD measurements	CV- 1.28_Mcps _tdd_sup		Boolean	TRUE means that the UE requires DL compressed mode in order to perform measurements on 1.28 Mcps TDD	REL-4
GSM measurements	CV- gsm_sup				
>GSM 900	MP		Boolean	TRUE means that the UE requires DL compressed mode in order to perform measurements on GSM 900	
>DCS 1800	MP		Boolean	TRUE means that the UE requires DL compressed mode in order to perform measurements on DCS 1800	
>GSM 1900	MP		Boolean	TRUE means that the UE requires DL compressed mode in order to perform measurements on GSM 1900	
Multi-carrier measurement	CV- mc_sup		Boolean	TRUE means that the UE requires DL compressed mode in order to perform measurements on	

Information Element/Group name	Need	Multi	Type and reference	Semantics description	Version
				multi-carrier	
Need for uplink compressed mode					
FDD measurements	MP		Boolean	TRUE means that the UE requires UL compressed mode in order to perform measurements on FDD	
3.84 Mcps TDD measurements	CV- 3.84_Mcps _tdd_sup		Boolean	TRUE means that the UE requires UL compressed mode in order to perform measurements on 3.84 Mcps TDD	Name changed in REL-4
7.68 Mcps TDD measurements	CV- 7.68_Mcps _tdd_sup		Boolean	TRUE means that the UE requires UL compressed mode in order to perform measurements on 7.68 Mcps TDD	REL-7
1.28 Mcps TDD measurements	CV- 1.28_Mcps _tdd_sup		Boolean	TRUE means that the UE requires DL compressed mode in order to perform measurements on 1.28 Mcps TDD	REL-4
GSM measurements	CV- gsm_sup				
>GSM 900	MP		Boolean	TRUE means that the UE requires UL compressed mode in order to perform measurements on GSM 900	
>DCS 1800	MP		Boolean	TRUE means that the UE requires UL compressed mode in order to perform measurements on DCS 1800	
>GSM 1900	MP		Boolean	TRUE means that the UE requires UL compressed mode in order to perform measurements on GSM 1900	
Multi-carrier measurement	CV- mc_sup		Boolean	TRUE means that the UE requires UL compressed mode in order to perform measurements on multi-carrier	

Condition	Explanation
<i>3.84_Mcps_tdd_sup</i>	The IE is mandatory present if an IE "TDD RF capability" is present with the IE "Chip rate capability" set to "3.84 Mcps". Otherwise this field is not needed in the message.
<i>7.68_Mcps_tdd_sup</i>	The IE is mandatory present if an IE "TDD RF capability" is present with the IE "Chip rate capability" set to "7.68 Mcps". Otherwise this field is not needed in the message.
<i>1.28_Mcps_tdd_sup</i>	The IE is mandatory present if an IE "TDD RF capability" is present with the IE "Chip rate capability" set to "1.28 Mcps". Otherwise this field is not needed in the message.
<i>gsm_sup</i>	The IE is mandatory present if the IE "Inter-RAT UE radio access capability" indicates support for GSM900, GSM1800 and/or GSM1900. Otherwise this field is not needed in the message.
<i>mc_sup</i>	The IE is mandatory present if the IE "Support of multi-carrier" has the value TRUE. Otherwise this field is not needed in the message.

10.3.3.21a Measurement capability extension

This IE may be used to replace the measurement capability information provided within IE "Measurement capability".

Information Element/Group name	Need	Multi	Type and reference	Semantics description	Version
FDD measurements	MP	1 to <maxFreqBands FDD>		The network should ignore the entry that includes the 'extension indicator'.	
>FDD Frequency band	MD		Enumerated(Band I, Band II,	The default value is the same as indicated in the IE "Frequency band" included in the IE "UE radio access capability extension". Band numbering is defined in [21].	
			Band III,		REL-5
			Band VI, Band IV, Band V, Band VII, extension indicator)	The default value is the same as R99, if the IE "FDD Frequency band 2" below is not included. The default value is the same as the IE "FDD Frequency band 2", if the IE "FDD Frequency band 2" is included. The setting of the value 'extension indicator' by the UE is not specified in the specification.	REL-6

Information Element/Group name	Need	Multi	Type and reference	Semantics description	Version
>FDD Frequency band 2	MD		Enumerated(Band VIII, Band IX, Band X, extension Indicator)	The default value is the same as indicated in the IE "Frequency band 2" included in the IE "UE radio access capability extension"., if the IE "FDD Frequency band" above is not included. The default value is the same as the IE "FDD Frequency band", if the IE "FDD Frequency band" is included. The setting of the value 'extension indicator' by the UE is not specified in the specification. Twelve spare values are needed	REL-6
>Need for DL compressed mode	MP		Boolean	TRUE means that the UE requires DL compressed mode in order to perform measurements on the FDD frequency band indicated by the IE "FDD Frequency band"	
>Need for UL compressed mode	MP		Boolean	TRUE means that the UE requires UL compressed mode in order to perform measurements on the FDD frequency band indicated by the IE "FDD Frequency band"	
TDD measurements	CV- <i>tdd_sup</i>	1 to <maxFreqBands TDD>			
>TDD Frequency band	MP		Enumerated(a, b, c)		REL-7
			Enumerated(a, b, c, d)		
>Need for DL compressed mode	MP		Boolean	TRUE means that the UE requires DL compressed mode in order to perform measurements on TDD frequency band indicated by the IE "TDD Frequency band"	
>Need for UL compressed mode	MP		Boolean	TRUE means that the UE requires UL compressed mode in order to perform measurements on TDD frequency band indicated by the IE "TDD Frequency band"	
GSM measurements	CV- <i>gsm_sup</i>	1 to <maxFreqBands GSM>			

Information Element/Group name	Need	Multi	Type and reference	Semantics description	Version
>GSM Frequency band	MP		Enumerated(GSM450, GSM480, GSM850, GSM900P, GSM900E, GSM1800, GSM1900)	as defined in [45]. Nine spare values are needed.	
>Need for DL compressed mode	MP		Boolean	TRUE means that the UE requires DL compressed mode in order to perform measurements on GSM frequency band indicated by the IE "GSM Frequency band"	
>Need for UL compressed mode	MP		Boolean	TRUE means that the UE requires UL compressed mode in order to perform measurements on GSM frequency band indicated by the IE "GSM Frequency band"	
Multi-carrier measurement	CV- <i>mc_sup</i>				
>Need for DL compressed mode	MP		Boolean	TRUE means that the UE requires DL compressed mode in order to perform measurements on multi-carrier	
>Need for UL compressed mode	MP		Boolean	TRUE means that the UE requires UL compressed mode in order to perform measurements on multi-carrier	

Condition	Explanation
<i>tdd_sup</i>	The IE is mandatory present if the IE "Multi-mode capability" has the value "TDD" or "FDD/TDD". Otherwise this field is not needed in the message.
<i>gsm_sup</i>	The IE is mandatory present if the IE "Support of GSM" has the value TRUE. Otherwise this field is not needed in the message.
<i>mc_sup</i>	The IE is mandatory present if the IE "Support of multi-carrier" has the value TRUE. Otherwise this field is not needed in the message.

10.3.3.22 Paging cause

Cause for a CN originated page.

Information Element/Group name	Need	Multi	Type and reference	Semantics description
Paging cause	MP		Enumerated(Terminating Conversational Call, Terminating Streaming Call, Terminating Interactive Call, Terminating Background Call, Terminating High Priority Signalling, Terminating Low Priority Signalling, Terminating – cause unknown)	One spare value is needed.

10.3.3.23 Paging record

Information Element/Group name	Need	Multi	Type and reference	Semantics description	Version
CHOICE <i>Used paging identity</i>	MP				
>CN identity					
>>Paging cause	MP		Paging cause 10.3.3.22		
>>>CN domain identity	MP		CN domain identity 10.3.1.1		
>>>CHOICE <i>UE Identity</i>	MP			Three spare values are needed.	
>>>>IMSI (GSM-MAP)			IMSI (GSM-MAP) 10.3.1.5		
>>>>TMSI (GSM-MAP)			TMSI (GSM-MAP) 10.3.1.17		
>>>>P-TMSI (GSM-MAP)			P-TMSI (GSM-MAP) 10.3.1.13		
>>>>IMSI (DS-41)			Octet string (SIZE (5..7))	TIA/EIA/IS-2000-4	
>>>>TMSI (DS-41)			Octet string (SIZE (2..17))	TIA/EIA/IS-2000-4	
>UTRAN single UE identity					
>>U-RNTI	MP		U-RNTI 10.3.3.47		
>>>CN originated page to connected mode UE	OP				
>>>>Paging cause	MP		Paging cause 10.3.3.22		

Information Element/Group name	Need	Multi	Type and reference	Semantics description	Version
>>>CN domain identity	MP		CN domain identity 10.3.1.1		
>>>Paging record type identifier	MP		Paging record type identifier 10.3.1.10		
>>RRC connection release information	MP		RRC connection release information 10.3.3.35o		REL-5
>UTRAN group identity		1 to <maxURNTIgroup>			REL-5
>>RRC connection release information	MP		RRC connection release information 10.3.3.35o		REL-5
>>Group release information	MP		Group release information 10.3.3.14o		REL-5

Condition	Explanation
CHOICE Used paging identity	Condition under which the given used paging identity is chosen
CN identity	For CN originating pages (for idle mode UEs)
UTRAN single UE identity	For UTRAN originating pages (for connected mode UEs), addressing a single UE
UTRAN group identity	For UTRAN originating pages (for connected mode UEs), addressing a group of UEs

10.3.3.24 PDCP capability

Indicates which algorithms and which value range of their parameters are supported by the UE.

Information Element/Group name	Need	Multi	Type and reference	Semantics description	Version
Support for lossless SRNS relocation	MP		Boolean	TRUE means supported	
Support for lossless DL RLC PDU size change	CV-not_iRAT_HoInfo2		Boolean	TRUE means supported Default value is FALSE	REL-5
Support for RFC2507	MP		Boolean	TRUE means supported	
>Max HC context space	MP		Integer(1024, 2048, 4096, 8192, 16384, 32768, 65536, 131072)	Note 1	REL-5
Support for RFC 3095	CV-not_iRAT_HoInfo		Boolean	TRUE means supported	REL-4
>Maximum number of ROHC context sessions	MD		Integer(2, 4, 8, 12, 16, 24, 32, 48, 64, 128, 256, 512, 1024, 16384)	Default value is 16.	REL-4
>Reverse decompression depth	MD		Integer	Default value is 0	REL-4

Information Element/Group name	Need	Multi	Type and reference	Semantics description	Version
			(0..65535)	(reverse decompression is not supported).	
>Support for RFC 3095 context relocation	MP		Boolean	TRUE means supported	REL-5
Note 1: The IE "Max HC context space" values 16384, 32768, 65536 and 131072 are not used in the INTER RAT HANDOVER INFO message.					

Condition	Explanation
<i>not_iRAT_HoInfo</i>	The IE is not needed in the INTER RAT HANDOVER INFO message. Otherwise, it is mandatory present.
<i>not_iRAT_HoInfo2</i>	The IE is not needed in the INTER RAT HANDOVER INFO message. Otherwise, it is mandatory default.

10.3.3.25 Physical channel capability

Information Element/Group name	Need	Multi	Type and Reference	Semantics description	Version
--------------------------------	------	-------	--------------------	-----------------------	---------

Information Element/Group name	Need	Multi	Type and Reference	Semantics description	Version
Downlink physical channel capability information elements					
FDD downlink physical channel capability	CH- <i>fdd_req_su</i> <i>p</i>				
>Max no DPCH codes	MP		Integer (1..8)	Maximum number of DPCH codes to be simultaneously received	
>Max no physical channel bits received	MP		Integer (1200, 2400, 3600, 4800, 7200, 9600, 14400, 19200, 28800, 38400, 48000, 57600, 67200, 76800)	Maximum number of physical channel bits received in any 10 ms interval (DPCH, S-CCPCH)	
>Support for SF 512 and 80 ms TTI for DPCH	MP		Boolean	TRUE means supported	
>CHOICE <i>Support of HS-PDSCH</i>	CV- <i>not_iRAT_</i> <i>HoInfo</i>				REL-5
>>Supported					REL-5
>>>HS-DSCH physical layer category	MP		Integer (1..64)	As defined in [35]. Values 13..64 are spares. See Note 5.	REL-5
>>>HS-DSCH physical layer category extension	OP		Integer (1..20)	As defined in [35]. See Note 6 See Note 7	REL-7
>>>HS-SCCHless HS-DSCH operation support	OP		Enumerated (TRUE)	The absence of this IE indicates that the UE does not support HS-SCCHless HS-DSCH operation.	REL-7
>>>Enhanced F-DPCH support	OP		Enumerated (TRUE)	The absence of this IE indicates that the UE does not support enhanced F-DPCH	REL-7
>>>HS-PDSCH in CELL_FACH	OP		Enumerated (TRUE)	The absence of this IE indicates that the UE does not support HS-PDSCH reception in CELL_FACH	REL-7
>>>HS-PDSCH in CELL_PCH and URA_PCH	OP		Enumerated (TRUE)	The absence of this IE indicates that the UE does not support HS-PDSCH in neither CELL_PCH nor URA_PCH states.	REL-7
>>Unsupported				(no data)	REL-5
3.84 Mcps TDD downlink physical channel capability	CH- <i>3.84_Mcps_</i> <i>tdd_req_s</i> <i>up</i>				Name changed in REL-4
>Maximum number of timeslots	MP		Integer		

Information Element/Group name	Need	Multi	Type and Reference	Semantics description	Version
per frame			(1..14)		
>Maximum number of physical channels per frame	MP		Integer (1..224)		
>Minimum SF	MP		Integer (1, 16)		
>Support of PDSCH	MP		Boolean	TRUE means supported	
>CHOICE <i>Support of HS-PDSCH</i>	CV-not_iRAT_HoInfo				REL-5
>>Supported					REL-5
>>>HS-DSCH physical layer category	MP		Integer (1..64)	As defined in [35]	REL-5
>>Unsupported				(no data)	REL-5
>Maximum number of physical channels per timeslot	MP		Integer (5..16)		
7.68 Mcps TDD downlink physical channel capability	CH-7.68_Mcps_tdd_req_s_up				REL-7
>Maximum number of timeslots per frame	MP		Integer (1..14)		REL-7
>Maximum number of physical channels per frame	MP		Integer (1..448)		REL-7
>Minimum SF	MP		Integer (1, 32)		REL-7
>Support of PDSCH	MP		Boolean	TRUE means supported	REL-7
>CHOICE <i>Support of HS-PDSCH</i>	CV-not_iRAT_HoInfo				REL-7
>>Supported					REL-7
>>>HS-DSCH physical layer category	MP		Integer (1..64)	As defined in [35]	REL-7
>>Unsupported				(no data)	REL-7
>Maximum number of physical channels per timeslot	MP		Integer (1..32)		REL-7
1.28 Mcps TDD downlink physical channel capability	CH-1.28_Mcps_tdd_req_s_up				REL-4
>Maximum number of timeslots per subframe	MP		Integer (1..6)		REL-4
>Maximum number of physical channels per subframe	MP		Integer (1..96)		REL-4
>Minimum SF	MP		Integer (1, 16)		REL-4
>Support of PDSCH	MP		Boolean	TRUE means supported	REL-4
>CHOICE <i>Support of HS-PDSCH</i>	CV-not_iRAT_HoInfo				REL-5
>>Supported					REL-5
>>>HS-DSCH physical layer category	MP		Integer (1..64)	As defined in [35]	REL-5
>>>Multi-carrier HS-DSCH physical layer category	OP		Integer (1..64)	As defined in [35] Absent if downlink multiple carrier is not supported	REL-7
>>Unsupported				(no data)	REL-5
>Maximum number of physical channels per timeslot	MP		Integer (1..16)		REL-4
>Support of 8PSK	MP		Boolean	TRUE means supported	REL-4
Uplink physical channel					

Information Element/Group name	Need	Multi	Type and Reference	Semantics description	Version
capability information elements					
FDD uplink physical channel capability	CH- <i>fdd_req_su p</i>				
>Maximum number of DPDCH bits transmitted per 10 ms	MP		Integer (600, 1200, 2400, 4800, 9600, 19200, 28800, 38400, 48000, 57600)		
>CHOICE <i>Support of E-DCH</i>	CV- <i>not_iRAT_ HoInfo</i>				REL-6
>>Supported					REL-6
>>>E-DCH physical layer category	MP		Integer (1..16)	As defined in [35] in Rel-6 Values 7 to 16 are spares. See Note 4.	REL-6
>>>E-DCH physical layer category extension	OP		Integer (7)	As defined in [35].	REL-7
>>>DPCCH Discontinuous Transmission support	OP		Enumerated (TRUE)	The absence of this IE indicates that the UE does not support DPCCH Discontinuous Transmission	REL-7
>>>Slot Format #4 support	OP		Enumerated (TRUE)	The absence of this IE indicates that the UE does not support Slot Format #4	REL-7
>>Unsupported				(no data)	REL-6
3.84 Mcps TDD uplink physical channel capability	CH- <i>3.84_Mcps_ _tdd_req_s up</i>				Name changed in REL-4
>Maximum Number of timeslots per frame	MP		Integer (1..14)		
>Maximum number of physical channels per timeslot	MP		Integer (1, 2)		
>Minimum SF	MP		Integer (1, 2, 4, 8)		
>Support of PUSCH	MP		Boolean	TRUE means supported	
>CHOICE <i>Support of E-DCH</i>	CV- <i>not_iRAT_ HoInfo</i>				REL-7
>>Supported					REL-7
>>>E-DCH physical layer category	MP		Integer (1..16)	As defined in [35]	REL-7
>>Unsupported				(no data)	REL-7
7.68 Mcps TDD uplink physical channel capability	CH- <i>7.68_Mcps_ _tdd_req_s up</i>				REL-7
>Maximum Number of timeslots per frame	MP		Integer (1..14)		REL-7
>Maximum number of physical channels per timeslot	MP		Integer (1, 2)		REL-7
>Minimum SF	MP		Integer		REL-7

Information Element/Group name	Need	Multi	Type and Reference	Semantics description	Version
			(1, 2, 4, 8)		
>Support of PUSCH	MP		Boolean	TRUE means supported	REL-7
>CHOICE <i>Support of E-DCH</i>	CV- not_iRAT_ HoInfo				REL-7
>>Supported					REL-7
>>>E-DCH physical layer category	MP		Integer (1..16)	As defined in [35]	REL-7
>>Unsupported				(no data)	REL-7
1.28 Mcps TDD uplink physical channel capability	CH- 1.28_Mcps _tdd_req_s up				REL-4
>Maximum Number of timeslots per subframe	MP		Integer (1..6)		REL-4
>Maximum number of physical channels per timeslot	MP		Integer (1, 2, 3, 4)		REL-4 REL-7
>Minimum SF	MP		Integer (1, 2, 4, 8, 16)		REL-4
>Support of PUSCH	MP		Boolean	TRUE means supported	REL-4
>Support of 8PSK	MP		Boolean	TRUE means supported	REL-4
>CHOICE Support of E-DCH	CV- not_iRAT_ HoInfo				REL-7
>>Supported					REL-7
>>>E-DCH physical layer category	MP		Integer (1..6)	As defined in [35]	REL-7
>>Unsupported				(no data)	REL-7
NOTE 1: Void.					
NOTE 2: Void.					
NOTE 3: Void.					
NOTE 4: All UEs supporting E-DCH should signal a category between 1 and 6 for this IE even if the UE physical capability category is above 6.					
NOTE 5: All UEs supporting HS-DSCH should signal a category between 1 and 12 for this IE even if the UE physical capability category is above 12. This IE corresponds to the HS-DSCH category supported by the UE when MAC-ehs is not configured.					
NOTE 6: This IE corresponds to the HS-DSCH category supported by the UE when MAC-ehs is configured.					
NOTE 7: In REL-7 the simultaneous configuration of MIMO and 64 QAM is not supported so a UE category 19 shall be treated as category 17 by the UTRAN and a UE category 20 shall be treated as category 18 by the UTRAN, except for total number of soft channel bits as specified in [35].					

Condition	Explanation
<i>3.84_Mcps_tdd_req_sup</i>	The IE is mandatory present if the IE "TDD RF capability" is present with the IE "Chip rate capability" set to "3.84 Mcps" and a 3.84 Mcps TDD capability update has been requested in a previous message. Otherwise this field is not needed in the message.
<i>7.68_Mcps_tdd_req_sup</i>	The IE is mandatory present if the IE "TDD RF capability" is present with the IE "Chip rate capability" set to "7.68 Mcps" and a 7.68 Mcps TDD capability update has been requested in a previous message. Otherwise this field is not needed in the message.
<i>1.28_Mcps_tdd_req_sup</i>	The IE is mandatory present if the IE "TDD RF capability" is present with the IE "Chip rate capability" set to "1.28 Mcps" and a 1.28 Mcps TDD capability update has been requested in a previous message. Otherwise this field is not needed in the message.
<i>fdd_req_sup</i>	The IE is mandatory present if the IE "Multi-mode capability" has the value "FDD" or "FDD/TDD" and a FDD capability update has been requested in a previous message. Otherwise this field is not needed in the message.
<i>not_iRAT_HoInfo</i>	The CHOICE <i>Support of HS-PDSCH</i> is not needed in the INTER RAT HANDOVER INFO message. Otherwise, it is mandatory present.
<i>not_iRAT_HoInfo</i>	The CHOICE <i>Support of E-DCH</i> is not needed in the INTER RAT HANDOVER INFO message. Otherwise, it is mandatory present.

10.3.3.26 Protocol error cause

This IE indicates the cause for a message or information that was not comprehended.

Information Element/Group name	Need	Multi	Type and reference	Semantics description
Protocol error cause	MP		Enumerated (ASN.1 violation or encoding error, Message type non-existent or not implemented, Message not compatible with receiver state, Information element value not comprehended, Information element missing, Message extension not comprehended)	Two spare values are needed.

10.3.3.27 Protocol error indicator

This IE indicates whether a message was transmitted due to a protocol error or not.

Information Element/Group name	Need	Multi	Type and Reference	Semantics description
Protocol error indicator	MP		Boolean	TRUE means a protocol error occurred. FALSE means a protocol error did not occur.

10.3.3.28 RB timer indicator

This IE is used to indicate to UTRAN if the timers T314 or T315 has expired in the UE.

Information Element/Group name	Need	Multi	Type and reference	Semantics description
T314 expired	MP		Boolean	TRUE means that the timer has expired or the stored value is zero. FALSE means that the timer has not expired.
T315 expired	MP		Boolean	TRUE means that the timer has expired or the stored value is zero. FALSE means that the timer has not expired.

10.3.3.29 Redirection info

This IE is used to redirect the UE to another frequency or other system. With the Release 6 version a list of cells may be provided to the UE, where cell selection shall be started.

Information Element/Group name	Need	Multi	Type and reference	Semantics description	Version
CHOICE <i>Redirection Information</i>	MP				
>Frequency info			Frequency info 10.3.6.36		
>Inter-RAT info			Inter-RAT info 10.3.7.25		

10.3.3.30 Re-establishment timer

This information element indicates which timer to associate with RAB.

Information Element/Group name	Need	Multi	Type and reference	Semantics description
Re-establishment timer	MP		Enumerated(useT314, useT315)	

10.3.3.31 Rejection cause

Cause for rejection of RRC connection establishment request.

Information Element/Group name	Need	Multi	Type and reference	Semantics description
Rejection cause	MP		Enumerated (congestion, unspecified)	

10.3.3.32 Release cause

Cause for release of RRC connection.

Information Element/Group name	Need	Multi	Type and reference	Semantics description
Release cause	MP		Enumerated (normal event, unspecified, pre-emptive release, congestion, re-establishment reject, user inactivity), directed signalling connection re-establishment)	One spare value is needed.

10.3.3.32a RF Capability Compressed

Information Element/Group name	Need	Multi	Type and reference	Semantics description	Version
CHOICE <i>FDD</i>	MP				REL-5
>Supported					REL-5
>>RF capability band FDD list Compressed	MP	1..<maxf reqband sFDD>			REL-5
		1..<maxf reqband sFDD-ext>			REL-6
>>>RF Capability Band FDD Compressed	MP		Enumerated (not supported, default TxRx separation)	TX/RX frequency separation capability for the supported frequency band(s). Default is the TX/RX frequency separation defined in [21] for each frequency band. Two spare values are needed.	REL-5
>Not supported			NULL		REL-5
CHOICE <i>TDD-3.84Mcps</i>	MP				REL-5
>Supported					REL-5
>>Radio Frequency Band TDD List	MP		Enumerated (a, b, c, a+b, a+c, b+c, a+b+c)	As defined in [22]. One spare value needed	REL-5
			Enumerated (a, b, c, d, a+b, a+c, a+d, b+c, b+d, c+d, a+b+c, a+b+d, a+c+d, b+c+d, a+b+c+d)		REL-7
>Not supported			NULL		REL-5
CHOICE <i>TDD-7.68Mcps</i>	MP				REL-7
>Supported					REL-7
>>Radio Frequency Band TDD List	MP		Enumerated (a, b, c, d, a+b, a+c, a+d, b+c, a+b+c, a+b+d, a+c+d, b+c+d, a+b+c+d)	As defined in [22]. One spare value needed	REL-7
>Not supported			NULL		REL-7
CHOICE <i>TDD-1.28Mcps</i>	MP				REL-5
>Supported					REL-5
>>Radio Frequency Band TDD List	MP		Enumerated (a, b, c, a+b, a+c, b+c, a+b+c)	As defined in [22]. One spare value needed	REL-5
			Enumerated (a, b, c, d, a+b, a+c, a+d, b+c, b+d, c+d, a+b+c, a+b+d, a+c+d, b+c+d, a+b+c+d)		REL-7
>Not supported			NULL		REL-5

10.3.3.33 RF capability FDD

Information Element/Group name	Need	Multi	Type and Reference	Semantics description	Version
UE power class	MP		Enumerated(1..4)	As defined in [21]	
Tx/Rx frequency separation	MP		Enumerated(default TxRx separation)	Default is the TX/RX frequency separation defined in [21] for each	

Information Element/Group name	Need	Multi	Type and Reference	Semantics description	Version
				frequency band. Two spare values are needed.	

10.3.3.33a RF capability FDD extension

Information Element/Group name	Need	Multi	Type and Reference	Semantics description
UE power class extension	MP		Enumerated(1..4)	As defined in [21]. A UE with UE power class 3bis signals the value 3. Four spare values are needed
Tx/Rx frequency separation	MP		Enumerated(default TxRx separation)	Default is the TX/RX frequency separation defined in [21] for each frequency band. Two spare values are needed.

10.3.3.33b RF capability TDD

Information Element/Group name	Need	Multi	Type and Reference	Semantics description	Version
UE power class	MP		Enumerated (1..4)	as defined in [22]	
Radio frequency bands	MP		Enumerated(a, b, c, a+b, a+c, b+c, a+b+c)	as defined in [22]. One spare value needed.	
			Enumerated (a, b, c, d, a+b, a+c, a+d, b+c, b+d, c+d, a+b+c, a+b+d, a+c+d, b+c+d, a+b+c+d)		REL-7
Chip rate capability	MP		Enumerated(3,8	as defined in [22]	
			4Mcps, 1.28Mcps, 7.68 Mcps)		REL-7

10.3.3.33c RF capability TDD 1.28 Mcps

Information Element/Group name	Need	Multi	Type and Reference	Semantics description	Version
Radio frequency bands	MP		Enumerated(a, b, c, a+b, a+c, b+c, a+b+c)	as defined in [22]. One spare value needed.	
			Enumerated (a, b, c, d, a+b, a+c, a+d, b+c, b+d, c+d, a+b+c, a+b+d, a+c+d, b+c+d, a+b+c+d)		REL-7

10.3.3.34 RLC capability

Information Element/Group name	Need	Multi	Type and Reference	Semantics description	Version
Total RLC AM buffer size	MP		Integer (10, 50, 100, 150, 500, 1000, 200, 300, 400, 750)	Total receiving and transmitting RLC AM buffer and MAC-hs reordering buffer capability in kBytes. Note 1.	REL-5
Maximum RLC AM Window Size	MP		Integer(20 47,4095)	Maximum supported RLC TX and RX window in UE	
Maximum number of AM entities	MP		Integer (4,5,6,8,1 6,30)		
Support for Two logical channel Configuration	CV- <i>not_iRA</i> <i>T_HolInfo</i>		Boolean	TRUE means supported	REL-7
Note 1: The IE "Total RLC AM buffer size" values 200, 300, 400 and 750 are not used in the INTER RAT HANDOVER INFO message.					

Condition	Explanation
<i>not_iRAT_HolInfo</i>	The IE is not needed in the INTER RAT HANDOVER INFO message. Otherwise, it is mandatory present.

10.3.3.35 RLC re-establish indicator

This IE is used to re-configure AM RLC on c-plane and u-plane.

Information Element/Group name	Need	Multi	Type and reference	Semantics description
RLC re-establish indicator	MP		Boolean	TRUE means re-establish required FALSE means re-establish not required

10.3.3.35o RRC connection release information

Indicates whether the UE shall perform a release of the RRC connection.

Information Element/Group name	Need	Multi	Type and reference	Semantics description	Version
CHOICE <i>Release indicator</i>	MD			Default value is "No release"	REL-5
>No release					REL-5
>Release					REL-5
>>Release cause	MP		Release cause 10.3.3.32		REL-5

10.3.3.35a RRC State Indicator

Indicates to a UE the RRC state to be entered.

Information Element/Group name	Need	Multi	Type and reference	Semantics description
RRC State indicator	MP		Enumerated(CELL_DCH, CELL_FACH, CELL_PCH, URA_PCH)	

10.3.3.36 RRC transaction identifier

This IE contains an identification of the RRC procedure transaction local for the type of the message this IE was included within.

Information Element/Group name	Need	Multi	Type and reference	Semantics description	Version
CHOICE RRC Tr Id type	MP				REL-5
>Normal					
>>RRC transaction identifier	MP		Integer (0..3)		
>Extended					REL-5
>>RRC transaction identifier	MP		Integer (0..15)		REL-5

CHOICE RRC Tr Id type	Condition under which the given RRC Tr Id type is chosen
Normal	All cases where the RRC Tr Id type: Extended is not chosen.
Extended	Optional in the MEASUREMENT CONTROL message. Mandatory in the MEASUREMENT CONTROL FAILURE message.

10.3.3.37 Security capability

Information Element/Group name	Need	Multi	Type and reference	Semantics description	Version
Ciphering algorithm capability	MP				
>UEA0	MP		Boolean		
>UEA1	MP		Boolean		
>UEA2	MP		Boolean	The value TRUE means that UEA2 is fully interoperability tested. If fully interoperability tested, also "Security capability indication" of "UE radio access capability compressed" shall be set to TRUE.	REL-7
>Spare	MP	13	Boolean	Shall be set to FALSE by UEs complying with this version of the protocol.	
Integrity protection algorithm capability	MP				
>UIA1	MP		Boolean	The value TRUE means that UIA1, Kasumi, is supported	
>UIA2	MP		Boolean	The value TRUE means that UIA2 is fully interoperability tested. If fully interoperability tested, also "Security capability indication" of "UE radio access capability compressed" shall be set to TRUE.	REL-7
>Spare	MP	14	Boolean	Shall be set to FALSE by UEs complying with this version of the protocol.	

10.3.3.38 START

There is a START value per CN domain. The START is used to initialise the 20 MSBs of all hyper frame numbers (MAC-d HFN, RLC UM HFN, RLC AM HFN, RRC HFN) for a CN domain.

Information Element/Group name	Need	Multi	Type and Reference	Semantics description
START	MP		Bit string (20)	START [40]. The first/leftmost bit of the bit string contains the most significant bit of the START.

10.3.3.39 Void

10.3.3.40 Transport channel capability

Information Element/Group name	Need	Multi	Type and Reference	Semantics description
Downlink transport channel capability information elements				
Max no of bits received	MP		Integer(640, 1280, 2560, 3840, 5120, 6400, 7680, 8960, 10240, 20480, 40960, 81920, 163840)	Maximum sum of number of bits of all transport blocks received at an arbitrary time instant
Max convolutionally coded bits received	MP		Integer(640, 1280, 2560, 3840, 5120, 6400, 7680, 8960, 10240, 20480, 40960, 81920, 163840)	Maximum sum of number of bits of all convolutionally coded transport blocks received at an arbitrary time instant
Max turbo coded bits received	CV- <i>turbo_dec_sup</i>		Integer(640, 1280, 2560, 3840, 5120, 6400, 7680, 8960, 10240, 20480, 40960, 81920, 163840)	Maximum sum of number of bits of all turbo coded transport blocks received at an arbitrary time instant
Maximum number of simultaneous transport channels	MP		Integer(4, 8, 16, 32)	
Maximum number of simultaneous CCTrCH	MP		Integer (1..8)	
Max no of received transport blocks	MP		Integer(4, 8, 16, 32, 48, 64, 96, 128, 256, 512)	Maximum total number of transport blocks received within TTIs that end at within the same 10ms interval
Maximum number of TFC	MP		Integer(16, 32, 48, 64, 96, 128, 256, 512, 1024)	
Maximum number of TF	MP		Integer(32, 64, 128, 256, 512, 1024)	

Information Element/Group name	Need	Multi	Type and Reference	Semantics description
Support for turbo decoding	MP		Boolean	TRUE means supported
Uplink transport channel capability information elements				
Max no of bits transmitted	MP		Integer(640, 1280, 2560, 3840, 5120, 6400, 7680, 8960, 10240, 20480, 40960, 81920, 163840)	Maximum sum of number of bits of all transport blocks transmitted at an arbitrary time instant
Max convolutionally coded bits transmitted	MP		Integer(640, 1280, 2560, 3840, 5120, 6400, 7680, 8960, 10240, 20480, 40960, 81920, 163840)	Maximum sum of number of bits of all convolutionally coded transport blocks transmitted at an arbitrary time instant
Max turbo coded bits transmitted	CV- <i>turbo_enc_sup</i>		Integer(640, 1280, 2560, 3840, 5120, 6400, 7680, 8960, 10240, 20480, 40960, 81920, 163840)	Maximum sum of number of bits of all turbo coded transport blocks transmitted at an arbitrary time instant
Maximum number of simultaneous transport channels	MP		Integer(4, 8, 16, 32)	
Maximum number of simultaneous CCTrCH of DCH type	CH- <i>tdd_req_sup</i>		Integer (1..8)	
Max no of transmitted transport blocks	MP		Integer(4, 8, 16, 32, 48, 64, 96, 128, 256, 512)	Maximum total number of transport blocks transmitted within TTIs that start at the same time
Maximum number of TFC	MP		Integer(16, 32, 48, 64, 96, 128, 256, 512, 1024)	
Maximum number of TF	MP		Integer(32, 64, 128, 256, 512, 1024)	
Support for turbo encoding	MP		Boolean	TRUE means supported

Condition	Explanation
<i>turbo_dec_sup</i>	The IE is mandatory present if the IE "Support of turbo decoding" = True. Otherwise this field is not needed in the message.
<i>turbo_enc_sup</i>	The IE is mandatory present if the IE "Support of turbo encoding" = True. Otherwise this field is not needed in the message.
<i>tdd_req_sup</i>	The IE is mandatory present if the IE "Multi-mode capability" has the value "TDD" or "FDD/TDD" and a TDD capability update has been requested in a previous message. Otherwise this field is not needed in the message.

10.3.3.41 UE multi-mode/multi-RAT capability

Information Element/Group name	Need	Multi	Type and Reference	Semantics description	Version
Multi-RAT capability					
Support of GSM	MP		Boolean		
Support of multi-carrier	MP		Boolean		
Multi-mode capability	MP		Enumerated (TDD, FDD, FDD/TDD)		
Support of UTRAN to GERAN NACC	CV-not_iRAT_HoInfo		Boolean		REL-5
Support of Handover to GAN	CV-not_iRAT_HoInfo2		Enumerated (DoesSupportHandoverToGAN)	Absence of this IE means that the UE does not support Handover to GAN.	REL-6
Support of Inter-RAT PS handover	CV-not_iRAT_HoInfo2		Enumerated (DoesSupportInterRAT-PS-Handover)	Absence of this IE means that the UE does not support Inter-RAT PS Handover	REL-6
Support of PS Handover to GAN	CV-not_iRAT_HoInfo2		Enumerated (DoesSupportPSHandoverToGAN)	Absence of this IE means that the UE does not support PS Handover to GAN.	REL-7

Condition	Explanation
<i>not_iRAT_HoInfo</i>	The IE is not needed in the INTER RAT HANDOVER INFO message. Otherwise, it is mandatory present.
<i>not_iRAT_HoInfo2</i>	The IE is not needed in the INTER RAT HANDOVER INFO message. Otherwise, it is optional.

NOTE: The UE sets the capability of Inter-RAT PS Handover (by means of the IE "Support of Inter-RAT PS handover") to the same value as the corresponding GERAN capability in [5].

10.3.3.42 UE radio access capability

Information Element/Group name	Need	Multi	Type and reference	Semantics description	Version	
Access stratum release indicator	MP		Enumerated(R99)	Indicates the release of the UE according to [35]. The IE also indicates the release of the RRC transfer syntax supported by the UE..		
	CV-not_rrc_connectionSetupComplete				Enumerated(REL-4,	REL-4
					REL-5,	REL-5
					REL-6,	REL-6
			REL-7)	REL-7		
DL capability with simultaneous	CV-		Enumerated(REL-5	

Information Element/Group name	Need	Multi	Type and reference	Semantics description	Version
HS-DSCH configuration	<i>not_iRAT_HoInfo</i>		32kbps, 64kbps, 128kbps, 384kbps)		
PDCP capability	MP		PDCP capability 10.3.3.24		
RLC capability	MP		RLC capability 10.3.3.34		
Transport channel capability	MP		Transport channel capability 10.3.3.40		
RF capability FDD	OP		RF capability FDD 10.3.3.33		
RF capability TDD	OP		RF capability TDD 10.3.3.33b	One "TDD RF capability" entity shall be included for every Chip rate capability supported.	
		1 to 2		Note 1	REL-4
RF capability TDD 1.28 Mcps	<i>CV-iRAT_HoInfo</i>		RF capability TDD 1.28 Mcps 10.3.3.33c	Note 1	REL-4
Physical channel capability	MP		Physical channel capability 10.3.3.25		
UE multi-mode/multi-RAT capability	MP		UE multi-mode/multi-RAT capability 10.3.3.41		
Security capability	MP		Security capability 10.3.3.37		
UE positioning capability	MP		UE positioning capability 10.3.3.45		
Measurement capability	<i>OP</i>		Measurement capability 10.3.3.21		
Device type	MD		Enumerated (DoesNotBenefitFromBatteryConsumptionOptimisation)	Absence of this value means that the device does benefit from NW-based battery consumption optimisation. UE may set the value to DoesNotBenefitFromBatteryConsumptionOptimisation when it does not foresee to particularly benefit from NW-based	REL-6
Support for System Information Block type 11bis	OP		Enumerated (True)		REL-6
				The IE shall be	REL-7

Information Element/Group name	Need	Multi	Type and reference	Semantics description	Version
				present and set to TRUE	

Information Element/Group name	Need	Multi	Type and reference	Semantics description	Version
Support for F-DPCH	OP		Enumerated (True)	The IE shall be set to TRUE when F-DPCH is fully supported by the UE. Absence of this information element indicates that F-DPCH is not fully supported	REL-6
MAC-ehs support	OP		Enumerated (TRUE)	The presence of this IE indicates that UE supports MAC-ehs, the use of special value of HE field to indicate end of an SDU for RLC AM and octet aligned transport block table. The absence of this IE indicates that the UE does not support either MAC-ehs, octet aligned transport block table or the use of special value of HE field to indicate end of an SDU for RLC AM.	REL-7
UE specific capability Information LCR TDD	OP		Enumerated (NF, TriRxUniTx, TriRxTriTx, HexRxUniTx, HexRxTriTx, HexRxHexTx)	For 1.28 Mcps TDD only 10 spare values needed.	REL-7
Support for E-DPCCH Power Boosting	OP		Enumerated (TRUE)	The IE shall be set to TRUE when E-DPCCH Power Boosting is fully supported by the UE. Absence of this information element indicates that E-DPCCH Power Boosting is not fully supported	REL-7
Support for Two DRX schemes in URA_PCH and CELL_PCH	OP		Enumerated (TRUE)	The absence of this IE indicates that the UE does not support Two DRX schemes in URA_PCH and CELL_PCH	REL-7
Support for E-DPDCH power interpolation formula	OP		Enumerated (TRUE)	The absence of this IE indicates that the UE does not support E-	REL-7

Information Element/Group name	Need	Multi	Type and reference	Semantics description	Version
				DPDCH power interpolation formula when 16QAM is not configured	
Support of TX Diversity on DL Control Channels by MIMO Capable UE when MIMO operation is active	CV- <i>not_iRAT_HoInfo</i>		Enumerated (TRUE)	The absence of this IE indicates that the MIMO capable UE does not support TX diversity on DL Control Channels (HS-SCCH, F-DPCH, E-AGCH, E-HICH, E-RGCH) when MIMO is active, P-CPICH is configured on antenna 1, and S-CPICH on antenna 2.	REL-7
Note 1: The second entity of the "RF capability TDD" is not needed in the INTER RAT HANDOVER INFO message: if both TDD 3.84/7.68 Mcps and TDD 1.28 Mcps are supported, the "RF capability TDD 1.28 Mcps" entity shall be used for TDD 1.28 Mcps; the "UE power class" in the "RF capability TDD" entity shall apply for both chip rates.					

Condition	Explanation
<i>not_rrc_connectionSetupComplete</i>	The IE is not needed in the RRC CONNECTION SETUP COMPLETE message. Otherwise the IE is mandatory present.
<i>not_iRAT_HoInfo</i>	The IE is not needed in the INTER RAT HANDOVER INFO message. Otherwise, it is optional.
<i>iRAT_HoInfo</i>	The IE is optional in the INTER RAT HANDOVER INFO message. Otherwise, the IE is not needed.

10.3.3.42o UE radio access capability compressed

Information Element/Group name	Need	Multi	Type and reference	Semantics description	Version
Access stratum release indicator	MP		Enumerated (R99, REL-4, REL-5, REL-6, REL-7)	12 spare values are needed	REL-5
					REL-6
					REL-7
Total AM RLC buffer size exceeds 10 kByte	MP		BOOLEAN		REL-5
RF capability compressed	MP		RF capability compressed 10.3.3.32a		REL-5
Support for System Information Block type 11bis	OP		Enumerated (True)		REL-6
				The IE shall be present and set to TRUE	REL-7
MAC-ehs support	OP		Enumerated (True)	The presence of this IE indicates that UE supports MAC-ehs and octet aligned transport table. Absent if either MAC-ehs, octet aligned transport block table or the	REL-7

Information Element/Group name	Need	Multi	Type and reference	Semantics description	Version
				use of special value of HE field to indicate end of an SDU for RLC AM is not supported	
Security capability indication	OP		Enumerated (True)	TRUE indicates UE security capabilities beyond R99 requirements, see 10.3.3.37	REL-7
GANSS support indication	OP		Enumerated (True)	TRUE indicates that the UE supports GANSS	REL-7

10.3.3.42oa UE radio access capability comp 2

Information Element/Group name	Need	Multi	Type and reference	Semantics description	Version
FDD physical channel capability for HS-PDSCH/E-DCH	OP			Absent if HS-PDSCH and E-DCH are not supported	REL-6
>DL capability with simultaneous HS-DSCH configuration	OP		Enumerated (32, 64, 128, 384)	Unit: kbps. This IE is always required, but the need is set to OP to align with ASN.1	REL-6
>HS-DSCH physical layer category	MP		Integer (1..64)	As defined in [35] Values 13...64 are spare.	REL-6
>HS-DSCH physical layer category extension	OP		Integer (1..20)	As defined in [35]. See Note 1	REL-7
>CHOICE Support of E-DCH	MP				REL-6
>>Supported					REL-6
>>>E-DCH physical layer category	MP		Integer (1..16)	As defined in [35]	REL-6
>>>E-DCH physical layer category extension	OP		Integer (7)	As defined in [35].	REL-7
>>Unsupported				(no data)	REL-6

Information Element/Group name	Need	Multi	Type and reference	Semantics description	Version
Support for F-DPCH	OP		Enumerated (True)		REL-6
				The IE shall be set to TRUE when F-DPCH is fully supported by the UE. Absence of this information element indicates that F-DPCH is not fully supported	REL-7
HS-SCCHless HS-DSCH operation support	OP		Enumerated (True)	The absence of this IE indicates that the UE does not support HS-SCCHless HS-DSCH operation.	REL-7
Enhanced F-DPCH support	OP		Enumerated (True)	The absence of this IE indicates that the UE does not support enhanced F-DPCH	REL-7
HS-PDSCH in CELL_FACH	OP		Enumerated (True)	The absence of this IE indicates that the UE does not support HS-PDSCH reception in CELL_FACH	REL-7
HS-PDSCH in CELL_PCH and URA_PCH	OP		Enumerated (True)	The absence of this IE indicates that the UE does not support HS-PDSCH in neither CELL_PCH nor URA_PCH states.	REL-7
DPCCH Discontinuous Transmission support	OP		Enumerated (True)	The absence of this IE indicates that the UE does not support DPCCH Discontinuous Transmission	REL-7
Slot Format #4 support	OP		Enumerated (True)	The absence of this IE indicates that the UE does not support Slot Format #4	REL-7
Support for E-DPCCH Power Boosting	OP		Enumerated (TRUE)		REL-7
				The IE shall be set to TRUE when E-DPCCH Power Boosting is fully supported by the UE. Absence of this information element indicates that E-DPCCH Power Boosting is not fully supported	
Support of TX Diversity on DL Control Channels by MIMO Capable UE when MIMO operation is active	OP		Enumerated (TRUE)	The absence of this IE indicates that the MIMO capable UE does not support TX diversity on DL	REL-7

Information Element/Group name	Need	Multi	Type and reference	Semantics description	Version
				Control Channels (HS-SCCH, F-DPCH, E-AGCH, E-HICH, E-RGCH) when MIMO is active, P-CPICH is configured on antenna 1, and S-CPICH on antenna 2.	

NOTE 1: This IE corresponds to the HS-DSCH category supported by the UE when MAC-e-hs is configured.

10.3.3.42a UE radio access capability extension

Information Element/Group name	Need	Multi	Type and reference	Semantics description	Version
Frequency band specific capability list	MP	1 to <maxFreqbandsFDD>		The network should ignore the entry that includes the 'extension indicator'.	
>Frequency band	MP		Enumerated(Band I, Band II,		
			Band III,		REL-5
			Band VI, Band IV, Band V, Band VII, extension indicator)	The setting of the value 'extension indicator' by the UE is not specified in the specification.	REL-6
>Frequency band 2	OP		Enumerated(Band VIII, Band IX, Band X, extension Indicator)	This IE indicates the supported frequency bands Band VIII and beyond. The setting of the value 'extension indicator' by the UE is not specified in the specification. Twelve spare values are needed	REL-6
>RF capability FDD extension	MD		RF capability FDD extension 10.3.3.33 a	the default values are the same values as in the immediately preceding IE "RF capability FDD extension"; the first occurrence is MP	
>Measurement capability extension	MP		Measurement capability extension 10.3.3.21 a		

10.3.3.42b UE security information

Upon receiving a UE information request from another system, the UE shall indicate the requested security information. The UE security information includes the following RRC information.

Information Element/Group name	Need	Multi	Type and reference	Semantics description
UE information elements				
START-CS	MP		START 10.3.3.38	START values to be used in this CN domain.

10.3.3.42c UE security information2

Upon receiving a UE information request from another system, the UE shall indicate the requested security information. The UE security information includes the following RRC information.

Information Element/Group name	Need	Multi	Type and reference	Semantics description	Version
START-PS	MP		START 10.3.3.38	START values to be used in this CN domain.	Rel-6

10.3.3.43 UE Timers and Constants in connected mode

This information element specifies timer- and constants values used by the UE in connected mode.

Information Element/Group name	Need	Multi	Type and reference	Semantics description	Version
T301	MD		Integer(100, 200 .. 2000 by step of 200, 3000, 4000, 6000, 8000)	Value in milliseconds. Default value is 2000. This IE should not be used by the UE in this release of the protocol. One spare value is needed.	
N301	MD		Integer(0..7)	Default value is 2. This IE should not be used by the UE in this release of the protocol.	
T302	MD		Integer(100, 200... 2000 by step of 200, 3000, 4000, 6000, 8000)	Value in milliseconds. Default value is 4000. One spare value is needed.	
N302	MD		Integer(0..7)	Default value is 3.	
T304	MD		Integer(100, 200, 400, 1000, 2000)	Value in milliseconds. Default value is 2000. Three spare values are needed.	
N304	MD		Integer(0..7)	Default value is 2..	
T305	MD		Integer(5, 10, 30, 60, 120, 360, 720, infinity)	Value in minutes. Default value is 30. Infinity means no update	
T307	MD		Integer(5, 10, 15, 20, 30, 40, 50)	Value in seconds. Default value is 30. One spare value is needed.	
T308	MD		Integer(40, 80, 160,	Value in milliseconds. Default value is 160.	

Information Element/Group name	Need	Multi	Type and reference	Semantics description	Version
			320)		
T309	MD		Integer(1...8)	Value in seconds. Default value is 5.	
T310	MD		Integer(40.. 320 by step of 40)	Value in milliseconds. Default value is 160.	
N310	MD		Integer(0.. 7)	Default value is 4.	
T311	MD		Integer(250 .. 2000 by step of 250)	Value in milliseconds. Default value is 2000.	
T312	MD		Integer (0..15)	Value in seconds. Default value is 1. The value 0 is not used in this version of the specification.	
N312	MD		Integer (1, 2, 4, 10, 20, 50, 100, 200, 400, 600, 800, 1000)	Default value is 1.	
T313	MD		Integer (0..15)	Value in seconds. Default value is 3.	
N313	MD		Integer (1, 2, 4, 10, 20, 50, 100, 200)	Default value is 20.	
T314	MD		Integer(0, 2, 4, 6, 8, 12, 16, 20)	Value in seconds. Default value is 12.	
T315	MD		Integer (0,10, 30, 60, 180, 600, 1200, 1800)	Value in seconds. Default value is 180.	
N315	MD		Integer (1, 2, 4, 10, 20, 50, 100, 200, 400, 600, 800, 1000)	Default value is 1.	
T316	MD		Integer(0, 10, 20, 30, 40, 50, infinity)	Value in seconds. Default value is 30. One spare value is needed.	
T317	MD			Default value is infinity.	
			Enumerated (infinity, infinity, infinity, infinity, infinity, infinity, infinity)	All the values are changed to "infinity" in the Rel-5.	REL-5

10.3.3.44 UE Timers and Constants in idle mode

This information element specifies timer- and constant values used by the UE in idle mode.

Information Element/Group name	Need	Multi	Type and reference	Semantics description
T300	MP		Integer(100, 200... 2000 by step of 200, 3000, 4000, 6000, 8000)	Value in milliseconds. Default value is 1000. Use of Default is described in 10.2.48.8.4 and in 10.2.48.8.16.
N300	MP		Integer(0..7)	Default value is 3. Use of Default is described in 10.2.48.8.4 and in 10.2.48.8.16.
T312	MP		Integer(0 .. 15)	Value in seconds. Default value is 1. Use of Default is described in 10.2.48.8.4 and in 10.2.48.8.16. The value 0 is not used in this version of the specification.
N312	MP		Integer (1, 2, 4, 10, 20, 50, 100, 200, 400, 600, 800, 1000)	Default value is 1. Use of Default is described in 10.2.48.8.4 and in 10.2.48.8.16.

10.3.3.45 UE positioning capability

Information Element/Group name	Need	Multi	Type and reference	Semantics description	Version
Standalone location method(s) supported	MP		Boolean	Defines if a UE can measure its location by some means unrelated to UTRAN TRUE means supported	
UE based OTDOA supported	MP		Boolean	TRUE means supported	
Network Assisted GPS support	MP		Enumerated ('Network based', 'UE based', 'Both', 'None')	Defines if the UE supports network based or UE based GPS methods.	
Network Assisted GANSS support List	CV- <i>not_iRAT_HoInfo</i>	1 to <maxGANSS>		Absent if GANSS is not supported	REL-7
>GANSS ID	OP		Enumerated ()	Absence of this IE means Galileo. Eight spare values needed.	REL-7
>GANSS mode	MP		Enumerated ('Network based', 'UE based', 'Both', 'None')	Defines if the UE supports network based or UE based GANSS methods	REL-7
>GANSS Signal ID	OP		10.3.3.45 a	Absence of this field means Galileo L1 OS if GANSS_ID refers to Galileo.	REL-7
>Support for GANSS timing of cell frames measurement	MP		Boolean	Defines if a UE has the capability to perform the UE GANSS timing of cell frames measurement. TRUE means capable	REL-7
>Support for GANSS Carrier-Phase Measurement	OP		Boolean	Defines if a UE has the capability to perform the UE GANSS Carrier-Phase Measurement. TRUE means capable	REL-7
GANSS support indication	CV- <i>iRAT_HoInfo</i>		Enumerated (True)	TRUE indicates that the UE supports GANSS	REL-7
Support for GPS timing of cell frames measurement	MP		Boolean	Defines if a UE has the capability to perform the UE GPS timing of cell frames measurement [7]. TRUE means capable	
Support for IPDL	MP		Boolean	Defines if a UE has the capability to use IPDL to enhance its 'SFN-SFN observed time difference –type 2' measurement. TRUE means supported	
Support for Rx-Tx time	MP		Boolean	TRUE means supported	

difference type2 measurement					
Support for UP assisted GPS measurement validity in CELL_PCH and URA_PCH states	CV-GPSsupported		Enumerated (true)		
Support for SFN-SFN observed time difference type 2 measurement	OP		Enumerated (true)	Absence of this element means not supported and presence means supported.	

Condition	Explanation
<i>GPSsupported</i>	This IE is mandatory present if the IE "Network Assisted GPS support" is set to 'Network based', 'UE based' or 'Both'. Otherwise, it is not needed.
<i>not_iRAT_HoInfo</i>	These IEs are not needed in the INTER RAT HANDOVER INFO message. Otherwise, they are optionally present.
<i>iRAT_HoInfo</i>	This IE is optionally present in the INTER RAT HANDOVER INFO message. Otherwise, the IE is not needed.

10.3.3.45a GANSS Signal Id

The GANSS Signal ID encodes the identification of the signal for each GANSS. It depends on the GANSS Id.

Information Element/Group name	Need	Multi	Type and reference	Semantics description	Version
GANSS Signal Identity per Signal Id	MD		INTEGER (0..7)	See NOTE 1	REL-7

NOTE 1 :

GANSS Id	Value	Explanation
Default : Galileo	Default Value	Galileo L1
	0	Galileo E5A
	1	Galileo E5B
	2	Galileo E6
	3	Galileo E5A + E5B
	4-7	Spare

10.3.3.46 URA update cause

Indicates the cause for s URA update.

Information Element/Group name	Need	Multi	Type and reference	Semantics description
URA update cause	MP		Enumerated (change of URA, periodic URA update)	One spare value is needed.

10.3.3.47 U-RNTI

The U-RNTI (UTRAN Radio Network Temporary Identity) is allocated to a UE having a RRC connection and identifies the UE within UTRAN.

Information Element/Group name	Need	Multi	Type and reference	Semantics description
SRNC identity	MP		bit string(12)	The SRNC ID unique in PLMN is encoded to SRNC identity IE in descending order from b31 . The b31 is the most significant bit. If the SRNC ID is more than 12 bits as defined in [57], the remaining bits are included as most significant bits of S-RNTI IE.
S-RNTI	MP		bit string(20)	The UE ID unique in SRNS is encoded to the S-RNTI IE in descending order. If the SRNC ID is more than 12 bits as defined in [57], S-RNTI include both part of the SRNC ID and the UE-ID. The least significant bits encode the UE-ID to the S-RNTI IE in descending order. The b0 is the least significant bit.

10.3.3.47a U-RNTI group

The U-RNTI group is used to identify a group of UEs having an RRC connection.

Information Element/Group name	Need	Multi	Type and reference	Semantics description	Version
CHOICE <i>group discriminator</i>	MP				REL-5
>All				(no data)	REL-5
>U-RNTI mask					REL-5
>>U-RNTI	MP		U-RNTI 10.3.3.47	The bits that are less significant than the bit position indicated by the U-RNTI bit mask index shall be ignored.	REL-5
>>U-RNTI bit mask index	MP		Enumerated(b1, b2,..b31)	Values b1 to b31 indicate bit positions in the S-RNTI and in the SRNC identity.	REL-5

10.3.3.48 U-RNTI Short

The U-RNTI (UTRAN Radio Network Temporary Identity) is allocated to a UE having a RRC connection and identifies the UE within UTRAN.

Information Element/Group name	Need	Multi	Type and reference	Semantics description
SRNC identity	MP		bit string(12)	The SRNC identity bits are numbered b20 to b31, where b20 is the least significant bit. If the SRNC ID is more than 12 bits as defined in [57], the remaining bits are included as most significant bits of S-RNTI 2 IE.
S-RNTI 2	MP		bit string(10)	The UE ID is encoded in S-RNTI 2 in descending order. If the SRNC ID is more than 12 bits as defined in [57], S-RNTI include both part of the SRNC ID and the UE-ID. The least significant bits encode the UE-ID to the S-RNTI IE in descending order. The b0 is the least significant bit.

10.3.3.49 UTRAN DRX cycle length coefficient

A coefficient in the formula to count the paging occasions to be used by a specific UE (specified in [4]).

Information Element/Group name	Need	Multi	Type and reference	Semantics description	Version
DRX cycle length coefficient	MP		Integer(3...9)	Refers to 'k' in the formula as specified in [4], Discontinuous reception	
DRX cycle length coefficient 2	MD		Integer(3..9)	Refers to 'k' in the formula as specified in [4], Discontinuous reception. The default value is "same as DRX cycle length coefficient".	REL-7
Time for DRX cycle 2	MD		Integer(80, 160, 320, 640, 1280, 2560, 5120)	Values in milliseconds. The default value is 0 ms.	REL-7

10.3.3.50 Wait time

Wait time defines the time period the UE has to wait before repeating the rejected procedure.

Information Element/Group name	Need	Multi	Type and reference	Semantics description
Wait time	MP		Integer(0..15)	Wait time in seconds The value 0 indicates that repetition is not allowed.

10.3.3.51 UE Specific Behaviour Information 1 idle

This IE indicates the UE conformance typically for RRC connection establishment from idle mode.

Information Element/Group name	Need	Multi	Type and Reference	Semantics description
UE Specific Behaviour Information 1 idle	MP		bit string(4)	

10.3.3.52 UE Specific Behaviour Information 1 interRAT

This IE indicates the UE conformance typically for RRC connection establishment from another RAT.

Information Element/Group name	Need	Multi	Type and Reference	Semantics description
UE Specific Behaviour Information 1 interRAT	MP		bit string(8)	

10.3.4 Radio Bearer Information elements

10.3.4.0a Common RB mapping info

NOTE: For FDD only.

A multiplexing option between a logical channel and a MAC-ehs queue.

Information Element/Group name	Need	Multi	Type and reference	Semantics description	Version
Logical channel identity	MP		Integer(1..15)	Note	REL-7
MAC-ehs queue identity	MP		MAC-ehs Queue Id 10.3.5.7f		REL-7

NOTE: the IE "Logical channel identity" conveys the value to be used in the "LCH-ID" field of the MAC-ehs header [15] associated with the MAC-ehs reordering queue identified by the IE "MAC-ehs queue identity".

10.3.4.0 Default configuration identity

This information element identifies a default radio parameter configuration. The corresponding default configurations are specified in subclause 13.7.

Information Element/Group name	Need	Multi	Type and reference	Semantics description	Version
Default configuration identity	MP		Integer (0..10,	For TDD, default configurations 0, 1, 5, 6 and 7 are incorrect and they should not be used in this version of the specification.	
			11,		REL-4
			13,	Default configuration ID 2 is not used.	REL-5
			12, 14, 15, 16		REL-6
			17,	Used only in RRC Connection Setup message.	REL-6
			18..22,	For TDD, default configuration 22 is incorrect and it should not be used in this version of the specification.	REL-6
			23..31)	Reserved for future extension	REL-6

10.3.4.1 Downlink RLC STATUS info

Information Element/Group name	Need	Multi	Type and reference	Semantics description
Timer_Status_Prohibit	OP		Integer(10..50 by step of 10, 550..1000 by step of 50)	Minimum time in ms between STATUS reports
Missing PDU Indicator	MP		Boolean	Value true indicates that UE should send a STATUS report for each missing PDU that is detected
Timer_STATUS_periodic	OP		Integer(100, 200, 300, 400, 500, 750, 1000, 2000)	Time in milliseconds

10.3.4.1a PDCP context relocation info

This information element indicates that the header compression context relocation is to be performed during SRNS relocation for the given radio bearer.

Information Element/Group name	Need	Multi	Type and reference	Semantics description	Version
RB identity	MP		RB identity 10.3.4.16		REL-5
Downlink RFC 3095 context relocation indication	MP		Boolean	TRUE means RFC 3095 context relocation is performed in downlink	REL-5
Uplink RFC 3095 context relocation indication	MP		Boolean	TRUE means RFC 3095 context relocation is performed in uplink	REL-5

10.3.4.2 PDCP info

The purpose of the PDCP info IE is to indicate which algorithms shall be established and to configure the parameters of each of the algorithms.

Information Element/Group name	Need	Multi	Type and reference	Semantics description	Version
Support for lossless SRNS relocation or for lossless DL RLC PDU size change	CV- <i>LosslessCriteria</i>		Boolean	TRUE means support	
Max PDCP SN window size	CV- <i>Lossless</i>		Enumerated(sn255, sn65535)	Maximum PDCP sequence number window size. The handling of sequence number when the Max PDCP SN window size is 255 is specified in [23].	
PDCP PDU header	MP		Enumerated (present, absent)	Whether a PDCP PDU header is existent or not.	
Header compression information	OP	1 to <maxPDCPAlgoType>			
>CHOICE <i>algorithm type</i>	MP			Note 1	
>>RFC 2507				Header compression according to IETF standard RFC 2507	
>>>F_MAX_PERIOD	MD		Integer (1..65535)	Largest number of compressed non-TCP headers that may be sent without sending a full header. Default value is 256.	
>>>F_MAX_TIME	MD		Integer (1..255)	Compressed headers may not be sent more than F_MAX_TIME seconds after sending last full header. Default value is 5.	
>>>MAX_HEADER	MD		Integer (60..65535)	The largest header size in octets that may be	

Information Element/Group name	Need	Multi	Type and reference	Semantics description	Version
				compressed. Default value is 168.	
>>>TCP_SPACE	MD		Integer (3..255)	Maximum CID value for TCP connections. Default value is 15.	
>>>NON_TCP_SPACE	MD		Integer (3..65535)	Maximum CID value for non-TCP connections. Default value is 15.	
>>>EXPECT_REORDERING	MD		Enumerated (reordering not expected, reordering expected)	Whether the algorithm shall reorder PDCP SDUs or not. Default value is "reordering not expected".	
>>RFC 3095				Header compression according to IETF standard RFC 3095	REL-4
>>>Profiles	MP	1 to <maxRO HC-Profiles>		Profiles supported by both compressor and decompressor in both UE and UTRAN. Profile 0 shall always be supported.	REL-4
>>>>Profile instance	MP		Integer(1.. 3)	1 = 0x0001, 2 = 0x0002, 3 = 0x0003 (see [52])	REL-4
>>>Uplink	OP			Indicates the necessary information elements for Uplink.	REL-4
>>>>Max_CID	MD		Integer (1.. 16383)	Highest context ID number to be used by the UE compressor. Default value is 15.	REL-4
>>>Downlink	OP			Indicates the necessary information elements for Downlink.	REL-4
>>>>Max_CID	MD		Integer (1.. 16383)	Highest context ID number to be used by the UE decompressor. Default value is 15.	REL-4
>>>>Reverse-Decompression_Depth	MD		Integer (0..65535)	Determines whether reverse decompression should be used or not and the maximum number of packets that can be reverse	REL-4

Information Element/Group name	Need	Multi	Type and reference	Semantics description	Version
				decompressed by the UE decompressor. Default value is 0 (reverse decompression shall not be used).	
Note 1: If several occurrences of the same algorithm type are included in the same IE "header compression information", the UE behaviour is unspecified.					

Condition	Explanation
<i>LosslessCriteria</i>	This IE is mandatory present if the IE "RLC mode" is "Acknowledged", the IE "In-sequence delivery " is TRUE and the IE "SDU Discard Mode" is "No discard" and not needed otherwise.
<i>Lossless</i>	This IE is mandatory present if the IE "Support for lossless SRNS relocation or for lossless RLC PDU size change" Is TRUE, otherwise it is not needed.

10.3.4.2a PDCP ROHC target mode

Information Element/Group name	Need	Multi	Type and Reference	Semantics description	Version
Target Mode	MP		Enumerated (O-mode, R-mode)	The UE shall only transit to the signalled mode for operation of ROHC as described in [36].	REL-5

10.3.4.3 PDCP SN info

Information Element/Group name	Need	Multi	Type and Reference	Semantics description
Receive PDCP sequence number	MP		Integer(0..65535)	The PDCP sequence number, which the sender of the message is expecting next to be received.

10.3.4.4 Polling info

Information Element/Group name	Need	Multi	Type and reference	Semantics description
Timer_poll_prohibit	OP		Integer(10..50 by step of 10, 600..1000 by step of 50)	Minimum time between polls in ms
Timer_poll	OP		Integer(10..50 by step of 10, 600..1000 by step of 50)	Time in ms.
Poll_PDU	OP		Integer(1,2,4,8,16,32,64,128)	Number of PDUs, interval between pollings
Poll_SDU	OP		Integer(1,4,16,64)	Number of SDUs, interval between pollings
Last transmission PDU poll	MP		Boolean	TRUE indicates that poll is made at last PDU in transmission buffer
Last retransmission PDU poll	MP		Boolean	TRUE indicates that poll is made at last PDU in retransmission buffer
Poll_Window	OP		Integer(50,60,70,80,85,90,95,99)	Percentage of transmission window, threshold for polling
Timer_poll_periodic	OP		Integer(100, 200, 300, 400, 500, 750, 1000, 2000)	Time in milliseconds Timer for periodic polling.

10.3.4.5 Predefined configuration identity

This information element identifies a pre- defined radio parameter configuration.

Information Element/Group name	Need	Multi	Type and reference	Semantics description
Predefined radio configuration identity	MP		Integer (0..15)	

10.3.4.5a Predefined configuration status information

Another system may provide the UE with one or more predefined UTRAN configurations, comprising of radio bearer, transport channel and physical channel parameters. If requested, the UE shall indicate the configurations it has stored. The predefined configuration status information should include the following RRC information.

Information Element/Group name	Need	Multi	Type and reference	Semantics description
RB information elements				
Predefined configurations		maxPredef ConfigCount		The list is in order of preconfiguration identity
>Predefined configuration value tag	OP		Predefined configuration value tag 10.3.4.6	The UE shall include the value tag if it has stored the concerned configuration

Multi Bound	Explanation
MaxPredefConfigCount	Maximum number of predefined configurations

10.3.4.5b Predefined configuration status information compressed

Another system may provide the UE with one or more predefined UTRAN configurations, comprising of radio bearer, transport channel and physical channel parameters. If requested, the UE shall indicate the configurations it has stored. The compressed predefined configuration status information should include the following RRC information.

Information Element/Group name	Need	Multi	Type and reference	Semantics description	Version
Sets with different value tags	MP				REL-5
>Pre-defined configuration set with different value tags	MP	1..2			REL-5
>>Start position	MD		INTEGER (0..10)	Default value is 0, corresponding with the first pre-defined configuration. The pre-defined configuration where the consecutive sequence of pre-defined configurations begins.	REL-5
>>Pre-defined configuration value tag list	MP	6..<max PredefConfig>	Pre-defined configuration value tag 10.3.4.6	Value Tags for each pre-defined configuration starting from the lowest.	REL-5
Other Entries	OP				REL-5
>Pre-defined configuration list with variable size	MP	1..<max PredefConfig>		List of other pre-defined configurations not included within the Sets with different value tags, in consecutive order starting with the lowest. If there are stored pre-defined configurations positioned after a pre-defined configuration that is not stored, the UE shall indicate the not-stored pre-defined configuration by explicitly indicating it to be absent. If there are no stored pre-defined configurations positioned after a pre-defined configuration that is not stored, then the UE may totally omit these pre-defined configurations from the IE, i.e. reduce the size of the list to correspond to the last position that contained a stored pre-defined configuration.	REL-5
>>Predefined configuration value tag	OP		Predefined configuration value tag 10.3.4.6	The UE shall include the value tag if it has stored the concerned configuration	REL-5

10.3.4.6 Predefined configuration value tag

This information element is used to identify different versions of a radio bearer configuration as may be used within one PLMN e.g. to support different UTRAN implementations.

Information Element/Group name	Need	Multi	Type and Reference	Semantics description
Predefined configuration value tag	MP		Integer(0..15)	

10.3.4.7 Predefined RB configuration

This information element concerns a pre- defined configuration of radio bearer parameters

Information Element/Group name	Need	Multi	Type and Reference	Semantics description
UE information elements				
Re-establishment timer	MP		Re-establishment timer 10.3.3.30	Only one RAB supported
Signalling radio bearer information				
Signalling RB information to setup List	MP	1 to <maxSRBs etup>		For each signalling radio bearer
>Signalling RB information to setup	MP		Signalling RB information to setup 10.3.4.24	
RB information				
RB information to setup list	MP	1 to <maxRBperRAB>		Only one RAB supported
>RB information to setup	MP		RB information to setup 10.3.4.20	

10.3.4.8 RAB info

This IE contains information used to uniquely identify a radio access bearer.

Information Element/Group name	Need	Multi	Type and reference	Semantics description	Version
RAB identity	MP		RAB identity 10.3.1.14		
MBMS Service Identity	CV- Message		MBMS service ID 10.3.9a.8a	Included when establishing a RB for a MBMS service of the broadcast type; NOTE 1	REL-6
MBMS Session identity	CV- Message		MBMS Session identity 10.3.9a.9		REL-6
CN domain identity	MP		CN domain identity 10.3.1.1		
NAS Synchronization Indicator	OP		NAS Synchronization indicator 10.3.4.12		
Re-establishment timer	MP		Re-establishment timer 10.3.3.30		
NOTE 1: Only the "MBMS Service ID" part of the MBMS service identity is signalled in this IE. The UE should consider that the "PLMN identity" part of the MBMS service identity equals the PLMN identity of an MBMS service with the same "MBMS Service ID" stored in the variable ACTIVATED_MBMS_SERVICES. If there is no such MBMS service or more than one such MBMS service, the UE behaviour is unspecified.					

Condition	Explanation
Message	This IE is optionally present in the RADIO BEARER SETUP and the SRNS RELOCATION INFO messages and not needed otherwise.

10.3.4.9 RAB info Post

This IE contains information used to uniquely identify a radio access bearer.

Information Element/Group name	Need	Multi	Type and reference	Semantics description
RAB identity	MP		RAB identity 10.3.1.14	
CN domain identity	MP		CN domain identity 10.3.1.1	
NAS Synchronization Indicator	OP		NAS Synchronization indicator 10.3.4.12	

10.3.4.9a RAB information for MBMS ptp bearers

Information Element/Group name	Need	Multi	Type and reference	Semantics description	Version
RB identity	MP		RB identity 10.3.4.16		REL-7
MBMS Service Identity	MP		MBMS Service ID 10.3.9a.8a	Indicates that this radio bearer is used for a different MBMS service.	REL-7
MBMS Session Identity	OP		MBMS Session identity 10.3.9a.9	Indicates that this radio bearer is used for a different session of the MBMS service.	REL-7

10.3.4.10 RAB information for setup

Information Element/Group name	Need	Multi	Type and reference	Semantics description
RAB info	MP		RAB info 10.3.4.8	
RB information to setup list	MP	1 to <maxRBperRAB>		
>RB information to setup	MP		RB information to setup 10.3.4.20	

10.3.4.11 RAB information to reconfigure

Information Element/Group name	Need	Multi	Type and reference	Semantics description
RAB identity	MP		RAB Identity 10.3.1.14	
CN domain identity	MP		CN domain	

Information Element/Group name	Need	Multi	Type and reference	Semantics description
			identity 10.3.1.1	
NAS synchronization indicator	MP		NAS Synchronizat ion info 10.3.4.12	Note 1

NOTE 1: This IE is only relevant for the CS domain.

10.3.4.12 NAS Synchronization indicator

A container for non-access stratum information to be transferred transparently through UTRAN.

Information Element/Group name	Need	Multi	Type and reference	Semantics description
NAS Synchronization indicator	MP		Bit string(4)	The first/leftmost bit of the bit string contains the most significant bit of the NAS Synchronization indicator.

10.3.4.13 RB activation time info

This IE contains the time, in terms of RLC sequence numbers, when a certain configuration shall be activated, for a number of radio bearers.

Information Element/Group name	Need	Multi	Type and reference	Semantics description
Radio bearer activation time	MP	1 to <maxRB>		
>RB identity	MP		RB identity 10.3.4.16	
>RLC sequence number	MP		Integer (0.. 4095)	RLC SN [16] . Used for radio bearers mapped on RLC AM and UM

10.3.4.14 RB COUNT-C MSB information

The MSB of the COUNT-C values of the radio bearer.

Information Element/Group name	Needed	Multi	Type and reference	Semantics description
RB identity	MP		RB identity 10.3.4.16	
COUNT-C-MSB-uplink	MP		Integer (0.. $2^{25}-1$)	25 MSBs from COUNT-C associated to this RB
COUNT-C-MSB-downlink	MP		Integer (0.. $2^{25}-1$)	25 MSBs from COUNT-C associated to this RB

10.3.4.15 RB COUNT-C information

The COUNT-C values of the radio bearer.

Information Element/Group name	Needed	Multi	Type and reference	Semantics description
RB identity	MP		RB identity 10.3.4.16	
COUNT-C-uplink	MP		Integer (0.. $2^{32}-1$)	
COUNT-C-downlink	MP		Integer (0.. $2^{32}-1$)	

10.3.4.16 RB identity

An identification number for the radio bearer affected by a certain message.

Information Element/Group name	Need	Multi	Type and reference	Semantics description
RB identity	MP		Integer(1..32)	Values 1-4 shall only be used for signalling radio bearers. The IE value minus one shall be used as BEARER in the ciphering algorithm.

10.3.4.17 RB information to be affected

Information Element/Group name	Need	Multi	Type and reference	Semantics description
RB identity	MP		RB identity 10.3.4.16	
RB mapping info	MP		RB mapping info 10.3.4.21	

10.3.4.18 RB information to reconfigure

Information Element/Group name	Need	Multi	Type and reference	Semantics description
RB identity	MP		RB identity 10.3.4.16	
PDCP info	OP		PDCP info 10.3.4.2	
PDCP SN info	OP		PDCP SN info 10.3.4.3	PDCP sequence number info from the network. Present only in case of lossless SRNS relocation.
RLC info	OP		RLC info 10.3.4.23	
RB mapping info	OP		RB mapping info 10.3.4.21	
RB stop/continue	OP		Enumerated(stop, continue)	

10.3.4.19 RB information to release

Information Element/Group name	Need	Multi	Type and reference	Semantics description
RB identity	MP		RB identity 10.3.4.16	

10.3.4.20 RB information to setup

Information Element/Group name	Need	Multi	Type and reference	Semantics description
RB identity	MP		RB identity 10.3.4.16	
PDCP info	OP		PDCP info 10.3.4.2	
CHOICE <i>RLC info type</i>	MP			
>RLC info			RLC info 10.3.4.23	
>Same as RB			RB identity 10.3.4.16	Identity of RB with exactly the same RLC info IE values
RB mapping info	MP		RB mapping info 10.3.4.21	

NOTE: This information element is included within IE "Predefined RB configuration".

10.3.4.21 RB mapping info

A multiplexing option for each possible transport channel MAC-d flow or E-DCH MAC-d flow this RB can be multiplexed on.

Information Element/Group name	Need	Multi	Type and reference	Semantics description	Version
Information for each multiplexing option	MP	1 to <maxRBM uxOptions>			
>RLC logical channel mapping indicator	<i>CV-UL-RLCLogicalChannels</i>		Boolean	TRUE indicates that the first logical channel shall be used for data PDUs and the second logical channel shall be used for control PDUs. FALSE indicates that control and data PDUs can be sent on either of the two logical channels. This parameter is not used in this release and shall be set to TRUE.	
>Number of uplink RLC logical channels	<i>CV-UL-RLC info</i>	1 to MaxLoCHperRLC		1 or 2 logical channels per RLC entity or radio bearer RLC [16]	
>>CHOICE <i>Uplink transport channel type</i>					REL-6
>>>DCH, RACH, USCH					REL-6
>>>>Uplink transport channel type	MP		Enumerated(DCH,RACH, USCH)	USCH is TDD only	
>>>>ULTransport channel identity	<i>CV-UL-DCH/USCH</i>		Transport channel identity 10.3.5.18	This is the ID of a DCH or USCH (TDD only) that this RB could be mapped onto.	
>>>>Logical channel identity	OP		Integer(1..15)	This parameter is used to	

Information Element/Group name	Need	Multi	Type and reference	Semantics description	Version
				distinguish logical channels multiplexed by MAC on a transport channel.	
>>>>CHOICE <i>RLC size list</i>	MP			The RLC sizes that are allowed for this logical channel.	
>>>>>All			Null	All RLC sizes listed in the <i>Transport Format Set</i> . 10.3.5.23	
>>>>>Configured			Null	The RLC sizes configured for this logical channel in the <i>Transport Format Set</i> . 10.3.5.23 if present in this message or in the previously stored configuration otherwise	
>>>>>Explicit List		1 to <maxTF>		Lists the RLC sizes that are valid for the logical channel.	
>>>>>>RLC size index	MP		Integer(1..maxTF)	The integer number is a reference to the <i>RLC size</i> which arrived at that position in the <i>Transport Format Set</i> 10.3.5.23	
>>>E-DCH				Note 4	REL-6
>>>>Logical channel identity	MP		Integer(1..15)	This parameter is used to distinguish logical channels multiplexed by MAC on a transport channel	REL-6
>>>>E-DCH MAC-d flow identity	MP		E-DCH MAC-d flow identity 10.3.5.7e		REL-6
>>>>>DDI	MP		Integer (0..62)	If more than 1 UL RLC PDU size is configured for this RB, the different sizes will use subsequent DDI values starting from this DDI value. Value "0x3F" is reserved	REL-6
>>>>>RLC PDU size list	MP	1 to <maxRLC PDUsizePerLogChan>			REL-6
>>>>>>RLC PDU size	MP		Integer(16..5000 by step)	Unit is bits	REL-6

Information Element/Group name	Need	Multi	Type and reference	Semantics description	Version
>>>>Include in Scheduling Info	MP		of 8) Boolean	Indicates whether or not this logical channel is to be considered when performing scheduling info reporting, as per [15]	REL-6
>>MAC logical channel priority	MP		Integer(1..8)	This is priority between a user's different RBs (or logical channels). [15]	
>Downlink RLC logical channel info	<i>CV-DL-RLC info</i>				
>>Number of downlink RLC logical channels	<i>MD</i>	1 to MaxLoCHperRLC		1 or 2 logical channels per RLC entity or radio bearer RLC [16] Default value is that parameter values for DL are exactly the same as for corresponding UL logical channel. In case two multiplexing options are specified for the UL, the first options shall be used as default for the DL. As regards to the IE "Channel type", rule is specified in 8.6.4.8.	
>>>Downlink transport channel type	MP		Enumerated(DCH,FACH, DSCH,DCH+ DSCH , HS-DSCH, DCH + HS-DSCH)	Note 3 Note 4	REL-5
>>>DL DCH Transport channel identity	<i>CV-DL-DCH</i>		Transport channel identity 10.3.5.18		
>>>DL DSCH Transport channel identity	<i>CV-DL-DSCH</i>		Transport channel identity 10.3.5.18		
>>>CHOICE DL MAC header type	<i>CV-DL-HS-DSCH</i>			Depending on the MAC-hs/ehs type of header selected for HS-DSCH	REL-7
>>>>MAC-hs					REL-7

Information Element/Group name	Need	Multi	Type and reference	Semantics description	Version
>>>>DL HS-DSCH MAC-d flow identity	MP		MAC-d flow identity 10.3.5.7c		REL-5
>>>>MAC-ehs					REL-7
>>>>DL HS-DSCH MAC-ehs Queue Id	MP		MAC-ehs Queue Id 10.3.5.7f	Note 5	REL-7
>>>Logical channel identity	OP		Integer(1..15)	16 is reserved Note 5	
Note 3:	The IE "Downlink transport channel type" values "DSCH" and "DCH+DSCH" should not be used for FDD. If received the UE behaviour is unspecified.				
Note 4:	If included in System Information Block Type 16, the values 'HS-DSCH' and 'DCH + HS-DSCH' do not apply for the IE "Downlink transport channel type". Furthermore, if included in System Information Block Type 16, the value "E-DCH" for the IE "Uplink transport channel type" does not apply.				
Note 5:	If the IE "Downlink transport channel type" is "HS-DSCH" or "DCH + HS-DSCH" and the DL MAC header type is "MAC-ehs", the IE "Logical channel identity" conveys the value to be used in the "LCH-ID" field of the MAC-ehs header [15], associating the logical channel with the MAC-ehs reordering queue identified by the IE "DL HS-DSCH MAC-ehs Queue Id".				

Condition	Explanation
<i>UL-RLC info</i>	If "CHOICE <i>Uplink RLC mode</i> " in the IE "RLC info" that applies for that RB (i.e. either the one stored or received in the same message for the RB for which the "RB mapping info" was received, or the one stored or received in the same message for the RB pointed at in the IE "Same as RB" in the IE "RB information to setup" stored or received in the same message) is present this IE is mandatory present. Otherwise the IE is not needed.
<i>DL-RLC info</i>	If "CHOICE <i>Downlink RLC mode</i> " in the IE "RLC info" that applies for that RB (i.e. either the one stored or received in the same message for the RB for which the "RB mapping info" was received, or the one stored or received in the same message for the RB pointed at in the IE "Same as RB" in the IE "RB information to setup" stored or received in the same message) is present this IE is mandatory present. Otherwise the IE is not needed.
<i>UL-RLCLogicalChannels</i>	If "Number of uplink RLC logical channels" in IE "RB mapping info" is 2, then this IE is mandatory present. Otherwise this IE is not needed.
<i>UL-DCH/USCH</i>	If IE "Uplink transport channel type" is equal to "DCH" or "USCH" (TDD only) this IE is mandatory present. Otherwise the IE is not needed.
<i>DL-DCH</i>	If IE "Downlink transport channel type" is equal to "DCH", "DCH+DSCH" or "DCH + HS-DSCH" this IE is mandatory present. Otherwise the IE is not needed.
<i>DL-DSCH</i>	If IE "Downlink transport channel type" is equal to "DSCH" or "DCH+DSCH" this IE is mandatory present. Otherwise the IE is not needed.
<i>DL-HS-DSCH</i>	If IE "Downlink transport channel type" is equal to "HS-DSCH" or "DCH + HS-DSCH" this IE is mandatory present. Otherwise the IE is not needed.

10.3.4.22 RB with PDCP information

Information Element/Group name	Need	Multi	Type and reference	Semantics description	Version
RB identity	MP		RB identity 10.3.4.16		

PDCP SN info	MP		PDCP SN info 10.3.4.3	PDCP sequence number info from the sender of the message for lossless SRNS relocation.	REL-5
				PDCP sequence number info from the sender of the message for lossless SRNS relocation or for lossless DL RLC PDU size change.	

10.3.4.23 RLC info

Information Element/Group name	Need	Multi	Type and reference	Semantics description	Version
CHOICE <i>Uplink RLC mode</i>	OP			Indicates if Acknowledged, Unacknowledged or Transparent mode RLC shall be used.	
>AM RLC					
>>Transmission RLC discard	MP		Transmission RLC discard 10.3.4.25		
>>Transmission window size	MP		Integer(1,8,16,32,64,128,256,512,768,1024,1536,2047,2560,3072,3584,4095)	Maximum number of RLC PUs sent without getting them acknowledged. This parameter is needed if acknowledged mode is used. UE shall also assume that the UTRAN receiver window is equal to this value.	
>>Timer_RST	MP		Integer(50, 100, 150, 200, 250, 300, 350, 400, 450, 500, 550, 600, 700, 800, 900, 1000)	Elapsed time in milliseconds. It is used to trigger the retransmission of RESET PDU.	
>>Max_RST	MP		Integer(1, 4, 6, 8, 12, 16, 24, 32)	Defined in [16]	
>>Polling info	OP		Polling info 10.3.4.4		
>UM RLC					
>>Transmission RLC discard	OP		Transmission RLC discard 10.3.4.25		
>TM RLC					
>>Transmission RLC discard	OP		Transmission RLC discard 10.3.4.25		
>>Segmentation indication	MP		Boolean	TRUE indicates that segmentation is performed.	
CHOICE <i>Downlink RLC mode</i>	OP			Indicates if Acknowledged, Unacknowledged or Transparent mode RLC shall be used	
>AM RLC					
>>CHOICE <i>DL RLC PDU size</i>	MP				REL-7
>>>Fixed size					REL-7

Information Element/Group name	Need	Multi	Type and reference	Semantics description	Version
>>>>DL RLC PDU size	MP		Integer(16..5000 by step of 8)	Unit is bits	REL-5
>>>Flexible size				NOTE 1	REL-7
>>>>Length indicator size	MP		Enumerated (7-bit, 15-bit)		REL-7
>>In-sequence delivery	MP		Boolean	TRUE indicates that RLC shall preserve the order of higher layer PDUs when these are delivered. FALSE indicates that receiving RLC entity could allow SDUs to be delivered to the higher layer in different order than submitted to RLC sublayer at the transmitting side.	
>>Receiving window size	MP		Integer(1,8,16,32,64,128,256,512,768,1024,1536,2047,2560,3072,3584,4095)	Maximum number of RLC PUs allowed to be received. This parameter is needed if acknowledged mode is used. UE shall also assume that the UTRAN transmitter window is equal to this value	
>>Downlink RLC status Info	MP		Downlink RLC status info 10.3.4.1		
>UM RLC					
>>DL UM RLC LI size	MP		Integer(7, 15)	Size in bits to use for the downlink RLC UM LI.	REL-5
>>DL Reception Window Size	CV-Not-SIB16o		Integer(32, 48, 64, 80, 96, 112)		REL-6
>TM RLC					
>>Segmentation indication	MP		Boolean	TRUE indicates that segmentation is performed.	
One sided RLC re-establishment	MP		Boolean	TRUE indicates that only one side of the AM RLC entity is re-established.	REL-5
Alternative E-bit interpretation	CV-Not-SIB16o		Enumerated (true)	The absence of this IE implies: "normal E-bit interpretation".	REL-6
Use special value of HE field	CV-Not-SIB16o		Enumerated (true)	The absence of this IE implies: "do not use special value of the HE field" NOTE 2, NOTE 4	REL-7
NOTE 1: If included in SIB type 16, the "Flexible size" does not apply for downlink RLC PDU size (AM RLC).					
NOTE 2: If the value of the IE "Use special value of HE field" is used in a reconfiguration, and the signalled value differs from the previously configured value, then both of the IEs "Uplink RLC mode" and "Downlink RLC mode" should be included in the message, otherwise the UE behaviour is unspecified.					
NOTE 3: Void					

NOTE 4: If the IE "Use special value of HE field" is absent in the received message while the previously configured value of IE "Use special value of HE field" is set to true and the received message does not initiate any RLC re-establishment procedure on the corresponding downlink RLC entity, then the UE will drop AM data PDUs with special value of HE and it will lead to either RLC reset procedure or RLC unrecoverable error [16].

Condition	Explanation
Not-SIB16o	If included in SYSTEM INFORMATION BLOCK TYPE 16, this IE is not needed. Otherwise the IE is optional

NOTE: This information element is included within IE "Predefined RB configuration".

10.3.4.23a RLC info MBMS

The IE RLC info MBMS is used for point-to-multipoint radio bearers, featuring only the downlink RLC UMD.

Information Element/Group name	Need	Multi	Type and reference	Semantics description	Version
DL UM RLC LI size	MP		Integer (7, 15)	Size in bits to use for the downlink RLC UM LI.	REL-6
DL Duplication Avoidance and Reordering info	CV-MTCH		UM Duplication Avoidance and Reordering info 10.3.4.26		REL-6
DL Out of sequence delivery info	CV-MCCH		UM Out of sequence delivery info 10.3.4.27		REL-6

Condition	Explanation
MTCH	If the IE concerns MTCH (see Note 1), this IE is optional. Otherwise the IE is not needed.
MCCH	If the IE concerns MCCH, this IE is optional. Otherwise the IE is not needed.

NOTE 1: The UE behaviour is unspecified if this IE is received with regard to an MTCH configured for MBSFN operation. A network should not send this IE with regard to an MTCH configured for MBSFN operation.

10.3.4.24 Signalling RB information to setup

Information Element/Group name	Need	Multi	Type and reference	Semantics description
RB identity	MD		RB identity 10.3.4.16	Default value is specified in subclause 8.6.4.1
CHOICE <i>RLC info type</i>	MP			
>RLC info			RLC info 10.3.4.23	
>Same as RB			RB identity 10.3.4.16	Identity of RB with exactly the same RLC info IE values
RB mapping info	MP		RB mapping info 10.3.4.21	

NOTE: This information element is included within IE "Predefined RB configuration".

10.3.4.25 Transmission RLC Discard

Information Element/Group name	Need	Multi	Type and reference	Semantics description
CHOICE <i>SDU Discard Mode</i>	MP			Different modes for discharge the RLC buffer on the transmitter side; "Timer based with explicit signalling", "Timer based without explicit signalling", "Discard after Max_DAT retransmissions" or "No_discard". For unacknowledged mode and

Information Element/Group name	Need	Multi	Type and reference	Semantics description
				transparent mode, only Timer based without explicit signalling is applicable. If "No_discard" is used, reset procedure shall be done after Max_DAT retransmissions
>Timer based explicit				
>>Timer_MRW	MP		Integer(50,60, 70, 80, 90, 100, 120, 140, 160, 180, 200, 300, 400, 500, 700, 900)	Elapsed time in milliseconds. It is used to trigger the retransmission of a STATUS PDU containing an MRW SUFI field
>>Timer_discard	MP		Integer(100, 250, 500, 750, 1000, 1250, 1500, 1750, 2000, 2500, 3000, 3500, 4000, 4500, 5000, 7500)	Elapsed time in milliseconds before a SDU is discarded.
>>MaxMRW	MP		Integer(1, 4, 6, 8, 12, 16, 24, 32)	Defined in [16]
>Timer based no explicit				
>>Timer_discard	MP		Integer(10,20,30,40,50,60,70,80,90,100)	Elapsed time in milliseconds before a SDU is discarded.
>Max DAT retransmissions				
>>Max_DAT	MP		Integer(1, 2, 3, 4, 5, 6, 7, 8, 9, 10, 15, 20, 25, 30, 35, 40)	Defined in [16]
>>Timer_MRW	MP		Integer(50, 60, 70, 80, 90, 100, 120, 140, 160, 180, 200, 300, 400, 500, 700, 900)	Elapsed time in milliseconds. It is used to trigger the retransmission of a STATUS PDU containing an MRW SUFI field
>>MaxMRW	MP		Integer(1, 4, 6, 8, 12, 16, 24, 32)	Defined in [16]
>No discard				
>>Max_DAT	MP		Integer(1, 2, 3, 4, 5, 6, 7, 8, 9, 10, 15, 20, 25, 30, 35, 40)	Defined in [16]

CHOICE SDU Discard Mode	Condition under which the given SDU Discard Mode is chosen
Timer based explicit	If the modes for discharge of the RLC buffer on the transmitter side is "Timer based with explicit signalling"
Timer based no explicit	If the modes for discharge of the RLC buffer on the transmitter side is "Timer based without explicit signalling" For unacknowledged mode, only Timer based without

	explicit signalling is applicable.
Max DAT retransmissions	If the modes for discharge of the RLC buffer on the transmitter side is "Discard after Max_DAT retransmissions"
No discard	If the modes for discharge the of RLC buffer on the transmitter side is "Reset procedure shall be done after Max_DAT retransmissions"

10.3.4.26 UM Duplication Avoidance and Reordering info

Information Element/Group name	Need	Multi	Type and reference	Semantics description	Version
Timer_DAR	MP		Integer(40, 80, 120, 160, 240, 320, 480, 640, 960, 1280, 1920, 2560, 3840, 5120)	Timer (in milliseconds) when PDUs are released to the upper layers even though there are outstanding PDUs with lower RLC SN values.	REL-6
Window size DAR	MP		Integer(4, 8, 16, 32, 40, 48, 56, 64)		REL-6

10.3.4.27 UM Out of sequence delivery info

Information Element/Group name	Need	Multi	Type and reference	Semantics description	Version
Timer_OSD	CV- <i>notMCCH</i>		Integer (40, 80, 120, 160, 240, 320, 480, 640, 960, 1280, 1920, 2560, 3840, 5120)		REL-6
Window size OSD	MP		Integer(8, 16, 32, 40, 48, 56, 64)		REL-6

NOTE: This timer used to flush the buffer is configured at RRC level and indicated via a local primitive.

Condition	Explanation
<i>notMCCH</i>	If this concerns a logical channel other than MCCH then this IE is mandatory otherwise it is not needed. In the latter case Timer_OSD takes the value of the IE Modification Period as indicated within the IE MCCH configuration information

10.3.5 Transport CH Information elements

10.3.5.1 Added or Reconfigured DL TrCH information

Information Element/Group name	Need	Multi	Type and reference	Semantics description	Version
Downlink transport channel type	MP		Enumerated(DCH, DSCH, HS-DSCH)	Note 2 Note 3	REL-5

Information Element/Group name	Need	Multi	Type and reference	Semantics description	Version
DL Transport channel identity	MP		Transport channel identity 10.3.5.18		
	<i>CV-not HS-DSCH</i>				REL-5
<i>CHOICE DL parameters</i>					
>Explicit					
>>TFS	MP		Transport Format Set 10.3.5.23		
>SameAsUL					
>>Uplink transport channel type	MP		Enumerated(DCH,USCH)	USCH is TDD only	
>>UL TrCH identity	MP		Transport channel identity 10.3.5.18	Same TFS applies as specified for indicated UL TrCH	
>HS-DSCH					REL-5
>>HARQ Info	OP		HARQ info 10.3.5.7a	For 1.28 Mcps TDD, if HARQ Information is included in the IE DL MultiCarrier Information, this IE shall not be present.	REL-5
>>>CHOICE DL MAC header type	OP				REL-7
>>>>MAC-hs					REL-7
>>>>>Added or reconfigured MAC-d flow	MP		Added or reconfigured MAC-d flow 10.3.5.1a		REL-5
>>>>MAC-ehs					REL-7
>>>>>Added or reconfigured MAC-ehs reordering queue	MP		Added or reconfigured MAC-ehs reordering queue 10.3.5.1c		REL-7
DCH quality target	OP		Quality target 10.3.5.10		
Note 1: Void					
Note 2: The IE "Downlink transport channel type" value "DSCH" should not be used for FDD. If received the UE behaviour is unspecified.					
Note 3: If included in SIB type 16, the value 'HS-DSCH' does not apply for the IE "Downlink transport channel type".					

Condition	Explanation
<i>NotHS-DSCH</i>	If the downlink transport channel type is DCH or DSCH then this IE is mandatory otherwise it is not needed.

10.3.5.1a Added or reconfigured MAC-d flow

This IE is used in relation to the MAC-d flows mapped to the HS-DSCH transport channel.

Information Element/Group name	Need	Multi	Type and reference	Semantics description	Version
MAC-hs queue to add or reconfigure list	OP	<1 to maxQueue ID>			REL-5
>MAC-hs queue Id	MP		Integer(0..7)	The MAC-hs queue ID is unique across all MAC-d flows.	REL-5
>MAC-d Flow Identity	MP		MAC-d Flow Identity 10.3.5.7c		REL-5
>T1	MP		Integer(10, 20, 30, 40, 50, 60, 70, 80, 90, 100, 120, 140, 160, 200, 300, 400)	Timer (in milliseconds) when PDUs are released to the upper layers even though there are outstanding PDUs with lower TSN values.	REL-5
>MAC-hs window size	MP		Integer(4, 6, 8, 12, 16, 24, 32)		REL-5
			Integer(32, 64, 96, 128, 160, 192, 256)	The set of values is used for Multi-carrier case in 1.28 Mcps TDD mode for 9bits TSN option.	REL-7
>MAC-d PDU size Info	OP	<1 to max MACdPDU sizes>		Mapping of the different MAC-d PDU sizes configured for the HS-DSCH to the MAC-d PDU size index in the MAC-hs header.	REL-5
>>MAC-d PDU size	MP		Integer (1..5000)		REL-5
>>MAC-d PDU size index	MP		Integer(0..7)		REL-5
MAC-hs queue to delete list	OP	<1 to maxQueue ID>			REL-5
>MAC-hs queue Id	MP		Integer(0..7)	The MAC-hs queue ID is unique across all MAC-d flows.	REL-5

10.3.5.1b Added or reconfigured E-DCH MAC-d flow

This IE is used in relation to MAC-d flows mapped to the E-DCH transport channel.

Information Element/Group name	Need	Multi	Type and reference	Semantics description	Version
E-DCH MAC-d flow identity	MP		E-DCH MAC-d flow identity 10.3.5.7e		REL-6
E-DCH MAC-d flow power offset	OP		Integer(0..6)	Only allowed to be absent when already defined for this E-DCH MAC-d flow, unit is dB	REL-6
E-DCH MAC-d flow maximum number of retransmissions	OP		Integer (0..15)	Only allowed to be absent when already defined for this E-DCH MAC-d flow	REL-6
E-DCH MAC-d flow retransmission timer	<i>CV-Tdd128</i>		Enumerated (10, 15, 20, 25, 30, 35, 40, 45, 50, 55, 60, 65, 70, 75, 80, 85, 90, 95, 100, 110, 120, 140, 160, 200, 240, 280, 320, 400, 480, 560)	Unit: ms	REL-7
E-DCH MAC-d flow multiplexing list	OP		Bitstring (maxE-DCHMACdFlow)	Indicates, if this is the first MAC-d flow for which PDUs are placed in the MAC-e PDU, the other MAC-d flows from which MAC-d PDUs are allowed to be included in the same MAC-e PDU. Bit 0 is for MAC-d flow 0, Bit 1 is for MAC-d flow 1, ... Value '1' for a bit means multiplexing is allowed. Bit 0 is the first/leftmost bit of the bit string. NOTE: The bit that corresponds to the MAC-d flow itself is ignored.	REL-6
CHOICE transmission grant type	OP			Only allowed to be absent when already defined for this E-DCH MAC-d flow	REL-6
>Non-scheduled transmission grant info					REL-6
>>CHOICE mode	MP				REL-7
>>>FDD					REL-7
>>>>Max MAC-e PDU contents size	MP		Integer (1..19982)		REL-6

>>>>2ms non-scheduled transmission grant HARQ process allocation	MD		Bitstring (8)	MAC-d PDUs for this MAC-d flow are only allowed to be transmitted in those processes for which the bit is set to "1". Bit 0 corresponds to HARQ process 0, bit 1 corresponds to HARQ process 1,... Default value is: transmission in all HARQ processes is allowed. Bit 0 is the first/leftmost bit of the bit string.	REL-6
>>>TDD			NULL	No data	REL-7
>Scheduled transmission grant info			NULL		REL-6

Condition	Explanation
<i>Tdd128</i>	This IE is mandatory present for 1.28Mcps TDD, otherwise it is not needed.

10.3.5.1c Added or reconfigured MAC-ehs reordering queue

This IE is used in relation to the MAC-ehs reordering queues mapped to the HS-DSCH transport channel.

Information Element/Group name	Need	Multi	Type and reference	Semantics description	Version
MAC-ehs queue to add or reconfigure list	OP	<1 to maxQueue ID>			REL-7
>MAC-ehs queue Id	MP		MAC-ehs Queue Id 10.3.5.7f		REL-7
>T1	MP		Integer (10, 20, 30, 40, 50, 60, 70, 80, 90, 100, 120, 140, 160, 200, 300, 400)	Timer (in milliseconds) when PDUs are released to the upper layers even though there are outstanding PDUs with lower TSN values.	REL-7
>Treset	MD		Integer (1, 2, 3, 4)	Timer in multiples of T1 values (milliseconds). Used when MAC-ehs reordering queue is reset in CELL_FACH and CELL_PCH (FDD only). Default value is 2	REL-7
>MAC-ehs window size	MP		Integer (4, 6, 8, 12, 16, 24, 32)	One spare value needed.	REL-7

10.3.5.2 Added or Reconfigured UL TrCH information

Information Element/Group name	Need	Multi	Type and reference	Semantics description	Version
Uplink transport channel type	MP		Enumerated(DCH,USCH	USCH is TDD only	
			,E-DCH)	Note 1	REL-6
UL Transport channel identity	MP		Transport channel identity 10.3.5.18		
	<i>CV-NotE-DCH</i>				REL-6
<i>CHOICE UL parameters</i>					REL-6
>DCH,USCH					REL-6
>>TFS	MP		Transport Format Set 10.3.5.23		
>E-DCH					REL-6
>>CHOICE mode	MP				REL-7
>>>FDD					REL-7
>>>>E-DCH Transmission Time Interval	MP		Integer(2,10)	Unit is ms.	REL-6
>>>>TDD				No data	REL-7
>>HARQ info for E-DCH	MP		10.3.5.7d		REL-6
>>Added or reconfigured E-DCH MAC-d flow list	OP	<1 to maxE-DCHMACd Flow>			REL-6
>>>Added or reconfigured E-DCH MAC-d flow	MP		Added or reconfigured E-DCH MAC-d flow 10.3.5.1b		REL-6
Note 1: If included in System Information Block Type 16, the values 'E-DCH' does not apply for the IE "Uplink transport channel type".					

Condition	Explanation
<i>NotE-DCH</i>	If the uplink transport channel type is DCH or USCH then this IE is mandatory otherwise it is not needed.

NOTE: This information element is included within IE "Predefined RB configuration".

10.3.5.2a Additional Dynamic Transport Format Information for CCCH

Information Element/Group name	Need	Multi	Type and reference	Semantics description	Version
RLC Size	MP		Integer (48..4968)	Unit is bits For FDD, values are restricted to: Integer (48..296 by step of 8, 312..1320 by step of 16, 1384..4968 by step of 64)	Rel-6
Number of Transport blocks	MP		Integer(1)	NOTE 1	Rel-6

NOTE 1: The "Integer (1)" type does not result in bits in the transfer syntax and is not needed in the ASN.1.

10.3.5.2b Additional RACH TFCS for CCCH

Information Element/Group name	Need	Multi	Type and reference	Semantics description	Version
Power offset Information	MP		Power Offset Information 10.3.5.8	The actual TFCS is specified in 8.6.5.12a	Rel-6

10.3.5.3 Void

10.3.5.3a Common MAC-ehs reordering queue list

NOTE: For FDD only.

This IE is defines common MAC-ehs priority queue parameters, which can be used for CCCH and SRB1 reception.

Information Element/Group name	Need	Multi	Type and reference	Semantics description	Version
MAC-ehs queue to configure list	MP	<1 to maxComm onQueueId>			REL-7
>MAC-ehs queue Id	MP		MAC-ehs Queue Id 10.3.5.7f		REL-7
>T1	MP		Integer (10, 20, 30, 40, 50, 60, 70, 80, 90, 100, 120, 140, 160, 200, 300, 400)	Timer (in milliseconds) when PDUs are released to the upper layers even though there are outstanding PDUs with lower TSN values.	REL-7
>Treset	MD		Integer (1, 2, 3, 4)	Timer in multiples of T1 values (milliseconds). Used when MAC-ehs reordering queue is reset in CELL_FACH and CELL_PCH (FDD only). Default value is 2	REL-7
>MAC-ehs window size	MP		Integer (4, 6, 8, 12, 16, 24, 32)		REL-7

10.3.5.4 Deleted DL TrCH information

Information Element/Group name	Need	Multi	Type and reference	Semantics description	Version
Downlink transport channel type	MP		Enumerated (DCH,DSCH, HS-DSCH)	Note 1	REL-5
DL Transport channel identity	MP		Transport channel identity 10.3.5.18		REL-5
	<i>CV-notHS-DSCH</i>				REL-5
CHOICE DL MAC header type	<i>CV-HS-DSCH</i>				REL-7
>MAC-hs					REL-7
>>DL HS-DSCH MAC-d flow identity	MP		MAC-d flow identity 10.3.5.7c		REL-5
>MAC-ehs					REL-7
>>DL HS-DSCH MAC-ehs reordering queue	MP		MAC-ehs Queue Id 10.3.5.7f		REL-7
Note 1: The IE "Downlink transport channel type" value " DSCH " should not be used for FDD. If received the UE behaviour is unspecified.					

Condition	Explanation
<i>NotHS-DSCH</i>	If the downlink transport channel type is DCH or DSCH then this IE is mandatory otherwise it is not needed.
<i>HS-DSCH</i>	If the downlink transport channel type is HS-DSCH then this IE is mandatory otherwise it is not needed.

10.3.5.5 Deleted UL TrCH information

Information Element/Group name	Need	Multi	Type and reference	Semantics description	Version
Uplink transport channel type	MP		Enumerated(DCH,USCH, E-DCH)	USCH is TDD only	REL-6
UL Transport channel identity	MP		Transport channel identity 10.3.5.18		REL-6
	<i>CV-NotE-DCH</i>				REL-6
E-DCH MAC-d flow identity	<i>CV-E-DCH</i>		E-DCH MAC-d flow identity 10.3.5.7e		REL-6

Condition	Explanation
<i>NotE-DCH</i>	If the uplink transport channel type is DCH or USCH then this IE is mandatory otherwise it is not needed.
<i>E-DCH</i>	If the uplink transport channel type is E-DCH then this IE is mandatory otherwise it is not needed.

10.3.5.6 DL Transport channel information common for all transport channels

Information Element/Group name	Need	Multi	Type and reference	Semantics description	Version
SCCPCH TFCS	OP		Transport Format Combination Set 10.3.5.20	This IE should not be included in this version of the protocol.	
CHOICE <i>mode</i>	MP			Although this IE is not always required, need is MP to align with ASN.1	
	OP				REL-4
>FDD					
>>CHOICE <i>DL parameters</i>	OP				
>>>Explicit					
>>>>DL DCH TFCS	MP		Transport Format Combination Set 10.3.5.20	Although this IE is not always required, need is MP to align with ASN.1	
	OP				REL-4
>>>SameAsUL				(no data) See note 2	
>TDD					
>>Individual DL CCTrCH information	OP	1 to <maxCCTrCH>			
>>>DL TFCS Identity	MP		Transport format combination set identity 10.3.5.21	Identifies a special CCTrCH for shared or dedicated channels.	
>>>CHOICE <i>DL parameters</i>	MP				
>>>>Independent					
>>>>>DL TFCS	MP		Transport format combination set 10.3.5.20		
>>>>>SameAsUL				See note 2	
>>>>>>UL DCH TFCS Identity	MP		Transport format combination set identity 10.3.5.21	Same TFCS applies as specified for the indicated UL DCH TFCS identity except for information applicable for UL only	

NOTE 1: This information element is included within IE "Predefined TrCh configuration".

NOTE 2: The UTRAN should only use the choice "SameAsUL" if the transport channel numbering, the number of TFs in the TFS of each transport channel, and the TFCS are identical in the uplink and downlink.

10.3.5.7 Void

10.3.5.7a HARQ Info

This IE is used in relation to the HS-DSCH transport channel.

Information Element/Group name	Need	Multi	Type and reference	Semantics description	Version
Number of Processes	MP		Integer (1..8,	NOTE 1, NOTE 2	REL-5
			12, 14, 16)		REL-7
<i>CHOICE Memory Partitioning</i>	MP				REL-5
>Implicit				UE shall apply memory partitioning of equal size across all HARQ processes	REL-5
>Explicit					REL-5
>>Memory size	MP	<1 to MaxHProcesses>			REL-5
>>>Process Memory size	MP		Integer(800 .. 16000 by step of 800, 17600 .. 32000 by step of 1600, 36000 .. 80000 by step of 4000, 88000 .. 160000 by step of 8000, 176000 .. 304000 by step of 16000)	Maximum number of soft channel bits available in the virtual IR buffer [27]	REL-5
>>Additional memory sizes for MIMO	OP	<1 to MaxHProcesses>		NOTE 2	REL-7
>>>Process Memory size	MP		Integer (800 .. 16000 by step of 800, 17600 .. 32000 by step of 1600, 36000 .. 80000 by step of 4000, 88000 .. 160000 by step of 8000, 176000 .. 304000 by step of 16000)	Maximum number of soft channel bits available in the virtual IR buffer [27]	REL-7
NOTE 1: If the IE "Number of processes" is not set to one of the values 12, 14 or 16 and the IE "MIMO parameters" (10.3.6.41a) is included and the IE "MIMO operation" is set to either "start" or "continue", the UE behaviour is unspecified. If the IE "Number of processes" is set to one of the values 12, 14, or 16 and the IE "MIMO parameters" (10.3.6.41a) is not included, the UE behaviour is unspecified.					
NOTE 2: The values of the IE "Number of processes" greater than 8 and the IE "Additional memory sizes for MIMO" are not needed in SIB type 5 and SIB type 5bis.					

10.3.5.7b Void

10.3.5.7c MAC-d Flow Identity

Information Element/Group name	Need	Multi	Type and reference	Semantics description	Version
MAC-d flow identity	MP		Integer (0..7)		REL-5

10.3.5.7d HARQ Info for E-DCH

This IE is used in relation to the E-DCH transport channel.

Information Element/Group name	Need	Multi	Type and reference	Semantics description	Version
CHOICE <i>mode</i>	MP				REL-7
>FDD					REL-7
>>HARQ RV Configuration	MP		Enumerated (rv0, rvtable)	If "rv0" is indicated, the UE shall only use E_DCH RV index 0. If "rvtable" is indicated, the UE shall use an RSN based RV index as specified in [27]	REL-6
>TDD					REL-7
>>HARQ RV Configuration	MP		Enumerated (rv0, rvtable)	If "rv0" is indicated, the UE shall only use E_DCH RV index 0. If "rvtable" is indicated, the UE shall use an RSN based RV index as specified in [31]	REL-7

10.3.5.7e E-DCH MAC-d Flow Identity

Information Element/Group name	Need	Multi	Type and reference	Semantics description	Version
E-DCH MAC-d flow identity	MP		Integer (0..maxE-DCHMACdFlow-1)		REL-6

10.3.5.7f MAC-ehs Queue Id

Information Element/Group name	Need	Multi	Type and reference	Semantics description	Version
MAC-ehs queue id	MP		Integer (0..7)		REL-7

10.3.5.8 Power Offset Information

Information Element/Group name	Need	Multi	Type and reference	Semantics description
CHOICE <i>Gain Factors</i>	MP			
>Signalled Gain Factors				
>>CHOICE <i>mode</i>				
>>>FDD				
>>>>Gain Factor β_c	MP		Integer (0.. 15)	For UL DPCH or control part of PRACH
>>>TDD				(no data)
>>Gain Factor β_d	MP		Integer (0..15)	For UL DPCH or data part of PRACH and all uplink channels in TDD
>>Reference TFC ID	OP		Integer (0..3)	If this TFC is a reference TFC, indicates the reference ID.
>Computed Gain Factors				
>>Reference TFC ID	MP		Integer (0.. 3)	Indicates the reference TFC Id of the TFC to be used to calculate the gain factors for this TFC. In case of using computed gain factors, at least one signalled gain factor is necessary for reference.
CHOICE <i>mode</i>	MP			
>FDD				
>>Power offset P _{p-m}	OP		Integer(-5..10)	In dB. Power offset between the last transmitted preamble and the control part of the message (added to the preamble power to receive the power of the message control part) Needed only for PRACH
>TDD				(no data)

CHOICE <i>Gain Factors</i>	Condition under which the way to signal the <i>Gain Factors</i> is chosen
<i>Signalled Gain Factors</i>	The values for gain factors β_c (only in FDD mode) and β_d are signalled directly for a TFC.
<i>Computed Gain Factors</i>	The gain factors β_c (only in FDD mode) and β_d are computed for a TFC, based on the signalled settings for the associated reference TFC.

10.3.5.9 Predefined TrCH configuration

This information element concerns a pre- defined configuration of transport channel parameters.

Information Element/Group name	Need	Multi	Type and Reference	Semantics description
UL Transport channel information common for all transport channels	MP		UL Transport channel information common for all transport channels 10.3.5.24	
Added or Reconfigured TrCH information				
Added or Reconfigured UL TrCH information	MP	1 to <maxTrCH preconf>		
>Added or Reconfigured UL TrCH information	MP		Added or Reconfigured UL TrCH information 10.3.5.2	
DL Transport channel information common for all transport channels	MP		DL Transport channel information common for all transport channels 10.3.5.6	
Downlink transport channels				
Added or Reconfigured DL TrCH information	MP	1 to <maxTrCH preconf>		
>Added or Reconfigured DL TrCH information	MP		Added or Reconfigured DL TrCH information 10.3.5.1	

10.3.5.10 Quality Target

Information Element/Group name	Need	Multi	Type and reference	Semantics description
BLER Quality value	MP		Real(-6.3 ..0 by step of 0.1)	Signalled value is Log10(Transport channel BLER quality target)

10.3.5.11 Semi-static Transport Format Information

Information Element/Group name	Need	Multi	Type and reference	Semantics description	Version
Transmission time interval	MP		Integer(10, 20, 40, 80, dynamic)	In ms. The value dynamic is only used in TDD mode. For FDD DCH, the value "80" is applicable only when SF=512.	

Information Element/Group name	Need	Multi	Type and reference	Semantics description	Version
			5)	5 is only applicable for the RACH in 1.28 Mcps TDD	REL-4
Type of channel coding	MP		Enumerated(No coding, Convolutional, Turbo)	The option "No coding" is only valid for TDD.	
Coding Rate	CV-Coding		Enumerated(1/2, 1/3)		
Rate matching attribute	MP		Integer(1..hi RM)		
CRC size	MP		Integer(0, 8, 12, 16, 24)	in bits	

Condition	Explanation
<i>Coding</i>	This IE is mandatory present if IE "Type of channel coding" is "Convolutional" and not needed otherwise.

10.3.5.12 Void

10.3.5.13 TFCS Explicit Configuration

Information Element/Group name	Need	Multi	IE type and reference	Semantics description
CHOICE <i>TFCS representation</i>	MP			
>Complete reconfiguration				
>>TFCS complete reconfiguration information	MP		TFCS Reconfiguration/Addition information 10.3.5.15	
>Addition				
>>TFCS addition information	MP		TFCS Reconfiguration/Addition information 10.3.5.15	
>Removal				
>>TFCS removal information	MP		TFCS Removal Information 10.3.5.16	
>Replace				
>>TFCS removal information	MP		TFCS Removal Information 10.3.5.16	
>>TFCS addition information	MP		TFCS Reconfiguration/Addition information 10.3.5.15	

10.3.5.14 Void

10.3.5.15 TFCS Reconfiguration/Addition Information

Information Element/Group name	Need	Multi	IE type and reference	Semantics description
CHOICE CTFC Size	MP			
>2 bit CTFC				
>>CTFC information	MP	1 to <maxTFC>		
>>>2bit CTFC	MP		Integer(0..3)	
>>>Power offset Information	OP		Power Offset Information 10.3.5.8	Needed only for uplink physical channels.
>4 bit CTFC				
>>CTFC information	MP	1 to <maxTFC>		
>>>4bit CTFC	MP		Integer(0..15)	
>>>Power offset Information	OP		Power Offset Information 10.3.5.8	Needed only for uplink physical channels.
>6 bit CTFC				
>>CTFC information	MP	1 to <maxTFC>		
>>>6 bit CTFC	MP		Integer(0..63)	
>>>Power offset Information	OP		Power Offset Information 10.3.5.8	Needed only for uplink physical channels.
>8 bit CTFC				
>>CTFC information	MP	1 to <MaxTFC>		
>>>8 bit CTFC	MP		Integer(0..255)	
>>>Power offset Information	OP		Power Offset Information 10.3.5.8	Needed only for uplink physical channels.
>12 bit CTFC				
>>CTFC information	MP	1 to <maxTFC>		
>>>12 bit CTFC	MP		Integer(0..4095)	
>>>Power offset Information	OP		Power Offset Information 10.3.5.8	Needed only for uplink physical channels.
>16 bit CTFC				
>>CTFC information	MP	1 to <maxTFC>		
>>>16 bit CTFC	MP		Integer(0..65535)	
>>>Power offset Information	OP		Power Offset Information 10.3.5.8	Needed only for uplink physical channels.
>24 bit CTFC				
>>CTFC information	MP	1 to <MaxTFC>		
>>>24 bit CTFC	MP		Integer(0..16777215)	
>>>Power offset Information	OP		Power Offset Information 10.3.5.8	Needed only for uplink physical channels.

10.3.5.16 TFCS Removal Information

Information Element/Group name	Need	Multi	IE type and reference	Semantics description
Removal TFCI information	MP	1 to <maxTFC>		
>TFCI	MP		Transport Format Combination (TFC) 10.3.5.19	In TDD 0 is a reserved value

10.3.5.17 Void

10.3.5.18 Transport channel identity

This information element is used to distinguish transport channels. Transport channels of different type (RACH, USCH, FACH/PCH, DSCH or DCH) have separate series of identities. This also holds for uplink and downlink transport channel identities (i.e. for DCH). Depending on in which context a transport channel identity n that is sent, it will have different meaning

Information Element/Group name	Need	Multi	Type and reference	Semantics description
Transport channel identity	MP		Integer(1..32)	

10.3.5.19 Transport Format Combination (TFC)

Information Element/Group name	Need	Multi	Type and reference	Semantics description
Transport format combination	MP		Integer (0..1023)	

10.3.5.20 Transport Format Combination Set

Indicates the allowed combinations of already defined Transport formats and the mapping between these allowed TFCs and the corresponding TFCI values.

For TDD, different coded composite transport channels have independent transport format combination sets and thus independent TFCI values.

Information Element/Group name	Need	Multi	IE type and reference	Semantics description
TFCI Field 1 Information	MP		TFCS explicit Configuration 10.3.5.13	

10.3.5.21 Transport Format Combination Set Identity

NOTE: Only for TDD.

Information Element/Group name	Need	Multi	Type and reference	Semantics description
TFCS ID	MD		Integer	Indicates the identity of every

			(1..8)	TFCS within a UE. Default value is 1.
Shared Channel Indicator	MP		Boolean	TRUE indicates the use of shared channels. Default is false.

10.3.5.22 Transport Format Combination Subset

Indicates which Transport format combinations in the already defined Transport format combination set are allowed.

Information Element/Group name	Need	Multi	Type and reference	Semantics description
CHOICE <i>Subset representation</i>	MP			
>Minimum allowed Transport format combination index			Transport format combination 10.3.5.19	
>Allowed transport format combination list		1 to <maxTFC>		
>>Allowed transport format combination	MP		Transport format combination 10.3.5.19	
>Non-allowed transport format combination list		1 to <maxTFC>		
>>Non-allowed transport format combination	MP		Transport format combination 10.3.5.19	
>Restricted TrCH information		1 to <maxTrCH>		
>>Uplink transport channel type	MP		Enumerated(DCH, USCH)	USCH is TDD only
>>Restricted UL TrCH identity	MP		Transport channel identity 10.3.5.18	
>>Allowed TFIs	OP	1 to <maxTF>		
>>>Allowed TFI	MP		Integer(0..31)	
>Full transport format combination set				(No data)

10.3.5.23 Transport Format Set

Information Element/Group name	Need	Multi	Type and reference	Semantics description	Version
CHOICE <i>Transport channel type</i>	MP				
>Dedicated transport channels				The transport channel that is configured with this TFS is of type DCH	
>>Dynamic Transport Format Information	MP	1 to <maxTF>			
>>>RLC Size	MP		Integer(16..5000 by step of 8)	Unit is bits	
>>>Number of TBs and TTI List	MP	1 to <maxTF>		Present for every valid number of TB's (and TTI) for this RLC Size.	
>>>>Transmission Time Interval	CV-dynamicTT		Integer(10,20,40,80)	Unit is ms.	

Information Element/Group name	Need	Multi	Type and reference	Semantics description	Version
	/				
>>>>Number of Transport blocks	MP		Integer(0..512)		
>>>CHOICE <i>Logical Channel List</i>	MP			The logical channels that are allowed to use this RLC Size	
>>>>ALL			Null	All logical channels mapped to this transport channel.	
>>>>Configured			Null	The logical channels configured to use this RLC size in the <i>RB mapping info</i> . 10.3.4.21 if present in this message or in the previously stored configuration otherwise	
>>>>Explicit List		1 to 15		Lists the logical channels that are allowed to use this RLC size.	
>>>>>RB Identity	MP		RB identity 10.3.4.16		
>>>>>LogicalChannel	CH-UL-RLCLogicalChannels		Integer(0..1)	Indicates the relevant UL logical channel for this RB. "0" corresponds to the first, "1" corresponds to the second UL logical channel configured for this RB in the IE "RB mapping info".	
>>Semi-static Transport Format Information	MP		Semi-static Transport Format Information 10.3.5.11		
>Common transport channels				The transport channel that is configured with this TFS is of a type not equal to DCH	
>>Dynamic Transport Format Information	MP	1 to <maxTF>		Note	
>>>RLC Size	MP		Integer (48..4968)	Unit is bits. For FDD, values are restricted to: Integer (48..296 by step of 8, 312..1320 by step of 16, 1384..4968 by step of 64).	
>>>Number of TBs and TTI List	MP	1 to <maxTF>		Present for every valid number of TB's (and TTI) for this RLC Size.	
>>>>Number of Transport blocks	MP		Integer(0..512)		
>>>>CHOICE <i>mode</i>	MP				
>>>>>FDD				(no data)	
>>>>>TDD					
>>>>>>Transmission Time Interval	CV-dynamicTTI		Integer(10,20,40,80)	Unit is ms.	
>>>CHOICE <i>Logical Channel List</i>	MP			The logical channels that are allowed to use this RLC Size.	
>>>>ALL			Null	All logical channels mapped to this transport channel.	
>>>>Configured			Null	The logical channels configured to use this RLC size in the <i>RB mapping info</i> . 10.3.4.21 if present in this message or in the previously stored configuration otherwise	
>>>>Explicit List		1 to 15		Lists the logical channels that are allowed to use this RLC size.	

Information Element/Group name	Need	Multi	Type and reference	Semantics description	Version
>>>>>RB Identity	MP		RB identity 10.3.4.16		
>>>>>LogicalChannel	<i>CV-UL-RLCLogicalChannels</i>		Integer(0..1)	Indicates the relevant UL logical channel for this RB. "0" corresponds to the first, "1" corresponds to the second UL logical channel configured for this RB in the IE "RB mapping info".	
>>Semi-static Transport Format Information	MP		Semi-static Transport Format Information 10.3.5.11		

Condition	Explanation
<i>dynamicTTI</i>	This IE is mandatory present if dynamic TTI usage is indicated in IE Transmission Time Interval in Semi-static Transport Format Information. Otherwise it is not needed.
<i>UL-RLCLogicalChannels</i>	If "Number of uplink RLC logical channels" in IE "RB mapping info" in this message is 2 or the IE "RB mapping info" is not present in this message and 2 UL logical channels are configured for this RB, then this IE is mandatory present. Otherwise this IE is not needed.

10.3.5.24 UL Transport channel information common for all transport channels

Information Element/Group name	Need	Multi	Type and reference	Semantics description	Version
PRACH TFCS	OP		Transport format combination set 10.3.5.20	This IE should not be included in this version of the protocol.	
CHOICE <i>mode</i>	OP				
>FDD					

>>TFC subset	MD		Transport Format Combination Subset 10.3.5.22	Default value is the complete existing set of transport format combinations	
>>UL DCH TFCS	MP		Transport format combination set 10.3.5.20		
>TDD					
>>Individual UL CCTrCH information	OP	1 to <maxCCTrCH>			
>>>UL TFCS Identity	MP		Transport format combination set identity 10.3.5.21	Identifies a special CCTrCH for shared or dedicated channels.	
>>>UL TFCS	MP		Transport format combination set 10.3.5.20		
>>>TFC subset	MD		Transport Format Combination Subset 10.3.5.22	Default value is the complete existing set of transport format combinations	
TFC subset list	OP	1 to <maxTFCsub>		The maximum number of elements in the TFC subset list is 8.	REL-4
>CHOICE mode	MP				REL-4
>>FDD				(no data)	REL-4
>>TDD					REL-4
>>>TFCS Id	OP		Transport Format Combination Set Identity 10.3.5.21		REL-4
>TFC subset	MD		Transport Format Combination Subset 10.3.5.22		REL-4

NOTE: This information element is included within IE "Predefined TrCh configuration".

10.3.6 Physical CH Information elements

10.3.6.1 AC-to-ASC mapping

Information Element/Group name	Need	Multi	Type and reference	Semantics description
AC-to-ASC mapping table	MP	maxASCmap		
>AC-to-ASC mapping	MP		Integer(0...7)	Mapping of Access Classes to Access Service Classes (see subclause 8.5.13.)

10.3.6.2 AICH Info

NOTE: Only for FDD.

Information Element/Group name	Need	Multi	Type and reference	Semantics description
Channelisation code	MP		Integer(0..255)	SF is fixed and equal to 256
STTD indicator	MP		STTD Indicator 10.3.6.78	
AICH transmission timing	MP		Enumerated(0, 1)	See parameter AICH_Transmission_Timing in [26]

10.3.6.3 AICH Power offset

NOTE: Only for FDD.

This parameter is used to indicate the power level of AICH channel. This is the power per transmitted Acquisition Indicator minus power of the Primary CPICH.

Information Element/Group name	Need	Multi	Type and reference	Semantics description
AICH Power offset	MP		Integer(-22..+5)	Offset in dB

10.3.6.4 Allocation period info

NOTE: Only for TDD.

Parameters used by UE to determine period of shared channel allocation.

Information Element/Group name	Need	Multi	Type and reference	Semantics description
Allocation Activation Time	MP		Integer(0..255)	Start the allocation period at the given CFN.
Allocation Duration	MP		Integer(1..256)	Total number of frames for the allocation period.

10.3.6.5 Alpha

Information Element/Group name	Need	Multi	Type and reference	Semantics description
Alpha Value	MP		Enumerated(0, 1/8, 2/8, 3/8, 4/8, 5/8, 6/8, 7/8, 1)	

10.3.6.6 ASC setting

Information Element/Group name	Need	Multi	Type and reference	Semantics description	Version
CHOICE <i>mode</i>	MP				
>FDD					
>>Available signature Start Index	MP		Integer(0..15)		
>>Available signature End Index	MP		Integer(0..15)		
>>Assigned Sub-Channel	MP		Bit string(4)	This IE defines	

Information Element/Group name	Need	Multi	Type and reference	Semantics description	Version
Number				the subchannel assignment as specified in 8.6.6.29. The first/leftmost bit of the bit string contains the most significant bit of the Assigned Sub-Channel Number..	
>TDD					
>>CHOICE <i>TDD option</i>	MP				REL-4
>>>3.84 Mcps TDD					REL-4
>>>>Available Channelisation codes indices	MD		Bit string(8)	Each bit indicates availability of a channelisation code index, where the channelisation code indices are numbered "channelisation code index 0" to "channelisation code index 7". The value 1 of a bit indicates that the channelisation code index is available for the ASC this IE is associated to. The value 0 of a bit indicates that the channelisation code index is not available for the ASC this IE is associated to. Default is that all channelisation codes defined in PRACH Info are available.	
>>>>7.68 Mcps TDD					REL-7
>>>>>Available Channelisation codes indices	MD		Bit string(16)	Each bit indicates availability of a channelisation code index, where the channelisation code indices are numbered "channelisation code index 0" to "channelisation code index 15". The value 1 of a bit indicates that the channelisation code index is available for the ASC this IE is associated to. The value 0 of a bit indicates that the channelisation code index is not	REL-7

Information Element/Group name	Need	Multi	Type and reference	Semantics description	Version
				available for the ASC this IE is associated to. Default is that all channelisation codes defined in PRACH Info are available.	
>>>1.28 Mcps TDD					REL-4
>>>>Available SYNC_UL codes indices	MD		Bit string(8)	Each bit indicates availability of a SYNC_UL code index, where the SYNC_UL code indices are numbered "SYNC_UL code index 0" to "SYNC_UL code index 7". The value 1 of a bit indicates that the SYNC_UL code index is available for the ASC this IE is associated to. The value 0 of a bit indicates that the SYNC_UL code index is not available for the ASC this IE is associated to. Default is that all SYNC_UL codes defined in SYNC_UL Info are available.	REL-4
>>CHOICE <i>subchannel size</i>	MP				
>>>Size1					
>>>>Available Subchannels	MP		null	Indicates that all Subchannels are available	
>>>Size2					
>>>>Available Subchannels	MD		Bit string (2)	NOTE	
>>>Size4					
>>>>Available Subchannels	MD		Bit string (4)	NOTE	
>>>Size8					
>>>>Available Subchannels	MD		Bit string (8)	NOTE	
>>>Size16					
>>>>Available Subchannels	MD		Bit string (16)	NOTE	

NOTE: Each bit indicates availability of a subchannel, where the subchannels are numbered subchannel 0, subchannel 1 etc. The value 1 of a bit indicates that the subchannel is available for the ASC this IE is associated with. The value 0 of a bit indicates that the subchannel is not available for the ASC this IE is associated with. Default value of the IE is that all subchannels within the size are available for the ASC this IE is associated with.

10.3.6.7 Void

10.3.6.8 CCTrCH power control info

Parameters used by UE to set the SIR target value for uplink open loop power control in TDD.

Information Element/Group name	Need	Multi	Type and Reference	Semantics description
TFCS Identity	OP		Transport Format Combination Set Identity 10.3.5.21	TFCS Identity of this CCTrCH. Default value is 1.
Uplink DPCH power control info	MP		Uplink DPCH power control info 10.3.6.91	

10.3.6.8a Cell and Channel Identity info

NOTE: Only for TDD.

Information Element/Group name	Need	Multi	Type and Reference	Semantics description
Burst type	MP		Enumerated (Type1, Type2)	Identifies the channel in combination with the Midamble shift and slot number. It is not used in 1.28 Mcps TDD and may be set to either value. This IE should be ignored by the receiver.
Midamble Shift	MP		Integer (0...15)	
Time Slot	MP		Timeslot number 10.3.6.84	This IE is present only if no IPDL scheme is configured in the reference cell. Otherwise the slot is defined by the IPDL configuration.
Cell parameters ID	MP		Cell parameters ID 10.3.6.9	Identifies the cell

10.3.6.9 Cell parameters Id

Information Element/Group name	Need	Multi	Type and Reference	Semantics description
Cell parameter Id	MP		Integer(0..127)	

10.3.6.10 Common timeslot info

Information Element/Group name	Need	Multi	Type and reference	Semantics description
2 nd interleaving mode	MD		Enumerated(Frame, Timeslot)	Frame timeslot related interleaving. Default value is "Frame"
TFCI coding	MD		Integer(4,8,16,32)	Describes the amount of bits for the TFCI bits code word as described in [31]. Defaults is no TFCI bit: In case of 8 PSK in 1.28Mcps TDD: 4 corresponds to 6 TFCI code word bits.

Information Element/Group name	Need	Multi	Type and reference	Semantics description
				8 corresponds to 12 TFCI code word bits. 16 corresponds to 24 TFCI code word bits. 32 corresponds to 48 TFCI code word bits.
Puncturing limit	MP		Real(0.40..1.0 by step of 0.04)	
Repetition period	MD		Integer(1, 2,4,8,16,32,64)	Default is continuous allocation. Value 1 indicate continuous
Repetition length	MP		Integer(1..Repetition period -1)	NOTE: This is empty if repetition period is set to 1.

10.3.6.10a Common timeslot info MBMS

Information Element/Group name	Need	Multi	Type and reference	Semantics description
2 nd interleaving mode	MD		Enumerated(Frame, Timeslot)	Frame timeslot related interleaving. Default value is "Frame"
TFCI coding	MD		Integer(4,8,16,32)	Describes the amount of bits for the TFCI bits code word as described in [31]. Defaults is no TFCI bit: In case of 8 PSK in 1.28Mcps TDD: 4 corresponds to 6 TFCI code word bits. 8 corresponds to 12 TFCI code word bits. 16 corresponds to 24 TFCI code word bits. 32 corresponds to 48 TFCI code word bits.
Puncturing limit	MP		Real(0.40..1.0 by step of 0.04)	

10.3.6.11 Constant value

NOTE: Only for FDD.

This constant value is used by the UE to calculate the initial output power on PRACH according to the Open loop power control procedure.

Information Element/Group name	Need	Multi	Type and reference	Semantics description
Constant value	MP		Integer (-35..-10)	In dB

10.3.6.11a Constant value TDD

NOTE: Only for 3.84 Mcps TDD and 7.68 Mcps TDD.

3.84 Mcps TDD and 7.68 Mcps TDD constant values are used for open loop power control of PRACH, USCH, HS-SICH and UL DPCH as defined in subclause 8.5.7.

Information Element/Group name	Need	Multi	Type and reference	Semantics description
TDD Constant value	MP		Integer (-35..+10)	In dB

10.3.6.12 Void

10.3.6.13 Void

10.3.6.14 Void

10.3.6.15 Void

10.3.6.16 Default DPCH Offset Value

Indicates the default offset value within interleaving size at a resolution of 512chip (1/5 slot) in FDD and a resolution of one frame in TDD to offset CFN in the UE. This is used to distribute discontinuous transmission periods in time and also to distribute NodeB-RNC transmission traffics in time. Even though the CFN is offset by DOFF, the start timing of the interleaving will be the timing that "CFN mod (interleaving size)"=0 (e.g. interleaving size: 2,4,8) in both UE and SRNC.

Information Element/Group name	Need	Multi	Type and reference	Semantics description
CHOICE <i>mode</i>				
>FDD				
>>Default DPCH Offset Value (DOFF)	MP		Integer (0..306688 by step of 512)	Number of chips=. 0 to 599 time 512 chips, see [10].
>TDD				
>>Default DPCH Offset Value (DOFF)	MP		Integer(0..7)	Number of frames; See [10]

10.3.6.17 Downlink channelisation codes

NOTE: Only for 1.28 Mcps TDD and 3.84 Mcps TDD.

Information Element/Group name	Need	Multi	Type and reference	Semantics description
CHOICE <i>codes representation</i>	MP			
>Consecutive codes				
>>First channelisation code	MP		Enumerated ((16/1)...(16/1 6))	If a TFCI exists in this timeslot, it is mapped to the channelisation code as defined in [30].
>>>Last channelisation code	MP		Enumerated ((16/1)...(16/1 6))	If this is the same as First channelisation code, only one code is used by the physical layer.
>Bitmap				
>>Channelisation codes bitmap	MP		Bit string(16)	Each bit indicates the availability of a channelisation code for SF16, where the channelisation codes are numbered as channelisation code 1 (SF16) to channelisation code 16 (SF16). (For SF 16, a 1 in the bitmap means that the corresponding code is used, a 0 means that the corresponding code is not used.) If all bits are set to zero, SF 1 shall be used. For dedicated MBSFN frequency timeslot, if the first half in the bit pattern is set to 1010101000000000, the first channelisation code with SF 2 shall be used; if the second half of bit pattern is set to 0000000010101010, the second channelisation code with SF 2 shall be used; if all bits are set to 1010101010101010, both the first and second channelisation codes with SF2 shall be used.

10.3.6.17a Downlink channelisation codes VHCR

NOTE: Only for 7.68 Mcps TDD VHCR

Information Element/Group name	Need	Multi	Type and reference	Semantics description	Version
CHOICE <i>codes representation</i>	MP				REL-7
>Consecutive codes					REL-7
>>First channelisation code	MP		Enumerated ((32/1)...(32/3 2))	If a TFCI exists in this timeslot, it is mapped to the channelisation code as defined in [30].	REL-7
>>>Last channelisation code	MP		Enumerated ((32/1)...(32/3 2))	If this is the same as First channelisation code, only one code is used by the physical layer.	REL-7
>Bitmap					REL-7
>>Channelisation codes bitmap	MP		Bit string(32)	Each bit indicates the availability of a channelisation code for SF32, where the channelisation codes are numbered as channelisation code 1 (SF32) to channelisation code 32 (SF32). (For SF 32, a 1 in the bitmap means that the corresponding code is used, a 0 means that the corresponding code is not used.) If all bits are set to zero, SF 1 shall be used.	REL-7

10.3.6.18 Downlink DPCH info common for all RL

Information Element/Group name	Need	Multi	Type and reference	Semantics description	Version
Timing Indication	MP		Enumerated(Initialise, Maintain)	NOTE	
Timing maintained Synchronization indicator	CV- <i>Synch</i>		Enumerated (false)	FALSE indicates that no synchronisation procedure shall be performed for timing maintained inter-frequency hard handover [29]. Absence of this element means that the synchronization procedure A shall be used.	REL-6
Downlink DPCH power control information	OP		Downlink DPCH power control information 10.3.6.23		
MAC-d HFN initial value	CV- <i>Message</i>		Bit string(24)		REL-4
CHOICE <i>mode</i>	MP				
>FDD					
>>Power offset $P_{\text{Pilot-DPCH}}$	MP		Integer(0..24)	Power offset equals $P_{\text{Pilot}} - P_{\text{DPCH}}$, range 0..6 dB, in steps of 0.25 dB	
>>>Downlink rate matching restriction information	OP		Downlink rate matching restriction information	If this IE is set to "absent", no Transport CH is restricted in TFI.	

Information Element/Group name	Need	Multi	Type and reference	Semantics description	Version
			n 10.3.6.31		
>>Spreading factor	MP		Integer(4, 8, 16, 32, 64, 128, 256, 512)		
>>Fixed or Flexible Position	MP		Enumerated (Fixed, Flexible)		
>>TFCI existence	MP		Boolean	TRUE indicates that TFCI is used. When spreading factor is less than or equal to 64, FALSE indicates that TFCI is not used and therefore DTX is used in the TFCI field.	
>>>CHOICE SF	MP				
>>>>SF = 256					
>>>>Number of bits for Pilot bits	MP		Integer (2,4,8)	In bits	
>>>>SF = 128					
>>>>Number of bits for Pilot bits	MP		Integer(4, 8)	In bits	
>>>>Otherwise				(no data). In ASN.1 choice "Otherwise" is not explicitly available as all values are available, it is implied by the use of any value other than 128 or 256.	
>TDD				(no data)	

CHOICE SF	Condition under which the given SF is chosen
SF=128	"Spreading factor" is set to 128
SF=256	"Spreading factor" is set to 256
Otherwise	"Spreading factor" is set to a value distinct from 128 and 256

Condition	Explanation
<i>Message</i>	This IE is not needed if the IE "Downlink DPCH info common for all RL" is included in RRC CONNECTION SETUP or HANDOVER TO UTRAN COMMAND messages. Otherwise it is optional.
<i>Synch</i>	The IE is not needed in the CELL UPDATE CONFIRM, HANDOVER TO UTRAN COMMAND and the RRC CONNECTION SETUP messages or if the IE "Timing Indication" is set to "Initialise" or if the IE "Frequency Info" is not included. Otherwise, it is optional.

NOTE: Within the HANDOVER TO UTRAN COMMAND message, only value "initialise" is applicable.

10.3.6.19 Downlink DPCH info common for all RL Post

Information Element/Group name	Need	Multi	Type and reference	Semantics description
Downlink DPCH power control information	OP		Downlink DPCH power control information 10.3.6.23	

10.3.6.20 Downlink DPCH info common for all RL Pre

Information Element/Group name	Need	Multi	Type and reference	Semantics description
CHOICE <i>mode</i>	MP			
>FDD				
>>Spreading factor	MP		Integer(4, 8, 16, 32, 64, 128, 256, 512)	Defined in CHOICE SF512-Andpilot with "number of its for pilot bits" in ASN.1
>>Fixed or Flexible Position	MP		Enumerated (Fixed, Flexible)	
>>TFCI existence	MP		Boolean	TRUE indicates that TFCI is used. When spreading factor is less than or equal to 64, FALSE indicates that TFCI is not used and therefore DTX is used in the TFCI field.
>>CHOICE <i>SF</i>	MP			
>>>SF = 256				
>>>>Number of bits for Pilot bits	MP		Integer (2,4,8)	In bits
>>>SF = 128				
>>>>Number of bits for Pilot bits	MP		Integer(4,8)	In bits
>>>Otherwise				(no data)
>TDD				
>>Common timeslot info	MP		Common Timeslot Info 10.3.6.10	

CHOICE <i>SF</i>	Condition under which the given <i>SF</i> is chosen
SF=128	"Spreading factor" is set to 128
SF=256	"Spreading factor" is set to 256
Otherwise	"Spreading factor" is set to a value distinct from 128 and 256

10.3.6.21 Downlink DPCH info for each RL

Information Element/Group name	Need	Multi	Type and reference	Semantics description	Version
CHOICE <i>mode</i>	MP				
>FDD					
>>Primary CPICH usage for channel estimation	MP		Primary CPICH usage for channel estimation 10.3.6.62		
>>DPCH frame offset	MP		Integer(0..38144 by	Offset (in number of chips) between the	

Information Element/Group name	Need	Multi	Type and reference	Semantics description	Version
			step of 256)	beginning of the P-CCPCH frame and the beginning of the DPCH frame This is called $\tau_{DPCH,n}$ in [26]	
>>Secondary CPICH info	OP		Secondary CPICH info 10.3.6.73		
>>DL channelisation code	MP	1 to <maxDPCH-DLchan >		For the purpose of physical channel mapping [27] the DPCHs are numbered, starting from DPCH number 1, according to the order that they are contained in this IE.	
>>>Secondary scrambling code	MD		Secondary scrambling code 10.3.6.74	Default is the same scrambling code as for the Primary CPICH	
>>>Spreading factor	MP		Integer(4, 8, 16, 32, 64, 128, 256, 512)	Defined in CHOICE SF512-AndCodenumbr with "code number" in ASN.1	
>>>Code number	MP		Integer(0.. Spreading factor - 1)		
>>>Scrambling code change	CH-SF/2		Enumerated (code change, no code change)	Indicates whether the alternative scrambling code is used for compressed mode method 'SF/2'.	
>>TPC combination index	MP		TPC combination index 10.3.6.85		
>>Power offset $P_{TPC-DPDC}$	OP		Integer (0..24)	Power offset equals $P_{TPC} - P_{DPDC}$, range 0..6 dB, in steps of 0.25 dB	REL-5
>>Closed loop timing adjustment mode	CH-TxDiversity Mode		Integer(1, 2)	It is present if Tx Diversity is used in the radio link.	
>1.28 Mcps TDD or 3.84 Mcps TDD					
>>DL CCTrCh List	OP	1..<max CCTrCH >		DL physical channels to establish or reconfigure list.	
>>>TFCS ID	MD		Integer(1.. 8)	Identity of this CCTrCh. Default value is 1	
>>>Time info	MP		Time Info 10.3.6.83		
>>>Common timeslot info	MD		Common Timeslot Info 10.3.6.10	Default is the current Common timeslot info	
>>>Downlink DPCH timeslots and codes	MD		Downlink Timeslots and Codes 10.3.6.32	Default is to use the old timeslots and codes.	
>>>UL CCTrCH TPC List	MD	0..<max CCTrCH		UL CCTrCH identities for TPC commands	

Information Element/Group name	Need	Multi	Type and reference	Semantics description	Version
		>		associated with this DL CcTrCH. Default is previous list or all defined UL CcTrCHs. This list is not required for 1.28 Mcps TDD and is to be ignored by the UE.	
>>>>UL TPC TFCS Identity	MP		Transport Format Combination Set Identity 10.3.5.21		
>>DL CcTrCH List to Remove	OP	1..<max CcTrCH >		DL physical channels to remove list.	
>>>TFCS ID	MP		Integer(1..8)		
>7.68 Mcps TDD					REL-7
>>DL CcTrCh List	OP	1..<max CcTrCH >		DL physical channels to establish or reconfigure list.	REL-7
>>>TFCS ID	MD		Integer(1..8)	Identity of this CcTrCh. Default value is 1	REL-7
>>>Time info	MP		Time Info 10.3.6.83		REL-7
>>>Common timeslot info	MD		Common Timeslot Info 10.3.6.10	Default is the current Common timeslot info	REL-7
>>>Downlink DPCH timeslots and codes VHCR	MD		Downlink Timeslots and Codes VHCR 10.3.6.32 a	Default is to use the old timeslots and codes.	REL-7
>>>>UL CcTrCH TPC List	MD	0..<max CcTrCH >		UL CcTrCH identities for TPC commands associated with this DL CcTrCH. Default is previous list or all defined UL CcTrCHs. This list is not required for 1.28 Mcps TDD and is to be ignored by the UE.	REL-7
>>>>UL TPC TFCS Identity	MP		Transport Format Combination Set Identity 10.3.5.21		REL-7
>>DL CcTrCH List to Remove	OP	1..<max CcTrCH >		DL physical channels to remove list.	REL-7
>>>TFCS ID	MP		Integer(1..8)		REL-7

Condition	Explanation
<i>SF/2</i>	The information element is mandatory present if the UE has a compressed mode pattern sequence configured in variable TGPS_IDENTITY or included in the message including IE "Downlink DPCH info for each RL", which is using compressed mode method "SF/2". Otherwise the IE is not needed.
<i>TxDiversity Mode</i>	This IE is mandatory present if any TX Diversity Mode is used on the radio link, i.e. if STTD or "closed loop mode 1" is used on the radio link. Otherwise the IE is not needed.

10.3.6.22 Downlink DPCH info for each RL Post

Information Element/Group name	Need	Multi	Type and reference	Semantics description
CHOICE <i>mode</i>	MP			
>FDD				
>>Primary CPICH usage for channel estimation	MP		Primary CPICH usage for channel estimation 10.3.6.62	
>>Secondary scrambling code	MD		Secondary scrambling code 10.3.6.74	Default is the same scrambling code as for the Primary CPICH
>>CHOICE <i>Spreading factor</i>	MP		Integer(4, 8, 16, 32, 64, 128, 256, 512)	Defined in CHOICE SF512-AndCodenumbr with "code number" in ASN.1
>>Code number	MP		Integer(0.. Spreading factor - 1)	
>>Scrambling code change	CH-SF/2		Enumerated (code change, no code change)	Indicates whether the alternative scrambling code is used for compressed mode method 'SF/2'.
>>TPC combination index	MP		TPC combination index 10.3.6.85	
>1.28 Mcps TDD or 3.84 Mcps TDD				
>>Downlink DPCH timeslots and codes	MP		Downlink Timeslots and Codes 10.3.6.32	
>7.68 Mcps TDD				REL-7
>>Downlink DPCH timeslots and codes VHCR	MP		Downlink Timeslots and Codes VHCR 10.3.6.32a	REL-7

Condition	Explanation
<i>SF/2</i>	The information element is mandatory present if the UE has a compressed mode pattern sequence configured in variable TGPS_IDENTITY or included in the message including IE "Downlink DPCH info for each RL Post", which is using compressed mode method "SF/2". Otherwise the IE is not needed.

10.3.6.23 Downlink DPCH power control information

Information Element/Group name	Need	Multi	Type and reference	Semantics description
CHOICE <i>mode</i>	MP			
>FDD				
>>DPC Mode	MP		Enumerated (Single TPC, TPC triplet in soft)	"Single TPC" is DPC_Mode=0 and "TPC triplet in soft" is DPC_mode=1 in [29].
>TDD				
>>TPC Step Size	OP		Integer (1, 2, 3)	In dB

10.3.6.23oa Downlink F-DPCH info common for all RL

NOTE: For FDD only.

Information Element/Group name	Need	Multi	Type and reference	Semantics description	Version
Timing Indication	MP		Enumerated (Initialise, Maintain)		REL-6
Timing maintained Synchronization indicator	CV- <i>Synch</i>		Enumerated (false)	FALSE indicates that no synchronisation procedure shall be performed for timing maintained intra- and inter-frequency hard handover [29]. Absence of this element means that the synchronization procedure A shall be used.	REL-6
Downlink F-DPCH power control information	OP		Downlink DPCH power control information 10.3.6.23		REL-6
TPC command error rate target	MP		Real (0.01..0.1 by step of 0.01)		REL-6

Condition	Explanation
<i>Synch</i>	The IE is not needed in the CELL UPDATE CONFIRM, HANDOVER TO UTRAN COMMAND and the RRC CONNECTION SETUP messages or if the IE "Timing Indication" is set to "Initialise". Otherwise, it is optional.

10.3.6.23ob Downlink F-DPCH info for each RL

NOTE: For FDD only.

Information Element/Group name	Need	Multi	Type and reference	Semantics description	Version
Primary CPICH usage for channel estimation	MP		Primary CPICH usage for channel estimation 10.3.6.62		REL-6
F-DPCH frame	MP		Integer (0..38144	Offset (in	REL-6

Information Element/Group name	Need	Multi	Type and reference	Semantics description	Version
offset			by step of 256)	number of chips) between the beginning of the P-CCPCH frame and the beginning of the F-DPCH frame This is called $\tau_{F-DPCH,n}$ in [26]	
F-DPCH slot format	OP		Integer (0..9 by steps of 1)	Slot format used by F-DPCH in [26]. Absence of this element means that slot format 0 is applied.	REL-7
Secondary CPICH info	OP		Secondary CPICH info 10.3.6.73		REL-6
Secondary scrambling code	MD		Secondary scrambling code 10.3.6.74	Default is the same scrambling code as for the Primary CPICH	REL-6
Code number	MP		Integer (0..255)		REL-6
TPC combination index	MP		TPC combination index 10.3.6.85		REL-6
STTD indication	CV- <i>NoHOtoUTRAN</i>		Enumerated (true)	This IE shall be set to TRUE when STTD is used. Absence of this element means STTD is not used.	REL-6

Condition	Explanation
<i>NoHOtoUTRAN</i>	This IE is not needed in the HANDOVER TO UTRAN COMMAND and it is optional in all the other messages in which the IE "Downlink F-DPCH info for each RL" can be included.

10.3.6.23a Downlink HS-PDSCH Information

Information Element/Group name	Need	Multi	Type and reference	Semantics description	Version
HS-SCCH Info	OP		HS-SCCH Info 10.3.6.36a	For 1.28 Mcps TDD, if IE DL Multi-Carrier Information is present, ignore this IE.	REL-5
Measurement Feedback Info	OP		Measurement Feedback Info 10.3.6.40a		REL-5
CHOICE mode	MP				REL-5
>TDD					
>>CHOICE <i>TDD option</i>	MP				REL-5
>>>3.84 Mcps					
>>>>HS-PDSCH Timeslot Configuration	OP		HS-PDSCH Timeslot Configuration 10.3.6.36o		REL-5
>>>>7.68 Mcps					REL-7
>>>>HS-PDSCH Timeslot Configuration VHCR	OP		HS-PDSCH Timeslot Configuration VHCR 10.3.6.36oa		REL-7
>>>>1.28 Mcps					
>>>>>HS-PDSCH Midamble Configuration	OP		HS-PDSCH Midamble Configuration 10.3.6.36oo	For 1.28 Mcps TDD, if IE DL Multi-Carrier Information is present, ignore this IE.	REL-5
>>>>>DL Multi-Carrier Information	OP		DL Multi-Carrier Information 10.3.6.28a		REL-7
>FDD					
>>Downlink 64QAM configured	OP		Enumerated (TRUE)	Absence of this IE means that the HS-SCCH does not use the 64QAM format. The presence of this IE means the UE uses the octet aligned table [15].	REL-7
>>HS-DSCH TB size table	CV- <i>Not64QAM</i>		Enumerated (octet aligned)	If this IE is present, octet aligned table [15] is used, else bit aligned table [15] is used. Note 1	REL-7
Note 1: UE shall apply this rule only if the IE "Downlink HS-PDSCH information" is present in the received message. UE behaviour is unspecified if the IE "Downlink HS-PDSCH information" is absent when the ASN.1 non-critical extension where the IE "HS-DSCH TB size table" is referenced is present in the received message.					

Condition	Explanation
<i>Not64QAM</i>	This IE is optionally present if 64QAM is not configured and MAC-ehs is configured. Otherwise it is not needed.

10.3.6.24 Downlink information common for all radio links

Information Element/Group name	Need	Multi	Type and reference	Semantics description	Version
CHOICE <i>DPCH info</i>	OP				REL-6
>Downlink DPCH info common for all RL	MP		Downlink DPCH info common for all RL 10.3.6.18		
>Downlink F-DPCH info common for all RL	MP		Downlink F-DPCH info common for all RL 10.3.6.23oa		REL-6
CHOICE <i>mode</i>	MP				
>FDD					
>>DPCH compressed mode info	OP		DPCH compressed mode info 10.3.6.33		
>>>TX Diversity Mode	MD		TX Diversity Mode 10.3.6.86	Default value is the existing value of TX Diversity mode	
>TDD				(no data)	
>>CHOICE <i>TDD option</i>	MP				REL-4
>>>3.84 Mcps TDD				(no data)	REL-4
>>>7.68 Mcps TDD				(no data)	REL-7
>>>1.28 Mcps TDD					REL-4
>>>>TSTD indicator	MP		TSTD indicator 10.3.6.85a		REL-4
Default DPCH Offset Value	OP		Default DPCH Offset Value, 10.3.6.16		
MAC-hs reset indicator	CV- <i>messageType</i>		Enumerated (true)	TRUE Indicates the MAC-hs/ehs entity needs to be reset.	REL-5
Post-verification period	OP		Enumerated (true)	TRUE indicates that a post-verification period shall be used [29]. Absence of this element means that a post-verification period shall not be used.	REL-6

Condition	Explanation
<i>MessageType</i>	The IE is not needed in the HANDOVER TO UTRAN COMMAND and the RRC CONNECTION SETUP messages. Otherwise, it is optional.

10.3.6.25 Downlink information common for all radio links Post

Information Element/Group name	Need	Multi	Type and reference	Semantics description
Downlink DPCH info common for all RL	MP		Downlink DPCH info common for all RL Post 10.3.6.19	

10.3.6.26 Downlink information common for all radio links Pre

Information Element/Group name	Need	Multi	Type and reference	Semantics description
Downlink DPCH info common for all RL	MP		Downlink DPCH info common for all RL Pre 10.3.6.20	

10.3.6.27 Downlink information for each radio link

Information Element/Group name	Need	Multi	Type and reference	Semantics description	Version
CHOICE <i>mode</i>	MP				
>FDD					
>>Primary CPICH info	MP		Primary CPICH info 10.3.6.60		
>>>Cell ID	OP		Cell ID 10.3.2.2		REL-4
>>>Serving HS-DSCH radio link indicator	MP		Boolean	The value TRUE indicates that this radio link is the serving HS-DSCH radio link	REL-5
>>>Serving E-DCH radio link indicator	MP		Boolean	The value TRUE indicates that this radio link is the serving E-DCH radio link	REL-6
>TDD					
>>Primary CCPCH info	MP		Primary CCPCH info 10.3.6.57		
CHOICE <i>DPCH info</i>	OP				REL-6
>Downlink DPCH info for each RL	MP		Downlink DPCH info for each RL 10.3.6.21		
>Downlink F-DPCH info for each RL	MP		Downlink F-DPCH info for each RL 10.3.6.23ob		REL-6
E-AGCH Info	OP		E-AGCH Info 10.3.6.100		REL-6
CHOICE <i>mode</i>					REL-7
>FDD					REL-7
>>CHOICE <i>E-HICH Information</i>	OP				REL-6
>>>E-HICH Information	MP		E-HICH Info 10.3.6.101		REL-6
>>>E-HICH release indicator				(no data)	REL-6
>>CHOICE <i>E-RGCH Information</i>	OP				REL-6
>>>E-RGCH Information	MP		E-RGCH Info 10.3.6.102		REL-6
>>>E-RGCH release indicator				(no data)	REL-6
>TDD				(no data)	REL-7
>>E-HICH Information	OP		E-HICH Info 10.3.6.101		REL-7

10.3.6.28 Downlink information for each radio link Post

Information Element/Group name	Need	Multi	Type and reference	Semantics description	Version
Choice mode	MP				
>FDD					
>>Primary CPICH info	MP		Primary CPICH info 10.3.6.60		
>TDD					
>>Primary CCPCH info	MP		Primary CCPCH info post		

Information Element/Group name	Need	Multi	Type and reference	Semantics description	Version
Downlink DPCH info for each RL	MP		10.3.6.58 Downlink DPCH info for each RL Post 10.3.6.22		

10.3.6.28a DL Multi-Carrier Information (1.28 Mcps TDD only)

Information Element/Group name	Need	Multi	Type and reference	Semantics description	Version
TSN-Length	OP		Enumerated (tsn-6bits, tsn-9bits)		REL-7
Multi-Carrier number	OP		Integer(1..maxTDD128Carrier)		REL-7
DI-HSPDSCH-MultiCarrier-Information	OP	1 to <maxTDD128Carrier>		The number of HS-SCCH Sets shall not be larger than UE Multi-Carrier capability	REL-7
>Carrier-Uarfcn	MP		Integer(0..16383)		REL-7
>HARQ Info	OP		HARQ info 10.3.5.7a		REL-7
>HS-PDSCH Midamble Configuration	OP		HS-PDSCH Midamble Configuration 10.3.6.36oo		REL-7
>HS-SCCH Set Configuration	OP	1 to <maxHS-SCCHs>			REL-7
>>HS-SCCH-Receive-Uarfcn	MP		Integer(0..16383)		REL-7
>>Timeslot number	MP		Integer (0..6)		REL-7
>>First Channelisation code	MP		Enumerated ((16/1)..(16/16))		REL-7
>>Second Channelisation code	MP		Enumerated ((16/1)..(16/16))		REL-7
>>Midamble Allocation mode	MP		Enumerated (Default midamble, Common midamble, UE specific midamble)		REL-7
>>Midamble Shift	CV-UE		Integer (0..15)		REL-7
>>Midamble configuration	MP		Integer (2, 4, 6, 8, 10, 12, 14, 16)		REL-7
>>BLER target	MP		Real (-3.15..0 by step of 0.05)	Signalled value is Log10(HS-SCCH BLER quality target). The UE shall use the BLER target signalled in the first occurrence of the HS-SCCH Set Configuration.	REL-7
>>HS-SICH configuration					REL-7
>>>Timeslot number	MP		Integer (0..6)		REL-7
>>>Channelisation code	MP		Enumerated ((16/1)..(16/16))		REL-7
>>>Midamble Allocation mode	MP		Enumerated		REL-7

			(Default midamble, UE specific midamble)		
>>>Midamble configuration	MP		Integer (2, 4, 6, 8, 10, 12, 14, 16)		REL-7
>>>Midamble Shift	CV-UE		Integer (0..15)		REL-7
>>>Ack-Nack Power Offset	MP		Integer (-7..8 by step of 1)	dB.	REL-7
>>>PRX _{HS-SICH}	MP		Integer (-120..-58 by step of 1)	dBm. Desired power level for HS-SICH.	REL-7
>>>TPC step size	MP		Integer (1, 2, 3)	dB.	REL-7

Condition	Explanation
UE	This IE is mandatory present when the value of the IE "Midamble Allocation Mode" is "UE specific midamble" and not needed otherwise.

10.3.6.29 Void

10.3.6.30 Void

10.3.6.31 Downlink rate matching restriction information

This IE indicates which TrCH is restricted in TFI.

Information Element/Group name	Need	Multi	Type and reference	Semantics description
Restricted TrCH information	OP	1 to <maxTrCH>		
>Downlink transport channel type	MP		Enumerated(DCH)	
>Restricted DL TrCH identity	MP		Transport channel identity 10.3.5.18	
>Allowed TFIs	MP	1 to <maxTF>		
>>Allowed TFI	MP		Integer(0..31)	

10.3.6.32 Downlink Timeslots and Codes

NOTE: Only for 1.28 Mcps TDD and 3.84 Mcps TDD.

Information Element/Group name	Need	Multi	Type and reference	Semantics description
First Individual timeslot info	MP		Individual timeslot info 10.3.6.37	Individual timeslot info for the first timeslot used by the physical layer.

Information Element/Group name	Need	Multi	Type and reference	Semantics description
First timeslot channelisation codes	MP		Downlink channelisation codes 10.3.6.17	These codes shall be used by the physical layer in the timeslot given in First Individual timeslot info.
CHOICE <i>more timeslots</i>	MP			
>No more timeslots				(no data)
>Consecutive timeslots				
>>Number of additional timeslots	MP		Integer(1..maxTS-1)	The timeslots used by the physical layer shall be timeslots: N mod maxTS (N+1) mod maxTS ... (N+k) mod maxTS in that order, where N is the timeslot number in the First individual timeslot info and k the Number of additional timeslots. The additional timeslots shall use the same parameters (e.g. channelisation codes, midamble shifts etc.) as the first timeslot.
>Timeslot list				
>>Additional timeslot list	MP	1 to <maxTS-1>		The first instance of this parameter corresponds to the timeslot that shall be used second by the physical layer, the second to the timeslot that shall be used third and so on.
>>>CHOICE <i>parameters</i>	MP			
>>>>Same as last				
>>>>>Timeslot number	MP		Timeslot Number 10.3.6.84	The physical layer shall use the same parameters (e.g. channelisation codes, midamble shifts etc.) for this timeslot as for the last one.
>>>>>New parameters				
>>>>>Individual timeslot info	MP		Individual timeslot info 10.3.6.37	
>>>>>Channelisation codes	MP		Downlink channelisation codes 10.3.6.17	

10.3.6.32a Downlink Timeslots and Codes VHCR

NOTE: Only for 7.68 Mcps TDD.

Information Element/Group name	Need	Multi	Type and reference	Semantics description	Version
First Individual timeslot info	MP		Individual timeslot info 10.3.6.37	Individual timeslot info for the first timeslot used by the physical layer.	REL-7
First timeslot channelisation codes VHCR	MP		Downlink channelisation codes VHCR 10.3.6.17a	These codes shall be used by the physical layer in the timeslot given in First Individual timeslot info.	REL-7
CHOICE <i>more timeslots</i>	MP				REL-7
>No more timeslots				(no data)	REL-7
>Consecutive timeslots					REL-7

Information Element/Group name	Need	Multi	Type and reference	Semantics description	Version
>>Number of additional timeslots	MP		Integer(1..maxTS-1)	The timeslots used by the physical layer shall be timeslots: N mod maxTS (N+1) mod maxTS ... (N+k) mod maxTS in that order, where N is the timeslot number in the First individual timeslot info and k the Number of additional timeslots. The additional timeslots shall use the same parameters (e.g. channelisation codes, midamble shifts etc.) as the first timeslot.	REL-7
>Timeslot list					REL-7
>>Additional timeslot list	MP	1 to <maxTS-1>		The first instance of this parameter corresponds to the timeslot that shall be used second by the physical layer, the second to the timeslot that shall be used third and so on.	REL-7
>>>CHOICE <i>parameters</i>	MP				REL-7
>>>>Same as last					REL-7
>>>>>Timeslot number	MP		Timeslot Number 10.3.6.84	The physical layer shall use the same parameters (e.g. channelisation codes, midamble shifts etc.) for this timeslot as for the last one.	REL-7
>>>>>New parameters					REL-7
>>>>>Individual timeslot info	MP		Individual timeslot info 10.3.6.37		REL-7
>>>>>Channelisation codes VHCR	MP		Downlink channelisation codes VHCR 10.3.6.17a		REL-7

10.3.6.33 DPCH compressed mode info

NOTE: Only for FDD.

This information element indicates the parameters of the compressed mode to be used by the UE in order to perform inter-frequency and inter-RAT measurements.

Information Element/Group name	Need	Multi	Type and reference	Semantics description
Transmission gap pattern sequence	MP	1 to <maxTGP S>		
>TGPSI	MP		TGPSI 10.3.6.82	
>TGPS Status Flag	MP		Enumerated(activate, deactivate)	This flag indicates whether the Transmission Gap Pattern Sequence shall be activated or deactivated.
>TGCFN	CV-Active		Integer (0..255)	Connection Frame Number of the first frame of the first pattern within the Transmission Gap Pattern Sequence.
>Transmission gap pattern sequence configuration	OP			

Information Element/Group name	Need	Multi	Type and reference	Semantics description
parameters				
>>TGMP	MP		Enumerated(TDD measurement, FDD measurement, GSM carrier RSSI measurement, GSM Initial BSIC identification, GSM BSIC re-confirmation, Multi-carrier measurement)	Transmission Gap pattern sequence Measurement Purpose.
>>TGPRC	MP		Integer (1..511, Infinity)	The number of transmission gap patterns within the Transmission Gap Pattern Sequence.
>>TGSN	MP		Integer (0..14)	Transmission Gap Starting Slot Number The slot number of the first transmission gap slot within the TGCFN.
>>TGL1	MP		Integer(1..14)	The length of the first Transmission Gap within the transmission gap pattern expressed in number of slots
>>TGL2	MD		Integer (1..14)	The length of the second Transmission Gap within the transmission gap pattern. If omitted, then TGL2=TGL1. The value of TGL2 shall be ignored if TGD is set to "undefined"
>>TGD	MP		Integer(15..269, undefined)	Transmission gap distance indicates the number of slots between starting slots of two consecutive transmission gaps within a transmission gap pattern. If there is only one transmission gap in the transmission gap pattern, this parameter shall be set to undefined.
>>TGPL1	MP		Integer (1..144)	The duration of transmission gap pattern 1.
>>RPP	MP		Enumerated (mode 0, mode 1).	Recovery Period Power control mode during the frame after the transmission gap within the compressed frame. Indicates whether normal PC mode or compressed PC mode is applied
>>ITP	MP		Enumerated (mode 0, mode 1).	Initial Transmit Power is the uplink power control method to be used to compute the initial transmit power after the compressed mode gap.
>>CHOICE <i>UL/DL mode</i>	MP			
>>>DL only				Compressed mode used in DL only

Information Element/Group name	Need	Multi	Type and reference	Semantics description
>>>>Downlink compressed mode method	MP		Enumerated (SF/2, higher layer scheduling)	Method for generating downlink compressed mode gap. If F-DPCH is configured this IE shall not be used by the UE
>>>UL only				Compressed mode used in UL only
>>>>Uplink compressed mode method	MP		Enumerated (SF/2, higher layer scheduling)	Method for generating uplink compressed mode gap
>>>UL and DL				Compressed mode used in UL and DL
>>>>Downlink compressed mode method	MP		Enumerated (SF/2, higher layer scheduling)	Method for generating downlink compressed mode gap. If F-DPCH is configured this IE shall not be used by the UE
>>>>Uplink compressed mode method	MP		Enumerated (SF/2, higher layer scheduling)	Method for generating uplink compressed mode gap
>>Downlink frame type	MP		Enumerated (A, B)	If F-DPCH is configured this IE shall not be used by the UE
>>DeltaSIR1	MP		Real(0..3 by step of 0.1)	Delta in DL SIR target value to be set in the UE during the frame containing the start of the first transmission gap in the transmission gap pattern (without including the effect of the bit-rate increase). If F-DPCH is configured this IE shall not be used by the UE
>>DeltaSIRafter1	MP		Real(0..3 by step of 0.1)	Delta in DL SIR target value to be set in the UE one frame after the frame containing the start of the first transmission gap in the transmission gap pattern. If F-DPCH is configured this IE shall not be used by the UE
>>DeltaSIR2	OP		Real(0..3 by step of 0.1)	Delta in DL SIR target value to be set in the UE during the frame containing the start of the second transmission gap in the transmission gap pattern (without including the effect of the bit-rate increase) When omitted, DeltaSIR2 = DeltaSIR1. If F-DPCH is configured this IE shall not be used by the UE
>>DeltaSIRafter2	OP		Real(0..3 by step of 0.1)	Delta in DL SIR target value to be set in the UE one frame after the frame containing the start of the second transmission gap in the transmission gap pattern. When omitted, DeltaSIRafter2 = DeltaSIRafter1. If F-DPCH is configured this IE shall not be used by the UE

Information Element/Group name	Need	Multi	Type and reference	Semantics description
>>N Identify abort	CV-Initial BSIC		Integer(1..128)	Indicates the maximum number of repeats of patterns that the UE shall use to attempt to decode the unknown BSIC of the GSM cell in the initial BSIC identification procedure
>>T Reconfirm abort	CV-Re-confirm BSIC		Real(0.5..10.0 by step of 0.5)	Indicates the maximum time allowed for the re-confirmation of the BSIC of one GSM cell in the BSIC re-confirmation procedure. The time is given in steps of 0.5 seconds.

Condition	Explanation
Active	This IE is mandatory present when the value of the IE "TGPS Status Flag" is "Activate" and not needed otherwise.
Initial BSIC	This IE is mandatory present when the value of the IE "TGMP" is set to "GSM Initial BSIC identification" and not needed otherwise.
Re-confirm BSIC	This IE is mandatory present when the value of the IE "TGMP" is set to "GSM BSIC re-confirmation" and not needed otherwise.

10.3.6.34 DPCH Compressed Mode Status Info

This information element indicates status information of the compressed mode used by the UE in order to perform inter-frequency and inter-RAT measurements.

Information Element/Group name	Need	Multi	Type and reference	Semantics description
TGPS reconfiguration CFN	MP		Integer (0..255)	
Transmission gap pattern sequence	MP	1 to <maxTGPS>		
>TGPSI	MP		TGPSI 10.3.6.82	Transmission Gap Pattern Sequence Identifier
>TGPS Status Flag	MP		Enumerated(activate, deactivate)	This flag indicates whether the Transmission Gap Pattern Sequence it shall be activated or deactivated.
>TGCFN	CV-Active		Integer (0..255)	Connection Frame Number of the first frame of the first pattern within the Transmission Gap Pattern Sequence.

Condition	Explanation
Active	This IE is mandatory present when the value of the IE "TGPS Status Flag" is "Activate" and not needed otherwise.

10.3.6.34a DTX-DRX information

NOTE: For FDD only.

Information Element/Group name	Need	Multi	Type and reference	Semantics description	Version
DTX Information	OP				REL-7
>CHOICE E-DCH TTI length	MP				REL-7
>>10 ms					REL-7
>>>UE DTX cycle 1	MP		Enumerated (1, 5, 10, 20)	Units of subframes.	REL-7
>>>UE DTX cycle 2	MP		Enumerated (5, 10, 20, 40, 80, 160)	Units of subframes. Two spare values are needed.	REL-7
>>>MAC DTX cycle	MP		Enumerated (5, 10, 20)	Units of subframes. One spare value is needed.	REL-7
>>2 ms					REL-7
>>>UE DTX cycle 1	MP		Enumerated (1, 4, 5, 8, 10, 16, 20)	Units of subframes. One spare value is needed.	REL-7
>>>UE DTX cycle 2	MP		Enumerated (4, 5, 8, 10, 16, 20, 32, 40, 64, 80, 128, 160)	Units of subframes. Four spare values are needed.	REL-7
>>>MAC DTX cycle	MP		Enumerated (1, 4, 5, 8, 10, 16, 20)	Units of subframes. One spare value is needed.	REL-7
>Inactivity Threshold for UE DTX cycle 2	MP		Enumerated (1, 4, 8, 16, 32, 64, 128, 256)	Units of E-DCH TTIs. Eight spare values are needed.	REL-7
>Default SG in DTX Cycle 2	OP		Integer (0..37,38)	Serving Grant value to be used at the transition in DTX-Cycle-2. (0..37) indicates E-DCH serving grant index as defined in [15]; index 38 means zero grant.	REL-7
>UE DTX long preamble length	MD		Enumerated (4, 15)	Units of slots Default value is 2 slots	REL-7
>MAC Inactivity Threshold	MP		Enumerated (1, 2, 4, 8, 16, 32, 64, 128, 256, 512, Infinity)	Units of E-DCH TTIs. Five spare values are needed.	REL-7
>CQI DTX Timer	MP		Enumerated (0, 1, 2, 4, 8, 16, 32, 64, 128, 256, 512, Infinity)	Units of subframes. Four spare values are needed.	REL-7
>UE DPCCH burst_1	MP		Enumerated (1, 2, 5)	Units of sub-frames One spare value is needed.	REL-7
>UE DPCCH burst_2	MP		Enumerated (1, 2, 5)	Units of sub-frames One spare value is needed.	REL-7
DRX Information	OP				REL-7
>UE DRX cycle	MP		Enumerated (4, 5, 8, 10, 16, 20)	Units of subframes. Two spare values are needed.	REL-7
>Inactivity Threshold for UE DRX cycle	MP		Enumerated (0, 1, 2, 4, 8, 16, 32, 64, 128, 256, 512)	Units of subframes Five spare values are needed.	REL-7
>Inactivity Threshold for UE Grant Monitoring	MP		Enumerated (0, 1, 2, 4, 8, 16, 32, 64, 128, 256)	Units of E-DCH TTIs Six spare values are needed.	REL-7
>UE DRX Grant Monitoring	MP		Boolean		REL-7
Uplink DPCCH slot format information	MP		Enumerated (1, 4)	Slot format # to be used on UL DPCCH [26] One spare value is needed.	REL-7

10.3.6.34b DTX-DRX timing information

NOTE: For FDD only.

Information Element/Group name	Need	Multi	Type and reference	Semantics description	Version
CHOICE <i>timing</i>	MP				REL-7
>Continue			(no data)	Used in reconfigurations without interruption of DTX-DRX and HS-SCCH less.	REL-7
>New timing					REL-7
>>Enabling Delay	MP		Enumerated (0, 1, 2, 4, 8, 16, 32, 64, 128)	In radio frames. Seven spare values are needed	REL-7
>>UE DTX DRX Offset	MP		Integer (0..159)	Units of subframes. Offset of the DTX and DRX cycles at the given TTI.	REL-7
Note: Only the values of the IE "UE DTX DRX Offset" that fulfill the equation $UE\ DTX\ DRX\ Offset \bmod 5=0$ can be configured with 10ms E-DCH TTI. The UE behaviour is not specified if any other values are used with 10ms TTI.					

10.3.6.35 Dynamic persistence level

Information Element/Group name	Need	Multi	Type and reference	Semantics description
Dynamic persistence level	MP		Integer(1..8)	Level shall be mapped to a dynamic persistence value in the range 0 .. 1. The mapping is described in subclause 8.5.12.

10.3.6.35a FPACH info

NOTE: Only for 1.28 Mcps TDD.

Information Element/Group name	Need	Multi	Type and reference	Semantics description	Version
Timeslot number	MP		Integer(0..6)		REL-4
Channelisation code	MP		Enumerated((16/1)..(16/16))		REL-4
Midamble Shift and burst type	MP		Midamble shift and burst type 10.3.6.41		REL-4
WT	MP		Integer(1..4)	The number of sub-frames, following the sub-frame in which the SYNC UL is transmitted, in which the FPACH can be transmitted.	REL-4

10.3.6.35b Frequency band indicator

Information Element/Group name	Need	Multi	Type and reference	Semantics description	Version
Frequency band indicator	MP		Enumerated(Band I, Band II, Band III, Band IV, Band V, Band VI, Band VII, extension indicator)		REL-6

10.3.6.35c Frequency band indicator 2

Information Element/Group name	Need	Multi	Type and reference	Semantics description	Version
Frequency band indicator 2	MP		Enumerated(Band VIII, Band IX, Band X, Band XI, Band XII, Band XIII, Band XIV, Band XV, Band XVI, Band XVII, Band XVIII, Band XIX, Band XX, Band XXI, Band XXII, extension indicator)	Band XI – Band XXII are yet to be defined in this version of the specification	REL-6

10.3.6.36 Frequency info

Information Element/Group name	Need	Multi	Type and reference	Semantics description
CHOICE <i>mode</i>	MP			
>FDD				
>>UARFCN uplink (Nu)	OP		Integer(0..16383)	If this IE is not present, the default duplex distance defined for the operating frequency band shall be used [21]
>>UARFCN downlink (Nd)	MP		Integer(0 .. 16383)	[21]
>TDD				
>>UARFCN (Nt)	MP		Integer(0 .. 16383)	[22]

10.3.6.36oo HS-PDSCH Midamble Configuration

NOTE: Only for TDD 1.28 Mcps.

Information Element/Group name	Need	Multi	Type and reference	Semantics description	Version
Midamble Allocation Mode	MP		Enumerated(Default midamble, Common midamble, UE specific midamble)	This midamble allocation mode applies to all HS-PDSCH resources assigned to the UE.	REL-5
Midamble Configuration	MP		Integer(2, 4, 6, 8, 10, 12, 14, 16)	This configuration applies to all HS-PDSCH resources assigned to the UE.	REL-5
Midamble Shift	CV-UE		Integer(0..15)	This shift, when present, applies to all HS-PDSCH resources assigned to the UE.	REL-5

Condition	Explanation
UE	This IE is mandatory present when the value of the IE "Midamble Allocation Mode" is "UE specific midamble" and not needed otherwise.

10.3.6.36o HS-PDSCH Timeslot Configuration

NOTE: Only for TDD 3.84 Mcps.

Information Element/Group name	Need	Multi	Type and reference	Semantics description	Version
HS-PDSCH Timeslot Configuration List	MP	1 to <maxTS-1>			REL-5
>Timeslot Number	MP		Integer (0..14)		REL-5
>CHOICE Burst Type	MP				REL-5
>>Type 1					REL-5
>>>Midamble Allocation Mode	MP		Enumerated (Default midamble, Common midamble, UE specific midamble)		REL-5
>>>Midamble configuration burst type 1 and 3	MP		Integer (4, 8, 16)	As defined in [30]	REL-5
>>>Midamble Shift	CV-UE		Integer (0..15)		REL-5
>>Type 2					REL-5
>>>Midamble Allocation Mode	MP		Enumerated (Default midamble, Common midamble, UE specific midamble)		REL-5
>>>Midamble configuration burst type 2	MP		Integer (3, 6)	As defined in [30]	REL-5
>>>Midamble Shift	CV-UE		Integer (0..5)		REL-5

Condition	Explanation
<i>UE</i>	This IE is mandatory present when the value of the IE "Midamble Allocation Mode" is "UE specific midamble" and not needed otherwise.

10.3.6.36oa HS-PDSCH Timeslot Configuration VHCR

NOTE: Only for TDD 7.68 Mcps.

Information Element/Group name	Need	Multi	Type and reference	Semantics description	Version
HS-PDSCH Timeslot Configuration List	MP	1 to <maxTS-1>			REL-7
>Timeslot Number	MP		Integer (0..14)		REL-7
>CHOICE Burst Type	MP				REL-7
>>Type 1					REL-7
>>>Midamble Allocation Mode	MP		Enumerated (Default midamble, Common midamble, UE specific midamble)		REL-7
>>>Midamble configuration burst type 1 and 3	MP		Integer (4, 8, 16)	As defined in [30]	REL-7
>>>Midamble Shift	CV-UE		Integer (0..15)		REL-7
>>Type 2					REL-7
>>>Midamble Allocation Mode	MP		Enumerated (Default midamble, Common midamble, UE specific midamble)		REL-7
>>>Midamble configuration burst type 2	MP		Integer (4, 8)	As defined in [30]	REL-7
>>>Midamble Shift	CV-UE		Integer (0..7)		REL-7

Condition	Explanation
<i>UE</i>	This IE is mandatory present when the value of the IE "Midamble Allocation Mode" is "UE specific midamble" and not needed otherwise.

10.3.6.36a HS-SCCH Info

Information Element/Group name	Need	Multi	Type and reference	Semantics description	Version
CHOICE mode	MP				REL-5
>FDD					REL-5
>>DL Scrambling Code	MD		Secondary scrambling code 10.3.6.74	DL Scrambling code to be applied for HS-DSCH and HS-SCCH. Default is same scrambling code as for the primary CPICH.	REL-5
>>HS-SCCH Channelisation Code Information	MP	1 to <maxHSS CCHs >		Note 2	REL-5
>>>HS-SCCH Channelisation Code	MP		Integer (0..127)		REL-5
>TDD					REL-5
>>CHOICE <i>TDD option</i>	MP				REL-5
>>>3.84 Mcps					REL-5
>>>> Ack-Nack Power Offset	MP		Integer (-7..8 by step of 1)	dB Note 1	REL-5
>>>> HS-SICH Power Control Info	MP		HS-SICH Power Control Info 10.3.6.36b		REL-5
>>>> BLER target	MP		Real (-3.15..0 by step of 0.05)	Signalled value is Log10(HS-SCCH BLER quality target). This IE is Not Present in REL-5.	REL-6
>>>> $D_{\text{hs-sync}}$	OP		Integer (-20..+10)	Value in dB set to indicate the dB difference between the maximum allowed HS-SCCH physical channel transmit power [33] and the beacon reference power (it is one means of controlling the area of HS-DSCH operation within the cell).	REL-6
>>>>HS-SCCH Set Configuration	MP	1 to <maxHSS CCHs>			REL-5
>>>>>Timeslot number	MP		Integer (0..14)		REL-5
>>>>>Channelisation code	MP		Enumerated ((16/1) ..(16/16))		REL-5
>>>>>Midamble Allocation mode	MP		Enumerated (Default midamble, Common midamble, UE specific midamble)	HS-SCCH always uses burst type 1.	REL-5
>>>>>Midamble configuration	MP		Integer		REL-5

			(4, 8, 16)		
>>>>>Midamble Shift	CV-UE		Integer(0..15)		REL-5
>>>>>BLER target	MP		Real (-3.15..0 by step of 0.05)	Signalled value is Log10(HS-SCCH BLER quality target). This IE is not present in REL-6 and beyond.	REL-5
>>>>>HS-SICH configuration					REL-5
>>>>>>Timeslot number	MP		Integer (0..14)		REL-5
>>>>>>>Channelisation code	MP		Enumerated ((16/1) ..(16/16))		REL-5
>>>>>>>Midamble Allocation mode	MP		Enumerated (Default midamble, UE specific midamble)	HS-SICH always uses burst type 1.	REL-5
>>>>>>>Midamble configuration	MP		Integer (4, 8, 16)		REL-5
>>>>>>>Midamble Shift	CV-UE		Integer (0..15)		REL-5
>>>7.68 Mcps					REL-7
>>>>Ack-Nack Power Offset	MP		Integer (-7..8 by step of 1)	dB	REL-7
>>>>HS-SICH Power Control Info	MP		HS-SICH Power Control Info 10.3.6.36b		REL-7
>>>>BLER target	MP		Real (-3.15..0 by step of 0.05)	Signalled value is Log10(HS-SCCH BLER quality target).	REL-7
>>>>D _{hs-sync}	OP		Integer (-20..+10)	Value in dB set to indicate the dB difference between the maximum allowed HS-SCCH physical channel transmit power [33] and the beacon reference power (it is one means of controlling the area of HS-DSCH operation within the cell).	REL-7
>>>>D _{hs-sync}	OP		Integer (-20..+10)	Value in dB set to indicate the dB difference between the maximum allowed HS-SCCH physical channel transmit power [33] and the beacon reference power (it is one means of controlling the area of HS-DSCH operation within the cell).	REL-7

>>>>HS-SCCH Set Configuration	MP	1 to <maxHS-SCCHs>			REL-7
>>>>>Timeslot number	MP		Integer (0..14)		REL-7
>>>>>Channelisation code	MP		Enumerated ((32/1)..(32/32))		REL-7
>>>>>Midamble Allocation mode	MP		Enumerated (Default midamble, Common midamble, UE specific midamble)	HS-SCCH always uses burst type 1.	REL-7
>>>>>Midamble configuration	MP		Integer (4, 8, 16)		REL-7
>>>>>Midamble Shift	CV-UE		Integer(0..15)		REL-7
>>>>>HS-SICH configuration					REL-5
>>>>>>Timeslot number	MP		Integer (0..14)		REL-5
>>>>>>Channelisation code	MP		Enumerated ((32/1)..(32/32))		REL-5
>>>>>>Midamble Allocation mode	MP		Enumerated (Default midamble, UE specific midamble)	HS-SICH always uses burst type 1.	REL-5
>>>>>>Midamble configuration	MP		Integer (4, 8, 16)		REL-5
>>>>>>Midamble Shift	CV-UE		Integer (0..15)		REL-5
>>>1.28 Mcps					REL-5
>>>>Ack-Nack Power Offset	MP		Integer (-7..8 by step of 1)	dB. This IE is Not Present in REL-5. Note	REL-6
>>>>PRX _{HS-SICH}	MP		Integer (-120..-58 by step of 1)	dBm. Desired power level for HS-SICH. This IE is Not Present in REL-5	REL-6
>>>>TPC step size	MP		Integer (1, 2, 3)	dB. This IE is Not Present in REL-5.	REL-6
>>>>BLER target	MP		Real (-3.15..0 by step of 0.05)	Signalled value is Log10(HS-SCCH BLER quality target). This IE is Not Present in REL-5.	REL-6
>>>>Power Control GAP	MD		Integer (1...255)	Unit: Number of subframes Default value is 1.	REL-7
>>>>Pathloss compensation switch	MD		Boolean	TRUE: UE shall perform the pathloss compensation for HS-SICH power control when HS-SICH transmission gap is less than "Power Control GAP".	REL-7

				FALSE: UE shall not consider the pathloss compensation for HS-SICH power control. Default value is FALSE.	
>>>>HS-SCCH Set Configuration	MP	1 to <maxHSS CCHs>			REL-5
>>>>>Timeslot number	MP		Integer (0..6)		REL-5
>>>>>First Channelisation code	MP		Enumerated ((16/1) ..(16/16))		REL-5
>>>>>Second Channelisation code	MP		Enumerated ((16/1) ..(16/16))		REL-5
>>>>>Midamble Allocation mode	MP		Enumerated (Default midamble, Common midamble, UE specific midamble)		REL-5
>>>>> Midamble Shift	CV-UE		Integer (0..15)		REL-5
>>>>>Midamble configuration	MP		Integer (2, 4, 6, 8, 10, 12, 14, 16)		REL-5
>>>>>BLER target	MP		Real (-3.15..0 by step of 0.05)	Signalled value is Log10(HS-SCCH BLER quality target). This IE is not present in REL-6 and beyond.	REL-5
>>>>>HS-SICH configuration					REL-5
>>>>>>Timeslot number	MP		Integer (0..6)		REL-5
>>>>>>Channelisation code	MP		Enumerated ((16/1) ..(16/16))		REL-5
>>>>>>Midamble Allocation mode	MP		Enumerated (Default midamble, UE specific midamble)		REL-5
>>>>>>Midamble configuration	MP		Integer (2, 4, 6, 8, 10, 12, 14, 16)		REL-5
>>>>>>Midamble Shift	CV-UE		Integer (0..15)		REL-5
>>>>>>Ack-Nack Power Offset	MP		Integer (-7..8 by step of 1)	dB. This IE is not present in REL-6 and beyond.	REL-5
>>>>>>PRX _{HS-SICH}	MP		Integer (-120..-58 by step of 1)	Note dBm. Desired power level for HS-SICH. This IE is not present in REL-6 and beyond.	REL-5

>>>>>TPC step size	MP		Integer (1, 2, 3)	dB. This IE is not present in REL-6 and beyond.	REL-5
Note 1: Ack-Nack Power Offset is the difference in the desired RX power between HS-SICH transmissions conveying an acknowledgement and transmissions conveying a negative acknowledgement signalled to the UE in IE "HS-SCCH Info".					
Note 2: The list of HS-SCCH(s) is assumed to be indexed starting from one.					

Condition	Explanation
UE	This IE is mandatory present when the value of the IE "Midamble Allocation Mode" is "UE specific midamble" and not needed otherwise.

10.3.6.36ab HS-SCCH less information

NOTE: For FDD only

Information Element/Group name	Need	Multi	Type and reference	Semantics description	Version
CHOICE <i>HS-SCCH less operation</i>	MP				REL-7
>Continue HS-SCCH less operation			(no data)		REL-7
>New HS-SCCH less operation					REL-7
>>HS-PDSCH Code Index	MP		Integer (1..15)	Index of first HS-PDSCH code	REL-7
>>>Transport Block Size List		1..<maxHS-SCCHLe ssTrBlk >			REL-7
>>>>Transport Block Size Index	MP		Integer (1..90)	Index of the MAC-hs or MAC-ehs transport block size as described in appendix A of [15]	REL-7
>>>>HS-PDSCH Second Code Support	MP		Boolean	Indicates whether the second HS-PDSCH code is used for this TB size. If TRUE, the HS-PDSCH second code index value is the value of IE "HS-PDSCH Code Index" incremented by 1.	REL-7

10.3.6.36b HS-SICH Power Control Info

This IE is used to transfer HS-SICH power control info to the UE and only applies to TDD 3.84 Mcps and 7.68 Mcps.

Information Element/Group name	Need	Multi	Type and reference	Semantics description	Version
UL target SIR	MP		Real (-11..20 by step of 0.5)	dB	REL-5
HS-SICH Constant value	MP		Constant value 10.3.6.11	NOTE 1	REL-5

NOTE 1: Alignment to ASN.1: the IE "Constant value TDD" (10.3.6.11a) should have been used to provide the correct value range. The IE "Constant value" (10.3.6.11) is used to keep compatibility with REL-5.

10.3.6.36c HS-DSCH common system information

NOTE: For FDD only.

Information Element/Group name	Need	Multi	Type and reference	Semantics description	Version
CCCH mapping info	MP		Common RB mapping info 10.3.4.0a		REL-7
SRB1 mapping info	MD		Common RB mapping info 10.3.4.0a	Note	REL-7
Common MAC-ehs reordering queue list	MP		Common MAC-ehs reordering queue list 10.3.5.3a		REL-7
HS-SCCH system info	MP		HS-SCCH system info 10.3.6.36e		REL-7
HARQ system Info	MP		HARQ Info 10.3.5.7a		REL-7
Common H-RNTI Information	MP	1 to <maxCommonHRNTI >			REL-7
>Common H-RNTI	MP		H-RNTI 10.3.3.14a		REL-7
BCCH specific H-RNTI	MP		H-RNTI 10.3.3.14a		REL-7

NOTE: The default values for the "SRB1 mapping info" are 1 for the Logical channel identity and 0 for the MAC-ehs queue identity.

10.3.6.36d HS-DSCH paging system information

These parameters enable the UE in CELL_PCH and URA_PCH to receive transmissions on HSDPA cell resources.

NOTE: Only for FDD.

Information Element/Group name	Need	Multi	Type and reference	Semantics description	Version
DL Scrambling Code	MD		Secondary scrambling code 10.3.6.74	DL Scrambling code to be applied for HS-DSCH and HS-SCCH. Default is same scrambling code as for the primary CPICH.	REL-7
PICH for HSDPA supported paging list	MP	1 to <maxSCCPCH>			REL-7

>HSDPA associated PICH info	MP		PICH info 10.3.6.49		REL-7
>HS-PDSCH Channelisation Code	MP		Integer (0..15)	HS-PDSCH channel, associated with the PICH for HS-SCCH less PAGING TYPE 1 message transmission.	REL-7
Number of PCCH transmissions	MP		Integer (1..5)	number of subframes used to transmit the PAGING TYPE 1.	REL-7
Transport Block Size List	MP	1 to 2			REL-7
>Transport Block Size Index	MP		Integer (1..32)	Index of value range 1 to 32 of the MAC-e-hs transport block size as described in appendix A of [15]	REL-7

10.3.6.36e HS-SCCH system info

These parameters enable the UE to receive transmission on HSDPA cell resources, when the UE is not in CELL_DCH.

NOTE: for FDD only.

Information Element/Group name	Need	Multi	Type and reference	Semantics description	Version
DL Scrambling Code	MD		Secondary scrambling code 10.3.6.74	DL Scrambling code to be applied for HS-DSCH and HS-SCCH. Default is same scrambling code as for the primary CPICH.	REL-7
HS-SCCH Channelisation Code Information	MP	1 to <maxHSS CCHs>			REL-7
>HS-SCCH Channelisation Code	MP		Integer (0..127) (NOTE)		REL-7

NOTE: UTRAN should use the first indexed HS-SCCH Channelisation code for the BCCH specific H-RNTI to indicate system information change information. Otherwise UE behaviour is unspecified.

10.3.6.37 Individual timeslot info

Information Element/Group name	Need	Multi	Type and reference	Semantics description	Version
Timeslot number	MP		Timeslot number 10.3.6.84	Timeslot within a frame	
TFCI existence	MP		Boolean	TRUE indicates that the TFCI exists. It shall be coded in the physical channel defined in [30] of this timeslot.	
Midamble Shift and burst type	MP		Midamble shift and burst type	For 1.28 Mcps TDD, if the cell is operating in	

Information Element/Group name	Need	Multi	Type and reference	Semantics description	Version
			10.3.6.41	MBSFN mode, the UE shall ignore the contents of this IE.	
CHOICE <i>TDD option</i>	MP				REL-4
>3.84 Mcps TDD				(no data)	REL-4
>7.68 Mcps TDD				(no data)	REL-7
>1.28 Mcps TDD					REL-4
>>Modulation	MP		Enumerated(QPSK, 8PSK)		REL-4
>>SS-TPC Symbols	MP		Enumerated(0, 1, 16/SF)	Denotes amount of SS and TPC bits send in this timeslot	REL-4
>>Additional TPC-SS Symbols	OP		Integer(1..15)	Specifies the number of additional codes in this timeslot that carry TPC and SS symbols as specified in [33]	REL-4

10.3.6.38 Individual Timeslot interference

Parameters used by the UE for uplink open loop power control in TDD.

Information element	Need	Multi	Type and reference	Semantics description
Timeslot number	MP		Timeslot number 10.3.6.84	
UL Timeslot Interference	MP		UL Interference TDD 10.3.6.87a	

10.3.6.39 Maximum allowed UL TX power

This information element indicates the maximum allowed uplink transmit power.

Information Element	Need	Multi	Type and reference	Semantics description
Maximum allowed UL TX power	MP		Integer(-50..33)	In dBm

10.3.6.39a Multi-frequency Info (1.28 Mcps TDD only)

IE/Group Name	Presence	Multi	IE Type and Reference	Semantics Description	Version
Second Frequency Info	OP		Integer (0 .. 16383)	1.28 Mcps TDD only	REL-7
FPACH Frequency Info	OP		Integer (0 .. 16383)	1.28 Mcps TDD only	REL-7
UpPCH Position Info	OP		Integer (0 .. 127)	Only for 1.28 Mcps TDD, if UpPCH occupies UpPTS, the parameter is not needed. Or the parameter is calculated for the uplink access position of a cell	REL-7

10.3.6.40 Void

10.3.6.40a Measurement Feedback Info

Information Element/Group name	Need	Multi	Type and reference	Semantics description	Version
CHOICE <i>mode</i>	MP				REL-5
>FDD					REL-5
>>Measurement Power Offset	MP		Real (-6 .. 13 by step of 0.5)	The measurement power offset, Γ , in dB, as described in [29].	REL-5
>>CQI Feedback cycle, k	MP		Integer (0, 2, 4, 8, 10, 20, 40, 80, 160, 16, 32, 64)	In milliseconds.	REL-5
>>CQI repetition factor	MP		Integer (1..4)	In milliseconds.	REL-7
>> Δ_{CQI}	MP		Integer (0..8)	Refer to quantization of the power offset in [28]	REL-5
>TDD				(no data)	REL-5

10.3.6.41 Midamble shift and burst type

NOTE: Only for TDD.

This information element indicates burst type and midamble allocation. Three different midamble allocation schemes exist:

- Default midamble: the midamble shift is selected by layer 1 depending on the associated channelisation code (DL and UL)
- Common midamble: the midamble shift is chosen by layer 1 depending on the number of channelisation codes (possible in DL only)
- UE specific midamble: a UE specific midamble is explicitly assigned (DL and UL).

Information Element/Group name	Need	Multi	Type and reference	Semantics description	Version
CHOICE <i>TDD option</i>	MP				REL-4
>3.84 Mcps TDD					REL-4
>>CHOICE <i>Burst Type</i>	MP				
>>>Type 1					
>>>>Midamble Allocation Mode	MP		Enumerated (Default midamble, Common midamble, UE specific midamble)		
>>>>Midamble configuration burst type 1 and 3	MP		Integer(4, 8, 16)	As defined in [30]	
>>>>Midamble Shift	CV-UE		Integer(0..15)		
>>>Type 2					
>>>>Midamble Allocation Mode	MP		Enumerated (Default midamble, Common midamble, UE specific midamble)		
>>>>Midamble configuration burst type 2	MP		Integer(3, 6)	As defined in [30]	
>>>>Midamble Shift	CV-UE		Integer(0..5)		
>>>Type 3					
>>>>Midamble Allocation Mode	MP		Enumerated (Default midamble, UE specific midamble)		
>>>>Midamble configuration burst type 1 and 3	MP		Integer(4, 8, 16)	As defined in [30]	
>>>>Midamble Shift	CV-UE		Integer (0..15)	NOTE: Burst Type 3 is only used in uplink.	
>>> MBSFN Burst Type				(no data) DL only	REL-7
>7.68 Mcps TDD					REL-7
>>CHOICE <i>Burst Type</i>	MP				REL-7
>>>Type 1					REL-7
>>>>Midamble Allocation Mode	MP		Enumerated (Default midamble, Common midamble, UE specific midamble)		REL-7
>>>>Midamble configuration burst type 1 and 3	MP		Integer(4, 8, 16)	As defined in [30]	REL-7
>>>>Midamble Shift	CV-UE		Integer(0..15)		REL-7
>>>Type 2					REL-7
>>>>Midamble Allocation Mode	MP		Enumerated (Default midamble, Common midamble, UE specific midamble)		REL-7
>>>>Midamble configuration burst type 2	MP		Integer(4, 8)	As defined in [30]	REL-7
>>>>Midamble Shift	CV-UE		Integer(0..7)		REL-7
>>>Type 3					REL-7

Information Element/Group name	Need	Multi	Type and reference	Semantics description	Version
>>>>Midamble Allocation Mode	MP		Enumerated (Default midamble, UE specific midamble)		REL-7
>>>>Midamble configuration burst type 1 and 3	MP		Integer(4, 8, 16)	As defined in [30]	REL-7
>>>>Midamble Shift	CV-UE		Integer (0..15)	NOTE: Burst Type 3 is only used in uplink.	REL-7
>>> MBSFN Burst Type				(no data) DL only	REL-7
>1.28 Mcps TDD					REL-4
>>Midamble Allocation Mode	MP		Enumerated (Default midamble, Common midamble, UE specific midamble)		REL-4
>>Midamble configuration	MP		Integer(2, 4, 6, 8, 10, 12, 14, 16)	As defined in [30]	REL-4
>>Midamble Shift	CV-UE		Integer (0..15)		REL-4

Condition	Explanation
UE	This IE is mandatory present when the value of the IE "Midamble Allocation Mode" is "UE-specific midamble" and not needed otherwise.

10.3.6.41a MIMO parameters

Information Element/Group name	Need	Multi	Type and reference	Semantics description	Version
MIMO operation	MP		Enumerated (start, continue)		REL-7
MIMO N_cqi_typeA/M_cqi ratio	OP		Enumerated(1/2, 2/3, 3/4, 4/5, 5/6, 6/7, 7/8, 8/9, 9/10, 1/1)		REL-7
MIMO pilot configuration	OP		MIMO pilot configuration 10.3.6.41b		REL-7
Precoding weight set restriction	OP		Enumerated (TRUE)	If present and MIMO operation is set to start, the UE starts using precoding weight set restriction.	REL-7

10.3.6.41b MIMO pilot configuration

Information Element/Group name	Need	Multi	Type and reference	Semantics description	Version
CHOICE <i>Second CPICH pattern</i>	MP				REL-7
>Antenna2 P-CPICH				(no data)	REL-7
>Antenna1 S-CPICH					REL-7
>>Channelisation code	MP		Integer (0..255)		REL-7
>>Power Offset for S-CPICH for	OP		Integer(-6)	Power offset relative to	REL-7

Information Element/Group name	Need	Multi	Type and reference	Semantics description	Version
MIMO			.. 0)	the P-CPICH Tx power in dB	

10.3.6.41c Non-scheduled transmission grant info (TDD only)

Information Element/Group name	Need	Multi	Type and reference	Semantics description	Version
CHOICE <i>TDD Option</i>					REL-7
>3.84/7.68 Mcps TDD					REL-7
>>Timeslot Resource Related InformationI	MP		Bitstring (13)	Bitmap indicating which of the timeslots configured for E-DCH are allocated for non-scheduled transmissions	REL-7
>>Power Resource Related Information	MP		Integer (1.. 32)	Specifies the maximum allowed E-PUCH resource that the UE may use [15].	REL-7
>>Activation Time	MP		Activation time 10.3.3.1		REL-7
>>Repetition period and length	MD			Default is "Repetition period" = 1 (continuous)	REL-7
>>>Repetition period	MP		Integer (1, 2, 4, 8, 16, 32, 64)	Periodicity in terms of TTIs for which resource is allocated. 1= continuous allocation, 2 indicates every other TTI, 4 = every 4 th , 8 every 8 th etc.	REL-7
>>>Repetition Length	MP		Integer (1..Repetition period-1)	TTI in which resource is assigned. If Repetition period = 1 then value is ignored	REL-7
>>Code Resource Information	MP		Enumerated ((1/1),(2/1),(2/2),(4/1)..(4/4),(8/1)..(8/8),(16/1)..(16/16))		REL-7
>1.28 Mcps TDD					REL-7
>>N _{E-UCCH}	MD		Integer (1..8)	Number of E-UCCH and TPC instances within an E-DCH TTI. Default = 1.	REL-7
>>N _{E-HICH}	CV-Scheduled E-PUCH		Integer(4..15)	Minimum number of slots between start last active slot of E-DCH TTI and start of ACK/NACK on E-HICH.	REL-7
>>Timeslot Resource Related InformationI	MP		Bitstring (5)	Bitmap indicating which of the timeslots configured for E-DCH are allocated for non-scheduled transmissions	REL-7
>>Power Resource Related Information	MP		Integer (1.. 32)	Indicates 0-31 PRRI index	REL-7

				defined in [31], which specifies the maximum allowed E-PUCH resource that the UE may use [15].	
>>Activation Time	MP		Activation time 10.3.3.1	Specifies the E-PUCH Offset in Radio Frame level.	REL-7
>>Subframe number	MP		Integer (0..1)	Specifies the E-PUCH Offset in subframe level.	REL-7
>>Repetition period and length	MD			Default is "Repetition period" = 1 (continuous)	REL-7
>>>Repetition period	MP		Integer (1, 2, 4, 8, 16, 32, 64)	Periodicity in terms of TTIs for which resource is allocated. 1= continuous allocation, 2 indicates every other TTI, 4 = every 4 th , 8 every 8 th etc.	REL-7
>>>Repetition Length	MP		Integer(1..Repetition period-1)	TTI in which resource is assigned. If Repetition period = 1 then value is ignored	REL-7
>>Code Resource Information	MP		Enumerated ((1/1),(2/1),(2/2),(4/1)..(4/4),(8/1)..(8/8),(16/1)..(16/16))		REL-7
>>E-HICH Information					REL-7
>>>Timeslot number	MP		Integer (0..6)		REL-7
>>>Channelisation code	MP		Enumerated ((16/1)..(16/16))		REL-7
>>>Midamble Allocation mode	MP		Enumerated (Default midamble, UE specific midamble)		REL-7
>>>Midamble configuration	MP		Integer (2, 4, 6, 8, 10, 12, 14, 16)		REL-7
>>>Midamble Shift	CV-UE specific		Integer (0..15)		REL-7
>>>Signature Sequence Group Index	MP		Integer (0..19)		REL-7
>>T-SI-NST	CV-E-RUCCH info		Enumerated (everyEDCH TTI, 20,40,60,80, 160,200)	Values in ms. If T-SI-NST expires then UE should include scheduling information in the next new non-scheduled MAC-e PDU.	REL-7

Condition	Explanation
<i>Scheduled E-PUCH</i>	If NE-HICH is given in scheduled E-PUCH information, this IE is not needed, otherwise it is mandatory
<i>UE specific</i>	If UE specific midamble allocation mode is configured, this IE is mandatory, otherwise it is not needed.
<i>E-RUCCH info</i>	This IE is optionally present if the IE "E-RUCCH Info" is not included, otherwise the IE is not needed.

10.3.6.42 PDSCH Capacity Allocation info

NOTE: Only for TDD.

Information Element/Group name	Need	Multi	Type and reference	Semantics description
PDSCH allocation period info	MP		Allocation Period Info 10.3.6.4	
<i>CHOICE Configuration</i>	MP			
>Old configuration				
>>TFCS ID	MD		Integer(1..8)	Default is 1.
>>PDSCH Identity	MP		Integer(1..hi PDSCHidentities)	
>New configuration				
>>PDSCH Info	MP		PDSCH Info 10.3.6.44	
>>PDSCH Identity	OP		Integer(1..hi PDSCHidentities)	
>>PDSCH power control info	OP		PDSCH power control info 10.3.6.45	

10.3.6.43 Void

10.3.6.44 PDSCH info

NOTE: Only for TDD.

Information Element/Group name	Need	Multi	Type and reference	Semantics description	Version
TFCS ID	MD		Integer(1..8)	TFCS to be used. Default value is 1.	
Common timeslot info	OP		Common timeslot info 10.3.6.10		
PDSCH timeslots and codes for 1.28 Mcps TDD or 3.84 Mcps TDD	OP		Downlink Timeslots and Codes 10.3.6.32	Default is to use the old timeslots and codes.	
PDSCH timeslots and codes for 7.68 Mcps TDD	OP		Downlink Timeslots and Codes VHR 10.3.6.32a	Default is to use the old timeslots and codes.	REL-7

10.3.6.45 PDSCH Power Control info

NOTE: Only for TDD.

Information Element/Group name	Need	Multi	Type and reference	Semantics description
TPC Step Size	OP		Integer (1, 2, 3)	In dB
UL CCTrCH TPC List	OP	1..<maxCC TrCH>		UL CCTrCH identities for TPC commands associated with this DL CCTrCH. This list is not used in 1.28 Mcps TDD.
>UL TPC TFCS Identity	MP		Transport Format Combination Set Identity 10.3.5.21	

10.3.6.46 PDSCH system information

NOTE: Only for TDD.

Information Element/Group name	Need	Multi	Type and reference	Semantics description	Version
PDSCH information	MP	1 to <maxPD SCH>			
>PDSCH Identity	MP		Integer(1..hiPDSCH identities)		
>PDSCH info	MP		PDSCH info 10.3.6.44		
>SFN Time Info	CH-Block17		SFN Time Info 10.3.6.75		
>DSCH TFS	OP		Transport format set 10.3.5.23		
>DSCH Transport Channels	OP	1 to <maxTr CH>		If PDSCH is configured for 3.84Mcps TDD in Rel-5 or for 7.68 Mcps in Rel-7 this IE may be included.	REL-5
>> DSCH Transport channel identity	MP		Transport channel identity 10.3.5.18		REL-5
>>>DSCH TFS	MP		Transport format set 10.3.5.23		REL-5
>DSCH TFCS	OP		Transport Format Combination Set 10.3.5.20		

Condition	Explanation
Block17	This IE is not needed in System Information Block 17. Otherwise it is optional.

10.3.6.47 Void

10.3.6.48 Persistence scaling factors

This IE defines scaling factors associated with ASC 2 – ASC 7 to be applied to the dynamic persistence value.

Information Element/Group name	Need	Multi	Type and reference	Semantics description
Access Service Class	MP	1 to maxASCpersistence		multiplicity corresponds to the number of PRACH partitions minus 2
>Persistence scaling factor	MP		Real(0.9..0.2, by step of 0.1)	Scaling factors in the range 0,...,1

10.3.6.49 PICH Info

Information Element/Group name	Need	Multi	Type and reference	Semantics description	Version
CHOICE <i>mode</i>	MP				
>FDD					
>>Channelisation code	MP		Integer(0..255)	SF is fixed and equal to 256	
>>Number of PI per frame	MP		Integer (18, 36, 72, 144)		
>>STTD indicator	MP		STTD Indicator 10.3.6.78		
>TDD					
>>Timeslot number	MD		Timeslot number 10.3.6.84	Default value is the timeslot used by the SCCPCH carrying the associated PCH.	
>>Midamble shift and burst type	MP		Midamble shift and burst type 10.3.6.41		
>>>CHOICE <i>TDD option</i>	MP				REL-4
>>>>3.84 Mcps TDD					REL-4
>>>>>Channelisation code	MD		Enumerated ((16/1)...(16/16))	Default value is the channelisation code used by the SCCPCH carrying the associated PCH.	
>>>>>7.68 Mcps TDD					REL-7
>>>>>>Channelisation code	MD		Enumerated ((32/1)...(32/32))	Default value is the channelisation code used by the SCCPCH carrying the associated PCH.	REL-7
>>>>>>>1.28 Mcps TDD					REL-4
>>>>>>>>Codes list	MP	1..2			REL-4
>>>>>>>>>Channelisation code	MP		Enumerated ((16/1)...(16/16))		REL-4
>>Repetition period/length	MD		Enumerated((4/2),(8/2),(8/4),(16/2),(16/4),	Default value is "(64/2)".	

			(32/2),(32/4), (64/2),(64/4))		
>>Offset	MP		Integer (0...Repetition period -1)	SFN mod Repetitionperiod = Offset.	
>>Paging indicator length	MD		Integer (4, 8, 16)	Indicates the length of one paging indicator in Bits. Default value is 4.	
>>N _{GAP}	MD		Integer(2, 4, 8)	Number of frames between the last frame carrying PICH for this Paging Occasion and the first frame carrying paging messages for this Paging Occasion. Default value is 4.	
>>N _{PCH}	MD		Integer(1 .. 8)	Number of paging groups. Default value is 2.	

10.3.6.50 PICH Power offset

This is the power transmitted on the PICH minus power of the Primary CPICH in FDD and Primary CCPCH Tx Power in TDD.

Information Element/Group name	Need	Multi	Type and reference	Semantics description
PICH Power offset	MP		Integer(-10 .. +5)	Offset in dB

10.3.6.50a PLCCH Info

NOTE: Only for 1.28 Mcps TDD

Information Element/Group name	Need	Multi	Type and reference	Semantics description
PLCCH sequence number	M		Integer(1.. 14)	
Timeslot number	M		Integer(0.. 6)	
Channelisation Code	M		Enumerated((16/1)..(1 6/16))	
TPC command target rate	M		Real(0.01.. 0.1 by steps of 0.01)	Transmit Power Control command target rate

10.3.6.51 PRACH Channelisation Code List

NOTE: Only for 3.84 Mcps TDD.

Information Element/Group name	Need	Multi	Type and reference	Semantics description	Version
CHOICE SF	MP				
>SF16					
>>Channelisation Code List	MP	1 to 8			
>>>Channelisation code	MP		Enumerated	There is a 1:1	

Information Element/Group name	Need	Multi	Type and reference	Semantics description	Version
			((16/1)...(16/16))	mapping between spreading code and midamble shift defined in [30] for channelisation codes (16/1) to (16/8). NOTE: channelisation codes (16/9) to (16/16) are not to be used.	
>SF8					
>>Channelisation Code List	MP	1 to 8			
>>>Channelisation Code	MP		Enumerated(8/1)..(8/8))		

10.3.6.51a PRACH Channelisation Code 1.28 Mcps TDD

NOTE: Only for 1.28 Mcps TDD.

Information Element/Group name	Need	Multi	Type and reference	Semantics description	Version
Channelisation Code List	MP	1 to 4			REL-4
>Channelisation Code	MP		Enumerated(4/1)..(4/4),(8/1)..(8/8),(16/1)..(16/16))		REL-4

10.3.6.51b PRACH Channelisation Code List VHCR

NOTE: Only for 7.68 Mcps TDD.

Information Element/Group name	Need	Multi	Type and reference	Semantics description	Version
CHOICE SF	MP				REL-7
>SF32					REL-7
>>Channelisation Code List	MP	1 to 16			REL-7
>>>Channelisation code	MP		Enumerated((32/1)...(32/32))	There is a 1:1 mapping between spreading code and midamble shift defined in [30] for channelisation codes (32/1) to (32/16). NOTE: channelisation codes (32/17) to (32/32) are not to be used.	REL-7
>SF16					REL-7
>>Channelisation Code List	MP	1 to 16			REL-7
>>>Channelisation code	MP		Enumerated((16/1)...(16/16))	There is a 1:1 mapping between spreading code and midamble shift defined in	REL-7

Information Element/Group name	Need	Multi	Type and reference	Semantics description	Version
				[30] for channelisation codes (16/1) to (16/16).	

10.3.6.52 PRACH info (for RACH)

Information Element/Group name	Need	Multi	Type and reference	Semantics description	Version
CHOICE <i>mode</i>	MP				
>FDD					
>>Available Signature	MP		Bit string(16)	Each bit indicates availability for a signature, where the signatures are numbered "signature 0" up to "signature 15". The value 1 of a bit indicates that the corresponding signature is available and the value 0 that it is not available.	
>>Available SF	MP		Integer (32,64,128,256)	In chips per symbol Defines the minimum allowed SF (i.e. the maximum rate)	
>>Preamble scrambling code number	MP		Integer (0 .. 15)	Identification of scrambling code see [28]	
>>Puncturing Limit	MP		Real(0.40..1.00 by step of 0.04)		
>>Available Sub Channel Number	MP		Bit string(12)	Each bit indicates availability for a subchannel, where the subchannels are numbered "subchannel 0" to "subchannel 11". The value 1 of a bit indicates that the corresponding subchannel is available and the value 0 indicates that it is not available.	
>TDD					
>>CHOICE <i>TDD option</i>	MP				REL-4
>>>3.84 Mcps TDD					REL-4
>>>>Timeslot number	MP		Timeslot number 10.3.6.84		
>>>>PRACH Channelisation Code List	MP		PRACH Channelisation Code List 10.3.6.51		

>>>>PRACH Midamble	MP		Enumerated (Direct, Direct/Inverted)	Direct or direct and inverted midamble are used for PRACH	
>>>>PNBSCH allocation	OP		PNBSCH allocation 10.3.8.10a	Identifies frames used for cell synchronisation purposes	REL-4
>>>7.68 Mcps TDD					REL-7
>>>>Timeslot number	MP		Timeslot number 10.3.6.84		REL-7
>>>>PRACH Channelisation Code List VHCR	MP		PRACH Channelisation Code List VHCR 10.3.6.51b		REL-7
>>>>PRACH Midamble	MP		Enumerated (Direct, Direct/Inverted)	Direct or direct and inverted midamble are used for PRACH	REL-7
>>>>PNBSCH allocation	OP		PNBSCH allocation 10.3.8.10a	Identifies frames used for cell synchronisation purposes	REL-7
>>>1.28 Mcps TDD					REL-4
>>>>SYNC_UL info	MP		SYNC_UL info 10.3.6.78a		REL-4
>>>>PRACH Definition	MP	1..<maxPRACH_FPA CH>			REL-4
>>>>>Timeslot number	MP		Timeslot number 10.3.6.84		REL-4
>>>>>PRACH Channelisation Code	MP		PRACH Channelisation Code 1.28 Mcps TDD 10.3.6.51a		REL-4
>>>>>Midamble Shift and burst type	MP		Midamble shift and burst type 10.3.6.41		REL-4
>>>>>FPACH info	MP		FPACH info 10.3.6.35a		REL-4

10.3.6.53 PRACH partitioning

Information Element/Group name	Need	Multi	Type and reference	Semantics description
Access Service class	MP	1 to maxASC		If only "NumASC+1" (with, NumASC+1 < maxASC) ASCs are listed, the remaining (NumASC+2 through maxASC) ASCs are unspecified.
>ASC Setting	MD		ASC setting 10.3.6.6	The default values are same as the previous ASC. If the "default" is used for the first ASC, the default values are all available signatures and "all available sub-channels" for FDD and "all available channelisation codes" and "all available subchannels" with "subchannel size=Size 1" in TDD.

10.3.6.54 PRACH power offset

NOTE: Only for FDD.

Information Element/Group name	Need	Multi	Type and reference	Semantics description
Power Ramp Step	MP		Integer (1..8)	Power step when no acquisition indicator is received in dB
Preamble Retrans Max	MP		Integer (1..64)	Maximum number of preambles in one preamble ramping cycle

10.3.6.55 PRACH system information list

Information element	Need	Multi	Type and reference	Semantics description	Version
PRACH system information	MP	1 .. <maxPRA CH>			
>PRACH info	MP		PRACH info (for RACH) 10.3.6.52		
>Transport channel identity	MP		Transport channel identity 10.3.5.18		
>RACH TFS	MD		Transport format set 10.3.5.23	Default value is the value of "RACH TFS" for the previous PRACH in the list NOTE: The first occurrence is then MP). NOTE: For TDD in this release there is a single TF within the RACH TFS.	
>Additional RACH TFS for CCCH	OP		Additional Dynamic Transport Format Information	FDD only	REL-6

Information element	Need	Multi	Type and reference	Semantics description	Version
			for CCCH 10.3.5.2a		
>RACH TFCS	MD		Transport Format Combination Set 10.3.5.20	Default value is the value of "RACH TFCS" for the previous PRACH in the list. NOTE: The first occurrence is then MP). NOTE: For TDD in this release there is no TFCS required.	
>Additional RACH TFCS for CCCH	CV-Add- RACH-TFS		Additional RACH TFCS for CCCH 10.3.5.2b		REL-6
>PRACH partitioning	MD		PRACH partitioning 10.3.6.53	Default value is the value of "PRACH partitioning" for the previous PRACH in the list (note : the first occurrence is then MP)	
>Persistence scaling factors	OP		Persistence scaling factors 10.3.6.48	This IE shall not be present if only ASC 0 and ASC 1 are defined. If this IE is absent, value is the value of "Persistence scaling factors" for the previous PRACH in the list if value exists	
>AC-to-ASC mapping	CV-SIB5- MD		AC-to-ASC mapping 10.3.6.1	Only present in SIB 5 and in SIB 5bis. Default value is the value of "AC-to-ASC mapping" for the previous PRACH in the list. NOTE: The first occurrence is then MP in SIB5 and in SIB5bis.	
>CHOICE <i>mode</i>	MP				
>>FDD					
>>>Primary CPICH TX power	MD		Primary CPICH TX power 10.3.6.61	Default value is the value of "Primary CPICH TX power" for the previous PRACH in the list. NOTE: The first occurrence is then MP.	
>>>Constant value	MD		Constant value 10.3.6.11	Default value is the value of "Constant value" for the previous PRACH in the list. NOTE: The first occurrence is then MP.	
>>>PRACH power offset	MD		PRACH power offset 10.3.6.54	Default value is the value of "PRACH power offset" for the previous PRACH in the list. NOTE: The first occurrence is then MP.	
>>>RACH transmission parameters	MD		RACH transmission parameters 10.3.6.67	Default value is the value of "RACH transmission parameters" for the previous PRACH in the list. NOTE: The first occurrence is then MP.	
>>>AICH info	MD		AICH info 10.3.6.2	Default value is the value of "AICH info" for the previous PRACH in the list. NOTE: The first occurrence is then MP.	
>>TDD				(no data)	

Condition	Explanation
<i>SIB5-MD</i>	The information element is present only in SIB 5 and in SIB5bis. In SIB 5 and in SIB 5bis it is mandatory with default.
<i>Add-RACH-TFS</i>	The information element is MP if the IE "Additional RACH TFS for CCCH" is included. Otherwise the information element is not needed.

NOTE: If the setting of the PRACH information results in that a combination of a signature, preamble scrambling code and subchannel corresponds to a RACH with different TFS and/or TFCS, then for that combination only the TFS/TFCS of the PRACH listed first is valid, where PRACHs listed in System Information Block type 5 or 5bis shall be counted first.

10.3.6.56 Predefined PhyCH configuration

This information element concerns a pre- defined configuration of physical channel parameters.

Information Element/Group name	Need	Multi	Type and Reference	Semantics description
Uplink radio resources				
Uplink DPCH info	MP		Uplink DPCH info Pre 10.3.6.90	
Downlink radio resources				
Downlink information common for all radio links	OP		Downlink information common for all radio links Pre 10.3.6.26	

10.3.6.57 Primary CCPCH info

Information Element/Group name	Need	Multi	Type and reference	Semantics description	Version
CHOICE <i>mode</i>	MP				
>FDD					
>>TX Diversity indicator	MP		Boolean	TRUE indicates that transmit diversity is used.	
>TDD					
>>CHOICE <i>TDD option</i>	MP				REL-4
>>>3.84 and 7.68 Mcps TDD					REL-4
>>>>CHOICE <i>SyncCase</i>	OP				
>>>>>Sync Case 1					
>>>>>>Timeslot	MP		Integer (0..14)	PCCPCH timeslot	
>>>>>>Sync Case 2					
>>>>>>>Timeslot	MP		Integer(0..6)		
>>>1.28 Mcps TDD					REL-4
>>>>TSTD indicator	MP		TSTD indicator 10.3.6.85a		REL-4
>>Cell parameters ID	OP		Cell parameters Id 10.3.6.9	The Cell parameters ID is described in [32].	
>>SCTD indicator	MP		SCTD indicator 10.3.6.70a		

10.3.6.58 Primary CCPCH info post

NOTE: Only for TDD

Information Element/Group name	Need	Multi	Type and reference	Semantics description	Version
CHOICE <i>TDD option</i>	MP				REL-4
>3.84 Mcps TDD					REL-4
>>CHOICE <i>SyncCase</i>	MP				
>>>Sync Case 1					
>>>>Timeslot	MP		Integer (0..14)	PCCPCH timeslot	
>>>Sync Case 2					
>>>>Timeslot	MP		Integer(0..6)		
>7.68 Mcps TDD					REL-7
>>CHOICE <i>SyncCase</i>	MP				REL-7
>>>Sync Case 1					REL-7
>>>>Timeslot	MP		Integer (0..14)	PCCPCH timeslot	REL-7
>>>Sync Case 2					REL-7
>>>>Timeslot	MP		Integer(0..6)		REL-7
>1.28 Mcps TDD					REL-4
>>TSTD indicator	MP		TSTD indicator 10.3.6.85a		REL-4
Cell parameters ID	MP		Cell parameters Id 10.3.6.9	The Cell parameters ID is described in [32].	
SCTD indicator	MP		SCTD indicator 10.3.6.70a		

10.3.6.59 Primary CCPCH TX Power

NOTE: Only for TDD.

Information Element/group name	Need	Multi	Type and reference	Semantics description
Primary CCPCH Tx Power	MP		Integer(6..43)	In dBm

10.3.6.60 Primary CPICH info

NOTE: Only for FDD.

Information Element/Group name	Need	Multi	Type and reference	Semantics description
Primary scrambling code	MP		Integer(0..511)	

10.3.6.61 Primary CPICH Tx power

NOTE: Only for FDD.

Information Element/Group name	Need	Multi	Type and reference	Semantics description
Primary CPICH Tx Power	MP		Integer(-10..50)	Power in dBm.

10.3.6.62 Primary CPICH usage for channel estimation

NOTE: Only for FDD.

Information Element/Group name	Need	Multi	Type and Reference	Semantics description
Primary CPICH usage for channel estimation	MP		Enumerated(Primary CPICH may be used, Primary CPICH shall not be used)	

10.3.6.63 PUSCH info

NOTE: Only for 1.28 Mcps and 3.84 Mcps TDD.

Information Element/Group name	Need	Multi	Type and reference	Semantics description
TFCS ID	MD		Integer(1..8)	Default value is 1
Common timeslot info	OP		Common timeslot info 10.3.6.10	
PUSCH timeslots and codes	OP		Uplink Timeslots and Codes 10.3.6.94	

10.3.6.63a PUSCH info VHCR

NOTE: Only 7.68 Mcps TDD (REL-7).

Information Element/Group name	Need	Multi	Type and reference	Semantics description	Version
TFCS ID	MD		Integer(1..8)	Default value is 1	REL-7
Common timeslot info	OP		Common timeslot info 10.3.6.10		REL-7
PUSCH timeslots and codes VHCR	OP		Uplink Timeslots and Codes VHCR 10.3.6.94b		REL-7

10.3.6.64 PUSCH Capacity Allocation info

NOTE: Only for TDD.

Information Element/Group name	Need	Multi	Type and reference	Semantics description	Version
CHOICE <i>PUSCH allocation</i>	MP				
>PUSCH allocation pending				(no data)	
>PUSCH allocation assignment					
>>PUSCH allocation period info	MP		Allocation Period Info 10.3.6.4		
>>PUSCH power control info	OP		PUSCH power control info 10.3.6.65		
>>CHOICE <i>Configuration</i>	MP				
>>>Old configuration					
>>>>TFCS ID	MD		Integer(1..8)	Default is 1.	
>>>>PUSCH Identity	MP		Integer(1..hiPUSCHidentities)		
>>>New 1.28 Mcps TDD or 3.84 Mcps TDD configuration					
>>>>PUSCH info	MP		PUSCH info 10.3.6.63		
>>>>PUSCH Identity	OP		Integer(1..hiPUSCHidentities)		
>>>New 7.68 Mcps TDD configuration					REL-7
>>>>PUSCH info VHCR	MP		PUSCH info VHCR 10.3.6.63a		REL-7
>>>>PUSCH Identity	OP		Integer(1..hiPUSCHidentities)		REL-7

10.3.6.65 PUSCH power control info

NOTE: Only for TDD.

Interference level measured for a frequency at the UTRAN access point used by UE to set PUSCH output power.

Information Element/Group name	Need	Multi	Type and reference	Semantics description	Version
UL target SIR	MP		Real (-11 .. 20 by step of 0.5 dB)	For 1.28 Mcps TDD this parameter represents PRXPUSCHdes with range Integer(-120...-58 by step of 1) dBm	REL-4
CHOICE TDD option	MP				REL-4
>3.84 Mcps TDD				(no data)	REL-4
>7.68 Mcps TDD				(no data)	REL-7
>1.28 Mcps TDD					REL-4
>>TPC Step Size	OP		Integer (1, 2, 3)	In dB	REL-4

Information Element/Group name	Need	Multi	Type and reference	Semantics description	Version
>>Beacon PL Est.	OP		Enumerated (true)	The presence of this IE indicates that the UE may take into account path loss estimated from beacon function physical channels. The absence indicates that UE may not take into account path loss estimated from beacon function physical channels	REL-6

10.3.6.66 PUSCH system information

NOTE: Only for 1.28 Mcps or 3.84 Mcps TDD.

Information Element/Group name	Need	Multi	Type and reference	Semantics description	Version
PUSCH information	MP	1 to <maxPUSCH>			
>PUSCH Identity	MP		Integer(1..hiPUSCHidentities)		
>PUSCH info	MP		PUSCH info 10.3.6.63		
>SFN Time Info	CH-Block17		SFN Time Info 10.3.6.75		
>USCH TFS	OP		Transport format set 10.3.5.23		
>USCH Transport Channels	OP	1 to <maxTrCH>		If PUSCH is configured for 3.84 Mcps TDD in Rel-5 this IE may be included.	REL-5
>> USCH Transport channel identity	MP		Transport channel identity 10.3.5.18		REL-5
>>USCH TFS	MP		Transport format set 10.3.5.23		REL-5
>USCH TFCS	OP		Transport Format Combination Set 10.3.5.20		

Condition	Explanation
Block17	This IE is not needed in System Information Block 17. Otherwise it is optional.

10.3.6.66a PUSCH system information VHCR

NOTE: Only for 7.68 Mcps TDD (REL-7).

Information Element/Group name	Need	Multi	Type and reference	Semantics description	Version
PUSCH information	MP	1 to <maxPUSCH>			REL-7
>PUSCH Identity	MP		Integer(1..hiPUSCHidentities)		REL-7
>PUSCH info VHCR	MP		PUSCH info VHCR 10.3.6.63 a		REL-7
>SFN Time Info	CH-Block17		SFN Time Info 10.3.6.75		REL-7
>USCH TFS	OP		Transport format set 10.3.5.23		REL-7
>USCH Transport Channels	OP	1 to <maxTrCH>		If PUSCH is configured for 7.68 Mcps TDD in Rel-7 this IE may be included.	REL-7
>> USCH Transport channel identity	MP		Transport channel identity 10.3.5.18		REL-7
>>USCH TFS	MP		Transport format set 10.3.5.23		REL-7
>USCH TFCS	OP		Transport Format Combination Set 10.3.5.20		REL-7

Condition	Explanation
Block17	This IE is not needed in System Information Block 17. Otherwise it is optional.

10.3.6.67 RACH transmission parameters

NOTE: Only for FDD.

Information Element/Group name	Need	Multi	Type and reference	Semantics description
Mmax	MP		Integer(1..32)	Maximum number of preamble cycles
NB01min	MP		Integer(0..50)	Sets lower bound for random back-off
NB01max	MP		Integer(0..50)	Sets upper bound for random back-off

10.3.6.68 Radio link addition information

Information Element/Group name	Need	Multi	Type and reference	Semantics description	Version
Primary CPICH info	MP		Primary CPICH info 10.3.6.60		
Cell ID	OP		Cell ID 10.3.2.2		REL-4
CHOICE DPCH info	MP				REL-6

Information Element/Group name	Need	Multi	Type and reference	Semantics description	Version
>Downlink DPCH info for each RL	MP		Downlink DPCH info for each RL 10.3.6.21		
>Downlink F-DPCH info for each RL	MP		Downlink F-DPCH info for each RL 10.3.6.23ob		REL-6
E-HICH Information	OP		E-HICH Info 10.3.6.101		REL-6
E-RGCH Information	OP		E-RGCH Info 10.3.6.102		REL-6

10.3.6.69 Radio link removal information

Information Element/Group name	Need	Multi	Type and reference	Semantics description
Primary CPICH info	MP		Primary CPICH info 10.3.6.60	

10.3.6.69a E-DCH reconfiguration information

NOTE: Only for FDD.

Information Element/Group name	Need	Multi	Type and reference	Semantics description	Version
E-DCH RL Info new serving cell	OP				REL-6
>Primary CPICH info	MP		Primary CPICH info 10.3.6.60	Indicates scheduling E-DCH cell from the active set cells.	REL-6
>E-AGCH Info	MP		E-AGCH Info 10.3.6.100		REL-6

Information Element/Group name	Need	Multi	Type and reference	Semantics description	Version
>Serving Grant	OP				REL-6
>>Serving Grant value	OP		Integer (0..37,38)	(0..37) indicates E-DCH serving grant index as defined in [15]; index 38 means zero grant.	REL-6
>>Primary/Secondary Grant Selector	MP		Enumerated ("primary", "secondary")	Indicates whether the Serving Grant is received with a Primary E-RNTI or Secondary E-RNTI.	REL-6
>E-DPCCH/DPCCH power offset	OP		Integer (0..8)	Refer to quantization of the power offset in [28].	REL-6
>Reference E-TFCIs	OP	1 to 8		See [29].	REL-6
>>Reference E-TFCI	MP		Integer (0..127)		REL-6
>>>Reference E-TFCI PO	MP		Integer (0..29, 30, 31)	Refer to quantization of the power offset in [28]. Values 30 and 31 are only used for E-TFCI > ETFCI Boost	REL-6 REL-7
>Power Offset for Scheduling Info	OP		Integer (0..6)	Only used when no MACd PDU's are included in the same MACe PDU. Unit is in dB.	REL-6
>3-Index-Step Threshold	OP		Integer (0..37)	Refers to an index in the "SG-Table" (see [15]). NOTE 1	REL-6
>2-Index-Step Threshold	OP		Integer (0..37)	Refers to an index in the "SG-Table" (see [15]). NOTE 1	REL-6
>E-HICH Information	OP		E-HICH Info 10.3.6.101	This IE is not present if the serving E-DCH cell is added to the active set with this message.	REL-6
>CHOICE E-RGCH Information	OP			This IE is not present if the serving E-DCH cell is added to the active set with this message	REL-6
>>E-RGCH Information	MP		E-RGCH Info 10.3.6.102		REL-6
>>>E-RGCH release indicator				(no data)	REL-6
E-DCH RL Info other cells	OP	1 to <maxEDC HRL>		This IE is not allowed to include information on a RL added by this message	REL-6
>Primary CPICH info	MP		Primary CPICH info 10.3.6.60		REL-6
>CHOICE E-HICH Information	OP				REL-6

Information Element/Group name	Need	Multi	Type and reference	Semantics description	Version
>>E-HICH Information	MP		E-HICH Info 10.3.6.101		REL-6
>>E-HICH release indicator				(no data)	REL-6
>CHOICE E-RGCH Information	OP				REL-6
>>E-RGCH Information	MP		E-RGCH Info 10.3.6.102		REL-6
>>E-RGCH release indicator				(no data)	REL-6
NOTE 1: If the 3-index-Step Threshold value is greater than 2-index-Step Threshold, the UE behaviour is unspecified.					

10.3.6.69b E-DCH reconfiguration information same serving cell

NOTE: Only for FDD.

Information Element/Group name	Need	Multi	Type and reference	Semantics description	Version
E-DPCCH/DPCCH power offset	OP		Integer (0..8)	This IE is not present if the serving E-DCH cell is changed with this message. Refer to quantization of the power offset in [28].	REL-7
Reference E-TFCIs	OP	1 to 8		This IE is not present if the serving E-DCH cell is changed with this message. See [29].	REL-7
>Reference E-TFCI	MP		Integer (0..127)		REL-7
>Reference E-TFCI PO	MP		Integer (0..29,	Refer to quantization of the power offset in [28].	REL-7
			30, 31)	Values 30 and 31 are only used for E-TFCI > ETFCI Boost	REL-7

10.3.6.70 Void

10.3.6.70a SCTD indicator

NOTE: Only for TDD

Information Element/Group name	Need	Multi	Type and reference	Semantics description
SCTD indicator	MP		Boolean	TRUE indicates that SCTD is used

10.3.6.71 Secondary CCPCH info

Information Element/Group name	Need	Multi	Type and reference	Semantics description	Version
CHOICE <i>mode</i>	MP				
>FDD					
>>Secondary scrambling code	OP		Secondary scrambling code 10.3.6.74	May only be sent for SCCPCH channels not carrying the PCH.	
>>STTD indicator	MP		STTD Indicator 10.3.6.78		
>>Spreading factor	MP		Integer(4, 8, 16, 32, 64, 128, 256)		
>>Code number	MP		Integer(0..Spreading factor - 1)		
>>Pilot symbol existence	MP		Boolean	TRUE means the existence.	
>>TFCI existence	MP		Boolean	TRUE indicates that TFCI is used. When spreading factor is less than or equal to 64, FALSE indicates that TFCI is not used and therefore DTX is used in the TFCI field.	
>>Fixed or Flexible Position	MP		Enumerated (Fixed, Flexible)		
>>Timing Offset	MD		Integer(0..38144 by step of 256)	Chip Delay of the Secondary CCPCH relative to the Primary CCPCH. Default value is 0.	
>1.28 Mcps TDD or 3.84 Mcps TDD					
>>Offset	MP		Integer (0..Repetition Period - 1)	SFN modulo Repetition period = offset. Repetition period is the one indicated in the accompanying Common timeslot info IE	
>>Common timeslot info	MP		Common		

Information Element/Group name	Need	Multi	Type and reference	Semantics description	Version
			timeslot info 10.3.6.10		
>>Individual timeslot info	MP		Individual timeslot info 10.3.6.37		
>>Code List	MP	1 to 16			
>>>Channelisation Code	MP		Enumerated((16/1)..(16/16))		
>7.68 Mcps TDD					REL-7
>>Offset	MP		Integer (0...Repetition Period -1)	SFN modulo Repetition period = offset. Repetition period is the one indicated in the accompanying Common timeslot info IE	REL-7
>>Common timeslot info	MP		Common timeslot info 10.3.6.10		REL-7
>>Individual timeslot info	MP		Individual timeslot info 10.3.6.37		REL-7
>>Code List	MP	1 to 32			REL-7
>>>Channelisation Code	MP		Enumerated((32/1)..(32/32))		REL-7

10.3.6.71a Secondary CCPCH info MBMS

Information Element/Group name	Need	Multi	Type and reference	Semantics description	Version
CHOICE <i>mode</i>	MP				REL-6
>FDD					REL-6
>>Secondary scrambling code	OP		Secondary scrambling code 10.3.6.74	May only be sent for SCCPCH channels not carrying the PCH.	REL-6
>>STTD indicator	MP		STTD Indicator 10.3.6.78		REL-6
>>Spreading factor	MP		Integer(4, 8, 16, 32, 64, 128, 256)		REL-6
>>Code number	MP		Integer(0..Spreading factor – 1)		REL-6
>>Timing Offset	MD		Integer(0..38144 by step of 256)	Chip Delay of the Secondary CCPCH relative to the Primary CCPCH. Default value is 0.	REL-6
>>CHOICE Modulation	CV-MBSFN				REL-7
>>>QPSK	MP			(no data)	REL-7
>>>16QAM	MP				REL-7
>>>>CPICH secondary CCPCH power offset	MP		Integer(-11..4)		REL-7
>1.28/3.84 Mcps TDD					REL-6
>> Common timeslot info MBMS	MP		Common timeslot info MBMS 10.3.6.10a	Interleaving mode, TFCI coding and puncturing limit for Secondary CCPCH info MBMS	REL-6
>>Downlink Timeslots and Codes	MP		Downlink timeslots and codes 10.3.6.32	One or more timeslots and codes for S-CCPCH supporting MBMS MTCH	REL-6
>> MBSFN Special Time Slot	OP		Time Slot LCR Extension 10.3.6.83a	For 1.28 Mcps TDD MBSFN only mode, this IE indicates the SCCPCH is deployed on the MBSFN Special Time Slot [30]. The IE 'Timeslot number' in 'Downlink Timeslots and Codes' shall be ignored if this IE appears.	REL-7
>>Modulation	MP		Enumerated (QPSK, 16QAM)		REL-7
>7.68 Mcps TDD					REL-7
>>Common timeslot info MBMS	MP		Common timeslot info MBMS 10.3.6.10a	Interleaving mode, TFCI coding and puncturing limit for Secondary CCPCH info MBMS	REL-7
>>Downlink Timeslots and Codes VHCR	MP		Downlink timeslots and codes VHCR 10.3.6.32a	One or more timeslots and codes for S-CCPCH supporting MBMS MTCH	REL-7

Information Element/Group name	Need	Multi	Type and reference	Semantics description	Version
>>Modulation	MP		Enumerated (QPSK, 16QAM)		REL-7

Condition	Explanation
<i>MBSFN</i>	This IE is mandatory present when the cell on which this IE is sent is operating in MBSFN mode according to subclause 8.1.1.6.3. Otherwise the IE is not needed.

NOTE: For FDD, the S-CCPCH signalled in this IE is always configured with flexible position, TFCI is always present and pilot is always absent.

10.3.6.71b Secondary CCPCH info MBMS Diff

Information Element/Group name	Need	Multi	Type and reference	Semantics description	Version
Secondary scrambling code	OP		Secondary scrambling code 10.3.6.74	May only be sent for SCCPCH channels not carrying the PCH.	REL-7
STTD indicator	MP		STTD Indicator 10.3.6.78		REL-7
Spreading factor	OP		Integer(4, 8, 16, 32, 64, 128, 256)		REL-7
Code number	OP		Integer(0..Spreading factor – 1)		REL-7
Timing Offset	OP		Integer(0..38144 by step of 256)	Chip Delay of the Secondary CCPCH relative to the Primary CCPCH.	REL-7

NOTE: For FDD, the S-CCPCH signalled in this IE is always configured with flexible position, TFCI is always present and pilot is always absent.

10.3.6.72 Secondary CCPCH system information

Information element	Need	Multi	Type and reference	Semantics description	Version
Secondary CCPCH system information list	MP	1 to <maxSCC PCH>			
>Secondary CCPCH info	MP		Secondary CCPCH info 10.3.6.71	Note 1	
>TFCS	MD		Transport format combination set 10.3.5.20	For FACHs and PCH Default value is the value of "TFCS" for the previous SCCPCH in the list. NOTE: The first occurrence is then MP.	
>FACH/PCH information list	MD	1 to <maxFAC HPCH>		Default value is the value of "FACH/PCH" for the previous SCCPCH in the list. NOTE: The first occurrence is then MP.	
>>TFS	MP		Transport format set 10.3.5.23	For each FACH and PCH Note 2	
>>Transport channel identity	MP		Transport channel identity 10.3.5.18		
>>CTCH indicator	MP		Boolean	The value TRUE indicates that a CTCH is mapped on the FACH, and FALSE that no CTCH is mapped.	
>PICH info	OP		PICH info 10.3.6.49	PICH info is present only when PCH is multiplexed on Secondary CCPCH	
MCCH configuration information	CV-SIB type 5		MCCH configuration information 10.3.9a.13	Included if MCCH is on an S-CCPCH used also for Non-MBMS Note 3	REL-6

NOTE 1: The secondary CCPCHs carrying a PCH shall be listed first.

NOTE 2: TFS for PCH shall be the first "FACH/PCH information" in the list if a PCH exists for the respective secondary CCPCH.

NOTE 3: If the IE "MCCH configuration information is included", it applies to the last S-CCPCH in the IE "Secondary CCPCH system information list" and to the last FACH included in the IE "FACH/PCH information list".

Condition	Explanation
SIB type 5	The IE is optional if the IE "Secondary CCPCH system information" is included in the SIB type 5 or 5bis, otherwise the IE is not needed in the message

10.3.6.72a Secondary CCPCH system information MBMS

Information element	Need	Multi	Type and reference	Semantics description	Version
Secondary CCPCH system information	MP			An S-CCPCH carrying MCCH and possibly also MTCH and MSCH	REL-6
>Secondary CCPCH info MBMS	MP		Secondary CCPCH info MBMS 10.3.6.71a		REL-6
>TFCS	MP		Transport format combination set 10.3.5.20		REL-6
>FACH carrying MCCH	MP				REL-6
>>TFS	MP		Transport format set 10.3.5.23		REL-6
>>MCCH configuration information	MP		MCCH configuration information 10.3.9a.13		REL-6
>FACH carrying MTCH list	OP	1 to <maxFAC HPCH>			REL-6
>>TFS	MP		Transport format set 10.3.5.23		REL-6
>Scheduling information	OP				REL-6
>>FACH carrying MSCH	MP		Transport format set 10.3.5.23	Transport channel carrying MSCH	REL-6

10.3.6.73 Secondary CPICH info

NOTE: Only for FDD.

Information Element/Group name	Need	Multi	Type and reference	Semantics description
Secondary scrambling code	MD		Secondary scrambling code 10.3.6.74	Default is the same scrambling code as for the Primary CPICH
Channelisation code	MP		Integer(0..255)	SF=256

10.3.6.74 Secondary scrambling code

Information Element/Group name	Need	Multi	Type and reference	Semantics description
Secondary scrambling code	MP		Integer(1..15)	

10.3.6.74a Serving HS-DSCH cell information

Information Element/Group name	Need	Multi	Type and reference	Semantics description	Version
Δ_{ACK}	OP		Integer(0..8)	Refer to quantization of the power offset in [28]	REL-6
Δ_{NACK}	OP		Integer(0..8)	Refer to quantization of the power offset in [28]	REL-6
HARQ_preamble_mode	MP		Integer(0, 1)	1 indicates that preamble and postamble are used on the HS-DPCCH – see [29]	REL-6
Primary CPICH info	OP		Primary CPICH info 10.3.6.60	Indicate the new HS-DSCH serving cell	REL-6
Downlink HS-PDSCH Information	OP		Downlink HS_PDSCH Information 10.3.6.23a		REL-6
HARQ Info	OP		HARQ info 10.3.5.7a		REL-6
MAC-hs reset indicator	OP		Enumerated (true)	TRUE Indicates the MAC-hs/ehs entity needs to be reset.	REL-6

10.3.6.75 SFN Time info

Information Element/Group name	Need	Multi	Type and reference	Semantics description
Activation time SFN	MP		Integer (0..4095)	System frame number start of the physical channel existence.
Duration	MP		Integer(1..4096)	Total number of frames the physical channel will exist.

10.3.6.75a Special Burst Scheduling

NOTE: Only for TDD.

Information Element/Group name	Need	Multi	Type and reference	Semantics description
Special Burst Generation Period	MP		Integer (0..7)	Value represents number of radio frames 0 = 2 frames, 1 = 4 frames, 2 = 8 frames, 3 = 16 frames, 4 = 32 frames, 5 = 64 frames, 6 = 128 frames, 7 = 256 frames

10.3.6.76 Void

10.3.6.77 Void

10.3.6.78 STTD indicator

NOTE: Only for FDD

Indicates whether STTD is used or not.

Information Element/Group name	Need	Multi	Type and reference	Semantics description
STTD Indicator	MP		Boolean	TRUE means that STTD is used

10.3.6.78o SYNC_UL codes bitmap

NOTE: Only for 1.28 Mcps TDD.

Information Element/ Group name	Need	Multi	Type and reference	Semantics description	Version
SYNC_UL codes bitmap	MP		Bitstring(8)	Each bit indicates availability of a SYNC_UL code, where the SYNC_UL codes are numbered "code 0" to "code 7". The value 1 of a bit indicates that the corresponding SYNC_UL code can be used. The value 0 of a bit indicates that the corresponding SYNC_UL code can not be used.	REL-7

10.3.6.78a SYNC_UL info

NOTE: Only for 1.28 Mcps TDD.

Information Element/ Group name	Need	Multi	Type and reference	Semantics description	Version
SYNC_UL codes bitmap	MP		SYNC_UL codes bitmap 10.3.6.78o		REL-4
$PRX_{UpPCHdes}$	MP		Integer(-120...-58 by step of 1)	In dBm	REL-4
Power Ramp Step	MP		Integer(0,1,2,3)	In dB	REL-4
Max SYNC_UL Transmissions	MP		Integer(1,2,4,8)	Maximum numbers of SYNC_UL transmissions in a power ramping sequence.	REL-4
Mmax	MP		Integer(1..32)	Maximum number of synchronisation attempts.	REL-4
E-RUCCH SYNC_UL codes bitmap	MP		SYNC_UL codes bitmap 10.3.6.78o		REL-7

10.3.6.78b TDD MBSFN Information

NOTE: Only for TDD

This information indicates which timeslots are assigned to TDD MBSFN and the scrambling codes assigned to each timeslot.

Information Element/Group name	Need	Multi	Type and reference	Semantics description	Version
Time slot list	MP	1.. <maxTS>			REL-7
>Timeslot Number	MP		Timeslot Number 10.3.6.84		REL-7
>Cell parameters ID	MP		Cell parameters Id 10.3.6.9		REL-7

10.3.6.78c LCR TDD MBSFN Information

NOTE: Only for 1.28Mcps TDD

This information indicates which timeslots of the secondary frequency of a multi-frequency cell are assigned to 1.28Mcps TDD MBSFN and the scrambling codes related to each timeslot.

Information Element/Group name	Need	Multi	Type and reference	Semantics description	Version
Time slot info list	MP	1 to <maxMBS FNclusters >			REL-7
>Frequency index	MP		Integer (1..<maxMB SFNclusters >)	For 1.28 Mcps TDD index pointing to a frequency indicated in the SIB 11.	REL-7
>Time slot list	MP	1 to <maxTS>			REL-7
>>Timeslot Number	MP		Timeslot Number 10.3.6.84		REL-7
>>>Cell parameters ID	MP		Cell parameters Id 10.3.6.9		REL-7

10.3.6.78d SYNC_UL info for E-RUCCH

NOTE: Only for 1.28 Mcps TDD.

Information Element/Group name	Need	Multi	Type and reference	Semantics description	Version
PRXUpPCHdes	CV-Synchronisation parameters		Integer(-120...-58 by step of 1)	In dBm	Rel-7
Power Ramp Step	CV-Synchronisation parameters		Integer(0,1,2,3)	In dB	Rel-7
Max SYNC_UL Transmissions	CV-Synchronisation parameters		Integer(1,2,4,8)	Maximum numbers of SYNC_UL transmissions in a power ramping sequence.	Rel-7
Mmax	MP		Integer(1..32)	Maximum number of synchronisation attempts.	Rel-7
E-RUCCH SYNC_UL codes bitmap	MP		SYNC_UL codes bitmap 10.3.6.78o		Rel-7

Condition	Explanation
Synchronisation parameters	This IE is mandatory present if the IE "Synchronisation parameters" does not exist, Otherwise it is not needed.

10.3.6.79 TDD open loop power control

This information element contains parameters for open loop power control setting for TDD.

Information Element/Group name	Need	Multi	Type and reference	Semantics description	Version
Primary CCPCH Tx Power	MP		Primary CCPCH Tx Power 10.3.6.59	For path loss calculation	
CHOICE <i>TDD option</i>	MP				REL-4
>3.84 Mcps TDD					REL-4
>>Alpha	OP		Alpha 10.3.6.5		
>>PRACH Constant Value	MP		Constant Value TDD 10.3.6.11a	Operator controlled PRACH Margin	
>>DPCH Constant Value	MP		Constant Value TDD 10.3.6.11a	Operator controlled UL DPCH Margin	
>>PUSCH Constant Value	OP		Constant Value TDD 10.3.6.11a	Operator controlled PUSCH Margin	
>>UE positioning related parameters	CV- <i>IPDLs</i>				REL-4
>>>IPDL-Alpha	MP		Alpha 10.3.6.5		REL-4
>>>Max power increase	MP		Integer (0..3)	In db	REL-4
>7.68 Mcps TDD					REL-7
>>Alpha	OP		Alpha 10.3.6.5		REL-7
>>PRACH Constant Value	MP		Constant Value TDD 10.3.6.11a	Operator controlled PRACH Margin	REL-7
>>DPCH Constant Value	MP		Constant Value TDD	Operator controlled UL	REL-7

Information Element/Group name	Need	Multi	Type and reference	Semantics description	Version
>>PUSCH Constant Value	OP		10.3.6.11a Constant Value TDD 10.3.6.11a	DPCH Margin Operator controlled PUSCH Margin	REL-7
>>UE positioning related parameters	CV- <i>IPDLs</i>				REL-7
>>>IPDL-Alpha	MP		Alpha 10.3.6.5		
>>>Max power increase	MP		Integer (0..3)	In db	REL-7
>1.28 Mcps TDD				(no data)	REL-4

Condition	Explanation
<i>IPDLs</i>	This IE is present only if idle periods are applied

10.3.6.80 TFC Control duration

Information Element/Group name	Need	Multi	Type and reference	Semantics description
TFC Control duration	MP		Integer (1, 2, 4, 8, 16, 24, 32, 48, 64, 128, 192, 256, 512)	Defines the period in multiples of 10 ms frames for which the defined TFC sub-set is to be applied.

10.3.6.81 Void

10.3.6.82 TGPSI

Information Element/Group name	Need	Multi	Type and reference	Semantics description
TGPSI	MP		Integer(1..MaxTGPS)	Transmission Gap Pattern Sequence Identifier Establish a reference to the compressed mode pattern sequence. Up to <MaxTGPS> simultaneous compressed mode pattern sequences can be used.

10.3.6.83 Time info

Information Element/Group name	Need	Multi	Type and reference	Semantics description
Activation time	MD		Activation time 10.3.3.1	Frame number start of the physical channel existence. Default value is "Now"
Duration	MD		Integer(1..4096, infinite)	Total number of frames the physical channel will exist. Default value is "infinite".

10.3.6.83a Time Slot LCR Extension

IE/Group Name	Presence	Range	IE Type and Reference	Semantics Description
Time Slot LCR Extension			ENUMERATED (TS7, ...)	TS7 indicates the MBSFN Special Timeslot for 1.28 Mcps TDD MBSFN Dedicated Carrier. Three spare values are reserved.

10.3.6.84 Timeslot number

Information Element/Group name	Need	Multi	Type and reference	Semantics description	Version
CHOICE <i>TDD option</i>	MP				REL-4
>3.84 Mcps TDD					REL-4
>>Timeslot number	MP		Integer(0..14)	Timeslot within a frame	
>7.68 Mcps TDD					REL-7
>>Timeslot number	MP		Integer(0..14)	Timeslot within a frame	REL-7
>1.28 Mcps TDD					REL-4
>>Timeslot number	MP		Integer(0..6)	Timeslot within a subframe	REL-4

10.3.6.85 TPC combination index

NOTE: Only for FDD.

Information Element/Group name	Need	Multi	Type and reference	Semantics description	Version
TPC combination index	MP		Integer(0..5)	Radio links with the same index have TPC bits, which for the UE are known to be the same.	
				Radio links that are part of the E-DCH active set and with the same index have acknowledgement feedback signals on the E-HICH which for the UE are known to be the same.	REL-6

10.3.6.85a TSTD indicator

NOTE: Only for 1.28 Mcps TDD.

Information Element/Group name	Need	Multi	Type and reference	Semantics description	Version
TSTD indicator	MD		Boolean	Default value is TRUE	REL-4

10.3.6.86 TX Diversity Mode

NOTE: Only for FDD.

Information Element/Group name	Need	Multi	Type and reference	Semantics description
Tx diversity Mode	MP		Enumerated (none, STTD, closed loop mode1)	

10.3.6.86o UL 16QAM configuration

NOTE: Only for FDD.

Information Element/Group name	Need	Multi	Type and reference	Semantics description	Version
UL 16QAM settings	CV- <i>2msTTI</i>		UL 16QAM settings 10.3.6.86a	Presence of this IE indicates that the UE should operate in 16QAM mode; absence indicates that the UE is not to operate in 16QAM mode. See Note 2.	REL-7
MAC-es/e reset indicator	OP		Enumerated (true)	TRUE Indicates the MAC-es/e entity needs to be reset.	REL-7
E-TFCI table index	OP		Integer (0..1)	Indicates which standardised E-TFCI TB size table shall be used. See Note 1.	REL-7
NOTE 1: If the UE is operating in 16QAM mode, the value of "E-TFCI table index" is increased by 2, and indices in the SG-Table refer to Scheduling Grant Table 2 in [15].					
NOTE 2: If this IE is not present, the indices signaled on the E-AGCH refer to the Mapping of Absolute Grant Value Table 16B in [27].					

Condition	Explanation
<i>2msTTI</i>	This IE is present only if 2ms TTI is configured, otherwise it is not needed.

10.3.6.86a UL 16QAM settings

Information Element/Group name	Need	Multi	Type and reference	Semantics description	Version
BetaEd gain E-AGCH table selection	MP		Integer (0..1)	The value 0 indicates that the indices signaled on the E-AGCH refer to the Mapping of Absolute Grant Value Table 16B in [27], and the value 1 indicates Mapping using Absolute Grant Value Table 16B.1 in [27].	REL-7

10.3.6.87 UL interference

Information Element/Group name	Need	Multi	Type and reference	Semantics description
UL interference	MP		Integer (-110..-70)	In dBm

NOTE: In TDD, this IE is a timeslot specific value.

10.3.6.87a UL interference TDD

NOTE: Only for TDD.

Information Element/Group name	Need	Multi	Type and reference	Semantics description
TDD UL interference	MP		Integer (-110..-52)	In dBm

NOTE: This IE is a timeslot specific value.

10.3.6.88 Uplink DPCH info

Information Element/Group name	Need	Multi	Type and reference	Semantics description	Version
Uplink DPCH power control info	OP		Uplink DPCH power control info 10.3.6.91		
CHOICE <i>mode</i>	MP				
>FDD					
>>Scrambling code type	MP		Enumerated(short, long)		
>>Scrambling code number	MP		Integer(0..16777215)		
>>Number of DPDCH	MD		Integer(1..maxDPDCH-UL, 0)	Default value is 1. Number of DPDCH is 1 in HANDOVER TO UTRAN COMMAND. Value 0 may only be used if target configuration has no uplink DPDCH.	REL-6
>>Spreading factor	CV- DPDCH present		Integer(4, 8, 16, 32, 64, 128, 256)	Minimum allowed SF of the channelisation code for data part	
>>TFCI existence	MP		Boolean	TRUE means existence.	
>>Number of FBI bits	OP		Integer (1, 2)	In bits.	
>>Number of TPC bits	CV- Neither TFCI nor FBI present		Integer (4)	In bits	REL-7
>>Puncturing Limit	CV- DPDCH present		Real(0.40 ..1 by step of 0.04)		
>TDD					
>>Uplink Timing Advance Control	OP		Uplink Timing Advance Control 10.3.6.96		
>>UL CCH List	OP	1 to <maxCC TrCH>		UL physical channels to establish or reconfigure list.	
>>>TFCS ID	MD		Integer(1..8)	Default value is 1.	
>>>UL target SIR	MP		Real (-11 .. 20 by step of 0.5dB)	In dB For 1.28 Mcps TDD this parameter represents PRX _{DPCHdes} with range Integer(-120...-58 by step of 1) dBm	REL-4
>>>Time info	MP		Time info 10.3.6.83		
>>>Common timeslot info	MD		Common timeslot info 10.3.6.10	Default is the current Common timeslot info	

Information Element/Group name	Need	Multi	Type and reference	Semantics description	Version
>>> CHOICE TDD option					REL-7
>>>> 3.84 Mcps TDD					REL-7
>>>>>Uplink DPCH timeslots and codes	MD		Uplink Timeslots and Codes 10.3.6.94	Default is to use the old timeslots and codes.	
>>>>>7.68 Mcps TDD					REL-7
>>>>>Uplink DPCH timeslots and codes VHCR	MD		Uplink Timeslots and Codes VHCR 10.3.6.94 b	Default is to use the old timeslots and codes	REL-7
>>>>> 1.28 Mcps TDD					REL-7
>>>>>Uplink DPCH timeslots and codes LCR	MD		Uplink Timeslots and Codes LCR 10.3.6.94 a	Default is to use the old timeslots and codes.	REL-7
>>UL CCTrCH List to Remove	OP	1..<max CCTrCH >		UL physical channels to remove list	
>>>TFCS ID	MP		Integer(1..8)		

Condition	Explanation
<i>DPDCHpresent</i>	This IE is mandatory if the target configuration includes a DPDCH, otherwise it is not needed.
<i>Neither TFCI nor FBI present</i>	This IE is optional if the IE "TFCI existence" is set to FALSE and the IE "Number of FBI bits" is not present, otherwise it is not needed.

10.3.6.89 Uplink DPCH info Post

Information Element/Group name	Need	Multi	Type and reference	Semantics description	Version
Uplink DPCH power control info	MP		Uplink DPCH power control info Post 10.3.6.92		
CHOICE <i>mode</i>	MP				
>FDD					
>>Scrambling code type	MP		Enumerated(short, long)		
>>>Reduced scrambling code number	MP		Integer(0..81 91)	Sub-range of values for initial use upon handover to UTRAN.	
>>>Spreading factor	MP		Integer(4, 8, 16, 32, 64, 128, 256)	SF of the channelisation code for data part There is only one DPDCH for this case	
>1.28 Mcps TDD and 3.84 Mcps TDD					
>>Uplink Timing Advance Control	OP		Uplink Timing Advance Control 10.3.6.96		
>>Uplink DPCH timeslots and codes	MP		Uplink Timeslots and Codes 10.3.6.94		
>7.68 Mcps TDD					REL-7
>>Uplink Timing Advance Control	OP		Uplink Timing Advance Control 10.3.6.96		REL-7
>>Uplink DPCH timeslots and codes	MP		Uplink Timeslots and Codes VHCR 10.3.6.94b		REL-7

10.3.6.90 Uplink DPCH info Pre

Information Element/Group name	Need	Multi	Type and reference	Semantics description	Version
Uplink DPCH power control info	OP		Uplink DPCH power control info Pre 10.3.6.93		
CHOICE <i>mode</i>	MP				
>FDD					
>>TFCI existence	MP		Boolean	TRUE means existence. Default value is TRUE See NOTE 1.	
>>Number of TPC bits	CV-No TFCI		Integer (4)	In bits	REL-7
>>Puncturing Limit	MP		Real(0.40 ..1 by step of 0.04)		
>TDD					
>>Common timeslot info	MP		Common Timeslot Info 10.3.6.10		

NOTE 1: Number of FBI bits is not signalled but 0 is implied as transmit diversity cannot be setup here.

Condition	Explanation
Single	This IE is mandatory present if the IE "Number of DPDCH" is "1" and not needed otherwise.
No TFCI	This IE is optional if the IE "TFCI existence" is set to FALSE, otherwise it is not needed.

10.3.6.91 Uplink DPCH power control info

Parameters used by UE to set DPCH initial output power and to use for closed-loop power control in FDD and 1.28 Mcps TDD and parameters for uplink open loop power control in 3.84 Mcps TDD and 7.68 Mcps TDD.

Information Element/Group name	Need	Multi	Type and reference	Semantics description	Version
CHOICE <i>mode</i>	MP				
>FDD					
>>DPCCH Power offset	MP		Integer(-164,..-6 by step of 2)	In dB	
>>PC Preamble	MP		Integer (0..7)	In number of frames	
>>SRB delay	MP		Integer(0..7)	In number of frames	
>>Power Control Algorithm	MP		Enumerated (algorithm 1, algorithm 2)	Specifies algorithm to be used by UE to interpret TPC commands	
>>TPC step size	CV- <i>algo</i>		Integer (1, 2)	In dB	
>> Δ_{ACK}	OP		Integer (0..8)	Refer to quantization of the power offset in [28]	REL-5
>> Δ_{NACK}	OP		Integer (0..8)	refer to quantization of the power offset in	REL-5

Information Element/Group name	Need	Multi	Type and reference	Semantics description	Version
				[28]	
>>Ack-Nack repetition factor	OP		Integer(1..4)		REL-5
>>HARQ_preamble_mode	MP		Integer (0, 1)	1 indicates that preamble and postamble are used on the HS-DPCCH – see [29]	REL-6
>TDD					
>>>>UL target SIR	OP		Real (-11 .. 20 by step of 0.5dB)	In dB For 1.28 Mcps TDD this parameter represents PRX _{DPCHdes} with range Integer(-120...-58 by step of 1) dBm	REL-4
>>CHOICE <i>UL OL PC info</i>	MP				
>>>Broadcast UL OL PC info			Null	No data	
>>>Individually Signalled	OP				
>>>>CHOICE <i>TDD option</i>	MP				REL-4
>>>>>3.84 Mcps TDD					REL-4
>>>>>>Individual timeslot interference info	MP	1 to <maxTS>			
>>>>>>>Individual timeslot interference	MP		Individual timeslot interference 10.3.6.38		
>>>>>>>DPCH Constant Value	OP		Constant Value TDD 10.3.6.11a	Quality Margin	
>>>>>>>7.68 Mcps TDD					REL-7
>>>>>>>>Individual timeslot interference info	MP	1 to <maxTS>			REL-7
>>>>>>>>>Individual timeslot interference	MP		Individual timeslot interference 10.3.6.38		REL-7
>>>>>>>>>>DPCH Constant Value	OP		Constant Value TDD 10.3.6.11a	Quality Margin	REL-7
>>>>>>>>>>>1.28 Mcps TDD					REL-4
>>>>>>>>>>>>Beacon PL Est.	CV-houtran		Enumerated (true)	The presence of this IE indicates that the UE may take into account path loss estimated from beacon function physical channels. The absence indicates that UE may not take into account path loss estimated from beacon function physical channels	REL-6
>>>>>>>>>>>>>TPC step size	MP		Integer(1,2,3)		REL-4
>>>>>>>>>>>>>>Primary CCPCH Tx Power	OP		Primary CCPCH Tx Power 10.3.6.59	For Pathloss Calculation	

Condition	Explanation
<i>algo</i>	The IE is mandatory present if the IE "Power Control Algorithm" is set to "algorithm 1", otherwise the IE is not needed
<i>houtran</i>	This IE is optional in Cell Update Confirm, Physical Channel Reconfiguration, Radio Bearer Reconfiguration, Radio Bearer Release, Radio Bearer Setup, Transport Channel Reconfiguration and Uplink Physical Channel Control. The IE is not included in the Handover To UTRAN Command

10.3.6.92 Uplink DPCH power control info Post

Parameters used by UE to set DPCH initial output power and to use for closed-loop power control.

Information Element/Group name	Need	Multi	Type and reference	Semantics description	Version
CHOICE <i>mode</i>	MP				
>FDD					
>>DPCCH Power offset	MP		Integer(-110..-50 by step of 4)	In dB	
>>PC Preamble	MP		Integer (0..7)	in number of frames	
>>SRB delay	MP		Integer (0..7)	In number of frames	
>TDD					
>>UL target SIR	MP		Real (-11 .. 20 by step of 0.5dB)	In dB For 1.28 Mcps TDD this parameter represents PRX _{DPCHdes} with range Integer(-120...-58 by step of 1) dBm	REL-4
>>CHOICE <i>TDD option</i>	MP				REL-4
>>>3.84 Mcps TDD					REL-4
>>>>UL Timeslot Interference	MP		UL Interference TDD 10.3.6.87a		
>>>>7.68 Mcps TDD					REL-7
>>>>UL Timeslot Interference	MP		UL Interference TDD 10.3.6.87a		REL-7
>>>>1.28 Mcps TDD				(no data)	REL-4

Condition	Explanation
<i>algo</i>	The IE is mandatory present if the IE "Power Control Algorithm" is set to "algorithm 1", otherwise the IE is not needed

10.3.6.93 Uplink DPCH power control info Pre

Parameters used by UE to set DPCH initial output power and to use for closed-loop power control in FDD and parameters for uplink open loop power control in 3.84 Mcps TDD and 7.68 Mcps TDD.

Information Element/Group name	Need	Multi	Type and reference	Semantics description	Version
CHOICE <i>mode</i>	MP				

Information Element/Group name	Need	Multi	Type and reference	Semantics description	Version
>FDD					
>>Power Control Algorithm	MP		Enumerated (algorithm 1, algorithm 2)	Specifies algorithm to be used by UE to interpret TPC commands	
>>TPC step size	<i>CV-algo</i>		Integer (1, 2)	In dB	
>TDD				(No data)	
>>CHOICE <i>TDD option</i>	MP				REL-4
>>>3.84 Mcps TDD					REL-4
>>DPCH Constant Value	MP		Constant Value TDD 10.3.6.11a	Quality Margin	
>>>7.68 Mcps TDD					REL-7
>>DPCH Constant Value	MP		Constant Value TDD 10.3.6.11a	Quality Margin	REL-7
>>>1.28 Mcps TDD				(no data)	REL-4

Condition	Explanation
<i>algo</i>	The IE is mandatory present if the IE "Power Control Algorithm" is set to "algorithm 1", otherwise the IE is not needed

10.3.6.94 Uplink Timeslots and Codes

NOTE: Only for 1.28 Mcps TDD and 3.84 Mcps TDD.

Information Element/Group name	Need	Multi	Type and reference	Semantics description
Dynamic SF usage	MP		Boolean	
First Individual timeslot info	MP		Individual timeslot info 10.3.6.37	Individual timeslot info for the first timeslot used by the physical layer.
First timeslot Code List	MP	1..2		Code list used in the timeslot. given in First individual timeslot info.
>Channelisation Code	MP		Enumerated((1/1),(2/1),(2/2),(4/1)..(4/4),(8/1)..(8/8),(16/1)..(16/16))	
CHOICE <i>more timeslots</i>	MP			
>No more timeslots				(no data)
>Consecutive timeslots				

Information Element/Group name	Need	Multi	Type and reference	Semantics description
>>Number of additional timeslots	MP		Integer(1..maxTS-1)	The timeslots used by the physical layer shall be timeslots: N mod maxTS (N+1) mod maxTS ... (N+k) mod maxTS in that order, where N is the timeslot number in the First individual timeslot info and k the Number of additional timeslots. The additional timeslots shall use the same parameters (e.g. channelisation codes, midamble shifts etc.) as the first timeslot.
>Timeslot list				
>>Additional timeslot list	MP	1 to <maxTS-1>		The first instance of this parameter corresponds to the timeslot that shall be used second by the physical layer, the second to the timeslot that shall be used third and so on.
>>>CHOICE parameters	MP			
>>>>Same as last				
>>>>>Timeslot number	MP		Timeslot Number 10.3.6.84	This physical layer shall use the same parameters (e.g. channelisation codes, midamble shifts etc.) for this timeslot as for the last one.
>>>>>New parameters				
>>>>>>Individual timeslot info	MP		Individual timeslot info 10.3.6.37	
>>>>>>>Code List	MP	1..2		
>>>>>>>>Channelisation Code	MP		Enumerated((1/1),(2/1),(2/2),(4/1)..(4/4),(8/1)..(8/8),(16/1)..(16/6))	

10.3.6.94a Uplink Timeslots and Codes LCR

NOTE: Only for 1.28 Mcps TDD

Information Element/Group name	Need	Multi	Type and reference	Semantics description
Dynamic SF usage	MP		Boolean	
First Individual timeslot info	MP		Individual timeslot info 10.3.6.37	Individual timeslot info for the first timeslot used by the physical layer.
First timeslot Code List	MP	1..2		Code list used in the timeslot. given in First individual timeslot info.
>Channelisation Code	MP		Enumerated((1/1),(2/1),(2/2),(4/1)..(4/4),(8/1)..(8/8),(16/1)..(16/6))	

Information Element/Group name	Need	Multi	Type and reference	Semantics description
>PLCCH Info	CV-no_DL_D PCH		PLCCH Info 10.3.6.50a	
CHOICE <i>more timeslots</i>	MP			
>No more timeslots				(no data)
>Consecutive timeslots				
>>Number of additional timeslots	MP		Integer(1..maxTS-1)	The timeslots used by the physical layer shall be timeslots: N mod maxTS (N+1) mod maxTS ... (N+k) mod maxTS in that order, where N is the timeslot number in the First individual timeslot info and k the Number of additional timeslots. The additional timeslots shall use the same parameters (e.g. channelisation codes, midamble shifts etc.) as the first timeslot.
>Timeslot list				
>>Additional timeslot list	MP	1 to <maxTS-1>		The first instance of this parameter corresponds to the timeslot that shall be used second by the physical layer, the second to the timeslot that shall be used third and so on.
>>>CHOICE <i>parameters</i>	MP			
>>>>Same as last				
>>>>>Timeslot number	MP		Timeslot Number 10.3.6.84	This physical layer shall use the same parameters (e.g. channelisation codes, midamble shifts etc.) for this timeslot as for the last one.
>>>>New parameters				
>>>>>Individual timeslot info	MP		Individual timeslot info 10.3.6.37	
>>>>>Code List	MP	1..2		
>>>>>>Channelisation Code	MP		Enumerate d((1/1),(2/1),(2/2),(4/1)..(4/4),(8/1)..(8/8),(16/1)..(16/16))	
>>>>>>> PLCCH Info	CV-no_DL_D PCH		PLCCH Info 10.3.6.50a	Default is same as set of parameter values as assigned to last timeslot

Condition	Explanation
<i>No_DL_DPCH</i>	This IE is mandatory present for 1.28 Mcps TDD only in the case that Uplink Timeslots and Codes are assigned for UL DPCH and no DL DPCH is allocated to the UE.

10.3.6.94b Uplink Timeslots and Codes VHCR

NOTE: Only for 7.68 Mcps TDD

Information Element/Group name	Need	Multi	Type and reference	Semantics description	Version
Dynamic SF usage	MP		Boolean		REL-7
First Individual timeslot info	MP		Individual timeslot info 10.3.6.37	Individual timeslot info for the first timeslot used by the physical layer.	REL-7
First timeslot Code List	MP	1..2		Code list used in the timeslot. given in First individual timeslot info.	REL-7
>Channelisation Code	MP		Enumerated((1/1),(2/1),(2/2),(4/1)..(4/4),(8/1)..(8/8..(16/1) ..(16/16).(32/1)..(32/32))		REL-7
CHOICE <i>more timeslots</i>	MP				REL-7
>No more timeslots				(no data)	REL-7
>Consecutive timeslots					REL-7
>>Number of additional timeslots	MP		Integer(1..maxTS-1)	The timeslots used by the physical layer shall be timeslots: N mod maxTS (N+1) mod maxTS ... (N+k) mod maxTS in that order, where N is the timeslot number in the First individual timeslot info and k the Number of additional timeslots. The additional timeslots shall use the same parameters (e.g. channelisation codes, midamble shifts etc.) as the first timeslot.	REL-7
>Timeslot list					REL-7
>>Additional timeslot list	MP	1 to <maxTS-1>		The first instance of this parameter corresponds to the timeslot that shall be used second by the physical layer, the second to the timeslot that shall be used third and so on.	REL-7
>>>CHOICE <i>parameters</i>	MP				REL-7
>>>>Same as last					REL-7
>>>>>Timeslot number	MP		Timeslot Number 10.3.6.84	This physical layer shall use the same parameters (e.g. channelisation codes, midamble shifts etc.) for this timeslot as for the last one.	REL-7
>>>>>New parameters					REL-7

Information Element/Group name	Need	Multi	Type and reference	Semantics description	Version
>>>>Individual timeslot info	MP		Individual timeslot info 10.3.6.37		REL-7
>>>>Code List	MP	1..2			REL-7
>>>>>Channelisation Code	MP		Enumerated((1/1),(2/1),(2/2),(4/1)..(4/4),(8/1)..(8/8) .(16/1)..(16/16).(32/1)..(32/32))		REL-7

10.3.6.95 Uplink Timing Advance

NOTE: Only for 3.84 Mcps TDD.

Information Element/Group name	Need	Multi	Type and reference	Semantics description	Version
UL Timing Advance	MP		Integer (0..63)	Absolute timing advance value to be used to avoid large delay spread at the NodeB	

10.3.6.95a Extended Uplink Timing Advance

NOTE: Only for 3.84 and 7.68 Mcps TDD.

Information Element/Group name	Need	Multi	Type and reference	Semantics description	Version
CHOICE <i>TDD mode</i>					REL-7
>3.84 Mcps TDD					REL-7
>>Extended UL Timing Advance	MP		Integer (0..255)	Absolute timing advance value to be used to avoid large delay spread at the NodeB	REL-7
>7.68.Mcps TDD					REL-7
>>Extended UL Timing Advance	MP		Integer (0..511)	Absolute timing advance value to be used to avoid large delay spread at the NodeB	REL-7

10.3.6.96 Uplink Timing Advance Control

NOTE: Only for TDD

Information Element/Group name	Need	Multi	Type and reference	Semantics description	Version
CHOICE <i>Timing Advance</i>	MP				
>Disabled			Null	Indicates that no timing advance is applied	
>Enabled					
>>CHOICE <i>TDD option</i>	MP				REL-4
>>>3.84 Mcps TDD					REL-4
>>>>UL Timing Advance	MD		Uplink Timing Advance	Absolute timing advance value to be used to avoid	

Information Element/Group name	Need	Multi	Type and reference	Semantics description	Version
			10.3.6.95	large delay spread at the NodeB. Default value is the existing value for uplink timing advance.	
>>Extended Timing Advance	OP		Extended UL Timing Advance Control 10.3.6.95a		REL-7
>>>>Activation Time	OP		Activation Time 10.3.3.1	Frame number timing advance is to be applied. This IE is required when a new UL Timing Advance adjustment is specified and Activation Time is not otherwise specified in the RRC message.	
>>>>7.68 Mcps TDD					REL-7
>>>>Extended UL Timing Advance	MD		Extended Uplink Timing Advance 10.3.6.95a	Absolute timing advance value to be used to avoid large delay spread at the NodeB. Default value is the existing value for uplink timing advance.	REL-7
>>>>Activation Time	OP		Activation Time 10.3.3.1	Frame number timing advance is to be applied. This IE is required when a new UL Timing Advance adjustment is specified and Activation Time is not otherwise specified in the RRC message.	REL-7
>>>>1.28 Mcps TDD				(no data)	REL-4
>>>>Uplink synchronisation parameters	MD			Default: Uplink synchronisation step size is 1. Uplink synchronisation frequency is 1.	REL-4
>>>>Uplink synchronisation step size	MP		Integer(1..8)	This parameter specifies the step size to be used for the adjustment of the uplink transmission timing	REL-4
>>>>Uplink synchronisation frequency	MP		Integer(1..8)	This parameter specifies the frequency of the adjustment of the uplink transmission timing	REL-4

Information Element/Group name	Need	Multi	Type and reference	Semantics description	Version
>>>Synchronisation parameters	OP				
>>>>SYNC_UL codes bitmap	MP		SYNC_UL codes bitmap 10.3.6.78o		REL-4
>>>>FPACH info	MP		FPACH info 10.3.6.35a		REL-4
>>>>PRX _{UpPCHdes}	MP		Integer(-120...-58 by step of 1)	In dBm	REL-4
>>>>SYNC_UL procedure	MD			Default is: Max SYNC_UL Transmission is 2. Power Ramp Step is 2.	REL-4
>>>>>Max SYNC_UL Transmissions	MP		Integer(1,2,4,8)	Maximum numbers of SYNC_UL transmissions in a power ramping sequence.	REL-4
>>>>>Power Ramp Step	MP		Integer(0,1,2,3)	In dB	REL-4

10.3.6.97 E-DCH Info

Information Element/Group name	Need	Multi	Type and reference	Semantics description	Version
MAC-es/e reset indicator	OP		Enumerated (true)	TRUE Indicates the MAC-es/e entity needs to be reset.	REL-6
CHOICE <i>mode</i>	MP				REL-7
>FDD					REL-7
>>E-DPCCH info	OP		E-DPCCH Info 10.3.6.98		REL-6
>>E-DPDCH info	OP		E-DPDCH info 10.3.6.99		REL-6
>>>Scheduled Transmission configuration	OP				REL-6
>>>>2ms scheduled transmission grant HARQ process allocation	MD		Bitstring (8)	MAC-d PDUs belonging to MAC-d flows not configured with a "Max MAC-e PDU contents size" are only allowed to be transmitted in those processes for which the bit is set to "1". Bit 0 corresponds to HARQ process 0, bit 1 corresponds to HARQ process 1, ... Default value is: transmission in all HARQ processes is allowed. Bit 0 is the first/leftmost bit of the bit string.	REL-6
>>>>Serving Grant	OP				REL-6
>>>>>Serving Grant value	MP		Integer (0..37,38)	(0..37) indicates E-DCH serving grant index as defined in [15]; index 38 means zero grant.	REL-6
>>>>>Primary/Secondary Grant Selector	MP		Enumerated ("primary", "secondary")	Indicates whether the Serving Grant is received with a Primary E-RNTI or Secondary E-RNTI	REL-6
>>>>>>UL 16QAM settings	OP		UL 16QAM settings 10.3.6.86a	Presence of this IE indicates that the UE should operate in 16QAM mode; absence indicates that the UE is not to operate in 16QAM mode. See Note 1.	REL-7
>TDD					REL-7
>>E-RUCCH info	OP		E-RUCCH Info 10.3.6.103		REL-7

>>E-PUCH info	OP		E-PUCH Info 10.3.6.104		REL-7
>>Non-scheduled transmission grant info	OP		Non-scheduled transmission grant info 10.3.6.41c		REL-7
NOTE 1: If this IE is not present, the indices signaled on the E-AGCH refer to the Mapping of Absolute Grant Value Table 16B in [27].					

10.3.6.98 E-DPCCH Info

Information Element/Group name	Need	Multi	Type and reference	Semantics description	Version
E-DPCCH/DPCCH power offset	MP		Integer (0..8)	Refer to quantization of the power offset in [28]	REL-6
Happy bit delay condition	MP		Enumerated (2ms, 10ms, 20ms, 50ms, 100ms, 200ms, 500ms, 1000ms)	To be used when determining the setting of the happy bit (see [15])	REL-6
E-TFC Boost Info	OP		E-TFC Boost Info 10.3.6.106	Absence of this IE means that boosting of E-DPCCH is disabled	REL-7
E-DPDCH power interpolation	OP		Boolean	True means E-DPDCH power interpolation formula is used, False means E-DPDCH power extrapolation formula is used for the computation of the gain factor β_{ed} according to [29]	REL-7

10.3.6.99 E-DPDCH Info

Information Element/Group name	Need	Multi	Type and reference	Semantics description	Version
E-TFCI table index	MP		Integer (0..1)	Indicates which standardised E-TFCI TB size table shall be used. See Note 3.	REL-6
E-DCH minimum set E-TFCI	MD		Integer (0..127)	See [15]; Absence means no E-DCH minimum set	REL-6
Reference E-TFCIs	MP	1 to 8		See [29]	REL-6
>Reference E-TFCI	MP		Integer (0..127)		REL-6
>Reference E-TFCI PO	MP		Integer (0..29,	Refer to quantization of the power offset in [28]	REL-6
			30, 31)	Values 30 and 31 are only used for E-TFCI > ETFCI Boost	REL-7
Maximum channelisation codes	MP		Enumerated (sf256, sf128, sf64, sf32, sf16, sf8, sf4, 2sf4, 2sf2, 2sf2and2sf4)		REL-6
$PL_{\text{non-max}}$	MP		Real (0.44 ..1.0 by step of 0.04)	As defined in [27]	REL-6
Scheduling Information Configuration	MP				REL-6
>Periodicity for Scheduling Info – no grant	MD		Enumerated (everyEDCHTTI,4,10,20,50,100,200,500,1000)	Values in ms. Default value is “no report” NOTE 1.	REL-6
>Periodicity for Scheduling Info – grant	MD		Enumerated (everyEDCHTTI,4,10,20,50,100,200,500,1000)	Values in ms. Default value is “no report” NOTE 1.	REL-6
>Power Offset for Scheduling Info	MP		Integer (0..6)	Only used when no MACd PDUs are included in the same MACe PDU. Unit is in dB.	REL-6
3-Index-Step Threshold	MD		Integer (0..37)	Refers to an index in the “SG-Table” (see [15]). Default value is 0. NOTES 2, 3.	REL-6
2-Index-Step Threshold	MD		Integer (0..37)	Refers to an index in the “SG-Table” (see [15]). Default value is 0. NOTES 2, 3.	REL-6
NOTE 1: If the Periodicity is set to 4ms and the E-DCH TTI is set to 10ms, the UE shall interpret the periodicity value as 10ms.					

<p>NOTE 2: If the 3-index-Step Threshold value is greater than 2-index-Step Threshold, the UE behaviour is unspecified.</p> <p>NOTE 3: If the UE is operating in 16QAM mode, the value of “E-TFCI table index” is increased by 2, and indices in the SG-Table refer to Scheduling Grant Table 2 in [15].</p>
--

10.3.6.100 E-AGCH Info

Includes the configuration for the E-DCH related Absolute Grant Channel.

Information Element/Group name	Need	Multi	Type and reference	Semantics description	Version
CHOICE <i>mode</i>	MP				REL-7
>FDD					REL-7
>>E-AGCH Channelisation Code	MP		Integer (0..255)		REL-6
>TDD					REL-7
>>CHOICE TDD Option	MP				REL-7
>>>3.84 Mcps TDD					REL-7
>>>>Long Term Grant Indicator	MD		Boolean	False = Short Term True = Long Term Default = False (Short Term)	REL-7
>>>>Length of TTRI field	MP		Integer(1..12)	Indicated length of the bitmap used to indicate which of the timeslots configured for E-DCH are allocated	REL-7
>>>>E-AGCH set configuration	MP	<1 to maxNumE-AGCH>			REL-7
>>>>>TS number	MP		Integer(0..14)		REL-7
>>>>>Channelisation code	MP		Enumerated(16/1, 16/2,....16/16)		REL-7
>>>>>CHOICE Burst Type					REL-7
>>>>>>Type 1					REL-7
>>>>>>>Midamble allocation mode	MP		Enumerated(Default, Common, UE specific)		REL-7
>>>>>>>Midamble configuration burst type 1	MP		Enumerated(4, 8, 16)		REL-7
>>>>>>>Midamble shift	CV-UE specific		Integer(0..15)		REL-7
>>>>>>>Type 2					
>>>>>>>Midamble allocation mode	MP		Enumerated(Default, Common, UE specific)		REL-7
>>>>>>>Midamble configuration burst type 2	MP		Enumerated(3, 6)		REL-7
>>>>>>>Midamble shift	CV-UE specific		Integer(0..5)		REL-7
>>>>E-AGCH BLER target	MP		Real(-3.15 to 0 step 0.05)		REL-7
>>>7.68 Mcps TDD					REL-7
>>>>Long Term Grant Indicator	MD		Boolean	False = Short Term True = Long Term Default = False (Short Term)	REL-7
>>>>Length of TTRI field	MP		Integer(1..12)	Indicated length of the bitmap used to indicate which of the timeslots configured for E-DCH are allocated	REL-7
>>>>E-AGCH set configuration	MP	<1 to maxNumE-AGCH>			REL-7
>>>>>TS number	MP		Integer(0..14)		REL-7

>>>>>Channelisation code	MP		Enumerated(32/1, 32/2,.....32/32)		REL-7
>>>>>CHOICE Burst Type					REL-7
>>>>>>Type 1					REL-7
>>>>>>>Midamble allocation mode	MP		Enumerated(Default, Common, UE specific)		REL-7
>>>>>>>Midamble configuration burst type 1	MP		Enumerated(4, 8, 16)		REL-7
>>>>>>>Midamble shift	CV-UE specific		Integer(0..15)		REL-7
>>>>>>>Type 2					
>>>>>>>Midamble allocation mode	MP		Enumerated(Default, Common, UE specific)		REL-7
>>>>>>>Midamble configuration burst type 2	MP		Enumerated(3, 6)		REL-7
>>>>>>>Midamble shift	CV-UE specific		Integer(0.5)		REL-7
>>>>>E-AGCH BLER target	MP		Real(-3.15 to 0 step 0.05)		REL-7
>>>1.28 Mcps TDD					REL-7
>>>>RDI Indicator	MP		Boolean	TRUE indicates a RDI field is present on E-AGCH,	REL-7
>>>>TPC step size	MP		Integer (1, 2, 3)	dB.	REL-7
>>>>E-AGCH set configuration	MP	<1 to maxNumE-AGCH>			REL-7
>>>>>Timeslot number	MP		Integer (0..6)		REL-7
>>>>>First Channelisation code	MP		Enumerated ((16/1) ..(16/16))		REL-7
>>>>>Second Channelisation code	MP		Enumerated ((16/1) ..(16/16))		REL-7
>>>>>Midamble Allocation mode	MP		Enumerated (Default midamble, Common midamble, UE specific midamble)		REL-7
>>>>>Midamble configuration	MP		Integer (2, 4, 6, 8, 10, 12, 14, 16)		REL-7
>>>>> Midamble Shift	CV-UE specific		Integer (0..15)		REL-7
>>>>>E-AGCH BLER target	MP		Real(-3.15 to 0 step 0.05)		REL-7

10.3.6.101 E-HICH Info

Includes the configuration for the E-DCH related HARQ Acknowledgement Indicator Channel.

Information Element/Group name	Need	Multi	Type and reference	Semantics description	Version
CHOICE <i>mode</i>	MP				REL-7
>FDD					REL-7
>>Channelisation Code	MP		Integer (0..127)		REL-6
>>Signature Sequence	MP		Integer (0..39)		REL-6
>TDD					REL-7
>>CHOICE <i>TDD Option</i>	MP				REL-7
>>>3.84 Mcps TDD					REL-7
>>>> N_{E-HICH}	MP		Integer(4..44)	Minimum number of slots between start last active slot of E-DCH TTI and start of ACK/NACK on E-HICH (see[?])	REL-7
>>>>TS number	MP		Integer(0..14)		REL-7
>>>>Channelisation Code	MP		Enumerated(16/1, 16/2,..16/16)		REL-7
>>>>Burst type	MP		Enumerated(Type1, Type2)		REL-7
>>>>Midambe allocation mode	MP		Enumerated(Default, Common)		REL-7
>>>>7.68 Mcps TDD					REL-7
>>>> N_{E-HICH}	MP		Integer(4..44)	Minimum number of slots between start last active slot of E-DCH TTI and start of ACK/NACK on E-HICH (see[?])	REL-7
>>>>TS number	MP		Integer(0..14)		REL-7
>>>>Channelisation Code	MP		Enumerated(32/1, 32/2,..32/32)		REL-7
>>>>Burst type	MP		Enumerated(Type1, Type2)		REL-7
>>>>Midambe allocation mode	MP		Enumerated(Default, Common)		REL-7
>>>>1.28 Mcps TDD					REL-7
>>>> N_{E-HICH}	MP		Integer (4..15)	Minimum number of slots between start last active slot of E-DCH TTI and start of ACK/NACK on E-HICH	REL-7
>>>>E-HICH set configuration		<1 to maxNumE-HICH>			REL-7
>>>>>EI	MP		Integer (0..3)		REL-7
>>>>>Timeslot number	MP		Integer (0..6)		REL-7
>>>>>Channelisation code	MP		Enumerated ((16/1) ..(16/16))		REL-7
>>>>>Midamble Allocation mode	MP		Enumerated (Default midamble,		REL-7

			UE specific midamble)		
>>>>Midamble configuration	MP		Integer (2, 4, 6, 8, 10, 12, 14, 16)		REL-7
>>>>Midamble Shift	CV-UE specific		Integer (0..15)		REL-7

10.3.6.102 E-RGCH Info (FDD only)

Includes the configuration for the E-DCH related Relative Grant Channel. The E-RGCH is using the same channelisation code as configured for the E-HICH channel (see subclause 10.3.6.101).

Information Element/Group name	Need	Multi	Type and reference	Semantics description	Version
Signature Sequence	MP		Integer(0..39)		REL-6
RG combination index	MP		Integer(0..5)	Cells with an index equal to the index of the Serving E-DCH cell belong to the Serving E-DCH RLS. The E-RGCH from these cells have RG commands which for the UE are known to be the same as the RG commands from the Serving E-DCH cell.	REL-6

10.3.6.103 E-RUCCH Info (TDD only)

Information Element/Group name	Need	Multi	Type and reference	Semantics description	Version
CHOICE TDD mode					REL-7
>3.84/7.68 Mcps TDD					REL-7
>>E-RUCCH constant value	MP		Integer (-35..10)	Power to be used	REL-7
>>E-RUCCH persistence scaling factor	MP		Real(0.9..0.2 by step of 0.1)		REL-7
>>T-RUCCH	MD		Integer(40..320 by step of 40)	Default =200ms If T-RUCH expires before Grant is received then uE should send scheduling information again on E-RUCH	REL-7
>>E-RUCCH timeslot number	MD		Timeslot number 10.3.6.84	Default is same as PRACH timeslot number	REL-7
>>E-RUCCH midamble	MD		Enumerated(Direct, Direct/Inverted)	Default is as PRACH midamble	REL-7
>>T-Adv	MD		Enumerated (1, 2, 4, 8, 16, 32, 128, infinity)	Default is 1 second	REL-7
>>T-SCHED	MD		Enumerated (0, 40ms, 80ms, 160ms, 250ms, 1sec, 2sec, 4sec)	Default is 0 second (include Scheduling Information in every MAC-e PDU)	REL-7
>>>CHOICE TDD option					REL-7
>>>3.84 Mcps TDD					REL-7
>>>>CHOICE SF	MP				REL-7
>>>>>SF16					REL-7
>>>>>>Channelisation Code List	MP	1 to 8			REL-7
>>>>>>>Channelisation code	MP		Enumerated ((16/1)..(16/8))	There is a 1:1 mapping between spreading code and midamble shift defined in [30] for channelisation codes (16/1) to (16/8). NOTE: channelisation codes (16/9) to (16/16) are not to be used.	REL-7
>>>>>>>>SF8					REL-7
>>>>>>>>>Channelisation Code List	MP	1 to 8			REL-7
>>>>>>>>>>Channelisation Code	MP		Enumerated((8/1)..(8/8))		REL-7
>>>>7.68 Mcps TDD					REL-7
>>>>>CHOICE SF	MP				REL-7
>>>>>>>>SF32					REL-7
>>>>>>>>>>Channelisation Code	MP	1 to 16			REL-7

List					
>>>>>>Channelisation code	MP		Enumerated ((32/1)...(32/16))	There is a 1:1 mapping between spreading code and midamble shift defined in [30] for channelisation codes (32/1) to (32/16). NOTE: channelisation codes (32/17) to (32/32) are not to be used.	REL-7
>>>>>SF16					REL-7
>>>>>Channelisation Code List	MP	1 to 16			REL-7
>>>>>>Channelisation Code	MP		Enumerated((16/1)..(16/16))		REL-7
>1.28 Mcps TDD					REL-7
>>T-RUCCH	MD		Enumerated (20, 40, 60, 80, 120, 160, 200, 240, 280, 320, 400, 500, 600, 800, 1000, 2000)	Default = 120 ms If T-RUCCH expires before Grant is received then UE should send scheduling information again on E-RUCCH	REL-7
>>N-RUCCH	MD		Integer (0...7)	Default = 3 Maximum number of retransmissions of scheduling information on E-RUCCH	REL-7
>>T-WAIT	MD		Enumerated (everyEDCH TTI, 40,80,160,320,640,1000,2000)	Values in ms. Default = 40ms If T-WAIT expires then UE should send scheduling information on E-RUCCH	REL-7
>>T-SI	MD		Enumerated (everyEDCH TTI, 20,40,60,80, 160,200)	Values in ms. Default = 40ms If periodic T-SI expires then UE should include scheduling information in a new MAC-e PDU	REL-7
>>Extended Estimation Window	OP		Integer (2..5)	Values in 5ms TTI. Indicates how many next consecutive 5ms TTIs the UE should estimate whether there is a Grant valid before sending Scheduling Information via E-RUCCH	REL-7
>>E-RUCCH Access Service class	OP	1 to <maxASC >		If only "NumASC+1" (with, NumASC+1	REL-7

				< maxASC) ASCs are listed, the remaining (NumASC+2 through maxASC) ASCs are unspecified.	
>>>E-RUCCH ASC Setting	MD		ASC setting 10.3.6.6	The default values are same as the PRACH ASC. If the "default" is used for the first ASC, the default values are all available signatures and "all available sub-channels" for FDD and "all available channelisation codes" and "all available subchannels" with "subchannel size=Size 1" in TDD.	REL-7
>>E-RUCCH persistence scaling factor list	OP	1 to maxASCp ersist		multiplicity corresponds to the number of E-RUCCH ASCs minus 2	REL-7
>>>Persistence scaling factor	MP		Real(0.9..0.2 by step of 0.1)		REL-7
>>SYNC_UL info	OP		SYNC_UL info for E- RUCCH 10.3.6.78d		REL-7
>>PRACH Information	OP	1..<maxPR ACH_FPA CH>			REL-7
>>>Timeslot number	MP		Timeslot number 10.3.6.84		REL-7
>>> Channelisation Code List	MP	1 to 2			REL-7
>>>> Channelisation Code	MP		Enumerated ((4/1)..(4/4),(8/1)..(8/8),(1 6/1)..(16/16))		REL-7
>>>Midamble Shift and burst type	MP		Midamble shift and burst type 10.3.6.41		REL-7
>>>FPACH info	OP		FPACH info 10.3.6.35a		REL-7

10.3.6.104 E-PUCH Info (TDD only)

Information Element/Group name	Need	Multi	Type and reference	Semantics description	Version
E-TFCS information	MP		E-TFCS info 10.3.6.105		REL-7
CHOICE TDD mode					REL-7
>3.84/7.68 Mcps TDD					REL-7
>>N _{E-UCCH}	MD		Integer(1..12)	No of slots that are required to carry TPC and TFCI (consecutively allocated slots beginning with the first). Default = 1 (first allocated slot).	REL-7
>>E-PUCH constant value	MP		Integer (-35..10)	Power to be used	REL-7
>>E-PUCH TS configuration list	MP	<1 to maxTS-2>			REL-7
>>>TS number	MP		Integer(0..14)		REL-7
>>>>CHOICE <i>Burst Type</i>	MP				REL-7
>>>>>Type 1					REL-7
>>>>>>Midamble allocation mode	MP		Enumerated(Default, UE specific)		REL-7
>>>>>>>Midamble configuration burst type 1	MP		Enumerated(4, 8, 16)		REL-7
>>>>>>>>Midamble shift	CV-UE specific		Integer(0..15)		REL-7
>>>>>>>>>Type 2					REL-7
>>>>>>>>>>Midamble allocation mode	MP		Enumerated(Default, UE specific)		REL-7
>>>>>>>>>>>Midamble configuration burst type 2	MP		Enumerated(3, 6)		REL-7
>>>>>>>>>>>>Midamble shift	CV-UE specific		Integer(0..5)		REL-7
>>E-PUCH code hopping	MP		Boolean		REL-7
>>E-PUCH TPC step size	MP		Integer(1,2,3)		REL-7
>>Minimum allowed code rate	MP		Integer(0..63)	Maps 0.055 to 1.0 in steps of 0.015	REL-7
>>Maximum allowed code rate	MP		Integer(0..63)	Maps 0.055 to 1.0 in steps of 0.015	REL-7
>1.28 Mcps TDD					REL-7
>>SNPL Reporting Type	OP		Enumerated (type1, type2)		REL-7
>>PRXdes_base	MP		Integer (-112..-50 by step of 1)	dBm. Reference desired power level for E-PUCH	REL-7
>>Beacon PL Est.	MD		Boolean	TRUE indicates that the UE may take into account path loss estimated from beacon function physical channels. Default value is FALSE	REL-7
>>TPC step size	MP		Integer (1, 2, 3)	dB.	REL-7
>>Pebase power control gap	MD		Integer	Unit: Number of	REL-7

			(1...255)	subframes, Default value is 1. Value 255 represents infinite in which case closed loop power control shall always be used.	
--	--	--	-----------	---	--

>>Uplink synchronisation parameters	MD			Default: Uplink synchronisation step size 1. Uplink synchronisation frequency 1.	REL-7
>>>Uplink synchronisation step size	MP		Integer (1..8)	This parameter specifies the step size to be used for the adjustment of the uplink transmission timing	REL-7
>>>Uplink synchronisation frequency	MP		Integer (1..8)	This parameter specifies the frequency of the adjustment of the uplink transmission timing	REL-7
>>E-PUCH TS configuration list	MP	<1 to maxTS-1>			REL-7
>>>TS number	MP		Integer (1..5)		REL-7
>>>Midamble shift and burst type	MP				REL-7
>>>>Midamble Allocation Mode	MP		Enumerated (Default midamble, UE specific midamble)		REL-7
>>>>Midamble configuration	MP		Integer (2, 4, 6, 8, 10, 12, 14, 16)	As defined in [30]	REL-7
>>>>Midamble Shift	CV-UE specific		Integer (0..15)		REL-7
>>Minimum allowed code rate	MP		Integer (0..63)	Maps 0.055 to 1.0 in steps of 0.015	REL-7
>>Maximum allowed code rate	MP		Integer (0..63)	Maps 0.055 to 1.0 in steps of 0.015	REL-7
>>Maximum number of retransmissions for Scheduling Info	MP		Integer (0..15)	Only used when no MAC-d PDUs are included in the same MAC-e PDU.	REL-7
>>Retransmission Timer for Scheduling Info	MP		Enumerated (10, 15, 20, 25, 30, 35, 40, 45, 50, 55, 60, 65, 70, 75, 80, 85, 90, 95, 100, 110, 120, 140, 160, 200, 240, 280, 320, 400, 480, 560)	Only used when no MAC-d PDUs are included in the same MAC-e PDU. Unit is ms.	REL-7
Power Offset for Scheduling Info	OP		Integer (0..6)	If present, this IE should be ignored for LCR TDD. Only used when no MACd PDUs are included in the same MACe PDU. Unit is in dB.	REL-7

10.3.6.105 E-TFCS info (TDD only)

IE/Group Name	Presence	Multi	IE Type and Reference	Semantics Description	Version
Reference Beta Information QPSK list	MP	<1 to 8>			REL-7
>Reference Code Rate	MP		Integer (0..10)	Unit: - Range: 0..1 Step: 0.1	REL-7
>Reference Beta	MP		Integer (-15..16)	Unit range -15db to +16db	REL-7
Reference Beta Information 16QAM list	MP	<1 to 8>			REL-7
>Reference Code Rate	MP		Integer (0..10)	Unit: - Range: 0..1 Step: 0.1	REL-7
>Reference Beta	MP		Integer (-15..16)	Unit range -15db to +16db	REL-7

10.3.6.106 E-TFC Boost Info

Information Element/Group name	Need	Multi	Type and reference	Semantics description	Version
E-TFCI boost	MP		Integer (0..127)	E-TFCI threshold beyond which boosting of E-DPCCH is enabled	REL-7
Delta T2TP	CV- E-TFCI boost127		Integer (0..6)		REL-7

Condition	Explanation
E-TFCI boost127	If E-TFCI-Boost is set to 127 this IE is not needed, otherwise it is mandatory.

10.3.7 Measurement Information elements

10.3.7.1 Additional measurements list

Information Element/Group name	Need	Multi	Type and reference	Semantics description
Additional measurements	MP	1 to <MaxAdditionalMeas>		
>Additional measurement identity	MP		Measurement identity 10.3.7.48	

10.3.7.2 Cell info

Includes non-frequency related cell info used in the IE "inter-frequency cell info list" and "intra frequency cell info list".

Information Element/Group name	Need	Multi	Type and reference	Semantics description	Version
Cell individual offset	MD		Real(-10..10 by step of 0.5)	In dB Default value is 0 dB Used to offset	

				measured quantity value If the cell from which this IE has been received is operating in MBSFN mode as indicated in subclause 8.1.1.6.3 the UE behaves as if this IE would not have been received.	
Reference time difference to cell	OP		Reference time difference to cell 10.3.7.60	In chips. This IE is absent for serving cell. If the cell from which this IE has been received is operating in MBSFN mode as indicated in subclause 8.1.1.6.3 the UE behaviour upon reception of this IE is unspecified.	
Read SFN indicator	MP		Boolean	TRUE indicates that read of SFN is requested for the target cell If the cell from which this IE has been received is operating in MBSFN mode as indicated in subclause 8.1.1.6.3 the UE behaves as if this IE would not have been received.	
CHOICE <i>mode</i>	MP				
>FDD					
>>Primary CPICH info	OP		Primary CPICH info 10.3.6.60	This IE is absent only if measuring RSSI only (broadband measurement.)	
>>Primary CPICH Tx power	OP		Primary CPICH Tx power 10.3.6.61	Required if calculating pathloss.	
>>TX Diversity Indicator	MP		Boolean	TRUE indicates that transmit diversity is used.	
>TDD					
>>Primary CCPCH info	MP		Primary CCPCH info 10.3.6.57		
>>Primary CCPCH TX power	OP		Primary CCPCH TX power 10.3.6.59		
>>Timeslot list	OP	1 to <maxTS>		The UE shall report Timeslot ISCP values according the	

				order of the listed Timeslot numbers. If the cell from which this IE has been received is operating in MBSFN mode as indicated in subclause 8.1.1.6.3 the UE behaviour upon reception of this IE is unspecified.	
>>>CHOICE <i>TDD option</i>	MP				REL-4
>>>>3.84 Mcps TDD					REL-4
>>>>>Timeslot number	MP		Integer (0...14)	Timeslot numbers, for which the UE shall report Timeslot ISCP	
>>>>>Burst Type	MD		Enumerated (Type1, Type2)	Use for Timeslot ISCP measurements only. Default value is "Type1"	
>>>>>7.68 Mcps TDD					REL-7
>>>>>>Timeslot number	MP		Integer (0...14)	Timeslot numbers, for which the UE shall report Timeslot ISCP	REL-7
>>>>>>Burst Type	MD		Enumerated (Type1, Type2)	Use for Timeslot ISCP measurements only. Default value is "Type1"	REL-7
>>>>>>1.28 Mcps TDD					REL-4
>>>>>>>Timeslot number	MP		Integer (0...6)	Timeslot numbers, for which the UE shall report Timeslot ISCP	REL-4
Cell Selection and Re-selection Info	CV- <i>BCHopt</i>		Cell Selection and Re-selection for SIB11/12Info 10.3.2.4	This IE is absent for the serving cell. If the cell from which this IE has been received is operating in MBSFN mode as indicated in subclause 8.1.1.6.3 the UE behaviour upon reception of this IE is unspecified.	

Condition	Explanation
<i>BCHopt</i>	This IE is Optional when sent in SYSTEM INFORMATION, Otherwise, the IE is not needed

10.3.7.3 Cell measured results

Includes non-frequency related measured results for a cell.

Information Element/Group name	Need	Multi	Type and reference	Semantics description	Version
Cell Identity	OP		Cell Identity 10.3.2.2		
Cell synchronisation information	OP		Cell synchronisation information 10.3.7.6		
CHOICE <i>mode</i>	MP				
>FDD					
>>Primary CPICH info	MP		Primary CPICH info 10.3.6.60		
>>CPICH Ec/No	OP		Integer(0..49)	According to CPICH_Ec/No in [19] and [20]. Fourteen spare values are needed.	
>>CPICH RSCP	OP		Integer(0..91)	According to CPICH_RSCP in [19] and [20]. Thirty-six spare values are needed.	
>>Delta _{CPICH RSCP}	CV-RSCP		Integer(-5..-1)	If present, the actual value of CPICH RSCP = CPICH RSCP + Delta _{CPICH RSCP}	REL-5
>>Pathloss	OP		Integer(46..158)	In dB. Fifteen spare values are needed.	
>TDD					
>>Cell parameters Id	MP		Cell parameters Id 10.3.6.9		
>>Proposed TGSN	OP		Integer(0..14)	Proposal for the next TGSN	
>>Primary CCPCH RSCP	OP		Primary CCPCH RSCP info 10.3.7.54		
>>Pathloss	OP		Integer(46..158)	In dB. Fifteen spare values are needed.	
>>Timeslot list	OP	1 to <maxTS>			
>>>Timeslot ISCP	MP		Timeslot ISCP Info 10.3.7.65	The UE shall report the Timeslot ISCP in the same order as indicated in the cell info	

Condition	Explanation
RSCP	This IE is mandatory if the IE "Cell measured results" is included in the IE "Measured Results" (i.e. not included in the IE "Additional Measured Results") and if CPICH RSCP is present and if the value of the CPICH RSCP is below 0. It is not needed otherwise.

10.3.7.4 Cell measurement event results

Includes non-frequency related cell reporting quantities.

Information Element/Group name	Need	Multi	Type and reference	Semantics description
CHOICE <i>mode</i>	MP			
>FDD				
>>Primary CPICH info	MP	1 to <maxCellIM eas>	Primary CPICH info 10.3.6.60	
>TDD				
>>Primary CCPCH info	MP	1 to <maxCellIM eas>	Primary CCPCH info 10.3.6.57	

10.3.7.5 Cell reporting quantities

Includes non-frequency related cell reporting quantities.

For all boolean types TRUE means inclusion in the report is requested.

Information Element/Group name	Need	Multi	Type and reference	Semantics description
Cell synchronisation information reporting indicator	MP		Boolean	
Cell Identity reporting indicator	MP		Boolean	
CHOICE <i>mode</i>	MP			
>FDD				
>>CPICH Ec/N0 reporting indicator	MP		Boolean	
>>CPICH RSCP reporting indicator	MP		Boolean	
>>Pathloss reporting indicator	MP		Boolean	
>TDD				
>>Timeslot ISCP reporting indicator	MP		Boolean	
>>Proposed TGSN Reporting required	MP		Boolean	
>>Primary CCPCH RSCP reporting indicator	MP		Boolean	
>>Pathloss reporting indicator	MP		Boolean	

10.3.7.6 Cell synchronisation information

The IE "Cell synchronisation information" contains the OFF and Tm as defined in [7] and [8] and the four most significant bits of the difference between the 12 least significant bits of the RLC Transparent Mode COUNT-C in the UE and the SFN of the measured cell. It is notified to SRNC by Measurement Report message or Measurement Information Element in other RRC messages

Information Element/Group name	Need	Multi	Type and reference	Semantics description
CHOICE <i>mode</i>	MP			
>FDD				
>>COUNT-C-SFN frame difference	OP			
>>>COUNT-C-SFN high	MP		Integer(0..3840 by step of 256)	in frames
>>>OFF	MP		Integer(0..255)	in frames
>>Tm	MP		Integer(0..38399)	in chips
>TDD				
>>COUNT-C-SFN frame difference	OP			
>>>COUNT-C-SFN high	MP		Integer(0..3840 by step of 256)	in frames
>>>OFF	MP		Integer(0..255)	in frames

10.3.7.7 Event results

Information Element/Group name	Need	Multi	Type and reference	Semantics description
CHOICE <i>event result</i>	MP			One spare value is needed.
>Intra-frequency measurement event results			Intra-frequency measurement event results 10.3.7.37	
>Inter-frequency measurement event results			Inter-frequency measurement event results 10.3.7.17	
>Inter-RAT measurement event results			Inter-RAT measurement event results 10.3.7.28	For IS-2000 results, include fields of the <i>Pilot Strength Measurement Message</i> from subclause 2.7.2.3.2.5 of TIA/EIA/IS-2000.5
>Traffic volume measurement event results			Traffic volume measurement event results 10.3.7.69	
>Quality measurement event results			Quality measurement event results 10.3.7.57	
>UE internal measurement event results			UE internal measurement event results 10.3.7.78	
>UE positioning measurement event results			UE positioning measurement event results	

Information Element/Group name	Need	Multi	Type and reference	Semantics description
			10.3.7.101	

CHOICE event result	Condition under which the given event result is chosen
Intra-frequency measurement event results	If measurement type = intra-frequency measurement
Inter-frequency measurement event results	If measurement type = inter-frequency measurement
Inter-RAT measurement event results	If measurement type = inter-RAT measurement
Traffic volume measurement event results	If measurement type = traffic volume measurement
Quality measurement event results	If measurement type = Quality measurement
UE internal measurement event results	If measurement type = UE internal measurement
UE positioning measurement event results	If measurement type = UE positioning measurement

10.3.7.8 FACH measurement occasion info

Information Element/Group name	Need	Multi	Type and reference	Semantics description	Version
FACH Measurement occasion cycle length coefficient	OP		Integer(1..12)		
Inter-frequency FDD measurement indicator	MP		Boolean	TRUE means that measurements are required	
Inter-frequency TDD 3.84 Mcps measurement indicator	MP		Boolean	TRUE means that measurements are required	REL-4
Inter-frequency TDD 7.68 Mcps measurement indicator	MP		Boolean	TRUE means that measurements are required	REL-7
Inter-frequency TDD 1.28 Mcps measurement indicator	MP		Boolean	TRUE means that measurements are required	REL-4
Inter-RAT measurement indicators	OP	1 to <maxOther RAT>			
>RAT type	MP		Enumerated(GSM, IS2000)		

10.3.7.9 Filter coefficient

Information Element/Group name	Need	Multi	Type and reference	Semantics description
Filter coefficient	MD		Integer(0, 1, 2, 3, 4, 5, 6, 7, 8, 9, 11, 13, 15, 17, 19)	Default value is 0

10.3.7.10 HCS Cell re-selection information

Information Element/Group name	Need	Multi	Type and reference	Semantics description
Penalty_time	MD		Integer(0, 10, 20, 30, 40, 50, 60)	Default value is 0 which means = not used In seconds
Temporary_offsets	<i>CV-Penalty used</i>			
>Temporary_offset1	MP		Integer(3, 6, 9, 12, 15, 18, 21, inf)	[dB]
>Temporary_offset2	<i>CV-FDD-Quality-Measure</i>		Integer(2, 3, 4, 6, 8, 10, 12, inf)	[dB]

Condition	Explanation
<i>Penalty used</i>	This IE is not needed if the IE "Penalty time" equals "not used", else it is mandatory present.
<i>FDD-Quality-Measure</i>	This IE is not needed if the IE "Cell selection and reselection quality measure" has the value CPICH RSCP, otherwise the IE is mandatory present. This conditional presence is implemented in ASN.1 by the use of a specific RSCP and EcN0 variant of 10.3.7.10.

10.3.7.11 HCS neighbouring cell information

Information Element/Group name	Need	Multi	Type and reference	Semantics description
HCS_PRIO	MD		Integer (0..7)	Default value = 0
Qhcs	MD		Qhcs 10.3.7.54a	Default value = 0
HCS Cell Re-selection Information	MP		HCS Cell Re-selection Information 10.3.7.10	

10.3.7.12 HCS Serving cell information

Information Element/Group name	Need	Multi	Type and Reference	Semantics description
HCS_PRIO	MD		Integer (0..7)	Default value = 0
Qhcs	MD		Qhcs 10.3.7.54a	Default value = 0
T _{CRmax}	MD		Enumerated(not used, 30, 60, 120, 180, 240)	[s] Default value is not used
N _{CR}	<i>CV-UE speed detector</i>		Integer(1..16)	Default value = 8
T _{CrmaxHyst}	<i>CV-UE speed detector</i>		Enumerated(not used, 10, 20, 30, 40, 50, 60, 70)	[s]

Condition	Explanation
<i>UE Speed detector</i>	This IE is not needed if T _{CRmax} equals 'not used', else it is mandatory present.

10.3.7.13 Inter-frequency cell info list

Contains the information for the list of measurement objects for an inter-frequency measurement.

Information Element/Group name	Need	Multi	Type and reference	Semantics description	Version
CHOICE <i>Inter-frequency cell removal</i>	OP				
>Remove all inter-frequency cells				No data	
>Remove some inter-frequency cells					
>>Removed inter-frequency cells	MP	1 .. <maxCellMeas>			
>>>Inter-frequency cell id	MP		Integer(0 .. <maxCellMeas>-1)		
>No inter-frequency cells removed				No data	
New inter-frequency cells	OP	1 to <maxCellMeas>			
>Inter-frequency cell id	MD		Integer(0 .. <maxCellMeas>-1)		
>Frequency info	MD		Frequency info 10.3.6.36	Default value is the value of the previous "frequency info" in the list. NOTE: The first occurrence is then MP.	
>Cell info	MP		Cell info 10.3.7.2		
>CHOICE <i>mode specific info</i>	MP				REL-7
>>No information				No data for FDD, TDD 3.84 Mcps or TDD 7.68 Mcps	REL-7
>>TDD 1.28 Mcps					REL-7
>>>Intra-SecondaryFrequencyIndicator	MP		Boolean	TRUE means the inter frequency neighbour cell has a secondary frequency which is the same as the current working frequency of UE.	REL-7
Cells for measurement	CV- <i>BCHopt</i>	1 to <maxCellMeas>			
>Inter-frequency cell id	MP		Integer(0 .. <maxCellMeas>-1)		

Condition	Explanation
<i>BCHopt</i>	This IE is not needed when sent in SYSTEM INFORMATION. Otherwise, the IE is Optional

10.3.7.14 Inter-frequency event identity

Information Element/Group name	Need	Multi	Type and reference	Semantics description
Inter-frequency event identity	MP		Enumerated(2a, 2b, 2c, 2d, 2e, 2f)	Two spare values are needed.

10.3.7.15 Inter-frequency measured results list

Information Element/Group name	Need	Multi	Type and reference	Semantics description
Inter-frequency measurement results	OP	1 to <maxFreq>		
>Frequency info	MD		Frequency info 10.3.6.36	Default value is the value of the previous "frequency info" in the list. NOTE: The first occurrence is then MP.
>UTRA carrier RSSI	OP		Integer(0..76)	According to UTRA_carrier_RSSI_LEV in [19] and [20]. Fifty-one spare values are needed.
>Inter-frequency cell measurement results	OP	1 to <maxCellMeas>		Only cells for which all reporting quantities are available should be included.
>>Cell measured results	MP		Cell measured results 10.3.7.3	

10.3.7.16 Inter-frequency measurement

Information Element/Group name	Need	Multi	Type and reference	Semantics description
Inter-frequency measurement objects list	MP		Inter-frequency cell info list 10.3.7.13	
Inter-frequency measurement quantity	OP		Inter-frequency measurement quantity 10.3.7.18	
Inter-frequency reporting quantity	OP		Inter-frequency reporting quantity 10.3.7.21	
Reporting cell status	CV-reporting		Reporting cell status 10.3.7.61	
Measurement validity	OP		Measurement validity 10.3.7.51	
Inter-frequency set update	OP		Inter-frequency set update 10.3.7.22	
CHOICE <i>report criteria</i>	MP			
>Intra-frequency measurement reporting criteria			Intra-frequency measurement	

Information Element/Group name	Need	Multi	Type and reference	Semantics description
			t reporting criteria 10.3.7.39	
>Inter-frequency measurement reporting criteria			Inter-frequency measurement reporting criteria 10.3.7.19	
>Periodical reporting criteria			Periodical reporting criteria 10.3.7.53	
>No reporting				(no data) Chosen when this measurement only is used as additional measurement to another measurement

Condition	Explanation
<i>reporting</i>	This IE is optional if the CHOICE " <i>report criteria</i> " is equal to "periodical reporting criteria" or "No reporting", otherwise the IE is not needed

10.3.7.17 Inter-frequency measurement event results

This IE contains the measurement event results that are reported to UTRAN for inter-frequency measurements.

Information Element/Group name	Need	Multi	Type and reference	Semantics description
Inter-frequency event identity	MP		Inter-frequency event identity 10.3.7.14	
Inter-frequency cells	OP	1 to <maxFreq>		
>Frequency info	MP		Frequency info 10.3.6.36	
>Non frequency related measurement event results	MP		Cell measurement event results 10.3.7.4	

10.3.7.18 Inter-frequency measurement quantity

The quantity the UE shall measure in case of inter-frequency measurement. It also includes the filtering of the measurements.

Information Element/Group name	Need	Multi	Type and reference	Semantics description
CHOICE <i>reporting criteria</i>	MP			
>Intra-frequency reporting criteria				
>>Intra-frequency measurement quantity	MP		Intra-frequency measurement quantity 10.3.7.38	

Information Element/Group name	Need	Multi	Type and reference	Semantics description
>Inter-frequency reporting criteria				
>>Filter coefficient	MP		Filter coefficient 10.3.7.9	
>>>CHOICE <i>mode</i>	MP			
>>>>FDD				
>>>>>Measurement quantity for frequency quality estimate	MP		Enumerated(CPICH Ec/N0, CPICH RSCP)	
>>>>>TDD				
>>>>>>Measurement quantity for frequency quality estimate	MP		Enumerated(Primary CCPCH RSCP)	

10.3.7.19 Inter-frequency measurement reporting criteria

The triggering of the event-triggered reporting for an inter-frequency measurements. All events concerning inter-frequency measurements are labelled 2x where x is a,b,c, ...

Event 2a: Change of best frequency.

Event 2b: The estimated quality of the currently used frequency is below a certain threshold **and** the estimated quality of a non-used frequency is above a certain threshold.

Event 2c: The estimated quality of a non-used frequency is above a certain threshold.

Event 2d: The estimated quality of the currently used frequency is below a certain threshold.

Event 2e: The estimated quality of a non-used frequency is below a certain threshold.

Event 2f: The estimated quality of the currently used frequency is above a certain threshold.

Information Element/Group name	Need	Multi	Type and reference	Semantics description	Version
Parameters required for each event	OP	1 to <maxMeasEvent>			
>Inter-frequency event identity	MP		Inter-frequency event identity 10.3.7.14		
>Threshold used frequency	CV- <i>clause 0</i>		Integer(-115..0)	Ranges used depend on measurement quantity. CPICH Ec/No -24..0dB CPICH/Primary CCPCH RSCP -115..-25dBm	
			Integer (-120..0)	Ranges used depend on measurement quantity. CPICH Ec/No -24..0dB CPICH/Primary CCPCH RSCP -120..-25dBm	REL-6
>Delta _{Threshold used frequency}	CV- <i>clause 3</i>		Integer(-5..-1)	If present, the actual value of Threshold used frequency = Threshold used frequency + Delta _{Threshold used frequency}	REL-5
				Not used in Release 6 and later	REL-6
>W used frequency	CV- <i>clause 2</i>		Real(0, 0.1..2.0 by step of 0.1)		
>Hysteresis	MP		Real(0, 0.5..14.5 by step of 0.5)	In event 2a, 2b, 2c, 2d, 2e, 2f	
>Time to trigger	MP		Time to trigger 10.3.7.64	Indicates the period of time during which the event condition has to be satisfied, before sending a Measurement Report. Time in ms.	
>Reporting cell status	OP		Reporting cell status 10.3.7.61		
>Parameters required for each non-used frequency	OP	1 to <maxFreq>		In this release, the first listed threshold and W parameter shall apply to all non-used frequencies.	

Information Element/Group name	Need	Multi	Type and reference	Semantics description	Version
>>Threshold non used frequency	CV- <i>clause 1</i>		Integer(-115..0)	Ranges used depend on measurement quantity. CPICH Ec/No -24..0dB CPICH/Primary CCPCH RSCP -115..-25dBm. This IE is not needed if the IE "Inter-frequency event identity" is set to 2a. However, it is specified to be mandatory to align with the ASN.1.	
			Integer (-120..0)	Ranges used depend on measurement quantity. CPICH Ec/No -24..0dB CPICH/Primary CCPCH RSCP -120..-25dBm This IE is not needed if the IE "Inter-frequency event identity" is set to 2a.	REL-6
>> Delta _{Threshold non used frequency}	CV- <i>clause 4</i>		Integer(-5..-1)	If present, the actual value of Threshold non used frequency = Threshold non used frequency + Delta _{Threshold non used frequency}	REL-5
				Not used in Release 6 and later	REL-6
>>W non-used frequency	CV- <i>clause 1</i>		Real(0, 0.1..2.0 by step of 0.1)		

Condition	Explanation
<i>Clause 0</i>	This IE is mandatory present if the IE "Inter frequency event identity" is set to 2b, 2d, or 2f, otherwise the IE is not needed.
<i>Clause 1</i>	This IE is mandatory present if the IE "Inter frequency event identity" is set to 2a, 2b, 2c or 2e, otherwise the IE is not needed
<i>Clause 2</i>	This IE is mandatory present if the IE "Inter-frequency event identity" is set to 2a, 2b, 2d or 2f, otherwise the IE is not needed.
<i>Clause 3</i>	This IE is optional if the IE "Inter frequency event identity" is set to 2b, 2d, or 2f. Otherwise the IE is not needed. Note that in order to align with the ASN.1, this IE is always included when the IE "Delta _{Threshold non used frequency} " is present, but the value shall be ignored if the "Inter-frequency event identity" is not set to 2b, 2d or 2f.
<i>Clause 4</i>	This IE is optional if the IE "Inter frequency event identity" is set to 2a, 2b, 2c or 2e. Otherwise the IE is not needed.

10.3.7.20 Inter-frequency measurement system information

Information Element/Group name	Need	Multi	Type and reference	Semantics description	Version
Inter-frequency cell info list	OP		Inter-frequency cell info list 10.3.7.13		
Inter-frequency RACH reporting information	OP		Inter-frequency RACH reporting information 10.3.7.20a		REL-6

10.3.7.20a Inter-frequency RACH reporting information

Contains the reporting configuration information for an inter-frequency measurement report, which is sent on the RACH.

Information Element/Group name	Need	Multi	Type and reference	Semantics description	Version
CHOICE <i>mode</i>	MP				REL-6
>FDD					REL-6
>> Inter-frequency RACH reporting quantity	MP		Enumerated(CPICH Ec/N0, CPICH RSCP)		REL-6
>TDD					REL-6
>>Reporting quantity list	MP	1 to 2			REL-6
>>> Inter-frequency RACH reporting quantity	MP		Enumerated(Primary CCPCH RSCP)		REL-6
Inter-frequency RACH reporting threshold	MP		Integer(-115..0)	Ranges used depend on measurement quantity. CPICH Ec/No - 24..0dB CPICH/Primary CCPCH RSCP - 115..-25dBm.	REL-6
Maximum number of inter-frequency RACH reporting cells	MP		Integer(1..8)	Indicates the total number for all non-used frequencies	REL-6

10.3.7.21 Inter-frequency reporting quantity

Information Element/Group name	Need	Multi	Type and reference	Semantics description
UTRA Carrier RSSI	MP		Boolean	TRUE means report is requested.
Frequency quality estimate	MP		Boolean	TRUE means that report is requested. This parameter is not used in this release and should be set to FALSE. It shall be ignored by the UE.
Non frequency related cell reporting quantities	MP		Cell reporting quantities 10.3.7.5	

10.3.7.22 Inter-frequency SET UPDATE

NOTE 1: Only for FDD.

This information makes it possible to use events defined for Intra-frequency measurement within the same non-used frequency for Inter-frequency measurement reporting criteria.

Information Element/group name	Need	Multi	Type and reference	Semantics description
UE autonomous update mode	MP		Enumerated (On with no reporting)	Required for backwards compatibility with a UE not supporting this revision of the standard

10.3.7.23 Inter-RAT cell info list

Contains the information for the list of measurement objects for an inter-RAT measurement.

Information Element/Group name	Need	Multi	Type and reference	Semantics description	Version
CHOICE <i>Inter-RAT cell removal</i>	MP				
>Remove all inter-RAT cells				(no data)	
>Remove some inter-RAT cells					
>>Removed inter-RAT cells	MP	1 to <maxCellMeas>			
>>>Inter-RAT cell id	MP		Integer(0 .. <maxCellMeas> - 1)		
>Remove no inter-RAT cells				(no data)	
New inter-RAT cells	MP	1 to <maxCellMeas>		Although this IE is not always required, need is MP to align with ASN.1	
	OP				REL-4
>Inter-RAT cell id	OP		Integer(0 .. <maxCellMeas> - 1)		
>CHOICE <i>Radio Access Technology</i>	MP				
>>GSM					
>>>Cell individual offset	MP		Integer (-50..50)	In dB Used to offset measured quantity value	
>>>Cell selection and re-selection info	OP		Cell selection and re-selection info for SIB11/12 10.3.2.4	See subclause 8.6.7.3	
>>>BSIC	MP		BSIC 10.3.8.2		
>>>Band indicator	MP		Enumerated (DCS 1800 band used, PCS 1900 band used)	Indicates how to interpret the BCCH ARFCN	
>>>BCCH ARFCN	MP		Integer (0..1023)	[45]	
>>IS-2000					
>>>System specific measurement info	MP		enumerated (frequency, timeslot,	For IS-2000, use fields from TIA/EIA/IS-	

Information Element/Group name	Need	Multi	Type and reference	Semantics description	Version
			colour code, output power, PN offset)	2000.5, subclause 3.7.3.3.2.27, <i>Candidate Frequency Neighbour List Message</i>	
>>None			(no data)	This value has been introduced to handle the case when IE "New inter-RAT cells" is not required	
Cell for measurement	OP	1 to <maxCellMeas>			
>Inter-RAT cell id	MP		Integer(0 .. <maxCellMeas>-1)		
Inter-RAT cell info indication	CV- <i>Message</i>		Integer (0..3)	NOTE 1 and 2	REL-5

Condition	Explanation
<i>Message</i>	The IE is optionally present in the MEASUREMENT CONTROL and in the SRNS RELOCATION INFO messages, otherwise the IE is not needed.

NOTE 1: The UTRAN may choose not to use the "Inter-RAT cell info indication" value "0" in the MEASUREMENT CONTROL message, to distinguish that case from those cases where the UE receives the IE "Inter-RAT cell info list" in SIB11 or SIB12.

NOTE 2: In case of an SRNS relocation, if the UE has been sent the "Inter-RAT cell info indication" in the MEASUREMENT CONTROL message and the IE "Inter-RAT cell info list" is included in the SRNS RELOCATION INFO sent from the source RNC to the target RNC, the "Inter-RAT cell info indication" should be included in the IE "Inter-RAT cell info list".

NOTE 3: If the UTRAN configures a UE with a "Inter-RAT cell info list" containing a set of GSM cells where one or more cell(s) belong to DCS 1800 band and one or more cell(s) belong to PCS 1900 band, the UE behaviour is unspecified.

10.3.7.24 Inter-RAT event identity

Information Element/Group name	Need	Multi	Type and reference	Semantics description
Inter-RAT event identity	MP		Enumerated (3a, 3b, 3c, 3d)	

10.3.7.25 Inter-RAT info

Inter-RAT info defines the target system for redirected cell selection.

Information Element/Group name	Need	Multi	Type and reference	Semantics description	Version
Inter-RAT info	MP		Enumerated (GSM)		
GSM target cell info	CV-GSM		GSM target cell info 10.3.8.4g		REL-6

Condition	Explanation
GSM	This IE is optional if the IE "Inter-RAT info" is set to 'GSM' and not needed otherwise.

10.3.7.26 Inter-RAT measured results list

Information Element/Group name	Need	Multi	Type and reference	Semantics description
Inter-RAT measurement results	OP	1 to <maxOther RAT-16>		
>CHOICE <i>system</i>	MP			One spare value is needed.
>>GSM				
>>>Measured GSM cells	MP	1 to <maxReportedGSMCells>		
>>>>GSM carrier RSSI	OP		bit string(6)	RXLEV is mapped to a value between 0 and 63, [46]. When mapping the RXLEV value to the RSSI bit string, the first/leftmost bit of the bit string contains the most significant bit.
>>>>CHOICE <i>BSIC</i>	MP			
>>>>>Verified BSIC				
>>>>>>inter-RAT cell id	MP		Integer(0..<maxCellMeasurements>-1)	
>>>>>>>Non verified BSIC				
>>>>>>>>BCCH ARFCN	MP		Integer (0..1023)	[45]

10.3.7.27 Inter-RAT measurement

Information Element/Group name	Need	Multi	Type and reference	Semantics description
Inter-RAT measurement objects list	OP		Inter-RAT cell info list 10.3.7.23	
Inter-RAT measurement quantity	OP		Inter-RAT measurement quantity 10.3.7.29	
Inter-RAT reporting quantity	OP		Inter-RAT reporting quantity 10.3.7.32	
Reporting cell status	CV-reporting		Reporting cell status 10.3.7.61	
CHOICE <i>report criteria</i>	MP			
>Inter-RAT measurement reporting criteria			Inter-RAT measurement reporting criteria 10.3.7.30	
>Periodical reporting criteria			Periodical reporting criteria 10.3.7.53	
>No reporting				(no data) Chosen when this measurement only is used as additional measurement to another measurement

Condition	Explanation
<i>reporting</i>	This IE is optional if the CHOICE " <i>report criteria</i> " is equal to "periodical reporting criteria" or "No reporting", otherwise the IE is not needed

10.3.7.28 Inter-RAT measurement event results

This IE contains the measurement event results that are reported to UTRAN for inter-RAT measurements.

Information Element/Group name	Need	Multi	Type and reference	Semantics description
Inter-RAT event identity	MP		Inter-RAT event identity 10.3.7.24	
Cells to report	MP	1 to <maxCellMeas>		
>CHOICE <i>BSIC</i>	MP			
>>Verified <i>BSIC</i>				
>>>inter-RAT cell id	MP		Integer(0..<maxCellMeas>-1)	
>>Non verified <i>BSIC</i>				
>>>BCCH ARFCN	MP		Integer (0..1023)	[45]

10.3.7.29 Inter-RAT measurement quantity

The quantity the UE shall measure in case of inter-RAT measurement. It also includes the filtering of the measurements.

Information Element/Group name	Need	Multi	Type and reference	Semantics description
Measurement quantity for UTRAN quality estimate	OP		Intra-frequency measurement quantity 10.3.7.38	
CHOICE system	MP			
>GSM				
>>Measurement quantity	MP		Enumerated(GSM Carrier RSSI)	
>>Filter coefficient	MP		Filter coefficient 10.3.7.9	
>>BSIC verification required	MP		Enumerated(required, not required)	
>IS2000				
>>TADD E_c/I_0	MP		Integer(0..63)	Admission criteria for neighbours, see subclause 2.6.6.2.6 of TIA/EIA/IS-2000.5
>>TCOMP E_c/I_0	MP		Integer(0..15)	Admission criteria for neighbours, see subclause 2.6.6.2.5.2 of TIA/EIA/IS-2000.5
>>SOFT SLOPE	OP		Integer(0..63)	Admission criteria for neighbours, see subclause 2.6.6.2.3 and 2.6.6.2.5.2 of TIA/EIA/IS-2000.5
>>ADD_INTERCEPT	OP		Integer(0..63)	Admission criteria for neighbours, see subclause 2.6.6.2.5.2 of TIA/EIA/IS-2000.5

10.3.7.30 Inter-RAT measurement reporting criteria

The triggering of the event-triggered reporting for an inter-RAT measurement. All events concerning inter-RAT measurements are labelled 3x where x is a,b,c, ...

Event 3a: The estimated quality of the currently used UTRAN frequency is below a certain threshold **and** the estimated quality of the other system is above a certain threshold.

Event 3b: The estimated quality of other system is below a certain threshold.

Event 3c: The estimated quality of other system is above a certain threshold.

Event 3d: Change of best cell in other system.

Information Element/Group name	Need	Multi	Type and reference	Semantics description
Parameters required for each event	OP	1 to <maxMeas Event>		
>Inter-RAT event identity	MP		Inter-RAT event identity 10.3.7.24	
>Threshold own system	CV-clause 0		Integer (-115..0)	
>W	CV-clause 0		Real(0, 0.1..2.0 by step of 0.1)	In event 3a
>Threshold other system	CV-clause 1		Integer (-115..0)	In event 3a, 3b, 3c
>Hysteresis	MP		Real(0..7.5 by step of 0.5)	
>Time to trigger	MP		Time to trigger 10.3.7.64	Indicates the period of time during which the event condition has to be satisfied, before sending a Measurement Report.
>Reporting cell status	OP		Reporting cell status 10.3.7.61	

Condition	Explanation
Clause 0	The IE is mandatory present if the IE "Inter-RAT event identity" is set to "3a", otherwise the IE is not needed
Clause 1	The IE is mandatory present if the IE "Inter-RAT event identity" is set to 3a, 3b or 3c, otherwise the IE is not needed

10.3.7.31 Inter-RAT measurement system information

Information Element/Group name	Need	Multi	Type and reference	Semantics description
Inter-RAT cell info list	OP		Inter-RAT cell info list 10.3.7.23	

10.3.7.32 Inter-RAT reporting quantity

For all boolean types TRUE means inclusion in the report is requested.

Information Element/Group name	Need	Multi	Type and reference	Semantics description
UTRAN estimated quality	MP		Boolean	This parameter is not used in this release and should be set to FALSE.
CHOICE <i>system</i>	MP			
>GSM				
>>GSM Carrier RSSI Reporting indicator	MP		Boolean	

10.3.7.33 Intra-frequency cell info list

Contains the information for the list of measurement objects for an intra-frequency measurement.

Information Element/Group name	Need	Multi	Type and reference	Semantics description
CHOICE <i>Intra-frequency cell removal</i>	OP			Absence of this IE is equivalent to choice "Remove no intra-frequency cells".
>Remove all intra-frequency cells				(no data)
>Remove some intra-frequency cells				
>>Removed intra-frequency cells	MP	1 to <maxCellMeas>		
>>>Intra-frequency cell id	MP		Integer(0 .. <maxCellMeas> - 1)	
>Remove no intra-frequency cells				(no data)
New intra-frequency cells	OP	1 to <maxCellMeas>		This information element must be present when "Intra-frequency cell info list" is included in the system information
>Intra-frequency cell id	OP		Integer(0 .. <maxCellMeas> - 1)	
>Cell info	MP		Cell info 10.3.7.2	This IE must be included for the serving cell when the IE "Intra frequency cell info list" is included in System Information Block type 11.
Cells for measurement	CV- <i>BCHopt</i>	1 to <maxCellMeas>		
>Intra-frequency cell id	MP		Integer(0 .. <maxCellMeas>-1)	

Condition	Explanation
<i>BCHopt</i>	This IE is not needed when sent in SYSTEM INFORMATION. Otherwise, the IE is Optional

10.3.7.34 Intra-frequency event identity

Information Element/Group name	Need	Multi	Type and reference	Semantics description	Version
Intra-frequency event identity	MP		Enumerated (1a,1b,1c,1d,1e,1f,1g,1h,1i,	Seven spare values are needed.	
			1j)	Six spare values are needed.	REL-6

10.3.7.35 Intra-frequency measured results list

Information Element/Group name	Need	Multi	Type and reference	Semantics description
Intra-frequency measurement results	OP	1 to <maxCellMeas>		
>Cell measured results	MP		Cell measured results 10.3.7.3	Only cells for which all reporting quantities are available should be included.

10.3.7.36 Intra-frequency measurement

Information Element/Group name	Need	Multi	Type and reference	Semantics description	Version
Intra-frequency measurement objects list	OP		Intra-frequency cell info list 10.3.7.33		
Intra-frequency measurement quantity	OP		Intra-frequency measurement quantity 10.3.7.38		
Intra-frequency reporting quantity	OP		Intra-frequency reporting quantity 10.3.7.41		
Reporting cell status	CV-reporting		Reporting cell status 10.3.7.61		
Measurement validity	OP		Measurement validity 10.3.7.51		
CHOICE <i>report criteria</i>	OP			NOTE 1	
	MP				REL-6
	OP				REL-7
>Intra-frequency measurement reporting criteria			Intra-frequency measurement reporting criteria 10.3.7.39		
>Periodical reporting criteria			Periodical reporting criteria 10.3.7.53		
>No reporting				(no data) Chosen when this measurement only is used as additional measurement to another measurement	

Condition	Explanation
<i>reporting</i>	This IE is optional if the CHOICE " <i>report criteria</i> " is equal to "periodical reporting criteria" or "No reporting", otherwise the IE is not needed

NOTE 1: The IE "report criteria" is optional in all releases except Rel-6. In Rel-6 the IE "report criteria" is mandatory present in order to align the tabular format with the Rel-6 ASN.1.

10.3.7.37 Intra-frequency measurement event results

This IE contains the measurement event results that are reported to UTRAN for intra-frequency measurements.

Information Element/Group name	Need	Multi	Type and reference	Semantics description
Intra-frequency event identity	MP		Intra-frequency event identity 10.3.7.34	
Cell measurement event results	MP		Cell measurement event results 10.3.7.4	

10.3.7.38 Intra-frequency measurement quantity

The quantity the UE shall measure in case of intra-frequency measurement. It also includes the filtering of the measurements.

Information Element/Group name	Need	Multi	Type and reference	Semantics description
Filter coefficient	MP		Filter coefficient 10.3.7.9	
CHOICE <i>mode</i>	MP			
>FDD				
>>Measurement quantity	MP		Enumerated(CPICH Ec/NO, CPICH RSCP, Pathloss)	
>TDD				
>>Measurement quantity list	MP	1 to 4		
>>>Measurement quantity	MP		Enumerated(Primary CCPCH RSCP, Pathloss, Timeslot ISCP)	

10.3.7.39 Intra-frequency measurement reporting criteria

The triggering of the event-triggered reporting for an intra-frequency measurement. All events concerning intra-frequency measurements are labelled 1x where x is a, b, c....

Event 1a: A Primary CPICH enters the Reporting Range (FDD only).

Event 1b: A Primary CPICH leaves the Reporting Range (FDD only).

Event 1c: A Non-active Primary CPICH becomes better than an active Primary CPICH (FDD only).

Event 1d: Change of best cell (FDD only).

Event 1e: A Primary CPICH becomes better than an absolute threshold (FDD only).

Event 1f: A Primary CPICH becomes worse than an absolute threshold (FDD only).

Event 1g: Change of best cell in TDD.

Event 1h: Timeslot ISCP below a certain threshold (TDD only).

Event 1i: Timeslot ISCP above a certain threshold (TDD only).

Event 1j: A Non-active E-DCH but active DCH Primary CPICH becomes better than an active E-DCH Primary CPICH (FDD only).

Information Element/Group name	Need	Multi	Type and reference	Semantics description	Version
Parameters required for each event	OP	1 to <maxMeasEvent>			
>Intra-frequency event identity	MP		Intra-frequency event identity 10.3.7.34		
>Triggering condition 1	CV-clause 0		Enumerated(Active set cells, Monitored set cells, Active set cells and monitored set cells)	Indicates which cells can trigger the event	
>Triggering condition 2	CV-clause 6		Enumerated(Active set cells, Monitored set cells, Active set cells and monitored set cells, Detected set cells, Detected set cells and monitored set cells)	Indicates which cells can trigger the event	REL-5
	CV-clause 10				
>Reporting Range Constant	CV-clause 2		Real(0..14.5 by step of 0.5)	In dB. In event 1a,1b.	
>Cells forbidden to affect Reporting range	CV-clause 1	1 to <maxCellMeas>		In event 1a,1b	
>>CHOICE mode	MP				
>>>FDD					
>>>>Primary CPICH info	MP		Primary CPICH info 10.3.6.60		
>>>TDD					
>>>>Primary CCPCH info	MP		Primary CCPCH info 10.3.6.57		
>W	CV-clause 2		Real(0.0..2.0 by step of 0.1)		
>Hysteresis	MP		Real(0..7.	In dB.	

Information Element/Group name	Need	Multi	Type and reference	Semantics description	Version
			5 by step of 0.5)		
>Threshold used frequency	CV- <i>clause 3</i>		Integer (-115..165)	Range used depend on measurement quantity. CPICH RSCP -115..-25 dBm CPICH Ec/No -24..0 dB Pathloss 30..165dB ISCP -115..-25 dBm	
			Integer (-120..165)	Range used depend on measurement quantity. CPICH RSCP -120..-25 dBm CPICH Ec/No -24..0 dB Pathloss 30..165dB ISCP -120..-25 dBm	REL-6
>Delta _{Threshold used frequency}	CV- <i>clause 8</i>		Integer(-5..-1)	If present, the actual value of Threshold used frequency = Threshold used frequency + Delta _{Threshold used frequency}	REL-5
				Not used in Release 6 and later	REL-6
>Reporting deactivation threshold	CV- <i>clause 4</i>		Integer(0, 1, 2, 3, 4, 5, 6, 7)	In event 1a Indicates the maximum number of cells allowed in the active set in order for event 1a to occur. 0 means not applicable	
>Replacement activation threshold	CV- <i>clause 5</i>		Integer(0, 1, 2, 3, 4, 5, 6, 7)	In event 1c Indicates the minimum number of cells allowed in the active set in order for event 1c to occur. 0 means not applicable	
				In event 1j Indicates the minimum number of cells allowed in the E-DCH active set in order for event 1j to occur. For event 1j values 5, 6 and 7 are not applicable. 0 means not applicable	REL-6
>Time to trigger	MP		Time to trigger 10.3.7.64	Indicates the period of time during which the event condition has to be satisfied, before sending a Measurement Report. Time in ms	
>Amount of reporting	CV- <i>clause 7</i>		Integer(1, 2, 4, 8, 16, 32, 64, Infinity)	In case the IE "Intra-frequency reporting criteria" is included in the IE "Inter-frequency measurement", this IE is not needed.	

Information Element/Group name	Need	Multi	Type and reference	Semantics description	Version
>Reporting interval	CV- <i>clause 7</i>		Integer(0, 250, 500, 1000, 2000, 4000, 8000, 16000)	Indicates the interval of periodical reporting when such reporting is triggered by an event. Interval in milliseconds. 0 means no periodical reporting. In case the IE "Intra-frequency reporting criteria" is included in the IE "Inter-frequency measurement", this IE is not needed.	
>Reporting cell status	OP		Reporting cell status 10.3.7.61		
>Periodical reporting information-1b	CV- <i>clause 9</i>		Periodical reporting info-1b 10.3.7.53 aa	In case the IE "Intra-frequency reporting criteria" is included in the IE "Inter-frequency measurement", this IE is not needed.	REL-5
>Use CIO	CV- <i>clause 10</i>		Boolean	TRUE indicates that the cell individual offset shall be used for event evaluation	REL-5

Condition	Explanation
<i>Clause 0</i>	The IE is mandatory present if the IE "Intra-frequency event identity" is set to "1b" or "1f", otherwise the IE is not needed.
<i>Clause 1</i>	The IE is optional if the IE "Intra-frequency event identity" is set to "1a" or "1b", otherwise the IE is not needed.
<i>Clause 2</i>	The IE is mandatory present if the IE "Intra-frequency event identity" is set to "1a" or "1b", otherwise the IE is not needed.
<i>Clause 3</i>	The IE is mandatory present if the IE "Intra-frequency event identity" is set to , "1e", "1f", "1h" or "1i", otherwise the IE is not needed.
<i>Clause 4</i>	The IE is mandatory present if the IE "Intra-frequency event identity" is set to "1a", otherwise the IE is not needed.
<i>Clause 5</i>	The IE is mandatory present if the IE "Intra-frequency event identity" is set to "1c" or 1j , otherwise the IE is not needed.
<i>Clause 6</i>	The IE is mandatory present if the IE "Intra-frequency event identity" is set to "1a" or "1e", otherwise the IE is not needed.
<i>Clause 7</i>	The IE is mandatory present if the IE "Intra-frequency event identity" is set to "1a", "1c" or 1j, otherwise the IE is not needed.
<i>Clause 8</i>	The IE is optional if the IE "Intra-frequency event identity" is set to "1e", "1f", "1h" or "1i". Otherwise the IE is not needed.
<i>Clause 9</i>	The IE is optional if the IE "Intra-frequency event identity" is set to "1b", otherwise the IE is not needed.
<i>Clause 10</i>	The IE is optional if the IE "Intra-frequency event identity" is set to "1d", otherwise the IE is not needed.

10.3.7.40 Intra-frequency measurement system information

Information Element/Group name	Need	Multi	Type and reference	Semantics description
Intra-frequency measurement identity	MD		Measurement identity 10.3.7.48	The intra-frequency measurement identity has default value 1. If the cell is operating in MBSFN mode as indicated in subclause 8.1.1.6.3 the UE behaviour upon reception of this IE is unspecified.
Intra-frequency cell info list	OP		Intra-frequency cell info list 10.3.7.33	
Intra-frequency measurement quantity	OP		Intra-frequency measurement quantity 10.3.7.38	If the cell is operating in MBSFN mode as indicated in subclause 8.1.1.6.3 the UE behaviour upon reception of this IE is unspecified.
Intra-frequency reporting quantity for RACH Reporting	OP		Intra-frequency reporting quantity for RACH Reporting 10.3.7.42	If the cell is operating in MBSFN mode as indicated in subclause 8.1.1.6.3 the UE behaviour upon reception of this IE is unspecified.
Maximum number of reported cells on RACH	OP		Maximum number of reported cells on RACH 10.3.7.43	If the cell is operating in MBSFN mode as indicated in subclause 8.1.1.6.3 the UE behaviour upon reception of this IE is unspecified.
Reporting information for state CELL_DCH	OP		Reporting information for state CELL_DCH 10.3.7.62	Note 1 If the cell is operating in MBSFN mode as indicated in subclause 8.1.1.6.3 the UE behaviour upon reception of this IE is unspecified.

NOTE 1: The reporting of intra-frequency measurements is activated when state CELL_DCH is entered.

10.3.7.41 Intra-frequency reporting quantity

Contains the reporting quantity information for an intra-frequency measurement.

Information Element/Group name	Need	Multi	Type and reference	Semantics description
Reporting quantities for active set cells	MP		Cell reporting quantities 10.3.7.5	
Reporting quantities for monitored set cells	MP		Cell reporting quantities 10.3.7.5	
Reporting quantities for detected set cells	OP		Cell reporting quantities 10.3.7.5	

10.3.7.42 Intra-frequency reporting quantity for RACH reporting

Contains the reporting quantity information for an intra-frequency measurement report, which is sent on the RACH.

Information Element/Group name	Need	Multi	Type and reference	Semantics description
SFN-SFN observed time difference reporting indicator	MP		Enumerated(No report, type 1, type 2)	
CHOICE <i>mode</i>	MP			
>FDD				
>>Reporting quantity	MP		Enumerated(CPICH Ec/N0, CPICH RSCP, Pathloss, No report)	
>TDD				
>>Reporting quantity list	MP	1 to 2		
>>>Reporting quantity	MP		Enumerated(Timeslot ISCP, Primary CCPCH RSCP, No report)	

10.3.7.43 Maximum number of reported cells on RACH

Contains the maximum number of intra-frequency cells to be reported on RACH.

Information Element/Group name	Need	Multi	Type and reference	Semantics description
Maximum number of reported cells	MP		Enumerated (no report, current cell, current cell + best neighbour, current cell+2 best neighbours, ..., current cell+6 best neighbours)	

10.3.7.43a MBMS preferred frequency information

Information Element/Group name	Need	Multi	Type and reference	Semantics description	Version
MBMS preferred frequency list	MP	1 to <maxMBMS-Freq>			REL-6
>MBMS preferred frequency	OP		Integer(1 .. <maxMBMS-Freq>)	Absence of this information element means the currently used frequency. Value n corresponds with the n th frequency included in the IE New inter-frequency cells that is specified within SIB 11	REL-6
>CHOICE <i>Layer convergence information</i>	MP				REL-6
>>No HCS					REL-6
>>>Qoffmbms	MP		Enumerated (4, 8, 12, 16, 20, 30, 40, infinity)	The offset in decibel [dB] added to cells on this MBMS preferred frequency	REL-6
>>HCS					REL-6
>>>HCS_OFF _{mbms}	MP		Integer (0..7)	Offset added to the normal HCS priority level of cells on this MBMS preferred frequency	REL-6
>MBMS PL Service Restriction Information	OP		Enumerated (TRUE)	Included if some service restrictions apply for this preferred frequency e.g. congestion	REL-6

10.3.7.43b MBSFN inter frequency neighbour list

Information Element/Group name	Need	Multi	Type and reference	Semantics description	Version
MBSFN inter frequency neighbour list	MP	1 to <maxMBMSFNclusters>			REL-7
>MBSFN frequency	MP		Frequency info 10.3.6.36		REL-7
>CHOICE MBSFN services notification	MP				REL-7
>>MBSFN services notified				(no data)	REL-7
>>MBSFN services not notified					REL-7
>>>All MBSFN services notified	OP		Enumerated (TRUE)		REL-7

10.3.7.44 Measured results

Contains the measured results of the quantity indicated optionally by Reporting Quantity in Measurement Control. "Measured results" can be used for both event trigger mode and periodical reporting mode. For intra-frequency and inter-frequency measurements the list shall be in the order of the value of the measurement quantity (the first cell shall be the best cell). The "best" FDD cell has the largest value when the measurement quantity is "Ec/No" or "RSCP". On the other hand, the "best" cell has the smallest value when the measurement quantity is "Pathloss". The "best" TDD cell has the largest value when measurement quantity is "Primary CCPCH RSCP". For intra-frequency measurements, the

ordering shall be applied to all cells included in the IE "Measured results". For inter-frequency measurements, the ordering shall be applied to all cells on the same frequency included in the IE "Measured results". For other measurements, the order of reported measurement objects is not specified.

Information Element/Group name	Need	Multi	Type and reference	Semantics description
CHOICE <i>Measurement</i>	MP			One spare value is needed.
>Intra-frequency measured results list			Intra-frequency measured results list 10.3.7.35	
>Inter-frequency measured results list			Inter-frequency measured results list 10.3.7.15	
>Inter-RAT measured results list			Inter-RAT measured results list 10.3.7.26	
>Traffic volume measured results list			Traffic volume measured results list 10.3.7.67	
>Quality measured results list			Quality measured results list 10.3.7.55	
>UE Internal measured results			UE Internal measured results 10.3.7.76	
>UE positioning measured results			UE positioning measured results 10.3.7.99	

10.3.7.45 Measured results on RACH

For measurements on used frequency, this IE contains the measured results on RACH of the quantity indicated by Reporting quantity in the IE "Intra-frequency reporting quantity for RACH Reporting" in system information broadcast on BCH. The list, measurement results for monitored cells (not including the current cell) shall be in the order of the value of the measurement quantity as indicated by Reporting Quantity in the IE "Intra-frequency reporting quantity for RACH Reporting" (the first cell shall be the best cell).

For measurements on non-used frequencies, this IE includes the best cell on each non-used frequency, in order of decreasing quality and up to a maximum number as specified by the IE "Maximum number of inter-frequency RACH reporting cells".

The "best" FDD cell has the largest value when the measurement quantity is "Ec/No" or "RSCP". On the other hand, the "best" cell has the smallest value when the measurement quantity is "Pathloss". The "best" TDD cell has the largest value when measurement quantity is "Primary CCPCH RSCP".

Information Element/group name	Need	Multi	Type and reference	Semantics description	Version
--------------------------------	------	-------	--------------------	-----------------------	---------

Information Element/group name	Need	Multi	Type and reference	Semantics description	Version
Measurement result for current cell	MP				
>CHOICE <i>mode</i>	MP				
>>FDD					
>>>CHOICE <i>measurement quantity</i>	MP			One spare value is needed.	
>>>>CPICH Ec/N0			Integer(0..49)	In dB. According to CPICH_Ec/No in [19]. Fourteen spare values are needed.	
>>>>CPICH RSCP			Integer(0..91)	In dBm. According to CPICH_RSCP_LEV in [19]. Thirty-six spare values are needed.	
>>>>Pathloss			Integer(46..158)	In dB. Fifteen spare values are needed.	
>>TDD					
>>>CHOICE <i>TDD option</i>	MP				REL-4
>>>>3.84 Mcps TDD					REL-4
>>>>>Timeslot List	OP	1 to 14			
>>>>>>Timeslot ISCP	MP		Timeslot ISCP info 10.3.7.65	The UE shall report the Timeslot ISCP in the same order as indicated in the cell info	
>>>>7.68 Mcps TDD					REL-7
>>>>>Timeslot List	OP	1 to 14			REL-7
>>>>>>Timeslot ISCP	MP		Timeslot ISCP info 10.3.7.65	The UE shall report the Timeslot ISCP in the same order as indicated in the cell info	REL-7
>>>>>1.28 Mcps TDD					REL-4
>>>>>>Timeslot List	OP	1 to 6			REL-4
>>>>>>>Timeslot ISCP	MP		Timeslot ISCP info 10.3.7.65	The UE shall report the Timeslot ISCP in the same order as indicated in the cell info	REL-4
>>>Primary CCPCH RSCP	OP		Primary CCPCH RSCP info 10.3.7.54		
Measurement results for monitored cells on used frequency	OP	1 to 8			
>SFN-SFN observed time difference	OP		SFN-SFN observed time difference 10.3.7.63		
>CHOICE <i>mode</i>	MP				
>>FDD					
>>>Primary CPICH info	MP		Primary CPICH info		

Information Element/group name	Need	Multi	Type and reference	Semantics description	Version
			10.3.6.60		
>>>CHOICE <i>measurement quantity</i>	OP			One spare value is needed.	
>>>>CPICH Ec/NO			Integer(0..49)	In dB. According to CPICH_Ec/No in [19]. Fourteen spare values are needed.	
>>>>CPICH RSCP			Integer(0..91)	In dBm. According to CPICH_RSCP_LEV in [19]. Thirty-six spare values are needed.	
>>>>Pathloss			Integer(46..158)	In dB. Fifteen spare values are needed.	
>>TDD					
>>>Cell parameters Id	MP		Cell parameters Id 10.3.6.9		
>>>Primary CCPCH RSCP	MP		Primary CCPCH RSCP info 10.3.7.54		
Measurement results for monitored cells on non-used frequencies	OP				REL-6
>Inter-frequency cell indication-SIB11	MP		Integer (0..1)		REL-6
>Inter-frequency cell indication-SIB12	MP		Integer (0..1)		REL-6
>Inter-frequency cell list	MP	1 to <maxFreq>			REL-6
>>Inter-frequency cell id	MP		Integer(0 .. <maxCellMeas>-1)		REL-6

NOTE: Monitored cells consist of neighbouring cells.

10.3.7.46 Measurement Command

Information Element/Group name	Need	Multi	Type and reference	Semantics description
Measurement command	MP		Enumerated(Setup, Modify, Release)	

10.3.7.47 Measurement control system information

Information element/Group name	Need	Multi	Type and reference	Semantics description
Use of HCS	MP		Enumerated (Not used, used)	Indicates if the serving cell belongs to a HCS structure If the cell is operating in MBSFN mode as indicated in subclause 8.1.1.6.3 the UE behaves as if this IE would not have been received.
Cell selection and reselection quality measure	MP		Enumerated (CPICH Ec/N0, CPICH RSCP)	Choice of measurement (CPICH Ec/N0 or CPICH RSCP) to use as quality measure Q. NOTE: For TDD, each choice of this parameter represents PCCPCH RSCP. If the cell is operating in MBSFN mode as indicated in subclause 8.1.1.6.3 the UE behaves as if this IE would not have been received
Intra-frequency measurement system information	OP		Intra-frequency measurement system information 10.3.7.40	
Inter-frequency measurement system information	OP		Inter-frequency measurement system information 10.3.7.20	If the cell is operating in MBSFN mode as indicated in subclause 8.1.1.6.3 the UE behaviour upon reception of this IE is unspecified.
Inter-RAT measurement system information	OP		Inter-RAT measurement system information 10.3.7.31	If the cell is operating in MBSFN mode as indicated in subclause 8.1.1.6.3 the UE behaviour upon reception of this IE is unspecified.
Traffic volume measurement system information	OP		Traffic volume measurement system information 10.3.7.73	If the cell is operating in MBSFN mode as indicated in subclause 8.1.1.6.3 the UE behaviour upon reception of this IE is unspecified.

Condition	Explanation
<i>MBSFN</i>	This IE is mandatory present in a cell operating in MBSFN mode.

10.3.7.47a Measurement control system information extension

Information element/Group name	Need	Multi	Type and reference	Semantics description	Version
Intra-frequency cell info list	OP				REL-6
>New intra-frequency cells	MP	1 to <maxCellMeas>			REL-6
>>Intra-frequency cell id	OP		Integer(0 .. <maxCellMeas> - 1)		REL-6
>>Cell info	MP		Cell info 10.3.7.2		REL-6
Inter-frequency cell info list	OP				REL-6
>New inter-frequency cells	MP	1 to <maxCellMeas>			REL-6
>>Frequency Info	MD		Frequency info 10.3.6.36	Default value is the value of the previous "frequency info" in the list. NOTE: The first occurrence is then MP.	REL-6
>>Inter-frequency cell id	OP		Integer(0 .. <maxCellMeas> - 1)		REL-6
>>Cell info	MP		Cell info 10.3.7.2		REL-6
Inter-RAT cell info list	OP				REL-6
>>New inter-RAT cells	MP	1 to <maxCellMeas>			REL-6
>>Inter-RAT cell id	OP		Integer(0 .. <maxCellMeas> - 1)		REL-6
>>CHOICE <i>Radio Access Technology</i>	MP				REL-6
>>>GSM					REL-6
>>>>Cell individual offset	MP		Integer (-50..50)	In dB Used to offset measured quantity value	REL-6
>>>>Cell selection and re-selection info	OP		Cell selection and re-selection info for SIB11/12 10.3.2.4	See subclause 8.6.7.3	REL-6
>>>>BSIC	MP		BSIC 10.3.8.2		REL-6
>>>>Band indicator	MP		Enumerated (DCS 1800 band used, PCS 1900 band used)	Indicates how to interpret the BCCH ARFCN	REL-6
>>>>BCCH ARFCN	MP		Integer (0..1023)	[45]	REL-6
>>>IS-2000					REL-6
>>>>System specific measurement info	MP		enumerated (frequency, timeslot, colour code, output power, PN offset)	For IS-2000, use fields from TIA/EIA/IS-2000.5, subclause 3.7.3.3.2.27, <i>Candidate</i>	REL-6

				<i>Frequency Neighbour List Message</i>	
>>>None			(no data)	This value has been introduced to handle the case when IE "New inter-RAT cells" is not required	REL-6

10.3.7.48 Measurement Identity

A reference number that is used by the UTRAN at modification and release of the measurement, and by the UE in the measurement report.

Information Element/Group name	Need	Multi	Type and reference	Semantics description
Measurement identity	MP		Integer(1..16)	

10.3.7.49 Measurement reporting mode

Contains the type of Measurement Report transfer mode and the indication of periodical/event trigger.

Information Element/Group name	Need	Multi	Type and reference	Semantics description
Measurement Report Transfer Mode	MP		enumerated (Acknowledged mode RLC, Unacknowledged mode RLC)	
Periodical Reporting / Event Trigger Reporting Mode	MP		Enumerated (Periodical reporting, Event trigger)	

10.3.7.50 Measurement Type

Information Element/Group name	Need	Multi	Type and reference	Semantics description
Measurement Type	MP		Enumerated (Intra-frequency, Inter-frequency, Inter-RAT, Traffic volume, Quality, UE internal, UE positioning)	

10.3.7.51 Measurement validity

Information Element/Group name	Need	Multi	Type and reference	Semantics description
UE state	MP		Enumerated(CELL_DCH, all states except CELL_DCH, all states)	

10.3.7.52 Void

10.3.7.53 Periodical reporting criteria

Contains the periodical reporting criteria information. It is necessary only in the periodical reporting mode.

Information Element/Group name	Need	Multi	Type and reference	Semantics description
Amount of reporting	MD		Integer(1, 2, 4, 8, 16, 32, 64, Infinity)	The default value is infinity.
Reporting interval	MP		Integer(250, 500, 1000, 2000, 3000, 4000, 6000, 8000, 12000, 16000, 20000, 24000, 28000, 32000, 64000)	Indicates the interval of periodical report. Interval in milliseconds

10.3.7.53aa Periodical reporting info-1b

Information Element/Group name	Need	Multi	Type and reference	Semantics description	Version
Amount of reporting	MP		Integer(1, 2, 4, 8, 16, 32, 64, Infinity)		REL-5
Reporting interval	MP		Integer(0, 250, 500, 1000, 2000, 4000, 8000, 16000)	Indicates the interval of periodical reporting when such reporting is triggered by an event. Interval in milliseconds. 0 means no periodical reporting.	REL-5

10.3.7.53a PLMN identities of neighbour cells

This IE contains the PLMN identities of neighbour cells.

Information Element/Group name	Need	Multi	Type and reference	Semantics description
PLMNs of intra-frequency cells list	OP	1 to <maxCellMEas>		

Information Element/Group name	Need	Multi	Type and reference	Semantics description
>PLMN identity	OP		PLMN identity 10.3.1.11	Action when not present is specified in subclause 8.1.1.6.18.
PLMNs of inter-frequency cells list	OP	1 to <maxCellM eas>		
>PLMN identity	OP		PLMN identity 10.3.1.11	Action when not present is specified in subclause 8.1.1.6.18.
PLMNs of inter-RAT cells list	OP	1 to <maxCellM eas>		
>PLMN identity	OP		PLMN identity 10.3.1.11	Action when not present is specified in subclause 8.1.1.6.18.

10.3.7.54 Primary CCPCH RSCP info

NOTE: Only for TDD

Information Element/Group name	Need	Multi	IE type and reference	Semantics description	Version
Primary CCPCH RSCP	MP		Integer(0..91)	According to P-CCPCH_RSCP_LEV in [19] and [20]. Thirty-six spare values are needed.	
Delta _{Primary} CCPCH RSCP	CV-Rel5		Integer(-5..-1)	If present, the actual value of Primary CCPCH RSCP = Primary CCPCH RSCP + Delta _{Primary} CCPCH RSCP	REL-5

Condition	Explanation
Rel5	This IE is mandatory if the value of Primary CCPCH RSCP is below 0. Otherwise the IE is not needed.

10.3.7.54a Qhcs

Information Element/Group name	Need	Multi	Type and Reference	Semantics description	Version
--------------------------------	------	-------	--------------------	-----------------------	---------

Information Element/Group name	Need	Multi	Type and Reference	Semantics description	Version
Qhcs	MP		Integer(0..99)	Qhcs, mapped from CPICH Ec/No (FDD), see [4] [dB] 0: -24 1: -23.5 2: -23 3: -22.5 ... 45: -1.5 46: -1 47: -0.5 48: 0 49: (spare) ... 98: (spare) 99: (spare)	
				Qhcs, mapped from CPICH RSCP (FDD), see [4] [dBm] 0: -115 1: -114 2: -113 : 88: -27 89: -26 90: -(spare) 91: -(spare) : 98: -(spare) 99: -(spare)	
				Qhcs, mapped from PCCPCH RSCP (TDD), see [4] [dBm] 0: -115 1: -114 2: -113 : 88: -27 89: -26 90: -(spare) 91: -(spare) : 98: -(spare) 99: -(spare)	

Information Element/Group name	Need	Multi	Type and Reference	Semantics description	Version
				Qhcs level, mapped from Averaged received signal level RSSI (GSM), see [4] [dBm] 0: -110 1: -109 2: -108 : 61: -49 62: -48 63: -47 64: -46 65: -45 66: -44 67: -43 68: -42 69: -41 70: -40 71: -39 72: -38 73: -37 74: -(spare) : 98: -(spare) 99: -(spare)	
Delta _{Qhcs-RSCP}	CV-RSCP		Integer(-5..-1)	If present, the actual value of Qhcs = Qhcs + Delta _{Qhcs-RSCP}	REL-5

Condition	Explanation
RSCP	This IE is optional if Qhcs is mapped from CPICH RSCP or PCCPCH RSCP, and if the value of the RSCP is below 0 (-115dBm). It is not needed otherwise.

10.3.7.55 Quality measured results list

Information Element/Group name	Need	Multi	Type and reference	Semantics description
BLER measurement results	OP	1 to <maxTrCH>		
>DL Transport channel identity	MP		Transport channel identity 10.3.5.18	transport channel type = DCH
>DL Transport Channel BLER	OP		Integer (0..63)	According to BLER_LOG in [19] and [20]
CHOICE mode	MP			
>FDD				No data
>TDD				
>>SIR measurement results	OP	1 to <MaxCCTrCH>		SIR measurements for DL CCTrCH
>>>TFCS ID	MP		Integer(1..8)	
>>>Timeslot list	MP	1 to <maxTS>		for all timeslot on which the CCTrCH is mapped on
>>>>SIR	MP		Integer(0..63)	According to UE_SIR in [20]

10.3.7.56 Quality measurement

Information Element/Group name	Need	Multi	Type and reference	Semantics description
Quality reporting quantity	OP		Quality reporting quantity 10.3.7.59	
<i>CHOICE report criteria</i>	MP			
>Quality measurement reporting criteria			Quality measurement reporting criteria 10.3.7.58	Note Given this choice, the IE "DL Transport Channel BLER" shall be set to FALSE (see subclause 10.3.7.59)
>Periodical reporting criteria			Periodical reporting criteria 10.3.7.53	Note
>No reporting				Note (no data) Chosen when this measurement only is used as additional measurement to another measurement

NOTE: In this version of the specification, BLER as additional measurement is not supported.

10.3.7.57 Quality measurement event results

Information Element/Group name	Need	Multi	Type and reference	Semantics description
Transport channels causing the event	OP	1 to <maxTrCH >		
>DL Transport channel identity	MP		Transport channel identity 10.3.5.18	transport channel type = DCH

10.3.7.58 Quality measurement reporting criteria

Event 5a: Number of bad CRCs on a certain transport channel exceeds a threshold.

Information Element/Group name	Need	Multi	Type and reference	Semantics description
Parameters sent for each transport channel	MP	1 to <maxTrCH >		
>DL Transport channel identity	MP		Transport channel identity 10.3.5.18	transport channel type = DCH
>Total CRC	MP		Integer(1..512)	Number of CRCs
>Bad CRC	MP		Integer(1..512)	Number of CRCs
>Pending after trigger	MP		Integer(1..512)	Number of CRCs

10.3.7.59 Quality reporting quantity

Information Element/Group name	Need	Multi	Type and reference	Semantics description
DL Transport Channel BLER	MP		Boolean	TRUE means report requested
Transport channels for BLER reporting	<i>CV-BLER reporting</i>	1 to <maxTrCH >		The default, if no transport channel identities are present, is that the BLER is reported for all downlink transport channels
>DL Transport channel identity	MP		Transport channel identity 10.3.5.18	transport channel type = DCH
CHOICE <i>mode</i>	MP			
>FDD				No data
>TDD				
>>SIR measurement list	OP	1 to <maxCCTr CH>		SIR measurements shall be reported for all listed TFCS IDs
>>>TFCS ID	MP		Integer(1..8)	

Condition	Explanation
<i>BLER reporting</i>	This IE is not needed if the IE "DL Transport Channel BLER" is FALSE and optional if the IE "DL Transport Channel BLER" is TRUE

10.3.7.60 Reference time difference to cell

In the System Information message, the reference time difference to cell indicates the timing difference between the primary CCPCH of the current cell and the primary CCPCH of a neighbouring cell..

In the Measurement Control message, the reference time difference to cell indicates the timing difference between UE uplink transmission timing and the primary CCPCH of a neighbouring cell.

Information Element/Group name	Need	Multi	Type and reference	Semantics description
CHOICE <i>accuracy</i>	MP			
>40 chips				
>>Reference time difference	MP		Integer(0..38400 by step of 40)	In chips
>256 chips				
>>Reference time difference	MP		Integer(0..38400 by step of 256)	In chips
>2560 chips				
>>Reference time difference	MP		Integer(0..38400 by step of 2560)	In chips

10.3.7.61 Reporting Cell Status

Indicates maximum allowed number of cells to report and whether active set cells and/or virtual active set cells and/or monitored set cells on and/or detected set cells used frequency and/or monitored set cells on non used frequency should/should not be included in the IE "Measured results".

Information Element/Group name	Need	Multi	Type and reference	Semantics description
CHOICE <i>reported cell</i>	MP			
>Report cells within active set				This choice is not valid for inter-RAT measurements. For inter-frequency measurements

Information Element/Group name	Need	Multi	Type and reference	Semantics description
				it is only valid for reporting events 2D and 2F. See NOTE 1.
>>Maximum number of reported cells	MP		Integer(1..6)	
>Report cells within monitored set cells on used frequency				This choice is not valid for inter-RAT or inter-frequency measurements
>>Maximum number of reported cells	MP		Integer(1..6)	
>Report cells within active set and/or monitored set cells on used frequency				This choice is not valid for inter-RAT or inter-frequency measurements
>>Maximum number of reported cells	MP		Integer(1..6)	
>Report cells within detected set on used frequency				This choice is not valid for inter-RAT or inter-frequency measurements
>>Maximum number of reported cells	MP		Integer(1..6)	
>Report cells within monitored set and/or detected set on used frequency				This choice is not valid for inter-RAT or inter-frequency measurements
>>Maximum number of reported cells	MP		Integer(1..6)	
>Report all active set cells + cells within monitored set on used frequency				This choice is not valid for inter-RAT or inter-frequency measurements
>>Maximum number of reported cells	MP		Enumerated (virtual/active set cells+1, virtual/active set cells+2,, virtual/active set cells+6)	
>Report all active set cells + cells within detected set on used frequency				This choice is not valid for inter-RAT or inter-frequency measurements
>>Maximum number of reported cells	MP		Enumerated (virtual/active set cells+1, virtual/active set cells+2,, virtual/active set cells+6)	
>Report all active set cells + cells within monitored set and/or detected set on used frequency				This choice is not valid for inter-RAT or inter-frequency measurements
>>Maximum number of reported cells	MP		Enumerated (virtual/active set cells+1, virtual/active set cells+2,, virtual/active set cells+6)	
>Report cells within virtual active set				This choice is not valid for intra-frequency or inter-RAT measurements
>>Maximum number of reported cells per reported non-used frequency	MP		Integer(1..6)	
>Report cells within monitored set on non-used frequency				This choice is not valid for intra-frequency or inter-RAT

Information Element/Group name	Need	Multi	Type and reference	Semantics description
				measurements
>>Maximum number of reported cells per reported non-used frequency	MP		Integer(1..6)	
>Report cells within monitored and/or virtual active set on non-used frequency				This choice is not valid for intra-frequency or inter-RAT measurements
>>Maximum number of reported cells per reported non-used frequency	MP		Integer(1..6)	
>Report all virtual active set cells + cells within monitored set on non-used frequency				This choice is not valid for intra-frequency or inter-RAT measurements
>>Maximum number of reported cells per reported non-used frequency	MP		Enumerated (virtual/active set cells+1, virtual/active set cells+2,, virtual/active set cells+6)	
>Report cells within active set or within virtual active set or of the other RAT				If this choice is selected for inter-RAT measurements, the UE shall report only cells of the other RAT. If this choice is selected for intra-frequency measurements, the UE shall report cells within the active set. If this choice is selected for inter-frequency measurements, the UE shall report cells within the virtual active set.
>>Maximum number of reported cells	MP		Integer (1..12)	
>Report cells within active and/or monitored set on used frequency or within virtual active and/or monitored set on non-used frequency				This choice is not valid for inter-RAT measurements. If this choice is selected for intra-frequency measurements, the UE shall report cells within the active and/or monitored set. If this choice is selected for inter-frequency measurements, the UE shall report cells within the virtual active set and/or monitored set on non-used frequency.
>>Maximum number of reported cells	MP		Integer(1..12)	

NOTE 1: For Inter-frequency reporting events 2D and 2F, only CHOICE "Report cells within active set" is valid.

10.3.7.62 Reporting information for state CELL_DCH

Information Element/Group name	Need	Multi	Type and reference	Semantics description
Intra-frequency reporting quantity	MP		Intra-frequency reporting quantity 10.3.7.41	
Measurement Reporting Mode	MP		Measurement Reporting Mode 10.3.7.49	
CHOICE <i>report criteria</i>	MP			
>Intra-frequency measurement reporting criteria			Intra-frequency measurement reporting criteria 10.3.7.39	This IE may only contain measurement events from 1A to 1I, but not measurement event 1J.
>Periodical reporting criteria			Periodical reporting criteria 10.3.7.53	

10.3.7.63 SFN-SFN observed time difference

Information Element/Group name	Need	Multi	Type and reference	Semantics description	Version
CHOICE <i>type</i>	MP				
>Type 1			Integer(0..9830399)	According to T1_SFN-SFN_TIME in [19] and [20]. For FDD and 3.84 Mcps TDD and 7.68 Mcps TDD: 6946816 spare values are needed.	
			Integer(0..3276799)	For 1.28 Mcps TDD: 13500416 spare values are needed.	Rel-4
>Type 2			Integer(0..40961)	According to T2_SFN-SFN_TIME in [19] and [20]. 24574 spare values are needed.	
			Integer(0..27649)	For 1.28 Mcps TDD: 37886 spare values are needed.	Rel-4

10.3.7.64 Time to trigger

Information Element/Group name	Need	Multi	Type and reference	Semantics description
Time to trigger	MP		Integer(0, 10, 20, 40, 60, 80, 100, 120, 160, 200, 240, 320, 640, 1280, 2560, 5000)	Time in ms

10.3.7.65 Timeslot ISCP info

NOTE: Only for TDD

Information Element/Group name	Need	Multi	IE type and reference	Semantics description
Timeslot ISCP	MP		Integer (0..91)	According to UE_TS_ISCP_LEV in [20]. Thirty-six spare values are needed.

10.3.7.66 Traffic volume event identity

Information Element/Group name	Need	Multi	Type and reference	Semantics description
Traffic volume event identity	MP		Enumerated(4a, 4b)	

10.3.7.67 Traffic volume measured results list

Information Element/Group name	Need	Multi	Type and reference	Semantics description
Traffic volume measurement results	OP	1 to <maxRB>		
>RB Identity	MP		RB Identity 10.3.4.16	
>RLC Buffers Payload	OP		Enumerated(0, 4, 8, 16, 32, 64, 128, 256, 512, 1024, 2K, 4K, 8K, 16K, 32K, 64K, 128K, 256K, 512K, 1024K)	In bytes And N Kbytes = N*1024 bytes. Twelve spare values are needed.
>Average of RLC Buffer Payload	OP		Enumerated(0, 4, 8, 16, 32, 64, 128, 256, 512, 1024, 2K, 4K, 8K, 16K, 32K, 64K, 128K, 256K, 512K, 1024K)	In bytes And N Kbytes = N*1024 bytes. Twelve spare values are needed.
>Variance of RLC Buffer Payload	OP		Enumerated(0, 4, 8, 16, 32, 64, 128, 256, 512, 1024, 2K, 4K, 8K, 16K)	In bytes And N Kbytes = N*1024 bytes. Two spare values are needed.

10.3.7.68 Traffic volume measurement

Information Element/Group name	Need	Multi	Type and reference	Semantics description
Traffic volume measurement Object	OP		Traffic volume measurement Object 10.3.7.70	
Traffic volume measurement quantity	OP		Traffic volume measurement quantity 10.3.7.71	
Traffic volume reporting quantity	OP		Traffic volume reporting quantity 10.3.7.74	
Measurement validity	OP		Measurement validity 10.3.7.51	
<i>CHOICE report criteria</i>	MP			
>Traffic volume measurement reporting criteria			Traffic volume measurement reporting criteria 10.3.7.72	
>Periodical reporting criteria			Periodical reporting criteria 10.3.7.53	
>No reporting				(no data) Chosen when this measurement only is used as additional measurement to another measurement

10.3.7.69 Traffic volume measurement event results

Contains the event result for a traffic volume measurement.

Information Element/Group name	Need	Multi	Type and reference	Semantics description
Uplink transport channel type causing the event	MP		Enumerated(DCH,RACH, USCH)	USCH is TDD only. RACH is the currently configured default in the uplink. For 1.28 Mcps TDD, if E-DCH is configured to the UE, and the Uplink transport channel type is USCH and UL Transport Channel identity is 32, it means E-DCH TVM is configured.
UL Transport Channel identity	<i>CV-UL-DCH/USCH</i>		Transport channel identity 10.3.5.18	
Traffic volume event identity	MP		Traffic volume event identity 10.3.7.66	

Condition	Explanation
<i>UL-DCH/USCH</i>	If IE "Uplink transport channel type" is equal to "DCH" or "USCH" (TDD only) this IE is mandatory present. Otherwise the IE is not needed.

10.3.7.70 Traffic volume measurement object

Contains the measurement object information for a traffic volume measurement.

Information Element/Group name	Need	Multi	Type and reference	Semantics description
Traffic volume measurement objects	MP	1 to <maxTrCH >		
>Uplink transport channel type	MP		Enumerated(DCH,RACH, USCH)	USCH is TDD only. RACH is the currently configured default in the uplink. For 1.28 Mcps TDD, if E-DCH is configured to the UE, and the Uplink transport channel type is USCH and UL Transport Channel identity is 32, it means E-DCH TVM is configured.
>UL Target Transport Channel ID	CV-UL-DCH/USCH		Transport channel identity 10.3.5.18	

Condition	Explanation
<i>UL-DCH/USCH</i>	If IE "Uplink transport channel type" is equal to "DCH" or "USCH" (TDD only) this IE is mandatory present. Otherwise the IE is not needed.

10.3.7.71 Traffic volume measurement quantity

Contains the measurement quantity information for a traffic volume measurement.

Information Element/Group name	Need	Multi	Type and reference	Semantics description
Measurement quantity	MP		Enumerated(RLC buffer payload, Average RLC buffer payload, Variance of RLC buffer payload)	This parameter should be ignored.
Time Interval to take an average or a variance	CV-A/V		Integer(20, 40, ..260, by steps of 20)	In ms

Condition	Explanation
<i>A/V</i>	This IE is mandatory present when "Average RLC buffer" or "Variance of RLC buffer payload" is chosen and not needed otherwise.

10.3.7.72 Traffic volume measurement reporting criteria

Contains the measurement reporting criteria information for a traffic volume measurement.

Event 4a: Transport Channel Traffic Volume [15] exceeds an absolute threshold.

Event 4b: Transport Channel Traffic Volume [15] becomes smaller than an absolute threshold.

Information Element/Group name	Need	Multi	Type and reference	Semantics description
Parameters sent for each transport channel	OP	1 to <maxTrCH >		This IE is always required, need is OP to align with ASN.1
>Uplink transport channel type	OP		Enumerated(DCH,RACH, USCH)	USCH is TDD only. RACH is the currently configured default in the uplink. For 1.28 Mcps TDD, if E-DCH is configured to the UE, and the Uplink transport channel type is USCH and UL Transport Channel identity is 32, it means E-DCH TVM is configured.
>UL Transport Channel ID	CV-UL-DCH/USCH		Transport channel identity 10.3.5.18	
>Parameters required for each Event	OP	1 to <maxMeas parEvent>		
>>Traffic volume event identity	MP		Traffic volume event identity 10.3.7.66	
>>Reporting Threshold	MP		Enumerated(8,16,32,64,128,256,512,1024,2K,3K,4K,6K,8K,12K,16K,24K,32K,48K,64K,96K,128K,192K,256K,384K,512K,768K)	Threshold in bytes And N Kbytes = N*1024 bytes
>>Time to trigger	OP		Time to trigger 10.3.7.64	Indicates the period of time during which the event condition has to be satisfied, before sending a Measurement Report. Time in ms
>>Pending time after trigger	OP		Integer(250, 500, 1000, 2000, 4000, 8000, 16000)	Indicates the period of time during which it is forbidden to send any new measurement reports with the same Traffic volume event identity even if the triggering condition is fulfilled. Time in milliseconds
>>Tx interruption after trigger	OP		Integer (250, 500, 1000, 2000, 4000, 8000, 16000)	Time in milliseconds. Indicates how long the UE shall block DTCH transmissions on the RACH after a measurement report is triggered.

Condition	Explanation
<i>UL-DCH/USCH</i>	If IE "Uplink transport channel type" is equal to "DCH" or "USCH" (TDD only) this IE is optional. Otherwise the IE is not needed.

10.3.7.73 Traffic volume measurement system information

Information Element/Group name	Need	Multi	Type and reference	Semantics description
Traffic volume measurement identity	MD		Measurement identity 10.3.7.48	The traffic volume measurement identity has default value 4.
Traffic volume measurement object	OP		Traffic volume measurement object 10.3.7.70	
Traffic volume measurement quantity	OP		Traffic volume measurement quantity 10.3.7.71	
Traffic volume reporting quantity	OP		Traffic volume reporting quantity 10.3.7.74	
Measurement validity	OP		Measurement validity 10.3.7.51	
Measurement Reporting Mode	MP		Measurement Reporting Mode 10.3.7.49	
<i>CHOICE reporting criteria</i>	MP			
>Traffic volume measurement reporting criteria			Traffic volume measurement reporting criteria 10.3.7.72	
>Periodical reporting criteria			Periodical reporting criteria 10.3.7.53	

10.3.7.74 Traffic volume reporting quantity

Contains the reporting quantity information for a traffic volume measurement.

For all boolean types TRUE means inclusion in the report is requested.

Information Element/Group name	Need	Multi	Type and reference	Semantics description
RLC Buffer Payload for each RB	MP		Boolean	
Average of RLC Buffer Payload for each RB	MP		Boolean	
Variance of RLC Buffer Payload for each RB	MP		Boolean	

10.3.7.75 UE internal event identity

Information Element/Group name	Need	Multi	Type and reference	Semantics description
UE internal event identity	MP		Enumerated(6a,6b,6c,6d,6e, 6f, 6g)	

10.3.7.76 UE internal measured results

Information Element/Group name	Need	Multi	Type and reference	Semantics description	Version
CHOICE <i>mode</i>	MP				
>FDD					
>>UE Transmitted Power	OP		UE Transmitted Power info 10.3.7.85		
>>>UE Rx-Tx report entries	OP	1 to <maxRL>			
>>>>Primary CPICH info	MP		Primary CPICH info 10.3.6.60	Primary CPICH info for each cell included in the active set	
>>>>UE Rx-Tx time difference type 1	MP		UE Rx-Tx time difference type 1 10.3.7.83	UE Rx-Tx time difference in chip for each RL included in the active set	
>TDD					
>>UE Transmitted Power list	OP	1 to <maxTS>		UE Transmitted Power for each used uplink timeslot in ascending timeslot number order	
>>>>UE Transmitted Power	MP		UE Transmitted Power info 10.3.7.85		
>>>>CHOICE <i>TDD option</i>	MP				REL-4
>>>>>3.84 Mcps TDD					REL-4
>>>>>>Applied TA	OP		Uplink Timing Advance 10.3.6.95	Uplink timing advance applied by the UE	
>>>>>>Extended Applied TA	OP		Extended Uplink Timing Advance 10.3.6.95a	Uplink timing advance applied by the UE	REL-7
>>>>>>>7.68 Mcps TDD					REL-7
>>>>>>>>Extended Applied TA	OP		Extended Uplink Timing Advance 10.3.6.95a	Uplink timing advance applied by the UE	REL-7
>>>>>>>>>1.28 Mcps TDD					REL-4
>>>>>>>>>>T _{ADV}	OP		T _{ADV} info 10.3.7.112		REL-4

10.3.7.77 UE internal measurement

Information Element/Group name	Need	Multi	Type and reference	Semantics description
UE internal measurement quantity	OP		UE internal measurement quantity 10.3.7.79	
UE internal reporting quantity	OP		UE internal reporting quantity 10.3.7.82	
<i>CHOICE report criteria</i>	MP			
>UE internal measurement reporting criteria			UE internal measurement reporting criteria 10.3.7.80	
>Periodical reporting criteria			Periodical reporting criteria 10.3.7.53	
>No reporting				(no data) Chosen when this measurement only is used as additional measurement to another measurement

<i>CHOICE report criteria</i>	Condition under which the given <i>report criteria</i> is chosen
UE internal measurement reporting criteria	Chosen when UE internal measurement event triggering is required
Periodical reporting criteria	Chosen when periodical reporting is required
No reporting	Chosen when this measurement only is used as additional measurement to another measurement

10.3.7.78 UE internal measurement event results

This IE contains the measurement event results that are reported to UTRAN for UE internal measurements.

Information Element/Group name	Need	Multi	Type and reference	Semantics description
UE internal event identity	MP		UE internal event identity 10.3.7.75	
<i>CHOICE mode</i>	MP			
>FDD				
>Primary CPICH info	<i>CV-clause 1</i>		Primary CPICH info 10.3.6.60	
>TDD				(no data)

Condition	Explanation
<i>Clause 1</i>	This IE is mandatory present if the IE "UE internal event identity" is set to "6f" or "6g", otherwise the IE is not needed.

10.3.7.79 UE internal measurement quantity

The quantity the UE shall measure in case of UE internal measurement.

Information Element/Group name	Need	Multi	Type and reference	Semantics description	Version
CHOICE <i>mode</i>	MP				
>FDD					
>>Measurement quantity	MP		Enumerated(UE Transmitted Power, UTRA Carrier RSSI, UE Rx-Tx time difference)		
>TDD					
>>Measurement quantity	MP		Enumerated(UE Transmitted Power, UTRA Carrier RSSI,		
			T _{ADV})	Measurement on Timing Advance is for 1.28 Mcps TDD	REL-4
Filter coefficient	OP		Filter coefficient 10.3.7.9	If the IE "Measurement quantity" is set to "Rx-Tx time difference" and this IE is present, the UE behaviour is unspecified.	

10.3.7.80 UE internal measurement reporting criteria

The triggering of the event-triggered reporting for a UE internal measurement. All events concerning UE internal measurements are labelled 6x where x is a, b, c.... In TDD, the events 6a - 6d are measured and reported on timeslot basis.

Event 6a: The UE Transmitted Power becomes larger than an absolute threshold

Event 6b: The UE Transmitted Power becomes less than an absolute threshold

Event 6c: The UE Transmitted Power reaches its minimum value

Event 6d: The UE Transmitted Power reaches its maximum value

Event 6e: The UE RSSI reaches the UEs dynamic receiver range

Event 6f (FDD): The UE Rx-Tx time difference for a RL included in the active set becomes larger than an absolute threshold

Event 6f (1.28 Mcps TDD): The time difference indicated by T_{ADV} becomes larger than an absolute threshold

Event 6g: The UE Rx-Tx time difference for a RL included in the active set becomes less than an absolute threshold

Information Element/Group name	Need	Multi	Type and reference	Semantics description	Version
Parameters sent for each UE internal measurement event	OP	1 to <maxMeas Event>			
>UE internal event identity	MP		UE internal event identity 10.3.7.75		

Information Element/Group name	Need	Multi	Type and reference	Semantics description	Version
>Time-to-trigger	MP		Integer(0, 10, 20, 40, 60, 80, 100, 120, 160, 200, 240, 320, 640, 1280, 2560, 5000)	Time in ms. Indicates the period of time between the timing of event detection and the timing of sending Measurement Report.	
>UE Transmitted Power Tx power threshold	CV-clause 1		Integer(-50..33)	Power in dBm. In event 6a, 6b.	
>UE Rx-Tx time difference threshold	CV-clause 2		Integer(768..1280)	Time difference in chip. In event 6f, 6g.	
>T _{ADV} threshold	CV-clause 3		Real (0..63 step 0.125)	Time difference in chip. In event 6f	REL-4

Condition	Explanation
Clause 1	The IE is mandatory present if the IE "UE internal event identity" is set to "6a" or "6b", otherwise the IE is not needed.
Clause 2	In FDD, the IE is mandatory present if the IE "UE internal event identity" is set to "6f" or "6g", otherwise the IE is not needed.
Clause 3	In 1.28 Mcps TDD the IE is mandatory present if the IE "UE internal event identity" is set to "6f", otherwise the IE is not needed.

10.3.7.81 Void

10.3.7.82 UE Internal reporting quantity

For all boolean types TRUE means inclusion in the report is requested.

Information Element/Group name	Need	Multi	Type and reference	Semantics description	Version
UE Transmitted Power	MP		Boolean		
CHOICE <i>mode</i>	MP				
>FDD					
>>UE Rx-Tx time difference	MP		Boolean		
>TDD					
>>CHOICE <i>TDD option</i>					REL-4
>>>3.84 Mcps TDD					REL-4
>>>>Applied TA	MP		Boolean		
>>>>7.68 Mcps TDD					REL-7
>>>>Applied TA	MP		Boolean		REL-7
>>>>1.28 Mcps TDD					REL-4
>>>>T _{ADV} info	MP		Boolean		REL-4

10.3.7.83 UE Rx-Tx time difference type 1

The difference in time between the UE uplink DPCCH/DPDCH frame transmission and the first detected path (in time), of the downlink DPCH or F-DPCH frame from the measured radio link, as defined in [7]. This measurement is for FDD only.

Information Element/Group name	Need	Multi	Type and reference	Semantics description
UE Rx-Tx time difference type 1	MP		Integer(768..1280)	In chips. 511 spare values are needed.

10.3.7.84 UE Rx-Tx time difference type 2

The difference in time between the UE uplink DPCCH/DPDCH frame transmission and the first detected path (in time), of the downlink DPCH or F-DPCH frame from the measured radio link, as defined in [7].

Information Element/Group name	Need	Multi	Type and reference	Semantics description
UE Rx-Tx time difference type 2	MP		Integer (0..8191)	According to [19].

10.3.7.85 UE Transmitted Power info

Information Element/Group name	Need	Multi	IE type and reference	Semantics description
UE Transmitted Power	MP		Integer (0..104)	According to UE_TX_POWER in [19] and [20]

10.3.7.86 UE positioning Ciphering info

This IE contains information for the ciphering of UE positioning assistance data broadcast in System Information.

Information Element/Group name	Need	Multi	Type and Reference	Semantics description
Ciphering Key Flag	MP		Bit string(1)	
Ciphering Serial Number	MP		Integer(0..65535)	The serial number used in the DES ciphering algorithm

10.3.7.87 UE positioning Error

Information Element/Group name	Need	Multi	Type and Reference	Semantics description	Version
Error reason	MP		Enumerated(Not Enough OTDOA Cells, Not Enough GPS Satellites, Assistance Data Missing, Not Accomplished GPS Timing Of Cell Frames, Undefined Error, Request Denied By User, Not Processed And Timeout, Reference Cell Not Serving Cell,	Note 1	
			Not Enough GANSS Satellites, Not Accomplished GANSS Timing Of Cell Frames)	Note 1	REL-7
GPS Additional Assistance Data Request	CV- <i>GPSdataMissing</i>		UE positioning GPS Additional Assistance Data Request 10.3.7.88a		
GANSS Additional Assistance Data Request	CV- <i>GANSSdataMissing</i>		UE positioning GANSS Additional Assistance Data Request 10.3.7.88c		REL-7

NOTE 1: The following table describes each value of the IE "Error reason".

Value	Indication
Not Enough OTDOA Cells	There were not enough cells to be received.
Not Enough GPS Satellites	There were not enough GPS satellites to be received.
Assistance Data Missing	UE positioning or/and GANSS GPS assistance data missing.
Not Accomplished GPS Timing Of Cell Frames	UE was not able to accomplish the GPS timing of cell frames measurement.
Undefined Error	Undefined error.
Request Denied By User	UE positioning request denied by upper layers.
Not Processed And Timeout	UE positioning request not processed by upper layers and timeout.
Reference Cell Not Serving Cell	UE was not able to read the SFN of the reference cell.
Not Enough GANSS Satellites	There were not enough GANSS satellites to be received.
Not Accomplished GANSS Timing Of Cell Frames	UE was not able to accomplish the GANSS timing of cell frames measurement.

Condition	Explanation
<i>GPSdataMissing</i>	The IE is optional if the IE "Error reason" is "Assistance Data Missing" and not needed otherwise.
<i>GANSSdataMissing</i>	The IE is optional if the IE "Error reason" is "Assistance Data Missing" and not needed otherwise.

10.3.7.88 UE positioning GPS acquisition assistance

This IE contains parameters that enable fast acquisition of the GPS signals in UE-assisted GPS positioning.

Information Element/Group name	Need	Multi	Type and Reference	Semantics description	Version
GPS TOW msec	MP		Integer(0..6.048*10 ⁸ -1)	GPS Time of Week in milliseconds rounded down to the nearest millisecond unit. It is also the time when satellite information is valid.	
UTRAN GPS reference time	OP				
>UTRAN GPS timing of cell frames	MP		Integer(0 ... 2322431999999)	GPS timing of cell frames in steps of 1 chip.	
>CHOICE mode	OP				
>>FDD					
>>>Primary CPICH Info	MP		Primary CPICH Info 10.3.6.60	Identifies the reference cell for the GPS TOW-SFN relationship	
>>TDD					
>>>cell parameters id	MP		Cell parameters id 10.3.6.9	Identifies the reference cell for the GPS TOW-SFN relationship	
>SFN	MP		Integer(0..4095)	The SFN which the UTRAN GPS timing of cell frames time stamps.	
UE Positioning GPS ReferenceTime Uncertainty	OP		UE positioning GPS reference time uncertainty 10.3.7.96a		REL-7
Satellite information	MP	1 to <maxSat>			
>SatID	MP		Integer (0..63)	Identifies the satellite and is equal to (SV ID No - 1) where SV ID No is defined in [12].	
>Doppler (0 th order term)	MP		Real(-5120..5117.5)	Hz	

Information Element/Group name	Need	Multi	Type and Reference	Semantics description	Version
			by step of 2.5)		
>Extra Doppler	OP				
>>Doppler (1 st order term)	MP		Real (-0.966..0.483 by step of 0.023)	Hz/s	
>>Doppler Uncertainty	MP		Enumerated (12,5,25,50,100,200)	Hz. Three spare values are needed. The Doppler experienced by a stationary UE is in the range "Doppler – Doppler Uncertainty" to "Doppler + Doppler Uncertainty".	
>Code Phase	MP		Integer(0..1022)	GPS chips. Increasing binary values of the field signify increasing predicted pseudoranges.	
>Integer Code Phase	MP		Integer(0..19)	Number of code periods that have elapsed since the latest GPS bit boundary, in units of C/A code period.	
>GPS Bit number	MP		Integer(0..3)	Specifies GPS bit number modulo 4	
>Code Phase Search Window	MP		Integer(1023,1,2,3,4,6,8,12,16,24,32,48,64,96,128,192)	Expected code-phase is in the range "Code Phase – Code Phase Search Window" to "Code Phase + Code Phase Search Window".	
>Azimuth and Elevation	OP				
>>Azimuth	MP		Real(0..348.75 by step of 11.25)	Degrees An angle of x degrees means the satellite azimuth a is in the range $x \leq a < x+11.25$ degrees.	
>>Elevation	MP		Real(0..78.75 by step of 11.25)	Degrees An angle of y degrees means the satellite elevation e is in the range $y \leq e < y+11.25$ degrees except for $y=78.75$ where the range is extended to include 90 degrees.	

10.3.7.88a UE positioning GPS Additional Assistance Data Request

Information Element/Group name	Need	Multi	Type and Reference	Semantics description
Almanac	MP		Boolean	TRUE means requested
UTC Model	MP		Boolean	TRUE means requested
Ionospheric model	MP		Boolean	TRUE means requested
Navigation Model	MP		Boolean	TRUE means requested
DGPS Corrections	MP		Boolean	TRUE means requested
Reference Location	MP		Boolean	TRUE means requested
Reference Time	MP		Boolean	TRUE means requested
Acquisition Assistance	MP		Boolean	TRUE means requested
Real-Time Integrity	MP		Boolean	TRUE means requested
Navigation Model Additional data	CV- <i>Navigation Model</i>			this IE is present only if "Navigation Model" is set to TRUE otherwise it is absent
>GPS Week	MP		Integer (0..1023)	

Information Element/Group name	Need	Multi	Type and Reference	Semantics description
>GPS_Toe	MP		Integer (0..167)	GPS time of ephemeris in hours of the latest ephemeris set contained by the UE. Eighty-eight spare values needed.
>T-Toe limit	MP		Integer (0..10)	ephemeris age tolerance of the UE to UTRAN in hours. Five spare values needed.
>Satellites list related data	MP	0 to <maxSat>		
>>SatID	MP		Integer (0..63)	Identifies the satellite and is equal to (SV ID No - 1) where SV ID No is defined in [12].
>>IODE	MP		Integer (0..255)	Issue of Data Ephemeris for SatID

10.3.7.88b UE positioning GANSS reference measurement information

This IE provides reference code and Doppler measurement information of visible satellites of a GNSS constellation. The information enables fast acquisition of the GANSS signals in UE-assisted GANSS positioning. If the IE "UE positioning GPS acquisition assistance" is not included in IE "UE positioning measurement", the Satellite Information is valid at the time as given in the IE "UE positioning GANSS reference time" IE. I.e., if IE "UE positioning GANSS reference measurement information" is included in IE "UE positioning GANSS assistance data" and IE "UE positioning GPS acquisition assistance" is not included in IE "UE positioning measurement", the IE "UE positioning GANSS reference time" shall also be included. If the IE "UE positioning GPS acquisition assistance" is included in IE "UE positioning measurement", the IE "GPS TOW msec" and IE "UTRAN GPS reference time" included in IE "UE positioning GPS acquisition assistance" is also valid for the Satellite information in IE "UE positioning GANSS reference measurement information".

Information Element/Group name	Need	Multi	Type and Reference	Semantics description	Version
GANSS Signal ID	OP		GANSS Signal Id 10.3.3.45a	Absence of this field means Galileo L1 OS if GANSS_ID refers to Galileo. If this IE is asked by SIB 15.6, the GANSS shall be solved by the scheduling information.	REL-7
Satellite information	MP	1 to <maxGAN SSSat>			REL-7
>SatID	MP		Integer (0..63)	Identifies the satellite and is equal to (SV ID No - 1) where SV ID No is defined in e.g. [61].	REL-7
>Doppler (0 th order term)	MP		Real(-1024..1023.5 by step of 0.5)	m/s Conversion between m/s and Hz shall be made by using the <i>nominal</i> wavelength of the assisted signal.	REL-7
>Extra Doppler	OP				REL-7
>>Doppler (1 st order term)	MP		Real (-0.2..0.1 by step of 1/210)	m/s ²	REL-7
>>Doppler Uncertainty	MP		Enumerated (40,20,10,5, 2.5)	m/s. The Doppler experienced by a stationary UE is in the range "Doppler – Doppler Uncertainty" to "Doppler + Doppler Uncertainty". Three spare values are needed.	REL-7
>Code Phase	MP		Integer(0..1023)	ms, scaling factor 2 ⁻¹⁰ <i>Nominal</i> chipping rate of the GNSS signal shall be used in conversion. Increasing binary values of the field signify increasing predicted code phases.	REL-7
>Integer Code Phase	MP		Integer(0..127)	ms. Integer code phase (expressed modulo 128 ms) currently being transmitted at the Reference Time included in either IE "UE positioning GANSS reference time" or IE "UE positioning GPS acquisition assistance", as seen by a receiver at the Reference Location. The UE can calculate the expected code phase as follows:	REL-7

Information Element/Group name	Need	Multi	Type and Reference	Semantics description	Version
				Reference Time – Integer Code Phase + Code Phase.	
>Code Phase Search Window	MP		Bit string (5)	Coded expected code-phase is in the range “Code Phase – Code Phase Search Window” to “Code Phase + Code Phase Search Window”. For coding description, see Note 1	REL-7
>Azimuth and Elevation	OP				REL-7
>>Azimuth	MP		Real(0..348.75 by step of 11.25)	Degrees An angle of x degrees means the satellite azimuth a is in the range $x \leq a < x+11.25$ degrees.	REL-7
>>Elevation	MP		Real(0..78.75 by step of 11.25)	Degrees An angle of y degrees means the satellite elevation e is in the range $y \leq e < y+11.25$ degrees except for $y=78.75$ where the range is extended to include 90 degrees.	REL-7

NOTE 1: Code phase search window parameter format:

CODE_PHASE_SEARCH_WINDOW	Code Phase Search Window [ms]
'00000'	No information
'00001'	0,002
'00010'	0,004
'00011'	0,008
'00100'	0,012
'00101'	0,016
'00110'	0,024
'00111'	0,032
'01000'	0,048
'01001'	0,064
'01010'	0,096
'01011'	0,128
'01100'	0,164
'01101'	0,200
'01110'	0,250
'01111'	0,300
'10000'	0,360
'10001'	0,420
'10010'	0,480
'10011'	0,540
'10100'	0,600
'10101'	0,660
'10110'	0,720
'10111'	0,780
'11000'	0,850
'11001'	1,000
'11010'	1,150
'11011'	1,300
'11100'	1,450
'11101'	1,600
'11110'	1,800
'11111'	2,000

10.3.7.88c UE positioning GANSS additional assistance data request

Information Element/Group name	Need	Multi	Type and Reference	Semantics description	Version
GANSS Reference Time	MP		Boolean	TRUE means requested	REL-7
GANSS Reference Location	MP		Boolean	TRUE means requested	REL-7
GANSS Ionospheric model	MP		Boolean	TRUE means requested	REL-7
GANSS Requested Generic Assistance Data	MP	1 to <maxGANSS>			REL-7
>GANSS ID	OP		Integer(0..7)	Absence of this IE means Galileo Values 0-7 reserved for future use.	REL-7
>GANSS Real-Time Integrity	MP		Boolean	TRUE means requested	REL-7
>DGANSS Signal	OP		DGANSS Signal Id 10.3.7.88d		REL-7
>GANSS Almanac	MP		Boolean	TRUE means requested	REL-7
>GANSS Navigation Model	MP		Boolean	TRUE means requested	REL-7
>GANSS Time Model GNSS-GNSS	OP		BIT STRING (8)	The reference system for requested GANSS time model GNSS-GNSS is as indicated in IE "GANSS ID". The models are requested for each system with respective bit set to "1". Bit 0 is set for GPS, Bit 1 is set for Galileo. Other bits are reserved	REL-7
>GANSS Reference Measurement Information	MP		Boolean	TRUE means requested	REL-7
>GANSS data bits	OP				REL-7
>>GANSS TOD	MP		INTEGER (0..86399)	This field contains the reference time modulo 86400 seconds of the first data bit of the requested data in integer seconds in GNSS specific system time of the GNSS indicated by IE "GANSS ID".	REL-7
>>Data bit assistance	MP				REL-7
>>>GANSS Signal ID	MP		DGANSS Signal Id 10.3.7.88d		REL-7
>>>GANSS Data Bit Interval	MP		Integer(0..15)	This field represents the time length for which the Data Bit Assistance is requested. The Data Bit Assistance shall be relative to the time interval (GANSS TOD, GANSS TOD + Data Bit Interval). The Data Bit Interval r , expressed in seconds, is mapped to a binary number K with the following formula: $r = 0.1 * 2^K$ Value $K=15$ means that the time interval is not specified.	REL-7
>>>Satellite Information	OP	1 to <maxGANSSSat>			REL-7
>>>>Satellite ID	MP		Integer (0..63)	Identifies the satellite for which the Data Bit Assistance request is applicable and is equal to (SV ID No - 1) where SV ID No is defined in e.g. [61].	REL-7
>GANSS UTC model	MP		Boolean	TRUE means Requested	REL-7

Information Element/Group name	Need	Multi	Type and Reference	Semantics description	Version
>GANSS Navigation Model Additional data	CV- GANSSNavigation Model			this IE is present only if IE "GANSS Navigation Model" is set to TRUE otherwise it is absent	REL-7
>>GANSS Week	MP		Integer (0..4095)		REL-7
>>GANSS_Toe	MP		Integer (0..167)	GANSS time of ephemeris in hours of the latest ephemeris set contained by the UE.	REL-7
>>T-Toe limit	MP		Integer (0..10)	ephemeris age tolerance of the UE to UTRAN in hours. Five spare values needed.	REL-7
>>Satellites list related data	OP	1 to <maxGANSSSat>			REL-7
>>>SatID	MP		Integer (0..63)	Identifies the satellite and is equal to (SV ID No - 1) where SV ID No is defined in e.g. [61].	REL-7
>>>IOD	MP		Integer (0..1023)	Issue of Data for SatID	REL-7

10.3.7.88d DGANSS Signal Id

The DGANSS signal Id refers to the signal for which differential corrections or data bit assistance are required. It depends on the GANSS ID. Each bit refers to a particular signal. When the bit is set to 1, this means that the differential corrections or data bit assistance are requested for this particular signal. Differential corrections or data bit assistance can be requested for several signals using the bit string.

Information Element/Group name	Need	Multi	Type and Reference	Semantics description	Version
DGANSS Signal Id	MP		BIT STRING (8)	See Note 1.	REL-7

NOTE 1:

GANSS Id	Bit number	Explanation
Default : Galileo	0	Galileo L1
	1	Galileo E5A
	2	Galileo E5B
	3	Galileo E6
	4	spare
	5	Spare
	6	Spare
	7	Spare

10.3.7.89 UE positioning GPS almanac

This IE contains a reduced-precision subset of the ephemeris and clock correction parameters.

Information Element/Group name	Need	Multi	Type and Reference	Semantics description
WN _a	MP		Bit string(8)	Almanac Reference Week [12]
Satellite information	MP	1 to <maxSat>		
>DataID	MP		Integer(0..3)	See [12]
>SatID	MP		Enumerated(0..63)	Identifies the satellite and is equal to (SV ID No - 1) where SV ID No is defined in [12].
>e	MP		Bit string(16)	Eccentricity [12]
>t _{oa}	MP		Bit string(8)	Reference Time of Almanac [12]
>δi	MP		Bit string(16)	
>OMEGADOT	MP		Bit string(16)	Longitude of Ascending Node of Orbit Plane at Weekly Epoch (semi-circles/sec) [12]
>SV Health	MP		Bit string(8)	
>A ^{1/2}	MP		Bit string(24)	Semi-Major Axis (meters) ^{1/2} [12]
>OMEGA ₀	MP		Bit string(24)	Longitude of Ascending Node of Orbit Plane at Weekly Epoch (semi-circles) [12]
>M ₀	MP		Bit string(24)	Mean Anomaly at Reference Time (semi-circles) [12]
>ω	MP		Bit string(24)	Argument of Perigee (semi-circles) [12]
>af ₀	MP		Bit string(11)	apparent clock correction [12]
>af ₁	MP		Bit string(11)	apparent clock correction [12]
SV Global Health	OP		Bit string(364)	This enables GPS time recovery and possibly extended GPS correlation intervals. It is specified in page 25 of subframes 4 and 5 [12]

10.3.7.89a UE positioning GANSS almanac

This IE contains a reduced-precision subset of the ephemeris and clock correction parameters.

Information Element/Group name	Need	Multi	Type and Reference	Semantics description	Version
Week Number	MP		Integer(0..255)	Almanac reference week , number of weeks since the beginning of GANSS specific system time (mod 256)	REL-7
Keplerian parameters	OP			NOTE	REL-7
>T _{oa}	MP		Integer(0..602112 by step of 4096)	Almanac Reference Time common to all satellites in GANSS Almanac using Keplerian Parameters given in GNSS specific system time	REL-7
>IOD _a	MP		INTEGER(0..3)	Issue-Of –Data, common to all satellites	REL-7
>Satellite information KP	MP	1 to <maxGANSSSat>		Almanacs are in the order of the SV IDs, the smallest ID first.	REL-7
>>SV ID	MP		Integer (0..63)	Satellite ID	REL-7
>>e	MP		Bit string(11)	Eccentricity, dimensionless [61]	REL-7
>>δi	MP		Bit string(11)	semi-circles [61]	REL-7
>>OMEGADOT	MP		Bit string(11)	Longitude of Ascending Node of Orbit Plane at Weekly Epoch (semi-circles/sec) [61]	REL-7
>>SV Health KP	MP		Bit string(4)	Dimensionless. For GANSS Id referring to Galileo, this is described in [61]	REL-7
>>delta A ^{1/2}	MP		Bit string(17)	Semi-Major Axis delta (meters) ^{1/2} [61]	REL-7
>>OMEGA ₀	MP		Bit string(16)	Longitude of Ascending Node of Orbit Plane at Weekly Epoch (semi-circles) [61]	REL-7
>>M ₀	MP		Bit string(16)	Mean Anomaly at Reference Time (semi-circles) [61]	REL-7
>>ω	MP		Bit string(16)	Argument of Perigee (semi-circles) [61]	REL-7
>>af ₀	MP		Bit string(14)	Seconds [61]	REL-7
>>af ₁	MP		Bit string(11)	sec/sec [61]	REL-7

NOTE: This IE shall contain exactly one of the optional fiels indicated by "NOTE".

10.3.7.90 UE positioning GPS assistance data

This IE contains GPS assistance data.

Information Element/Group name	Need	Multi	Type and Reference	Semantics description
UE positioning GPS reference time	OP		UE positioning GPS reference time 10.3.7.96	
UE positioning GPS reference UE position	OP		Ellipsoid point with altitude and uncertainty ellipsoid 10.3.8.4c	A priori knowledge of UE 3-D position.
UE positioning GPS DGPS corrections	OP		UE positioning GPS DGPS corrections 10.3.7.91	
UE positioning GPS navigation model	OP		UE positioning GPS navigation model 10.3.7.94	
UE positioning GPS ionospheric model	OP		UE positioning GPS ionospheric model 10.3.7.92	
UE positioning GPS UTC model	OP		UE positioning GPS UTC model 10.3.7.97	
UE positioning GPS almanac	OP		UE positioning GPS almanac 10.3.7.89	
UE positioning GPS acquisition assistance	OP		UE positioning GPS acquisition assistance 10.3.7.88	
UE positioning GPS real-time integrity	OP		UE positioning GPS real-time integrity 10.3.7.95	

10.3.7.90a Void

10.3.7.90b UE positioning GANSS assistance data

This IE contains GANSS assistance data.

Information Element/Group name	Need	Multi	Type and Reference	Semantics description	Version
UE positioning GANSS reference time	OP		UE positioning GANSS reference time 10.3.7.96o		REL-7
UE positioning GANSS reference UE position	OP		Ellipsoid point with altitude and uncertainty ellipsoid 10.3.8.4c	A priori knowledge of UE 3-D position.If IE "UE positioning GPS assistance data" is present, this IE should not be included to both IEs.	REL-7
UE positioning GANSS ionospheric model	OP		UE positioning GANSS ionospheric model 10.3.7.92a		REL-7
GANSS Generic Assistance Data	OP	1 to <maxGANSS>			REL-7
>GANSS ID	OP		Integer(0..7)	Absence of this IE means Galileo Values 0-7 reserved for future use.	REL-7
>GANSS Time Models	OP	1 to <maxGANSS-1>			REL-7
>>GANSS Time Model	MP		UE positioning GANSS time model 10.3.7.97a		REL-7
>UE positioning DGANSS corrections	OP		UE positioning DGANSS corrections 10.3.7.91b		REL-7
>UE positioning GANSS navigation model	OP		UE positioning GANSS navigation model 10.3.7.94a		REL-7
>UE positioning GANSS real-time integrity	OP		UE positioning GANSS real-time integrity 10.3.7.95b		REL-7
>UE positioning GANSS data bit assistance	OP		UE positioning GANSS data bit assistance 10.3.7.97b		REL-7
>UE positioning GANSS reference measurement information	OP		UE positioning GANSS reference measurement information 10.3.7.88b		REL-7
>UE positioning GANSS almanac	OP		UE positioning GANSS almanac		REL-7

Information Element/Group name	Need	Multi	Type and Reference	Semantics description	Version
>UE positioning GANSS UTC model	OP		10.3.7.89a UE positioning GANSS UTC model 10.3.7.97c		REL-7

10.3.7.91 UE positioning GPS DGPS corrections

This IE contains DGPS corrections to be used by the UE.

Information Element/Group name	Need	Multi	Type and Reference	Semantics description
GPS TOW sec	MP		Integer(0..604799)	seconds GPS time-of-week when the DGPS corrections were calculated
Status/Health	MP		Enumerated(UDRE scale 1.0, UDRE scale 0.75, UDRE scale 0.5, UDRE scale 0.3, UDRE scale 0.2, UDRE scale 0.1, no data, invalid data)	
DGPS information	CV- Status/Health	1 to <maxSat>		If the Cipher information is included these fields are ciphered.
>SatID	MP		Enumerated (0..63)	Identifies the satellite and is equal to (SV ID No - 1) where SV ID No is defined in [12].
>IODE	MP		Integer(0..255)	
>UDRE	MP		Enumerated(UDRE ≤ 1.0 m, 1.0m < UDRE ≤ 4.0m, 4.0m < UDRE ≤ 8.0m, 8.0m < UDRE)	The value in this field shall be multiplied by the UDRE Scale Factor in the IE Status/Health to determine the final UDRE estimate for the particular satellite.
>PRC	MP		Real(-655.04..655.04 by step of 0.32)	meters (different from [13])
>RRC	MP		Real(-4.064..4.064 by step of 0.032)	meters/sec (different from [13])
>Delta PRC2	MP		Integer(-127..127)	In this version of the protocol this IE should be set to zero and the UE shall ignore it
>Delta RRC2	MP		Real(-0.224..0.224 by step of 0.032)	In this version of the protocol this IE should be set to zero and the UE shall ignore it

Information Element/Group name	Need	Multi	Type and Reference	Semantics description
>Delta PRC3	OP		Integer(-127..127)	This IE should not be included in this version of the protocol and if received the UE shall ignore it
>Delta RRC3	OP		Real(-0.224..0.224 by step of 0.032)	This IE should not be included in this version of the protocol and if received the UE shall ignore it

Condition	Explanation
<i>Status/Health</i>	This IE is mandatory present if "status" is not equal to "no data" or "invalid data", otherwise the IE is not needed.

10.3.7.91a UE positioning GPS Ephemeris and Clock Correction parameters

This IE contains information for GPS ephemeris and clock correction.

Information Element/Group name	Need	Multi	Type and Reference	Semantics description
C/A or P on L2	MP		Bit string(2)	Code(s) on L2 Channel [12]
URA Index	MP		Bit string(4)	User Range Accuracy [12]
SV Health	MP		Bit string(6)	[12]
IODC	MP		Bit string(10)	Issue of Data, Clock [12]
L2 P Data Flag	MP		Bit string(1)	[12]
SF 1 Reserved	MP		Bit string(87)	[12]
TGD	MP		Bit string(8)	Estimated group delay differential [12]
t _{oc}	MP		Bit string(16)	apparent clock correction [12]
af ₂	MP		Bit string(8)	apparent clock correction [12]
af ₁	MP		Bit string(16)	apparent clock correction [12]
af ₀	MP		Bit string(22)	apparent clock correction [12]
C _{rs}	MP		Bit string(16)	Amplitude of the Sine Harmonic Correction Term to the Orbit Radius (meters) [12]
Δn	MP		Bit string(16)	Mean Motion Difference From Computed Value (semi-circles/sec) [12]
M ₀	MP		Bit string(32)	Mean Anomaly at Reference Time (semi-circles) [12]
C _{uc}	MP		Bit string(16)	Amplitude of the Cosine Harmonic Correction Term To The Argument Of Latitude (radians) [12]
e	MP		Bit string(32)	c
C _{us}	MP		Bit string(16)	Amplitude of the Sine Harmonic Correction Term To The Argument Of Latitude (radians) [12]
(A) ^{1/2}	MP		Bit string(32)	Semi-Major Axis (meters) ^{1/2} [12]
t _{oe}	MP		Bit string(16)	Reference Time Ephemeris [12]
Fit Interval Flag	MP		Bit string(1)	[12]
AODO	MP		Bit string(5)	Age Of Data Offset [12]
C _{ic}	MP		Bit string(16)	Amplitude of the Cosine Harmonic Correction Term To The Angle Of Inclination (radians) [12]

Information Element/Group name	Need	Multi	Type and Reference	Semantics description
OMEGA ₀	MP		Bit string(32)	Longitude of Ascending Node of Orbit Plane at Weekly Epoch (semi-circles) [12]
C _{is}	MP		Bit string(16)	Amplitude of the Sine Harmonic Correction Term To The Angle Of Inclination (radians) [12]
i ₀	MP		Bit string(32)	Inclination Angle at Reference Time (semi-circles) [12]
C _{rc}	MP		Bit string(16)	Amplitude of the Cosine Harmonic Correction Term to the Orbit Radius (meters) [12]
ω	MP		Bit string(32)	Argument of Perigee (semi-circles) [12]
OMEGA _{dot}	MP		Bit string(24)	Longitude of Ascending Node of Orbit Plane at Weekly Epoch (semi-circles/sec) [12]
Idot	MP		Bit string(14)	Rate of Inclination Angle (semi-circles/sec) [12]

10.3.7.91b UE positioning DGNSS corrections

This IE contains DGNSS corrections to be used by the UE.

Information Element/Group name	Need	Multi	Type and Reference	Semantics description	Version
DGANSS Reference Time	MP		Integer(0..3570 by step of 30)	Seconds. Time in GNSS system time (modulo 3600 s) when the DGANSS corrections were calculated	REL-7
DGANSS information	MP	1 to <maxSgnType>			REL-7
>GANSS Signal ID	OP		GANSS Signal Id 10.3.3.45a	Absence of this field means Galileo L1 OS if GANSS_ID refers to Galileo.	REL-7
>Status/Health	MP		Enumerated(UDRE scale 1.0, UDRE scale 0.75, UDRE scale 0.5, UDRE scale 0.3, UDRE scale 0.2, UDRE scale 0.1, no data, invalid data)		REL-7
>DGANSS signal information	CV- Status/Health	1 to <maxGANSSSat>		If the Cipher information is included these fields are ciphered.	REL-7
>>SatID	MP		Integer (0...63)	Identifies the satellite and is equal to (SV ID No - 1)	REL-7
>>IOD	MP		Bit string(10)		REL-7
>>UDRE	MP		Enumerated(UDRE ≤ 1.0 m, 1.0m < UDRE ≤ 4.0m, 4.0m < UDRE ≤ 8.0m, 8.0m < UDRE)	The value in this field shall be multiplied by the UDRE Scale Factor in the IE Status/Health to determine the final UDRE estimate for the particular satellite.	REL-7
>>PRC	MP		Real(-655.04..655.04 by step of 0.32)	meters	REL-7
>>RRC	MP		Real(-4.064..4.064 by step of 0.032)	meters/sec	REL-7

Condition	Explanation
<i>Status/Health</i>	This IE is mandatory present if "status" is not equal to "no data" or "invalid data", otherwise the IE is not needed.

10.3.7.91c UE positioning GANSS orbit model

This IE contains information for GANSS orbit model parameters.

Information Element/Group name	Need	Multi	Type and Reference	Semantics description	Version
Keplerian Parameters	OP			NOTE	REL-7
>toe	MP		Bit String(14)	Time-of-Ephemeris in seconds, scale factor 60 [61]	REL-7
> ω	MP		Bit string(32)	Argument of Perigee (semi-circles) [61]	REL-7
> Δn	MP		Bit string(16)	Mean Motion Difference From Computed Value (semi-circles/sec) [61]	REL-7
> M_0	MP		Bit string(32)	Mean Anomaly at Reference Time (semi-circles) [61]	REL-7
>OMEGA _{dot}	MP		Bit string(24)	Longitude of Ascending Node of Orbit Plane at Weekly Epoch (semi-circles/sec) [61]	REL-7
>e	MP		Bit string(32)	Eccentricity, scale factor 2^{-33} [61]	REL-7
>ldot	MP		Bit string(14)	Rate of Inclination Angle (semi-circles/sec) [61]	REL-7
>sqrtA	MP		Bit String(32)	Semi-Major Axis in (meters) ^{1/2} , scale factor 2^{-19} [61]	REL-7
>i ₀	MP		Bit string(32)	Inclination Angle at Reference Time (semi-circles) [61]	REL-7
>OMEGA ₀	MP		Bit string(32)	Longitude of Ascending Node of Orbit Plane at Weekly Epoch (semi-circles) [61]	REL-7
>C _{rs}	MP		Bit string(16)	Amplitude of the Sine Harmonic Correction Term to the Orbit Radius (meters) [61]	REL-7
>C _{is}	MP		Bit string(16)	Amplitude of the Sine Harmonic Correction Term To The Angle Of Inclination (radians) [61]	REL-7
>C _{us}	MP		Bit string(16)	Amplitude of the Sine Harmonic Correction Term To The Argument Of Latitude (radians) [61]	REL-7
>C _{rc}	MP		Bit string(16)	Amplitude of the Cosine Harmonic Correction Term to the Orbit Radius (meters) [61]	REL-7
>C _{ic}	MP		Bit string(16)	Amplitude of the Cosine Harmonic Correction Term To The Angle Of Inclination (radians) [61]	REL-7
>C _{uc}	MP		Bit string(16)	Amplitude of the Cosine Harmonic Correction Term To The Argument Of Latitude (radians) [61]	REL-7

NOTE: This IE shall contain exactly one of the optional fiels indicated by "NOTE".

10.3.7.91d UE positioning GANSS clock model

The IE contains fields needed to model the GANSS clock parameters.

Information Element/Group name	Need	Multi	Type and Reference	Semantics description	Version
Satellite clock model	MP	1 to <maxSatClockModels>		There may be more than one clock model included if defined in SIS ICD (e.g. two for Galileo)	REL-7
>t _{oc}	MP		BIT STRING(14)	Time-of-Clock in seconds. Scale factor 60 seconds.	REL-7
>a _{f2}	MP		BIT STRING (12)	sec/sec ² , scale factor 2 ⁻⁶⁵ for Galileo	REL-7
>a _{f1}	MP		BIT STRING (18)	sec/sec, scale factor 2 ⁻⁴⁵	REL-7
>a _{f0}	MP		BIT STRING (28)	sec, scale factor 2 ⁻³³	REL-7
>T _{GD}	OP		BIT STRING (10)	sec, scale factor 2 ⁻³² for Galileo	REL-7
>Model ID	OP		Integer(0..1)	NOTE 1	REL-7

NOTE 1: Coding of Model ID:

GNSS	Value	Explanation
Galileo	0	I/Nav
	1	F/Nav

10.3.7.92 UE positioning GPS ionospheric model

The IE contains fields needed to model the propagation delays of the GPS signals through the ionosphere.

Information Element/Group name	Need	Multi	Type and Reference	Semantics description
α_0	MP		Bit string(8)	Note 1
α_1	MP		Bit string(8)	Note 1
α_2	MP		Bit string(8)	Note 1
α_3	MP		Bit string(8)	Note 1
β_0	MP		Bit string(8)	Note 2
β_1	MP		Bit string(8)	Note 2
β_2	MP		Bit string(8)	Note 2
β_3	MP		Bit string(8)	Note 2

NOTE 1: The parameters α_n are the coefficients of a cubic equation representing the amplitude of the vertical delay [12].

NOTE 2: The parameters β_n are the coefficients of a cubic equation representing the period of the ionospheric model [12].

10.3.7.92a UE positioning GANSS ionospheric model

The IE contains fields needed to model the propagation delays of the GANSS signals through the ionosphere.

Information Element/Group name	Need	Multi	Type and Reference	Semantics description	Version
a _{i0}	MP		Bit string(12)	This parameter is used as defined in [61]	REL-7
a _{i1}	MP		Bit string(12)	This parameter is used as defined in [61]	REL-7
a _{i2}	MP		Bit string(12)	This parameter is used as defined in [61]	REL-7
GANSS Ionosphere Regional Storm Flags	OP				REL-7
>Storm Flag 1	MP		Boolean	This parameter is used as defined in [61]	REL-7
>Storm Flag 2	MP		Boolean	This parameter is used as defined in [61]	REL-7
>Storm Flag 3	MP		Boolean	This parameter is used as defined in [61]	REL-7
>Storm Flag 4	MP		Boolean	This parameter is used as defined in [61]	REL-7
>Storm Flag 5	MP		Boolean	This parameter is used as defined in [61]	REL-7

10.3.7.93 UE positioning GPS measured results

Information Element/Group name	Need	Multi	Type and Reference	Semantics description	Version
CHOICE <i>Reference Time</i>	MP				
>UTRAN reference time					
>>UE GPS timing of cell frames	MP		Integer(0..37158911999999)	GPS Time of Week in units of 1/16 th UMTS chips according to [19]. 33209832177664 spare values are needed.	
>>>CHOICE <i>mode</i>	MP				
>>>>FDD					
>>>>Primary CPICH Info	MP		Primary CPICH Info 10.3.6.60	Identifies the reference cell for the GPS TOW-SFN relationship.	
>>>>TDD					
>>>>cell parameters id	MP		Cell parameters id 10.3.6.9	Identifies the reference cell for the GPS TOW-SFN relationship.	
>>Reference SFN	MP		Integer(0..4095)	The SFN for which the location is valid. This IE indicates the SFN at which the UE timing of cell frames is captured.	
>GPS reference time only					
>>GPS TOW msec	MP		Integer(0..6.048*10 ⁸ -1)	GPS Time of Week in milliseconds (rounded down to the nearest millisecond unit).	
UE Positioning GPS	OP		UE positioning		REL-7

Information Element/Group name	Need	Multi	Type and Reference	Semantics description	Version
ReferenceTime Uncertainty			GPS reference time uncertainty 10.3.7.96a		
Measurement Parameters	MP	1 to <maxSat>			
>Satellite ID	MP		Enumerated(0..63)	Identifies the satellite and is equal to (SV ID No - 1) where SV ID No is defined in [12].	
>C/N ₀	MP		Integer(0..63)	the estimate of the carrier-to-noise ratio of the received signal from the particular satellite used in the measurement. It is given in units of dB-Hz (typical levels will be in the range of 20 – 50 dB-Hz).	
>Doppler	MP		Integer(-32768..32768)	Hz, scale factor 0.2.	
>Whole GPS Chips	MP		Integer(0..1022)	Unit in GPS chips. Whole value of the UE GPS code-phase measurement, where increasing binary values of the field signify increasing measured pseudoranges. The UE GPS code-phase measurement is divided into the fields "Whole GPS Chips" and "Fractional GPS Chips".	
>Fractional GPS Chips	MP		Integer(0..(2 ¹⁰ -1))	Scale factor 2 ⁻¹⁰ Fractional value of the UE GPS code-phase measurement.	
>Multipath Indicator	MP		Enumerated(NM, low, medium, high)	Note 1.	
>Pseudorange RMS Error	MP		Enumerated(range index 0..range index 63)	Note 2.	

NOTE 1: The following table gives the mapping of the multipath indicator field.

Value	Multipath Indication
NM	Not measured
Low	MP error < 5m
Medium	5m < MP error < 43m
High	MP error > 43m

NOTE 2: The following table gives the bitmapping of the Pseudorange RMS Error field.

Range Index	Mantissa	Exponent	Floating-Point value, x_i	Pseudorange value, P
0	000	000	0.5	$P < 0.5$
1	001	000	0.5625	$0.5 \leq P < 0.5625$
I	X	Y	$0.5 * (1 + x/8) * 2^Y$	$x_{i-1} \leq P < x_i$
62	110	111	112	$104 \leq P < 112$
63	111	111	--	$112 \leq P$

10.3.7.93a UE positioning GANSS measured results

Information Element/Group name	Need	Multi	Type and Reference	Semantics description	Version
CHOICE Reference Time	MP				REL-7
>UTRAN reference time					REL-7
>>UE GANSS timing of cell frames	MP		Integer(0..8639999999750 by step of 250)	GANSS Time of Day in ns	REL-7
>>>GANSS Time Id	OP		INTEGER (0..7)	Absence means Galileo	
>>>GANSS TOD Uncertainty	OP		Integer(0..127)	Coding as in 10.3.7.96a	REL-7
>>>CHOICE mode	MP				REL-7
>>>>FDD					REL-7
>>>>Primary CPICH Info	MP		Primary CPICH Info 10.3.6.60	Identifies the reference cell for the GANSS TOD-SFN relationship.	REL-7
>>>>TDD					REL-7
>>>>cell parameters id	MP		Cell parameters id 10.3.6.9	Identifies the reference cell for the GANSS TOD-SFN relationship.	REL-7
>>>Reference SFN	MP		Integer(0..4095)	The SFN for which the location is valid. This IE indicates the SFN at which the UE timing of cell frames is captured.	REL-7
>GANSS reference time only					REL-7
>>>GANSS Time Id	OP		INTEGER (0..7)	Absence means Galileo	
>>>GANSS TOD msec	MP		Integer(0..3599999)	GANSS Time of Day (modulo 1 hour) in milliseconds (rounded down to the nearest millisecond unit).	REL-7
>>>GANSS TOD Uncertainty	OP		Integer(0..127)	Coding as in 10.3.7.96a	REL-7
GANSS Generic Measurement Information	MP	1 to <maxGANSS>			REL-7
>GANSS ID	OP		Integer(0..7)	Absence of this IE means Galileo Values 0-7 reserved for future use.	REL-7
>GANSS Signal Measurement Information	MP	1 to <maxSgnType>			REL-7
>>>GANSS Signal ID	OP		GANSS Signal Id 10.3.3.45a	Absence of this field means Galileo L1 OS if GANSS_ID refers to Galileo.	REL-7
>>>GANSS Code Phase Ambiguity	OP		Integer (0..31)	The GANSS Code Phase Ambiguity field gives the ambiguity of the code phase measurement. It is given in ms and is an integer between 0 and 31. The Total Code Phase for a satellite k (Satk) is given modulo this GANSS Code Phase Ambiguity and is reconstructed with: $Code_Phase_Tot(Satk) = Code_Phase(Satk) + Integer\ Code\ Phase(Satk)$ If there is no code phase ambiguity, the GANSS Code Phase Ambiguity shall be set to 0. The field is optional. If GANSS Code Phase Ambiguity is	REL-7

Information Element/Group name	Need	Multi	Type and Reference	Semantics description	Version
				absent, the default value is 1ms.	
>>GANSS Measurement Parameters	MP	1 to <maxGANSSSat>			REL-7
>>>Satellite ID	MP		Integer (0..63)	Identifies the satellite and is equal to (SV ID No - 1) where SV ID No is defined in e.g. [61].	REL-7
>>>C/N ₀	MP		Integer(0..63)	the estimate of the carrier-to-noise ratio of the received signal from the particular satellite used in the measurement. It is given in units of dB-Hz (typical levels will be in the range of 20 – 50 dB-Hz).	REL-7
>>>Multipath Indicator	MP		Enumerated(NM, low, medium, high)	Coding as in 10.3.7.93	REL-7
>>>Carrier Quality Indication	OP		Bit string(2)	Note 1	REL-7
>>>GANSS Code Phase	MP		Integer(0..2 ²¹ -1)	Scale factor 2 ⁻²¹ Code phase for the particular satellite signal at the time of measurement in the units of milliseconds. Increasing binary values of the field signify increasing measured pseudoranges. GNSS specific code phase measurements (e.g. chips) are converted into unit of ms by dividing the measurements by the nominal values of the measured signal chipping rate.	REL-7
>>>GANSS Integer Code Phase	OP		Integer(0..63)	In ms Indicates the integer millisecond part of the code phase, that is expressed modulo the GANSS Code Phase Ambiguity. The Integer code phase is optional, when it is not reported whereas the GANSS Code Phase Ambiguity is set to a certain value, this means that the mobile phone has no information about the integer code phase of the related satellite measurement. In this case, the code phase is reported modulo 1ms even if the GANSS Ambiguity indicates another value.	REL-7
>>>Code Phase RMS Error	MP		Enumerated(range index 0..range index 63)	Coding as in Note 2 of 10.3.7.93	REL-7
>>>Doppler	MP		Integer(-32768..32767)	m/s, scale factor 0.04. Doppler measured by the UE for the particular satellite signal	REL-7
>>>ADR	OP		Integer(0..33554431)	Meters, scale factor 2 ⁻¹⁰ ADR measurement measured by the UE for the particular satellite signal.	REL-7

NOTE 2: Coding of Carrier quality indication:

MSB	LSB	Explanation
0		Carrier phase not continuous
1		Carrier phase continuous
	0	Data direct
	1	Data Inverted

10.3.7.94 UE positioning GPS navigation model

This IE contain information required to manage the transfer of precise navigation data to the GPS-capable UE.

Information Element/Group name	Need	Multi	Type and Reference	Semantics description
Satellite information	MP	1 to <maxSat>		
>SatID	MP		Enumerated(0..63)	Identifies the satellite and is equal to (SV ID No - 1) where SV ID No is defined in [12].
>Satellite Status	MP		Enumerated(NS_NN, ES_SN, ES_NN, REVD)	NOTE
>GPS Ephemeris and Clock Correction parameters	CV- <i>Satellite status</i>		UE positioning GPS Ephemeris and Clock Correction parameters 10.3.7.91a	

NOTE: The UE shall interpret enumerated symbols as follows.

Value	Indication
NS_NN	New satellite, new Navigation Model
ES_SN	Existing satellite, same Navigation Model
ES_NN	Existing satellite, new Navigation Model
REVD	Reserved

Condition	Explanation
<i>Satellite status</i>	The IE is not needed if the IE "Satellite status" is ES_SN and mandatory present otherwise.

10.3.7.94a UE positioning GANSS navigation model

This IE contains information required to manage the transfer of precise navigation data to the GANSS-capable UE.

Information Element/Group name	Need	Multi	Type and Reference	Semantics description	Version
Non-Broadcast Indication	OP		Enumerated(true)	If this IE is present, GANSS navigation model is not derived from satellite broadcast	REL-7
Satellite information	MP	1 to <maxGANSSSat>			REL-7
>SatID	MP		Integer (0..63)	Identifies the satellite and is equal to (SV ID No - 1).	REL-7
>SV Health	MP		Bit string(5)	NOTE	REL-7
>IOD	MP		Bit string(10)		REL-7
>GANSS Clock Model	MP		UE positioning GANSS clock model 10.3.7.91d		REL-7
> GANSS Orbit Model	MP		UE positioning GANSS orbit model 10.3.7.91c		REL-7

NOTE: The Health values are GNSS specific. For Galileo, the UE shall interpret bit string as follows:

Parameter	Bit	Type	Explanation
E5a Data Validity Status	0	Boolean	
E5b Data Validity Status	1	Boolean	
E1-B Data Validity Status	2	Boolean	
E5a Signal Health Status	3-4	Bit string	See [61], Table 67

10.3.7.95 UE positioning GPS real-time integrity

This IE contains parameters that describe the real-time status of the GPS constellation.

Information Element/Group name	Need	Multi	Type and Reference	Semantics description
Satellite information	MP	1 to <maxSat>		
>BadSatID	MP		Enumerated(0..63)	Identifies the satellite and is equal to (SV ID No - 1) where SV ID No is defined in [12].

10.3.7.95a Void

10.3.7.95b UE positioning GANSS real-time integrity

This IE contains parameters that describe the real-time status of the GANSS constellation.

Information Element/Group name	Need	Multi	Type and Reference	Semantics description	Version
Satellite information	MP	1 to <maxGAN SSSat>			REL-7
>Bad GANSS SatID	MP		Integer (0..63)	Identifies the satellite and is equal to (SV ID No - 1).	REL-7
>Bad GANSS Signal ID	OP		Bit string (8)	Absence of this IE means that all signals of the specific SV are bad. NOTE	REL-7

NOTE: Coding of Bad GANSS Signal ID

GNSS	Bit	Explanation
Galileo	1	L1
	2	E5A
	3	E5B
	4	E6
	5	E5A + E5B
	6-8	Spare

10.3.7.96 UE positioning GPS reference time

Information Element/Group name	Need	Multi	Type and Reference	Semantics description	Version
GPS Week	MP		Integer(0..1023)		
GPS TOW msec	MP		Integer(0..6.048*10 ⁸ -1)	GPS Time of Week in milliseconds (rounded down to the nearest millisecond unit).	
UTRAN GPS reference time	OP				
>UTRAN GPS timing of cell frames	MP		Integer(0..232243199999)	UTRAN GPS timing of cell frames in steps of 1 chip	
>CHOICE mode	OP				
>>FDD					
>>>Primary CPICH Info	MP		Primary CPICH Info 10.3.6.60	Identifies the reference cell for the GPS TOW-SFN relationship	
>>TDD					
>>>cell parameters id	MP		Cell parameters id 10.3.6.9	Identifies the reference cell for the GPS TOW-SFN relationship	
>SFN	MP		Integer(0..4095)	The SFN which the UTRAN GPS timing of cell frames time stamps.	
UE Positioning GPS ReferenceTime Uncertainty	OP		UE positioning GPS reference time uncertainty 10.3.7.96a	NOTE 1	REL-7
SFN-TOW Uncertainty	OP		Enumerated (lessThan10,	This field indicates the uncertainty of the relation GPS	

Information Element/Group name	Need	Multi	Type and Reference	Semantics description	Version
			moreThan10)	TOW/SFN. lessThan10 means the relation is accurate to at least 10 ms. NOTE 1	
T _{UTRAN-GPS} drift rate	OP		Integer (0, 1, 2, 5, 10, 15, 25, 50, -1, -2, -5, -10, -15, -25, -50)	in 1/256 chips per sec.	
GPS TOW Assist	OP	1 to <maxSat>			
>SatID	MP		Enumerated(0..63)	Identifies the satellite and is equal to (SV ID No - 1) where SV ID No is defined in [12].	
>TLM Message	MP		Bit string(14)		
>TLM Reserved	MP		Bit string(2)		
>Alert	MP		Boolean		
>Anti-Spoof	MP		Boolean		
NOTE 1: If the IE "UE Positioning GPS ReferenceTime Uncertainty" is present, the IE "SFN-TOW Uncertainty" is not needed and shall be ignored.					

10.3.7.96o UE positioning GANSS reference time

Information Element/Group name	Need	Multi	Type and Reference	Semantics description	Version
GANSS Day	OP		Integer(0..8191)	The sequential number of days from the origin of the GNSS system time indicated by GANSS Time ID modulo 8192 days (about 22 years).	REL-7
GANSS TOD	MP		Integer(0..86399)	GANSS Time of Day in seconds	REL-7
GANSS TOD Uncertainty	OP		Integer(0..127)	Coding as in subclause 10.3.7.96a	REL-7
GANSS Time ID	OP		Integer (0..7)	Absence of this IE means Galileo, values 0-7 are reserved for future use	REL-7
UTRAN GANSS reference time	OP				REL-7
>UTRAN GANSS timing of cell frames	MP		Integer(0..999999750 by step of 250)	UTRAN GANSS timing of cell frames in steps of 250 ns. Indicates sub-second part of GANSS TOD	REL-7
>CHOICE <i>mode</i>	MP				REL-7
>>FDD					REL-7
>>>Primary CPICH Info	MP		Primary CPICH Info 10.3.6.60	Identifies the reference cell for the GANSS TOD-SFN relationship	REL-7
>>TDD					REL-7
>>>cell parameters id	MP		Cell parameters id 10.3.6.9	Identifies the reference cell for the GANSS TOD-SFN relationship	REL-7
>SFN	MP		Integer(0..4095)	The SFN which the UTRAN GANSS timing of cell frames time stamps.	REL-7
T _{UTRAN-GANSS} drift rate	OP		ENUMERATED (0, 1, 2, 5, 10, 15, 25, 50, -1, -2, -5, -10, -15, -25, -50)	in 1/256 chips per sec. One spare value needed.	REL-7

10.3.7.96a UE positioning GPS reference time uncertainty

Information Element/Group name	Need	Multi	Type and reference	Semantics description	Version
UE Positioning GPS Reference Time Uncertainty	MP		Integer (0..127)	This element provides the accuracy of the provided GPS time, or alternatively the accuracy of the provided relation between GPS and UTRAN time. If "GPS TOW" is the provided GPS time, or alternatively the GPS time corresponding to the UTRAN time provided, then the true GPS time lies in the interval ["GPS TOW" - "GPS Reference Time Uncertainty", "GPS TOW" + "GPS Reference Time Uncertainty"]. The uncertainty r , expressed in microseconds, is mapped to a number K with the following formula: $r = C * ((1+x)^K - 1)$ with $C = 0.0022$ and $x = 0.18$. To encode any higher value of the uncertainty than that corresponding to $K=127$ in the formula above, or to indicate an undefined value of the "GPS TOW", the same value, $K=127$, shall be used.	REL-7

NOTE: This IE is not needed in the SRNS RELOCATION INFO message.

10.3.7.97 UE positioning GPS UTC model

The UTC Model field contains a set of parameters needed to relate GPS time to Universal Time Coordinate (UTC).

Information Element/Group name	Need	Multi	Type and Reference	Semantics description
A_1	MP		Bit string(24)	sec/sec [12]
A_0	MP		Bit string(32)	seconds [12]
t_{ot}	MP		Bit string(8)	seconds [12]
WN_t	MP		Bit string(8)	weeks [12]
Δt_{LS}	MP		Bit string(8)	seconds [12]
WN_{LSF}	MP		Bit string(8)	weeks [12]
DN	MP		Bit string(8)	days [12]
Δt_{LSF}	MP		Bit string(8)	seconds [12]

10.3.7.97a UE positioning GANSS time model

The GANSS time model field contains a set of parameters needed to relate GANSS time to selected time reference indicated by GNSS_TO_ID.

Information Element/Group name	Need	Multi	Type and Reference	Semantics description	Version
GANSS Time Model Reference Time	MP		Integer(0..604784 by step of 16)	GANSS reference time of week for GANSS Time Model, given in GNSS specific system time, with a 16s scale factor.	REL-7
T _{A0}	MP		Integer (-2147483648 .. 2147483647)	Seconds, scale factor 2 ⁻³⁵	REL-7
T _{A1}	OP		Integer (-8388608 .. 8388607)	sec/sec, scale factor 2 ⁻⁵¹	REL-7
T _{A2}	OP		Integer (-64 .. 63)	sec/sec ² , scale factor 2 ⁻⁶⁸	REL-7
GNSS_TO_ID	MP		Enumerated (GPS)	GNSS Time Offset ID Seven spare values needed.	REL-7
Week Number	OP		Integer(0..8191)	Reference week of GANSS Time Model given in GNSS specific system time	REL-7

10.3.7.97b UE positioning GANSS data bit assistance

This element provides data bit assistance data for specific satellite signals for data wipe-off.

Information Element/Group name	Need	Multi	Type and Reference	Semantics description	Version
GANSS TOD	MP		Integer(0..59)	Reference time (modulo 1 minute) of the first bit of the data in IE "Data Bits", in seconds	REL-7
Data Bit Assistance List	MP	1 to <maxGANSSSat>		The following fields are present N_Sat times, with 1 ≤ N_Sat ≤ maxGANSSSat	REL-7
>Satellite ID	MP		Integer (0..63)		REL-7
>Data bit assistance Sgn List	MP	1 to <maxSgnType>		The following fields are present N_Sgn times, with 1 ≤ N_Sgn ≤ maxSgnType	REL-7
>>GANSS Signal ID	MP		GANSS Signal ID 10.3.3.45a	Absence of this field means Galileo L1 OS if GANSS_ID refers to Galileo.	REL-7
>>>Data Bits	MP		Bit string (1..1024)	Raw data bits as transmitted from a specific satellite at the time indicated by GANSS_TOD. In case of Galileo, it contains the FEC encoded and interleaved modulation symbols. The logical levels 1 and 0 correspond to signal levels -1 and +1, respectively. N_BIT is the actual number of elements in Data bits: 1 ≤ N_BIT ≤ 1024.	REL-7

10.3.7.97c UE positioning GANSS UTC model

The UTC Model field contains a set of parameters needed to relate GANSS time to Universal Time Coordinate (UTC).

Information Element/Group name	Need	Multi	Type and Reference	Semantics description
A_1	MP		Bit string(24)	
A_0	MP		Bit string(32)	
t_{ot}	MP		Bit string(8)	
Δt_{LS}	MP		Bit string(8)	
WN_t	MP		Bit string(8)	
WN_{LSF}	MP		Bit string(8)	
DN	MP		Bit string(8)	
Δt_{LSF}	MP		Bit string(8)	

For a GANSS Id referring to Galileo, the definition and the unit of the elements are provided in [61].

10.3.7.98 UE positioning IPDL parameters

This IE contains parameters for the IPDL mode. The use of this parameters is described in [29].

Information Element/Group name	Need	Multi	Type and Reference	Semantics description	Version
CHOICE <i>mode</i>					REL-4
>FDD					REL-4
>>IP spacing	MP		Integer(5,7,10,15,20,30,40,50)	See [29]	
>>IP length	MP		Integer(5,10)	See [29]	
>>IP offset	MP		Integer(0..9)	See [29]	
>>Seed	MP		Integer(0..63)	See [29]	
>TDD					REL-4
>>IP spacing	MP		Integer(30,40,50,70,100)	See [33]	REL-4
>>IP_Start	MP		Integer(0..4095)	See [33]	REL-4
>>IP_Slot	MP		Integer(0..14)	See [33]	REL-4
>>IP_PCCPCH	CV-channel		Boolean	See [33]	REL-4
Burst mode parameters	OP				
>Burst Start	MP		Integer(0..15)	See [29] and [33]	
>Burst Length	MP		Integer(10..25)	See [29] and [33]	
>Burst freq	MP		Integer(1..16)	See [29] and [33]	

Condition	Explanation
<i>channel</i>	This IE is present only if the idle slot carries the PCCPCH

10.3.7.99 UE positioning measured results

Information Element/Group name	Need	Multi	Type and reference	Semantics description	Version
UE positioning OTDOA measured results	OP		UE positioning OTDOA measured results 10.3.7.105		
UE positioning Position estimate info	OP		UE positioning Position estimate info 10.3.7.109		
UE positioning GPS measured results	OP		UE positioning GPS measured results 10.3.7.93		
UE positioning error	OP		UE positioning error 10.3.7.87	Included if UE positioning error occurred	
UE positioning GANSS measured results	OP		UE positioning GANSS measured results 10.3.7.93a		REL-7

10.3.7.100 UE positioning measurement

Information Element/Group name	Need	Multi	Type and reference	Semantics description	Version
UE positioning reporting quantity	MP		UE positioning reporting quantity 10.3.7.111		
Measurement validity	OP		Measurement validity 10.3.7.51		
<i>CHOICE reporting criteria</i>	MP				
>UE positioning reporting criteria			UE positioning reporting criteria 10.3.7.110		
>Periodical reporting criteria			Periodical reporting criteria 10.3.7.53		
>No reporting				(no data)	
UE positioning OTDOA assistance data for UE-assisted	OP		UE positioning OTDOA assistance data for UE-assisted 10.3.7.103		
UE positioning OTDOA assistance data for UE-based	OP		UE positioning		

Information Element/Group name	Need	Multi	Type and reference	Semantics description	Version
			OTDOA assistance data for UE-based 10.3.7.103a		
UE positioning GPS assistance data	OP		UE positioning GPS assistance data 10.3.7.90		
UE positioning GANSS assistance data	OP		UE positioning GANSS assistance data 10.3.7.90b		REL-7

10.3.7.101 UE positioning measurement event results

This IE contains the measurement event results that are reported to UTRAN for UE positioning measurements.

Information Element/Group name	Need	Multi	Type and Reference	Semantics description
CHOICE <i>Event ID</i>	MP			One spare value is needed.
>7a				
>>UE positioning Position estimate info	MP		UE positioning Position estimate info 10.3.7.109	
>7b				
>>UE positioning OTDOA measured results	MP		UE positioning OTDOA measured results 10.3.7.105	
>7c				
>>UE positioning GPS measurement	MP		UE positioning GPS measured results 10.3.7.93	
>7d				
>>UE positioning GANSS measurement	MP		UE positioning GANSS measured results 10.3.7.93a	

10.3.7.102 Void

10.3.7.103 UE positioning OTDOA assistance data for UE-assisted

Information Element/Group name	Need	Multi	Type and Reference	Semantics description
UE positioning OTDOA reference cell info for UE-assisted	OP		UE positioning OTDOA reference cell info 10.3.7.108	
UE positioning OTDOA neighbour cell list for UE-assisted	OP	1 to <maxCellMEas>		
>UE positioning OTDOA neighbour cell info for UE-assisted	MP		UE positioning OTDOA neighbour cell info 10.3.7.106	

10.3.7.103a UE positioning OTDOA assistance data for UE-based

Information Element/Group name	Need	Multi	Type and Reference	Semantics description
UE positioning OTDOA reference cell info for UE-based	OP		UE positioning OTDOA reference cell info for UE-based 10.3.7.108a	
UE positioning OTDOA neighbour cell list for UE-based	OP	1 to <maxCellMEas>		
>UE positioning OTDOA neighbour cell info for UE-based	MP		UE positioning OTDOA neighbour cell info for UE-based 10.3.7.106a	

10.3.7.104 Void

10.3.7.105 UE positioning OTDOA measured results

Information Element/Group name	Need	Multi	Type and Reference	Semantics description
SFN	MP		Integer(0..4095)	SFN during which the last measurement was performed
CHOICE <i>mode</i>				
>FDD				
>>Reference cell id	MP		Primary CPICH info 10.3.6.60	
>>UE Rx-Tx time difference type 2 info	MP			
>>>UE Rx-Tx time difference type 2	MP		UE Rx-Tx time difference	

Information Element/Group name	Need	Multi	Type and Reference	Semantics description
			type 2 10.3.7.84	
>>>UE positioning OTDOA quality	MP		UE positioning OTDOA quality 10.3.7.107	Quality of the UE Rx-Tx time difference type 2 measurement from the reference cell.
>TDD				(no data)
>>Reference cell id	MP		Cell parameters ID 10.3.6.9	
Neighbours	OP	1 to <maxCellMeas>		
>CHOICE mode	MP			
>>FDD				
>>>Neighbour Identity	MD		Primary CPICH info 10.3.6.60	Default value is the same as in the first set of multiple sets.
>>>Frequency info	MD		Frequency info 10.3.6.36	Default value is the existing value of frequency information
>>>UE Rx-Tx time difference type 2 info	OP			Included for cell in the active set excluding the reference cell.
>>>>UE Rx-Tx time difference type 2	MP		UE Rx-Tx time difference type 2 10.3.7.84	
>>>>UE positioning OTDOA quality	MP		UE positioning OTDOA quality 10.3.7.107	Quality of the UE Rx-Tx time difference type 2 measurement from the neighbour cell.
>>TDD				
>>>Cell and Channel ID	MD		Cell and Channel Identity info 10.3.6.8a	Default value is the same as in the first set of multiple sets.
>>>UARFCN	MP		Integer (0..16383)	
>UE positioning OTDOA quality	MP		UE positioning OTDOA quality 10.3.7.107	Quality of the SFN-SFN observed time difference type 2 measurement from the neighbour cell.
>SFN-SFN observed time difference type 2	MP		SFN-SFN observed time difference 10.3.7.63	Gives the timing relative to the reference cell. Only type 2 is allowed.

10.3.7.106 UE positioning OTDOA neighbour cell info

This IE gives approximate cell timing in order to decrease the search window.

Information Element/Group name	Need	Multi	Type and Reference	Semantics description
CHOICE mode	MP			
>FDD				
>>Primary CPICH info	MP		Primary CPICH info	

Information Element/Group name	Need	Multi	Type and Reference	Semantics description
>TDD			10.3.6.60	
>>cell and channel ID	MP		Cell and Channel Identity info 10.3.6.8a	Identifies the channel to be measured on.
Frequency info	MD		Frequency info 10.3.6.36	Default value is the existing value of frequency information
IPDL parameters	CV-IPDLs		UE positioning IPDL parameters 10.3.7.98	
SFN offset	MP		Integer (0 .. 4095)	Although this IE is not always required, need is MP to align with ASN.1. Define Tref as the time of beginning of system frame number SFNref of the reference cell. Define Tnc as the beginning of a frame from the neighbour cell occurring immediately after the time Tref. Let the corresponding system frame number be SFNnc. Then SFNnc = SFNref-SFN offset modulo 4096.
SFN offset validity	MD		Enumerated (false)	Absence of this element means SFN offset is valid. False means SFN offset is not valid.
SFN-SFN relative time difference	MP		Integer(0..38399)	Gives the relative timing compared to the reference cell. Equal to $\lfloor (T_{nc} - T_{ref}) * (3.84 * 10^6) \rfloor$ where $\lfloor \cdot \rfloor$ denotes rounding to the nearest lower integer. In chips, Tnc = the time of beginning of a system frame from the neighbour cell, Tref = the time of beginning of a system frame from the reference cell.
SFN-SFN drift	OP		Integer (0, -1, -2, -3, -4, -5, -8, -10, -15, -25, -35, -50, -65, -80, -100, 1, 2, 3, 4, 5, 8, 10, 15, 25, 35, 50, 65, 80, 100)	in 1/256 chips per second
Search Window Size	MP		Integer(20, 40, 80, 160, 320, 640, 1280, infinity)	In chips. If the value is X then the expected SFN-SFN observed time difference is in the range [RTD-X, RTD+X] where RTD is the value of the field SFN-SFN relative time difference. Infinity means that the uncertainty is larger than 1280 chips.
CHOICE <i>PositioningMode</i>	MP			

Information Element/Group name	Need	Multi	Type and Reference	Semantics description
>UE based				(no data)
>UE assisted				(no data)

Condition	Explanation
<i>IPDLs</i>	This IE is mandatory present if IPDLs are applied and not needed otherwise.

10.3.7.106a UE positioning OTDOA neighbour cell info for UE-based

This IE gives approximate cell timing in order to decrease the search window, as well as the cell locations and fine cell timing for UE based OTDOA.

Information Element/Group name	Need	Multi	Type and Reference	Semantics description	Version
UE positioning OTDOA neighbour cell info	MP		UE positioning OTDOA neighbour cell info 10.3.7.106		
Cell Position	MD			Default is the same as previous cell	
>Relative North	OP		Integer(-20000..20000)	Seconds of angle, scale factor 0.03. Relative position compared to reference cell.	
>Relative East	OP		Integer(-20000..20000)	Seconds of angle, scale factor 0.03. Relative position compared to reference cell.	
>Relative Altitude	OP		Integer(-4000..4000)	Relative altitude in meters compared to ref. cell.	
Fine SFN-SFN	MP		Real(0..0.9375 in steps of 0.0625)	Gives finer resolution	
UE positioning Relative Time Difference Quality	MP		UE positioning OTDOA quality 10.3.7.109a	Quality of the relative time difference between neighbour and reference cell.	
Round Trip Time	OP		Real (876.00 .. 2923.875 in steps of 0.0625)	In chips. Included if cell is in active set.	
Round Trip Time Extension	CV-FDD		Real (0 .. 4392.125 in steps of 0.0625)	In chips. Included if cell is in active set. Default = 0. NOTE.	REL-7
NOTE: Total Round Trip Time = IE "Round Trip Time" + IE "Round Trip Time Extension".					

Condition	Explanation
<i>FDD</i>	The IE is optionally present in FDD, otherwise it is not needed.

10.3.7.107 UE positioning OTDOA quality

Information Element/Group name	Need	Multi	Type and Reference	Semantics description
Std Resolution	MP		Bit string(2)	Std Resolution field includes the resolution used in Std of OTDOA Measurements field.

Information Element/Group name	Need	Multi	Type and Reference	Semantics description
				Encoding on two bits as follows: '00' 10 meters '01' 20 meters '10' 30 meters '11' Reserved
Number of OTDOA Measurements	MP		Bit string(3)	The 'Number of OTDOA measurements' field indicates how many OTDOA measurements have been used in the UE to determine the sample standard deviation of the measurements. Following 3 bit encoding is used: '001' 5-9 '010' 10-14 '011' 15-24 '100' 25-34 '101' 35-44 '110' 45-54 '111' 55 or more Special case: '000': In this case the field 'Std of OTDOA measurements' contains the std of the reported SFN-SFN otd value = $\sqrt{E[(x-\mu)^2]}$, where x is the reported value and $\mu = E[x]$ is the expectation value (i.e. the true value) of x. This std can be used irrespective of the number of measurements and reporting of the number of measurements is not needed. Also other measurements such as Ec/No or Rx levels can be utilised in this case to evaluate the 'Std of OTDOA measurements' reported in this IE.

Information Element/Group name	Need	Multi	Type and Reference	Semantics description
Std of OTDOA Measurements	MP		Bit string(5)	Std of OTDOA Measurements field includes sample standard deviation of OTDOA measurements (when number of measurements is reported in 'Number of OTDOA measurements field') or standard deviation of the reported SFN-SFN otd value = $\sqrt{E[(x-\mu)^2]}$, where x is the reported value and $\mu = E[x]$ is the expectation value (i.e. the true value) of x (when '000' is given in 'Number of OTDOA measurements' field). Following linear 5 bit encoding is used: '00000' 0 - (R*1-1) meters '00001' R*1 - (R*2-1) meters '00010' R*2 - (R*3-1) meters ... '11111' R*31 meters or more where R is the resolution defined by Std Resolution field. E.g. R=20 m corresponds to 0-19 m, 20-39 m,...,620+ m.

10.3.7.108 UE positioning OTDOA reference cell info

This IE defines the cell used for time references in all OTDOA measurements.

Information Element/Group name	Need	Multi	Type and Reference	Semantics description
SFN	OP		Integer (0..4095)	Time stamp (SFN of Reference Cell) of the SFN-SFN relative time differences and SFN-SFN drift rates. Included if any SFN-SFN drift value is included in IE UE positioning OTDOA neighbour cell info.
CHOICE <i>mode</i>	MP			
>FDD				
>>Primary CPICH info	MP		Primary CPICH info 10.3.6.60	
>TDD				
>>cell and channel ID	MP		Cell and Channel Identity info 10.3.6.8a	Identifies the channel to be measured on.
Frequency info	MD		Frequency info 10.3.6.36	Default value is the existing value of frequency information. This IE shall always be set to default value
CHOICE <i>PositioningMode</i>	MP			
>UE based				
>UE assisted				(no data)
IPDL parameters	OP		UE positioning IPDL parameters 10.3.7.98	If this element is not included there are no idle periods present

10.3.7.108a UE positioning OTDOA reference cell info for UE-based

This IE defines the cell used for time references in all OTDOA measurements for UE-based methods.

Information Element/Group name	Need	Multi	Type and Reference	Semantics description	Version
UE positioning OTDOA reference cell info	MP		UE positioning OTDOA reference cell info 10.3.7.108		
CHOICE <i>Cell Position</i>	OP			The position of the antenna that defines the cell. Used for the UE based method.	
>Ellipsoid					
>>Ellipsoid point	MP		Ellipsoid point 10.3.8.4a		
>Ellipsoid with altitude					
>>Ellipsoid point with altitude	MP		Ellipsoid point with altitude 10.3.8.4b		
Round Trip Time	OP		Real (876.00 .. 2923.875 in steps of 0.0625)	In chips.	
Round Trip Time Extension	CV-FDD		Real (0 .. 4392.125 in steps of 0.0625)	In chips. Default = 0. NOTE.	REL-7
NOTE: Total Round Trip Time = IE "Round Trip Time" + IE "Round Trip Time Extension".					

Condition	Explanation
FDD	The IE is optionally present in FDD, otherwise it is not needed.

10.3.7.109 UE positioning position estimate info

The purpose of this IE is to provide the position estimate from the UE to the network, if the UE is capable of determining its own position.

Information Element/Group name	Need	Multi	Type and Reference	Semantics description	Version
CHOICE <i>Reference Time</i>	MP				
>UTRAN GPS reference time					
>>UE GPS timing of cell frames	MP		Integer(0..371589119999)	GPS Time of Week in units of 1/16 th UMTS chips according to [19]. 33209832177664 spare values are needed.	
>>CHOICE <i>mode</i>	MP				
>>>FDD					
>>>>Primary CPICH Info	MP		Primary CPICH Info 10.3.6.60	Identifies the reference cell for the GPS TOW-SFN relationship	
>>>TDD					
>>cell parameters id	MP		Cell parameters id 10.3.6.9	Identifies the reference cell for the GPS TOW-SFN relationship.	
>>Reference SFN	MP		Integer(0..4095)	The SFN for which the location is valid. This IE indicates the SFN at which the UE timing of cell frame is captured.	

Information Element/Group name	Need	Multi	Type and Reference	Semantics description	Version
>GPS reference time only					
>>GPS TOW msec	MP		Integer(0..6.048*10 ⁸ -1)	GPS Time of Week in milliseconds (rounded down to the nearest millisecond unit).	
>Cell timing					
>>SFN	MP		Integer(0..4095)	SFN during which the position was calculated.	
>>>CHOICE <i>mode</i>	MP				
>>>>FDD					
>>>>Primary CPICH Info	MP		Primary CPICH Info 10.3.6.60	Identifies the reference cell for SFN	
>>>>TDD					
>>>>cell parameters id	MP		Cell parameters id 10.3.6.9	Identifies reference cell for SFN	
>UTRAN GANSS reference time					REL-7
>>UE GANSS timing of cell frames	MP		Integer(0..86399999999750 by step of 250)	GANSS Time of Day in ns	REL-7
>>>GANSS Time ID	OP		Integer(0..7)	0-7: Reserved for future use Absence of this field means Galileo	REL-7
>>>>GANSS TOD Uncertainty	OP		Integer(0..127)	Coding as in 10.3.7.96a	REL-7
>>>>CHOICE <i>mode</i>	MP				REL-7
>>>>>FDD					REL-7
>>>>>Primary CPICH Info	MP		Primary CPICH Info 10.3.6.60	Identifies the reference cell for the GANSS TOD-SFN relationship	REL-7
>>>>>TDD					REL-7
>>>>>cell parameters id	MP		Cell parameters id 10.3.6.9	Identifies the reference cell for the GANSS TOD-SFN relationship.	REL-7
>>>>>Reference SFN	MP		Integer(0..4095)	The SFN for which the location is valid. This IE indicates the SFN at which the UE timing of cell frame is captured.	REL-7
>GANSS reference time only					REL-7
>>GANSS TOD msec	MP		Integer(0..3599999)	GANSS Time of Day in milliseconds (rounded down to the nearest millisecond unit).	REL-7
>>>GANSS Time ID	OP		Integer(0..7)	0-7: Reserved for future use Absence of this field means Galileo	REL-7
CHOICE <i>Position estimate</i>	MP				
>Ellipsoid Point			Ellipsoid Point; 10.3.8.4a		
>Ellipsoid point with uncertainty circle			Ellipsoid point with uncertainty circle 10.3.8.4d		
>Ellipsoid point with uncertainty ellipse			Ellipsoid point with uncertainty ellipse 10.3.8.4e		

Information Element/Group name	Need	Multi	Type and Reference	Semantics description	Version
>Ellipsoid point with altitude			Ellipsoid point with altitude 10.3.8.4b		
>Ellipsoid point with altitude and uncertainty ellipsoid			Ellipsoid point with altitude and uncertainty ellipsoid 10.3.8.4c		
Position Data	MP		Bit string(16)	For each bit, if set to '1', indicates that respective GNSS or position system was used for position calculation. Bit 0: OTDOA bit 1: GPS bit 2: Galileo bit 3-15: reserved	REL-7
CHOICE <i>Velocity estimate</i>	OP				REL-7
>Horizontal Velocity			Horizontal Velocity 10.3.8.4h		REL-7
>Horizontal with Vertical Velocity			Horizontal with Vertical Velocity 10.3.8.4i		REL-7
>Horizontal Velocity with Uncertainty			Horizontal Velocity with Uncertainty 10.3.8.4j		REL-7
>Horizontal with Vertical Velocity and Uncertainty			Horizontal with Vertical Velocity and Uncertainty 10.3.8.4k		REL-7
UE Positioning GPS ReferenceTime Uncertainty	<i>CV-Tutran-gps</i>		UE positioning GPS reference time uncertainty 10.3.7.96a		REL-7

Condition	Explanation
<i>Tutran-gps</i>	This IE is optionally present if "UTRAN GPS reference time" is included and not needed otherwise.

10.3.7.109a UE positioning Relative Time Difference quality

Information Element/Group name	Need	Multi	Type and Reference	Semantics description
Relative Time Difference Std Resolution	MP		Bit string(2)	Std Resolution field includes the resolution used in Std of Relative Time Difference field. Encoding on two bits as follows: '00' 10 meters '01' 20 meters '10' 30 meters '11' Reserved
Std of Relative Time Difference	MP		Bit string(5)	Std of Relative Time difference field includes standard deviation of (SFN-SFN relative time difference + Fine SFN-SFN). Following linear 5 bit encoding is used: '00000' 0 - (R*1-1) meters '00001' R*1 - (R*2-1) meters '00010' R*2 - (R*3-1) meters ... '11111' R*31 meters or more where R is the resolution defined by Std Resolution field. E.g. R=20 m corresponds to 0-19 m, 20-39 m, ..., 620+ m.

10.3.7.110 UE positioning reporting criteria

The triggering of the event-triggered reporting for a UE positioning measurement.

Information Element/Group name	Need	Multi	Type and Reference	Semantics description	Version
Parameters required for each event	MP	1 to <maxMeasEvent>		Note: need corrected to MP in Rel-7 to align with ASN.1.	
>Amount of reporting	MP		Integer(1, 2, 4, 8, 16, 32, 64,infinite)		
>Report first fix	MP		Boolean	If true the UE reports the position once the measurement control is received, and then each time an event is triggered.	
>Measurement interval	MP		Integer(5,15,60,300,900,1800,3600,7200)	Indicates how often the UE should make the measurement In seconds	
>CHOICE Event ID	MP				
>>7a					
>>>Threshold Position Change	MP		Integer(10, 20,30,40,50,100,200, 300,500,1000,2000,5000,10000,20000,50000,100000)	Meters. Indicated how much the position should change compared to last reported position fix in order to trigger the event.	
>>7b					
>>>Threshold SFN-SFN change	MP		Real(0.25, 0.5,1,2,3,4, 5,10,20,50, 100,200,500,1000,2000,5000)	Chips. Indicates how much the SFN-SFN measurement of ANY measured cell is allowed to change before the event is triggered.	
>>7c					
>>>Threshold SFN-GPS TOW	MP		Integer(1,2,3,5,10,20, 50,100)	Time in ms. When the GPS TOW and SFN timer has drifted apart more than the specified value the event is triggered.	
				Time in micro seconds (NOTE 1).	REL-7
>>7d					REL-7
>>>Threshold SFN-GANSS TOW	MP		Integer(1,2,3,5,10,20, 50,100)	Time in micro seconds. When the GANSS TOW and SFN timer has drifted apart more than the specified value the event is triggered.	REL-7
NOTE 1: In previous versions of the protocol, the IE "Threshold SFN-GPS TOW" was provided in units of milli seconds. If the information is provided in units of micro seconds, the UE shall ignore any information provided in units of milli seconds.					

10.3.7.111 UE positioning reporting quantity

The purpose of the element is to express the allowed/required location method(s), and to provide information desired QoS.

Information Element/Group name	Need	Multi	Type and Reference	Semantics description	Version
Method Type	MP		Enumerated(UE assisted, UE		

Information Element/Group name	Need	Multi	Type and Reference	Semantics description	Version
			based, UE based is preferred but UE assisted is allowed, UE assisted is preferred but UE based is allowed)		
Positioning Methods	MP		Enumerated(OTD OA, GPS, OTDOA or GPS, Cell ID)		
Response Time	MP		Integer(1,2,4, 8, 16, 32, 64, 128)	This IE shall be ignored.	
Horizontal Accuracy	CV- <i>MethodType</i>		Bit string(7)	The uncertainty is derived from the "uncertainty code" k by $r = 10*(1.1^k - 1)$ in meters.	
Vertical Accuracy	CV- <i>MethodType</i>		Bit string(7)	The uncertainty is derived from the "uncertainty code" k by $r = 45*(1.025^k - 1)$ in meters.	
GPS timing of Cell wanted	MP		Boolean	If true the SRNC wants the UE to report the SFN-GPS timing of the reference cell. This is however optional in the UE.	
Multiple Sets	MP		Boolean	This IE shall be ignored.	
Additional Assistance Data Request	MP		Boolean	TRUE indicates that the UE is requested to send the IE "Additional assistance Data Request" when the IE "UE positioning Error" is present in the UE positioning measured results. FALSE indicates that the UE shall use the assistance data available.	
Environment Characterisation	OP		Enumerated(possibly heavy multipath and NLOS conditions, no or light multipath and usually LOS conditions, not defined or mixed environment)	One spare value is needed.	
Velocity Requested	OP		Enumerated (TRUE)	If this element is present the UE is requested to send a velocity estimate	REL-7

Information Element/Group name	Need	Multi	Type and Reference	Semantics description	Version
GANSS Positioning Methods	OP		Bit string(16)	For each bit, if set to '1', indicates that respective GNSS is allowed. bit 0: GPS bit 1: Galileo bit 2-15: reserved for future GNSSes Note 1	REL-7
GANSS timing of Cell wanted	OP		Bit string(8)	Each bit refers to a GANSS. Bit 0 is for Galileo. Other bits are reserved. If one bit is set to one the SRNC wants the UE to report the SFN-GANSS timing of the reference cell. This is however optional in the UE.	REL-7
GANSS Carrier-Phase Measurement Requested	OP		Bit string(8)	Each bit refers to a GANSS. Bit 0 is for Galileo. Other bits are reserved. This is however optional in the UE.	REL-7

Condition	Explanation
<i>Method Type</i>	The IE is optional if the IE "Method Type" is "UE assisted"; otherwise it is mandatory present.

NOTE 1: Bit 0 of this bitmap shall not be the only one set to 1.

10.3.7.112 T_{ADV} info

NOTE: Only for 1.28 Mcps TDD.

T_{ADV} indicates the difference between the Rx timing and Tx timing of a UE.

Information Element/group name	Need	Multi	Type and reference	Semantics description	Version
T_{ADV}	MP		Integer (0..2047,	As defined in [20].	REL-4
			2048..8191)		REL-7
SFN	MP		Integer(0..4095)	SFN during which the T_{ADV} measurement was performed.	REL-4

10.3.8 Other Information elements

10.3.8.1 BCCH modification info

Indicates modification of the System Information on BCCH.

Information Element/Group name	Need	Multi	Type and reference	Semantics description
MIB Value tag	MP		MIB Value tag 10.3.8.9	
BCCH modification time	OP		Integer (0..4088 in step of 8)	All SFN values in which MIB may be mapped are allowed.

10.3.8.2 BSIC

Information Element/Group name	Need	Multi	Type and reference	Semantics description
Base transceiver Station Identity Code (BSIC)	MP			[11]
>Network Colour Code (NCC)	MP		bit string(3)	The first/leftmost bit of the bit string contains the most significant bit of the NCC.
>Base Station Colour Code (BCC)	MP		bit string(3)	The first/leftmost bit of the bit string contains the most significant bit of the BCC.

10.3.8.3 CBS DRX Level 1 information

This information element contains the CBS discontinuous reception information to be broadcast for CBS DRX Level 1 calculations in the UE.

Information Element/Group name	Need	Multi	Type and reference	Semantics description	Version
Period of CTCH allocation (N)	MP		Integer (1..256)	$M_{TTI} \leq N \leq 256$, N multiple of M_{TTI}	
CBS frame offset (K)	MP		Integer (0..255)	$0 \leq K \leq N-1$, K multiple of M_{TTI}	
Period of BMC scheduling messages (P)	CV-SIB5		Integer (8, 16, 32, 64, 128, 256)		REL-6

Condition	Explanation
SIB5	The IE is optional when the IE "CBS DRX Level 1 information" in SIB5, otherwise the IE is not needed

10.3.8.4 Cell Value tag

Information Element/Group name	Need	Multi	Type and reference	Semantics description
Cell Value tag	MP		Integer (1..4)	

10.3.8.4a Ellipsoid point

This IE contains the description of an ellipsoid point as in [24].

Information Element/Group name	Need	Multi	Type and Reference	Semantics description
Latitude sign	MP		Enumerated (North, South)	
Degrees Of Latitude	MP		Integer (0...2 ²³ -1)	The IE value (<i>N</i>) is derived by this formula: $N \leq 2^{23} X / 90 < N+1$ <i>X</i> being the latitude in degree (0°.. 90°)
Degrees Of Longitude	MP		Integer (-2 ²³ ...2 ²³ -1)	The IE value (<i>N</i>) is derived by this formula: $N \leq 2^{24} X / 360 < N+1$ <i>X</i> being the longitude in degree (-180°..+180°)

10.3.8.4b Ellipsoid point with Altitude

This IE contains the description of an ellipsoid point with altitude as in [24].

Information Element/Group name	Need	Multi	Type and Reference	Semantics description
Latitude sign	MP		Enumerated (North, South)	
Degrees Of Latitude	MP		Integer (0...2 ²³ -1)	The IE value (<i>N</i>) is derived by this formula: $N \leq 2^{23} X / 90 < N+1$ <i>X</i> being the latitude in degree (0°.. 90°)
Degrees Of Longitude	MP		Integer (-2 ²³ ...2 ²³ -1)	The IE value (<i>N</i>) is derived by this formula: $N \leq 2^{24} X / 360 < N+1$ <i>X</i> being the longitude in degree (-180°..+180°)
Altitude Direction	MP		Enumerated (Height, Depth)	
Altitude	MP		Integer (0..2 ¹⁵ -1)	The IE value (<i>N</i>) is derived by this formula: $N \leq a < N+1$ <i>a</i> being the altitude in metres

10.3.8.4c Ellipsoid point with Altitude and uncertainty ellipsoid

This IE contains the description of an ellipsoid point with altitude and uncertainty ellipsoid as in [24].

Information Element/Group name	Need	Multi	Type and Reference	Semantics description
Latitude sign	MP		Enumerated (North, South)	
Degrees Of Latitude	MP		Integer (0...2 ²³ -1)	The IE value (<i>N</i>) is derived by this formula: $N \leq 2^{23} X / 90 < N+1$ <i>X</i> being the latitude in degree (0°.. 90°)

Information Element/Group name	Need	Multi	Type and Reference	Semantics description
Degrees Of Longitude	MP		Integer (- $2^{23} \dots 2^{23}-1$)	The IE value (N) is derived by this formula: $N \leq 2^{24} X / 360 < N+1$ X being the longitude in degree (-180° .. +180°)
Altitude Direction	MP		Enumerated (Height, Depth)	
Altitude	MP		Integer (0.. $2^{15}-1$)	The IE value (N) is derived by this formula: $N \leq a < N+1$ a being the altitude in metres
Uncertainty semi-major	MP		Integer (0...127)	The uncertainty r is derived from the "uncertainty code" k by $r = 10x(1.1^k-1)$
Uncertainty semi-minor	MP		Integer (0...127)	The uncertainty r is derived from the "uncertainty code" k by $r = 10x(1.1^k-1)$
Orientation of major axis	MP		Integer (0..89)	The IE value (N) is derived by this formula: $2N \leq a < 2(N+1)$ a being the orientation in degree (0° .. 179°)
Uncertainty Altitude	MP		Integer(0..127)	The uncertainty in altitude, h , expressed in metres is mapped from the IE value (K), with the following formula: $h = C((1+x)^K - 1)$ with $C = 45$ and $x = 0.025$.
Confidence	MP		Integer (0..100)	in percentage

10.3.8.4d Ellipsoid point with uncertainty Circle

This IE contains the description of an ellipsoid point with an uncertainty circle as in [24].

Information Element/Group name	Need	Multi	Type and Reference	Semantics description
Latitude sign	MP		Enumerated (North, South)	
Degrees Of Latitude	MP		Integer (0... $2^{23}-1$)	The IE value (N) is derived by this formula: $N \leq 2^{23} X / 90 < N+1$ X being the latitude in degree (0° .. 90°)
Degrees Of Longitude	MP		Integer (- $2^{23} \dots 2^{23}-1$)	The IE value (N) is derived by this formula: $N \leq 2^{24} X / 360 < N+1$ X being the longitude in degree (-180° .. +180°)
Uncertainty Code	MP		Integer (0...127)	The uncertainty r is derived from the "uncertainty code" k by $r = 10x(1.1^k-1)$

10.3.8.4e Ellipsoid point with uncertainty Ellipse

This IE contains the description of an ellipsoid point with an uncertainty ellipse as in [24].

Information Element/Group name	Need	Multi	Type and Reference	Semantics description
Latitude sign	MP		Enumerated (North, South)	
Degrees Of Latitude	MP		Integer (0...2 ²³ -1)	The IE value (N) is derived by this formula: $N \leq 2^{23} X / 90 < N+1$ X being the latitude in degree (0°.. 90°)
Degrees Of Longitude	MP		Integer (-2 ²³ ...2 ²³ -1)	The IE value (N) is derived by this formula: $N \leq 2^{24} X / 360 < N+1$ X being the longitude in degree (-180°..+180°)
Uncertainty semi-major	MP		Integer (0...127)	The uncertainty <i>r</i> is derived from the "uncertainty code" <i>k</i> by $r = 10 \times (1.1^k - 1)$
Uncertainty semi-minor	MP		Integer (0...127)	The uncertainty <i>r</i> is derived from the "uncertainty code" <i>k</i> by $r = 10 \times (1.1^k - 1)$
Orientation of major axis	MP		Integer (0..89)	The IE value (N) is derived by this formula: $2N \leq a < 2(N+1)$ <i>a</i> being the orientation in degree (0°.. 179°)
Confidence	MP		Integer (0..100)	in percentage

10.3.8.4f GERAN system information

Information Element/Group name	Need	Multi	Type and reference	Semantics description	Version
>>> GERAN System Info	MP	1 to <maxGERAN SI>			REL-5
>>>> GERAN system info block	MP		Octet string(1..23)	The first octet contains octet 1 of the GERAN system information block, the second octet contains octet 2 of the GERAN system information block and so on.	REL-5

10.3.8.4g GSM Target Cell Info

Information Element/Group name	Need	Multi	Type and reference	Semantics description	Version
GSM Target Cell Info List	MP	1 to <maxGSMTar getCells>			REL-6
>BCCH ARFCN	MP		Integer (0..1023)	[45]	REL-6
>Band indicator	MP		Enumerated	Indicates how to	REL-6

Information Element/Group name	Need	Multi	Type and reference	Semantics description	Version
			(DCS 1800 band used, PCS 1900 band used)	interpret the BCCH ARFCN	
>BSIC	OP		BSIC 10.3.8.2		REL-6

10.3.8.4h Horizontal Velocity

This IE contains the description of a horizontal velocity as in [24].

Information Element/Group name	Need	Multi	Type and Reference	Semantics description
Bearing	MP		Integer (0...359)	The direction of movement is given in degrees where '0' represents North, '90' represents East, etc.
Horizontal Speed	MP		Integer (0... $2^{11}-1$)	The relationship between (N) and the horizontal speed (h) in kilometers per hour it describes is: $N \leq h < N + 0.5$, for (N=0) $N-0.5 \leq h < N + 0.5$, for (0<N< $2^{11}-1$) $N - 0.5 \leq h$, for (N = $2^{11}-1$)

10.3.8.4i Horizontal with Vertical Velocity

This IE contains the description of horizontal with vertical velocity as in [24].

Information Element/Group name	Need	Multi	Type and Reference	Semantics description
Vertical Speed direction	MP		ENUMERATED (upward, downward)	
Bearing	MP		Integer (0...359)	The direction of movement is given in degrees where '0' represents North, '90' represents East, etc.
Horizontal Speed	MP		Integer (0... $2^{11}-1$)	The relationship between (N) and the horizontal speed (h) in kilometers per hour it describes is: $N \leq h < N + 0.5$, for (N=0) $N-0.5 \leq h < N + 0.5$, for (0<N< $2^{11}-1$) $N - 0.5 \leq h$, for (N = $2^{11}-1$)
Vertical Speed	MP		Integer (0..255)	The relationship between (N) and the vertical speed (v) in kilometres per hour it describes is given by the formula: $N \leq v < N + 0.5$, for (N=0) $N-0.5 \leq v < N + 0.5$, for (0<N< 2^8-1) $N - 0.5 \leq v$, for (N = 2^8-1)

10.3.8.4j Horizontal Velocity with Uncertainty

This IE contains the description of horizontal velocity with uncertainty as in [24].

Information Element/Group name	Need	Multi	Type and Reference	Semantics description
Bearing	MP		Integer (0...359)	The direction of movement is given in degrees where '0' represents North, '90' represents East, etc.
Horizontal Speed	MP		Integer (0... $2^{11}-1$)	The relationship between (N) and the horizontal speed (h) in kilometers per hour it describes is: $N \leq h < N + 0.5$, for (N=0) $N-0.5 \leq h < N + 0.5$, for (0<N< $2^{11}-1$) $N - 0.5 \leq h$, for (N = $2^{11}-1$)
Horizontal Uncertainty Speed	MP		Integer (0..255)	The IE value is encoded in increments of 1 kilometer per hour. The value of N give the uncertainty speed except for N=255 which indicates that the uncertainty is not specified

10.3.8.4k Horizontal with Vertical Velocity and Uncertainty

This IE contains the description of horizontal with vertical velocity and uncertainty as in [24].

Information Element/Group name	Need	Multi	Type and Reference	Semantics description
Vertical Speed direction	MP		ENUMERATED (upward, downward)	
Bearing	MP		Integer (0...359)	The direction of movement is given in degrees where '0' represents North, '90' represents East, etc.
Horizontal Speed	MP		Integer (0... $2^{11}-1$)	The relationship between (N) and the horizontal speed (h) in kilometers per hour it describes is: $N \leq h < N + 0.5$, for (N=0) $N-0.5 \leq h < N + 0.5$, for (0<N< $2^{11}-1$) $N - 0.5 \leq h$, for (N = $2^{11}-1$)
Vertical Speed	MP		Integer (0..255)	The relationship between (N) and the vertical speed (v) in kilometres per hour it describes is given by the formula: $N \leq v < N + 0.5$, for (N=0) $N-0.5 \leq v < N + 0.5$, for (0<N< 2^8-1) $N - 0.5 \leq v$, for (N = 2^8-1)
Horizontal Uncertainty Speed	MP		Integer (0..255)	The IE value is encoded in increments of 1 kilometer per hour. The value of N give the uncertainty speed except for N=255 which indicates that the uncertainty is not specified

Information Element/Group name	Need	Multi	Type and Reference	Semantics description
Vertical Uncertainty Speed	MP		Integer (0..255)	The IE value is encoded in increments of 1 kilometer per hour. The value of N give the uncertainty speed except for N=255 which indicates that the uncertainty is not specified

10.3.8.5 Inter-RAT change failure

Information Element/Group name	Need	Multi	Type and reference	Semantics description
Inter-RAT change failure cause	MP		Enumerated(Configuration unacceptable, physical channel failure, protocol error, unspecified)	Four spare values are needed.
Protocol error information	CV-ProtErr		Protocol error information 10.3.8.12	

Condition	Explanation
<i>ProtErr</i>	The IE is mandatory present if the IE "Inter-RAT change failure cause" has the value "Protocol error" and not needed otherwise.

10.3.8.6 Inter-RAT handover failure

Information Element/Group name	Need	Multi	Type and reference	Semantics description
Inter-RAT handover failure cause	MD		Enumerated(Configuration unacceptable, physical channel failure, protocol error, inter-RAT protocol error, unspecified)	Default value is "unspecified". Eleven spare values are needed.
Protocol error information	CV-ProtErr		Protocol error information 10.3.8.12	

Condition	Explanation
<i>ProtErr</i>	The IE is mandatory present if the IE "Inter-RAT handover failure cause" has the value "Protocol error" and not needed otherwise.

10.3.8.7 Inter-RAT UE radio access capability

This Information Element contains the inter-RAT UE radio access capability that is structured and coded according to the specification used for the corresponding system type.

Information Element/Group name	Need	Multi	Type and reference	Semantics description	Version
CHOICE <i>system</i>	MP				
>GSM					
>>Mobile Station Classmark 2	MP		Octet string (5)	This IE is formatted as 'TLV' and is coded in the same way as the <i>Mobile Station Classmark 2</i> information element in [5]. The first octet is the <i>Mobile station classmark 2 IEI</i> and its value shall be set to 33H (except in the case of NOTE 2). The second octet is the <i>Length of mobile station classmark 2</i> and its value shall be set to 3. The octet 3 contains the first octet of the value part of the <i>Mobile Station Classmark 2</i> information element, the octet 4 contains the second octet of the value part of the <i>Mobile Station Classmark 2</i> information element and so on. For each of these octets, the first/leftmost/ most significant bit of the octet contains b8 of the corresponding octet of the <i>Mobile Station Classmark 2</i> . See NOTE 2.	
>>Mobile Station Classmark 3	MP		Octet string (1..32)	This IE is formatted as 'V' and is coded in the same way as the value part in the <i>Mobile station classmark 3</i> information element in [5]. The first octet contains octet 1 of the value part of <i>Mobile station classmark 3</i> , the second octet contains octet 2 of the value part of <i>Mobile station classmark 3</i> and so on. See NOTE 1, NOTE 2.	
>>MS Radio Access Capability	OP		Octet string (1..64)	This IE is formatted as 'V' and is coded in the same way as the value part in the <i>MS Radio Access Capability</i> information element in [5].	REL-6
>GERAN lu					REL-5
>>MS GERAN lu mode Radio Access Capability	MP		Bit string (1..170)	Formatted and coded according to [53]. The first/leftmost/most significant bit of the bit string contains bit 8 of the first octet of the IE.	REL-5
>cdma2000					
>>cdma2000Message	MP	1.to.<maxInterSystemMessages>			
>>>MSG_TYPE(s)	MP		Bit string (8)	Formatted and coded according to cdma2000 specifications. The first/leftmost/most significant bit of the bit string contains bit 7 of the MSG_TYPE.	
>>>cdma2000MessagePayload(s)	MP		Bit string (1..512)	Formatted and coded according to cdma2000 specifications. The first/leftmost/most significant bit of the bit string contains bit 7 of the first octet of the cdma2000 message.	

Information Element/Group name	Need	Multi	Type and reference	Semantics description	Version
NOTE 1: The value part is specified by means of CSN.1, which encoding results in a bit string, to which final padding may be appended upto the next octet boundary [5]. The first/ leftmost bit of the CSN.1 bit string is placed in the first/ leftmost/ most significant bit of the first octet. This continues until the last bit of the CSN.1 bit string, which is placed in the last/ rightmost/ least significant bit of the last octet.					
NOTE 2: The information in these IEs is optionally present in the INTER RAT HANDOVER INFO WITH INTER RAT CAPABILITIES message, otherwise it is mandatory present. If the information in the IEs "Mobile Station Classmark 2" and "Mobile Station Classmark 3" is not included, it is indicated by setting the first octet (IEI) of the IE "Mobile Station Classmark 2" to 00H. In this case, the receiver should ignore the value parts of the <i>Mobile Station Classmark 2</i> and the <i>Mobile Station Classmark 3</i> . The contents of those are set to zero.					

10.3.8.8 Void

10.3.8.8a Inter-RAT UE security capability

Information Element/Group name	Need	Multi	Type and reference	Semantics description	Version
CHOICE <i>system</i>	MP				
>GSM					
>>GSM security capability	MP			The value TRUE means that the indicated ciphering algorithm is supported.	
>>>A5/7 supported	MP		Boolean		
>>>A5/6 supported	MP		Boolean		
>>>A5/5 supported	MP		Boolean		
>>>A5/4 supported	MP		Boolean		
>>>A5/3 supported	MP		Boolean		
>>>A5/2 supported	MP		Boolean		
>>>A5/1 supported	MP		Boolean		

10.3.8.9 MIB Value tag

Information Element/Group name	Need	Multi	Type and reference	Semantics description
MIB Value tag	MP		Integer (1..8)	

10.3.8.10 PLMN Value tag

Information Element/Group name	Need	Multi	Type and reference	Semantics description
PLMN Value tag	MP		Integer (1..256)	

10.3.8.10a PNBSCH allocation

UTRAN may use this IE to provide silent periods in the cell that may be used for cell synchronisation purposes.

Information Element/Group name	Need	Multi	Type and reference	Semantics description	Version
Number of repetitions per SFN period	MP		Integer(2, 3, 4, 5, 6, 7, 8, 9, 10, 12, 14, 16, 18, 20, 24, 28, 32, 36, 40, 48, 56, 64, 72, 80)		REL-4

10.3.8.11 Predefined configuration identity and value tag

Information Element/Group name	Need	Multi	Type and reference	Semantics description
Predefined configuration identity	MP		Predefined configuration identity 10.3.4.5	
Predefined configuration value tag	MP		Predefined configuration value tag 10.3.4.6	

10.3.8.12 Protocol error information

This information element contains diagnostics information returned by the receiver of a message that was not completely understood.

Information Element/Group name	Need	Multi	Type and reference	Semantics description
CHOICE <i>diagnostics type</i>	MP			One spare value is needed.
>Protocol error cause			Protocol error cause 10.3.3.26	

10.3.8.13 References to other system information blocks

Information element/Group name	Need	Multi	Type and reference	Semantics description	Version
References to other system information blocks	MP	1 to <maxSIB>		System information blocks for which multiple occurrences are used, may appear more than once in this list	
>Scheduling information	MP		Scheduling information, 10.3.8.16		
>SIB type SIBs only	MP		SIB Type SIBs only, 10.3.8.22		
References to other extension system information blocks	OP	1 to <maxSIB>			REL-6
>Scheduling information	MP		Scheduling information, 10.3.8.16		REL-6
>Extension SIB type	MP		SIB type extension 10.3.8.18b		REL-6

10.3.8.14 References to other system information blocks and scheduling blocks

Information element/Group name	Need	Multi	Type and reference	Semantics description	Version
References to other system information blocks	MP	1 to <maxSIB>		System information blocks for which multiple occurrences are used, may appear more than once in this list	
>Scheduling information	MP		Scheduling information, 10.3.8.16		
>SIB and SB type	MP		SIB and SB Type, 10.3.8.18a		
References to other extension system information blocks	OP	1 to <maxSIB>			REL-6
>Scheduling information	MP		Scheduling information, 10.3.8.16		REL-6
>Extension SIB type	MP		SIB type extension 10.3.8.18b		REL-6

10.3.8.15 Rplmn information

Contains information to provide faster RPLMN selection in the UE.

Information Element/Group name	Need	Multi	Type and reference	Semantics description	Version
GSM BA Range	OP	1 to maxNumGSMFreqRanges		GSM BA Range	
>GSM Lower Range (UARFCN)	MP		Integer(0..16383)	Lower bound for range of GSM BA freqs	
>GSM Upper Range (UARFCN)	MP		Integer(0..16383)	Upper bound for range of GSM BA freqs	
FDD UMTS Frequency list	OP	1 to maxNumFDDFreqs			
>UARFCN (Nlow)	MP		Integer(0..16383)	[21]	
>UARFCN (Nupper)	OP		Integer(0..16383)	[21] This IE is only needed when the FDD frequency list is specifying a range.	
3.84 Mcps TDD UMTS Frequency list	OP	1 to maxNumTDDFreqs			
>UARFCN	MP		Integer(0..16383)	[22]	
7.68 Mcps TDD UMTS Frequency list	OP	1 to maxNumTDDFreqs			REL-7
>UARFCN	MP		Integer(0..16383)	[22]	REL-7
1.28 Mcps TDD UMTS Frequency list	OP	1 to maxNumTDDFreqs			REL-4

Information Element/Group name	Need	Multi	Type and reference	Semantics description	Version
>UARFCN	MP		Integer(0..16383)	[22]	REL-4
CDMA2000 UMTS Frequency list	OP	1 to maxNumCDMA2000Freqs			
>BAND_CLASS	MP		Bit string(5 bits)	TIA/EIA/IS-2000 When mapping the BAND_CLASS to the bit string, the first/leftmost bit of the bit string contains the most significant bit..	
>CDMA_FREQ	MP		Bit string (11 bits)	TIA/EIA/IS-2000 When mapping the CDMA_FREQ to the bit string, the first/leftmost bit of the bit string contains the most significant bit..	

10.3.8.16 Scheduling information

Information Element/Group name	Need	Multi	Type and reference	Semantics description
CHOICE <i>Value tag</i>	OP			
>PLMN Value tag			PLMN Value tag 10.3.8.10	This IE is included if the following conditions are fulfilled: the SIB type equals system information block type 1 Note: IE 'PLMN value tag' is used for SIB1 but the area scope for SIB 1 is Cell.
>Predefined configuration identity and value tag			Predefined configuration identity and value tag 10.3.8.11	This IE is included if the following conditions are fulfilled: the SIB type equals system information block type 16
>Cell Value tag			Cell Value tag 10.3.8.4	This IE is included if the following conditions are fulfilled: the SIB type does not equal system information block type 1; and the area scope for the system information block is set to "cell" in table 8.1.1; and a value tag is used to indicate changes in the system information block.
>SIB occurrence identity and value tag			SIB occurrence identity and value tag 10.3.8.20b	This IE is included if the following conditions are fulfilled: the SIB type equals system information block types 15.2, 15.2bis, 15.3 and 15.3bis
Scheduling	MP			
>SEG_COUNT	MD		SEG COUNT 10.3.8.17	Default value is 1

Information Element/Group name	Need	Multi	Type and reference	Semantics description
>SIB_REP	MP		Integer (4, 8, 16, 32, 64, 128, 256, 512, 1024, 2048, 4096)	Repetition period for the SIB in frames
>SIB_POS	MP		Integer (0 ..Rep-2 by step of 2)	Position of the first segment Rep is the value of the SIB_REP IE
>SIB_POS offset info	MD	1..15		see below for default value
>>SIB_OFF	MP		Integer(2..32 by step of 2)	Offset of subsequent segments

Field	Default value
SIB_POS offset info	The default value is that all segments are consecutive, i.e., that the SIB_OFF = 2 for all segments except when MIB segment/complete MIB is scheduled to be transmitted in between segments from same SIB. In that case, SIB_OFF=4 in between segments which are scheduled to be transmitted at SFNprime = 8 *n-2 and 8*n + 2, and SIB_OFF=2 for the rest of the segments.

10.3.8.17 SEG COUNT

Information Element/Group name	Need	Multi	Type and reference	Semantics description
SEG_COUNT	MP		Integer (1..16)	Number of segments in the system information block

10.3.8.18 Segment index

Each system information segment has an individual segment index.

Information Element/Group name	Need	Multi	Type and reference	Semantics description
Segment index	MP		Integer (1..15)	Segments of a system information block are numbered starting with 0 for the first segment and 1 for the next segment, which can be the first subsequent segment or a last segment.

10.3.8.18a SIB and SB type

The SIB type identifies a specific system information block.

Information Element/Group name	Need	Multi	Type and reference	Semantics description
SIB and SB type	MP		Enumerated, see below	Two spare values are needed

List of enumerated values	Version
System Information Type 1, System Information Type 2, System Information Type 3, System Information Type 4, System Information Type 5, System Information Type 6, System Information Type 7, System Information Type 11, System Information Type 12, System Information Type 13, System Information Type 13.1, System Information Type 13.2, System Information Type 13.3, System Information Type 13.4, System Information Type 14, System Information Type 15, System Information Type 15.1, System Information Type 15.2, System Information Type 15.3, System Information Type 15.4, System Information Type 15.5, System Information Type 16, System Information Type 17, System Information Type 18, Scheduling Block 1, Scheduling Block 2,	
System Information Type 5bis	REL-6

10.3.8.18b SIB type extension

The SIB type identifies a specific extension system information block.

Information Element/Group name	Need	Multi	Type and reference	Semantics description	Version
SIB type extension	MP		Enumerated, see below		REL-6

List of enumerated values	Version
System Information Type 11bis	REL-6
System Information Type 15bis, System Information Type 15.1bis, System Information Type 15.2bis, System Information Type 15.3bis, System Information Type 15.6, System Information Type 15.7 System Information Type 15.8	REL-7

10.3.8.19 SIB data fixed

Contains the result of a master information block or a system information block after encoding and segmentation. The IE is used for segments with fixed length (segments filling an entire transport block).

Information Element/Group name	Need	Multi	Type and reference	Semantics description
SIB data fixed	MP		Bit string (222)	The first bit contains the first bit of the segment.

10.3.8.20 SIB data variable

Contains either a complete system information block or a segment of a system information block. Contains the result of a master information block or a system information block after encoding and segmentation. The IE is used for segments with variable length. The system information blocks are defined in clauses 10.2.48.8.1 to 10.2.48.8.18.

Information Element/Group name	Need	Multi	Type and reference	Semantics description
SIB data variable	MP		Bit string (1..214)	The first bit contains the first bit of the segment.

10.3.8.20a SIB occurrence identity

This information element identifies a SIB occurrence for System Information Block types 15.2 and 15.3. For System Information Block type 15.2, this identity is assigned to the visible satellite only. Unused identities are claimed by newly rising satellites.

Information Element/Group name	Need	Multi	Type and reference	Semantics description
SIB occurrence identity	MP		Integer (0..15)	

10.3.8.20b SIB occurrence identity and value tag

Information Element/Group name	Need	Multi	Type and reference	Semantics description
SIB occurrence identity	MP		SIB occurrence identity 10.3.8.20a	
SIB occurrence value tag	MP		SIB occurrence value tag 10.3.8.20c	

10.3.8.20c SIB occurrence value tag

This information element is used to identify different versions of SIB occurrence for System Information Block types 15.2 and 15.3.

Information Element/Group name	Need	Multi	Type and Reference	Semantics description
SIB occurrence value tag	MP		Integer(0..15)	

10.3.8.21 SIB type

The SIB type identifies a specific system information block.

Information Element/Group name	Need	Multi	Type and reference	Semantics description
SIB type	MP		Enumerated, see below	NOTE 1
NOTE 1: If the value "Extension Type" is signalled, the UE shall use the scheduling information in the MIB and, if present, in the SB1 and SB2 to identify the specific type of system information block.				

List of enumerated values	Version
Master information block, System Information Type 1, System Information Type 2, System Information Type 3, System Information Type 4, System Information Type 5, System Information Type 6, System Information Type 7, System Information Type 11, System Information Type 12, System Information Type 13, System Information Type 13.1, System Information Type 13.2, System Information Type 13.3, System Information Type 13.4, System Information Type 14, System Information Type 15, System Information Type 15.1, System Information Type 15.2, System Information Type 15.3, System Information Type 15.4, System Information Type 15.5, System Information Type 16, System Information Type 17, System Information Type 18, Scheduling Block 1, Scheduling Block 2,	
System Information Type 5bis, Extension Type	REL-6

10.3.8.22 SIB type SIBs only

The SIB type identifies a specific system information block.

Information Element/Group name	Need	Multi	Type and reference	Semantics description
SIB type SIBs only	MP		Enumerated, see below	Four spare values are needed

List of enumerated values	Version
System Information Type 1, System Information Type 2, System Information Type 3, System Information Type 4, System Information Type 5, System Information Type 6, System Information Type 7, System Information Type 11, System Information Type 12, System Information Type 13, System Information Type 13.1, System Information Type 13.2, System Information Type 13.3, System Information Type 13.4, System Information Type 14, System Information Type 15, System Information Type 15.1, System Information Type 15.2, System Information Type 15.3, System Information Type 15.4, System Information Type 15.5, System Information Type 16, System Information Type 17, System Information Type 18,	
System Information Type 5bis	REL-6

10.3.9 ANSI-41 Information elements

10.3.9.1 ANSI-41 Core Network Information

Information element/Group name	Need	Multi	Type and reference	Semantics description
P_REV	MP		P_REV 10.3.9.10	
MIN_P_REV	MP		MIN_P_REV 10.3.9.8	
SID	MP		SID 10.3.9.11	
NID	MP		NID 10.3.9.9	

10.3.9.2 ANSI-41 Global Service Redirection information

This Information Element contains ANSI-41 Global Service Redirection information.

Information Element/Group name	Need	Multi	Type and reference	Semantics description
ANSI-41 Global Service Redirection information	MP		ANSI-41 NAS parameter, 10.3.9.3	Formatted and coded according to the 3GPP2 document "G3G CDMA DS on ANSI-41"

10.3.9.3 ANSI-41 NAS parameter

This Information Element contains ANSI-41 User Zone Identification information.

Information Element/Group name	Need	Multi	Type and reference	Semantics description
ANSI-41 NAS parameter	MP		Bit string (size (1..2048))	The first bit contains the first bit of the ANSI-41 information.

10.3.9.4 ANSI-41 NAS system information

This Information Element contains ANSI-41 system information.

Information Element/Group name	Need	Multi	Type and reference	Semantics description
NAS (ANSI-41) system information	MP		ANSI-41 NAS parameter, 10.3.9.3	Formatted and coded according to the 3GPP2 document "G3G CDMA DS on ANSI-41"

10.3.9.5 ANSI-41 Private Neighbour List information

This Information Element contains ANSI-41 Private Neighbour List information.

Information Element/Group name	Need	Multi	Type and reference	Semantics description
ANSI-41 Private Neighbour List information	MP		ANSI-41 NAS parameter, 10.3.9.3	Formatted and coded according to the 3GPP2 document "G3G CDMA DS on ANSI-41"

10.3.9.6 ANSI-41 RAND information

This Information Element contains ANSI-41 RAND information.

Information Element/Group name	Need	Multi	Type and reference	Semantics description
ANSI-41 RAND information	MP		ANSI-41 NAS parameter, 10.3.9.3	Formatted and coded according to the 3GPP2 document "G3G CDMA DS on ANSI-41"

10.3.9.7 ANSI-41 User Zone Identification information

This Information Element contains ANSI-41 User Zone Identification information.

Information Element/Group name	Need	Multi	Type and reference	Semantics description
ANSI-41 User Zone Identification information	MP		ANSI-41 NAS parameter, 10.3.9.3	Formatted and coded according to the 3GPP2 document "G3G CDMA DS on ANSI-41"

10.3.9.8 MIN_P_REV

This Information Element contains minimum protocol revision level.

Information Element/Group name	Need	Multi	Type and reference	Semantics description
MIN_P_REV	MP		Bit string (8)	Minimum protocol revision level. The first/leftmost bit of the bit string contains the most significant bit of the MIN_P_REV.

10.3.9.9 NID

This Information Element contains Network identification.

Information Element/Group name	Need	Multi	Type and reference	Semantics description
NID	MP		Bit string (16)	Network identification. The first/leftmost bit of the bit string contains the most significant bit of the NID.

10.3.9.10 P_REV

This Information Element contains protocol revision level.

Information Element/Group name	Need	Multi	Type and reference	Semantics description
P_REV	MP		Bit string (8)	Protocol revision level. The first/leftmost bit of the bit string contains the most significant bit of the P_REV.

10.3.9.11 SID

This Information Element contains System identification.

Information Element/Group name	Need	Multi	Type and reference	Semantics description
SID	MP		Bit string (15)	System identification. The first/leftmost bit of the bit string contains the most significant bit of the SID.

10.3.9a MBMS Information elements

10.3.9a.1 MBMS Common CCTrCH identity

Identifies a Coded Composite Transport channel configuration included within the MBMS COMMON P-T-M RB INFORMATION message.

Information element/Group name	Need	Multi	Type and reference	Semantics description	Version
MBMS Common CCTrCh identity	MP		Integer (1..32)		REL-6

10.3.9a.2 MBMS Common PhyCh identity

Identifies a physical channel configuration included within the MBMS COMMON P-T-M RB INFORMATION message.

Information element/Group name	Need	Multi	Type and reference	Semantics description	Version
MBMS Common PhyCh identity	MP		Integer (1..32)		REL-6

10.3.9a.3 MBMS Common RB identity

Identifies a radio bearer channel configuration included within the MBMS COMMON P-T-M RB INFORMATION message.

Information element/Group name	Need	Multi	Type and reference	Semantics description	Version
MBMS Common RB identity	MP		Integer (1..32)		REL-6

10.3.9a.4 MBMS Common TrCh identity

Identifies a transport channel configuration included within the MBMS COMMON P-T-M RB INFORMATION message.

Information element/Group name	Need	Multi	Type and reference	Semantics description	Version
MBMS Common TrCh identity	MP		Integer (1..32)		REL-6

10.3.9a.5 MBMS Current cell S-CCPCH identity

Identifies one of the current cell's Secondary CCPCH's.

Information element/Group name	Need	Multi	Type and reference	Semantics description	Version
MBMS Current cell S-CCPCH identity	MP		Integer (1..maxSC CPCH)		REL-6

10.3.9a.6 Void

10.3.9a.7 MBMS L1 combining schedule

Includes information about the MBMS L1 combining schedule.

Information element/Group name	Need	Multi	Type and reference	Semantics description	Version
MBMS L1 combining cycle length	MP		Enumerated (32, 64, 128, 256, 512, 1024)	In number of radio frames	REL-6
MBMS L1 combining cycle offset	MD		Integer (0.. MBMS L1 combining cycle length - 4) by step of 4	Start of the L1 combining cycle (relative to the timing of the current cell) in number of radio frames. Default value is no offset	REL-6
MTCH L1- combining period list	MP	1 to < maxMBMS-L1CP>		One or more periods in which L1 combining is performed	REL-6
>Start	MP		Integer (0.. MBMS L1 combining cycle length - 4) by step of 4	Number of frames from the end of the previous combining period or the start of the cycle (for the first period)	REL-6
>Duration	MP		Integer (4.. MBMS L1 combining cycle length) by step of 4	Number of frames (see note)	REL-6

NOTE: The MTCH L1- combining period should indicate one or more complete TTIs.

10.3.9a.7o MBMS p-t-m activation time

Information Element/Group name	Need	Multi	Type and reference	Semantics description	Version
MBMS p-t-m activation time	MP		Integer (0..2047)	The 11 LSB of the SFN. Note 1 and 2.	REL-6
Note 1:	The "MBMS p-t-m activation time" indicates the start of the 10 ms frame corresponding to the indicated SFN value and of the primary CCPCH of the cell where this IE is transmitted.				
Note 2:	The range of the "MBMS p-t-m activation time" is from 10 ms after the beginning of the MCCH modification period wherein it is transmitted and to the end of next following MCCH modification period. The UE shall consider a value out of this range as expired.				

10.3.9a.7a MBMS p-t-m RB information

Includes information about an MBMS p-t-m radio bearers mapped on a TrCH.

Information element/Group name	Need	Multi	Type and reference	Semantics description	Version
RB information	<i>CV-Curr</i>		MBMS Common RB identity 10.3.9a.3		REL-6
MBMS short transmission ID	MP		MBMS Short transmission identity 10.3.9a.10		REL-6
MBMS logical channel identity	MP		Integer (1..15)	This identifier is used to distinguish different MTCH mapped on to a TrCh ("MBMS-Id" within the MAC header[15])	REL-6
L1 combining status	<i>CV-Neigh</i>		Boolean	The IE is only applicable in case of partial L1 combining, in which case value TRUE means that L1 combining is used for this radio bearer	REL-6

Condition	Explanation
<i>Curr</i>	The IE is mandatory present if the IE "MBMS p-t-m RB information list" is included in the MBMS CURRENT CELL P-T-M RB INFORMATION message and not needed otherwise
<i>Neigh</i>	The IE is mandatory present if the IE "MBMS p-t-m RB information list" is included in the MBMS NEIGHBOURING CELL P-T-M RB INFORMATION message and not needed otherwise

10.3.9a.7b MBMS Selected Service Info

This IE indicates whether the UE has any MBMS Selected Services, and if it does it includes the list of MBMS Selected Services.

Information element/Group name	Need	Multi	Type and reference	Semantics description	Version
CHOICE <i>Status</i>					
>None				(no data)	
>Some	MP		MBMS Selected Services Full 10.3.9a.7c		REL-6

10.3.9a.7c MBMS Selected Services Full

This IE provides the MBMS Selected Services by means of the full identity.

Information element/Group name	Need	Multi	Type and reference	Semantics description	Version
MBMS Selected Services	MP	1 to <maxMBMSservSelect>			REL-6
>MBMS Selected Service ID	MP		MBMS service identity 10.3.9a.8		REL-6

10.3.9a.7d MBMS Selected Services Short

This IE indicates the MBMS Selected Services by means of a short identity to identify the MBMS transmission by referencing the services included in the MBMS MODIFIED SERVICES INFORMATION and the MBMS UNMODIFIED SERVICES INFORMATION messages.

Information element/Group name	Need	Multi	Type and reference	Semantics description	Version
MBMS Selected Services	MP	1 to <maxMBMSservSelect>			REL-6
>MBMS Selected Service ID	MP		MBMS Short transmission identity 10.3.9a.10		REL-6
Modification period identity	MP		Integer (0..1)	Indicates the modification period the MBMS short transmission identities refer to	REL-6

10.3.9a.8 MBMS Service identity

Includes information about the identity of an MBMS service.

Information element/Group name	Need	Multi	Type and reference	Semantics description	Version
MBMS Service ID	MP		MBMS Service ID 10.3.9a.8a		REL-6
CHOICE <i>PLMN identity</i>	MP				REL-6
> <i>SameAsMIB</i>				(No data) The PLMN identity is the same as indicated by the IE "PLMN identity" in MIB	REL-6
> <i>SameAsMIB-MultiPLMN-Id</i>					REL-6
>>Multi PLMN id	MP		Integer (1..5)	The PLMN identity is one of the PLMN identities (1 to 5) in the IE "Multiple PLMN List" in MIB	REL-6
> <i>ExplicitPLMN-Id</i>					REL-6
>>PLMN identity	MP		PLMN identity 10.3.1.11		REL-6

10.3.9a.8a MBMS Service ID

Uniquely identifies an MBMS bearer service within a PLMN.

Information element/Group name	Need	Multi	Type and reference	Semantics description	Version
MBMS Service ID	MP		Octet string (3)	The content of the MBMS Service ID field is coded as octets 3 to 5 of the IE <i>Temporary Mobile Group Identity</i> [5]	REL-6

10.3.9a.9 MBMS Session identity

Includes information about the the identity of a session of an MBMS service.

Information element/Group name	Need	Multi	Type and reference	Semantics description	Version
MBMS Session ID	MP		Octet string (1)		REL-6

10.3.9a.10 MBMS Short transmission identity

Includes a short identity of the MBMS transmission identity, which concerns a session of a specific service.

Information element/Group name	Need	Multi	Type and reference	Semantics description	Version
MBMS short transmission identity	MP		Integer (1..maxMBMSservUnmodif)	Reference/ index to a transmission listed in the MBMS MODIFIED SERVICES INFORMATION or MBMS UNMODIFIED SERVICES INFORMATION	REL-6

10.3.9a.10a MBMS Soft Combining Timing Offset

Indicates the timing offset applied in the CFN calculation in sub-clause 8.5.15.5 for a secondary CCPCH carrying only MBMS logical channels. It is used for FDD only.

Information Element/Group name	Need	Multi	Type and reference	Semantics description	Version
>MBMS Soft Combining Timing Offset	MP		Integer (0, 10, 20, 40)	Timing offset applied in the CFN calculation in sub-clause 8.5.15.5, in ms.	REL-6

10.3.9a.11 MBMS specific timers and counters

Includes MBMS specific timers and counters.

Information element/Group name	Need	Multi	Type and reference	Semantics description	Version
T318	MD		Integer(25 0... 2000 by step of 250, 3000, 4000, 6000, 8000, 10000, 12000, 16000)	Value in milliseconds. Default value is 1000.	REL-6

10.3.9a.12 MBMS Transmission identity

Includes information about the MBMS transmission identity, which concerns a session of a specific service.

Information element/Group name	Need	Multi	Type and reference	Semantics description	Version
MBMS Service ID	MP		MBMS Service identity 10.3.9a.8		REL-6
MBMS Session ID	OP		MBMS Session identity 10.3.9a.9		REL-6

10.3.9a.12a MBSFN frequency list

Information Element/Group name	Need	Multi	Type and reference	Semantics description	Version
MBSFN frequency list	MP	0 to <maxMBSFNclusters>			REL-7
>MBSFN frequency	MP		Frequency info 10.3.6.36		REL-7
>Cell parameter ID	OP	<0..127>	Cell parameter Id 10.3.6.9	Only for 1.28 Mcps TDD [32]. NOTE 1	REL-7

NOTE 1: For 1.28 Mcps TDD the IE "Cell Parameter ID" indicates the cell which is providing MBMS service in MBSFN only mode on the corresponding frequency; if it is not included, the IE "MBSFN frequency" indicates the secondary frequency providing MBMS service in non-MBSFN only mode of current multi-frequency cell.

10.3.9a.12b MBSFN TDM Information List

Information element/Group name	Need	Multi	Type and reference	Semantics description	Version
MBSFN TDM Information List	MP	1 to <maxM BMSservUnmodified>			REL-7
>MBMS short transmission ID	MP		MBMS Short transmission identity 10.3.9a.10		REL-7
>TDM_Rep	MP		Integer (2..9)		REL-7
>TDM_Offset	MP		Integer (0..8)		REL-7
>TDM_Length	MP		Integer (1..8)		REL-7

10.3.9a.13 MCCH configuration information

Includes information about the MCCH configuration.

Information element/Group name	Need	Multi	Type and reference	Semantics description	Version
Access Info Period coefficient	MP		Integer (0..3)	Represents a , the access information coefficient. The number of repetitions per modification period equals 2^a while the actual access information period, in number of frames, equals $MP \text{ DIV } 2^a$	REL-6
Repetition Period coefficient	MP		Integer (0..3)	Represents r , the repetition period coefficient. The number of repetitions per modification period equals 2^r while the actual repetition period, in number of frames, equals $MP \text{ DIV } 2^r$	REL-6
Modification period coefficient	MP		Integer (7..10)	Represents m , the modification period coefficient. The actual modification period (MP), in number of frames, equals 2^m	REL-6
RLC info	MP		RLC info MBMS 10.3.4.23a		REL-6
TCTF presence	CV-MBMS		Enumerated (false)	By default the TCTF is present even though the FACH only carries one logical channel (type). When this IE is included, the TCTF is absent	REL-6

Condition	Explanation
MBMS	This IE is not needed if the IE is contained within the IE "Secondary CCPCH system information", otherwise the IE is optional.

10.3.9a.14 MICH configuration information

Includes information about the MICH configuration.

Information element/Group name	Need	Multi	Type and reference	Semantics description	Version
MICH Power offset	MP		MICH Power offset 10.3.9a.15		REL-6
CHOICE <i>mode</i>	MP				REL-6
>FDD					REL-6
>>Channelisation code	MP		Integer (0..255)		REL-6
>>Number of NI per frame	MP		Integer (18, 36, 72, 144)		REL-6
>>STTD indicator	MP		STTD Indicator 10.3.6.78		REL-6
>TDD					REL-6
>>Timeslot number	MP		Timeslot number 10.3.6.84		REL-6
>>Midamble shift and burst type	MP		Midamble shift and burst type 10.3.6.41	For 1.28 Mcps TDD, if the cell is operating in MBSFN mode, the UE shall ignore the contents of this IE.	REL-6
>>CHOICE <i>TDD option</i>	MP				REL-6
>>>3.84 Mcps TDD					REL-6
>>>>Channelisation code	MP		Enumerated (16/1)...(16/16)		REL-6
>>>>7.68 Mcps TDD					REL-7
>>>>Channelisation code	MP		Enumerated (32/1)...(32/32)		REL-7
>>>>1.28 Mcps TDD					REL-6
>>>>Codes list	MP	1 to 2			REL-6
>>>>>Channelisation code	MP		Enumerated (16/1)...(16/16)		REL-6
>>>>> MBSFN Special Time Slot	OP		Time Slot LCR Extension 10.3.6.83a	For 1.28 Mcps TDD MBSFN only mode, this IE indicates the SCCPCH is deployed on the MBSFN Special Time Slot [30]. The IE 'Timeslot number' shall be ignored if this IE appears.	REL-7
>>Repetition period/length	MD		Enumerated (4/2),(8/2), (8/4),(16/2), (16/4), (32/2),(32/	Default value is "(64/2)".	REL-6

			4),(64/2),(64/4))		
>>Offset	MP		Integer (0...Repetition period - 1)	SFN mod Repetitionperiod = Offset.	REL-6
>>MBMS Notification indicator length	MD		Integer (4, 8, 16)	Indicates the length of one MBMS Notification indicator in bits. Default value is 4.	REL-6

10.3.9a.15 MICH Power offset

This is the power transmitted on the MICH minus power of the Primary CPICH in FDD and Primary CCPCH Tx Power in TDD.

Information Element/Group name	Need	Multi	Type and reference	Semantics description	Version
MICH Power offset	MP		Integer(-10 .. +5)	Offset in dB	REL-6

10.3.9a.16 MSCH configuration information

Includes information about the MSCH configuration.

Information element/Group name	Need	Multi	Type and reference	Semantics description	Version
MSCH Scheduling information	MP			For FDD, scheduling information is provided starting at (SFN – (SCTO div 10ms)) mod MSCH_REP = MSCH_OFF For TDD, scheduling information is provided starting at SFN mod MSCH_REP = MSCH_OFF	REL-6
>Scheduling period	MD		Enumerated (32, 64, 128, 256, 512, 1024)	The period, in number of frames, between MBMS scheduling messages (MSCH_REP) Default value is the value included in the MBMS GENERAL INFORMATION message	REL-6
>Scheduling offset	MD		Integer (0..(MSCH_REP-1))	The position of MBMS scheduling messages relative to timing of the corresponding cell (MSCH_OFF) Default value is the value included in the MBMS GENERAL INFORMATION message	REL-6
>RLC info	MD		RLC info MBMS 10.3.4.23a	Default value is the one included in the MBMS GENERAL INFORMATION message	REL-6
TCTF presence	OP		Enumerated (false)	By default the TCTF is present even though the FACH only carries one logical channel (type). When this IE is included, the TCTF is absent	REL-6

10.3.10 Multiplicity values and type constraint values

The following table includes constants that are either used as multi bounds (name starting with "max") or as high or low value in a type specification (name starting with "lo" or "hi"). Constants are specified only for values appearing more than once in the RRC specification. In case a constant is related to one or more other constants, an expression is included in the "value" column instead of the actual value.

Constant	Explanation	Value	Version
CN information			
maxCNdomains	Maximum number of CN domains	4	
UTRAN mobility information			
maxRAT	Maximum number of Radio Access Technologies	maxOtherRAT + 1	
maxOtherRAT	Maximum number of other Radio Access Technologies	15	

Constant	Explanation	Value	Version
maxURA	Maximum number of URAs in a cell	8	
maxInterSysMessages	Maximum number of Inter System Messages	4	
maxRABsetup	Maximum number of RABs to be established	16	
UE information			
maxtransactions	Maximum number of parallel RRC transactions in downlink	25	
maxPDCPalgoType	Maximum number of PDCP algorithm types	8	
maxFreqBandsFDD	Maximum number of frequency bands supported by the UE as defined in [21]	8	
maxFreqBandsFDD-ext	Maximum number of frequency bands as defined in [21] and treated by RRC	22	REL-6
maxFreqBandsTDD	Maximum number of frequency bands supported by the UE as defined in [22]	4	
maxFreqBandsGSM	Maximum number of frequency bands supported by the UE as defined in [45]	16	
maxPage1	Number of UEs paged in the Paging Type 1 message	8	
maxSystemCapability	Maximum number of system specific capabilities that can be requested in one message.	16	
MaxURNTIgroup	Maximum number of U-RNTI groups in one message	8	REL-5
maxCommonHRNTI	Maximum number of common H-RNTI per cell	4	REL-7
RB information			
maxPredefConfig	Maximum number of predefined configurations	16	
maxRB	Maximum number of RBs	32	
maxSRBsetup	Maximum number of signalling RBs to be established	8	
maxRBperRAB	Maximum number of RBs per RAB	8	
maxRBallRBs	Maximum number of non signalling RBs	27	
maxRBperTrCh	Maximum number of RB per TrCh	16	REL-6
maxRBMuxOptions	Maximum number of RB multiplexing options	8	
maxLoChperRLC	Maximum number of logical channels per RLC entity	2	
maxRLCPDUsizePerLogChan	Maximum number of RLC PDU sizes per logical channel mapped on E-DCH	32	REL-6
MaxROHC-PacketSizes	Maximum number of packet sizes that are allowed to be produced by ROHC.	16	
MaxROHC-Profiles	Maximum number of profiles supported by ROHC on a given RB.	8	
maxRFC 3095-CID	Maximum number of available CID values per radio bearer	16384	REL-5
TrCH information			
maxCommonQueueID	Maximum number of common Mac-ehs queues	2	REL-7
maxE-DCHMACdFlow	Maximum number of E-DCH MAC-d flows	8	REL-6
MaxHProcesses	Maximum number of H-ARQ processes	8	REL-5
MaxHSDSCH_TB_index	Maximum number of TB set size configurations for the HS-DSCH.	64 (FDD and 1.28 MCPS TDD); 512 (3.84 Mcps TDD); 1024 (7.68 Mcps TDD)	REL-5
maxMACdPDUSizes	Maximum number of MAC-d PDU sizes per queue permitted for MAC-hs	8	REL-5
maxTrCH	Maximum number of transport channels used in one direction (UL or DL)	32	
maxTrCHpreconf	Maximum number of preconfigured Transport channels, per direction	16	
maxCCTrCH	Maximum number of CCTrCHs	8	
maxQueueID	Maximum number of Mac-hs queues	8	REL-5
MaxTF	Maximum number of different transport formats that can be included in the Transport format set for one transport channel	32	
maxTFC	Maximum number of Transport Format Combinations	1024	

Constant	Explanation	Value	Version
maxTFCsub	Maximum number of Transport Format Combinations Subset	1024	
maxSIBperMsg	Maximum number of complete system information blocks per SYSTEM INFORMATION message	16	
maxSIB	Maximum number of references to other system information blocks.	32	
maxSIB-FACH	Maximum number of references to system information blocks on the FACH	8	
PhyCH information			
maxHSSCCHs	Maximum number of HSSCCH codes that can be assigned to a UE	4	REL-5
maxHS-SCCHLessTrBlk	Maximum number of HS-DSCH Transport Block Sizes used for HS-SCCH-less operation	[4]	REL-7
maxTDD128Carrier	The maximum number of carriers for 1.28 Mcps TDD	6	REL-7
maxAC	Maximum number of access classes	16	
maxASC	Maximum number of access service classes	8	
maxASCmap	Maximum number of access class to access service classes mappings	7	
maxASCpersist	Maximum number of access service classes for which persistence scaling factors are specified	6	
maxPRACH	Maximum number of PRACHs in a cell	16	
MaxPRACH_FPACH	Maximum number of PRACH / FPACH pairs in a cell (1.28 Mcps TDD)	8	REL-4
maxFACHPCH	Maximum number of FACHs and PCHs mapped onto one secondary CCPCHs	8	
maxRL	Maximum number of radio links	8	
maxEDCHRL	Maximum number of E-DCH radio links	4	REL-6
maxSCCPCH	Maximum number of secondary CCPCHs per cell	16	
maxDPDCH-UL	Maximum number of DPDCHs per cell	6	
maxDPCH-DLchan	Maximum number of channelisation codes used for DL DPCH	8	
maxPUSCH	Maximum number of PUSCHs	(8)	
maxPDSCH	Maximum number of PDSCHs	8	
maxTS	Maximum number of timeslots used in one direction (UL or DL)	14 (3.84 Mcps TDD and 7.68 Mcps TDD) 6 (1.28 Mcps TDD)	REL-4
hiPUSCHidentities	Maximum number of PUSCH Identities	64	
hiPDSCHidentities	Maximum number of PDSCH Identities	64	
maxNumE-AGCH	Maximum number of E-AGCHs (TDD)	4	REL-7
maxNumE-HICH	Maximum number of E-HICHs (1.28 Mcps TDD)	4	REL-7
Measurement information			
maxTGPS	Maximum number of transmission gap pattern sequences	6	
maxAdditionalMeas	Maximum number of additional measurements for a given measurement identity	4	
maxMeasEvent	Maximum number of events that can be listed in measurement reporting criteria	8	
maxMeasParEvent	Maximum number of measurement parameters (e.g. thresholds) per event	2	
maxMeasIntervals	Maximum number of intervals that define the mapping function between the measurements for the cell quality Q of a cell and the representing quality value	1	
maxCellMeas	Maximum number of cells to measure	32	
maxReportedGSMCells	Maximum number of GSM cells to be reported	8	
maxFreq	Maximum number of frequencies to measure	8	
maxSat	Maximum number of satellites to measure	16	

Constant	Explanation	Value	Version
maxGANSSSat	Maximum number of GANSS satellites to measure	64	REL-7
maxGANSS	Maximum number of GANSS supported	8	REL-7
maxSgnType	Maximum number of additional signals in GANSS to measure	8	REL-7
maxSatClockModels	Maximum number of clock models in a GANSS	4	REL-7
maxSatAlmanacStorage	Maximum number of satellites for which to store GPS Almanac information	32	
HiRM	Maximum number that could be set as rate matching attribute for a transport channel	256	
Frequency information			
MaxFDDFreqList	Maximum number of FDD carrier frequencies to be stored in USIM	4	
MaxTDDFreqList	Maximum number of TDD carrier frequencies to be stored in USIM	4	
MaxFDDFreqCellList	Maximum number of neighbouring FDD cells to be stored in USIM	32	
MaxTDDFreqCellList	Maximum number of neighbouring TDD cells to be stored in USIM	32	
MaxGSMCellList	Maximum number of GSM cells to be stored in USIM	32	
Other information			
MaxGERANSI	Maximum number of GERAN SI blocks that can be provided as part of NACC information	8	REL-5
maxNumGSMFreqRanges	Maximum number of GSM Frequency Ranges to store	32	
MaxNumFDDFreqs	Maximum number of FDD centre frequencies to store	8	
MaxNumTDDFreqs	Maximum number of TDD centre frequencies to store	8	
maxNumCDMA200Freqs	Maximum number of CDMA2000 centre frequencies to store	8	

Constant	Explanation	Value	Version
maxGSMTargetCells	Maximum number of GSM target cells	32	REL-6
MBMS information			
maxMBMS-CommonCCTrCh	Maximum number of CCTrCh configurations included in the MBMS COMMON P-T-M RB INFORMATION message	32	REL-6
maxMBMS-CommonPhyCh	Maximum number of PhyCh configurations included in the MBMS COMMON P-T-M RB INFORMATION message	32	REL-6
maxMBMS-CommonRB	Maximum number of RB configurations included in the MBMS COMMON P-T-M RB INFORMATION message	32	REL-6
maxMBMS-CommonTrCh	Maximum number of TrCh configurations included in the MBMS COMMON P-T-M RB INFORMATION message	32	REL-6
maxMBMS-Freq	Maximum number of MBMS preferred frequencies	4	REL-6
maxMBMS-L1CP	Maximum number of periods in which layer 1 combining applies	4	REL-6
maxMBMSservCount	Maximum number of MBMS services in a Access Info message	8	REL-6
maxMBMSservModif	Maximum number of MBMS services in a MBMS MODIFIED SERVICES INFORMATION message	32	REL-6
maxMBMSservSched	Maximum number of MBMS services in a MBMS SCHEDULING INFORMATION message	16	REL-6
maxMBMSservSelect	Maximum number of MBMS Selected Services in a CELL UPDATE or RRC CONNECTION REQUEST message	8	REL-6
maxMBMSservUnmodif	Maximum number of MBMS services in a MBMS UNMODIFIED SERVICES INFORMATION message	64	REL-6
maxMBMSTransmis	Maximum number of transmissions for which scheduling information is provided within a scheduling period	4	REL-6
maxMBMS-Services	Maximum number of MBMS services the UE stores in the variable MBMS_ACTIVATED_SERVICES	64	REL-6
maxMBSFNclusters	Maximum number of MBSFN clusters indicated in system information	16	REL-7

11 Message and Information element abstract syntax (with ASN.1)

This clause contains definitions for RRC PDUs and IEs using a subset of ASN.1 as specified in [14]. PDU and IE definitions are grouped into separate ASN.1 modules.

11.0 General

Some messages and/or IEs may include one or more IEs with name "dummy" that are included only in the ASN.1. The UE should avoid sending information elements that are named "dummy" to UTRAN. Likewise, UTRAN should avoid sending IEs with name "dummy" to the UE. If the UE anyhow receives an information element named "dummy", it shall ignore the IE and process the rest of the message as if the IE was not included.

NOTE: An IE with name "dummy" concerns an information element that was (erroneously) included in a previous version of the specification and has been removed by replacing it with a dummy with same type.

The UE shall only include the "variable length extension container" when it sends a non critical extension that according to this specification shall be transferred within this container.

If the abstract syntax of an IE is defined using the ASN.1 type "BIT STRING", and this IE corresponds to a functional IE definition in tabular format, in which the significance of bits is semantically defined, the following general rule shall be applied:

The bits in the ASN.1 bit string shall represent the semantics of the functional IE definition in decreasing order of bit significance;

- with the first (or leftmost) bit in the bit string representing the most significant bit; and
- with the last (or rightmost) bit in the bit string representing the least significant bit.

11.1 General message structure

```
Class-definitions DEFINITIONS AUTOMATIC TAGS ::=
```

```
BEGIN
```

```
IMPORTS
```

```

ActiveSetUpdate,
ActiveSetUpdateComplete,
ActiveSetUpdateFailure,
AssistanceDataDelivery,
CellChangeOrderFromUTRAN,
CellChangeOrderFromUTRANFailure,
CellUpdate,
CellUpdateConfirm-CCCH,
CellUpdateConfirm,
CounterCheck,
CounterCheckResponse,
DownlinkDirectTransfer,
HandoverToUTRANComplete,
InitialDirectTransfer,
HandoverFromUTRANCommand-GERANIu,
HandoverFromUTRANCommand-GSM,
HandoverFromUTRANCommand-CDMA2000,
HandoverFromUTRANFailure,
MBMSAccessInformation,
MBMSCommonPTMRBInformation,
MBMSCurrentCellPTMRBInformation,
MBMSGeneralInformation,
MBMSModificationRequest,
MBMSModifiedServicesInformation,
MBMSNeighbouringCellPTMRBInformation,
MBMSSchedulingInformation,
MBMSUnmodifiedServicesInformation,
MeasurementControl,
MeasurementControlFailure,
MeasurementReport,
PagingType1,
PagingType2,
PhysicalChannelReconfiguration,
PhysicalChannelReconfigurationComplete,
PhysicalChannelReconfigurationFailure,
PhysicalSharedChannelAllocation,
PUSCHCapacityRequest,
RadioBearerReconfiguration,
RadioBearerReconfigurationComplete,
RadioBearerReconfigurationFailure,
RadioBearerRelease,
RadioBearerReleaseComplete,
RadioBearerReleaseFailure,
RadioBearerSetup,
RadioBearerSetupComplete,
RadioBearerSetupFailure,
RRCConnectionReject,
RRCConnectionRelease,
RRCConnectionRelease-CCCH,
RRCConnectionReleaseComplete,
RRCConnectionRequest,
RRCConnectionSetup,
RRCConnectionSetupComplete,
RRCStatus,
SecurityModeCommand,

```



```

SecurityModeComplete,
SecurityModeFailure,
SignallingConnectionRelease,
SignallingConnectionReleaseIndication,
SystemInformation-BCH,
SystemInformation-FACH,
SystemInformationChangeIndication,
TransportChannelReconfiguration,
TransportChannelReconfigurationComplete,
TransportChannelReconfigurationFailure,
TransportFormatCombinationControl,
TransportFormatCombinationControlFailure,
UECapabilityEnquiry,
UECapabilityInformation,
UECapabilityInformationConfirm,
UplinkDirectTransfer,
UplinkPhysicalChannelControl,
URAUUpdate,
URAUUpdateConfirm,
URAUUpdateConfirm-CCCH,
UTRANMobilityInformation,
UTRANMobilityInformationConfirm,
UTRANMobilityInformationFailure
FROM PDU-definitions

-- User Equipment IEs :
    IntegrityCheckInfo
FROM InformationElements;

--*****
--
-- Downlink DCCH messages
--
--*****

DL-DCCH-Message ::= SEQUENCE {
    integrityCheckInfo      IntegrityCheckInfo      OPTIONAL,
    message                  DL-DCCH-MessageType
}

DL-DCCH-MessageType ::= CHOICE {
    activeSetUpdate                ActiveSetUpdate,
    assistanceDataDelivery         AssistanceDataDelivery,
    cellChangeOrderFromUTRAN      CellChangeOrderFromUTRAN,
    cellUpdateConfirm              CellUpdateConfirm,
    counterCheck                   CounterCheck,
    downlinkDirectTransfer         DownlinkDirectTransfer,
    handoverFromUTRANCommand-GSM   HandoverFromUTRANCommand-GSM,
    handoverFromUTRANCommand-CDMA2000 HandoverFromUTRANCommand-CDMA2000,
    measurementControl             MeasurementControl,
    pagingType2                    PagingType2,
    physicalChannelReconfiguration PhysicalChannelReconfiguration,
    physicalSharedChannelAllocation PhysicalSharedChannelAllocation,
    radioBearerReconfiguration     RadioBearerReconfiguration,
    radioBearerRelease             RadioBearerRelease,
    radioBearerSetup               RadioBearerSetup,
    rrcConnectionRelease           RRCConnectionRelease,
    securityModeCommand            SecurityModeCommand,
    signallingConnectionRelease    SignallingConnectionRelease,
    transportChannelReconfiguration TransportChannelReconfiguration,
    transportFormatCombinationControl TransportFormatCombinationControl,
    ueCapabilityEnquiry            UECapabilityEnquiry,
    ueCapabilityInformationConfirm  UECapabilityInformationConfirm,
    uplinkPhysicalChannelControl   UplinkPhysicalChannelControl,
    uraUpdateConfirm               URAUpdateConfirm,
    utranMobilityInformation        UTRANMobilityInformation,
    handoverFromUTRANCommand-GERANIu HandoverFromUTRANCommand-GERANIu,
    mbmsModifiedServicesInformation MBMSModifiedServicesInformation,
    spare5                          NULL,
    spare4                          NULL,
    spare3                          NULL,
    spare2                          NULL,
    spare1                          NULL
}

--*****
--
-- Uplink DCCH messages

```

```

--
--*****
UL-DCCH-Message ::= SEQUENCE {
    integrityCheckInfo    IntegrityCheckInfo    OPTIONAL,
    message                UL-DCCH-MessageType
}

UL-DCCH-MessageType ::= CHOICE {
    activeSetUpdateComplete           ActiveSetUpdateComplete,
    activeSetUpdateFailure            ActiveSetUpdateFailure,
    cellChangeOrderFromUTRANFailure  CellChangeOrderFromUTRANFailure,
    counterCheckResponse              CounterCheckResponse,
    handoverToUTRANComplete           HandoverToUTRANComplete,
    initialDirectTransfer              InitialDirectTransfer,
    handoverFromUTRANFailure           HandoverFromUTRANFailure,
    measurementControlFailure         MeasurementControlFailure,
    measurementReport                 MeasurementReport,
    physicalChannelReconfigurationComplete PhysicalChannelReconfigurationComplete,
    physicalChannelReconfigurationFailure PhysicalChannelReconfigurationFailure,
    radioBearerReconfigurationComplete RadioBearerReconfigurationComplete,
    radioBearerReconfigurationFailure RadioBearerReconfigurationFailure,
    radioBearerReleaseComplete        RadioBearerReleaseComplete,
    radioBearerReleaseFailure         RadioBearerReleaseFailure,
    radioBearerSetupComplete          RadioBearerSetupComplete,
    radioBearerSetupFailure           RadioBearerSetupFailure,
    rrcConnectionReleaseComplete      RRCConnectionReleaseComplete,
    rrcConnectionSetupComplete        RRCConnectionSetupComplete,
    rrcStatus                          RRCStatus,
    securityModeComplete              SecurityModeComplete,
    securityModeFailure                SecurityModeFailure,
    signallingConnectionReleaseIndication SignallingConnectionReleaseIndication,
    transportChannelReconfigurationComplete TransportChannelReconfigurationComplete,
    transportChannelReconfigurationFailure TransportChannelReconfigurationFailure,
    transportFormatCombinationControlFailure TransportFormatCombinationControlFailure,
    ueCapabilityInformation            UECapabilityInformation,
    uplinkDirectTransfer                UplinkDirectTransfer,
    utranMobilityInformationConfirm     UTRANMobilityInformationConfirm,
    utranMobilityInformationFailure     UTRANMobilityInformationFailure,
    mbmsModificationRequest            MBMSModificationRequest,
    spare1                              NULL
}

--*****
--
-- Downlink CCCH messages
--
--*****

DL-CCCH-Message ::= SEQUENCE {
    integrityCheckInfo    IntegrityCheckInfo    OPTIONAL,
    message                DL-CCCH-MessageType
}

DL-CCCH-MessageType ::= CHOICE {
    cellUpdateConfirm           CellUpdateConfirm-CCCH,
    rrcConnectionReject         RRCConnectionReject,
    rrcConnectionRelease        RRCConnectionRelease-CCCH,
    rrcConnectionSetup          RRCConnectionSetup,
    uraUpdateConfirm            URAUpdateConfirm-CCCH,
    spare3                       NULL,
    spare2                       NULL,
    spare1                       NULL
}

--*****
--
-- Uplink CCCH messages
--
--*****

UL-CCCH-Message ::= SEQUENCE {

```

```

    integrityCheckInfo      IntegrityCheckInfo      OPTIONAL,
    message                  UL-CCCH-MessageType
}

UL-CCCH-MessageType ::= CHOICE {
    cellUpdate              CellUpdate,
    rrcConnectionRequest   RRCConnectionRequest,
    uraUpdate                URAUpdate,
    spare                    NULL,
}

--*****
--
-- PCCH messages
--
--*****

PCCH-Message ::= SEQUENCE {
    message                  PCCH-MessageType
}

PCCH-MessageType ::= CHOICE {
    pagingType1             PagingType1,
    spare                    NULL,
}

--*****
--
-- Downlink SHCCH messages
--
--*****

DL-SHCCH-Message ::= SEQUENCE {
    message                  DL-SHCCH-MessageType
}

DL-SHCCH-MessageType ::= CHOICE {
    physicalSharedChannelAllocation PhysicalSharedChannelAllocation,
    spare                    NULL,
}

--*****
--
-- Uplink SHCCH messages
--
--*****

UL-SHCCH-Message ::= SEQUENCE {
    message                  UL-SHCCH-MessageType
}

UL-SHCCH-MessageType ::= CHOICE {
    puschCapacityRequest    PUSCHCapacityRequest,
    spare                    NULL,
}

--*****
--
-- BCCH messages sent on FACH
--
--*****

BCCH-FACH-Message ::= SEQUENCE {
    message                  BCCH-FACH-MessageType
}

BCCH-FACH-MessageType ::= CHOICE {
    systemInformation        SystemInformation-FACH,
    systemInformationChangeIndication SystemInformationChangeIndication,
    spare2                   NULL,
    spare1                   NULL,
}

--*****
--
-- BCCH messages sent on BCH
--

```

```

--*****
BCH-BCH-Message ::= SEQUENCE {
    message          SystemInformation-BCH
}

--*****
--
-- MCCH messages
--
--*****

MCCH-Message ::= SEQUENCE {
    message          MCCH-MessageType
}

MCCH-MessageType ::= CHOICE {
    mbmsAccessInformation          MBMSAccessInformation,
    mbmsCommonPTMRBInformation    MBMSCommonPTMRBInformation,
    mbmsCurrentCellPTMRBInformation MBMSCurrentCellPTMRBInformation,
    mbmsGeneralInformation        MBMSGeneralInformation,
    mbmsModifiedServicesInformation MBMSModifiedServicesInformation,
    mbmsNeighbouringCellPTMRBInformation MBMSNeighbouringCellPTMRBInformation,
    mbmsUnmodifiedServicesInformation MBMSUnmodifiedServicesInformation,
    spare9                         NULL,
    spare8                         NULL,
    spare7                         NULL,
    spare6                         NULL,
    spare5                         NULL,
    spare4                         NULL,
    spare3                         NULL,
    spare2                         NULL,
    spare1                         NULL
}

--*****
--
-- MSCH messages
--
--*****

MSCH-Message ::= SEQUENCE {
    message          MSCH-MessageType
}

MSCH-MessageType ::= CHOICE {
    mbmsSchedulingInformation    MBMS SchedulingInformation,
    spare3                       NULL,
    spare2                       NULL,
    spare1                       NULL
}

END

```

11.2 PDU definitions

```

--*****
--
-- TABULAR: The message type and integrity check info are not
-- visible in this module as they are defined in the class module.
-- Also, all FDD/TDD specific choices have the FDD option first
-- and TDD second, just for consistency.
--
--*****

PDU-definitions DEFINITIONS AUTOMATIC TAGS ::=

BEGIN

--*****
--
-- IE parameter types from other modules
--
--*****

IMPORTS

```

```
-- Core Network IEs :
  CN-DomainIdentity,
  CN-InformationInfo,
  CN-InformationInfo-r6,
  CN-InformationInfoFull,
  NAS-Message,
  PagingRecordTypeID,
  PLMN-Identity,
-- UTRAN Mobility IEs :
  CellIdentity,
  CellIdentity-PerRL-List,
  URA-Identity,
-- User Equipment IEs :
  AccessStratumReleaseIndicator,
  ActivationTime,
  C-RNTI,
  CapabilityUpdateRequirement,
  CapabilityUpdateRequirement-r4,
  CapabilityUpdateRequirement-r4-ext,
  CapabilityUpdateRequirement-r5,
  CapabilityUpdateRequirement-v770ext,
  CapabilityUpdateRequirement-r7,
  CellUpdateCause,
  CellUpdateCause-ext,
  CipheringAlgorithm,
  CipheringAlgorithm-r7,
  CipheringModeInfo,
  CipheringModeInfo-r7,
  DelayRestrictionFlag,
  DL-PhysChCapabilityFDD-v380ext,
  DSCH-RNTI,
  E-RNTI,
  EstablishmentCause,
  FailureCauseWithProtErr,
  FailureCauseWithProtErrTrId,
  GroupReleaseInformation,
  H-RNTI,
  High-MobilityDetected,
  InitialUE-Identity,
  IntegrityProtActivationInfo,
  IntegrityProtectionModeInfo,
  IntegrityProtectionModeInfo-r7,
  N-308,
  PagingCause,
  PagingRecordList,
  PagingRecord2List-r5,
  PDCP-Capability-v770ext,
  Pre-RedirectionInfo,
  ProtocolErrorIndicator,
  ProtocolErrorIndicatorWithMoreInfo,
  RadioFrequencyBandTDDList,
  Rb-timer-indicator,
  RedirectionInfo,
  RedirectionInfo-r6,
  RejectionCause,
  ReleaseCause,
  RF-CapabilityComp,
  RRC-StateIndicator,
  RRC-TransactionIdentifier,
  SecurityCapability,
  START-Value,
  STARTList,
  SystemSpecificCapUpdateReq-v590ext,
  U-RNTI,
  U-RNTI-Short,
  UESpecificBehaviourInformation1idle,
  UESpecificBehaviourInformation1interRAT,
  UE-CapabilityContainer-IEs,
  UE-ConnTimersAndConstants,
  UE-ConnTimersAndConstants-v3a0ext,
  UE-ConnTimersAndConstants-r5,
  UE-HSPA-Identities-r6,
  UE-RadioAccessCapabBandFDDList2,
  UE-RadioAccessCapabBandFDDList-ext,
  UE-RadioAccessCapability,
  UE-RadioAccessCapability-v370ext,
  UE-RadioAccessCapability-v380ext,
```

```
UE-RadioAccessCapability-v3a0ext,
UE-RadioAccessCapability-v3g0ext,
UE-RadioAccessCapability-v4b0ext,
UE-RadioAccessCapability-v590ext,
UE-RadioAccessCapability-v5c0ext,
UE-RadioAccessCapability-v650ext,
UE-RadioAccessCapability-v680ext,
UE-RadioAccessCapability-v7e0ext,
UE-RadioAccessCapability-v7f0ext,
UE-RadioAccessCapabilityComp,
UE-RadioAccessCapabilityComp-ext,
UE-RadioAccessCapabilityComp-v770ext,
UE-RadioAccessCapabilityComp2,
UE-RadioAccessCapabilityComp2-v770ext,
UE-RadioAccessCapabilityComp2-v7f0ext,
UE-RadioAccessCapabilityInfo-v770ext,
UE-SecurityInformation,
UE-SecurityInformation2,
UE-SpecificCapabilityInformation-LCRTDD,
URA-UpdateCause,
UTRAN-DRX-CycleLengthCoefficient,
UTRAN-DRX-CycleLengthCoefficient-r7,
WaitTime,
-- Radio Bearer IEs :
  DefaultConfigIdentity,
  DefaultConfigIdentity-r4,
  DefaultConfigIdentity-r5,
  DefaultConfigIdentity-r6,
  DefaultConfigMode,
  DL-CounterSynchronisationInfo,
  DL-CounterSynchronisationInfo-r5,
  PDCP-ROHC-TargetMode,
  PredefinedConfigIdentity,
  PredefinedConfigStatusList,
  PredefinedConfigStatusListComp,
  PredefinedConfigSetWithDifferentValueTag,
  RAB-Info,
  RAB-Info-r6,
  RAB-Info-r7,
  RAB-Info-Post,
  RAB-InformationList,
  RAB-InformationList-r6,
  RAB-InformationReconfigList,
  RAB-InformationMBMSPTpList,
  RAB-InformationSetupList,
  RAB-InformationSetupList-r4,
  RAB-InformationSetupList-r5,
  RAB-InformationSetupList-r6-ext,
  RAB-InformationSetupList-r6,
  RAB-InformationSetupList-v6b0ext,
  RAB-InformationSetupList-r7,
  RAB-InformationSetupList-v820ext,
  RB-ActivationTimeInfoList,
  RB-COUNT-C-InformationList,
  RB-COUNT-C-MSB-InformationList,
  RB-IdentityList,
  RB-InformationAffectedList,
  RB-InformationAffectedList-r5,
  RB-InformationAffectedList-r6,
  RB-InformationAffectedList-r7,
  RB-InformationChangedList-r6,
  RB-InformationReconfigList,
  RB-InformationReconfigList-r4,
  RB-InformationReconfigList-r5,
  RB-InformationReconfigList-r6,
  RB-InformationReconfigList-r7,
  RB-InformationReleaseList,
  RB-PDCPContextRelocationList,
  SRB-InformationSetupList,
  SRB-InformationSetupList-r5,
  SRB-InformationSetupList-r6,
  SRB-InformationSetupList-r7,
  SRB-InformationSetupList2,
  SRB-InformationSetupList2-r6,
  SRB-InformationSetupList2-r7,
  UL-CounterSynchronisationInfo,
-- Transport Channel IEs:
  CPCH-SetID,
```

DL-AddReconfTransChInfo2List,
 DL-AddReconfTransChInfoList,
 DL-AddReconfTransChInfoList-r4,
 DL-AddReconfTransChInfoList-r5,
 DL-AddReconfTransChInfoList-r7,
 DL-CommonTransChInfo,
 DL-CommonTransChInfo-r4,
 DL-DeletedTransChInfoList,
 DL-DeletedTransChInfoList-r5,
 DL-DeletedTransChInfoList-r7,
 DRAC-StaticInformationList,
 PowerOffsetInfoShort,
 TFC-Subset,
 TFCS-Identity,
 UL-AddReconfTransChInfoList,
 UL-AddReconfTransChInfoList-r6,
 UL-AddReconfTransChInfoList-r7,
 UL-CommonTransChInfo,
 UL-CommonTransChInfo-r4,
 UL-DeletedTransChInfoList,
 UL-DeletedTransChInfoList-r6,
 -- Physical Channel IEs :
 Alpha,
 BEACON-PL-Est,
 CCTrCH-PowerControlInfo,
 CCTrCH-PowerControlInfo-r4,
 CCTrCH-PowerControlInfo-r5,
 CCTrCH-PowerControlInfo-r7,
 ConstantValue,
 ConstantValueTdd,
 CPCH-SetInfo,
 DHS-Sync,
 DL-CommonInformation,
 DL-CommonInformation-r4,
 DL-CommonInformation-r5,
 DL-CommonInformation-r6,
 DL-CommonInformation-r7,
 DL-CommonInformationPost,
 DL-HSPDSCH-Information,
 DL-HSPDSCH-Information-r6,
 DL-HSPDSCH-Information-r7,
 DL-HSPDSCH-MultiCarrier-Information,
 DL-InformationPerRL-List,
 DL-InformationPerRL-List-r4,
 DL-InformationPerRL-List-r5,
 DL-InformationPerRL-List-r5bis,
 DL-InformationPerRL-List-r6,
 DL-InformationPerRL-List-r7,
 DL-InformationPerRL-List-v6b0ext,
 DL-InformationPerRL-ListPostFDD,
 DL-InformationPerRL-PostTDD,
 DL-InformationPerRL-PostTDD-LCR-r4,
 DL-MultiCarrier-Information,
 DL-PDSCH-Information,
 DL-TPC-PowerOffsetPerRL-List,
 DPC-Mode,
 DPCH-CompressedModeStatusInfo,
 HS-DSCH-TBSizeTable,
 DTX-DRX-TimingInfo-r7,
 DTX-DRX-Info-r7,
 DynamicPersistenceLevel,
 E-DCH-ReconfigurationInfo,
 E-DCH-ReconfigurationInfo-r7,
 E-DCH-RL-InfoSameServingCell,
 E-TFC-Boost-Info-r7,
 E-DPDCH-PowerInterpolation,
 EXT-UL-TimingAdvance,
 Feedback-cycle-r7,
 FrequencyInfo,
 FrequencyInfoFDD,
 FrequencyInfoTDD,
 HARQ-Info-r7,
 HARQ-Preamble-Mode,
 HS-SCCH-LessInfo-r7,
 HS-SICH-Power-Control-Info-TDD384,
 HS-SICH-Power-Control-Info-TDD768,
 MaxAllowedUL-TX-Power,
 MIMO-Parameters-r7,

```

MIMO-Parameters-v7f0ext,
MIMO-Parameters-v7g0ext,
OpenLoopPowerControl-IPDL-TDD-r4,
PDSCH-CapacityAllocationInfo,
PDSCH-CapacityAllocationInfo-r4,
PDSCH-CapacityAllocationInfo-r7,
PDSCH-Identity,
Multi-frequencyInfo-LCR-r7,
PrimaryCPICH-Info,
PrimaryCCPCH-TX-Power,
PUSCH-CapacityAllocationInfo,
PUSCH-CapacityAllocationInfo-r4,
PUSCH-CapacityAllocationInfo-r7,
PUSCH-Identity,
PUSCH-SysInfoList-HCR-r5,
PDSCH-SysInfoList-HCR-r5,
RL-AdditionInformationList,
RL-AdditionInformationList-r6,
RL-AdditionInformationList-v6b0ext,
RL-AdditionInformationList-r7,
RL-RemovalInformationList,
Serving-HSDSCH-CellInformation,
Serving-HSDSCH-CellInformation-r7,
SpecialBurstScheduling,
SSDT-Information,
SSDT-Information-r4,
TFC-ControlDuration,
SSDT-UL,
TimingMaintainedSynchInd,
TimeslotList,
TimeslotList-r4,
TX-DiversityMode,
UL-16QAM-Config,
UL-ChannelRequirement,
UL-ChannelRequirement-r4,
UL-ChannelRequirement-r5,
UL-ChannelRequirementWithCPCH-SetID,
UL-ChannelRequirementWithCPCH-SetID-r4,
UL-ChannelRequirementWithCPCH-SetID-r5,
UL-DPCH-Info,
UL-DPCH-Info-r4,
UL-DPCH-Info-r5,
UL-DPCH-Info-r6,
UL-DPCH-Info-r7,
UL-DPCH-InfoPostFDD,
UL-DPCH-InfoPostTDD,
UL-DPCH-InfoPostTDD-LCR-r4,
UL-EDCH-Information-ext,
UL-EDCH-Information-r6,
UL-EDCH-Information-r7,
UL-SynchronisationParameters-r4,
UL-TimingAdvance,
UL-TimingAdvanceControl,
UL-TimingAdvanceControl-r4,
UL-TimingAdvanceControl-r7,
UpPCHposition-LCR,
-- Measurement IEs :
AdditionalMeasurementID-List,
DeltaRSCP,
Frequency-Band,
EventResults,
EventResults-v770ext,
Inter-FreqEventCriteriaList-v590ext,
Intra-FreqEventCriteriaList-v590ext,
IntraFreqReportingCriteria-1b-r5,
IntraFreqEvent-1d-r5,
IntraFreqCellID,
InterFreqEventResults-LCR-r4-ext,
InterRATCellInfoIndication,
InterRAT-TargetCellDescription,
MeasuredResults,
MeasuredResults-v390ext,
MeasuredResults-v590ext,
MeasuredResults-v770ext,
MeasuredResultsList,
MeasuredResultsList-LCR-r4-ext,
MeasuredResultsList-v770ext,
MeasuredResultsOnRACH,
MeasuredResultsOnRACH-v7g0ext,

```



```

MeasuredResultsOnRACHinterFreq,
MeasurementCommand,
MeasurementCommand-r4,
MeasurementCommand-r6,
MeasurementCommand-r7,
MeasurementIdentity,
MeasurementReportingMode,
NewInterFreqCellList-v7b0ext,
PrimaryCCPCH-RSCP,
SFN-Offset-Validity,
TimeslotListWithISCP,
TrafficVolumeMeasuredResultsList,
UE-Positioning-GPS-AssistanceData,
UE-Positioning-GPS-AssistanceData-v770ext,
UE-Positioning-GPS-ReferenceTimeUncertainty,
UE-Positioning-Measurement-v390ext,
UE-Positioning-OTDOA-AssistanceData,
UE-Positioning-OTDOA-AssistanceData-r4ext,
UE-Positioning-OTDOA-AssistanceData-UEB,
UE-Positioning-OTDOA-AssistanceData-UEB-ext,
UE-Positioning-OTDOA-MeasuredResultsTDD-ext,
UE-Positioning-GANSS-AssistanceData,
-- Other IEs :
BCCH-ModificationInfo,
CDMA2000-MessageList,
GSM-TargetCellInfoList,
GERANIu-MessageList,
GERAN-SystemInformation,
GSM-MessageList,
InterRAT-ChangeFailureCause,
InterRAT-HO-FailureCause,
InterRAT-UE-RadioAccessCapabilityList,
InterRAT-UE-RadioAccessCapability-v590ext,
InterRAT-UE-SecurityCapList,
IntraDomainNasNodeSelector,
MTB-ValueTag,
ProtocolErrorMoreInformation,
Rplmn-Information,
Rplmn-Information-r4,
SegCount,
SegmentIndex,
SFN-Prime,
SIB-Data-fixed,
SIB-Data-variable,
SIB-Type,
-- MBMS IEs:
MBMS-CellGroupIdentity-r6,
MBMS-CommonRBInformationList-r6,
MBMS-CurrentCell-SCCPCHList-r6,
MBMS-JoinedInformation-r6,
MBMS-MICHConfigurationInfo-r6,
MBMS-MICHConfigurationInfo-v770ext,
MBMS-ModifiedServiceList-r6,
MBMS-ModifiedServiceList-LCR-v7c0ext,
MBMS-ModifiedServiceList-v770ext,
MBMS-MSCH-ConfigurationInfo-r6,
MBMS-NeighbouringCellSCCPCHList-r6,
MBMS-NeighbouringCellSCCPCHList-v770ext,
MBMS-NumberOfNeighbourCells-r6,
MBMS-PhyChInformationList-r6,
MBMS-PhyChInformationList-r7,
MBMS-PL-ServiceRestrictInfo-r6,
MBMS-PreferredFrequencyList-r6,
MBMS-PTMActivationTime-r6,
MBMS-SelectedServiceInfo,
MBMS-SelectedServicesShort,
MBMS-ServiceAccessInfoList-r6,
MBMS-ServiceIdentity-r6,
MBMS-ServiceSchedulingInfoList-r6,
MBMS-SIBType5-SCCPCHList-r6,
MBMS-TimersAndCounters-r6,
MBMS-TranspChInfoForEachCCTrCh-r6,
MBMS-TranspChInfoForEachTrCh-r6,
MBMS-UnmodifiedServiceList-r6,
MBMS-UnmodifiedServiceList-v770ext,
MBSFN-ClusterFrequency-r7,
MBSFN-InterFrequencyNeighbourList-r7,
MBSFN-TDM-Info-List,
MBSFN-TDDInformation-LCR

```

FROM InformationElements

maxSIBperMsg,
maxURNTI-Group

FROM Constant-definitions;

-- *****
--
-- ACTIVE SET UPDATE (FDD only)
--
-- *****

```
ActiveSetUpdate ::= CHOICE {
  r3
    activeSetUpdate-r3          SEQUENCE {
      laterNonCriticalExtensions  ActiveSetUpdate-r3-IEs,
      -- Container for additional R99 extensions
      activeSetUpdate-r3-add-ext  BIT STRING OPTIONAL,
      v4b0NonCriticalExtensions  SEQUENCE {
        activeSetUpdate-v4b0ext  ActiveSetUpdate-v4b0ext-IEs,
        v590NonCriticalExtensions SEQUENCE {
          activeSetUpdate-v590ext  ActiveSetUpdate-v590ext-IEs,
          v690NonCriticalExtensions SEQUENCE {
            activeSetUpdate-v690ext  ActiveSetUpdate-v690ext-IEs,
            nonCriticalExtensions  SEQUENCE {} OPTIONAL
          } OPTIONAL
        } OPTIONAL
      } OPTIONAL
    } OPTIONAL
  },
  later-than-r3
    rrc-TransactionIdentifier  RRC-TransactionIdentifier,
    criticalExtensions
      r6
        activeSetUpdate-r6          SEQUENCE {
          activeSetUpdate-r6-add-ext  BIT STRING OPTIONAL,
          v6b0NonCriticalExtensions  SEQUENCE {
            activeSetUpdate-v6b0ext  ActiveSetUpdate-v6b0ext-IEs,
            nonCriticalExtensions  SEQUENCE {} OPTIONAL
          } OPTIONAL
        },
        criticalExtensions
          r7
            activeSetUpdate-r7          SEQUENCE {
              activeSetUpdate-r7-add-ext  BIT STRING OPTIONAL,
              v780NonCriticalExtensions  SEQUENCE {
                activeSetUpdate-v780ext  ActiveSetUpdate-v780ext-IEs,
                v7f0NonCriticalExtensions SEQUENCE {
                  activeSetUpdate-v7f0ext  ActiveSetUpdate-v7f0ext-IEs,
                  v7g0NonCriticalExtensions SEQUENCE {
                    activeSetUpdate-v7g0ext  ActiveSetUpdate-v7g0ext-IEs,
                    nonCriticalExtensions  SEQUENCE {} OPTIONAL
                  } OPTIONAL
                } OPTIONAL
              } OPTIONAL
            } OPTIONAL
          } OPTIONAL
        },
        criticalExtensions  SEQUENCE {}
      }
    }
}

```

```
ActiveSetUpdate-r3-IEs ::= SEQUENCE {
  -- User equipment IEs
  rrc-TransactionIdentifier  RRC-TransactionIdentifier,
  -- dummy and dummy2 are not used in this version of the specification, they should
  -- not be sent and if received they should be ignored.
  dummy                      IntegrityProtectionModeInfo  OPTIONAL,
  dummy2                     CipheringModeInfo           OPTIONAL,
  activationTime              ActivationTime               OPTIONAL,
  newU-RNTI                   U-RNTI                     OPTIONAL,
  -- Core network IEs
  cn-InformationInfo          CN-InformationInfo           OPTIONAL,
  -- Radio bearer IEs
  -- dummy3 is not used in this version of the specification, it should
  -- not be sent and if received it should be ignored.
  dummy3                      DL-CounterSynchronisationInfo  OPTIONAL,
  -- Physical channel IEs

```

```

maxAllowedUL-TX-Power      MaxAllowedUL-TX-Power      OPTIONAL,
rl-AdditionInformationList  RL-AdditionInformationList  OPTIONAL,
rl-RemovalInformationList   RL-RemovalInformationList   OPTIONAL,
tx-DiversityMode           TX-DiversityMode            OPTIONAL,
-- dummy4 is not used in this version of the specification, it should
-- not be sent and if received it should be ignored.
dummy4                     SSDT-Information           OPTIONAL
}

ActiveSetUpdate-v4b0ext-IEs ::= SEQUENCE {
-- Physical channel IEs
-- dummy is not used in this version of the specification, it should
-- not be sent and if received it should be ignored.
dummy                      SSDT-UL                      OPTIONAL,
-- The order of the RLs in IE cell-id-PerRL-List is the same as
-- in IE RL-AdditionInformationList included in this message
cell-id-PerRL-List         CellIdentity-PerRL-List     OPTIONAL
}

ActiveSetUpdate-v590ext-IEs ::= SEQUENCE {
-- Physical channel IEs
dpc-Mode                   DPC-Mode,
dl-TPC-PowerOffsetPerRL-List  DL-TPC-PowerOffsetPerRL-List  OPTIONAL
}

ActiveSetUpdate-v690ext-IEs ::= SEQUENCE {
-- Core network IEs
primary-plmn-Identity       PLMN-Identity                OPTIONAL
}

ActiveSetUpdate-r6-IEs ::= SEQUENCE {
-- User equipment IEs
activationTime              ActivationTime                 OPTIONAL,
newU-RNTI                   U-RNTI                       OPTIONAL,
newH-RNTI                   H-RNTI                       OPTIONAL,
newPrimary-E-RNTI          E-RNTI                       OPTIONAL,
newSecondary-E-RNTI        E-RNTI                       OPTIONAL,
-- Core network IEs
cn-InformationInfo          CN-InformationInfo-r6        OPTIONAL,
-- Physical channel IEs
maxAllowedUL-TX-Power      MaxAllowedUL-TX-Power        OPTIONAL,
rl-AdditionInformationList  RL-AdditionInformationList-r6  OPTIONAL,
rl-RemovalInformationList   RL-RemovalInformationList     OPTIONAL,
tx-DiversityMode           TX-DiversityMode             OPTIONAL,
dpc-Mode                   DPC-Mode                     OPTIONAL,
serving-HSDSCH-CellInformation  Serving-HSDSCH-CellInformation  OPTIONAL,
e-dch-ReconfigurationInfo   E-DCH-ReconfigurationInfo     OPTIONAL
}

ActiveSetUpdate-v6b0ext-IEs ::= SEQUENCE {
-- Physical channel IEs
rl-AdditionInformation-list-v6b0ext  RL-AdditionInformation-list-v6b0ext  OPTIONAL
}

ActiveSetUpdate-r7-IEs ::= SEQUENCE {
-- User equipment IEs
activationTime              ActivationTime                 OPTIONAL,
newU-RNTI                   U-RNTI                       OPTIONAL,
newH-RNTI                   H-RNTI                       OPTIONAL,
newPrimary-E-RNTI          E-RNTI                       OPTIONAL,
newSecondary-E-RNTI        E-RNTI                       OPTIONAL,
-- Core network IEs
cn-InformationInfo          CN-InformationInfo-r6        OPTIONAL,
-- Physical channel IEs
dtx-drx-TimingInfo         DTX-DRX-TimingInfo-r7        OPTIONAL,
dtx-drx-Info               DTX-DRX-Info-r7              OPTIONAL,
hs-scch-LessInfo           HS-SCCH-LessInfo-r7          OPTIONAL,
mimoParameters             MIMO-Parameters-r7           OPTIONAL,
maxAllowedUL-TX-Power      MaxAllowedUL-TX-Power        OPTIONAL,
rl-AdditionInformationList  RL-AdditionInformationList-r7  OPTIONAL,
rl-RemovalInformationList   RL-RemovalInformationList     OPTIONAL,
tx-DiversityMode           TX-DiversityMode             OPTIONAL,
dpc-Mode                   DPC-Mode                     OPTIONAL,
serving-HSDSCH-CellInformation  Serving-HSDSCH-CellInformation-r7  OPTIONAL,
e-dch-ReconfigurationInfo   E-DCH-ReconfigurationInfo-r7  OPTIONAL,
ul-16QAM-Config            UL-16QAM-Config              OPTIONAL,
e-dch-ReconfInfoSameCell   E-DCH-RL-InfoSameServingCell  OPTIONAL,
e-TFC-Boost-Info          E-TFC-Boost-Info-r7          OPTIONAL
}

```

```

    e-DPDCH-PowerInterpolation          E-DPDCH-PowerInterpolation          OPTIONAL
}
ActiveSetUpdate-v780ext-IEs ::= SEQUENCE {
  -- Physical channel IEs
  hs-DSCH-TBSizeTable                  HS-DSCH-TBSizeTable                  OPTIONAL
}
ActiveSetUpdate-v7f0ext-IEs ::= SEQUENCE {
  -- Physical channel IEs
  mimoParameters                        MIMO-Parameters-v7f0ext              OPTIONAL
}
ActiveSetUpdate-v7g0ext-IEs ::= SEQUENCE {
  -- Physical channel IEs
  mimoParameters                        MIMO-Parameters-v7g0ext              OPTIONAL
}

-- *****
--
-- ACTIVE SET UPDATE COMPLETE (FDD only)
--
-- *****

ActiveSetUpdateComplete ::= SEQUENCE {
  -- User equipment IEs
  rrc-TransactionIdentifier              RRC-TransactionIdentifier,
  -- dummy is not used in this version of the specification, it should
  -- not be sent and if received it should be ignored.
  dummy                                  IntegrityProtActivationInfo          OPTIONAL,
  -- Radio bearer IEs
  -- dummy2 and dummy3 are not used in this version of the specification, they should
  -- not be sent and if received they should be ignored.
  dummy2                                 RB-ActivationTimeInfoList           OPTIONAL,
  dummy3                                 UL-CounterSynchronisationInfo       OPTIONAL,
  laterNonCriticalExtensions              SEQUENCE {
    -- Container for additional R99 extensions
    activeSetUpdateComplete-r3-add-ext    BIT STRING                           OPTIONAL,
    nonCriticalExtensions                  SEQUENCE {}                          OPTIONAL
  }
}

-- *****
--
-- ACTIVE SET UPDATE FAILURE (FDD only)
--
-- *****

ActiveSetUpdateFailure ::= SEQUENCE {
  -- User equipment IEs
  rrc-TransactionIdentifier              RRC-TransactionIdentifier,
  failureCause                           FailureCauseWithProtErr,
  laterNonCriticalExtensions              SEQUENCE {
    -- Container for additional R99 extensions
    activeSetUpdateFailure-r3-add-ext     BIT STRING                           OPTIONAL,
    nonCriticalExtensions                  SEQUENCE {}                          OPTIONAL
  }
}

-- *****
--
-- ASSISTANCE DATA DELIVERY--
-- *****

AssistanceDataDelivery ::= CHOICE {
  r3                                       SEQUENCE {
    assistanceDataDelivery-r3            AssistanceDataDelivery-r3-IEs,
    v3a0NonCriticalExtensions             SEQUENCE {
      assistanceDataDelivery-v3a0ext      AssistanceDataDelivery-v3a0ext,
      laterNonCriticalExtensions          SEQUENCE {
        -- Container for additional R99 extensions
        assistanceDataDelivery-r3-add-ext  BIT STRING                           OPTIONAL,
        v4b0NonCriticalExtensions          SEQUENCE {
          assistanceDataDelivery-v4b0ext   AssistanceDataDelivery-v4b0ext-IEs,
          v770NonCriticalExtension         SEQUENCE {
            assistanceDataDelivery-v770ext AssistanceDataDelivery-v770ext-IEs,
            nonCriticalExtensions          SEQUENCE {}                          OPTIONAL
          }
        }
      }
    }
  }
}

```

```

    } OPTIONAL
  } OPTIONAL
},
later-than-r3 SEQUENCE {
  rrc-TransactionIdentifier RRC-TransactionIdentifier,
  criticalExtensions SEQUENCE {}
}
}

AssistanceDataDelivery-r3-IEs ::= SEQUENCE {
  -- User equipment IEs
  rrc-TransactionIdentifier RRC-TransactionIdentifier,
  -- Measurement Information Elements
  ue-positioning-GPS-AssistanceData UE-Positioning-GPS-AssistanceData
  OPTIONAL,
  ue-positioning-OTDOA-AssistanceData-UEB UE-Positioning-OTDOA-AssistanceData-UEB
  OPTIONAL
}

AssistanceDataDelivery-v3a0ext ::= SEQUENCE {
  sfm-Offset-Validity SFM-Offset-Validity OPTIONAL
}

AssistanceDataDelivery-v4b0ext-IEs ::= SEQUENCE {
  ue-Positioning-OTDOA-AssistanceData-r4ext UE-Positioning-OTDOA-AssistanceData-r4ext OPTIONAL
}

AssistanceDataDelivery-v770ext-IEs ::= SEQUENCE {
  ue-Positioning-OTDOA-AssistanceData-UEB-ext UE-Positioning-OTDOA-AssistanceData-UEB-ext OPTIONAL,
  ue-Positioning-GPS-AssistanceData UE-Positioning-GPS-AssistanceData-v770ext OPTIONAL,
  ue-positioning-GANSS-AssistanceData UE-Positioning-GANSS-AssistanceData OPTIONAL
}

-- *****
--
-- CELL CHANGE ORDER FROM UTRAN
--
-- *****

CellChangeOrderFromUTRAN ::= CHOICE {
  r3 SEQUENCE {
    cellChangeOrderFromUTRAN-IEs CellChangeOrderFromUTRAN-r3-IEs,
    laterNonCriticalExtensions SEQUENCE {
      -- Container for additional R99 extensions
      cellChangeOrderFromUTRAN-r3-add-ext BIT STRING OPTIONAL,
      v590NonCriticalExtensions SEQUENCE {
        cellChangeOrderFromUTRAN-v590ext CellChangeOrderFromUTRAN-v590ext-IEs,
        nonCriticalExtensions SEQUENCE {} OPTIONAL
      } OPTIONAL
    } OPTIONAL
  } OPTIONAL
},
later-than-r3 SEQUENCE {
  rrc-TransactionIdentifier RRC-TransactionIdentifier,
  criticalExtensions SEQUENCE {}
}
}

CellChangeOrderFromUTRAN-r3-IEs ::= SEQUENCE {
  -- User equipment IEs
  rrc-TransactionIdentifier RRC-TransactionIdentifier,
  -- dummy is not used in this version of the specification, it should
  -- not be sent and if received it should be ignored.
  dummy IntegrityProtectionModeInfo OPTIONAL,
  activationTime ActivationTime OPTIONAL,
  -- the IE rab-InformationList is not used in this version of the specification, it should
  -- not be sent and if received it should be ignored. The IE may be used in a later
  -- version of the protocol and hence it is not changed into a dummy
  rab-InformationList RAB-InformationList OPTIONAL,
  interRAT-TargetCellDescription InterRAT-TargetCellDescription
}

CellChangeOrderFromUTRAN-v590ext-IEs ::= SEQUENCE {
  geran-SystemInfoType CHOICE {
    sI GERAN-SystemInformation,
    pSI GERAN-SystemInformation
  } OPTIONAL
}

```

```

}

-- *****
--
-- CELL CHANGE ORDER FROM UTRAN FAILURE
--
-- *****

CellChangeOrderFromUTRANFailure ::= CHOICE {
  r3 SEQUENCE {
    cellChangeOrderFromUTRANFailure-r3
    laterNonCriticalExtensions SEQUENCE {
      CellChangeOrderFromUTRANFailure-r3-IEs,
      -- Container for additional R99 extensions
      cellChangeOrderFromUTRANFailure-r3-add-ext BIT STRING OPTIONAL,
      nonCriticalExtensions SEQUENCE {} OPTIONAL
    } OPTIONAL
  },
  -- dummy is not used in this version of the specification and it
  -- should be ignored.
  dummy SEQUENCE {
    rrc-TransactionIdentifier RRC-TransactionIdentifier,
    criticalExtensions SEQUENCE {}
  }
}

CellChangeOrderFromUTRANFailure-r3-IEs ::= SEQUENCE {
  -- User equipment IEs
  rrc-TransactionIdentifier RRC-TransactionIdentifier,
  -- dummy is not used in this version of the specification, it should
  -- not be sent and if received it should be ignored.
  dummy IntegrityProtectionModeInfo OPTIONAL,
  interRAT-ChangeFailureCause InterRAT-ChangeFailureCause
}

-- *****
--
-- CELL UPDATE
--
-- *****

CellUpdate ::= SEQUENCE {
  -- User equipment IEs
  u-RNTI U-RNTI,
  startList STARTList,
  am-RLC-ErrorIndicationRb2-3or4 BOOLEAN,
  am-RLC-ErrorIndicationRb5orAbove BOOLEAN,
  cellUpdateCause CellUpdateCause,
  -- TABULAR: RRC transaction identifier is nested in FailureCauseWithProtErrTrId
  failureCause FailureCauseWithProtErrTrId OPTIONAL,
  rb-timer-indicator Rb-timer-indicator,
  -- Measurement IEs
  measuredResultsOnRACH MeasuredResultsOnRACH OPTIONAL,
  laterNonCriticalExtensions SEQUENCE {
    -- Container for additional R99 extensions
    cellUpdate-r3-add-ext BIT STRING
      (CONTAINING CellUpdate-r3-add-ext-IEs) OPTIONAL,
    v590NonCriticalExtensions SEQUENCE {
      cellUpdate-v590ext CellUpdate-v590ext,
      v690NonCriticalExtensions SEQUENCE {
        cellUpdate-v690ext CellUpdate-v690ext-IEs,
        v6b0NonCriticalExtensions SEQUENCE {
          cellUpdate-v6b0ext CellUpdate-v6b0ext-IEs,
          v770NonCriticalExtensions SEQUENCE {
            cellUpdate-v770ext CellUpdate-v770ext-IEs,
            nonCriticalExtensions SEQUENCE {} OPTIONAL
          }
        } OPTIONAL
      }
    } OPTIONAL
  } OPTIONAL
} OPTIONAL
}

CellUpdate-r3-add-ext-IEs ::= SEQUENCE {
  cellUpdate-v7e0ext CellUpdate-v7e0ext-IEs,
  v7g0NonCriticalExtensions SEQUENCE {
    cellUpdate-v7g0ext CellUpdate-v7g0ext-IEs,
    nonCriticalExtensions SEQUENCE {} OPTIONAL
  }
}

```

```

    }
  }
  OPTIONAL
}

CellUpdate-v590ext ::= SEQUENCE {
  establishmentCause      EstablishmentCause  OPTIONAL
}

CellUpdate-v690ext-IEs ::= SEQUENCE {
  -- User equipment IEs
  cellUpdateCause-ext      CellUpdateCause-ext      OPTIONAL,
  trafficVolumeIndicator    ENUMERATED { true }      OPTIONAL,
  -- Measurement IEs
  measuredResultsOnRACHinterFreq MeasuredResultsOnRACHinterFreq  OPTIONAL,
  reconfigurationStatusIndicator ENUMERATED { true }      OPTIONAL
}

CellUpdate-v6b0ext-IEs ::= SEQUENCE {
  -- MBMS IEs
  mbmsSelectedServices      MBMS-SelectedServicesShort  OPTIONAL
}

CellUpdate-v770ext-IEs ::= SEQUENCE {
  -- User equipment IEs
  csCallType                ENUMERATED { speech, video, other, spare }  OPTIONAL,
  hspdschReception-CellFach ENUMERATED { true }      OPTIONAL,
  ueMobilityStateIndicator   High-MobilityDetected  OPTIONAL,
  capabilityChangeIndicator  ENUMERATED { true }      OPTIONAL
}

CellUpdate-v7e0ext-IEs ::= SEQUENCE {
  -- User equipment IEs
  supportForTwoDRXschemesInPCH ENUMERATED { true }      OPTIONAL
}

CellUpdate-v7g0ext-IEs ::= SEQUENCE {
  -- Measurement IEs
  measuredResultsOnRACH-v7g0ext MeasuredResultsOnRACH-v7g0ext  OPTIONAL
}

-- *****
--
-- CELL UPDATE CONFIRM
--
-- *****

CellUpdateConfirm ::= CHOICE {
  r3 SEQUENCE {
    cellUpdateConfirm-r3 CellUpdateConfirm-r3-IEs,
    v3a0NonCriticalExtensions SEQUENCE {
      cellUpdateConfirm-v3a0ext CellUpdateConfirm-v3a0ext,
      laterNonCriticalExtensions SEQUENCE {
        -- Container for additional R99 extensions
        cellUpdateConfirm-r3-add-ext BIT STRING OPTIONAL,
        v4b0NonCriticalExtensions SEQUENCE {
          cellUpdateConfirm-v4b0ext CellUpdateConfirm-v4b0ext-IEs,
          v590NonCriticalExtensions SEQUENCE {
            cellUpdateConfirm-v590ext CellUpdateConfirm-v590ext-IEs,
            v5d0NonCriticalExtensions SEQUENCE {
              cellUpdateConfirm-v5d0ext CellUpdateConfirm-v5d0ext-IEs,
              v690NonCriticalExtensions SEQUENCE {
                cellUpdateConfirm-v690ext CellUpdateConfirm-v690ext-IEs,
                nonCriticalExtensions SEQUENCE {} OPTIONAL
              }
            } OPTIONAL
          }
        } OPTIONAL
      }
    } OPTIONAL
  }
  later-than-r3 SEQUENCE {
    rrc-TransactionIdentifier RRC-TransactionIdentifier,
    criticalExtensions CHOICE {
      r4 SEQUENCE {
        cellUpdateConfirm-r4 CellUpdateConfirm-r4-IEs,
        v4d0NonCriticalExtensions SEQUENCE {
          -- Container for adding non critical extensions after freezing REL-5
          cellUpdateConfirm-r4-add-ext BIT STRING OPTIONAL,
          v590NonCriticalExtensions SEQUENCE {

```



```

modeSpecificTransChInfo      CHOICE {
  fdd                         SEQUENCE {
    -- dummy and dummy2 are not used in this version of the specification, they should
    -- not be sent and if received they should be ignored.
    dummy                      CPCH-SetID          OPTIONAL,
    dummy2                     DRAC-StaticInformationList OPTIONAL
  },
  tdd                         NULL
},
dl-CommonTransChInfo         DL-CommonTransChInfo          OPTIONAL,
dl-DeletedTransChInfoList    DL-DeletedTransChInfoList      OPTIONAL,
dl-AddReconfTransChInfoList  DL-AddReconfTransChInfoList  OPTIONAL,
-- Physical channel IEs
frequencyInfo                FrequencyInfo              OPTIONAL,
maxAllowedUL-TX-Power        MaxAllowedUL-TX-Power      OPTIONAL,
ul-ChannelRequirement        UL-ChannelRequirement      OPTIONAL,
modeSpecificPhysChInfo      CHOICE {
  fdd                         SEQUENCE {
    -- dummy is not used in this version of specification, it should
    -- not be sent and if received it should be ignored.
    dummy                      DL-PDSCH-Information    OPTIONAL
  },
  tdd                         NULL
},
dl-CommonInformation         DL-CommonInformation          OPTIONAL,
dl-InformationPerRL-List     DL-InformationPerRL-List      OPTIONAL
}

CellUpdateConfirm-v3a0ext ::= SEQUENCE {
  -- The IE "new-DSCH-RNTI" should not be included in FDD mode, and if received the UE behaviour
  -- is unspecified
  new-DSCH-RNTI              DSCH-RNTI                  OPTIONAL
}

CellUpdateConfirm-v4b0ext-IEs ::= SEQUENCE {
  -- Physical channel IEs
  -- dummy is not used in this version of the specification, it should
  -- not be sent and if received it should be ignored.
  dummy                      SSdT-UL                      OPTIONAL,
  -- The order of the RLs in IE cell-id-PerRL-List is the same as
  -- in IE DL-InformationPerRL-List included in this message
  cell-id-PerRL-List         CellIdentity-PerRL-List      OPTIONAL
}

CellUpdateConfirm-v590ext-IEs ::= SEQUENCE {
  -- Physical channel IEs
  dl-TPC-PowerOffsetPerRL-List DL-TPC-PowerOffsetPerRL-List  OPTIONAL
}

CellUpdateConfirm-v5d0ext-IEs ::= SEQUENCE {
  --Radio Bearer IEs
  pdcp-ROHC-TargetMode       PDCP-ROHC-TargetMode        OPTIONAL
}

CellUpdateConfirm-r4-IEs ::= SEQUENCE {
  -- User equipment IEs
  integrityProtectionModeInfo IntegrityProtectionModeInfo  OPTIONAL,
  cipheringModeInfo          CipheringModeInfo              OPTIONAL,
  activationTime              ActivationTime                    OPTIONAL,
  new-U-RNTI                  U-RNTI                          OPTIONAL,
  new-C-RNTI                  C-RNTI                          OPTIONAL,
  -- The IE "new-DSCH-RNTI" should not be included in FDD mode, and if received
  -- the UE behaviour is unspecified
  new-DSCH-RNTI              DSCH-RNTI                  OPTIONAL,
  rrc-StateIndicator          RRC-StateIndicator,
  utran-DRX-CycleLengthCoeff UTRAN-DRX-CycleLengthCoefficient OPTIONAL,
  rlc-Re-establishIndicatorRb2-3or4 BOOLEAN,
  rlc-Re-establishIndicatorRb5orAbove BOOLEAN,
  -- CN information elements
  cn-InformationInfo          CN-InformationInfo              OPTIONAL,
  -- UTRAN mobility IEs
  ura-Identity                URA-Identity                    OPTIONAL,
  -- Radio bearer IEs
  rb-InformationReleaseList   RB-InformationReleaseList  OPTIONAL,
  rb-InformationReconfigList  RB-InformationReconfigList-r4 OPTIONAL,
  rb-InformationAffectedList  RB-InformationAffectedList OPTIONAL,
  dl-CounterSynchronisationInfo DL-CounterSynchronisationInfo OPTIONAL,
  -- Transport channel IEs
  ul-CommonTransChInfo       UL-CommonTransChInfo-r4        OPTIONAL,

```

```

ul-deletedTransChInfoList      UL-DeletedTransChInfoList      OPTIONAL,
ul-AddReconfTransChInfoList    UL-AddReconfTransChInfoList      OPTIONAL,
modeSpecificTransChInfo        CHOICE {
  fdd                           SEQUENCE {
    -- dummy and dummy2 are not used in this version of the specification, they should
    -- not be sent and if received they should be ignored.
    dummy                        CPCH-SetID                            OPTIONAL,
    dummy2                       DRAC-StaticInformationList          OPTIONAL
  },
  tdd                           NULL
},
dl-CommonTransChInfo           DL-CommonTransChInfo-r4          OPTIONAL,
dl-DeletedTransChInfoList      DL-DeletedTransChInfoList        OPTIONAL,
dl-AddReconfTransChInfoList    DL-AddReconfTransChInfoList-r4   OPTIONAL,
-- Physical channel IEs
frequencyInfo                  FrequencyInfo                     OPTIONAL,
maxAllowedUL-TX-Power          MaxAllowedUL-TX-Power            OPTIONAL,
ul-ChannelRequirement          UL-ChannelRequirement-r4         OPTIONAL,
modeSpecificPhysChInfo        CHOICE {
  fdd                           SEQUENCE {
    -- dummy is not used in this version of specification, it should
    -- not be sent and if received it should be ignored.
    dummy                        DL-PDSCH-Information              OPTIONAL
  },
  tdd                           NULL
},
dl-CommonInformation           DL-CommonInformation-r4          OPTIONAL,
dl-InformationPerRL-List       DL-InformationPerRL-List-r4      OPTIONAL
}

CellUpdateConfirm-r5-IEs ::= SEQUENCE {
-- User equipment IEs
integrityProtectionModeInfo    IntegrityProtectionModeInfo      OPTIONAL,
cipheringModeInfo              CipheringModeInfo                 OPTIONAL,
activationTime                  ActivationTime                     OPTIONAL,
new-U-RNTI                     U-RNTI                           OPTIONAL,
new-C-RNTI                     C-RNTI                           OPTIONAL,
-- The IE "new-DSCH-RNTI" should not be included in FDD mode, and if received
-- the UE behaviour is unspecified
new-DSCH-RNTI                  DSCH-RNTI                         OPTIONAL,
new-H-RNTI                     H-RNTI                           OPTIONAL,
rrc-StateIndicator             RRC-StateIndicator,
utran-DRX-CycleLengthCoeff     UTRAN-DRX-CycleLengthCoefficient  OPTIONAL,
rlc-Re-establishIndicatorRb2-3or4  BOOLEAN,
rlc-Re-establishIndicatorRb5orAbove  BOOLEAN,
-- CN information elements
cn-InformationInfo             CN-InformationInfo               OPTIONAL,
-- UTRAN mobility IEs
ura-Identity                    URA-Identity                     OPTIONAL,
-- Radio bearer IEs
rb-InformationReleaseList      RB-InformationReleaseList         OPTIONAL,
rb-InformationReconfList       RB-InformationReconfList-r5       OPTIONAL,
rb-InformationAffectedList     RB-InformationAffectedList-r5     OPTIONAL,
dl-CounterSynchronisationInfo  DL-CounterSynchronisationInfo-r5  OPTIONAL,
-- Transport channel IEs
ul-CommonTransChInfo           UL-CommonTransChInfo-r4          OPTIONAL,
ul-deletedTransChInfoList      UL-DeletedTransChInfoList        OPTIONAL,
ul-AddReconfTransChInfoList    UL-AddReconfTransChInfoList      OPTIONAL,
modeSpecificTransChInfo        CHOICE {
  fdd                           SEQUENCE {
    -- dummy and dummy2 are not used in this version of the specification, they should
    -- not be sent and if received they should be ignored.
    dummy                        CPCH-SetID                            OPTIONAL,
    dummy2                       DRAC-StaticInformationList          OPTIONAL
  },
  tdd                           NULL
},
dl-CommonTransChInfo           DL-CommonTransChInfo-r4          OPTIONAL,
dl-DeletedTransChInfoList      DL-DeletedTransChInfoList-r5     OPTIONAL,
dl-AddReconfTransChInfoList    DL-AddReconfTransChInfoList-r5   OPTIONAL,
-- Physical channel IEs
frequencyInfo                  FrequencyInfo                     OPTIONAL,
maxAllowedUL-TX-Power          MaxAllowedUL-TX-Power            OPTIONAL,
ul-ChannelRequirement          UL-ChannelRequirement-r5         OPTIONAL,
modeSpecificPhysChInfo        CHOICE {
  fdd                           SEQUENCE {
    -- dummy is not used in this version of specification, it should
    -- not be sent and if received it should be ignored.

```

```

        dummy                                DL-PDSCH-Information    OPTIONAL
    },
    tdd                                       NULL
},
dl-HSPDSCH-Information                      DL-HSPDSCH-Information    OPTIONAL,
dl-CommonInformation                       DL-CommonInformation-r5   OPTIONAL,
dl-InformationPerRL-List                   DL-InformationPerRL-List-r5 OPTIONAL
}

CellUpdateConfirm-r6-IEs ::= SEQUENCE {
-- User equipment IEs
  integrityProtectionModeInfo              IntegrityProtectionModeInfo OPTIONAL,
  cipheringModeInfo                       CipheringModeInfo          OPTIONAL,
  activationTime                           ActivationTime              OPTIONAL,
  new-U-RNTI                               U-RNTI                    OPTIONAL,
  new-C-RNTI                               C-RNTI                    OPTIONAL,
  -- The IE "new-DSCH-RNTI" should not be included in FDD mode,
  -- and if received the UE behaviour is unspecified
  new-DSCH-RNTI                           DSCH-RNTI                 OPTIONAL,
  new-H-RNTI                               H-RNTI                    OPTIONAL,
  newPrimary-E-RNTI                       E-RNTI                    OPTIONAL,
  newSecondary-E-RNTI                     E-RNTI                    OPTIONAL,
  rrc-StateIndicator                      RRC-StateIndicator,
  utran-DRX-CycleLengthCoeff              UTRAN-DRX-CycleLengthCoefficient OPTIONAL,
  rlc-Re-establishIndicatorRb2-3or4        BOOLEAN,
  rlc-Re-establishIndicatorRb5orAbove      BOOLEAN,
-- CN information elements
  cn-InformationInfo                       CN-InformationInfo-r6     OPTIONAL,
-- UTRAN mobility IEs
  ura-Identity                             URA-Identity              OPTIONAL,
-- Radio bearer IEs
  rb-InformationReleaseList                RB-InformationReleaseList OPTIONAL,
  rb-InformationReconfigList               RB-InformationReconfigList-r6 OPTIONAL,
  rb-InformationAffectedList               RB-InformationAffectedList-r6 OPTIONAL,
  dl-CounterSynchronisationInfo           DL-CounterSynchronisationInfo-r5 OPTIONAL,
  pdcp-ROHC-TargetMode                    PDCP-ROHC-TargetMode     OPTIONAL,
-- Transport channel IEs
  ul-CommonTransChInfo                    UL-CommonTransChInfo-r4   OPTIONAL,
  ul-deletedTransChInfoList               UL-DeletedTransChInfoList-r6 OPTIONAL,
  ul-AddReconfTransChInfoList             UL-AddReconfTransChInfoList-r6 OPTIONAL,
  dl-CommonTransChInfo                    DL-CommonTransChInfo-r4   OPTIONAL,
  dl-DeletedTransChInfoList               DL-DeletedTransChInfoList-r5 OPTIONAL,
  dl-AddReconfTransChInfoList             DL-AddReconfTransChInfoList-r5 OPTIONAL,
-- Physical channel IEs
  frequencyInfo                           FrequencyInfo              OPTIONAL,
  maxAllowedUL-TX-Power                   MaxAllowedUL-TX-Power     OPTIONAL,
  ul-DPCH-Info                            UL-DPCH-Info-r6          OPTIONAL,
  ul-EDCH-Information                     UL-EDCH-Information-r6   OPTIONAL,
  dl-HSPDSCH-Information                  DL-HSPDSCH-Information-r6 OPTIONAL,
  dl-CommonInformation                    DL-CommonInformation-r6   OPTIONAL,
  dl-InformationPerRL-List                 DL-InformationPerRL-List-r6 OPTIONAL,
-- MBMS IEs
  mbms-PL-ServiceRestrictInfo             MBMS-PL-ServiceRestrictInfo-r6 OPTIONAL
}

CellUpdateConfirm-v690ext-IEs ::= SEQUENCE {
-- Core network IEs
  primary-plmn-Identity                   PLMN-Identity              OPTIONAL,
-- Physical channel IEs
  -- The IE harq-Preamble-Mode should not be used in the r3 and r4 versions of the message
  -- If included in the r3 or r4 version of the message, the UE should ignore the IE
  harq-Preamble-Mode                     HARQ-Preamble-Mode        OPTIONAL,
  beaconPLEst                             BEACON-PL-Est             OPTIONAL,
  postVerificationPeriod                   ENUMERATED { true }      OPTIONAL,
  dhs-sync                                 DHS-Sync                  OPTIONAL,
-- MBMS IEs
  mbms-PL-ServiceRestrictInfo             MBMS-PL-ServiceRestrictInfo-r6 OPTIONAL
}

CellUpdateConfirm-v6b0ext-IEs ::= SEQUENCE {
-- Physical channel IEs
  dl-InformationPerRL-List-v6b0ext         DL-InformationPerRL-List-v6b0ext OPTIONAL
}

CellUpdateConfirm-r7-IEs ::= SEQUENCE {
-- User equipment IEs
  integrityProtectionModeInfo              IntegrityProtectionModeInfo-r7 OPTIONAL,
  cipheringModeInfo                       CipheringModeInfo-r7      OPTIONAL,

```

```

activationTime          ActivationTime          OPTIONAL,
new-U-RNTI              U-RNTI              OPTIONAL,
new-C-RNTI              C-RNTI              OPTIONAL,
-- The IE "new-DSCH-RNTI" should not be included in FDD mode,
-- and if received the UE behaviour is unspecified
new-DSCH-RNTI          DSCH-RNTI          OPTIONAL,
new-H-RNTI              H-RNTI              OPTIONAL,
newPrimary-E-RNTI      E-RNTI              OPTIONAL,
newSecondary-E-RNTI    E-RNTI              OPTIONAL,
rrc-StateIndicator     RRC-StateIndicator,
utran-DRX-CycleLengthCoeff  UTRAN-DRX-CycleLengthCoefficient-r7 OPTIONAL,
waitTime                WaitTime                OPTIONAL,
rlc-Re-establishIndicatorRb2-3or4  BOOLEAN,
rlc-Re-establishIndicatorRb5orAbove  BOOLEAN,
-- CN information elements
  cn-InformationInfo    CN-InformationInfo-r6    OPTIONAL,
-- UTRAN mobility IEs
  ura-Identity          URA-Identity          OPTIONAL,
  supportForChangeOfUE-Capability  BOOLEAN
-- Radio bearer IEs
  rb-InformationReleaseList  RB-InformationReleaseList  OPTIONAL,
  rb-InformationReconfigList  RB-InformationReconfigList-r7  OPTIONAL,
  rb-InformationAffectedList  RB-InformationAffectedList-r7  OPTIONAL,
  dl-CounterSynchronisationInfo  DL-CounterSynchronisationInfo-r5  OPTIONAL,
  pdcp-ROHC-TargetMode      PDCP-ROHC-TargetMode      OPTIONAL,
-- Transport channel IEs
  ul-CommonTransChInfo      UL-CommonTransChInfo-r4      OPTIONAL,
  ul-deletedTransChInfoList  UL-DeletedTransChInfoList-r6  OPTIONAL,
  ul-AddReconfTransChInfoList  UL-AddReconfTransChInfoList-r7  OPTIONAL,
  dl-CommonTransChInfo      DL-CommonTransChInfo-r4      OPTIONAL,
  dl-DeletedTransChInfoList  DL-DeletedTransChInfoList-r7  OPTIONAL,
  dl-AddReconfTransChInfoList  DL-AddReconfTransChInfoList-r7  OPTIONAL,
-- Physical channel IEs
  frequencyInfo            FrequencyInfo            OPTIONAL,
  multi-frequencyInfo      Multi-frequencyInfo-LCR-r7  OPTIONAL,
  dtx-drx-TimingInfo       DTX-DRX-TimingInfo-r7      OPTIONAL,
  dtx-drx-Info             DTX-DRX-Info-r7          OPTIONAL,
  hs-scch-LessInfo         HS-SCCH-LessInfo-r7       OPTIONAL,
  mimoParameters           MIMO-Parameters-r7      OPTIONAL,
  maxAllowedUL-TX-Power    MaxAllowedUL-TX-Power    OPTIONAL,
  ul-DPCH-Info             UL-DPCH-Info-r7         OPTIONAL,
  ul-EDCH-Information       UL-EDCH-Information-r7    OPTIONAL,
  dl-HSPDSCH-Information    DL-HSPDSCH-Information-r7  OPTIONAL,
  dl-CommonInformation      DL-CommonInformation-r7   OPTIONAL,
  dl-InformationPerRL-List  DL-InformationPerRL-List-r7  OPTIONAL,
-- MBMS IEs
  mbms-PL-ServiceRestrictInfo  MBMS-PL-ServiceRestrictInfo-r6  OPTIONAL
}

CellUpdateConfirm-r7-add-ext-IEs ::= SEQUENCE {
  cellUpdateConfirm-v7d0ext  CellUpdateConfirm-v7d0ext-IEs  OPTIONAL,
  v7f0NonCriticalExtensions  SEQUENCE {
    cellUpdateConfirm-v7f0ext  CellUpdateConfirm-v7f0ext-IEs,
    v7g0NonCriticalExtensions  SEQUENCE {
      cellUpdateConfirm-v7g0ext  CellUpdateConfirm-v7g0ext-IEs,
      nonCriticalExtensions      SEQUENCE {} OPTIONAL
    } OPTIONAL
  } OPTIONAL
}

CellUpdateConfirm-v780ext-IEs ::= SEQUENCE {
  -- Physical channel IEs
  hs-DSCH-TBSizeTable        HS-DSCH-TBSizeTable        OPTIONAL
}

CellUpdateConfirm-v7d0ext-IEs ::= SEQUENCE {
  -- Physical channel IEs
  ul-EDCH-Information         UL-EDCH-Information-ext    OPTIONAL
}

CellUpdateConfirm-v7f0ext-IEs ::= SEQUENCE {
  -- Physical channel IEs
  mimoParameters             MIMO-Parameters-v7f0ext    OPTIONAL
}

CellUpdateConfirm-v7g0ext-IEs ::= SEQUENCE {
  -- Physical channel IEs
  mimoParameters             MIMO-Parameters-v7g0ext    OPTIONAL
}

```

```

}

-- *****
--
-- CELL UPDATE CONFIRM for CCCH
--
-- *****

CellUpdateConfirm-CCCH ::= CHOICE {
  r3          SEQUENCE {
    -- User equipment IES
    u-RNTI          U-RNTI,
    -- The rest of the message is identical to the one sent on DCCH.
    cellUpdateConfirm-r3          CellUpdateConfirm-r3-IEs,
    laterNonCriticalExtensions    SEQUENCE {
      -- Container for additional R99 extensions
      cellUpdateConfirm-CCCH-r3-add-ext    BIT STRING OPTIONAL,
      v4b0NonCriticalExtensions    SEQUENCE {
        cellUpdateConfirm-v4b0ext          CellUpdateConfirm-v4b0ext-IEs,
        v590NonCriticalExtensions    SEQUENCE {
          cellUpdateConfirm-v590ext          CellUpdateConfirm-v590ext-IEs,
          v5d0NonCriticalExtensions    SEQUENCE {
            cellUpdateConfirm-v5d0ext          CellUpdateConfirm-v5d0ext-IEs,
            v690NonCriticalExtensions    SEQUENCE {
              cellUpdateConfirm-v690ext          CellUpdateConfirm-v690ext-IEs,
              nonCriticalExtensions          SEQUENCE {} OPTIONAL
            } OPTIONAL
          } OPTIONAL
        } OPTIONAL
      } OPTIONAL
    } OPTIONAL
  },
  later-than-r3          SEQUENCE {
    u-RNTI          U-RNTI,
    rrc-TransactionIdentifier          RRC-TransactionIdentifier,
    criticalExtensions          CHOICE {
      r4          SEQUENCE {
        -- The rest of the message is identical to the one sent on DCCH.
        cellUpdateConfirm-r4          CellUpdateConfirm-r4-IEs,
        v4d0NonCriticalExtensions    SEQUENCE {
          -- Container for adding non critical extensions after freezing REL-5
          cellUpdateConfirm-CCCH-r4-add-ext    BIT STRING OPTIONAL,
          v590NonCriticalExtensions    SEQUENCE {
            cellUpdateConfirm-v590ext          CellUpdateConfirm-v590ext-IEs,
            v5d0NonCriticalExtensions    SEQUENCE {
              cellUpdateConfirm-v5d0ext          CellUpdateConfirm-v5d0ext-IEs,
              v690NonCriticalExtensions    SEQUENCE {
                cellUpdateConfirm-v690ext          CellUpdateConfirm-v690ext-IEs,
                nonCriticalExtensions          SEQUENCE {} OPTIONAL
              } OPTIONAL
            } OPTIONAL
          } OPTIONAL
        } OPTIONAL
      } OPTIONAL
    },
    criticalExtensions          CHOICE {
      r5          SEQUENCE {
        cellUpdateConfirm-r5          CellUpdateConfirm-r5-IEs,
        cellUpdateConfirm-CCCH-r5-add-ext    BIT STRING OPTIONAL,
        v5d0NonCriticalExtensions    SEQUENCE {
          cellUpdateConfirm-v5d0ext          CellUpdateConfirm-v5d0ext-IEs,
          v690NonCriticalExtensions    SEQUENCE {
            cellUpdateConfirm-v690ext          CellUpdateConfirm-v690ext-IEs,
            nonCriticalExtensions          SEQUENCE {} OPTIONAL
          } OPTIONAL
        } OPTIONAL
      },
      criticalExtensions          CHOICE {
        r6          SEQUENCE {
          cellUpdateConfirm-r6          CellUpdateConfirm-r6-IEs,
          cellUpdateConfirm-r6-add-ext    BIT STRING OPTIONAL,
          v6b0NonCriticalExtensions    SEQUENCE {
            cellUpdateConfirm-v6b0ext          CellUpdateConfirm-v6b0ext-IEs,
            nonCriticalExtensions          SEQUENCE {} OPTIONAL
          } OPTIONAL
        },
        criticalExtensions          CHOICE {
          r7          SEQUENCE {
            cellUpdateConfirm-r7          CellUpdateConfirm-r7-IEs,

```



```

        criticalExtensions          SEQUENCE {}
    }
}

DownlinkDirectTransfer-r3-IEs ::= SEQUENCE {
    -- User equipment IEs
    rrc-TransactionIdentifier      RRC-TransactionIdentifier,
    -- Core network IEs
    cn-DomainIdentity             CN-DomainIdentity,
    nas-Message                    NAS-Message
}

-- *****
--
-- HANDOVER TO UTRAN COMMAND
--
-- *****

HandoverToUTRANCommand ::= CHOICE {
    r3                             SEQUENCE {
        handoverToUTRANCommand-r3  HandoverToUTRANCommand-r3-IEs,
        nonCriticalExtensions       SEQUENCE {} OPTIONAL
    },
    criticalExtensions             CHOICE {
        r4                         SEQUENCE {
            handoverToUTRANCommand-r4  HandoverToUTRANCommand-r4-IEs,
            nonCriticalExtensions       SEQUENCE {} OPTIONAL
        },
        criticalExtensions          CHOICE {
            r5                     SEQUENCE {
                handoverToUTRANCommand-r5  HandoverToUTRANCommand-r5-IEs,
                nonCriticalExtensions       SEQUENCE {} OPTIONAL
            },
            criticalExtensions       CHOICE {
                r6                 SEQUENCE {
                    handoverToUTRANCommand-r6  HandoverToUTRANCommand-r6-IEs,
                    v6b0NonCriticalExtensions  SEQUENCE {
                        handoverToUTRANCommand-v6b0ext  HandoverToUTRANCommand-v6b0ext-IEs,
                        nonCriticalExtensions  SEQUENCE {} OPTIONAL
                    } OPTIONAL
                },
                criticalExtensions  CHOICE {
                    r7             SEQUENCE {
                        handoverToUTRANCommand-r7  HandoverToUTRANCommand-r7-IEs,
                        v780NonCriticalExtensions  SEQUENCE {
                            handoverToUTRANCommand-v780ext  HandoverToUTRANCommand-v780ext-IEs,
                            v820NonCriticalExtensions  SEQUENCE {
                                handoverToUTRANCommand-v820ext  HandoverToUTRANCommand-v820ext-IEs,
                                v7d0NonCriticalExtensions  SEQUENCE {
                                    handoverToUTRANCommand-v7d0ext
                                        HandoverToUTRANCommand-v7d0ext-IEs,
                                    nonCriticalExtensions  SEQUENCE {} OPTIONAL
                                } OPTIONAL
                            } OPTIONAL
                        } OPTIONAL
                    } OPTIONAL
                },
                criticalExtensions  SEQUENCE {}
            }
        },
        criticalExtensions          SEQUENCE {}
    }
}

HandoverToUTRANCommand-r3-IEs ::= SEQUENCE {
    -- User equipment IEs
    new-U-RNTI                    U-RNTI-Short,
    -- dummy is not used in this version of specification, it should
    -- not be sent and if received it should be ignored.
    dummy                          ActivationTime          OPTIONAL,
    cipheringAlgorithm             CipheringAlgorithm      OPTIONAL,
    -- Radio bearer IEs
    -- Specification mode information
    specificationMode              CHOICE {
        complete                   SEQUENCE {
            srb-InformationSetupList  SRB-InformationSetupList,
            rab-InformationSetupList  RAB-InformationSetupList      OPTIONAL,
            ul-CommonTransChInfo     UL-CommonTransChInfo,
        }
    }
}

```

```

    ul-AddReconfTransChInfoList      UL-AddReconfTransChInfoList,
    dl-CommonTransChInfo             DL-CommonTransChInfo,
    dl-AddReconfTransChInfoList      DL-AddReconfTransChInfoList,
    ul-DPCH-Info                     UL-DPCH-Info,
    modeSpecificInfo                  CHOICE {
        fdd                            SEQUENCE {
            -- dummy and dummy2 are not used in this version of specification,
            -- they should not be sent and if received they should be ignored.
            dummy                        DL-PDSCH-Information OPTIONAL,
            dummy2                       CPCH-SetInfo          OPTIONAL
        },
        tdd                            NULL
    },
    dl-CommonInformation              DL-CommonInformation,
    dl-InformationPerRL-List          DL-InformationPerRL-List,
    frequencyInfo                     FrequencyInfo
},
preconfiguration                     SEQUENCE {
-- All IEs that include an FDD/TDD choice are split in two IEs for this message,
-- one for the FDD only elements and one for the TDD only elements, so that one
-- FDD/TDD choice in this level is sufficient.
    preConfigMode                     CHOICE {
        predefinedConfigIdentity        PredefinedConfigIdentity,
        defaultConfig                   SEQUENCE {
            defaultConfigMode           DefaultConfigMode,
            defaultConfigIdentity       DefaultConfigIdentity
        }
    },
    rab-Info                           RAB-Info-Post          OPTIONAL,
    modeSpecificInfo                    CHOICE {
        fdd                             SEQUENCE {
            ul-DPCH-Info                 UL-DPCH-InfoPostFDD,
            dl-CommonInformationPost     DL-CommonInformationPost,
            dl-InformationPerRL-List     DL-InformationPerRL-ListPostFDD,
            frequencyInfo                FrequencyInfoFDD
        },
        tdd                             SEQUENCE {
            ul-DPCH-Info                 UL-DPCH-InfoPostTDD,
            dl-CommonInformationPost     DL-CommonInformationPost,
            dl-InformationPerRL          DL-InformationPerRL-PostTDD,
            frequencyInfo                FrequencyInfoTDD,
            primaryCCPCH-TX-Power       PrimaryCCPCH-TX-Power
        }
    }
},
},
-- Physical channel IEs
    maxAllowedUL-TX-Power              MaxAllowedUL-TX-Power
}

HandoverToUTRANCommand-r4-IEs ::= SEQUENCE {
-- User equipment IEs
    new-U-RNTI                         U-RNTI-Short,
    cipheringAlgorithm                  CipheringAlgorithm          OPTIONAL,
-- Radio bearer IEs
-- Specification mode information
    specificationMode                   CHOICE {
        complete                         SEQUENCE {
            srb-InformationSetupList     SRB-InformationSetupList,
            rab-InformationSetupList     RAB-InformationSetupList-r4    OPTIONAL,
            ul-CommonTransChInfo        UL-CommonTransChInfo-r4,
            ul-AddReconfTransChInfoList UL-AddReconfTransChInfoList,
            dl-CommonTransChInfo        DL-CommonTransChInfo-r4,
            dl-AddReconfTransChInfoList DL-AddReconfTransChInfoList-r4,
            ul-DPCH-Info                 UL-DPCH-Info-r4,
            modeSpecificInfo             CHOICE {
                fdd                       SEQUENCE {
                    -- dummy and dummy2 are not used in this version of specification,
                    -- they should not be sent and if received they should be ignored.
                    dummy                 DL-PDSCH-Information OPTIONAL,
                    dummy2                CPCH-SetInfo          OPTIONAL
                },
                tdd                       NULL
            }
        },
        dl-CommonInformation              DL-CommonInformation-r4,
        dl-InformationPerRL-List          DL-InformationPerRL-List-r4,
        frequencyInfo                     FrequencyInfo
    },
},

```



```

preconfiguration SEQUENCE {
-- All IEs that include an FDD/TDD choice are split in two IEs for this message,
-- one for the FDD only elements and one for the TDD only elements, so that one
-- FDD/TDD choice in this level is sufficient.
preConfigMode CHOICE {
predefinedConfigIdentity PredefinedConfigIdentity,
defaultConfig SEQUENCE {
defaultConfigMode DefaultConfigMode,
defaultConfigIdentity DefaultConfigIdentity-r4
}
},
rab-Info RAB-Info-Post OPTIONAL,
modeSpecificInfo CHOICE {
fdd SEQUENCE {
ul-DPCH-Info UL-DPCH-InfoPostFDD,
dl-CommonInformationPost DL-CommonInformationPost,
dl-InformationPerRL-List DL-InformationPerRL-ListPostFDD,
frequencyInfo FrequencyInfoFDD
},
tdd CHOICE {
tdd384 SEQUENCE {
ul-DPCH-Info UL-DPCH-InfoPostTDD,
dl-InformationPerRL DL-InformationPerRL-PostTDD,
frequencyInfo FrequencyInfoTDD,
primaryCCPCH-TX-Power PrimaryCCPCH-TX-Power
},
tdd128 SEQUENCE {
ul-DPCH-Info UL-DPCH-InfoPostTDD-LCR-r4,
dl-InformationPerRL DL-InformationPerRL-PostTDD-LCR-r4,
frequencyInfo FrequencyInfoTDD,
primaryCCPCH-TX-Power PrimaryCCPCH-TX-Power
}
}
}
},
-- Physical channel IEs
maxAllowedUL-TX-Power MaxAllowedUL-TX-Power
}

HandoverToUTRANCommand-r5-IEs ::= SEQUENCE {
-- User equipment IEs
new-U-RNTI U-RNTI-Short,
cipheringAlgorithm CipheringAlgorithm OPTIONAL,
-- Radio bearer IEs
-- Specification mode information
specificationMode CHOICE {
complete SEQUENCE {
srb-InformationSetupList SRB-InformationSetupList-r5,
rab-InformationSetupList RAB-InformationSetupList-r5 OPTIONAL,
ul-CommonTransChInfo UL-CommonTransChInfo-r4,
ul-AddReconfTransChInfoList UL-AddReconfTransChInfoList,
dl-CommonTransChInfo DL-CommonTransChInfo-r4,
dl-AddReconfTransChInfoList DL-AddReconfTransChInfoList-r5,
ul-DPCH-Info UL-DPCH-Info-r5,
modeSpecificInfo CHOICE {
fdd SEQUENCE {
-- dummy and dummy2 are not used in this version of specification,
-- they should not be sent and if received they should be ignored.
dummy DL-PDSCH-Information OPTIONAL,
dummy2 CPCH-SetInfo OPTIONAL
},
tdd NULL
},
dl-CommonInformation DL-CommonInformation-r4,
dl-InformationPerRL-List DL-InformationPerRL-List-r5,
frequencyInfo FrequencyInfo
},
preconfiguration SEQUENCE {
-- All IEs that include an FDD/TDD choice are split in two IEs for this message,
-- one for the FDD only elements and one for the TDD only elements, so that one
-- FDD/TDD choice in this level is sufficient.
preConfigMode CHOICE {
predefinedConfigIdentity PredefinedConfigIdentity,
defaultConfig SEQUENCE {
defaultConfigMode DefaultConfigMode,
defaultConfigIdentity DefaultConfigIdentity-r5
}
}
}
}

```

```

    },
    rab-Info
    modeSpecificInfo
        fdd
            ul-DPCH-Info
            dl-CommonInformationPost
            dl-InformationPerRL-List
            frequencyInfo
        },
        tdd
            tdd384
                ul-DPCH-Info
                dl-InformationPerRL
                frequencyInfo
                primaryCCPCH-TX-Power
            },
            tdd128
                ul-DPCH-Info
                dl-InformationPerRL
                frequencyInfo
                primaryCCPCH-TX-Power
            }
        }
    },
    -- Physical channel IEs
    maxAllowedUL-TX-Power
}

HandoverToUTRANCommand-r6-IEs ::= SEQUENCE {
-- User equipment IEs
new-U-RNTI
    U-RNTI-Short,
cipheringAlgorithm
    CipheringAlgorithm
    OPTIONAL,
-- Radio bearer IEs
-- Specification mode information
specificationMode
    CHOICE {
        complete
            SEQUENCE {
                srb-InformationSetupList
                    SRB-InformationSetupList-r6,
                rab-InformationSetupList
                    RAB-InformationSetupList-r6
                    OPTIONAL,
                ul-CommonTransChInfo
                    UL-CommonTransChInfo-r4,
                ul-AddReconfTransChInfoList
                    UL-AddReconfTransChInfoList-r6,
                dl-CommonTransChInfo
                    DL-CommonTransChInfo-r4,
                dl-AddReconfTransChInfoList
                    DL-AddReconfTransChInfoList-r5,
                ul-DPCH-Info
                    UL-DPCH-Info-r6,
                ul-EDCH-Information
                    UL-EDCH-Information-r6
                    OPTIONAL,
                dl-HSPDSCH-Information
                    DL-HSPDSCH-Information-r6
                    OPTIONAL,
                dl-CommonInformation
                    DL-CommonInformation-r6,
                dl-InformationPerRL-List
                    DL-InformationPerRL-List-r6,
                frequencyInfo
                    FrequencyInfo
            },
        preconfiguration
            SEQUENCE {
                -- All IEs that include an FDD/TDD choice are split in two IEs for this message,
                -- one for the FDD only elements and one for the TDD only elements, so that one
                -- FDD/TDD choice in this level is sufficient.
                preConfigMode
                    CHOICE {
                        predefinedConfigIdentity
                            PredefinedConfigIdentity,
                        defaultConfig
                            SEQUENCE {
                                defaultConfigMode
                                    DefaultConfigMode,
                                defaultConfigIdentity
                                    DefaultConfigIdentity-r6
                            }
                    },
                rab-Info
                    RAB-Info-Post
                    OPTIONAL,
                modeSpecificInfo
                    CHOICE {
                        fdd
                            SEQUENCE {
                                ul-DPCH-Info
                                    UL-DPCH-InfoPostFDD,
                                dl-CommonInformationPost
                                    DL-CommonInformationPost,
                                dl-InformationPerRL-List
                                    DL-InformationPerRL-ListPostFDD,
                                frequencyInfo
                                    FrequencyInfoFDD
                            },
                        tdd
                            CHOICE {
                                tdd384
                                    SEQUENCE {
                                        ul-DPCH-Info
                                            UL-DPCH-InfoPostTDD,
                                        dl-InformationPerRL
                                            DL-InformationPerRL-PostTDD,
                                        frequencyInfo
                                            FrequencyInfoTDD,
                                        primaryCCPCH-TX-Power
                                            PrimaryCCPCH-TX-Power
                                    },
                                tdd128
                                    SEQUENCE {

```

```

        ul-DPCH-Info                UL-DPCH-InfoPostTDD-LCR-r4,
        dl-InformationPerRL          DL-InformationPerRL-PostTDD-LCR-r4,
        frequencyInfo                FrequencyInfoTDD,
        primaryCCPCH-TX-Power        PrimaryCCPCH-TX-Power
    }
}
},
-- Physical channel IEs
    maxAllowedUL-TX-Power            MaxAllowedUL-TX-Power
}

HandoverToUTRANCommand-v6b0ext-IEs ::= SEQUENCE {
    ue-hspa-identities                UE-HSPA-Identities-r6    OPTIONAL
}

HandoverToUTRANCommand-r7-IEs ::= SEQUENCE {
    -- User equipment IEs
    new-U-RNTI                        U-RNTI-Short,
    cipheringAlgorithm                 CipheringAlgorithm-r7    OPTIONAL,
    supportForChangeOfUE-Capability    BOOLEAN,
    new-H-RNTI                         H-RNTI                OPTIONAL,
    newPrimary-E-RNTI                  E-RNTI                OPTIONAL,
    newSecondary-E-RNTI                 E-RNTI                OPTIONAL,
    -- Radio bearer IEs
    -- Specification mode information
    specificationMode                  CHOICE {
        complete                        SEQUENCE {
            srb-InformationSetupList    SRB-InformationSetupList-r7,
            rab-InformationSetupList    RAB-InformationSetupList-r7    OPTIONAL,
            ul-CommonTransChInfo        UL-CommonTransChInfo-r4,
            ul-AddReconfTransChInfoList UL-AddReconfTransChInfoList-r7,
            dl-CommonTransChInfo        DL-CommonTransChInfo-r4,
            dl-AddReconfTransChInfoList DL-AddReconfTransChInfoList-r7,
            ul-DPCH-Info                 UL-DPCH-Info-r7,
            ul-EDCH-Information          UL-EDCH-Information-r7    OPTIONAL,
            dl-HSPDSCH-Information       DL-HSPDSCH-Information-r7    OPTIONAL,
            dl-CommonInformation         DL-CommonInformation-r7,
            dl-InformationPerRL-List     DL-InformationPerRL-List-r7,
            frequencyInfo                FrequencyInfo,
            multi-frequencyInfo          Multi-frequencyInfo-LCR-r7    OPTIONAL
        },
        preconfiguration                SEQUENCE {
            -- All IEs that include an FDD/TDD choice are split in two IEs for this message,
            -- one for the FDD only elements and one for the TDD only elements, so that one
            -- FDD/TDD choice in this level is sufficient.
            preConfigMode                CHOICE {
                predefinedConfigIdentity PredefinedConfigIdentity,
                defaultConfig            SEQUENCE {
                    defaultConfigMode    DefaultConfigMode,
                    defaultConfigIdentity DefaultConfigIdentity-r6
                }
            },
            rab-Info                      RAB-Info-Post            OPTIONAL,
            modeSpecificInfo              CHOICE {
                fdd                        SEQUENCE {
                    ul-DPCH-Info           UL-DPCH-InfoPostFDD,
                    dl-CommonInformationPost DL-CommonInformationPost,
                    dl-InformationPerRL-List DL-InformationPerRL-ListPostFDD,
                    frequencyInfo          FrequencyInfoFDD
                },
                tdd                        CHOICE {
                    tdd384                 SEQUENCE {
                        ul-DPCH-Info        UL-DPCH-InfoPostTDD,
                        dl-InformationPerRL DL-InformationPerRL-PostTDD,
                        frequencyInfo        FrequencyInfoTDD,
                        primaryCCPCH-TX-Power PrimaryCCPCH-TX-Power
                    },
                    tdd128                 SEQUENCE {
                        ul-DPCH-Info        UL-DPCH-Info-r7,
                        dl-InformationPerRL DL-InformationPerRL-PostTDD-LCR-r4,
                        frequencyInfo        FrequencyInfoTDD,
                        primaryCCPCH-TX-Power PrimaryCCPCH-TX-Power,
                        multi-frequencyInfo Multi-frequencyInfo-LCR-r7    OPTIONAL
                    },
                    tdd768                 SEQUENCE {
                        ul-DPCH-Info        UL-DPCH-Info-r7,

```

```

        dl-InformationPerRL          DL-InformationPerRL-List-r7,
        frequencyInfo                FrequencyInfoTDD,
        primaryCCPCH-TX-Power         PrimaryCCPCH-TX-Power
    }
}
},
-- Physical channel IEs
    maxAllowedUL-TX-Power            MaxAllowedUL-TX-Power
}

HandoverToUTRANCommand-v780ext-IEs ::= SEQUENCE {
    -- Physical channel IEs
    hs-DSCH-TBSizeTable              HS-DSCH-TBSizeTable          OPTIONAL
}

HandoverToUTRANCommand-v7d0ext-IEs ::= SEQUENCE {
    -- Physical channel IEs
    ul-EDCH-Information              UL-EDCH-Information-ext      OPTIONAL
}

HandoverToUTRANCommand-v820ext-IEs ::= SEQUENCE {
    -- Radio bearer IEs
    -- 'dummy' is reserved to ensure compatibility with future v820 extension. It shall
    -- be ignored by a UE not having support for the v820 feature.
    dummy                             RAB-InformationSetupList-v820ext  OPTIONAL
}

-- *****
--
-- HANDOVER TO UTRAN COMPLETE
--
-- *****

HandoverToUTRANComplete ::= SEQUENCE {
    --TABULAR: Integrity protection shall not be performed on this message.
    -- User equipment IEs
    -- TABULAR: startList is conditional on history.
    startList                          STARTList                    OPTIONAL,
    -- Radio bearer IEs
    count-C-ActivationTime              ActivationTime              OPTIONAL,
    laterNonCriticalExtensions           SEQUENCE {
        -- Container for additional R99 extensions
        handoverToUTRANComplete-r3-add-ext  BIT STRING OPTIONAL,
        nonCriticalExtensions               SEQUENCE {}              OPTIONAL
    } OPTIONAL
}

-- *****
--
-- INITIAL DIRECT TRANSFER
--
-- *****

InitialDirectTransfer ::= SEQUENCE {
    -- Core network IEs
    cn-DomainIdentity                  CN-DomainIdentity,
    intraDomainNasNodeSelector          IntraDomainNasNodeSelector,
    nas-Message                          NAS-Message,
    -- Measurement IEs
    measuredResultsOnRACH                MeasuredResultsOnRACH      OPTIONAL,
    v3a0NonCriticalExtensions            SEQUENCE {
        initialDirectTransfer-v3a0ext        InitialDirectTransfer-v3a0ext,
        laterNonCriticalExtensions           SEQUENCE {
            -- Container for additional R99 extensions
            initialDirectTransfer-r3-add-ext  BIT STRING
                (CONTAINING InitialDirectTransfer-r3-add-ext-IEs)  OPTIONAL,
            v590NonCriticalExtensions        SEQUENCE {
                initialDirectTransfer-v590ext  InitialDirectTransfer-v590ext,
                v690NonCriticalExtensions     SEQUENCE {
                    initialDirectTransfer-v690ext  InitialDirectTransfer-v690ext-IEs,
                    v770NonCriticalExtensions     SEQUENCE {
                        initialDirectTransfer-v770ext  InitialDirectTransfer-v770ext-IEs,
                        nonCriticalExtensions         SEQUENCE {}              OPTIONAL
                    } OPTIONAL
                } OPTIONAL
            } OPTIONAL
        } OPTIONAL
    } OPTIONAL
}

```

```

    } OPTIONAL
  } OPTIONAL
}

InitialDirectTransfer-v3a0ext ::= SEQUENCE {
  -- start-value shall always be included in this version of the protocol
  start-Value          START-Value          OPTIONAL
}

InitialDirectTransfer-v590ext ::= SEQUENCE {
  establishmentCause  EstablishmentCause  OPTIONAL
}

InitialDirectTransfer-v690ext-IEs ::= SEQUENCE {
  -- Core network IEs
  plmn-Identity          PLMN-Identity          OPTIONAL,
  -- Measurement IEs
  measuredResultsOnRACHinterFreq  MeasuredResultsOnRACHinterFreq  OPTIONAL,
  -- MBMS IEs
  mbms-JoinedInformation  MBMS-JoinedInformation-r6  OPTIONAL
}

InitialDirectTransfer-v770ext-IEs ::= SEQUENCE {
  csCallType          ENUMERATED { speech, video, other, spare }  OPTIONAL
}

InitialDirectTransfer-r3-add-ext-IEs ::= SEQUENCE {
  initialDirectTransfer-v7g0ext          InitialDirectTransfer-v7g0ext-IEs,
  nonCriticalExtensions          SEQUENCE {}  OPTIONAL
}

InitialDirectTransfer-v7g0ext-IEs ::= SEQUENCE {
  -- Measurement IEs
  measuredResultsOnRACH-v7g0ext          MeasuredResultsOnRACH-v7g0ext  OPTIONAL
}

-- *****
--
-- HANDOVER FROM UTRAN COMMAND
--
-- *****

HandoverFromUTRANCommand-GSM ::= CHOICE {
  r3          SEQUENCE {
    handoverFromUTRANCommand-GSM-r3
    HandoverFromUTRANCommand-GSM-r3-IEs,
    -- UTRAN should not include the IE laterNonCriticalExtensions when it sets the IE
    -- gsm-message included in handoverFromUTRANCommand-GSM-r3 to single-GSM-Message. The UE
    -- behaviour upon receiving a message with this combination of IE values is unspecified.
    laterNonCriticalExtensions          SEQUENCE {
      -- Container for additional R99 extensions
      handoverFromUTRANCommand-GSM-r3-add-ext  BIT STRING  OPTIONAL,
      -- UTRAN may apply the r3 version of the message to perform PS handover
      -- for a single RAB only
      v690NonCriticalExtensions          SEQUENCE {
        handoverFromUTRANCommand-GSM-v690ext  HandoverFromUTRANCommand-GSM-v690ext-IEs,
        nonCriticalExtensions          SEQUENCE {}  OPTIONAL
      }  OPTIONAL
    }  OPTIONAL
  },
  later-than-r3          SEQUENCE {
    rrc-TransactionIdentifier          RRC-TransactionIdentifier,
    criticalExtensions          CHOICE {
      r6          SEQUENCE {
        handoverFromUTRANCommand-GSM-r6          HandoverFromUTRANCommand-GSM-r6-IEs,
        handoverFromUTRANCommand-GSM-r6-add-ext  BIT STRING  OPTIONAL,
        nonCriticalExtensions          SEQUENCE {}  OPTIONAL
      },
      criticalExtensions          SEQUENCE {}
    }
  }
}

HandoverFromUTRANCommand-GSM-r3-IEs ::= SEQUENCE {
  -- User equipment IEs
  rrc-TransactionIdentifier          RRC-TransactionIdentifier,
  activationTime          ActivationTime          OPTIONAL,
  -- Radio bearer IEs
  toHandoverRAB-Info          RAB-Info          OPTIONAL,

```

```

-- Measurement IEs
  frequency-band          Frequency-Band,
-- Other IEs
  gsm-message             CHOICE {
  -- In the single-GSM-Message case the following rules apply:
  -- 1> the GSM message directly follows the basic production; the final padding that
  --    results when PER encoding the abstract syntax value is removed prior to appending
  --    the GSM message.
  -- 2> the RRC message excluding the GSM part, does not contain a length determinant;
  --    there is no explicit parameter indicating the size of the included GSM message.
  -- 3> depending on need, final padding (all "0"s) is added to ensure the final result
  --    comprises a full number of octets
  single-GSM-Message      SEQUENCE {},
  gsm-MessageList         SEQUENCE {
    gsm-Messages          GSM-MessageList
  }
}

HandoverFromUTRANCommand-GSM-r6-IEs ::= SEQUENCE {
  -- User equipment IEs
  activationTime          ActivationTime          OPTIONAL,
  -- Radio bearer IEs
  toHandoverRAB-Info     RAB-InformationList-r6  OPTIONAL,
  -- Measurement IEs
  frequency-band         Frequency-Band,
  -- Other IEs
  gsm-message            CHOICE {
  -- In the single-GSM-Message case the following rules apply:
  -- 1> the GSM message directly follows the basic production; the final padding that
  --    results when PER encoding the abstract syntax value is removed prior to appending
  --    the GSM message.
  -- 2> the RRC message excluding the GSM part, does not contain a length determinant;
  --    there is no explicit parameter indicating the size of the included GSM message.
  -- 3> depending on need, final padding (all "0"s) is added to ensure the final result
  --    comprises a full number of octets
  single-GSM-Message      SEQUENCE {},
  gsm-MessageList         SEQUENCE {
    gsm-Messages          GSM-MessageList
  }
},
  geran-SystemInfoType   CHOICE {
    sI                    GERAN-SystemInformation,
    pSI                   GERAN-SystemInformation
  } OPTIONAL
}

HandoverFromUTRANCommand-GSM-v690ext-IEs ::= SEQUENCE {
  geran-SystemInfoType   CHOICE {
    sI                    GERAN-SystemInformation,
    pSI                   GERAN-SystemInformation
  } OPTIONAL
}

HandoverFromUTRANCommand-GERANIu ::= SEQUENCE {
  rrc-TransactionIdentifier RRC-TransactionIdentifier,
  handoverFromUTRANCommand-GERANIu CHOICE {
    r5                    SEQUENCE {
      handoverFromUTRANCommand-GERANIu-r5
      HandoverFromUTRANCommand-GERANIu-r5-IEs,
      -- UTRAN should not include the IE nonCriticalExtensions when it sets
      -- the IE geranIu-message included in handoverFromUTRANCommand-GERANIu-r5 to
      -- single-GERANIu-Message
      -- The UE behaviour upon receiving a message including this combination of IE values is
      -- not specified
      nonCriticalExtensions SEQUENCE {} OPTIONAL
    },
    later-than-r5          SEQUENCE {
      criticalExtensions   SEQUENCE {}
    }
  }
}

HandoverFromUTRANCommand-GERANIu-r5-IEs ::= SEQUENCE {
  -- User equipment IEs
  activationTime          ActivationTime          OPTIONAL,
  -- Measurement IEs
  frequency-Band         Frequency-Band,

```

```

-- Other IEs
geranIu-Message CHOICE {
-- In the single-GERANIu-Message case the following rules apply:
-- 1> the GERAN Iu message directly follows the basic production; the final padding that
-- results when PER encoding the abstract syntax value is removed prior to appending
-- the GERAN Iu message.
-- 2> the RRC message excluding the GERAN Iu part does not contain a length determinant;
-- there is no explicit parameter indicating the size of the included GERAN Iu
-- message.
-- 3> depending on need, final padding (all "0"s) is added to ensure the final result
-- comprises a full number of octets.
single-GERANIu-Message SEQUENCE {},
geranIu-MessageList SEQUENCE {
    geranIu-Messages GERANIu-MessageList
}
}

HandoverFromUTRANCommand-CDMA2000 ::= CHOICE {
    r3 SEQUENCE {
        handoverFromUTRANCommand-CDMA2000-r3
        HandoverFromUTRANCommand-CDMA2000-r3-IEs,
        laterNonCriticalExtensions SEQUENCE {
            -- Container for additional R99 extensions
            handoverFromUTRANCommand-CDMA2000-r3-add-ext
                BIT STRING OPTIONAL,
            nonCriticalExtensions SEQUENCE {} OPTIONAL
        } OPTIONAL,
        later-than-r3 SEQUENCE {
            rrc-TransactionIdentifier RRC-TransactionIdentifier,
            criticalExtensions SEQUENCE {}
        }
    }

HandoverFromUTRANCommand-CDMA2000-r3-IEs ::= SEQUENCE {
    -- User equipment IEs
    rrc-TransactionIdentifier RRC-TransactionIdentifier,
    activationTime ActivationTime OPTIONAL,
    -- Radio bearer IEs
    toHandoverRAB-Info RAB-Info OPTIONAL,
    -- Other IEs
    cdma2000-MessageList CDMA2000-MessageList
}

-- *****
--
-- HANDOVER FROM UTRAN FAILURE
--
-- *****

HandoverFromUTRANFailure ::= SEQUENCE {
    -- User equipment IEs
    rrc-TransactionIdentifier RRC-TransactionIdentifier,
    -- Other IEs
    interRAT-HO-FailureCause InterRAT-HO-FailureCause OPTIONAL,
    -- In case the interRATMessage to be transferred is for GERAN Iu mode, the
    -- message should be placed in the HandoverFromUtranFailure-v590ext-IEs
    -- non-critical extension container.
    interRATMessage CHOICE {
        gsm SEQUENCE {
            gsm-MessageList GSM-MessageList
        },
        cdma2000 SEQUENCE {
            cdma2000-MessageList CDMA2000-MessageList
        }
    } OPTIONAL,
    laterNonCriticalExtensions SEQUENCE {
        -- Container for additional R99 extensions
        handoverFromUTRANFailure-r3-add-ext BIT STRING OPTIONAL,
        v590NonCriticalExtensions SEQUENCE {
            handoverFromUTRANFailure-v590ext HandoverFromUtranFailure-v590ext-IEs,
            nonCriticalExtensions SEQUENCE {} OPTIONAL
        } OPTIONAL
    } OPTIONAL
}

HandoverFromUtranFailure-v590ext-IEs ::= SEQUENCE {

```

```

    geranIu-MessageList                GERANIu-MessageList                OPTIONAL
  }

-- *****
--
-- INTER RAT HANDOVER INFO
--
-- *****

InterRATHandoverInfo ::= SEQUENCE {
  -- This structure is defined for historical reasons, backward compatibility with 44.018
  predefinedConfigStatusList          CHOICE {
    absent                             NULL,
    present                             PredefinedConfigStatusList
  },
  ue-SecurityInformation              CHOICE {
    absent                             NULL,
    present                             UE-SecurityInformation
  },
  ue-CapabilityContainer              CHOICE {
    absent                             NULL,
    -- present is an octet aligned string containing IE UE-RadioAccessCapabilityInfo
    present                             OCTET STRING (SIZE (0..63))
  },
  -- Non critical extensions
  v390NonCriticalExtensions          CHOICE {
    absent                             NULL,
    present                             SEQUENCE {
      interRATHandoverInfo-v390ext    InterRATHandoverInfo-v390ext-IEs,
      v3a0NonCriticalExtensions        SEQUENCE {
        interRATHandoverInfo-v3a0ext    InterRATHandoverInfo-v3a0ext-IEs,
        laterNonCriticalExtensions      SEQUENCE {
          interRATHandoverInfo-v3d0ext    InterRATHandoverInfo-v3d0ext-IEs,
          -- Container for additional R99 extensions
          interRATHandoverInfo-r3-add-ext    BIT STRING
            (CONTAINING InterRATHandoverInfo-r3-add-ext-IEs)    OPTIONAL,
          v3g0NonCriticalExtensions      SEQUENCE {
            interRATHandoverInfo-v3g0ext    InterRATHandoverInfo-v3g0ext-IEs,
            v4b0NonCriticalExtensions      SEQUENCE {
              interRATHandoverInfo-v4b0ext    InterRATHandoverInfo-v4b0ext-IEs,
              v4d0NonCriticalExtensions      SEQUENCE {
                interRATHandoverInfo-v4d0ext    InterRATHandoverInfo-v4d0ext-IEs,
                -- Reserved for future non critical extension
                v590NonCriticalExtensions      SEQUENCE {
                  interRATHandoverInfo-v590ext
                    InterRATHandoverInfo-v590ext-IEs,
                  v690NonCriticalExtensions      SEQUENCE {
                    interRATHandoverInfo-v690ext
                      InterRATHandoverInfo-v690ext-IEs,
                    v6b0NonCriticalExtensions      SEQUENCE {
                      interRATHandoverInfo-v6b0ext
                        InterRATHandoverInfo-v6b0ext-IEs,
                      v6e0NonCriticalExtensions      SEQUENCE {
                        interRATHandoverInfo-v6e0ext
                          InterRATHandoverInfo-v6e0ext-IEs,
                        v770NonCriticalExtensions      SEQUENCE {
                          interRATHandoverInfo-v770ext
                            InterRATHandoverInfo-v770ext-IEs,
                          v790nonCriticalExtensions      SEQUENCE {
                            interRATHandoverInfo-v790ext
                              InterRATHandoverInfo-v790ext-IEs,
                            nonCriticalExtensions      SEQUENCE {} OPTIONAL
                          } OPTIONAL
                        } OPTIONAL
                      } OPTIONAL
                    } OPTIONAL
                  } OPTIONAL
                } OPTIONAL
              } OPTIONAL
            } OPTIONAL
          } OPTIONAL
        } OPTIONAL
      } OPTIONAL
    } OPTIONAL
  } OPTIONAL
}

InterRATHandoverInfo-v390ext-IEs ::= SEQUENCE {

```



```

-- User equipment IEs
  ue-RadioAccessCapability-v380ext    UE-RadioAccessCapability-v380ext    OPTIONAL,
  dl-PhysChCapabilityFDD-v380ext      DL-PhysChCapabilityFDD-v380ext
}

InterRATHandoverInfo-v3a0ext-IEs ::= SEQUENCE {
  -- User equipment IEs
  ue-RadioAccessCapability-v3a0ext    UE-RadioAccessCapability-v3a0ext    OPTIONAL
}

InterRATHandoverInfo-v3d0ext-IEs ::= SEQUENCE {
  -- User equipment IEs
  uESpecificBehaviourInformation1interRAT    UESpecificBehaviourInformation1interRAT
  OPTIONAL
}

InterRATHandoverInfo-v3g0ext-IEs ::= SEQUENCE {
  -- User equipment IEs
  ue-RadioAccessCapability-v3g0ext    UE-RadioAccessCapability-v3g0ext    OPTIONAL
}

InterRATHandoverInfo-r3-add-ext-IEs ::= SEQUENCE {
  interRATHandoverInfo-v690ext1        InterRATHandoverInfo-v690ext1-IEs,
  v7e0NonCriticalExtensions            SEQUENCE {
    interRATHandoverInfo-v7e0ext        InterRATHandoverInfo-v7e0ext-IEs,
    v7f0NonCriticalExtensions            SEQUENCE {
      interRATHandoverInfo-v7f0ext      InterRATHandoverInfo-v7f0ext-IEs,
      nonCriticalExtensions              SEQUENCE {}    OPTIONAL
    }    OPTIONAL
  }    OPTIONAL
}

InterRATHandoverInfo-v4b0ext-IEs ::= SEQUENCE {
  -- User equipment IEs
  accessStratumReleaseIndicator        AccessStratumReleaseIndicator
}

InterRATHandoverInfo-v4d0ext-IEs ::= SEQUENCE {
  -- User equipment IEs
  tdd128-RF-Capability                  RadioFrequencyBandTDDList    OPTIONAL
}

InterRATHandoverInfo-v590ext-IEs ::= SEQUENCE {
  -- User equipment IEs
  predefinedConfigStatusListComp        PredefinedConfigStatusListComp    OPTIONAL,
  ue-RadioAccessCapabilityComp          UE-RadioAccessCapabilityComp    OPTIONAL
}

InterRATHandoverInfo-v690ext1-IEs ::= SEQUENCE {
  -- User equipment IEs
  ue-RadioAccessCapability-v650ext      UE-RadioAccessCapability-v650ext    OPTIONAL
}

InterRATHandoverInfo-v690ext-IEs ::= SEQUENCE {
  -- User equipment IEs
  ue-SecurityInformation2                UE-SecurityInformation2    OPTIONAL,
  ue-RadioAccessCapabilityComp          UE-RadioAccessCapabilityComp-ext    OPTIONAL,
  ue-RadioAccessCapabilityComp2        UE-RadioAccessCapabilityComp2
}

InterRATHandoverInfo-v6b0ext-IEs ::= SEQUENCE {
  -- User equipment IEs
  supportForSIB11bis                    ENUMERATED { true }    OPTIONAL
}

InterRATHandoverInfo-v6e0ext-IEs ::= SEQUENCE {
  -- User equipment IEs
  supportForFDPCH                        ENUMERATED { true }    OPTIONAL
}

InterRATHandoverInfo-v770ext-IEs ::= SEQUENCE {
  ue-RadioAccessCapabilityInfo          UE-RadioAccessCapabilityInfo-v770ext    OPTIONAL,
  ue-RadioAccessCapabilityComp          UE-RadioAccessCapabilityComp-v770ext    OPTIONAL,
  ue-RadioAccessCapabilityComp2        UE-RadioAccessCapabilityComp2-v770ext    OPTIONAL
}

InterRATHandoverInfo-v790ext-IEs ::= SEQUENCE {
  -- User equipment IEs

```

```

    supportForEDPCCHPowerBoosting                ENUMERATED { true }        OPTIONAL
}

InterRATHandoverInfo-v7e0ext-IEs ::= SEQUENCE {
  -- User equipment IEs
  ue-RadioAccessCapability                      UE-RadioAccessCapability-v7e0ext    OPTIONAL
}

InterRATHandoverInfo-v7f0ext-IEs ::= SEQUENCE {
  -- User equipment IEs
  ue-RadioAccessCapability                      UE-RadioAccessCapability-v7f0ext    OPTIONAL,
  ue-RadioAccessCapabilityComp2                UE-RadioAccessCapabilityComp2-v7f0ext  OPTIONAL
}

-- *****
--
-- MEASUREMENT CONTROL
--
-- *****

MeasurementControl ::= CHOICE {
  -- The Rel-4 functionality of UE Positioning OTDOA AssistanceData TDD is only available
  -- in the later-than-r3 branch of this message (i.e. through the use of the IE
  -- ue-Positioning-OTDOA-AssistanceData-r4)
  r3 SEQUENCE {
    measurementControl-r3                      MeasurementControl-r3-IEs,
    v390nonCriticalExtensions                  SEQUENCE {
      measurementControl-v390ext              MeasurementControl-v390ext,
      v3a0NonCriticalExtensions                SEQUENCE {
        measurementControl-v3a0ext            MeasurementControl-v3a0ext,
        laterNonCriticalExtensions            SEQUENCE {
          -- Container for additional R99 extensions
          measurementControl-r3-add-ext        BIT STRING OPTIONAL,
          v4b0NonCriticalExtensions            SEQUENCE{
            -- The content of the v4b0 non-critical extension has been removed. If sent
            -- to a UE of AS release 4, the UE behaviour is unspecified. A UE of AS
            -- release 5 onward shall comply with the v4b0 and later extensions in this
            -- branch of the message.
            v590NonCriticalExtensions          SEQUENCE {
              measurementControl-v590ext        MeasurementControl-v590ext-IEs,
              v5b0NonCriticalExtensions          SEQUENCE {
                measurementControl-v5b0ext        MeasurementControl-v5b0ext-IEs,
                nonCriticalExtensions            SEQUENCE {} OPTIONAL
              } OPTIONAL
            } OPTIONAL
          } OPTIONAL
        } OPTIONAL
      } OPTIONAL
    } OPTIONAL
  },
  later-than-r3 SEQUENCE {
    rrc-TransactionIdentifier                  RRC-TransactionIdentifier,
    criticalExtensions                         CHOICE {
      r4 SEQUENCE {
        measurementControl-r4                  MeasurementControl-r4-IEs,
        v4d0NonCriticalExtensions              SEQUENCE {
          -- Container for adding non critical extensions after freezing REL-5
          measurementControl-r4-add-ext        BIT STRING OPTIONAL,
          v590NonCriticalExtensions            SEQUENCE{
            measurementControl-v590ext          MeasurementControl-v590ext-IEs,
            v5b0NonCriticalExtensions            SEQUENCE {
              measurementControl-v5b0ext        MeasurementControl-v5b0ext-IEs,
              nonCriticalExtensions            SEQUENCE {} OPTIONAL
            } OPTIONAL
          } OPTIONAL
        } OPTIONAL
      } OPTIONAL
    } OPTIONAL
  },
  later-than-r4 SEQUENCE {
    -- Most significant part of "RRC transaction identifier" (MSP),
    -- "RRC transaction identifier" = rrc-TransactionIdentifier-MSP * 4 +
    -- rrc-TransactionIdentifier
    rrc-TransactionIdentifier-MSP              RRC-TransactionIdentifier,
    criticalExtensions                         CHOICE {
      r6 SEQUENCE {
        measurementControl-r6                  MeasurementControl-r6-IEs,
        v6a0NonCriticalExtensions              SEQUENCE {
          measurementControl-v6a0ext            MeasurementControl-v6a0ext-IEs,
          nonCriticalExtensions                SEQUENCE {} OPTIONAL
        }
      }
    }
  }
}

```

```
    } OPTIONAL
  },
  criticalExtensions CHOICE {
    r7 SEQUENCE {
      measurementControl-r7 MeasurementControl-r7-IEs,
      -- Container for adding non critical extensions after freezing REL-7
      measurementControl-r7-add-ext BIT STRING OPTIONAL,
      v7b0NonCriticalExtensions SEQUENCE {
        measurementControl-v7b0ext MeasurementControl-v7b0ext-IEs,
        nonCriticalExtensions SEQUENCE {} OPTIONAL
      } OPTIONAL
    },
    criticalExtensions SEQUENCE {}
  }
}

MeasurementControl-r3-IEs ::= SEQUENCE {
  -- User equipment IEs
  rrc-TransactionIdentifier RRC-TransactionIdentifier,
  -- Measurement IEs
  measurementIdentity MeasurementIdentity,
  -- TABULAR: The measurement type is included in MeasurementCommand.
  measurementCommand MeasurementCommand,
  measurementReportingMode MeasurementReportingMode OPTIONAL,
  additionalMeasurementList AdditionalMeasurementID-List OPTIONAL,
  -- Physical channel IEs
  dpch-CompressedModeStatusInfo DPCH-CompressedModeStatusInfo OPTIONAL
}

MeasurementControl-v390ext ::= SEQUENCE {
  ue-Positioning-Measurement-v390ext UE-Positioning-Measurement-v390ext OPTIONAL
}

MeasurementControl-v3a0ext ::= SEQUENCE {
  sfn-Offset-Validity SFN-Offset-Validity OPTIONAL
}

MeasurementControl-r4-IEs ::= SEQUENCE {
  -- Measurement IEs
  measurementIdentity MeasurementIdentity,
  -- TABULAR: The measurement type is included in measurementCommand.
  measurementCommand MeasurementCommand-r4,
  measurementReportingMode MeasurementReportingMode OPTIONAL,
  additionalMeasurementList AdditionalMeasurementID-List OPTIONAL,
  -- Physical channel IEs
  dpch-CompressedModeStatusInfo DPCH-CompressedModeStatusInfo OPTIONAL
}

MeasurementControl-v590ext-IEs ::= SEQUENCE {
  measurementCommand-v590ext CHOICE {
    -- the choice "intra-frequency" shall be used for the case of intra-frequency measurement,
    -- as well as when intra-frequency events are configured for inter-frequency measurement
    intra-frequency Intra-FreqEventCriteriaList-v590ext,
    inter-frequency Inter-FreqEventCriteriaList-v590ext
  } OPTIONAL,
  intraFreqReportingCriteria-1b-r5 IntraFreqReportingCriteria-1b-r5 OPTIONAL,
  intraFreqEvent-1d-r5 IntraFreqEvent-1d-r5 OPTIONAL,
  -- most significant part of "RRC transaction identifier" (MSP),
  -- "RRC transaction identifier" = rrc-TransactionIdentifier-MSP-v590ext * 4 +
  -- rrc-TransactionIdentifier
  rrc-TransactionIdentifier-MSP-v590ext RRC-TransactionIdentifier
}

MeasurementControl-v5b0ext-IEs ::= SEQUENCE {
  interRATCellInfoIndication InterRATCellInfoIndication OPTIONAL
}

MeasurementControl-r6-IEs ::= SEQUENCE {
  -- Measurement IEs
  measurementIdentity MeasurementIdentity,
  -- TABULAR: The measurement type is included in measurementCommand.
  measurementCommand MeasurementCommand-r6,
  measurementReportingMode MeasurementReportingMode OPTIONAL,
  additionalMeasurementList AdditionalMeasurementID-List OPTIONAL,

```

```

-- Physical channel IEs
  dpch-CompressedModeStatusInfo  DPCH-CompressedModeStatusInfo  OPTIONAL
}

MeasurementControl-v6a0ext-IEs ::= SEQUENCE {
  intraFreqReportingCriteria-1b-r5  IntraFreqReportingCriteria-1b-r5  OPTIONAL
}

MeasurementControl-r7-IEs ::= SEQUENCE {
  -- Measurement IEs
  measurementIdentity  MeasurementIdentity,
  -- TABULAR: The measurement type is included in measurementCommand.
  measurementCommand  MeasurementCommand-r7,
  measurementReportingMode  MeasurementReportingMode  OPTIONAL,
  additionalMeasurementList  AdditionalMeasurementID-List  OPTIONAL,
  -- Physical channel IEs
  dpch-CompressedModeStatusInfo  DPCH-CompressedModeStatusInfo  OPTIONAL
}

MeasurementControl-v7b0ext-IEs ::= SEQUENCE {
  -- Measurement IEs
  newInterFreqCellList  NewInterFreqCellList-v7b0ext  OPTIONAL
}

-- *****
--
-- MEASUREMENT CONTROL FAILURE
--
-- *****

MeasurementControlFailure ::= SEQUENCE {
  -- User equipment IEs
  rrc-TransactionIdentifier  RRC-TransactionIdentifier,
  failureCause  FailureCauseWithProtErr,
  laterNonCriticalExtensions  SEQUENCE {
    -- Container for additional R99 extensions
    measurementControlFailure-r3-add-ext  BIT STRING  OPTIONAL,
    v590NonCriticalExtensions  SEQUENCE {
      measurementControlFailure-v590ext  MeasurementControlFailure-v590ext-IEs,
      nonCriticalExtensions  SEQUENCE {}  OPTIONAL
    }  OPTIONAL
  }  OPTIONAL
}

MeasurementControlFailure-v590ext-IEs ::= SEQUENCE {
  -- most significant part of "RRC transaction identifier" (MSP),
  -- "RRC transaction identifier" = rrc-TransactionIdentifier-MSP-v590ext * 4 +
  -- rrc-TransactionIdentifier
  -- If the rrc-TransactionIdentifier-MSP-v590ext was not received in the MEASUREMENT CONTROL
  -- message, then the rrc-TransactionIdentifier-MSP-v590ext shall be set to zero
  rrc-TransactionIdentifier-MSP-v590ext  RRC-TransactionIdentifier
}

-- *****
--
-- MEASUREMENT REPORT
--
-- *****

MeasurementReport ::= SEQUENCE {
  -- Measurement IEs
  measurementIdentity  MeasurementIdentity,
  measuredResults  MeasuredResults  OPTIONAL,
  measuredResultsOnRACH  MeasuredResultsOnRACH  OPTIONAL,
  additionalMeasuredResults  MeasuredResultsList  OPTIONAL,
  eventResults  EventResults  OPTIONAL,
  -- Non-critical extensions
  v390nonCriticalExtensions  SEQUENCE {
    measurementReport-v390ext  MeasurementReport-v390ext,
    laterNonCriticalExtensions  SEQUENCE {
      -- Container for additional R99 extensions
      measurementReport-r3-add-ext  BIT STRING  OPTIONAL,
      v4b0NonCriticalExtensions  SEQUENCE {
        measurementReport-v4b0ext  MeasurementReport-v4b0ext-IEs,
        -- Extension mechanism for non-Rel4 information
        v590NonCriticalExtensions  SEQUENCE {
          measurementReport-v590ext  MeasurementReport-v590ext-IEs,

```

```

        v5b0NonCriticalExtensions SEQUENCE {
            measurementReport-v5b0ext MeasurementReport-v5b0ext-IEs,
            v690NonCriticalExtensions SEQUENCE {
                measurementReport-v690ext MeasurementReport-v690ext-IEs,
                v770NonCriticalExtensions SEQUENCE {
                    measurementReport-v770ext MeasurementReport-v770ext-IEs,
                    nonCriticalExtensions SEQUENCE {} OPTIONAL
                } OPTIONAL
            } OPTIONAL
        } OPTIONAL
    } OPTIONAL
}

MeasurementReport-v390ext ::= SEQUENCE {
    measuredResults-v390ext MeasuredResults-v390ext OPTIONAL
}

MeasurementReport-v4b0ext-IEs ::= SEQUENCE {
    interFreqEventResults-LCR InterFreqEventResults-LCR-r4-ext OPTIONAL,
    -- additionalMeasuredResults-LCR shall contain measurement results and additional measurement
    -- results list.
    additionalMeasuredResults-LCR MeasuredResultsList-LCR-r4-ext OPTIONAL,
    -- dummy is not used in this version of the specification. It should not be sent and
    -- if received it should be ignored.
    dummy PrimaryCPICH-Info OPTIONAL
}

MeasurementReport-v590ext-IEs ::= SEQUENCE {
    measuredResults-v590ext MeasuredResults-v590ext OPTIONAL
}

MeasurementReport-v5b0ext-IEs ::= SEQUENCE {
    interRATCellInfoIndication InterRATCellInfoIndication OPTIONAL
}

MeasurementReport-v690ext-IEs ::= SEQUENCE {
    measuredResultsOnRACHinterFreq MeasuredResultsOnRACHinterFreq OPTIONAL
}

MeasurementReport-v770ext-IEs ::= SEQUENCE {
    measuredResults MeasuredResults-v770ext OPTIONAL,
    additionalMeasuredResults MeasuredResultsList-v770ext OPTIONAL,
    eventResults EventResults-v770ext OPTIONAL,
    ue-Positioning-OTDOA-MeasuredResults UE-Positioning-OTDOA-MeasuredResultsTDD-ext OPTIONAL
}

-- *****
--
-- PAGING TYPE 1
--
-- *****

PagingType1 ::= SEQUENCE {
    -- User equipment IEs
    pagingRecordList PagingRecordList OPTIONAL,
    -- Other IEs
    bcch-ModificationInfo BCCH-ModificationInfo OPTIONAL,
    laterNonCriticalExtensions SEQUENCE {
        -- Container for additional R99 extensions
        pagingType1-r3-add-ext BIT STRING OPTIONAL,
        v590NonCriticalExtensions SEQUENCE {
            pagingType1-v590ext PagingType1-v590ext-IEs,
            nonCriticalExtensions SEQUENCE {} OPTIONAL
        } OPTIONAL
    } OPTIONAL
}

PagingType1-v590ext-IEs ::= SEQUENCE {
    -- User equipment IEs
    pagingRecord2List PagingRecord2List-r5 OPTIONAL
}

-- *****
--

```

```

-- PAGING TYPE 2
--
-- *****

PagingType2 ::= SEQUENCE {
  -- User equipment IEs
  rrc-TransactionIdentifier    RRC-TransactionIdentifier,
  pagingCause                  PagingCause,
  -- Core network IEs
  cn-DomainIdentity           CN-DomainIdentity,
  pagingRecordTypeID          PagingRecordTypeID,
  laterNonCriticalExtensions   SEQUENCE {
    -- Container for additional R99 extensions
    pagingType2-r3-add-ext     BIT STRING      OPTIONAL,
    nonCriticalExtensions      SEQUENCE {}      OPTIONAL
  } OPTIONAL
}

-- *****
--
-- PHYSICAL CHANNEL RECONFIGURATION
--
-- *****

PhysicalChannelReconfiguration ::= CHOICE {
  r3
    physicalChannelReconfiguration-r3
      PhysicalChannelReconfiguration-r3-IEs,
      v3a0NonCriticalExtensions SEQUENCE {
        physicalChannelReconfiguration-v3a0ext PhysicalChannelReconfiguration-v3a0ext,
        laterNonCriticalExtensions SEQUENCE {
          -- Container for additional R99 extensions
          physicalChannelReconfiguration-r3-add-ext BIT STRING      OPTIONAL,
          v4b0NonCriticalExtensions SEQUENCE {
            physicalChannelReconfiguration-v4b0ext
              PhysicalChannelReconfiguration-v4b0ext-IEs,
            v590NonCriticalExtensions SEQUENCE {
              physicalChannelReconfiguration-v590ext
                PhysicalChannelReconfiguration-v590ext-IEs,
            v690NonCriticalExtensions SEQUENCE {
              physicalChannelReconfiguration-v690ext
                PhysicalChannelReconfiguration-v690ext-IEs,
            v770NonCriticalExtensions SEQUENCE {
              physicalChannelReconfiguration-v770ext
                PhysicalChannelReconfiguration-v770ext-IEs,
              nonCriticalExtensions SEQUENCE {} OPTIONAL
            } OPTIONAL
          } OPTIONAL
        } OPTIONAL
      } OPTIONAL
    },
  later-than-r3
    SEQUENCE {
      rrc-TransactionIdentifier RRC-TransactionIdentifier,
      criticalExtensions CHOICE {
        r4
          SEQUENCE {
            physicalChannelReconfiguration-r4
              PhysicalChannelReconfiguration-r4-IEs,
            v4d0NonCriticalExtensions SEQUENCE {
              -- Container for adding non critical extensions after freezing REL-5
              physicalChannelReconfiguration-r4-add-ext BIT STRING      OPTIONAL,
              v590NonCriticalExtensions SEQUENCE {
                physicalChannelReconfiguration-v590ext
                  PhysicalChannelReconfiguration-v590ext-IEs,
              v690NonCriticalExtensions SEQUENCE {
                physicalChannelReconfiguration-v690ext
                  PhysicalChannelReconfiguration-v690ext-IEs,
              v770NonCriticalExtensions SEQUENCE {
                physicalChannelReconfiguration-v770ext
                  PhysicalChannelReconfiguration-v770ext-IEs,
                nonCriticalExtensions SEQUENCE {} OPTIONAL
              } OPTIONAL
            } OPTIONAL
          } OPTIONAL
        } OPTIONAL
      } OPTIONAL
    },
  criticalExtensions CHOICE {

```

```

r5
    SEQUENCE {
    physicalChannelReconfiguration-r5
        PhysicalChannelReconfiguration-r5-IEs,
    -- Container for adding non critical extensions after freezing REL-6
    physicalChannelReconfiguration-r5-add-ext BIT STRING OPTIONAL,
    v690NonCriticalExtensions SEQUENCE {
        physicalChannelReconfiguration-v690ext
            PhysicalChannelReconfiguration-v690ext-IEs,
        v770NonCriticalExtensions SEQUENCE {
            physicalChannelReconfiguration-v770ext
                PhysicalChannelReconfiguration-v770ext-IEs,
            nonCriticalExtensions SEQUENCE {} OPTIONAL
        } OPTIONAL
    } OPTIONAL
},
criticalExtensions CHOICE {
    r6
        SEQUENCE {
        physicalChannelReconfiguration-r6
            PhysicalChannelReconfiguration-r6-IEs,
        -- Container for adding non critical extensions after freezing REL-7
        physicalChannelReconfiguration-r6-add-ext BIT STRING OPTIONAL,
        v6b0NonCriticalExtensions SEQUENCE {
            physicalChannelReconfiguration-v6b0ext
                PhysicalChannelReconfiguration-v6b0ext-IEs,
            v770NonCriticalExtensions SEQUENCE {
                physicalChannelReconfiguration-v770ext
                    PhysicalChannelReconfiguration-v770ext-IEs,
                nonCriticalExtensions SEQUENCE {} OPTIONAL
            } OPTIONAL
        } OPTIONAL
    },
    criticalExtensions CHOICE {
        r7
            SEQUENCE {
            physicalChannelReconfiguration-r7
                PhysicalChannelReconfiguration-r7-IEs,
            -- Container for adding non critical extensions after freezing REL-8
            physicalChannelReconfiguration-r7-add-ext BIT STRING OPTIONAL,
            v780NonCriticalExtensions SEQUENCE {
                physicalChannelReconfiguration-v780ext
                    PhysicalChannelReconfiguration-v780ext-IEs,
                v7d0NonCriticalExtensions SEQUENCE {
                    physicalChannelReconfiguration-v7d0ext
                        PhysicalChannelReconfiguration-v7d0ext-IEs,
                    v7f0NonCriticalExtensions SEQUENCE {
                        physicalChannelReconfiguration-v7f0ext
                            PhysicalChannelReconfiguration-v7f0ext-IEs,
                        v7g0NonCriticalExtensions SEQUENCE {
                            physicalChannelReconfiguration-v7g0ext
                                PhysicalChannelReconfiguration-v7g0ext-IEs,
                            nonCriticalExtensions SEQUENCE {} OPTIONAL
                        } OPTIONAL
                    } OPTIONAL
                } OPTIONAL
            } OPTIONAL
        },
        criticalExtensions SEQUENCE {}
    }
}
}
}
}
}
}
}

PhysicalChannelReconfiguration-r3-IEs ::= SEQUENCE {
    -- User equipment IEs
    rrc-TransactionIdentifier RRC-TransactionIdentifier,
    integrityProtectionModeInfo IntegrityProtectionModeInfo OPTIONAL,
    cipheringModeInfo CipheringModeInfo OPTIONAL,
    activationTime ActivationTime OPTIONAL,
    new-U-RNTI U-RNTI OPTIONAL,
    new-C-RNTI C-RNTI OPTIONAL,
    rrc-StateIndicator RRC-StateIndicator,
    utran-DRX-CycleLengthCoeff UTRAN-DRX-CycleLengthCoefficient OPTIONAL,
    -- Core network IEs
    cn-InformationInfo CN-InformationInfo OPTIONAL,
    -- UTRAN mobility IEs
    ura-Identity URA-Identity OPTIONAL,
    -- Radio bearer IEs

```

```

    dl-CounterSynchronisationInfo DL-CounterSynchronisationInfo OPTIONAL,
-- Physical channel IEs
    frequencyInfo FrequencyInfo OPTIONAL,
    maxAllowedUL-TX-Power MaxAllowedUL-TX-Power OPTIONAL,
-- Note: the reference to CPCH in the element name below is incorrect. The name is not
-- changed to keep it aligned with R99.
    ul-ChannelRequirement UL-ChannelRequirementWithCPCH-SetID OPTIONAL,
    modeSpecificInfo CHOICE {
        fdd SEQUENCE {
            -- dummy is not used in this version of specification, it should
            -- not be sent and if received it should be ignored.
            dummy DL-PDSCH-Information OPTIONAL
        },
        tdd NULL
    },
    dl-CommonInformation DL-CommonInformation OPTIONAL,
    dl-InformationPerRL-List DL-InformationPerRL-List OPTIONAL
}

PhysicalChannelReconfiguration-v3a0ext ::= SEQUENCE {
-- The IE "new-DSCH-RNTI" should not be included in FDD mode, and if received the UE behaviour
-- is unspecified
    new-DSCH-RNTI DSCH-RNTI OPTIONAL
}

PhysicalChannelReconfiguration-v4b0ext-IEs ::= SEQUENCE {
-- Physical channel IEs
-- dummy is not used in this version of the specification, it should
-- not be sent and if received it should be ignored.
    dummy SSDT-UL OPTIONAL,
-- The order of the RLs in IE cell-id-PerRL-List is the same as
-- in IE DL-InformationPerRL-List included in this message
    cell-id-PerRL-List CellIdentity-PerRL-List OPTIONAL
}

PhysicalChannelReconfiguration-v590ext-IEs ::= SEQUENCE {
-- Physical channel IEs
    dl-TPC-PowerOffsetPerRL-List DL-TPC-PowerOffsetPerRL-List OPTIONAL
}

PhysicalChannelReconfiguration-r4-IEs ::= SEQUENCE {
-- User equipment IEs
    integrityProtectionModeInfo IntegrityProtectionModeInfo OPTIONAL,
    cipheringModeInfo CipheringModeInfo OPTIONAL,
    activationTime ActivationTime OPTIONAL,
    new-U-RNTI U-RNTI OPTIONAL,
    new-C-RNTI C-RNTI OPTIONAL,
-- The IE "new-DSCH-RNTI" should not be included in FDD mode, and if received
-- the UE behaviour is unspecified
    new-DSCH-RNTI DSCH-RNTI OPTIONAL,
    rrc-StateIndicator RRC-StateIndicator,
    utran-DRX-CycleLengthCoeff UTRAN-DRX-CycleLengthCoefficient OPTIONAL,
-- Core network IEs
    cn-InformationInfo CN-InformationInfo OPTIONAL,
-- UTRAN mobility IEs
    ura-Identity URA-Identity OPTIONAL,
-- Radio bearer IEs
    dl-CounterSynchronisationInfo DL-CounterSynchronisationInfo OPTIONAL,
-- Physical channel IEs
    frequencyInfo FrequencyInfo OPTIONAL,
    maxAllowedUL-TX-Power MaxAllowedUL-TX-Power OPTIONAL,
-- Note: the reference to CPCH in the element name below is incorrect. The name is not
-- changed to keep it aligned with R99.
    ul-ChannelRequirement UL-ChannelRequirementWithCPCH-SetID-r4 OPTIONAL,
    modeSpecificInfo CHOICE {
        fdd SEQUENCE {
            -- dummy is not used in this version of specification, it should
            -- not be sent and if received it should be ignored.
            dummy DL-PDSCH-Information OPTIONAL
        },
        tdd NULL
    },
    dl-CommonInformation DL-CommonInformation-r4 OPTIONAL,
    dl-InformationPerRL-List DL-InformationPerRL-List-r4 OPTIONAL
}

PhysicalChannelReconfiguration-r5-IEs ::= SEQUENCE {
-- User equipment IEs

```



```

integrityProtectionModeInfo    IntegrityProtectionModeInfo    OPTIONAL,
cipheringModeInfo              CipheringModeInfo                OPTIONAL,
activationTime                  ActivationTime                     OPTIONAL,
new-U-RNTI                      U-RNTI                           OPTIONAL,
new-C-RNTI                      C-RNTI                           OPTIONAL,
-- The IE "new-DSCH-RNTI" should not be included in FDD mode, and if received
-- the UE behaviour is unspecified
new-DSCH-RNTI                  DSCH-RNTI                        OPTIONAL,
new-H-RNTI                      H-RNTI                           OPTIONAL,
rrc-StateIndicator              RRC-StateIndicator,
utran-DRX-CycleLengthCoeff      UTRAN-DRX-CycleLengthCoefficient  OPTIONAL,
-- Core network IEs
  cn-InformationInfo            CN-InformationInfo                OPTIONAL,
-- UTRAN mobility IEs
  ura-Identity                  URA-Identity                      OPTIONAL,
-- Radio bearer IEs
  dl-CounterSynchronisationInfo DL-CounterSynchronisationInfo-r5  OPTIONAL,
-- Physical channel IEs
  frequencyInfo                 FrequencyInfo                      OPTIONAL,
  maxAllowedUL-TX-Power         MaxAllowedUL-TX-Power             OPTIONAL,
-- Note: the reference to CPCH in the element name below is incorrect. The name is not
-- changed to keep it aligned with R99.
  ul-ChannelRequirement         UL-ChannelRequirementWithCPCH-SetID-r5  OPTIONAL,
  modeSpecificInfo              CHOICE {
    fdd                          SEQUENCE {
      -- dummy is not used in this version of specification, it should
      -- not be sent and if received it should be ignored.
      dummy                      DL-PDSCH-Information              OPTIONAL
    },
    tdd                          NULL
  },
  dl-HSPDSCH-Information        DL-HSPDSCH-Information            OPTIONAL,
  dl-CommonInformation          DL-CommonInformation-r5           OPTIONAL,
  dl-InformationPerRL-List      DL-InformationPerRL-List-r5       OPTIONAL
}

```

```

PhysicalChannelReconfiguration-r6-IEs ::= SEQUENCE {
-- User equipment IEs
  integrityProtectionModeInfo    IntegrityProtectionModeInfo    OPTIONAL,
  cipheringModeInfo              CipheringModeInfo                OPTIONAL,
  activationTime                  ActivationTime                     OPTIONAL,
  delayRestrictionFlag            DelayRestrictionFlag              OPTIONAL,
  new-U-RNTI                      U-RNTI                           OPTIONAL,
  new-C-RNTI                      C-RNTI                           OPTIONAL,
-- The IE "new-DSCH-RNTI" should not be included in FDD mode,
-- and if received the UE behaviour is unspecified
  new-DSCH-RNTI                  DSCH-RNTI                        OPTIONAL,
  new-H-RNTI                      H-RNTI                           OPTIONAL,
  newPrimary-E-RNTI              E-RNTI                           OPTIONAL,
  newSecondary-E-RNTI            E-RNTI                           OPTIONAL,
  rrc-StateIndicator              RRC-StateIndicator,
  utran-DRX-CycleLengthCoeff      UTRAN-DRX-CycleLengthCoefficient  OPTIONAL,
-- Core network IEs
  cn-InformationInfo            CN-InformationInfo-r6            OPTIONAL,
-- UTRAN mobility IEs
  ura-Identity                  URA-Identity                      OPTIONAL,
-- Radio bearer IEs
  dl-CounterSynchronisationInfo DL-CounterSynchronisationInfo-r5  OPTIONAL,
-- Physical channel IEs
  frequencyInfo                 FrequencyInfo                      OPTIONAL,
  maxAllowedUL-TX-Power         MaxAllowedUL-TX-Power             OPTIONAL,
  ul-DPCH-Info                  UL-DPCH-Info-r6                  OPTIONAL,
  ul-EDCH-Information            UL-EDCH-Information-r6           OPTIONAL,
  dl-HSPDSCH-Information        DL-HSPDSCH-Information-r6        OPTIONAL,
  dl-CommonInformation          DL-CommonInformation-r6           OPTIONAL,
  dl-InformationPerRL-List      DL-InformationPerRL-List-r6       OPTIONAL,
-- MBMS IEs
  mbms-PL-ServiceRestrictInfo    MBMS-PL-ServiceRestrictInfo-r6  OPTIONAL
}

```

```

PhysicalChannelReconfiguration-v690ext-IEs ::= SEQUENCE {
-- User Equipment IEs
  delayRestrictionFlag            DelayRestrictionFlag              OPTIONAL,
-- Core network IEs
  primary-plmn-Identity          PLMN-Identity                    OPTIONAL,
-- Physical channel IEs
  -- The IE harq-Preamble-Mode should not be used in the r3 and r4 versions of the message
  -- If included in the r3 or r4 version of the message, the UE should ignore the IE

```

```

    harq-Preamble-Mode          HARQ-Preamble-Mode          OPTIONAL,
    beaconPLEst                 BEACON-PL-Est                 OPTIONAL,
    postVerificationPeriod      ENUMERATED { true }        OPTIONAL,
    dhs-sync                    DHS-Sync                    OPTIONAL,
    timingMaintainedSynchInd    TimingMaintainedSynchInd  OPTIONAL,
-- MBMS IEs
    mbms-PL-ServiceRestrictInfo MBMS-PL-ServiceRestrictInfo-r6 OPTIONAL
}

PhysicalChannelReconfiguration-v6b0ext-IEs ::= SEQUENCE {
-- Physical channel IEs
    dl-InformationPerRL-List-v6b0ext    DL-InformationPerRL-List-v6b0ext    OPTIONAL
}

PhysicalChannelReconfiguration-r7-IEs ::= SEQUENCE {
-- User equipment IEs
    integrityProtectionModeInfo    IntegrityProtectionModeInfo-r7    OPTIONAL,
    cipheringModeInfo              CipheringModeInfo-r7              OPTIONAL,
    activationTime                  ActivationTime                      OPTIONAL,
    delayRestrictionFlag            DelayRestrictionFlag              OPTIONAL,
    new-U-RNTI                      U-RNTI                            OPTIONAL,
    new-C-RNTI                      C-RNTI                            OPTIONAL,
-- The IE "new-DSCH-RNTI" should not be included in FDD mode,
-- and if received the UE behaviour is unspecified
    new-DSCH-RNTI                  DSCH-RNTI                          OPTIONAL,
    new-H-RNTI                      H-RNTI                            OPTIONAL,
    newPrimary-E-RNTI              E-RNTI                            OPTIONAL,
    newSecondary-E-RNTI            E-RNTI                            OPTIONAL,
    rrc-StateIndicator              RRC-StateIndicator,
    ueMobilityStateIndicator        High-MobilityDetected             OPTIONAL,
    utran-DRX-CycleLengthCoeff     UTRAN-DRX-CycleLengthCoefficient-r7 OPTIONAL,
-- Core network IEs
    cn-InformationInfo              CN-InformationInfo-r6             OPTIONAL,
-- UTRAN mobility IEs
    ura-Identity                    URA-Identity                      OPTIONAL,
    supportForChangeOfUE-Capability BOOLEAN                          OPTIONAL,
    responseToChangeOfUE-Capability ENUMERATED { true }        OPTIONAL,
-- Radio bearer IEs
    dl-CounterSynchronisationInfo  DL-CounterSynchronisationInfo-r5  OPTIONAL,
-- Physical channel IEs
    frequencyInfo                  FrequencyInfo                      OPTIONAL,
    multi-frequencyInfo            Multi-frequencyInfo-LCR-r7        OPTIONAL,
    dtx-drx-TimingInfo             DTX-DRX-TimingInfo-r7            OPTIONAL,
    dtx-drx-Info                   DTX-DRX-Info-r7                  OPTIONAL,
    hs-scch-LessInfo               HS-SCCH-LessInfo-r7              OPTIONAL,
    mimoParameters                 MIMO-Parameters-r7              OPTIONAL,
    maxAllowedUL-TX-Power           MaxAllowedUL-TX-Power            OPTIONAL,
    ul-DPCH-Info                   UL-DPCH-Info-r7                  OPTIONAL,
    ul-EDCH-Information             UL-EDCH-Information-r7           OPTIONAL,
    dl-HSPDSCH-Information          DL-HSPDSCH-Information-r7        OPTIONAL,
    dl-CommonInformation            DL-CommonInformation-r7          OPTIONAL,
    dl-InformationPerRL-List        DL-InformationPerRL-List-r7      OPTIONAL,
-- MBMS IEs
    mbms-PL-ServiceRestrictInfo    MBMS-PL-ServiceRestrictInfo-r6  OPTIONAL
}

PhysicalChannelReconfiguration-v770ext-IEs ::= SEQUENCE {
-- User equipment IEs
    ueMobilityStateIndicator        High-MobilityDetected             OPTIONAL
}

PhysicalChannelReconfiguration-v780ext-IEs ::= SEQUENCE {
-- Physical channel IEs
    harqInfo                        HARQ-Info-r7                      OPTIONAL,
    hs-DSCH-TBSizeTable             HS-DSCH-TBSizeTable              OPTIONAL
}

PhysicalChannelReconfiguration-v7d0ext-IEs ::= SEQUENCE {
-- Physical channel IEs
    ul-EDCH-Information             UL-EDCH-Information-ext           OPTIONAL
}

PhysicalChannelReconfiguration-v7f0ext-IEs ::= SEQUENCE {
-- Physical channel IEs
    mimoParameters                 MIMO-Parameters-v7f0ext          OPTIONAL
}

PhysicalChannelReconfiguration-v7g0ext-IEs ::= SEQUENCE {

```

```

-- Physical channel IEs
  mimoParameters                MIMO-Parameters-v7g0ext                OPTIONAL
}
-- *****
--
-- PHYSICAL CHANNEL RECONFIGURATION COMPLETE
--
-- *****

PhysicalChannelReconfigurationComplete ::= SEQUENCE {
  -- User equipment IEs
  rrc-TransactionIdentifier      RRC-TransactionIdentifier,
  ul-IntegProtActivationInfo     IntegrityProtActivationInfo    OPTIONAL,
  -- TABULAR: UL-TimingAdvance is applicable for TDD mode only.
  ul-TimingAdvance              UL-TimingAdvance                    OPTIONAL,
  -- Radio bearer IEs
  count-C-ActivationTime        ActivationTime                    OPTIONAL,
  -- dummy is not used in this version of the specification and
  -- it should be ignored by the receiver.
  dummy                          RB-ActivationTimeInfoList    OPTIONAL,
  ul-CounterSynchronisationInfo UL-CounterSynchronisationInfo  OPTIONAL,
  laterNonCriticalExtensions     SEQUENCE {
    -- Container for additional R99 extensions
    physicalChannelReconfigurationComplete-r3-add-ext    BIT STRING    OPTIONAL,
    v770NonCriticalExtensions                             SEQUENCE {
      physicalChannelReconfigurationComplete-v770ext
      PhysicalChannelReconfigurationComplete-v770ext-IEs,
      nonCriticalExtensions                             SEQUENCE {}    OPTIONAL
    }    OPTIONAL
  }    OPTIONAL
}

PhysicalChannelReconfigurationComplete-v770ext-IEs ::= SEQUENCE {
  -- TABULAR: EXT-UL-TimingAdvance is applicable for TDD mode only.
  ext-UL-TimingAdvance          EXT-UL-TimingAdvance    OPTIONAL,
  deferredMeasurementControlReading    ENUMERATED { true }    OPTIONAL
}

-- *****
--
-- PHYSICAL CHANNEL RECONFIGURATION FAILURE
--
-- *****

PhysicalChannelReconfigurationFailure ::= SEQUENCE {
  -- User equipment IEs
  rrc-TransactionIdentifier      RRC-TransactionIdentifier    OPTIONAL,
  failureCause                  FailureCauseWithProtErr,
  laterNonCriticalExtensions     SEQUENCE {
    -- Container for additional R99 extensions
    physicalChannelReconfigurationFailure-r3-add-ext    BIT STRING    OPTIONAL,
    nonCriticalExtensions         SEQUENCE {}    OPTIONAL
  }    OPTIONAL
}

-- *****
--
-- PHYSICAL SHARED CHANNEL ALLOCATION (TDD only)
--
-- *****

PhysicalSharedChannelAllocation ::= CHOICE {
  r3                             SEQUENCE {
    physicalSharedChannelAllocation-r3
    PhysicalSharedChannelAllocation-r3-IEs,
    laterNonCriticalExtensions    SEQUENCE {
      -- Container for additional R99 extensions
      physicalSharedChannelAllocation-r3-add-ext    BIT STRING    OPTIONAL,
      nonCriticalExtensions         SEQUENCE {}    OPTIONAL
    }    OPTIONAL
  },
  later-than-r3                  SEQUENCE {
    dsch-RNTI                    DSCH-RNTI                    OPTIONAL,
    rrc-TransactionIdentifier      RRC-TransactionIdentifier,
    criticalExtensions             CHOICE {
      r4                          SEQUENCE {

```

```

    physicalSharedChannelAllocation-r4
    v4d0NonCriticalExtensions      PhysicalSharedChannelAllocation-r4-IEs,
                                  SEQUENCE {
      -- Container for adding non critical extensions after freezing REL-5
      physicalSharedChannelAllocation-r4-add-ext      BIT STRING      OPTIONAL,
      v690NonCriticalExtensions      SEQUENCE {
        physicalSharedChannelAllocation-v690ext
        v770NonCriticalExtensions      SEQUENCE {
          PhysicalSharedChannelAllocation-v690ext-IEs,
          physicalSharedChannelAllocation-v770ext
          nonCriticalExtensions      SEQUENCE {}      OPTIONAL
        }
      }
    }
  },
  criticalExtensions      SEQUENCE {}
}
}

PhysicalSharedChannelAllocation-r3-IEs ::= SEQUENCE {
  -- TABULAR: Integrity protection shall not be performed on this message.
  -- User equipment IEs
  dsch-RNTI      DSCH-RNTI      OPTIONAL,
  rrc-TransactionIdentifier      RRC-TransactionIdentifier,
  -- Physical channel IEs
  ul-TimingAdvance      UL-TimingAdvanceControl      OPTIONAL,
  pusch-CapacityAllocationInfo      PUSCH-CapacityAllocationInfo      OPTIONAL,
  pdsch-CapacityAllocationInfo      PDSCH-CapacityAllocationInfo      OPTIONAL,
  -- TABULAR: If confirmRequest is not present, the default value "No Confirm"
  -- shall be used as specified in 10.2.25.
  confirmRequest      ENUMERATED {
    confirmPDSCH, confirmPUSCH }      OPTIONAL,
  trafficVolumeReportRequest      INTEGER (0..255)      OPTIONAL,
  iscpTimeslotList      TimeslotList      OPTIONAL,
  requestPCCPCHRSCP      BOOLEAN
}

PhysicalSharedChannelAllocation-r4-IEs ::= SEQUENCE {
  -- TABULAR: Integrity protection shall not be performed on this message.
  -- Physical channel IEs
  ul-TimingAdvance      UL-TimingAdvanceControl-r4      OPTIONAL,
  pusch-CapacityAllocationInfo      PUSCH-CapacityAllocationInfo-r4      OPTIONAL,
  pdsch-CapacityAllocationInfo      PDSCH-CapacityAllocationInfo-r4      OPTIONAL,
  -- TABULAR: If confirmRequest is not present, the default value "No Confirm"
  -- shall be used as specified in 10.2.25.
  confirmRequest      ENUMERATED {
    confirmPDSCH, confirmPUSCH }      OPTIONAL,
  trafficVolumeReportRequest      INTEGER (0..255)      OPTIONAL,
  iscpTimeslotList      TimeslotList-r4      OPTIONAL,
  requestPCCPCHRSCP      BOOLEAN
}

PhysicalSharedChannelAllocation-v690ext-IEs ::= SEQUENCE {
  -- Physical Channel IEs
  beaconPLEst      BEACON-PL-Est      OPTIONAL
}

PhysicalSharedChannelAllocation-v770ext-IEs ::= SEQUENCE {
  ul-TimingAdvance      UL-TimingAdvanceControl-r7      OPTIONAL,
  pusch-CapacityAllocationInfo      PUSCH-CapacityAllocationInfo-r7      OPTIONAL,
  pdsch-CapacityAllocationInfo      PDSCH-CapacityAllocationInfo-r7      OPTIONAL
}

-- *****
--
-- PUSCH CAPACITY REQUEST (TDD only)
--
-- *****

PUSCHCapacityRequest ::= SEQUENCE {
  -- User equipment IEs
  dsch-RNTI      DSCH-RNTI      OPTIONAL,
  -- Measurement IEs
  trafficVolume      TrafficVolumeMeasuredResultsList      OPTIONAL,
  timeslotListWithISCP      TimeslotListWithISCP      OPTIONAL,
  primaryCCPCH-RSCP      PrimaryCCPCH-RSCP      OPTIONAL,

```

```

allocationConfirmation CHOICE {
  pdschConfirmation PDSCH-Identity,
  pusSchConfirmation PUSCH-Identity
}
} OPTIONAL,
protocolErrorIndicator ProtocolErrorIndicatorWithMoreInfo,
laterNonCriticalExtensions SEQUENCE {
  -- Container for additional R99 extensions
  pusSchCapacityRequest-r3-add-ext BIT STRING OPTIONAL,
  v590NonCriticalExtensions SEQUENCE {
    pusSchCapacityRequest-v590ext PUSCHCapacityRequest-v590ext,
    nonCriticalExtensions SEQUENCE {} OPTIONAL
  }
} OPTIONAL
}

PUSCHCapacityRequest-v590ext ::= SEQUENCE {
  primaryCCPCH-RSCP-delta DeltaRSCP OPTIONAL
}
-- *****
--
-- RADIO BEARER RECONFIGURATION
--
-- *****

RadioBearerReconfiguration ::= CHOICE {
  r3 SEQUENCE {
    radioBearerReconfiguration-r3 RadioBearerReconfiguration-r3-IEs,
    -- Prefix "v3ao" is used (in one instance) to keep alignment with R99
    v3aoNonCriticalExtensions SEQUENCE {
      radioBearerReconfiguration-v3a0ext RadioBearerReconfiguration-v3a0ext,
      laterNonCriticalExtensions SEQUENCE {
        -- Container for additional R99 extensions
        radioBearerReconfiguration-r3-add-ext BIT STRING OPTIONAL,
        v4b0NonCriticalExtensions SEQUENCE {
          radioBearerReconfiguration-v4b0ext
            RadioBearerReconfiguration-v4b0ext-IEs,
          v590NonCriticalExtensions SEQUENCE {
            radioBearerReconfiguration-v590ext
              RadioBearerReconfiguration-v590ext-IEs,
            v5d0NonCriticalExtensions SEQUENCE {
              radioBearerReconfiguration-v5d0ext
                RadioBearerReconfiguration-v5d0ext-IEs,
            v690NonCriticalExtensions SEQUENCE {
              radioBearerReconfiguration-v690ext
                RadioBearerReconfiguration-v690ext-IEs,
            v770NonCriticalExtensions SEQUENCE {
              radioBearerReconfiguration-v770ext
                RadioBearerReconfiguration-v770ext-IEs,
            nonCriticalExtensions SEQUENCE {} OPTIONAL
          } OPTIONAL
        } OPTIONAL
      } OPTIONAL
    } OPTIONAL
  } OPTIONAL
},
  later-than-r3 SEQUENCE {
    rrc-TransactionIdentifier RRC-TransactionIdentifier,
    criticalExtensions CHOICE {
      r4 SEQUENCE {
        radioBearerReconfiguration-r4 RadioBearerReconfiguration-r4-IEs,
        v4d0NonCriticalExtensions SEQUENCE {
          -- Container for adding non critical extensions after freezing REL-5
          radioBearerReconfiguration-r4-add-ext BIT STRING OPTIONAL,
          v590NonCriticalExtensions SEQUENCE {
            radioBearerReconfiguration-v590ext
              RadioBearerReconfiguration-v590ext-IEs,
            v5d0NonCriticalExtensions SEQUENCE {
              radioBearerReconfiguration-v5d0ext
                RadioBearerReconfiguration-v5d0ext-IEs,
            v690NonCriticalExtensions SEQUENCE {
              radioBearerReconfiguration-v690ext
                RadioBearerReconfiguration-v690ext-IEs,
            v770NonCriticalExtensions SEQUENCE {
              radioBearerReconfiguration-v770ext
                RadioBearerReconfiguration-v770ext-IEs,
            nonCriticalExtensions SEQUENCE {} OPTIONAL
          }
        }
      }
    }
  }
}

```

```

        } OPTIONAL
    } OPTIONAL
} OPTIONAL
},
criticalExtensions CHOICE {
    r5 SEQUENCE {
        radioBearerReconfiguration-r5 RadioBearerReconfiguration-r5-IEs,
        -- Container for adding non critical extensions after freezing REL-6
        radioBearerReconfiguration-r5-add-ext BIT STRING OPTIONAL,
        v5d0NonCriticalExtensitions SEQUENCE {
            radioBearerReconfiguration-v5d0ext RadioBearerReconfiguration-v5d0ext-IEs,
            v690NonCriticalExtensions SEQUENCE {
                radioBearerReconfiguration-v690ext
                    RadioBearerReconfiguration-v690ext-IEs,
                v770NonCriticalExtensions SEQUENCE {
                    radioBearerReconfiguration-v770ext
                        RadioBearerReconfiguration-v770ext-IEs,
                    nonCriticalExtensions SEQUENCE {} OPTIONAL
                } OPTIONAL
            } OPTIONAL
        } OPTIONAL
    } OPTIONAL
},
criticalExtensions CHOICE {
    r6 SEQUENCE {
        radioBearerReconfiguration-r6 RadioBearerReconfiguration-r6-IEs,
        -- Container for adding non critical extensions after freezing REL-7
        radioBearerReconfiguration-r6-add-ext BIT STRING OPTIONAL,
        v6b0NonCriticalExtensions SEQUENCE {
            radioBearerReconfiguration-v6b0ext
                RadioBearerReconfiguration-v6b0ext-IEs,
            v6f0NonCriticalExtensions SEQUENCE {
                radioBearerRconfiguration-v6f0ext
                    RadioBearerReconfiguration-v6f0ext-IEs,
            v770NonCriticalExtensions SEQUENCE {
                radioBearerReconfiguration-v770ext
                    RadioBearerReconfiguration-v770ext-IEs,
            nonCriticalExtensions SEQUENCE {} OPTIONAL
            } OPTIONAL
        } OPTIONAL
    } OPTIONAL
},
criticalExtensions CHOICE {
    r7 SEQUENCE {
        radioBearerReconfiguration-r7 RadioBearerReconfiguration-r7-IEs,
        v780NonCriticalExtensions SEQUENCE {
            radioBearerReconfiguration-v780ext
                RadioBearerReconfiguration-v780ext-IEs,
            v790NonCriticalExtensions SEQUENCE {
                radioBearerReconfiguration-v790ext
                    RadioBearerReconfiguration-v790ext-IEs,
            v7d0NonCriticalExtensions SEQUENCE {
                radioBearerReconfiguration-v7d0ext
                    RadioBearerReconfiguration-v7d0ext-IEs,
            v7f0NonCriticalExtensions SEQUENCE {
                radioBearerReconfiguration-v7f0ext
                    RadioBearerReconfiguration-v7f0ext-IEs,
            v7g0NonCriticalExtensions SEQUENCE {
                radioBearerReconfiguration-v7g0ext
                    RadioBearerReconfiguration-v7g0ext-IEs,
            nonCriticalExtensions SEQUENCE {} OPTIONAL
            } OPTIONAL
        } OPTIONAL
    } OPTIONAL
},
criticalExtensions SEQUENCE {}
}
}
}
}
}
RadioBearerReconfiguration-r3-IEs ::= SEQUENCE {
    -- User equipment IEs

```

```

rrc-TransactionIdentifier      RRC-TransactionIdentifier,
integrityProtectionModeInfo    IntegrityProtectionModeInfo    OPTIONAL,
cipheringModeInfo              CipheringModeInfo                OPTIONAL,
activationTime                  ActivationTime                    OPTIONAL,
new-U-RNTI                     U-RNTI                          OPTIONAL,
new-C-RNTI                     C-RNTI                          OPTIONAL,
rrc-StateIndicator             RRC-StateIndicator,
utran-DRX-CycleLengthCoeff     UTRAN-DRX-CycleLengthCoefficient OPTIONAL,
-- Core network IEs
cn-InformationInfo             CN-InformationInfo              OPTIONAL,
-- UTRAN mobility IEs
ura-Identity                   URA-Identity                    OPTIONAL,
-- Radio bearer IEs
rab-InformationReconfigList    RAB-InformationReconfigList     OPTIONAL,
-- NOTE: IE rb-InformationReconfigList should be optional in later versions
-- of this message
rb-InformationReconfigList     RB-InformationReconfigList,
rb-InformationAffectedList     RB-InformationAffectedList      OPTIONAL,
-- Transport channel IEs
ul-CommonTransChInfo          UL-CommonTransChInfo           OPTIONAL,
ul-deletedTransChInfoList     UL-DeletedTransChInfoList      OPTIONAL,
ul-AddReconfTransChInfoList   UL-AddReconfTransChInfoList    OPTIONAL,
-- 'dummy', 'dummy1' and 'dummy2' are not used in this version of the specification,
-- they should not be sent and if received they should be ignored.
dummy                          CHOICE {
  fdd                           SEQUENCE {
    dummy1                       CPCH-SetID                     OPTIONAL,
    dummy2                       DRAC-StaticInformationList     OPTIONAL,
  },
  tdd                           NULL
}
dl-CommonTransChInfo          DL-CommonTransChInfo           OPTIONAL,
dl-DeletedTransChInfoList     DL-DeletedTransChInfoList      OPTIONAL,
dl-AddReconfTransChInfoList   DL-AddReconfTransChInfo2List   OPTIONAL,
-- Physical channel IEs
frequencyInfo                  FrequencyInfo                    OPTIONAL,
maxAllowedUL-TX-Power          MaxAllowedUL-TX-Power          OPTIONAL,
ul-ChannelRequirement          UL-ChannelRequirement          OPTIONAL,
modeSpecificPhysChInfo        CHOICE {
  fdd                           SEQUENCE {
    -- dummy is not used in this version of specification, it should
    -- not be sent and if received it should be ignored.
    dummy                       DL-PDSCH-Information          OPTIONAL,
  },
  tdd                           NULL
},
dl-CommonInformation          DL-CommonInformation           OPTIONAL,
-- NOTE: IE dl-InformationPerRL-List is optional in later versions
-- of this message
dl-InformationPerRL-List      DL-InformationPerRL-List
}

RadioBearerReconfiguration-v3a0ext ::= SEQUENCE {
  -- The IE "new-DSCH-RNTI" should not be included in FDD mode, and if received the UE behaviour
  -- is unspecified
  new-DSCH-RNTI                DSCH-RNTI                      OPTIONAL
}

RadioBearerReconfiguration-v4b0ext-IEs ::= SEQUENCE {
  -- Physical channel IEs
  -- dummy is not used in this version of the specification, it should
  -- not be sent and if received it should be ignored.
  dummy                        SSDT-UL                          OPTIONAL,
  -- The order of the RLs in IE cell-id-PerRL-List is the same as
  -- in IE DL-InformationPerRL-List included in this message
  cell-id-PerRL-List           CellIdentity-PerRL-List         OPTIONAL
}

RadioBearerReconfiguration-v590ext-IEs ::= SEQUENCE {
  -- Physical channel IEs
  dl-TPC-PowerOffsetPerRL-List DL-TPC-PowerOffsetPerRL-List   OPTIONAL
}

RadioBearerReconfiguration-v5d0ext-IEs ::= SEQUENCE {
  --Radio Bearer IEs
  pdcp-ROHC-TargetMode         PDCP-ROHC-TargetMode           OPTIONAL
}

```

```

RadioBearerReconfiguration-r4-IEs ::= SEQUENCE {
  -- User equipment IEs
  integrityProtectionModeInfo    IntegrityProtectionModeInfo    OPTIONAL,
  cipheringModeInfo              CipheringModeInfo                OPTIONAL,
  activationTime                  ActivationTime                    OPTIONAL,
  new-U-RNTI                      U-RNTI                          OPTIONAL,
  new-C-RNTI                      C-RNTI                          OPTIONAL,
  -- The IE "new-DSCH-RNTI" should not be included in FDD mode, and if received
  -- the UE behaviour is unspecified
  new-DSCH-RNTI                  DSCH-RNTI                        OPTIONAL,
  rrc-StateIndicator              RRC-StateIndicator,
  utran-DRX-CycleLengthCoeff      UTRAN-DRX-CycleLengthCoefficient OPTIONAL,
  -- Core network IEs
  cn-InformationInfo              CN-InformationInfo                OPTIONAL,
  -- UTRAN mobility IEs
  ura-Identity                    URA-Identity                      OPTIONAL,
  -- Radio bearer IEs
  rab-InformationReconfigList     RAB-InformationReconfigList      OPTIONAL,
  rb-InformationReconfigList-r4   RB-InformationReconfigList-r4    OPTIONAL,
  rb-InformationAffectedList      RB-InformationAffectedList        OPTIONAL,
  -- Transport channel IEs
  ul-CommonTransChInfo            UL-CommonTransChInfo-r4          OPTIONAL,
  ul-deletedTransChInfoList       UL-DeletedTransChInfoList        OPTIONAL,
  ul-AddReconfTransChInfoList     UL-AddReconfTransChInfoList      OPTIONAL,
  -- 'dummy', 'dummy1' and 'dummy2' are not used in this version of the specification,
  -- they should not be sent and if received they should be ignored.
  dummy                            CHOICE {
    fdd                            SEQUENCE {
      dummy1                        CPCH-SetID                        OPTIONAL,
      dummy2                        DRAC-StaticInformationList        OPTIONAL,
    },
    tdd                            NULL
  } OPTIONAL,
  dl-CommonTransChInfo            DL-CommonTransChInfo-r4          OPTIONAL,
  dl-DeletedTransChInfoList       DL-DeletedTransChInfoList        OPTIONAL,
  dl-AddReconfTransChInfoList-r4  DL-AddReconfTransChInfoList-r4   OPTIONAL,
  -- Physical channel IEs
  frequencyInfo                   FrequencyInfo                      OPTIONAL,
  maxAllowedUL-TX-Power            MaxAllowedUL-TX-Power            OPTIONAL,
  ul-ChannelRequirement            UL-ChannelRequirement-r4         OPTIONAL,
  modeSpecificPhysChInfo          CHOICE {
    fdd                            SEQUENCE {
      -- dummy is not used in this version of specification, it should
      -- not be sent and if received it should be ignored.
      dummy                          DL-PDSCH-Information              OPTIONAL,
    },
    tdd                            NULL
  },
  dl-CommonInformation             DL-CommonInformation-r4           OPTIONAL,
  dl-InformationPerRL-List         DL-InformationPerRL-List-r4      OPTIONAL,
}

RadioBearerReconfiguration-r5-IEs ::= SEQUENCE {
  -- User equipment IEs
  integrityProtectionModeInfo    IntegrityProtectionModeInfo    OPTIONAL,
  cipheringModeInfo              CipheringModeInfo                OPTIONAL,
  activationTime                  ActivationTime                    OPTIONAL,
  new-U-RNTI                      U-RNTI                          OPTIONAL,
  new-C-RNTI                      C-RNTI                          OPTIONAL,
  -- The IE "new-DSCH-RNTI" should not be included in FDD mode, and if received
  -- the UE behaviour is unspecified
  new-DSCH-RNTI                  DSCH-RNTI                        OPTIONAL,
  new-H-RNTI                      H-RNTI                          OPTIONAL,
  rrc-StateIndicator              RRC-StateIndicator,
  utran-DRX-CycleLengthCoeff      UTRAN-DRX-CycleLengthCoefficient OPTIONAL,
  -- Core network IEs
  cn-InformationInfo              CN-InformationInfo                OPTIONAL,
  -- UTRAN mobility IEs
  ura-Identity                    URA-Identity                      OPTIONAL,
  -- Specification mode information
  specificationMode               CHOICE {
    complete                       SEQUENCE {
      -- Radio bearer IEs
      rab-InformationReconfigList   RAB-InformationReconfigList      OPTIONAL,
      rb-InformationReconfigList-r5  RB-InformationReconfigList-r5    OPTIONAL,
      rb-InformationAffectedList-r5  RB-InformationAffectedList-r5    OPTIONAL,
      rb-PDCPContextRelocationList  RB-PDCPContextRelocationList    OPTIONAL,
      -- Transport channel IEs
    }
  }
}

```



```

    ul-CommonTransChInfo          UL-CommonTransChInfo-r4          OPTIONAL,
    ul-deletedTransChInfoList     UL-DeletedTransChInfoList     OPTIONAL,
    ul-AddReconfTransChInfoList   UL-AddReconfTransChInfoList   OPTIONAL,
    -- 'dummy', 'dummy1' and 'dummy2' are not used in this version of the
    -- specification, they should not be sent and if received they should be ignored.
    dummy                          CHOICE {
        fdd                          SEQUENCE {
            dummy1                    CPCH-SetID                    OPTIONAL,
            dummy2                    DRAC-StaticInformationList  OPTIONAL
        },
        tdd                          NULL
    }
    dl-CommonTransChInfo          DL-CommonTransChInfo-r4          OPTIONAL,
    dl-DeletedTransChInfoList     DL-DeletedTransChInfoList-r5    OPTIONAL,
    dl-AddReconfTransChInfoList   DL-AddReconfTransChInfoList-r5  OPTIONAL
},
preconfiguration                 SEQUENCE {
    -- All IEs that include an FDD/TDD choice are split in two IEs for this message,
    -- one for the FDD only elements and one for the TDD only elements, so that one
    -- FDD/TDD choice in this level is sufficient.
    preConfigMode                 CHOICE {
        predefinedConfigIdentity     PredefinedConfigIdentity,
        defaultConfig                SEQUENCE {
            defaultConfigMode        DefaultConfigMode,
            defaultConfigIdentity    DefaultConfigIdentity-r5
        }
    }
},
},
-- Physical channel IEs
frequencyInfo                    FrequencyInfo                    OPTIONAL,
maxAllowedUL-TX-Power            MaxAllowedUL-TX-Power            OPTIONAL,
ul-ChannelRequirement            UL-ChannelRequirement-r5        OPTIONAL,
modeSpecificPhysChInfo          CHOICE {
    fdd                          SEQUENCE {
        -- dummy is not used in this version of specification, it should
        -- not be sent and if received it should be ignored.
        dummy                      DL-PDSCH-Information            OPTIONAL
    },
    tdd                          NULL
},
dl-HSPDSCH-Information           DL-HSPDSCH-Information           OPTIONAL,
dl-CommonInformation             DL-CommonInformation-r5          OPTIONAL,
dl-InformationPerRL-List         DL-InformationPerRL-List-r5      OPTIONAL
}

RadioBearerReconfiguration-r6-IEs ::= SEQUENCE {
    -- User equipment IEs
    integrityProtectionModeInfo   IntegrityProtectionModeInfo     OPTIONAL,
    cipheringModeInfo             CipheringModeInfo                OPTIONAL,
    activationTime                 ActivationTime                     OPTIONAL,
    delayRestrictionFlag           DelayRestrictionFlag              OPTIONAL,
    new-U-RNTI                     U-RNTI                           OPTIONAL,
    new-C-RNTI                     C-RNTI                           OPTIONAL,
    -- The IE "new-DSCH-RNTI" should not be included in FDD mode,
    -- and if received the UE behaviour is unspecified
    new-DSCH-RNTI                 DSCH-RNTI                         OPTIONAL,
    new-H-RNTI                     H-RNTI                             OPTIONAL,
    newPrimary-E-RNTI              E-RNTI                             OPTIONAL,
    newSecondary-E-RNTI            E-RNTI                             OPTIONAL,
    rrc-StateIndicator             RRC-StateIndicator,
    utran-DRX-CycleLengthCoeff    UTRAN-DRX-CycleLengthCoefficient  OPTIONAL,
    -- Core network IEs
    cn-InformationInfo             CN-InformationInfo-r6            OPTIONAL,
    -- UTRAN mobility IEs
    ura-Identity                   URA-Identity                       OPTIONAL,
    -- Specification mode information
    specificationMode              CHOICE {
        complete                   SEQUENCE {
            -- Radio bearer IEs
            rab-InformationReconfigList  RAB-InformationReconfigList     OPTIONAL,
            rb-InformationReconfigList    RB-InformationReconfigList-r6    OPTIONAL,
            rb-InformationAffectedList    RB-InformationAffectedList-r6    OPTIONAL,
            rb-PDCPContextRelocationList  RB-PDCPContextRelocationList    OPTIONAL,
            pdcp-ROHC-TargetMode         PDCP-ROHC-TargetMode            OPTIONAL,
            -- Transport channel IEs
            ul-CommonTransChInfo         UL-CommonTransChInfo-r4         OPTIONAL,
            ul-deletedTransChInfoList     UL-DeletedTransChInfoList-r6     OPTIONAL,

```

```

        ul-AddReconfTransChInfoList      UL-AddReconfTransChInfoList-r6      OPTIONAL,
        dl-CommonTransChInfo              DL-CommonTransChInfo-r4                OPTIONAL,
        dl-DeletedTransChInfoList         DL-DeletedTransChInfoList-r5          OPTIONAL,
        dl-AddReconfTransChInfoList       DL-AddReconfTransChInfoList-r5       OPTIONAL
    },
    preconfiguration                      SEQUENCE {
        -- All IEs that include an FDD/TDD choice are split in two IEs for this message,
        -- one for the FDD only elements and one for the TDD only elements, so that one
        -- FDD/TDD choice in this level is sufficient.
        preConfigMode                      CHOICE {
            predefinedConfigIdentity        PredefinedConfigIdentity,
            defaultConfig                   SEQUENCE {
                defaultConfigMode           DefaultConfigMode,
                defaultConfigIdentity       DefaultConfigIdentity-r6
            }
        }
    }
},
-- Physical channel IEs
frequencyInfo                            FrequencyInfo                            OPTIONAL,
maxAllowedUL-TX-Power                     MaxAllowedUL-TX-Power                     OPTIONAL,
ul-DPCH-Info                              UL-DPCH-Info-r6                          OPTIONAL,
ul-EDCH-Information                       UL-EDCH-Information-r6                    OPTIONAL,
dl-HSPDSCH-Information                    DL-HSPDSCH-Information-r6                OPTIONAL,
dl-CommonInformation                      DL-CommonInformation-r6                   OPTIONAL,
dl-InformationPerRL-List                  DL-InformationPerRL-List-r6              OPTIONAL,
-- MBMS IEs
mbms-PL-ServiceRestrictInfo              MBMS-PL-ServiceRestrictInfo-r6           OPTIONAL
}

RadioBearerReconfiguration-v690ext-IEs ::= SEQUENCE {
-- User Equipment IEs
delayRestrictionFlag                      DelayRestrictionFlag                      OPTIONAL,
-- Core network IEs
primary-plmn-Identity                     PLMN-Identity                            OPTIONAL,
-- Physical channel IEs
-- The IE harq-Preamble-Mode should not be used in the r3 and r4 versions of the message
-- If included in the r3 or r4 version of the message, the UE should ignore the IE
harq-Preamble-Mode                        HARQ-Preamble-Mode                       OPTIONAL,
beaconPLEst                               BEACON-PL-Est                            OPTIONAL,
postVerificationPeriod                    ENUMERATED { true }                      OPTIONAL,
dhs-sync                                   DHS-Sync                                  OPTIONAL,
timingMaintainedSynchInd                  TimingMaintainedSynchInd                  OPTIONAL,
-- MBMS IEs
mbms-PL-ServiceRestrictInfo              MBMS-PL-ServiceRestrictInfo-r6           OPTIONAL
}

RadioBearerReconfiguration-v6b0ext-IEs ::= SEQUENCE {
-- Physical channel IEs
dl-InformationPerRL-List-v6b0ext          DL-InformationPerRL-List-v6b0ext         OPTIONAL
}

RadioBearerReconfiguration-v6f0ext-IEs ::= SEQUENCE {
-- Specification mode information
specificationMode                         CHOICE {
    complete                               SEQUENCE {
        -- Radio bearer IEs
        rab-InformationMBMSptList          RAB-InformationMBMSptList               OPTIONAL
    }
}
}

RadioBearerReconfiguration-r7-IEs ::= SEQUENCE {
-- User equipment IEs
integrityProtectionModeInfo               IntegrityProtectionModeInfo-r7           OPTIONAL,
cipheringModeInfo                         CipheringModeInfo-r7                     OPTIONAL,
activationTime                             ActivationTime                             OPTIONAL,
delayRestrictionFlag                      DelayRestrictionFlag                     OPTIONAL,
new-U-RNTI                                U-RNTI                                   OPTIONAL,
new-C-RNTI                                C-RNTI                                   OPTIONAL,
-- The IE "new-DSCH-RNTI" should not be included in FDD mode,
-- and if received the UE behaviour is unspecified
new-DSCH-RNTI                             DSCH-RNTI                                OPTIONAL,
new-H-RNTI                                 H-RNTI                                   OPTIONAL,
newPrimary-E-RNTI                         E-RNTI                                   OPTIONAL,
newSecondary-E-RNTI                       E-RNTI                                   OPTIONAL,
rrc-StateIndicator                        RRC-StateIndicator,
ueMobilityStateIndicator                  High-MobilityDetected                     OPTIONAL,

```

```

    utran-DRX-CycleLengthCoeff      UTRAN-DRX-CycleLengthCoefficient-r7  OPTIONAL,
-- Core network IEs
  cn-InformationInfo                CN-InformationInfo-r6                  OPTIONAL,
-- UTRAN mobility IEs
  ura-Identity                      URA-Identity                          OPTIONAL,
  supportForChangeOfUE-Capability  BOOLEAN                                OPTIONAL,
  responseToChangeOfUE-Capability  ENUMERATED { true }                   OPTIONAL,
-- Specification mode information
  specificationMode                 CHOICE {
    complete                        SEQUENCE {
-- Radio bearer IEs
      rab-InformationReconfigList  RAB-InformationReconfigList          OPTIONAL,
      rab-InformationMBMSPTpList   RAB-InformationMBMSPTpList          OPTIONAL,
      rb-InformationReconfigList   RB-InformationReconfigList-r7       OPTIONAL,
      rb-InformationAffectedList   RB-InformationAffectedList-r7      OPTIONAL,
      rb-PDCPContextRelocationList RB-PDCPContextRelocationList       OPTIONAL,
      pdcp-ROHC-TargetMode        PDCP-ROHC-TargetMode               OPTIONAL,
-- Transport channel IEs
      ul-CommonTransChInfo        UL-CommonTransChInfo-r4             OPTIONAL,
      ul-deletedTransChInfoList   UL-DeletedTransChInfoList-r6       OPTIONAL,
      ul-AddReconfTransChInfoList UL-AddReconfTransChInfoList-r7     OPTIONAL,
      dl-CommonTransChInfo        DL-CommonTransChInfo-r4             OPTIONAL,
      dl-DeletedTransChInfoList   DL-DeletedTransChInfoList-r7      OPTIONAL,
      dl-AddReconfTransChInfoList DL-AddReconfTransChInfoList-r7     OPTIONAL
    },
  preconfiguration                  SEQUENCE {
-- All IEs that include an FDD/TDD choice are split in two IEs for this message,
-- one for the FDD only elements and one for the TDD only elements, so that one
-- FDD/TDD choice in this level is sufficient.
    preConfigMode                  CHOICE {
      predefinedConfigIdentity     PredefinedConfigIdentity,
      defaultConfig               SEQUENCE {
        defaultConfigMode         DefaultConfigMode,
        defaultConfigIdentity     DefaultConfigIdentity-r6
      }
    }
  },
},
-- Physical channel IEs
  frequencyInfo                    FrequencyInfo                          OPTIONAL,
  multi-frequencyInfo              Multi-frequencyInfo-LCR-r7            OPTIONAL,
  dtx-drx-TimingInfo              DTX-DRX-TimingInfo-r7                OPTIONAL,
  dtx-drx-Info                     DTX-DRX-Info-r7                      OPTIONAL,
  hs-scch-LessInfo                HS-SCCH-LessInfo-r7                  OPTIONAL,
  mimoParameters                  MIMO-Parameters-r7                  OPTIONAL,
  maxAllowedUL-TX-Power            MaxAllowedUL-TX-Power                OPTIONAL,
  ul-DPCH-Info                     UL-DPCH-Info-r7                      OPTIONAL,
  ul-EDCH-Information              UL-EDCH-Information-r7               OPTIONAL,
  dl-HSPDSCH-Information           DL-HSPDSCH-Information-r7            OPTIONAL,
  dl-CommonInformation             DL-CommonInformation-r7              OPTIONAL,
  dl-InformationPerRL-List         DL-InformationPerRL-List-r7         OPTIONAL,
-- MBMS IEs
  mbms-PL-ServiceRestrictInfo     MBMS-PL-ServiceRestrictInfo-r6     OPTIONAL
}

RadioBearerReconfiguration-v770ext-IEs ::= SEQUENCE {
-- User equipment IEs
  ueMobilityStateIndicator         High-MobilityDetected                OPTIONAL
}

RadioBearerReconfiguration-v780ext-IEs ::= SEQUENCE {
-- Physical channel IEs
  hs-DSCH-TBSizeTable             HS-DSCH-TBSizeTable                 OPTIONAL
}

RadioBearerReconfiguration-v790ext-IEs ::= SEQUENCE {
-- Container for adding non critical extensions after freezing REL-8
  radioBearerReconfiguration-r7-add-ext  BIT STRING                          OPTIONAL
}

RadioBearerReconfiguration-v7d0ext-IEs ::= SEQUENCE {
-- Physical channel IEs
  ul-EDCH-Information             UL-EDCH-Information-ext              OPTIONAL
}

RadioBearerReconfiguration-v7f0ext-IEs ::= SEQUENCE {
-- Physical channel IEs
  mimoParameters                  MIMO-Parameters-v7f0ext             OPTIONAL
}

```

```

}

RadioBearerReconfiguration-v7g0ext-IEs ::= SEQUENCE {
  -- Physical channel IEs
  mimoParameters                MIMO-Parameters-v7g0ext                OPTIONAL
}

-- *****
--
-- RADIO BEARER RECONFIGURATION COMPLETE
--
-- *****

RadioBearerReconfigurationComplete ::= SEQUENCE {
  -- User equipment IEs
  rrc-TransactionIdentifier      RRC-TransactionIdentifier,
  ul-IntegProtActivationInfo     IntegrityProtActivationInfo     OPTIONAL,
  -- TABULAR: UL-TimingAdvance is applicable for TDD mode only.
  ul-TimingAdvance              UL-TimingAdvance                      OPTIONAL,
  -- Radio bearer IEs
  count-C-ActivationTime        ActivationTime                      OPTIONAL,
  -- dummy is not used in this version of the specification and
  -- it should be ignored by the receiver.
  dummy                          RB-ActivationTimeInfoList        OPTIONAL,
  ul-CounterSynchronisationInfo  UL-CounterSynchronisationInfo    OPTIONAL,
  laterNonCriticalExtensions     SEQUENCE {
    -- Container for additional R99 extensions
    radioBearerReconfigurationComplete-r3-add-ext        BIT STRING        OPTIONAL,
    v770NonCriticalExtensions        SEQUENCE {
      radioBearerReconfigurationComplete-v770ext
      RadioBearerReconfigurationComplete-v770ext-IEs,
      nonCriticalExtensions        SEQUENCE {} OPTIONAL
    } OPTIONAL
  } OPTIONAL
}

RadioBearerReconfigurationComplete-v770ext-IEs ::= SEQUENCE {
  -- TABULAR: EXT-UL-TimingAdvance is applicable for TDD mode only.
  ext-UL-TimingAdvance          EXT-UL-TimingAdvance        OPTIONAL,
  deferredMeasurementControlReading  ENUMERATED { true }        OPTIONAL
}

-- *****
--
-- RADIO BEARER RECONFIGURATION FAILURE
--
-- *****

RadioBearerReconfigurationFailure ::= SEQUENCE {
  -- User equipment IEs
  rrc-TransactionIdentifier      RRC-TransactionIdentifier,
  failureCause                  FailureCauseWithProtErr,
  -- Radio bearer IEs
  potentiallySuccessfulBearerList  RB-IdentityList                OPTIONAL,
  laterNonCriticalExtensions     SEQUENCE {
    -- Container for additional R99 extensions
    radioBearerReconfigurationFailure-r3-add-ext        BIT STRING        OPTIONAL,
    nonCriticalExtensions        SEQUENCE {} OPTIONAL
  } OPTIONAL
}

-- *****
--
-- RADIO BEARER RELEASE
--
-- *****

RadioBearerRelease ::= CHOICE {
  r3                             SEQUENCE {
    radioBearerRelease-r3        RadioBearerRelease-r3-IEs,
    v3a0NonCriticalExtensions    SEQUENCE {
      radioBearerRelease-v3a0ext  RadioBearerRelease-v3a0ext,
      laterNonCriticalExtensions  SEQUENCE {
        -- Container for additional R99 extensions
        radioBearerRelease-r3-add-ext  BIT STRING        OPTIONAL,
        v4b0NonCriticalExtensions    SEQUENCE {
          radioBearerRelease-v4b0ext  RadioBearerRelease-v4b0ext-IEs,
          v590NonCriticalExtensions  SEQUENCE {

```

```

        radioBearerRelease-v590ext      RadioBearerRelease-v590ext-IEs,
        v690NonCriticalExtensions      SEQUENCE {
            radioBearerRelease-v690ext  RadioBearerRelease-v690ext-IEs,
            v770NonCriticalExtensions  SEQUENCE {
                radioBearerRelease-v770ext  RadioBearerRelease-v770ext-IEs,
                nonCriticalExtensions      SEQUENCE {} OPTIONAL
            } OPTIONAL
        } OPTIONAL
    } OPTIONAL
},
later-than-r3      SEQUENCE {
    rrc-TransactionIdentifier  RRC-TransactionIdentifier,
    criticalExtensions        CHOICE {
        r4      SEQUENCE {
            radioBearerRelease-r4      RadioBearerRelease-r4-IEs,
            v4d0NonCriticalExtensions  SEQUENCE {
                -- Container for adding non critical extensions after freezing REL-5
                radioBearerRelease-r4-add-ext  BIT STRING  OPTIONAL,
                v590NonCriticalExtensions  SEQUENCE {
                    radioBearerRelease-v590ext  RadioBearerRelease-v590ext-IEs,
                    v690NonCriticalExtensions  SEQUENCE {
                        radioBearerRelease-v690ext  RadioBearerRelease-v690ext-IEs,
                        v770NonCriticalExtensions  SEQUENCE {
                            radioBearerRelease-v770ext  RadioBearerRelease-v770ext-IEs,
                            nonCriticalExtensions  SEQUENCE {}  OPTIONAL
                        } OPTIONAL
                    } OPTIONAL
                } OPTIONAL
            } OPTIONAL
        } OPTIONAL
    },
    criticalExtensions        CHOICE {
        r5      SEQUENCE {
            radioBearerRelease-r5      RadioBearerRelease-r5-IEs,
            -- Container for adding non critical extensions after freezing REL-6
            radioBearerRelease-r5-add-ext  BIT STRING  OPTIONAL,
            v690NonCriticalExtensions  SEQUENCE {
                radioBearerRelease-v690ext  RadioBearerRelease-v690ext-IEs,
                v770NonCriticalExtensions  SEQUENCE {
                    radioBearerRelease-v770ext  RadioBearerRelease-v770ext-IEs,
                    nonCriticalExtensions  SEQUENCE {}  OPTIONAL
                } OPTIONAL
            } OPTIONAL
        } OPTIONAL
    },
    criticalExtensions        CHOICE {
        r6      SEQUENCE {
            radioBearerRelease-r6      RadioBearerRelease-r6-IEs,
            -- Container for adding non critical extensions after freezing REL-7
            radioBearerRelease-r6-add-ext  BIT STRING  OPTIONAL,
            v6b0NonCriticalExtensions  SEQUENCE {
                radioBearerRelease-v6b0ext  RadioBearerRelease-v6b0ext-IEs,
                v770NonCriticalExtensions  SEQUENCE {
                    radioBearerRelease-v770ext  RadioBearerRelease-v770ext-IEs,
                    nonCriticalExtensions  SEQUENCE {}  OPTIONAL
                } OPTIONAL
            } OPTIONAL
        } OPTIONAL
    },
    criticalExtensions        CHOICE {
        r7      SEQUENCE {
            radioBearerRelease-r7      RadioBearerRelease-r7-IEs,
            -- Container for adding non critical extensions after freezing REL-8
            radioBearerRelease-r7-add-ext  BIT STRING  OPTIONAL,
            v780NonCriticalExtensions  SEQUENCE {
                radioBearerRelease-v780ext  RadioBearerRelease-v780ext-IEs,
                v7d0NonCriticalExtensions  SEQUENCE {
                    radioBearerRelease-v7d0ext  RadioBearerRelease-v7d0ext-IEs,
                    v7f0NonCriticalExtensions  SEQUENCE {
                        radioBearerRelease-v7f0ext  RadioBearerRelease-v7f0ext-IEs,
                        v7g0NonCriticalExtensions  SEQUENCE {
                            radioBearerRelease-v7g0ext  RadioBearerRelease-v7g0ext-
IEs,
                            nonCriticalExtensions  SEQUENCE {}  OPTIONAL
                        } OPTIONAL
                    } OPTIONAL
                } OPTIONAL
            } OPTIONAL
        } OPTIONAL
    }
}

```

```

    },
    criticalExtensions SEQUENCE {}
  }
}
}
}
}

RadioBearerRelease-r3-IEs ::= SEQUENCE {
  -- User equipment IEs
  rrc-TransactionIdentifier RRC-TransactionIdentifier,
  integrityProtectionModeInfo IntegrityProtectionModeInfo OPTIONAL,
  cipheringModeInfo CipheringModeInfo OPTIONAL,
  activationTime ActivationTime OPTIONAL,
  new-U-RNTI U-RNTI OPTIONAL,
  new-C-RNTI C-RNTI OPTIONAL,
  rrc-StateIndicator RRC-StateIndicator,
  utran-DRX-CycleLengthCoeff UTRAN-DRX-CycleLengthCoefficient OPTIONAL,
  -- Core network IEs
  cn-InformationInfo CN-InformationInfo OPTIONAL,
  signallingConnectionRelIndication CN-DomainIdentity OPTIONAL,
  -- UTRAN mobility IEs
  ura-Identity URA-Identity OPTIONAL,
  -- Radio bearer IEs
  rab-InformationReconfigList RAB-InformationReconfigList OPTIONAL,
  rb-InformationReleaseList RB-InformationReleaseList,
  rb-InformationAffectedList RB-InformationAffectedList OPTIONAL,
  dl-CounterSynchronisationInfo DL-CounterSynchronisationInfo OPTIONAL,
  -- Transport channel IEs
  ul-CommonTransChInfo UL-CommonTransChInfo OPTIONAL,
  ul-deletedTransChInfoList UL-DeletedTransChInfoList OPTIONAL,
  ul-AddReconfTransChInfoList UL-AddReconfTransChInfoList OPTIONAL,
  -- 'dummy', 'dummy1' and 'dummy2' are not used in this version of the specification,
  -- they should not be sent and if received they should be ignored.
  dummy CHOICE {
    fdd SEQUENCE {
      dummy1 CPCH-SetID OPTIONAL,
      dummy2 DRAC-StaticInformationList OPTIONAL
    },
    tdd NULL
  } OPTIONAL,
  dl-CommonTransChInfo DL-CommonTransChInfo OPTIONAL,
  dl-DeletedTransChInfoList DL-DeletedTransChInfoList OPTIONAL,
  dl-AddReconfTransChInfoList DL-AddReconfTransChInfo2List OPTIONAL,
  -- Physical channel IEs
  frequencyInfo FrequencyInfo OPTIONAL,
  maxAllowedUL-TX-Power MaxAllowedUL-TX-Power OPTIONAL,
  ul-ChannelRequirement UL-ChannelRequirement OPTIONAL,
  modeSpecificPhysChInfo CHOICE {
    fdd SEQUENCE {
      -- dummy is not used in this version of specification, it should
      -- not be sent and if received it should be ignored.
      dummy DL-PDSCH-Information OPTIONAL
    },
    tdd NULL
  },
  dl-CommonInformation DL-CommonInformation OPTIONAL,
  dl-InformationPerRL-List DL-InformationPerRL-List OPTIONAL
}

RadioBearerRelease-v3a0ext ::= SEQUENCE {
  -- The IE "new-DSCH-RNTI" should not be included in FDD mode, and if received the UE behaviour
  -- is unspecified
  new-DSCH-RNTI DSCH-RNTI OPTIONAL
}

RadioBearerRelease-v4b0ext-IEs ::= SEQUENCE {
  -- Physical channel IEs
  -- dummy is not used in this version of the specification, it should
  -- not be sent and if received it should be ignored.
  dummy SSdT-UL OPTIONAL,
  -- The order of the RLs in IE cell-id-PerRL-List is the same as
  -- in IE DL-InformationPerRL-List included in this message
  cell-id-PerRL-List CellIdentity-PerRL-List OPTIONAL
}

RadioBearerRelease-v590ext-IEs ::= SEQUENCE {

```

```

-- Physical channel IEs
  dl-TPC-PowerOffsetPerRL-List    DL-TPC-PowerOffsetPerRL-List    OPTIONAL
}

RadioBearerRelease-r4-IEs ::= SEQUENCE {
-- User equipment IEs
  integrityProtectionModeInfo    IntegrityProtectionModeInfo    OPTIONAL,
  cipheringModeInfo              CipheringModeInfo              OPTIONAL,
  activationTime                  ActivationTime                  OPTIONAL,
  new-U-RNTI                      U-RNTI                        OPTIONAL,
  new-C-RNTI                      C-RNTI                        OPTIONAL,
  -- The IE "new-DSCH-RNTI" should not be included in FDD mode, and if received
  -- the UE behaviour is unspecified
  new-DSCH-RNTI                  DSCH-RNTI                     OPTIONAL,
  rrc-StateIndicator              RRC-StateIndicator,
  utran-DRX-CycleLengthCoeff      UTRAN-DRX-CycleLengthCoefficient    OPTIONAL,
-- Core network IEs
  cn-InformationInfo              CN-InformationInfo            OPTIONAL,
  signallingConnectionRelIndication  CN-DomainIdentity            OPTIONAL,
-- UTRAN mobility IEs
  ura-Identity                    URA-Identity                  OPTIONAL,
-- Radio bearer IEs
  rab-InformationReconfigList      RAB-InformationReconfigList    OPTIONAL,
  rb-InformationReleaseList        RB-InformationReleaseList,
  rb-InformationAffectedList       RB-InformationAffectedList     OPTIONAL,
  dl-CounterSynchronisationInfo    DL-CounterSynchronisationInfo  OPTIONAL,
-- Transport channel IEs
  ul-CommonTransChInfo            UL-CommonTransChInfo-r4       OPTIONAL,
  ul-deletedTransChInfoList        UL-DeletedTransChInfoList     OPTIONAL,
  ul-AddReconfTransChInfoList      UL-AddReconfTransChInfoList   OPTIONAL,
  -- 'dummy', 'dummy1' and 'dummy2' are not used in this version of the specification,
  -- they should not be sent and if received they should be ignored.
  dummy                            CHOICE {
    fdd                             SEQUENCE {
      dummy1                        CPCH-SetID                     OPTIONAL,
      dummy2                        DRAC-StaticInformationList     OPTIONAL
    },
    tdd                             NULL
  }
  dl-CommonTransChInfo            DL-CommonTransChInfo-r4       OPTIONAL,
  dl-DeletedTransChInfoList        DL-DeletedTransChInfoList     OPTIONAL,
  dl-AddReconfTransChInfoList      DL-AddReconfTransChInfoList-r4  OPTIONAL,
-- Physical channel IEs
  frequencyInfo                   FrequencyInfo                   OPTIONAL,
  maxAllowedUL-TX-Power            MaxAllowedUL-TX-Power         OPTIONAL,
  ul-ChannelRequirement            UL-ChannelRequirement-r4      OPTIONAL,
  modeSpecificPhysChInfo          CHOICE {
    fdd                             SEQUENCE {
      -- dummy is not used in this version of specification, it should
      -- not be sent and if received it should be ignored.
      dummy                          DL-PDSCH-Information          OPTIONAL
    },
    tdd                             NULL
  },
  dl-CommonInformation            DL-CommonInformation-r4       OPTIONAL,
  dl-InformationPerRL-List        DL-InformationPerRL-List-r4   OPTIONAL
}

RadioBearerRelease-r5-IEs ::= SEQUENCE {
-- User equipment IEs
  integrityProtectionModeInfo    IntegrityProtectionModeInfo    OPTIONAL,
  cipheringModeInfo              CipheringModeInfo              OPTIONAL,
  activationTime                  ActivationTime                  OPTIONAL,
  new-U-RNTI                      U-RNTI                        OPTIONAL,
  new-C-RNTI                      C-RNTI                        OPTIONAL,
  -- The IE "new-DSCH-RNTI" should not be included in FDD mode,
  -- and if received the UE behaviour is unspecified
  new-DSCH-RNTI                  DSCH-RNTI                     OPTIONAL,
  new-H-RNTI                      H-RNTI                        OPTIONAL,
  rrc-StateIndicator              RRC-StateIndicator,
  utran-DRX-CycleLengthCoeff      UTRAN-DRX-CycleLengthCoefficient    OPTIONAL,
-- Core network IEs
  cn-InformationInfo              CN-InformationInfo            OPTIONAL,
  signallingConnectionRelIndication  CN-DomainIdentity            OPTIONAL,
-- UTRAN mobility IEs
  ura-Identity                    URA-Identity                  OPTIONAL,
-- Radio bearer IEs
  rab-InformationReconfigList      RAB-InformationReconfigList    OPTIONAL,

```

```

    rb-InformationReleaseList      RB-InformationReleaseList,
    rb-InformationAffectedList     RB-InformationAffectedList-r5      OPTIONAL,
    dl-CounterSynchronisationInfo DL-CounterSynchronisationInfo-r5  OPTIONAL,
-- Transport channel IEs
    ul-CommonTransChInfo          UL-CommonTransChInfo-r4          OPTIONAL,
    ul-deletedTransChInfoList     UL-DeletedTransChInfoList        OPTIONAL,
    ul-AddReconfTransChInfoList   UL-AddReconfTransChInfoList      OPTIONAL,
-- 'dummy', 'dummy1' and 'dummy2' are not used in this version of the specification,
-- they should not be sent and if received they should be ignored.
    dummy                          CHOICE {
        fdd                        SEQUENCE {
            dummy1                  CPCH-SetID                        OPTIONAL,
            dummy2                  DRAC-StaticInformationList     OPTIONAL,
        },
        tdd                        NULL
    }
    dl-CommonTransChInfo          DL-CommonTransChInfo-r4          OPTIONAL,
    dl-DeletedTransChInfoList     DL-DeletedTransChInfoList-r5     OPTIONAL,
    dl-AddReconfTransChInfoList   DL-AddReconfTransChInfoList-r5  OPTIONAL,
-- Physical channel IEs
    frequencyInfo                 FrequencyInfo                     OPTIONAL,
    maxAllowedUL-TX-Power         MaxAllowedUL-TX-Power           OPTIONAL,
    ul-ChannelRequirement         UL-ChannelRequirement-r5        OPTIONAL,
    modeSpecificPhysChInfo       CHOICE {
        fdd                        SEQUENCE {
            -- dummy is not used in this version of specification, it should
            -- not be sent and if received it should be ignored.
            dummy                   DL-PDSCH-Information             OPTIONAL,
        },
        tdd                        NULL
    },
    dl-HSPDSCH-Information        DL-HSPDSCH-Information          OPTIONAL,
    dl-CommonInformation          DL-CommonInformation-r5         OPTIONAL,
    dl-InformationPerRL-List      DL-InformationPerRL-List-r5     OPTIONAL,
}

RadioBearerRelease-v690ext-IEs ::= SEQUENCE {
-- Core network IEs
    primary-plmn-Identity         PLMN-Identity                    OPTIONAL,
-- Physical channel IEs
-- The IE harq-Preamble-Mode should not be used in the r3 and r4 versions of the message
-- If included in the r3 or r4 version of the message, the UE should ignore the IE
    harq-Preamble-Mode           HARQ-Preamble-Mode               OPTIONAL,
    beaconPLEst                  BEACON-PL-Est                    OPTIONAL,
    postVerificationPeriod        ENUMERATED { true }              OPTIONAL,
    dhs-sync                      DHS-Sync                          OPTIONAL,
    timingMaintainedSynchInd     TimingMaintainedSynchInd         OPTIONAL,
-- MBMS IEs
    mbms-PL-ServiceRestrictInfo  MBMS-PL-ServiceRestrictInfo-r6  OPTIONAL,
    mbms-RB-ListReleasedToChangeTransferMode
                                RB-InformationReleaseList             OPTIONAL,
}

RadioBearerRelease-r6-IEs ::= SEQUENCE {
-- User equipment IEs
    integrityProtectionModeInfo  IntegrityProtectionModeInfo      OPTIONAL,
    cipheringModeInfo            CipheringModeInfo                 OPTIONAL,
    activationTime                ActivationTime                     OPTIONAL,
    new-U-RNTI                   U-RNTI                           OPTIONAL,
    new-C-RNTI                   C-RNTI                           OPTIONAL,
-- The IE "new-DSCH-RNTI" should not be included in FDD mode,
-- and if received the UE behaviour is unspecified
    new-DSCH-RNTI                DSCH-RNTI                         OPTIONAL,
    new-H-RNTI                   H-RNTI                           OPTIONAL,
    newPrimary-E-RNTI            E-RNTI                           OPTIONAL,
    newSecondary-E-RNTI          E-RNTI                           OPTIONAL,
    rrc-StateIndicator           RRC-StateIndicator,
    utran-DRX-CycleLengthCoeff   UTRAN-DRX-CycleLengthCoefficient OPTIONAL,
-- Core network IEs
    cn-InformationInfo           CN-InformationInfo-r6             OPTIONAL,
    signallingConnectionRelIndication
                                CN-DomainIdentity                 OPTIONAL,
-- UTRAN mobility IEs
    ura-Identity                 URA-Identity                      OPTIONAL,
-- Radio bearer IEs
    rab-InformationReconfigList   RAB-InformationReconfigList      OPTIONAL,
    rb-InformationReleaseList     RB-InformationReleaseList,
    rb-InformationReconfigList-r6
                                RB-InformationReconfigList-r6     OPTIONAL,
    rb-InformationAffectedList   RB-InformationAffectedList-r6    OPTIONAL,
}

```



```

    dl-CounterSynchronisationInfo DL-CounterSynchronisationInfo-r5 OPTIONAL,
-- Transport channel IEs
  ul-CommonTransChInfo           UL-CommonTransChInfo-r4           OPTIONAL,
  ul-deletedTransChInfoList      UL-DeletedTransChInfoList-r6        OPTIONAL,
  ul-AddReconfTransChInfoList    UL-AddReconfTransChInfoList-r6     OPTIONAL,
  dl-CommonTransChInfo           DL-CommonTransChInfo-r4           OPTIONAL,
  dl-DeletedTransChInfoList      DL-DeletedTransChInfoList-r5       OPTIONAL,
  dl-AddReconfTransChInfoList    DL-AddReconfTransChInfoList-r5     OPTIONAL,
-- Physical channel IEs
  frequencyInfo                  FrequencyInfo                       OPTIONAL,
  maxAllowedUL-TX-Power          MaxAllowedUL-TX-Power              OPTIONAL,
  ul-DPCH-Info                   UL-DPCH-Info-r6                   OPTIONAL,
  ul-EDCH-Information            UL-EDCH-Information-r6            OPTIONAL,
  dl-HSPDSCH-Information         DL-HSPDSCH-Information-r6         OPTIONAL,
  dl-CommonInformation           DL-CommonInformation-r6           OPTIONAL,
  dl-InformationPerRL-List       DL-InformationPerRL-List-r6       OPTIONAL,
-- MBMS IEs
  mbms-PL-ServiceRestrictInfo    MBMS-PL-ServiceRestrictInfo-r6    OPTIONAL,
  mbms-RB-ListReleasedToChangeTransferMode
                                  RB-InformationReleaseList         OPTIONAL,
}

RadioBearerRelease-v6b0ext-IEs ::= SEQUENCE {
-- Physical channel IEs
  dl-InformationPerRL-List-v6b0ext DL-InformationPerRL-List-v6b0ext OPTIONAL
}

RadioBearerRelease-r7-IEs ::= SEQUENCE {
-- User equipment IEs
  integrityProtectionModeInfo     IntegrityProtectionModeInfo-r7     OPTIONAL,
  cipheringModeInfo              CipheringModeInfo-r7               OPTIONAL,
  activationTime                  ActivationTime                      OPTIONAL,
  new-U-RNTI                      U-RNTI                            OPTIONAL,
  new-C-RNTI                      C-RNTI                            OPTIONAL,
  -- The IE "new-DSCH-RNTI" should not be included in FDD mode,
  -- and if received the UE behaviour is unspecified
  new-DSCH-RNTI                  DSCH-RNTI                          OPTIONAL,
  new-H-RNTI                      H-RNTI                            OPTIONAL,
  newPrimary-E-RNTI              E-RNTI                            OPTIONAL,
  newSecondary-E-RNTI            E-RNTI                            OPTIONAL,
  rrc-StateIndicator             RRC-StateIndicator,
  ueMobilityStateIndicator        High-MobilityDetected              OPTIONAL,
  utran-DRX-CycleLengthCoeff     UTRAN-DRX-CycleLengthCoefficient-r7 OPTIONAL,
-- Core network IEs
  cn-InformationInfo              CN-InformationInfo-r6              OPTIONAL,
  signallingConnectionRelIndication CN-DomainIdentity                OPTIONAL,
-- UTRAN mobility IEs
  ura-Identity                    URA-Identity                      OPTIONAL,
  supportForChangeOfUE-Capability BOOLEAN                            OPTIONAL,
-- Radio bearer IEs
  rab-InformationReconfigList     RAB-InformationReconfigList        OPTIONAL,
  rb-InformationReleaseList       RB-InformationReleaseList,
  rb-InformationReconfigList-r7   RB-InformationReconfigList-r7     OPTIONAL,
  rb-InformationAffectedList-r7   RB-InformationAffectedList-r7     OPTIONAL,
  dl-CounterSynchronisationInfo   DL-CounterSynchronisationInfo-r5  OPTIONAL,
-- Transport channel IEs
  ul-CommonTransChInfo           UL-CommonTransChInfo-r4           OPTIONAL,
  ul-deletedTransChInfoList      UL-DeletedTransChInfoList-r6        OPTIONAL,
  ul-AddReconfTransChInfoList    UL-AddReconfTransChInfoList-r7     OPTIONAL,
  dl-CommonTransChInfo           DL-CommonTransChInfo-r4           OPTIONAL,
  dl-DeletedTransChInfoList-r7   DL-DeletedTransChInfoList-r7     OPTIONAL,
  dl-AddReconfTransChInfoList-r7 DL-AddReconfTransChInfoList-r7     OPTIONAL,
-- Physical channel IEs
  frequencyInfo                  FrequencyInfo                       OPTIONAL,
  multi-frequencyInfo            Multi-frequencyInfo-LCR-r7         OPTIONAL,
  dtx-drx-TimingInfo-r7         DTX-DRX-TimingInfo-r7            OPTIONAL,
  dtx-drx-Info-r7               DTX-DRX-Info-r7                  OPTIONAL,
  hs-scch-LessInfo-r7           HS-SCCH-LessInfo-r7              OPTIONAL,
  mimoParameters-r7             MIMO-Parameters-r7               OPTIONAL,
  maxAllowedUL-TX-Power          MaxAllowedUL-TX-Power              OPTIONAL,
  ul-DPCH-Info-r7               UL-DPCH-Info-r7                  OPTIONAL,
  ul-EDCH-Information-r7         UL-EDCH-Information-r7            OPTIONAL,
  dl-HSPDSCH-Information-r7     DL-HSPDSCH-Information-r7         OPTIONAL,
  dl-CommonInformation-r7       DL-CommonInformation-r7           OPTIONAL,
  dl-InformationPerRL-List-r7   DL-InformationPerRL-List-r7       OPTIONAL,
-- MBMS IEs
  mbms-PL-ServiceRestrictInfo    MBMS-PL-ServiceRestrictInfo-r6    OPTIONAL,
  mbms-RB-ListReleasedToChangeTransferMode

```

```

        RB-InformationReleaseList                OPTIONAL
    }
RadioBearerRelease-v770ext-IEs ::= SEQUENCE {
    -- User equipment IEs
        ueMobilityStateIndicator                High-MobilityDetected                OPTIONAL
    }
RadioBearerRelease-v780ext-IEs ::= SEQUENCE {
    -- Physical channel IEs
        hs-DSCH-TBSizeTable                    HS-DSCH-TBSizeTable                    OPTIONAL
    }
RadioBearerRelease-v7d0ext-IEs ::= SEQUENCE {
    -- Physical channel IEs
        ul-EDCH-Information                    UL-EDCH-Information-ext                OPTIONAL
    }
RadioBearerRelease-v7f0ext-IEs ::= SEQUENCE {
    -- Physical channel IEs
        mimoParameters                        MIMO-Parameters-v7f0ext                OPTIONAL
    }
RadioBearerRelease-v7g0ext-IEs ::= SEQUENCE {
    -- Physical channel IEs
        mimoParameters                        MIMO-Parameters-v7g0ext                OPTIONAL
    }
-- *****
--
-- RADIO BEARER RELEASE COMPLETE
--
-- *****

RadioBearerReleaseComplete ::= SEQUENCE {
    -- User equipment IEs
        rrc-TransactionIdentifier              RRC-TransactionIdentifier,
        ul-IntegProtActivationInfo              IntegrityProtActivationInfo              OPTIONAL,
        -- TABULAR: UL-TimingAdvance is applicable for TDD mode only.
        ul-TimingAdvance                       UL-TimingAdvance                       OPTIONAL,
    -- Radio bearer IEs
        count-C-ActivationTime                 ActivationTime                           OPTIONAL,
        -- dummy is not used in this version of the specification and
        -- it should be ignored by the receiver.
        dummy                                  RB-ActivationTimeInfoList              OPTIONAL,
        ul-CounterSynchronisationInfo          UL-CounterSynchronisationInfo          OPTIONAL,
        laterNonCriticalExtensions              SEQUENCE {
            -- Container for additional R99 extensions
            radioBearerReleaseComplete-r3-add-ext    BIT STRING    OPTIONAL,
            v770NonCriticalExtensions              SEQUENCE {
                radioBearerReleaseComplete-v770ext
            }
        } OPTIONAL
    } OPTIONAL
}

RadioBearerReleaseComplete-v770ext-IEs ::= SEQUENCE {
    -- TABULAR: EXT-UL-TimingAdvance is applicable for TDD mode only.
        ext-UL-TimingAdvance                    EXT-UL-TimingAdvance                    OPTIONAL,
        deferredMeasurementControlReading        ENUMERATED { true }                    OPTIONAL
    }

-- *****
--
-- RADIO BEARER RELEASE FAILURE
--
-- *****

RadioBearerReleaseFailure ::= SEQUENCE {
    -- User equipment IEs
        rrc-TransactionIdentifier              RRC-TransactionIdentifier,
        failureCause                           FailureCauseWithProtErr,
    -- Radio bearer IEs
        potentiallySuccessfulBearerList        RB-IdentityList                        OPTIONAL,
        laterNonCriticalExtensions              SEQUENCE {
            -- Container for additional R99 extensions
            radioBearerReleaseFailure-r3-add-ext    BIT STRING    OPTIONAL,

```

```

    nonCriticalExtensions      SEQUENCE {}      OPTIONAL
  }
  OPTIONAL
}

-- *****
--
-- RADIO BEARER SETUP
--
-- *****

RadioBearerSetup ::= CHOICE {
  r3
    SEQUENCE {
      radioBearerSetup-r3      RadioBearerSetup-r3-IEs,
      v3a0NonCriticalExtensions SEQUENCE {
        radioBearerSetup-v3a0ext      RadioBearerSetup-v3a0ext,
        laterNonCriticalExtensions    SEQUENCE {
          -- Container for additional R99 extensions
          radioBearerSetup-r3-add-ext  BIT STRING      OPTIONAL,
          v4b0NonCriticalExtensions    SEQUENCE {
            radioBearerSetup-v4b0ext    RadioBearerSetup-v4b0ext-IEs,
            v590NonCriticalExtensions    SEQUENCE {
              radioBearerSetup-v590ext    RadioBearerSetup-v590ext-IEs,
              v5d0NonCriticalExtensions    SEQUENCE {
                radioBearerSetup-v5d0ext    RadioBearerSetup-v5d0ext-IEs,
                v690NonCriticalExtensions    SEQUENCE {
                  radioBearerSetup-v690ext    RadioBearerSetup-v690ext-IEs,
                  nonCriticalExtensions      SEQUENCE {}      OPTIONAL
                }
              }
            }
          }
        }
      }
    }
  OPTIONAL
},
  later-than-r3
    SEQUENCE {
      rrc-TransactionIdentifier      RRC-TransactionIdentifier,
      criticalExtensions              CHOICE {
        r4
          SEQUENCE {
            radioBearerSetup-r4      RadioBearerSetup-r4-IEs,
            v4d0NonCriticalExtensions SEQUENCE {
              -- Container for adding non critical extensions after freezing REL-5
              radioBearerSetup-r4-add-ext  BIT STRING      OPTIONAL,
              v590NonCriticalExtensions    SEQUENCE {
                radioBearerSetup-v590ext    RadioBearerSetup-v590ext-IEs,
                v5d0NonCriticalExtensions    SEQUENCE {
                  radioBearerSetup-v5d0ext    RadioBearerSetup-v5d0ext-IEs,
                  v690NonCriticalExtensions    SEQUENCE {
                    radioBearerSetup-v690ext    RadioBearerSetup-v690ext-IEs,
                    nonCriticalExtensions      SEQUENCE {}      OPTIONAL
                  }
                }
              }
            }
          }
        }
      }
    }
  OPTIONAL
},
  criticalExtensions              CHOICE {
    r5
      SEQUENCE {
        radioBearerSetup-r5      RadioBearerSetup-r5-IEs,
        -- Container for adding non critical extensions after freezing REL-6
        radioBearerSetup-r5-add-ext  BIT STRING      OPTIONAL,
        v5d0NonCriticalExtensions    SEQUENCE {
          radioBearerSetup-v5d0ext    RadioBearerSetup-v5d0ext-IEs,
          v690NonCriticalExtensions    SEQUENCE {
            radioBearerSetup-v690ext    RadioBearerSetup-v690ext-IEs,
            nonCriticalExtensions      SEQUENCE {}      OPTIONAL
          }
        }
      }
    }
  OPTIONAL
},
  criticalExtensions              CHOICE {
    r6
      SEQUENCE {
        radioBearerSetup-r6      RadioBearerSetup-r6-IEs,
        -- Container for adding non critical extensions after freezing REL-7
        radioBearerSetup-r6-add-ext  BIT STRING      OPTIONAL,
        v6b0NonCriticalExtensions    SEQUENCE {
          radioBearerSetup-v6b0ext    RadioBearerSetup-v6b0ext-IEs,
          nonCriticalExtensions      SEQUENCE {}      OPTIONAL
        }
      }
    }
  OPTIONAL
},
  criticalExtensions              CHOICE {

```

```

        r7
        radioBearerSetup-r7          SEQUENCE {
        -- Container for adding non critical extensions after freezing REL-8
        radioBearerSetup-r7-add-ext  BIT STRING
        (CONTAINING RadioBearerSetup-r7-add-ext-IEs)  OPTIONAL,
        v780NonCriticalExtensions    SEQUENCE {
        radioBearerSetup-v780ext     RadioBearerSetup-v780ext-IEs,
        nonCriticalExtensions        SEQUENCE {}  OPTIONAL
        },
        },
        criticalExtensions            SEQUENCE {}
    }
}

RadioBearerSetup-r3-IEs ::= SEQUENCE {
-- User equipment IEs
rrc-TransactionIdentifier          RRC-TransactionIdentifier,
integrityProtectionModeInfo       IntegrityProtectionModeInfo  OPTIONAL,
cipheringModeInfo                  CipheringModeInfo              OPTIONAL,
activationTime                      ActivationTime                  OPTIONAL,
new-U-RNTI                          U-RNTI                        OPTIONAL,
new-C-RNTI                          C-RNTI                        OPTIONAL,
rrc-StateIndicator                  RRC-StateIndicator,
utran-DRX-CycleLengthCoeff         UTRAN-DRX-CycleLengthCoefficient  OPTIONAL,
-- UTRAN mobility IEs
ura-Identity                        URA-Identity                  OPTIONAL,
-- Core network IEs
cn-InformationInfo                  CN-InformationInfo            OPTIONAL,
-- Radio bearer IEs
srb-InformationSetupList           SRB-InformationSetupList      OPTIONAL,
rab-InformationSetupList           RAB-InformationSetupList      OPTIONAL,
rb-InformationAffectedList         RB-InformationAffectedList     OPTIONAL,
dl-CounterSynchronisationInfo     DL-CounterSynchronisationInfo  OPTIONAL,
-- Transport channel IEs
ul-CommonTransChInfo              UL-CommonTransChInfo         OPTIONAL,
ul-deletedTransChInfoList          UL-DeletedTransChInfoList     OPTIONAL,
ul-AddReconfTransChInfoList       UL-AddReconfTransChInfoList   OPTIONAL,
-- 'dummy', 'dummy1' and 'dummy2' are not used in this version of the specification,
-- they should not be sent and if received they should be ignored.
dummy                               CHOICE {
    fdd                             SEQUENCE {
        dummy1                       CPCH-SetID                     OPTIONAL,
        dummy2                       DRAC-StaticInformationList     OPTIONAL
    },
    tdd                             NULL
}
dl-CommonTransChInfo              DL-CommonTransChInfo         OPTIONAL,
dl-DeletedTransChInfoList          DL-DeletedTransChInfoList     OPTIONAL,
dl-AddReconfTransChInfoList       DL-AddReconfTransChInfoList   OPTIONAL,
-- Physical channel IEs
frequencyInfo                      FrequencyInfo                  OPTIONAL,
maxAllowedUL-TX-Power              MaxAllowedUL-TX-Power         OPTIONAL,
ul-ChannelRequirement              UL-ChannelRequirement         OPTIONAL,
modeSpecificPhysChInfo             CHOICE {
    fdd                             SEQUENCE {
        -- dummy is not used in this version of specification, it should
        -- not be sent and if received it should be ignored.
        dummy                         DL-PDSCH-Information          OPTIONAL
    },
    tdd                             NULL
},
dl-CommonInformation              DL-CommonInformation         OPTIONAL,
dl-InformationPerRL-List           DL-InformationPerRL-List     OPTIONAL
}

RadioBearerSetup-v3a0ext ::= SEQUENCE {
-- The IE "new-DSCH-RNTI" should not be included in FDD mode, and if received the UE behaviour
-- is unspecified
new-DSCH-RNTI                      DSCH-RNTI                     OPTIONAL
}

RadioBearerSetup-v4b0ext-IEs ::= SEQUENCE {
-- Physical channel IEs
-- dummy is not used in this version of the specification, it should

```

```

-- not be sent and if received it should be ignored.
dummy                SSĐT-UL                OPTIONAL,
-- The order of the RLs in IE cell-id-PerRL-List is the same as
-- in IE DL-InformationPerRL-List included in this message
cell-id-PerRL-List  CellIdentity-PerRL-List  OPTIONAL
}

RadioBearerSetup-v590ext-IEs ::= SEQUENCE {
-- Physical channel IEs
dl-TPC-PowerOffsetPerRL-List  DL-TPC-PowerOffsetPerRL-List  OPTIONAL
}

RadioBearerSetup-v5d0ext-IEs ::= SEQUENCE {
--Radio Bearer IEs
pcdp-ROHC-TargetMode          PDCP-ROHC-TargetMode          OPTIONAL
}

RadioBearerSetup-r4-IEs ::= SEQUENCE {
-- User equipment IEs
integrityProtectionModeInfo    IntegrityProtectionModeInfo    OPTIONAL,
cipheringModeInfo              CipheringModeInfo              OPTIONAL,
activationTime                  ActivationTime                  OPTIONAL,
new-U-RNTI                      U-RNTI                        OPTIONAL,
new-C-RNTI                      C-RNTI                        OPTIONAL,
-- The IE "new-DSCH-RNTI" should not be included in FDD mode, and if received
-- the UE behaviour is unspecified
new-DSCH-RNTI                  DSCH-RNTI                      OPTIONAL,
rrc-StateIndicator              RRC-StateIndicator,
utran-DRX-CycleLengthCoeff      UTRAN-DRX-CycleLengthCoefficient  OPTIONAL,
-- UTRAN mobility IEs
ura-Identity                    URA-Identity                    OPTIONAL,
-- Core network IEs
cn-InformationInfo              CN-InformationInfo              OPTIONAL,
-- Radio bearer IEs
srb-InformationSetupList        SRB-InformationSetupList        OPTIONAL,
rab-InformationSetupList        RAB-InformationSetupList-r4     OPTIONAL,
rb-InformationAffectedList      RB-InformationAffectedList      OPTIONAL,
dl-CounterSynchronisationInfo  DL-CounterSynchronisationInfo  OPTIONAL,
-- Transport channel IEs
ul-CommonTransChInfo           UL-CommonTransChInfo-r4        OPTIONAL,
ul-deletedTransChInfoList       UL-DeletedTransChInfoList       OPTIONAL,
ul-AddReconfTransChInfoList     UL-AddReconfTransChInfoList     OPTIONAL,
-- 'dummy', 'dummy1' and 'dummy2' are not used in this version of the specification,
-- they should not be sent and if received they should be ignored.
dummy                            CHOICE {
fdd                               SEQUENCE {
dummy1                            CPCH-SetID                      OPTIONAL,
dummy2                            DRAC-StaticInformationList      OPTIONAL
},
tdd                               NULL
},
dl-CommonTransChInfo           DL-CommonTransChInfo-r4        OPTIONAL,
dl-DeletedTransChInfoList       DL-DeletedTransChInfoList       OPTIONAL,
dl-AddReconfTransChInfoList     DL-AddReconfTransChInfoList-r4  OPTIONAL,
-- Physical channel IEs
frequencyInfo                   FrequencyInfo                    OPTIONAL,
maxAllowedUL-TX-Power           MaxAllowedUL-TX-Power           OPTIONAL,
ul-ChannelRequirement           UL-ChannelRequirement-r4        OPTIONAL,
modeSpecificPhysChInfo         CHOICE {
fdd                               SEQUENCE {
-- dummy is not used in this version of specification, it should
-- not be sent and if received it should be ignored.
dummy                            DL-PDSCH-Information            OPTIONAL
},
tdd                               NULL
},
dl-CommonInformation           DL-CommonInformation-r4         OPTIONAL,
dl-InformationPerRL-List        DL-InformationPerRL-List-r4     OPTIONAL
}

RadioBearerSetup-r5-IEs ::= SEQUENCE {
-- User equipment IEs
integrityProtectionModeInfo    IntegrityProtectionModeInfo    OPTIONAL,
cipheringModeInfo              CipheringModeInfo              OPTIONAL,
activationTime                  ActivationTime                  OPTIONAL,
new-U-RNTI                      U-RNTI                        OPTIONAL,
new-C-RNTI                      C-RNTI                        OPTIONAL,
-- The IE "new-DSCH-RNTI" should not be included in FDD mode, and if received

```

```

-- the UE behaviour is unspecified
new-DSCH-RNTI          DSCH-RNTI          OPTIONAL,
new-H-RNTI             H-RNTI            OPTIONAL,
rrc-StateIndicator     RRC-StateIndicator,
utran-DRX-CycleLengthCoeff  UTRAN-DRX-CycleLengthCoefficient  OPTIONAL,
-- UTRAN mobility IEs
ura-Identity           URA-Identity       OPTIONAL,
-- Core network IEs
cn-InformationInfo     CN-InformationInfo  OPTIONAL,
-- Radio bearer IEs
srb-InformationSetupList  SRB-InformationSetupList-r5  OPTIONAL,
rab-InformationSetupList  RAB-InformationSetupList-r5  OPTIONAL,
rb-InformationAffectedList  RB-InformationAffectedList-r5  OPTIONAL,
dl-CounterSynchronisationInfo  DL-CounterSynchronisationInfo-r5  OPTIONAL,
-- Transport channel IEs
ul-CommonTransChInfo    UL-CommonTransChInfo-r4      OPTIONAL,
ul-deletedTransChInfoList  UL-DeletedTransChInfoList      OPTIONAL,
ul-AddReconfTransChInfoList  UL-AddReconfTransChInfoList    OPTIONAL,
-- 'dummy', 'dummy1' and 'dummy2' are not used in this version of the specification,
-- they should not be sent and if received they should be ignored.
dummy                  CHOICE {
    fdd                  SEQUENCE {
        dummy1           CPCH-SetID          OPTIONAL,
        dummy2           DRAC-StaticInformationList  OPTIONAL
    },
    tdd                  NULL
}
dl-CommonTransChInfo    DL-CommonTransChInfo-r4      OPTIONAL,
dl-DeletedTransChInfoList  DL-DeletedTransChInfoList-r5  OPTIONAL,
dl-AddReconfTransChInfoList  DL-AddReconfTransChInfoList-r5  OPTIONAL,
-- Physical channel IEs
frequencyInfo           FrequencyInfo      OPTIONAL,
maxAllowedUL-TX-Power    MaxAllowedUL-TX-Power      OPTIONAL,
ul-ChannelRequirement    UL-ChannelRequirement-r5  OPTIONAL,
modeSpecificPhysChInfo    CHOICE {
    fdd                  SEQUENCE {
        -- dummy is not used in this version of specification, it should
        -- not be sent and if received it should be ignored.
        dummy            DL-PDSCH-Information      OPTIONAL
    },
    tdd                  NULL
},
dl-HSPDSCH-Information    DL-HSPDSCH-Information      OPTIONAL,
dl-CommonInformation     DL-CommonInformation-r5    OPTIONAL,
dl-InformationPerRL-List  DL-InformationPerRL-List-r5  OPTIONAL
}

RadioBearerSetup-v690ext-IEs ::= SEQUENCE {
-- Core network IEs
primary-plmn-Identity    PLMN-Identity          OPTIONAL,
-- Physical channel IEs
-- The IE harq-Preamble-Mode should not be used in the r3 and r4 versions of the message
-- If included in the r3 or r4 version of the message, the UE should ignore the IE
harq-Preamble-Mode      HARQ-Preamble-Mode      OPTIONAL,
beaconPLEst             BEACON-PL-Est           OPTIONAL,
postVerificationPeriod  ENUMERATED { true }
dhs-sync                DHS-Sync                OPTIONAL,
timingMaintainedSynchInd  TimingMaintainedSynchInd  OPTIONAL,
-- Radio bearer IEs
rab-InformationSetupList  RAB-InformationSetupList-r6-ext  OPTIONAL,
-- MBMS IEs
mbms-PL-ServiceRestrictInfo  MBMS-PL-ServiceRestrictInfo-r6  OPTIONAL
}

RadioBearerSetup-r6-IEs ::= SEQUENCE {
-- User equipment IEs
integrityProtectionModeInfo  IntegrityProtectionModeInfo  OPTIONAL,
cipheringModeInfo           CipheringModeInfo            OPTIONAL,
activationTime               ActivationTime                OPTIONAL,
new-U-RNTI                   U-RNTI                      OPTIONAL,
new-C-RNTI                     C-RNTI                      OPTIONAL,
-- The IE "new-DSCH-RNTI" should not be included in FDD mode,
-- and if received the UE behaviour is unspecified
new-DSCH-RNTI                DSCH-RNTI                    OPTIONAL,
new-H-RNTI                     H-RNTI                      OPTIONAL,
newPrimary-E-RNTI             E-RNTI                      OPTIONAL,
newSecondary-E-RNTI           E-RNTI                      OPTIONAL,
rrc-StateIndicator           RRC-StateIndicator,

```

```

    utran-DRX-CycleLengthCoeff      UTRAN-DRX-CycleLengthCoefficient      OPTIONAL,
-- UTRAN mobility IEs
  ura-Identity                       URA-Identity                           OPTIONAL,
-- Core network IEs
  cn-InformationInfo                 CN-InformationInfo-r6                  OPTIONAL,
  specificationMode                  CHOICE {
    complete                           SEQUENCE {
-- Radio bearer IEs
      srb-InformationSetupList        SRB-InformationSetupList-r6           OPTIONAL,
      rab-InformationSetupList        RAB-InformationSetupList-r6           OPTIONAL,
      rab-InformationReconfigList     RAB-InformationReconfigList           OPTIONAL,
      rb-InformationReconfigList      RB-InformationReconfigList-r6         OPTIONAL,
      rb-InformationAffectedList      RB-InformationAffectedList-r6         OPTIONAL,
      dl-CounterSynchronisationInfo   DL-CounterSynchronisationInfo-r5     OPTIONAL,
      pdcp-ROHC-TargetMode            PDCP-ROHC-TargetMode                 OPTIONAL,
-- Transport channel IEs
      ul-CommonTransChInfo            UL-CommonTransChInfo-r4              OPTIONAL,
      ul-deletedTransChInfoList       UL-DeletedTransChInfoList-r6         OPTIONAL,
      ul-AddReconfTransChInfoList     UL-AddReconfTransChInfoList-r6       OPTIONAL,
      dl-CommonTransChInfo            DL-CommonTransChInfo-r4              OPTIONAL,
      dl-DeletedTransChInfoList       DL-DeletedTransChInfoList-r5        OPTIONAL,
      dl-AddReconfTransChInfoList     DL-AddReconfTransChInfoList-r5      OPTIONAL
    },
-- dummy is not used in this version of the specification
-- if it is sent, the UE behaviour is unspecified.
  dummy                               SEQUENCE {
      rab-Info                        RAB-Info-r6,
      defaultConfigMode               DefaultConfigMode,
      defaultConfigIdentity            DefaultConfigIdentity-r6,
      rb-InformationChangedList        RB-InformationChangedList-r6         OPTIONAL,
      powerOffsetInfoShort             PowerOffsetInfoShort
    }
  },
-- Physical channel IEs
  frequencyInfo                      FrequencyInfo                           OPTIONAL,
  maxAllowedUL-TX-Power               MaxAllowedUL-TX-Power                   OPTIONAL,
  ul-DPCH-Info                        UL-DPCH-Info-r6                        OPTIONAL,
  ul-EDCH-Information                 UL-EDCH-Information-r6                 OPTIONAL,
  dl-HSPDSCH-Information              DL-HSPDSCH-Information-r6              OPTIONAL,
  dl-CommonInformation                DL-CommonInformation-r6                OPTIONAL,
  dl-InformationPerRL-List            DL-InformationPerRL-List-r6            OPTIONAL,
-- MBMS IEs
  mbms-PL-ServiceRestrictInfo        MBMS-PL-ServiceRestrictInfo-r6        OPTIONAL
}

RadioBearerSetup-v6b0ext-IEs ::= SEQUENCE {
-- Physical channel IEs
  dl-InformationPerRL-List-v6b0ext    DL-InformationPerRL-List-v6b0ext      OPTIONAL,
-- MBMS IEs
-- The order of the RABs in IE rab-InformationSetupListExt is the same as
-- in IE rab-InformationSetupList that is included in this message
  rab-InformationSetupListExt        RAB-InformationSetupList-v6b0ext     OPTIONAL
}

RadioBearerSetup-r7-IEs ::= SEQUENCE {
-- User equipment IEs
  integrityProtectionModeInfo         IntegrityProtectionModeInfo-r7        OPTIONAL,
  cipheringModeInfo                   CipheringModeInfo-r7                  OPTIONAL,
  activationTime                       ActivationTime                          OPTIONAL,
  new-U-RNTI                           U-RNTI                                OPTIONAL,
  new-C-RNTI                           C-RNTI                                OPTIONAL,
-- The IE "new-DSCH-RNTI" should not be included in FDD mode,
-- and if received the UE behaviour is unspecified
  new-DSCH-RNTI                       DSCH-RNTI                             OPTIONAL,
  new-H-RNTI                           H-RNTI                                OPTIONAL,
  newPrimary-E-RNTI                    E-RNTI                                OPTIONAL,
  newSecondary-E-RNTI                  E-RNTI                                OPTIONAL,
  rrc-StateIndicator                  RRC-StateIndicator,
  utran-DRX-CycleLengthCoeff          UTRAN-DRX-CycleLengthCoefficient-r7   OPTIONAL,
-- UTRAN mobility IEs
  ura-Identity                         URA-Identity                           OPTIONAL,
  supportForChangeOfUE-Capability      BOOLEAN                                OPTIONAL,
-- Core network IEs
  cn-InformationInfo                 CN-InformationInfo-r6                  OPTIONAL,
  specificationMode                  CHOICE {
    complete                           SEQUENCE {
-- Radio bearer IEs
      srb-InformationSetupList        SRB-InformationSetupList-r7           OPTIONAL,

```

```

        rab-InformationSetupList          RAB-InformationSetupList-r7          OPTIONAL,
        rab-InformationReconfigList      RAB-InformationReconfigList          OPTIONAL,
        rb-InformationReconfigList       RB-InformationReconfigList-r7       OPTIONAL,
        rb-InformationAffectedList       RB-InformationAffectedList-r7       OPTIONAL,
        dl-CounterSynchronisationInfo    DL-CounterSynchronisationInfo-r5    OPTIONAL,
        pdcp-ROHC-TargetMode             PDCP-ROHC-TargetMode                OPTIONAL,
    -- Transport channel IEs
        ul-CommonTransChInfo             UL-CommonTransChInfo-r4             OPTIONAL,
        ul-deletedTransChInfoList        UL-DeletedTransChInfoList-r6        OPTIONAL,
        ul-AddReconfTransChInfoList      UL-AddReconfTransChInfoList-r7      OPTIONAL,
        dl-CommonTransChInfo             DL-CommonTransChInfo-r4             OPTIONAL,
        dl-DeletedTransChInfoList        DL-DeletedTransChInfoList-r7        OPTIONAL,
        dl-AddReconfTransChInfoList      DL-AddReconfTransChInfoList-r7      OPTIONAL
    },
    -- dummy is not used in this version of the specification
    -- if it is sent, the UE behaviour is unspecified.
    dummy                                NULL
},
-- Physical channel IEs
    frequencyInfo                       FrequencyInfo                         OPTIONAL,
    multi-frequencyInfo                  Multi-frequencyInfo-LCR-r7           OPTIONAL,
    dtx-drx-TimingInfo                   DTX-DRX-TimingInfo-r7               OPTIONAL,
    dtx-drx-Info                          DTX-DRX-Info-r7                     OPTIONAL,
    hs-scch-LessInfo                      HS-SCCH-LessInfo-r7                  OPTIONAL,
    mimoParameters                       MIMO-Parameters-r7                   OPTIONAL,
    maxAllowedUL-TX-Power                 MaxAllowedUL-TX-Power                 OPTIONAL,
    ul-DPCH-Info                          UL-DPCH-Info-r7                      OPTIONAL,
    ul-EDCH-Information                   UL-EDCH-Information-r7               OPTIONAL,
    dl-HSPDSCH-Information                DL-HSPDSCH-Information-r7            OPTIONAL,
    dl-CommonInformation                  DL-CommonInformation-r7              OPTIONAL,
    dl-InformationPerRL-List              DL-InformationPerRL-List-r7          OPTIONAL,
-- MBMS IEs
    mbms-PL-ServiceRestrictInfo          MBMS-PL-ServiceRestrictInfo-r6       OPTIONAL
}

RadioBearerSetup-r7-add-ext-IEs ::= SEQUENCE {
    radioBearerSetup-v7d0ext             RadioBearerSetup-v7d0ext-IEs         OPTIONAL,
    v7f0NonCriticalExtensions             SEQUENCE {
        radioBearerSetup-v7f0ext         RadioBearerSetup-v7f0ext-IEs,
        v7g0NonCriticalExtensions        SEQUENCE {
            radioBearerSetup-v7g0ext     RadioBearerSetup-v7g0ext-IEs,
            nonCriticalExtensions         SEQUENCE {} OPTIONAL
        } OPTIONAL
    } OPTIONAL
}

RadioBearerSetup-v780ext-IEs ::= SEQUENCE {
    -- Physical channel IEs
    hs-DSCH-TBSizeTable                   HS-DSCH-TBSizeTable                  OPTIONAL
}

RadioBearerSetup-v7d0ext-IEs ::= SEQUENCE {
    -- Physical channel IEs
    ul-EDCH-Information                    UL-EDCH-Information-ext              OPTIONAL
}

RadioBearerSetup-v7f0ext-IEs ::= SEQUENCE {
    -- Physical channel IEs
    mimoParameters                        MIMO-Parameters-v7f0ext              OPTIONAL
}

RadioBearerSetup-v7g0ext-IEs ::= SEQUENCE {
    -- Physical channel IEs
    mimoParameters                        MIMO-Parameters-v7g0ext              OPTIONAL
}

-- *****
--
-- RADIO BEARER SETUP COMPLETE
--
-- *****

RadioBearerSetupComplete ::= SEQUENCE {
    -- User equipment IEs
    rrc-TransactionIdentifier              RRC-TransactionIdentifier,
    ul-IntegProtActivationInfo              IntegrityProtActivationInfo           OPTIONAL,
    -- TABULAR: UL-TimingAdvance is applicable for TDD mode only.
    ul-TimingAdvance                       UL-TimingAdvance                     OPTIONAL,
}

```



```

    start-Value          START-Value          OPTIONAL,
-- Radio bearer IEs
count-C-ActivationTime  ActivationTime          OPTIONAL,
-- dummy is not used in this version of the specification and
-- it should be ignored by the receiver.
dummy                  RB-ActivationTimeInfoList  OPTIONAL,
ul-CounterSynchronisationInfo  UL-CounterSynchronisationInfo  OPTIONAL,
laterNonCriticalExtensions  SEQUENCE {
  -- Container for additional R99 extensions
  radioBearerSetupComplete-r3-add-ext  BIT STRING          OPTIONAL,
  v770NonCriticalExtensions  SEQUENCE {
    radioBearerSetupComplete-v770ext
                                RadioBearerSetupComplete-v770ext-IEs,
                                SEQUENCE {}          OPTIONAL
  }  OPTIONAL
}  OPTIONAL
}

RadioBearerSetupComplete-v770ext-IEs ::= SEQUENCE {
  -- TABULAR: EXT-UL-TimingAdvance is applicable for TDD mode only.
  ext-UL-TimingAdvance  EXT-UL-TimingAdvance  OPTIONAL,
  deferredMeasurementControlReading  ENUMERATED { true }  OPTIONAL
}

-- *****
--
-- RADIO BEARER SETUP FAILURE
--
-- *****

RadioBearerSetupFailure ::= SEQUENCE {
  -- User equipment IEs
  rrc-TransactionIdentifier  RRC-TransactionIdentifier,
  failureCause  FailureCauseWithProtErr,
  -- Radio bearer IEs
  potentiallySuccessfulBearerList  RB-IdentityList          OPTIONAL,
  laterNonCriticalExtensions  SEQUENCE {
    -- Container for additional R99 extensions
    radioBearerSetupFailure-r3-add-ext  BIT STRING          OPTIONAL,
    nonCriticalExtensions  SEQUENCE {}          OPTIONAL
  }  OPTIONAL
}

-- *****
--
-- RRC CONNECTION REJECT
--
-- *****

RRCConnectionReject ::= CHOICE {
  r3          SEQUENCE {
    rrcConnectionReject-r3  RRCConnectionReject-r3-IEs,
    laterNonCriticalExtensions  SEQUENCE {
      -- Container for additional R99 extensions
      rrcConnectionReject-r3-add-ext  BIT STRING          OPTIONAL,
      v690NonCriticalExtensions  SEQUENCE {
        rrcConnectionReject-v690ext  RRCConnectionReject-v690ext-IEs,
        v6f0NonCriticalExtensions  SEQUENCE {
          rrcConnectionReject-v6f0ext  RRCConnectionReject-v6f0ext-IEs,
          nonCriticalExtensions  SEQUENCE {}          OPTIONAL
        }  OPTIONAL
      }  OPTIONAL
    }  OPTIONAL
  },
  later-than-r3  SEQUENCE {
    initialUE-Identity  InitialUE-Identity,
    rrc-TransactionIdentifier  RRC-TransactionIdentifier,
    criticalExtensions  SEQUENCE {}
  }
}

RRCConnectionReject-r3-IEs ::= SEQUENCE {
  -- TABULAR: Integrity protection shall not be performed on this message.
  -- User equipment IEs
  initialUE-Identity  InitialUE-Identity,
  rrc-TransactionIdentifier  RRC-TransactionIdentifier,
  rejectionCause  RejectionCause,
  waitTime  WaitTime,

```

```

        redirectionInfo          RedirectionInfo          OPTIONAL
    }
RRCConnectionReject-v690ext-IEs ::= SEQUENCE {
    redirectionInfo-v690ext      GSM-TargetCellInfoList    OPTIONAL
}
RRCConnectionReject-v6f0ext-IEs ::= SEQUENCE {
    countingCompletion          ENUMERATED { true }        OPTIONAL
}
-- *****
--
-- RRC CONNECTION RELEASE
--
-- *****

RRCConnectionRelease ::= CHOICE {
    r3          SEQUENCE {
        rrcConnectionRelease-r3          RRCConnectionRelease-r3-IEs,
        laterNonCriticalExtensions        SEQUENCE {
            -- Container for additional R99 extensions
            rrcConnectionRelease-r3-add-ext BIT STRING      OPTIONAL,
            v690NonCriticalExtensions      SEQUENCE {
                rrcConnectionRelease-v690ext          RRCConnectionRelease-v690ext-IEs,
                v770NonCriticalExtensions            SEQUENCE {
                    rrcConnectionRelease-v770ext          RRCConnectionRelease-v770ext-IEs,
                    nonCriticalExtensions                SEQUENCE {}      OPTIONAL
                }
            } OPTIONAL
        } OPTIONAL
    },
    later-than-r3          SEQUENCE {
        rrc-TransactionIdentifier          RRC-TransactionIdentifier,
        criticalExtensions                CHOICE {
            r4          SEQUENCE {
                rrcConnectionRelease-r4          RRCConnectionRelease-r4-IEs,
                v4d0NonCriticalExtensions        SEQUENCE {
                    -- Container for adding non critical extensions after freezing REL-6
                    rrcConnectionRelease-r4-add-ext BIT STRING      OPTIONAL,
                    v690NonCriticalExtensions      SEQUENCE {
                        rrcConnectionRelease-v690ext          RRCConnectionRelease-v690ext-IEs,
                        v770NonCriticalExtensions            SEQUENCE {
                            rrcConnectionRelease-v770ext          RRCConnectionRelease-v770ext-IEs,
                            nonCriticalExtensions                SEQUENCE {}      OPTIONAL
                        }
                    } OPTIONAL
                } OPTIONAL
            } OPTIONAL
        }
    },
    criticalExtensions      SEQUENCE {}
}
}

RRCConnectionRelease-r3-IEs ::= SEQUENCE {
    -- User equipment IEs
    rrc-TransactionIdentifier          RRC-TransactionIdentifier,
    -- n-308 is conditional on the UE state
    n-308                              N-308          OPTIONAL,
    releaseCause                        ReleaseCause,
    rplmn-information                  Rplmn-Information    OPTIONAL
}

RRCConnectionRelease-r4-IEs ::= SEQUENCE {
    -- User equipment IEs
    -- n-308 is conditional on the UE state.
    n-308                              N-308          OPTIONAL,
    releaseCause                        ReleaseCause,
    rplmn-information                  Rplmn-Information-r4    OPTIONAL
}

RRCConnectionRelease-v690ext-IEs ::= SEQUENCE {
    redirectionInfo-v690ext          RedirectionInfo-r6    OPTIONAL
}

RRCConnectionRelease-v770ext-IEs ::= SEQUENCE {
    -- User equipment IEs
    ueMobilityStateIndicator          High-MobilityDetected    OPTIONAL
}

```

```

}

-- *****
--
-- RRC CONNECTION RELEASE for CCCH
--
-- *****

RRCConnectionRelease-CCCH ::= CHOICE {
  r3          SEQUENCE {
    rrcConnectionRelease-CCCH-r3      RRCConnectionRelease-CCCH-r3-IEs,
    laterNonCriticalExtensions        SEQUENCE {
      -- Container for additional R99 extensions
      rrcConnectionRelease-CCCH-r3-add-ext  BIT STRING      OPTIONAL,
      v690NonCriticalExtensions            SEQUENCE {
        rrcConnectionRelease-v690ext      RRCConnectionRelease-CCCH-v690ext-IEs,
        nonCriticalExtensions              SEQUENCE {} OPTIONAL
      } OPTIONAL
    } OPTIONAL
  },
  later-than-r3          SEQUENCE {
    u-RNTI                U-RNTI,
    rrc-TransactionIdentifier  RRC-TransactionIdentifier,
    criticalExtensions        CHOICE {
      r4          SEQUENCE {
        rrcConnectionRelease-CCCH-r4      RRCConnectionRelease-CCCH-r4-IEs,
        v4d0NonCriticalExtensions        SEQUENCE {
          -- Container for adding non critical extensions after freezing REL-5
          rrcConnectionRelease-CCCH-r4-add-ext  BIT STRING      OPTIONAL,
          v690NonCriticalExtensions            SEQUENCE {
            rrcConnectionRelease-v690ext      RRCConnectionRelease-CCCH-v690ext-IEs,
            nonCriticalExtensions              SEQUENCE {} OPTIONAL
          } OPTIONAL
        } OPTIONAL
      } OPTIONAL
    },
    criticalExtensions        SEQUENCE {
      -- TABULAR: CHOICE IdentityType (U-RNTI, GroupIdentity) is replaced with the
      -- optional element groupIdentity, since the U-RNTI is mandatory in ASN.1.
      -- In case CHOICE IdentityType is equal to GroupIdentity the value of the U-RNTI
      -- shall be ignored by a UE complying with this version of the message.
      groupIdentity          SEQUENCE ( SIZE (1 .. maxURNTI-Group) ) OF
        GroupReleaseInformation  OPTIONAL,
      criticalExtensions      CHOICE {
        r5          SEQUENCE {
          rrcConnectionRelease-CCCH-r5      RRCConnectionRelease-CCCH-r5-IEs,
          -- Container for adding non critical extensions after freezing REL-6
          rrcConnectionRelease-CCCH-r5-add-ext  BIT STRING      OPTIONAL,
          v690NonCriticalExtensions            SEQUENCE {
            rrcConnectionRelease-v690ext      RRCConnectionRelease-CCCH-v690ext-IEs,
            nonCriticalExtensions              SEQUENCE {} OPTIONAL
          } OPTIONAL
        }
      },
      criticalExtensions      SEQUENCE {}
    }
  }
}

}
}

RRCConnectionRelease-CCCH-r3-IEs ::= SEQUENCE {
  -- User equipment IEs
  u-RNTI                U-RNTI,
  -- The rest of the message is identical to the one sent on DCCH.
  rrcConnectionRelease  RRCConnectionRelease-r3-IEs
}

RRCConnectionRelease-CCCH-r4-IEs ::= SEQUENCE {
  -- The rest of the message is identical to the one sent on DCCH.
  rrcConnectionRelease  RRCConnectionRelease-r4-IEs
}

-- The R5 and R4 sequence of IEs are identical in this message
RRCConnectionRelease-CCCH-r5-IEs ::= RRCConnectionRelease-CCCH-r4-IEs

-- The R6 non-critical extension is identical to the one sent on DCCH.
RRCConnectionRelease-CCCH-v690ext-IEs ::= RRCConnectionRelease-v690ext-IEs

```

```

-- *****
--
-- RRC CONNECTION RELEASE COMPLETE
--
-- *****

RRCConnectionReleaseComplete ::= SEQUENCE {
  -- User equipment IEs
  rrc-TransactionIdentifier      RRC-TransactionIdentifier,
  errorIndication                FailureCauseWithProtErr          OPTIONAL,
  laterNonCriticalExtensions     SEQUENCE {
    -- Container for additional R99 extensions
    rrcConnectionReleaseComplete-r3-add-ext  BIT STRING          OPTIONAL,
    nonCriticalExtensions                SEQUENCE {}          OPTIONAL
  }
}

-- *****
--
-- RRC CONNECTION REQUEST
--
-- *****

RRCConnectionRequest ::= SEQUENCE {
  -- TABULAR: Integrity protection shall not be performed on this message.
  -- User equipment IEs
  initialUE-Identity              InitialUE-Identity,
  establishmentCause              EstablishmentCause,
  -- protocolErrorIndicator is MD, but for compactness reasons no default value
  -- has been assigned to it.
  protocolErrorIndicator          ProtocolErrorIndicator,
  -- Measurement IEs
  measuredResultsOnRACH           MeasuredResultsOnRACH          OPTIONAL,
  -- Non critical Extensions
  v3d0NonCriticalExtensions       SEQUENCE {
    rrcConnectionRequest-v3d0ext    RRCConnectionRequest-v3d0ext-IEs,
    -- Reserved for future non critical extension
    v4b0NonCriticalExtensions       SEQUENCE {
      rrcConnectionRequest-v4b0ext  RRCConnectionRequest-v4b0ext-IEs,
      v590NonCriticalExtensions     SEQUENCE {
        rrcConnectionRequest-v590ext RRCConnectionRequest-v590ext-IEs,
        v690NonCriticalExtensions   SEQUENCE {
          rrcConnectionRequest-v690ext RRCConnectionRequest-v690ext-IEs,
          -- Reserved for future non critical extension
          v6b0NonCriticalExtensions SEQUENCE {
            rrcConnectionRequest-v6b0ext RRCConnectionRequest-v6b0ext-IEs,
            v6e0NonCriticalExtensions SEQUENCE {
              rrcConnectionRequest-v6e0ext RRCConnectionRequest-v6e0ext-IEs,
              v770NonCriticalExtensions SEQUENCE {
                rrcConnectionRequest-v770ext
                RRCConnectionRequest-v770ext-IEs,
                v7b0NonCriticalExtensions SEQUENCE {
                  rrcConnectionRequest-v7b0ext
                  RRCConnectionRequest-v7b0ext-IEs,
                  v860NonCriticalExtensions SEQUENCE {
                    rrcConnectionRequest-v860ext
                    RRCConnectionRequest-v860ext-IEs,
                    v7e0NonCriticalExtensions SEQUENCE {
                      rrcConnectionRequest-v7e0ext
                      RRCConnectionRequest-v7e0ext-IEs,
                      v7g0NonCriticalExtensions SEQUENCE {
                        rrcConnectionRequest-v7g0ext
                        RRCConnectionRequest-v7g0ext-IEs,
                        nonCriticalExtensions SEQUENCE {} OPTIONAL
                      } OPTIONAL
                    } OPTIONAL
                  } OPTIONAL
                } OPTIONAL
              } OPTIONAL
            } OPTIONAL
          } OPTIONAL
        } OPTIONAL
      } OPTIONAL
    } OPTIONAL
  } OPTIONAL
}

RRCConnectionRequest-v3d0ext-IEs ::= SEQUENCE {

```

```

-- User equipment IEs
  ueSpecificBehaviourInformationIdle      UESpecificBehaviourInformationIdle      OPTIONAL
}

RRCConnectionRequest-v4b0ext-IEs ::= SEQUENCE {
-- User equipment IEs
  accessStratumReleaseIndicator          AccessStratumReleaseIndicator
}

RRCConnectionRequest-v590ext-IEs ::= SEQUENCE {
-- User equipment IEs
  predefinedConfigStatusInfo             BOOLEAN
}

RRCConnectionRequest-v690ext-IEs ::= SEQUENCE {
-- User equipment IEs
  ueCapabilityIndication                  ENUMERATED { hsdch, hsdch-edch }      OPTIONAL,
-- Measurement IEs
  measuredResultsOnRACHinterFreq         MeasuredResultsOnRACHinterFreq       OPTIONAL,
  domainIndicator                        CHOICE {
    cs-domain                             SEQUENCE {
      csCallType                          ENUMERATED { speech, video, other, spare }
    },
    ps-domain                             NULL
  }
}

RRCConnectionRequest-v6b0ext-IEs ::= SEQUENCE {
-- MBMS IEs
  mbmsSelectedServices                   MBMS-SelectedServicesShort           OPTIONAL
}

RRCConnectionRequest-v6e0ext-IEs ::= SEQUENCE {
-- User equipment IEs
  supportForFDPCH                        ENUMERATED { true }                  OPTIONAL
}

RRCConnectionRequest-v770ext-IEs ::= SEQUENCE {
-- User equipment IEs
  ueMobilityStateIndicator                High-MobilityDetected                 OPTIONAL,
  hspdschReception-CellFach              ENUMERATED { true }                  OPTIONAL,
  mac-eHsSupport                          ENUMERATED { true }                  OPTIONAL,
  discontinuousDpcchTransmission         ENUMERATED { true }                  OPTIONAL
}

RRCConnectionRequest-v7b0ext-IEs ::= SEQUENCE {
-- User equipment IEs
  supportForE-FDPCH                      ENUMERATED { true }                  OPTIONAL
}

RRCConnectionRequest-v7e0ext-IEs ::= SEQUENCE {
  reservedForFutureUse                   ENUMERATED { true }                  OPTIONAL
}

RRCConnectionRequest-v7g0ext-IEs ::= SEQUENCE {
-- Measurement IEs
  measuredResultsOnRACH-v7g0ext          MeasuredResultsOnRACH-v7g0ext       OPTIONAL
}

RRCConnectionRequest-v860ext-IEs ::= SEQUENCE {
-- 'dummy' is reserved to ensure compatibility with future v860 extension. It shall
-- not be set by a UE not having support for the v860 feature.
  dummy1                                  ENUMERATED { true }                  OPTIONAL,
  dummy2                                  ENUMERATED { true }                  OPTIONAL,
  dummy3                                  Pre-RedirectionInfo                 OPTIONAL,
  dummy4                                  ENUMERATED { true }                  OPTIONAL,
  dummy5                                  ENUMERATED { true }                  OPTIONAL
}

-- *****
--
-- RRC CONNECTION SETUP
--
-- *****

RRCConnectionSetup ::= CHOICE {
  r3                                       SEQUENCE {
    rrcConnectionSetup-r3                RRCConnectionSetup-r3-IEs,

```

```

laterNonCriticalExtensions    SEQUENCE {
-- Container for additional R99 extensions
rrcConnectionSetup-r3-add-ext  BIT STRING      OPTIONAL,
v4b0NonCriticalExtensions      SEQUENCE {
  rrcConnectionSetup-v4b0ext    RRCConnectionSetup-v4b0ext-IEs,
  v590NonCriticalExtensions      SEQUENCE {
    rrcConnectionSetup-v590ext  RRCConnectionSetup-v590ext-IEs,
    v690NonCriticalExtensions    SEQUENCE {
      rrcConnectionSetup-v690ext RRCConnectionSetup-v690ext-IEs,
      nonCriticalExtensions      SEQUENCE {}      OPTIONAL
    } OPTIONAL
  } OPTIONAL
} OPTIONAL
},
later-than-r3                  SEQUENCE {
  initialUE-Identity            InitialUE-Identity,
  rrc-TransactionIdentifier      RRC-TransactionIdentifier,
  criticalExtensions             CHOICE {
    r4                          SEQUENCE {
      rrcConnectionSetup-r4      RRCConnectionSetup-r4-IEs,
      v4d0NonCriticalExtensions  SEQUENCE {
        -- Container for adding non critical extensions after freezing REL-5
        rrcConnectionSetup-r4-add-ext BIT STRING      OPTIONAL,
        v590NonCriticalExtensions  SEQUENCE {
          rrcConnectionSetup-v590ext RRCConnectionSetup-v590ext-IEs,
          v690NonCriticalExtensions  SEQUENCE {
            rrcConnectionSetup-v690ext RRCConnectionSetup-v690ext-IEs,
            nonCriticalExtensions      SEQUENCE {}      OPTIONAL
          } OPTIONAL
        } OPTIONAL
      } OPTIONAL
    } OPTIONAL
  },
  criticalExtensions            CHOICE {
    r5                          SEQUENCE {
      rrcConnectionSetup-r5      RRCConnectionSetup-r5-IEs,
      -- Container for adding non critical extensions after freezing REL-6
      rrcConnectionSetup-r5-add-ext BIT STRING      OPTIONAL,
      v690NonCriticalExtensions  SEQUENCE {
        rrcConnectionSetup-v690ext RRCConnectionSetup-v690ext-IEs,
        nonCriticalExtensions      SEQUENCE {}      OPTIONAL
      } OPTIONAL
    },
    criticalExtensions           CHOICE {
      r6                          SEQUENCE {
        rrcConnectionSetup-r6      RRCConnectionSetup-r6-IEs,
        -- Container for adding non critical extensions after freezing REL-7
        rrcConnectionSetup-r6-add-ext BIT STRING      OPTIONAL,
        v6b0NonCriticalExtensions  SEQUENCE {
          rrcConnectionSetup-v6b0ext RRCConnectionSetup-v6b0ext-IEs,
          nonCriticalExtensions      SEQUENCE {}      OPTIONAL
        } OPTIONAL
      },
      criticalExtensions          CHOICE {
        r7                          SEQUENCE {
          rrcConnectionSetup-r7      RRCConnectionSetup-r7-IEs,
          -- Container for adding non critical extensions after freezing REL-8
          rrcConnectionSetup-r7-add-ext BIT STRING      OPTIONAL,
          v780NonCriticalExtensions SEQUENCE {
            rrcConnectionSetup-v780ext RRCConnectionSetup-v780ext-IEs,
            v7d0NonCriticalExtensions  SEQUENCE {
              rrcConnectionSetup-v7d0ext RRCConnectionSetup-v7d0ext-IEs,
              nonCriticalExtensions      SEQUENCE {}      OPTIONAL
            } OPTIONAL
          } OPTIONAL
        } OPTIONAL
      },
      criticalExtensions           SEQUENCE {}
    }
  }
}
},
},
},
},
},
RRCCConnectionSetup-r3-IEs ::= SEQUENCE {
-- TABULAR: Integrity protection shall not be performed on this message.
-- User equipment IEs
  initialUE-Identity            InitialUE-Identity,

```

```

    rrc-TransactionIdentifier      RRC-TransactionIdentifier,
    activationTime                  ActivationTime                      OPTIONAL,
    new-U-RNTI                      U-RNTI,
    new-c-RNTI                      C-RNTI                      OPTIONAL,
    rrc-StateIndicator              RRC-StateIndicator,
    utran-DRX-CycleLengthCoeff      UTRAN-DRX-CycleLengthCoefficient,
    -- TABULAR: If capabilityUpdateRequirement is not present, the default value
    -- defined in 10.3.3.2 shall be used.
    capabilityUpdateRequirement      CapabilityUpdateRequirement      OPTIONAL,
-- Radio bearer IEs
    srb-InformationSetupList        SRB-InformationSetupList2,
-- Transport channel IEs
    ul-CommonTransChInfo            UL-CommonTransChInfo          OPTIONAL,
    -- NOTE: ul-AddReconfTransChInfoList should be optional in later versions of
    -- this message
    ul-AddReconfTransChInfoList     UL-AddReconfTransChInfoList,
    dl-CommonTransChInfo            DL-CommonTransChInfo          OPTIONAL,
    -- NOTE: dl-AddReconfTransChInfoList should be optional in later versions
    -- of this message
    dl-AddReconfTransChInfoList     DL-AddReconfTransChInfoList,
-- Physical channel IEs
    frequencyInfo                   FrequencyInfo                  OPTIONAL,
    maxAllowedUL-TX-Power            MaxAllowedUL-TX-Power         OPTIONAL,
    ul-ChannelRequirement            UL-ChannelRequirement         OPTIONAL,
    dl-CommonInformation              DL-CommonInformation          OPTIONAL,
    dl-InformationPerRL-List         DL-InformationPerRL-List      OPTIONAL
}

RRCConnectionSetup-v4b0ext-IEs ::= SEQUENCE {
    capabilityUpdateRequirement-r4-ext  CapabilityUpdateRequirement-r4-ext  OPTIONAL,
-- Physical channel IEs
    -- dummy is not used in this version of the specification, it should
    -- not be sent and if received it should be ignored.
    dummy                              SSDT-UL                          OPTIONAL,
    -- The order of the RLs in IE cell-id-PerRL-List is the same as
    -- in IE DL-InformationPerRL-List included in this message
    cell-id-PerRL-List                 CellIdentity-PerRL-List          OPTIONAL
}

RRCConnectionSetup-v590ext-IEs ::= SEQUENCE {
-- User equipment IEs
    systemSpecificCapUpdateReq         SystemSpecificCapUpdateReq-v590ext  OPTIONAL,
-- Physical channel IEs
    dl-TPC-PowerOffsetPerRL-List       DL-TPC-PowerOffsetPerRL-List       OPTIONAL
}

RRCConnectionSetup-r4-IEs ::= SEQUENCE {
-- TABULAR: Integrity protection shall not be performed on this message.
    activationTime                      ActivationTime                      OPTIONAL,
    new-U-RNTI                          U-RNTI,
    new-c-RNTI                          C-RNTI                            OPTIONAL,
    rrc-StateIndicator                  RRC-StateIndicator,
    utran-DRX-CycleLengthCoeff          UTRAN-DRX-CycleLengthCoefficient,
    -- TABULAR: If capabilityUpdateRequirement is not present, the default value
    -- defined in 10.3.3.2 shall be used.
    capabilityUpdateRequirement-r4      CapabilityUpdateRequirement-r4      OPTIONAL,
-- Radio bearer IEs
    srb-InformationSetupList            SRB-InformationSetupList2,
-- Transport channel IEs
    ul-CommonTransChInfo-r4            UL-CommonTransChInfo-r4           OPTIONAL,
    ul-AddReconfTransChInfoList-r4     UL-AddReconfTransChInfoList-r4    OPTIONAL,
    dl-CommonTransChInfo-r4            DL-CommonTransChInfo-r4           OPTIONAL,
    dl-AddReconfTransChInfoList-r4     DL-AddReconfTransChInfoList-r4    OPTIONAL,
-- Physical channel IEs
    frequencyInfo                       FrequencyInfo                       OPTIONAL,
    maxAllowedUL-TX-Power-r4            MaxAllowedUL-TX-Power-r4          OPTIONAL,
    ul-ChannelRequirement-r4            UL-ChannelRequirement-r4          OPTIONAL,
    dl-CommonInformation-r4             DL-CommonInformation-r4           OPTIONAL,
    dl-InformationPerRL-List-r4         DL-InformationPerRL-List-r4       OPTIONAL
}

RRCConnectionSetup-r5-IEs ::= SEQUENCE {
-- TABULAR: Integrity protection shall not be performed on this message.
    activationTime                      ActivationTime                      OPTIONAL,
    new-U-RNTI                          U-RNTI,
    new-c-RNTI                          C-RNTI                            OPTIONAL,
    rrc-StateIndicator                  RRC-StateIndicator,
    utran-DRX-CycleLengthCoeff          UTRAN-DRX-CycleLengthCoefficient,

```

```

-- TABULAR: If capabilityUpdateRequirement is not present, the default value
-- defined in 10.3.3.2 shall be used.
capabilityUpdateRequirement      CapabilityUpdateRequirement-r5      OPTIONAL,
-- Specification mode information
specificationMode                 CHOICE {
  complete                         SEQUENCE {
    -- Radio bearer IEs
    srb-InformationSetupList       SRB-InformationSetupList2,
    -- Transport channel IEs
    ul-CommonTransChInfo          UL-CommonTransChInfo-r4          OPTIONAL,
    ul-AddReconfTransChInfoList   UL-AddReconfTransChInfoList   OPTIONAL,
    dl-CommonTransChInfo          DL-CommonTransChInfo-r4      OPTIONAL,
    dl-AddReconfTransChInfoList   DL-AddReconfTransChInfoList-r4 OPTIONAL
  },
  preconfiguration                SEQUENCE {
    -- All IEs that include an FDD/TDD choice are split in two IEs for this message,
    -- one for the FDD only elements and one for the TDD only elements, so that one
    -- FDD/TDD choice in this level is sufficient.
    preConfigMode                 CHOICE {
      predefinedConfigIdentity     PredefinedConfigIdentity,
      defaultConfig               SEQUENCE {
        defaultConfigMode         DefaultConfigMode,
        defaultConfigIdentity     DefaultConfigIdentity-r5
      }
    }
  }
},
-- Physical channel IEs
frequencyInfo                    FrequencyInfo                    OPTIONAL,
maxAllowedUL-TX-Power            MaxAllowedUL-TX-Power            OPTIONAL,
ul-ChannelRequirement           UL-ChannelRequirement-r4        OPTIONAL,
dl-CommonInformation            DL-CommonInformation-r4        OPTIONAL,
dl-InformationPerRL-List        DL-InformationPerRL-List-r5bis  OPTIONAL
}

RRCConnectionSetup-v690ext-IEs ::= SEQUENCE {
  -- Physical Channel IEs
  beaconPLEst                   BEACON-PL-Est                   OPTIONAL,
  postVerificationPeriod        ENUMERATED { true }             OPTIONAL
}

RRCConnectionSetup-r6-IEs ::= SEQUENCE {
  -- TABULAR: Integrity protection shall not be performed on this message.
  activationTime                ActivationTime                    OPTIONAL,
  new-U-RNTI                    U-RNTI,
  new-c-RNTI                    C-RNTI                          OPTIONAL,
  new-H-RNTI                    H-RNTI                          OPTIONAL,
  newPrimary-E-RNTI            E-RNTI                          OPTIONAL,
  newSecondary-E-RNTI          E-RNTI                          OPTIONAL,
  rrc-StateIndicator            RRC-StateIndicator,
  utran-DRX-CycleLengthCoeff   UTRAN-DRX-CycleLengthCoefficient,
  -- TABULAR: If capabilityUpdateRequirement is not present, the default value
  -- defined in 10.3.3.2 shall be used.
  capabilityUpdateRequirement   CapabilityUpdateRequirement-r5   OPTIONAL,
  -- Specification mode information
  specificationMode             CHOICE {
    complete                     SEQUENCE {
      -- Radio bearer IEs
      srb-InformationSetupList   SRB-InformationSetupList2-r6,
      -- Transport channel IEs
      ul-CommonTransChInfo      UL-CommonTransChInfo-r4          OPTIONAL,
      ul-AddReconfTransChInfoList UL-AddReconfTransChInfoList-r6 OPTIONAL,
      dl-CommonTransChInfo      DL-CommonTransChInfo-r4          OPTIONAL,
      dl-AddReconfTransChInfoList DL-AddReconfTransChInfoList-r5 OPTIONAL
    },
    preconfiguration            SEQUENCE {
      -- All IEs that include an FDD/TDD choice are split in two IEs for this message,
      -- one for the FDD only elements and one for the TDD only elements, so that one
      -- FDD/TDD choice in this level is sufficient.
      preConfigMode             CHOICE {
        predefinedConfigIdentity PredefinedConfigIdentity,
        defaultConfig           SEQUENCE {
          defaultConfigMode     DefaultConfigMode,
          defaultConfigIdentity DefaultConfigIdentity-r6
        }
      }
    }
  }
},
}

```



```

-- Physical channel IEs
  frequencyInfo          FrequencyInfo          OPTIONAL,
  maxAllowedUL-TX-Power  MaxAllowedUL-TX-Power  OPTIONAL,
  ul-DPCH-Info          UL-DPCH-Info-r6          OPTIONAL,
  ul-EDCH-Information    UL-EDCH-Information-r6  OPTIONAL,
  dl-HSPDSCH-Information DL-HSPDSCH-Information-r6  OPTIONAL,
  dl-CommonInformation  DL-CommonInformation-r6  OPTIONAL,
  dl-InformationPerRL-List DL-InformationPerRL-List-r6  OPTIONAL
}

RRCConnectionSetup-v6b0ext-IEs ::= SEQUENCE {
  -- Physical channel IEs
  dl-InformationPerRL-List-v6b0ext  DL-InformationPerRL-List-v6b0ext  OPTIONAL
}

RRCConnectionSetup-r7-IEs ::= SEQUENCE {
  -- TABULAR: Integrity protection shall not be performed on this message.
  activationTime          ActivationTime          OPTIONAL,
  new-U-RNTI              U-RNTI,
  new-c-RNTI              C-RNTI                OPTIONAL,
  new-H-RNTI              H-RNTI                OPTIONAL,
  newPrimary-E-RNTI      E-RNTI                OPTIONAL,
  newSecondary-E-RNTI    E-RNTI                OPTIONAL,
  rrc-StateIndicator      RRC-StateIndicator,
  utran-DRX-CycleLengthCoeff  UTRAN-DRX-CycleLengthCoefficient-r7,
  -- TABULAR: If capabilityUpdateRequirement is not present, the default value
  -- defined in 10.3.3.2 shall be used.
  capabilityUpdateRequirement  CapabilityUpdateRequirement-r7  OPTIONAL,
  supportForChangeOfUE-Capability  BOOLEAN,
  -- Specification mode information
  specificationMode        CHOICE {
    complete                SEQUENCE {
      -- Radio bearer IEs
      srb-InformationSetupList  SRB-InformationSetupList2-r7,
      -- Transport channel IEs
      ul-CommonTransChInfo      UL-CommonTransChInfo-r4          OPTIONAL,
      ul-AddReconfTransChInfoList  UL-AddReconfTransChInfoList-r7  OPTIONAL,
      dl-CommonTransChInfo      DL-CommonTransChInfo-r4          OPTIONAL,
      dl-AddReconfTransChInfoList  DL-AddReconfTransChInfoList-r7  OPTIONAL
    },
    preconfiguration          SEQUENCE {
      -- All IEs that include an FDD/TDD choice are split in two IEs for this message,
      -- one for the FDD only elements and one for the TDD only elements, so that one
      -- FDD/TDD choice in this level is sufficient.
      preConfigMode            CHOICE {
        predefinedConfigIdentity  PredefinedConfigIdentity,
        defaultConfig              SEQUENCE {
          defaultConfigMode      DefaultConfigMode,
          defaultConfigIdentity  DefaultConfigIdentity-r6
        }
      }
    }
  },
  -- Physical channel IEs
  frequencyInfo          FrequencyInfo          OPTIONAL,
  multi-frequencyInfo    Multi-frequencyInfo-LCR-r7  OPTIONAL,
  dtx-drx-TimingInfo     DTX-DRX-TimingInfo-r7          OPTIONAL,
  dtx-drx-Info           DTX-DRX-Info-r7          OPTIONAL,
  hs-scch-LessInfo       HS-SCCH-LessInfo-r7          OPTIONAL,
  maxAllowedUL-TX-Power  MaxAllowedUL-TX-Power  OPTIONAL,
  ul-DPCH-Info          UL-DPCH-Info-r7          OPTIONAL,
  ul-EDCH-Information    UL-EDCH-Information-r7  OPTIONAL,
  dl-HSPDSCH-Information DL-HSPDSCH-Information-r7  OPTIONAL,
  dl-CommonInformation  DL-CommonInformation-r7  OPTIONAL,
  dl-InformationPerRL-List DL-InformationPerRL-List-r7  OPTIONAL
}

RRCConnectionSetup-v780ext-IEs ::= SEQUENCE {
  -- Physical channel IEs
  hs-DSCH-TBSizeTable    HS-DSCH-TBSizeTable  OPTIONAL
}

RRCConnectionSetup-v7d0ext-IEs ::= SEQUENCE {
  -- Physical channel IEs
  ul-EDCH-Information    UL-EDCH-Information-ext  OPTIONAL
}

-- *****

```

```

--
-- RRC CONNECTION SETUP COMPLETE
--
-- *****
RRCConnectionSetupComplete ::= SEQUENCE {
  -- TABULAR: Integrity protection shall not be performed on this message.
  -- User equipment IEs
  rrc-TransactionIdentifier      RRC-TransactionIdentifier,
  startList                      STARTList,
  ue-RadioAccessCapability       UE-RadioAccessCapability          OPTIONAL,
  -- Other IEs
  ue-RATSpecificCapability       InterRAT-UE-RadioAccessCapabilityList  OPTIONAL,
  -- Non critical extensions
  v370NonCriticalExtensions      SEQUENCE {
    rrcConnectionSetupComplete-v370ext  RRCConnectionSetupComplete-v370ext,
    v380NonCriticalExtensions          SEQUENCE {
      rrcConnectionSetupComplete-v380ext  RRCConnectionSetupComplete-v380ext-IEs,
      -- Reserved for future non critical extension
      v3a0NonCriticalExtensions          SEQUENCE {
        rrcConnectionSetupComplete-v3a0ext  RRCConnectionSetupComplete-v3a0ext-IEs,
        laterNonCriticalExtensions        SEQUENCE {
          -- Container for additional R99 extensions
          rrcConnectionSetupComplete-r3-add-ext  BIT STRING
            (CONTAINING RRCConnectionSetupComplete-r3-add-ext-IEs)  OPTIONAL,
          v3g0NonCriticalExtensions        SEQUENCE {
            rrcConnectionSetupComplete-v3g0ext  RRCConnectionSetupComplete-v3g0ext-IEs,
            v4b0NonCriticalExtensions        SEQUENCE {
              rrcConnectionSetupComplete-v4b0ext
                RRCConnectionSetupComplete-v4b0ext-IEs,
              v590NonCriticalExtensions      SEQUENCE {
                rrcConnectionSetupComplete-v590ext
                  RRCConnectionSetupComplete-v590ext-IEs,
                v5c0NonCriticalExtensions    SEQUENCE {
                  rrcConnectionSetupComplete-v5c0ext
                    RRCConnectionSetupComplete-v5c0ext-IEs,
                  v690NonCriticalExtensions  SEQUENCE {
                    rrcConnectionSetupComplete-v690ext
                      RRCConnectionSetupComplete-v690ext-IEs,
                    v770NonCriticalExtensions SEQUENCE {
                      rrcConnectionSetupComplete-v770ext
                        RRCConnectionSetupComplete-v770ext-IEs,
                      nonCriticalExtensions  SEQUENCE {}  OPTIONAL
                    }  OPTIONAL
                  }  OPTIONAL
                }  OPTIONAL
              }  OPTIONAL
            }  OPTIONAL
          }  OPTIONAL
        }  OPTIONAL
      }  OPTIONAL
    }  OPTIONAL
  }  OPTIONAL
}

RRCConnectionSetupComplete-v370ext ::= SEQUENCE {
  -- User equipment IEs
  ue-RadioAccessCapability-v370ext  UE-RadioAccessCapability-v370ext  OPTIONAL
}

RRCConnectionSetupComplete-v380ext-IEs ::= SEQUENCE {
  -- User equipment IEs
  ue-RadioAccessCapability-v380ext  UE-RadioAccessCapability-v380ext  OPTIONAL,
  dl-PhysChCapabilityFDD-v380ext    DL-PhysChCapabilityFDD-v380ext
}

RRCConnectionSetupComplete-v3a0ext-IEs ::= SEQUENCE {
  -- User equipment IEs
  ue-RadioAccessCapability-v3a0ext  UE-RadioAccessCapability-v3a0ext  OPTIONAL
}

RRCConnectionSetupComplete-v3g0ext-IEs ::= SEQUENCE {
  -- User equipment IEs
  ue-RadioAccessCapability-v3g0ext  UE-RadioAccessCapability-v3g0ext  OPTIONAL
}

RRCConnectionSetupComplete-r3-add-ext-IEs ::= SEQUENCE {
  rrcConnectionSetupComplete-v650ext  RRCConnectionSetupComplete-v650ext-IEs  OPTIONAL,

```

```

v680NonCriticalExtensions SEQUENCE {
  rrcConnectionSetupComplete-v680ext RRCConnectionSetupComplete-v680ext-IEs,
  v7e0NonCriticalExtensions SEQUENCE {
    rrcConnectionSetupComplete-v7e0ext RRCConnectionSetupComplete-v7e0ext-IEs,
    v7f0NonCriticalExtensions SEQUENCE {
      rrcConnectionSetupComplete-v7f0ext RRCConnectionSetupComplete-v7f0ext-IEs,
      nonCriticalExtensions SEQUENCE {} OPTIONAL
    } OPTIONAL
  } OPTIONAL
}

RRCConnectionSetupComplete-v4b0ext-IEs ::= SEQUENCE {
  -- User equipment IEs
  ue-RadioAccessCapability-v4b0ext UE-RadioAccessCapability-v4b0ext OPTIONAL
}

RRCConnectionSetupComplete-v590ext-IEs ::= SEQUENCE {
  -- User equipment IEs
  ue-RadioAccessCapability-v590ext UE-RadioAccessCapability-v590ext OPTIONAL,
  -- Other IEs
  ue-RATSpecificCapability-v590ext InterRAT-UE-RadioAccessCapability-v590ext OPTIONAL
}

RRCConnectionSetupComplete-v5c0ext-IEs ::= SEQUENCE {
  -- User equipment IEs
  ue-RadioAccessCapability-v5c0ext UE-RadioAccessCapability-v5c0ext OPTIONAL
}

RRCConnectionSetupComplete-v650ext-IEs ::= SEQUENCE {
  -- User equipment IEs
  ue-RadioAccessCapability-v650ext UE-RadioAccessCapability-v650ext
}

RRCConnectionSetupComplete-v680ext-IEs ::= SEQUENCE {
  -- User equipment IEs
  ue-RadioAccessCapability-v680ext UE-RadioAccessCapability-v680ext
}

RRCConnectionSetupComplete-v690ext-IEs ::= SEQUENCE {
  -- User equipment IEs
  ueCapabilityContainer BIT STRING
  (CONTAINING UE-CapabilityContainer-IEs) OPTIONAL
}

RRCConnectionSetupComplete-v770ext-IEs ::= SEQUENCE {
  deferredMeasurementControlReading ENUMERATED { true } OPTIONAL
}

RRCConnectionSetupComplete-v7e0ext-IEs ::= SEQUENCE {
  -- User equipment IEs
  ue-RadioAccessCapability UE-RadioAccessCapability-v7e0ext
}

RRCConnectionSetupComplete-v7f0ext-IEs ::= SEQUENCE {
  -- User equipment IEs
  ue-RadioAccessCapability UE-RadioAccessCapability-v7f0ext OPTIONAL
}

-- *****
--
-- RRC FAILURE INFO
--
-- *****

RRC-FailureInfo ::= CHOICE {
  r3 SEQUENCE {
    rRC-FailureInfo-r3 RRC-FailureInfo-r3-IEs,
    laterNonCriticalExtensions SEQUENCE {
      -- Container for additional R99 extensions
      rrc-FailureInfo-r3-add-ext BIT STRING OPTIONAL,
      nonCriticalExtensions SEQUENCE {} OPTIONAL
    } OPTIONAL
  },
  criticalExtensions SEQUENCE {}
}

RRC-FailureInfo-r3-IEs ::= SEQUENCE {

```

```

-- Non-RRC IEs
  failureCauseWithProtErr          FailureCauseWithProtErr
}
-- *****
--
-- RRC STATUS
--
-- *****

RRCStatus ::= SEQUENCE {
  -- Other IEs
  -- TABULAR: Identification of received message is nested in
  -- ProtocolErrorMoreInformation
  protocolErrorInformation          ProtocolErrorMoreInformation,
  laterNonCriticalExtensions        SEQUENCE {
    -- Container for additional R99 extensions
    rrcStatus-r3-add-ext            BIT STRING          OPTIONAL,
    nonCriticalExtensions           SEQUENCE {}          OPTIONAL
  } OPTIONAL
}

-- *****
--
-- SECURITY MODE COMMAND
--
-- *****

SecurityModeCommand ::= CHOICE {
  r3                                SEQUENCE {
    securityModeCommand-r3          SecurityModeCommand-r3-IEs,
    laterNonCriticalExtensions      SEQUENCE {
      -- Container for additional R99 extensions
      securityModeCommand-r3-add-ext BIT STRING          OPTIONAL,
      nonCriticalExtensions         SEQUENCE {}          OPTIONAL
    } OPTIONAL
  },
  later-than-r3                     SEQUENCE {
    rrc-TransactionIdentifier       RRC-TransactionIdentifier,
    criticalExtensions              CHOICE {
      r7                            SEQUENCE {
        securityModeCommand-r7      SecurityModeCommand-r7-IEs,
        -- Container for adding non critical extensions after freezing REL-8
        securityModeCommand-r7-add-ext BIT STRING          OPTIONAL,
        nonCriticalExtensions        SEQUENCE {}          OPTIONAL
      },
      criticalExtensions            SEQUENCE {}
    }
  }
}

SecurityModeCommand-r3-IEs ::= SEQUENCE {
-- TABULAR: Integrity protection shall always be performed on this message.
-- User equipment IEs
  rrc-TransactionIdentifier         RRC-TransactionIdentifier,
  securityCapability                SecurityCapability,
  cipheringModeInfo                CipheringModeInfo          OPTIONAL,
  integrityProtectionModeInfo      IntegrityProtectionModeInfo  OPTIONAL,
-- Core network IEs
  cn-DomainIdentity                CN-DomainIdentity,
-- Other IEs
  ue-SystemSpecificSecurityCap     InterRAT-UE-SecurityCapList  OPTIONAL
}

SecurityModeCommand-r7-IEs ::= SEQUENCE {
-- TABULAR: Integrity protection shall always be performed on this message.
-- User equipment IEs
  securityCapability                SecurityCapability,
  cipheringModeInfo                CipheringModeInfo-r7      OPTIONAL,
  integrityProtectionModeInfo      IntegrityProtectionModeInfo-r7  OPTIONAL,
-- Core network IEs
  cn-DomainIdentity                CN-DomainIdentity,
-- Other IEs
  ue-SystemSpecificSecurityCap     InterRAT-UE-SecurityCapList  OPTIONAL
}

-- *****
--

```

```

-- SECURITY MODE COMPLETE
--
-- *****
SecurityModeComplete ::= SEQUENCE {
-- TABULAR: Integrity protection shall always be performed on this message.

-- User equipment IEs
  rrc-TransactionIdentifier      RRC-TransactionIdentifier,
  ul-IntegProtActivationInfo     IntegrityProtActivationInfo      OPTIONAL,
-- Radio bearer IEs
  rb-UL-CiphActivationTimeInfo  RB-ActivationTimeInfoList      OPTIONAL,
  laterNonCriticalExtensions    SEQUENCE {
    -- Container for additional R99 extensions
    securityModeComplete-r3-add-ext  BIT STRING      OPTIONAL,
    nonCriticalExtensions            SEQUENCE {}      OPTIONAL
  }
}

-- *****
--
-- SECURITY MODE FAILURE
--
-- *****

SecurityModeFailure ::= SEQUENCE {
-- User equipment IEs
  rrc-TransactionIdentifier      RRC-TransactionIdentifier,
  failureCause                  FailureCauseWithProtErr,
  laterNonCriticalExtensions    SEQUENCE {
    -- Container for additional R99 extensions
    securityModeFailure-r3-add-ext  BIT STRING      OPTIONAL,
    nonCriticalExtensions            SEQUENCE {}      OPTIONAL
  }
}

-- *****
--
-- SIGNALLING CONNECTION RELEASE
--
-- *****

SignallingConnectionRelease ::= CHOICE {
  r3                            SEQUENCE {
    signallingConnectionRelease-r3 SignallingConnectionRelease-r3-IEs,
    laterNonCriticalExtensions    SEQUENCE {
      -- Container for additional R99 extensions
      signallingConnectionRelease-r3-add-ext  BIT STRING      OPTIONAL,
      nonCriticalExtensions            SEQUENCE {}      OPTIONAL
    }
  },
  later-than-r3                 SEQUENCE {
    rrc-TransactionIdentifier      RRC-TransactionIdentifier,
    criticalExtensions            SEQUENCE {}
  }
}

SignallingConnectionRelease-r3-IEs ::= SEQUENCE {
-- User equipment IEs
  rrc-TransactionIdentifier      RRC-TransactionIdentifier,
-- Core network IEs
  cn-DomainIdentity             CN-DomainIdentity
}

-- *****
--
-- SIGNALLING CONNECTION RELEASE INDICATION
--
-- *****

SignallingConnectionReleaseIndication ::= SEQUENCE {
-- Core network IEs
  cn-DomainIdentity             CN-DomainIdentity,
  laterNonCriticalExtensions    SEQUENCE {
    -- Container for additional R99 extensions
    signallingConnectionReleaseIndication-r3-add-ext  BIT STRING      OPTIONAL,
    nonCriticalExtensions            SEQUENCE {}      OPTIONAL
  }
}

```

```

}

-- *****
--
-- SYSTEM INFORMATION for BCH
--
-- *****

SystemInformation-BCH ::= SEQUENCE {
  -- Other information elements
  sfn-Prime                SFN-Prime,
  payload                  CHOICE {
    noSegment              NULL,
    firstSegment           FirstSegment,
    subsequentSegment      SubsequentSegment,
    lastSegmentShort       LastSegmentShort,
    lastAndFirst           SEQUENCE {
      lastSegmentShort     LastSegmentShort,
      firstSegment         FirstSegmentShort
    },
    lastAndComplete        SEQUENCE {
      lastSegmentShort     LastSegmentShort,
      completeSIB-List     CompleteSIB-List
    },
    lastAndCompleteAndFirst SEQUENCE {
      lastSegmentShort     LastSegmentShort,
      completeSIB-List     CompleteSIB-List,
      firstSegment         FirstSegmentShort
    },
    completeSIB-List       CompleteSIB-List,
    completeAndFirst       SEQUENCE {
      completeSIB-List     CompleteSIB-List,
      firstSegment         FirstSegmentShort
    },
    completeSIB            CompleteSIB,
    lastSegment            LastSegment,
    spare5                 NULL,
    spare4                 NULL,
    spare3                 NULL,
    spare2                 NULL,
    spare1                 NULL
  }
}

-- *****
--
-- SYSTEM INFORMATION for FACH
--
-- *****

SystemInformation-FACH ::= SEQUENCE {
  -- Other information elements
  payload                  CHOICE {
    noSegment              NULL,
    firstSegment           FirstSegment,
    subsequentSegment      SubsequentSegment,
    lastSegmentShort       LastSegmentShort,
    lastAndFirst           SEQUENCE {
      lastSegmentShort     LastSegmentShort,
      firstSegment         FirstSegmentShort
    },
    lastAndComplete        SEQUENCE {
      lastSegmentShort     LastSegmentShort,
      completeSIB-List     CompleteSIB-List
    },
    lastAndCompleteAndFirst SEQUENCE {
      lastSegmentShort     LastSegmentShort,
      completeSIB-List     CompleteSIB-List,
      firstSegment         FirstSegmentShort
    },
    completeSIB-List       CompleteSIB-List,
    completeAndFirst       SEQUENCE {
      completeSIB-List     CompleteSIB-List,
      firstSegment         FirstSegmentShort
    },
    completeSIB            CompleteSIB,
    lastSegment            LastSegment,
    spare5                 NULL,
  }
}

```

```

        spare4                NULL,
        spare3                NULL,
        spare2                NULL,
        spare1                NULL
    }
}

-- *****
--
-- First segment
--
-- *****

FirstSegment ::=
    SEQUENCE {
        -- Other information elements
        sib-Type                SIB-Type,
        seg-Count                SegCount,
        sib-Data-fixed            SIB-Data-fixed
    }

-- *****
--
-- First segment (short)
--
-- *****

FirstSegmentShort ::=
    SEQUENCE {
        -- Other information elements
        sib-Type                SIB-Type,
        seg-Count                SegCount,
        sib-Data-variable        SIB-Data-variable
    }

-- *****
--
-- Subsequent segment
--
-- *****

SubsequentSegment ::=
    SEQUENCE {
        -- Other information elements
        sib-Type                SIB-Type,
        segmentIndex            SegmentIndex,
        sib-Data-fixed            SIB-Data-fixed
    }

-- *****
--
-- Last segment
--
-- *****

LastSegment ::=
    SEQUENCE {
        -- Other information elements
        sib-Type                SIB-Type,
        segmentIndex            SegmentIndex,
        -- For sib-Data-fixed, in case the SIB data is less than 222 bits, padding
        -- shall be used. The same padding bits shall be used as defined in clause 12.1
        sib-Data-fixed            SIB-Data-fixed
    }

LastSegmentShort ::=
    SEQUENCE {
        -- Other information elements
        sib-Type                SIB-Type,
        segmentIndex            SegmentIndex,
        sib-Data-variable        SIB-Data-variable
    }

-- *****
--
-- Complete SIB
--
-- *****

CompleteSIB-List ::=
    SEQUENCE (SIZE (1..maxSIBperMsg)) OF
        CompleteSIBshort

CompleteSIB ::=
    SEQUENCE {

```

```

-- Other information elements
sib-Type                SIB-Type,
-- For sib-Data-fixed, in case the SIB data is less than 226 bits, padding
-- shall be used. The same padding bits shall be used as defined in clause 12.1
sib-Data-fixed          BIT STRING (SIZE (226))
}

CompleteSIBshort ::=          SEQUENCE {
-- Other information elements
sib-Type                SIB-Type,
sib-Data-variable       SIB-Data-variable
}

-- *****
--
-- SYSTEM INFORMATION CHANGE INDICATION
--
-- *****

SystemInformationChangeIndication ::= SEQUENCE {
-- Other IEs
bcch-ModificationInfo  BCCH-ModificationInfo,
laterNonCriticalExtensions SEQUENCE {
-- Container for additional R99 extensions
systemInformationChangeIndication-r3-add-ext BIT STRING OPTIONAL,
nonCriticalExtensions SEQUENCE {} OPTIONAL
}
}

-- *****
--
-- TRANSPORT CHANNEL RECONFIGURATION
--
-- *****

TransportChannelReconfiguration ::= CHOICE {
r3 SEQUENCE {
transportChannelReconfiguration-r3
TransportChannelReconfiguration-r3-IEs,
v3a0NonCriticalExtensions SEQUENCE {
transportChannelReconfiguration-v3a0ext
TransportChannelReconfiguration-v3a0ext,
laterNonCriticalExtensions SEQUENCE {
-- Container for additional R99 extensions
transportChannelReconfiguration-r3-add-ext BIT STRING OPTIONAL,
v4b0NonCriticalExtensions SEQUENCE {
transportChannelReconfiguration-v4b0ext
TransportChannelReconfiguration-v4b0ext-IEs,
v590NonCriticalExtensions SEQUENCE {
transportChannelReconfiguration-v590ext
TransportChannelReconfiguration-v590ext-IEs,
v690NonCriticalExtensions SEQUENCE {
transportChannelReconfiguration-v690ext
TransportChannelReconfiguration-v690ext-IEs,
v770NonCriticalExtensions SEQUENCE {
transportChannelReconfiguration-v770ext
TransportChannelReconfiguration-v770ext-IEs,
nonCriticalExtensions SEQUENCE {} OPTIONAL
}
} OPTIONAL
}
} OPTIONAL
}
},
later-than-r3 SEQUENCE {
rrc-TransactionIdentifier RRC-TransactionIdentifier,
criticalExtensions CHOICE {
r4 SEQUENCE {
transportChannelReconfiguration-r4
TransportChannelReconfiguration-r4-IEs,
v4d0NonCriticalExtensions SEQUENCE {
-- Container for adding non critical extensions after freezing REL-5
transportChannelReconfiguration-r4-add-ext BIT STRING OPTIONAL,
v590NonCriticalExtensions SEQUENCE {
transportChannelReconfiguration-v590ext
TransportChannelReconfiguration-v590ext-IEs,
v690NonCriticalExtensions SEQUENCE {

```



```

    transportChannelReconfiguration-v690ext
      TransportChannelReconfiguration-v690ext-IEs,
    v770NonCriticalExtensions SEQUENCE {
      transportChannelReconfiguration-v770ext
        TransportChannelReconfiguration-v770ext-IEs,
      nonCriticalExtensions SEQUENCE {} OPTIONAL
    } OPTIONAL
  } OPTIONAL
},
criticalExtensions CHOICE {
  r5 SEQUENCE {
    transportChannelReconfiguration-r5
      TransportChannelReconfiguration-r5-IEs,
    -- Container for adding non critical extensions after freezing REL-6
    transportChannelReconfiguration-r5-add-ext BIT STRING OPTIONAL,
    v690NonCriticalExtensions SEQUENCE {
      transportChannelReconfiguration-v690ext
        TransportChannelReconfiguration-v690ext-IEs,
      v770NonCriticalExtensions SEQUENCE {
        transportChannelReconfiguration-v770ext
          TransportChannelReconfiguration-v770ext-IEs,
        nonCriticalExtensions SEQUENCE {} OPTIONAL
      } OPTIONAL
    } OPTIONAL
  },
  criticalExtensions CHOICE {
    r6 SEQUENCE {
      transportChannelReconfiguration-r6
        TransportChannelReconfiguration-r6-IEs,
      -- Container for adding non critical extensions after freezing REL-7
      transportChannelReconfiguration-r6-add-ext BIT STRING OPTIONAL,
      v6b0NonCriticalExtensions SEQUENCE {
        transportChannelReconfiguration-v6b0ext
          TransportChannelReconfiguration-v6b0ext-IEs,
        v770NonCriticalExtensions SEQUENCE {
          transportChannelReconfiguration-v770ext
            TransportChannelReconfiguration-v770ext-IEs,
          nonCriticalExtensions SEQUENCE {} OPTIONAL
        } OPTIONAL
      } OPTIONAL
    },
    criticalExtensions CHOICE {
      r7 SEQUENCE {
        transportChannelReconfiguration-r7
          TransportChannelReconfiguration-r7-IEs,
        -- Container for adding non critical extensions after freezing REL-8
        transportChannelReconfiguration-r7-add-ext BIT STRING OPTIONAL,
        v780NonCriticalExtensions SEQUENCE {
          transportChannelReconfiguration-v780ext
            TransportChannelReconfiguration-v780ext-IEs,
          v7d0NonCriticalExtensions SEQUENCE {
            transportChannelReconfiguration-v7d0ext
              TransportChannelReconfiguration-v7d0ext-IEs,
            v7f0NonCriticalExtensions SEQUENCE {
              transportChannelReconfiguration-v7f0ext
                TransportChannelReconfiguration-v7f0ext-IEs,
              v7g0NonCriticalExtensions SEQUENCE {
                transportChannelReconfiguration-v7g0ext
                  TransportChannelReconfiguration-v7g0ext-IEs,
                nonCriticalExtensions SEQUENCE {} OPTIONAL
              } OPTIONAL
            } OPTIONAL
          } OPTIONAL
        } OPTIONAL
      },
      criticalExtensions SEQUENCE {}
    }
  }
}

TransportChannelReconfiguration-r3-IEs ::= SEQUENCE {
  -- User equipment IEs
  rrc-TransactionIdentifier RRC-TransactionIdentifier,

```

```

    integrityProtectionModeInfo      IntegrityProtectionModeInfo      OPTIONAL,
    cipheringModeInfo                CipheringModeInfo                OPTIONAL,
    activationTime                    ActivationTime                    OPTIONAL,
    new-U-RNTI                       U-RNTI                          OPTIONAL,
    new-C-RNTI                       C-RNTI                          OPTIONAL,
    rrc-StateIndicator               RRC-StateIndicator,
    utran-DRX-CycleLengthCoeff      UTRAN-DRX-CycleLengthCoefficient OPTIONAL,
-- Core network IEs
  cn-InformationInfo                CN-InformationInfo                OPTIONAL,
-- UTRAN mobility IEs
  ura-Identity                      URA-Identity                    OPTIONAL,
-- Radio bearer IEs
  dl-CounterSynchronisationInfo    DL-CounterSynchronisationInfo    OPTIONAL,
-- Transport channel IEs
  ul-CommonTransChInfo             UL-CommonTransChInfo             OPTIONAL,
  ul-AddReconfTransChInfoList      UL-AddReconfTransChInfoList      OPTIONAL,
  -- 'dummy', 'dummy1' and 'dummy2' are not used in this version of the specification,
  -- they should not be sent and if received they should be ignored.
  dummy                             CHOICE {
    fdd                              SEQUENCE {
      dummy1                        CPCH-SetID                       OPTIONAL,
      dummy2                        DRAC-StaticInformationList        OPTIONAL,
    },
    tdd                              NULL
  }
  dl-CommonTransChInfo             DL-CommonTransChInfo             OPTIONAL,
  dl-AddReconfTransChInfoList      DL-AddReconfTransChInfoList      OPTIONAL,
-- Physical channel IEs
  frequencyInfo                    FrequencyInfo                     OPTIONAL,
  maxAllowedUL-TX-Power             MaxAllowedUL-TX-Power            OPTIONAL,
  ul-ChannelRequirement             UL-ChannelRequirement            OPTIONAL,
  modeSpecificPhysChInfo           CHOICE {
    fdd                              SEQUENCE {
      -- dummy is not used in this version of specification, it should
      -- not be sent and if received it should be ignored.
      dummy                         DL-PDSCH-Information             OPTIONAL,
    },
    tdd                              NULL
  },
  dl-CommonInformation             DL-CommonInformation             OPTIONAL,
  dl-InformationPerRL-List          DL-InformationPerRL-List         OPTIONAL,
}

TransportChannelReconfiguration-v3a0ext ::= SEQUENCE {
  -- The IE "new-DSCH-RNTI" should not be included in FDD mode, and if received
  -- the UE behaviour is unspecified
  new-DSCH-RNTI                    DSCH-RNTI                        OPTIONAL,
}

TransportChannelReconfiguration-v4b0ext-IEs ::= SEQUENCE {
  -- Physical channel IEs
  -- dummy is not used in this version of the specification, it should
  -- not be sent and if received it should be ignored.
  dummy                             SSDT-UL                            OPTIONAL,
  -- The order of the RLs in IE cell-id-PerRL-List is the same as
  -- in IE DL-InformationPerRL-List included in this message
  cell-id-PerRL-List                CellIdentity-PerRL-List          OPTIONAL,
}

TransportChannelReconfiguration-v590ext-IEs ::= SEQUENCE {
  -- Physical channel IEs
  dl-TPC-PowerOffsetPerRL-List      DL-TPC-PowerOffsetPerRL-List    OPTIONAL,
}

TransportChannelReconfiguration-r4-IEs ::= SEQUENCE {
  -- User equipment IEs
  integrityProtectionModeInfo      IntegrityProtectionModeInfo      OPTIONAL,
  cipheringModeInfo                CipheringModeInfo                OPTIONAL,
  activationTime                    ActivationTime                    OPTIONAL,
  new-U-RNTI                       U-RNTI                          OPTIONAL,
  new-C-RNTI                       C-RNTI                          OPTIONAL,
  -- The IE "new-DSCH-RNTI" should not be included in FDD mode, and if received
  -- the UE behaviour is unspecified
  new-DSCH-RNTI                    DSCH-RNTI                        OPTIONAL,
  rrc-StateIndicator               RRC-StateIndicator,
  utran-DRX-CycleLengthCoeff      UTRAN-DRX-CycleLengthCoefficient OPTIONAL,
-- Core network IEs
  cn-InformationInfo                CN-InformationInfo                OPTIONAL,
}

```

```

-- UTRAN mobility IEs
  ura-Identity          URA-Identity          OPTIONAL,
-- Radio bearer IEs
  dl-CounterSynchronisationInfo  DL-CounterSynchronisationInfo  OPTIONAL,
-- Transport channel IEs
  ul-CommonTransChInfo          UL-CommonTransChInfo-r4          OPTIONAL,
  ul-AddReconfTransChInfoList   UL-AddReconfTransChInfoList   OPTIONAL,
  -- 'dummy', 'dummy1' and 'dummy2' are not used in this version of the specification,
  -- they should not be sent and if received they should be ignored.
  dummy                      CHOICE {
    fdd                      SEQUENCE {
      dummy1                  CPCH-SetID          OPTIONAL,
      dummy2                  DRAC-StaticInformationList  OPTIONAL
    },
    tdd                      NULL
  }
  dl-CommonTransChInfo          DL-CommonTransChInfo-r4          OPTIONAL,
  dl-AddReconfTransChInfoList   DL-AddReconfTransChInfoList-r4  OPTIONAL,
-- Physical channel IEs
  frequencyInfo              FrequencyInfo              OPTIONAL,
  maxAllowedUL-TX-Power       MaxAllowedUL-TX-Power       OPTIONAL,
  ul-ChannelRequirement       UL-ChannelRequirement-r4       OPTIONAL,
  modeSpecificPhysChInfo      CHOICE {
    fdd                      SEQUENCE {
      -- dummy is not used in this version of specification, it should
      -- not be sent and if received it should be ignored.
      dummy                  DL-PDSCH-Information       OPTIONAL
    },
    tdd                      NULL
  },
  dl-CommonInformation         DL-CommonInformation-r4         OPTIONAL,
  dl-InformationPerRL-List     DL-InformationPerRL-List-r4     OPTIONAL
}

```

```

TransportChannelReconfiguration-r5-IEs ::= SEQUENCE {
-- User equipment IEs
  integrityProtectionModeInfo  IntegrityProtectionModeInfo  OPTIONAL,
  cipheringModeInfo           CipheringModeInfo             OPTIONAL,
  activationTime              ActivationTime                 OPTIONAL,
  new-U-RNTI                  U-RNTI                       OPTIONAL,
  new-C-RNTI                  C-RNTI                       OPTIONAL,
  -- The IE "new-DSCH-RNTI" should not be included in FDD mode, and if received
  -- the UE behaviour is unspecified
  new-DSCH-RNTI              DSCH-RNTI                     OPTIONAL,
  new-H-RNTI                  H-RNTI                       OPTIONAL,
  rrc-StateIndicator          RRC-StateIndicator,
  utran-DRX-CycleLengthCoeff  UTRAN-DRX-CycleLengthCoefficient  OPTIONAL,
-- Core network IEs
  cn-InformationInfo          CN-InformationInfo           OPTIONAL,
-- UTRAN mobility IEs
  ura-Identity                URA-Identity                OPTIONAL,
-- Radio bearer IEs
  dl-CounterSynchronisationInfo  DL-CounterSynchronisationInfo-r5  OPTIONAL,
-- Transport channel IEs
  ul-CommonTransChInfo          UL-CommonTransChInfo-r4          OPTIONAL,
  ul-AddReconfTransChInfoList   UL-AddReconfTransChInfoList   OPTIONAL,
  -- 'dummy', 'dummy1' and 'dummy2' are not used in this version of the specification,
  -- they should not be sent and if received they should be ignored.
  dummy                      CHOICE {
    fdd                      SEQUENCE {
      dummy1                  CPCH-SetID          OPTIONAL,
      dummy2                  DRAC-StaticInformationList  OPTIONAL
    },
    tdd                      NULL
  }
  dl-CommonTransChInfo          DL-CommonTransChInfo-r4          OPTIONAL,
  dl-AddReconfTransChInfoList   DL-AddReconfTransChInfoList-r5  OPTIONAL,
-- Physical channel IEs
  frequencyInfo              FrequencyInfo              OPTIONAL,
  maxAllowedUL-TX-Power       MaxAllowedUL-TX-Power       OPTIONAL,
  ul-ChannelRequirement       UL-ChannelRequirement-r5       OPTIONAL,
  modeSpecificPhysChInfo      CHOICE {
    fdd                      SEQUENCE {
      -- dummy is not used in this version of specification, it should
      -- not be sent and if received it should be ignored.
      dummy                  DL-PDSCH-Information       OPTIONAL
    },
    tdd                      NULL
  }
}

```

```

    },
    dl-HSPDSCH-Information      DL-HSPDSCH-Information      OPTIONAL,
    dl-CommonInformation        DL-CommonInformation-r5    OPTIONAL,
    dl-InformationPerRL-List    DL-InformationPerRL-List-r5  OPTIONAL
  }
}

TransportChannelReconfiguration-v690ext-IEs ::= SEQUENCE {
  -- User Equipment IEs
  delayRestrictionFlag        DelayRestrictionFlag        OPTIONAL,
  -- Core network IEs
  primary-plmn-Identity        PLMN-Identity                    OPTIONAL,
  -- Physical channel IEs
  -- The IE harq-Preamble-Mode should not be used in the r3 and r4 versions of the message
  -- If included in the r3 or r4 version of the message, the UE should ignore the IE
  harq-Preamble-Mode          HARQ-Preamble-Mode          OPTIONAL,
  beaconPLEst                  BEACON-PL-Est                OPTIONAL,
  postVerificationPeriod       ENUMERATED { true }          OPTIONAL,
  dhs-sync                      DHS-Sync                      OPTIONAL,
  timingMaintainedSynchInd     TimingMaintainedSynchInd    OPTIONAL,
  -- MBMS IEs
  mbms-PL-ServiceRestrictInfo MBMS-PL-ServiceRestrictInfo-r6  OPTIONAL
}

TransportChannelReconfiguration-r6-IEs ::= SEQUENCE {
  -- User equipment IEs
  integrityProtectionModeInfo  IntegrityProtectionModeInfo  OPTIONAL,
  cipheringModeInfo            CipheringModeInfo             OPTIONAL,
  activationTime                ActivationTime                 OPTIONAL,
  delayRestrictionFlag          DelayRestrictionFlag          OPTIONAL,
  new-U-RNTI                    U-RNTI                       OPTIONAL,
  new-C-RNTI                    C-RNTI                       OPTIONAL,
  -- The IE "new-DSCH-RNTI" should not be included in FDD mode,
  -- and if received the UE behaviour is unspecified
  new-DSCH-RNTI                DSCH-RNTI                    OPTIONAL,
  new-H-RNTI                    H-RNTI                       OPTIONAL,
  newPrimary-E-RNTI             E-RNTI                       OPTIONAL,
  newSecondary-E-RNTI           E-RNTI                       OPTIONAL,
  rrc-StateIndicator            RRC-StateIndicator,         OPTIONAL,
  utran-DRX-CycleLengthCoeff    UTRAN-DRX-CycleLengthCoefficient  OPTIONAL,
  -- Core network IEs
  cn-InformationInfo            CN-InformationInfo-r6        OPTIONAL,
  -- UTRAN mobility IEs
  ura-Identity                  URA-Identity                 OPTIONAL,
  -- Radio bearer IEs
  dl-CounterSynchronisationInfo DL-CounterSynchronisationInfo-r5  OPTIONAL,
  -- Transport channel IEs
  ul-CommonTransChInfo          UL-CommonTransChInfo-r4      OPTIONAL,
  ul-AddReconfTransChInfoList   UL-AddReconfTransChInfoList-r6  OPTIONAL,
  dl-CommonTransChInfo          DL-CommonTransChInfo-r4      OPTIONAL,
  dl-AddReconfTransChInfoList   DL-AddReconfTransChInfoList-r5  OPTIONAL,
  -- Physical channel IEs
  frequencyInfo                 FrequencyInfo                  OPTIONAL,
  maxAllowedUL-TX-Power          MaxAllowedUL-TX-Power        OPTIONAL,
  ul-DPCH-Info                  UL-DPCH-Info-r6             OPTIONAL,
  ul-EDCH-Information           UL-EDCH-Information-r6      OPTIONAL,
  dl-HSPDSCH-Information        DL-HSPDSCH-Information-r6    OPTIONAL,
  dl-CommonInformation          DL-CommonInformation-r6      OPTIONAL,
  dl-InformationPerRL-List      DL-InformationPerRL-List-r6  OPTIONAL,
  -- MBMS IEs
  mbms-PL-ServiceRestrictInfo   MBMS-PL-ServiceRestrictInfo-r6  OPTIONAL
}

TransportChannelReconfiguration-v6b0ext-IEs ::= SEQUENCE {
  -- Physical channel IEs
  dl-InformationPerRL-List-v6b0ext  DL-InformationPerRL-List-v6b0ext  OPTIONAL
}

TransportChannelReconfiguration-r7-IEs ::= SEQUENCE {
  -- User equipment IEs
  integrityProtectionModeInfo  IntegrityProtectionModeInfo-r7  OPTIONAL,
  cipheringModeInfo            CipheringModeInfo-r7           OPTIONAL,
  activationTime                ActivationTime                   OPTIONAL,
  delayRestrictionFlag          DelayRestrictionFlag           OPTIONAL,
  new-U-RNTI                    U-RNTI                        OPTIONAL,
  new-C-RNTI                    C-RNTI                        OPTIONAL,
  -- The IE "new-DSCH-RNTI" should not be included in FDD mode,
  -- and if received the UE behaviour is unspecified
  new-DSCH-RNTI                DSCH-RNTI                     OPTIONAL,

```

```

    new-H-RNTI                H-RNTI                OPTIONAL,
    newPrimary-E-RNTI         E-RNTI                OPTIONAL,
    newSecondary-E-RNTI       E-RNTI                OPTIONAL,
    rrc-StateIndicator        RRC-StateIndicator,
    ueMobilityStateIndicator  High-MobilityDetected OPTIONAL,
    utran-DRX-CycleLengthCoeff UTRAN-DRX-CycleLengthCoefficient-r7 OPTIONAL,
-- Core network IES
  cn-InformationInfo         CN-InformationInfo-r6  OPTIONAL,
-- UTRAN mobility IES
  ura-Identity               URA-Identity          OPTIONAL,
  supportForChangeOfUE-Capability BOOLEAN                OPTIONAL,
  responseToChangeOfUE-Capability ENUMERATED { true }      OPTIONAL,
-- Radio bearer IES
  dl-CounterSynchronisationInfo DL-CounterSynchronisationInfo-r5 OPTIONAL,
-- Transport channel IES
  ul-CommonTransChInfo       UL-CommonTransChInfo-r4  OPTIONAL,
  ul-AddReconfTransChInfoList UL-AddReconfTransChInfoList-r7 OPTIONAL,
  dl-CommonTransChInfo       DL-CommonTransChInfo-r4  OPTIONAL,
  dl-AddReconfTransChInfoList DL-AddReconfTransChInfoList-r7 OPTIONAL,
-- Physical channel IES
  frequencyInfo              FrequencyInfo            OPTIONAL,
  multi-frequencyInfo        Multi-frequencyInfo-LCR-r7 OPTIONAL,
  dtx-drx-TimingInfo         DTX-DRX-TimingInfo-r7  OPTIONAL,
  dtx-drx-Info               DTX-DRX-Info-r7        OPTIONAL,
  hs-scch-LessInfo           HS-SCCH-LessInfo-r7    OPTIONAL,
  mimoParameters             MIMO-Parameters-r7    OPTIONAL,
  maxAllowedUL-TX-Power      MaxAllowedUL-TX-Power  OPTIONAL,
  ul-DPCH-Info               UL-DPCH-Info-r7        OPTIONAL,
  ul-EDCH-Information        UL-EDCH-Information-r7 OPTIONAL,
  dl-HSPDSCH-Information     DL-HSPDSCH-Information-r7 OPTIONAL,
  dl-CommonInformation        DL-CommonInformation-r7 OPTIONAL,
  dl-InformationPerRL-List    DL-InformationPerRL-List-r7 OPTIONAL,
-- MBMS IES
  mbms-PL-ServiceRestrictInfo MBMS-PL-ServiceRestrictInfo-r6 OPTIONAL
}

TransportChannelReconfiguration-v770ext-IES ::= SEQUENCE {
-- User equipment IES
  ueMobilityStateIndicator  High-MobilityDetected  OPTIONAL
}

TransportChannelReconfiguration-v780ext-IES ::= SEQUENCE {
-- Physical channel IES
  hs-DSCH-TBSizeTable       HS-DSCH-TBSizeTable    OPTIONAL
}

TransportChannelReconfiguration-v7d0ext-IES ::= SEQUENCE {
-- Physical channel IES
  ul-EDCH-Information        UL-EDCH-Information-ext OPTIONAL
}

TransportChannelReconfiguration-v7f0ext-IES ::= SEQUENCE {
-- Physical channel IES
  mimoParameters            MIMO-Parameters-v7f0ext OPTIONAL
}

TransportChannelReconfiguration-v7g0ext-IES ::= SEQUENCE {
-- Physical channel IES
  mimoParameters            MIMO-Parameters-v7g0ext  OPTIONAL
}

-- *****
--
-- TRANSPORT CHANNEL RECONFIGURATION COMPLETE
--
-- *****

TransportChannelReconfigurationComplete ::= SEQUENCE {
-- User equipment IES
  rrc-TransactionIdentifier  RRC-TransactionIdentifier,
  ul-IntegProtActivationInfo IntegrityProtActivationInfo  OPTIONAL,
-- TABULAR: UL-TimingAdvance is applicable for TDD mode only.
  ul-TimingAdvance           UL-TimingAdvance           OPTIONAL,
-- Radio bearer IES
  count-C-ActivationTime     ActivationTime           OPTIONAL,
-- dummy is not used in this version of the specification and
-- it should be ignored by the receiver.
  dummy                      RB-ActivationTimeInfoList  OPTIONAL,

```

```

    ul-CounterSynchronisationInfo    UL-CounterSynchronisationInfo    OPTIONAL,
    laterNonCriticalExtensions        SEQUENCE {
      -- Container for additional R99 extensions
      transportChannelReconfigurationComplete-r3-add-ext    BIT STRING    OPTIONAL,
      v770NonCriticalExtensions        SEQUENCE {
        transportChannelReconfigurationComplete-v770ext
          TransportChannelReconfigurationComplete-v770ext-IEs,
          nonCriticalExtensions        SEQUENCE {}    OPTIONAL
        }    OPTIONAL
      }    OPTIONAL
  }

TransportChannelReconfigurationComplete-v770ext-IEs ::= SEQUENCE {
  -- TABULAR: EXT-UL-TimingAdvance is applicable for TDD mode only.
  ext-UL-TimingAdvance                EXT-UL-TimingAdvance    OPTIONAL,
  deferredMeasurementControlReading    ENUMERATED { true }    OPTIONAL
}

-- *****
--
-- TRANSPORT CHANNEL RECONFIGURATION FAILURE
--
-- *****

TransportChannelReconfigurationFailure ::= SEQUENCE {
  -- User equipment IEs
  rrc-TransactionIdentifier            RRC-TransactionIdentifier,
  failureCause                         FailureCauseWithProtErr,
  laterNonCriticalExtensions            SEQUENCE {
    -- Container for additional R99 extensions
    transportChannelReconfigurationFailure-r3-add-ext    BIT STRING    OPTIONAL,
    nonCriticalExtensions                SEQUENCE {}    OPTIONAL
  }    OPTIONAL
}

-- *****
--
-- TRANSPORT FORMAT COMBINATION CONTROL in AM or UM RLC mode
--
-- *****

TransportFormatCombinationControl ::= SEQUENCE {
  -- rrc-TransactionIdentifier is always included in this version of the specification
  rrc-TransactionIdentifier            RRC-TransactionIdentifier    OPTIONAL,
  modeSpecificInfo                    CHOICE {
    fdd                                NULL,
    tdd                                SEQUENCE {
      tfcs-ID                          TFCS-Identity    OPTIONAL
    }
  },
  dpch-TFCS-InUplink                  TFC-Subset,
  activationTimeForTFCSsubset          ActivationTime    OPTIONAL,
  tfc-ControlDuration                  TFC-ControlDuration    OPTIONAL,
  laterNonCriticalExtensions            SEQUENCE {
    -- Container for additional R99 extensions
    transportFormatCombinationControl-r3-add-ext    BIT STRING    OPTIONAL,
    nonCriticalExtensions                SEQUENCE {}    OPTIONAL
  }    OPTIONAL
}

-- *****
--
-- TRANSPORT FORMAT COMBINATION CONTROL FAILURE
--
-- *****

TransportFormatCombinationControlFailure ::= SEQUENCE {
  -- User equipment IEs
  rrc-TransactionIdentifier            RRC-TransactionIdentifier,
  failureCause                         FailureCauseWithProtErr,
  laterNonCriticalExtensions            SEQUENCE {
    -- Container for additional R99 extensions
    transportFormatCombinationControlFailure-r3-add-ext    BIT STRING    OPTIONAL,
    nonCriticalExtensions                SEQUENCE {}    OPTIONAL
  }    OPTIONAL
}

-- *****

```

```

--
-- UE CAPABILITY ENQUIRY
--
-- *****
UECapabilityEnquiry ::= CHOICE {
    r3 SEQUENCE {
        ueCapabilityEnquiry-r3 UECapabilityEnquiry-r3-IEs,
        laterNonCriticalExtensions SEQUENCE {
            -- Container for additional R99 extensions
            ueCapabilityEnquiry-r3-add-ext BIT STRING OPTIONAL,
            v4b0NonCriticalExtensions SEQUENCE {
                ueCapabilityEnquiry-v4b0ext UECapabilityEnquiry-v4b0ext-IEs,
                v590NonCriticalExtensions SEQUENCE {
                    ueCapabilityEnquiry-v590ext UECapabilityEnquiry-v590ext-IEs,
                    v770NonCriticalExtensions SEQUENCE {
                        ueCapabilityEnquiry-v770ext UECapabilityEnquiry-v770ext-IEs,
                        nonCriticalExtensions SEQUENCE {} OPTIONAL
                    } OPTIONAL
                } OPTIONAL
            } OPTIONAL
        } OPTIONAL
    },
    later-than-r3 SEQUENCE {
        rrc-TransactionIdentifier RRC-TransactionIdentifier,
        criticalExtensions SEQUENCE {}
    }
}

UECapabilityEnquiry-r3-IEs ::= SEQUENCE {
    -- User equipment IEs
    rrc-TransactionIdentifier RRC-TransactionIdentifier,
    capabilityUpdateRequirement CapabilityUpdateRequirement
}

UECapabilityEnquiry-v4b0ext-IEs ::= SEQUENCE {
    capabilityUpdateRequirement-r4-ext CapabilityUpdateRequirement-r4-ext
}

UECapabilityEnquiry-v590ext-IEs ::= SEQUENCE {
    systemSpecificCapUpdateReq SystemSpecificCapUpdateReq-v590ext
}

UECapabilityEnquiry-v770ext-IEs ::= SEQUENCE {
    capabilityUpdateRequirement CapabilityUpdateRequirement-v770ext OPTIONAL
}

-- *****
--
-- UE CAPABILITY INFORMATION
--
-- *****
UECapabilityInformation ::= SEQUENCE {
    -- User equipment IEs
    rrc-TransactionIdentifier RRC-TransactionIdentifier OPTIONAL,
    ue-RadioAccessCapability UE-RadioAccessCapability OPTIONAL,
    -- Other IEs
    ue-RATSpecificCapability InterRAT-UE-RadioAccessCapabilityList OPTIONAL,
    v370NonCriticalExtensions SEQUENCE {
        ueCapabilityInformation-v370ext UECapabilityInformation-v370ext,
        v380NonCriticalExtensions SEQUENCE {
            ueCapabilityInformation-v380ext UECapabilityInformation-v380ext-IEs,
            v3a0NonCriticalExtensions SEQUENCE {
                ueCapabilityInformation-v3a0ext UECapabilityInformation-v3a0ext-IEs,
                laterNonCriticalExtensions SEQUENCE {
                    -- Container for additional R99 extensions
                    ueCapabilityInformation-r3-add-ext BIT STRING
                    (CONTAINING UECapabilityInformation-r3-add-ext-IEs) OPTIONAL,
                    -- Reserved for future non critical extension
                    v4b0NonCriticalExtensions SEQUENCE {
                        ueCapabilityInformation-v4b0ext UECapabilityInformation-v4b0ext,
                        v590NonCriticalExtensions SEQUENCE {
                            ueCapabilityInformation-v590ext UECapabilityInformation-v590ext,
                            v5c0NonCriticalExtensions SEQUENCE {
                                ueCapabilityInformation-v5c0ext
                                UECapabilityInformation-v5c0ext,
                                v690NonCriticalExtensions SEQUENCE {

```

```

        ueCapabilityInformation-v690ext
        nonCriticalExtensions          UECapabilityInformation-v690ext-IEs,
        }                               SEQUENCE {}          OPTIONAL
    }                                   OPTIONAL
    }                                   OPTIONAL
    }                                   OPTIONAL
    }                                   OPTIONAL
    }                                   OPTIONAL
    }                                   OPTIONAL
}

UECapabilityInformation-v370ext ::= SEQUENCE {
    -- User equipment IEs
    ue-RadioAccessCapability-v370ext    UE-RadioAccessCapability-v370ext    OPTIONAL
}

UECapabilityInformation-v380ext-IEs ::= SEQUENCE {
    -- User equipment IEs
    ue-RadioAccessCapability-v380ext    UE-RadioAccessCapability-v380ext    OPTIONAL,
    dl-PhysChCapabilityFDD-v380ext      DL-PhysChCapabilityFDD-v380ext
}

UECapabilityInformation-v3a0ext-IEs ::= SEQUENCE {
    -- User equipment IEs
    ue-RadioAccessCapability-v3a0ext    UE-RadioAccessCapability-v3a0ext    OPTIONAL
}

UECapabilityInformation-r3-add-ext-IEs ::= SEQUENCE {
    ueCapabilityInformation-v650ext      UECapabilityInformation-v650ext-IEs    OPTIONAL,
    v680NonCriticalExtensions           SEQUENCE {
        ueCapabilityInformation-v680ext    UECapabilityInformation-v680ext-IEs,
        v7e0NonCriticalExtensions         SEQUENCE {
            ueCapabilityInformation-v7e0ext    UECapabilityInformation-v7e0ext-IEs,
            v7f0NonCriticalExtensions         SEQUENCE {
                ueCapabilityInformation-v7f0ext    UECapabilityInformation-v7f0ext-IEs,
                nonCriticalExtensions           SEQUENCE {}          OPTIONAL
            }
        }
    }
}

UECapabilityInformation-v4b0ext ::= SEQUENCE {
    -- User equipment IEs
    ue-RadioAccessCapability-v4b0ext    UE-RadioAccessCapability-v4b0ext    OPTIONAL
}

UECapabilityInformation-v590ext ::= SEQUENCE {
    -- User equipment IEs
    ue-RadioAccessCapability-v3g0ext    UE-RadioAccessCapability-v3g0ext    OPTIONAL,
    ue-RadioAccessCapability-v590ext    UE-RadioAccessCapability-v590ext    OPTIONAL,
    -- Other IEs
    ue-RATSpecificCapability-v590ext    InterRAT-UE-RadioAccessCapability-v590ext    OPTIONAL
}

UECapabilityInformation-v5c0ext ::= SEQUENCE {
    -- User equipment IEs
    ue-RadioAccessCapability-v5c0ext    UE-RadioAccessCapability-v5c0ext    OPTIONAL
}

UECapabilityInformation-v650ext-IEs ::= SEQUENCE {
    ue-RadioAccessCapability-v650ext    UE-RadioAccessCapability-v650ext
}

UECapabilityInformation-v680ext-IEs ::= SEQUENCE {
    -- User equipment IEs
    ue-RadioAccessCapability-v680ext    UE-RadioAccessCapability-v680ext
}

UECapabilityInformation-v690ext-IEs ::= SEQUENCE {
    -- User equipment IEs
    ueCapabilityContainer                BIT STRING
                                         (CONTAINING UE-CapabilityContainer-IEs) OPTIONAL
}

UECapabilityInformation-v7e0ext-IEs ::= SEQUENCE {
    -- User equipment IEs

```



```

    ue-RadioAccessCapability          UE-RadioAccessCapability-v7e0ext
}

UECapabilityInformation-v7f0ext-IEs ::= SEQUENCE {
    -- User equipment IEs
    ue-RadioAccessCapability          UE-RadioAccessCapability-v7f0ext    OPTIONAL
}

-- *****
--
-- UE CAPABILITY INFORMATION CONFIRM
--
-- *****

UECapabilityInformationConfirm ::= CHOICE {
    r3                               SEQUENCE {
        ueCapabilityInformationConfirm-r3
        laterNonCriticalExtensions    SEQUENCE {
            -- Container for additional R99 extensions
            ueCapabilityInformationConfirm-r3-add-ext    BIT STRING    OPTIONAL,
            v770NonCriticalExtensions    SEQUENCE {
                ueCapabilityInformationConfirm-v770ext    UECapabilityInformationConfirm-v770ext-IEs,
                nonCriticalExtensions    SEQUENCE {}    OPTIONAL
            }    OPTIONAL
        }    OPTIONAL
    },
    later-than-r3                    SEQUENCE {
        rrc-TransactionIdentifier      RRC-TransactionIdentifier,
        criticalExtensions              SEQUENCE {}
    }
}

UECapabilityInformationConfirm-r3-IEs ::= SEQUENCE {
    -- User equipment IEs
    rrc-TransactionIdentifier          RRC-TransactionIdentifier
}

UECapabilityInformationConfirm-v770ext-IEs ::= SEQUENCE {
    -- User equipment IEs
    acceptanceOfChangeOfCapability    ENUMERATED {
        refused, accepted, acceptedWithReconfigurationToFollow
    }    OPTIONAL
}

-- *****
--
-- UPLINK DIRECT TRANSFER
--
-- *****

UplinkDirectTransfer ::= SEQUENCE {
    -- Core network IEs
    cn-DomainIdentity                 CN-DomainIdentity,
    nas-Message                        NAS-Message,
    -- Measurement IEs
    measuredResultsOnRACH              MeasuredResultsOnRACH    OPTIONAL,
    laterNonCriticalExtensions         SEQUENCE {
        -- Container for additional R99 extensions
        uplinkDirectTransfer-r3-add-ext    BIT STRING    OPTIONAL,
        v690NonCriticalExtensions         SEQUENCE {
            uplinkDirectTransfer-v690ext    UplinkDirectTransfer-v690ext-IEs,
            v7g0NonCriticalExtensions      SEQUENCE {
                uplinkDirectTransfer-v7g0ext    UplinkDirectTransfer-v7g0ext-IEs,
                nonCriticalExtensions        SEQUENCE {}    OPTIONAL
            }    OPTIONAL
        }    OPTIONAL
    }    OPTIONAL
}

UplinkDirectTransfer-v690ext-IEs ::= SEQUENCE {
    -- Measurement IEs
    measuredResultsOnRACHinterFreq      MeasuredResultsOnRACHinterFreq    OPTIONAL
}

UplinkDirectTransfer-v7g0ext-IEs ::= SEQUENCE {
    -- Measurement IEs
    measuredResultsOnRACH-v7g0ext       MeasuredResultsOnRACH-v7g0ext    OPTIONAL
}

```

```

}
-- *****
--
-- UPLINK PHYSICAL CHANNEL CONTROL
--
-- *****

UplinkPhysicalChannelControl ::= CHOICE {
  r3
    SEQUENCE {
      uplinkPhysicalChannelControl-r3 UplinkPhysicalChannelControl-r3-IEs,
      laterNonCriticalExtensions
        SEQUENCE {
          -- Container for additional R99 extensions
          uplinkPhysicalChannelControl-r3-add-ext BIT STRING OPTIONAL,
          v4b0NonCriticalExtensions
            SEQUENCE {
              uplinkPhysicalChannelControl-v4b0ext UplinkPhysicalChannelControl-v4b0ext-IEs,
              -- Extension mechanism for non-release 4 information
              noncriticalExtensions
                SEQUENCE {} OPTIONAL
            } OPTIONAL
        } OPTIONAL
    },
  later-than-r3
    SEQUENCE {
      rrc-TransactionIdentifier RRC-TransactionIdentifier,
      criticalExtensions
        CHOICE {
          r4
            SEQUENCE {
              uplinkPhysicalChannelControl-r4 UplinkPhysicalChannelControl-r4-IEs,
              v4d0NonCriticalExtensions
                SEQUENCE {
                  -- Container for adding non critical extensions after freezing REL-5
                  uplinkPhysicalChannelControl-r4-add-ext BIT STRING OPTIONAL,
                  v690NonCriticalExtensions
                    SEQUENCE {
                      uplinkPhysicalChannelControl-v690ext UplinkPhysicalChannelControl-v690ext-IEs,
                      nonCriticalExtensions
                        SEQUENCE {} OPTIONAL
                    } OPTIONAL
                } OPTIONAL
            } OPTIONAL
        },
      criticalExtensions
        CHOICE {
          r5
            SEQUENCE {
              uplinkPhysicalChannelControl-r5 UplinkPhysicalChannelControl-r5-IEs,
              -- Container for adding non critical extensions after freezing REL-6
              uplinkPhysicalChannelControl-r5-add-ext BIT STRING OPTIONAL,
              v690NonCriticalExtensions
                SEQUENCE {
                  uplinkPhysicalChannelControl-v690ext UplinkPhysicalChannelControl-v690ext-IEs,
                  v6a0NonCriticalExtensions
                    SEQUENCE {
                      uplinkPhysicalChannelControl-v6a0ext
                        UplinkPhysicalChannelControl-v6a0ext-IEs,
                      nonCriticalExtensions
                        SEQUENCE {} OPTIONAL
                    } OPTIONAL
                } OPTIONAL
            } OPTIONAL
        },
      criticalExtensions
        CHOICE {
          r7
            SEQUENCE {
              uplinkPhysicalChannelControl-r7 UplinkPhysicalChannelControl-r7-IEs,
              -- Container for adding non critical extensions after freezing REL-8
              uplinkPhysicalChannelControl-r7-add-ext BIT STRING OPTIONAL,
              nonCriticalExtensions
                SEQUENCE {} OPTIONAL
            },
          criticalExtensions
            SEQUENCE {}
        }
    }
}

UplinkPhysicalChannelControl-r3-IEs ::= SEQUENCE {
  -- User equipment IEs
  rrc-TransactionIdentifier RRC-TransactionIdentifier,
  -- Physical channel IEs
  ccTrCH-PowerControlInfo CCTrCH-PowerControlInfo OPTIONAL,
  timingAdvance UL-TimingAdvanceControl OPTIONAL,
  alpha Alpha OPTIONAL,
  specialBurstScheduling SpecialBurstScheduling OPTIONAL,
  prach-ConstantValue ConstantValueTdd OPTIONAL,
  pusch-ConstantValue ConstantValueTdd OPTIONAL
}

UplinkPhysicalChannelControl-v4b0ext-IEs ::= SEQUENCE {
  -- In case of TDD, openLoopPowerControl-IPDL-TDD is included instead of IE
  -- up-IPDL-Parameters in up-OTDOA-AssistanceData

```

```

    openLoopPowerControl-IPDL-TDD    OpenLoopPowerControl-IPDL-TDD-r4    OPTIONAL
  }
}

UplinkPhysicalChannelControl-r4-IEs ::= SEQUENCE {
  -- Physical channel IEs
  ccTrCH-PowerControlInfo           CCTrCH-PowerControlInfo-r4           OPTIONAL,
  specialBurstScheduling             SpecialBurstScheduling                OPTIONAL,
  tddOption                          CHOICE {
    tdd384                          SEQUENCE {
      timingAdvance                 UL-TimingAdvanceControl-r4    OPTIONAL,
      alpha                         Alpha                            OPTIONAL,
      prach-ConstantValue           ConstantValueTdd              OPTIONAL,
      pusch-ConstantValue           ConstantValueTdd              OPTIONAL,
      openLoopPowerControl-IPDL-TDD OpenLoopPowerControl-IPDL-TDD-r4 OPTIONAL
    },
    tdd128                          SEQUENCE {
      ul-SynchronisationParameters UL-SynchronisationParameters-r4 OPTIONAL
    }
  }
}

UplinkPhysicalChannelControl-r5-IEs ::= SEQUENCE {
  -- Physical channel IEs
  ccTrCH-PowerControlInfo           CCTrCH-PowerControlInfo-r5           OPTIONAL,
  specialBurstScheduling             SpecialBurstScheduling                OPTIONAL,
  tddOption                          CHOICE {
    tdd384                          SEQUENCE {
      timingAdvance                 UL-TimingAdvanceControl-r4    OPTIONAL,
      alpha                         Alpha                            OPTIONAL,
      prach-ConstantValue           ConstantValueTdd              OPTIONAL,
      pusch-ConstantValue           ConstantValueTdd              OPTIONAL,
      openLoopPowerControl-IPDL-TDD OpenLoopPowerControl-IPDL-TDD-r4    OPTIONAL,
      hs-SICH-PowerControl           HS-SICH-Power-Control-Info-TDD384  OPTIONAL
    },
    tdd128                          SEQUENCE {
      ul-SynchronisationParameters UL-SynchronisationParameters-r4    OPTIONAL
    }
  }
}

UplinkPhysicalChannelControl-v690ext-IEs ::= SEQUENCE {
  -- Physical Channel IEs
  beaconPLEst                       BEACON-PL-Est                       OPTIONAL
}

UplinkPhysicalChannelControl-v6a0ext-IEs ::= SEQUENCE {
  -- Physical Channel IEs
  desired-HS-SICH-PowerLevel         INTEGER (-120..-58)                 OPTIONAL,
  tpc-Step-Size                     ENUMERATED { s1, s2, s3 , spare1 }  OPTIONAL
}

UplinkPhysicalChannelControl-r7-IEs ::= SEQUENCE {
  -- Physical channel IEs
  ccTrCH-PowerControlInfo           CCTrCH-PowerControlInfo-r7           OPTIONAL,
  specialBurstScheduling             SpecialBurstScheduling                OPTIONAL,
  tddOption                          CHOICE {
    tdd384                          SEQUENCE {
      timingAdvance                 UL-TimingAdvanceControl-r4    OPTIONAL,
      alpha                         Alpha                            OPTIONAL,
      prach-ConstantValue           ConstantValueTdd              OPTIONAL,
      pusch-ConstantValue           ConstantValueTdd              OPTIONAL,
      openLoopPowerControl-IPDL-TDD OpenLoopPowerControl-IPDL-TDD-r4    OPTIONAL,
      hs-SICH-PowerControl           HS-SICH-Power-Control-Info-TDD384  OPTIONAL
    },
    tdd768                          SEQUENCE {
      timingAdvance                 UL-TimingAdvanceControl-r7    OPTIONAL,
      alpha                         Alpha                            OPTIONAL,
      prach-ConstantValue           ConstantValueTdd              OPTIONAL,
      pusch-ConstantValue           ConstantValueTdd              OPTIONAL,
      openLoopPowerControl-IPDL-TDD OpenLoopPowerControl-IPDL-TDD-r4    OPTIONAL,
      hs-SICH-PowerControl           HS-SICH-Power-Control-Info-TDD768  OPTIONAL
    },
    tdd128                          SEQUENCE {
      ul-SynchronisationParameters UL-SynchronisationParameters-r4    OPTIONAL,
      desired-HS-SICH-PowerLevel     INTEGER (-120..-58)             OPTIONAL,
      tpc-Step-Size                 ENUMERATED { s1, s2, s3 , spare1 }  OPTIONAL
    }
  }
}

```

```

}

-- *****
--
-- URA UPDATE
--
-- *****

URAUUpdate ::= SEQUENCE {
  -- User equipment IEs
  u-RNTI                U-RNTI,
  ura-UpdateCause       URA-UpdateCause,
  protocolErrorIndicator ProtocolErrorIndicatorWithMoreInfo,
  laterNonCriticalExtensions SEQUENCE {
    -- Container for additional R99 extensions
    uraUpdate-r3-add-ext BIT STRING
                        (CONTAINING URAUpdate-r3-add-ext-IEs) OPTIONAL,
    v770NonCriticalExtensions SEQUENCE {
      uraUpdate-v770ext UraUpdate-v770ext-IEs,
      nonCriticalExtensions SEQUENCE {} OPTIONAL
    } OPTIONAL
  } OPTIONAL
}

URAUUpdate-r3-add-ext-IEs ::= SEQUENCE {
  uraUpdate-v7e0ext URAUpdate-v7e0ext-IEs,
  nonCriticalExtensions SEQUENCE {} OPTIONAL
}

UraUpdate-v770ext-IEs ::= SEQUENCE {
  -- User equipment IEs
  support-hsdschReception-CellUraPch ENUMERATED { true } OPTIONAL,
  support-hsdschReception-CellFach  ENUMERATED { true } OPTIONAL
}

URAUUpdate-v7e0ext-IEs ::= SEQUENCE {
  -- User equipment IEs
  supportForTwoDRXschemesInPCH ENUMERATED { true } OPTIONAL
}

-- *****
--
-- URA UPDATE CONFIRM
--
-- *****

URAUUpdateConfirm ::= CHOICE {
  r3 SEQUENCE {
    uraUpdateConfirm-r3 URAUpdateConfirm-r3-IEs,
    laterNonCriticalExtensions SEQUENCE {
      -- Container for additional R99 extensions
      uraUpdateConfirm-r3-add-ext BIT STRING OPTIONAL,
      v690NonCriticalExtensions SEQUENCE {
        uraUpdateConfirm-v690ext URAUpdateConfirm-v690ext-IEs,
        nonCriticalExtensions SEQUENCE {} OPTIONAL
      } OPTIONAL
    } OPTIONAL
  },
  later-than-r3 SEQUENCE {
    rrc-TransactionIdentifier RRC-TransactionIdentifier,
    criticalExtensions CHOICE {
      r5 SEQUENCE {
        uraUpdateConfirm-r5 URAUpdateConfirm-r5-IEs,
        v690NonCriticalExtensions SEQUENCE {
          uraUpdateConfirm-v690ext URAUpdateConfirm-v690ext-IEs,
          nonCriticalExtensions SEQUENCE {} OPTIONAL
        } OPTIONAL
      },
      r7 SEQUENCE {
        uraUpdateConfirm-r7 URAUpdateConfirm-r7-IEs,
        -- Container for adding non critical extensions after freezing REL-8
        uraUpdateConfirm-r7-add-ext BIT STRING OPTIONAL,
        nonCriticalExtensions SEQUENCE {} OPTIONAL
      },
      criticalExtensions SEQUENCE {}
    }
  }
}

```

```

    }
}

URAUUpdateConfirm-r3-IEs ::= SEQUENCE {
    -- User equipment IEs
    rrc-TransactionIdentifier      RRC-TransactionIdentifier,
    integrityProtectionModeInfo    IntegrityProtectionModeInfo    OPTIONAL,
    cipheringModeInfo              CipheringModeInfo              OPTIONAL,
    new-U-RNTI                     U-RNTI                     OPTIONAL,
    new-C-RNTI                     C-RNTI                     OPTIONAL,
    rrc-StateIndicator             RRC-StateIndicator,
    utran-DRX-CycleLengthCoeff     UTRAN-DRX-CycleLengthCoefficient OPTIONAL,
    -- CN information elements
    cn-InformationInfo             CN-InformationInfo             OPTIONAL,
    -- UTRAN mobility IEs
    ura-Identity                   URA-Identity                   OPTIONAL,
    -- Radio bearer IEs
    dl-CounterSynchronisationInfo  DL-CounterSynchronisationInfo  OPTIONAL
}

URAUUpdateConfirm-r5-IEs ::= SEQUENCE {
    -- User equipment IEs
    integrityProtectionModeInfo    IntegrityProtectionModeInfo    OPTIONAL,
    cipheringModeInfo              CipheringModeInfo              OPTIONAL,
    new-U-RNTI                     U-RNTI                     OPTIONAL,
    new-C-RNTI                     C-RNTI                     OPTIONAL,
    rrc-StateIndicator             RRC-StateIndicator,
    utran-DRX-CycleLengthCoeff     UTRAN-DRX-CycleLengthCoefficient OPTIONAL,
    -- CN information elements
    cn-InformationInfo             CN-InformationInfo             OPTIONAL,
    -- UTRAN mobility IEs
    ura-Identity                   URA-Identity                   OPTIONAL,
    -- Radio bearer IEs
    dl-CounterSynchronisationInfo  DL-CounterSynchronisationInfo-r5 OPTIONAL
}

URAUUpdateConfirm-v690ext-IEs ::= SEQUENCE {
    -- Core network IEs
    primary-plmn-Identity          PLMN-Identity          OPTIONAL
}

URAUUpdateConfirm-r7-IEs ::= SEQUENCE {
    -- User equipment IEs
    integrityProtectionModeInfo    IntegrityProtectionModeInfo-r7 OPTIONAL,
    cipheringModeInfo              CipheringModeInfo-r7      OPTIONAL,
    new-U-RNTI                     U-RNTI                     OPTIONAL,
    new-C-RNTI                     C-RNTI                     OPTIONAL,
    rrc-StateIndicator             RRC-StateIndicator,
    utran-DRX-CycleLengthCoeff     UTRAN-DRX-CycleLengthCoefficient-r7 OPTIONAL,
    -- CN information elements
    cn-InformationInfo             CN-InformationInfo             OPTIONAL,
    primary-plmn-Identity          PLMN-Identity             OPTIONAL,
    -- UTRAN mobility IEs
    ura-Identity                   URA-Identity                   OPTIONAL,
    supportForChangeOfUE-Capability BOOLEAN                       OPTIONAL,
    -- Radio bearer IEs
    dl-CounterSynchronisationInfo  DL-CounterSynchronisationInfo-r5 OPTIONAL
}

-- *****
--
-- URA UPDATE CONFIRM for CCCH
--
-- *****

URAUUpdateConfirm-CCCH ::= CHOICE {
    r3          SEQUENCE {
        uraUpdateConfirm-CCCH-r3          URAUpdateConfirm-CCCH-r3-IEs,
        laterNonCriticalExtensions        SEQUENCE {
            -- Container for additional R99 extensions
            uraUpdateConfirm-CCCH-r3-add-ext BIT STRING          OPTIONAL,
            v690NonCriticalExtensions      SEQUENCE {
                uraUpdateConfirm-v690ext  URAUpdateConfirm-v690ext-IEs,
                nonCriticalExtensions      SEQUENCE {}          OPTIONAL
            }
        }
    } OPTIONAL
},
    later-than-r3          SEQUENCE {

```

```

        u-RNTI                U-RNTI,
        rrc-TransactionIdentifier RRC-TransactionIdentifier,
        criticalExtensions      SEQUENCE {}
    }
}

URAUUpdateConfirm-CCCH-r3-IEs ::= SEQUENCE {
    -- User equipment IEs
    u-RNTI                U-RNTI,
    -- The rest of the message is identical to the one sent on DCCH.
    uraUpdateConfirm      URAUpdateConfirm-r3-IEs
}

-- *****
--
-- UTRAN MOBILITY INFORMATION
--
-- *****

UTRANMobilityInformation ::= CHOICE {
    r3                SEQUENCE {
        utranMobilityInformation-r3      UTRANMobilityInformation-r3-IEs,
        v3a0NonCriticalExtensions        SEQUENCE {
            utranMobilityInformation-v3a0ext UTRANMobilityInformation-v3a0ext-IEs,
            laterNonCriticalExtensions      SEQUENCE {
                -- Container for additional R99 extensions
                utranMobilityInformation-r3-add-ext BIT STRING OPTIONAL,
                v690NonCriticalExtensions          SEQUENCE {
                    utranMobilityInformation-v690ext UtranMobilityInformation-v690ext-IEs,
                    nonCriticalExtensions          SEQUENCE {} OPTIONAL
                }
            } OPTIONAL
        } OPTIONAL
    },
    later-than-r3      SEQUENCE {
        rrc-TransactionIdentifier RRC-TransactionIdentifier,
        criticalExtensions        CHOICE {
            r5                SEQUENCE {
                utranMobilityInformation-r5      UTRANMobilityInformation-r5-IEs,
                v690NonCriticalExtensions        SEQUENCE {
                    utranMobilityInformation-v690ext UtranMobilityInformation-v690ext-IEs,
                    nonCriticalExtensions          SEQUENCE {} OPTIONAL
                }
            } OPTIONAL
        },
        criticalExtensions        CHOICE {
            r7                SEQUENCE {
                utranMobilityInformation-r7      UTRANMobilityInformation-r7-IEs,
                -- Container for adding non critical extensions after freezing REL-8
                utranMobilityInformation-r7-add-ext BIT STRING OPTIONAL,
                nonCriticalExtensions          SEQUENCE {} OPTIONAL
            }
        },
        criticalExtensions        SEQUENCE {}
    }
}

UTRANMobilityInformation-r3-IEs ::= SEQUENCE {
    -- User equipment IEs
    rrc-TransactionIdentifier RRC-TransactionIdentifier,
    integrityProtectionModeInfo IntegrityProtectionModeInfo OPTIONAL,
    cipheringModeInfo         CipheringModeInfo OPTIONAL,
    new-U-RNTI                 U-RNTI OPTIONAL,
    new-C-RNTI                 C-RNTI OPTIONAL,
    ue-ConnTimersAndConstants UE-ConnTimersAndConstants OPTIONAL,
    -- CN information elements
    cn-InformationInfo         CN-InformationInfoFull OPTIONAL,
    -- UTRAN mobility IEs
    ura-Identity               URA-Identity OPTIONAL,
    -- Radio bearer IEs
    dl-CounterSynchronisationInfo DL-CounterSynchronisationInfo OPTIONAL,
    -- Extension mechanism for non- release99 information
    nonCriticalExtensions      SEQUENCE {} OPTIONAL
}

UTRANMobilityInformation-v3a0ext-IEs ::= SEQUENCE {
    ue-ConnTimersAndConstants-v3a0ext UE-ConnTimersAndConstants-v3a0ext
}

```

```

UTRANMobilityInformation-r5-IEs ::= SEQUENCE {
  -- User equipment IEs
  integrityProtectionModeInfo    IntegrityProtectionModeInfo    OPTIONAL,
  cipheringModeInfo              CipheringModeInfo                OPTIONAL,
  new-U-RNTI                     U-RNTI                          OPTIONAL,
  new-C-RNTI                     C-RNTI                          OPTIONAL,
  ue-ConnTimersAndConstants      UE-ConnTimersAndConstants-r5    OPTIONAL,
  -- CN information elements
  cn-InformationInfo             CN-InformationInfoFull          OPTIONAL,
  -- UTRAN mobility IEs
  ura-Identity                   URA-Identity                    OPTIONAL,
  -- Radio bearer IEs
  dl-CounterSynchronisationInfo DL-CounterSynchronisationInfo-r5 OPTIONAL
}

UtranMobilityInformation-v690ext-IEs ::= SEQUENCE {
  -- Core network IEs
  primary-plmn-Identity          PLMN-Identity                    OPTIONAL
}

UTRANMobilityInformation-r7-IEs ::= SEQUENCE {
  -- User equipment IEs
  integrityProtectionModeInfo    IntegrityProtectionModeInfo-r7   OPTIONAL,
  cipheringModeInfo              CipheringModeInfo-r7             OPTIONAL,
  new-U-RNTI                     U-RNTI                          OPTIONAL,
  new-C-RNTI                     C-RNTI                          OPTIONAL,
  new-H-RNTI                     H-RNTI                          OPTIONAL,
  ue-ConnTimersAndConstants      UE-ConnTimersAndConstants-r5    OPTIONAL,
  -- CN information elements
  cn-InformationInfo             CN-InformationInfoFull          OPTIONAL,
  primary-plmn-Identity          PLMN-Identity                    OPTIONAL,
  -- UTRAN mobility IEs
  ura-Identity                   URA-Identity                    OPTIONAL,
  supportForChangeOfUE-Capability BOOLEAN                          OPTIONAL,
  -- Radio bearer IEs
  dl-CounterSynchronisationInfo DL-CounterSynchronisationInfo-r5 OPTIONAL
}

-- *****
--
-- UTRAN MOBILITY INFORMATION CONFIRM
--
-- *****

UTRANMobilityInformationConfirm ::= SEQUENCE {
  -- User equipment IEs
  rrc-TransactionIdentifier      RRC-TransactionIdentifier,
  ul-IntegProtActivationInfo     IntegrityProtActivationInfo      OPTIONAL,
  -- Radio bearer IEs
  count-C-ActivationTime        ActivationTime                    OPTIONAL,
  -- dummy is not used in this version of the specification and
  -- it should be ignored by the receiver.
  dummy                         RB-ActivationTimeInfoList      OPTIONAL,
  ul-CounterSynchronisationInfo UL-CounterSynchronisationInfo  OPTIONAL,
  laterNonCriticalExtensions     SEQUENCE {
    -- Container for additional R99 extensions
    utranMobilityInformationConfirm-r3-add-ext BIT STRING  OPTIONAL,
    v770NonCriticalExtension     SEQUENCE {
      utranMobilityInformationConfirm-v770ext
      UTRANMobilityInformationConfirm-v770ext-IEs,
    } OPTIONAL
  } OPTIONAL
}

UTRANMobilityInformationConfirm-v770ext-IEs ::= SEQUENCE {
  deferredMeasurementControlReading ENUMERATED { true }  OPTIONAL
}

-- *****
--
-- UTRAN MOBILITY INFORMATION FAILURE
--
-- *****

UTRANMobilityInformationFailure ::= SEQUENCE {
  -- UE information elements

```

```

rrc-TransactionIdentifier      RRC-TransactionIdentifier,
failureCause                   FailureCauseWithProtErr,
laterNonCriticalExtensions     SEQUENCE {
  -- Container for additional R99 extensions
  utranMobilityInformationFailure-r3-add-ext  BIT STRING      OPTIONAL,
  nonCriticalExtensions                 SEQUENCE {}      OPTIONAL
}
}

-- *****
--
-- MBMS ACCESS INFORMATION
--
-- *****

MBMSAccessInformation ::= SEQUENCE {
  -- Access Information IEs
  mbms-ServiceAccessInfoList      MBMS-ServiceAccessInfoList-r6,
  -- Non critical extensions
  nonCriticalExtensions           SEQUENCE {}          OPTIONAL
}

-- *****
--
-- MBMS COMMON PTM RB INFORMATION
--
-- *****

MBMSCommonPTMRBInformation ::= SEQUENCE {
  -- Common PTM RB Information IEs
  mbms-CommonRBInformationList    MBMS-CommonRBInformationList-r6,
  mbms-TranspChInfoForEachTrCh    MBMS-TranspChInfoForEachTrCh-r6,
  mbms-TranspChInfoForEachCCTrCh  MBMS-TranspChInfoForEachCCTrCh-r6  OPTIONAL,
  -- For FDD and TDD 3.84Mcps in a cell operating in MBSFN only mode and for TDD 7.68Mcps the
  -- IE mbms-PhyChInformationList shall be ignored.
  mbms-PhyChInformationList       MBMS-PhyChInformationList-r6,
  -- Non critical extensions
  v770NonCriticalExtensions       SEQUENCE {
    mbmsCommonPTMRBInformation-v770ext
    MBMSCommonPTMRBInformation-v770ext-IEs,
  v780NonCriticalExtensions       SEQUENCE {
    mbmsCommonPTMRBInformation-v780ext
    MBMSCommonPTMRBInformation-v780ext-IEs,
    nonCriticalExtensions         SEQUENCE {}          OPTIONAL
  }
  }
  OPTIONAL
}

MBMSCommonPTMRBInformation-v770ext-IEs ::= SEQUENCE {
  mbms-PhyChInformationList-r7    MBMS-PhyChInformationList-r7      OPTIONAL
}

MBMSCommonPTMRBInformation-v780ext-IEs ::= SEQUENCE {
  mbsfn-TDDInformation-LCR        MBSFN-TDDInformation-LCR          OPTIONAL
}

-- *****
--
-- MBMS CURRENT CELL PTM RB INFORMATION
--
-- *****

MBMSCurrentCellPTMRBInformation ::= SEQUENCE {
  -- Current Cell PTM RB Information IEs
  mbms-CurrentCell-SCCPCHList     MBMS-CurrentCell-SCCPCHList-r6    OPTIONAL,
  mbms-SIBType5-SCCPCHList       MBMS-SIBType5-SCCPCHList-r6      OPTIONAL,
  -- Non critical extensions
  v770NonCriticalExtensions       SEQUENCE {
    mbmsCurrentCellPTMRBInfo-v770ext
    MBMSCurrentCellPTMRBInfo-v770ext-IEs,
  nonCriticalExtensions           SEQUENCE {}          OPTIONAL
  }
}

MBMSCurrentCellPTMRBInfo-v770ext-IEs ::= SEQUENCE {
  mbsfn-TDM-Info-List            MBSFN-TDM-Info-List              OPTIONAL
}

```



```

-- *****
--
-- MBMS GENERAL INFORMATION
--
-- *****

MBMSGeneralInformation ::= SEQUENCE {
  -- MBMS General Information IEs
  mbms-PreferredFrequencyInfo      MBMS-PreferredFrequencyList-r6      OPTIONAL,
  mbms-TimersAndCounters           MBMS-TimersAndCounters-r6,
  michConfigurationInfo            MBMS-MICHConfigurationInfo-r6,
  cellGroupIdentity                MBMS-CellGroupIdentity-r6,
  mschDefaultConfigurationInfo     MBMS-MSCH-ConfigurationInfo-r6  OPTIONAL,
  -- Non critical extensions
  v6b0NonCriticalExtensions        SEQUENCE {
    mbmsGeneralInformation-v6b0ext  MBMSGeneralInformation-v6b0ext-IEs,
    v770NonCriticalExtensions       SEQUENCE {
      mbmsGeneralInformation-v770ext MBMSGeneralInformation-v770ext-IEs,
      nonCriticalExtensions         SEQUENCE {}      OPTIONAL
    }
  }
}

MBMSGeneralInformation-v6b0ext-IEs ::= SEQUENCE {
  indicateChangeInSelectedServices  BOOLEAN
}

MBMSGeneralInformation-v770ext-IEs ::= SEQUENCE {
  mbmsMICHConfiguration            MBMS-MICHConfigurationInfo-v770ext  OPTIONAL,
  mbsfnInterFrequencyNeighbourList MBSFN-InterFrequencyNeighbourList-r7  OPTIONAL
}

-- *****
--
-- MBMS MODIFICATION REQUEST
--
-- *****

MBMSModificationRequest ::= SEQUENCE {
  -- MBMS Modification Request IEs
  mbms-PreferredFreqRequest        MBMS-ServiceIdentity-r6      OPTIONAL,
  rb-InformationReleaseList        RB-InformationReleaseList      OPTIONAL,
  -- Non critical extensions
  v6b0NonCriticalExtensions        SEQUENCE {
    mbmsModificationRequest-v6b0ext MBMSModificationRequest-v6b0ext-IEs,
    v6f0NonCriticalExtensions       SEQUENCE {
      mbmsModificationRequest-v6f0ext MBMSModificationRequest-v6f0ext-IEs,
      nonCriticalExtensions         SEQUENCE {}      OPTIONAL
    }
  }
}

MBMSModificationRequest-v6b0ext-IEs ::= SEQUENCE {
  mbmsSelectedServiceInfo          MBMS-SelectedServiceInfo
}

MBMSModificationRequest-v6f0ext-IEs ::= SEQUENCE {
  mbmsSupportOfServiceChangeForAPtprB  ENUMERATED { true }      OPTIONAL
}

-- *****
--
-- MBMS MODIFIED SERVICES INFORMATION
--
-- *****

MBMSModifiedServicesInformation ::= SEQUENCE {
  -- MBMS Modified Services Information IEs
  modifiedServiceList              MBMS-ModifiedServiceList-r6      OPTIONAL,
  mbms-ReacquireMCCH               ENUMERATED { true }      OPTIONAL,
  mbms-DynamicPersistenceLevel     DynamicPersistenceLevel          OPTIONAL,
  endOfModifiedMCCHInformation     INTEGER (1..16)            OPTIONAL,
  mbmsNumberOfNeighbourCells       MBMS-NumberOfNeighbourCells-r6,
  mbms-AllUnmodifiedPTMServices    ENUMERATED { true }      OPTIONAL,
  mbms-PTMActivationTime           MBMS-PTMActivationTime-r6      OPTIONAL,
  -- Non critical extensions
  v770NonCriticalExtensions        SEQUENCE {

```

```

    mbmsModifiedServicesInformation-v770ext
    v7c0NonCriticalExtensions          MBMSModifiedServicesInformation-v770ext-IEs,
        SEQUENCE {
        mbmsModifiedServicesInformation-v7c0ext
            MBMSModifiedServicesInformation-v7c0ext-IEs,
            nonCriticalExtensions          SEQUENCE {} OPTIONAL
        }
    }
}

MBMSModifiedServicesInformation-v770ext-IEs ::= SEQUENCE {
    modifiedServiceList          MBMS-ModifiedServiceList-v770ext          OPTIONAL,
    mib-ValueTag                 MIB-ValueTag                             OPTIONAL
}

MBMSModifiedServicesInformation-v7c0ext-IEs ::= SEQUENCE {
    modifiedServiceList          MBMS-ModifiedServiceList-LCR-v7c0ext          OPTIONAL
}

-- *****
--
-- MBMS NEIGHBOURING CELL PTM RB INFORMATION
--
-- *****

MBMSNeighbouringCellPTMRBInformation ::= SEQUENCE {
    -- MBMS Neighbouring Cell PTM RB Information IEs
    neighbouringCellIdentity      IntraFreqCellID,
    neighbouringCellSCCPCHList    MBMS-NeighbouringCellSCCPCHList-r6,
    -- Non critical extensions
    v770NonCriticalExtensions     SEQUENCE {
        mbmsNeighbouringCellPTMRBInformation-v770ext
            MBMSNeighbouringCellPTMRBInformation-v770ext-IEs,
            nonCriticalExtensions     SEQUENCE {} OPTIONAL
        }
    }
}

MBMSNeighbouringCellPTMRBInformation-v770ext-IEs ::= SEQUENCE {
    -- The "choice_PhyCH" in the tabular is realized by using the following IE due to the
    -- constraint in the ASN.1 implementation.
    neighbouringCellSCCPCHList    MBMS-NeighbouringCellSCCPCHList-v770ext          OPTIONAL
}

-- *****
--
-- MBMS SCHEDULING INFORMATION
--
-- *****

MBMSSchedulingInformation ::= SEQUENCE {
    -- MBMS Scheduling Information IEs
    serviceSchedulingInfoList     MBMS-ServiceSchedulingInfoList-r6,
    -- Non critical extensions
    nonCriticalExtensions         SEQUENCE {} OPTIONAL
}

-- *****
--
-- MBMS UNMODIFIED SERVICES INFORMATION
--
-- *****

MBMSUnmodifiedServicesInformation ::= SEQUENCE {
    -- MBMS Unmodified Services Information IEs
    unmodifiedServiceList         MBMS-UnmodifiedServiceList-r6          OPTIONAL,
    -- Non critical extensions
    v770NonCriticalExtensions     SEQUENCE {
        mbmsUnmodifiedServicesInformation-v770ext
            MBMSUnmodifiedServicesInformation-v770ext-IEs,
            nonCriticalExtensions     SEQUENCE {} OPTIONAL
        }
    }
}

MBMSUnmodifiedServicesInformation-v770ext-IEs ::= SEQUENCE {
    unmodifiedServiceList         MBMS-UnmodifiedServiceList-v770ext          OPTIONAL
}

```

END

11.3 Information element definitions

InformationElements DEFINITIONS AUTOMATIC TAGS ::=

```
-- *****
--
-- CORE NETWORK INFORMATION ELEMENTS (10.3.1)
--
-- *****
```

BEGIN

IMPORTS

```
hiPDSCHidentities,
hiPUSCHidentities,
hiRM,
maxAC,
maxAdditionalMeas,
maxASC,
maxASCmap,
maxASCpersist,
maxCCTrCH,
maxCellMeas,
maxCellMeas-1,
maxCNdomains,
maxCommonHRNTI,
maxCommonQueueID,
maxCPCHsets,
maxDPCH-DLchan,
maxDPDCH-UL,
maxDRACclasses,
maxE-DCHMACdFlow,
maxE-DCHMACdFlow-1,
maxFACHPCH,
maxFreq,
maxFreqBandsFDD,
maxFreqBandsFDD-ext,
maxFreqBandsTDD,
maxFreqBandsGSM,
maxGANSS,
maxGANSS-1,
maxGANSSSat,
maxGANSSSat-1,
maxGERAN-SI,
maxHProcesses,
maxHSDSCHTBIndex,
maxHSDSCHTBIndex-tdd384,
maxHSSCCHs,
maxHS-SCCHLessTrBlk,
maxInterSysMessages,
maxLoCHperRLC,
maxMAC-d-PDU sizes,
maxMBMS-CommonCCTrCh,
maxMBMS-CommonPhyCh,
maxMBMS-CommonRB,
maxMBMS-CommonTrCh,
maxMBMS-Freq,
maxMBMS-L1CP,
maxMBMSservCount,
maxMBMSservModif,
maxMBMSservSched,
maxMBMSservSelect,
maxMBMSservUnmodif,
maxMBMSTransmis,
maxMBSFNclusters,
maxMeasEvent,
maxMeasIntervals,
maxMeasParEvent,
maxNumCDMA2000Freqs,
maxNumE-AGCH,
maxNumE-HICH,
maxNumFDDFreqs,
maxNumGSMFreqRanges,
maxGSMTTargetCells,
maxNumTDDFreqs,
```

```

maxOtherRAT,
maxOtherRAT-16,
maxPage1,
maxPCPCH-APsig,
maxPCPCH-APsubCh,
maxPCPCH-CDsig,
maxPCPCH-CDSUBch,
maxPCPCH-SF,
maxPCPCHs,
maxPDCPAlgoType,
maxPDSCH,
maxPDSCH-TFCIgroups,
maxPRACH,
maxPRACH-FPACH,
maxPredefConfig,
maxPUSCH,
maxQueueIDs,
maxRABsetup,
maxRAT,
maxRB,
maxRBallRABs,
maxRBperTrCh,
maxRBMuxOptions,
maxRBperRAB,
maxReportedGSMCells,
maxRLCPDUsPerLogChan,
maxSRBsetup,
maxRL,
maxRL-1,
maxEDCHRL,
maxROHC-PacketSizes-r4,
maxROHC-Profile-r4,
maxSat,
maxSatClockModels,
maxSCCPCH,
maxSgnType,
maxSIB,
maxSIB-FACH,
maxSystemCapability,
maxTDD128Carrier,
maxTF,
maxTF-CPCH,
maxTFC,
maxTFCsub,
maxTFCI-2-Combs,
maxTGPS,
maxTrCH,
maxTrCHpreconf,
maxTS,
maxTS-1,
maxTS-2,
maxTS-LCR,
maxTS-LCR-1,
maxURA,
maxURNTI-Group
FROM Constant-definitions;

Ansi-41-IDNNS ::= BIT STRING (SIZE (14))

CN-DomainIdentity ::= ENUMERATED {
    cs-domain,
    ps-domain }

CN-DomainInformation ::= SEQUENCE {
    cn-DomainIdentity
    cn-DomainSpecificNAS-Info
}

CN-DomainInformationFull ::= SEQUENCE {
    cn-DomainIdentity
    cn-DomainSpecificNAS-Info
    cn-DRX-CycleLengthCoeff
}

CN-DomainInformationList ::= SEQUENCE (SIZE (1..maxCNdomains)) OF
    CN-DomainInformation

CN-DomainInformationListFull ::= SEQUENCE (SIZE (1..maxCNdomains)) OF
    CN-DomainInformationFull

```

```

CN-DomainSysInfo ::=
  cn-DomainIdentity
  cn-Type
    gsm-MAP
    ansi-41
  },
  cn-DRX-CycleLengthCoeff
}

CN-DomainSysInfoList ::=
  SEQUENCE (SIZE (1..maxCNdomains)) OF
  CN-DomainSysInfo

CN-InformationInfo ::=
  plmn-Identity
  cn-CommonGSM-MAP-NAS-SysInfo
  cn-DomainInformationList
}

CN-InformationInfo-r6 ::=
  SEQUENCE {
    plmn-Identity
    cn-CommonGSM-MAP-NAS-SysInfo
    cn-DomainInformationList
    primary-plmn-Identity
}

CN-InformationInfoFull ::=
  SEQUENCE {
    plmn-Identity
    cn-CommonGSM-MAP-NAS-SysInfo
    cn-DomainInformationListFull
}

Digit ::=
  INTEGER (0..9)

Gsm-map-IDNNS ::=
  SEQUENCE {
    routingbasis
      localPTMSI
      routingparameter
    },
    tMSIofofsamePLMN
      routingparameter
    },
    tMSIofofdifferentPLMN
      routingparameter
    },
    iMSIresponsetopaging
      routingparameter
    },
    iMSIcauseUEinitiatedEvent
      routingparameter
    },
    iMEI
      routingparameter
    },
    spare2
      routingparameter
    },
    spare1
      routingparameter
  },
  -- dummy is not used in this version of the specification and
  -- it should be ignored by the receiver.
  dummy
}

IMEI ::=
  SEQUENCE (SIZE (15)) OF
  IMEI-Digit

IMEI-Digit ::=
  INTEGER (0..15)

IMSI-GSM-MAP ::=
  SEQUENCE (SIZE (6..21)) OF
  Digit

IntraDomainNasNodeSelector ::=
  SEQUENCE {
    version
      CHOICE {
        release99
        cn-Type
      }
  }

```

```

        }
        },
        later
        futurecoding
    }
}

LAI ::=
    plmn-Identity
    lac
}

MCC ::=
    SEQUENCE (SIZE (3)) OF
        Digit

MNC ::=
    SEQUENCE (SIZE (2..3)) OF
        Digit

MultiplePLMN-List-r6 ::=
    mibPLMN-Identity
    multiplePLMNs
}

NAS-Message ::=
    OCTET STRING (SIZE (1..4095))

NAS-Synchronisation-Indicator ::=
    BIT STRING (SIZE (4))

NAS-SystemInformationGSM-MAP ::=
    OCTET STRING (SIZE (1..8))

P-TMSI-GSM-MAP ::=
    BIT STRING (SIZE (32))

PagingRecordTypeID ::=
    ENUMERATED {
        imsi-GSM-MAP,
        tmsi-GSM-MAP-P-TMSI,
        imsi-DS-41,
        tmsi-DS-41 }

PLMN-Identity ::=
    mcc
    mnc
}

PLMN-IdentityWithOptionalMCC-r6 ::= SEQUENCE {
    mcc
    mnc
}

PLMN-Type ::=
    gsm-MAP
    plmn-Identity
    },
    ansi-41
    p-REV
    min-P-REV
    sid
    nid
    },
    gsm-MAP-and-ANSI-41
    plmn-Identity
    p-REV
    min-P-REV
    sid
    nid
    },
    spare
}

RAB-Identity ::=
    gsm-MAP-RAB-Identity
    ansi-41-RAB-Identity
}

RAI ::=
    lai
}

```

```

Gsm-map-IDNNS,
Ansi-41-IDNNS

```

```

SEQUENCE {
    BIT STRING (SIZE (15))
}

```

```

SEQUENCE {
    PLMN-Identity,
    BIT STRING (SIZE (16))
}

```

```

SEQUENCE (SIZE (3)) OF
    Digit

```

```

SEQUENCE (SIZE (2..3)) OF
    Digit

```

```

SEQUENCE {
    BOOLEAN,
    SEQUENCE (SIZE (1..5)) OF
        PLMN-IdentityWithOptionalMCC-r6
}

```

```

OCTET STRING (SIZE (1..4095))

```

```

BIT STRING (SIZE (4))

```

```

OCTET STRING (SIZE (1..8))

```

```

BIT STRING (SIZE (32))

```

```

ENUMERATED {
    imsi-GSM-MAP,
    tmsi-GSM-MAP-P-TMSI,
    imsi-DS-41,
    tmsi-DS-41 }

```

```

SEQUENCE {
    MCC,
    MNC
}

```

```

SEQUENCE {
    MCC
    MNC
}
OPTIONAL,

```

```

CHOICE {
    SEQUENCE {
        PLMN-Identity
    }
}

```

```

SEQUENCE {
    P-REV,
    Min-P-REV,
    SID,
    NID
}

```

```

SEQUENCE {
    PLMN-Identity,
    P-REV,
    Min-P-REV,
    SID,
    NID
}

```

```

NULL

```

```

CHOICE {
    BIT STRING (SIZE (8)),
    BIT STRING (SIZE (8))
}

```

```

SEQUENCE {
    LAI,
}

```

```

    rac                RoutingAreaCode
}

RoutingAreaCode ::=          BIT STRING (SIZE (8))

RoutingParameter ::=          BIT STRING (SIZE (10))

TMSI-GSM-MAP ::=          BIT STRING (SIZE (32))

-- *****
--
--     UTRAN MOBILITY INFORMATION ELEMENTS (10.3.2)
--
-- *****

AccessClassBarred ::=          ENUMERATED {
                                barred, notBarred }

AccessClassBarredList ::=      SEQUENCE (SIZE (maxAC)) OF
                                AccessClassBarred

AllowedIndicator ::=          ENUMERATED {
                                allowed, notAllowed }

CellAccessRestriction ::=      SEQUENCE {
    cellBarred                CellBarred,
    cellReservedForOperatorUse ReservedIndicator,
    cellReservationExtension   ReservedIndicator,
    -- NOTE: IE accessClassBarredList should not be included if the IE CellAccessRestriction
    -- is included in the IE SysInfoType4
    accessClassBarredList      AccessClassBarredList           OPTIONAL
}

CellBarred ::=                CHOICE {
    barred                      SEQUENCE {
        intraFreqCellReselectionInd AllowedIndicator,
        t-Barred                    T-Barred
    },
    notBarred                   NULL
}

CellIdentity ::=              BIT STRING (SIZE (28))

CellIdentity-PerRL-List ::=    SEQUENCE (SIZE (1..maxRL)) OF CellIdentity

CellSelectReselectInfoSIB-3-4 ::= SEQUENCE {
    mappingInfo                MappingInfo           OPTIONAL,
    cellSelectQualityMeasure    CHOICE {
        cpich-Ec-N0              SEQUENCE {
            -- Default value for q-HYST-2-S is q-HYST-1-S
            q-HYST-2-S            Q-Hyst-S           OPTIONAL
        },
        cpich-RSCP                NULL
    },
    modeSpecificInfo            CHOICE {
        fdd                       SEQUENCE {
            s-Intrasearch          S-SearchQual           OPTIONAL,
            s-Intersearch          S-SearchQual           OPTIONAL,
            s-SearchHCS            S-SearchRXLEV          OPTIONAL,
            rat-List               RAT-FDD-InfoList           OPTIONAL,
            q-QualMin              Q-QualMin,
            q-RxlevMin             Q-RxlevMin
        },
        tdd                       SEQUENCE {
            s-Intrasearch          S-SearchRXLEV          OPTIONAL,
            s-Intersearch          S-SearchRXLEV          OPTIONAL,
            s-SearchHCS            S-SearchRXLEV          OPTIONAL,
            rat-List               RAT-TDD-InfoList           OPTIONAL,
            q-RxlevMin             Q-RxlevMin
        }
    },
    q-Hyst-1-S                  Q-Hyst-S,
    t-Reselection-S            T-Reselection-S,
    hcs-ServingCellInformation   HCS-ServingCellInformation   OPTIONAL,
    maxAllowedUL-TX-Power        MaxAllowedUL-TX-Power
}

DomainSpecificAccessRestrictionForSharedNetwork-v670ext ::= CHOICE {

```

```

        domainSpecificAccessRestrictionList          DomainSpecificAccessRestrictionList-
v670ext,
        domainSpecificAccessRestrictionParametersForAll  DomainSpecificAccessRestrictionParam-
v670ext
    }

DomainSpecificAccessRestrictionList-v670ext ::= SEQUENCE {
    domainSpecificAccessRestrictionParametersForOperator1
        DomainSpecificAccessRestrictionParam-v670ext    OPTIONAL,
    domainSpecificAccessRestrictionParametersForOperator2
        DomainSpecificAccessRestrictionParam-v670ext    OPTIONAL,
    domainSpecificAccessRestrictionParametersForOperator3
        DomainSpecificAccessRestrictionParam-v670ext    OPTIONAL,
    domainSpecificAccessRestrictionParametersForOperator4
        DomainSpecificAccessRestrictionParam-v670ext    OPTIONAL,
    domainSpecificAccessRestrictionParametersForOperator5
        DomainSpecificAccessRestrictionParam-v670ext    OPTIONAL
}

DomainSpecificAccessRestrictionParam-v670ext ::= SEQUENCE {
    cSDomainSpecificAccessRestriction    DomainSpecificAccessRestriction-v670ext,
    pSDomainSpecificAccessRestriction    DomainSpecificAccessRestriction-v670ext
}

DomainSpecificAccessRestriction-v670ext ::= CHOICE {
    noRestriction        NULL,
    restriction          SEQUENCE {
        domainSpecificAccessClassBarredList    AccessClassBarredList    OPTIONAL
    }
}

MapParameter ::=
    INTEGER (0..127)

Mapping ::=
    SEQUENCE {
        rat                RAT,
        mappingFunctionParameterList    MappingFunctionParameterList
    }

Mapping-LCR-r4 ::=
    SEQUENCE {
        mappingFunctionParameterList    MappingFunctionParameterList
    }

MappingFunctionParameter ::=
    SEQUENCE {
        functionType        MappingFunctionType,
        mapParameter1        MapParameter                OPTIONAL,
        mapParameter2        MapParameter,
        -- The presence of upperLimit is conditional on the number of repetition
        upperLimit            UpperLimit                OPTIONAL
    }

MappingFunctionParameterList ::=
    SEQUENCE (SIZE (1..maxMeasIntervals)) OF
        MappingFunctionParameter

MappingFunctionType ::=
    ENUMERATED {
        linear,
        functionType2,
        functionType3,
        functionType4 }

-- In MappingInfo list, mapping for FDD and 3.84Mcps TDD is defined.
-- For 1.28Mcps TDD, Mapping-LCR-r4 is used instead.
MappingInfo ::=
    SEQUENCE (SIZE (1..maxRAT)) OF
        Mapping

-- Actual value Q-Hyst-S = IE value * 2
Q-Hyst-S ::=
    INTEGER (0..20)

Q-Hyst-S-Fine ::= INTEGER (0..40)

RAT ::=
    ENUMERATED {
        ultra-FDD,
        ultra-TDD,
        gsm,
        cdma2000 }

RAT-FDD-Info ::=
    SEQUENCE {
        rat-Identifier        RAT-Identifier,
        s-SearchRAT            S-SearchQual,

```



```

    s-HCS-RAT                S-SearchRXLEV                OPTIONAL,
    s-Limit-SearchRAT        S-SearchQual
}

RAT-FDD-InfoList ::=
    SEQUENCE (SIZE (1..maxOtherRAT)) OF
        RAT-FDD-Info

RAT-Identifier ::=
    ENUMERATED {
        gsm, cdma2000 }

RAT-TDD-Info ::=
    SEQUENCE {
        rat-Identifier        RAT-Identifier,
        s-SearchRAT           S-SearchRXLEV,
        s-HCS-RAT             S-SearchRXLEV                OPTIONAL,
        s-Limit-SearchRAT    S-SearchRXLEV
    }

RAT-TDD-InfoList ::=
    SEQUENCE (SIZE (1..maxOtherRAT)) OF
        RAT-TDD-Info

ReservedIndicator ::=
    ENUMERATED {
        reserved,
        notReserved }

-- Actual value S-SearchQual = IE value * 2
S-SearchQual ::=
    INTEGER (-16..10)

-- Actual value S-SearchRXLEV = (IE value * 2) + 1
S-SearchRXLEV ::=
    INTEGER (-53..45)

-- Actual value ScalingFactor = IE value * 0.1
SpeedDependentScalingFactor ::=
    INTEGER (0..10)

T-Barred ::=
    ENUMERATED {
        s10, s20, s40, s80,
        s160, s320, s640, s1280 }

T-Reselection-S ::=
    INTEGER (0..31)

-- Actual value T-Reselection-S-Fine = IE value * 0.2
T-Reselection-S-Fine ::=
    INTEGER (0..31)

-- Actual value ScalingFactor = IE value * 0.25
TreselectionScalingFactor ::=
    INTEGER (4..19)

-- For UpperLimit, the used range depends on the RAT used.
UpperLimit ::=
    INTEGER (1..91)

URA-Identity ::=
    BIT STRING (SIZE (16))

URA-IdentityList ::=
    SEQUENCE (SIZE (1..maxURA)) OF
        URA-Identity

-- *****
--
--     USER EQUIPMENT INFORMATION ELEMENTS (10.3.3)
--
-- *****

AccessStratumReleaseIndicator ::=
    ENUMERATED {
        rel-4, rel-5, rel-6, rel-7,
        spare12, spare11, spare10, spare9, spare8,
        spare7, spare6, spare5, spare4, spare3,
        spare2, spare1 }

-- TABULAR : for ActivationTime, value 'now' always appear as default, and is encoded
-- by absence of the field
ActivationTime ::=
    INTEGER (0..255)

BackoffControlParams ::=
    SEQUENCE {
        n-AP-RetransMax        N-AP-RetransMax,
        n-AccessFails          N-AccessFails,
        nf-BO-NoAICH           NF-BO-NoAICH,
        ns-BO-Busy             NS-BO-Busy,
        nf-BO-AllBusy          NF-BO-AllBusy,
        nf-BO-Mismatch         NF-BO-Mismatch,
        t-CPCH                 T-CPCH
    }

```

```

C-RNTI ::= BIT STRING (SIZE (16))

CapabilityUpdateRequirement ::= SEQUENCE {
    ue-RadioCapabilityFDDUpdateRequirement BOOLEAN,
    -- ue-RadioCapabilityTDDUpdateRequirement is for 3.84Mcps TDD update requirement
    ue-RadioCapabilityTDDUpdateRequirement BOOLEAN,
    systemSpecificCapUpdateReqList SystemSpecificCapUpdateReqList OPTIONAL
}

CapabilityUpdateRequirement-r4-ext ::= SEQUENCE {
    ue-RadioCapabilityUpdateRequirement-TDD128 BOOLEAN
}

CapabilityUpdateRequirement-r4 ::= SEQUENCE {
    ue-RadioCapabilityFDDUpdateRequirement-FDD BOOLEAN,
    ue-RadioCapabilityTDDUpdateRequirement-TDD384 BOOLEAN,
    ue-RadioCapabilityTDDUpdateRequirement-TDD128 BOOLEAN,
    systemSpecificCapUpdateReqList SystemSpecificCapUpdateReqList OPTIONAL
}

CapabilityUpdateRequirement-r5 ::= SEQUENCE {
    ue-RadioCapabilityFDDUpdateRequirement-FDD BOOLEAN,
    ue-RadioCapabilityTDDUpdateRequirement-TDD384 BOOLEAN,
    ue-RadioCapabilityTDDUpdateRequirement-TDD128 BOOLEAN,
    systemSpecificCapUpdateReqList SystemSpecificCapUpdateReqList-r5 OPTIONAL
}

CapabilityUpdateRequirement-v770ext ::= SEQUENCE {
    ue-RadioCapabilityTDDUpdateRequirement-TDD768 BOOLEAN
}

CapabilityUpdateRequirement-r7 ::= SEQUENCE {
    ue-RadioCapabilityFDDUpdateRequirement-FDD BOOLEAN,
    ue-RadioCapabilityTDDUpdateRequirement-TDD384 BOOLEAN,
    ue-RadioCapabilityTDDUpdateRequirement-TDD768 BOOLEAN,
    ue-RadioCapabilityTDDUpdateRequirement-TDD128 BOOLEAN,
    systemSpecificCapUpdateReqList SystemSpecificCapUpdateReqList-r5 OPTIONAL
}

-- If the IE CellUpdateCause has the value 'cellUpdateCause-ext', the actual value is
-- defined in the IE CellUpdateCause-ext.
CellUpdateCause ::= ENUMERATED {
    cellReselection,
    periodicalCellUpdate,
    uplinkDataTransmission,
    utran-pagingResponse,
    re-enteredServiceArea,
    radiolinkFailure,
    rlc-unrecoverableError,
    cellUpdateCause-ext }

-- The IE CellUpdateCause-ext shall be present, if the IE CellUpdateCause has the
-- value 'cellUpdateCause-ext'.
-- dummy is not used in this version of the specification, it should not be sent
-- and if received it should be ignored by the receiver.
CellUpdateCause-ext ::= ENUMERATED {
    mbms-Reception,
    mbms-PTP-RB-Request,
    dummy,
    spare1 }

ChipRateCapability ::= ENUMERATED {
    mcps3-84, mcps1-28 }

CipheringAlgorithm ::= ENUMERATED {
    uea0, uea1 }

CipheringAlgorithm-r7 ::= ENUMERATED {
    uea0, uea1, uea2 }

CipheringModeCommand ::= CHOICE {
    startRestart CipheringAlgorithm,
    dummy NULL
}

CipheringModeCommand-r7 ::= SEQUENCE {

```

```

    startRestart                CipheringAlgorithm-r7
}

CipheringModeInfo ::=
    SEQUENCE {
        -- TABULAR: The ciphering algorithm is included in the CipheringModeCommand.
        cipheringModeCommand      CipheringModeCommand,
        activationTimeForDPCH      ActivationTime                OPTIONAL,
        rb-DL-CiphActivationTimeInfo RB-ActivationTimeInfoList    OPTIONAL
    }

CipheringModeInfo-r7 ::=
    SEQUENCE {
        -- TABULAR: The ciphering algorithm is included in the CipheringModeCommand.
        cipheringModeCommand      CipheringModeCommand-r7,
        activationTimeForDPCH      ActivationTime                OPTIONAL,
        rb-DL-CiphActivationTimeInfo RB-ActivationTimeInfoList    OPTIONAL
    }

CN-DRX-CycleLengthCoefficient ::= INTEGER (6..9)

CN-PagedUE-Identity ::= CHOICE {
    imsi-GSM-MAP                IMSI-GSM-MAP,
    tmsi-GSM-MAP                TMSI-GSM-MAP,
    p-TMSI-GSM-MAP              P-TMSI-GSM-MAP,
    imsi-DS-41                  IMSI-DS-41,
    tmsi-DS-41                  TMSI-DS-41,
    spare3                       NULL,
    spare2                       NULL,
    spare1                       NULL
}

CompressedModeMeasCapability ::= SEQUENCE {
    fdd-Measurements             BOOLEAN,
    -- TABULAR: The IEs tdd-Measurements, gsm-Measurements and multiCarrierMeasurements
    -- are made optional since they are conditional based on another information element.
    -- Their absence corresponds to the case where the condition is not true.
    -- The IE 'tdd-Measurements' applies to either or both TDD 3.84 Mcps and TDD 7.68 Mcps,
    -- depending on the RF capability conditions.
    tdd-Measurements             BOOLEAN                OPTIONAL,
    gsm-Measurements             GSM-Measurements        OPTIONAL,
    multiCarrierMeasurements     BOOLEAN                OPTIONAL
}

CompressedModeMeasCapability-LCR-r4 ::= SEQUENCE {
    tdd128-Measurements          BOOLEAN                OPTIONAL
}

CompressedModeMeasCapabFDDList ::= SEQUENCE (SIZE (1..maxFreqBandsFDD)) OF
    CompressedModeMeasCapabFDD

CompressedModeMeasCapabFDDList2 ::= SEQUENCE (SIZE (1..maxFreqBandsFDD)) OF
    CompressedModeMeasCapabFDD2

CompressedModeMeasCapabFDDList-ext ::= SEQUENCE (SIZE (1..maxFreqBandsFDD)) OF
    CompressedModeMeasCapabFDD-ext

CompressedModeMeasCapabFDD ::= SEQUENCE {
    radioFrequencyBandFDD       RadioFrequencyBandFDD    OPTIONAL,
    dl-MeasurementsFDD          BOOLEAN,
    ul-MeasurementsFDD          BOOLEAN
}

CompressedModeMeasCapabFDD2 ::= SEQUENCE {
    -- UE may omit both IEs if this IE indicates the compressed mode capability within the same
    -- frequency band. Otherwise, the UE shall include either one of the following OPTIONAL IEs.
    radioFrequencyBandFDD       RadioFrequencyBandFDD    OPTIONAL,
    radioFrequencyBandFDD2     RadioFrequencyBandFDD2    OPTIONAL,
    dl-MeasurementsFDD          BOOLEAN,
    ul-MeasurementsFDD          BOOLEAN
}

CompressedModeMeasCapabFDD-ext ::= SEQUENCE {
    radioFrequencyBandFDD2     RadioFrequencyBandFDD2,
    dl-MeasurementsFDD          BOOLEAN,
    ul-MeasurementsFDD          BOOLEAN
}

CompressedModeMeasCapabTDDList ::= SEQUENCE (SIZE (1..maxFreqBandsTDD)) OF
    CompressedModeMeasCapabTDD

```

```

CompressedModeMeasCapabTDD ::= SEQUENCE {
    radioFrequencyBandTDD      RadioFrequencyBandTDD,
    dl-MeasurementsTDD         BOOLEAN,
    ul-MeasurementsTDD         BOOLEAN
}

CompressedModeMeasCapabGSMList ::= SEQUENCE (SIZE (1..maxFreqBandsGSM)) OF
    CompressedModeMeasCapabGSM

CompressedModeMeasCapabGSM ::= SEQUENCE {
    radioFrequencyBandGSM      RadioFrequencyBandGSM,
    dl-MeasurementsGSM         BOOLEAN,
    ul-MeasurementsGSM         BOOLEAN
}

CompressedModeMeasCapabMC ::= SEQUENCE {
    dl-MeasurementsMC          BOOLEAN,
    ul-MeasurementsMC          BOOLEAN
}

CPCH-Parameters ::= SEQUENCE {
    initialPriorityDelayList    InitialPriorityDelayList          OPTIONAL,
    backoffControlParams        BackoffControlParams,
    -- TABULAR: TPC step size nested inside PowerControlAlgorithm
    powerControlAlgorithm       PowerControlAlgorithm,
    dl-DPCCH-BER                DL-DPCCH-BER
}

DL-CapabilityWithSimultaneousHS-DSCHConfig ::= ENUMERATED {kbps32, kbps64, kbps128, kbps384}

DL-DPCCH-BER ::= INTEGER (0..63)

DL-PhysChCapabilityFDD ::= SEQUENCE {
    -- The IE "maxNoDPCH-PDSCH-Codes" only gives information on the maximum number of DPCH Codes.
    maxNoDPCH-PDSCH-Codes      INTEGER (1..8),
    maxNoPhysChBitsReceived     MaxNoPhysChBitsReceived,
    supportForSF-512            BOOLEAN,
    -- dummy and dummy2 are not used in this version of the specification
    -- and if received they should be ignored.
    dummy                       BOOLEAN,
    dummy2                      SimultaneousSCCPCH-DPCH-Reception
}

DL-PhysChCapabilityFDD-v380ext ::= SEQUENCE {
    -- dummy is not used in this version of the specification, it should
    -- not be sent and if received it should be ignored.
    dummy                       SupportOfDedicatedPilotsForChEstimation OPTIONAL
}

SupportOfDedicatedPilotsForChEstimation ::= ENUMERATED { true }

DL-PhysChCapabilityFDD-v770ext ::= SEQUENCE {
    hsdSCH-physical-layer-category-ext HSDSCH-physical-layer-category-ext OPTIONAL,
    hsschlessHsdSCH-operation          ENUMERATED { true } OPTIONAL,
    enhancedFdpch                     ENUMERATED { true } OPTIONAL,
    hsdSCH-reception-CellFach          ENUMERATED { true } OPTIONAL,
    hsdSCH-reception-CellUraPch       ENUMERATED { true } OPTIONAL
}

DL-PhysChCapabilityTDD ::= SEQUENCE {
    maxTS-PerFrame                  MaxTS-PerFrame,
    maxPhysChPerFrame               MaxPhysChPerFrame,
    minimumSF                       MinimumSF-DL,
    supportOfPDSCH                   BOOLEAN,
    maxPhysChPerTS                   MaxPhysChPerTS
}

DL-PhysChCapabilityTDD-LCR-r4 ::= SEQUENCE {
    maxTS-PerSubFrame               MaxTS-PerSubFrame-r4,
    maxPhysChPerSubFrame-r4         MaxPhysChPerSubFrame-r4,
    minimumSF                       MinimumSF-DL,
    supportOfPDSCH                   BOOLEAN,
    maxPhysChPerTS                   MaxPhysChPerTS,
    supportOf8PSK                    BOOLEAN
}

DL-PhysChCapabilityTDD-128-v770ext ::= SEQUENCE {

```

```

    multiCarrier-physical-layer-category    MultiCarrier-HSDSCH-physical-layer-category OPTIONAL
}

DL-PhysChCapabilityTDD-768 ::=             SEQUENCE {
    maxTS-PerFrame                        MaxTS-PerFrame,
    maxPhysChPerFrame                    MaxPhysChPerFrame-768,
    minimumSF                             MinimumSF-DL-768,
    supportOfPDSCH                        BOOLEAN,
    tdd768-hspdsch                        CHOICE {
        supported                          HSDSCH-physical-layer-category,
        unsupported                         NULL
    },
    maxPhysChPerTS                        MaxPhysChPerTS-768
}

DL-PhysChCapabilityInfoTDD-768 ::= SEQUENCE {
    maxTS-PerFrame                        MaxTS-PerFrame,
    maxPhysChPerFrame                    MaxPhysChPerFrame-768,
    minimumSF                             MinimumSF-DL-768,
    supportOfPDSCH                        BOOLEAN,
    maxPhysChPerTS                        MaxPhysChPerTS-768
}

DL-TransChCapability ::=                 SEQUENCE {
    maxNoBitsReceived                    MaxNoBits,
    maxConvCodeBitsReceived              MaxNoBits,
    turboDecodingSupport                  TurboSupport,
    maxSimultaneousTransChs              MaxSimultaneousTransChsDL,
    maxSimultaneousCCTrCH-Count          MaxSimultaneousCCTrCH-Count,
    maxReceivedTransportBlocks           MaxTransportBlocksDL,
    maxNumberOfTFC                        MaxNumberOfTFC-DL,
    maxNumberOfTF                          MaxNumberOfTF
}

DRAC-SysInfo ::=                        SEQUENCE {
    transmissionProbability                TransmissionProbability,
    maximumBitRate                         MaximumBitRate
}

DRAC-SysInfoList ::=                    SEQUENCE (SIZE (1..maxDRACclasses)) OF
    DRAC-SysInfo

DSCH-RNTI ::=                            BIT STRING (SIZE (16))

DelayRestrictionFlag ::=                 ENUMERATED { true }

E-RNTI ::=                                BIT STRING (SIZE (16))

ESN-DS-41 ::=                             BIT STRING (SIZE (32))

EstablishmentCause ::=                   ENUMERATED {
    originatingConversationalCall,
    originatingStreamingCall,
    originatingInteractiveCall,
    originatingBackgroundCall,
    originatingSubscribedTrafficCall,
    terminatingConversationalCall,
    terminatingStreamingCall,
    terminatingInteractiveCall,
    terminatingBackgroundCall,
    emergencyCall,
    interRAT-CellReselection,
    interRAT-CellChangeOrder,
    registration,
    detach,
    originatingHighPrioritySignalling,
    originatingLowPrioritySignalling,
    callRe-establishment,
    terminatingHighPrioritySignalling,
    terminatingLowPrioritySignalling,
    terminatingCauseUnknown,
    mbms-Reception,
    mbms-PTP-RB-Request,
    spare10,
    spare9,
    spare8,
    spare7,
    spare6,
}

```

```

        spare5,
        spare4,
        spare3,
        spare2,
        spare1 }

FailureCauseWithProtErr ::= CHOICE {
    configurationUnsupported          NULL,
    physicalChannelFailure           NULL,
    incompatibleSimultaneousReconfiguration
        NULL,
    compressedModeRuntimeError       TGPSI,
    protocolError                    ProtocolErrorInformation,
    cellUpdateOccurred               NULL,
    invalidConfiguration             NULL,
    configurationIncomplete          NULL,
    unsupportedMeasurement           NULL,
    mbmsSessionAlreadyReceivedCorrectly NULL,
    lowerPriorityMBMSService         NULL,
    spare5                           NULL,
    spare4                           NULL,
    spare3                           NULL,
    spare2                           NULL,
    spare1                           NULL
}

FailureCauseWithProtErrTrId ::= SEQUENCE {
    rrc-TransactionIdentifier        RRC-TransactionIdentifier,
    failureCause                    FailureCauseWithProtErr
}

GANSS-Mode ::= ENUMERATED {
    networkBased,
    ueBased,
    both,
    none }

GroupIdentityWithReleaseInformation ::= SEQUENCE {
    rrc-ConnectionReleaseInformation RRC-ConnectionReleaseInformation,
    groupReleaseInformation          GroupReleaseInformation
}

GroupReleaseInformation ::= SEQUENCE {
    uRNTI-Group                    U-RNTI-Group
}

GSM-Measurements ::= SEQUENCE {
    gsm900                         BOOLEAN,
    dcs1800                        BOOLEAN,
    gsm1900                        BOOLEAN
}

H-RNTI ::= BIT STRING (SIZE (16))

High-MobilityDetected ::= ENUMERATED { high-MobilityDetected }

HSDSCH-physical-layer-category ::= INTEGER (1..64)

HSDSCH-physical-layer-category-ext ::= INTEGER (1..20)

MultiCarrier-HSDSCH-physical-layer-category ::= INTEGER (1..64)

UESpecificBehaviourInformationIdle ::= BIT STRING (SIZE (4))

UESpecificBehaviourInformationInterRAT ::= BIT STRING (SIZE (8))

IMSI-and-ESN-DS-41 ::= SEQUENCE {
    imsi-DS-41                    IMSI-DS-41,
    esn-DS-41                     ESN-DS-41
}

IMSI-DS-41 ::= OCTET STRING (SIZE (5..7))

InitialPriorityDelayList ::= SEQUENCE (SIZE (1..maxASC)) OF
    NS-IP

InitialUE-Identity ::= CHOICE {

```

```

    imsi                IMSI-GSM-MAP,
    tmsi-and-LAI        TMSI-and-LAI-GSM-MAP,
    p-TMSI-and-RAI     P-TMSI-and-RAI-GSM-MAP,
    imei                IMEI,
    esn-DS-41          ESN-DS-41,
    imsi-DS-41         IMSI-DS-41,
    imsi-and-ESN-DS-41 IMSI-and-ESN-DS-41,
    tmsi-DS-41         TMSI-DS-41
}

IntegrityCheckInfo ::= SEQUENCE {
    messageAuthenticationCode    MessageAuthenticationCode,
    rrc-MessageSequenceNumber    RRC-MessageSequenceNumber
}

IntegrityProtActivationInfo ::= SEQUENCE {
    rrc-MessageSequenceNumberList RRC-MessageSequenceNumberList
}

IntegrityProtectionAlgorithm ::= ENUMERATED {
    uia1 }

IntegrityProtectionAlgorithm-r7 ::= ENUMERATED {
    uia1, uia2 }

IntegrityProtectionModeCommand ::= CHOICE {
    startIntegrityProtection SEQUENCE {
        integrityProtInitNumber    IntegrityProtInitNumber
    },
    modify                      SEQUENCE {
        dl-IntegrityProtActivationInfo IntegrityProtActivationInfo
    }
}

IntegrityProtectionModeInfo ::= SEQUENCE {
    -- TABULAR: DL integrity protection activation info and Integrity
    -- protection intialisation number have been nested inside
    -- IntegrityProtectionModeCommand.
    integrityProtectionModeCommand    IntegrityProtectionModeCommand,
    integrityProtectionAlgorithm       IntegrityProtectionAlgorithm    OPTIONAL
}

IntegrityProtectionModeInfo-r7 ::= SEQUENCE {
    -- TABULAR: DL integrity protection activation info and Integrity
    -- protection intialisation number have been nested inside
    -- IntegrityProtectionModeCommand.
    integrityProtectionModeCommand    IntegrityProtectionModeCommand,
    integrityProtectionAlgorithm-r7    IntegrityProtectionAlgorithm-r7    OPTIONAL
}

IntegrityProtInitNumber ::= BIT STRING (SIZE (32))

-- dummy is not used in this version of the specification, it should
-- not be sent and if received it should be ignored.
MaxHcContextSpace ::= ENUMERATED {
    dummy, by1024, by2048, by4096,
    by8192 }

MaxHcContextSpace-r5-ext ::= ENUMERATED {
    by16384, by32768, by65536, by131072 }

MaxROHC-ContextSessions-r4 ::= ENUMERATED {
    s2, s4, s8, s12, s16, s24, s32, s48,
    s64, s128, s256, s512, s1024, s16384 }

MaximumAM-EntityNumberRLC-Cap ::= ENUMERATED {
    dummy, am4, am5, am6,
    am8, am16, am30 }

-- Actual value MaximumBitRate = IE value * 16
MaximumBitRate ::= INTEGER (0..32)

MaximumRLC-WindowSize ::= ENUMERATED { mws2047, mws4095 }

MaxNoDPDCH-BitsTransmitted ::= ENUMERATED {
    b600, b1200, b2400, b4800,
    b9600, b19200, b28800, b38400,

```

```

        b48000, b57600 }

MaxNoBits ::=
    ENUMERATED {
        b640, b1280, b2560, b3840, b5120,
        b6400, b7680, b8960, b10240,
        b20480, b40960, b81920, b163840 }

MaxNoPhysChBitsReceived ::=
    ENUMERATED {
        dummy, b1200, b2400, b3600,
        b4800, b7200, b9600, b14400,
        b19200, b28800, b38400, b48000,
        b57600, b67200, b76800 }

MaxNoSCCPCH-RL ::=
    ENUMERATED {
        r11 }

MaxNumberOfTF ::=
    ENUMERATED {
        tf32, tf64, tf128, tf256,
        tf512, tf1024 }

MaxNumberOfTFC-DL ::=
    ENUMERATED {
        tfc16, tfc32, tfc48, tfc64, tfc96,
        tfc128, tfc256, tfc512, tfc1024 }

MaxNumberOfTFC-UL ::=
    ENUMERATED {
        dummy1, dummy2, tfc16, tfc32, tfc48, tfc64,
        tfc96, tfc128, tfc256, tfc512, tfc1024 }

-- the values 1 to 4 for MaxPhysChPerFrame are not used in this version of the protocol
MaxPhysChPerFrame ::=
    INTEGER (1..224)

MaxPhysChPerFrame-768 ::=
    INTEGER (1..448)

MaxPhysChPerSubFrame-r4 ::=
    INTEGER (1..96)

MaxPhysChPerTimeslot ::=
    ENUMERATED {
        ts1, ts2 }

MaxPhysChPerTimeslot-LCR-r7 ::=
    INTEGER (1..4)

-- the values 1 to 4 for MaxPhysChPerTS are not used in this version of the protocol
MaxPhysChPerTS ::=
    INTEGER (1..16)

MaxPhysChPerTS-768 ::=
    INTEGER (1..32)

MaxSimultaneousCCTrCH-Count ::=
    INTEGER (1..8)

MaxSimultaneousTransChsDL ::=
    ENUMERATED {
        e4, e8, e16, e32 }

MaxSimultaneousTransChsUL ::=
    ENUMERATED {
        dummy, e4, e8, e16, e32 }

MaxTransportBlocksDL ::=
    ENUMERATED {
        tb4, tb8, tb16, tb32, tb48,
        tb64, tb96, tb128, tb256, tb512 }

MaxTransportBlocksUL ::=
    ENUMERATED {
        dummy, tb4, tb8, tb16, tb32, tb48,
        tb64, tb96, tb128, tb256, tb512 }

MaxTS-PerFrame ::=
    INTEGER (1..14)

MaxTS-PerSubFrame-r4 ::=
    INTEGER (1..6)

-- TABULAR: MeasurementCapability contains dependencies to UE-MultiModeRAT-Capability,
-- the conditional fields have been left mandatory for now.
MeasurementCapability ::=
    SEQUENCE {
        downlinkCompressedMode    CompressedModeMeasCapability,
        uplinkCompressedMode      CompressedModeMeasCapability
    }

MeasurementCapabilityExt ::=
    SEQUENCE{
        compressedModeMeasCapabFDDList    CompressedModeMeasCapabFDDList,
        compressedModeMeasCapabTDDList    CompressedModeMeasCapabTDDList    OPTIONAL,
        compressedModeMeasCapabGSMLList   CompressedModeMeasCapabGSMLList    OPTIONAL,
        compressedModeMeasCapabMC         CompressedModeMeasCapabMC         OPTIONAL
    }

```



```

MeasurementCapabilityExt2 ::= SEQUENCE{
    compressedModeMeasCapabFDDList      CompressedModeMeasCapabFDDList2,
    compressedModeMeasCapabTDDList      CompressedModeMeasCapabTDDList  OPTIONAL,
    compressedModeMeasCapabGSMList      CompressedModeMeasCapabGSMList  OPTIONAL,
    compressedModeMeasCapabMC           CompressedModeMeasCapabMC       OPTIONAL
}

MeasurementCapability-r4-ext ::= SEQUENCE {
    downlinkCompressedMode-LCR          CompressedModeMeasCapability-LCR-r4,
    uplinkCompressedMode-LCR           CompressedModeMeasCapability-LCR-r4
}

MessageAuthenticationCode ::= BIT STRING (SIZE (32))

MinimumSF-DL ::= ENUMERATED {
    sf1, sf16 }

MinimumSF-DL-768 ::= ENUMERATED {
    sf1, sf32 }

MinimumSF-UL ::= ENUMERATED {
    sf1, sf2, sf4, sf8, dummy }

MultiModeCapability ::= ENUMERATED {
    tdd, fdd, fdd-tdd }

MultiRAT-Capability ::= SEQUENCE {
    supportOfGSM                BOOLEAN,
    supportOfMulticarrier        BOOLEAN
}

MultiModeRAT-Capability-v590ext ::= SEQUENCE {
    supportOfUTRAN-ToGERAN-NACC  BOOLEAN
}

MultiModeRAT-Capability-v680ext ::= SEQUENCE {
    supportOfHandoverToGAN        ENUMERATED { doesSupportHandoverToGAN }  OPTIONAL
}

MultiModeRAT-Capability-v770ext ::= SEQUENCE {
    supportOfPSHandoverToGAN      ENUMERATED { doesSupportPSHandoverToGAN }  OPTIONAL
}

N-300 ::= INTEGER (0..7)
N-301 ::= INTEGER (0..7)
N-302 ::= INTEGER (0..7)
N-304 ::= INTEGER (0..7)
N-308 ::= INTEGER (1..8)
N-310 ::= INTEGER (0..7)
N-312 ::= ENUMERATED {
    s1, s50, s100, s200, s400,
    s600, s800, s1000 }
N-312ext ::= ENUMERATED {
    s2, s4, s10, s20 }
N-312-r5 ::= ENUMERATED {
    s1, s2, s4, s10, s20,
    s50, s100, s200, s400,
    s600, s800, s1000 }
N-313 ::= ENUMERATED {
    s1, s2, s4, s10, s20,
    s50, s100, s200 }
N-315 ::= ENUMERATED {
    s1, s50, s100, s200, s400,
    s600, s800, s1000 }
N-315ext ::= ENUMERATED {

```

```

s2, s4, s10, s20 }

N-315-r5 ::=
    ENUMERATED {
        s1, s2, s4, s10, s20,
        s50, s100, s200, s400,
        s600, s800, s1000 }

N-AccessFails ::=
    INTEGER (1..64)

N-AP-RetransMax ::=
    INTEGER (1..64)

NetworkAssistedGANSS-Supported-List ::= SEQUENCE (SIZE (1..maxGANSS)) OF SEQUENCE {
    gANSS-Id
        ENUMERATED {
            spare8, spare7, spare6, spare5, spare4,
            spare3, spare2, spare1 } OPTIONAL,
    gANSS-Mode
        GANSS-Mode,
    gANSS-SignalId
        GANSS-Signal-Id OPTIONAL,
    supportForUE-GANSS-TimingOfCellFrames
        BOOLEAN,
    supportForUE-GANSS-CarrierPhaseMeasurement
        BOOLEAN OPTIONAL
}

NetworkAssistedGPS-Supported ::=
    ENUMERATED {
        networkBased,
        ue-Based,
        bothNetworkAndUE-Based,
        noNetworkAssistedGPS }

NF-BO-AllBusy ::=
    INTEGER (0..31)

NF-BO-NoAICH ::=
    INTEGER (0..31)

NF-BO-Mismatch ::=
    INTEGER (0..127)

NS-BO-Busy ::=
    INTEGER (0..63)

NS-IP ::=
    INTEGER (0..28)

P-TMSI-and-RAI-GSM-MAP ::=
    SEQUENCE {
        p-TMSI
        P-TMSI-GSM-MAP,
        rai
        RAI
    }

PagingCause ::=
    ENUMERATED {
        terminatingConversationalCall,
        terminatingStreamingCall,
        terminatingInteractiveCall,
        terminatingBackgroundCall,
        terminatingHighPrioritySignalling,
        terminatingLowPrioritySignalling,
        terminatingCauseUnknown,
        spare
    }

PagingRecord ::=
    CHOICE {
        cn-Identity
            SEQUENCE {
                pagingCause
                PagingCause,
                cn-DomainIdentity
                CN-DomainIdentity,
                cn-pagedUE-Identity
                CN-PagedUE-Identity
            },
        utran-Identity
            SEQUENCE {
                u-RNTI
                U-RNTI,
                cn-OriginatedPage-connectedMode-UE
                SEQUENCE {
                    pagingCause
                    PagingCause,
                    cn-DomainIdentity
                    CN-DomainIdentity,
                    pagingRecordTypeID
                    PagingRecordTypeID
                }
            } OPTIONAL
    }

PagingRecord2-r5 ::=
    CHOICE {
        utran-SingleUE-Identity
            SEQUENCE {
                u-RNTI
                U-RNTI,
                cn-OriginatedPage-connectedMode-UE
                SEQUENCE {
                    pagingCause
                    PagingCause,
                    cn-DomainIdentity
                    CN-DomainIdentity,
                    pagingRecordTypeID
                    PagingRecordTypeID
                }
            } OPTIONAL,
    }

```

```

        rrc-ConnectionReleaseInformation      RRC-ConnectionReleaseInformation
    },
    utran-GroupIdentity                       SEQUENCE ( SIZE (1 .. maxURNTI-Group) ) OF
                                              GroupIdentityWithReleaseInformation
}

PagingRecordList ::=                       SEQUENCE (SIZE (1..maxPage1)) OF
                                              PagingRecord

PagingRecord2List-r5 ::=                   SEQUENCE (SIZE (1..maxPage1)) OF
                                              PagingRecord2-r5

PDCP-Capability ::=                       SEQUENCE {
    losslessSRNS-RelocationSupport          BOOLEAN,
    -- If present, the "maxHcContextSpace" in the IE "PDCP-Capability-r5-ext" overrides the
    -- "supported" value in this IE. The value in this IE may be used by a pre-REL-5 UTRAN.
    supportForRfc2507                       CHOICE {
        notSupported                         NULL,
        supported                             MaxHcContextSpace
    }
}

PDCP-Capability-r4-ext ::=                 SEQUENCE {
    supportForRfc3095                       CHOICE {
        notSupported                         NULL,
        supported                             SEQUENCE {
            maxROHC-ContextSessions          MaxROHC-ContextSessions-r4   DEFAULT s16,
            reverseCompressionDepth          INTEGER (0..65535)           DEFAULT 0
        }
    }
}

PDCP-Capability-r5-ext ::=                 SEQUENCE {
    supportForRfc3095ContextRelocation      BOOLEAN,
    maxHcContextSpace                       MaxHcContextSpace-r5-ext   OPTIONAL
}

PDCP-Capability-r5-ext2 ::=                SEQUENCE {
    losslessDLRLC-PDUSizeChange            ENUMERATED { true }           OPTIONAL
}

PDCP-Capability-v770ext ::=                SEQUENCE {
    reservedForFutureUse                    ENUMERATED { true }           OPTIONAL
}

PhysicalChannelCapability ::=              SEQUENCE {
    fddPhysChCapability                     SEQUENCE {
        downlinkPhysChCapability            DL-PhysChCapabilityFDD,
        uplinkPhysChCapability              UL-PhysChCapabilityFDD
    }
    -- tddPhysChCapability describes the 3.84Mcps TDD physical channel capability
    tddPhysChCapability                     SEQUENCE {
        downlinkPhysChCapability            DL-PhysChCapabilityTDD,
        uplinkPhysChCapability              UL-PhysChCapabilityTDD
    }
    OPTIONAL
}

PhysicalChannelCapability-v770ext ::=      SEQUENCE {
    fddPhysChCapability                     SEQUENCE {
        downlinkPhysChCapability            DL-PhysChCapabilityFDD-v770ext,
        uplinkPhysChCapability              UL-PhysChCapabilityFDD-v770ext
    }
    OPTIONAL,
    tddPhysChCapability-384                 SEQUENCE {
        -- No TDD384 DL physical channel capability extension
        uplinkPhysChCapability              UL-PhysChCapabilityTDD-384-v770ext
    }
    OPTIONAL,
    tddPhysChCapability-768                 SEQUENCE {
        downlinkPhysChCapability            DL-PhysChCapabilityTDD-768,
        uplinkPhysChCapability              UL-PhysChCapabilityTDD-768
    }
    OPTIONAL,
    tddPhysChCapability-128                 SEQUENCE {
        downlinkPhysChCapability            DL-PhysChCapabilityTDD-128-v770ext,
        uplinkPhysChCapability              UL-PhysChCapabilityTDD-128-v770ext
    }
    OPTIONAL
}

PhysicalChannelCapabilityInfo-v770ext ::= SEQUENCE {
    tddPhysChCapability-768                 SEQUENCE {

```

```

        downlinkPhysChCapability          DL-PhysChCapabilityInfoTDD-768,
        uplinkPhysChCapability            UL-PhysChCapabilityTDD
    }
    OPTIONAL,
    tddPhysChCapability-128                SEQUENCE {
        uplinkPhysChCapability            UL-PhysChCapabilityInfoTDD-128-v770ext
    }
    OPTIONAL
}

-- PhysicalChannelCapability-LCR-r4 describes the 1.28Mcps TDD physical channel capability
PhysicalChannelCapability-LCR-r4 ::= SEQUENCE {
    tdd128-PhysChCapability                SEQUENCE {
        downlinkPhysChCapability          DL-PhysChCapabilityTDD-LCR-r4,
        uplinkPhysChCapability            UL-PhysChCapabilityTDD-LCR-r4
    }
    OPTIONAL
}

-- PhysicalChannelCapability-hspdsch-r5 describes the HS-PDSCH physical channel capability
PhysicalChannelCapability-hspdsch-r5 ::= SEQUENCE {
    fdd-hspdsch                            CHOICE {
        supported                          SEQUENCE {
            -- hsdSCH-physical-layer-category values shall be restricted to the range [1..12]
            -- even if the UE physical capability category is above 12.
            hsdSCH-physical-layer-category HSDSCH-physical-layer-category,
            -- dummy and dummy2 are not used in this version of the specification
            -- and if received they should be ignored.
            dummy                            BOOLEAN,
            dummy2                            BOOLEAN
        },
        unsupported                          NULL
    },
    tdd384-hspdsch                          CHOICE {
        supported                          HSDSCH-physical-layer-category,
        unsupported                          NULL
    },
    tdd128-hspdsch                          CHOICE {
        supported                          HSDSCH-physical-layer-category,
        unsupported                          NULL
    }
}

PNBSCH-Allocation-r4 ::= SEQUENCE {
    numberOfRepetitionsPerSFNPeriod ENUMERATED {
        c2, c3, c4, c5, c6, c7, c8, c9, c10,
        c12, c14, c16, c18, c20, c24, c28, c32,
        c36, c40, c48, c56, c64, c72, c80 }
}

ProtocolErrorCause ::= ENUMERATED {
    asn1-ViolationOrEncodingError,
    messageTypeNonexistent,
    messageNotCompatibleWithReceiverState,
    ie-ValueNotComprehended,
    informationElementMissing,
    messageExtensionNotComprehended,
    spare2, spare1 }

ProtocolErrorIndicator ::= ENUMERATED {
    noError, errorOccurred }

ProtocolErrorIndicatorWithMoreInfo ::= CHOICE {
    noError NULL,
    errorOccurred SEQUENCE {
        rrc-TransactionIdentifier RRC-TransactionIdentifier,
        protocolErrorInformation ProtocolErrorInformation
    }
}

ProtocolErrorMoreInformation ::= SEQUENCE {
    diagnosticsType CHOICE {
        type1 CHOICE {
            asn1-ViolationOrEncodingError NULL,
            messageTypeNonexistent NULL,
            messageNotCompatibleWithReceiverState
                IdentificationOfReceivedMessage,
            ie-ValueNotComprehended IdentificationOfReceivedMessage,
            conditionalInformationElementError IdentificationOfReceivedMessage,
            messageExtensionNotComprehended IdentificationOfReceivedMessage,
        }
    }
}

```

```

        spare1                NULL,
        spare2                NULL
    },
    spare                      NULL
}
}

RadioFrequencyBandFDD ::=          ENUMERATED {
    -- fdd2100, fdd1900, fdd1800 correspond to Band I, Band II and Band III respectively
    fdd2100,
    fdd1900,
    fdd1800,
    bandVI,
    bandIV,
    bandV,
    bandVII,
    extension-indicator }

RadioFrequencyBandFDD2 ::=        ENUMERATED {
    bandVIII,
    bandIX,
    bandX,
    bandXI,
    bandXII,
    bandXIII,
    bandXIV,
    bandXV,
    bandXVI,
    bandXVII,
    bandXVIII,
    bandXIX,
    bandXX,
    bandXXI,
    bandXXII,
    extension-indicator }

RadioFrequencyBandTDDList ::=     ENUMERATED {
    a, b, c, ab, ac, bc, abc, spare }

RadioFrequencyBandTDDList-r7 ::=  ENUMERATED {
    a, b, c, d, ab, ac, ad, bc, bd, cd, abc, abd, acd, bcd,
    abcd, spare }

RadioFrequencyBandTDD ::=         ENUMERATED {
    a, b, c, d }

RadioFrequencyBandGSM ::=         ENUMERATED {
    gsm450,
    gsm480,
    gsm850,
    gsm900P,
    gsm900E,
    gsm1800,
    gsm1900,
    spare9, spare8, spare7, spare6, spare5,
    spare4, spare3, spare2, spare1}

Rb-timer-indicator ::=           SEQUENCE {
    t314-expired                BOOLEAN,
    t315-expired                BOOLEAN }

Re-EstablishmentTimer ::=        ENUMERATED {
    useT314, useT315
}

RedirectionInfo ::=              CHOICE {
    frequencyInfo               FrequencyInfo,
    interRATInfo                InterRATInfo
}

RedirectionInfo-r6 ::=           CHOICE {
    frequencyInfo               FrequencyInfo,
    interRATInfo                InterRATInfo-r6
}

RejectionCause ::=               ENUMERATED {
    congestion,
    unspecified }

```

```

ReleaseCause ::=
    ENUMERATED {
        normalEvent,
        unspecified,
        pre-emptiveRelease,
        congestion,
        re-establishmentReject,
        directedsignallingconnectionre-establishment,
        userInactivity,
        spare }

RF-Capability ::=
    SEQUENCE {
        fddRF-Capability
            SEQUENCE {
                ue-PowerClass
                    UE-PowerClass,
                txRxFrequencySeparation
                    TxRxFrequencySeparation
            }
            OPTIONAL,
        tddRF-Capability
            SEQUENCE {
                ue-PowerClass
                    UE-PowerClass,
                radioFrequencyBandTDDList
                    RadioFrequencyBandTDDList,
                chipRateCapability
                    ChipRateCapability
            }
            OPTIONAL
    }

RF-Capability-r4-ext ::=
    SEQUENCE {
        tddRF-Capability
            SEQUENCE {
                ue-PowerClass
                    UE-PowerClass,
                radioFrequencyBandTDDList
                    RadioFrequencyBandTDDList,
                chipRateCapability
                    ChipRateCapability
            }
            OPTIONAL
    }

RF-Capability-v770ext ::=
    SEQUENCE {
        -- If TDD384 and/or TDD128 RF capability is indicated in IEs 'RF-Capability' or
        -- 'RF-Capability-r4-ext', the corresponding IE 'RadioFrequencyBandTDDList-r7' shall
        -- be included in this IE.
        tdd384RF-Capability
            RadioFrequencyBandTDDList-r7
            OPTIONAL,
        tdd768RF-Capability
            SEQUENCE {
                ue-PowerClass
                    UE-PowerClass,
                radioFrequencyBandTDDList
                    RadioFrequencyBandTDDList-r7
                -- The element 'chipRateCapability' = 'mcps7-68'
            }
            OPTIONAL,
        tdd128RF-Capability
            RadioFrequencyBandTDDList-r7
            OPTIONAL
    }

RLC-Capability ::=
    SEQUENCE {
        -- If present, the "totalRLC-AM-BufferSize" in the IE "RLC-Capability-r5-ext" overrides the
        -- corresponding value in this IE. The value in this IE may be used by a pre-REL-5 UTRAN.
        totalRLC-AM-BufferSize
            TotalRLC-AM-BufferSize,
        maximumRLC-WindowSize
            MaximumRLC-WindowSize,
        maximumAM-EntityNumber
            MaximumAM-EntityNumberRLC-Cap
    }

RLC-Capability-r5-ext ::=
    SEQUENCE {
        totalRLC-AM-BufferSize
            TotalRLC-AM-BufferSize-r5-ext
            OPTIONAL
    }

RLC-Capability-v770ext ::=
    SEQUENCE {
        supportOfTwoLogicalChannel
            BOOLEAN
    }

RRC-ConnectionReleaseInformation ::=
    CHOICE {
        noRelease
            NULL,
        release
            SEQUENCE {
                releaseCause
                    ReleaseCause
            }
    }

RRC-MessageSequenceNumber ::=
    INTEGER (0..15)

RRC-MessageSequenceNumberList ::=
    SEQUENCE (SIZE (4..5)) OF
        RRC-MessageSequenceNumber

RRC-StateIndicator ::=
    ENUMERATED {
        cell-DCH, cell-FACH, cell-PCH, ura-PCH }

RRC-TransactionIdentifier ::=
    INTEGER (0..3)

```

```

S-RNTI ::= BIT STRING (SIZE (20))

S-RNTI-2 ::= BIT STRING (SIZE (10))

SecurityCapability ::=
  cipheringAlgorithmCap
  integrityProtectionAlgorithmCap
}

SEQUENCE {
  BIT STRING {
    -- For each bit value "0" means false/ not supported
    spare15(0),
    spare14(1),
    spare13(2),
    spare12(3),
    spare11(4),
    spare10(5),
    spare9(6),
    spare8(7),
    spare7(8),
    spare6(9),
    spare5(10),
    spare4(11),
    spare3(12),
    uea2(13),
    uea1(14),
    uea0(15)
  } (SIZE (16)),
  BIT STRING {
    -- For each bit value "0" means false/ not supported
    spare15(0),
    spare14(1),
    spare13(2),
    spare12(3),
    spare11(4),
    spare10(5),
    spare9(6),
    spare8(7),
    spare7(8),
    spare6(9),
    spare5(10),
    spare4(11),
    spare3(12),
    uia2(13),
    uia1(14),
    spare0(15)
  } (SIZE (16))
}

Serving-HSDSCH-CellInformation ::= SEQUENCE {
  deltaACK DeltaACK OPTIONAL,
  deltaNACK DeltaNACK OPTIONAL,
  harq-Preamble-Mode HARQ-Preamble-Mode,
  primaryCPICH-Info PrimaryCPICH-Info OPTIONAL,
  dl-hspdsch-Information DL-HSPDSCH-Information OPTIONAL,
  harqInfo HARQ-Info OPTIONAL,
  mac-hsResetIndicator ENUMERATED { true } OPTIONAL
}

Serving-HSDSCH-CellInformation-r7 ::= SEQUENCE {
  deltaACK DeltaACK OPTIONAL,
  deltaNACK DeltaNACK OPTIONAL,
  harq-Preamble-Mode HARQ-Preamble-Mode,
  primaryCPICH-Info PrimaryCPICH-Info OPTIONAL,
  dl-hspdsch-Information DL-HSPDSCH-Information-r7 OPTIONAL,
  harqInfo HARQ-Info-r7 OPTIONAL,
  mac-hsResetIndicator ENUMERATED { true } OPTIONAL
}

SimultaneousSCCPCH-DPCH-Reception ::= CHOICE {
  notSupported NULL,
  supported SEQUENCE {
    maxNoSCCPCH-RL MaxNoSCCPCH-RL,
    -- simultaneousSCCPCH-DPCH-DPDCH-Reception is applicable only if
    -- the IE Support of PDSCH = TRUE
    -- Note: the reference to DPDCH in the element name below is incorrect (see tabular). The
    -- name is not changed, to keep it aligned with R99.
    simultaneousSCCPCH-DPCH-DPDCH-Reception BOOLEAN
  }
}

SRNC-Identity ::= BIT STRING (SIZE (12))

```

```

START-Value ::= BIT STRING (SIZE (20))

STARTList ::= SEQUENCE (SIZE (1..maxCNdomains)) OF
               STARTSingle

STARTSingle ::= SEQUENCE {
  cn-DomainIdentity CN-DomainIdentity,
  start-Value       START-Value
}

SystemSpecificCapUpdateReq ::= ENUMERATED {
  gsm }

SystemSpecificCapUpdateReq-v590ext ::= ENUMERATED {
  geranIu }

SystemSpecificCapUpdateReq-r5 ::= ENUMERATED {
  gsm, geranIu }

SystemSpecificCapUpdateReqList ::= SEQUENCE (SIZE (1..maxSystemCapability)) OF
  SystemSpecificCapUpdateReq

SystemSpecificCapUpdateReqList-r5 ::= SEQUENCE (SIZE (1..maxSystemCapability)) OF
  SystemSpecificCapUpdateReq-r5

T-300 ::= ENUMERATED {
  ms100, ms200, ms400, ms600, ms800,
  ms1000, ms1200, ms1400, ms1600,
  ms1800, ms2000, ms3000, ms4000,
  ms6000, ms8000 }

T-301 ::= ENUMERATED {
  ms100, ms200, ms400, ms600, ms800,
  ms1000, ms1200, ms1400, ms1600,
  ms1800, ms2000, ms3000, ms4000,
  ms6000, ms8000, spare }

T-302 ::= ENUMERATED {
  ms100, ms200, ms400, ms600, ms800,
  ms1000, ms1200, ms1400, ms1600,
  ms1800, ms2000, ms3000, ms4000,
  ms6000, ms8000, spare }

T-304 ::= ENUMERATED {
  ms100, ms200, ms400,
  ms1000, ms2000, spare3, spare2, spare1 }

T-305 ::= ENUMERATED {
  noUpdate, m5, m10, m30,
  m60, m120, m360, m720 }

T-307 ::= ENUMERATED {
  s5, s10, s15, s20,
  s30, s40, s50, spare }

T-308 ::= ENUMERATED {
  ms40, ms80, ms160, ms320 }

T-309 ::= INTEGER (1..8)

T-310 ::= ENUMERATED {
  ms40, ms80, ms120, ms160,
  ms200, ms240, ms280, ms320 }

T-311 ::= ENUMERATED {
  ms250, ms500, ms750, ms1000,
  ms1250, ms1500, ms1750, ms2000 }

-- The value 0 for T-312 is not used in this version of the specification
T-312 ::= INTEGER (0..15)

T-313 ::= INTEGER (0..15)

T-314 ::= ENUMERATED {
  s0, s2, s4, s6, s8,
  s12, s16, s20 }

```



```

T-315 ::=
    ENUMERATED {
        s0, s10, s30, s60, s180,
        s600, s1200, s1800 }

T-316 ::=
    ENUMERATED {
        s0, s10, s20, s30, s40,
        s50, s-inf, spare }

-- All the values are changed to "infinity" in Rel-5
T-317 ::=
    ENUMERATED {
        infinity0, infinity1, infinity2, infinity3, infinity4,
        infinity5, infinity6, infinity7}

T-318 ::=
    ENUMERATED {
        ms250, ms500, ms750, ms1000, ms1250, ms1500,
        ms1750, ms2000, ms3000, ms4000, ms6000, ms8000,
        ms10000, ms12000, ms16000 }

T-319 ::=
    ENUMERATED {
        ms80, ms160, ms320, ms640, ms1280, ms2560, ms5120 }

T-CPCH ::=
    ENUMERATED {
        ct0, ct1 }

TMSI-and-LAI-GSM-MAP ::=
    tmsi
    lai
    }

TMSI-DS-41 ::=
    OCTET STRING (SIZE (2..17))

TotalRLC-AM-BufferSize ::=
    ENUMERATED {
        dummy, kb10, kb50, kb100,
        kb150, kb500, kb1000, spare }

TotalRLC-AM-BufferSize-r5-ext ::=
    ENUMERATED {
        kb200, kb300, kb400, kb750 }

-- Actual value TransmissionProbability = IE value * 0.125
TransmissionProbability ::=
    INTEGER (1..8)

TransportChannelCapability ::=
    dl-TransChCapability
    ul-TransChCapability
    }

TurboSupport ::=
    notSupported
    supported
    }

-- Values defined as spare shall not be sent in this version of the protocol. If a spare value is
-- received, it should be interpreted as 'default-RxTX-separation'.
TxRxFrequencySeparation ::=
    ENUMERATED {
        default-TxRx-separation, spare2, spare1 }

U-RNTI ::=
    src-Identity
    s-RNTI
    }

U-RNTI-Group ::=
    -- TABULAR: not following the tabular strictly, but this will most likely save bits
    all
    u-RNTI-BitMaskIndex-b1
    u-RNTI-BitMaskIndex-b2
    u-RNTI-BitMaskIndex-b3
    u-RNTI-BitMaskIndex-b4
    u-RNTI-BitMaskIndex-b5
    u-RNTI-BitMaskIndex-b6
    u-RNTI-BitMaskIndex-b7
    u-RNTI-BitMaskIndex-b8
    u-RNTI-BitMaskIndex-b9
    u-RNTI-BitMaskIndex-b10
    u-RNTI-BitMaskIndex-b11
    u-RNTI-BitMaskIndex-b12
    u-RNTI-BitMaskIndex-b13

```

```

u-RNTI-BitMaskIndex-b14          BIT STRING (SIZE (18)),
u-RNTI-BitMaskIndex-b15          BIT STRING (SIZE (17)),
u-RNTI-BitMaskIndex-b16          BIT STRING (SIZE (16)),
u-RNTI-BitMaskIndex-b17          BIT STRING (SIZE (15)),
u-RNTI-BitMaskIndex-b18          BIT STRING (SIZE (14)),
u-RNTI-BitMaskIndex-b19          BIT STRING (SIZE (13)),
u-RNTI-BitMaskIndex-b20          BIT STRING (SIZE (12)),
u-RNTI-BitMaskIndex-b21          BIT STRING (SIZE (11)),
u-RNTI-BitMaskIndex-b22          BIT STRING (SIZE (10)),
u-RNTI-BitMaskIndex-b23          BIT STRING (SIZE (9)),
u-RNTI-BitMaskIndex-b24          BIT STRING (SIZE (8)),
u-RNTI-BitMaskIndex-b25          BIT STRING (SIZE (7)),
u-RNTI-BitMaskIndex-b26          BIT STRING (SIZE (6)),
u-RNTI-BitMaskIndex-b27          BIT STRING (SIZE (5)),
u-RNTI-BitMaskIndex-b28          BIT STRING (SIZE (4)),
u-RNTI-BitMaskIndex-b29          BIT STRING (SIZE (3)),
u-RNTI-BitMaskIndex-b30          BIT STRING (SIZE (2)),
u-RNTI-BitMaskIndex-b31          BIT STRING (SIZE (1))
}

U-RNTI-Short ::= SEQUENCE {
    srnc-Identity          SRNC-Identity,
    s-RNTI-2              S-RNTI-2
}

UE-CapabilityContainer-IEs ::= SEQUENCE {
-- Container for transparent transfer of capability information not related to
-- features for which early implementation is desired
    ue-RadioAccessCapability-v690ext    UE-RadioAccessCapability-v690ext,
    ue-RATSpecificCapability-v690ext    InterRAT-UE-RadioAccessCapability-v690ext OPTIONAL,
    v6b0NonCriticalExtensions          SEQUENCE {
        ue-RadioAccessCapability-v6b0ext    UE-RadioAccessCapability-v6b0ext-IEs,
        v6e0NonCriticalExtensions          SEQUENCE {
            ue-RadioAccessCapability-v6e0ext    UE-RadioAccessCapability-v6e0ext-IEs,
            v770NonCriticalExtensions          SEQUENCE {
                ue-RadioAccessCapability-v770ext    UE-RadioAccessCapability-v770ext-IEs,
                v790nonCriticalExtensions          SEQUENCE {
                    ue-RadioAccessCapability-v790ext    UE-RadioAccessCapability-v790ext-IEs,
                    nonCriticalExtensions          SEQUENCE {} OPTIONAL
                } OPTIONAL
            } OPTIONAL
        } OPTIONAL
    } OPTIONAL
}

UE-RadioAccessCapability-v6b0ext-IEs ::= SEQUENCE {
-- User equipment IEs
    supportForSIB11bis          ENUMERATED { true } OPTIONAL
}

UE-RadioAccessCapability-v6e0ext-IEs ::= SEQUENCE {
-- User equipment IEs
    supportForFDPCH          ENUMERATED { true } OPTIONAL
}

UE-RadioAccessCapability-v770ext-IEs ::= SEQUENCE {
-- User equipment IEs
    pdcp-Capability          PDCP-Capability-v770ext OPTIONAL,
    rlc-Capability          RLC-Capability-v770ext,
    rf-Capability          RF-Capability-v770ext OPTIONAL,
    physicalChannelCapability    PhysicalChannelCapability-v770ext,
    multiModeRAT-Capability    MultiModeRAT-Capability-v770ext,
    ue-PositioningCapability    UE-PositioningCapability-v770ext,
    mac-ehsSupport          ENUMERATED { true } OPTIONAL,
    ue-specificCapabilityInformation    UE-SpecificCapabilityInformation-LCRTDD OPTIONAL
}

UE-RadioAccessCapability-v790ext-IEs ::= SEQUENCE {
-- User equipment IEs
    supportForEDPCCHPowerBoosting    ENUMERATED { true } OPTIONAL
}

UE-ConnTimersAndConstants ::= SEQUENCE {
-- Optional is used also for parameters for which the default value is the last one read in SIB1
-- t-301 and n-301 should not be used by the UE in this version of the specification
    t-301          T-301          DEFAULT ms2000,
    n-301          N-301          DEFAULT 2,
    t-302          T-302          DEFAULT ms4000,

```

```

n-302          N-302          DEFAULT 3,
t-304          T-304          DEFAULT ms2000,
n-304          N-304          DEFAULT 2,
t-305          T-305          DEFAULT m30,
t-307          T-307          DEFAULT s30,
t-308          T-308          DEFAULT ms160,
t-309          T-309          DEFAULT 5,
t-310          T-310          DEFAULT ms160,
n-310          N-310          DEFAULT 4,
t-311          T-311          DEFAULT ms2000,
t-312          T-312          DEFAULT 1,
-- n-312 shall be ignored if n-312 in UE-ConnTimersAndConstants-v3a0ext is present, and the
-- value of that element shall be used instead.
n-312          N-312          DEFAULT s1,
t-313          T-313          DEFAULT 3,
n-313          N-313          DEFAULT s20,
t-314          T-314          DEFAULT s12,
t-315          T-315          DEFAULT s180,
-- n-315 shall be ignored if n-315 in UE-ConnTimersAndConstants-v3a0ext is present, and the
-- value of that element shall be used instead.
n-315          N-315          DEFAULT s1,
t-316          T-316          DEFAULT s30,
t-317          T-317          DEFAULT infinity4
}

UE-ConnTimersAndConstants-v3a0ext ::= SEQUENCE {
    n-312          N-312ext          OPTIONAL,
    n-315          N-315ext          OPTIONAL
}

UE-ConnTimersAndConstants-r5 ::= SEQUENCE {
-- Optional is used also for parameters for which the default value is the last one read in SIB1
-- t-301 and n-301 should not be used by the UE in this version of the specification
    t-301          T-301          DEFAULT ms2000,
    n-301          N-301          DEFAULT 2,
    t-302          T-302          DEFAULT ms4000,
    n-302          N-302          DEFAULT 3,
    t-304          T-304          DEFAULT ms2000,
    n-304          N-304          DEFAULT 2,
    t-305          T-305          DEFAULT m30,
    t-307          T-307          DEFAULT s30,
    t-308          T-308          DEFAULT ms160,
    t-309          T-309          DEFAULT 5,
    t-310          T-310          DEFAULT ms160,
    n-310          N-310          DEFAULT 4,
    t-311          T-311          DEFAULT ms2000,
    t-312          T-312          DEFAULT 1,
    n-312          N-312-r5        DEFAULT s1,
    t-313          T-313          DEFAULT 3,
    n-313          N-313          DEFAULT s20,
    t-314          T-314          DEFAULT s12,
    t-315          T-315          DEFAULT s180,
    n-315          N-315-r5        DEFAULT s1,
    t-316          T-316          DEFAULT s30,
    t-317          T-317          DEFAULT infinity4
}

UE-GANSSPositioning-Capability ::= SEQUENCE {
    networkAssistedGANSS-supportedList NetworkAssistedGANSS-Supported-List OPTIONAL
}

UE-IdleTimersAndConstants ::= SEQUENCE {
    t-300          T-300,
    n-300          N-300,
    t-312          T-312,
    -- n-312 shall be ignored if n-312 in UE-IdleTimersAndConstants-v3a0ext is present, and the
    -- value of that element shall be used instead.
    n-312          N-312
}

UE-HSPA-Identities-r6 ::= SEQUENCE {
    new-H-RNTI          H-RNTI          OPTIONAL,
    newPrimary-E-RNTI   E-RNTI          OPTIONAL,
    newSecondary-E-RNTI E-RNTI          OPTIONAL
}

UE-IdleTimersAndConstants-v3a0ext ::= SEQUENCE {
    n-312          N-312ext          OPTIONAL
}

```

```

}

UE-MultiModeRAT-Capability ::= SEQUENCE {
    multiRAT-CapabilityList    MultiRAT-Capability,
    multiModeCapability        MultiModeCapability
}

UE-PowerClass ::= INTEGER (1..4)

UE-PowerClassExt ::= ENUMERATED {class1, class2, class3, class4,
    spare4, spare3, spare2, spare1 }

UE-RadioAccessCapability ::= SEQUENCE {
    -- UE-RadioAccessCapability is compatible with R99, although accessStratumReleaseIndicator
    -- is removed from this IE, since its encoding did not result in bits. The
    -- accessStratumReleaseIndicator is provided in the relevant REL-4 extension IEs.
    pdcp-Capability            PDCP-Capability,
    rlc-Capability             RLC-Capability,
    transportChannelCapability TransportChannelCapability,
    rf-Capability              RF-Capability,
    physicalChannelCapability   PhysicalChannelCapability,
    ue-MultiModeRAT-Capability UE-MultiModeRAT-Capability,
    securityCapability          SecurityCapability,
    ue-positioning-Capability   UE-Positioning-Capability,
    measurementCapability      MeasurementCapability        OPTIONAL
}

UE-RadioAccessCapabilityInfo ::= SEQUENCE {
    ue-RadioAccessCapability    UE-RadioAccessCapability,
    ue-RadioAccessCapability-v370ext UE-RadioAccessCapability-v370ext
}

UE-RadioAccessCapability-v370ext ::= SEQUENCE {
    ue-RadioAccessCapabBandFDDList UE-RadioAccessCapabBandFDDList
}

UE-RadioAccessCapability-v380ext ::= SEQUENCE {
    ue-PositioningCapabilityExt-v380 UE-PositioningCapabilityExt-v380
}

UE-RadioAccessCapability-v3a0ext ::= SEQUENCE {
    ue-PositioningCapabilityExt-v3a0 UE-PositioningCapabilityExt-v3a0
}

UE-RadioAccessCapability-v3g0ext ::= SEQUENCE {
    ue-PositioningCapabilityExt-v3g0 UE-PositioningCapabilityExt-v3g0
}

UE-RadioAccessCapability-v650ext ::= SEQUENCE {
    ue-RadioAccessCapabBandFDDList2 UE-RadioAccessCapabBandFDDList2,
    -- This IE shall be included if the UE also supports Band I-VII
    ue-RadioAccessCapabBandFDDList-ext UE-RadioAccessCapabBandFDDList-ext    OPTIONAL
}

UE-RadioAccessCapability-v690ext ::= SEQUENCE {
    physicalchannelcapability-edch PhysicalChannelCapability-edch-r6,
    -- TABULAR: deviceType is MD in tabular description
    -- Default value is 'doesBenefitFromBatteryConsumptionOptimisation'
    deviceType      ENUMERATED { doesNotBenefitFromBatteryConsumptionOptimisation } OPTIONAL
}

UE-RadioAccessCapability-v7e0ext ::= SEQUENCE {
    -- User equipment IEs
    supportForTwoDRXSchemesInPCH      ENUMERATED { true }          OPTIONAL,
    supportEDPDCHPowerInterpolation    ENUMERATED { true }          OPTIONAL
}

UE-RadioAccessCapability-v7f0ext ::= SEQUENCE {
    supportOfTxDivOnNonMIMOChannel      ENUMERATED { true }          OPTIONAL,
    -- IE physicalChannelCapability-LCR and ue-RadioAccessCapabilityComp-TDD128 shall only be
    -- included in InterRATHandoverInfo for 1.28 Mcps TDD, otherwise these IEs are not needed here.
    physicalChannelCapability-LCR        PhysicalChannelCapability-LCR-r4    OPTIONAL,
    ue-RadioAccessCapabilityComp-TDD128 UE-RadioAccessCapabilityComp-TDD128-v7f0ext OPTIONAL
}

UE-RadioAccessCapabilityInfo-v770ext ::= SEQUENCE {
    rf-Capability            RF-Capability-v770ext          OPTIONAL,
    physicalChannelCapability PhysicalChannelCapabilityInfo-v770ext
}

```

```

    ganssSupportIndication          ENUMERATED { true }          OPTIONAL,
    mac-ehsSupport                  ENUMERATED { true }          OPTIONAL,
    ue-SpecificCapabilityInformation UE-SpecificCapabilityInformation-LCRTDD OPTIONAL
}

UE-RadioAccessCapabBandFDDList2 ::= SEQUENCE (SIZE (1..maxFreqBandsFDD)) OF
    UE-RadioAccessCapabBandFDD2

UE-RadioAccessCapabBandFDD2 ::= SEQUENCE {
    radioFrequencyBandFDD2          RadioFrequencyBandFDD2,
    fddRF-Capability                SEQUENCE {
        ue-PowerClass              UE-PowerClassExt,
        txRxFrequencySeparation    TxRxFrequencySeparation
    } OPTIONAL,
    measurementCapability2          MeasurementCapabilityExt2
}

UE-PositioningCapabilityExt-v380 ::= SEQUENCE {
    rx-tx-TimeDifferenceType2Capable BOOLEAN
}

UE-PositioningCapabilityExt-v3a0 ::= SEQUENCE {
    validity-CellPCH-UraPCH        ENUMERATED { true }
}

UE-PositioningCapabilityExt-v3g0 ::= SEQUENCE {
    sfn-sfnType2Capability          ENUMERATED { true }
}

UE-PositioningCapability-v770ext ::= SEQUENCE {
    ue-GANSSPositioning-Capability UE-GANSSPositioning-Capability OPTIONAL
}

UE-RadioAccessCapabBandFDDList ::= SEQUENCE (SIZE (1..maxFreqBandsFDD)) OF
    UE-RadioAccessCapabBandFDD

UE-RadioAccessCapabBandFDDList-ext ::= SEQUENCE (SIZE (1..maxFreqBandsFDD)) OF
    UE-RadioAccessCapabBandFDD-ext

UE-RadioAccessCapabBandFDD ::= SEQUENCE{
    radioFrequencyBandFDD          RadioFrequencyBandFDD,
    fddRF-Capability              SEQUENCE {
        ue-PowerClass              UE-PowerClassExt,
        txRxFrequencySeparation    TxRxFrequencySeparation
    } OPTIONAL,
    measurementCapability          MeasurementCapabilityExt
}

UE-RadioAccessCapabBandFDD-ext ::= SEQUENCE {
    radioFrequencyBandFDD          RadioFrequencyBandFDD,
    compressedModeMeasCapabFDDList-ext CompressedModeMeasCapabFDDList-ext
}

UE-RadioAccessCapability-v4b0ext ::= SEQUENCE {
    pdcp-Capability-r4-ext        PDCP-Capability-r4-ext,
    tdd-CapabilityExt            SEQUENCE {
        rf-Capability              RF-Capability-r4-ext,
        physicalChannelCapability-LCR PhysicalChannelCapability-LCR-r4,
        measurementCapability-r4-ext MeasurementCapability-r4-ext
    } OPTIONAL,
    -- IE " AccessStratumReleaseIndicator" is not needed in RRC CONNECTION SETUP COMPLETE
    accessStratumReleaseIndicator AccessStratumReleaseIndicator OPTIONAL
}

UE-RadioAccessCapabilityComp ::= SEQUENCE {
    totalAM-RLCMemoryExceeds10kB BOOLEAN,
    rf-CapabilityComp            RF-CapabilityComp
}

UE-RadioAccessCapabilityComp-ext ::= SEQUENCE {
    rf-CapabilityFDDComp          RF-CapabBandListFDDComp-ext
}

UE-RadioAccessCapabilityComp-TDD128-v7f0ext ::= SEQUENCE {
    hSDSCH-physical-layer-category HSDSCH-physical-layer-category OPTIONAL,
    multiCarrier-physical-layer-category
}

```

```

        MultiCarrier-HSDSCH-physical-layer-category          OPTIONAL,
        tdd-edch-PhysicalLayerCategory                       INTEGER (1..6)      OPTIONAL,
        dl-CapabilityWithSimultaneousHS-DSCHConfig          DL-CapabilityWithSimultaneousHS-DSCHConfig OPTIONAL,
        supportForCSVoiceoverHSPA                           ENUMERATED { true } OPTIONAL,
        totalRLC-AM-BufferSize                              TotalRLC-AM-BufferSize-r5-ext OPTIONAL
    }

UE-RadioAccessCapabilityComp-v770ext ::= SEQUENCE {
    rf-CapabilityComp          RF-CapabilityComp-v770ext,
    securityCapabilityIndication    ENUMERATED { true }      OPTIONAL,
    ganssSupportIndication          ENUMERATED { true }      OPTIONAL,
    mac-ehsSupport                 ENUMERATED { true }      OPTIONAL
}

UE-RadioAccessCapabilityComp2 ::= SEQUENCE {
    fddPhysicalChannelCapab-hspdsch-edch SEQUENCE {
        dl-CapabilityWithSimultaneousHS-DSCHConfig          DL-CapabilityWithSimultaneousHS-DSCHConfig OPTIONAL,
        physicalChannelCapabComp-hspdsch-r6                HSDSCH-physical-layer-category,
        physicalChannelCapability-edch-r6                  PhysicalChannelCapability-edch-r6
    }
    OPTIONAL
}

UE-RadioAccessCapabilityComp2-v770ext ::= SEQUENCE {
    hsdSCH-physical-layer-category-ext          HSDSCH-physical-layer-category-ext    OPTIONAL,
    edch-PhysicalLayerCategory-extension        INTEGER (7)                          OPTIONAL,
    hsscchlessHsdSCHOperation                  ENUMERATED { true }                  OPTIONAL,
    enhancedFdpch                              ENUMERATED { true }                  OPTIONAL,
    hsdSCHReception-CellFach                   ENUMERATED { true }                  OPTIONAL,
    hsdSCHReception-CellUraPch                 ENUMERATED { true }                  OPTIONAL,
    discontinuousDpcchTransmission             ENUMERATED { true }                  OPTIONAL,
    slotFormat4                                ENUMERATED { true }                  OPTIONAL,
    pdcp-Capability                            PDCP-Capability-v770ext             OPTIONAL
}

UE-RadioAccessCapabilityComp2-v7f0ext ::= SEQUENCE {
    supportofTxDivOnNonMIMOChannel             ENUMERATED { true }                  OPTIONAL
}

RF-CapabilityComp ::= SEQUENCE {
    fdd CHOICE {
        notSupported          NULL,
        supported              RF-CapabBandListFDDComp
    },
    tdd384-RF-Capability CHOICE {
        notSupported          NULL,
        supported              RadioFrequencyBandTDDList
    },
    tdd128-RF-Capability CHOICE {
        notSupported          NULL,
        supported              RadioFrequencyBandTDDList
    }
}

RF-CapabilityComp-v770ext ::= SEQUENCE {
    -- If support of TDD384 and/or TDD128 RF capability is indicated in IEs 'RF-CapabilityComp',
    -- the corresponding IE 'RadioFrequencyBandTDDList-r7' shall be included in this IE.
    tdd384-RF-Capability          RadioFrequencyBandTDDList-r7          OPTIONAL,
    tdd768-RF-Capability CHOICE {
        notSupported          NULL,
        supported              RadioFrequencyBandTDDList-r7
    },
    tdd128-RF-Capability          RadioFrequencyBandTDDList-r7          OPTIONAL
}

-- NOTE: This IE defines the supported TX/RX frequency separation for the respective supported
-- frequency band. Values defined as spare shall not be sent in this version of the protocol.
-- If a spare value is received, it should be interpreted as 'default-RxTX-sparation'.
RF-CapabBandFDDComp ::= ENUMERATED { notSupported,
    default-TxRx-separation, spare2, spare1 }

RF-CapabBandListFDDComp ::= SEQUENCE (SIZE (1..maxFreqBandsFDD)) OF
    -- The first entry corresponds with the first value of IE RadioFrequencyBandFDD,
    -- fdd2100, and so on. No more than seven entries should be included in this IE. The
    -- 8'th entry, if present, shall be ignored.
    -- An extension of this IE may be provided using the IE 'RF-CapabBandListFDDComp-ext'.
    RF-CapabBandFDDComp

```

```

RF-CapabBandListFDDComp-ext ::= SEQUENCE (SIZE (1..maxFreqBandsFDD-ext)) OF
-- The first entry corresponds with the first value of IE RadioFrequencyBandFDD2,
-- bandVIII, and so on.
RF-CapabBandFDDComp

UE-RadioAccessCapability-v590ext ::= SEQUENCE {
dl-CapabilityWithSimultaneousHS-DSCHConfig DL-CapabilityWithSimultaneousHS-DSCHConfig
OPTIONAL,
pdcp-Capability-r5-ext PDCP-Capability-r5-ext,
rlc-Capability-r5-ext RLC-Capability-r5-ext,
physicalChannelCapability PhysicalChannelCapability-hspdsch-r5,
multiModerAT-Capability-v590ext MultiModerAT-Capability-v590ext
}

UE-RadioAccessCapability-v5c0ext ::= SEQUENCE {
pdcp-Capability-r5-ext2 PDCP-Capability-r5-ext2
}

UE-RadioAccessCapability-v680ext ::= SEQUENCE {
multiModerAT-Capability-v680ext MultiModerAT-Capability-v680ext
}

UL-PhysChCapabilityFDD ::= SEQUENCE {
maxNoDPDCH-BitsTransmitted MaxNoDPDCH-BitsTransmitted,
-- dummy is not used in this version of the specification and
-- it should be ignored by the receiver.
dummy BOOLEAN
}

UL-PhysChCapabilityFDD-r6 ::= SEQUENCE {
maxNoDPDCH-BitsTransmitted MaxNoDPDCH-BitsTransmitted,
physicalchannelcapability-edch PhysicalChannelCapability-edch-r6
}

UL-PhysChCapabilityFDD-v770ext ::= SEQUENCE {
edch-PhysicalLayerCategory-extension INTEGER (7) OPTIONAL,
discontinuousDpcchTransmission ENUMERATED { true } OPTIONAL,
slotFormat4 ENUMERATED { true } OPTIONAL
}

UL-PhysChCapabilityTDD ::= SEQUENCE {
maxTS-PerFrame MaxTS-PerFrame,
maxPhysChPerTimeslot MaxPhysChPerTimeslot,
minimumSF MinimumSF-UL,
supportOfPUSCH BOOLEAN
}

UL-PhysChCapabilityTDD-384-v770ext ::= SEQUENCE {
tdd384-edch CHOICE {
supported SEQUENCE {
tdd-edch-PhysicalLayerCategory INTEGER (1..16)
},
unsupported NULL
}
}

UL-PhysChCapabilityTDD-LCR-r4 ::= SEQUENCE {
maxTS-PerSubFrame MaxTS-PerSubFrame-r4,
maxPhysChPerTimeslot MaxPhysChPerTimeslot,
minimumSF MinimumSF-UL,
supportOfPUSCH BOOLEAN,
supportOf8PSK BOOLEAN
}

UL-PhysChCapabilityTDD-128-v770ext ::= SEQUENCE {
maxPhysChPerTimeslot MaxPhysChPerTimeslot-LCR-r7,
tdd128-edch CHOICE {
supported SEQUENCE {
tdd-edch-PhysicalLayerCategory INTEGER (1..6)
},
unsupported NULL
}
}

UL-PhysChCapabilityInfoTDD-128-v770ext ::= SEQUENCE {
maxPhysChPerTimeslot MaxPhysChPerTimeslot-LCR-r7
}

```

```

UL-PhysChCapabilityTDD-768 ::= SEQUENCE {
    maxTS-PerFrame           MaxTS-PerFrame,
    maxPhysChPerTimeslot    MaxPhysChPerTimeslot,
    minimumSF                MinimumSF-UL,
    supportOfPUSCH          BOOLEAN,
    tdd384-edch              CHOICE {
        supported            SEQUENCE {
            tdd-edch-PhysicalLayerCategory    INTEGER (1..16)
        },
        unsupported          NULL
    }
}

PhysicalChannelCapability-edch-r6 ::= SEQUENCE {
    fdd-edch                 CHOICE {
        supported            SEQUENCE {
            edch-PhysicalLayerCategory        INTEGER (1..16)
        },
        unsupported          NULL
    }
}

UL-TransChCapability ::= SEQUENCE {
    maxNoBitsTransmitted    MaxNoBits,
    maxConvCodeBitsTransmitted    MaxNoBits,
    turboEncodingSupport    TurboSupport,
    maxSimultaneousTransChs    MaxSimultaneousTransChsUL,
    modeSpecificInfo        CHOICE {
        fdd                  NULL,
        tdd                  SEQUENCE {
            maxSimultaneousCCTrCH-Count    MaxSimultaneousCCTrCH-Count
        }
    },
    maxTransmittedBlocks    MaxTransportBlocksUL,
    maxNumberOfTFC          MaxNumberOfTFC-UL,
    maxNumberOfTF           MaxNumberOfTF
}

UE-Positioning-Capability ::= SEQUENCE {
    standaloneLocMethodsSupported    BOOLEAN,
    ue-BasedOTDOA-Supported          BOOLEAN,
    networkAssistedGPS-Supported     NetworkAssistedGPS-Supported,
    supportForUE-GPS-TimingOfCellFrames    BOOLEAN,
    supportForIPDL                   BOOLEAN
}

UE-SecurityInformation ::= SEQUENCE {
    start-CS                      START-Value
}

UE-SecurityInformation2 ::= SEQUENCE {
    start-PS                      START-Value
}

UE-SpecificCapabilityInformation-LCRTDD ::= ENUMERATED {
    nF,
    nFMc-TriRx-UniTx,
    nFMc-TriRx-TriTx,
    nFMc-HexRx-UniTx,
    nFMc-HexRx-TriTx,
    nFMc-HexRx-HexTx,
    spare10,
    spare9,
    spare8,
    spare7,
    spare6,
    spare5,
    spare4,
    spare3,
    spare2,
    spare1
}

URA-UpdateCause ::= ENUMERATED {
    changeOfURA,
    periodicURAUpdate,
    dummy,
    spare1
}

```



```

UTRAN-DRX-CycleLengthCoefficient ::= INTEGER (3..9)

UTRAN-DRX-CycleLengthCoefficient-r7 ::= SEQUENCE {
    drx-CycleLengthCoefficient      INTEGER (3..9),
    drx-CycleLengthCoefficient2     INTEGER (3..9)
}
OPTIONAL,
OPTIONAL

WaitTime ::=
    INTEGER (0..15)

Pre-RedirectionInfo ::=
    SEQUENCE {
        supportEUTRA-FDD           BOOLEAN,
        supportEUTRA-TDD           BOOLEAN
    }

-- *****
--
--     RADIO BEARER INFORMATION ELEMENTS (10.3.4)
--
-- *****

AlgorithmSpecificInfo ::=
    CHOICE {
        rfc2507-Info               RFC2507-Info
    }

AlgorithmSpecificInfo-r4 ::=
    CHOICE {
        rfc2507-Info               RFC2507-Info,
        rfc3095-Info               RFC3095-Info-r4
    }

CID-InclusionInfo-r4 ::=
    ENUMERATED {
        pdcp-Header,
        rfc3095-PacketFormat }

CommonRBMappingInfo ::=
    SEQUENCE {
        logicalChannelIdentity     LogicalChannelIdentity,
        mac-ehs-QueueId            MAC-ehs-QueueId
    }

-- Upper limit of COUNT-C is 2^32 - 1
COUNT-C ::=
    INTEGER (0..4294967295)

-- Upper limit of COUNT-C-MSB is 2^25 - 1
COUNT-C-MSB ::=
    INTEGER (0..33554431)

CS-HSPA-Information ::=
    SEQUENCE {
        ul-AMR-Rate                UL-AMR-Rate
        maxCS-Delay                 MaxCS-Delay
    }
OPTIONAL,

DefaultConfigIdentity ::=
    INTEGER (0..10)

DefaultConfigIdentity-r4 ::=
    INTEGER (0..12)

DefaultConfigIdentity-r5 ::=
    INTEGER (0..13)

-- DefaultConfigIdentity-r6 values 23..31 are spare and shall not be used in this version of
-- the protocol
DefaultConfigIdentity-r6 ::=
    INTEGER (0..31)

DefaultConfigMode ::=
    ENUMERATED {
        fdd,
        tdd }

DDI ::=
    INTEGER (0..62)

DL-AM-RLC-Mode ::=
    SEQUENCE {
        inSequenceDelivery          BOOLEAN,
        receivingWindowSize         ReceivingWindowSize,
        dl-RLC-StatusInfo           DL-RLC-StatusInfo
    }

DL-AM-RLC-Mode-r5 ::=
    SEQUENCE {
        dl-RLC-PDU-size             OctetModeRLC-SizeInfoType1,
        inSequenceDelivery          BOOLEAN,
        receivingWindowSize         ReceivingWindowSize,
        dl-RLC-StatusInfo           DL-RLC-StatusInfo
    }

```

```

}
DL-AM-RLC-Mode-r7 ::= SEQUENCE {
    dl-RLC-PDU-size CHOICE {
        fixedSize OctetModeRLC-SizeInfoType1,
        flexibleSize ENUMERATED { size7, size15 }
    },
    inSequenceDelivery BOOLEAN,
    receivingWindowSize ReceivingWindowSize,
    dl-RLC-StatusInfo DL-RLC-StatusInfo
}
DL-CounterSynchronisationInfo ::= SEQUENCE {
    rB-WithPDCP-InfoList RB-WithPDCP-InfoList OPTIONAL
}
DL-CounterSynchronisationInfo-r5 ::= SEQUENCE {
    rb-WithPDCP-InfoList RB-WithPDCP-InfoList OPTIONAL,
    rb-PDCPContextRelocationList RB-PDCPContextRelocationList OPTIONAL
}
DL-LogicalChannelMapping ::= SEQUENCE {
    -- TABULAR: DL-TransportChannelType contains TransportChannelIdentity as well.
    dl-TransportChannelType DL-TransportChannelType,
    logicalChannelIdentity LogicalChannelIdentity OPTIONAL
}
DL-LogicalChannelMapping-r5 ::= SEQUENCE {
    -- TABULAR: DL-TransportChannelType contains TransportChannelIdentity as well.
    dl-TransportChannelType DL-TransportChannelType-r5,
    logicalChannelIdentity LogicalChannelIdentity OPTIONAL
}
DL-LogicalChannelMapping-r7 ::= SEQUENCE {
    -- TABULAR: DL-TransportChannelType contains TransportChannelIdentity as well.
    dl-TransportChannelType DL-TransportChannelType-r7,
    logicalChannelIdentity LogicalChannelIdentity OPTIONAL
}
DL-LogicalChannelMappingList ::= SEQUENCE (SIZE (1..maxLoCHperRLC)) OF
    DL-LogicalChannelMapping
DL-LogicalChannelMappingList-r5 ::= SEQUENCE (SIZE (1..maxLoCHperRLC)) OF
    DL-LogicalChannelMapping-r5
DL-LogicalChannelMappingList-r7 ::= SEQUENCE (SIZE (1..maxLoCHperRLC)) OF
    DL-LogicalChannelMapping-r7
DL-Reception-Window-Size-r6 ::= ENUMERATED { size32, size48, size64, size80, size96, size112 }
DL-RFC3095-r4 ::= SEQUENCE {
    -- dummy is not used in this version of the specification and shall be ignored by the receiver.
    dummy CID-InclusionInfo-r4,
    max-CID INTEGER (1..16383) DEFAULT 15,
    reverseDecompressionDepth INTEGER (0..65535) DEFAULT 0
}
DL-RLC-Mode ::= CHOICE {
    dl-AM-RLC-Mode DL-AM-RLC-Mode,
    dl-UM-RLC-Mode NULL,
    dl-TM-RLC-Mode DL-TM-RLC-Mode
}
DL-RLC-Mode-r5 ::= CHOICE {
    dl-AM-RLC-Mode DL-AM-RLC-Mode-r5,
    dl-UM-RLC-Mode DL-UM-RLC-Mode-r5,
    dl-TM-RLC-Mode DL-TM-RLC-Mode
}
DL-RLC-Mode-r6 ::= CHOICE {
    dl-AM-RLC-Mode DL-AM-RLC-Mode-r5,
    dl-UM-RLC-Mode DL-UM-RLC-Mode-r6,
    dl-TM-RLC-Mode DL-TM-RLC-Mode
}
DL-RLC-Mode-r7 ::= CHOICE {
    dl-AM-RLC-Mode DL-AM-RLC-Mode-r7,
    dl-UM-RLC-Mode DL-UM-RLC-Mode-r6,
}

```

```

    dl-TM-RLC-Mode                DL-TM-RLC-Mode
}

DL-RLC-StatusInfo ::=
    timerStatusProhibit            TimerStatusProhibit                OPTIONAL,
    -- dummy is not used in this version of the specification, it should not be sent
    -- and if received they should be ignored.
    dummy                          TimerEPC                          OPTIONAL,
    missingPDU-Indicator            BOOLEAN,
    timerStatusPeriodic            TimerStatusPeriodic                OPTIONAL
}

DL-TM-RLC-Mode ::=
    segmentationIndication        BOOLEAN
}

DL-TransportChannelType ::=
    CHOICE {
        dch                        TransportChannelIdentity,
        fach                       NULL,
        -- The choice "dsch" should not be used in FDD mode, and if received
        -- the UE behaviour is unspecified.
        dsch                       TransportChannelIdentity,
        -- The choice "dch-and-dsch" should not be used in FDD mode, and if received the UE
        -- behaviour is unspecified
        dch-and-dsch               TransportChannelIdentityDCHandDSCH
    }

DL-TransportChannelType-r5 ::=
    CHOICE {
        dch                        TransportChannelIdentity,
        fach                       NULL,
        -- The choice "dsch" should not be used in FDD mode, and if received
        -- the UE behaviour is unspecified.
        dsch                       TransportChannelIdentity,
        -- The choice "dch-and-dsch" should not be used in FDD mode, and if received the UE
        -- behaviour is unspecified
        dch-and-dsch               TransportChannelIdentityDCHandDSCH,
        hsdSCH                     MAC-d-FlowIdentity,
        dch-and-hsdSCH             MAC-d-FlowIdentityDCHandHSDSCH
    }

DL-TransportChannelType-r7 ::=
    CHOICE {
        dch                        TransportChannelIdentity,
        fach                       NULL,
        -- The choice "dsch" should not be used in FDD mode, and if received
        -- the UE behaviour is unspecified.
        dsch                       TransportChannelIdentity,
        -- The choice "dch-and-dsch" should not be used in FDD mode, and if received the UE
        -- behaviour is unspecified
        dch-and-dsch               TransportChannelIdentityDCHandDSCH,
        hsdSCH                     CHOICE {
            mac-hs                 MAC-d-FlowIdentity,
            mac-ehs                 MAC-ehs-QueueId
        },
        dch-and-hsdSCH             CHOICE {
            mac-hs                 MAC-d-FlowIdentityDCHandHSDSCH,
            mac-ehs                 MAC-ehs-QueueIdDCHandHSDSCH
        }
    }

DL-UM-RLC-LI-size ::=
    ENUMERATED {
        size7, size15 }

DL-UM-RLC-Mode-r5 ::=
    dl-UM-RLC-LI-size            DL-UM-RLC-LI-size
}

DL-UM-RLC-Mode-r6 ::=
    dl-UM-RLC-LI-size            DL-UM-RLC-LI-size,
    dl-Reception-Window-Size     DL-Reception-Window-Size-r6        OPTIONAL
}

ExpectReordering ::=
    ENUMERATED {
        reorderingNotExpected,
        reorderingExpected }

ExplicitDiscard ::=
    timerMRW                     TimerMRW,
    timerDiscard                 TimerDiscard,

```

```

    maxMRW                               MaxMRW
}

HeaderCompressionInfo ::=                SEQUENCE {
    algorithmSpecificInfo                 AlgorithmSpecificInfo
}

HeaderCompressionInfoList ::=            SEQUENCE (SIZE (1..maxPDCPALgoType)) OF
    HeaderCompressionInfo

HeaderCompressionInfo-r4 ::=             SEQUENCE {
    algorithmSpecificInfo-r4              AlgorithmSpecificInfo-r4
}

HeaderCompressionInfoList-r4 ::=         SEQUENCE (SIZE (1..maxPDCPALgoType)) OF
    HeaderCompressionInfo-r4

LogicalChannelIdentity ::=               INTEGER (1..15)

LosslessSRNS-RelocSupport ::=            CHOICE {
    supported                             MaxPDCP-SN-WindowSize,
    notSupported                           NULL
}

MAC-d-HFN-initial-value ::=              BIT STRING (SIZE (24))

MAC-LogicalChannelPriority ::=             INTEGER (1..8)

MaxCS-Delay ::=                          INTEGER (0..18)

MaxDAT ::=                                ENUMERATED {
    dat1, dat2, dat3, dat4, dat5, dat6,
    dat7, dat8, dat9, dat10, dat15, dat20,
    dat25, dat30, dat35, dat40 }

MaxDAT-Retransmissions ::=                SEQUENCE {
    maxDAT                                 MaxDAT,
    timerMRW                               TimerMRW,
    maxMRW                                 MaxMRW
}

MaxMRW ::=                                ENUMERATED {
    mm1, mm4, mm6, mm8, mm12, mm16,
    mm24, mm32 }

MaxPDCP-SN-WindowSize ::=                 ENUMERATED {
    sn255, sn65535 }

MaxRST ::=                                ENUMERATED {
    rst1, rst4, rst6, rst8, rst12,
    rst16, rst24, rst32 }

NoExplicitDiscard ::=                     ENUMERATED {
    dt10, dt20, dt30, dt40, dt50,
    dt60, dt70, dt80, dt90, dt100 }

PDCP-Info ::=                             SEQUENCE {
    losslessSRNS-RelocSupport              LosslessSRNS-RelocSupport          OPTIONAL,
    -- TABULAR: pdcP-PDU-Header is MD in the tabular format and it can be encoded
    -- in one bit, so the OPTIONAL is removed for compactness.
    pdcP-PDU-Header                       PDCP-PDU-Header,
    headerCompressionInfoList              HeaderCompressionInfoList          OPTIONAL
}

PDCP-Info-r4 ::=                           SEQUENCE {
    losslessSRNS-RelocSupport              LosslessSRNS-RelocSupport          OPTIONAL,
    -- TABULAR: pdcP-PDU-Header is MD in the tabular format and it can be encoded
    -- in one bit, so the OPTIONAL is removed for compactness.
    pdcP-PDU-Header                       PDCP-PDU-Header,
    headerCompressionInfoList              HeaderCompressionInfoList-r4      OPTIONAL
}

PDCP-InfoReconfig ::=                      SEQUENCE {
    pdcP-Info                             PDCP-Info,
    -- dummy is not used in this version of the specification and
    -- it should be ignored.
    dummy                                  INTEGER (0..65535)
}

```

```

PDCP-InfoReconfig-r4 ::= SEQUENCE {
    pdcP-Info PDCP-Info-r4
}

PDCP-PDU-Header ::= ENUMERATED {
    present, absent }

PDCP-ROHC-TargetMode ::= ENUMERATED { o-Mode, r-Mode }

PDCP-SN-Info ::= INTEGER (0..65535)

Poll-PDU ::= ENUMERATED {
    pdu1, pdu2, pdu4, pdu8, pdu16,
    pdu32, pdu64, pdu128 }

Poll-SDU ::= ENUMERATED {
    sdu1, sdu4, sdu16, sdu64 }

PollingInfo ::= SEQUENCE {
    timerPollProhibit TimerPollProhibit OPTIONAL,
    timerPoll TimerPoll OPTIONAL,
    poll-PDU Poll-PDU OPTIONAL,
    poll-SDU Poll-SDU OPTIONAL,
    lastTransmissionPDU-Poll BOOLEAN,
    lastRetransmissionPDU-Poll BOOLEAN,
    pollWindow PollWindow OPTIONAL,
    timerPollPeriodic TimerPollPeriodic OPTIONAL
}

PollWindow ::= ENUMERATED {
    pw50, pw60, pw70, pw80, pw85,
    pw90, pw95, pw99 }

PredefinedConfigIdentity ::= INTEGER (0..15)

PredefinedConfigValueTag ::= INTEGER (0..15)

PredefinedRB-Configuration ::= SEQUENCE {
    re-EstablishmentTimer Re-EstablishmentTimer,
    srb-InformationList SRB-InformationSetupList,
    rb-InformationList RB-InformationSetupList
}

PreDefRadioConfiguration ::= SEQUENCE {
    -- Radio bearer IEs
    predefinedRB-Configuration PredefinedRB-Configuration,
    -- Transport channel IEs
    preDefTransChConfiguration PreDefTransChConfiguration,
    -- Physical channel IEs
    preDefPhyChConfiguration PreDefPhyChConfiguration
}

PreDefRadioConfiguration-v770ext ::= SEQUENCE {
    -- Physical channel IEs
    preDefPhyChConfiguration PreDefPhyChConfiguration-v770ext
}

PredefinedConfigStatusList ::= SEQUENCE (SIZE (maxPredefConfig)) OF
    PredefinedConfigStatusInfo

PredefinedConfigStatusInfo ::= CHOICE {
    storedWithValueTagSameAsPrevious NULL,
    other CHOICE {
        notStored NULL,
        storedWithDifferentValueTag PredefinedConfigValueTag
    }
}

PredefinedConfigStatusListComp ::= SEQUENCE {
    setsWithDifferentValueTag PredefinedConfigSetsWithDifferentValueTag,
    otherEntries PredefinedConfigStatusListVarSz OPTIONAL
}

PredefinedConfigSetsWithDifferentValueTag ::= SEQUENCE (SIZE (1..2)) OF
    PredefinedConfigSetWithDifferentValueTag

PredefinedConfigSetWithDifferentValueTag ::= SEQUENCE {

```

```

startPosition                INTEGER (0..10)    DEFAULT 0,
-- numberOfEntries           INTEGER (6..16),
-- numberOfEntries is covered by the size of the list in IE PredefinedConfigValueTagList
valueTagList                 PredefinedConfigValueTagList
}

PredefinedConfigValueTagList ::= SEQUENCE (SIZE (1..maxPredefConfig)) OF
    PredefinedConfigValueTag

PredefinedConfigStatusListVarSz ::= SEQUENCE (SIZE (1..maxPredefConfig)) OF
    PredefinedConfigStatusInfo

RAB-Info ::= SEQUENCE {
    rab-Identity                RAB-Identity,
    cn-DomainIdentity          CN-DomainIdentity,
    nas-Synchronisation-Indicator NAS-Synchronisation-Indicator OPTIONAL,
    re-EstablishmentTimer     Re-EstablishmentTimer
}

RAB-Info-r6-ext ::= SEQUENCE {
    mbms-SessionIdentity       MBMS-SessionIdentity OPTIONAL
}

RAB-Info-v6b0ext ::= SEQUENCE {
    mbms-ServiceIdentity       OCTET STRING (SIZE (3))
}

RAB-Info-r6 ::= SEQUENCE {
    rab-Identity                RAB-Identity,
    mbms-SessionIdentity       MBMS-SessionIdentity OPTIONAL,
    cn-DomainIdentity          CN-DomainIdentity,
    nas-Synchronisation-Indicator NAS-Synchronisation-Indicator OPTIONAL,
    re-EstablishmentTimer     Re-EstablishmentTimer
}

RAB-Info-r7 ::= SEQUENCE {
    rab-Identity                RAB-Identity,
    mbms-SessionIdentity       MBMS-SessionIdentity OPTIONAL,
    mbms-ServiceIdentity       OCTET STRING (SIZE (3)) OPTIONAL,
    cn-DomainIdentity          CN-DomainIdentity,
    nas-Synchronisation-Indicator NAS-Synchronisation-Indicator OPTIONAL,
    re-EstablishmentTimer     Re-EstablishmentTimer
}

RAB-InformationList ::= SEQUENCE (SIZE (1..maxRABsetup)) OF
    RAB-Info

RAB-InformationList-r6 ::= SEQUENCE (SIZE (1..maxRABsetup)) OF
    RAB-Info-r6

RAB-InformationReconfigList ::= SEQUENCE (SIZE (1..maxRABsetup)) OF
    RAB-InformationReconfig

RAB-InformationReconfig ::= SEQUENCE {
    rab-Identity                RAB-Identity,
    cn-DomainIdentity          CN-DomainIdentity,
    nas-Synchronisation-Indicator NAS-Synchronisation-Indicator
}

RAB-Info-Post ::= SEQUENCE {
    rab-Identity                RAB-Identity,
    cn-DomainIdentity          CN-DomainIdentity,
    nas-Synchronisation-Indicator NAS-Synchronisation-Indicator OPTIONAL
}

RAB-InformationMBMSPTp ::= SEQUENCE {
    rb-Identity                RB-Identity,
    mbms-ServiceIdentity       OCTET STRING (SIZE (3)),
    mbms-SessionIdentity       MBMS-SessionIdentity OPTIONAL
}

RAB-InformationMBMSPTpList ::= SEQUENCE (SIZE (1..maxMBMSservSelect)) OF
    RAB-InformationMBMSPTp

RAB-InformationSetup ::= SEQUENCE {
    rab-Info                    RAB-Info,
    rb-InformationSetupList     RB-InformationSetupList
}

```

```

}
RAB-InformationSetup-r4 ::= SEQUENCE {
    rab-Info
    rb-InformationSetupList
}
RAB-InformationSetup-r5 ::= SEQUENCE {
    rab-Info
    rb-InformationSetupList
}
RAB-InformationSetup-r6-ext ::= SEQUENCE {
    rab-Info-r6-ext
}
RAB-InformationSetup-r6 ::= SEQUENCE {
    rab-Info
    rb-InformationSetupList
}
RAB-InformationSetup-v6b0ext ::= SEQUENCE {
    rab-Info-v6b0ext
} OPTIONAL
RAB-InformationSetup-r7 ::= SEQUENCE {
    rab-Info
    rb-InformationSetupList
}
RAB-InformationSetup-v820ext ::= SEQUENCE {
    cs-HSPA-Information
} OPTIONAL
RAB-InformationSetupList ::= SEQUENCE (SIZE (1..maxRABsetup)) OF
    RAB-InformationSetup
RAB-InformationSetupList-r4 ::= SEQUENCE (SIZE (1..maxRABsetup)) OF
    RAB-InformationSetup-r4
RAB-InformationSetupList-r5 ::= SEQUENCE (SIZE (1..maxRABsetup)) OF
    RAB-InformationSetup-r5
RAB-InformationSetupList-r6 ::= SEQUENCE (SIZE (1..maxRABsetup)) OF
    RAB-InformationSetup-r6
-- The IE 'RAB-InformationSetupList-r6-ext' provides elements of extension information, which
-- are added to the corresponding elements of the IE 'RAB-InformationSetupList/-r4/-r5'.
RAB-InformationSetupList-r6-ext ::= SEQUENCE (SIZE (1..maxRABsetup)) OF
    RAB-InformationSetup-r6-ext
RAB-InformationSetupList-v6b0ext ::= SEQUENCE (SIZE (1..maxRABsetup)) OF
    RAB-InformationSetup-v6b0ext
RAB-InformationSetupList-r7 ::= SEQUENCE (SIZE (1..maxRABsetup)) OF
    RAB-InformationSetup-r7
RAB-InformationSetupList-v820ext ::= SEQUENCE (SIZE (1..maxRABsetup)) OF
    RAB-InformationSetup-v820ext
RB-ActivationTimeInfo ::= SEQUENCE {
    rb-Identity
    rlc-SequenceNumber
}
RB-ActivationTimeInfoList ::= SEQUENCE (SIZE (1..maxRB)) OF
    RB-ActivationTimeInfo
RB-COUNT-C-Information ::= SEQUENCE {
    rb-Identity
    count-C-UL
    count-C-DL
}
RB-COUNT-C-InformationList ::= SEQUENCE (SIZE (1..maxRBallRABs)) OF
    RB-COUNT-C-Information
RB-COUNT-C-MSB-Information ::= SEQUENCE {

```

```

    rb-Identity                RB-Identity,
    count-C-MSB-UL             COUNT-C-MSB,
    count-C-MSB-DL             COUNT-C-MSB
}

RB-COUNT-C-MSB-InformationList ::= SEQUENCE (SIZE (1..maxRBallRABs)) OF
    RB-COUNT-C-MSB-Information

RB-Identity ::= INTEGER (1..32)

RB-IdentityList ::= SEQUENCE (SIZE (1..maxRB)) OF
    RB-Identity

RB-InformationAffected ::= SEQUENCE {
    rb-Identity                RB-Identity,
    rb-MappingInfo             RB-MappingInfo
}

RB-InformationAffected-r5 ::= SEQUENCE {
    rb-Identity                RB-Identity,
    rb-MappingInfo             RB-MappingInfo-r5
}

RB-InformationAffected-r6 ::= SEQUENCE {
    rb-Identity                RB-Identity,
    rb-MappingInfo             RB-MappingInfo-r6
}

RB-InformationAffected-r7 ::= SEQUENCE {
    rb-Identity                RB-Identity,
    rb-MappingInfo             RB-MappingInfo-r7
}

RB-InformationAffectedList ::= SEQUENCE (SIZE (1..maxRB)) OF
    RB-InformationAffected

RB-InformationAffectedList-r5 ::= SEQUENCE (SIZE (1..maxRB)) OF
    RB-InformationAffected-r5

RB-InformationAffectedList-r6 ::= SEQUENCE (SIZE (1..maxRB)) OF
    RB-InformationAffected-r6

RB-InformationAffectedList-r7 ::= SEQUENCE (SIZE (1..maxRB)) OF
    RB-InformationAffected-r7

RB-InformationChanged-r6 ::= SEQUENCE {
    rb-Identity                RB-Identity,
    rb-Change                   CHOICE {
        release                 NULL,
        re-mapToDefaultRb       RB-Identity
    }
}

RB-InformationChangedList-r6 ::= SEQUENCE (SIZE (1..maxRB)) OF
    RB-InformationChanged-r6

RB-InformationReconfig ::= SEQUENCE {
    rb-Identity                RB-Identity,
    pdcp-Info                   PDCP-InfoReconfig                OPTIONAL,
    pdcp-SN-Info                 PDCP-SN-Info                OPTIONAL,
    rlc-Info                       RLC-Info                OPTIONAL,
    rb-MappingInfo                 RB-MappingInfo                OPTIONAL,
    rb-StopContinue                 RB-StopContinue                OPTIONAL
}

RB-InformationReconfig-r4 ::= SEQUENCE {
    rb-Identity                RB-Identity,
    pdcp-Info                   PDCP-InfoReconfig-r4                OPTIONAL,
    pdcp-SN-Info                 PDCP-SN-Info                OPTIONAL,
    rlc-Info                       RLC-Info                OPTIONAL,
    rb-MappingInfo                 RB-MappingInfo                OPTIONAL,
    rb-StopContinue                 RB-StopContinue                OPTIONAL
}

RB-InformationReconfig-r5 ::= SEQUENCE {
    rb-Identity                RB-Identity,
    pdcp-Info                   PDCP-InfoReconfig-r4                OPTIONAL,
    pdcp-SN-Info                 PDCP-SN-Info                OPTIONAL,

```

rlc-Info	RLC-Info-r5	OPTIONAL,
rb-MappingInfo	RB-MappingInfo-r5	OPTIONAL,
rb-StopContinue	RB-StopContinue	OPTIONAL
}		
RB-InformationReconfig-r6 ::=	SEQUENCE {	
rb-Identity	RB-Identity,	
pdcp-Info	PDCP-InfoReconfig-r4	OPTIONAL,
pdcp-SN-Info	PDCP-SN-Info	OPTIONAL,
rlc-Info	RLC-Info-r6	OPTIONAL,
rb-MappingInfo	RB-MappingInfo-r6	OPTIONAL,
rb-StopContinue	RB-StopContinue	OPTIONAL
}		
RB-InformationReconfig-r7 ::=	SEQUENCE {	
rb-Identity	RB-Identity,	
pdcp-Info	PDCP-InfoReconfig-r4	OPTIONAL,
pdcp-SN-Info	PDCP-SN-Info	OPTIONAL,
rlc-Info	RLC-Info-r7	OPTIONAL,
rb-MappingInfo	RB-MappingInfo-r7	OPTIONAL,
rb-StopContinue	RB-StopContinue	OPTIONAL
}		
RB-InformationReconfigList ::=	SEQUENCE (SIZE (1..maxRB)) OF	
	RB-InformationReconfig	
RB-InformationReconfigList-r4 ::=	SEQUENCE (SIZE (1..maxRB)) OF	
	RB-InformationReconfig-r4	
RB-InformationReconfigList-r5 ::=	SEQUENCE (SIZE (1..maxRB)) OF	
	RB-InformationReconfig-r5	
RB-InformationReconfigList-r6 ::=	SEQUENCE (SIZE (1..maxRB)) OF	
	RB-InformationReconfig-r6	
RB-InformationReconfigList-r7 ::=	SEQUENCE (SIZE (1..maxRB)) OF	
	RB-InformationReconfig-r7	
RB-InformationReleaseList ::=	SEQUENCE (SIZE (1..maxRB)) OF	
	RB-Identity	
RB-InformationSetup ::=	SEQUENCE {	
rb-Identity	RB-Identity,	
pdcp-Info	PDCP-Info	OPTIONAL,
rlc-InfoChoice	RLC-InfoChoice,	
rb-MappingInfo	RB-MappingInfo	
}		
RB-InformationSetup-r4 ::=	SEQUENCE {	
rb-Identity	RB-Identity,	
pdcp-Info	PDCP-Info-r4	OPTIONAL,
rlc-InfoChoice	RLC-InfoChoice,	
rb-MappingInfo	RB-MappingInfo	
}		
RB-InformationSetup-r5 ::=	SEQUENCE {	
rb-Identity	RB-Identity,	
pdcp-Info	PDCP-Info-r4	OPTIONAL,
rlc-InfoChoice	RLC-InfoChoice-r5,	
rb-MappingInfo	RB-MappingInfo-r5	
}		
RB-InformationSetup-r6 ::=	SEQUENCE {	
rb-Identity	RB-Identity,	
pdcp-Info	PDCP-Info-r4	OPTIONAL,
rlc-InfoChoice	RLC-InfoChoice-r6,	
rb-MappingInfo	RB-MappingInfo-r6	
}		
RB-InformationSetup-r7 ::=	SEQUENCE {	
rb-Identity	RB-Identity,	
pdcp-Info	PDCP-Info-r4	OPTIONAL,
rlc-InfoChoice	RLC-InfoChoice-r7,	
rb-MappingInfo	RB-MappingInfo-r7	
}		
RB-InformationSetupList ::=	SEQUENCE (SIZE (1..maxRBperRAB)) OF	
	RB-InformationSetup	

```

RB-InformationSetupList-r4 ::= SEQUENCE (SIZE (1..maxRBperRAB)) OF
                                RB-InformationSetup-r4

RB-InformationSetupList-r5 ::= SEQUENCE (SIZE (1..maxRBperRAB)) OF
                                RB-InformationSetup-r5

RB-InformationSetupList-r6 ::= SEQUENCE (SIZE (1..maxRBperRAB)) OF
                                RB-InformationSetup-r6

RB-InformationSetupList-r7 ::= SEQUENCE (SIZE (1..maxRBperRAB)) OF
                                RB-InformationSetup-r7

RB-MappingInfo ::= SEQUENCE (SIZE (1..maxRBMuxOptions)) OF
                    RB-MappingOption

RB-MappingInfo-r5 ::= SEQUENCE (SIZE (1..maxRBMuxOptions)) OF
                       RB-MappingOption-r5

RB-MappingInfo-r6 ::= SEQUENCE (SIZE (1..maxRBMuxOptions)) OF
                       RB-MappingOption-r6

RB-MappingInfo-r7 ::= SEQUENCE (SIZE (1..maxRBMuxOptions)) OF
                       RB-MappingOption-r7

RB-MappingOption ::= SEQUENCE {
    ul-LogicalChannelMappings          UL-LogicalChannelMappings          OPTIONAL,
    dl-LogicalChannelMappingList      DL-LogicalChannelMappingList      OPTIONAL
}

RB-MappingOption-r5 ::= SEQUENCE {
    ul-LogicalChannelMappings          UL-LogicalChannelMappings          OPTIONAL,
    dl-LogicalChannelMappingList-r5    DL-LogicalChannelMappingList-r5    OPTIONAL
}

RB-MappingOption-r6 ::= SEQUENCE {
    ul-LogicalChannelMappings-r6      UL-LogicalChannelMappings-r6      OPTIONAL,
    dl-LogicalChannelMappingList-r5    DL-LogicalChannelMappingList-r5    OPTIONAL
}

RB-MappingOption-r7 ::= SEQUENCE {
    ul-LogicalChannelMappings-r6      UL-LogicalChannelMappings-r6      OPTIONAL,
    dl-LogicalChannelMappingList-r7    DL-LogicalChannelMappingList-r7    OPTIONAL
}

RB-PDCPContextRelocation ::= SEQUENCE {
    rb-Identity                        RB-Identity,
    dl-RFC3095-Context-Relocation      BOOLEAN,
    ul-RFC3095-Context-Relocation      BOOLEAN
}

RB-PDCPContextRelocationList ::= SEQUENCE (SIZE (1..maxRBallRABs)) OF
                                   RB-PDCPContextRelocation

RB-StopContinue ::= ENUMERATED {
    stopRB, continueRB }

RB-WithPDCP-Info ::= SEQUENCE {
    rb-Identity                        RB-Identity,
    pdcp-SN-Info                       PDCP-SN-Info
}

RB-WithPDCP-InfoList ::= SEQUENCE (SIZE (1..maxRBallRABs)) OF
                           RB-WithPDCP-Info

ReceivingWindowSize ::= ENUMERATED {
    rw1, rw8, rw16, rw32, rw64, rw128, rw256,
    rw512, rw768, rw1024, rw1536, rw2047,
    rw2560, rw3072, rw3584, rw4095 }

RFC2507-Info ::= SEQUENCE {
    f-MAX-PERIOD                       INTEGER (1..65535)                DEFAULT 256,
    f-MAX-TIME                          INTEGER (1..255)                  DEFAULT 5,
    max-HEADER                          INTEGER (60..65535)             DEFAULT 168,
    tcp-SPACE                           INTEGER (3..255)                DEFAULT 15,
    non-TCP-SPACE                       INTEGER (3..65535)             DEFAULT 15,
    -- TABULAR: expectReordering has only two possible values, so using Optional or Default
    -- would be wasteful
}

```

expectReordering	ExpectReordering	
}		
RFC3095-Info-r4 ::=	SEQUENCE {	
rohProfileList	ROHC-ProfileList-r4,	OPTIONAL,
ul-RFC3095	UL-RFC3095-r4	OPTIONAL,
dl-RFC3095	DL-RFC3095-r4	OPTIONAL
}		
RLC-Info ::=	SEQUENCE {	
ul-RLC-Mode	UL-RLC-Mode	OPTIONAL,
dl-RLC-Mode	DL-RLC-Mode	OPTIONAL
}		
RLC-Info-r5 ::=	SEQUENCE {	
ul-RLC-Mode	UL-RLC-Mode	OPTIONAL,
dl-RLC-Mode	DL-RLC-Mode-r5	OPTIONAL,
rlc-OneSidedReEst	BOOLEAN	
}		
RLC-Info-r6 ::=	SEQUENCE {	
ul-RLC-Mode	UL-RLC-Mode	OPTIONAL,
dl-RLC-Mode	DL-RLC-Mode-r6	OPTIONAL,
rlc-OneSidedReEst	BOOLEAN,	
altE-bitInterpretation	ENUMERATED { true }	OPTIONAL
}		
RLC-Info-r7 ::=	SEQUENCE {	
ul-RLC-Mode	UL-RLC-Mode	OPTIONAL,
dl-RLC-Mode	DL-RLC-Mode-r7	OPTIONAL,
rlc-OneSidedReEst	BOOLEAN,	
altE-bitInterpretation	ENUMERATED { true }	OPTIONAL,
useSpecialValueOfHEField	ENUMERATED { true }	OPTIONAL
}		
RLC-Info-MCCH-r6 ::=	SEQUENCE {	
dl-UM-RLC-LI-size	DL-UM-RLC-LI-size,	
dl-UM-RLC-OutOSeqDelivery-Info	UM-RLC-OutOSeqDelivery-Info-r6	OPTIONAL
}		
RLC-Info-MSCH-r6 ::=	SEQUENCE {	
dl-UM-RLC-LI-size	DL-UM-RLC-LI-size	
}		
RLC-Info-MTCH-r6 ::=	SEQUENCE {	
dl-UM-RLC-LI-size	DL-UM-RLC-LI-size,	
dl-UM-RLC-DuplAvoid-Reord-Info	UM-RLC-DuplAvoid-Reord-Info-r6	OPTIONAL
}		
RLC-InfoChoice ::=	CHOICE {	
rlc-Info	RLC-Info,	
same-as-RB	RB-Identity	
}		
RLC-InfoChoice-r5 ::=	CHOICE {	
rlc-Info	RLC-Info-r5,	
same-as-RB	RB-Identity	
}		
RLC-InfoChoice-r6 ::=	CHOICE {	
rlc-Info	RLC-Info-r6,	
same-as-RB	RB-Identity	
}		
RLC-InfoChoice-r7 ::=	CHOICE {	
rlc-Info	RLC-Info-r7,	
same-as-RB	RB-Identity	
}		
RLC-PDU-Size ::=	OctetModeRLC-SizeInfoType1	
RLC-PDU-SizeList ::=	SEQUENCE (SIZE (1..maxRLCPDUsizePerLogChan)) OF	
	RLC-PDU-Size	
RLC-SequenceNumber ::=	INTEGER (0..4095)	
RLC-SizeInfo ::=	SEQUENCE {	
rlc-SizeIndex	INTEGER (1..maxTF)	

```

}
RLC-SizeExplicitList ::=          SEQUENCE (SIZE (1..maxTF)) OF
                                   RLC-SizeInfo

ROHC-Profile-r4 ::=              INTEGER (1..3)

ROHC-ProfileList-r4 ::=         SEQUENCE (SIZE (1..maxROHC-Profile-r4)) OF
                                   ROHC-Profile-r4

ROHC-PacketSize-r4 ::=         INTEGER (2..1500)

ROHC-PacketSizeList-r4 ::=     SEQUENCE (SIZE (1..maxROHC-PacketSizes-r4)) OF
                                   ROHC-PacketSize-r4

SRB-InformationSetup ::=        SEQUENCE {
    -- The default value for rb-Identity is the smallest value not used yet.
    rb-Identity                  RB-Identity                      OPTIONAL,
    rlc-InfoChoice               RLC-InfoChoice,
    rb-MappingInfo              RB-MappingInfo
}

SRB-InformationSetup-r5 ::=     SEQUENCE {
    -- The default value for rb-Identity is the smallest value not used yet.
    rb-Identity                  RB-Identity                      OPTIONAL,
    rlc-InfoChoice               RLC-InfoChoice-r5,
    rb-MappingInfo              RB-MappingInfo-r5
}

SRB-InformationSetup-r6 ::=     SEQUENCE {
    -- The default value for rb-Identity is the smallest value not used yet.
    rb-Identity                  RB-Identity                      OPTIONAL,
    rlc-InfoChoice               RLC-InfoChoice-r6,
    rb-MappingInfo              RB-MappingInfo-r6
}

SRB-InformationSetup-r7 ::=     SEQUENCE {
    -- The default value for rb-Identity is the smallest value not used yet.
    rb-Identity                  RB-Identity                      OPTIONAL,
    rlc-InfoChoice               RLC-InfoChoice-r7,
    rb-MappingInfo              RB-MappingInfo-r7
}

SRB-InformationSetupList ::=    SEQUENCE (SIZE (1..maxSRBsetup)) OF
                                   SRB-InformationSetup

SRB-InformationSetupList-r5 ::= SEQUENCE (SIZE (1..maxSRBsetup)) OF
                                   SRB-InformationSetup-r5

SRB-InformationSetupList-r6 ::= SEQUENCE (SIZE (1..maxSRBsetup)) OF
                                   SRB-InformationSetup-r6

SRB-InformationSetupList-r7 ::= SEQUENCE (SIZE (1..maxSRBsetup)) OF
                                   SRB-InformationSetup-r7

SRB-InformationSetupList2 ::=   SEQUENCE (SIZE (3..4)) OF
                                   SRB-InformationSetup

SRB-InformationSetupList2-r6 ::= SEQUENCE (SIZE (3..4)) OF
                                   SRB-InformationSetup-r6

SRB-InformationSetupList2-r7 ::= SEQUENCE (SIZE (3..4)) OF
                                   SRB-InformationSetup-r7

TimerDAR-r6 ::=                ENUMERATED {
    ms40, ms80, ms120, ms160, ms240, ms320, ms480, ms640,
    ms960, ms1280, ms1920, ms2560, ms3840, ms5120 }

TimerDiscard ::=               ENUMERATED {
    td0-1, td0-25, td0-5, td0-75,
    td1, td1-25, td1-5, td1-75,
    td2, td2-5, td3, td3-5, td4,
    td4-5, td5, td7-5 }

TimerEPC ::=                   ENUMERATED {
    te50, te60, te70, te80, te90,
    te100, te120, te140, te160, te180,
    te200, te300, te400, te500, te700,

```

```

        te900 }

TimerMRW ::=
    ENUMERATED {
        te50, te60, te70, te80, te90, te100,
        te120, te140, te160, te180, te200,
        te300, te400, te500, te700, te900 }

TimerOSD-r6 ::=
    ENUMERATED {
        ms40, ms80, ms120, ms160, ms240, ms320, ms480, ms640,
        ms960, ms1280, ms1920, ms2560, ms3840, ms5120 }

TimerPoll ::=
    ENUMERATED {
        tp10, tp20, tp30, tp40, tp50,
        tp60, tp70, tp80, tp90, tp100,
        tp110, tp120, tp130, tp140, tp150,
        tp160, tp170, tp180, tp190, tp200,
        tp210, tp220, tp230, tp240, tp250,
        tp260, tp270, tp280, tp290, tp300,
        tp310, tp320, tp330, tp340, tp350,
        tp360, tp370, tp380, tp390, tp400,
        tp410, tp420, tp430, tp440, tp450,
        tp460, tp470, tp480, tp490, tp500,
        tp510, tp520, tp530, tp540, tp550,
        tp600, tp650, tp700, tp750, tp800,
        tp850, tp900, tp950, tp1000 }

TimerPollPeriodic ::=
    ENUMERATED {
        tper100, tper200, tper300, tper400,
        tper500, tper750, tper1000, tper2000 }

TimerPollProhibit ::=
    ENUMERATED {
        tpp10, tpp20, tpp30, tpp40, tpp50,
        tpp60, tpp70, tpp80, tpp90, tpp100,
        tpp110, tpp120, tpp130, tpp140, tpp150,
        tpp160, tpp170, tpp180, tpp190, tpp200,
        tpp210, tpp220, tpp230, tpp240, tpp250,
        tpp260, tpp270, tpp280, tpp290, tpp300,
        tpp310, tpp320, tpp330, tpp340, tpp350,
        tpp360, tpp370, tpp380, tpp390, tpp400,
        tpp410, tpp420, tpp430, tpp440, tpp450,
        tpp460, tpp470, tpp480, tpp490, tpp500,
        tpp510, tpp520, tpp530, tpp540, tpp550,
        tpp600, tpp650, tpp700, tpp750, tpp800,
        tpp850, tpp900, tpp950, tpp1000 }

TimerRST ::=
    ENUMERATED {
        tr50, tr100, tr150, tr200, tr250, tr300,
        tr350, tr400, tr450, tr500, tr550,
        tr600, tr700, tr800, tr900, tr1000 }

TimerStatusPeriodic ::=
    ENUMERATED {
        tsp100, tsp200, tsp300, tsp400, tsp500,
        tsp750, tsp1000, tsp2000 }

TimerStatusProhibit ::=
    ENUMERATED {
        tsp10, tsp20, tsp30, tsp40, tsp50,
        tsp60, tsp70, tsp80, tsp90, tsp100,
        tsp110, tsp120, tsp130, tsp140, tsp150,
        tsp160, tsp170, tsp180, tsp190, tsp200,
        tsp210, tsp220, tsp230, tsp240, tsp250,
        tsp260, tsp270, tsp280, tsp290, tsp300,
        tsp310, tsp320, tsp330, tsp340, tsp350,
        tsp360, tsp370, tsp380, tsp390, tsp400,
        tsp410, tsp420, tsp430, tsp440, tsp450,
        tsp460, tsp470, tsp480, tsp490, tsp500,
        tsp510, tsp520, tsp530, tsp540, tsp550,
        tsp600, tsp650, tsp700, tsp750, tsp800,
        tsp850, tsp900, tsp950, tsp1000 }

TransmissionRLC-Discard ::=
    timerBasedExplicit
    timerBasedNoExplicit
    maxDAT-Retransmissions
    noDiscard
}

TransmissionWindowSize ::=
    ENUMERATED {
        tw1, tw8, tw16, tw32, tw64, tw128, tw256,

```

```

tw512, tw768, tw1024, tw1536, tw2047,
tw2560, tw3072, tw3584, tw4095 }

UL-AMR-Rate ::= ENUMERATED {
    t0, t1, t2, t3, t4, t5, t6, t7, t8, spare7, spare6, spare5,
    spare4, spare3, spare2, spare1 }

UL-AM-RLC-Mode ::= SEQUENCE {
    transmissionRLC-Discard      TransmissionRLC-Discard,
    transmissionWindowSize      TransmissionWindowSize,
    timerRST                     TimerRST,
    max-RST                      MaxRST,
    pollingInfo                  PollingInfo                                OPTIONAL
}

UL-CounterSynchronisationInfo ::= SEQUENCE {
    rB-WithPDCP-InfoList        RB-WithPDCP-InfoList    OPTIONAL,
    startList                   STARTList
}

UL-LogicalChannelMapping ::= SEQUENCE {
    -- TABULAR: UL-TransportChannelType contains TransportChannelIdentity as well.
    ul-TransportChannelType      UL-TransportChannelType,
    logicalChannelIdentity       LogicalChannelIdentity    OPTIONAL,
    rlc-SizeList                 CHOICE {
        allSizes                 NULL,
        configured               NULL,
        explicitList             RLC-SizeExplicitList
    },
    mac-LogicalChannelPriority    MAC-LogicalChannelPriority
}

UL-LogicalChannelMapping-r6 ::= SEQUENCE {
    ul-TrCH-Type                 CHOICE {
        dch-rach-usch            SEQUENCE {
            -- TABULAR: UL-TransportChannelType contains TransportChannelIdentity as well.
            ul-TransportChannelType  UL-TransportChannelType,
            logicalChannelIdentity    LogicalChannelIdentity    OPTIONAL,
            rlc-SizeList             CHOICE {
                allSizes           NULL,
                configured         NULL,
                explicitList       RLC-SizeExplicitList
            }
        },
        e-dch                    SEQUENCE {
            logicalChannelIdentity    LogicalChannelIdentity,
            e-DCH-MAC-d-FlowIdentity  E-DCH-MAC-d-FlowIdentity,
            ddi                      DDI,
            rlc-PDU-SizeList         RLC-PDU-SizeList,
            includeInSchedulingInfo   BOOLEAN
        }
    },
    mac-LogicalChannelPriority    MAC-LogicalChannelPriority
}

UL-LogicalChannelMappingList ::= SEQUENCE {
    -- rlc-LogicalChannelMappingIndicator shall be set to TRUE in this version
    -- of the specification
    rlc-LogicalChannelMappingIndicator  BOOLEAN,
    ul-LogicalChannelMapping            SEQUENCE (SIZE (maxLoCHperRLC)) OF
                                        UL-LogicalChannelMapping
}

UL-LogicalChannelMappingList-r6 ::= SEQUENCE {
    -- rlc-LogicalChannelMappingIndicator shall be set to TRUE in this version
    -- of the specification
    rlc-LogicalChannelMappingIndicator  BOOLEAN,
    ul-LogicalChannelMapping            SEQUENCE (SIZE (maxLoCHperRLC)) OF
                                        UL-LogicalChannelMapping-r6
}

UL-LogicalChannelMappings ::= CHOICE {
    oneLogicalChannel              UL-LogicalChannelMapping,
    twoLogicalChannels             UL-LogicalChannelMappingList
}

UL-LogicalChannelMappings-r6 ::= CHOICE {
    oneLogicalChannel              UL-LogicalChannelMapping-r6,

```

```

    twoLogicalChannels          UL-LogicalChannelMappingList-r6
  }

UL-RFC3095-r4 ::=
  SEQUENCE {
    -- dummy1 is not used in this version of the specification and shall be ignored by the receiver.
    dummy1                      CID-InclusionInfo-r4,
    max-CID                      INTEGER (1..16383)           DEFAULT 15,
    -- dummy is not used in this version of the specification and
    -- it should be ignored by the receiver.
    dummy                        ROHC-PacketSizeList-r4
  }

UL-RLC-Mode ::=
  CHOICE {
    ul-AM-RLC-Mode              UL-AM-RLC-Mode,
    ul-UM-RLC-Mode              UL-UM-RLC-Mode,
    ul-TM-RLC-Mode              UL-TM-RLC-Mode,
    spare                        NULL
  }

UL-TM-RLC-Mode ::=
  SEQUENCE {
    transmissionRLC-Discard      TransmissionRLC-Discard      OPTIONAL,
    segmentationIndication      BOOLEAN
  }

UL-UM-RLC-Mode ::=
  SEQUENCE {
    transmissionRLC-Discard      TransmissionRLC-Discard      OPTIONAL
  }

UL-TransportChannelType ::=
  CHOICE {
    dch                          TransportChannelIdentity,
    rach                          NULL,
    -- dummy is not used in this version of the specification and
    -- if received the UE behaviour is not specified.
    dummy                          NULL,
    usch                          TransportChannelIdentity
  }

UM-RLC-DuplAvoid-Reord-Info-r6 ::= SEQUENCE {
  timer-DAR                      TimerDAR-r6,
  widowSize-DAR                  WindowSizeDAR-r6
}

UM-RLC-OutOSeqDelivery-Info-r6 ::= SEQUENCE {
  timer-OSD                      TimerOSD-r6           OPTIONAL,
  windowSize-OSD                  WindowSizeOSD-r6
}

WindowSizeDAR-r6 ::=
  ENUMERATED {
    ws4, ws8, ws16, ws32, ws40, ws48,
    ws56, ws64 }

WindowSizeOSD-r6 ::=
  ENUMERATED {
    ws8, ws16, ws32, ws40, ws48,
    ws56, ws64 }

-- *****
--
-- TRANSPORT CHANNEL INFORMATION ELEMENTS (10.3.5)
--
-- *****

AddOrReconfMAC-dFlow ::=
  SEQUENCE {
    mac-hs-AddReconfQueue-List    MAC-hs-AddReconfQueue-List    OPTIONAL,
    mac-hs-DelQueue-List          MAC-hs-DelQueue-List          OPTIONAL
  }

AddOrReconfMAC-ehs-ReordQ ::=
  SEQUENCE {
    mac-ehs-AddReconfQueue-List    MAC-ehs-AddReconfReordQ-List    OPTIONAL,
    -- dummy is not used in this version of the specification, it should
    -- not be sent and if received it should be ignored.
    dummy                          MAC-ehs-DelReordQ-List    OPTIONAL
  }

AllowedTFC-List ::=
  SEQUENCE (SIZE (1..maxTFC)) OF
  TFC-Value

AllowedTFI-List ::=
  SEQUENCE (SIZE (1..maxTF)) OF
  INTEGER (0..31)

```

```

BitModeRLC-SizeInfo ::= CHOICE {
    sizeType1          INTEGER (0..127),
    -- Actual value sizeType2 = (part1 * 8) + 128 + part2
    sizeType2          SEQUENCE {
        part1          INTEGER (0..15),
        part2          INTEGER (1..7)
    },
    -- Actual value sizeType3 = (part1 * 16) + 256 + part2
    sizeType3          SEQUENCE {
        part1          INTEGER (0..47),
        part2          INTEGER (1..15)
    },
    -- Actual value sizeType4 = (part1 * 64) + 1024 + part2
    sizeType4          SEQUENCE {
        part1          INTEGER (0..62),
        part2          INTEGER (1..63)
    }
}

-- Actual value BLER-QualityValue = IE value * 0.1
BLER-QualityValue ::= INTEGER (-63..0)

ChannelCodingType ::= CHOICE {
    -- noCoding is only used for TDD in this version of the specification,
    -- otherwise it should be ignored
    noCoding           NULL,
    convolutional      CodingRate,
    turbo              NULL
}

CodingRate ::= ENUMERATED {
    half,
    third
}

CommonDynamicTF-Info ::= SEQUENCE {
    rlc-Size           CHOICE {
        fdd             SEQUENCE {
            octetModeRLC-SizeInfoType2 OctetModeRLC-SizeInfoType2
        },
        tdd             SEQUENCE {
            commonTDD-Choice           CHOICE {
                bitModeRLC-SizeInfo    BitModeRLC-SizeInfo,
                octetModeRLC-SizeInfoType1 OctetModeRLC-SizeInfoType1
            }
        }
    },
    numberOfTbSizeList SEQUENCE (SIZE (1..maxTF)) OF
        NumberOfTransportBlocks,
    logicalChannelList LogicalChannelList
}

CommonDynamicTF-Info-DynamicTTI ::= SEQUENCE {
    commonTDD-Choice CHOICE {
        bitModeRLC-SizeInfo    BitModeRLC-SizeInfo,
        octetModeRLC-SizeInfoType1 OctetModeRLC-SizeInfoType1
    },
    numberOfTbSizeAndTTIList  NumberOfTbSizeAndTTIList,
    logicalChannelList        LogicalChannelList
}

CommonDynamicTF-InfoList ::= SEQUENCE (SIZE (1..maxTF)) OF
    CommonDynamicTF-Info

CommonDynamicTF-InfoList-DynamicTTI ::= SEQUENCE (SIZE (1..maxTF)) OF
    CommonDynamicTF-Info-DynamicTTI

CommonTransChTFS ::= SEQUENCE {
    tti CHOICE {
        tti10    CommonDynamicTF-InfoList,
        tti20    CommonDynamicTF-InfoList,
        tti40    CommonDynamicTF-InfoList,
        tti80    CommonDynamicTF-InfoList,
        dynamic  CommonDynamicTF-InfoList-DynamicTTI
    },
    semistaticTF-Information SemistaticTF-Information
}

```



```

CommonTransChTFS-LCR ::= SEQUENCE {
  tti CHOICE {
    tti5 CommonDynamicTF-InfoList,
    tti10 CommonDynamicTF-InfoList,
    tti20 CommonDynamicTF-InfoList,
    tti40 CommonDynamicTF-InfoList,
    tti80 CommonDynamicTF-InfoList,
    dynamic CommonDynamicTF-InfoList-DynamicTTI
  },
  semistaticTF-Information SemistaticTF-Information
}

Common-MAC-ehs-ReorderingQueue ::= SEQUENCE {
  mac-ehs-QueueId MAC-ehs-QueueId,
  t1-ReleaseTimer T1-ReleaseTimer,
  reorderingResetTimer Treset-ResetTimer OPTIONAL,
  mac-ehsWindowSize MAC-hs-WindowSize
}

Common-MAC-ehs-ReorderingQueueList ::= SEQUENCE (SIZE (1..maxCommonQueueID)) OF
Common-MAC-ehs-ReorderingQueue

CPCH-SetID ::= INTEGER (1..maxCPCHsets)

CRC-Size ::= ENUMERATED {
  crc0, crc8, crc12, crc16, crc24 }

DedicatedDynamicTF-Info ::= SEQUENCE {
  rlc-Size CHOICE {
    bitMode BitModeRLC-SizeInfo,
    octetModeType1 OctetModeRLC-SizeInfoType1
  },
  numberOfTbSizeList SEQUENCE (SIZE (1..maxTF)) OF
  NumberOfTransportBlocks,
  logicalChannelList LogicalChannelList
}

DedicatedDynamicTF-Info-DynamicTTI ::= SEQUENCE {
  rlc-Size CHOICE {
    bitMode BitModeRLC-SizeInfo,
    octetModeType1 OctetModeRLC-SizeInfoType1
  },
  numberOfTbSizeAndTTIList NumberOfTbSizeAndTTIList,
  logicalChannelList LogicalChannelList
}

DedicatedDynamicTF-InfoList ::= SEQUENCE (SIZE (1..maxTF)) OF
DedicatedDynamicTF-Info

DedicatedDynamicTF-InfoList-DynamicTTI ::= SEQUENCE (SIZE (1..maxTF)) OF
DedicatedDynamicTF-Info-DynamicTTI

DedicatedTransChTFS ::= SEQUENCE {
  tti CHOICE {
    tti10 DedicatedDynamicTF-InfoList,
    tti20 DedicatedDynamicTF-InfoList,
    tti40 DedicatedDynamicTF-InfoList,
    tti80 DedicatedDynamicTF-InfoList,
    dynamic DedicatedDynamicTF-InfoList-DynamicTTI
  },
  semistaticTF-Information SemistaticTF-Information
}

-- The maximum allowed size of DL-AddReconfTransChInfo2List sequence is 16
DL-AddReconfTransChInfo2List ::= SEQUENCE (SIZE (1..maxTrCHpreconf)) OF
DL-AddReconfTransChInformation2

-- The maximum allowed size of DL-AddReconfTransChInfoList sequence is 16
DL-AddReconfTransChInfoList ::= SEQUENCE (SIZE (1..maxTrCHpreconf)) OF
DL-AddReconfTransChInformation

-- The maximum allowed size of DL-AddReconfTransChInfoList-r4 sequence is 16
DL-AddReconfTransChInfoList-r4 ::= SEQUENCE (SIZE (1..maxTrCHpreconf)) OF
DL-AddReconfTransChInformation-r4

-- The maximum allowed size of DL-AddReconfTransChInfoList-r5 sequence is 16
DL-AddReconfTransChInfoList-r5 ::= SEQUENCE (SIZE (1..maxTrCHpreconf)) OF
DL-AddReconfTransChInformation-r5

```

```

-- The maximum allowed size of DL-AddReconfTransChInfoList-r7 sequence is 16
DL-AddReconfTransChInfoList-r7 ::= SEQUENCE (SIZE (1..maxTrCHpreconf)) OF
    DL-AddReconfTransChInformation-r7

-- ASN.1 for IE "Added or Reconfigured DL TrCH information"
-- in case of messages other than: Radio Bearer Release message and
-- Radio Bearer Reconfiguration message
DL-AddReconfTransChInformation ::= SEQUENCE {
    dl-TransportChannelType          DL-TrCH-Type,
    dl-transportChannelIdentity      TransportChannelIdentity,
    tfs-SignallingMode              CHOICE {
        explicit-config             TransportFormatSet,
        sameAsULTrCH               UL-TransportChannelIdentity
    },
    dch-QualityTarget               QualityTarget                OPTIONAL,
    -- dummy is not used in this version of the specification, it should
    -- not be sent and if received it should be ignored.
    dummy                           TM-SignallingInfo          OPTIONAL
}

DL-AddReconfTransChInformation-r4 ::= SEQUENCE {
    dl-TransportChannelType          DL-TrCH-Type,
    dl-transportChannelIdentity      TransportChannelIdentity,
    tfs-SignallingMode              CHOICE {
        explicit-config             TransportFormatSet,
        sameAsULTrCH               UL-TransportChannelIdentity
    },
    dch-QualityTarget               QualityTarget                OPTIONAL
}

DL-AddReconfTransChInformation-r5 ::= SEQUENCE {
    dl-TransportChannelType          DL-TrCH-TypeId1-r5,
    tfs-SignallingMode              CHOICE {
        explicit-config             TransportFormatSet,
        sameAsULTrCH               UL-TransportChannelIdentity,
        hsdSCH                      HSDSCH-Info
    },
    dch-QualityTarget               QualityTarget                OPTIONAL
}

DL-AddReconfTransChInformation-r7 ::= SEQUENCE {
    dl-TransportChannelType          DL-TrCH-TypeId1-r5,
    tfs-SignallingMode              CHOICE {
        explicit-config             TransportFormatSet,
        sameAsULTrCH               UL-TransportChannelIdentity,
        hsdSCH                      HSDSCH-Info-r7
    },
    dch-QualityTarget               QualityTarget                OPTIONAL
}

-- ASN.1 for IE "Added or Reconfigured DL TrCH information"
-- in case of Radio Bearer Release message and
-- Radio Bearer Reconfiguration message
DL-AddReconfTransChInformation2 ::= SEQUENCE {
    dl-TransportChannelType          DL-TrCH-Type,
    transportChannelIdentity        TransportChannelIdentity,
    tfs-SignallingMode              CHOICE {
        explicit-config             TransportFormatSet,
        sameAsULTrCH               UL-TransportChannelIdentity
    },
    qualityTarget                   QualityTarget                OPTIONAL
}

DL-CommonTransChInfo ::= SEQUENCE {
    sccpch-TFCS                     TFCS                        OPTIONAL,
    -- modeSpecificInfo should be optional. A new version of this IE should be defined
    -- to be used in later versions of messages using this IE
    modeSpecificInfo                 CHOICE {
        fdd                          SEQUENCE {
            dl-Parameters              CHOICE {
                dl-DCH-TFCS            TFCS,
                sameAsUL                NULL
            }
        },
        tdd                          SEQUENCE {
            individualDL-CCTrCH-InfoList IndividualDL-CCTrCH-InfoList
        }
    }
}

```

```

    }
  }
}

DL-CommonTransChInfo-r4 ::= SEQUENCE {
  sccpch-TFCS          TFCS          OPTIONAL,
  modeSpecificInfo    CHOICE {
    fdd                SEQUENCE {
      dl-Parameters   CHOICE {
        dl-DCH-TFCS   SEQUENCE {
          tfcs         TFCS          OPTIONAL
        },
        sameAsUL      NULL          OPTIONAL
      }
    },
    tdd                SEQUENCE {
      individualDL-CCTrCH-InfoList IndividualDL-CCTrCH-InfoList OPTIONAL
    }
  }
} OPTIONAL

DL-DeletedTransChInfoList ::= SEQUENCE (SIZE (1..maxTrCH)) OF
  DL-TransportChannelIdentity

DL-DeletedTransChInfoList-r5 ::= SEQUENCE (SIZE (1..maxTrCH)) OF
  DL-TransportChannelIdentity-r5

DL-DeletedTransChInfoList-r7 ::= SEQUENCE (SIZE (1..maxTrCH)) OF
  DL-TransportChannelIdentity-r7

DL-TransportChannelIdentity ::= SEQUENCE {
  dl-TransportChannelType DL-TrCH-Type,
  dl-TransportChannelIdentity TransportChannelIdentity
}

DL-TransportChannelIdentity-r5 ::= SEQUENCE {
  dl-TransportChannelType DL-TrCH-TypeId2-r5
}

DL-TransportChannelIdentity-r7 ::= SEQUENCE {
  dl-TransportChannelType DL-TrCH-TypeId2-r7
}

-- The choice "dsch" should not be used in FDD mode, and if received the UE behaviour is unspecified
DL-TrCH-Type ::= ENUMERATED {dch, dsch}

DL-TrCH-TypeId1-r5 ::= CHOICE {
  dch          TransportChannelIdentity,
  -- The choice "dsch" should not be used in FDD mode, and if received
  -- the UE behaviour is unspecified.
  dsch        TransportChannelIdentity,
  hsdsch     NULL
}

DL-TrCH-TypeId2-r5 ::= CHOICE {
  dch          TransportChannelIdentity,
  -- The choice "dsch" should not be used in FDD mode, and if received
  -- the UE behaviour is unspecified.
  dsch        TransportChannelIdentity,
  hsdsch     MAC-d-FlowIdentity
}

DL-TrCH-TypeId2-r7 ::= CHOICE {
  dch          TransportChannelIdentity,
  -- The choice "dsch" should not be used in FDD mode, and if received
  -- the UE behaviour is unspecified.
  dsch        TransportChannelIdentity,
  hsdsch     CHOICE {
    mac-hs    MAC-d-FlowIdentity,
    mac-ehs   MAC-ehs-QueueId
  }
}

DRAC-ClassIdentity ::= INTEGER (1..maxDRACclasses)

DRAC-StaticInformation ::= SEQUENCE {
  transmissionTimeValidity TransmissionTimeValidity,

```

```

    timeDurationBeforeRetry          TimeDurationBeforeRetry,
    drac-ClassIdentity                DRAC-ClassIdentity
}

DRAC-StaticInformationList ::=      SEQUENCE (SIZE (1..maxTrCH)) OF
                                     DRAC-StaticInformation

E-DCH-AddReconf-MAC-d-Flow ::=     SEQUENCE {
    mac-d-FlowIdentity               E-DCH-MAC-d-FlowIdentity,
    mac-d-FlowPowerOffset            E-DCH-MAC-d-FlowPowerOffset      OPTIONAL,
    mac-d-FlowMaxRetrans              E-DCH-MAC-d-FlowMaxRetrans        OPTIONAL,
    mac-d-FlowMultiplexingList        E-DCH-MAC-d-FlowMultiplexingList  OPTIONAL,
    transmissionGrantType             CHOICE {
        non-ScheduledTransGrantInfo SEQUENCE {
            maxMAC-e-PDUContents      INTEGER (1..19982),
            ms2-NonSchedTransmGranthARQAlloc BIT STRING (SIZE (8))    OPTIONAL
        },
        scheduledTransmissionGrantInfo NULL
    }
    OPTIONAL
}

E-DCH-AddReconf-MAC-d-Flow-r7 ::= SEQUENCE {
    mac-d-FlowIdentity               E-DCH-MAC-d-FlowIdentity,
    mac-d-FlowPowerOffset            E-DCH-MAC-d-FlowPowerOffset      OPTIONAL,
    mac-d-FlowMaxRetrans              E-DCH-MAC-d-FlowMaxRetrans        OPTIONAL,
    mac-d-FlowRetransTimer            E-DCH-MAC-d-FlowRetransTimer      OPTIONAL,
    mac-d-FlowMultiplexingList        E-DCH-MAC-d-FlowMultiplexingList  OPTIONAL,
    transmissionGrantType             CHOICE {
        non-ScheduledTransGrantInfo SEQUENCE {
            modeSpecificInfo           CHOICE {
                fdd                     SEQUENCE {
                    maxMAC-e-PDUContents      INTEGER (1..19982),
                    ms2-NonSchedTransmGranthARQAlloc BIT STRING (SIZE (8))    OPTIONAL
                },
                tdd                     NULL
            }
        },
        scheduledTransmissionGrantInfo NULL
    }
    OPTIONAL
}

E-DCH-AddReconf-MAC-d-FlowList ::= SEQUENCE (SIZE (1..maxE-DCHMACdFlow)) OF
                                     E-DCH-AddReconf-MAC-d-Flow

E-DCH-AddReconf-MAC-d-FlowList-r7 ::= SEQUENCE (SIZE (1..maxE-DCHMACdFlow)) OF
                                        E-DCH-AddReconf-MAC-d-Flow-r7

E-DCH-MAC-d-FlowIdentity ::=         INTEGER (0..maxE-DCHMACdFlow-1)

E-DCH-MAC-d-FlowMaxRetrans ::=       INTEGER (0..15)

E-DCH-MAC-d-FlowMultiplexingList ::= BIT STRING (SIZE (maxE-DCHMACdFlow))

E-DCH-MAC-d-FlowPowerOffset ::=      INTEGER (0..6)

E-DCH-MAC-d-FlowRetransTimer ::=     ENUMERATED {
    ms10, ms15, ms20, ms25, ms30, ms35, ms40, ms45, ms50,
    ms55, ms60, ms65, ms70, ms75, ms80, ms85, ms90, ms95,
    ms100, ms110, ms120, ms140, ms160, ms200, ms240, ms280,
    ms320, ms400, ms480, ms560 }

E-DCH-TTI ::=                        ENUMERATED { tti2, tti10 }

ExplicitTFCS-Configuration ::=       CHOICE {
    complete                          TFCS-ReconfAdd,
    addition                          TFCS-ReconfAdd,
    removal                           TFCS-RemovalList,
    replacement                        SEQUENCE {
        tfcsRemoval                  TFCS-RemovalList,
        tfcsAdd                      TFCS-ReconfAdd
    }
}

GainFactor ::=                       INTEGER (0..15)

GainFactorInformation ::=             CHOICE {
    signalledGainFactors              SignalledGainFactors,
    computedGainFactors               ReferenceTFC-ID
}

```

```

}

HSDSCH-Info ::=
    harqInfo
    addOrReconfMAC-dFlow
}

SEQUENCE {
    HARQ-Info          OPTIONAL,
    AddOrReconfMAC-dFlow  OPTIONAL
}

HSDSCH-Info-r7 ::=
    harqInfo
    dl-MAC-HeaderType
    mac-hs
    mac-ehs
} OPTIONAL

SEQUENCE {
    HARQ-Info-r7          OPTIONAL,
    CHOICE {
        AddOrReconfMAC-dFlow,
        AddOrReconfMAC-ehs-ReordQ
    }
}

HARQ-Info ::=
    numberOfProcesses
    memoryPartitioning
    implicit
    explicit
}

SEQUENCE {
    INTEGER (1..8),
    CHOICE {
        NULL,
        SEQUENCE (SIZE (1..maxHProcesses)) OF
            HARQMemorySize
    }
}

HARQ-Info-r7 ::=
    numberOfProcesses
    memoryPartitioning
    implicit
    explicit
    memorySize
    additionalMemorySizesForMIMO
}

SEQUENCE {
    ENUMERATED { n1, n2, n3, n4, n5, n6, n7, n8,
        n12, n14, n16 },
    CHOICE {
        NULL,
        SEQUENCE {
            SEQUENCE (SIZE (1..maxHProcesses)) OF
                HARQMemorySize,
            SEQUENCE (SIZE (1..maxHProcesses)) OF
                HARQMemorySize          OPTIONAL
        }
    }
}

HARQMemorySize ::=
    ENUMERATED {
        hms800, hms1600, hms2400, hms3200, hms4000,
        hms4800, hms5600, hms6400, hms7200, hms8000,
        hms8800, hms9600, hms10400, hms11200, hms12000,
        hms12800, hms13600, hms14400, hms15200, hms16000,
        hms17600, hms19200, hms20800, hms22400, hms24000,
        hms25600, hms27200, hms28800, hms30400, hms32000,
        hms36000, hms40000, hms44000, hms48000, hms52000,
        hms56000, hms60000, hms64000, hms68000, hms72000,
        hms76000, hms80000, hms88000, hms96000, hms104000,
        hms112000, hms120000, hms128000, hms136000, hms144000,
        hms152000, hms160000, hms176000, hms192000, hms208000,
        hms224000, hms240000, hms256000, hms272000, hms288000,
        hms304000 }

IndividualDL-CCTrCH-Info ::=
    dl-TFCS-Identity
    tfcs-SignallingMode
    explicit-config
    sameAsUL
}

SEQUENCE {
    TFCS-Identity,
    CHOICE {
        TFCS,
        TFCS-Identity
    }
}

IndividualDL-CCTrCH-InfoList ::=
    SEQUENCE (SIZE (1..maxCCTrCH)) OF
        IndividualDL-CCTrCH-Info

IndividualUL-CCTrCH-Info ::=
    ul-TFCS-Identity
    ul-TFCS
    tfc-Subset
}

SEQUENCE {
    TFCS-Identity,
    TFCS,
    TFC-Subset
}

IndividualUL-CCTrCH-InfoList ::=
    SEQUENCE (SIZE (1..maxCCTrCH)) OF
        IndividualUL-CCTrCH-Info

LogicalChannelByRB ::=
    rb-Identity
    logChOfRb
}

SEQUENCE {
    RB-Identity,
    INTEGER (0..1)          OPTIONAL
}

```

```

LogicalChannelList ::= CHOICE {
    allSizes                NULL,
    configured              NULL,
    explicitList            SEQUENCE (SIZE (1..15)) OF
                           LogicalChannelByRB
}

MAC-d-FlowIdentityDCHandHSDSCH ::= SEQUENCE {
    dch-transport-ch-id    TransportChannelIdentity,
    hsdSCH-mac-d-flow-id  MAC-d-FlowIdentity
}

MAC-d-FlowIdentity ::= INTEGER (0..7)

MAC-d-PDU-SizeInfo-List ::= SEQUENCE (SIZE(1.. maxMAC-d-PDU-sizes)) OF
                             MAC-d-PDUsizeInfo

--MAC-d-Pdu sizes need to be defined
MAC-d-PDUsizeInfo ::= SEQUENCE{
    mac-d-PDU-Size        INTEGER (1..5000),
    mac-d-PDU-Index      INTEGER(0..7)
}

MAC-hs-AddReconfQueue-List ::= SEQUENCE (SIZE(1..maxQueueIDs)) OF
                                MAC-hs-AddReconfQueue

MAC-hs-AddReconfQueue ::= SEQUENCE {
    mac-hsQueueId        INTEGER (0..7),
    mac-dFlowId          MAC-d-FlowIdentity,
    reorderingReleaseTimer T1-ReleaseTimer,
    mac-hsWindowSize     MAC-hs-WindowSize,
    mac-d-PDU-SizeInfo-List MAC-d-PDU-SizeInfo-List OPTIONAL
}

MAC-hs-DelQueue-List ::= SEQUENCE (SIZE(1..maxQueueIDs)) OF
                          MAC-hs-DelQueue

MAC-hs-DelQueue ::= SEQUENCE {
    mac-hsQueueId        INTEGER(0..7)
}

MAC-ehs-AddReconfReordQ-List ::= SEQUENCE (SIZE(1..maxQueueIDs)) OF
                                  MAC-ehs-AddReconfReordQ

MAC-ehs-AddReconfReordQ ::= SEQUENCE {
    mac-ehs-QueueId      MAC-ehs-QueueId,
    reorderingReleaseTimer T1-ReleaseTimer,
    reorderingResetTimer Treset-ResetTimer
    mac-ehsWindowSize     MAC-hs-WindowSize OPTIONAL,
}

MAC-ehs-DelReordQ-List ::= SEQUENCE (SIZE(1..maxQueueIDs)) OF
                            MAC-ehs-DelReordQ

MAC-ehs-DelReordQ ::= SEQUENCE {
    mac-ehs-QueueId      MAC-ehs-QueueId
}

MAC-ehs-QueueIdDCHandHSDSCH ::= SEQUENCE {
    dch-transport-ch-id    TransportChannelIdentity,
    hsdSCH-mac-ehs-QueueId MAC-ehs-QueueId
}

MAC-ehs-QueueId ::= INTEGER (0..7)

MAC-hs-WindowSize ::= ENUMERATED {
    mws4, mws6, mws8, mws12, mws16, mws24, mws32 }

NumberOfTbSizeAndTTIList ::= SEQUENCE (SIZE (1..maxTF)) OF SEQUENCE {
    numberOfTransportBlocks    NumberOfTransportBlocks,
    transmissionTimeInterval    TransmissionTimeInterval
}

MessType ::= ENUMERATED {
    transportFormatCombinationControl }

Non-allowedTFC-List ::= SEQUENCE (SIZE (1..maxTFC)) OF
                        TFC-Value

```

```

NumberOfTransportBlocks ::=          CHOICE {
  zero                               NULL,
  one                                NULL,
  small                              INTEGER (2..17),
  large                              INTEGER (18..512)
}

OctetModeRLC-SizeInfoType1 ::=      CHOICE {
  -- Actual size = (8 * sizeType1) + 16
  sizeType1                          INTEGER (0..31),
  sizeType2                          SEQUENCE {
    -- Actual size = (32 * part1) + 272 + (part2 * 8)
    part1                             INTEGER (0..23),
    part2                             INTEGER (1..3)
  },
  sizeType3                          SEQUENCE {
    -- Actual size = (64 * part1) + 1040 + (part2 * 8)
    part1                             INTEGER (0..61),
    part2                             INTEGER (1..7)
  }
}

OctetModeRLC-SizeInfoType2 ::=      CHOICE {
  -- Actual size = (sizeType1 * 8) + 48
  sizeType1                          INTEGER (0..31),
  -- Actual size = (sizeType2 * 16) + 312
  sizeType2                          INTEGER (0..63),
  -- Actual size = (sizeType3 * 64) + 1384
  sizeType3                          INTEGER (0..56)
}

PowerOffsetInfoShort ::=            SEQUENCE {
  referenceTFC                        TFC-Value,
  modeSpecificInfo                   CHOICE {
    fdd                               SEQUENCE {
      gainFactorBetaC                GainFactor
    },
    tdd                               NULL
  },
  gainFactorBetaD                    GainFactor
}

PowerOffsetInformation ::=           SEQUENCE {
  gainFactorInformation               GainFactorInformation,
  -- PowerOffsetPp-m is always absent in TDD
  powerOffsetPp-m                    PowerOffsetPp-m
}

PowerOffsetPp-m ::=                 INTEGER (-5..10)

PreDefTransChConfiguration ::=      SEQUENCE {
  ul-CommonTransChInfo               UL-CommonTransChInfo,
  ul-AddReconfTrChInfoList           UL-AddReconfTransChInfoList,
  dl-CommonTransChInfo               DL-CommonTransChInfo,
  dl-TrChInfoList                    DL-AddReconfTransChInfoList
}

QualityTarget ::=                   SEQUENCE {
  bler-QualityValue                  BLER-QualityValue
}

RateMatchingAttribute ::=            INTEGER (1..hiRM)

ReferenceTFC-ID ::=                  INTEGER (0..3)

RestrictedTrChInfo ::=               SEQUENCE {
  ul-TransportChannelType             UL-TrCH-Type,
  restrictedTrChIdentity               TransportChannelIdentity,
  allowedTFI-List                     AllowedTFI-List
}

RestrictedTrChInfoList ::=           SEQUENCE (SIZE (1..maxTrCH)) OF
  RestrictedTrChInfo

SemistaticTF-Information ::=         SEQUENCE {
  -- TABULAR: Transmission time interval has been included in the IE CommonTransChTFS.

```

```

channelCodingType           ChannelCodingType,
rateMatchingAttribute       RateMatchingAttribute,
crc-Size                     CRC-Size
}

SignalledGainFactors ::=
  modeSpecificInfo
    fdd
      gainFactorBetaC
    },
    tdd
  },
  gainFactorBetaD
  referenceTFC-ID
}

SplitTFCI-Signalling ::=
  splitType
  tfci-Field2-Length
  tfci-Field1-Information
  tfci-Field2-Information
}

SplitType ::=
  ENUMERATED {
    hardSplit, logicalSplit }

T1-ReleaseTimer ::=
  ENUMERATED {
    rt10, rt20, rt30, rt40, rt50,
    rt60, rt70, rt80, rt90, rt100,
    rt120, rt140, rt160, rt200, rt300,
    rt400 }

TFC-Subset ::=
  minimumAllowedTFC-Number
  allowedTFC-List
  non-allowedTFC-List
  restrictedTrChInfoList
  fullTFCS
}

TFC-SubsetList ::=
  modeSpecificInfo
    fdd
      tfcs-ID
    },
    tdd
  },
  tfcs-Identity
  TFC-Subset
}

TFC-Value ::=
  INTEGER (0..1023)

TFCI-Field2-Information ::=
  tfci-Range
  explicit-config
}

TFCI-Range ::=
  maxTFCIField2Value
  tfcs-InfoForDSCH
}

TFCI-RangeList ::=
  SEQUENCE (SIZE (1..maxPDSCH-TFCIgroups)) OF
  TFCI-Range

TFCS ::=
  normalTFCI-Signalling
  -- dummy is not used in this version of specification, it should
  -- not be sent and if received the UE behaviour is not specified.
  dummy
  SplitTFCI-Signalling
}

TFCS-Identity ::=
  tfcs-ID
  sharedChannelIndicator
}

TFCS-IdentityPlain ::=
  INTEGER (1..8)

```



```

TFCS-InfoForDSCH ::=
    ctfc2bit
    ctfc4bit
    ctfc6bit
    ctfc8bit
    ctfc12bit
    ctfc16bit
    ctfc24bit
}
CHOICE {
    INTEGER (0..3),
    INTEGER (0..15),
    INTEGER (0..63),
    INTEGER (0..255),
    INTEGER (0..4095),
    INTEGER (0..65535),
    INTEGER (0..16777215)
}

TFCS-ReconfAdd ::=
    ctfcSize
        ctfc2Bit
            ctfc2
            powerOffsetInformation
        },
        ctfc4Bit
            ctfc4
            powerOffsetInformation
        },
        ctfc6Bit
            ctfc6
            powerOffsetInformation
        },
        ctfc8Bit
            ctfc8
            powerOffsetInformation
        },
        ctfc12Bit
            ctfc12
            powerOffsetInformation
        },
        ctfc16Bit
            ctfc16
            powerOffsetInformation
        },
        ctfc24Bit
            ctfc24
            powerOffsetInformation
    }
}
SEQUENCE{
    CHOICE{
        SEQUENCE (SIZE (1..maxTFC)) OF SEQUENCE {
            INTEGER (0..3),
            PowerOffsetInformation OPTIONAL
        },
        SEQUENCE (SIZE (1..maxTFC)) OF SEQUENCE {
            INTEGER (0..15),
            PowerOffsetInformation OPTIONAL
        },
        SEQUENCE (SIZE (1..maxTFC)) OF SEQUENCE {
            INTEGER (0..63),
            PowerOffsetInformation OPTIONAL
        },
        SEQUENCE (SIZE (1..maxTFC)) OF SEQUENCE {
            INTEGER (0..255),
            PowerOffsetInformation OPTIONAL
        },
        SEQUENCE (SIZE (1..maxTFC)) OF SEQUENCE {
            INTEGER (0..4095),
            PowerOffsetInformation OPTIONAL
        },
        SEQUENCE (SIZE (1..maxTFC)) OF SEQUENCE {
            INTEGER (0..65535),
            PowerOffsetInformation OPTIONAL
        },
        SEQUENCE (SIZE (1..maxTFC)) OF SEQUENCE {
            INTEGER (0..16777215),
            PowerOffsetInformation OPTIONAL
        }
    }
}

TFCS-Removal ::=
    tfci
}
SEQUENCE {
    INTEGER (0..1023)
}

TFCS-RemovalList ::=
SEQUENCE (SIZE (1..maxTFC)) OF
    TFCS-Removal

TimeDurationBeforeRetry ::=
    INTEGER (1..256)

TM-SignallingInfo ::=
    messType
    tm-SignallingMode
        mode1
        mode2
        -- in ul-controlledTrChList, TrCH-Type is always DCH
        ul-controlledTrChList
    }
}

TransmissionTimeInterval ::=
    ENUMERATED {
        tti10, tti20, tti40, tti80 }

TransmissionTimeValidity ::=
    INTEGER (1..256)

TransportChannelIdentity ::=
    INTEGER (1..32)

TransportChannelIdentityDCHandDSCH ::= SEQUENCE {
    dch-transport-ch-id
    dsch-transport-ch-id
}
TransportChannelIdentity,
TransportChannelIdentity

TransportFormatSet ::=
    CHOICE {

```

```

    dedicatedTransChTFS          DedicatedTransChTFS,
    commonTransChTFS             CommonTransChTFS
}

TransportFormatSet-LCR ::=
    dedicatedTransChTFS          DedicatedTransChTFS,
    commonTransChTFS-LCR        CommonTransChTFS-LCR
}

Treset-ResetTimer ::=
    ENUMERATED {
        rt1, rt2, rt3, rt4 }

-- The maximum allowed size of UL-AddReconfTransChInfoList sequence is 16
UL-AddReconfTransChInfoList ::= SEQUENCE (SIZE (1..maxTrCHpreconf)) OF
    UL-AddReconfTransChInformation

-- The maximum allowed size of UL-AddReconfTransChInfoList-r6 sequence is 32
UL-AddReconfTransChInfoList-r6 ::= SEQUENCE (SIZE (1..maxTrCH)) OF
    UL-AddReconfTransChInformation-r6

-- The maximum allowed size of UL-AddReconfTransChInfoList-r7 sequence is 32
UL-AddReconfTransChInfoList-r7 ::= SEQUENCE (SIZE (1..maxTrCH)) OF
    UL-AddReconfTransChInformation-r7

UL-AddReconfTransChInformation ::= SEQUENCE {
    ul-TransportChannelType      UL-TrCH-Type,
    transportChannelIdentity     TransportChannelIdentity,
    transportFormatSet           TransportFormatSet
}

UL-AddReconfTransChInformation-r6 ::= CHOICE {
    dch-usch                     SEQUENCE {
        ul-TransportChannelType    UL-TrCH-Type,
        transportChannelIdentity   TransportChannelIdentity,
        transportFormatSet         TransportFormatSet
    },
    e-dch                        SEQUENCE {
        tti                        E-DCH-TTI,
        harq-Info                 ENUMERATED { rv0, rvtable },
        addReconf-MAC-d-FlowList  E-DCH-AddReconf-MAC-d-FlowList OPTIONAL
    }
}

UL-AddReconfTransChInformation-r7 ::= CHOICE {
    dch-usch                     SEQUENCE {
        ul-TransportChannelType    UL-TrCH-Type,
        transportChannelIdentity   TransportChannelIdentity,
        transportFormatSet         TransportFormatSet
    },
    e-dch                        SEQUENCE {
        modeSpecific              CHOICE {
            fdd                   SEQUENCE {
                tti               E-DCH-TTI
            },
            tdd                   NULL
        },
        harq-Info                 ENUMERATED { rv0, rvtable },
        addReconf-MAC-d-FlowList  E-DCH-AddReconf-MAC-d-FlowList-r7 OPTIONAL
    }
}

UL-CommonTransChInfo ::= SEQUENCE {
    -- TABULAR: tfc-subset is applicable to FDD only, TDD specifies tfc-subset in individual
    -- CCTrCH Info.
    tfc-Subset                    TFC-Subset                    OPTIONAL,
    prach-TFCS                    TFCS                    OPTIONAL,
    modeSpecificInfo              CHOICE {
        fdd                       SEQUENCE {
            ul-TFCS                TFCS
        },
        tdd                       SEQUENCE {
            individualUL-CCTrCH-InfoList  IndividualUL-CCTrCH-InfoList
                                                OPTIONAL
        }
    }
}

```

```

UL-CommonTransChInfo-r4 ::= SEQUENCE {
  -- TABULAR: tfc-subset is applicable to FDD only, TDD specifies tfc-subset in individual
  -- CCH Info.
  tfc-Subset TFC-Subset OPTIONAL,
  prach-TFCS TFCS OPTIONAL,
  modeSpecificInfo CHOICE {
    fdd SEQUENCE {
      ul-TFCS TFCS
    },
    tdd SEQUENCE {
      individualUL-CCH-InfoList IndividualUL-CCH-InfoList OPTIONAL
    }
  }
  tfc-SubsetList TFC-SubsetList OPTIONAL,
}

-- In UL-ControlledTrChList, TrCH-Type is always DCH
UL-ControlledTrChList ::= SEQUENCE (SIZE (1..maxTrCH)) OF
  TransportChannelIdentity

UL-DeletedTransChInfoList ::= SEQUENCE (SIZE (1..maxTrCH)) OF
  UL-TransportChannelIdentity

UL-DeletedTransChInfoList-r6 ::= SEQUENCE (SIZE (1..maxTrCH)) OF
  UL-TransportChannelIdentity-r6

UL-TransportChannelIdentity ::= SEQUENCE {
  ul-TransportChannelType UL-TrCH-Type,
  ul-TransportChannelIdentity TransportChannelIdentity
}

UL-TransportChannelIdentity-r6 ::= CHOICE {
  dch-usch SEQUENCE {
    ul-TransportChannelType UL-TrCH-Type,
    ul-TransportChannelIdentity TransportChannelIdentity
  },
  e-dch E-DCH-MAC-d-FlowIdentity
}

UL-TrCH-Type ::= ENUMERATED {dch, usch}

USCH-TransportChannelsInfo ::= SEQUENCE (SIZE (1..maxTrCH)) OF
  SEQUENCE {
    usch-TransportChannelIdentity TransportChannelIdentity,
    usch-TFCS TransportFormatSet
  }
-- *****
--
-- PHYSICAL CHANNEL INFORMATION ELEMENTS (10.3.6)
--
-- *****

ACK-NACK-repetitionFactor ::= INTEGER(1..4)

AC-To-ASC-Mapping ::= INTEGER (0..7)

AC-To-ASC-MappingTable ::= SEQUENCE (SIZE (maxASCmap)) OF
  AC-To-ASC-Mapping

AccessServiceClass-FDD ::= SEQUENCE {
  availableSignatureStartIndex INTEGER (0..15),
  availableSignatureEndIndex INTEGER (0..15),

  assignedSubChannelNumber BIT STRING {
    b3(0),
    b2(1),
    b1(2),
    b0(3)
  } (SIZE(4))
}

AccessServiceClass-TDD ::= SEQUENCE {
  channelisationCodeIndices BIT STRING {
    chCodeIndex7(0),
    chCodeIndex6(1),
    chCodeIndex5(2),
    chCodeIndex4(3),
    chCodeIndex3(4),
  }
}

```

```

        chCodeIndex2(5),
        chCodeIndex1(6),
        chCodeIndex0(7)
    } (SIZE(8)) OPTIONAL,
subchannelSize CHOICE {
    size1 NULL,
    size2 SEQUENCE {
        -- subch0 means bitstring '01' in the tabular, subch1 means bitsring '10'
        subchannels ENUMERATED { subch0, subch1 } OPTIONAL
    },
    size4 SEQUENCE {
        subchannels BIT STRING {
            subCh3(0),
            subCh2(1),
            subCh1(2),
            subCh0(3)
        } (SIZE(4)) OPTIONAL
    },
    size8 SEQUENCE {
        subchannels BIT STRING {
            subCh7(0),
            subCh6(1),
            subCh5(2),
            subCh4(3),
            subCh3(4),
            subCh2(5),
            subCh1(6),
            subCh0(7)
        } (SIZE(8)) OPTIONAL
    }
}
}
}

AccessServiceClass-TDD-r7 ::=
channelisationCodeIndices SEQUENCE {
    BIT STRING {
        chCodeIndex15(0),
        chCodeIndex14(1),
        chCodeIndex13(2),
        chCodeIndex12(3),
        chCodeIndex11(4),
        chCodeIndex10(5),
        chCodeIndex9(6),
        chCodeIndex8(7),
        chCodeIndex7(8),
        chCodeIndex6(9),
        chCodeIndex5(10),
        chCodeIndex4(11),
        chCodeIndex3(12),
        chCodeIndex2(13),
        chCodeIndex1(14),
        chCodeIndex0(15)
    } (SIZE(16)) OPTIONAL,
subchannelSize CHOICE {
    size1 NULL,
    size2 SEQUENCE {
        -- subch0 means bitstring '01' in the tabular, subch1 means bitsring '10'
        subchannels ENUMERATED { subch0, subch1 } OPTIONAL
    },
    size4 SEQUENCE {
        subchannels BIT STRING {
            subCh3(0),
            subCh2(1),
            subCh1(2),
            subCh0(3)
        } (SIZE(4)) OPTIONAL
    },
    size8 SEQUENCE {
        subchannels BIT STRING {
            subCh7(0),
            subCh6(1),
            subCh5(2),
            subCh4(3),
            subCh3(4),
            subCh2(5),
            subCh1(6),
            subCh0(7)
        } (SIZE(8)) OPTIONAL
    },
}
}

```

```

size16
  subchannels
    SEQUENCE {
      BIT STRING {
        subCh15 (0),
        subCh14 (1),
        subCh13 (2),
        subCh12 (3),
        subCh11 (4),
        subCh10 (5),
        subCh9 (6),
        subCh8 (7),
        subCh7 (8),
        subCh6 (9),
        subCh5 (10),
        subCh4 (11),
        subCh3 (12),
        subCh2 (13),
        subCh1 (14),
        subCh0 (15)
      } (SIZE(16))
    }
  }
}

AccessServiceClass-TDD-LCR-r4 ::= SEQUENCE {
  availableSYNC-UlCodesIndics
    BIT STRING {
      sulCodeIndex7 (0),
      sulCodeIndex6 (1),
      sulCodeIndex5 (2),
      sulCodeIndex4 (3),
      sulCodeIndex3 (4),
      sulCodeIndex2 (5),
      sulCodeIndex1 (6),
      sulCodeIndex0 (7)
    } (SIZE(8))
    OPTIONAL,
  subchannelSize
    CHOICE {
      size1
        NULL,
      size2
        SEQUENCE {
          -- subch0 means bitstring '01' in the tabular, subch1 means bitsring '10'.
          subchannels
            ENUMERATED { subch0, subch1 } OPTIONAL
        },
      size4
        SEQUENCE {
          subchannels
            BIT STRING {
              subCh3 (0),
              subCh2 (1),
              subCh1 (2),
              subCh0 (3)
            } (SIZE(4))
            OPTIONAL
        },
      size8
        SEQUENCE {
          subchannels
            BIT STRING {
              subCh7 (0),
              subCh6 (1),
              subCh5 (2),
              subCh4 (3),
              subCh3 (4),
              subCh2 (5),
              subCh1 (6),
              subCh0 (7)
            } (SIZE(8))
            OPTIONAL
        }
    }
}

AdditionalPRACH-TF-and-TFCS-CCCH-IEs ::= SEQUENCE {
  powerOffsetInformation
    PowerOffsetInformation,
  dynamicTFInformationCCCH
    DynamicTFInformationCCCH
}

AdditionalPRACH-TF-and-TFCS-CCCH ::= SEQUENCE {
  additionalPRACH-TF-and-TFCS-CCCH-IEs
    AdditionalPRACH-TF-and-TFCS-CCCH-IEs
    OPTIONAL
}

-- The order is the same as in the PRACH-SystemInformationList
AdditionalPRACH-TF-and-TFCS-CCCH-List ::= SEQUENCE (SIZE (1..maxPRACH)) OF
  AdditionalPRACH-TF-and-TFCS-CCCH

AICH-Info ::= SEQUENCE {

```

```

    channelisationCode256          ChannelisationCode256,
    sttd-Indicator                 BOOLEAN,
    aich-TransmissionTiming        AICH-TransmissionTiming
}

AICH-PowerOffset ::=              INTEGER (-22..5)

AICH-TransmissionTiming ::=      ENUMERATED {
    e0, e1 }

AllocationPeriodInfo ::=         SEQUENCE {
    allocationActivationTime       INTEGER (0..255),
    allocationDuration             INTEGER (1..256)
}

-- Actual value Alpha = IE value * 0.125
Alpha ::=                        INTEGER (0..8)

AP-AICH-ChannelisationCode ::=   INTEGER (0..255)

AP-PreambleScramblingCode ::=   INTEGER (0..79)

AP-Signature ::=                 INTEGER (0..15)

AP-Signature-VCAM ::=           SEQUENCE {
    ap-Signature                  AP-Signature,
    availableAP-SubchannelList    AvailableAP-SubchannelList OPTIONAL
}

AP-Subchannel ::=               INTEGER (0..11)

ASCSetting-FDD ::=              SEQUENCE {
    -- TABULAR: accessServiceClass-FDD is MD in tabular description
    -- Default value is previous ASC
    -- If this is the first ASC, the default value is all available signature and sub-channels
    accessServiceClass-FDD        AccessServiceClass-FDD OPTIONAL
}

ASCSetting-TDD ::=              SEQUENCE {
    -- TABULAR: accessServiceClass-TDD is MD in tabular description
    -- Default value is previous ASC
    -- If this is the first ASC, the default value is all available channelisation codes and
    -- all available sub-channels with subchannelSize=size1.
    accessServiceClass-TDD        AccessServiceClass-TDD OPTIONAL
}

ASCSetting-TDD-r7 ::=           SEQUENCE {
    -- TABULAR: accessServiceClass-TDD is MD in tabular description
    -- Default value is previous ASC
    -- If this is the first ASC, the default value is all available channelisation codes and
    -- all available sub-channels with subchannelSize=size1.
    accessServiceClass-TDD        AccessServiceClass-TDD-r7 OPTIONAL
}

ASCSetting-TDD-LCR-r4 ::=       SEQUENCE {
    -- TABULAR: accessServiceClass-TDD-LCR is MD in tabular description
    -- Default value is previous ASC
    -- If this is the first ASC, the default value is all available SYNC_UL codes and
    -- all available sub-channels with subchannelSize=size1.
    accessServiceClass-TDD-LCR    AccessServiceClass-TDD-LCR-r4 OPTIONAL
}

AvailableAP-Signature-VCAMList ::= SEQUENCE (SIZE (1..maxPCPCH-APsig)) OF
    AP-Signature-VCAM

AvailableAP-SignatureList ::=   SEQUENCE (SIZE (1..maxPCPCH-APsig)) OF
    AP-Signature

AvailableAP-SubchannelList ::=  SEQUENCE (SIZE (1..maxPCPCH-APsubCh)) OF
    AP-Subchannel

AvailableMinimumSF-ListVCAM ::= SEQUENCE (SIZE (1..maxPCPCH-SF)) OF
    AvailableMinimumSF-VCAM

AvailableMinimumSF-VCAM ::=     SEQUENCE {
    minimumSpreadingFactor        MinimumSpreadingFactor,
    nf-Max                        NF-Max,
    maxAvailablePCPCH-Number      MaxAvailablePCPCH-Number,
}

```

```

    availableAP-Signature-VCAMList      AvailableAP-Signature-VCAMList
}

AvailableSignatures ::=                BIT STRING {
    signature15 (0),
    signature14 (1),
    signature13 (2),
    signature12 (3),
    signature11 (4),
    signature10 (5),
    signature9 (6),
    signature8 (7),
    signature7 (8),
    signature6 (9),
    signature5 (10),
    signature4 (11),
    signature3 (12),
    signature2 (13),
    signature1 (14),
    signature0 (15)
} (SIZE(16))

AvailableSubChannelNumbers ::=         BIT STRING {
    subCh11 (0),
    subCh10 (1),
    subCh9 (2),
    subCh8 (3),
    subCh7 (4),
    subCh6 (5),
    subCh5 (6),
    subCh4 (7),
    subCh3 (8),
    subCh2 (9),
    subCh1 (10),
    subCh0 (11)
} (SIZE(12))

BEACON-PL-Est ::=                     ENUMERATED { true }

BurstType ::=                          ENUMERATED {
    type1, type2 }

-- Actual value Bler-Target = IE value * 0.05
Bler-Target ::=                        INTEGER (-63..0)

CCTrCH-PowerControlInfo ::=           SEQUENCE {
    tfcs-Identity                       TFCS-Identity                       OPTIONAL,
    ul-DPCH-PowerControlInfo           UL-DPCH-PowerControlInfo
}

CCTrCH-PowerControlInfo-r4 ::=        SEQUENCE {
    tfcs-Identity                       TFCS-Identity                       OPTIONAL,
    ul-DPCH-PowerControlInfo-r4       UL-DPCH-PowerControlInfo-r4
}

CCTrCH-PowerControlInfo-r5 ::=        SEQUENCE {
    tfcs-Identity                       TFCS-Identity                       OPTIONAL,
    ul-DPCH-PowerControlInfo-r5       UL-DPCH-PowerControlInfo-r5
}

CCTrCH-PowerControlInfo-r7 ::=        SEQUENCE {
    tfcs-Identity                       TFCS-Identity                       OPTIONAL,
    ul-DPCH-PowerControlInfo-r7       UL-DPCH-PowerControlInfo-r7
}

CD-AccessSlotSubchannel ::=           INTEGER (0..11)

CD-AccessSlotSubchannelList ::=       SEQUENCE (SIZE (1..maxPCPCH-CDsubCh)) OF
    CD-AccessSlotSubchannel

CD-CA-ICH-ChannelisationCode ::=      INTEGER (0..255)

CD-PreambleScramblingCode ::=         INTEGER (0..79)

CD-SignatureCode ::=                  INTEGER (0..15)

CD-SignatureCodeList ::=              SEQUENCE (SIZE (1..maxPCPCH-CDsig)) OF
    CD-SignatureCode

```

```

CellAndChannelIdentity ::=          SEQUENCE {
    -- burstType may be set to either value and should be ignored by the receiver for 1.28 Mcps TDD.
    burstType                       BurstType,
    midambleShift                   MidambleShiftLong,
    timeslot                        TimeslotNumber,
    cellParametersID                CellParametersID
}

CellParametersID ::=                INTEGER (0..127)

Cfntargetsfnframeoffset ::=        INTEGER (0..255)

ChannelAssignmentActive ::=         CHOICE {
    notActive                       NULL,
    isActive                       AvailableMinimumSF-ListVCAM
}

ChannelisationCode256 ::=          INTEGER (0..255)

ChannelReqParamsForUCSM ::=         SEQUENCE {
    availableAP-SignatureList        AvailableAP-SignatureList,
    availableAP-SubchannelList       AvailableAP-SubchannelList           OPTIONAL
}

ClosedLoopTimingAdjMode ::=        ENUMERATED {
    slot1, slot2 }

CodeNumberDSCH ::=                 INTEGER (0..255)

CodeRange ::=                       SEQUENCE {
    pdsch-CodeMapList               PDSCH-CodeMapList
}

CodeWordSet ::=                     ENUMERATED {
    longCWS,
    mediumCWS,
    shortCWS,
    ssdtOff }

CommonTimeslotInfo ::=              SEQUENCE {
    -- TABULAR: secondInterleavingMode is MD, but since it can be encoded in a single
    -- bit it is not defined as OPTIONAL.
    secondInterleavingMode          SecondInterleavingMode,
    tfci-Coding                    TFCI-Coding                       OPTIONAL,
    puncturingLimit                 PuncturingLimit,
    repetitionPeriodAndLength       RepetitionPeriodAndLength         OPTIONAL
}

CommonTimeslotInfoMBMS ::=          SEQUENCE {
    -- TABULAR: secondInterleavingMode is MD, but since it can be encoded in a single
    -- bit it is not defined as OPTIONAL.
    secondInterleavingMode          SecondInterleavingMode,
    tfci-Coding                    TFCI-Coding                       OPTIONAL,
    puncturingLimit                 PuncturingLimit
}

CommonTimeslotInfoSCCPCH ::=        SEQUENCE {
    -- TABULAR: secondInterleavingMode is MD, but since it can be encoded in a single
    -- bit it is not defined as OPTIONAL.
    secondInterleavingMode          SecondInterleavingMode,
    tfci-Coding                    TFCI-Coding                       OPTIONAL,
    puncturingLimit                 PuncturingLimit,
    repetitionPeriodLengthAndOffset RepetitionPeriodLengthAndOffset   OPTIONAL
}

ConstantValue ::=                   INTEGER (-35..-10)

ConstantValueTdd ::=                INTEGER (-35..10)

CPCH-PersistenceLevels ::=          SEQUENCE {
    cpch-SetID                      CPCH-SetID,
    dynamicPersistenceLevelTF-List   DynamicPersistenceLevelTF-List
}

CPCH-PersistenceLevelsList ::=      SEQUENCE (SIZE (1..maxCPCHsets)) OF
    CPCH-PersistenceLevels

```



```

CPCH-SetInfo ::=
    cpch-SetID
    transportFormatSet
    tfcs
    ap-PreambleScramblingCode
    ap-AICH-ChannelisationCode
    cd-PreambleScramblingCode
    cd-CA-ICH-ChannelisationCode
    cd-AccessSlotSubchannelList
    cd-SignatureCodeList
    deltaPp-m
    ul-DPCCH-SlotFormat
    n-StartMessage
    n-EOT
    -- TABULAR: VCAM info has been nested inside ChannelAssignmentActive,
    -- which in turn is mandatory since it's only a binary choice.
    channelAssignmentActive
    cpch-StatusIndicationMode
    pcpch-ChannelInfoList
}

SEQUENCE {
    CPCH-SetID,
    TransportFormatSet,
    TFCS,
    AP-PreambleScramblingCode,
    AP-AICH-ChannelisationCode,
    CD-PreambleScramblingCode,
    CD-CA-ICH-ChannelisationCode,
    CD-AccessSlotSubchannelList
    CD-SignatureCodeList
    DeltaPp-m,
    UL-DPCCH-SlotFormat,
    N-StartMessage,
    N-EOT,
    ChannelAssignmentActive,
    CPCH-StatusIndicationMode,
    PCPCH-ChannelInfoList
}

OPTIONAL,
OPTIONAL,

CPCH-SetInfoList ::=
    SEQUENCE (SIZE (1..maxCPCHsets)) OF
        CPCH-SetInfo

CPCH-StatusIndicationMode ::=
    ENUMERATED {
        pa-mode,
        pamsf-mode }

CQI-DTX-Timer ::=
    ENUMERATED {
        sub-frames-0,
        sub-frames-1,
        sub-frames-2,
        sub-frames-4,
        sub-frames-8,
        sub-frames-16,
        sub-frames-32,
        sub-frames-64,
        sub-frames-128,
        sub-frames-256,
        sub-frames-512,
        sub-frames-Infinity,
        spare4,
        spare3,
        spare2,
        spare1 }

CQI-RepetitionFactor ::=
    INTEGER(1..4)

CSICH-PowerOffset ::=
    INTEGER (-10..5)

-- DefaultDPCH-OffsetValueFDD and DefaultDPCH-OffsetValueTDD corresponds to
-- IE "Default DPCH Offset Value" depending on the mode.
-- Actual value DefaultDPCH-OffsetValueFDD = IE value * 512
DefaultDPCH-OffsetValueFDD ::=
    INTEGER (0..599)

DefaultDPCH-OffsetValueTDD ::=
    INTEGER (0..7)

DeltaPp-m ::=
    INTEGER (-10..10)

DeltaCQI ::=
    INTEGER (0..8)

DeltaNACK ::=
    INTEGER (0..8)

DeltaACK ::=
    INTEGER (0..8)

-- Actual value DeltaSIR = IE value * 0.1
DeltaSIR ::=
    INTEGER (0..30)

DHS-Sync ::=
    INTEGER (-20..10)

DL-CCTrCh ::=
    tfcs-ID
    timeInfo
    commonTimeslotInfo
    dl-CCTrCH-TimeslotsCodes
    ul-CCTrChTPCList
}

SEQUENCE {
    TFCS-IdentityPlain
    TimeInfo,
    CommonTimeslotInfo
    DownlinkTimeslotsCodes
    UL-CCTrChTPCList
}

DEFAULT 1,
OPTIONAL,
OPTIONAL,
OPTIONAL

```

```

DL-CCTrCh-r4 ::= SEQUENCE {
    tfcs-ID          TFCS-IdentityPlain          DEFAULT 1,
    timeInfo        TimeInfo,
    commonTimeslotInfo CommonTimeslotInfo      OPTIONAL,
    tddOption       CHOICE {
        tdd384      SEQUENCE {
            dl-CCTrCH-TimeslotsCodes DownlinkTimeslotsCodes OPTIONAL
        },
        tdd128      SEQUENCE {
            dl-CCTrCH-TimeslotsCodes DownlinkTimeslotsCodes-LCR-r4 OPTIONAL
        }
    },
    ul-CCTrChTPCList UL-CCTrChTPCList          OPTIONAL
}

DL-CCTrCh-r7 ::= SEQUENCE {
    tfcs-ID          TFCS-IdentityPlain          DEFAULT 1,
    timeInfo        TimeInfo,
    commonTimeslotInfo CommonTimeslotInfo      OPTIONAL,
    tddOption       CHOICE {
        tdd384      SEQUENCE {
            dl-CCTrCH-TimeslotsCodes DownlinkTimeslotsCodes-r7 OPTIONAL
        },
        tdd768      SEQUENCE {
            dl-CCTrCH-TimeslotsCodes DownlinkTimeslotsCodes-VHCR   OPTIONAL
        },
        tdd128      SEQUENCE {
            dl-CCTrCH-TimeslotsCodes DownlinkTimeslotsCodes-LCR-r4 OPTIONAL
        }
    },
    ul-CCTrChTPCList UL-CCTrChTPCList          OPTIONAL
}

DL-CCTrChList ::= SEQUENCE (SIZE (1..maxCCTrCH)) OF
    DL-CCTrCh

DL-CCTrChList-r7 ::= SEQUENCE (SIZE (1..maxCCTrCH)) OF
    DL-CCTrCh-r7

DL-CCTrChList-r4 ::= SEQUENCE (SIZE (1..maxCCTrCH)) OF
    DL-CCTrCh-r4

DL-CCTrChListToRemove ::= SEQUENCE (SIZE (1..maxCCTrCH)) OF
    TFCS-IdentityPlain

DL-ChannelisationCode ::= SEQUENCE {
    secondaryScramblingCode SecondaryScramblingCode    OPTIONAL,
    sf-AndCodeNumber       SF512-AndCodeNumber,
    scramblingCodeChange   ScramblingCodeChange    OPTIONAL
}

DL-ChannelisationCodeList ::= SEQUENCE (SIZE (1..maxDPCH-DLchan)) OF
    DL-ChannelisationCode

DL-CommonInformation ::= SEQUENCE {
    dl-DPCH-InfoCommon DL-DPCH-InfoCommon          OPTIONAL,
    modeSpecificInfo   CHOICE {
        fdd SEQUENCE {
            defaultDPCH-OffsetValue DefaultDPCH-OffsetValueFDD OPTIONAL,
            dpch-CompressedModeInfo  DPCH-CompressedModeInfo  OPTIONAL,
            tx-DiversityMode         TX-DiversityMode          OPTIONAL,
            -- dummy is not used in this version of the specification, it should
            -- not be sent and if received it should be ignored.
            dummy                   SSdT-Information          OPTIONAL
        },
        tdd SEQUENCE {
            defaultDPCH-OffsetValue DefaultDPCH-OffsetValueTDD OPTIONAL
        }
    }
}

DL-CommonInformation-r4 ::= SEQUENCE {
    dl-DPCH-InfoCommon DL-DPCH-InfoCommon-r4          OPTIONAL,
    modeSpecificInfo   CHOICE {
        fdd SEQUENCE {
            defaultDPCH-OffsetValue DefaultDPCH-OffsetValueFDD OPTIONAL,
            dpch-CompressedModeInfo  DPCH-CompressedModeInfo  OPTIONAL,
            tx-DiversityMode         TX-DiversityMode          OPTIONAL,

```

```

-- dummy is not used in this version of the specification, it should
-- not be sent and if received it should be ignored.
dummy                SSDT-Information-r4                OPTIONAL
    },
    tdd                SEQUENCE {
        tddOption      CHOICE {
            tdd384      NULL,
            tdd128      SEQUENCE {
                tstd-Indicator      BOOLEAN
            }
        },
        defaultDPCH-OffsetValue      DefaultDPCH-OffsetValueTDD      OPTIONAL
    }
}

DL-CommonInformation-r5 ::= SEQUENCE {
    dl-DPCH-InfoCommon      DL-DPCH-InfoCommon-r4                OPTIONAL,
    modeSpecificInfo        CHOICE {
        fdd                SEQUENCE {
            defaultDPCH-OffsetValue      DefaultDPCH-OffsetValueFDD      OPTIONAL,
            dpch-CompressedModeInfo      DPCH-CompressedModeInfo      OPTIONAL,
            tx-DiversityMode              TX-DiversityMode              OPTIONAL,
            -- dummy is not used in this version of the specification, it should
            -- not be sent and if received it should be ignored.
            dummy                SSDT-Information-r4                OPTIONAL
        },
        tdd                SEQUENCE {
            tddOption      CHOICE {
                tdd384      NULL,
                tdd128      SEQUENCE {
                    tstd-Indicator      BOOLEAN
                }
            },
            defaultDPCH-OffsetValue      DefaultDPCH-OffsetValueTDD      OPTIONAL
        }
    },
    mac-hsResetIndicator      ENUMERATED { true }                OPTIONAL
}

DL-CommonInformation-r6 ::= SEQUENCE {
    dl-dpchInfoCommon        CHOICE {
        dl-DPCH-InfoCommon      DL-DPCH-InfoCommon-r6,
        dl-FDPCH-InfoCommon      DL-FDPCH-InfoCommon-r6
    }                OPTIONAL,
    modeSpecificInfo        CHOICE {
        fdd                SEQUENCE {
            defaultDPCH-OffsetValue      DefaultDPCH-OffsetValueFDD      OPTIONAL,
            dpch-CompressedModeInfo      DPCH-CompressedModeInfo      OPTIONAL,
            tx-DiversityMode              TX-DiversityMode              OPTIONAL
        },
        tdd                SEQUENCE {
            tddOption      CHOICE {
                tdd384      NULL,
                tdd128      SEQUENCE {
                    tstd-Indicator      BOOLEAN
                }
            },
            defaultDPCH-OffsetValue      DefaultDPCH-OffsetValueTDD      OPTIONAL
        }
    },
    mac-hsResetIndicator      ENUMERATED { true }                OPTIONAL,
    postVerificationPeriod      ENUMERATED { true }                OPTIONAL
}

DL-CommonInformation-r7 ::= SEQUENCE {
    dl-dpchInfoCommon        CHOICE {
        dl-DPCH-InfoCommon      DL-DPCH-InfoCommon-r6,
        dl-FDPCH-InfoCommon      DL-FDPCH-InfoCommon-r6
    }                OPTIONAL,
    modeSpecificInfo        CHOICE {
        fdd                SEQUENCE {
            defaultDPCH-OffsetValue      DefaultDPCH-OffsetValueFDD      OPTIONAL,
            dpch-CompressedModeInfo      DPCH-CompressedModeInfo      OPTIONAL,
            tx-DiversityMode              TX-DiversityMode              OPTIONAL
        },
        tdd                SEQUENCE {

```

```

        tddOption                CHOICE {
            tdd384                NULL,
            tdd768                NULL,
            tdd128                SEQUENCE {
                tstd-Indicator    BOOLEAN
            }
        },
        defaultDPCH-OffsetValue    DefaultDPCH-OffsetValueTDD OPTIONAL
    },
    mac-hsResetIndicator            ENUMERATED { true }        OPTIONAL,
    postVerificationPeriod          ENUMERATED { true }        OPTIONAL
}

DL-CommonInformationPost ::=      SEQUENCE {
    dl-DPCH-InfoCommon            DL-DPCH-InfoCommonPost
}

DL-CommonInformationPredef ::=    SEQUENCE {
    dl-DPCH-InfoCommon            DL-DPCH-InfoCommonPredef    OPTIONAL
}

DL-CompressedModeMethod ::=      ENUMERATED {
    -- dummy is not used in this version of the specification, it should
    -- not be sent and if received the UE behaviour is not specified.
    dummy, sf-2,
    higherLayerScheduling }

DL-DPCH-InfoCommon ::=          SEQUENCE {
    cfnHandling                    CHOICE {
        maintain                    NULL,
        initialise                    SEQUENCE {
            -- IE dummy is not used in this version of the specification
            -- The IE should not be sent and if received it should be ignored
            dummy                    Cfntargetsfnsframeoffset    OPTIONAL
        }
    },
    modeSpecificInfo                CHOICE {
        fdd                        SEQUENCE {
            dl-DPCH-PowerControlInfo    DL-DPCH-PowerControlInfo        OPTIONAL,
            powerOffsetPilot-pdpdch    PowerOffsetPilot-pdpdch,
            dl-rate-matching-restriction    Dl-rate-matching-restriction    OPTIONAL,
            -- TABULAR: The number of pilot bits is nested inside the spreading factor.
            spreadingFactorAndPilot    SF512-AndPilot,
            positionFixedOrFlexible    PositionFixedOrFlexible,
            tfci-Existence            BOOLEAN
        },
        tdd                        SEQUENCE {
            dl-DPCH-PowerControlInfo    DL-DPCH-PowerControlInfo        OPTIONAL
        }
    }
}

DL-DPCH-InfoCommon-r4 ::=      SEQUENCE {
    cfnHandling                    CHOICE {
        maintain                    NULL,
        initialise                    SEQUENCE {
            -- IE dummy is not used in this version of the specification
            -- The IE should not be sent and if received it should be ignored
            dummy                    Cfntargetsfnsframeoffset    OPTIONAL
        }
    },
    modeSpecificInfo                CHOICE {
        fdd                        SEQUENCE {
            dl-DPCH-PowerControlInfo    DL-DPCH-PowerControlInfo        OPTIONAL,
            powerOffsetPilot-pdpdch    PowerOffsetPilot-pdpdch,
            dl-rate-matching-restriction    Dl-rate-matching-restriction    OPTIONAL,
            -- TABULAR: The number of pilot bits is nested inside the spreading factor.
            spreadingFactorAndPilot    SF512-AndPilot,
            positionFixedOrFlexible    PositionFixedOrFlexible,
            tfci-Existence            BOOLEAN
        },
        tdd                        SEQUENCE {
            dl-DPCH-PowerControlInfo    DL-DPCH-PowerControlInfo        OPTIONAL
        }
    },
    -- The IE mac-d-HFN-initial-value should be absent in the RRCConnectionSetup-r4-IEs or
    -- RRCConnectionSetup-r5-IEs or HandoverToUTRANCommand-r4-IEs or HandoverToUTRANCommand-r5-IEs and

```

```

-- if the IE is included, the general error handling for conditional IEs applies.
mac-d-HFN-initial-value          MAC-d-HFN-initial-value          OPTIONAL
}

DL-DPCH-InfoCommon-r6 ::=
  cfnHandling                     CHOICE {
    maintain                       SEQUENCE {
      timingmaintainedsynchind     TimingMaintainedSynchInd     OPTIONAL
    },
    initialise                      NULL
  },
  modeSpecificInfo                CHOICE {
    fdd                            SEQUENCE {
      dl-DPCH-PowerControlInfo     DL-DPCH-PowerControlInfo     OPTIONAL,
      powerOffsetPilot-pdpdch      PowerOffsetPilot-pdpdch,
      dl-rate-matching-restriction Dl-rate-matching-restriction  OPTIONAL,
      -- TABULAR: The number of pilot bits is nested inside the spreading factor.
      spreadingFactorAndPilot      SF512-AndPilot,
      positionFixedOrFlexible      PositionFixedOrFlexible,
      tfci-Existence               BOOLEAN
    },
    tdd                            SEQUENCE {
      dl-DPCH-PowerControlInfo     DL-DPCH-PowerControlInfo     OPTIONAL
    }
  },
  -- The IE mac-d-HFN-initial-value should be absent in the RRCConnectionSetup and the
  -- HandoverToUTRANCommand messages. If the IE is included, the general error handling
  -- for conditional IEs applies.
  mac-d-HFN-initial-value          MAC-d-HFN-initial-value          OPTIONAL
}

DL-DPCH-InfoCommonPost ::=
  dl-DPCH-PowerControlInfo        DL-DPCH-PowerControlInfo        OPTIONAL
}

DL-DPCH-InfoCommonPredef ::=
  modeSpecificInfo                CHOICE {
    fdd                            SEQUENCE {
      -- TABULAR: The number of pilot bits is nested inside the spreading factor.
      spreadingFactorAndPilot      SF512-AndPilot,
      positionFixedOrFlexible      PositionFixedOrFlexible,
      tfci-Existence               BOOLEAN
    },
    tdd                            SEQUENCE {
      commonTimeslotInfo           CommonTimeslotInfo
    }
  }
}

DL-DPCH-InfoPerRL ::=
  fdd                             CHOICE {
    SEQUENCE {
      pCPICH-UsageForChannelEst    PCPICH-UsageForChannelEst,
      dpch-FrameOffset             DPCH-FrameOffset,
      secondaryCPICH-Info           SecondaryCPICH-Info           OPTIONAL,
      dl-ChannelisationCodeList    DL-ChannelisationCodeList,
      tpc-CombinationIndex          TPC-CombinationIndex,
      -- dummy is not used in this version of the specification, it should
      -- not be sent and if received it should be ignored.
      dummy                        SSdT-CellIdentity           OPTIONAL,
      closedLoopTimingAdjMode      ClosedLoopTimingAdjMode     OPTIONAL
    },
    tdd                             SEQUENCE {
      dl-CCTrChListToEstablish     DL-CCTrChList               OPTIONAL,
      dl-CCTrChListToRemove        DL-CCTrChListToRemove       OPTIONAL
    }
  }
}

DL-DPCH-InfoPerRL-r4 ::=
  fdd                             CHOICE {
    SEQUENCE {
      pCPICH-UsageForChannelEst    PCPICH-UsageForChannelEst,
      dpch-FrameOffset             DPCH-FrameOffset,
      secondaryCPICH-Info           SecondaryCPICH-Info           OPTIONAL,
      dl-ChannelisationCodeList    DL-ChannelisationCodeList,
      tpc-CombinationIndex          TPC-CombinationIndex,
      -- dummy is not used in this version of the specification, it should
      -- not be sent and if received it should be ignored.
      dummy                        SSdT-CellIdentity           OPTIONAL,

```

```

        closedLoopTimingAdjMode          ClosedLoopTimingAdjMode          OPTIONAL
    },
    tdd
        dl-CCTrChListToEstablish          DL-CCTrChList-r4                OPTIONAL,
        dl-CCTrChListToRemove            DL-CCTrChListToRemove          OPTIONAL
    }
}

DL-DPCH-InfoPerRL-r5 ::=
    fdd
        pCPICH-UsageForChannelEst        PCPICH-UsageForChannelEst,
        dpch-FrameOffset                  DPCH-FrameOffset,
        secondaryCPICH-Info                SecondaryCPICH-Info              OPTIONAL,
        dl-ChannelisationCodeList         DL-ChannelisationCodeList,
        tpc-CombinationIndex               TPC-CombinationIndex,
        powerOffsetTPC-pdpdch              PowerOffsetTPC-pdpdch          OPTIONAL,
        -- dummy is not used in this version of the specification, it should
        -- not be sent and if received it should be ignored.
        dummy                              SSDT-CellIdentity                OPTIONAL,
        closedLoopTimingAdjMode            ClosedLoopTimingAdjMode          OPTIONAL
    },
    tdd
        dl-CCTrChListToEstablish          DL-CCTrChList-r4                OPTIONAL,
        dl-CCTrChListToRemove            DL-CCTrChListToRemove          OPTIONAL
    }
}

DL-DPCH-InfoPerRL-r6 ::=
    fdd
        pCPICH-UsageForChannelEst        PCPICH-UsageForChannelEst,
        dpch-FrameOffset                  DPCH-FrameOffset,
        secondaryCPICH-Info                SecondaryCPICH-Info              OPTIONAL,
        dl-ChannelisationCodeList         DL-ChannelisationCodeList,
        tpc-CombinationIndex               TPC-CombinationIndex,
        powerOffsetTPC-pdpdch              PowerOffsetTPC-pdpdch          OPTIONAL,
        closedLoopTimingAdjMode            ClosedLoopTimingAdjMode          OPTIONAL
    },
    tdd
        dl-CCTrChListToEstablish          DL-CCTrChList-r4                OPTIONAL,
        dl-CCTrChListToRemove            DL-CCTrChListToRemove          OPTIONAL
    }
}

DL-DPCH-InfoPerRL-r7 ::=
    fdd
        pCPICH-UsageForChannelEst        PCPICH-UsageForChannelEst,
        dpch-FrameOffset                  DPCH-FrameOffset,
        secondaryCPICH-Info                SecondaryCPICH-Info              OPTIONAL,
        dl-ChannelisationCodeList         DL-ChannelisationCodeList,
        tpc-CombinationIndex               TPC-CombinationIndex,
        powerOffsetTPC-pdpdch              PowerOffsetTPC-pdpdch          OPTIONAL,
        closedLoopTimingAdjMode            ClosedLoopTimingAdjMode          OPTIONAL
    },
    tdd
        dl-CCTrChListToEstablish          DL-CCTrChList-r7                OPTIONAL,
        dl-CCTrChListToRemove            DL-CCTrChListToRemove          OPTIONAL
    }
}

DL-FDPCH-InfoPerRL-r6 ::=
    pCPICH-UsageForChannelEst            PCPICH-UsageForChannelEst,
    fdpch-FrameOffset                    DPCH-FrameOffset,
    secondaryCPICH-Info                    SecondaryCPICH-Info              OPTIONAL,
    secondaryScramblingCode                SecondaryScramblingCode          OPTIONAL,
    dl-ChannelisationCode                  INTEGER (0..255),
    tpc-CombinationIndex                   TPC-CombinationIndex
}

DL-FDPCH-InfoPerRL-r7 ::=
    pCPICH-UsageForChannelEst            PCPICH-UsageForChannelEst,
    fdpch-FrameOffset                    DPCH-FrameOffset,
    fdpch-SlotFormat                      FDPCH-SlotFormat                OPTIONAL,
    secondaryCPICH-Info                    SecondaryCPICH-Info              OPTIONAL,
    secondaryScramblingCode                SecondaryScramblingCode          OPTIONAL,
    dl-ChannelisationCode                  INTEGER (0..255),
    tpc-CombinationIndex                   TPC-CombinationIndex,
    sttdIndication                        STTDIndication                  OPTIONAL
}

```

```

DL-DPCH-InfoPerRL-PostFDD ::=                               SEQUENCE {
    pCPICH-UsageForChannelEst    PCPICH-UsageForChannelEst,
    dl-ChannelisationCode        DL-ChannelisationCode,
    tpc-CombinationIndex         TPC-CombinationIndex
}

DL-DPCH-InfoPerRL-PostTDD ::=                               SEQUENCE {
    dl-DPCH-TimeslotsCodes       DownlinkTimeslotsCodes
}

DL-DPCH-InfoPerRL-PostTDD-LCR-r4 ::=                       SEQUENCE {
    dl-CCTrCH-TimeslotsCodes     DownlinkTimeslotsCodes-LCR-r4
}

DL-DPCH-PowerControlInfo ::=                               SEQUENCE {
    modeSpecificInfo             CHOICE {
        fdd                      SEQUENCE {
            dpc-Mode              DPC-Mode
        },
        tdd                      SEQUENCE {
            tpc-StepSizeTDD       TPC-StepSizeTDD           OPTIONAL
        }
    }
}

DL-FDPCH-InfoCommon-r6 ::=                               SEQUENCE {
    cfnHandling                  CHOICE {
        maintain                  SEQUENCE {
            timingMaintainedSynchInd TimingMaintainedSynchInd           OPTIONAL
        },
        initialise                 NULL
    },
    dl-FDPCH-PowerControlInfo    DL-DPCH-PowerControlInfo           OPTIONAL,
    -- Actual value dl-FDPCH-TPCcommandErrorRate = IE value * 0.01
    -- dl-FDPCH-TPCcommandErrorRate values 11..16 are spare and shall not be used in this version of
    -- the protocol.
    -- In addition, this IE shall always be included otherwise the UE behaviour is unspecified.
    dl-FDPCH-TPCcommandErrorRate INTEGER (1..16)           OPTIONAL
}

DL-FrameType ::=                                         ENUMERATED {
    dl-FrameTypeA, dl-FrameTypeB }

DL-HSPDSCH-Information ::=                               SEQUENCE {
    hs-scch-Info                 HS-SCCH-Info           OPTIONAL,
    measurement-feedback-Info    Measurement-Feedback-Info OPTIONAL,
    modeSpecificInfo             CHOICE {
        tdd                      CHOICE {
            tdd384                SEQUENCE {
                dl-HSPDSCH-TS-Configuration DL-HSPDSCH-TS-Configuration OPTIONAL
            },
            tdd128                SEQUENCE {
                hs-PDSCH-Midamble-Configuration-tdd128
                HS-PDSCH-Midamble-Configuration-TDD128           OPTIONAL
            }
        }
    },
    fdd                          NULL
}

DL-HSPDSCH-Information-r6 ::=                               SEQUENCE {
    hs-scch-Info                 HS-SCCH-Info-r6           OPTIONAL,
    measurement-feedback-Info    Measurement-Feedback-Info OPTIONAL,
    modeSpecificInfo             CHOICE {
        tdd                      CHOICE {
            tdd384                SEQUENCE {
                dl-HSPDSCH-TS-Configuration DL-HSPDSCH-TS-Configuration OPTIONAL
            },
            tdd128                SEQUENCE {
                hs-PDSCH-Midamble-Configuration-tdd128
                HS-PDSCH-Midamble-Configuration-TDD128           OPTIONAL
            }
        }
    },
    fdd                          NULL
}

```

```

DL-HSPDSCH-Information-r7 ::= SEQUENCE {
    hs-scch-Info          HS-SCCH-Info-r7          OPTIONAL,
    measurement-feedback-Info Measurement-Feedback-Info-r7  OPTIONAL,
    modeSpecificInfo     CHOICE {
        tdd              CHOICE {
            tdd384      SEQUENCE {
                dl-HSPDSCH-TS-Configuration DL-HSPDSCH-TS-Configuration OPTIONAL
            },
            tdd768      SEQUENCE {
                dl-HSPDSCH-TS-Configuration DL-HSPDSCH-TS-Configuration-VHCR  OPTIONAL
            },
            tdd128      SEQUENCE {
                hs-PDSCH-Midamble-Configuration-tdd128
                HS-PDSCH-Midamble-Configuration-TDD128          OPTIONAL,
                dl-MultiCarrier-Information DL-MultiCarrier-Information  OPTIONAL
            }
        },
        fdd              SEQUENCE {
            dl-64QAM-Configured          ENUMERATED { true }          OPTIONAL
        }
    }
}

DL-HSPDSCH-MultiCarrier-Information ::= SEQUENCE (SIZE (1..maxTDD128Carrier)) OF
    SEQUENCE {
        uarfcn-Carrier          UARFCN,
        harqInfo                HARQ-Info          OPTIONAL,
        hs-PDSCH-Midamble-Configuration HS-PDSCH-Midamble-Configuration-TDD128  OPTIONAL,
        hs-SCCH-TDD128-MultiCarrier SEQUENCE (SIZE (1..maxHSSCCHs)) OF
            HS-SCCH-TDD128-MultiCarrier          OPTIONAL
    }

-- The IE 'DL-HSPDSCH-TS-Configuration' applies to tdd-384 REL-5 onward
DL-HSPDSCH-TS-Configuration ::= SEQUENCE (SIZE (1..maxTS-1)) OF
    SEQUENCE {
        timeslot                TimeslotNumber,
        midambleShiftAndBurstType MidambleShiftAndBurstType-DL
    }

-- The IE 'DL-HSPDSCH-TS-Configuration-VHCR' applies to tdd-768 REL-7 onward
DL-HSPDSCH-TS-Configuration-VHCR ::= SEQUENCE (SIZE (1..maxTS-1)) OF
    SEQUENCE {
        timeslot                TimeslotNumber,
        midambleShiftAndBurstType MidambleShiftAndBurstType-DL-VHCR
    }

DL-InformationPerRL ::= SEQUENCE {
    modeSpecificInfo          CHOICE {
        fdd                  SEQUENCE {
            primaryCPICH-Info PrimaryCPICH-Info,
            -- dummy1 and dummy 2 are not used in this version of specification, they should
            -- not be sent and if received they should be ignored.
            dummy1            PDSCH-SHO-DCH-Info          OPTIONAL,
            dummy2            PDSCH-CodeMapping          OPTIONAL
        },
        tdd                  PrimaryCCPCH-Info
    },
    dl-DPCH-InfoPerRL        DL-DPCH-InfoPerRL          OPTIONAL,
    -- dummy is not used in this version of the specification, it should
    -- not be sent and if received it should be ignored.
    dummy                    SCCPCH-InfoForFACH          OPTIONAL
}

DL-InformationPerRL-r4 ::= SEQUENCE {
    modeSpecificInfo          CHOICE {
        fdd                  SEQUENCE {
            primaryCPICH-Info PrimaryCPICH-Info,
            -- dummy1 and dummy 2 are not used in this version of specification, they should
            -- not be sent and if received they should be ignored.
            dummy1            PDSCH-SHO-DCH-Info          OPTIONAL,
            dummy2            PDSCH-CodeMapping          OPTIONAL
        },
        tdd                  PrimaryCCPCH-Info-r4
    },
    dl-DPCH-InfoPerRL        DL-DPCH-InfoPerRL-r4      OPTIONAL,
    -- dummy is not used in this version of the specification, it should
    -- not be sent and if received it should be ignored.
    dummy                    SCCPCH-InfoForFACH-r4      OPTIONAL,
}

```



```

    cell-id                CellIdentity                OPTIONAL
}

DL-InformationPerRL-r5 ::= SEQUENCE {
    modeSpecificInfo      CHOICE {
        fdd                SEQUENCE {
            primaryCPICH-Info    PrimaryCPICH-Info,
            -- dummy1 and dummy 2 are not used in this version of specification, they should
            -- not be sent and if received they should be ignored.
            dummy1              PDSCH-SHO-DCH-Info    OPTIONAL,
            dummy2              PDSCH-CodeMapping    OPTIONAL,
            servingHSDSCH-RL-indicator    BOOLEAN
        },
        tdd                PrimaryCCPCH-Info-r4
    },
    dl-DPCH-InfoPerRL    DL-DPCH-InfoPerRL-r5        OPTIONAL,
    -- dummy is not used in this version of the specification, it should
    -- not be sent and if received it should be ignored.
    dummy                SCCPCH-InfoForFACH-r4        OPTIONAL,
    cell-id              CellIdentity                OPTIONAL
}

DL-InformationPerRL-r5bis ::= SEQUENCE {
    modeSpecificInfo      CHOICE {
        fdd                SEQUENCE {
            primaryCPICH-Info    PrimaryCPICH-Info,
            -- dummy1 and dummy 2 are not used in this version of specification, they should
            -- not be sent and if received they should be ignored.
            dummy1              PDSCH-SHO-DCH-Info    OPTIONAL,
            dummy2              PDSCH-CodeMapping    OPTIONAL
        },
        tdd                PrimaryCCPCH-Info-r4
    },
    dl-DPCH-InfoPerRL    DL-DPCH-InfoPerRL-r5        OPTIONAL,
    -- dummy is not used in this version of the specification, it should
    -- not be sent and if received it should be ignored.
    dummy                SCCPCH-InfoForFACH-r4        OPTIONAL,
    cell-id              CellIdentity                OPTIONAL
}

DL-InformationPerRL-r6 ::= SEQUENCE {
    modeSpecificInfo      CHOICE {
        fdd                SEQUENCE {
            primaryCPICH-Info    PrimaryCPICH-Info,
            servingHSDSCH-RL-indicator    BOOLEAN,
            servingEDCH-RL-indicator    BOOLEAN
        },
        tdd                PrimaryCCPCH-Info-r4
    },
    dl-dpchInfo          CHOICE {
        dl-DPCH-InfoPerRL    DL-DPCH-InfoPerRL-r6,
        dl-FDPCH-InfoPerRL    DL-FDPCH-InfoPerRL-r6
    } OPTIONAL,
    e-AGCH-Information    E-AGCH-Information          OPTIONAL,
    e-HICH-Info          CHOICE {
        e-HICH-Information    E-HICH-Information,
        releaseIndicator      NULL
    } OPTIONAL,
    e-RGCH-Info          CHOICE {
        e-RGCH-Information    E-RGCH-Information,
        releaseIndicator      NULL
    } OPTIONAL,
    cell-id              CellIdentity                OPTIONAL
}

DL-InformationPerRL-v6b0ext ::= SEQUENCE {
    sttdIndication      STTDIndication                OPTIONAL
}

DL-InformationPerRL-r7 ::= SEQUENCE {
    modeSpecificInfo      CHOICE {
        fdd                SEQUENCE {
            primaryCPICH-Info    PrimaryCPICH-Info,
            servingHSDSCH-RL-indicator    BOOLEAN,
            servingEDCH-RL-indicator    BOOLEAN
        },
        tdd                PrimaryCCPCH-Info-r4
    },

```

```

dl-dpchsInfo
  dl-DPCH-InfoPerRL
  dl-FDPCH-InfoPerRL
}
e-AGCH-Information
modeSpecificInfo2
  fdd
    e-HICH-Info
    e-HICH-Information
    releaseIndicator
  } OPTIONAL,
  e-RGCH-Info
  e-RGCH-Information
  releaseIndicator
} OPTIONAL
},
tdd
  tdd384-tdd768
  e-HICH-Info
  },
  tdd128
  e-HICH-Info
}
},
cell-id
}

DL-InformationPerRL-List ::= SEQUENCE (SIZE (1..maxRL)) OF
  DL-InformationPerRL

DL-InformationPerRL-List-r4 ::= SEQUENCE (SIZE (1..maxRL)) OF
  DL-InformationPerRL-r4

DL-InformationPerRL-List-r5 ::= SEQUENCE (SIZE (1..maxRL)) OF
  DL-InformationPerRL-r5

DL-InformationPerRL-List-r6 ::= SEQUENCE (SIZE (1..maxRL)) OF
  DL-InformationPerRL-r6

DL-InformationPerRL-List-v6b0ext ::= SEQUENCE (SIZE (1..maxRL)) OF
  DL-InformationPerRL-v6b0ext

DL-InformationPerRL-List-r5bis ::= SEQUENCE (SIZE (1..maxRL)) OF
  DL-InformationPerRL-r5bis

DL-InformationPerRL-List-r7 ::= SEQUENCE (SIZE (1..maxRL)) OF
  DL-InformationPerRL-r7

DL-InformationPerRL-ListPostFDD ::= SEQUENCE (SIZE (1..maxRL)) OF
  DL-InformationPerRL-PostFDD

DL-InformationPerRL-PostFDD ::= SEQUENCE {
  primaryCPICH-Info PrimaryCPICH-Info,
  dl-DPCH-InfoPerRL DL-DPCH-InfoPerRL-PostFDD
}

DL-InformationPerRL-PostTDD ::= SEQUENCE {
  primaryCCPCH-Info PrimaryCCPCH-InfoPost,
  dl-DPCH-InfoPerRL DL-DPCH-InfoPerRL-PostTDD
}

DL-InformationPerRL-PostTDD-LCR-r4 ::= SEQUENCE {
  primaryCCPCH-Info PrimaryCCPCH-InfoPostTDD-LCR-r4,
  dl-DPCH-InfoPerRL DL-DPCH-InfoPerRL-PostTDD-LCR-r4
}

--for 1.28Mcps TDD Multi-Carrier
DL-MultiCarrier-Information ::= SEQUENCE {
  tsn-Length ENUMERATED { tsn-6bits, tsn-9bits } OPTIONAL,
  multiCarrierNumber INTEGER (1..maxTDD128Carrier) OPTIONAL,
  dl-HSPDSCH-MultiCarrier-Information DL-HSPDSCH-MultiCarrier-Information OPTIONAL
}

DL-PDSCH-Information ::= SEQUENCE {
  -- dummy1 and dummy 2 are not used in this version of specification, it should
  -- not be sent and if received it should be ignored.
  dummy1 PDSCH-SHO-DCH-Info OPTIONAL,

```

```

    dummy2                                PDSCH-CodeMapping                OPTIONAL
}

DL-rate-matching-restriction ::= SEQUENCE {
    restrictedTrCH-InfoList                RestrictedTrCH-InfoList                OPTIONAL
}

DL-TPC-PowerOffsetPerRL ::= SEQUENCE {
    powerOffsetTPC-pdpdch                  PowerOffsetTPC-pdpdch                OPTIONAL
}

-- NOTE: The radio links in the following list have a one-to-one mapping with the
-- radio links in the message.
DL-TPC-PowerOffsetPerRL-List ::= SEQUENCE (SIZE (1..maxRL)) OF
    DL-TPC-PowerOffsetPerRL

DL-TS-ChannelisationCode ::= ENUMERATED {
    cc16-1, cc16-2, cc16-3, cc16-4,
    cc16-5, cc16-6, cc16-7, cc16-8,
    cc16-9, cc16-10, cc16-11, cc16-12,
    cc16-13, cc16-14, cc16-15, cc16-16 }

DL-TS-ChannelisationCode-VHCR ::= ENUMERATED {
    cc32-1, cc32-2, cc32-3, cc32-4,
    cc132-5, cc32-6, cc32-7, cc32-8,
    cc32-9, cc32-10, cc32-11, cc32-12,
    cc32-13, cc32-14, cc32-15, cc32-16,
    cc32-17, cc32-18, cc32-19, cc32-20,
    cc32-21, cc32-22, cc32-23, cc32-24,
    cc32-25, cc32-26, cc32-27, cc32-28,
    cc32-29, cc32-30, cc32-31, cc32-32 }

DL-TS-ChannelisationCodesShort ::= SEQUENCE {
    codesRepresentation                    CHOICE {
        consecutive                        SEQUENCE {
            firstChannelisationCode        DL-TS-ChannelisationCode,
            lastChannelisationCode         DL-TS-ChannelisationCode
        },
        bitmap                             BIT STRING {
            chCode16-SF16(0),
            chCode15-SF16(1),
            chCode14-SF16(2),
            chCode13-SF16(3),
            chCode12-SF16(4),
            chCode11-SF16(5),
            chCode10-SF16(6),
            chCode9-SF16(7),
            chCode8-SF16(8),
            chCode7-SF16(9),
            chCode6-SF16(10),
            chCode5-SF16(11),
            chCode4-SF16(12),
            chCode3-SF16(13),
            chCode2-SF16(14),
            chCode1-SF16(15)
        } (SIZE (16))
    }
}

DL-TS-ChannelisationCodesShort-VHCR ::= SEQUENCE {
    codesRepresentation                    CHOICE {
        consecutive                        SEQUENCE {
            firstChannelisationCode        DL-TS-ChannelisationCode-VHCR,
            lastChannelisationCode         DL-TS-ChannelisationCode-VHCR
        },
        bitmap                             BIT STRING {
            chCode32-SF32(0),
            chCode31-SF32(1),
            chCode30-SF32(2),
            chCode29-SF32(3),
            chCode28-SF32(4),
            chCode27-SF32(5),
            chCode26-SF32(6),
            chCode25-SF32(7),
            chCode24-SF32(8),
            chCode23-SF32(9),
            chCode22-SF32(10),
            chCode21-SF32(11),

```

```

        chCode20-SF32(12),
        chCode19-SF32(13),
        chCode18-SF32(14),
        chCode17-SF32(15),
        chCode16-SF32(16),
        chCode15-SF32(17),
        chCode14-SF32(18),
        chCode13-SF32(19),
        chCode12-SF32(20),
        chCode11-SF32(21),
        chCode10-SF32(22),
        chCode9-SF32(23),
        chCode8-SF32(24),
        chCode7-SF32(25),
        chCode6-SF32(26),
        chCode5-SF32(27),
        chCode4-SF32(28),
        chCode3-SF32(29),
        chCode2-SF32(30),
        chCode1-SF32(31)
    } (SIZE (32))
}
}

DownlinkAdditionalTimeslots ::= SEQUENCE {
    parameters CHOICE {
        sameAsLast SEQUENCE {
            timeslotNumber TimeslotNumber
        },
        newParameters SEQUENCE {
            individualTimeslotInfo IndividualTimeslotInfo,
            dl-TS-ChannelisationCodesShort DL-TS-ChannelisationCodesShort
        }
    }
}

DownlinkAdditionalTimeslots-VHCR ::= SEQUENCE {
    parameters CHOICE {
        sameAsLast SEQUENCE {
            timeslotNumber TimeslotNumber
        },
        newParameters SEQUENCE {
            individualTimeslotInfo IndividualTimeslotInfo-VHCR,
            dl-TS-ChannelisationCodesShort DL-TS-ChannelisationCodesShort-VHCR
        }
    }
}

DownlinkAdditionalTimeslots-LCR-r4 ::= SEQUENCE {
    parameters CHOICE {
        sameAsLast SEQUENCE {
            timeslotNumber TimeslotNumber-LCR-r4
        },
        newParameters SEQUENCE {
            individualTimeslotInfo IndividualTimeslotInfo-LCR-r4,
            dl-TS-ChannelisationCodesShort DL-TS-ChannelisationCodesShort
        }
    }
}

DownlinkAdditionalTimeslots-r7 ::= SEQUENCE {
    parameters CHOICE {
        sameAsLast SEQUENCE {
            timeslotNumber TimeslotNumber
        },
        newParameters SEQUENCE {
            individualTimeslotInfo IndividualTimeslotInfo-r7,
            dl-TS-ChannelisationCodesShort DL-TS-ChannelisationCodesShort
        }
    }
}

DownlinkTimeslotsCodes ::= SEQUENCE {
    firstIndividualTimeslotInfo IndividualTimeslotInfo,
    dl-TS-ChannelisationCodesShort DL-TS-ChannelisationCodesShort,
    moreTimeslots CHOICE {
        noMore NULL,
        additionalTimeslots CHOICE {

```

```

        consecutive
        timeslotList
    }
}

DownlinkTimeslotsCodes-VHCR ::= SEQUENCE {
    firstIndividualTimeslotInfo IndividualTimeslotInfo-VHCR,
    dl-TS-ChannelisationCodesShort DL-TS-ChannelisationCodesShort-VHCR,
    moreTimeslots CHOICE {
        noMore NULL,
        additionalTimeslots CHOICE {
            consecutive INTEGER (1..maxTS-1),
            timeslotList SEQUENCE (SIZE (1..maxTS-1)) OF
                DownlinkAdditionalTimeslots-VHCR
        }
    }
}

DownlinkTimeslotsCodes-LCR-r4 ::= SEQUENCE {
    firstIndividualTimeslotInfo IndividualTimeslotInfo-LCR-r4,
    dl-TS-ChannelisationCodesShort DL-TS-ChannelisationCodesShort,
    moreTimeslots CHOICE {
        noMore NULL,
        additionalTimeslots CHOICE {
            consecutive INTEGER (1..maxTS-LCR-1),
            timeslotList SEQUENCE (SIZE (1..maxTS-LCR-1)) OF
                DownlinkAdditionalTimeslots-LCR-r4
        }
    }
}

DownlinkTimeslotsCodes-r7 ::= SEQUENCE {
    firstIndividualTimeslotInfo IndividualTimeslotInfo-r7,
    dl-TS-ChannelisationCodesShort DL-TS-ChannelisationCodesShort,
    moreTimeslots CHOICE {
        noMore NULL,
        additionalTimeslots CHOICE {
            consecutive INTEGER (1..maxTS-1),
            timeslotList SEQUENCE (SIZE (1..maxTS-1)) OF
                DownlinkAdditionalTimeslots-r7
        }
    }
}

DPC-Mode ::= ENUMERATED {
    singleTPC,
    tpcTripletInSoft }

-- Actual value DPCCH-PowerOffset = IE value * 2
DPCCH-PowerOffset ::= INTEGER (-82..-3)

-- Actual value DPCCH-PowerOffset2 = 2 + (IE value * 4)
DPCCH-PowerOffset2 ::= INTEGER (-28..-13)

DPCH-CompressedModeInfo ::= SEQUENCE {
    tgp-SequenceList TGP-SequenceList
}

DPCH-CompressedModeStatusInfo ::= SEQUENCE {
    tgps-Reconfiguration-CFN TGPS-Reconfiguration-CFN,
    tgp-SequenceShortList SEQUENCE (SIZE (1..maxTGPS)) OF
        TGP-SequenceShort
}

-- Actual value DPCH-FrameOffset = IE value * 256
DPCH-FrameOffset ::= INTEGER (0..149)

FDPCH-SlotFormat ::= INTEGER (0..9)

UE-DRX-Cycle-InactivityThreshold ::= ENUMERATED {
    sub-frames-0,
    sub-frames-1,
    sub-frames-2,
    sub-frames-4,
    sub-frames-8,
    sub-frames-16,
    sub-frames-32,

```

```

sub-frames-64,
sub-frames-128,
sub-frames-256,
sub-frames-512,
spare5,
spare4,
spare3,
spare2,
spare1 }

DRX-Info ::= SEQUENCE {
    ue-drx-Cycle UE-DRX-Cycle,
    ue-drx-Cycle-InactivityThreshold UE-DRX-Cycle-InactivityThreshold,
    ue-GrantMonitoring-InactivityThreshold UE-GrantMonitoring-InactivityThreshold,
    ue-drx-GrantMonitoring BOOLEAN
}

DSCH-Mapping ::= SEQUENCE {
    maxTFCI-Field2Value MaxTFCI-Field2Value,
    spreadingFactor SF-PDSCH,
    codeNumber CodeNumberDSCH,
    multiCodeInfo MultiCodeInfo
}

DSCH-MappingList ::= SEQUENCE (SIZE (1..maxPDSCH-TFCIgroups)) OF
    DSCH-Mapping

DSCH-RadioLinkIdentifier ::= INTEGER (0..511)

DSCH-TransportChannelsInfo ::= SEQUENCE (SIZE (1..maxTrCH)) OF
    SEQUENCE {
        dsch-transport-channel-identity TransportChannelIdentity,
        dsch-TFS TransportFormatSet
    }

DTX-DRX-Info-r7 ::= SEQUENCE {
    dtx-Info DTX-Info OPTIONAL,
    drx-Info DRX-Info OPTIONAL,
    uplink-DPCCHSlotFormatInformation Uplink-DPCCH-Slot-Format-Information
}

DTX-E-DCH-TTI-10ms ::= SEQUENCE {
    ue-dtx-Cycle1-10ms UE-DTX-Cycle1-10ms,
    ue-dtx-Cycle2-10ms UE-DTX-Cycle2-10ms,
    mac-dtx-Cycle-10ms MAC-DTX-Cycle-10ms
}

DTX-E-DCH-TTI-2ms ::= SEQUENCE {
    ue-dtx-Cycle1-2ms UE-DTX-Cycle1-2ms,
    ue-dtx-Cycle2-2ms UE-DTX-Cycle2-2ms,
    mac-dtx-Cycle-2ms MAC-DTX-Cycle-2ms
}

DTX-Info ::= SEQUENCE {
    e-dch-TTI-Length CHOICE {
        dtx-e-dch-TTI-10ms DTX-E-DCH-TTI-10ms,
        dtx-e-dch-TTI-2ms DTX-E-DCH-TTI-2ms
    },
    ue-dtx-cycle2InactivityThreshold UE-DTX-Cycle2InactivityThreshold,
    ue-dtx-cycle2DefaultSG INTEGER (0..38) OPTIONAL,
    -- if ue-dtx-long-preamble-length is not present, the value is '2 slots'
    ue-dtx-long-preamble-length UE-DTX-long-preamble-length OPTIONAL,
    mac-InactivityThreshold MAC-InactivityThreshold,
    cqi-dtx-Timer CQI-DTX-Timer,
    ue-dpcch-Burst1 UE-DPCCH-Burst,
    ue-dpcch-Burst2 UE-DPCCH-Burst
}

DurationTimeInfo ::= INTEGER (1..4096)

DynamicPersistenceLevel ::= INTEGER (1..8)

DynamicPersistenceLevelList ::= SEQUENCE (SIZE (1..maxPRACH)) OF
    DynamicPersistenceLevel

DynamicPersistenceLevelTF-List ::= SEQUENCE (SIZE (1..maxTF-CPCH)) OF
    DynamicPersistenceLevel

```

```

DynamicTFInformationCCCH ::= SEQUENCE {
    octetModeRLC-SizeInfoType2      OctetModeRLC-SizeInfoType2
}

E-AGCH-ChannelisationCode ::= INTEGER (0..255)

E-AGCH-Individual ::= SEQUENCE {
    tS-number                        INTEGER (0..14),
    channelisation-code              DL-TS-ChannelisationCode,
    midambleShiftAndBurstType       MidambleShiftAndBurstType-EDCH
}

E-AGCH-Individual-VHCR ::= SEQUENCE {
    tS-number                        INTEGER (0..14),
    channelisation-code              DL-TS-ChannelisationCode-VHCR,
    midambleShiftAndBurstType       MidambleShiftAndBurstType-EDCH
}

E-AGCH-Individual-LCR ::= SEQUENCE {
    timeslotNumber                  TimeslotNumber-LCR-r4,
    firstChannelisationCode         HS-ChannelisationCode-LCR,
    secondChannelisationCode        HS-ChannelisationCode-LCR,
    midambleAllocationMode         CHOICE {
        defaultMidamble            NULL,
        commonMidamble             NULL,
        ueSpecificMidamble         INTEGER (0..15)
    },
    -- Actual value midambleConfiguration = IE value * 2
    midambleConfiguration          INTEGER (1..8)
}

E-AGCH-Information ::= SEQUENCE {
    e-AGCH-ChannelisationCode      E-AGCH-ChannelisationCode
}

E-AGCH-Information-r7 ::= SEQUENCE {
    modeSpecific                   CHOICE {
        fdd                         SEQUENCE {
            e-AGCH-ChannelisationCode E-AGCH-ChannelisationCode
        },
        tdd                         CHOICE {
            tdd384                   SEQUENCE {
                long-Term-Grant-Indicator    BOOLEAN OPTIONAL,
                length-of-TTRI-field        INTEGER (1..12),
                e-AGCH-Set-Config          E-AGCH-Set-Config,
                e-AGCH-BLER-Target         Bler-Target
            },
            tdd768                   SEQUENCE {
                long-Term-Grant-Indicator    BOOLEAN OPTIONAL,
                length-of-TTRI-field        INTEGER (1..12),
                e-AGCH-Set-Config          E-AGCH-Set-Config-VHCR,
                e-AGCH-BLER-Target         Bler-Target
            },
            tdd128                   SEQUENCE {
                rdi-Indicator              BOOLEAN,
                tpc-StepSize               TPC-StepSizeTDD,
                e-AGCH-Set-Config          E-AGCH-Set-Config-LCR,
                e-AGCH-BLER-Target         Bler-Target
            }
        }
    }
}

E-AGCH-Set-Config ::= SEQUENCE (SIZE (1..maxNumE-AGCH)) OF
    E-AGCH-Individual

E-AGCH-Set-Config-VHCR ::= SEQUENCE (SIZE (1..maxNumE-AGCH)) OF
    E-AGCH-Individual-VHCR

E-AGCH-Set-Config-LCR ::= SEQUENCE (SIZE (1..maxNumE-AGCH)) OF
    E-AGCH-Individual-LCR

E-DCH-MinimumSet-E-TFCI ::= INTEGER (0..127)

E-DCH-ReconfigurationInfo ::= SEQUENCE {
    e-DCH-RL-InfoNewServingCell      E-DCH-RL-InfoNewServingCell          OPTIONAL,
    e-DCH-RL-InfoOtherCellList       SEQUENCE (SIZE (1..maxEDCHRL)) OF
}

```

```

}
E-DCH-InfoOtherCell ::= SEQUENCE {
    E-DCH-RL-InfoOtherCell OPTIONAL
}
E-DCH-ReconfigurationInfo-r7 ::= SEQUENCE {
    e-DCH-RL-InfoNewServingCell E-DCH-RL-InfoNewServingCell-r7 OPTIONAL,
    e-DCH-RL-InfoOtherCellList SEQUENCE (SIZE (1..maxEDCHRL)) OF
        E-DCH-RL-InfoOtherCell OPTIONAL
}
E-DCH-RL-InfoNewServingCell ::= SEQUENCE {
    primaryCPICH-Info PrimaryCPICH-Info,
    e-AGCH-Information E-AGCH-Information,
    servingGrant SEQUENCE {
        value INTEGER (0..38) OPTIONAL,
        primary-Secondary-GrantSelector ENUMERATED { primary, secondary }
    } OPTIONAL,
    e-DPCCH-DPCCH-PowerOffset E-DPCCH-DPCCH-PowerOffset OPTIONAL,
    reference-E-TFCIs E-DPCCH-Reference-E-TFCIList OPTIONAL,
    powerOffsetForSchedInfo INTEGER (0..6) OPTIONAL,
    threeIndexStepThreshold INTEGER (0..37) OPTIONAL,
    twoIndexStepThreshold INTEGER (0..37) OPTIONAL,
    e-HICH-Information E-HICH-Information OPTIONAL,
    e-RGCH-Info CHOICE {
        e-RGCH-Information E-RGCH-Information,
        releaseIndicator NULL
    } OPTIONAL
}
E-DCH-RL-InfoNewServingCell-r7 ::= SEQUENCE {
    primaryCPICH-Info PrimaryCPICH-Info,
    e-AGCH-Information E-AGCH-Information,
    servingGrant SEQUENCE {
        value INTEGER (0..38) OPTIONAL,
        primary-Secondary-GrantSelector ENUMERATED { primary, secondary }
    } OPTIONAL,
    e-DPCCH-DPCCH-PowerOffset E-DPCCH-DPCCH-PowerOffset OPTIONAL,
    reference-E-TFCIs E-DPCCH-Reference-E-TFCIList-r7 OPTIONAL,
    powerOffsetForSchedInfo INTEGER (0..6) OPTIONAL,
    threeIndexStepThreshold INTEGER (0..37) OPTIONAL,
    twoIndexStepThreshold INTEGER (0..37) OPTIONAL,
    e-HICH-Information E-HICH-Information OPTIONAL,
    e-RGCH-Info CHOICE {
        e-RGCH-Information E-RGCH-Information,
        releaseIndicator NULL
    } OPTIONAL
}
E-DCH-RL-InfoOtherCell ::= SEQUENCE {
    primaryCPICH-Info PrimaryCPICH-Info,
    e-HICH-Info CHOICE {
        e-HICH-Information E-HICH-Information,
        releaseIndicator NULL
    } OPTIONAL,
    e-RGCH-Info CHOICE {
        e-RGCH-Information E-RGCH-Information,
        releaseIndicator NULL
    } OPTIONAL
}
E-DCH-RL-InfoSameServingCell ::= SEQUENCE {
    e-DPCCH-DPCCH-PowerOffset E-DPCCH-DPCCH-PowerOffset OPTIONAL,
    reference-E-TFCIs E-DPCCH-Reference-E-TFCIList-r7 OPTIONAL
}
E-DPCCH-Info ::= SEQUENCE {
    e-DPCCH-DPCCH-PowerOffset E-DPCCH-DPCCH-PowerOffset,
    happyBit-DelayCondition HappyBit-DelayCondition
}
E-DPCCH-Info-r7 ::= SEQUENCE {
    e-DPCCH-DPCCH-PowerOffset E-DPCCH-DPCCH-PowerOffset,
    happyBit-DelayCondition HappyBit-DelayCondition,
    e-TFC-Boost-Info E-TFC-Boost-Info-r7 OPTIONAL,
    e-DPCCH-PowerInterpolation E-DPCCH-PowerInterpolation OPTIONAL
}
E-DPCCH-DPCCH-PowerOffset ::= INTEGER (0..8)

```



```

E-DPDCH-Info ::= SEQUENCE {
    e-TFCI-TableIndex          E-TFCI-TableIndex,
    e-DCH-MinimumSet-E-TFCI    E-DCH-MinimumSet-E-TFCI          OPTIONAL,
    reference-E-TFCIs          E-DPDCH-Reference-E-TFCIList,
    maxChannelisationCodes     E-DPDCH-MaxChannelisationCodes,
    pl-NonMax                  E-DPDCH-PL-NonMax,
    schedulingInfoConfiguration E-DPDCH-SchedulingInfoConfiguration,
    threeIndexStepThreshold    INTEGER (0..37)          OPTIONAL,
    twoIndexStepThreshold      INTEGER (0..37)          OPTIONAL
}

E-DPDCH-Info-r7 ::= SEQUENCE {
    e-TFCI-TableIndex          E-TFCI-TableIndex,
    e-DCH-MinimumSet-E-TFCI    E-DCH-MinimumSet-E-TFCI          OPTIONAL,
    reference-E-TFCIs          E-DPDCH-Reference-E-TFCIList-r7,
    maxChannelisationCodes     E-DPDCH-MaxChannelisationCodes,
    pl-NonMax                  E-DPDCH-PL-NonMax,
    schedulingInfoConfiguration E-DPDCH-SchedulingInfoConfiguration,
    threeIndexStepThreshold    INTEGER (0..37)          OPTIONAL,
    twoIndexStepThreshold      INTEGER (0..37)          OPTIONAL
}

E-DPDCH-PeriodicityOfSchedInfo ::= ENUMERATED {
    everyEDCHTTI, ms4, ms10, ms20, ms50, ms100, ms200, ms500,
    ms1000 }

-- The actual value of E-DPDCH-PL-NonMax is: IE value * 0.04
E-DPDCH-PL-NonMax ::= INTEGER (11..25)

E-DPDCH-PowerInterpolation ::= BOOLEAN

E-DPDCH-Reference-E-TFCI ::= SEQUENCE {
    reference-E-TFCI          INTEGER (0..127),
    reference-E-TFCI-PO      INTEGER (0..29)
}

E-DPDCH-Reference-E-TFCI-r7 ::= SEQUENCE {
    reference-E-TFCI          INTEGER (0..127),
    reference-E-TFCI-PO-r7   INTEGER (0..31)
}

E-DPDCH-Reference-E-TFCIList ::= SEQUENCE (SIZE (1..8)) OF E-DPDCH-Reference-E-TFCI

E-DPDCH-Reference-E-TFCIList-r7 ::= SEQUENCE (SIZE (1..8)) OF E-DPDCH-Reference-E-TFCI-r7

E-DPDCH-SchedulingInfoConfiguration ::= SEQUENCE {
    periodicityOfSchedInfo-NoGrant E-DPDCH-PeriodicityOfSchedInfo          OPTIONAL,
    periodicityOfSchedInfo-Grant   E-DPDCH-PeriodicityOfSchedInfo          OPTIONAL,
    powerOffsetForSchedInfo        INTEGER (0..6)
}

E-DPDCH-SchedulingTransmConfiguration ::= SEQUENCE {
    ms2-SchedTransmGrantHARQAlloc BIT STRING (SIZE (8))          OPTIONAL,
    servingGrant                   SEQUENCE {
        value                      INTEGER (0..38),
        primary-Secondary-GrantSelector ENUMERATED { primary, secondary }
    }
    OPTIONAL
}

E-DPDCH-MaxChannelisationCodes ::= ENUMERATED {
    sf256, sf128, sf64, sf32, sf16, sf8, sf4, sf4x2, sf2x2,
    sf4x2-and-sf2x2 }

E-HICH-ChannelisationCode ::= INTEGER (0..127)

E-HICH-Information ::= SEQUENCE {
    channelisationCode          E-HICH-ChannelisationCode,
    signatureSequence           E-HICH-RGCH-SignatureSequence
}

E-HICH-Information-TDD384-768 ::= SEQUENCE {
    n-E-HICH                    INTEGER (4..44),
    tS-Number                   INTEGER (0..14),
    modeSpecificInfo            CHOICE {
        tdd384                   DL-TS-ChannelisationCode,
        tdd768                   DL-TS-ChannelisationCode-VHCR
    },
    burst-Type                  ENUMERATED { type1, type2 },

```

```

midamble-Allocation-Mode          ENUMERATED { default, common }
}

E-HICH-Information-LCR ::=          SEQUENCE {
  ei                                INTEGER (0..3),
  timeslotNumber                    TimeslotNumber-LCR-r4,
  channelisation-Code               HS-ChannelisationCode-LCR,
  midambleAllocationMode            CHOICE {
    defaultMidamble                 NULL,
    ueSpecificMidamble              INTEGER (0..15)
  },
  -- Actual value midambleConfiguration = IE value * 2
  midambleConfiguration            INTEGER (1..8)
}

E-HICH-Information-TDD128 ::=       SEQUENCE {
  n-E-HICH                           INTEGER (4..15),
  e-HICH-InfoList                   E-HICH-Information-LCR-List
}

E-HICH-Information-LCR-List ::=     SEQUENCE (SIZE (1..maxNumE-HICH)) OF
  E-HICH-Information-LCR

E-HICH-RGCH-SignatureSequence ::=  INTEGER (0..39)

E-PUCH-Info ::=                    SEQUENCE {
  e-TFCS-Info                       E-TFCS-Info,
  modeSpecificInfo                  CHOICE {
    tdd348-tdd768                   SEQUENCE {
      noSlotsForTFCIandTPC          INTEGER (1..12),
      e-PUCH-ContantValue           INTEGER (-35..10),
      e-PUCH-TS-ConfigurationList   SEQUENCE (SIZE (1..maxTS-2)) OF E-PUCH-TS-Slots,
      e-PUCH-CodeHopping            BOOLEAN,
      e-PUCH-TPC-Step-Size          INTEGER (1..3),
      minimum-Allowed-Code-Rate     INTEGER (0..63),
      maximum-Allowed-Code-Rate     INTEGER (0..63)
    },
    tdd128                           SEQUENCE {
      snpl-ReportType               ENUMERATED { type1, type2 }           OPTIONAL,
      prxBASEdes                    INTEGER (-112..-50),
      beaconPLEst                   BOOLEAN                           OPTIONAL,
      tpc-StepSize                   TPC-StepSizeTDD,
      pebase-PowerControlGAP         PowerControlGAP           OPTIONAL,
      ul-SynchronisationParameters  UL-SynchronisationParameters-r4  OPTIONAL,
      e-PUCH-TS-ConfigurationList    SEQUENCE (SIZE (1..maxTS-LCR-1)) OF
        E-PUCH-TS-Slots-LCR,
      minimum-Allowed-Code-Rate     INTEGER (0..63),
      maximum-Allowed-Code-Rate     INTEGER (0..63),
      maximumNumOfRetransSchedInfo  INTEGER (0..15),
      retransTimerForSchedInfo      ENUMERATED { ms10, ms15, ms20, ms25, ms30, ms35,
        ms40, ms45, ms50, ms55, ms60, ms65, ms70, ms75,
        ms80, ms85, ms90, ms95, ms100, ms110, ms120,
        ms140, ms160, ms200, ms240, ms280, ms320, ms400,
        ms480, ms560 }
    }
  },
  -- For 3.84/7.68 TDD only, should be ignored for 1.28Mcps TDD mode
  powerOffsetForSchedInfo           INTEGER (0..6)                       OPTIONAL
}

E-PUCH-TS-Slots ::=                SEQUENCE {
  ts-Number                         INTEGER (0..14),
  midambleShiftAndBurstType         MidambleShiftAndBurstType-EDCH
}

E-PUCH-TS-Slots-LCR ::=            SEQUENCE {
  timeslotNumber                    TimeslotNumber-LCR-r4,
  midambleAllocationMode            CHOICE {
    defaultMidamble                 NULL,
    ueSpecificMidamble              INTEGER (0..15)
  },
  -- Actual value midambleConfiguration = IE value * 2
  midambleConfiguration            INTEGER (1..8)
}

E-RGCH-CombinationIndex ::=        INTEGER (0..5)

E-RGCH-Information ::=              SEQUENCE {

```

```

signatureSequence          E-HICH-RGCH-SignatureSequence,
rg-CombinationIndex       E-RGCH-CombinationIndex
}

E-RUCCH-AccessServiceClass ::=          PRACH-Partitioning-LCR-r4

E-RUCCH-Info ::=          SEQUENCE {
  modeSpecificInfo        CHOICE {
    tdd384-tdd768          SEQUENCE {
      e-RUCCH-ConstantValue      INTEGER (-35..10),
      e-RUCCH-PersistenceScalingFactor PersistenceScalingFactor,
      t-RUCCH                     ENUMERATED {ms40, ms80, ms120, ms160, ms200,
                                             ms240, ms280, ms320}          OPTIONAL,
      e-RUCCH-TS-Number           INTEGER (0..14)                      OPTIONAL,
      e-RUCCH-Midamble            ENUMERATED {direct, direct-Inverted}  OPTIONAL,
      t-adv                       ENUMERATED { sec1, sec2, sec4, sec8, sec16,
                                             sec32, sec128, infinity }    OPTIONAL,
      t-SCHED                     ENUMERATED { zero, ms40, ms80, ms160, ms250,
                                             sec1, sec2, sec4 }          OPTIONAL,
      modeSpecificInfo            CHOICE {
        tdd384                   CHOICE {
          sF16                     SEQUENCE (SIZE (1..8)) OF SF16Codes,
          sF8                       SEQUENCE (SIZE (1..8)) OF SF8Codes
        },
        tdd768                   CHOICE {
          sF32                     SEQUENCE (SIZE (1..16)) OF SF32Codes,
          sF816                   SEQUENCE (SIZE (1..16)) OF SF16Codes2
        }
      }
    },
    tdd128                    SEQUENCE {
      t-RUCCH                     ENUMERATED { ms20, ms40, ms60, ms80, ms120,
                                             ms160, ms200, ms240, ms280, ms320,
                                             ms400, ms500, ms600, ms800, ms1000,
                                             ms2000 }          OPTIONAL,
      n-RUCCH                     INTEGER (0..7)                      OPTIONAL,
      t-WAIT                      ENUMERATED { everyEDCHTTI, ms40, ms80, ms160,
                                             ms320, ms640, ms1000, ms2000 }  OPTIONAL,
      t-SI                       ENUMERATED { everyEDCHTTI, ms20, ms40, ms60, ms80,
                                             ms160, ms200 }          OPTIONAL,
      extendedEstimationWindow    INTEGER (2..5)                      OPTIONAL,
      e-RUCCH-AccessServiceClass  E-RUCCH-AccessServiceClass          OPTIONAL,
      e-RUCCH-PersistenceScalingFactor PersistenceScalingFactorList    OPTIONAL,
      sync-UL-InfoForE-RUCCH      SYNC-UL-InfoForE-RUCCH          OPTIONAL,
      prach-information            PRACH-Information-LCR-List          OPTIONAL
    }
  }
}

E-TFC-Boost-Info-r7 ::=          SEQUENCE {
  e-TFCI-Boost                INTEGER (0..127),
  delta-T2TP                  INTEGER (0..6)                      OPTIONAL
}

E-TFCI-TableIndex ::=          INTEGER (0..1)

E-TFCS-Info ::=          SEQUENCE {
  reference-Beta-QPSK-List     SEQUENCE (SIZE (1..8)) OF Reference-Beta-QPSK,
  reference-Beta-16QAM-List    SEQUENCE (SIZE (1..8)) OF Reference-Beta-16QAM
}

EnablingDelay ::=          ENUMERATED {
  radio-frames-0,
  radio-frames-1,
  radio-frames-2,
  radio-frames-4,
  radio-frames-8,
  radio-frames-16,
  radio-frames-32,
  radio-frames-64,
  radio-frames-128,
  spare7,
  spare6,
  spare5,
  spare4,
  spare3,
  spare2,
}

```

```

        spare1 }

EXT-UL-TimingAdvance ::=
    modeSpecificInfo
        tdd384
            ex-ul-TimingAdvance
        },
        tdd768
            ex-ul-TimingAdvance
    }
}

FACH-PCH-Information ::=
    transportFormatSet
    transportChannelIdentity
    ctch-Indicator
}

FACH-PCH-InformationList ::=
    SEQUENCE (SIZE (1..maxFACHPCH)) OF
        FACH-PCH-Information

Feedback-cycle ::=
    ENUMERATED {
        fc0, fc2, fc4, fc8, fc10, fc20, fc40, fc80, fc160}

Feedback-cycle-r7 ::=
    ENUMERATED {
        fc0, fc2, fc4, fc8, fc10, fc20, fc40, fc80, fc160,
        fc16, fc32, fc64, spare4, spare3, spare2, spare1 }

FPACH-Info-r4 ::=
    timeslot
    channelisationCode
    midambleShiftAndBurstType
    wi
}

FrequencyInfo ::=
    modeSpecificInfo
        fdd
        tdd
}

FrequencyInfoFDD ::=
    uarfcn-UL
    uarfcn-DL
}

FrequencyInfoTDD ::=
    uarfcn-Nt
}

HappyBit-DelayCondition ::=
    ENUMERATED {
        ms2, ms10, ms20, ms50, ms100, ms200, ms500, ms1000 }

HARQ-Preamble-Mode ::=
    INTEGER (0..1)

HS-ChannelisationCode-LCR ::=
    ENUMERATED {
        cc16-1, cc16-2, cc16-3, cc16-4,
        cc16-5, cc16-6, cc16-7, cc16-8,
        cc16-9, cc16-10, cc16-11, cc16-12,
        cc16-13, cc16-14, cc16-15, cc16-16 }

HS-DSCH-CommonSystemInformation ::=
    ccch-MappingInfo
    srbl-MappingInfo
    common-MAC-ehs-ReorderingQueueList
    hs-scch-SystemInfo
    harq-SystemInfo
    common-H-RNTI-information
    bcchSpecific-H-RNTI
}

HS-DSCH-PagingSystemInformation ::=
    dlScramblingCode
    pich-ForHSDPASupportedPagingList
    numberOfPcchTransmissions
}

```

```

transportBlockSizeList          SEQUENCE (SIZE (1..2)) OF
                                TransportBlockSizeIndex
}

HS-DSCH-TBSizeTable ::=          ENUMERATED { octetAligned }

HS-PDSCH-Midamble-Configuration-TDD128 ::= SEQUENCE {
  midambleAllocationMode        CHOICE {
    defaultMidamble              NULL,
    commonMidamble               NULL,
    ueSpecificMidamble           INTEGER (0..15)
  },
  -- Actual value midambleConfiguration = IE value * 2
  midambleConfiguration         INTEGER (1..8)
}

HS-SCCH-Info ::=                SEQUENCE {
  modeSpecificInfo              CHOICE {
    fdd                          SEQUENCE {
      hs-SCCHChannelisationCodeInfo SEQUENCE (SIZE (1..maxHSSCCHs)) OF
                                   HS-SCCH-Codes,
      dl-ScramblingCode           SecondaryScramblingCode      OPTIONAL
    },
    tdd                          CHOICE {
      tdd384                     SEQUENCE {
        nack-ack-power-offset      INTEGER (-7..8),
        hs-SICH-PowerControl-Info  HS-SICH-Power-Control-Info-TDD384,
        hs-SCCH-SetConfiguration  SEQUENCE (SIZE (1..maxHSSCCHs)) OF
                                   HS-SCCH-TDD384
      },
      tdd128                     SEQUENCE (SIZE (1..maxHSSCCHs)) OF
                                   HS-SCCH-TDD128
    }
  }
}

HS-SCCH-Info-r6 ::=            SEQUENCE {
  modeSpecificInfo              CHOICE {
    fdd                          SEQUENCE {
      hs-SCCHChannelisationCodeInfo SEQUENCE (SIZE (1..maxHSSCCHs)) OF
                                   HS-SCCH-Codes,
      dl-ScramblingCode           SecondaryScramblingCode      OPTIONAL
    },
    tdd                          CHOICE {
      tdd384                     SEQUENCE {
        nack-ack-power-offset      INTEGER (-7..8),
        hs-SICH-PowerControl-Info  HS-SICH-Power-Control-Info-TDD384,
        dhs-sync                   DHS-Sync                    OPTIONAL,
        bler-target                Bler-Target,
        hs-SCCH-SetConfiguration  SEQUENCE (SIZE (1..maxHSSCCHs)) OF
                                   HS-SCCH-TDD384-r6
      },
      tdd128                     SEQUENCE {
        nack-ack-power-offset      INTEGER (-7..8),
        power-level-HSSICH         INTEGER (-120..-58),
        tpc-step-size              ENUMERATED { s1, s2, s3 , spare1 },
        bler-target                Bler-Target,
        hs-SCCH-SetConfiguration  SEQUENCE (SIZE (1..maxHSSCCHs)) OF
                                   HS-SCCH-TDD128-r6
      }
    }
  }
}

HS-SCCH-Info-r7 ::=            SEQUENCE {
  modeSpecificInfo              CHOICE {
    fdd                          SEQUENCE {
      hs-SCCHChannelisationCodeInfo SEQUENCE (SIZE (1..maxHSSCCHs)) OF
                                   HS-SCCH-Codes,
      dl-ScramblingCode           SecondaryScramblingCode      OPTIONAL
    },
    tdd                          CHOICE {
      tdd384                     SEQUENCE {
        nack-ack-power-offset      INTEGER (-7..8),
        hs-SICH-PowerControl-Info  HS-SICH-Power-Control-Info-TDD384,
        dhs-sync                   DHS-Sync                    OPTIONAL,
        bler-target                Bler-Target,
        hs-SCCH-SetConfiguration  SEQUENCE (SIZE (1..maxHSSCCHs)) OF

```

```

    },
    tdd768
        nack-ack-power-offset          INTEGER (-7..8),
        hs-SICH-PowerControl-Info      HS-SICH-Power-Control-Info-TDD768,
        dhs-sync                        DHS-Sync OPTIONAL,
        bler-target                     Bler-Target,
        hs-SCCH-SetConfiguration       SEQUENCE (SIZE (1..maxHSSCCHs)) OF
                                        HS-SCCH-TDD768
    },
    tdd128
        nack-ack-power-offset          INTEGER (-7..8),
        power-level-HSSICH             INTEGER (-120..-58),
        tpc-step-size                  ENUMERATED { s1, s2, s3 , spare1 },
        bler-target                     Bler-Target,
        powerControlGAP                 PowerControlGAP OPTIONAL,
        pathlossCompensationSwitch      BOOLEAN OPTIONAL,
        hs-SCCH-SetConfiguration       SEQUENCE (SIZE (1..maxHSSCCHs)) OF
                                        HS-SCCH-TDD128-r6
    }
}
}

HS-SCCH-Codes ::= INTEGER (0..127)

HS-SCCH-Less-NewOperation ::= SEQUENCE {
    hs-pdsch-CodeIndex          INTEGER (1..15),
    hs-scch-LessTFSList        HS-SCCH-LessTFSList
}

HS-SCCH-LessInfo-r7 ::= SEQUENCE {
    hs-scchLessOperation        CHOICE {
        continue                NULL,
        newOperation            HS-SCCH-Less-NewOperation
    }
}

HS-SCCH-LessTFSList ::= SEQUENCE (SIZE (1..maxHS-SCCHLessTrBlk)) OF
    SEQUENCE {
        hs-scch-LessTFSI        INTEGER (1..90),
        hs-scch-LessSecondCodeSupport BOOLEAN
    }
}

HS-SCCH-SystemInfo ::= SEQUENCE {
    dl-ScramblingCode           SecondaryScramblingCode OPTIONAL,
    hs-SCCHChannelisationCodeInfo SEQUENCE (SIZE (1..maxHSSCCHs)) OF
        HS-SCCH-Codes
}

HS-SCCH-TDD128 ::= SEQUENCE {
    timeslotNumber              TimeslotNumber-LCR-r4,
    firstChannelisationCode     HS-ChannelisationCode-LCR,
    secondChannelisationCode    HS-ChannelisationCode-LCR,
    midambleAllocationMode      CHOICE {
        defaultMidamble         NULL,
        commonMidamble          NULL,
        ueSpecificMidamble      INTEGER(0..15)
    },
    -- Actual value midambleConfiguration = IE value * 2
    midambleConfiguration      INTEGER (1..8),
    bler-target                 Bler-Target,
    hs-sich-configuration       HS-SICH-Configuration-TDD128
}

HS-SCCH-TDD128-r6 ::= SEQUENCE {
    timeslotNumber              TimeslotNumber-LCR-r4,
    firstChannelisationCode     HS-ChannelisationCode-LCR,
    secondChannelisationCode    HS-ChannelisationCode-LCR,
    midambleAllocationMode      CHOICE {
        defaultMidamble         NULL,
        commonMidamble          NULL,
        ueSpecificMidamble      INTEGER(0..15)
    },
    -- Actual value midambleConfiguration = IE value * 2
    midambleConfiguration      INTEGER (1..8),
    hs-sich-configuration       HS-SICH-Configuration-TDD128-r6
}
}

```

```

--for TDD128 Multi-Carrier
HS-SCCH-TDD128-MultiCarrier ::= SEQUENCE {
    uarfcn-HS-SCCH-Rx          UARFCN,
    timeslotNumber            TimeslotNumber-LCR-r4,
    firstChannelisationCode   HS-ChannelisationCode-LCR,
    secondChannelisationCode  HS-ChannelisationCode-LCR,
    midambleAllocationMode    CHOICE {
        defaultMidamble      NULL,
        commonMidamble       NULL,
        ueSpecificMidamble   INTEGER(0..15)
    },
    -- Actual value midambleConfiguration = IE value * 2
    midambleConfiguration    INTEGER (1..8),
    bler-target               Bler-Target,
    hs-sich-configuration    HS-SICH-Configuration-TDD128
}

HS-SICH-Configuration-TDD128 ::= SEQUENCE {
    timeslotNumber            TimeslotNumber-LCR-r4,
    channelisationCode       HS-ChannelisationCode-LCR,
    midambleAllocationMode    CHOICE {
        defaultMidamble      NULL,
        ueSpecificMidamble   SEQUENCE {
            midambleShift    MidambleShiftLong
        }
    },
    -- Actual value midambleConfiguration = IE value * 2
    midambleConfiguration    INTEGER (1..8),
    nack-ack-power-offset    INTEGER (-7..8),
    power-level-HSSICH       INTEGER (-120..-58),
    tpc-step-size            ENUMERATED { s1, s2, s3 , spare1}
}

HS-SICH-Configuration-TDD128-r6 ::= SEQUENCE {
    timeslotNumber            TimeslotNumber-LCR-r4,
    channelisationCode       HS-ChannelisationCode-LCR,
    midambleAllocationMode    CHOICE {
        defaultMidamble      NULL,
        ueSpecificMidamble   SEQUENCE {
            midambleShift    MidambleShiftLong
        }
    },
    -- Actual value midambleConfiguration = IE value * 2
    midambleConfiguration    INTEGER (1..8)
}

HS-SCCH-TDD384 ::= SEQUENCE {
    timeslotNumber            TimeslotNumber,
    channelisationCode        DL-TS-ChannelisationCode,
    midambleAllocationMode    CHOICE {
        defaultMidamble      NULL,
        commonMidamble       NULL,
        ueSpecificMidamble   SEQUENCE {
            midambleShift    MidambleShiftLong
        }
    },
    midambleconfiguration    MidambleConfigurationBurstTypeland3,
    bler-target               Bler-Target,
    hs-sich-configuration    HS-SICH-Configuration-TDD384
}

HS-SCCH-TDD384-r6 ::= SEQUENCE {
    timeslotNumber            TimeslotNumber,
    channelisationCode        DL-TS-ChannelisationCode,
    midambleAllocationMode    CHOICE {
        defaultMidamble      NULL,
        commonMidamble       NULL,
        ueSpecificMidamble   SEQUENCE {
            midambleShift    MidambleShiftLong
        }
    },
    midambleconfiguration    MidambleConfigurationBurstTypeland3,
    hs-sich-configuration    HS-SICH-Configuration-TDD384
}

HS-SCCH-TDD768 ::= SEQUENCE {
    timeslotNumber            TimeslotNumber,

```

```

channelisationCode          DL-TS-ChannelisationCode-VHCR,
midambleAllocationMode     CHOICE {
  defaultMidamble          NULL,
  commonMidamble           NULL,
  ueSpecificMidamble       SEQUENCE {
    midambleShift          MidambleShiftLong
  }
},
midambleconfiguration      MidambleConfigurationBurstTypeand3,
hs-sich-configuration      HS-SICH-Configuration-TDD768
}

HS-SICH-Configuration-TDD384 ::= SEQUENCE {
  timeslotNumber           TimeslotNumber,
  channelisationCode       DL-TS-ChannelisationCode,
  midambleAllocationMode   CHOICE {
    defaultMidamble        NULL,
    ueSpecificMidamble     SEQUENCE {
      midambleShift        MidambleShiftLong
    }
  },
  midambleconfiguration    MidambleConfigurationBurstTypeand3
}

HS-SICH-Configuration-TDD768 ::= SEQUENCE {
  timeslotNumber           TimeslotNumber,
  channelisationCode       DL-TS-ChannelisationCode-VHCR,
  midambleAllocationMode   CHOICE {
    defaultMidamble        NULL,
    ueSpecificMidamble     SEQUENCE {
      midambleShift        MidambleShiftLong
    }
  },
  midambleconfiguration    MidambleConfigurationBurstTypeand3
}

HS-SICH-Power-Control-Info-TDD384 ::= SEQUENCE {
  -- Actual value ul-target-SIR = IE value * 0.5
  ul-target-SIR            INTEGER (-22..40),
  -- Note: IE 'ConstantValue' is used (instead of IE 'ConstantValueTDD') to keep
  -- compatibility with REL-5
  hs-sich-ConstantValue    ConstantValue
}

HS-SICH-Power-Control-Info-TDD768 ::= SEQUENCE {
  -- Actual value ul-target-SIR = IE value * 0.5
  ul-target-SIR            INTEGER (-22..40),
  -- Note: IE 'ConstantValue' is used (instead of IE 'ConstantValueTDD') to keep
  -- compatibility with REL-5
  hs-sich-ConstantValue    ConstantValue
}

IndividualTimeslotInfo ::= SEQUENCE {
  timeslotNumber           TimeslotNumber,
  tfci-Existence          BOOLEAN,
  midambleShiftAndBurstType MidambleShiftAndBurstType
}

IndividualTimeslotInfo-VHCR ::= SEQUENCE {
  timeslotNumber           TimeslotNumber,
  tfci-Existence          BOOLEAN,
  midambleShiftAndBurstType-VHCR MidambleShiftAndBurstType-VHCR
}

IndividualTimeslotInfo-LCR-r4 ::= SEQUENCE {
  timeslotNumber           TimeslotNumber-LCR-r4,
  tfci-Existence          BOOLEAN,
  midambleShiftAndBurstType MidambleShiftAndBurstType-LCR-r4,
  modulation               ENUMERATED { mod-QPSK, mod-8PSK },
  ss-TPC-Symbols           ENUMERATED { zero, one, sixteenOverSF },
  additionalSS-TPC-Symbols INTEGER (1..15) OPTIONAL
}

IndividualTimeslotInfo-LCR-r4-ext ::= SEQUENCE {
  -- timeslotNumber and tfci-Existence is taken from IndividualTimeslotInfo.
  -- midambleShiftAndBurstType in IndividualTimeslotInfo shall be ignored.
  midambleShiftAndBurstType MidambleShiftAndBurstType-LCR-r4,
  modulation               ENUMERATED { mod-QPSK, mod-8PSK },
}

```



```

    ss-TPC-Symbols          ENUMERATED { zero, one, sixteenOverSF }
}

IndividualTimeslotInfo-r7 ::= SEQUENCE {
    timeslotNumber          TimeslotNumber,
    tfci-Existence         BOOLEAN,
    midambleShiftAndBurstType MidambleShiftAndBurstType-r7
}

IndividualTS-Interference ::= SEQUENCE {
    timeslot                TimeslotNumber,
    ul-TimeslotInterference TDD-UL-Interference
}

IndividualTS-InterferenceList ::= SEQUENCE (SIZE (1..maxTS)) OF
    IndividualTS-Interference

ITP ::= ENUMERATED {
    mode0, mode1 }

NidentifyAbort ::= INTEGER (1..128)

MAC-DTX-Cycle-10ms ::= ENUMERATED {
    sub-frames-5,
    sub-frames-10,
    sub-frames-20,
    spare1 }

MAC-DTX-Cycle-2ms ::= ENUMERATED {
    sub-frames-1,
    sub-frames-4,
    sub-frames-5,
    sub-frames-8,
    sub-frames-10,
    sub-frames-16,
    sub-frames-20,
    spare1 }

MAC-InactivityThreshold ::= ENUMERATED {
    e-dch-tti-1,
    e-dch-tti-2,
    e-dch-tti-4,
    e-dch-tti-8,
    e-dch-tti-16,
    e-dch-tti-32,
    e-dch-tti-64,
    e-dch-tti-128,
    e-dch-tti-256,
    e-dch-tti-512,
    e-dch-tti-Infinity,
    spare5,
    spare4,
    spare3,
    spare2,
    spare1 }

MaxAllowedUL-TX-Power ::= INTEGER (-50..33)

MaxAvailablePCPCH-Number ::= INTEGER (1..64)
MaxPowerIncrease-r4 ::= INTEGER (0..3)

MaxTFCI-Field2Value ::= INTEGER (1..1023)

Measurement-Feedback-Info ::= SEQUENCE {
    modeSpecificInfo      CHOICE {
        fdd                SEQUENCE {
            measurementPowerOffset MeasurementPowerOffset,
            feedback-cycle   Feedback-cycle,
            cqi-RepetitionFactor CQI-RepetitionFactor,
            deltaCQI         DeltaCQI
        },
        tdd                NULL
    }
}

Measurement-Feedback-Info-r7 ::= SEQUENCE {
    modeSpecificInfo      CHOICE {
        fdd                SEQUENCE {

```

```

        measurementPowerOffset      MeasurementPowerOffset,
        feedback-cycle               Feedback-cycle-r7,
        cqi-RepetitionFactor         CQI-RepetitionFactor,
        deltaCQI                     DeltaCQI
    },
    tdd                               NULL
}
}

MidambleConfigurationBurstTypeLand3 ::= ENUMERATED {ms4, ms8, ms16}

MidambleConfigurationBurstType1 ::= ENUMERATED {ms4, ms8, ms16}

MidambleConfigurationBurstType2 ::=      ENUMERATED {ms3, ms6}

MidambleConfigurationBurstType2-VHCR ::=      ENUMERATED {ms4, ms8}

MidambleShiftAndBurstType ::=      SEQUENCE {
    burstType                          CHOICE {
        type1                          SEQUENCE {
            midambleConfigurationBurstTypeLand3 MidambleConfigurationBurstTypeLand3,
            midambleAllocationMode             CHOICE {
                defaultMidamble              NULL,
                commonMidamble               NULL,
                ueSpecificMidamble           SEQUENCE {
                    midambleShift            MidambleShiftLong
                }
            }
        },
        type2                          SEQUENCE {
            midambleConfigurationBurstType2    MidambleConfigurationBurstType2,
            midambleAllocationMode             CHOICE {
                defaultMidamble              NULL,
                commonMidamble               NULL,
                ueSpecificMidamble           SEQUENCE {
                    midambleShift            MidambleShiftShort
                }
            }
        },
        type3                          SEQUENCE {
            midambleConfigurationBurstTypeLand3 MidambleConfigurationBurstTypeLand3,
            midambleAllocationMode             CHOICE {
                defaultMidamble              NULL,
                ueSpecificMidamble           SEQUENCE {
                    midambleShift            MidambleShiftLong
                }
            }
        }
    }
}

MidambleShiftAndBurstType-VHCR ::= SEQUENCE {
    burstType                          CHOICE {
        type1                          SEQUENCE {
            midambleConfigurationBurstTypeLand3 MidambleConfigurationBurstTypeLand3,
            midambleAllocationMode             CHOICE {
                defaultMidamble              NULL,
                commonMidamble               NULL,
                ueSpecificMidamble           SEQUENCE {
                    midambleShift            MidambleShiftLong
                }
            }
        },
        type2                          SEQUENCE {
            midambleConfigurationBurstType2    MidambleConfigurationBurstType2-VHCR,
            midambleAllocationMode             CHOICE {
                defaultMidamble              NULL,
                commonMidamble               NULL,
                ueSpecificMidamble           SEQUENCE {
                    midambleShift            MidambleShiftShort-VHCR
                }
            }
        },
        type3                          SEQUENCE {
            midambleConfigurationBurstTypeLand3 MidambleConfigurationBurstTypeLand3,
            midambleAllocationMode             CHOICE {
                defaultMidamble              NULL,
                ueSpecificMidamble           SEQUENCE {

```

```

        midambleShift                               MidambleShiftLong
    }
}
},
-- mbsfnBurstType4 is only used DL
mbsfnBurstType4                                NULL
}
}

MidambleShiftAndBurstType-r7 ::= SEQUENCE {
    burstType CHOICE {
        type1 SEQUENCE {
            midambleConfigurationBurstType1and3 MidambleConfigurationBurstType1and3,
            midambleAllocationMode CHOICE {
                defaultMidamble NULL,
                commonMidamble NULL,
                ueSpecificMidamble SEQUENCE {
                    midambleShift MidambleShiftLong
                }
            }
        },
        type2 SEQUENCE {
            midambleConfigurationBurstType2 MidambleConfigurationBurstType2,
            midambleAllocationMode CHOICE {
                defaultMidamble NULL,
                commonMidamble NULL,
                ueSpecificMidamble SEQUENCE {
                    midambleShift MidambleShiftShort
                }
            }
        },
        type3 SEQUENCE {
            midambleConfigurationBurstType1and3 MidambleConfigurationBurstType1and3,
            midambleAllocationMode CHOICE {
                defaultMidamble NULL,
                ueSpecificMidamble SEQUENCE {
                    midambleShift MidambleShiftLong
                }
            }
        },
        -- mbsfnBurstType4 is only used DL
        mbsfnBurstType4 NULL
    }
}

MidambleShiftAndBurstType-DL ::= SEQUENCE {
    burstType CHOICE {
        type1 SEQUENCE {
            midambleConfigurationBurstType1and3 MidambleConfigurationBurstType1and3,
            midambleAllocationMode CHOICE {
                defaultMidamble NULL,
                commonMidamble NULL,
                ueSpecificMidamble SEQUENCE {
                    midambleShift MidambleShiftLong
                }
            }
        },
        type2 SEQUENCE {
            midambleConfigurationBurstType2 MidambleConfigurationBurstType2,
            midambleAllocationMode CHOICE {
                defaultMidamble NULL,
                commonMidamble NULL,
                ueSpecificMidamble SEQUENCE {
                    midambleShift MidambleShiftShort
                }
            }
        }
    }
}

MidambleShiftAndBurstType-DL-VHCR ::= SEQUENCE {
    burstType CHOICE {
        type1 SEQUENCE {
            midambleConfigurationBurstType1and3 MidambleConfigurationBurstType1and3,
            midambleAllocationMode CHOICE {
                defaultMidamble NULL,
                commonMidamble NULL,
                ueSpecificMidamble SEQUENCE {

```

```

        midambleShift
    }
},
type2
    midambleConfigurationBurstType2 SEQUENCE {
        midambleAllocationMode CHOICE {
            defaultMidamble NULL,
            commonMidamble NULL,
            ueSpecificMidamble SEQUENCE {
                midambleShift MidambleShiftShort-VHCR
            }
        }
    }
}

MidambleShiftAndBurstType-LCR-r4 ::= SEQUENCE {
    midambleAllocationMode CHOICE {
        defaultMidamble NULL,
        commonMidamble NULL,
        ueSpecificMidamble SEQUENCE {
            midambleShift INTEGER (0..15)
        }
    }
},
-- Actual value midambleConfiguration = IE value * 2
midambleConfiguration INTEGER (1..8)
}

MidambleShiftAndBurstType-EDCH ::= SEQUENCE {
    burstType CHOICE {
        type1 SEQUENCE {
            midambleConfigurationBurstType1 MidambleConfigurationBurstType1,
            midambleAllocationMode CHOICE {
                defaultMidamble NULL,
                commonMidamble NULL,
                ueSpecificMidamble SEQUENCE {
                    midambleShift MidambleShiftLong
                }
            }
        }
    }
},
type2 SEQUENCE {
    midambleConfigurationBurstType2 MidambleConfigurationBurstType2,
    midambleAllocationMode CHOICE {
        defaultMidamble NULL,
        commonMidamble NULL,
        ueSpecificMidamble SEQUENCE {
            midambleShift MidambleShiftShort
        }
    }
}
}

MidambleShiftLong ::= INTEGER (0..15)

MidambleShiftShort ::= INTEGER (0..5)

MidambleShiftShort-VHCR ::= INTEGER (0..7)

MIMO-N-M-Ratio ::= ENUMERATED {
    mnm12, mnm23, mnm34, mnm45, mnm56,
    mnm67, mnm78, mnm89, mnm910, mnm11 }

MIMO-Operation ::= ENUMERATED {
    start, continue }

MIMO-Parameters-r7 ::= SEQUENCE {
    mimoOperation MIMO-Operation,
    mimoN-M-Ratio MIMO-N-M-Ratio OPTIONAL,
    mimoPilotConfiguration MIMO-PilotConfiguration OPTIONAL
}

MIMO-Parameters-v7f0ext ::= MIMO-PilotConfiguration-v7f0ext

MIMO-Parameters-v7g0ext ::= SEQUENCE {
    precodingWeightSetRestriction ENUMERATED { true } OPTIONAL
}

```

```

}

MIMO-PilotConfiguration ::= SEQUENCE {
    secondCPICH-Pattern CHOICE {
        normalPattern NULL,
        diversityPattern SEQUENCE {
            channelisationCode ChannelisationCode256
        }
    }
}

MIMO-PilotConfiguration-v7f0ext ::= SEQUENCE {
    s-cpich-PowerOffset-Mimo S-CPICH-PowerOffset-MIMO OPTIONAL
}

MinimumSpreadingFactor ::= ENUMERATED {
    sf4, sf8, sf16, sf32,
    sf64, sf128, sf256 }

MultiCodeInfo ::= INTEGER (1..16)

-- These IEs are applied for 1.28 Mcps TDD only
Multi-frequencyInfo-LCR-r7 ::= SEQUENCE {
    -- If the secondary frequency is present, it indicates working frequency
    secondFrequencyInfo FrequencyInfoTDD OPTIONAL,
    fPachFrequencyInfo FrequencyInfoTDD OPTIONAL,
    -- If a cell UpPCH uses other uplink service timeslot, it indicates the UpPCH position
    upPCHpositionInfo UpPCHposition-LCR OPTIONAL
}

N-EOT ::= INTEGER (0..7)

N-GAP ::= ENUMERATED {
    f2, f4, f8 }

N-PCH ::= INTEGER (1..8)

N-StartMessage ::= INTEGER (1..8)

NB01 ::= INTEGER (0..50)

NewTiming ::= SEQUENCE {
    enablingDelay EnablingDelay,
    ue-dtx-drx-Offset UE-DTX-DRX-Offset
}

NF-Max ::= INTEGER (1..64)

Non-ScheduledTransGrantInfoTDD ::= CHOICE {
    tdd384-768 SEQUENCE {
        timeslotResourceRelatedInfo BIT STRING (SIZE (13)),
        powerResourceRelatedInfo INTEGER (1..32),
        activationTime ActivationTime,
        repetitionPeriodAndLength RepetitionPeriodAndLength OPTIONAL,
        codeResourceInfo UL-TS-ChannelisationCode
    },
    tdd128 SEQUENCE {
        n-E-UCCH INTEGER (1..8) OPTIONAL,
        n-E-HICH INTEGER (4..15) OPTIONAL,
        timeslotResourceRelatedInfo BIT STRING (SIZE (5)),
        powerResourceRelatedInfo INTEGER (1..32),
        activationTime ActivationTime,
        sfNum INTEGER (0..1),
        repetitionPeriodAndLength RepetitionPeriodAndLength OPTIONAL,
        codeResourceInfo UL-TS-ChannelisationCode,
        e-HICH-Info SEQUENCE {
            timeslotNumber TimeslotNumber-LCR-r4,
            channelisation-Code HS-ChannelisationCode-LCR,
            midambleAllocationMode CHOICE {
                defaultMidamble NULL,
                ueSpecificMidamble INTEGER (0..15)
            }
        },
        -- Actual value midambleConfiguration = IE value * 2
        midambleConfiguration INTEGER (1..8),
        signatureSequenceGroupIndex INTEGER (0..19)
    }
}

```

```

    }
}

Non-ScheduledTransGrantInfoTDD-ext ::= CHOICE {
    tdd384-768          NULL,
    tdd128             SEQUENCE {
        t-SI-nst       ENUMERATED {
            everyEDCHTTI, ms20, ms40, ms60, ms80, ms160,
            ms200 } OPTIONAL
        }
    }
}

NumberOfDPDCH ::= INTEGER (1..maxDPDCH-UL)

NumberOfFBI-Bits ::= INTEGER (1..2)

NumberOfTPC-Bits ::= ENUMERATED { tpc4 }

OpenLoopPowerControl-TDD ::= SEQUENCE {
    primaryCCPCH-TX-Power PrimaryCCPCH-TX-Power,
    -- alpha, prach-ConstantValue, dpch-ConstantValue and pusch-ConstantValue
    -- shall be ignored in 1.28Mcps TDD mode.
    alpha                Alpha OPTIONAL,
    prach-ConstantValue  ConstantValueTdd,
    dpch-ConstantValue   ConstantValueTdd,
    pusch-ConstantValue  ConstantValueTdd OPTIONAL
}

OpenLoopPowerControl-IPDL-TDD-r4 ::= SEQUENCE {
    ipdl-alpha           Alpha,
    maxPowerIncrease     MaxPowerIncrease-r4
}

PagingIndicatorLength ::= ENUMERATED {
    pi4, pi8, pi16 }

PC-Preamble ::= INTEGER (0..7)

PCP-Length ::= ENUMERATED {
    as0, as8 }

PCPCH-ChannelInfo ::= SEQUENCE {
    pcpch-UL-ScramblingCode INTEGER (0..79),
    pcpch-DL-ChannelisationCode INTEGER (0..511),
    pcpch-DL-ScramblingCode SecondaryScramblingCode OPTIONAL,
    pcp-Length              PCP-Length,
    ucsm-Info               UCSM-Info OPTIONAL
}

PCPCH-ChannelInfoList ::= SEQUENCE (SIZE (1..maxPCPCHs)) OF
    PCPCH-ChannelInfo

PCPICH-UsageForChannelEst ::= ENUMERATED {
    maybeUsed,
    shallNotBeUsed }

PDSCH-CapacityAllocationInfo ::= SEQUENCE {
    -- pdsch-PowerControlInfo is conditional on new-configuration branch below, if this
    -- selected the IE is OPTIONAL otherwise it should not be sent
    pdsch-PowerControlInfo PDSCH-PowerControlInfo OPTIONAL,
    pdsch-AllocationPeriodInfo AllocationPeriodInfo,
    configuration          CHOICE {
        old-Configuration SEQUENCE {
            tfcs-ID          TFCS-IdentityPlain DEFAULT 1,
            pdsch-Identity  PDSCH-Identity
        },
        new-Configuration SEQUENCE {
            pdsch-Info       PDSCH-Info,
            pdsch-Identity  PDSCH-Identity OPTIONAL
        }
    }
}

PDSCH-CapacityAllocationInfo-r4 ::= SEQUENCE {
    pdsch-AllocationPeriodInfo AllocationPeriodInfo,
    configuration          CHOICE {
        old-Configuration SEQUENCE {
            tfcs-ID          TFCS-IdentityPlain DEFAULT 1,

```

```

        pdsch-Identity                PDSCH-Identity
    },
    new-Configuration                 SEQUENCE {
        pdsch-Info                    PDSCH-Info-r4,
        pdsch-Identity                PDSCH-Identity                OPTIONAL,
        pdsch-PowerControlInfo        PDSCH-PowerControlInfo        OPTIONAL
    }
}

PDSCH-CapacityAllocationInfo-r7 ::= SEQUENCE {
    pdsch-AllocationPeriodInfo        AllocationPeriodInfo,
    configuration                       CHOICE {
        old-Configuration              SEQUENCE {
            tfcs-ID                    TFCS-IdentityPlain                DEFAULT 1,
            pdsch-Identity              PDSCH-Identity
        },
        new-Configuration              SEQUENCE {
            pdsch-Info                  PDSCH-Info-r7,
            pdsch-Identity              PDSCH-Identity                OPTIONAL,
            pdsch-PowerControlInfo      PDSCH-PowerControlInfo        OPTIONAL
        }
    }
}

PDSCH-CodeInfo ::= SEQUENCE {
    spreadingFactor                    SF-PDSCH,
    codeNumber                         CodeNumberDSCH,
    multiCodeInfo                     MultiCodeInfo
}

PDSCH-CodeInfoList ::= SEQUENCE (SIZE (1..maxTFCI-2-Combs)) OF
    PDSCH-CodeInfo

PDSCH-CodeMap ::= SEQUENCE {
    spreadingFactor                    SF-PDSCH,
    multiCodeInfo                     MultiCodeInfo,
    codeNumberStart                   CodeNumberDSCH,
    codeNumberStop                     CodeNumberDSCH
}

PDSCH-CodeMapList ::= SEQUENCE (SIZE (1..maxPDSCH-TFCIgroups)) OF
    PDSCH-CodeMap

PDSCH-CodeMapping ::= SEQUENCE {
    dl-ScramblingCode                 SecondaryScramblingCode                OPTIONAL,
    signallingMethod                   CHOICE {
        codeRange                       CodeRange,
        tfci-Range                       DSCH-MappingList,
        explicit-config                 PDSCH-CodeInfoList,
        replace                           ReplacedPDSCH-CodeInfoList
    }
}

PDSCH-Identity ::= INTEGER (1..hiPDSCHidentities)

PDSCH-Info ::= SEQUENCE {
    tfcs-ID                            TFCS-IdentityPlain                DEFAULT 1,
    commonTimeslotInfo                 CommonTimeslotInfo                OPTIONAL,
    pdsch-TimeslotsCodes               DownlinkTimeslotsCodes            OPTIONAL
}

PDSCH-Info-r4 ::= SEQUENCE {
    tfcs-ID                            TFCS-IdentityPlain                DEFAULT 1,
    commonTimeslotInfo                 CommonTimeslotInfo                OPTIONAL,
    tddOption                           CHOICE {
        tdd384                          SEQUENCE {
            pdsch-TimeslotsCodes         DownlinkTimeslotsCodes            OPTIONAL
        },
        tdd128                          SEQUENCE {
            pdsch-TimeslotsCodes         DownlinkTimeslotsCodes-LCR-r4    OPTIONAL
        }
    }
}

PDSCH-Info-r7 ::= SEQUENCE {
    tfcs-ID                            TFCS-IdentityPlain                DEFAULT 1,
    commonTimeslotInfo                 CommonTimeslotInfo                OPTIONAL,

```

```

tddOption
  tdd384
    pdsch-TimeslotsCodes
  },
  tdd768
    pdsch-TimeslotsCodes
  },
  tdd128
    pdsch-TimeslotsCodes
  }
}

PDSCH-Info-LCR-r4 ::=
  tfcs-ID
  commonTimeslotInfo
  pdsch-TimeslotsCodes
}

PDSCH-PowerControlInfo ::=
  tpc-StepSizeTDD
  ul-CCTrChTPCList
}

PDSCH-SHO-DCH-Info ::=
  dsch-RadioLinkIdentifier
  rl-IdentifierList
}

PDSCH-SysInfo ::=
  pdsch-Identity
  pdsch-Info
  dsch-TFS
  dsch-TFCS
}

PDSCH-SysInfo-VHCR-r7 ::=
  pdsch-Identity
  pdsch-Info
  dsch-TransportChannelsInfo
  dsch-TFCS
}

PDSCH-SysInfo-HCR-r5 ::=
  pdsch-Identity
  pdsch-Info
  dsch-TransportChannelsInfo
  dsch-TFCS
}

PDSCH-SysInfo-LCR-r4 ::=
  pdsch-Identity
  pdsch-Info
  dsch-TFS
  dsch-TFCS
}

PDSCH-SysInfoList ::=
  SEQUENCE (SIZE (1..maxPDSCH)) OF
    PDSCH-SysInfo

PDSCH-SysInfoList-VHCR-r7 ::=
  SEQUENCE (SIZE (1..maxPDSCH)) OF PDSCH-SysInfo-VHCR-r7

PDSCH-SysInfoList-HCR-r5 ::=
  SEQUENCE (SIZE (1..maxPDSCH)) OF PDSCH-SysInfo-HCR-r5

PDSCH-SysInfoList-LCR-r4 ::=
  SEQUENCE (SIZE (1..maxPDSCH)) OF
    PDSCH-SysInfo-LCR-r4

PDSCH-SysInfoList-SFN ::=
  SEQUENCE (SIZE (1..maxPDSCH)) OF
    SEQUENCE {
      pdsch-SysInfo
      sfn-TimeInfo
    }
    OPTIONAL

PDSCH-SysInfoList-SFN-HCR-r5 ::=
  SEQUENCE (SIZE (1..maxPDSCH)) OF
    SEQUENCE {
      pdsch-SysInfo
      sfn-TimeInfo
    }
    OPTIONAL

```



```

PDSCH-SysInfoList-SFN-LCR-r4 ::= SEQUENCE (SIZE (1..maxPDSCH)) OF
    SEQUENCE {
        pdsch-SysInfo          PDSCH-SysInfo-LCR-r4,
        sfm-TimeInfo           SFN-TimeInfo
    }
    OPTIONAL

PersistenceScalingFactor ::= ENUMERATED {
    psf0-9, psf0-8, psf0-7, psf0-6,
    psf0-5, psf0-4, psf0-3, psf0-2 }

PersistenceScalingFactorList ::= SEQUENCE (SIZE (1..maxASCpersist)) OF
    PersistenceScalingFactor

PI-CountPerFrame ::= ENUMERATED {
    e18, e36, e72, e144 }

PichChannelisationCodeList-LCR-r4 ::= SEQUENCE (SIZE (1..2)) OF
    DL-TS-ChannelisationCode

PICH-ForHSDPASupportedPaging ::= SEQUENCE {
    hsdpa-AssociatedPichInfo    PICH-Info,
    hs-pdschChannelisationCode INTEGER(1..15)
}

PICH-Info ::= CHOICE {
    fdd SEQUENCE {
        channelisationCode256    ChannelisationCode256,
        pi-CountPerFrame         PI-CountPerFrame,
        sttd-Indicator           BOOLEAN
    },
    tdd SEQUENCE {
        channelisationCode        TDD-PICH-CCode
        timeslot                  TimeslotNumber
        midambleShiftAndBurstType MidambleShiftAndBurstType,
        repetitionPeriodLengthOffset RepPerLengthOffset-PICH
        pagingIndicatorLength     PagingIndicatorLength
        n-GAP                     N-GAP
        n-PCH                     N-PCH
    }
}
    OPTIONAL,
    OPTIONAL,
    OPTIONAL,
    DEFAULT pi4,
    DEFAULT f4,
    DEFAULT 2

PICH-Info-HCR-VHCR-r7 ::= SEQUENCE {
    channelisationCode          CHOICE {
        tdd384                  TDD-PICH-CCode,
        tdd768                  TDD768-PICH-CCode
    }
    OPTIONAL,
    TimeslotNumber              OPTIONAL,
    MidambleShiftAndBurstType   OPTIONAL,
    RepPerLengthOffset-PICH     OPTIONAL,
    PagingIndicatorLength       DEFAULT pi4,
    N-GAP                       DEFAULT f4,
    N-PCH                       DEFAULT 2
}

PICH-Info-LCR-r4 ::= SEQUENCE {
    timeslot                    TimeslotNumber-LCR-r4
    pichChannelisationCodeList-LCR-r4 PichChannelisationCodeList-LCR-r4,
    midambleShiftAndBurstType   MidambleShiftAndBurstType-LCR-r4,
    repetitionPeriodLengthOffset RepPerLengthOffset-PICH
    pagingIndicatorLength       PagingIndicatorLength
    n-GAP                       N-GAP
    n-PCH                       N-PCH
}
    OPTIONAL,
    OPTIONAL,
    OPTIONAL,
    DEFAULT pi4,
    DEFAULT f4,
    DEFAULT 2

PICH-PowerOffset ::= INTEGER (-10..5)

PilotBits128 ::= ENUMERATED {
    pb4, pb8 }

PilotBits256 ::= ENUMERATED {
    pb2, pb4, pb8 }

-- Actual measurement power offset value = IE value * 0.5
MeasurementPowerOffset ::= INTEGER (-12..26)

PLCCH-Info ::= SEQUENCE {
    plcchSequenceNumber        INTEGER(1..14),
}

```

```

    timeslotNumber          TimeslotNumber-LCR-r4,
    channelisationCode      DL-TS-ChannelisationCode,
    tpcCommandTargetRate    TPC-CommandTargetRate
}

PositionFixedOrFlexible ::= ENUMERATED {
    fixed,
    flexible }

PowerControlAlgorithm ::= CHOICE {
    algorithm1              TPC-StepSizeFDD,
    algorithm2              NULL
}

PowerControlGAP ::= INTEGER (0..255)

PowerOffsetPilot-pdpdch ::= INTEGER (0..24)

PowerOffsetTPC-pdpdch ::= INTEGER (0..24)

PowerRampStep ::= INTEGER (1..8)

PRACH-ChanCodes-LCR-r4 ::= SEQUENCE (SIZE (1..4)) OF
    TDD-PRACH-CCode-LCR-r4

PRACH-ChanCodes-List-LCR ::= SEQUENCE (SIZE (1..2)) OF
    TDD-PRACH-CCode-LCR-r4

PRACH-Definition-LCR-r4 ::= SEQUENCE {
    timeslot                TimeslotNumber-PRACH-LCR-r4,
    prach-ChanCodes-LCR     PRACH-ChanCodes-LCR-r4,
    midambleShiftAndBurstType MidambleShiftAndBurstType-LCR-r4,
    fpach-Info              FPACH-Info-r4
}

PRACH-Information-LCR ::= SEQUENCE {
    timeslot                TimeslotNumber-PRACH-LCR-r4,
    prach-ChanCodes-list-LCR PRACH-ChanCodes-List-LCR,
    midambleShiftAndBurstType MidambleShiftAndBurstType-LCR-r4,
    fpach-Info              FPACH-Info-r4
} OPTIONAL

PRACH-Information-LCR-List ::= SEQUENCE (SIZE (1..maxPRACH-FPACH)) OF
    PRACH-Information-LCR

PRACH-Midamble ::= ENUMERATED {
    direct,
    direct-Inverted }

PRACH-Partitioning ::= CHOICE {
    fdd                     SEQUENCE (SIZE (1..maxASC)) OF
        -- TABULAR: If only "NumASC+1" (with, NumASC+1 < maxASC) ASCSetting-FDD are listed,
        -- the remaining (NumASC+2 through maxASC) ASCs are unspecified.
        ASCSetting-FDD,
    tdd                     SEQUENCE (SIZE (1..maxASC)) OF
        -- TABULAR: If only "NumASC+1" (with, NumASC+1 < maxASC) ASCSetting-TDD are listed,
        -- the remaining (NumASC+2 through maxASC) ASCs are unspecified.
        ASCSetting-TDD
}

PRACH-Partitioning-r7 ::= CHOICE {
    fdd                     SEQUENCE (SIZE (1..maxASC)) OF
        -- TABULAR: If only "NumASC+1" (with, NumASC+1 < maxASC) ASCSetting-FDD are listed,
        -- the remaining (NumASC+2 through maxASC) ASCs are unspecified.
        ASCSetting-FDD,
    tdd                     SEQUENCE (SIZE (1..maxASC)) OF
        -- TABULAR: If only "NumASC+1" (with, NumASC+1 < maxASC) ASCSetting-TDD are listed,
        -- the remaining (NumASC+2 through maxASC) ASCs are unspecified.
        ASCSetting-TDD-r7
}

PRACH-Partitioning-LCR-r4 ::= SEQUENCE (SIZE (1..maxASC)) OF
    -- TABULAR: If only "NumASC+1" (with, NumASC+1 < maxASC) ASCSetting-TDD-LCR-r4 are listed,
    -- the remaining (NumASC+2 through maxASC) ASCs are unspecified.
    ASCSetting-TDD-LCR-r4

PRACH-PowerOffset ::= SEQUENCE {
    powerRampStep          PowerRampStep,
}

```

```

    preambleRetransMax          PreambleRetransMax
  }
PRACH-RACH-Info ::=
  modeSpecificInfo             SEQUENCE {
    fdd                         CHOICE {
      availableSignatures      AvailableSignatures,
      availableSF              SF-PRACH,
      preambleScramblingCodeWordNumber PreambleScramblingCodeWordNumber,
      puncturingLimit          PuncturingLimit,
      availableSubChannelNumbers AvailableSubChannelNumbers
    },
    tdd                         SEQUENCE {
      timeslot                  TimeslotNumber,
      channelisationCodeList    TDD-PRACH-CCodeList,
      prach-Midamble            PRACH-Midamble
    }
  }
}

PRACH-RACH-Info-VHCR-r7 ::= SEQUENCE {
  timeslot                      TimeslotNumber,
  channelisationCodeList        TDD768-PRACH-CCodeList,
  prach-Midamble                PRACH-Midamble
}

PRACH-RACH-Info-LCR-v770ext ::= SEQUENCE {
  e-RUCCH-Sync-UL-Codes-Bitmap Sync-UL-Codes-Bitmap
}

PRACH-RACH-Info-LCR-r4 ::= SEQUENCE {
  sync-UL-Info                  SYNC-UL-Info-r4,
  prach-DefinitionList          SEQUENCE (SIZE (1..maxPRACH-FPACH)) OF
                                PRACH-Definition-LCR-r4
}

PRACH-SystemInformation ::= SEQUENCE {
  prach-RACH-Info                PRACH-RACH-Info,
  transportChannelIdentity        TransportChannelIdentity,
  rach-TransportFormatSet         TransportFormatSet                OPTIONAL,
  rach-TFCS                       TFCS                            OPTIONAL,
  prach-Partitioning              PRACH-Partitioning                OPTIONAL,
  persistenceScalingFactorList    PersistenceScalingFactorList    OPTIONAL,
  ac-To-ASC-MappingTable          AC-To-ASC-MappingTable          OPTIONAL,
  modeSpecificInfo                CHOICE {
    fdd                            SEQUENCE {
      primaryCPICH-TX-Power        PrimaryCPICH-TX-Power        OPTIONAL,
      constantValue                 ConstantValue                 OPTIONAL,
      prach-PowerOffset             PRACH-PowerOffset             OPTIONAL,
      rach-TransmissionParameters  RACH-TransmissionParameters OPTIONAL,
      aich-Info                     AICH-Info                     OPTIONAL
    },
    tdd                            NULL
  }
}

PRACH-SystemInformation-VHCR-r7 ::= SEQUENCE {
  prach-RACH-Info                PRACH-RACH-Info-VHCR-r7,
  prach-Partitioning              PRACH-Partitioning-r7                OPTIONAL
}

PRACH-SystemInformation-LCR-r4 ::= SEQUENCE {
  prach-RACH-Info-LCR            PRACH-RACH-Info-LCR-r4,
  rach-TransportFormatSet-LCR     TransportFormatSet-LCR        OPTIONAL,
  prach-Partitioning-LCR         PRACH-Partitioning-LCR-r4    OPTIONAL
}

PRACH-SystemInformation-LCR-v770ext ::= SEQUENCE {
  prach-RACH-Info-LCR            PRACH-RACH-Info-LCR-v770ext
}

PRACH-SystemInformationList ::= SEQUENCE (SIZE (1..maxPRACH)) OF
  PRACH-SystemInformation

PRACH-SystemInformationList-VHCR-r7 ::= SEQUENCE (SIZE (1..maxPRACH)) OF
  PRACH-SystemInformation-VHCR-r7

PRACH-SystemInformationList-LCR-r4 ::= SEQUENCE (SIZE (1..maxPRACH)) OF
  PRACH-SystemInformation-LCR-r4

```

```

PRACH-SystemInformation-LCR-r4

PRACH-SystemInformationList-LCR-v770ext ::= SEQUENCE (SIZE (1..maxPRACH)) OF
PRACH-SystemInformation-LCR-v770ext

PreambleRetransMax ::=
INTEGER (1..64)

PreambleScramblingCodeWordNumber ::=
INTEGER (0..15)

PreDefPhyChConfiguration ::=
SEQUENCE {
  ul-DPCH-InfoPredef          UL-DPCH-InfoPredef,
  dl-CommonInformationPredef  DL-CommonInformationPredef  OPTIONAL
}

PreDefPhyChConfiguration-v770ext ::= SEQUENCE {
  ul-DPCH-InfoPredef          UL-DPCH-InfoPredef-v770ext
}

PrimaryCCPCH-Info ::=
CHOICE {
  fdd
    tx-DiversityIndicator      BOOLEAN
  },
  tdd
    -- syncCase should be ignored for 1.28Mcps TDD mode
    syncCase                   CHOICE {
      syncCase1                 SEQUENCE {
        timeslot                TimeslotNumber
      },
      syncCase2                 SEQUENCE {
        timeslotSync2           TimeslotSync2
      }
    }
    cellParametersID           CellParametersID           OPTIONAL,
    sctd-Indicator              BOOLEAN                   OPTIONAL,
}

PrimaryCCPCH-Info-r4 ::=
CHOICE {
  fdd
    tx-DiversityIndicator      BOOLEAN
  },
  tdd
    tddOption                  CHOICE {
      tdd384-tdd768            SEQUENCE {
        syncCase                CHOICE {
          syncCase1             SEQUENCE {
            timeslot            TimeslotNumber
          },
          syncCase2             SEQUENCE {
            timeslotSync2       TimeslotSync2
          }
        }
      }
    }
    tdd128                      SEQUENCE {
      tstd-Indicator            BOOLEAN
    }
    cellParametersID           CellParametersID           OPTIONAL,
    sctd-Indicator              BOOLEAN                   OPTIONAL,
}

PrimaryCCPCH-Info-LCR-r4 ::=
SEQUENCE {
  tstd-Indicator              BOOLEAN,
  cellParametersID           CellParametersID           OPTIONAL,
  sctd-Indicator              BOOLEAN
}

-- For 1.28Mcps TDD, the following IE includes elements for the PCCPCH Info additional to those
-- in PrimaryCCPCH-Info
PrimaryCCPCH-Info-LCR-r4-ext ::=
SEQUENCE {
  tstd-Indicator              BOOLEAN
}

PrimaryCCPCH-InfoPost ::=
SEQUENCE {
  syncCase                   CHOICE {
    syncCase1                 SEQUENCE {
      timeslot                TimeslotNumber
    }
  }
}

```

```

    },
    syncCase2
        timeslotSync2
    }
},
cellParametersID
sctd-Indicator
}

PrimaryCCPCH-InfoPostTDD-LCR-r4 ::= SEQUENCE {
    tstd-Indicator          BOOLEAN,
    cellParametersID       CellParametersID,
    sctd-Indicator         BOOLEAN
}

PrimaryCCPCH-TX-Power ::= INTEGER (6..43)

PrimaryCPICH-Info ::= SEQUENCE {
    primaryScramblingCode PrimaryScramblingCode
}

PrimaryCPICH-TX-Power ::= INTEGER (-10..50)

PrimaryScramblingCode ::= INTEGER (0..511)

PuncturingLimit ::= ENUMERATED {
    pl0-40, pl0-44, pl0-48, pl0-52, pl0-56,
    pl0-60, pl0-64, pl0-68, pl0-72, pl0-76,
    pl0-80, pl0-84, pl0-88, pl0-92, pl0-96, pl1 }

PUSCH-CapacityAllocationInfo ::= SEQUENCE {
    pusch-Allocation
        pusch-AllocationPending
        pusch-AllocationAssignment
        pusch-AllocationPeriodInfo
        pusch-PowerControlInfo
        configuration
            old-Configuration
                tfcs-ID
                pusch-Identity
            },
            new-Configuration
                pusch-Info
                pusch-Identity
        }
    }
}

PUSCH-CapacityAllocationInfo-r4 ::= SEQUENCE {
    pusch-Allocation
        pusch-AllocationPending
        pusch-AllocationAssignment
        pusch-AllocationPeriodInfo
        pusch-PowerControlInfo
        configuration
            old-Configuration
                tfcs-ID
                pusch-Identity
            },
            new-Configuration
                pusch-Info
                pusch-Identity
        }
    }
}

PUSCH-CapacityAllocationInfo-r7 ::= SEQUENCE {
    pusch-Allocation
        pusch-AllocationPending
        pusch-AllocationAssignment
        pusch-AllocationPeriodInfo
        pusch-PowerControlInfo
        configuration
            old-Configuration
                tfcs-ID
                pusch-Identity
            },
            new-Configuration
                pusch-Info
                pusch-Identity
        }
    }
}

```

```

        tfcs-ID
        pusch-Identity
    },
    new-Configuration
    pusch-Info
    pusch-Identity
}
}
}
}
}
}
}
}

PUSCH-Identity ::=
    INTEGER (1..hiPUSCHidentities)

PUSCH-Info ::=
    SEQUENCE {
        tfcs-ID
        commonTimeslotInfo
        pusch-TimeslotsCodes
    }

PUSCH-Info-r4 ::=
    SEQUENCE {
        tfcs-ID
        commonTimeslotInfo
        tddOption
        tdd384
        pusch-TimeslotsCodes
    },
    tdd128
        pusch-TimeslotsCodes
    }

PUSCH-Info-VHCR ::=
    SEQUENCE {
        tfcs-ID
        commonTimeslotInfo
        pusch-TimeslotsCodes-VHCR
    }

PUSCH-Info-LCR-r4 ::=
    SEQUENCE {
        tfcs-ID

        commonTimeslotInfo
        pusch-TimeslotsCodes
    }

PUSCH-PowerControlInfo-r4 ::=
    SEQUENCE {
        -- The IE ul-TargetSIR corresponds to PRX-PUSCHdes for 1.28Mcps TDD
        -- Actual value PRX-PUSCHdes = (value of IE "ul-TargetSIR" - 120)
        ul-TargetSIR
        tddOption
        tdd384
        tdd128
        tpc-StepSize
    }

PUSCH-PowerControlInfo-r7 ::=
    SEQUENCE {
        -- The IE ul-TargetSIR corresponds to PRX-PUSCHdes for 1.28Mcps TDD
        -- Actual value PRX-PUSCHdes = (value of IE "ul-TargetSIR" - 120)
        ul-TargetSIR
        tddOption
        tdd384
        tdd768
        tdd128
        tpc-StepSize
    }

PUSCH-SysInfo ::=
    SEQUENCE {
        pusch-Identity
        pusch-Info
        usch-TFS
        usch-TFCS
    }

```

TFCS-IdentityPlain
PUSCH-Identity

SEQUENCE {
PUSCH-Info-VHCR,
PUSCH-Identity

DEFAULT 1,
OPTIONAL

DEFAULT 1,
OPTIONAL,
OPTIONAL

DEFAULT 1,
OPTIONAL,
OPTIONAL

OPTIONAL,
OPTIONAL

OPTIONAL

OPTIONAL,
OPTIONAL

OPTIONAL

OPTIONAL,
OPTIONAL

OPTIONAL

OPTIONAL,
OPTIONAL

OPTIONAL,
OPTIONAL

```

PUSCH-SysInfo-VHCR ::=
    pusch-Identity
    pusch-Info-VHCR
    usch-TransportChannelsInfo
    usch-TFCS
}
SEQUENCE {
    PUSCH-Identity,
    PUSCH-Info-VHCR,
    USCH-TransportChannelsInfo
    TFCS
}
OPTIONAL,
OPTIONAL

PUSCH-SysInfo-HCR-r5 ::=
    pusch-Identity
    pusch-Info
    usch-TransportChannelsInfo
    usch-TFCS
}
SEQUENCE {
    PUSCH-Identity,
    PUSCH-Info,
    USCH-TransportChannelsInfo
    TFCS
}
OPTIONAL,
OPTIONAL

PUSCH-SysInfo-LCR-r4 ::=
    pusch-Identity
    pusch-Info
    usch-TFS
    usch-TFCS
}
SEQUENCE {
    PUSCH-Identity,
    PUSCH-Info-LCR-r4,
    TransportFormatSet
    TFCS
}
OPTIONAL,
OPTIONAL

PUSCH-SysInfoList ::=
SEQUENCE (SIZE (1..maxPUSCH)) OF
    PUSCH-SysInfo

PUSCH-SysInfoList-HCR-r5 ::=
SEQUENCE (SIZE (1..maxPUSCH)) OF PUSCH-SysInfo-HCR-r5

PUSCH-SysInfoList-LCR-r4 ::=
SEQUENCE (SIZE (1..maxPUSCH)) OF
    PUSCH-SysInfo-LCR-r4

PUSCH-SysInfoList-SFN ::=
SEQUENCE (SIZE (1..maxPUSCH)) OF
    SEQUENCE {
        pusch-SysInfo
        sfn-TimeInfo
    }
    PUSCH-SysInfo,
    SFN-TimeInfo
}
OPTIONAL

PUSCH-SysInfoList-SFN-HCR-r5 ::=
SEQUENCE (SIZE (1..maxPUSCH)) OF
    SEQUENCE {
        pusch-SysInfo
        sfn-TimeInfo
    }
    PUSCH-SysInfo-HCR-r5,
    SFN-TimeInfo
}
OPTIONAL

PUSCH-SysInfoList-SFN-LCR-r4 ::=
SEQUENCE (SIZE (1..maxPUSCH)) OF
    SEQUENCE {
        pusch-SysInfo
        sfn-TimeInfo
    }
    PUSCH-SysInfo-LCR-r4,
    SFN-TimeInfo
}
OPTIONAL

PUSCH-SysInfoList-SFN-VHCR ::=
SEQUENCE (SIZE (1..maxPUSCH)) OF
    SEQUENCE {
        pusch-SysInfo-VHCR
        sfn-TimeInfo
    }
    PUSCH-SysInfo-VHCR,
    SFN-TimeInfo
}
OPTIONAL

RACH-TransmissionParameters ::=
    mmax
    nb01Min
    nb01Max
}
SEQUENCE {
    INTEGER (1..32),
    NB01,
    NB01
}

ReducedScramblingCodeNumber ::=
INTEGER (0..8191)

Reference-Beta-QPSK ::=
    reference-Code-Rate
    reference-Beta
}
SEQUENCE {
    INTEGER (0..10),
    INTEGER (-15..16)
}

Reference-Beta-16QAM ::=
    reference-Code-Rate
    reference-Beta
}
SEQUENCE {
    INTEGER (0..10),
    INTEGER (-15..16)
}

RepetitionPeriodAndLength ::=
    repetitionPeriod1
    -- repetitionPeriod2 could just as well be NULL also.
    repetitionPeriod2
    repetitionPeriod4
    repetitionPeriod8
    repetitionPeriod16
}
CHOICE {
    NULL,
    INTEGER (1..1),
    INTEGER (1..3),
    INTEGER (1..7),
    INTEGER (1..15),
}

```

```

    repetitionPeriod32          INTEGER (1..31),
    repetitionPeriod64          INTEGER (1..63)
}

RepetitionPeriodLengthAndOffset ::= CHOICE {
    repetitionPeriod1          NULL,
    repetitionPeriod2          SEQUENCE {
        length                  NULL,
        offset                  INTEGER (0..1)
    },
    repetitionPeriod4          SEQUENCE {
        length                  INTEGER (1..3),
        offset                  INTEGER (0..3)
    },
    repetitionPeriod8          SEQUENCE {
        length                  INTEGER (1..7),
        offset                  INTEGER (0..7)
    },
    repetitionPeriod16         SEQUENCE {
        length                  INTEGER (1..15),
        offset                  INTEGER (0..15)
    },
    repetitionPeriod32         SEQUENCE {
        length                  INTEGER (1..31),
        offset                  INTEGER (0..31)
    },
    repetitionPeriod64         SEQUENCE {
        length                  INTEGER (1..63),
        offset                  INTEGER (0..63)
    }
}

ReplacedPDSCH-CodeInfo ::= SEQUENCE {
    tfci-Field2                MaxTFCI-Field2Value,
    spreadingFactor            SF-PDSCH,
    codeNumber                  CodeNumberDSCH,
    multiCodeInfo              MultiCodeInfo
}

ReplacedPDSCH-CodeInfoList ::= SEQUENCE (SIZE (1..maxTFCI-2-Combs)) OF
    ReplacedPDSCH-CodeInfo

RepPerLengthOffset-PICH ::= CHOICE {
    rpp4-2                     INTEGER (0..3),
    rpp8-2                     INTEGER (0..7),
    rpp8-4                     INTEGER (0..7),
    rpp16-2                    INTEGER (0..15),
    rpp16-4                    INTEGER (0..15),
    rpp32-2                    INTEGER (0..31),
    rpp32-4                    INTEGER (0..31),
    rpp64-2                    INTEGER (0..63),
    rpp64-4                    INTEGER (0..63)
}

RepPerLengthOffset-MICH ::= CHOICE {
    rpp4-2                     INTEGER (0..3),
    rpp8-2                     INTEGER (0..7),
    rpp8-4                     INTEGER (0..7),
    rpp16-2                    INTEGER (0..15),
    rpp16-4                    INTEGER (0..15),
    rpp32-2                    INTEGER (0..31),
    rpp32-4                    INTEGER (0..31),
    rpp64-2                    INTEGER (0..63),
    rpp64-4                    INTEGER (0..63)
}

RestrictedTrCH ::= SEQUENCE {
    dl-restrictedTrCh-Type     DL-TrCH-Type,
    restrictedDL-TrCH-Identity TransportChannelIdentity,
    allowedTFIList             AllowedTFI-List
}

RestrictedTrCH-InfoList ::= SEQUENCE (SIZE(1..maxTrCH)) OF
    RestrictedTrCH

RL-AdditionInformation ::= SEQUENCE {
    primaryCPICH-Info          PrimaryCPICH-Info,
    dl-DPCH-InfoPerRL         DL-DPCH-InfoPerRL,
}

```



```

-- dummy and dummy2 are not used in this version of specification
-- and the IEs should be ignored.
dummy          BOOLEAN,
dummy2         SCCPCH-InfoForFACH          OPTIONAL
}

RL-AdditionInformation-r6 ::= SEQUENCE {
  primaryCPICH-Info      PrimaryCPICH-Info,
  cell-Id                CellIdentity      OPTIONAL,
  dl-dpchInfo            CHOICE {
    dl-DPCH-InfoPerRL    DL-DPCH-InfoPerRL-r5,
    dl-FDPCH-InfoPerRL    DL-FDPCH-InfoPerRL-r6
  },
  e-HICH-Information     E-HICH-Information OPTIONAL,
  e-RGCH-Information     E-RGCH-Information OPTIONAL
}

RL-AdditionInformation-r7 ::= SEQUENCE {
  primaryCPICH-Info      PrimaryCPICH-Info,
  cell-Id                CellIdentity      OPTIONAL,
  dl-dpchInfo            CHOICE {
    dl-DPCH-InfoPerRL    DL-DPCH-InfoPerRL-r5,
    dl-FDPCH-InfoPerRL    DL-FDPCH-InfoPerRL-r7
  },
  e-HICH-Information     E-HICH-Information OPTIONAL,
  e-RGCH-Information     E-RGCH-Information OPTIONAL
}

RL-AdditionInformation-v6b0ext ::= SEQUENCE {
  sttdIndication         STTDIndication    OPTIONAL
}

RL-AdditionInformationList ::= SEQUENCE (SIZE (1..maxRL-1)) OF
  RL-AdditionInformation

RL-AdditionInformationList-r6 ::= SEQUENCE (SIZE (1..maxRL-1)) OF
  RL-AdditionInformation-r6

RL-AdditionInformationList-r7 ::= SEQUENCE (SIZE (1..maxRL-1)) OF
  RL-AdditionInformation-r7

RL-AdditionInformation-list-v6b0ext ::= SEQUENCE (SIZE (1..maxRL)) OF
  RL-AdditionInformation-v6b0ext

RL-IdentiferList ::= SEQUENCE (SIZE (1..maxRL)) OF
  PrimaryCPICH-Info

RL-RemovalInformationList ::= SEQUENCE (SIZE (1..maxRL)) OF
  PrimaryCPICH-Info

RPP ::= ENUMERATED {
  mode0, mode1 }

S-Field ::= ENUMERATED {
  e1bit, e2bits }

SCCPCH-ChannelisationCode ::= ENUMERATED {
  cc16-1, cc16-2, cc16-3, cc16-4,
  cc16-5, cc16-6, cc16-7, cc16-8,
  cc16-9, cc16-10, cc16-11, cc16-12,
  cc16-13, cc16-14, cc16-15, cc16-16 }

SCCPCH-ChannelisationCode-VHCR ::= ENUMERATED {
  cc32-1, cc32-2, cc32-3, cc32-4,
  cc32-5, cc32-6, cc32-7, cc32-8,
  cc32-9, cc32-10, cc32-11, cc32-12,
  cc32-13, cc32-14, cc32-15, cc32-16,
  cc32-17, cc32-18, cc32-19, cc32-20,
  cc32-21, cc32-22, cc32-23, cc32-24,
  cc32-25, cc32-26, cc32-27, cc32-28,
  cc32-29, cc32-30, cc32-31, cc32-32 }

SCCPCH-ChannelisationCodeList ::= SEQUENCE (SIZE (1..16)) OF
  SCCPCH-ChannelisationCode

SCCPCH-ChannelisationCodeList-VHCR ::= SEQUENCE (SIZE (1..32)) OF
  SCCPCH-ChannelisationCode-VHCR

```

```

SCCPCH-InfoForFACH ::= SEQUENCE {
    secondaryCCPCH-Info      SecondaryCCPCH-Info,
    tfcs                     TFCS,
    modeSpecificInfo        CHOICE {
        fdd                  SEQUENCE {
            fach-PCH-InformationList  FACH-PCH-InformationList,
            sib-ReferenceListFACH      SIB-ReferenceListFACH
        },
        tdd                  SEQUENCE {
            fach-PCH-InformationList  FACH-PCH-InformationList
        }
    }
}

SCCPCH-InfoForFACH-r4 ::= SEQUENCE {
    secondaryCCPCH-Info      SecondaryCCPCH-Info-r4,
    tfcs                     TFCS,
    fach-PCH-InformationList FACH-PCH-InformationList,
    modeSpecificInfo        CHOICE {
        fdd                  SEQUENCE {
            sib-ReferenceListFACH      SIB-ReferenceListFACH
        },
        tdd                  NULL
    }
}

SCCPCH-SystemInformation ::= SEQUENCE {
    secondaryCCPCH-Info      SecondaryCCPCH-Info,
    tfcs                     TFCS,
    fach-PCH-InformationList FACH-PCH-InformationList,
    pich-Info                PICH-Info
}
OPTIONAL,
OPTIONAL,
OPTIONAL

SCCPCH-SystemInformation-LCR-r4-ext ::= SEQUENCE {
    secondaryCCPCH-LCR-Extensions SecondaryCCPCH-Info-LCR-r4-ext,
    -- pich-Info in the SCCPCH-SystemInformation IE shall be absent,
    -- and instead the following used.
    pich-Info                PICH-Info-LCR-r4
}
OPTIONAL

SCCPCH-SystemInformation-HCR-VHCR-r7 ::= SEQUENCE {
    secondaryCCPCH-Info      SecondaryCCPCH-Info-HCR-VHCR-r7,
    tfcs                     TFCS,
    fach-PCH-InformationList FACH-PCH-InformationList,
    pich-Info                PICH-Info-HCR-VHCR-r7
}
OPTIONAL,
OPTIONAL,
OPTIONAL

SCCPCH-SystemInformationList ::= SEQUENCE (SIZE (1..maxSCCPCH)) OF
    SCCPCH-SystemInformation

SCCPCH-SystemInformationList-HCR-VHCR-r7 ::= SEQUENCE (SIZE (1..maxSCCPCH)) OF
    SCCPCH-SystemInformation-HCR-VHCR-r7

-- SCCPCH-SystemInformationList-LCR-r4-ext includes elements additional to those in
-- SCCPCH-SystemInformationList for the 1.28Mcps TDD. The order of the IEs
-- indicates which SCCPCH-SystemInformation-LCR-r4-ext IE extends which
-- SCCPCH-SystemInformation IE.
SCCPCH-SystemInformationList-LCR-r4-ext ::= SEQUENCE (SIZE (1..maxSCCPCH)) OF
    SCCPCH-SystemInformation-LCR-r4-ext

-- The SCCPCH-SystemInformation-MBMS-r6 is used for an S-CCPCH dedicated for MBMS purposes.
SCCPCH-SystemInformation-MBMS-r6 ::= SEQUENCE {
    secondaryCCPCHInfo-MBMS      SecondaryCCPCHInfo-MBMS-r6,
    transportFormatCombinationSet TFCS,
    fachCarryingMCCH             SEQUENCE {
        mcch-transportFormatSet      TransportFormatSet,
        mcch-ConfigurationInfo        MBMS-MCCH-ConfigurationInfo-r6
    },
    fachCarryingMTCH-List        MBMS-FACHCarryingMTCH-List
}
OPTIONAL,
-- If schedulingInformation is provided
fachCarryingMSCH               SEQUENCE {
    msch-transportFormatSet      TransportFormatSet,
    -- dummy is not used in this version of the specification, it should
    -- not be sent and if received it should be ignored.
    dummy                        MBMS-MSCH-ConfigurationInfo-r6
}
OPTIONAL
}

```

```

-- The SCCPCH-SystemInformation-MBMS-r7 is used for an S-CCPCH dedicated for MBMS purposes.
SCCPCH-SystemInformation-MBMS-r7 ::= SEQUENCE {
  secondaryCCPCHInfo-MBMS          SecondaryCCPCHInfo-MBMS-r7,
  transportFormatCombinationSet     TFCS,
  fachCarryingMCCH                  SEQUENCE {
    mcch-transportFormatSet         TransportFormatSet,
    mcch-ConfigurationInfo          MBMS-MCCH-ConfigurationInfo-r6
  },
  fachCarryingMTCH-List             MBMS-FACHCarryingMTCH-List      OPTIONAL,
  -- If scheduling information is provided
  fachCarryingMSCH                  SEQUENCE {
    msch-transportFormatSet         TransportFormatSet
  }
  OPTIONAL
}

S-CPICH-PowerOffset-MIMO ::=          INTEGER (-6..0)

ScramblingCodeChange ::=             ENUMERATED {
  codeChange, noCodeChange }

ScramblingCodeType ::=               ENUMERATED {
  shortSC,
  longSC }

SecondaryCCPCH-Info ::=              SEQUENCE {
  modeSpecificInfo                  CHOICE {
    fdd                               SEQUENCE {
      -- dummy1 is not used in this version of the specification and should be ignored.
      dummy1                          PCPICH-UsageForChannelEst,
      -- dummy2 is not used in this version of the specification. It should not
      -- be sent and if received it should be ignored.
      dummy2                          SecondaryCPICH-Info          OPTIONAL,
      secondaryScramblingCode          SecondaryScramblingCode      OPTIONAL,
      sttd-Indicator                   BOOLEAN,
      sf-AndCodeNumber                 SF256-AndCodeNumber,
      pilotSymbolExistence             BOOLEAN,
      tfci-Existence                   BOOLEAN,
      positionFixedOrFlexible          PositionFixedOrFlexible,
      timingOffset                     TimingOffset                DEFAULT 0
    },
    tdd                               SEQUENCE {
      -- TABULAR: the offset is included in CommonTimeslotInfoSCCPCH
      commonTimeslotInfo               CommonTimeslotInfoSCCPCH,
      individualTimeslotInfo           IndividualTimeslotInfo,
      channelisationCode               SCCPCH-ChannelisationCodeList
    }
  }
}

SecondaryCCPCH-Info-r4 ::=           SEQUENCE {
  modeSpecificInfo                  CHOICE {
    fdd                               SEQUENCE {
      secondaryScramblingCode          SecondaryScramblingCode      OPTIONAL,
      sttd-Indicator                   BOOLEAN,
      sf-AndCodeNumber                 SF256-AndCodeNumber,
      pilotSymbolExistence             BOOLEAN,
      tfci-Existence                   BOOLEAN,
      positionFixedOrFlexible          PositionFixedOrFlexible,
      timingOffset                     TimingOffset                DEFAULT 0
    },
    tdd                               SEQUENCE {
      -- TABULAR: the offset is included in CommonTimeslotInfoSCCPCH
      commonTimeslotInfo               CommonTimeslotInfoSCCPCH,
      tddOption                        CHOICE {
        tdd384                         SEQUENCE {
          individualTimeslotInfo       IndividualTimeslotInfo
        },
        tdd128                         SEQUENCE {
          individualTimeslotInfo       IndividualTimeslotInfo-LCR-r4
        }
      }
    },
    channelisationCode                 SCCPCH-ChannelisationCodeList
  }
}

SecondaryCCPCH-Info-HCR-VHCR-r7 ::= SEQUENCE {
  modeSpecificInfo                  CHOICE {

```

```

        tdd384
            individualTimeslotInfo
            channelisationCode
        },
        tdd768
            individualTimeslotInfo
            channelisationCode
        }
    }
}

SecondaryCCPCH-Info-LCR-r4-ext ::= SEQUENCE {
    individualTimeslotLCR-Ext    IndividualTimeslotInfo-LCR-r4-ext
}

SecondaryCCPCHInfo-MBMS-r6 ::= SEQUENCE {
    modeSpecificInfo            CHOICE {
        fdd                     SEQUENCE {
            secondaryScramblingCode    SecondaryScramblingCode    OPTIONAL,
            sttd-Indicator             BOOLEAN,
            sf-AndCodeNumber           SF256-AndCodeNumber,
            timingOffset               TimingOffset                DEFAULT 0
        },
        tdd384                   SEQUENCE {
            commonTimeslotInfoMBMS     CommonTimeslotInfoMBMS,
            downlinkTimeslotsCodes     DownlinkTimeslotsCodes
        },
        tdd128                   SEQUENCE {
            commonTimeslotInfoMBMS     CommonTimeslotInfoMBMS,
            downlinkTimeslotsCodes     DownlinkTimeslotsCodes-LCR-r4
        }
    }
}

SecondaryCCPCHInfo-MBMS-r7 ::= SEQUENCE {
    modeSpecificInfo            CHOICE {
        fdd                     SEQUENCE {
            secondaryScramblingCode    SecondaryScramblingCode    OPTIONAL,
            sttd-Indicator             BOOLEAN,
            sf-AndCodeNumber           SF256-AndCodeNumber,
            timingOffset               TimingOffset                DEFAULT 0,
            modulation               CHOICE {
                modQPSK                NULL,
                mod16QAM               INTEGER (-11..4)
            } OPTIONAL
        },
        tdd384                   SEQUENCE {
            commonTimeslotInfoMBMS     CommonTimeslotInfoMBMS,
            downlinkTimeslotsCodes     DownlinkTimeslotsCodes-r7,
            modulation                ENUMERATED { modQPSK, mod16QAM }
        },
        tdd768                   SEQUENCE {
            commonTimeslotInfoMBMS     CommonTimeslotInfoMBMS,
            downlinkTimeslotsCodes     DownlinkTimeslotsCodes-VHCR,
            modulation                ENUMERATED { modQPSK, mod16QAM }
        },
        tdd128                   SEQUENCE {
            commonTimeslotInfoMBMS     CommonTimeslotInfoMBMS,
            downlinkTimeslotsCodes     DownlinkTimeslotsCodes-LCR-r4,
            mbsfnSpecialTimeSlot      TimeSlotLCR-ext            OPTIONAL,
            modulation                ENUMERATED { modQPSK, mod16QAM }
        }
    }
}

SecondaryCCPCHInfoDiff-MBMS ::= SEQUENCE {
    secondaryScramblingCode    SecondaryScramblingCode    OPTIONAL,
    sttd-Indicator             BOOLEAN,
    sf-AndCodeNumber           SF256-AndCodeNumber            OPTIONAL,
    timingOffset               TimingOffset                OPTIONAL
}

SecondaryCPICH-Info ::= SEQUENCE {
    secondaryDL-ScramblingCode    SecondaryScramblingCode    OPTIONAL,
    channelisationCode           ChannelisationCode256
}

SecondaryScramblingCode ::= INTEGER (1..15)

```

```

SecondInterleavingMode ::=          ENUMERATED {
                                        frameRelated, timeslotRelated }

SF8Codes ::=                        ENUMERATED {
                                        cc8-1, cc8-2, cc8-3, cc8-4, cc8-5, cc8-6, cc8-7, cc8-8}

SF16Codes ::=                       ENUMERATED {
                                        cc16-1, cc16-2, cc16-3, cc16-4, cc16-5, cc16-6, cc16-7,
                                        cc16-8}

SF16Codes2 ::=                     ENUMERATED {
                                        cc16-1, cc16-2, cc16-3, cc16-4, cc16-5, cc16-6, cc16-7,
                                        cc16-8, cc16-9, cc16-10, cc16-11, cc16-12, cc16-13, cc16-14,
                                        cc16-15, cc16-16}

SF32Codes ::=                      ENUMERATED {
                                        cc32-1, cc32-2, cc32-3, cc32-4, cc32-5, cc32-6, cc32-7,
                                        cc32-8, cc32-9, cc32-10, cc32-11, cc32-12, cc32-13, cc32-14,
                                        cc32-15, cc32-16}

-- SF256-AndCodeNumber encodes both "Spreading factor" and "Code Number"
SF256-AndCodeNumber ::=            CHOICE {
    sf4                               INTEGER (0..3),
    sf8                               INTEGER (0..7),
    sf16                              INTEGER (0..15),
    sf32                              INTEGER (0..31),
    sf64                              INTEGER (0..63),
    sf128                             INTEGER (0..127),
    sf256                             INTEGER (0..255)
}

-- SF512-AndCodeNumber encodes both "Spreading factor" and "Code Number"
SF512-AndCodeNumber ::=            CHOICE {
    sf4                               INTEGER (0..3),
    sf8                               INTEGER (0..7),
    sf16                              INTEGER (0..15),
    sf32                              INTEGER (0..31),
    sf64                              INTEGER (0..63),
    sf128                             INTEGER (0..127),
    sf256                             INTEGER (0..255),
    sf512                             INTEGER (0..511)
}

-- SF512-AndPilot encodes both "Spreading factor" and "Number of bits for Pilot bits"
SF512-AndPilot ::=                CHOICE {
    sfd4                              NULL,
    sfd8                              NULL,
    sfd16                             NULL,
    sfd32                             NULL,
    sfd64                              NULL,
    sfd128                            PilotBits128,
    sfd256                             PilotBits256,
    sfd512                             NULL
}

SF-PDSCH ::=                      ENUMERATED {
    sfp4, sfp8, sfp16, sfp32,
    sfp64, sfp128, sfp256 }

SF-PRACH ::=                      ENUMERATED {
    sfpr32, sfpr64, sfpr128, sfpr256 }

SFN-TimeInfo ::=                  SEQUENCE {
    activationTimeSFN                 INTEGER (0..4095),
    physChDuration                    DurationTimeInfo
}

-- actual scheduling value = 2(signalled value +1) and is the periodicity of sending special burst frames
SpecialBurstScheduling ::=        INTEGER (0..7)

SpreadingFactor ::=               ENUMERATED {
    sf4, sf8, sf16, sf32,
    sf64, sf128, sf256 }

SRB-delay ::=                     INTEGER (0..7)

SSDT-CellIdentity ::=            ENUMERATED {
    ssdt-id-a, ssdt-id-b, ssdt-id-c,

```

```

        ssdt-id-d, ssdt-id-e, ssdt-id-f,
        ssdt-id-g, ssdt-id-h }

SSDT-Information ::=
    s-Field
    codeWordSet
}

SSDT-Information-r4 ::=
    s-Field
    codeWordSet
    ssdt-UL-r4
}

SSDT-UL ::=
    ENUMERATED {
        ul, ul-AndDL }

STTDIndication ::=
    ENUMERATED { true }

SynchronisationParameters-r4 ::=
    sync-UL-CodesBitmap
    fpach-Info
    -- Actual value prxUpPCHdes = IE value - 120
    prxUpPCHdes
    sync-UL-Procedure
}

Sync-UL-Codes-Bitmap ::=
    BIT STRING {
        code7(0),
        code6(1),
        code5(2),
        code4(3),
        code3(4),
        code2(5),
        code1(6),
        code0(7)
    } (SIZE (8))

SYNC-UL-Procedure-r4 ::=
    max-SYNC-UL-Transmissions
    powerRampStep
}

SYNC-UL-Info-r4 ::=
    sync-UL-Codes-Bitmap
    -- Actual value prxUpPCHdes = IE value - 120
    prxUpPCHdes
    powerRampStep
    max-SYNC-UL-Transmissions
    mmax
}

SYNC-UL-InfoForE-RUCCH ::=
    prxUpPCHdes
    powerRampStep
    max-SYNC-UL-Transmissions
    e-RUCCH-Sync-UL-Codes-Bitmap
    mmax
}

TDD-FPACH-CCode16-r4 ::=
    ENUMERATED {
        cc16-1, cc16-2, cc16-3, cc16-4,
        cc16-5, cc16-6, cc16-7, cc16-8,
        cc16-9, cc16-10, cc16-11, cc16-12,
        cc16-13, cc16-14, cc16-15, cc16-16 }

TDD-UL-Interference ::=
    INTEGER (-110..-52)

TDD-PICH-CCode ::=
    ENUMERATED {

```

```

cc16-1, cc16-2, cc16-3, cc16-4,
cc16-5, cc16-6, cc16-7, cc16-8,
cc16-9, cc16-10, cc16-11, cc16-12,
cc16-13, cc16-14, cc16-15, cc16-16 }

TDD768-PICH-CCode ::=          ENUMERATED {
                                cc32-1, cc32-2, cc32-3, cc32-4,
                                cc32-5, cc32-6, cc32-7, cc32-8,
                                cc32-9, cc32-10, cc32-11, cc32-12,
                                cc32-13, cc32-14, cc32-15, cc32-16,
                                cc32-17, cc32-18, cc32-19, cc32-20,
                                cc32-21, cc32-22, cc32-23, cc32-24,
                                cc32-25, cc32-26, cc32-27, cc32-28,
                                cc32-29, cc32-30, cc32-31, cc32-32 }

TDD-MBSFNInformation ::=      SEQUENCE (SIZE (1..maxTS)) OF
                                TDD-MBSFNslotInfo

TDD-MBSFNslotInfo ::=         SEQUENCE {
                                timeslotNumber
                                CellParametersID
                                }

TDD-PRACH-CCode8 ::=          ENUMERATED {
                                cc8-1, cc8-2, cc8-3, cc8-4,
                                cc8-5, cc8-6, cc8-7, cc8-8 }

TDD-PRACH-CCode16 ::=         ENUMERATED {
                                cc16-1, cc16-2, cc16-3, cc16-4,
                                cc16-5, cc16-6, cc16-7, cc16-8,
                                cc16-9, cc16-10, cc16-11, cc16-12,
                                cc16-13, cc16-14, cc16-15, cc16-16 }

TDD-PRACH-CCode-LCR-r4 ::=    ENUMERATED {
                                cc4-1, cc4-2, cc4-3, cc4-4,
                                cc8-1, cc8-2, cc8-3, cc8-4,
                                cc8-5, cc8-6, cc8-7, cc8-8,
                                cc16-1, cc16-2, cc16-3, cc16-4,
                                cc16-5, cc16-6, cc16-7, cc16-8,
                                cc16-9, cc16-10, cc16-11, cc16-12,
                                cc16-13, cc16-14, cc16-15, cc16-16 }

TDD-PRACH-CCodeList ::=      CHOICE {
                                sf8
                                SEQUENCE (SIZE (1..8)) OF
                                    TDD-PRACH-CCode8,
                                -- Channelisation codes cc16-9, cc16-10, cc16-11, cc16-12, cc16-13, cc16-14,
                                -- cc16-15 and cc16-16 shall not be used
                                sf16
                                SEQUENCE (SIZE (1..8)) OF
                                    TDD-PRACH-CCode16
                                }

TDD768-PRACH-CCode16 ::=     ENUMERATED {
                                cc16-1, cc16-2, cc16-3, cc16-4,
                                cc16-5, cc16-6, cc16-7, cc16-8,
                                cc16-9, cc16-10, cc16-11, cc16-12,
                                cc16-13, cc16-14, cc16-15, cc16-16 }

TDD768-PRACH-CCode32 ::=     ENUMERATED {
                                cc32-1, cc32-2, cc32-3, cc32-4,
                                cc32-5, cc32-6, cc32-7, cc32-8,
                                cc32-9, cc32-10, cc32-11, cc32-12,
                                cc32-13, cc32-14, cc32-15, cc32-16 }

TDD768-PRACH-CCodeList ::=   CHOICE {
                                sf32
                                SEQUENCE (SIZE (1..16)) OF
                                    TDD768-PRACH-CCode32,
                                -- Channelisation codes cc32-17, cc32-18, cc32-19, cc32-20, cc32-21, cc32-22,
                                -- cc32-23, cc32-24, cc32-25, cc32-26, cc32-27, cc32-28, cc32-29, cc32-30, cc32-31
                                -- and cc32-32 shall not be used
                                sf16
                                SEQUENCE (SIZE (1..16)) OF
                                    TDD768-PRACH-CCode16
                                }

TFC-ControlDuration ::=      ENUMERATED {
                                tfc-cd1, tfc-cd2, tfc-cd4, tfc-cd8,
                                tfc-cd16, tfc-cd24, tfc-cd32,
                                tfc-cd48, tfc-cd64, tfc-cd128,
                                tfc-cd192, tfc-cd256, tfc-cd512 }

```

```

TFCI-Coding ::=
    ENUMERATED {
        tfci-bits-4, tfci-bits-8,
        tfci-bits-16, tfci-bits-32 }

TGCFN ::=
    INTEGER (0..255)

-- In TGD, value 270 represents "undefined" in the tabular description.
TGD ::=
    INTEGER (15..270)

TGL ::=
    INTEGER (1..14)

TGMP ::=
    ENUMERATED {
        tdd-Measurement, fdd-Measurement,
        gsm-CarrierRSSIMeasurement,
        gsm-initialBSICIdentification, gsmBSICReconfirmation,
        multi-carrier }

TGP-Sequence ::=
    SEQUENCE {
        tgpsi
        tgps-Status
            activate
                tgcfn
            },
        deactivate
            NULL
    },
    tgps-ConfigurationParams
        TGPS-ConfigurationParams
        OPTIONAL
}

TGPS-Reconfiguration-CFN ::=
    INTEGER (0..255)

TGP-SequenceList ::=
    SEQUENCE (SIZE (1..maxTGPS)) OF
        TGP-Sequence

TGP-SequenceShort ::=
    SEQUENCE {
        tgpsi
        tgps-Status
            activate
                tgcfn
            },
        deactivate
            NULL
    }

TGPL ::=
    INTEGER (1..144)

-- TABULAR: In TGPRC, value 0 represents "infinity" in the tabular description.
TGPRC ::=
    INTEGER (0..511)

TGPS-ConfigurationParams ::=
    SEQUENCE {
        tgmp
            TGMP,
        tgprc
            TGPRC,
        tgsn
            TGSN,
        tg11
            TGL,
        tg12
            TGL
            OPTIONAL,
        tgd
            TGD,
        tgpl1
            TGPL,
        -- dummy is not used in this version of the specification, it should
        -- not be sent and if received it shall be ignored.
        dummy
            TGPL
            OPTIONAL,
        rpp
            RPP,
        itp
            ITP,
        -- TABULAR: Compressed mode method is nested inside UL-DL-Mode
        ul-DL-Mode
            UL-DL-Mode,
        dl-FrameType
            DL-FrameType,
        deltaSIR1
            DeltaSIR,
        deltaSIRAfter1
            DeltaSIR,
        deltaSIR2
            DeltaSIR
            OPTIONAL,
        deltaSIRAfter2
            DeltaSIR
            OPTIONAL,
        nidentifyAbort
            NidentifyAbort
            OPTIONAL,
        treconfirmAbort
            TreconfirmAbort
            OPTIONAL
    }

TGPSI ::=
    INTEGER (1..maxTGPS)

TGSN ::=
    INTEGER (0..14)

TimeInfo ::=
    SEQUENCE {

```



```

    activationTime          ActivationTime          OPTIONAL,
    durationTimeInfo       DurationTimeInfo        OPTIONAL
}

TimeslotLCR-ext ::=          ENUMERATED {
                              ts7, spare3, spare2, spare1 }

TimeslotList ::=           SEQUENCE (SIZE (1..maxTS)) OF
                              TimeslotNumber

TimeslotList-r4 ::=        CHOICE {
-- the choice for 7.68 Mcps TDD is as for 3.84 Mcps TDD --
    tdd384                  SEQUENCE (SIZE (1..maxTS)) OF
                              TimeslotNumber,
    tdd128                  SEQUENCE (SIZE (1..maxTS-LCR)) OF
                              TimeslotNumber-LCR-r4
}

-- If TimeslotNumber is included for a 1.28Mcps TDD description, it shall take values from 0..6
TimeslotNumber ::=        INTEGER (0..14)

TimeslotNumber-LCR-r4 ::=  INTEGER (0..6)

TimeslotNumber-PRACH-LCR-r4 ::=  INTEGER (1..6)

TimeslotSync2 ::=         INTEGER (0..6)

DTX-DRX-TimingInfo-r7 ::= SEQUENCE {
    timing                  CHOICE {
        continue            NULL,
        newTiming           NewTiming
    }
}

-- Actual value TimingOffset = IE value * 256
TimingOffset ::=         INTEGER (0..149)

TimingMaintainedSynchInd ::= ENUMERATED { false }

TPC-CombinationIndex ::=  INTEGER (0..5)

TPC-CommandTargetRate ::= INTEGER (0..10)

-- Actual value TPC-StepSizeFDD = IE value + 1
TPC-StepSizeFDD ::=      INTEGER (0..1)

TPC-StepSizeTDD ::=      INTEGER (1..3)

TransportBlockSizeIndex ::= INTEGER (1..32)

-- Actual value TreconfirmAbort = IE value * 0.5 seconds
TreconfirmAbort ::=      INTEGER (1..20)

TX-DiversityMode ::=     ENUMERATED {
    noDiversity,
    sttd,
    closedLoopModel1,
    -- dummy is not used in this version of the specification, it should
    -- not be sent and if received it should be ignored.
    dummy }

UARFCN ::=               INTEGER (0..16383)

UCSM-Info ::=            SEQUENCE {
    minimumSpreadingFactor  MinimumSpreadingFactor,
    nf-Max                  NF-Max,
    channelReqParamsForUCSM ChannelReqParamsForUCSM
}

UE-DPCCH-Burst ::=      ENUMERATED {
    sub-frames-1,
    sub-frames-2,
    sub-frames-5,
    spare1 }

UE-DRX-Cycle ::=        ENUMERATED {
    sub-frames-4,
    sub-frames-5,

```

```
sub-frames-8,
sub-frames-10,
sub-frames-16,
sub-frames-20,
spare2,
spare1 }

UE-DTX-Cycle1-10ms ::= ENUMERATED {
sub-frames-1,
sub-frames-5,
sub-frames-10,
sub-frames-20 }

UE-DTX-Cycle1-2ms ::= ENUMERATED {
sub-frames-1,
sub-frames-4,
sub-frames-5,
sub-frames-8,
sub-frames-10,
sub-frames-16,
sub-frames-20,
spare1 }

UE-DTX-Cycle2-10ms ::= ENUMERATED {
sub-frames-5,
sub-frames-10,
sub-frames-20,
sub-frames-40,
sub-frames-80,
sub-frames-160,
spare2,
spare1 }

UE-DTX-Cycle2-2ms ::= ENUMERATED {
sub-frames-4,
sub-frames-5,
sub-frames-8,
sub-frames-10,
sub-frames-16,
sub-frames-20,
sub-frames-32,
sub-frames-40,
sub-frames-64,
sub-frames-80,
sub-frames-128,
sub-frames-160,
spare4,
spare3,
spare2,
spare1 }

UE-DTX-Cycle2InactivityThreshold ::= ENUMERATED {
e-dch-tti-1,
e-dch-tti-4,
e-dch-tti-8,
e-dch-tti-16,
e-dch-tti-32,
e-dch-tti-64,
e-dch-tti-128,
e-dch-tti-256,
spare8,
spare7,
spare6,
spare5,
spare4,
spare3,
spare2,
spare1 }

UE-DTX-long-preamble-length ::= ENUMERATED {
slots-4,
slots-15 }

UE-DTX-DRX-Offset ::= INTEGER (0..159)

UE-GrantMonitoring-InactivityThreshold ::= ENUMERATED {
e-dch-tti-0,
e-dch-tti-1,
```

```

e-dch-tti-2,
e-dch-tti-4,
e-dch-tti-8,
e-dch-tti-16,
e-dch-tti-32,
e-dch-tti-64,
e-dch-tti-128,
e-dch-tti-256,
spare6,
spare5,
spare4,
spare3,
spare2,
spare1 }

UL-16QAM-Config ::= SEQUENCE {
    ul-16QAM-Settings          UL-16QAM-Settings          OPTIONAL,
    e-TFCI-TableIndex          E-TFCI-TableIndex          OPTIONAL,
    mac-es-e-resetIndicator    ENUMERATED { true }      OPTIONAL
}

UL-16QAM-Settings ::= SEQUENCE {
    beta-Ed-Gain-E-AGCH-Table-Selection INTEGER (0..1)
}

UL-CCTrCH ::= SEQUENCE {
    tfcs-ID                    TFCS-IdentityPlain          DEFAULT 1,
    ul-TargetSIR               UL-TargetSIR,
    timeInfo                   TimeInfo,
    commonTimeslotInfo         CommonTimeslotInfo          OPTIONAL,
    ul-CCTrCH-TimeslotsCodes   UplinkTimeslotsCodes      OPTIONAL
}

UL-CCTrCH-r4 ::= SEQUENCE {
    tfcs-ID                    TFCS-IdentityPlain          DEFAULT 1,
    -- The IE ul-TargetSIR corresponds to PRX-DPCHdes for 1.28Mcps TDD
    -- Actual value PRX-DPCHdes = (value of IE "ul-TargetSIR" - 120)
    ul-TargetSIR               UL-TargetSIR,
    timeInfo                   TimeInfo,
    commonTimeslotInfo         CommonTimeslotInfo          OPTIONAL,
    tddOption                   CHOICE {
        tdd384                  SEQUENCE {
            ul-CCTrCH-TimeslotsCodes   UplinkTimeslotsCodes      OPTIONAL
        },
        tdd128                  SEQUENCE {
            ul-CCTrCH-TimeslotsCodes   UplinkTimeslotsCodes-LCR-r4 OPTIONAL
        }
    }
}

UL-CCTrCH-r7 ::= SEQUENCE {
    tfcs-ID                    TFCS-IdentityPlain          DEFAULT 1,
    -- The IE ul-TargetSIR corresponds to PRX-DPCHdes for 1.28Mcps TDD
    -- Actual value PRX-DPCHdes = (value of IE "ul-TargetSIR" - 120)
    ul-TargetSIR               UL-TargetSIR,
    timeInfo                   TimeInfo,
    commonTimeslotInfo         CommonTimeslotInfo          OPTIONAL,
    tddOption                   CHOICE {
        tdd384                  SEQUENCE {
            ul-CCTrCH-TimeslotsCodes   UplinkTimeslotsCodes      OPTIONAL
        },
        tdd768                  SEQUENCE {
            ul-CCTrCH-TimeslotsCodes   UplinkTimeslotsCodes-VHCR  OPTIONAL
        },
        tdd128                  SEQUENCE {
            ul-CCTrCH-TimeslotsCodes   UplinkTimeslotsCodes-LCR-r7  OPTIONAL
        }
    }
}

UL-CCTrCHList ::= SEQUENCE (SIZE (1..maxCCTrCH)) OF
    UL-CCTrCH

UL-CCTrCHList-r4 ::= SEQUENCE (SIZE (1..maxCCTrCH)) OF
    UL-CCTrCH-r4

UL-CCTrCHList-r7 ::= SEQUENCE (SIZE (1..maxCCTrCH)) OF
    UL-CCTrCH-r7

```

```

UL-CCTrCHListToRemove ::=          SEQUENCE (SIZE (1..maxCCTrCH)) OF
                                     TFCS-IdentityPlain

UL-CCTrChTPCList ::=              SEQUENCE (SIZE (0..maxCCTrCH)) OF
                                     TFCS-Identity

UL-ChannelRequirement ::=         CHOICE {
  ul-DPCH-Info                    UL-DPCH-Info,
  -- dummy is not used in this version of the specification, it should
  -- not be sent and if received the UE behaviour is not specified.
  dummy                            CPCH-SetInfo
}

UL-ChannelRequirement-r4 ::=      CHOICE {
  ul-DPCH-Info                    UL-DPCH-Info-r4,
  -- dummy is not used in this version of the specification, it should
  -- not be sent and if received the UE behaviour is not specified.
  dummy                            CPCH-SetInfo
}

UL-ChannelRequirement-r5 ::=      CHOICE {
  ul-DPCH-Info                    UL-DPCH-Info-r5,
  -- dummy is not used in this version of the specification, it should
  -- not be sent and if received the UE behaviour is not specified.
  dummy                            CPCH-SetInfo
}

-- Note: the reference to CPCH in the element name below is incorrect. The name is not
-- changed to keep it aligned with R99.
UL-ChannelRequirementWithCPCH-SetID ::= CHOICE {
  ul-DPCH-Info                    UL-DPCH-Info,
  -- dummy1 and dummy 2 are not used in this version of the specification, they should
  -- not be sent and if received the UE behaviour is not specified.
  dummy1                          CPCH-SetInfo,
  dummy2                          CPCH-SetID
}

-- Note: the reference to CPCH in the element name below is incorrect. The name is not
-- changed to keep it aligned with R99.
UL-ChannelRequirementWithCPCH-SetID-r4 ::= CHOICE {
  ul-DPCH-Info                    UL-DPCH-Info-r4,
  -- dummy1 and dummy2 are not used in this version of the specification, they
  -- should not be sent and if received the UE behaviour is not specified.
  dummy1                          CPCH-SetInfo,
  dummy2                          CPCH-SetID
}

-- Note: the reference to CPCH in the element name below is incorrect. The name is not
-- changed to keep it aligned with R99.
UL-ChannelRequirementWithCPCH-SetID-r5 ::= CHOICE {
  ul-DPCH-Info                    UL-DPCH-Info-r5,
  -- dummy1 and dummy2 are not used in this version of the specification, they should
  -- not be sent and if received the UE behaviour is not specified.
  dummy1                          CPCH-SetInfo,
  dummy2                          CPCH-SetID
}

UL-CompressedModeMethod ::=       ENUMERATED {
  sf-2,
  higherLayerScheduling }

UL-DL-Mode ::=                   CHOICE {
  ul                               UL-CompressedModeMethod,
  dl                               DL-CompressedModeMethod,
  ul-and-dl                        SEQUENCE {
    ul                             UL-CompressedModeMethod,
    dl                             DL-CompressedModeMethod
  }}

UL-DPCCH-SlotFormat ::=          ENUMERATED {
  slf0, slf1, slf2 }

UL-DPCH-Info ::=                 SEQUENCE {
  ul-DPCH-PowerControlInfo        UL-DPCH-PowerControlInfo          OPTIONAL,
  modeSpecificInfo                CHOICE {
    fdd                            SEQUENCE {
      scramblingCodeType           ScramblingCodeType,

```

```

        scramblingCode                UL-ScramblingCode,
        numberOfDPDCH                 NumberOfDPDCH                DEFAULT 1,
        spreadingFactor               SpreadingFactor,
        tfci-Existence                BOOLEAN,
        -- numberOfFBI-Bits is conditional based on history
        numberOfFBI-Bits              NumberOfFBI-Bits                OPTIONAL,
        puncturingLimit               PuncturingLimit
    },
    tdd                                SEQUENCE {
        ul-TimingAdvance              UL-TimingAdvanceControl    OPTIONAL,
        ul-CCTrCHList                 UL-CCTrCHList             OPTIONAL,
        ul-CCTrCHListToRemove         UL-CCTrCHListToRemove     OPTIONAL
    }
}
}

UL-DPCH-Info-r4 ::= SEQUENCE {
    ul-DPCH-PowerControlInfo         UL-DPCH-PowerControlInfo-r4    OPTIONAL,
    modeSpecificInfo                 CHOICE {
        fdd                           SEQUENCE {
            scramblingCodeType        ScramblingCodeType,
            scramblingCode             UL-ScramblingCode,
            numberOfDPDCH              NumberOfDPDCH                DEFAULT 1,
            spreadingFactor            SpreadingFactor,
            tfci-Existence             BOOLEAN,
            -- numberOfFBI-Bits is conditional based on history
            numberOfFBI-Bits          NumberOfFBI-Bits                OPTIONAL,
            puncturingLimit           PuncturingLimit
        },
        tdd                            SEQUENCE {
            ul-TimingAdvance           UL-TimingAdvanceControl-r4    OPTIONAL,
            ul-CCTrCHList              UL-CCTrCHList-r4            OPTIONAL,
            ul-CCTrCHListToRemove      UL-CCTrCHListToRemove       OPTIONAL
        }
    }
}

UL-DPCH-Info-r5 ::= SEQUENCE {
    ul-DPCH-PowerControlInfo         UL-DPCH-PowerControlInfo-r5    OPTIONAL,
    modeSpecificInfo                 CHOICE {
        fdd                           SEQUENCE {
            scramblingCodeType        ScramblingCodeType,
            scramblingCode             UL-ScramblingCode,
            numberOfDPDCH              NumberOfDPDCH                DEFAULT 1,
            spreadingFactor            SpreadingFactor,
            tfci-Existence             BOOLEAN,
            -- numberOfFBI-Bits is conditional based on history
            numberOfFBI-Bits          NumberOfFBI-Bits                OPTIONAL,
            puncturingLimit           PuncturingLimit
        },
        tdd                            SEQUENCE {
            ul-TimingAdvance           UL-TimingAdvanceControl-r4    OPTIONAL,
            ul-CCTrCHList              UL-CCTrCHList-r4            OPTIONAL,
            ul-CCTrCHListToRemove      UL-CCTrCHListToRemove       OPTIONAL
        }
    }
}

UL-DPCH-Info-r6 ::= SEQUENCE {
    ul-DPCH-PowerControlInfo         UL-DPCH-PowerControlInfo-r6    OPTIONAL,
    modeSpecificInfo                 CHOICE {
        fdd                           SEQUENCE {
            scramblingCodeType        ScramblingCodeType,
            scramblingCode             UL-ScramblingCode,
            dpdchPresence              CHOICE {
                present                SEQUENCE {
                    numberOfDPDCH      NumberOfDPDCH                DEFAULT 1,
                    spreadingFactor    SpreadingFactor,
                    tfci-Existence     BOOLEAN,
                    -- numberOfFBI-Bits is conditional based on history
                    numberOfFBI-Bits  NumberOfFBI-Bits                OPTIONAL,
                    puncturingLimit    PuncturingLimit
                },
                notPresent              SEQUENCE {
                    tfci-Existence     BOOLEAN,
                    -- numberOfFBI-Bits is conditional based on history
                    numberOfFBI-Bits  NumberOfFBI-Bits                OPTIONAL
                }
            }
        }
    }
}

```

```

    }
  },
  tdd
    ul-TimingAdvance          UL-TimingAdvanceControl-r4  OPTIONAL,
    ul-CCTrCHList            UL-CCTrCHList-r4            OPTIONAL,
    ul-CCTrCHListToRemove    UL-CCTrCHListToRemove        OPTIONAL
  }
}

UL-DPCH-Info-r7 ::=
  ul-DPCH-PowerControlInfo    UL-DPCH-PowerControlInfo-r7    OPTIONAL,
  modeSpecificInfo
  fdd
    scramblingCodeType        ScramblingCodeType,
    scramblingCode            UL-ScramblingCode,
    dpdchPresence
    present
      numberOfDPDCH          NumberOfDPDCH                DEFAULT 1,
      spreadingFactor        SpreadingFactor,
      tfci-Existence        BOOLEAN,
      -- numberOfFBI-Bits is conditional based on history
      numberOfFBI-Bits      NumberOfFBI-Bits              OPTIONAL,
      numberOfTPC-Bits      NumberOfTPC-Bits              OPTIONAL,
      puncturingLimit        PuncturingLimit
    },
    notPresent
      tfci-Existence        BOOLEAN,
      -- numberOfFBI-Bits is conditional based on history
      numberOfFBI-Bits      NumberOfFBI-Bits              OPTIONAL,
      numberOfTPC-Bits      NumberOfTPC-Bits              OPTIONAL
  }
},
  tdd
    ul-TimingAdvance          UL-TimingAdvanceControl-r7  OPTIONAL,
    ul-CCTrCHList            UL-CCTrCHList-r7            OPTIONAL,
    ul-CCTrCHListToRemove    UL-CCTrCHListToRemove        OPTIONAL
  }
}

UL-DPCH-InfoPostFDD ::=
  ul-DPCH-PowerControlInfo    UL-DPCH-PowerControlInfoPostFDD,
  scramblingCodeType          ScramblingCodeType,
  reducedScramblingCodeNumber ReducedScramblingCodeNumber,
  spreadingFactor              SpreadingFactor
}

UL-DPCH-InfoPostTDD ::=
  ul-DPCH-PowerControlInfo    UL-DPCH-PowerControlInfoPostTDD,
  ul-TimingAdvance            UL-TimingAdvanceControl        OPTIONAL,
  ul-CCTrCH-TimeslotsCodes    UplinkTimeslotsCodes
}

UL-DPCH-InfoPostTDD-LCR-r4 ::=
  ul-DPCH-PowerControlInfo    UL-DPCH-PowerControlInfoPostTDD-LCR-r4,
  ul-TimingAdvance            UL-TimingAdvanceControl-LCR-r4  OPTIONAL,
  ul-CCTrCH-TimeslotsCodes    UplinkTimeslotsCodes-LCR-r4
}

UL-DPCH-InfoPredef ::=
  ul-DPCH-PowerControlInfo    UL-DPCH-PowerControlInfoPredef,
  modeSpecificInfo
  fdd
    tfci-Existence          BOOLEAN,
    puncturingLimit        PuncturingLimit
  },
  tdd
    commonTimeslotInfo      CommonTimeslotInfo
  }
}

UL-DPCH-InfoPredef-v770ext ::=
  modeSpecificInfo
  fdd
    SEQUENCE {

```

```

        numberOfTPC-Bits                NumberOfTPC-Bits                OPTIONAL
    },
    tdd                                  NULL }
}

UL-DPCH-PowerControlInfo ::=          CHOICE {
    fdd                                  SEQUENCE {
        dpcch-PowerOffset                DPCCH-PowerOffset,
        pc-Preamble                       PC-Preamble,
        srb-delay                         SRB-delay,
        -- TABULAR: TPC step size nested inside PowerControlAlgorithm
        powerControlAlgorithm            PowerControlAlgorithm
    },
    tdd                                  SEQUENCE {
        ul-TargetSIR                      UL-TargetSIR                OPTIONAL,
        ul-OL-PC-Signalling                CHOICE {
            broadcast-UL-OL-PC-info        NULL,
            individuallySignalled          SEQUENCE {
                individualTS-InterferenceList IndividualTS-InterferenceList,
                dpch-ConstantValue         ConstantValueTdd,
                primaryCCPCH-TX-Power      PrimaryCCPCH-TX-Power
            }
        }
    }
}
}

UL-DPCH-PowerControlInfo-r4 ::=       CHOICE {
    fdd                                  SEQUENCE {
        dpcch-PowerOffset                DPCCH-PowerOffset,
        pc-Preamble                       PC-Preamble,
        srb-delay                         SRB-delay,
        -- TABULAR: TPC step size nested inside PowerControlAlgorithm
        powerControlAlgorithm            PowerControlAlgorithm
    },
    tdd                                  SEQUENCE {
        -- The IE ul-TargetSIR corresponds to PRX-DPCHdes for 1.28Mcps TDD
        -- Actual value PRX-DPCHdes = (value of IE "ul-TargetSIR" - 120)
        ul-TargetSIR                      UL-TargetSIR                OPTIONAL,
        ul-OL-PC-Signalling                CHOICE {
            broadcast-UL-OL-PC-info        NULL,
            individuallySignalled          SEQUENCE {
                tddOption                   CHOICE {
                    tdd384                   SEQUENCE {
                        individualTS-InterferenceList IndividualTS-InterferenceList,
                        dpch-ConstantValue     ConstantValue
                    },
                    tdd128                   SEQUENCE {
                        tpc-StepSize          TPC-StepSizeTDD
                    }
                }
            },
            primaryCCPCH-TX-Power          PrimaryCCPCH-TX-Power
        }
    }
}

UL-DPCH-PowerControlInfo-r5 ::=       CHOICE {
    fdd                                  SEQUENCE {
        dpcch-PowerOffset                DPCCH-PowerOffset,
        pc-Preamble                       PC-Preamble,
        srb-delay                         SRB-delay,
        -- TABULAR: TPC step size nested inside PowerControlAlgorithm
        powerControlAlgorithm            PowerControlAlgorithm,
        deltaACK                          DeltaACK                    OPTIONAL,
        deltaNACK                          DeltaNACK                   OPTIONAL,
        ack-NACK-repetition-factor         ACK-NACK-repetitionFactor  OPTIONAL
    },
    tdd                                  SEQUENCE {
        -- The IE ul-TargetSIR corresponds to PRX-DPCHdes for 1.28Mcps TDD
        -- Actual value PRX-DPCHdes = (value of IE "ul-TargetSIR" - 120)
        ul-TargetSIR                      UL-TargetSIR                OPTIONAL,
        ul-OL-PC-Signalling                CHOICE {
            broadcast-UL-OL-PC-info        NULL,
            individuallySignalled          SEQUENCE {
                tddOption                   CHOICE {
                    tdd384                   SEQUENCE {
                        individualTS-InterferenceList IndividualTS-InterferenceList,
                        dpch-ConstantValue     ConstantValue
                    }
                }
            }
        }
    }
}

```

```

        },
        tdd128
        tpc-StepSize
    }
    },
    primaryCCPCH-TX-Power
}
}
}

UL-DPCH-PowerControlInfo-r6 ::= CHOICE {
    fdd
        dpcch-PowerOffset
        pc-Preamble
        srb-delay
        -- TABULAR: TPC step size nested inside PowerControlAlgorithm
        powerControlAlgorithm
        deltaACK
        deltaNACK
        ack-NACK-repetition-factor
        harq-Preamble-Mode
    },
    tdd
        -- The IE ul-TargetSIR corresponds to PRX-DPCHdes for 1.28Mcps TDD
        -- Actual value PRX-DPCHdes = (value of IE "ul-TargetSIR" - 120)
        ul-TargetSIR
        ul-OL-PC-Signalling
        broadcast-UL-OL-PC-info
        individuallySignalled
        tddOption
            tdd384
                individualTS-InterferenceList
                dpch-ConstantValue
            },
            tdd128
                beaconPLEst
                tpc-StepSize
            }
        },
        primaryCCPCH-TX-Power
    }
}

UL-DPCH-PowerControlInfo-r7 ::= CHOICE {
    fdd
        dpcch-PowerOffset
        pc-Preamble
        srb-delay
        -- TABULAR: TPC step size nested inside PowerControlAlgorithm
        powerControlAlgorithm
        deltaACK
        deltaNACK
        ack-NACK-repetition-factor
        harq-Preamble-Mode
    },
    tdd
        -- The IE ul-TargetSIR corresponds to PRX-DPCHdes for 1.28Mcps TDD
        -- Actual value PRX-DPCHdes = (value of IE "ul-TargetSIR" - 120)
        ul-TargetSIR
        ul-OL-PC-Signalling
        broadcast-UL-OL-PC-info
        individuallySignalled
        tddOption
            tdd384
                individualTS-InterferenceList
                dpch-ConstantValue
            },
            tdd768
                individualTS-InterferenceList
                dpch-ConstantValue
            },
            tdd128
                beaconPLEst
                tpc-StepSize
            }
    }
}

```



```

        },
        primaryCCPCH-TX-Power          PrimaryCCPCH-TX-Power
    }
}
}

UL-DPCH-PowerControlInfoPostFDD ::= SEQUENCE {
    -- DPCCH-PowerOffset2 has a smaller range to save bits
    dpcch-PowerOffset          DPCCH-PowerOffset2,
    pc-Preamble                PC-Preamble,
    sRB-delay                  SRB-delay
}

UL-DPCH-PowerControlInfoPostTDD ::= SEQUENCE {
    ul-TargetSIR                UL-TargetSIR,
    ul-TimeslotInterference     TDD-UL-Interference
}

UL-DPCH-PowerControlInfoPostTDD-LCR-r4 ::= SEQUENCE {
    -- The IE ul-TargetSIR corresponds to PRX-DPCHdes for 1.28Mcps TDD
    -- Actual value PRX-DPCHdes = (value of IE "ul-TargetSIR" - 120)
    ul-TargetSIR                UL-TargetSIR
}

UL-DPCH-PowerControlInfoPredef ::= CHOICE {
    fdd                          SEQUENCE {
        -- TABULAR: TPC step size nested inside PowerControlAlgorithm
        powerControlAlgorithm    PowerControlAlgorithm
    },
    tdd                          SEQUENCE {
        -- dpch-ConstantValue shall be ignored if in 1.28Mcps TDD mode.
        dpch-ConstantValue      ConstantValueTdd
    }
}

UL-EDCH-Information-ext ::= CHOICE {
    fdd                          NULL,
    tdd                          SEQUENCE {
        non-ScheduledTransGrantInfo    Non-ScheduledTransGrantInfoTDD-ext OPTIONAL
    }
}

UL-EDCH-Information-r6 ::= SEQUENCE {
    mac-es-e-resetIndicator      ENUMERATED { true } OPTIONAL,
    e-DPCCH-Info                 E-DPCCH-Info OPTIONAL,
    e-DPDCH-Info                 E-DPDCH-Info OPTIONAL,
    schedulingTransmConfiguration E-DPDCH-SchedulingTransmConfiguration OPTIONAL
}

UL-EDCH-Information-r7 ::= SEQUENCE {
    mac-es-e-resetIndicator      ENUMERATED { true } OPTIONAL,
    modeSpecificInfo             CHOICE {
        fdd                       SEQUENCE {
            e-DPCCH-Info           E-DPCCH-Info-r7 OPTIONAL,
            e-DPDCH-Info           E-DPDCH-Info-r7 OPTIONAL,
            schedulingTransmConfiguration E-DPDCH-SchedulingTransmConfiguration OPTIONAL,
            ul-16QAM-Settings      UL-16QAM-Settings OPTIONAL
        },
        tdd                       SEQUENCE {
            e-RUCCH-Info           E-RUCCH-Info OPTIONAL,
            e-PUCH-Info            E-PUCH-Info OPTIONAL,
            non-ScheduledTransGrantInfo Non-ScheduledTransGrantInfoTDD OPTIONAL
        }
    }
}

UL-Interference ::= INTEGER (-110..-70)

UL-ScramblingCode ::= INTEGER (0..16777215)

UL-SynchronisationParameters-r4 ::= SEQUENCE {
    stepSize                      INTEGER (1..8),
    frequency                     INTEGER (1..8)
}

-- Actual value UL-TargetSIR = (IE value * 0.5) - 11

```

```

UL-TargetSIR ::= INTEGER (0..62)

UL-TimingAdvance ::= INTEGER (0..63)

UL-TimingAdvanceControl ::= CHOICE {
    disabled NULL,
    enabled SEQUENCE {
        ul-TimingAdvance UL-TimingAdvance OPTIONAL,
        activationTime ActivationTime OPTIONAL
    }
}

UL-TimingAdvanceControl-r4 ::= CHOICE {
    disabled NULL,
    enabled SEQUENCE {
        tddOption CHOICE {
            tdd384 SEQUENCE {
                ul-TimingAdvance UL-TimingAdvance OPTIONAL,
                activationTime ActivationTime OPTIONAL
            },
            tdd128 SEQUENCE {
                ul-SynchronisationParameters UL-SynchronisationParameters-r4 OPTIONAL,
                synchronisationParameters SynchronisationParameters-r4 OPTIONAL
            }
        }
    }
}

UL-TimingAdvanceControl-r7 ::= CHOICE {
    disabled NULL,
    enabled SEQUENCE {
        tddOption CHOICE {
            tdd384 SEQUENCE {
                ul-TimingAdvance UL-TimingAdvance OPTIONAL,
                ext-UL-TimingAdvance EXT-UL-TimingAdvance OPTIONAL,
                activationTime ActivationTime OPTIONAL
            },
            tdd768 SEQUENCE {
                ext-UL-TimingAdvance EXT-UL-TimingAdvance OPTIONAL,
                activationTime ActivationTime OPTIONAL
            },
            tdd128 SEQUENCE {
                ul-SynchronisationParameters UL-SynchronisationParameters-r4 OPTIONAL,
                synchronisationParameters SynchronisationParameters-r4 OPTIONAL
            }
        }
    }
}

UL-TimingAdvanceControl-LCR-r4 ::= CHOICE {
    disabled NULL,
    enabled SEQUENCE {
        ul-SynchronisationParameters UL-SynchronisationParameters-r4 OPTIONAL,
        synchronisationParameters SynchronisationParameters-r4 OPTIONAL
    }
}

UL-TS-ChannelisationCode ::= ENUMERATED {
    cc1-1, cc2-1, cc2-2,
    cc4-1, cc4-2, cc4-3, cc4-4,
    cc8-1, cc8-2, cc8-3, cc8-4,
    cc8-5, cc8-6, cc8-7, cc8-8,
    cc16-1, cc16-2, cc16-3, cc16-4,
    cc16-5, cc16-6, cc16-7, cc16-8,
    cc16-9, cc16-10, cc16-11, cc16-12,
    cc16-13, cc16-14, cc16-15, cc16-16 }

UL-TS-ChannelisationCodeList ::= SEQUENCE (SIZE (1..2)) OF
    UL-TS-ChannelisationCode

UL-TS-ChannelisationCodeList-r7 ::= SEQUENCE (SIZE (1..2)) OF
    SEQUENCE {
        ul-TS-Channelisation-Code UL-TS-ChannelisationCode,
        plcch-info PLCCH-Info OPTIONAL
    }
}

UL-TS-ChannelisationCode-VHCR ::= ENUMERATED {
    cc1-1, cc2-1, cc2-2,

```

```

cc4-1, cc4-2, cc4-3, cc4-4,
cc8-1, cc8-2, cc8-3, cc8-4,
cc8-5, cc8-6, cc8-7, cc8-8,
cc16-1, cc16-2, cc16-3, cc16-4,
cc16-5, cc16-6, cc16-7, cc16-8,
cc16-9, cc16-10, cc16-11, cc16-12,
cc16-13, cc16-14, cc16-15, cc16-16,
cc32-1, cc32-2, cc32-3, cc32-4,
cc32-5, cc32-6, cc32-7, cc32-8,
cc32-9, cc32-10, cc32-11, cc32-12,
cc32-13, cc32-14, cc32-15, cc32-16,
cc32-17, cc32-18, cc32-19, cc32-20,
cc32-21, cc32-22, cc32-23, cc32-24,
cc32-25, cc32-26, cc32-27, cc32-28,
cc32-29, cc32-30, cc32-31, cc32-32 }

```

```

UL-TS-ChannelisationCodeList-VHCR ::= SEQUENCE (SIZE (1..2)) OF
    UL-TS-ChannelisationCode-VHCR

Uplink-DPCCH-Slot-Format-Information ::= ENUMERATED {
    slot-format-1,
    -- dummy is not used in this version of
    -- specification, it should not be sent and if
    -- received it should be ignored.
    dummy,
    slot-format-4,
    spare1 }

UplinkAdditionalTimeslots ::= SEQUENCE {
    parameters CHOICE {
        sameAsLast SEQUENCE {
            timeslotNumber TimeslotNumber
        },
        newParameters SEQUENCE {
            individualTimeslotInfo IndividualTimeslotInfo,
            ul-TS-ChannelisationCodeList UL-TS-ChannelisationCodeList
        }
    }
}

UplinkAdditionalTimeslots-LCR-r4 ::= SEQUENCE {
    parameters CHOICE {
        sameAsLast SEQUENCE {
            timeslotNumber TimeslotNumber
        },
        newParameters SEQUENCE {
            individualTimeslotInfo IndividualTimeslotInfo-LCR-r4,
            ul-TS-ChannelisationCodeList UL-TS-ChannelisationCodeList
        }
    }
}

UplinkAdditionalTimeslots-LCR-r7 ::= SEQUENCE {
    parameters CHOICE {
        sameAsLast SEQUENCE {
            timeslotNumber TimeslotNumber
            -- plcch-info assigned as previously defined slot
        },
        newParameters SEQUENCE {
            individualTimeslotInfo IndividualTimeslotInfo-LCR-r4,
            ul-TS-ChannelisationCodeList UL-TS-ChannelisationCodeList-r7
        }
    }
}

UplinkAdditionalTimeslots-VHCR ::= SEQUENCE {
    parameters CHOICE {
        sameAsLast SEQUENCE {
            timeslotNumber TimeslotNumber
        },
        newParameters SEQUENCE {
            individualTimeslotInfo IndividualTimeslotInfo-VHCR,
            ul-TS-ChannelisationCodeList UL-TS-ChannelisationCodeList
        }
    }
}

UplinkTimeslotsCodes ::= SEQUENCE {

```

```

dynamicSFusage                BOOLEAN,
firstIndividualTimeslotInfo    IndividualTimeslotInfo,
ul-TS-ChannelisationCodeList  UL-TS-ChannelisationCodeList,
moreTimeslots                  CHOICE {
  noMore                        NULL,
  additionalTimeslots           CHOICE {
    consecutive                  SEQUENCE {
      numAdditionalTimeslots     INTEGER (1..maxTS-1)
    },
    timeslotList                SEQUENCE (SIZE (1..maxTS-1)) OF
      UplinkAdditionalTimeslots
  }
}
}

UplinkTimeslotsCodes-VHCR ::= SEQUENCE {
  dynamicSFusage                BOOLEAN,
  firstIndividualTimeslotInfo    IndividualTimeslotInfo-VHCR,
  ul-TS-ChannelisationCodeList  UL-TS-ChannelisationCodeList-VHCR,
  moreTimeslots                  CHOICE {
    noMore                        NULL,
    additionalTimeslots           CHOICE {
      consecutive                  SEQUENCE {
        numAdditionalTimeslots     INTEGER (1..maxTS-1)
      },
      timeslotList                SEQUENCE (SIZE (1..maxTS-1)) OF
        UplinkAdditionalTimeslots-VHCR
    }
  }
}

UplinkTimeslotsCodes-LCR-r4 ::= SEQUENCE {
  dynamicSFusage                BOOLEAN,
  firstIndividualTimeslotInfo    IndividualTimeslotInfo-LCR-r4,
  ul-TS-ChannelisationCodeList  UL-TS-ChannelisationCodeList,
  moreTimeslots                  CHOICE {
    noMore                        NULL,
    additionalTimeslots           CHOICE {
      consecutive                  SEQUENCE {
        numAdditionalTimeslots     INTEGER (1..maxTS-LCR-1)
      },
      timeslotList                SEQUENCE (SIZE (1..maxTS-LCR-1)) OF
        UplinkAdditionalTimeslots-LCR-r4
    }
  }
}

UplinkTimeslotsCodes-LCR-r7 ::= SEQUENCE {
  dynamicSFusage                BOOLEAN,
  firstIndividualTimeslotInfo    IndividualTimeslotInfo-LCR-r4,
  ul-TS-ChannelisationCodeList  UL-TS-ChannelisationCodeList-r7,
  moreTimeslots                  CHOICE {
    noMore                        NULL,
    additionalTimeslots           CHOICE {
      consecutive                  SEQUENCE {
        -- the choice of 'consecutive' is not needed because there is only 1 option.
        numAdditionalTimeslots     INTEGER (1..maxTS-LCR-1)
      },
      timeslotList                SEQUENCE (SIZE (1..maxTS-LCR-1)) OF
        UplinkAdditionalTimeslots-LCR-r7
    }
  }
}

UpPCHposition-LCR ::= INTEGER (0..127)

Wi-LCR ::= INTEGER(1..4)

-- *****
--
-- MEASUREMENT INFORMATION ELEMENTS (10.3.7)
--
-- *****

AcquisitionSatInfo ::= SEQUENCE {
  satID                        SatID,
  -- Actual value dopplerOthOrder = IE value * 2.5
  dopplerOthOrder              INTEGER (-2048..2047),

```

```

    extraDopplerInfo          ExtraDopplerInfo          OPTIONAL,
    codePhase                 INTEGER (0..1022),
    integerCodePhase          INTEGER (0..19),
    gps-BitNumber             INTEGER (0..3),
    codePhaseSearchWindow    CodePhaseSearchWindow,
    azimuthAndElevation      AzimuthAndElevation      OPTIONAL
}

AcquisitionSatInfoList ::= SEQUENCE (SIZE (1..maxSat)) OF
    AcquisitionSatInfo

AdditionalMeasurementID-List ::= SEQUENCE (SIZE (1..maxAdditionalMeas)) OF
    MeasurementIdentity

AlmanacSatInfo ::= SEQUENCE {
    dataID                    INTEGER (0..3),
    satID                     SatID,
    e                          BIT STRING (SIZE (16)),
    t-oa                       BIT STRING (SIZE (8)),
    deltaI                     BIT STRING (SIZE (16)),
    omegaDot                   BIT STRING (SIZE (16)),
    satHealth                  BIT STRING (SIZE (8)),
    a-Sqrt                     BIT STRING (SIZE (24)),
    omega0                     BIT STRING (SIZE (24)),
    m0                         BIT STRING (SIZE (24)),
    omega                      BIT STRING (SIZE (24)),
    af0                        BIT STRING (SIZE (11)),
    af1                        BIT STRING (SIZE (11))
}

AlmanacSatInfoList ::= SEQUENCE (SIZE (1..maxSat)) OF
    AlmanacSatInfo

ALM-keplerianParameters ::= SEQUENCE {
    t-oa                       INTEGER (0..147),    -- time of week by 4096s steps
    iod-a                       INTEGER (0..3),
    sat-info-kpList             GANSS-SAT-Info-Almanac-KpList
}

AverageRLC-BufferPayload ::= ENUMERATED {
    pla0, pla4, pla8, pla16, pla32,
    pla64, pla128, pla256, pla512,
    pla1024, pla2k, pla4k, pla8k, pla16k,
    pla32k, pla64k, pla128k, pla256k,
    pla512k, pla1024k, spare12, spare11,
    spare10, spare9, spare8, spare7, spare6,
    spare5, spare4, spare3, spare2, spare1 }

AzimuthAndElevation ::= SEQUENCE {
    -- Actual value azimuth = IE value * 11.25
    azimuth                    INTEGER (0..31),
    -- Actual value elevation = IE value * 11.25
    elevation                   INTEGER (0..7)
}

BadSatList ::= SEQUENCE (SIZE (1..maxSat)) OF
    INTEGER (0..63)

Frequency-Band ::= ENUMERATED {
    dcs1800BandUsed, pcs1900BandUsed }

BCCH-ARFCN ::= INTEGER (0..1023)

BLER-MeasurementResults ::= SEQUENCE {
    transportChannelIdentity    TransportChannelIdentity,
    dl-TransportChannelBLER     DL-TransportChannelBLER    OPTIONAL
}

BLER-MeasurementResultsList ::= SEQUENCE (SIZE (1..maxTrCH)) OF
    BLER-MeasurementResults

BLER-TransChIdList ::= SEQUENCE (SIZE (1..maxTrCH)) OF
    TransportChannelIdentity

BSIC-VerificationRequired ::= ENUMERATED {
    required, notRequired }

```

```

BSICReported ::= CHOICE {
  -- Value maxCellMeas is not allowed for verifiedBSIC
  verifiedBSIC      INTEGER (0..maxCellMeas),
  nonVerifiedBSIC  BCCH-ARFCN
}

BurstModeParameters ::= SEQUENCE {
  burstStart      INTEGER (0..15),
  burstLength     INTEGER (10..25),
  burstFreq       INTEGER (1..16)
}

CellDCH-ReportCriteria ::= CHOICE {
  intraFreqReportingCriteria  IntraFreqReportingCriteria,
  periodicalReportingCriteria PeriodicalReportingCriteria
}

CellDCH-ReportCriteria-LCR-r4 ::= CHOICE {
  intraFreqReportingCriteria  IntraFreqReportingCriteria-LCR-r4,
  periodicalReportingCriteria PeriodicalReportingCriteria
}

-- Actual value CellIndividualOffset = IE value * 0.5
CellIndividualOffset ::= INTEGER (-20..20)

CellInfo ::= SEQUENCE {
  cellIndividualOffset      CellIndividualOffset      DEFAULT 0,
  referenceTimeDifferenceToCell ReferenceTimeDifferenceToCell OPTIONAL,
  modeSpecificInfo         CHOICE {
    fdd                     SEQUENCE {
      primaryCPICH-Info      PrimaryCPICH-Info      OPTIONAL,
      primaryCPICH-TX-Power  PrimaryCPICH-TX-Power OPTIONAL,
      readSFN-Indicator      BOOLEAN,
      tx-DiversityIndicator  BOOLEAN
    },
    tdd                     SEQUENCE {
      primaryCCPCH-Info      PrimaryCCPCH-Info,
      primaryCCPCH-TX-Power  PrimaryCCPCH-TX-Power OPTIONAL,
      timeslotInfoList       TimeslotInfoList   OPTIONAL,
      readSFN-Indicator      BOOLEAN
    }
  }
}

CellInfo-r4 ::= SEQUENCE {
  cellIndividualOffset      CellIndividualOffset      DEFAULT 0,
  referenceTimeDifferenceToCell ReferenceTimeDifferenceToCell OPTIONAL,
  modeSpecificInfo         CHOICE {
    fdd                     SEQUENCE {
      primaryCPICH-Info      PrimaryCPICH-Info      OPTIONAL,
      primaryCPICH-TX-Power  PrimaryCPICH-TX-Power OPTIONAL,
      readSFN-Indicator      BOOLEAN,
      tx-DiversityIndicator  BOOLEAN
    },
    tdd                     SEQUENCE {
      primaryCCPCH-Info      PrimaryCCPCH-Info-r4,
      primaryCCPCH-TX-Power  PrimaryCCPCH-TX-Power OPTIONAL,
      timeslotInfoList-r4    TimeslotInfoList-r4   OPTIONAL,
      readSFN-Indicator      BOOLEAN
    }
  }
}

CellInfoSI-RSCP ::= SEQUENCE {
  cellIndividualOffset      CellIndividualOffset      DEFAULT 0,
  referenceTimeDifferenceToCell ReferenceTimeDifferenceToCell OPTIONAL,
  modeSpecificInfo         CHOICE {
    fdd                     SEQUENCE {
      primaryCPICH-Info      PrimaryCPICH-Info      OPTIONAL,
      primaryCPICH-TX-Power  PrimaryCPICH-TX-Power OPTIONAL,
      readSFN-Indicator      BOOLEAN,
      tx-DiversityIndicator  BOOLEAN
    },
    tdd                     SEQUENCE {
      primaryCCPCH-Info      PrimaryCCPCH-Info,
      primaryCCPCH-TX-Power  PrimaryCCPCH-TX-Power OPTIONAL,
    }
  }
}

```

```

        timeslotInfoList          TimeslotInfoList          OPTIONAL,
        readSFN-Indicator          BOOLEAN
    },
    cellSelectionReselectionInfo    CellSelectReselectInfoSIB-11-12-RSCP    OPTIONAL
}

CellInfoSI-RSCP-LCR-r4 ::= SEQUENCE {
    cellIndividualOffset          CellIndividualOffset          DEFAULT 0,
    referenceTimeDifferenceToCell ReferenceTimeDifferenceToCell    OPTIONAL,
    primaryCCPCH-Info             PrimaryCCPCH-Info-LCR-r4,
    primaryCCPCH-TX-Power         PrimaryCCPCH-TX-Power          OPTIONAL,
    timeslotInfoList              TimeslotInfoList-LCR-r4        OPTIONAL,
    readSFN-Indicator             BOOLEAN,
    cellSelectionReselectionInfo    CellSelectReselectInfoSIB-11-12-RSCP    OPTIONAL
}

CellInfoSI-ECN0 ::= SEQUENCE {
    cellIndividualOffset          CellIndividualOffset          DEFAULT 0,
    referenceTimeDifferenceToCell ReferenceTimeDifferenceToCell    OPTIONAL,
    modeSpecificInfo              CHOICE {
        fdd                       SEQUENCE {
            primaryCPICH-Info      PrimaryCPICH-Info            OPTIONAL,
            primaryCPICH-TX-Power  PrimaryCPICH-TX-Power       OPTIONAL,
            readSFN-Indicator      BOOLEAN,
            tx-DiversityIndicator  BOOLEAN
        },
        tdd                       SEQUENCE {
            primaryCCPCH-Info      PrimaryCCPCH-Info,          OPTIONAL,
            primaryCCPCH-TX-Power  PrimaryCCPCH-TX-Power       OPTIONAL,
            timeslotInfoList       TimeslotInfoList            OPTIONAL,
            readSFN-Indicator      BOOLEAN
        }
    },
    cellSelectionReselectionInfo    CellSelectReselectInfoSIB-11-12-ECN0    OPTIONAL
}

CellInfoSI-ECN0-LCR-r4 ::= SEQUENCE {
    cellIndividualOffset          CellIndividualOffset          DEFAULT 0,
    referenceTimeDifferenceToCell ReferenceTimeDifferenceToCell    OPTIONAL,
    primaryCCPCH-Info             PrimaryCCPCH-Info-LCR-r4,
    primaryCCPCH-TX-Power         PrimaryCCPCH-TX-Power          OPTIONAL,
    timeslotInfoList              TimeslotInfoList-LCR-r4        OPTIONAL,
    readSFN-Indicator             BOOLEAN,
    cellSelectionReselectionInfo    CellSelectReselectInfoSIB-11-12-ECN0    OPTIONAL
}

CellInfoSI-HCS-RSCP ::= SEQUENCE {
    cellIndividualOffset          CellIndividualOffset          DEFAULT 0,
    referenceTimeDifferenceToCell ReferenceTimeDifferenceToCell    OPTIONAL,
    modeSpecificInfo              CHOICE {
        fdd                       SEQUENCE {
            primaryCPICH-Info      PrimaryCPICH-Info            OPTIONAL,
            primaryCPICH-TX-Power  PrimaryCPICH-TX-Power       OPTIONAL,
            readSFN-Indicator      BOOLEAN,
            tx-DiversityIndicator  BOOLEAN
        },
        tdd                       SEQUENCE {
            primaryCCPCH-Info      PrimaryCCPCH-Info,          OPTIONAL,
            primaryCCPCH-TX-Power  PrimaryCCPCH-TX-Power       OPTIONAL,
            timeslotInfoList       TimeslotInfoList            OPTIONAL,
            readSFN-Indicator      BOOLEAN
        }
    },
    cellSelectionReselectionInfo    CellSelectReselectInfoSIB-11-12-HCS-RSCP    OPTIONAL
}

CellInfoSI-HCS-RSCP-LCR-r4 ::= SEQUENCE {
    cellIndividualOffset          CellIndividualOffset          DEFAULT 0,
    referenceTimeDifferenceToCell ReferenceTimeDifferenceToCell    OPTIONAL,
    primaryCCPCH-Info             PrimaryCCPCH-Info-LCR-r4,
    primaryCCPCH-TX-Power         PrimaryCCPCH-TX-Power          OPTIONAL,
    timeslotInfoList              TimeslotInfoList-LCR-r4        OPTIONAL,
    readSFN-Indicator             BOOLEAN,
    cellSelectionReselectionInfo    CellSelectReselectInfoSIB-11-12-HCS-RSCP    OPTIONAL
}

CellInfoSI-HCS-ECN0 ::= SEQUENCE {

```

```

cellIndividualOffset          CellIndividualOffset          DEFAULT 0,
referenceTimeDifferenceToCell ReferenceTimeDifferenceToCell OPTIONAL,
modeSpecificInfo             CHOICE {
  fdd                         SEQUENCE {
    primaryCPICH-Info        PrimaryCPICH-Info        OPTIONAL,
    primaryCPICH-TX-Power    PrimaryCPICH-TX-Power    OPTIONAL,
    readSFN-Indicator        BOOLEAN,
    tx-DiversityIndicator    BOOLEAN
  },
  tdd                         SEQUENCE {
    primaryCCPCH-Info        PrimaryCCPCH-Info,
    primaryCCPCH-TX-Power    PrimaryCCPCH-TX-Power    OPTIONAL,
    timeslotInfoList        TimeslotInfoList        OPTIONAL,
    readSFN-Indicator        BOOLEAN
  }
},
cellSelectionReselectionInfo CellSelectReselectInfoSIB-11-12-HCS-ECNO OPTIONAL
}

CellInfoSI-HCS-ECNO-LCR-r4 ::= SEQUENCE {
  cellIndividualOffset          CellIndividualOffset          DEFAULT 0,
  referenceTimeDifferenceToCell ReferenceTimeDifferenceToCell OPTIONAL,
  primaryCCPCH-Info            PrimaryCCPCH-Info-LCR-r4,
  primaryCCPCH-TX-Power        PrimaryCCPCH-TX-Power        OPTIONAL,
  timeslotInfoList            TimeslotInfoList-LCR-r4      OPTIONAL,
  readSFN-Indicator            BOOLEAN,
  cellSelectionReselectionInfo CellSelectReselectInfoSIB-11-12-HCS-ECNO OPTIONAL
}

CellMeasuredResults ::= SEQUENCE {
  cellIdentity                  CellIdentity                  OPTIONAL,
  -- dummy is not used in this version of the specification, it should
  -- not be sent and if received it should be ignored.
  dummy                         SFN-SFN-ObsTimeDifference          OPTIONAL,
  cellSynchronisationInfo      CellSynchronisationInfo      OPTIONAL,
  modeSpecificInfo             CHOICE {
    fdd                         SEQUENCE {
      primaryCPICH-Info        PrimaryCPICH-Info,
      cpich-Ec-N0              CPICH-Ec-N0                OPTIONAL,
      cpich-RSCP                CPICH-RSCP                  OPTIONAL,
      pathloss                  Pathloss                    OPTIONAL
    },
    tdd                         SEQUENCE {
      cellParametersID         CellParametersID,
      proposedTGSN             TGSN                        OPTIONAL,
      primaryCCPCH-RSCP        PrimaryCCPCH-RSCP           OPTIONAL,
      pathloss                  Pathloss                    OPTIONAL,
      timeslotISCP-List        TimeslotISCP-List          OPTIONAL
    }
  }
}

CellMeasurementEventResults ::= CHOICE {
  fdd                           SEQUENCE (SIZE (1..maxCellMeas)) OF
    PrimaryCPICH-Info,
  tdd                           SEQUENCE (SIZE (1..maxCellMeas)) OF
    PrimaryCCPCH-Info
}

CellMeasurementEventResults-LCR-r4 ::= SEQUENCE (SIZE (1..maxCellMeas)) OF
  PrimaryCCPCH-Info-LCR-r4

CellReportingQuantities ::= SEQUENCE {
  -- dummy is not used in this version of the specification
  -- and if received it should be ignored.
  dummy                         SFN-SFN-OTD-Type,
  cellIdentity-reportingIndicator          BOOLEAN,
  cellSynchronisationInfo-reportingIndicator          BOOLEAN,
  modeSpecificInfo                         CHOICE {
    fdd                                     SEQUENCE {
      cpich-Ec-N0-reportingIndicator          BOOLEAN,
      cpich-RSCP-reportingIndicator          BOOLEAN,
      pathloss-reportingIndicator            BOOLEAN
    },
    tdd                                     SEQUENCE {
      timeslotISCP-reportingIndicator          BOOLEAN,
      proposedTGSN-ReportingRequired          BOOLEAN,
      primaryCCPCH-RSCP-reportingIndicator    BOOLEAN,

```



```

        pathloss-reportingIndicator                BOOLEAN
    }
}

CellSelectReselectInfoSIB-11-12 ::= SEQUENCE {
    q-Offset1S-N                Q-OffsetS-N                DEFAULT 0,
    q-Offset2S-N                Q-OffsetS-N                OPTIONAL,
    maxAllowedUL-TX-Power       MaxAllowedUL-TX-Power      OPTIONAL,
    hcs-NeighbouringCellInformation-RSCP    HCS-NeighbouringCellInformation-RSCP
    OPTIONAL,
    modeSpecificInfo            CHOICE {
        fdd                     SEQUENCE {
            q-QualMin           Q-QualMin                 OPTIONAL,
            q-RxlevMin          Q-RxlevMin                 OPTIONAL
        },
        tdd                     SEQUENCE {
            q-RxlevMin          Q-RxlevMin                 OPTIONAL
        },
        gsm                     SEQUENCE {
            q-RxlevMin          Q-RxlevMin                 OPTIONAL
        }
    }
}

CellSelectReselectInfoSIB-11-12-RSCP ::= SEQUENCE {
    q-OffsetS-N                Q-OffsetS-N                DEFAULT 0,
    maxAllowedUL-TX-Power       MaxAllowedUL-TX-Power      OPTIONAL,
    modeSpecificInfo            CHOICE {
        fdd                     SEQUENCE {
            q-QualMin           Q-QualMin                 OPTIONAL,
            q-RxlevMin          Q-RxlevMin                 OPTIONAL
        },
        tdd                     SEQUENCE {
            q-RxlevMin          Q-RxlevMin                 OPTIONAL
        },
        gsm                     SEQUENCE {
            q-RxlevMin          Q-RxlevMin                 OPTIONAL
        }
    }
}

CellSelectReselectInfoSIB-11-12-ECNO ::= SEQUENCE {
    q-Offset1S-N                Q-OffsetS-N                DEFAULT 0,
    q-Offset2S-N                Q-OffsetS-N                DEFAULT 0,
    maxAllowedUL-TX-Power       MaxAllowedUL-TX-Power      OPTIONAL,
    modeSpecificInfo            CHOICE {
        fdd                     SEQUENCE {
            q-QualMin           Q-QualMin                 OPTIONAL,
            q-RxlevMin          Q-RxlevMin                 OPTIONAL
        },
        tdd                     SEQUENCE {
            q-RxlevMin          Q-RxlevMin                 OPTIONAL
        },
        gsm                     SEQUENCE {
            q-RxlevMin          Q-RxlevMin                 OPTIONAL
        }
    }
}

CellSelectReselectInfoSIB-11-12-HCS-RSCP ::= SEQUENCE {
    q-OffsetS-N                Q-OffsetS-N                DEFAULT 0,
    maxAllowedUL-TX-Power       MaxAllowedUL-TX-Power      OPTIONAL,
    hcs-NeighbouringCellInformation-RSCP    HCS-NeighbouringCellInformation-RSCP
    OPTIONAL,
    modeSpecificInfo            CHOICE {
        fdd                     SEQUENCE {
            q-QualMin           Q-QualMin                 OPTIONAL,
            q-RxlevMin          Q-RxlevMin                 OPTIONAL
        },
        tdd                     SEQUENCE {
            q-RxlevMin          Q-RxlevMin                 OPTIONAL
        },
        gsm                     SEQUENCE {
            q-RxlevMin          Q-RxlevMin                 OPTIONAL
        }
    }
}

```

```

CellSelectReselectInfoSIB-11-12-HCS-ECNO ::= SEQUENCE {
    q-Offset1S-N                Q-OffsetS-N                DEFAULT 0,
    q-Offset2S-N                Q-OffsetS-N                DEFAULT 0,
    maxAllowedUL-TX-Power       MaxAllowedUL-TX-Power       OPTIONAL,
    hcs-NeighbouringCellInformation-ECNO HCS-NeighbouringCellInformation-ECNO
    OPTIONAL,
    modeSpecificInfo            CHOICE {
        fdd                     SEQUENCE {
            q-QualMin           Q-QualMin           OPTIONAL,
            q-RxlevMin          Q-RxlevMin          OPTIONAL
        },
        tdd                     SEQUENCE {
            q-RxlevMin          Q-RxlevMin          OPTIONAL
        },
        gsm                     SEQUENCE {
            q-RxlevMin          Q-RxlevMin          OPTIONAL
        }
    }
}

CellSelectReselectInfo-v590ext ::= SEQUENCE {
    deltaQrxlevmin              DeltaQrxlevmin              OPTIONAL,
    deltaQhcs                   DeltaRSCP                OPTIONAL
}

CellSelectReselectInfoPCHFACH-v5b0ext ::= SEQUENCE {
    q-Hyst-1-S-PCH              Q-Hyst-S-Fine                OPTIONAL,
    q-Hyst-1-S-FACH             Q-Hyst-S-Fine                OPTIONAL,
    q-Hyst-2-S-PCH              Q-Hyst-S-Fine                OPTIONAL,
    q-Hyst-2-S-FACH             Q-Hyst-S-Fine                OPTIONAL,
    t-Reselection-S-PCH         T-Reselection-S             OPTIONAL,
    t-Reselection-S-FACH        T-Reselection-S-Fine        OPTIONAL
}

CellSelectReselectInfoTreseselectionScaling-v5c0ext ::= SEQUENCE {
    -- For speed detection, the same HCS parameters are utilised
    non-HCS-t-CR-Max            T-CRMax                    OPTIONAL,
    speedDependentScalingFactor SpeedDependentScalingFactor OPTIONAL,
    interFrequencyTreseselectionScalingFactor TreseselectionScalingFactor OPTIONAL,
    interRATTreseselectionScalingFactor TreseselectionScalingFactor OPTIONAL
}

CellsForInterFreqMeasList ::= SEQUENCE (SIZE (1..maxCellMeas)) OF
    InterFreqCellID
CellsForInterRATMeasList ::= SEQUENCE (SIZE (1..maxCellMeas)) OF
    InterRATCellID
CellsForIntraFreqMeasList ::= SEQUENCE (SIZE (1..maxCellMeas)) OF
    IntraFreqCellID

CellSynchronisationInfo ::= SEQUENCE {
    modeSpecificInfo            CHOICE {
        fdd                     SEQUENCE {
            countC-SFN-Frame-difference CountC-SFN-Frame-difference OPTIONAL,
            tm                   INTEGER(0..38399)
        },
        tdd                     SEQUENCE {
            countC-SFN-Frame-difference CountC-SFN-Frame-difference OPTIONAL
        }
    }
}

CellToReport ::= SEQUENCE {
    bsicReported                BSICReported
}

CellToReportList ::= SEQUENCE (SIZE (1..maxCellMeas)) OF
    CellToReport

CodePhaseSearchWindow ::= ENUMERATED {
    w1023, w1, w2, w3, w4, w6, w8,
    w12, w16, w24, w32, w48, w64,
    w96, w128, w192 }

CountC-SFN-Frame-difference ::= SEQUENCE {
    -- Actual value countC-SFN-High = IE value * 256
    countC-SFN-High             INTEGER(0..15),
    off                          INTEGER(0..255)
}

```

```

}

-- SPARE: CPICH-Ec-No, Max = 49
-- Values above Max are spare
CPICH-Ec-NO ::= INTEGER (0..63)

-- SPARE: CPICH- RSCP, Max = 91
-- Values above Max are spare
CPICH-RSCP ::= INTEGER (0..127)

DataBitAssistance ::= SEQUENCE {
    ganss-signal-id      GANSS-Signal-Id,
    data-bits            BIT STRING (SIZE (1..1024))
}

DataBitAssistanceList ::= SEQUENCE (SIZE (1..maxGANSSSat)) OF
    DataBitAssistanceSat

DataBitAssistanceSat ::= SEQUENCE {
    satID                INTEGER(0..63),
    dataBitAssistanceSgnList DataBitAssistanceSgnList
}

DataBitAssistanceSgnList ::= SEQUENCE (SIZE (1..maxSgnType)) OF
    DataBitAssistance

DeltaPRC ::= INTEGER (-127..127)

--Actual value DeltaQrxlevmin = IE value * 2
DeltaQrxlevmin ::= INTEGER (-2..-1)

DeltaRSCP ::= INTEGER (-5..-1)

DeltaRSCPPerCell ::= SEQUENCE {
    deltaRSCP            DeltaRSCP    OPTIONAL
}

-- Actual value DeltaRRC = IE value * 0.032
DeltaRRC ::= INTEGER (-7..7)

DGANSSInfo ::= SEQUENCE {
    ganssSignalId        GANSS-Signal-Id                OPTIONAL,
    ganssStatusHealth    GANSS-Status-Health,
    dgansssSignalInformationList DGANSSSignalInformationList OPTIONAL
}

DGANSSInfoList ::= SEQUENCE (SIZE (1..maxSgnType)) OF
    DGANSSInfo

DGANSSSignalInformation ::= SEQUENCE {
    satId                INTEGER (0..63),
    iode-dganss          BIT STRING (SIZE (10)),
    udre                 UDRE,
    ganss-prc            INTEGER (-2047..2047),        -- scale factor 0.32
    ganss-rrc            INTEGER (-127..127)          -- scale factor 0.032
}

DGANSSSignalInformationList ::= SEQUENCE (SIZE (1..maxGANSSSat)) OF
    DGANSSSignalInformation

DGANSS-Sig-Id-Req ::= BIT STRING (SIZE (8))

DGPS-CorrectionSatInfo ::= SEQUENCE {
    satID                SatID,
    iode                 IODE,
    udre                 UDRE,
    prc                  PRC,
    rrc                  RRC,
    -- dummy1 and dummy2 are not used in this version of the specification and should be ignored.
    dummy1               DeltaPRC,
    dummy2               DeltaRRC,
    -- dummy3 and dummy4 are not used in this version of the specification. They should not
    -- be sent and if received they should be ignored.
    dummy3               DeltaPRC                OPTIONAL,
    dummy4               DeltaRRC                OPTIONAL
}

DGPS-CorrectionSatInfoList ::= SEQUENCE (SIZE (1..maxSat)) OF

```

DGPS-CorrectionSatInfo

```

DiffCorrectionStatus ::=          ENUMERATED {
    udre-1-0, udre-0-75, udre-0-5, udre-0-3,
    udre-0-2, udre-0-1, noData, invalidData }

DL-TransportChannelBLER ::=      INTEGER (0..63)

DopplerUncertainty ::=           ENUMERATED {
    hz12-5, hz25, hz50, hz100, hz200,
    spare3, spare2, spare1 }

EllipsoidPoint ::=              SEQUENCE {
    latitudeSign          ENUMERATED { north, south },
    latitude              INTEGER (0..8388607),
    longitude             INTEGER (-8388608..8388607)
}

EllipsoidPointAltitude ::=      SEQUENCE {
    latitudeSign          ENUMERATED { north, south },
    latitude              INTEGER (0..8388607),
    longitude             INTEGER (-8388608..8388607),
    altitudeDirection     ENUMERATED {height, depth},
    altitude              INTEGER (0..32767)
}

EllipsoidPointAltitudeEllipsoide ::= SEQUENCE {
    latitudeSign          ENUMERATED { north, south },
    latitude              INTEGER (0..8388607),
    longitude             INTEGER (-8388608..8388607),
    altitudeDirection     ENUMERATED {height, depth},
    altitude              INTEGER (0..32767),
    uncertaintySemiMajor  INTEGER (0..127),
    uncertaintySemiMinor  INTEGER (0..127),
    -- Actual value orientationMajorAxis = IE value * 2
    orientationMajorAxis  INTEGER (0..89),
    uncertaintyAltitude   INTEGER (0..127),
    confidence             INTEGER (0..100)
}

EllipsoidPointUncertCircle ::=  SEQUENCE {
    latitudeSign          ENUMERATED { north, south },
    latitude              INTEGER (0..8388607),
    longitude             INTEGER (-8388608..8388607),
    uncertaintyCode       INTEGER (0..127)
}

EllipsoidPointUncertEllipse ::= SEQUENCE {
    latitudeSign          ENUMERATED { north, south },
    latitude              INTEGER (0..8388607),
    longitude             INTEGER (-8388608..8388607),
    uncertaintySemiMajor  INTEGER (0..127),
    uncertaintySemiMinor  INTEGER (0..127),
    -- Actual value orientationMajorAxis = IE value * 2
    orientationMajorAxis  INTEGER (0..89),
    confidence             INTEGER (0..100)
}

EnvironmentCharacterisation ::= ENUMERATED {
    possibleHeavyMultipathNLOS,
    lightMultipathLOS,
    notDefined,
    spare }

Event1a ::=                     SEQUENCE {
    triggeringCondition    TriggeringCondition2,
    reportingRange        ReportingRange,
    forbiddenAffectCellList ForbiddenAffectCellList          OPTIONAL,
    w                     W,
    reportDeactivationThreshold ReportDeactivationThreshold,
    reportingAmount        ReportingAmount,
    reportingInterval      ReportingInterval
}

```

```

Event1a-r4 ::=
    triggeringCondition
    reportingRange
    forbiddenAffectCellList
    w
    reportDeactivationThreshold
    reportingAmount
    reportingInterval
}
SEQUENCE {
    TriggeringCondition2,
    ReportingRange,
    ForbiddenAffectCellList-r4
    OPTIONAL,
    W,
    ReportDeactivationThreshold,
    ReportingAmount,
    ReportingInterval
}

Event1a-LCR-r4 ::=
    triggeringCondition
    reportingRange
    forbiddenAffectCellList
    w
    reportDeactivationThreshold
    reportingAmount
    reportingInterval
}
SEQUENCE {
    TriggeringCondition2,
    ReportingRange,
    ForbiddenAffectCellList-LCR-r4
    OPTIONAL,
    W,
    ReportDeactivationThreshold,
    ReportingAmount,
    ReportingInterval
}

Event1b ::=
    triggeringCondition
    reportingRange
    forbiddenAffectCellList
    w
}
SEQUENCE {
    TriggeringCondition1,
    ReportingRange,
    ForbiddenAffectCellList
    OPTIONAL,
    W
}

Event1b-r4 ::=
    triggeringCondition
    reportingRange
    forbiddenAffectCellList
    w
}
SEQUENCE {
    TriggeringCondition1,
    ReportingRange,
    ForbiddenAffectCellList-r4
    OPTIONAL,
    W
}

Event1b-r7 ::=
    triggeringCondition
    reportingRange
    forbiddenAffectCellList
    w
    periodicReportingInfo-1b
}
SEQUENCE {
    TriggeringCondition1,
    ReportingRange,
    ForbiddenAffectCellList-r4
    OPTIONAL,
    W,
    PeriodicReportingInfo-1b
    OPTIONAL
}

Event1b-LCR-r4 ::=
    triggeringCondition
    reportingRange
    forbiddenAffectCellList
    w
}
SEQUENCE {
    TriggeringCondition1,
    ReportingRange,
    ForbiddenAffectCellList-LCR-r4
    OPTIONAL,
    W
}

Event1c ::=
    replacementActivationThreshold
    reportingAmount
    reportingInterval
}
SEQUENCE {
    ReplacementActivationThreshold,
    ReportingAmount,
    ReportingInterval
}

Event1d ::=
    triggeringCondition
    useCIO
}
SEQUENCE {
    TriggeringCondition2
    OPTIONAL,
    BOOLEAN
    OPTIONAL
}

Event1e ::=
    triggeringCondition
    thresholdUsedFrequency
}
SEQUENCE {
    TriggeringCondition2,
    ThresholdUsedFrequency
}

Event1e-r6 ::=
    triggeringCondition
    thresholdUsedFrequency
}
SEQUENCE {
    TriggeringCondition2,
    ThresholdUsedFrequency-r6
}

Event1f ::=
    triggeringCondition
    thresholdUsedFrequency
}
SEQUENCE {
    TriggeringCondition1,
    ThresholdUsedFrequency
}

Event1f-r6 ::=
    triggeringCondition
}
SEQUENCE {
    TriggeringCondition1,
}

```

```

    thresholdUsedFrequency          ThresholdUsedFrequency-r6
  }

Event1j-r6 ::=                      SEQUENCE {
  replacementActivationThreshold    ReplacementActivationThreshold,
  reportingAmount                   ReportingAmount,
  reportingInterval                  ReportingInterval
}

Event2a ::=                          SEQUENCE {
  -- dummy is not used in this version of the specification and should be ignored
  dummy                             Threshold,
  usedFreqW                          W,
  hysteresis                          HysteresisInterFreq,
  timeToTrigger                       TimeToTrigger,
  reportingCellStatus                 ReportingCellStatus          OPTIONAL,
  nonUsedFreqParameterList           NonUsedFreqParameterList    OPTIONAL
}

Event2a-r6 ::=                      SEQUENCE {
  usedFreqW                          W,
  hysteresis                          HysteresisInterFreq,
  timeToTrigger                       TimeToTrigger,
  reportingCellStatus                 ReportingCellStatus          OPTIONAL,
  nonUsedFreqParameterList           NonUsedFreqWList-r6        OPTIONAL
}

Event2b ::=                          SEQUENCE {
  usedFreqThreshold                  Threshold,
  usedFreqW                          W,
  hysteresis                          HysteresisInterFreq,
  timeToTrigger                       TimeToTrigger,
  reportingCellStatus                 ReportingCellStatus          OPTIONAL,
  nonUsedFreqParameterList           NonUsedFreqParameterList    OPTIONAL
}

Event2b-r6 ::=                      SEQUENCE {
  usedFreqThreshold                  Threshold-r6,
  usedFreqW                          W,
  hysteresis                          HysteresisInterFreq,
  timeToTrigger                       TimeToTrigger,
  reportingCellStatus                 ReportingCellStatus          OPTIONAL,
  nonUsedFreqParameterList           NonUsedFreqParameterList-r6  OPTIONAL
}

Event2c ::=                          SEQUENCE {
  hysteresis                          HysteresisInterFreq,
  timeToTrigger                       TimeToTrigger,
  reportingCellStatus                 ReportingCellStatus          OPTIONAL,
  nonUsedFreqParameterList           NonUsedFreqParameterList    OPTIONAL
}

Event2c-r6 ::=                      SEQUENCE {
  hysteresis                          HysteresisInterFreq,
  timeToTrigger                       TimeToTrigger,
  reportingCellStatus                 ReportingCellStatus          OPTIONAL,
  nonUsedFreqParameterList           NonUsedFreqParameterList-r6  OPTIONAL
}

Event2d ::=                          SEQUENCE {
  usedFreqThreshold                  Threshold,
  usedFreqW                          W,
  hysteresis                          HysteresisInterFreq,
  timeToTrigger                       TimeToTrigger,
  reportingCellStatus                 ReportingCellStatus          OPTIONAL
}

Event2d-r6 ::=                      SEQUENCE {
  usedFreqThreshold                  Threshold-r6,
  usedFreqW                          W,
  hysteresis                          HysteresisInterFreq,
  timeToTrigger                       TimeToTrigger,
  reportingCellStatus                 ReportingCellStatus          OPTIONAL
}

Event2e ::=                          SEQUENCE {
  hysteresis                          HysteresisInterFreq,
  timeToTrigger                       TimeToTrigger,

```

reportingCellStatus	ReportingCellStatus	OPTIONAL,
nonUsedFreqParameterList	NonUsedFreqParameterList	OPTIONAL
}		
Event2e-r6 ::=	SEQUENCE {	
hysteresis	HysteresisInterFreq,	
timeToTrigger	TimeToTrigger,	
reportingCellStatus	ReportingCellStatus	OPTIONAL,
nonUsedFreqParameterList	NonUsedFreqParameterList-r6	OPTIONAL
}		
Event2f ::=	SEQUENCE {	
usedFreqThreshold	Threshold,	
usedFreqW	W,	
hysteresis	HysteresisInterFreq,	
timeToTrigger	TimeToTrigger,	
reportingCellStatus	ReportingCellStatus	OPTIONAL
}		
Event2f-r6 ::=	SEQUENCE {	
usedFreqThreshold	Threshold-r6,	
usedFreqW	W,	
hysteresis	HysteresisInterFreq,	
timeToTrigger	TimeToTrigger,	
reportingCellStatus	ReportingCellStatus	OPTIONAL
}		
Event3a ::=	SEQUENCE {	
thresholdOwnSystem	Threshold,	
w	W,	
thresholdOtherSystem	Threshold,	
hysteresis	Hysteresis,	
timeToTrigger	TimeToTrigger,	
reportingCellStatus	ReportingCellStatus	OPTIONAL
}		
Event3b ::=	SEQUENCE {	
thresholdOtherSystem	Threshold,	
hysteresis	Hysteresis,	
timeToTrigger	TimeToTrigger,	
reportingCellStatus	ReportingCellStatus	OPTIONAL
}		
Event3c ::=	SEQUENCE {	
thresholdOtherSystem	Threshold,	
hysteresis	Hysteresis,	
timeToTrigger	TimeToTrigger,	
reportingCellStatus	ReportingCellStatus	OPTIONAL
}		
Event3d ::=	SEQUENCE {	
hysteresis	Hysteresis,	
timeToTrigger	TimeToTrigger,	
reportingCellStatus	ReportingCellStatus	OPTIONAL
}		
EventIDInterFreq ::=	ENUMERATED {	
	e2a, e2b, e2c, e2d, e2e, e2f, spare2, spare1 }	
EventIDInterRAT ::=	ENUMERATED {	
	e3a, e3b, e3c, e3d }	
EventIDIntraFreq ::=	ENUMERATED {	
	e1a, e1b, e1c, e1d, e1e,	
	e1f, e1g, e1h, e1i, e1j,	
	spare6, spare5, spare4, spare3, spare2,	
	spare1 }	
EventResults ::=	CHOICE {	
intraFreqEventResults	IntraFreqEventResults,	
interFreqEventResults	InterFreqEventResults,	
interRATEEventResults	InterRATEEventResults,	
trafficVolumeEventResults	TrafficVolumeEventResults,	
qualityEventResults	QualityEventResults,	
ue-InternalEventResults	UE-InternalEventResults,	
ue-positioning-MeasurementEventResults	UE-Positioning-MeasurementEventResults,	
spare	NULL	

```

}
EventResults-v770ext ::= CHOICE {
  ue-positioning-MeasurementEventResults UE-Positioning-MeasurementEventResults-v770ext
}
ExtraDoppler ::= SEQUENCE {
  -- Doppler 1st order term, -0.2..+0.1 m/s2
  -- ( = -42..+21 with 1/210 m/s2 resolution)
  dopplerFirstOrder INTEGER (-42.. 21),
  dopplerUncertainty ENUMERATED { dopU40, dopU20, dopU10, dopU5, dopU2-5,
  spare3, spare2, spare1 }
}
ExtraDopplerInfo ::= SEQUENCE {
  -- Actual value doppler1stOrder = IE value * 0.023
  doppler1stOrder INTEGER (-42..21),
  dopplerUncertainty DopplerUncertainty
}
FACH-MeasurementOccasionInfo ::= SEQUENCE {
  fACH-meas-occasion-coeff INTEGER (1..12) OPTIONAL,
  inter-freq-FDD-meas-ind BOOLEAN,
  -- inter-freq-TDD-meas-ind is for 3.84Mcps TDD and 7.68 Mcps TDD. For 1.28Mcps TDD, the IE in
  -- FACH-MeasurementOccasionInfo-LCR-r4-ext is used.
  inter-freq-TDD-meas-ind BOOLEAN,
  inter-RAT-meas-ind SEQUENCE (SIZE (1..maxOtherRAT)) OF
  RAT-Type OPTIONAL
}
FACH-MeasurementOccasionInfo-LCR-r4-ext ::= SEQUENCE {
  inter-freq-TDD128-meas-ind BOOLEAN
}
FilterCoefficient ::= ENUMERATED {
  fc0, fc1, fc2, fc3, fc4, fc5,
  fc6, fc7, fc8, fc9, fc11, fc13,
  fc15, fc17, fc19, spare1 }
-- Actual value FineSFN-SFN = IE value * 0.0625
FineSFN-SFN ::= INTEGER (0..15)
ForbiddenAffectCell ::= CHOICE {
  fdd PrimaryCPICH-Info,
  tdd PrimaryCCPCH-Info
}
ForbiddenAffectCell-r4 ::= CHOICE {
  fdd PrimaryCPICH-Info,
  tdd PrimaryCCPCH-Info-r4
}
ForbiddenAffectCell-LCR-r4 ::= SEQUENCE {
  tdd PrimaryCCPCH-Info-LCR-r4
}
ForbiddenAffectCellList ::= SEQUENCE (SIZE (1..maxCellMeas)) OF
  ForbiddenAffectCell
ForbiddenAffectCellList-r4 ::= SEQUENCE (SIZE (1..maxCellMeas)) OF
  ForbiddenAffectCell-r4
ForbiddenAffectCellList-LCR-r4 ::= SEQUENCE (SIZE (1..maxCellMeas)) OF
  ForbiddenAffectCell-LCR-r4
FreqQualityEstimateQuantity-FDD ::= ENUMERATED {
  cpich-Ec-N0,
  cpich-RSCP }
FreqQualityEstimateQuantity-TDD ::= ENUMERATED {
  primaryCCPCH-RSCP }
GanssDataBits ::= SEQUENCE {
  ganssTod INTEGER (0..86399),
  dataBitAssistance ReqDataBitAssistance
}
GANSDecipheringKeys ::= SEQUENCE {

```



```

    currentDecipheringKey          BIT STRING (SIZE (56)),
    nextDecipheringKey            BIT STRING (SIZE (56))
}

GANSSGenericData ::= SEQUENCE {
    ganssId                        INTEGER (0..7)                                OPTIONAL,
    ganssTimeModelsList           GANSSTimeModelsList                        OPTIONAL,
    uePositioningDGANSSCorrections UE-Positioning-DGANSSCorrections        OPTIONAL,
    uePositioningGANSSNavigationModel UE-Positioning-GANSS-NavigationModel    OPTIONAL,
    uePositioningGANSSRealTimeIntegrity UE-Positioning-GANSS-RealTimeIntegrity  OPTIONAL,
    uePositioningGANSSDataBitAssistance UE-Positioning-GANSS-Data-Bit-Assistance  OPTIONAL,
    uePositioningGANSSReferenceMeasurementInfo UE-Positioning-GANSS-ReferenceMeasurementInfo  OPTIONAL,
    uePositioningGANSSAlmanac      UE-Positioning-GANSS-Almanac                OPTIONAL,
    uePositioningGANSSUTCModel     UE-Positioning-GANSS-UTCModel                OPTIONAL
}

GANSSGenericDataList ::= SEQUENCE (SIZE (1..maxGANSS)) OF
    GANSSGenericData

GANSSGenericMeasurementInfo ::= SEQUENCE (SIZE (1..maxGANSS)) OF SEQUENCE {
    ganssId                        INTEGER (0..7)                                OPTIONAL,
    ganssMeasurementSignalList     GANSSMeasurementSignalList
}

GANSSMeasurementParameters ::= SEQUENCE (SIZE (1..maxGANSSSat)) OF SEQUENCE {
    satId                          INTEGER (0..63),
    cSurNzero                      INTEGER (0..63),
    multipathIndicator             ENUMERATED { nm, low, medium, high },
    carrierQualityIndication       BIT STRING (SIZE (2))                            OPTIONAL,
    ganssCodePhase                 INTEGER (0..2097151),
    ganssIntegerCodePhase          INTEGER (0..63)                                OPTIONAL,
    codePhaseRmsError             INTEGER (0..63),
    doppler                       INTEGER (-32768..32767),
    adr                           INTEGER (0..33554431)                            OPTIONAL
}

GANSSMeasurementSignalList ::= SEQUENCE (SIZE (1..maxSgnType)) OF SEQUENCE {
    ganssSignalId                 GANSS-Signal-Id                            OPTIONAL,
    ganssCodePhaseAmbiguity       INTEGER (0..31)                            OPTIONAL,
    ganssMeasurementParameters    GANSSMeasurementParameters
}

GanssNavigationModelAdditionalData ::= SEQUENCE {
    ganssWeek                     INTEGER (0..4095),
    ganssToe                      INTEGER (0..167),
    t-toeLimit                   INTEGER (0..10),
    satellitesListRelatedDataList SatellitesListRelatedDataList        OPTIONAL
}

GANSSReferenceTimeOnly ::= SEQUENCE {
    gANSS-tod                    INTEGER (0..3599999),
    gANSS-timeId                 INTEGER (0..7)                                OPTIONAL,
    gANSS-tod-uncertainty        INTEGER (0..127)                            OPTIONAL
}

GanssReqGenericData ::= SEQUENCE {
    ganssId                      INTEGER (0..7)                                OPTIONAL,
    ganssRealTimeIntegrity       BOOLEAN,
    ganssDifferentialCorrection  DGANSS-Sig-Id-Req                            OPTIONAL,
    ganssAlmanac                BOOLEAN,
    ganssNavigationModel        BOOLEAN,
    ganssTimeModelGNSS-GNSS     BIT STRING (SIZE (8))                            OPTIONAL,
    ganssReferenceMeasurementInfo BOOLEAN,
    ganssDataBits               GanssDataBits                            OPTIONAL,
    ganssUTCModel               BOOLEAN,
    ganssNavigationModelAdditionalData GanssNavigationModelAdditionalData  OPTIONAL
}

GanssRequestedGenericAssistanceDataList ::= SEQUENCE (SIZE (1..maxGANSS)) OF
    GanssReqGenericData

GANSSSatelliteInformation ::= SEQUENCE {
    ganssSatId                   INTEGER (0..63),
    dopplerZeroOrder            INTEGER (-2048..2047),                -- scale factor 0.5m/s
    extraDoppler                ExtraDoppler                            OPTIONAL,
    codePhase                   INTEGER (0..1023),
    integerCodePhase            INTEGER (0..127),

```

```

    codePhaseSearchWindow          BIT STRING (SIZE (5)),
    azimuthAndElevation            AzimuthAndElevation          OPTIONAL
}

GANSSSatelliteInformationList ::= SEQUENCE (SIZE (1..maxGANSSSat)) OF
    GANSSSatelliteInformation

GANSSTimeModelsList ::= SEQUENCE (SIZE (1..maxGANSS-1)) OF
    UE-Positioning-GANSS-TimeModel

GANSS-SAT-Info-Almanac-Kp ::= SEQUENCE {
    svId                INTEGER (0..63),
    ganss-alm-e         BIT STRING (SIZE (11)),
    ganss-delta-I-alm   BIT STRING (SIZE (11)),
    ganss-omegadot-alm BIT STRING (SIZE (11)),
    ganss-svhealth-alm BIT STRING (SIZE (4)),
    ganss-delta-a-sqrt-alm BIT STRING (SIZE (17)),
    ganss-omegazero-alm BIT STRING (SIZE (16)),
    ganss-m-zero-alm   BIT STRING (SIZE (16)),
    ganss-omega-alm    BIT STRING (SIZE (16)),
    ganss-af-zero-alm  BIT STRING (SIZE (14)),
    ganss-af-one-alm   BIT STRING (SIZE (11))
}

GANSS-SAT-Info-Almanac-KpList ::= SEQUENCE (SIZE (1..maxGANSSSat)) OF
    GANSS-SAT-Info-Almanac-Kp

Ganss-Sat-Info-Nav ::= SEQUENCE {
    satId                INTEGER (0..63),
    svHealth             BIT STRING (SIZE (5)),
    iod                  BIT STRING (SIZE (10)),
    ganssClockModel      UE-Positioning-GANSS-ClockModel,
    ganssOrbitModel      UE-Positioning-GANSS-OrbitModel
}

Ganss-Sat-Info-NavList ::= SEQUENCE (SIZE (1..maxGANSSSat)) OF
    Ganss-Sat-Info-Nav

GANSS-Signal-Id ::= INTEGER (0..7)

GANSS-Status-Health ::= ENUMERATED {
    udre-scale-1dot0,
    udre-scale-0dot75,
    udre-scale-0dot5,
    udre-scale-0dot3,
    udre-scale-0dot2,
    udre-scale-0dot1,
    no-data,
    invalid-data }

GANSS-Storm-Flag ::= SEQUENCE {
    storm-flag-one      BOOLEAN,
    storm-flag-two      BOOLEAN,
    storm-flag-three    BOOLEAN,
    storm-flag-four     BOOLEAN,
    storm-flag-five     BOOLEAN
}

GPS-MeasurementParam ::= SEQUENCE {
    satelliteID          INTEGER (0..63),
    c-N0                 INTEGER (0..63),
    doppler               INTEGER (-32768..32768),
    wholeGPS-Chips        INTEGER (0..1022),
    fractionalGPS-Chips   INTEGER (0..1023),
    multipathIndicator    MultipathIndicator,
    pseudorangeRMS-Error INTEGER (0..63)
}

GPS-MeasurementParamList ::= SEQUENCE (SIZE (1..maxSat)) OF
    GPS-MeasurementParam

GSM-CarrierRSSI ::= BIT STRING (SIZE (6))

GSM-MeasuredResults ::= SEQUENCE {
    gsm-CarrierRSSI      GSM-CarrierRSSI          OPTIONAL,
    -- dummy is not used in this version of the specification, it should
    -- not be sent and if received it should be ignored.
}

```

```

dummy                INTEGER (46..173)                OPTIONAL,
bsicReported         BSICReported,
-- dummy2 is not used in this version of the specification, it should
-- not be sent and if received it should be ignored.
dummy2              ObservedTimeDifferenceToGSM        OPTIONAL
}

GSM-MeasuredResultsList ::= SEQUENCE (SIZE (1..maxReportedGSMCells)) OF
                             GSM-MeasuredResults

GPS-TOW-1msec ::= INTEGER (0..604799999)

GPS-TOW-1sec ::= INTEGER (0..604799)

GPS-TOW-Assist ::= SEQUENCE {
    satID              SatID,
    tlm-Message        BIT STRING (SIZE (14)),
    tlm-Reserved       BIT STRING (SIZE (2)),
    alert              BOOLEAN,
    antiSpooF          BOOLEAN
}

GPS-TOW-AssistList ::= SEQUENCE (SIZE (1..maxSat)) OF
                        GPS-TOW-Assist

HCS-CellReselectInformation-RSCP ::= SEQUENCE {
    -- TABULAR: The default value for penaltyTime is "notUsed"
    -- Temporary offset is nested inside PenaltyTime-RSCP
    penaltyTime        PenaltyTime-RSCP
}

HCS-CellReselectInformation-ECNO ::= SEQUENCE {
    -- TABULAR: The default value for penaltyTime is "notUsed"
    -- Temporary offset is nested inside PenaltyTime-ECNO
    penaltyTime        PenaltyTime-ECNO
}

HCS-NeighbouringCellInformation-RSCP ::= SEQUENCE {
    hcs-PRIO           HCS-PRIO                DEFAULT 0,
    q-HCS              Q-HCS                  DEFAULT 0,
    hcs-CellReselectInformation HCS-CellReselectInformation-RSCP
}

HCS-NeighbouringCellInformation-ECNO ::= SEQUENCE {
    hcs-PRIO           HCS-PRIO                DEFAULT 0,
    q-HCS              Q-HCS                  DEFAULT 0,
    hcs-CellReselectInformation HCS-CellReselectInformation-ECNO
}

HCS-PRIO ::= INTEGER (0..7)

HCS-ServingCellInformation ::= SEQUENCE {
    hcs-PRIO           HCS-PRIO                DEFAULT 0,
    q-HCS              Q-HCS                  DEFAULT 0,
    t-CR-Max          T-CRMax                 OPTIONAL
}

HorizontalVelocity ::= SEQUENCE {
    bearing            INTEGER (0..359),
    horizontalSpeed    INTEGER (0..2047)
}

HorizontalWithVerticalVelocity ::= SEQUENCE {
    verticalSpeedDirection ENUMERATED { upward, downward },
    bearing              INTEGER (0..359),
    horizontalSpeed      INTEGER (0..2047),
    verticalSpeed        INTEGER (0..255)
}

HorizontalVelocityWithUncertainty ::= SEQUENCE {
    bearing            INTEGER (0..359),
    horizontalSpeed    INTEGER (0..2047),
    horizontalSpeedUncertainty INTEGER (0..255)
}

HorizontalWithVerticalVelocityAndUncertainty ::= SEQUENCE {
    verticalSpeedDirection ENUMERATED { upward, downward },
    bearing              INTEGER (0..359),

```

```

    horizontalSpeed                INTEGER (0..2047),
    verticalSpeed                  INTEGER (0..255),
    horizontalUncertaintySpeed    INTEGER (0..255),
    verticalUncertaintySpeed      INTEGER (0..255)
}

-- Actual value Hysteresis = IE value * 0.5
Hysteresis ::=                    INTEGER (0..15)

-- Actual value HysteresisInterFreq = IE value * 0.5
HysteresisInterFreq ::=          INTEGER (0..29)

InterFreqCell ::=                SEQUENCE {
    frequencyInfo                 FrequencyInfo,
    nonFreqRelatedEventResults    CellMeasurementEventResults
}

InterFreqCell-LCR-r4 ::=         SEQUENCE {
    frequencyInfo                 FrequencyInfo,
    nonFreqRelatedEventResults    CellMeasurementEventResults-LCR-r4
}

InterFreqCellID ::=              INTEGER (0..maxCellMeas-1)

InterFreqCellInfoList ::=        SEQUENCE {
    removedInterFreqCellList      RemovedInterFreqCellList      OPTIONAL,
    newInterFreqCellList          NewInterFreqCellList          OPTIONAL,
    cellsForInterFreqMeasList     CellsForInterFreqMeasList     OPTIONAL
}

InterFreqCellInfoList-r4 ::=     SEQUENCE {
    removedInterFreqCellList      RemovedInterFreqCellList      OPTIONAL,
    newInterFreqCellList-r4      NewInterFreqCellList-r4      OPTIONAL,
    cellsForInterFreqMeasList     CellsForInterFreqMeasList     OPTIONAL
}

InterFreqCellInfoSI-List-RSCP ::= SEQUENCE {
    removedInterFreqCellList      RemovedInterFreqCellList      OPTIONAL,
    newInterFreqCellList          NewInterFreqCellSI-List-RSCP  OPTIONAL
}

InterFreqCellInfoSI-List-ECN0 ::= SEQUENCE {
    removedInterFreqCellList      RemovedInterFreqCellList      OPTIONAL,
    newInterFreqCellList          NewInterFreqCellSI-List-ECN0  OPTIONAL
}

InterFreqCellInfoSI-List-HCS-RSCP ::= SEQUENCE {
    removedInterFreqCellList      RemovedInterFreqCellList      OPTIONAL,
    newInterFreqCellList          NewInterFreqCellSI-List-HCS-RSCP  OPTIONAL
}

InterFreqCellInfoSI-List-HCS-ECN0 ::= SEQUENCE {
    removedInterFreqCellList      RemovedInterFreqCellList      OPTIONAL,
    newInterFreqCellList          NewInterFreqCellSI-List-HCS-ECN0  OPTIONAL
}

InterFreqCellInfoSI-List-RSCP-LCR ::= SEQUENCE {
    removedInterFreqCellList      RemovedInterFreqCellList      OPTIONAL,
    newInterFreqCellList          NewInterFreqCellSI-List-RSCP-LCR-r4  OPTIONAL
}

InterFreqCellInfoSI-List-ECN0-LCR ::= SEQUENCE {
    removedInterFreqCellList      RemovedInterFreqCellList      OPTIONAL,
    newInterFreqCellList          NewInterFreqCellSI-List-ECN0-LCR-r4  OPTIONAL
}

InterFreqCellInfoSI-List-HCS-RSCP-LCR ::= SEQUENCE {
    removedInterFreqCellList      RemovedInterFreqCellList      OPTIONAL,
    newInterFreqCellList          NewInterFreqCellSI-List-HCS-RSCP-LCR-r4  OPTIONAL
}

InterFreqCellInfoSI-List-HCS-ECN0-LCR ::= SEQUENCE {
    removedInterFreqCellList      RemovedInterFreqCellList      OPTIONAL,
    newInterFreqCellList          NewInterFreqCellSI-List-HCS-ECN0-LCR-r4  OPTIONAL
}

InterFreqCellList ::=            SEQUENCE (SIZE (1..maxFreq)) OF
    InterFreqCell

InterFreqCellList-LCR-r4-ext ::= SEQUENCE (SIZE (1..maxFreq)) OF

```

InterFreqCell-LCR-r4

```
InterFreqCellMeasuredResultsList ::= SEQUENCE (SIZE (1..maxCellMeas)) OF
    CellMeasuredResults
```

```
InterFreqEvent ::= CHOICE {
    event2a      Event2a,
    event2b      Event2b,
    event2c      Event2c,
    event2d      Event2d,
    event2e      Event2e,
    event2f      Event2f
}
```

```
InterFreqEvent-r6 ::= CHOICE {
    event2a-r6   Event2a-r6,
    event2b-r6   Event2b-r6,
    event2c-r6   Event2c-r6,
    event2d-r6   Event2d-r6,
    event2e-r6   Event2e-r6,
    event2f-r6   Event2f-r6
}
```

```
InterFreqEventList ::= SEQUENCE (SIZE (1..maxMeasEvent)) OF
    InterFreqEvent
```

```
InterFreqEventList-r6 ::= SEQUENCE (SIZE (1..maxMeasEvent)) OF
    InterFreqEvent-r6
```

--Following IE shall be used regardless of CPICH RSCP(FDD) or Primary CCPCH RSCP(TDD)
 --The order of the list corresponds to the order of the cells in InterFrequencyMeasuredResultsList
 --The IE is only used for measured results and not for additional measured results.

```
InterFrequencyMeasuredResultsList-v590ext ::= SEQUENCE (SIZE (1..maxCellMeas)) OF
    DeltaRSCPPerCell
```

```
Inter-FreqEventCriteria-v590ext ::= SEQUENCE {
    thresholdUsedFrequency-delta      DeltaRSCP,
    thresholdNonUsedFrequency-deltaList ThresholdNonUsedFrequency-deltaList OPTIONAL
}
```

--The order of the list corresponds to the order of the events in Inter-FreqEventList

```
Inter-FreqEventCriteriaList-v590ext ::= SEQUENCE (SIZE (1..maxMeasEvent)) OF
    Inter-FreqEventCriteria-v590ext
```

--The order of the list corresponds to the order of relevant events in Intra-FreqEventCriteriaList
 --i.e. the first element of the list corresponds to the first occurrence of event 1e, 1f, 1h, 1i,
 --the second element of the list corresponds to the second occurrence of event 1e, 1f, 1h, 1i

```
Intra-FreqEventCriteriaList-v590ext ::= SEQUENCE (SIZE (1..maxMeasEvent)) OF
    DeltaRSCP
```

--Following IE shall be used regardless of CPICH RSCP(FDD) or Primary CCPCH RSCP(TDD)
 --The order of the list corresponds to the order of the cells in IntraFrequencyMeasuredResultsList
 --The IE is only used for measured results and not for additional measured results.

```
IntraFrequencyMeasuredResultsList-v590ext ::= SEQUENCE (SIZE (1..maxCellMeas)) OF
    DeltaRSCPPerCell
```

```
IntraFreqReportingCriteria-1b-r5 ::= SEQUENCE {
    periodicReportingInfo-1b      PeriodicReportingInfo-1b
}
```

```
PeriodicReportingInfo-1b ::= SEQUENCE {
    reportingAmount      ReportingAmount,
    reportingInterval     ReportingInterval
}
```

```
InterFreqEventResults ::= SEQUENCE {
    eventID              EventIDInterFreq,
    interFreqCellList    InterFreqCellList OPTIONAL
}
```

```
InterFreqEventResults-LCR-r4-ext ::= SEQUENCE {
    eventID              EventIDInterFreq,
    interFreqCellList    InterFreqCellList-LCR-r4-ext OPTIONAL
}
```

```
InterFreqMeasQuantity ::= SEQUENCE {
    reportingCriteria     CHOICE {
        intraFreqReportingCriteria      SEQUENCE {
```

```

        intraFreqMeasQuantity          IntraFreqMeasQuantity
    },
    interFreqReportingCriteria          SEQUENCE {
        filterCoefficient               FilterCoefficient          DEFAULT fc0,
        modeSpecificInfo                CHOICE {
            fdd                          SEQUENCE {
                freqQualityEstimateQuantity-FDD  FreqQualityEstimateQuantity-FDD
            },
            tdd                          SEQUENCE {
                freqQualityEstimateQuantity-TDD  FreqQualityEstimateQuantity-TDD
            }
        }
    }
}

InterFreqMeasuredResults ::= SEQUENCE {
    frequencyInfo                FrequencyInfo                OPTIONAL,
    ultra-CarrierRSSI            UTRA-CarrierRSSI            OPTIONAL,
    interFreqCellMeasuredResultsList  InterFreqCellMeasuredResultsList  OPTIONAL
}

InterFreqMeasuredResultsList ::= SEQUENCE (SIZE (1..maxFreq)) OF
    InterFreqMeasuredResults

InterFreqMeasurementSysInfo-RSCP ::= SEQUENCE {
    interFreqCellInfoSI-List      InterFreqCellInfoSI-List-RSCP      OPTIONAL
}

InterFreqMeasurementSysInfo-ECNO ::= SEQUENCE {
    interFreqCellInfoSI-List      InterFreqCellInfoSI-List-ECNO      OPTIONAL
}

InterFreqMeasurementSysInfo-HCS-RSCP ::= SEQUENCE {
    interFreqCellInfoSI-List      InterFreqCellInfoSI-List-HCS-RSCP  OPTIONAL
}

InterFreqMeasurementSysInfo-HCS-ECNO ::= SEQUENCE {
    interFreqCellInfoSI-List      InterFreqCellInfoSI-List-HCS-ECNO  OPTIONAL
}

InterFreqMeasurementSysInfo-RSCP-LCR-r4 ::= SEQUENCE {
    interFreqCellInfoSI-List      InterFreqCellInfoSI-List-RSCP-LCR  OPTIONAL
}

InterFreqMeasurementSysInfo-ECNO-LCR-r4 ::= SEQUENCE {
    interFreqCellInfoSI-List      InterFreqCellInfoSI-List-ECNO-LCR  OPTIONAL
}

InterFreqMeasurementSysInfo-HCS-RSCP-LCR-r4 ::= SEQUENCE {
    interFreqCellInfoSI-List      InterFreqCellInfoSI-List-HCS-RSCP-LCR  OPTIONAL
}

InterFreqMeasurementSysInfo-HCS-ECNO-LCR-r4 ::= SEQUENCE {
    interFreqCellInfoSI-List      InterFreqCellInfoSI-List-HCS-ECNO-LCR  OPTIONAL
}

InterFreqRACHRepCellsList ::= SEQUENCE (SIZE (1..maxFreq)) OF
    InterFreqCellID

Dummy-InterFreqRACHReportingInfo ::= SEQUENCE {
    modeSpecificInfo              CHOICE {
        fdd                        SEQUENCE {
            interFreqRepQuantityRACH-FDD  InterFreqRepQuantityRACH-FDD
        },
        tdd                        SEQUENCE {
            interFreqRepQuantityRACH-TDDList  InterFreqRepQuantityRACH-TDDList
        }
    },
    interFreqRACHReportingThreshold  Threshold,
    maxReportedCellsOnRACHinterFreq  MaxReportedCellsOnRACHinterFreq
}

InterFreqRACHReportingInfo ::= SEQUENCE {
    modeSpecificInfo              CHOICE {
        fdd                        SEQUENCE {
            interFreqRepQuantityRACH-FDD  InterFreqRepQuantityRACH-FDD
        }
    }
}

```

```

    },
    tdd                               SEQUENCE {
        interFreqRepQuantityRACH-TDDList  InterFreqRepQuantityRACH-TDDList
    }
},
interFreqRACHReportingThreshold      Threshold,
maxReportedCellsOnRACHinterFreq     MaxReportedCellsOnRACHinterFreq
}

InterFreqReportCriteria ::=          CHOICE {
    intraFreqReportingCriteria        IntraFreqReportingCriteria,
    interFreqReportingCriteria        InterFreqReportingCriteria,
    periodicalReportingCriteria       PeriodicalWithReportingCellStatus,
    noReporting                       ReportingCellStatusOpt
}

InterFreqReportCriteria-r4 ::=      CHOICE {
    intraFreqReportingCriteria        IntraFreqReportingCriteria-r4,
    interFreqReportingCriteria        InterFreqReportingCriteria,
    periodicalReportingCriteria       PeriodicalWithReportingCellStatus,
    noReporting                       ReportingCellStatusOpt
}

InterFreqReportCriteria-r6 ::=      CHOICE {
    intraFreqReportingCriteria        IntraFreqReportingCriteria-r6,
    interFreqReportingCriteria        InterFreqReportingCriteria-r6,
    periodicalReportingCriteria       PeriodicalWithReportingCellStatus,
    noReporting                       ReportingCellStatusOpt
}

InterFreqReportCriteria-r7 ::=      CHOICE {
    intraFreqReportingCriteria        IntraFreqReportingCriteria-r7,
    interFreqReportingCriteria        InterFreqReportingCriteria-r6,
    periodicalReportingCriteria       PeriodicalWithReportingCellStatus,
    noReporting                       ReportingCellStatusOpt
}

InterFreqReportingCriteria ::=      SEQUENCE {
    interFreqEventList                InterFreqEventList                OPTIONAL
}

InterFreqReportingCriteria-r6 ::=   SEQUENCE {
    interFreqEventList                InterFreqEventList-r6                OPTIONAL
}

InterFreqReportingQuantity ::=      SEQUENCE {
    ultra-Carrier-RSSI                BOOLEAN,
    frequencyQualityEstimate          BOOLEAN,
    nonFreqRelatedQuantities         CellReportingQuantities
}

InterFreqRepQuantityRACH-FDD ::=    ENUMERATED {
    cpich-EcN0, cpich-RSCP }

-- dummy is not used in this version of the specification, it should
-- not be sent and if received the UE behaviour is not specified.
InterFreqRepQuantityRACH-TDD ::=    ENUMERATED {
    dummy,
    primaryCCPCH-RSCP }

InterFreqRepQuantityRACH-TDDList ::= SEQUENCE (SIZE (1..2)) OF
    InterFreqRepQuantityRACH-TDD

InterFrequencyMeasurement ::=       SEQUENCE {
    interFreqCellInfoList             InterFreqCellInfoList,
    interFreqMeasQuantity              InterFreqMeasQuantity              OPTIONAL,
    interFreqReportingQuantity        InterFreqReportingQuantity        OPTIONAL,
    measurementValidity               MeasurementValidity                OPTIONAL,
    interFreqSetUpdate                UE-AutonomousUpdateMode          OPTIONAL,
    reportCriteria                    InterFreqReportCriteria
}

InterFrequencyMeasurement-r4 ::=    SEQUENCE {
    interFreqCellInfoList             InterFreqCellInfoList-r4,
    interFreqMeasQuantity              InterFreqMeasQuantity              OPTIONAL,
    interFreqReportingQuantity        InterFreqReportingQuantity        OPTIONAL,
    measurementValidity               MeasurementValidity                OPTIONAL,
    interFreqSetUpdate                UE-AutonomousUpdateMode          OPTIONAL,

```

```

    reportCriteria                InterFreqReportCriteria-r4
  }

InterFrequencyMeasurement-r6 ::= SEQUENCE {
    interFreqCellInfoList        InterFreqCellInfoList-r4,
    interFreqMeasQuantity         InterFreqMeasQuantity           OPTIONAL,
    interFreqReportingQuantity    InterFreqReportingQuantity      OPTIONAL,
    measurementValidity           MeasurementValidity             OPTIONAL,
    interFreqSetUpdate            UE-AutonomousUpdateMode         OPTIONAL,
    reportCriteria                InterFreqReportCriteria-r6
}

InterFrequencyMeasurement-r7 ::= SEQUENCE {
    interFreqCellInfoList        InterFreqCellInfoList-r4,
    interFreqMeasQuantity         InterFreqMeasQuantity           OPTIONAL,
    interFreqReportingQuantity    InterFreqReportingQuantity      OPTIONAL,
    measurementValidity           MeasurementValidity             OPTIONAL,
    interFreqSetUpdate            UE-AutonomousUpdateMode         OPTIONAL,
    reportCriteria                InterFreqReportCriteria-r7
}

InterRAT-TargetCellDescription ::= SEQUENCE {
    technologySpecificInfo        CHOICE {
        gsm                       SEQUENCE {
            bsic                   BSIC,
            frequency-band         Frequency-Band,
            bcch-ARFCN            BCCH-ARFCN,
            ncMode                 NC-Mode                OPTIONAL
        },
        is-2000                   NULL,
        spare2                     NULL,
        spare1                     NULL
    }
}

InterRATCellID ::= INTEGER (0..maxCellMeas-1)

InterRATCellInfoIndication ::= INTEGER (0..3)

InterRATCellInfoList ::= SEQUENCE {
    removedInterRATCellList       RemovedInterRATCellList,
    -- NOTE: Future revisions of dedicated messages including IE newInterRATCellList
    -- should use a corrected version of this IE
    newInterRATCellList           NewInterRATCellList,
    cellsForInterRATMeasList      CellsForInterRATMeasList           OPTIONAL
}

InterRATCellInfoList-B ::= SEQUENCE {
    removedInterRATCellList       RemovedInterRATCellList,
    -- NOTE: IE newInterRATCellList should be optional. However, system information
    -- does not support message versions. Hence, this can not be corrected
    newInterRATCellList           NewInterRATCellList-B
}

InterRATCellInfoList-r4 ::= SEQUENCE {
    removedInterRATCellList       RemovedInterRATCellList,
    newInterRATCellList           NewInterRATCellList           OPTIONAL,
    cellsForInterRATMeasList      CellsForInterRATMeasList           OPTIONAL
}

InterRATCellInfoList-r6 ::= SEQUENCE {
    removedInterRATCellList       RemovedInterRATCellList,
    newInterRATCellList           NewInterRATCellList           OPTIONAL,
    cellsForInterRATMeasList      CellsForInterRATMeasList           OPTIONAL,
    interRATCellInfoIndication-r6 InterRATCellInfoIndication      OPTIONAL
}

InterRATCellIndividualOffset ::= INTEGER (-50..50)

InterRATEvent ::= CHOICE {
    event3a                       Event3a,
    event3b                       Event3b,
    event3c                       Event3c,
    event3d                       Event3d
}

InterRATEventList ::= SEQUENCE (SIZE (1..maxMeasEvent)) OF
    InterRATEvent

```



```

InterRATEventResults ::= SEQUENCE {
    eventID                EventIDInterRAT,
    cellToReportList      CellToReportList
}

InterRATInfo ::= ENUMERATED {
    gsm
}

InterRATInfo-r6 ::= SEQUENCE {
    rat                    InterRATInfo,
    gsm-TargetCellInfoList GSM-TargetCellInfoList OPTIONAL
}

InterRATMeasQuantity ::= SEQUENCE {
    measQuantityUTRAN-QualityEstimate IntraFreqMeasQuantity OPTIONAL,
    ratSpecificInfo CHOICE {
        gsm SEQUENCE {
            measurementQuantity MeasurementQuantityGSM,
            filterCoefficient FilterCoefficient DEFAULT fc0,
            bsic-VerificationRequired BSIC-VerificationRequired
        },
        is-2000 SEQUENCE {
            tadd-EcIo INTEGER (0..63),
            tcomp-EcIo INTEGER (0..15),
            softSlope INTEGER (0..63) OPTIONAL,
            addIntercept INTEGER (0..63) OPTIONAL
        }
    }
}

InterRATMeasuredResults ::= CHOICE {
    gsm                    GSM-MeasuredResultsList,
    spare                  NULL
}

InterRATMeasuredResultsList ::= SEQUENCE (SIZE (1..maxOtherRAT-16)) OF
    InterRATMeasuredResults

InterRATMeasurement ::= SEQUENCE {
    interRATCellInfoList InterRATCellInfoList OPTIONAL,
    interRATMeasQuantity InterRATMeasQuantity OPTIONAL,
    interRATReportingQuantity InterRATReportingQuantity OPTIONAL,
    reportCriteria InterRATReportCriteria
}

InterRATMeasurement-r4 ::= SEQUENCE {
    interRATCellInfoList InterRATCellInfoList-r4 OPTIONAL,
    interRATMeasQuantity InterRATMeasQuantity OPTIONAL,
    interRATReportingQuantity InterRATReportingQuantity OPTIONAL,
    reportCriteria InterRATReportCriteria
}

InterRATMeasurement-r6 ::= SEQUENCE {
    interRATCellInfoList InterRATCellInfoList-r6 OPTIONAL,
    interRATMeasQuantity InterRATMeasQuantity OPTIONAL,
    interRATReportingQuantity InterRATReportingQuantity OPTIONAL,
    reportCriteria InterRATReportCriteria
}

InterRATMeasurementSysInfo ::= SEQUENCE {
    interRATCellInfoList InterRATCellInfoList OPTIONAL
}

InterRATMeasurementSysInfo-B ::= SEQUENCE {
    interRATCellInfoList InterRATCellInfoList-B OPTIONAL
}

InterRATReportCriteria ::= CHOICE {
    interRATReportingCriteria InterRATReportingCriteria,
    periodicalReportingCriteria PeriodicalWithReportingCellStatus,
    noReporting ReportingCellStatusOpt
}

InterRATReportingCriteria ::= SEQUENCE {
    interRATEventList InterRATEventList OPTIONAL
}

```

```

InterRATReportingQuantity ::= SEQUENCE {
    utran-EstimatedQuality          BOOLEAN,
    ratSpecificInfo                 CHOICE {
        gsm                         SEQUENCE {
            -- dummy and dummy2 are not used in this version of the specification
            -- and when received they should be ignored.
            dummy                    BOOLEAN,
            dummy2                   BOOLEAN,
            gsm-Carrier-RSSI         BOOLEAN
        }
    }
}

IntraFreqCellID ::= INTEGER (0..maxCellMeas-1)

IntraFreqCellInfoList ::= SEQUENCE {
    removedIntraFreqCellList      RemovedIntraFreqCellList      OPTIONAL,
    newIntraFreqCellList          NewIntraFreqCellList          OPTIONAL,
    cellsForIntraFreqMeasList     CellsForIntraFreqMeasList     OPTIONAL
}

IntraFreqCellInfoList-r4 ::= SEQUENCE {
    removedIntraFreqCellList      RemovedIntraFreqCellList      OPTIONAL,
    newIntraFreqCellList          NewIntraFreqCellList-r4      OPTIONAL,
    cellsForIntraFreqMeasList     CellsForIntraFreqMeasList     OPTIONAL
}

IntraFreqCellInfoSI-List-RSCP ::= SEQUENCE {
    removedIntraFreqCellList      RemovedIntraFreqCellList      OPTIONAL,
    newIntraFreqCellList          NewIntraFreqCellSI-List-RSCP
}

IntraFreqCellInfoSI-List-ECNO ::= SEQUENCE {
    removedIntraFreqCellList      RemovedIntraFreqCellList      OPTIONAL,
    newIntraFreqCellList          NewIntraFreqCellSI-List-ECNO
}

IntraFreqCellInfoSI-List-HCS-RSCP ::= SEQUENCE {
    removedIntraFreqCellList      RemovedIntraFreqCellList      OPTIONAL,
    newIntraFreqCellList          NewIntraFreqCellSI-List-HCS-RSCP
}

IntraFreqCellInfoSI-List-HCS-ECNO ::= SEQUENCE {
    removedIntraFreqCellList      RemovedIntraFreqCellList      OPTIONAL,
    newIntraFreqCellList          NewIntraFreqCellSI-List-HCS-ECNO
}

IntraFreqCellInfoSI-List-RSCP-LCR-r4 ::= SEQUENCE {
    removedIntraFreqCellList      RemovedIntraFreqCellList      OPTIONAL,
    newIntraFreqCellList          NewIntraFreqCellSI-List-RSCP-LCR-r4
}

IntraFreqCellInfoSI-List-ECNO-LCR-r4 ::= SEQUENCE {
    removedIntraFreqCellList      RemovedIntraFreqCellList      OPTIONAL,
    newIntraFreqCellList          NewIntraFreqCellSI-List-ECNO-LCR-r4
}

IntraFreqCellInfoSI-List-HCS-RSCP-LCR-r4 ::= SEQUENCE {
    removedIntraFreqCellList      RemovedIntraFreqCellList      OPTIONAL,
    newIntraFreqCellList          NewIntraFreqCellSI-List-HCS-RSCP-LCR-r4
}

IntraFreqCellInfoSI-List-HCS-ECNO-LCR-r4 ::= SEQUENCE {
    removedIntraFreqCellList      RemovedIntraFreqCellList      OPTIONAL,
    newIntraFreqCellList          NewIntraFreqCellSI-List-HCS-ECNO-LCR-r4
}

IntraFreqEvent ::= CHOICE {
    e1a                            Event1a,
    e1b                            Event1b,
    e1c                            Event1c,
    e1d                            NULL,
    e1e                            Event1e,
    e1f                            Event1f,
    e1g                            NULL,
    e1h                            ThresholdUsedFrequency,
    e1i                            ThresholdUsedFrequency
}

```

```

IntraFreqEvent-r4 ::= CHOICE {
    e1a          Event1a-r4,
    e1b          Event1b-r4,
    e1c          Event1c,
    e1d          NULL,
    e1e          Event1e,
    e1f          Event1f,
    e1g          NULL,
    e1h          ThresholdUsedFrequency,
    e1i          ThresholdUsedFrequency
}

IntraFreqEvent-LCR-r4 ::= CHOICE {
    e1a          Event1a-LCR-r4,
    e1b          Event1b-LCR-r4,
    e1c          Event1c,
    e1d          NULL,
    e1e          Event1e,
    e1f          Event1f,
    e1g          NULL,
    e1h          ThresholdUsedFrequency,
    e1i          ThresholdUsedFrequency
}

IntraFreqEvent-r6 ::= CHOICE {
    e1a          Event1a-r4,
    e1b          Event1b-r4,
    e1c          Event1c,
    e1d          Event1d,
    e1e          Event1e-r6,
    e1f          Event1f-r6,
    e1g          NULL,
    e1h          ThresholdUsedFrequency-r6,
    e1i          ThresholdUsedFrequency-r6,
    e1j          Event1j-r6
}

IntraFreqEvent-r7 ::= CHOICE {
    e1a          Event1a-r4,
    e1b          Event1b-r7,
    e1c          Event1c,
    e1d          Event1d,
    e1e          Event1e-r6,
    e1f          Event1f-r6,
    e1g          NULL,
    e1h          ThresholdUsedFrequency-r6,
    e1i          ThresholdUsedFrequency-r6,
    e1j          Event1j-r6
}

IntraFreqEvent-1d-r5 ::= SEQUENCE {
    triggeringCondition      TriggeringCondition2      OPTIONAL,
    useCIO                   BOOLEAN                   OPTIONAL
}

IntraFreqEventCriteria ::= SEQUENCE {
    event                    IntraFreqEvent,
    hysteresis               Hysteresis,
    timeToTrigger            TimeToTrigger,
    reportingCellStatus     ReportingCellStatus          OPTIONAL
}

IntraFreqEventCriteria-r4 ::= SEQUENCE {
    event                    IntraFreqEvent-r4,
    hysteresis               Hysteresis,
    timeToTrigger            TimeToTrigger,
    reportingCellStatus     ReportingCellStatus          OPTIONAL
}

IntraFreqEventCriteria-LCR-r4 ::= SEQUENCE {
    event                    IntraFreqEvent-LCR-r4,
    hysteresis               Hysteresis,
    timeToTrigger            TimeToTrigger,
    reportingCellStatus     ReportingCellStatus          OPTIONAL
}

IntraFreqEventCriteria-r6 ::= SEQUENCE {

```

```

    event                IntraFreqEvent-r6,
    hysteresis           Hysteresis,
    timeToTrigger       TimeToTrigger,
    reportingCellStatus ReportingCellStatus                OPTIONAL
}

IntraFreqEventCriteria-r7 ::= SEQUENCE {
    event                IntraFreqEvent-r7,
    hysteresis           Hysteresis,
    timeToTrigger       TimeToTrigger,
    reportingCellStatus ReportingCellStatus                OPTIONAL
}

IntraFreqEventCriteriaList ::= SEQUENCE (SIZE (1..maxMeasEvent)) OF
    IntraFreqEventCriteria

IntraFreqEventCriteriaList-r4 ::= SEQUENCE (SIZE (1..maxMeasEvent)) OF
    IntraFreqEventCriteria-r4

IntraFreqEventCriteriaList-LCR-r4 ::= SEQUENCE (SIZE (1..maxMeasEvent)) OF
    IntraFreqEventCriteria-LCR-r4

IntraFreqEventCriteriaList-r6 ::= SEQUENCE (SIZE (1..maxMeasEvent)) OF
    IntraFreqEventCriteria-r6

IntraFreqEventCriteriaList-r7 ::= SEQUENCE (SIZE (1..maxMeasEvent)) OF
    IntraFreqEventCriteria-r7

IntraFreqEventResults ::= SEQUENCE {
    eventID              EventIDIntraFreq,
    cellMeasurementEventResults CellMeasurementEventResults
}

IntraFreqMeasQuantity ::= SEQUENCE {
    filterCoefficient    FilterCoefficient                DEFAULT fc0,
    modeSpecificInfo     CHOICE {
        fdd               SEQUENCE {
            intraFreqMeasQuantity-FDD IntraFreqMeasQuantity-FDD
        },
        tdd               SEQUENCE {
            intraFreqMeasQuantity-TDDList IntraFreqMeasQuantity-TDDList
        }
    }
}

-- If IntraFreqMeasQuantity-FDD is used in InterRATMeasQuantity, then only
-- cpich-Ec-N0 and cpich-RSCP are allowed.
-- dummy is not used in this version of the specification, it should
-- not be sent and if received the UE behaviour is not specified.
IntraFreqMeasQuantity-FDD ::= ENUMERATED {
    cpich-Ec-N0,
    cpich-RSCP,
    pathloss,
    dummy }

IntraFreqMeasQuantity-FDD-sib3 ::= ENUMERATED {
    cpich-Ec-N0, cpich-RSCP }

-- dummy is not used in this version of the specification, it should
-- not be sent and if received the UE behaviour is not specified.
IntraFreqMeasQuantity-TDD ::= ENUMERATED {
    primaryCCPCH-RSCP,
    pathloss,
    timeslotISCP,
    dummy }

IntraFreqMeasQuantity-TDDList ::= SEQUENCE (SIZE (1..4)) OF
    IntraFreqMeasQuantity-TDD

IntraFreqMeasQuantity-TDD-sib3List ::= SEQUENCE (SIZE (1..2)) OF
    ENUMERATED { primaryCCPCH-RSCP, timeslotISCP }

IntraFreqMeasuredResultsList ::= SEQUENCE (SIZE (1..maxCellMeas)) OF
    CellMeasuredResults

IntraFreqMeasurementSysInfo-RSCP ::= SEQUENCE {
    intraFreqMeasurementID MeasurementIdentity        DEFAULT 1,
    intraFreqCellInfoSI-List IntraFreqCellInfoSI-List-RSCP    OPTIONAL,

```

```

    intraFreqMeasQuantity          IntraFreqMeasQuantity          OPTIONAL,
    intraFreqReportingQuantityForRACH IntraFreqReportingQuantityForRACH OPTIONAL,
    maxReportedCellsOnRACH         MaxReportedCellsOnRACH         OPTIONAL,
    reportingInfoForCellDCH        ReportingInfoForCellDCH        OPTIONAL
}

IntraFreqMeasurementSysInfo-ECN0 ::= SEQUENCE {
    intraFreqMeasurementID          MeasurementIdentity          DEFAULT 1,
    intraFreqCellInfoSI-List       IntraFreqCellInfoSI-List-ECN0 OPTIONAL,
    intraFreqMeasQuantity          IntraFreqMeasQuantity      OPTIONAL,
    intraFreqReportingQuantityForRACH IntraFreqReportingQuantityForRACH OPTIONAL,
    maxReportedCellsOnRACH         MaxReportedCellsOnRACH     OPTIONAL,
    reportingInfoForCellDCH        ReportingInfoForCellDCH     OPTIONAL
}

IntraFreqMeasurementSysInfo-HCS-RSCP ::= SEQUENCE {
    intraFreqMeasurementID          MeasurementIdentity          DEFAULT 1,
    intraFreqCellInfoSI-List       IntraFreqCellInfoSI-List-HCS-RSCP OPTIONAL,
    intraFreqMeasQuantity          IntraFreqMeasQuantity      OPTIONAL,
    intraFreqReportingQuantityForRACH IntraFreqReportingQuantityForRACH OPTIONAL,
    maxReportedCellsOnRACH         MaxReportedCellsOnRACH     OPTIONAL,
    reportingInfoForCellDCH        ReportingInfoForCellDCH     OPTIONAL
}

IntraFreqMeasurementSysInfo-HCS-ECN0 ::= SEQUENCE {
    intraFreqMeasurementID          MeasurementIdentity          DEFAULT 1,
    intraFreqCellInfoSI-List       IntraFreqCellInfoSI-List-HCS-ECN0 OPTIONAL,
    intraFreqMeasQuantity          IntraFreqMeasQuantity      OPTIONAL,
    intraFreqReportingQuantityForRACH IntraFreqReportingQuantityForRACH OPTIONAL,
    maxReportedCellsOnRACH         MaxReportedCellsOnRACH     OPTIONAL,
    reportingInfoForCellDCH        ReportingInfoForCellDCH     OPTIONAL
}

IntraFreqMeasurementSysInfo-RSCP-LCR-r4 ::= SEQUENCE {
    intraFreqMeasurementID          MeasurementIdentity          DEFAULT 1,
    intraFreqCellInfoSI-List       IntraFreqCellInfoSI-List-RSCP-LCR-r4 OPTIONAL,
    intraFreqMeasQuantity          IntraFreqMeasQuantity      OPTIONAL,
    intraFreqReportingQuantityForRACH IntraFreqReportingQuantityForRACH OPTIONAL,
    maxReportedCellsOnRACH         MaxReportedCellsOnRACH     OPTIONAL,
    reportingInfoForCellDCH        ReportingInfoForCellDCH-LCR-r4 OPTIONAL
}

IntraFreqMeasurementSysInfo-ECN0-LCR-r4 ::= SEQUENCE {
    intraFreqMeasurementID          MeasurementIdentity          DEFAULT 1,
    intraFreqCellInfoSI-List       IntraFreqCellInfoSI-List-ECN0-LCR-r4 OPTIONAL,
    intraFreqMeasQuantity          IntraFreqMeasQuantity      OPTIONAL,
    intraFreqReportingQuantityForRACH IntraFreqReportingQuantityForRACH OPTIONAL,
    maxReportedCellsOnRACH         MaxReportedCellsOnRACH     OPTIONAL,
    reportingInfoForCellDCH        ReportingInfoForCellDCH-LCR-r4 OPTIONAL
}

IntraFreqMeasurementSysInfo-HCS-RSCP-LCR-r4 ::= SEQUENCE {
    intraFreqMeasurementID          MeasurementIdentity          DEFAULT 1,
    intraFreqCellInfoSI-List       IntraFreqCellInfoSI-List-HCS-RSCP-LCR-r4 OPTIONAL,
    intraFreqMeasQuantity          IntraFreqMeasQuantity      OPTIONAL,
    intraFreqReportingQuantityForRACH IntraFreqReportingQuantityForRACH OPTIONAL,
    maxReportedCellsOnRACH         MaxReportedCellsOnRACH     OPTIONAL,
    reportingInfoForCellDCH        ReportingInfoForCellDCH-LCR-r4 OPTIONAL
}

IntraFreqMeasurementSysInfo-HCS-ECN0-LCR-r4 ::= SEQUENCE {
    intraFreqMeasurementID          MeasurementIdentity          DEFAULT 1,
    intraFreqCellInfoSI-List       IntraFreqCellInfoSI-List-HCS-ECN0-LCR-r4 OPTIONAL,
    intraFreqMeasQuantity          IntraFreqMeasQuantity      OPTIONAL,
    intraFreqReportingQuantityForRACH IntraFreqReportingQuantityForRACH OPTIONAL,
    maxReportedCellsOnRACH         MaxReportedCellsOnRACH     OPTIONAL,
    reportingInfoForCellDCH        ReportingInfoForCellDCH-LCR-r4 OPTIONAL
}

IntraFreqReportCriteria ::= CHOICE {
    intraFreqReportingCriteria      IntraFreqReportingCriteria,
    periodicalReportingCriteria     PeriodicalWithReportingCellStatus,
    noReporting                     ReportingCellStatusOpt
}

IntraFreqReportCriteria-r4 ::= CHOICE {
    intraFreqReportingCriteria      IntraFreqReportingCriteria-r4,
    periodicalReportingCriteria     PeriodicalWithReportingCellStatus,

```

```

    noReporting                ReportingCellStatusOpt
}

IntraFreqReportCriteria-r6 ::= CHOICE {
    intraFreqReportingCriteria
    periodicalReportingCriteria
    noReporting
}

IntraFreqReportCriteria-r7 ::= CHOICE {
    intraFreqReportingCriteria
    periodicalReportingCriteria
    noReporting
}

IntraFreqReportingCriteria ::= SEQUENCE {
    eventCriteriaList                IntraFreqEventCriteriaList    OPTIONAL
}

IntraFreqReportingCriteria-r4 ::= SEQUENCE {
    eventCriteriaList                IntraFreqEventCriteriaList-r4    OPTIONAL
}

IntraFreqReportingCriteria-LCR-r4 ::= SEQUENCE {
    eventCriteriaList                IntraFreqEventCriteriaList-LCR-r4    OPTIONAL
}

IntraFreqReportingCriteria-r6 ::= SEQUENCE {
    eventCriteriaList                IntraFreqEventCriteriaList-r6    OPTIONAL
}

IntraFreqReportingCriteria-r7 ::= SEQUENCE {
    eventCriteriaList                IntraFreqEventCriteriaList-r7    OPTIONAL
}

IntraFreqReportingQuantity ::= SEQUENCE {
    activeSetReportingQuantities      CellReportingQuantities,
    monitoredSetReportingQuantities   CellReportingQuantities,
    detectedSetReportingQuantities    CellReportingQuantities    OPTIONAL
}

IntraFreqReportingQuantityForRACH ::= SEQUENCE {
    sfn-SFN-OTD-Type                 SFN-SFN-OTD-Type,
    modeSpecificInfo                  CHOICE {
        fdd                           SEQUENCE {
            intraFreqRepQuantityRACH-FDD    IntraFreqRepQuantityRACH-FDD
        },
        tdd                            SEQUENCE {
            intraFreqRepQuantityRACH-TDDList    IntraFreqRepQuantityRACH-TDDList
        }
    }
}

IntraFreqRepQuantityRACH-FDD ::= ENUMERATED {
    cpich-EcN0, cpich-RSCP,
    pathloss, noReport }

IntraFreqRepQuantityRACH-TDD ::= ENUMERATED {
    timeslotISCP,
    primaryCCPCH-RSCP,
    noReport }

IntraFreqRepQuantityRACH-TDDList ::= SEQUENCE (SIZE (1..2)) OF
    IntraFreqRepQuantityRACH-TDD

IntraFrequencyMeasurement ::= SEQUENCE {
    intraFreqCellInfoList            IntraFreqCellInfoList        OPTIONAL,
    intraFreqMeasQuantity            IntraFreqMeasQuantity        OPTIONAL,
    intraFreqReportingQuantity       IntraFreqReportingQuantity    OPTIONAL,
    measurementValidity              MeasurementValidity           OPTIONAL,
    reportCriteria                   IntraFreqReportCriteria      OPTIONAL
}

IntraFrequencyMeasurement-r4 ::= SEQUENCE {
    intraFreqCellInfoList            IntraFreqCellInfoList-r4    OPTIONAL,
    intraFreqMeasQuantity            IntraFreqMeasQuantity        OPTIONAL,
    intraFreqReportingQuantity       IntraFreqReportingQuantity    OPTIONAL,
    measurementValidity              MeasurementValidity           OPTIONAL,
}

```

```

    reportCriteria                IntraFreqReportCriteria-r4                OPTIONAL
  }

IntraFrequencyMeasurement-r6 ::= SEQUENCE {
  intraFreqCellInfoList          IntraFreqCellInfoList-r4                OPTIONAL,
  intraFreqMeasQuantity          IntraFreqMeasQuantity                OPTIONAL,
  intraFreqReportingQuantity     IntraFreqReportingQuantity          OPTIONAL,
  measurementValidity            MeasurementValidity                OPTIONAL,
  -- reportCriteria is optional in later versions of this message
  reportCriteria                 IntraFreqReportCriteria-r6
}

IntraFrequencyMeasurement-r7 ::= SEQUENCE {
  intraFreqCellInfoList          IntraFreqCellInfoList-r4                OPTIONAL,
  intraFreqMeasQuantity          IntraFreqMeasQuantity                OPTIONAL,
  intraFreqReportingQuantity     IntraFreqReportingQuantity          OPTIONAL,
  measurementValidity            MeasurementValidity                OPTIONAL,
  reportCriteria                 IntraFreqReportCriteria-r7                OPTIONAL
}

IODE ::= INTEGER (0..255)

IP-Length ::= ENUMERATED {
  ip15, ip110 }

IP-PCCPCH-r4 ::= BOOLEAN

IP-Spacing ::= ENUMERATED {
  e5, e7, e10, e15, e20,
  e30, e40, e50 }

IP-Spacing-TDD ::= ENUMERATED {
  e30, e40, e50, e70, e100}

IS-2000SpecificMeasInfo ::= ENUMERATED {
  frequency, timeslot, colourcode,
  outputpower, pn-Offset }

KeplerianParameters ::= SEQUENCE {
  toe-nav                        BIT STRING (SIZE (14)),
  ganss-omega-nav               BIT STRING (SIZE (32)),
  delta-n-nav                   BIT STRING (SIZE (16)),
  m-zero-nav                    BIT STRING (SIZE (32)),
  omegadot-nav                  BIT STRING (SIZE (24)),
  ganss-e-lsb-nav               BIT STRING (SIZE (32)),
  idot-nav                      BIT STRING (SIZE (14)),
  a-sqrt-nav                    BIT STRING (SIZE (32)),
  i-zero-nav                    BIT STRING (SIZE (32)),
  omega-zero-nav                BIT STRING (SIZE (32)),
  c-rs-nav                      BIT STRING (SIZE (16)),
  c-is-nav                      BIT STRING (SIZE (16)),
  c-us-nav                      BIT STRING (SIZE (16)),
  c-rc-nav                      BIT STRING (SIZE (16)),
  c-ic-nav                      BIT STRING (SIZE (16)),
  c-uc-nav                      BIT STRING (SIZE (16))
}

MaxNumberOfReportingCellsType1 ::= ENUMERATED {
  e1, e2, e3, e4, e5, e6}

MaxNumberOfReportingCellsType2 ::= ENUMERATED {
  e1, e2, e3, e4, e5, e6, e7, e8, e9, e10, e11, e12}

MaxNumberOfReportingCellsType3 ::= ENUMERATED {
  viactCellsPlus1,
  viactCellsPlus2,
  viactCellsPlus3,
  viactCellsPlus4,
  viactCellsPlus5,
  viactCellsPlus6 }

MaxReportedCellsOnRACH ::= ENUMERATED {
  noReport,
  currentCell,
  currentAnd-1-BestNeighbour,
  currentAnd-2-BestNeighbour,
  currentAnd-3-BestNeighbour,
  currentAnd-4-BestNeighbour,

```

```

currentAnd-5-BestNeighbour,
currentAnd-6-BestNeighbour }

MaxReportedCellsOnRACHinterFreq ::= INTEGER (1..8)

MeasuredResults ::= CHOICE {
    intraFreqMeasuredResultsList      IntraFreqMeasuredResultsList,
    interFreqMeasuredResultsList      InterFreqMeasuredResultsList,
    interRATMeasuredResultsList       InterRATMeasuredResultsList,
    trafficVolumeMeasuredResultsList  TrafficVolumeMeasuredResultsList,
    qualityMeasuredResults             QualityMeasuredResults,
    ue-InternalMeasuredResults         UE-InternalMeasuredResults,
    ue-positioning-MeasuredResults     UE-Positioning-MeasuredResults,
    spare                              NULL
}

MeasuredResults-v390ext ::= SEQUENCE {
    ue-positioning-MeasuredResults-v390ext UE-Positioning-MeasuredResults-v390ext
}

MeasuredResults-v590ext ::= CHOICE {
    intraFrequencyMeasuredResultsList      IntraFrequencyMeasuredResultsList-v590ext,
    interFrequencyMeasuredResultsList      InterFrequencyMeasuredResultsList-v590ext
}

MeasuredResults-v770ext ::= CHOICE {
    ueInternalMeasuredResults             UE-InternalMeasuredResults-v770ext,
    ue-positioning-MeasuredResults        UE-Positioning-MeasuredResults-v770ext
}

MeasuredResults-LCR-r4 ::= CHOICE {
    intraFreqMeasuredResultsList      IntraFreqMeasuredResultsList,
    interFreqMeasuredResultsList      InterFreqMeasuredResultsList,
    interRATMeasuredResultsList       InterRATMeasuredResultsList,
    trafficVolumeMeasuredResultsList  TrafficVolumeMeasuredResultsList,
    qualityMeasuredResults             QualityMeasuredResults,
    ue-InternalMeasuredResults         UE-InternalMeasuredResults-LCR-r4,
    ue-positioning-MeasuredResults     UE-Positioning-MeasuredResults,
    spare                              NULL
}

MeasuredResultsList ::= SEQUENCE (SIZE (1..maxAdditionalMeas)) OF
    MeasuredResults

MeasuredResultsList-LCR-r4-ext ::= SEQUENCE (SIZE (1..maxAdditionalMeas)) OF
    MeasuredResults-LCR-r4

MeasuredResultsList-v770ext ::= SEQUENCE (SIZE (1..maxAdditionalMeas)) OF SEQUENCE {
    -- The 'measuredResults' element shall be present, if 'v770' extended measurement results
    -- associated with the corresponding element in the IE 'MeasuredResultsList' shall be
    -- provided, otherwise it is not needed
    measuredResults             MeasuredResults-v770ext             OPTIONAL
}

MeasuredResultsOnRACH ::= SEQUENCE {
    currentCell                SEQUENCE {
        modeSpecificInfo      CHOICE {
            fdd                SEQUENCE {
                measurementQuantity CHOICE {
                    cpich-Ec-N0    CPICH-Ec-N0,
                    cpich-RSCP     CPICH-RSCP,
                    pathloss       Pathloss,
                    spare          NULL
                }
            },
            tdd                SEQUENCE {
                -- For 3.84 Mcps, 7.68 Mcps and 1.28 Mcps TDD
                timeslotISCP     TimeslotISCP-List             OPTIONAL,
                primaryCCPCH-RSCP PrimaryCCPCH-RSCP             OPTIONAL
            }
        },
        monitoredCells          MonitoredCellRACH-List           OPTIONAL
    }
}

MeasuredResultsOnRACH-v7g0ext ::= SEQUENCE {
    currentCell-DeltaRSCP      DeltaRSCPPerCell             OPTIONAL,

```



```

        monitoredCellRACH-List-v7g0ext      MonitoredCellRACH-List-v7g0ext      OPTIONAL
    }

--The order of the list corresponds to the order of the cells in MonitoredCellRACH-List
MonitoredCellRACH-List-v7g0ext ::= SEQUENCE (SIZE (1..8)) OF
    DeltaRSCPPerCell

MeasuredResultsOnRACHinterFreq ::= SEQUENCE {
    interFreqCellIndication-SIB11      INTEGER (0..1),
    interFreqCellIndication-SIB12      INTEGER (0..1),
    interFreqRACHRepCellsList          InterFreqRACHRepCellsList
}

MeasurementCommand ::= CHOICE {
    setup                               MeasurementType,
    modify                               SEQUENCE {
        measurementType                MeasurementType                OPTIONAL
    },
    release                              NULL
}

MeasurementCommand-r4 ::= CHOICE {
    setup                               MeasurementType-r4,
    modify                               SEQUENCE {
        measurementType                MeasurementType-r4            OPTIONAL
    },
    release                              NULL
}

MeasurementCommand-r6 ::= CHOICE {
    setup                               MeasurementType-r6,
    modify                               SEQUENCE {
        measurementType                MeasurementType-r6            OPTIONAL
    },
    release                              NULL
}

MeasurementCommand-r7 ::= CHOICE {
    setup                               MeasurementType-r7,
    modify                               SEQUENCE {
        measurementType                MeasurementType-r7            OPTIONAL
    },
    release                              NULL
}

MeasurementControlSysInfo ::= SEQUENCE {
    -- CHOICE cellSelectQualityMeasure represents PCCPCH-RSCP in TDD mode.
    use-of-HCS                          CHOICE {
        hcs-not-used                    SEQUENCE {
            cellSelectQualityMeasure    CHOICE {
                cpich-RSCP              SEQUENCE {
                    intraFreqMeasurementSysInfo      IntraFreqMeasurementSysInfo-RSCP
                },
                interFreqMeasurementSysInfo          InterFreqMeasurementSysInfo-RSCP    OPTIONAL
            },
            cpich-Ec-NO                  SEQUENCE {
                intraFreqMeasurementSysInfo          IntraFreqMeasurementSysInfo-ECNO
            },
            interFreqMeasurementSysInfo          InterFreqMeasurementSysInfo-ECNO    OPTIONAL
        }
    },
    interRATMeasurementSysInfo          InterRATMeasurementSysInfo-B        OPTIONAL
    },
    hcs-used                            SEQUENCE {
        cellSelectQualityMeasure        CHOICE {
            cpich-RSCP                  SEQUENCE {
                intraFreqMeasurementSysInfo          IntraFreqMeasurementSysInfo-HCS-RSCP
            },
            interFreqMeasurementSysInfo          InterFreqMeasurementSysInfo-HCS-RSCP
        },
        cpich-Ec-NO                      SEQUENCE {
            intraFreqMeasurementSysInfo          IntraFreqMeasurementSysInfo-HCS-ECNO
        },
        interFreqMeasurementSysInfo          InterFreqMeasurementSysInfo-HCS-ECNO
    }
}

```

```

        interRATMeasurementSysInfo      InterRATMeasurementSysInfo      OPTIONAL
    },
    trafficVolumeMeasSysInfo            TrafficVolumeMeasSysInfo            OPTIONAL,
    -- dummy is not used in this version of specification and it shall be ignored by the UE.
    dummy                                UE-InternalMeasurementSysInfo      OPTIONAL
}

MeasurementControlSysInfoExtension ::= SEQUENCE {
    -- CHOICE cellSelectQualityMeasure represents PCCPCH-RSCP in TDD mode.
    use-of-HCS                           CHOICE {
        hcs-not-used                       SEQUENCE {
            cellSelectQualityMeasure      CHOICE {
                cpich-RSCP                 SEQUENCE {
                    newIntraFreqCellList   NewIntraFreqCellSI-List-RSCP      OPTIONAL,
                    newInterFreqCellList   NewInterFreqCellSI-List-RSCP     OPTIONAL
                },
                cpich-Ec-N0                SEQUENCE {
                    newIntraFreqCellList   NewIntraFreqCellSI-List-ECN0     OPTIONAL,
                    newInterFreqCellList   NewInterFreqCellSI-List-ECN0     OPTIONAL
                }
            },
            newInterRATCellList            NewInterRATCellList              OPTIONAL
        },
        hcs-used                           SEQUENCE {
            cellSelectQualityMeasure      CHOICE {
                cpich-RSCP                 SEQUENCE {
                    newIntraFreqCellList   NewIntraFreqCellSI-List-HCS-RSCP  OPTIONAL,
                    newInterFreqCellList   NewInterFreqCellSI-List-HCS-RSCP  OPTIONAL
                },
                cpich-Ec-N0                SEQUENCE {
                    newIntraFreqCellList   NewIntraFreqCellSI-List-HCS-ECN0  OPTIONAL,
                    newInterFreqCellList   NewInterFreqCellSI-List-HCS-ECN0  OPTIONAL
                }
            },
            newInterRATCellList            NewInterRATCellList              OPTIONAL
        }
    }
}

MeasurementControlSysInfoExtensionAddon-r5 ::= SEQUENCE {
    --The order of the list corresponds to the order of cell in newIntraFrequencyCellInfoList
    newIntraFrequencyCellInfoListAddon-r5 SEQUENCE (SIZE (1..maxCellMeas)) OF
        CellSelectReselectInfo-v590ext OPTIONAL,
    --The order of the list corresponds to the order of cell in newInterFrequencyCellInfoList
    newInterFrequencyCellInfoListAddon-r5 SEQUENCE (SIZE (1..maxCellMeas)) OF
        CellSelectReselectInfo-v590ext OPTIONAL,
    --The order of the list corresponds to the order of cell in newInterRATCellInfoList
    newInterRATCellInfoListAddon-r5 SEQUENCE (SIZE (1..maxCellMeas)) OF
        CellSelectReselectInfo-v590ext OPTIONAL
}

MeasurementControlSysInfoExtension-LCR-r4 ::= SEQUENCE {
    -- CHOICE cellSelectQualityMeasure represents PCCPCH-RSCP in TDD mode.
    use-of-HCS                           CHOICE {
        hcs-not-used                       SEQUENCE {
            cellSelectQualityMeasure      CHOICE {
                cpich-RSCP                 SEQUENCE {
                    newIntraFreqCellList   NewIntraFreqCellSI-List-RSCP-LCR-r4 OPTIONAL,
                    newInterFreqCellList   NewInterFreqCellSI-List-RSCP-LCR-r4 OPTIONAL
                },
                cpich-Ec-N0                SEQUENCE {
                    newIntraFreqCellList   NewIntraFreqCellSI-List-ECN0-LCR-r4 OPTIONAL,
                    newInterFreqCellList   NewInterFreqCellSI-List-ECN0-LCR-r4 OPTIONAL
                }
            },
            newInterRATCellList            NewInterRATCellList              OPTIONAL
        },
        hcs-used                           SEQUENCE {
            cellSelectQualityMeasure      CHOICE {
                cpich-RSCP                 SEQUENCE {
                    newIntraFreqCellList   NewIntraFreqCellSI-List-HCS-RSCP-LCR-r4 OPTIONAL,
                    newInterFreqCellList   NewInterFreqCellSI-List-HCS-RSCP-LCR-r4 OPTIONAL
                },
                cpich-Ec-N0                SEQUENCE {
                    newIntraFreqCellList   NewIntraFreqCellSI-List-HCS-ECN0-LCR-r4 OPTIONAL,
                    newInterFreqCellList   NewInterFreqCellSI-List-HCS-ECN0-LCR-r4 OPTIONAL
                }
            }
        }
    }
}

```

```

    },
    newInterRATCellList          NewInterRATCellList          OPTIONAL
  }
}

MeasurementControlSysInfo-LCR-r4-ext ::= SEQUENCE {
  -- CHOICE use-of-HCS shall have the same value as the use-of-HCS
  -- in MeasurementControlSysInfo
  -- CHOICE cellSelectQualityMeasure represents PCCPCH-RSCP in TDD mode.
  use-of-HCS                      CHOICE {
    hcs-not-used                   SEQUENCE {
      -- CHOICE cellSelectQualityMeasure shall have the same value as the
      -- cellSelectQualityMeasure in MeasurementControlSysInfo
      cellSelectQualityMeasure     CHOICE {
        cpich-RSCP                 SEQUENCE {
          intraFreqMeasurementSysInfo IntraFreqMeasurementSysInfo-RSCP-LCR-r4 OPTIONAL,
          interFreqMeasurementSysInfo InterFreqMeasurementSysInfo-RSCP-LCR-r4 OPTIONAL
        },
        cpich-Ec-N0                SEQUENCE {
          intraFreqMeasurementSysInfo IntraFreqMeasurementSysInfo-ECN0-LCR-r4 OPTIONAL,
          interFreqMeasurementSysInfo InterFreqMeasurementSysInfo-ECN0-LCR-r4 OPTIONAL
        }
      }
    },
    hcs-used                       SEQUENCE {
      -- CHOICE cellSelectQualityMeasure shall have the same value as the
      -- cellSelectQualityMeasure in MeasurementControlSysInfo
      cellSelectQualityMeasure     CHOICE {
        cpich-RSCP                 SEQUENCE {
          intraFreqMeasurementSysInfo IntraFreqMeasurementSysInfo-HCS-RSCP-LCR-r4
OPTIONAL,
          interFreqMeasurementSysInfo InterFreqMeasurementSysInfo-HCS-RSCP-LCR-r4 OPTIONAL
        },
        cpich-Ec-N0                SEQUENCE {
          intraFreqMeasurementSysInfo IntraFreqMeasurementSysInfo-HCS-ECN0-LCR-r4
OPTIONAL,
          interFreqMeasurementSysInfo InterFreqMeasurementSysInfo-HCS-ECN0-LCR-r4 OPTIONAL
        }
      }
    }
  }
}

MeasurementIdentity ::= INTEGER (1..16)

MeasurementQuantityGSM ::= ENUMERATED {
  gsm-CarrierRSSI,
  dummy }

MeasurementReportingMode ::= SEQUENCE {
  measurementReportTransferMode TransferMode,
  periodicalOrEventTrigger      PeriodicalOrEventTrigger
}

MeasurementType ::= CHOICE {
  intraFrequencyMeasurement      IntraFrequencyMeasurement,
  interFrequencyMeasurement      InterFrequencyMeasurement,
  interRATMeasurement            InterRATMeasurement,
  ue-positioning-Measurement      UE-Positioning-Measurement,
  trafficVolumeMeasurement        TrafficVolumeMeasurement,
  qualityMeasurement              QualityMeasurement,
  ue-InternalMeasurement          UE-InternalMeasurement
}

MeasurementType-r4 ::= CHOICE {
  intraFrequencyMeasurement-r4   IntraFrequencyMeasurement-r4,
  interFrequencyMeasurement-r4   InterFrequencyMeasurement-r4,
  interRATMeasurement-r4         InterRATMeasurement-r4,
  up-Measurement                  UE-Positioning-Measurement-r4,
  trafficVolumeMeasurement        TrafficVolumeMeasurement,
  qualityMeasurement              QualityMeasurement,
  ue-InternalMeasurement-r4       UE-InternalMeasurement-r4
}

MeasurementType-r6 ::= CHOICE {
  intraFrequencyMeasurement      IntraFrequencyMeasurement-r6,

```

```

interFrequencyMeasurement      InterFrequencyMeasurement-r6,
interRATMeasurement           InterRATMeasurement-r6,
up-Measurement                 UE-Positioning-Measurement-r4,
trafficVolumeMeasurement       TrafficVolumeMeasurement,
qualityMeasurement             QualityMeasurement,
ue-InternalMeasurement         UE-InternalMeasurement-r4
}

MeasurementType-r7 ::=
  intraFrequencyMeasurement    IntraFrequencyMeasurement-r7,
  interFrequencyMeasurement    InterFrequencyMeasurement-r7,
  interRATMeasurement          InterRATMeasurement-r6,
  up-Measurement               UE-Positioning-Measurement-r7,
  trafficVolumeMeasurement     TrafficVolumeMeasurement,
  qualityMeasurement           QualityMeasurement,
  ue-InternalMeasurement       UE-InternalMeasurement-r4
}

MeasurementValidity ::=
  ue-State                     SEQUENCE {
                                ENUMERATED {
                                  cell-DCH, all-But-Cell-DCH, all-States }
                                }
}

MonitoredCellRACH-List ::=
  SEQUENCE (SIZE (1..8)) OF
    MonitoredCellRACH-Result

MonitoredCellRACH-Result ::=
  sfm-SFM-ObsTimeDifference    SFM-SFM-ObsTimeDifference          OPTIONAL,
  modeSpecificInfo             CHOICE {
    fdd                         SEQUENCE {
      primaryCPICH-Info        PrimaryCPICH-Info,
      measurementQuantity      CHOICE {
        cpich-Ec-NO            CPICH-Ec-NO,
        cpich-RSCP             CPICH-RSCP,
        pathloss               Pathloss,
        spare                  NULL
      }
    },
    tdd                         SEQUENCE {
      cellParametersID         CellParametersID,
      primaryCCPCH-RSCP        PrimaryCCPCH-RSCP
    }
  }
}

MultipathIndicator ::=
  ENUMERATED {
    nm,
    low,
    medium,
    high }

N-CR-T-CRMaxHyst ::=
  n-CR                         SEQUENCE {
    t-CRMaxHyst                 INTEGER (1..16)          DEFAULT 8,
  }

NavigationModelSatInfo ::=
  satID                        SEQUENCE {
    satID,
    satelliteStatus,
    ephemerisParameter         OPTIONAL
  }

NavigationModelSatInfoList ::=
  SEQUENCE (SIZE (1..maxSat)) OF
    NavigationModelSatInfo

EphemerisParameter ::=
  codeOnL2                     SEQUENCE {
    codeOnL2                    BIT STRING (SIZE (2)),
    uraIndex                    BIT STRING (SIZE (4)),
    satHealth                   BIT STRING (SIZE (6)),
    iodc                        BIT STRING (SIZE (10)),
    l2Pflag                     BIT STRING (SIZE (1)),
    sf1Revd                     SubFrame1Reserved,
    t-GD                        BIT STRING (SIZE (8)),
    t-oc                        BIT STRING (SIZE (16)),
    af2                         BIT STRING (SIZE (8)),
    af1                         BIT STRING (SIZE (16)),
    af0                         BIT STRING (SIZE (22)),
    c-rs                        BIT STRING (SIZE (16)),
  }

```

```

delta-n          BIT STRING (SIZE (16)),
m0              BIT STRING (SIZE (32)),
c-uc           BIT STRING (SIZE (16)),
e              BIT STRING (SIZE (32)),
c-us           BIT STRING (SIZE (16)),
a-Sqrt         BIT STRING (SIZE (32)),
t-oe          BIT STRING (SIZE (16)),
fitInterval    BIT STRING (SIZE (1)),
aodo           BIT STRING (SIZE (5)),
c-ic           BIT STRING (SIZE (16)),
omega0         BIT STRING (SIZE (32)),
c-is           BIT STRING (SIZE (16)),
i0             BIT STRING (SIZE (32)),
c-rc           BIT STRING (SIZE (16)),
omega          BIT STRING (SIZE (32)),
omegaDot       BIT STRING (SIZE (24)),
iDot           BIT STRING (SIZE (14))
}
NC-Mode ::= BIT STRING (SIZE (3))

Neighbour ::= SEQUENCE {
  modeSpecificInfo CHOICE {
    fdd SEQUENCE {
      neighbourIdentity PrimaryCPICH-Info OPTIONAL,
      ue-RX-TX-TimeDifferenceType2Info UE-RX-TX-TimeDifferenceType2Info OPTIONAL
    },
    tdd SEQUENCE {
      neighbourAndChannelIdentity CellAndChannelIdentity OPTIONAL
    }
  },
  neighbourQuality NeighbourQuality,
  sfm-SFN-ObsTimeDifference2 SFM-SFN-ObsTimeDifference2}

Neighbour-v390ext ::= SEQUENCE {
  modeSpecificInfo CHOICE {
    fdd SEQUENCE {
      frequencyInfo FrequencyInfo
    },
    tdd NULL
  }
}

NeighbourList ::= SEQUENCE (SIZE (1..maxCellMeas)) OF Neighbour

Neighbour-TDD-r7 ::= SEQUENCE {
  uarfcn UARFCN OPTIONAL
}

-- The order of the cells in IE NeighbourList-TDD-r7 shall be the
-- same as the order in IE NeighbourList
NeighbourList-TDD-r7 ::= SEQUENCE (SIZE (1..maxCellMeas)) OF Neighbour-TDD-r7

-- The order of the cells in IE NeighbourList-v390ext shall be the
-- same as the order in IE NeighbourList
NeighbourList-v390ext ::= SEQUENCE (SIZE (1..maxCellMeas)) OF Neighbour-v390ext

NeighbourQuality ::= SEQUENCE {
  ue-Positioning-OTDOA-Quality UE-Positioning-OTDOA-Quality
}

NewInterFreqCell ::= SEQUENCE {
  interFreqCellID InterFreqCellID OPTIONAL,
  frequencyInfo FrequencyInfo OPTIONAL,
  cellInfo CellInfo
}

NewInterFreqCell-r4 ::= SEQUENCE {
  interFreqCellID InterFreqCellID OPTIONAL,
  frequencyInfo FrequencyInfo OPTIONAL,
  cellInfo-r4 CellInfo-r4
}

NewInterFreqCell-v7b0ext ::= SEQUENCE {
  intraSecondaryFreqIndicator BOOLEAN
}

```

```

NewInterFreqCellList ::= SEQUENCE (SIZE (1..maxCellMeas)) OF
                           NewInterFreqCell

NewInterFreqCellList-r4 ::= SEQUENCE (SIZE (1..maxCellMeas)) OF
                             NewInterFreqCell-r4

-- The order of the list corresponds to the order of cells in newInterFreqCellList
NewInterFreqCellList-v7b0ext ::= SEQUENCE (SIZE (1..maxCellMeas)) OF
                                   NewInterFreqCell-v7b0ext

NewInterFreqCellSI-RSCP ::= SEQUENCE {
    interFreqCellID          InterFreqCellID          OPTIONAL,
    frequencyInfo            FrequencyInfo              OPTIONAL,
    cellInfo                  CellInfoSI-RSCP
}

NewInterFreqCellSI-ECN0 ::= SEQUENCE {
    interFreqCellID          InterFreqCellID          OPTIONAL,
    frequencyInfo            FrequencyInfo              OPTIONAL,
    cellInfo                  CellInfoSI-ECN0
}

NewInterFreqCellSI-HCS-RSCP ::= SEQUENCE {
    interFreqCellID          InterFreqCellID          OPTIONAL,
    frequencyInfo            FrequencyInfo              OPTIONAL,
    cellInfo                  CellInfoSI-HCS-RSCP
}

NewInterFreqCellSI-HCS-ECN0 ::= SEQUENCE {
    interFreqCellID          InterFreqCellID          OPTIONAL,
    frequencyInfo            FrequencyInfo              OPTIONAL,
    cellInfo                  CellInfoSI-HCS-ECN0
}

NewInterFreqCellSI-RSCP-LCR-r4 ::= SEQUENCE {
    interFreqCellID          InterFreqCellID          OPTIONAL,
    frequencyInfo            FrequencyInfo              OPTIONAL,
    cellInfo                  CellInfoSI-RSCP-LCR-r4
}

NewInterFreqCellSI-ECN0-LCR-r4 ::= SEQUENCE {
    interFreqCellID          InterFreqCellID          OPTIONAL,
    frequencyInfo            FrequencyInfo              OPTIONAL,
    cellInfo                  CellInfoSI-ECN0-LCR-r4
}

NewInterFreqCellSI-HCS-RSCP-LCR-r4 ::= SEQUENCE {
    interFreqCellID          InterFreqCellID          OPTIONAL,
    frequencyInfo            FrequencyInfo              OPTIONAL,
    cellInfo                  CellInfoSI-HCS-RSCP-LCR-r4
}

NewInterFreqCellSI-HCS-ECN0-LCR-r4 ::= SEQUENCE {
    interFreqCellID          InterFreqCellID          OPTIONAL,
    frequencyInfo            FrequencyInfo              OPTIONAL,
    cellInfo                  CellInfoSI-HCS-ECN0-LCR-r4
}

NewInterFreqCellSI-List-ECN0 ::= SEQUENCE (SIZE (1..maxCellMeas)) OF
                                   NewInterFreqCellSI-ECN0

NewInterFreqCellSI-List-HCS-RSCP ::= SEQUENCE (SIZE (1..maxCellMeas)) OF
                                       NewInterFreqCellSI-HCS-RSCP

NewInterFreqCellSI-List-HCS-ECN0 ::= SEQUENCE (SIZE (1..maxCellMeas)) OF
                                       NewInterFreqCellSI-HCS-ECN0

NewInterFreqCellSI-List-RSCP ::= SEQUENCE (SIZE (1..maxCellMeas)) OF
                                   NewInterFreqCellSI-RSCP

NewInterFreqCellSI-List-ECN0-LCR-r4 ::= SEQUENCE (SIZE (1..maxCellMeas)) OF
                                       NewInterFreqCellSI-ECN0-LCR-r4

NewInterFreqCellSI-List-HCS-RSCP-LCR-r4 ::= SEQUENCE (SIZE (1..maxCellMeas)) OF
                                       NewInterFreqCellSI-HCS-RSCP-LCR-r4

NewInterFreqCellSI-List-HCS-ECN0-LCR-r4 ::= SEQUENCE (SIZE (1..maxCellMeas)) OF
                                       NewInterFreqCellSI-HCS-ECN0-LCR-r4

```

```

NewInterFreqCellSI-List-RSCP-LCR-r4 ::= SEQUENCE (SIZE (1..maxCellMeas)) OF
                                         NewInterFreqCellSI-RSCP-LCR-r4

NewInterRATCell ::= SEQUENCE {
  interRATCellID InterRATCellID OPTIONAL,
  technologySpecificInfo CHOICE {
    gsm SEQUENCE {
      cellSelectionReselectionInfo CellSelectReselectInfoSIB-11-12 OPTIONAL,
      interRATCellIndividualOffset InterRATCellIndividualOffset,
      bsic BSIC,
      frequency-band Frequency-Band,
      bcch-ARFCN BCCH-ARFCN,
      -- dummy is not used in this version of the specification, it should
      -- not be sent and if received it should be ignored.
      dummy NULL OPTIONAL
    },
    is-2000 SEQUENCE {
      is-2000SpecificMeasInfo IS-2000SpecificMeasInfo
    },
    -- ASN.1 inconsistency: NewInterRATCellList should be optional within
    -- InterRATCellInfoList. The UE shall consider IE NewInterRATCell with
    -- technologySpecificInfo set to "absent" as valid and handle the
    -- message as if the IE NewInterRATCell was absent
    absent NULL,
    spare1 NULL
  }
}

NewInterRATCell-B ::= SEQUENCE {
  interRATCellID InterRATCellID OPTIONAL,
  technologySpecificInfo CHOICE {
    gsm SEQUENCE {
      cellSelectionReselectionInfo CellSelectReselectInfoSIB-11-12 OPTIONAL,
      interRATCellIndividualOffset InterRATCellIndividualOffset,
      bsic BSIC,
      frequency-band Frequency-Band,
      bcch-ARFCN BCCH-ARFCN,
      -- dummy is not used in this version of the specification, it should
      -- not be sent and if received it should be ignored.
      dummy NULL OPTIONAL
    },
    is-2000 SEQUENCE {
      is-2000SpecificMeasInfo IS-2000SpecificMeasInfo
    },
    -- ASN.1 inconsistency: NewInterRATCellList-B should be optional within
    -- InterRATCellInfoList-B. The UE shall consider IE NewInterRATCell-B with
    -- technologySpecificInfo set to "absent" as valid and handle the
    -- message as if the IE NewInterRATCell-B was absent
    absent NULL,
    spare1 NULL
  }
}

NewInterRATCellList ::= SEQUENCE (SIZE (1..maxCellMeas)) OF
                        NewInterRATCell

NewInterRATCellList-B ::= SEQUENCE (SIZE (1..maxCellMeas)) OF
                          NewInterRATCell-B

NewIntraFreqCell ::= SEQUENCE {
  intraFreqCellID IntraFreqCellID OPTIONAL,
  cellInfo CellInfo
}

NewIntraFreqCell-r4 ::= SEQUENCE {
  intraFreqCellID IntraFreqCellID OPTIONAL,
  cellInfo CellInfo-r4
}

NewIntraFreqCellList ::= SEQUENCE (SIZE (1..maxCellMeas)) OF
                        NewIntraFreqCell

NewIntraFreqCellList-r4 ::= SEQUENCE (SIZE (1..maxCellMeas)) OF
                            NewIntraFreqCell-r4

NewIntraFreqCellSI-RSCP ::= SEQUENCE {
  intraFreqCellID IntraFreqCellID OPTIONAL,
}

```

```

    cellInfo                CellInfoSI-RSCP
}

NewIntraFreqCellSI-ECNO ::= SEQUENCE {
    intraFreqCellID        IntraFreqCellID        OPTIONAL,
    cellInfo                CellInfoSI-ECNO
}

NewIntraFreqCellSI-HCS-RSCP ::= SEQUENCE {
    intraFreqCellID        IntraFreqCellID        OPTIONAL,
    cellInfo                CellInfoSI-HCS-RSCP
}

NewIntraFreqCellSI-HCS-ECNO ::= SEQUENCE {
    intraFreqCellID        IntraFreqCellID        OPTIONAL,
    cellInfo                CellInfoSI-HCS-ECNO
}

NewIntraFreqCellSI-RSCP-LCR-r4 ::= SEQUENCE {
    intraFreqCellID        IntraFreqCellID        OPTIONAL,
    cellInfo                CellInfoSI-RSCP-LCR-r4
}

NewIntraFreqCellSI-ECNO-LCR-r4 ::= SEQUENCE {
    intraFreqCellID        IntraFreqCellID        OPTIONAL,
    cellInfo                CellInfoSI-ECNO-LCR-r4
}

NewIntraFreqCellSI-HCS-RSCP-LCR-r4 ::= SEQUENCE {
    intraFreqCellID        IntraFreqCellID        OPTIONAL,
    cellInfo                CellInfoSI-HCS-RSCP-LCR-r4
}

NewIntraFreqCellSI-HCS-ECNO-LCR-r4 ::= SEQUENCE {
    intraFreqCellID        IntraFreqCellID        OPTIONAL,
    cellInfo                CellInfoSI-HCS-ECNO-LCR-r4
}

NewIntraFreqCellSI-List-RSCP ::= SEQUENCE (SIZE (1..maxCellMeas)) OF
    NewIntraFreqCellSI-RSCP

NewIntraFreqCellSI-List-ECNO ::= SEQUENCE (SIZE (1..maxCellMeas)) OF
    NewIntraFreqCellSI-ECNO

NewIntraFreqCellSI-List-HCS-RSCP ::= SEQUENCE (SIZE (1..maxCellMeas)) OF
    NewIntraFreqCellSI-HCS-RSCP

NewIntraFreqCellSI-List-HCS-ECNO ::= SEQUENCE (SIZE (1..maxCellMeas)) OF
    NewIntraFreqCellSI-HCS-ECNO

NewIntraFreqCellSI-List-RSCP-LCR-r4 ::= SEQUENCE (SIZE (1..maxCellMeas)) OF
    NewIntraFreqCellSI-RSCP-LCR-r4

NewIntraFreqCellSI-List-ECNO-LCR-r4 ::= SEQUENCE (SIZE (1..maxCellMeas)) OF
    NewIntraFreqCellSI-ECNO-LCR-r4

NewIntraFreqCellSI-List-HCS-RSCP-LCR-r4 ::= SEQUENCE (SIZE (1..maxCellMeas)) OF
    NewIntraFreqCellSI-HCS-RSCP-LCR-r4

NewIntraFreqCellSI-List-HCS-ECNO-LCR-r4 ::= SEQUENCE (SIZE (1..maxCellMeas)) OF
    NewIntraFreqCellSI-HCS-ECNO-LCR-r4

-- IE "nonUsedFreqThreshold" is not needed in case of event 2a
-- In case of event 2a UTRAN should include value 0 within IE "nonUsedFreqThreshold"
-- In case of event 2a, the UE shall be ignore IE "nonUsedFreqThreshold"
-- In later versions of the message including this IE, a special version of
-- IE "NonUsedFreqParameterList" may be defined for event 2a, namely a
-- version not including IE "nonUsedFreqThreshold"
NonUsedFreqParameter ::= SEQUENCE {
    nonUsedFreqThreshold    Threshold,
    nonUsedFreqW            W
}

NonUsedFreqParameter-r6 ::= SEQUENCE {
    nonUsedFreqThreshold    Threshold-r6,
    nonUsedFreqW            W
}

NonUsedFreqParameterList ::= SEQUENCE (SIZE (1..maxFreq)) OF
    NonUsedFreqParameter

```



```

NonUsedFreqParameterList-r6 ::= SEQUENCE (SIZE (1..maxFreq)) OF
    NonUsedFreqParameter-r6

NonUsedFreqWList-r6 ::= SEQUENCE (SIZE (1..maxFreq)) OF W

ObservedTimeDifferenceToGSM ::= INTEGER (0..4095)

OTDOA-SearchWindowSize ::= ENUMERATED {
    c20, c40, c80, c160, c320,
    c640, c1280, moreThan1280 }

-- SPARE: Pathloss, Max = 158
-- Values above Max are spare
Pathloss ::= INTEGER (46..173)

PenaltyTime-RSCP ::= CHOICE {
    notUsed          NULL,
    pt10             TemporaryOffset1,
    pt20             TemporaryOffset1,
    pt30             TemporaryOffset1,
    pt40             TemporaryOffset1,
    pt50             TemporaryOffset1,
    pt60             TemporaryOffset1
}

PenaltyTime-ECNO ::= CHOICE {
    notUsed          NULL,
    pt10             TemporaryOffsetList,
    pt20             TemporaryOffsetList,
    pt30             TemporaryOffsetList,
    pt40             TemporaryOffsetList,
    pt50             TemporaryOffsetList,
    pt60             TemporaryOffsetList
}

PendingTimeAfterTrigger ::= ENUMERATED {
    ptat0-25, ptat0-5, ptat1,
    ptat2, ptat4, ptat8, ptat16 }

PeriodicalOrEventTrigger ::= ENUMERATED {
    periodical,
    eventTrigger }

PeriodicalReportingCriteria ::= SEQUENCE {
    reportingAmount      ReportingAmount          DEFAULT ra-Infinity,
    reportingInterval    ReportingIntervalLong
}

PeriodicalWithReportingCellStatus ::= SEQUENCE {
    periodicalReportingCriteria    PeriodicalReportingCriteria,
    reportingCellStatus            ReportingCellStatus          OPTIONAL
}

PLMNIdentitiesOfNeighbourCells ::= SEQUENCE {
    plmnsOfIntraFreqCellsList    PLMNsOfIntraFreqCellsList    OPTIONAL,
    plmnsOfInterFreqCellsList    PLMNsOfInterFreqCellsList    OPTIONAL,
    plmnsOfInterRATCellsList     PLMNsOfInterRATCellsList     OPTIONAL
}

PLMNsOfInterFreqCellsList ::= SEQUENCE (SIZE (1..maxCellMeas)) OF
    SEQUENCE {
        plmn-Identity          PLMN-Identity          OPTIONAL
    }

PLMNsOfIntraFreqCellsList ::= SEQUENCE (SIZE (1..maxCellMeas)) OF
    SEQUENCE {
        plmn-Identity          PLMN-Identity          OPTIONAL
    }

PLMNsOfInterRATCellsList ::= SEQUENCE (SIZE (1..maxCellMeas)) OF
    SEQUENCE {
        plmn-Identity          PLMN-Identity          OPTIONAL
    }

PositionEstimate ::= CHOICE {
    ellipsoidPoint            EllipsoidPoint,
    ellipsoidPointUncertCircle EllipsoidPointUncertCircle,
}

```

```

    ellipsoidPointUncertEllipse      EllipsoidPointUncertEllipse,
    ellipsoidPointAltitude           EllipsoidPointAltitude,
    ellipsoidPointAltitudeEllipse    EllipsoidPointAltitudeEllipsoide
}

PositioningMethod ::=                ENUMERATED {
    otdoa,
    gps,
    otdoaOrGPS, cellID }

-- Actual value PRC = IE value * 0.32
PRC ::=                              INTEGER (-2047..2047)

-- SPARE: PrimaryCCPCH-RSCP, Max = 91
-- Values above Max are spare
PrimaryCCPCH-RSCP ::=               INTEGER (0..127)

Q-HCS ::=                            INTEGER (0..99)

Q-OffsetS-N ::=                     INTEGER (-50..50)

Q-QualMin ::=                        INTEGER (-24..0)

Q-QualMin-Offset ::=                INTEGER (1..16)

-- Actual value Q-RxlevMin = (IE value * 2) + 1
Q-RxlevMin ::=                      INTEGER (-58..-13)

-- Actual value Q-RxlevMin-Offset = (IE value * 2)
Q-RxlevMin-Offset ::=               INTEGER (1..8)

QualityEventResults ::=              SEQUENCE (SIZE (1..maxTrCH)) OF
    TransportChannelIdentity

QualityMeasuredResults ::=           SEQUENCE {
    blerMeasurementResultsList       BLER-MeasurementResultsList      OPTIONAL,
    modeSpecificInfo                 CHOICE {
        fdd                           NULL,
        tdd                           SEQUENCE {
            sir-MeasurementResults     SIR-MeasurementList            OPTIONAL
        }
    }
}

QualityMeasurement ::=               SEQUENCE {
    qualityReportingQuantity          QualityReportingQuantity          OPTIONAL,
    reportCriteria                    QualityReportCriteria
}

QualityReportCriteria ::=            CHOICE {
    qualityReportingCriteria          QualityReportingCriteria,
    periodicalReportingCriteria      PeriodicalReportingCriteria,
    noReporting                       NULL
}

QualityReportingCriteria ::=         SEQUENCE (SIZE (1..maxTrCH)) OF
    QualityReportingCriteriaSingle

QualityReportingCriteriaSingle ::=   SEQUENCE {
    transportChannelIdentity          TransportChannelIdentity,
    totalCRC                          INTEGER (1..512),
    badCRC                             INTEGER (1..512),
    pendingAfterTrigger               INTEGER (1..512)
}

QualityReportingQuantity ::=         SEQUENCE {
    dl-TransChBLER                    BOOLEAN,
    bler-dl-TransChIdList             BLER-TransChIdList                OPTIONAL,
    modeSpecificInfo                  CHOICE {
        fdd                           NULL,
        tdd                           SEQUENCE {
            sir-TFCS-List              SIR-TFCS-List                    OPTIONAL
        }
    }
}

RAT-Type ::=                         ENUMERATED {
    gsm, is2000 }

```

```

ReferenceCellPosition ::= CHOICE {
    ellipsoidPoint           EllipsoidPoint,
    ellipsoidPointWithAltitude EllipsoidPointAltitude
}

-- ReferenceLocation, as defined in 23.032
ReferenceLocation ::= SEQUENCE {
    ellipsoidPointAltitudeEllipsoide EllipsoidPointAltitudeEllipsoide
}

ReferenceLocationGANSS ::= SEQUENCE {
    ellipsoidPointAltitudeEllipsoide EllipsoidPointAltitudeEllipsoide
}

ReferenceTimeDifferenceToCell ::= CHOICE {
    -- Actual value accuracy40 = IE value * 40
    accuracy40           INTEGER (0..960),
    -- Actual value accuracy256 = IE value * 256
    accuracy256          INTEGER (0..150),
    -- Actual value accuracy2560 = IE value * 2560
    accuracy2560         INTEGER (0..15)
}

RemovedInterFreqCellList ::= CHOICE {
    removeAllInterFreqCells      NULL,
    removeSomeInterFreqCells     SEQUENCE (SIZE (1..maxCellMeas)) OF
                                InterFreqCellID,
    removeNoInterFreqCells       NULL
}

RemovedInterRATCellList ::= CHOICE {
    removeAllInterRATCells        NULL,
    removeSomeInterRATCells       SEQUENCE (SIZE (1..maxCellMeas)) OF
                                InterRATCellID,
    removeNoInterRATCells         NULL
}

RemovedIntraFreqCellList ::= CHOICE {
    removeAllIntraFreqCells        NULL,
    removeSomeIntraFreqCells       SEQUENCE (SIZE (1..maxCellMeas)) OF
                                IntraFreqCellID,
    removeNoIntraFreqCells         NULL
}

ReplacementActivationThreshold ::= ENUMERATED {
    notApplicable, t1, t2,
    t3, t4, t5, t6, t7 }

ReportDeactivationThreshold ::= ENUMERATED {
    notApplicable, t1, t2,
    t3, t4, t5, t6, t7 }

ReportingAmount ::= ENUMERATED {
    ra1, ra2, ra4, ra8, ra16, ra32,
    ra64, ra-Infinity }

ReportingCellStatus ::= CHOICE{
    withinActiveSet                MaxNumberOfReportingCellsType1,
    withinMonitoredSetUsedFreq      MaxNumberOfReportingCellsType1,
    withinActiveAndOrMonitoredUsedFreq MaxNumberOfReportingCellsType1,
    withinDetectedSetUsedFreq       MaxNumberOfReportingCellsType1,
    withinMonitoredAndOrDetectedUsedFreq
                                MaxNumberOfReportingCellsType1,
    allActiveplusMonitoredSet        MaxNumberOfReportingCellsType3,
    allActivePlusDetectedSet         MaxNumberOfReportingCellsType3,
    allActivePlusMonitoredAndOrDetectedSet
                                MaxNumberOfReportingCellsType3,
    withinVirtualActSet              MaxNumberOfReportingCellsType1,
    withinMonitoredSetNonUsedFreq    MaxNumberOfReportingCellsType1,
    withinMonitoredAndOrVirtualActiveSetNonUsedFreq
                                MaxNumberOfReportingCellsType1,
    allVirtualActSetplusMonitoredSetNonUsedFreq
                                MaxNumberOfReportingCellsType3,
    withinActSetOrVirtualActSet-InterRATcells
                                MaxNumberOfReportingCellsType2,
    withinActSetAndOrMonitoredUsedFreqOrVirtualActSetAndOrMonitoredNonUsedFreq
                                MaxNumberOfReportingCellsType2
}

```

```

}

ReportingCellStatusOpt ::= SEQUENCE {
    reportingCellStatus          OPTIONAL
}

ReportingInfoForCellDCH ::= SEQUENCE {
    intraFreqReportingQuantity   IntraFreqReportingQuantity,
    measurementReportingMode     MeasurementReportingMode,
    reportCriteria               CellDCH-ReportCriteria
}

ReportingInfoForCellDCH-LCR-r4 ::= SEQUENCE {
    intraFreqReportingQuantity   IntraFreqReportingQuantity,
    measurementReportingMode     MeasurementReportingMode,
    reportCriteria               CellDCH-ReportCriteria-LCR-r4
}

ReportingInterval ::= ENUMERATED {
    noPeriodicalreporting, ri0-25,
    ri0-5, ril, ri2, ri4, ri8, ril6 }

ReportingIntervalLong ::= ENUMERATED {
    ril0, ril0-25, ril0-5, ril1,
    ril2, ril3, ril4, ril6, ril8,
    ril12, ril16, ril20, ril24,
    ril28, ril32, ril64 }
-- When the value "ril0" is used, the UE behaviour is not
-- defined.

-- Actual value ReportingRange = IE value * 0.5
ReportingRange ::= INTEGER (0..29)

ReqDataBitAssistance ::= SEQUENCE {
    ganssSignalID               DGANSS-Sig-Id-Req,
    ganssDataBitInterval        INTEGER(0..15),
    ganssSatelliteInfo          SEQUENCE (SIZE (1..maxGANSSSat)) OF INTEGER(0..63) OPTIONAL
}

RL-AdditionInfoList ::= SEQUENCE (SIZE (1..maxRL)) OF
    PrimaryCPICH-Info

RL-InformationLists ::= SEQUENCE {
    rl-AdditionInfoList         OPTIONAL,
    rl-RemovalInformationList   OPTIONAL
}

RLC-BuffersPayload ::= ENUMERATED {
    p10, p14, p18, p116, p132,
    p164, p1128, p1256, p1512, p11024,
    p12k, p14k, p18k, p116k, p132k,
    p164k, p1128k, p1256k, p1512k, p11024k,
    spare12, spare11, spare10, spare9, spare8,
    spare7, spare6, spare5, spare4, spare3,
    spare2, spare1 }

-- Actual value RRC = IE value * 0.032
RRC ::= INTEGER (-127..127)

SatData ::= SEQUENCE{
    satID          SatID,
    iode           IODE
}

SatDataList ::= SEQUENCE (SIZE (0..maxSat)) OF
    SatData

SatellitesListRelatedData ::= SEQUENCE {
    satId          INTEGER (0..63),
    iod            INTEGER (0..1023)
}

SatellitesListRelatedDataList ::= SEQUENCE (SIZE (1..maxGANSSSat)) OF
    SatellitesListRelatedData

SatelliteStatus ::= ENUMERATED {
    ns-NN-U,

```

```

        es-SN,
        es-NN-U,
        rev2,
        rev }

Satellite-clock-model ::=          SEQUENCE {
    t-oc                            BIT STRING (SIZE (14)),
    af2                              BIT STRING (SIZE (12)),
    af1                              BIT STRING (SIZE (18)),
    af0                              BIT STRING (SIZE (28)),
    tgd                              BIT STRING (SIZE (10))                OPTIONAL,
    model-id                         INTEGER (0..1)                    OPTIONAL
}

Satellite-clock-modelList ::=      SEQUENCE (SIZE (1..maxSatClockModels)) OF Satellite-clock-model

-- Identifies the satellite and is equal to (SV ID No - 1) where SV ID No is defined in [12].
SatID ::=                          INTEGER (0..63)

SFN-Offset-Validity ::=           ENUMERATED { false }

SFN-SFN-Drift ::=                 ENUMERATED {
    sfnsfndrift0, sfnsfndrift1, sfnsfndrift2,
    sfnsfndrift3, sfnsfndrift4, sfnsfndrift5,
    sfnsfndrift8, sfnsfndrift10, sfnsfndrift15,
    sfnsfndrift25, sfnsfndrift35, sfnsfndrift50,
    sfnsfndrift65, sfnsfndrift80, sfnsfndrift100,
    sfnsfndrift-1, sfnsfndrift-2, sfnsfndrift-3,
    sfnsfndrift-4, sfnsfndrift-5, sfnsfndrift-8,
    sfnsfndrift-10, sfnsfndrift-15, sfnsfndrift-25,
    sfnsfndrift-35, sfnsfndrift-50, sfnsfndrift-65,
    sfnsfndrift-80, sfnsfndrift-100}

SFN-SFN-ObsTimeDifference ::=     CHOICE {
    type1                            SFN-SFN-ObsTimeDifference1,
    type2                            SFN-SFN-ObsTimeDifference2
}

-- SPARE: SFN-SFN-ObsTimeDifference1, Max = 9830399
-- For 1.28Mcps TDD, Max value of SFN-SFN-ObsTimeDifference1 is 3276799.
-- Values above Max are spare
SFN-SFN-ObsTimeDifference1 ::=    INTEGER (0..16777215)

-- SPARE: SFN-SFN-ObsTimeDifference2, Max = 40961
-- For 1.28Mcps TDD, Max value of SFN-SFN-ObsTimeDifference2 is 27649.
-- Values above Max are spare
SFN-SFN-ObsTimeDifference2 ::=    INTEGER (0..65535)

SFN-SFN-OTD-Type ::=             ENUMERATED {
    noReport,
    type1,
    type2 }

SFN-SFN-RelTimeDifference1 ::=    SEQUENCE {
    sfn-Offset                       INTEGER (0 .. 4095),
    sfn-sfn-Reltimedifference        INTEGER (0.. 38399)
}

SFN-TOW-Uncertainty ::=          ENUMERATED {
    lessThan10,
    moreThan10 }

SIR ::=                          INTEGER (0..63)

SIR-MeasurementList ::=          SEQUENCE (SIZE (1..maxCCTrCH)) OF
    SIR-MeasurementResults

SIR-MeasurementResults ::=       SEQUENCE {
    tfcs-ID                          TFCS-IdentityPlain,
    sir-TimeslotList                 SIR-TimeslotList
}

SIR-TFCS ::=                     TFCS-IdentityPlain

```

```

SIR-TFCS-List ::= SEQUENCE (SIZE (1..maxCCTrCH)) OF
                  SIR-TFCS

SIR-TimeslotList ::= SEQUENCE (SIZE (1..maxTS)) OF
                    SIR

-- SubFrame1Reserved, reserved bits in subframe 1 of the GPS navigation message
SubFrame1Reserved ::= SEQUENCE {
    reserved1 BIT STRING (SIZE (23)),
    reserved2 BIT STRING (SIZE (24)),
    reserved3 BIT STRING (SIZE (24)),
    reserved4 BIT STRING (SIZE (16))
}

T-ADVinfo ::= SEQUENCE {
    t-ADV INTEGER (0..2047),
    sfn INTEGER (0..4095)
}

T-ADVinfo-ext ::= SEQUENCE {
    t-ADV INTEGER (0..8191),
    sfn INTEGER (0..4095)
}

T-CRMax ::= CHOICE {
    notUsed NULL,
    t30 N-CR-T-CRMaxHyst,
    t60 N-CR-T-CRMaxHyst,
    t120 N-CR-T-CRMaxHyst,
    t180 N-CR-T-CRMaxHyst,
    t240 N-CR-T-CRMaxHyst
}

T-CRMaxHyst ::= ENUMERATED {
    notUsed, t10, t20, t30,
    t40, t50, t60, t70 }

TemporaryOffset1 ::= ENUMERATED {
    to3, to6, to9, to12, to15,
    to18, to21, infinite }

TemporaryOffset2 ::= ENUMERATED {
    to2, to3, to4, to6, to8,
    to10, to12, infinite }

TemporaryOffsetList ::= SEQUENCE {
    temporaryOffset1 TemporaryOffset1,
    temporaryOffset2 TemporaryOffset2
}

Threshold ::= INTEGER (-115..0)

Threshold-r6 ::= INTEGER (-120..0)

-- The order of the list corresponds to the order of frequency defined in Inter-FreqEventCriteria
ThresholdNonUsedFrequency-deltaList ::= SEQUENCE (SIZE (1..maxFreq)) OF
DeltaRSCPPerCell

ThresholdPositionChange ::= ENUMERATED {
    pc10, pc20, pc30, pc40, pc50,
    pc100, pc200, pc300, pc500,
    pc1000, pc2000, pc5000, pc10000,
    pc20000, pc50000, pc100000 }

ThresholdSFN-GANSS-TOW ::= ENUMERATED {
    us1, us2, us3, us5, us10,
    us20, us50, us100 }

ThresholdSFN-GPS-TOW ::= ENUMERATED {
    ms1, ms2, ms3, ms5, ms10,
    ms20, ms50, ms100 }

ThresholdSFN-GPS-TOW-us ::= ENUMERATED {
    us1, us2, us3, us5, us10,
    us20, us50, us100 }

ThresholdSFN-SFN-Change ::= ENUMERATED {

```

```

        c0-25, c0-5, c1, c2, c3, c4, c5,
        c10, c20, c50, c100, c200, c500,
        c1000, c2000, c5000 }

ThresholdUsedFrequency ::=          INTEGER (-115..165)

ThresholdUsedFrequency-r6 ::=       INTEGER (-120..165)

-- Actual value TimeInterval = IE value * 20.
TimeInterval ::=                    INTEGER (1..13)

TimeslotInfo ::=                    SEQUENCE {
    timeslotNumber                   TimeslotNumber,
    burstType                         BurstType
}

TimeslotInfo-LCR-r4 ::=              SEQUENCE {
    timeslotNumber                   TimeslotNumber-LCR-r4
}

TimeslotInfoList ::=                SEQUENCE (SIZE (1..maxTS)) OF
    TimeslotInfo

TimeslotInfoList-LCR-r4 ::=         SEQUENCE (SIZE (1..maxTS-LCR)) OF
    TimeslotInfo-LCR-r4

TimeslotInfoList-r4 ::=             CHOICE {
    -- the choice for 7.68 Mcps TDD is the same as for 3.84 Mcps TDD --
    tdd384                           SEQUENCE (SIZE (1..maxTS)) OF
        TimeslotInfo,
    tdd128                           SEQUENCE (SIZE (1..maxTS-LCR)) OF
        TimeslotInfo-LCR-r4
}

-- SPARE: TimeslotISCP, Max = 91
-- Values above Max are spare
TimeslotISCP ::=                    INTEGER (0..127)

-- TimeslotISCP-List shall not include more than 6 elements in 1.28Mcps TDD mode.
TimeslotISCP-List ::=              SEQUENCE (SIZE (1..maxTS)) OF
    TimeslotISCP

TimeslotListWithISCP ::=           SEQUENCE (SIZE (1..maxTS)) OF
    TimeslotWithISCP

TimeslotWithISCP ::=              SEQUENCE {
    timeslot                          TimeslotNumber,
    timeslotISCP                      TimeslotISCP
}

TimeToTrigger ::=                  ENUMERATED {
    ttt0, ttt10, ttt20, ttt40, ttt60,
    ttt80, ttt100, ttt120, ttt160,
    ttt200, ttt240, ttt320, ttt640,
    ttt1280, ttt2560, ttt5000 }

TrafficVolumeEventParam ::=        SEQUENCE {
    eventID                           TrafficVolumeEventType,
    reportingThreshold                 TrafficVolumeThreshold,
    timeToTrigger                      TimeToTrigger                      OPTIONAL,
    pendingTimeAfterTrigger            PendingTimeAfterTrigger            OPTIONAL,
    tx-InterruptionAfterTrigger        TX-InterruptionAfterTrigger        OPTIONAL
}

TrafficVolumeEventResults ::=       SEQUENCE {
    ul-transportChannelCausingEvent    UL-TrCH-Identity,
    trafficVolumeEventIdentity         TrafficVolumeEventType
}

TrafficVolumeEventType ::=          ENUMERATED {
    e4a,
    e4b }

TrafficVolumeMeasQuantity ::=       CHOICE {
    rlc-BufferPayload                 NULL,
    averageRLC-BufferPayload          TimeInterval,

```

```

    varianceOfRLC-BufferPayload      TimeInterval
  }

TrafficVolumeMeasSysInfo ::=      SEQUENCE {
    trafficVolumeMeasurementID      MeasurementIdentity      DEFAULT 4,
    trafficVolumeMeasurementObjectList TrafficVolumeMeasurementObjectList OPTIONAL,
    trafficVolumeMeasQuantity      TrafficVolumeMeasQuantity  OPTIONAL,
    trafficVolumeReportingQuantity  TrafficVolumeReportingQuantity  OPTIONAL,
    -- dummy is not used in this version of specification, it should
    -- not be sent and if received it should be ignored.
    dummy                          TrafficVolumeReportingCriteria  OPTIONAL,
    measurementValidity            MeasurementValidity          OPTIONAL,
    measurementReportingMode       MeasurementReportingMode,
    reportCriteriaSysInf          TrafficVolumeReportCriteriaSysInfo
  }

TrafficVolumeMeasuredResults ::= SEQUENCE {
    rb-Identity                    RB-Identity,
    rlc-BuffersPayload             RLC-BuffersPayload          OPTIONAL,
    averageRLC-BufferPayload       AverageRLC-BufferPayload     OPTIONAL,
    varianceOfRLC-BufferPayload    VarianceOfRLC-BufferPayload  OPTIONAL
  }

TrafficVolumeMeasuredResultsList ::= SEQUENCE (SIZE (1..maxRB)) OF
    TrafficVolumeMeasuredResults

TrafficVolumeMeasurement ::= SEQUENCE {
    trafficVolumeMeasurementObjectList TrafficVolumeMeasurementObjectList  OPTIONAL,
    trafficVolumeMeasQuantity        TrafficVolumeMeasQuantity          OPTIONAL,
    trafficVolumeReportingQuantity    TrafficVolumeReportingQuantity     OPTIONAL,
    measurementValidity              MeasurementValidity                OPTIONAL,
    reportCriteria                   TrafficVolumeReportCriteria
  }

TrafficVolumeMeasurementObjectList ::= SEQUENCE (SIZE (1..maxTrCH)) OF
    UL-TrCH-Identity

TrafficVolumeReportCriteria ::= CHOICE {
    trafficVolumeReportingCriteria  TrafficVolumeReportingCriteria,
    periodicalReportingCriteria     PeriodicalReportingCriteria,
    noReporting                     NULL
  }

TrafficVolumeReportCriteriaSysInfo ::= CHOICE {
    trafficVolumeReportingCriteria  TrafficVolumeReportingCriteria,
    periodicalReportingCriteria     PeriodicalReportingCriteria
  }

TrafficVolumeReportingCriteria ::= SEQUENCE {
    -- NOTE: transChCriteriaList should be mandatory in later versions of this message
    transChCriteriaList             TransChCriteriaList              OPTIONAL
  }

TrafficVolumeReportingQuantity ::= SEQUENCE {
    rlc-RB-BufferPayload            BOOLEAN,
    rlc-RB-BufferPayloadAverage     BOOLEAN,
    rlc-RB-BufferPayloadVariance    BOOLEAN
  }

TrafficVolumeThreshold ::= ENUMERATED {
    th8, th16, th32, th64, th128,
    th256, th512, th1024, th2k, th3k,
    th4k, th6k, th8k, th12k, th16k,
    th24k, th32k, th48k, th64k, th96k,
    th128k, th192k, th256k, th384k,
    th512k, th768k }

TransChCriteria ::= SEQUENCE {
    ul-transportChannelID          UL-TrCH-Identity              OPTIONAL,
    eventSpecificParameters        SEQUENCE (SIZE (1..maxMeasParEvent)) OF
    TrafficVolumeEventParam        OPTIONAL
  }

TransChCriteriaList ::= SEQUENCE (SIZE (1..maxTrCH)) OF
    TransChCriteria

TransferMode ::= ENUMERATED {

```



```

        acknowledgedModeRLC,
        unacknowledgedModeRLC }

TransmittedPowerThreshold ::= INTEGER (-50..33)

TriggeringCondition1 ::= ENUMERATED {
    activeSetCellsOnly,
    monitoredSetCellsOnly,
    activeSetAndMonitoredSetCells }

TriggeringCondition2 ::= ENUMERATED {
    activeSetCellsOnly,
    monitoredSetCellsOnly,
    activeSetAndMonitoredSetCells,
    detectedSetCellsOnly,
    detectedSetAndMonitoredSetCells }

Tutran-Ganss-DriftRate ::= ENUMERATED {
    ugdr0, ugdr1, ugdr2, ugdr5, ugdr10, ugdr15, ugdr25,
    ugdr50, ugdr-1, ugdr-2, ugdr-5, ugdr-10, ugdr-15,
    ugdr-25, ugdr-50, spare }

TX-InterruptionAfterTrigger ::= ENUMERATED {
    txiat0-25, txiat0-5, txiat1,
    txiat2, txiat4, txiat8, txiat16 }

UDRE ::= ENUMERATED {
    lessThan1,
    between1-and-4,
    between4-and-8,
    over8 }

UE-6AB-Event ::= SEQUENCE {
    timeToTrigger          TimeToTrigger,
    transmittedPowerThreshold TransmittedPowerThreshold
}

UE-6FG-Event ::= SEQUENCE {
    timeToTrigger          TimeToTrigger,
    -- in 1.28 Mcps TDD ue-RX-TX-TimeDifferenceThreshold corresponds to TADV Threshold
    ue-RX-TX-TimeDifferenceThreshold UE-RX-TX-TimeDifferenceThreshold
}

-- dummy and dummy2 are not used in this version of the specification, they should
-- not be sent and if received the UE behaviour is not specified.
UE-AutonomousUpdateMode ::= CHOICE {
    dummy          NULL,
    onWithNoReporting NULL,
    dummy2        RL-InformationLists
}

UE-InternalEventParam ::= CHOICE {
    event6a      UE-6AB-Event,
    event6b      UE-6AB-Event,
    event6c      TimeToTrigger,
    event6d      TimeToTrigger,
    event6e      TimeToTrigger,
    event6f      UE-6FG-Event,
    event6g      UE-6FG-Event
}

UE-InternalEventParamList ::= SEQUENCE (SIZE (1..maxMeasEvent)) OF
    UE-InternalEventParam

UE-InternalEventResults ::= CHOICE {
    event6a      NULL,
    event6b      NULL,
    event6c      NULL,
    event6d      NULL,
    event6e      NULL,
    event6f      PrimaryCPICH-Info,
    event6g      PrimaryCPICH-Info,
    spare        NULL
}

UE-InternalMeasQuantity ::= SEQUENCE {
    measurementQuantity UE-MeasurementQuantity,
    filterCoefficient   FilterCoefficient           DEFAULT fc0
}

```

```

}
UE-InternalMeasuredResults ::= SEQUENCE {
  modeSpecificInfo CHOICE {
    fdd SEQUENCE {
      ue-TransmittedPowerFDD UE-TransmittedPower OPTIONAL,
      ue-RX-TX-ReportEntryList UE-RX-TX-ReportEntryList OPTIONAL
    },
    tdd SEQUENCE {
      ue-TransmittedPowerTDD-List UE-TransmittedPowerTDD-List OPTIONAL,
      appliedTA UL-TimingAdvance OPTIONAL
    }
  }
}

UE-InternalMeasuredResults-LCR-r4 ::= SEQUENCE {
  ue-TransmittedPowerTDD-List UE-TransmittedPowerTDD-List OPTIONAL,
  -- If TA value is not greater than 2047, then use this IE to report.
  t-ADVinfo T-ADVinfo OPTIONAL
}

UE-InternalMeasuredResults-v770ext ::= SEQUENCE {
  modeSpecificInfo CHOICE {
    tdd384-768 SEQUENCE {
      appliedTA EXT-UL-TimingAdvance OPTIONAL
    },
    tdd128 SEQUENCE {
      -- If TA value is greater than 2047, then use this IE to report
      t-ADVinfo T-ADVinfo-ext OPTIONAL
    }
  }
}

UE-InternalMeasurement ::= SEQUENCE {
  ue-InternalMeasQuantity UE-InternalMeasQuantity OPTIONAL,
  ue-InternalReportingQuantity UE-InternalReportingQuantity OPTIONAL,
  reportCriteria UE-InternalReportCriteria
}

UE-InternalMeasurement-r4 ::= SEQUENCE {
  ue-InternalMeasQuantity UE-InternalMeasQuantity OPTIONAL,
  ue-InternalReportingQuantity UE-InternalReportingQuantity-r4 OPTIONAL,
  reportCriteria UE-InternalReportCriteria
}

UE-InternalMeasurementSysInfo ::= SEQUENCE {
  ue-InternalMeasurementID MeasurementIdentity DEFAULT 5,
  ue-InternalMeasQuantity UE-InternalMeasQuantity
}

UE-InternalReportCriteria ::= CHOICE {
  ue-InternalReportingCriteria UE-InternalReportingCriteria,
  periodicalReportingCriteria PeriodicalReportingCriteria,
  noReporting NULL
}

UE-InternalReportingCriteria ::= SEQUENCE {
  ue-InternalEventParamList UE-InternalEventParamList OPTIONAL
}

UE-InternalReportingQuantity ::= SEQUENCE {
  ue-TransmittedPower BOOLEAN,
  modeSpecificInfo CHOICE {
    fdd SEQUENCE {
      ue-RX-TX-TimeDifference BOOLEAN
    },
    tdd SEQUENCE {
      appliedTA BOOLEAN
    }
  }
}

UE-InternalReportingQuantity-r4 ::= SEQUENCE {
  ue-TransmittedPower BOOLEAN,
  modeSpecificInfo CHOICE {
    fdd SEQUENCE {
      ue-RX-TX-TimeDifference BOOLEAN
    },

```

```

    tdd
        tddOption
            -- appliedTA applies to both 3.84 Mcps TDD and to 7.68 Mcps TDD.
            -- Therefore, no additional choice of TDD mode is necessary
            tdd384
                appliedTA
            },
            tdd128
                t-ADVinfo
            }
        }
    }
}

-- TABULAR: UE-MeasurementQuantity, for 3.84 Mcps TDD only the first two values
-- ue-TransmittedPower and ultra-Carrier-RSSI are used.
-- For 1.28 Mcps TDD ue-RX-TX-TimeDifference corresponds to T-ADV in the tabular
UE-MeasurementQuantity ::=
    ENUMERATED {
        ue-TransmittedPower,
        ultra-Carrier-RSSI,
        ue-RX-TX-TimeDifference }

UE-RX-TX-ReportEntry ::=
    SEQUENCE {
        primaryCPICH-Info
        ue-RX-TX-TimeDifferenceType1
    }

UE-RX-TX-ReportEntryList ::=
    SEQUENCE (SIZE (1..maxRL)) OF
        UE-RX-TX-ReportEntry

-- SPARE: UE-RX-TX-TimeDifferenceType1, Max = 1280
-- Values above Max are spare
UE-RX-TX-TimeDifferenceType1 ::=
    INTEGER (768..1791)

UE-RX-TX-TimeDifferenceType2 ::=
    INTEGER (0..8191)

UE-RX-TX-TimeDifferenceType2Info ::=
    SEQUENCE {
        ue-RX-TX-TimeDifferenceType2
        neighbourQuality
    }

-- In 1.28 Mcps TDD, actual value for
-- T-ADV Threshold = (UE-RX-TX-TimeDifferenceThreshold - 768) * 0.125
UE-RX-TX-TimeDifferenceThreshold ::=
    INTEGER (768..1280)

UE-TransmittedPower ::=
    INTEGER (0..104)

UE-TransmittedPowerTDD-List ::=
    SEQUENCE (SIZE (1..maxTS)) OF
        UE-TransmittedPower

UL-TrCH-Identity ::=
    CHOICE{
        dch
            -- Note: the reference to CPCH in the element name below is incorrect. The name is not changed
            -- to keep it aligned with R99.
            rachorcpcch
        usch
    }

UE-Positioning-Accuracy ::=
    BIT STRING (SIZE (7))

UE-Positioning-CipherParameters ::=
    SEQUENCE {
        cipheringKeyFlag
        cipheringSerialNumber
    }

UE-Positioning-DGANSSCorrections ::=
    SEQUENCE {
        dganssreferencetime
        dganssInfoList
    }

UE-Positioning-Error ::=
    SEQUENCE {
        errorReason
        ue-positioning-GPS-additionalAssistanceDataRequest
        AdditionalAssistanceDataRequest OPTIONAL
    }

```

```

UE-Positioning-Error-r7 ::= SEQUENCE {
    errorReason UE-Positioning-ErrorCause-r7,
    ue-positioning-GPS-additionalAssistanceDataRequest
        UE-Positioning-GPS-AdditionalAssistanceDataRequest OPTIONAL,
    ue-positioning-GANSS-additionalAssistanceDataRequest
        UE-Positioning-GANSS-AdditionalAssistanceDataRequest OPTIONAL
}

UE-Positioning-ErrorCause ::= ENUMERATED {
    notEnoughOTDOA-Cells,
    notEnoughGPS-Satellites,
    assistanceDataMissing,
    notAccomplishedGPS-TimingOfCellFrames,
    undefinedError,
    requestDeniedByUser,
    notProcessedAndTimeout,
    referenceCellNotServingCell }

UE-Positioning-ErrorCause-r7 ::= ENUMERATED {
    notEnoughOTDOA-Cells,
    notEnoughGPS-Satellites,
    assistanceDataMissing,
    notAccomplishedGPS-TimingOfCellFrames,
    undefinedError,
    requestDeniedByUser,
    notProcessedAndTimeout,
    referenceCellNotServingCell,
    notEnoughGANSS-Satellites,
    notAccomplishedGANSS-TimingOfCellFrames,
    spare6, spare5, spare4, spare3, spare2, spare1 }

UE-Positioning-EventParam ::= SEQUENCE {
    reportingAmount ReportingAmount,
    reportFirstFix BOOLEAN,
    measurementInterval UE-Positioning-MeasurementInterval,
    eventSpecificInfo UE-Positioning-EventSpecificInfo
}

UE-Positioning-EventParam-r7 ::= SEQUENCE {
    reportingAmount ReportingAmount,
    reportFirstFix BOOLEAN,
    measurementInterval UE-Positioning-MeasurementInterval,
    eventSpecificInfo UE-Positioning-EventSpecificInfo-r7
}

UE-Positioning-EventParamList ::= SEQUENCE (SIZE (1..maxMeasEvent)) OF
    UE-Positioning-EventParam

UE-Positioning-EventParamList-r7 ::= SEQUENCE (SIZE (1..maxMeasEvent)) OF
    UE-Positioning-EventParam-r7

UE-Positioning-EventSpecificInfo ::= CHOICE {
    e7a ThresholdPositionChange,
    e7b ThresholdSFN-SFN-Change,
    e7c ThresholdSFN-GPS-TOW
}

UE-Positioning-EventSpecificInfo-r7 ::= CHOICE {
    e7a ThresholdPositionChange,
    e7b ThresholdSFN-SFN-Change,
    e7c ThresholdSFN-GPS-TOW-us,
    e7d ThresholdSFN-GANSS-TOW
}

UE-Positioning-GANSS-Almanac ::= SEQUENCE{
    ganss-wk-number INTEGER (0..255),
    alm-keplerianParameters ALM-keplerianParameters OPTIONAL
}

UE-Positioning-GANSS-AdditionalAssistanceDataRequest ::= SEQUENCE {
    ganssReferenceTime BOOLEAN,
    ganssreferenceLocation BOOLEAN,
    ganssIonosphericModel BOOLEAN,
    ganssRequestedGenericAssistanceDataList GanssRequestedGenericAssistanceDataList
}

UE-Positioning-GANSS-AssistanceData ::= SEQUENCE {

```

```

    ue-positioning-GANSS-ReferenceTime  UE-Positioning-GANSS-ReferenceTime  OPTIONAL,
    uePositioningGanssReferencePosition ReferenceLocationGANSS      OPTIONAL,
    uePositioningGanssIonosphericModel  UE-Positioning-GANSS-IonosphericModel  OPTIONAL,
    ganssGenericDataList                 GANSSGenericDataList                 OPTIONAL
}

UE-Positioning-GANSS-ClockModel ::= SEQUENCE {
    satellite-clock-modelList           Satellite-clock-modelList
}

UE-Positioning-GANSS-Data ::= SEQUENCE {
    ganssDataCipheringInfo              UE-Positioning-CipherParameters      OPTIONAL,
    ganssDecipheringKeys                GANSSDecipheringKeys                OPTIONAL,
    uePositioningGanssReferenceTime     UE-Positioning-GANSS-ReferenceTime  OPTIONAL,
    uePositioningGanssReferencePosition ReferenceLocationGANSS                OPTIONAL,
    uePositioningGanssIonosphericModel  UE-Positioning-GANSS-IonosphericModel  OPTIONAL,
    ganssGenericDataList                GANSSGenericDataList                OPTIONAL
}

UE-Positioning-GANSS-Data-Bit-Assistance ::= SEQUENCE {
    ganss-tod                           INTEGER (0..59),
    dataBitAssistanceList                DataBitAssistanceList
}

UE-Positioning-GANSS-IonosphericModel ::= SEQUENCE {
    alpha-zero-ionos                    BIT STRING (SIZE (12)),
    alpha-one-ionos                     BIT STRING (SIZE (12)),
    alpha-two-ionos                     BIT STRING (SIZE (12)),
    gANSS-storm-flags                   GANSS-Storm-Flag                    OPTIONAL
}

UE-Positioning-GANSS-MeasuredResults ::= SEQUENCE {
    referenceTime                       CHOICE {
        utran-GANSSReferenceTimeResult  UTRAN-GANSSReferenceTime,
        ganssReferenceTimeOnly          GANSSReferenceTimeOnly
    },
    ganssGenericMeasurementInfo         GANSSGenericMeasurementInfo
}

UE-Positioning-GANSS-NavigationModel ::= SEQUENCE {
    non-broadcastIndication             ENUMERATED { true }                  OPTIONAL,
    ganssSatInfoNavList                 Ganss-Sat-Info-NavList
}

UE-Positioning-GANSS-OrbitModel ::= SEQUENCE {
    keplerianParameters                 KeplerianParameters                  OPTIONAL
}

UE-Positioning-GANSS-RealTimeIntegrity ::= SEQUENCE (SIZE (1..maxGANSSSat)) OF SEQUENCE {
    bad-ganss-satId                     INTEGER (0..63),
    bad-ganss-signalId                  BIT STRING (SIZE (8))                OPTIONAL
}

UE-Positioning-GANSS-ReferenceMeasurementInfo ::= SEQUENCE {
    ganssSignalId                       GANSS-Signal-Id                     OPTIONAL,
    satelliteInformationList             GANSSSatelliteInformationList
}

UE-Positioning-GANSS-ReferenceTime ::= SEQUENCE {
    ganssDay                             INTEGER (0..8191)                    OPTIONAL,
    ganssTod                              INTEGER (0..86399),
    ganssTodUncertainty                  INTEGER (0..127)                    OPTIONAL,
    ganssTimeId                          INTEGER (0..7)                      OPTIONAL,
    utran-ganssreferenceTime              SEQUENCE {
        timingOfCellFrames              INTEGER (0..3999999),
        mode                             CHOICE {
            fdd                          SEQUENCE {
                primary-CPICH-Info      PrimaryCPICH-Info
            },
            tdd                          SEQUENCE {
                cellParameters           CellParametersID
            }
        },
        referenceSfn                     INTEGER (0..4095)
    } OPTIONAL,
    tutran-ganss-driftRate                Tutran-Ganss-DriftRate              OPTIONAL
}

```

```

UE-Positioning-GANSS-TimeModel ::= SEQUENCE {
    ganss-timeModelreferenceTime    INTEGER (0..37799),           -- scale factor 16s
    ganss-t-a0                      INTEGER (-2147483648..2147483647), -- scale factor 2-35
    -- 'ganss-t-a1' scale factor 2-51
    ganss-t-a1                      INTEGER (-8388608..8388607)         OPTIONAL,
    -- 'ganss-t-a2' scale factor 2-68
    ganss-t-a2                      INTEGER (-64..63)                   OPTIONAL,
    gnss-to-id                      ENUMERATED { gps, spare7, spare6,
                                                spare5, spare4, spare3, spare2, spare1 },
    ganss-wk-number                 INTEGER (0..8191)                     OPTIONAL
}

UE-Positioning-GANSS-TimeModels ::= SEQUENCE (SIZE (1..maxGANSS-1)) OF
    UE-Positioning-GANSS-TimeModel

UE-Positioning-GANSS-UTCModel ::= SEQUENCE {
    a-one-utc                      BIT STRING (SIZE (24)),
    a-zero-utc                     BIT STRING (SIZE (32)),
    t-ot-utc                       BIT STRING (SIZE (8)),
    delta-t-ls-utc                 BIT STRING (SIZE (8)),
    w-n-t-utc                      BIT STRING (SIZE (8)),
    w-n-lsf-utc                   BIT STRING (SIZE (8)),
    dn-utc                        BIT STRING (SIZE (8)),
    delta-t-lsf-utc               BIT STRING (SIZE (8))
}

UE-Positioning-GPS-AcquisitionAssistance ::= SEQUENCE {
    gps-ReferenceTime              GPS-TOW-1msec,
    utran-GPSReferenceTime         UTRAN-GPSReferenceTime             OPTIONAL,
    satelliteInformationList       AcquisitionSatInfoList
}

UE-Positioning-GPS-AcquisitionAssistance-v770ext ::= SEQUENCE {
    ue-Positioning-GPS-ReferenceTimeUncertainty
                                                UE-Positioning-GPS-ReferenceTimeUncertainty    OPTIONAL
}

UE-Positioning-GPS-AcquisitionAssistance-r7 ::= SEQUENCE {
    gps-ReferenceTime              GPS-TOW-1msec,
    utran-GPSReferenceTime         UTRAN-GPSReferenceTime             OPTIONAL,
    ue-Positioning-GPS-ReferenceTimeUncertainty
                                                UE-Positioning-GPS-ReferenceTimeUncertainty    OPTIONAL,
    satelliteInformationList       AcquisitionSatInfoList
}

UE-Positioning-GPS-AdditionalAssistanceDataRequest ::= SEQUENCE {
    almanacRequest                 BOOLEAN,
    utcModelRequest                BOOLEAN,
    ionosphericModelRequest        BOOLEAN,
    navigationModelRequest         BOOLEAN,
    dgpsCorrectionsRequest         BOOLEAN,
    referenceLocationRequest       BOOLEAN,
    referenceTimeRequest           BOOLEAN,
    acquisitionAssistanceRequest   BOOLEAN,
    realTimeIntegrityRequest       BOOLEAN,
    navModelAddDataRequest         UE-Positioning-GPS-NavModelAddDataReq    OPTIONAL
}

UE-Positioning-GPS-Almanac ::= SEQUENCE {
    wn-a                          BIT STRING (SIZE (8)),
    almanacSatInfoList            AlmanacSatInfoList,
    sv-GlobalHealth               BIT STRING (SIZE (364))                OPTIONAL
}

UE-Positioning-GPS-AssistanceData ::= SEQUENCE {
    ue-positioning-GPS-ReferenceTime    UE-Positioning-GPS-ReferenceTime             OPTIONAL,
    ue-positioning-GPS-ReferenceLocation ReferenceLocation                            OPTIONAL,
    ue-positioning-GPS-DGPS-Corrections UE-Positioning-GPS-DGPS-Corrections          OPTIONAL,
    ue-positioning-GPS-NavigationModel  UE-Positioning-GPS-NavigationModel           OPTIONAL,
    ue-positioning-GPS-IonosphericModel UE-Positioning-GPS-IonosphericModel         OPTIONAL,
    ue-positioning-GPS-UTC-Model       UE-Positioning-GPS-UTC-Model                 OPTIONAL,
    ue-positioning-GPS-Almanac         UE-Positioning-GPS-Almanac                   OPTIONAL,
    ue-positioning-GPS-AcquisitionAssistance
                                                UE-Positioning-GPS-AcquisitionAssistance    OPTIONAL,
    ue-positioning-GPS-Real-timeIntegrity
    BadSatList                      BadSatList                                    OPTIONAL,
    -- dummy is not used in this version of the specification, it should

```

```

    -- not be sent and if received it should be ignored.
    dummy          UE-Positioning-GPS-ReferenceCellInfo          OPTIONAL
  }

UE-Positioning-GPS-AssistanceData-v770ext ::= SEQUENCE {
    ue-positioning-GPS-ReferenceTime          UE-Positioning-GPS-ReferenceTime-v770ext          OPTIONAL,
    ue-positioning-GPS-AcquisitionAssistance          UE-Positioning-GPS-AcquisitionAssistance-v770ext          OPTIONAL
  }

UE-Positioning-GPS-AssistanceData-r7 ::= SEQUENCE {
    ue-positioning-GPS-ReferenceTime          UE-Positioning-GPS-ReferenceTime-r7          OPTIONAL,
    ue-positioning-GPS-ReferenceLocation          ReferenceLocation          OPTIONAL,
    ue-positioning-GPS-DGPS-Corrections          UE-Positioning-GPS-DGPS-Corrections          OPTIONAL,
    ue-positioning-GPS-NavigationModel          UE-Positioning-GPS-NavigationModel          OPTIONAL,
    ue-positioning-GPS-IonosphericModel          UE-Positioning-GPS-IonosphericModel          OPTIONAL,
    ue-positioning-GPS-UTC-Model          UE-Positioning-GPS-UTC-Model          OPTIONAL,
    ue-positioning-GPS-Almanac          UE-Positioning-GPS-Almanac          OPTIONAL,
    ue-positioning-GPS-AcquisitionAssistance          UE-Positioning-GPS-AcquisitionAssistance-r7          OPTIONAL,
    ue-positioning-GPS-Real-timeIntegrity          BadSatList          OPTIONAL
  }

UE-Positioning-GPS-DGPS-Corrections ::= SEQUENCE {
    gps-TOW          GPS-TOW-1sec,
    statusHealth          DiffCorrectionStatus,
    dgps-CorrectionSatInfoList          DGPS-CorrectionSatInfoList
  }

UE-Positioning-GPS-IonosphericModel ::= SEQUENCE {
    alfa0          BIT STRING (SIZE (8)),
    alfa1          BIT STRING (SIZE (8)),
    alfa2          BIT STRING (SIZE (8)),
    alfa3          BIT STRING (SIZE (8)),
    beta0          BIT STRING (SIZE (8)),
    beta1          BIT STRING (SIZE (8)),
    beta2          BIT STRING (SIZE (8)),
    beta3          BIT STRING (SIZE (8))
  }

UE-Positioning-GPS-MeasurementResults ::= SEQUENCE {
    referenceTime          CHOICE {
        utran-GPSReferenceTimeResult          UTRAN-GPSReferenceTimeResult,
        gps-ReferenceTimeOnly          GPS-TOW-1msec
    },
    gps-MeasurementParamList          GPS-MeasurementParamList
  }

UE-Positioning-GPS-MeasurementResults-v770ext ::= SEQUENCE {
    ue-Positioning-GPS-ReferenceTimeUncertainty          UE-Positioning-GPS-ReferenceTimeUncertainty          OPTIONAL
  }

UE-Positioning-GPS-NavigationModel ::= SEQUENCE {
    navigationModelSatInfoList          NavigationModelSatInfoList
  }

UE-Positioning-GPS-NavModelAddDataReq ::= SEQUENCE {
    gps-Week          INTEGER (0..1023),
    -- SPARE: gps-Toe, Max = 167
    -- Values above Max are spare
    gps-Toe          INTEGER (0..255),
    -- SPARE: tToeLimit, Max = 10
    -- Values above Max are spare
    tToeLimit          INTEGER (0..15),
    satDataList          SatDataList
  }

UE-Positioning-GPS-ReferenceCellInfo ::= SEQUENCE {
    modeSpecificInfo          CHOICE {
        fdd          SEQUENCE {
            referenceIdentity          PrimaryCPICH-Info
        },
        tdd          SEQUENCE {
            referenceIdentity          CellParametersID
        }
    }
  }

```

```

UE-Positioning-GPS-ReferenceTime ::= SEQUENCE {
    gps-Week                INTEGER (0..1023),
    gps-tow-1msec           GPS-TOW-1msec,
    utran-GPSReferenceTime  UTRAN-GPSReferenceTime           OPTIONAL,
    sfn-tow-Uncertainty     SFN-TOW-Uncertainty             OPTIONAL,
    utran-GPS-DriftRate     UTRAN-GPS-DriftRate             OPTIONAL,
    gps-TOW-AssistList      GPS-TOW-AssistList              OPTIONAL
}

UE-Positioning-GPS-ReferenceTime-v770ext ::= SEQUENCE {
    ue-Positioning-GPS-ReferenceTimeUncertainty  OPTIONAL
}

UE-Positioning-GPS-ReferenceTime-r7 ::= SEQUENCE {
    gps-Week                INTEGER (0..1023),
    gps-tow-1msec           GPS-TOW-1msec,
    utran-GPSReferenceTime  UTRAN-GPSReferenceTime           OPTIONAL,
    ue-Positioning-GPS-ReferenceTimeUncertainty  OPTIONAL,
    sfn-tow-Uncertainty     SFN-TOW-Uncertainty             OPTIONAL,
    utran-GPS-DriftRate     UTRAN-GPS-DriftRate             OPTIONAL,
    gps-TOW-AssistList      GPS-TOW-AssistList              OPTIONAL
}

UE-Positioning-GPS-ReferenceTimeUncertainty ::= INTEGER (0..127)

UE-Positioning-GPS-UTC-Model ::= SEQUENCE {
    a1                BIT STRING (SIZE (24)),
    a0                BIT STRING (SIZE (32)),
    t-ot              BIT STRING (SIZE (8)),
    wn-t              BIT STRING (SIZE (8)),
    delta-t-LS        BIT STRING (SIZE (8)),
    wn-lsf            BIT STRING (SIZE (8)),
    dn                BIT STRING (SIZE (8)),
    delta-t-LSF        BIT STRING (SIZE (8))
}

UE-Positioning-IPDL-Parameters ::= SEQUENCE {
    ip-Spacing        IP-Spacing,
    ip-Length         IP-Length,
    ip-Offset         INTEGER (0..9),
    seed              INTEGER (0..63),
    burstModeParameters  OPTIONAL
}

UE-Positioning-IPDL-Parameters-r4 ::= SEQUENCE {
    modeSpecificInfo CHOICE {
        fdd SEQUENCE {
            ip-Spacing        IP-Spacing,
            ip-Length         IP-Length,
            ip-Offset         INTEGER (0..9),
            seed              INTEGER (0..63)
        },
        tdd SEQUENCE {
            ip-Spacing-TDD    IP-Spacing-TDD,
            ip-slot           INTEGER (0..14),
            ip-Start          INTEGER (0..4095),
            ip-PCCPCG         IP-PCCPCH-r4           OPTIONAL
        }
    },
    burstModeParameters  BurstModeParameters  OPTIONAL
}

UE-Positioning-IPDL-Parameters-TDD-r4-ext ::= SEQUENCE {
    ip-Spacing        IP-Spacing-TDD,
    ip-slot           INTEGER (0..14),
    ip-Start          INTEGER (0..4095),
    ip-PCCPCG         IP-PCCPCH-r4           OPTIONAL,
    burstModeParameters  BurstModeParameters
}

UE-Positioning-MeasuredResults ::= SEQUENCE {
    ue-positioning-OTDOA-Measurement  UE-Positioning-OTDOA-Measurement  OPTIONAL,
    -- Extended 'ue-positioning-PositionEstimateInfo' information may be provided using IE
    -- 'UE-Positioning-PositionEstimateInfo-v770ext' in IE 'UE-Positioning-MeasuredResults-v770ext'.
    ue-positioning-PositionEstimateInfo  UE-Positioning-PositionEstimateInfo  OPTIONAL,

```



```

ue-positioning-GPS-Measurement          UE-Positioning-GPS-MeasurementResults          OPTIONAL,
-- The 'ue-positioning-Error' information may be provided using IE 'UE-Positioning-Error-r7' in
-- IE 'UE-Positioning-MeasuredResults-v770ext'.
-- If IE 'UE-Positioning-Error-r7' is present, the corresponding IE 'UE-Positioning-Error' shall
-- be excluded.
ue-positioning-Error                    UE-Positioning-Error                                OPTIONAL
}

UE-Positioning-MeasuredResults-v770ext ::= SEQUENCE {
  ue-positioning-PositionEstimateInfo    UE-Positioning-PositionEstimateInfo-v770ext    OPTIONAL,
  ue-positioning-GPS-Measurement         UE-Positioning-GPS-MeasurementResults-v770ext
                                          OPTIONAL,
  ue-positioning-Error                   UE-Positioning-Error-r7                         OPTIONAL,
  ue-positioning-GANSS-MeasuredResults   UE-Positioning-GANSS-MeasuredResults           OPTIONAL
}

UE-Positioning-MeasuredResults-v390ext ::= SEQUENCE {
  ue-Positioning-OTDOA-Measurement-v390ext    UE-Positioning-OTDOA-Measurement-v390ext
}

UE-Positioning-Measurement ::= SEQUENCE {
  ue-positioning-ReportingQuantity          UE-Positioning-ReportingQuantity,
  reportCriteria                           UE-Positioning-ReportCriteria,
  ue-positioning-OTDOA-AssistanceData      UE-Positioning-OTDOA-AssistanceData            OPTIONAL,
  ue-positioning-GPS-AssistanceData        UE-Positioning-GPS-AssistanceData              OPTIONAL
}

UE-Positioning-Measurement-v390ext ::= SEQUENCE {
  ue-positioning-ReportingQuantity-v390ext    UE-Positioning-ReportingQuantity-v390ext    OPTIONAL,
  measurementValidity                       MeasurementValidity                           OPTIONAL,
  ue-positioning-OTDOA-AssistanceData-UEB    UE-Positioning-OTDOA-AssistanceData-UEB     OPTIONAL
}

UE-Positioning-Measurement-r4 ::= SEQUENCE {
  ue-positioning-ReportingQuantity          UE-Positioning-ReportingQuantity-r4,
  measurementValidity                     MeasurementValidity                            OPTIONAL,
  reportCriteria                           UE-Positioning-ReportCriteria,
  ue-positioning-OTDOA-AssistanceData      UE-Positioning-OTDOA-AssistanceData-r4
  OPTIONAL,
  ue-positioning-GPS-AssistanceData        UE-Positioning-GPS-AssistanceData              OPTIONAL
}

UE-Positioning-Measurement-r7 ::= SEQUENCE {
  ue-positioning-ReportingQuantity          UE-Positioning-ReportingQuantity-r7,
  measurementValidity                     MeasurementValidity                            OPTIONAL,
  reportCriteria                           UE-Positioning-ReportCriteria-r7,
  ue-positioning-OTDOA-AssistanceData      UE-Positioning-OTDOA-AssistanceData-r7    OPTIONAL,
  ue-positioning-GPS-AssistanceData        UE-Positioning-GPS-AssistanceData-r7      OPTIONAL,
  ue-positioning-GANSS-AssistanceData      UE-Positioning-GANSS-AssistanceData        OPTIONAL
}

UE-Positioning-MeasurementEventResults ::= CHOICE {
  -- In case of 'event7a' reporting, if IE 'UE-Positioning-PositionEstimateInfo' is not needed,
  -- CHOICE shall be set to 'additionalOrReplacedPosMeasEvent' and the 'event7a' shall be included
  -- in IE 'UE-Positioning-MeasurementEventResults-v770ext'.
  event7a                                  UE-Positioning-PositionEstimateInfo,
  event7b                                  UE-Positioning-OTDOA-Measurement,
  event7c                                  UE-Positioning-GPS-MeasurementResults,
  -- If CHOICE is set to 'additionalOrReplacedPosMeasEvent',
  -- IE 'UE-Positioning-MeasurementEventResults-v770ext' shall be present.
  additionalOrReplacedPosMeasEvent        NULL
}

UE-Positioning-MeasurementEventResults-v770ext ::= CHOICE {
  event7a                                  UE-Positioning-PositionEstimateInfo-v770ext,
  event7c                                  UE-Positioning-GPS-MeasurementResults-v770ext,
  event7d                                  UE-Positioning-GANSS-MeasuredResults,
  spare                                    NULL
}

UE-Positioning-MeasurementInterval ::= ENUMERATED {
  e5, e15, e60, e300,
  e900, e1800, e3600, e7200 }

UE-Positioning-MethodType ::= ENUMERATED {
  ue-Assisted,
  ue-Based,
}

```

```

        ue-BasedPreferred,
        ue-AssistedPreferred }

UE-Positioning-OTDOA-AssistanceData ::= SEQUENCE {
    ue-positioning-OTDOA-ReferenceCellInfo    UE-Positioning-OTDOA-ReferenceCellInfo
    OPTIONAL,
    ue-positioning-OTDOA-NeighbourCellList    UE-Positioning-OTDOA-NeighbourCellList
    OPTIONAL
}

UE-Positioning-OTDOA-AssistanceData-r4 ::= SEQUENCE {
    ue-positioning-OTDOA-ReferenceCellInfo    UE-Positioning-OTDOA-ReferenceCellInfo-r4
    OPTIONAL,
    ue-positioning-OTDOA-NeighbourCellList    UE-Positioning-OTDOA-NeighbourCellList-r4
    OPTIONAL
}

UE-Positioning-OTDOA-AssistanceData-r4ext ::= SEQUENCE {
    -- In case of TDD these IPDL parameters shall be used for the reference cell instead of
    -- IPDL Parameters in IE UE-Positioning-OTDOA-ReferenceCellInfo
    ue-Positioning-IPDL-Parameters-TDD-r4-ext    UE-Positioning-IPDL-Parameters-TDD-r4-ext
    OPTIONAL,
    -- These IPDL parameters shall be used for the neighbour cells in case of TDD instead of
    -- IPDL Parameters in IE UE-Positioning-OTDOA-NeighbourCellInfoList. The cells shall be
    -- listed in the same order as in IE UE-Positioning-OTDOA-NeighbourCellInfoList
    ue-Positioning-IPDL-Parameters-TDDList-r4-ext    UE-Positioning-IPDL-Parameters-TDDList-r4-ext
    OPTIONAL
}

UE-Positioning-OTDOA-AssistanceData-UEB ::= SEQUENCE {
    ue-positioning-OTDOA-ReferenceCellInfo-UEB    UE-Positioning-OTDOA-ReferenceCellInfo-UEB    OPTIONAL,
    ue-positioning-OTDOA-NeighbourCellList-UEB    UE-Positioning-OTDOA-NeighbourCellList-UEB    OPTIONAL
}

UE-Positioning-OTDOA-AssistanceData-UEB-ext ::= SEQUENCE {
    ue-positioning-OTDOA-ReferenceCellInfo-UEB-ext    UE-Positioning-OTDOA-ReferenceCellInfo-UEB-ext    OPTIONAL,
    ue-positioning-OTDOA-NeighbourCellList-UEB-ext    UE-Positioning-OTDOA-NeighbourCellList-UEB-ext    OPTIONAL
}

UE-Positioning-OTDOA-AssistanceData-r7 ::= SEQUENCE {
    ue-positioning-OTDOA-ReferenceCellInfo    UE-Positioning-OTDOA-ReferenceCellInfo-r7    OPTIONAL,
    ue-positioning-OTDOA-NeighbourCellList    UE-Positioning-OTDOA-NeighbourCellList-r7    OPTIONAL
}

UE-Positioning-IPDL-Parameters-TDDList-r4-ext ::= SEQUENCE (SIZE (1..maxCellMeas)) OF
    UE-Positioning-IPDL-Parameters-TDD-r4-ext

UE-Positioning-OTDOA-MeasuredResultsTDD-ext ::= SEQUENCE {
    neighbourList    NeighbourList-TDD-r7    OPTIONAL
}

UE-Positioning-OTDOA-Measurement ::= SEQUENCE {
    sfn    INTEGER (0..4095),
    modeSpecificInfo    CHOICE {
        fdd    SEQUENCE {
            referenceCellIdentity    PrimaryCPICH-Info,
            ue-RX-TX-TimeDifferenceType2Info    UE-RX-TX-TimeDifferenceType2Info
        },
        tdd    SEQUENCE {
            referenceCellIdentity    CellParametersID
        }
    },
    neighbourList    NeighbourList    OPTIONAL
}

UE-Positioning-OTDOA-Measurement-v390ext ::= SEQUENCE {
    neighbourList-v390ext    NeighbourList-v390ext
}

UE-Positioning-OTDOA-NeighbourCellInfo ::= SEQUENCE {
    modeSpecificInfo    CHOICE {
        fdd    SEQUENCE {
            primaryCPICH-Info    PrimaryCPICH-Info
        },

```

```

        tdd
            cellAndChannelIdentity
        },
        frequencyInfo
        ue-positioning-IPDL-Parameters
        OPTIONAL,
        sfn-SFN-RelTimeDifference
        sfn-SFN-Drift
        searchWindowSize
        positioningMode CHOICE {
            ueBased
            ueAssisted
        }
    }

UE-Positioning-OTDOA-NeighbourCellInfo-r4 ::= SEQUENCE {
    modeSpecificInfo CHOICE {
        fdd
            primaryCPICH-Info
        },
        tdd
            cellAndChannelIdentity
    },
    frequencyInfo
    ue-positioning-IPDL-Parameters
    sfn-SFN-RelTimeDifference
    sfn-Offset-Validity
    sfn-SFN-Drift
    searchWindowSize
    positioningMode CHOICE {
        ueBased
            relativeNorth
            relativeEast
            relativeAltitude
            fineSFN-SFN
            -- actual value roundTripTime = (IE value * 0.0625) + 876
            roundTripTime
        },
        ueAssisted
    }
}

UE-Positioning-OTDOA-NeighbourCellInfo-UEB ::= SEQUENCE {
    modeSpecificInfo CHOICE {
        fdd
            primaryCPICH-Info
        },
        tdd
            cellAndChannelIdentity
    },
    frequencyInfo
    ue-positioning-IPDL-Parameters
    sfn-SFN-RelTimeDifference
    sfn-SFN-Drift
    searchWindowSize
    relativeNorth
    relativeEast
    relativeAltitude
    fineSFN-SFN
    -- actual value roundTripTime = (IE value * 0.0625) + 876
    roundTripTime
}

UE-Positioning-OTDOA-NeighbourCellInfo-UEB-ext ::= SEQUENCE {
    -- actual value roundTripTimeExtension = (IE value * 0.0625)
    roundTripTimeExtension
}

UE-Positioning-OTDOA-NeighbourCellInfo-r7 ::= SEQUENCE {
    modeSpecificInfo CHOICE {
        fdd
            primaryCPICH-Info
        },
        tdd
            cellAndChannelIdentity
    }
}

```

```

    },
    frequencyInfo          FrequencyInfo          OPTIONAL,
    ue-positioning-IPDL-Parameters UE-Positioning-IPDL-Parameters-r4 OPTIONAL,
    sfn-SFN-RelTimeDifference SFN-SFN-RelTimeDifference1,
    sfn-Offset-Validity      SFN-Offset-Validity      OPTIONAL,
    sfn-SFN-Drift            SFN-SFN-Drift            OPTIONAL,
    searchWindowSize         OTDOA-SearchWindowSize,
    positioningMode         CHOICE {
        ueBased              SEQUENCE {
            relativeNorth    INTEGER (-20000..20000)    OPTIONAL,
            relativeEast     INTEGER (-20000..20000)    OPTIONAL,
            relativeAltitude  INTEGER (-4000..4000)     OPTIONAL,
            fineSFN-SFN      FineSFN-SFN              OPTIONAL,
            -- actual value roundTripTime = (IE value * 0.0625) + 876
            roundTripTime    INTEGER (0.. 32766)        OPTIONAL,
            -- actual value roundTripTimeExtension = (IE value * 0.0625)
            roundTripTimeExtension INTEGER (0..70274)    OPTIONAL
        },
        ueAssisted          SEQUENCE {}
    }
}

UE-Positioning-OTDOA-NeighbourCellList ::= SEQUENCE (SIZE (1..maxCellMeas)) OF
    UE-Positioning-OTDOA-NeighbourCellInfo

UE-Positioning-OTDOA-NeighbourCellList-r4 ::= SEQUENCE (SIZE (1..maxCellMeas)) OF
    UE-Positioning-OTDOA-NeighbourCellInfo-r4

UE-Positioning-OTDOA-NeighbourCellList-UEB ::= SEQUENCE (SIZE (1..maxCellMeas)) OF
    UE-Positioning-OTDOA-NeighbourCellInfo-UEB

-- The order of the list corresponds to the order of UE-Positioning-OTDOA-NeighbourCellInfo-UEB
-- in UE-Positioning-OTDOA-NeighbourCellList-UEB
UE-Positioning-OTDOA-NeighbourCellList-UEB-ext ::= SEQUENCE (SIZE (1..maxCellMeas)) OF
    UE-Positioning-OTDOA-NeighbourCellInfo-UEB-ext

UE-Positioning-OTDOA-NeighbourCellList-r7 ::= SEQUENCE (SIZE (1..maxCellMeas)) OF
    UE-Positioning-OTDOA-NeighbourCellInfo-r7

UE-Positioning-OTDOA-Quality ::= SEQUENCE {
    stdResolution          BIT STRING (SIZE (2)),
    numberOfOTDOA-Measurements BIT STRING (SIZE (3)),
    stdOfOTDOA-Measurements BIT STRING (SIZE (5))
}

UE-Positioning-OTDOA-ReferenceCellInfo ::= SEQUENCE {
    sfn                    INTEGER (0..4095)
    OPTIONAL,
    modeSpecificInfo CHOICE {
        fdd                SEQUENCE {
            primaryCPICH-Info PrimaryCPICH-Info
        },
        tdd                SEQUENCE {
            cellAndChannelIdentity CellAndChannelIdentity
        }
    },
    frequencyInfo          FrequencyInfo          OPTIONAL,
    positioningMode CHOICE {
        ueBased              SEQUENCE {},
        ueAssisted          SEQUENCE {}
    },
    ue-positioning-IPDL-Parameters UE-Positioning-IPDL-Parameters OPTIONAL
}

UE-Positioning-OTDOA-ReferenceCellInfo-r4 ::= SEQUENCE {
    sfn                    INTEGER (0..4095)
    OPTIONAL,
    modeSpecificInfo CHOICE {
        fdd                SEQUENCE {
            primaryCPICH-Info PrimaryCPICH-Info
        },
        tdd                SEQUENCE {
            cellAndChannelIdentity CellAndChannelIdentity
        }
    },
    frequencyInfo          FrequencyInfo          OPTIONAL,
    positioningMode CHOICE {

```

```

        ueBased
            cellPosition
                -- actual value roundTripTime = (IE value * 0.0625) + 876
                roundTripTime
            },
        ueAssisted
    },
    ue-positioning-IPDL-Parameters
}

UE-Positioning-OTDOA-ReferenceCellInfo-UEB ::= SEQUENCE {
    sfn
        INTEGER (0..4095)
    modeSpecificInfo CHOICE {
        fdd
            primaryCPICH-Info
        },
        tdd
            cellAndChannelIdentity
    },
    frequencyInfo
        FrequencyInfo
    cellPosition
        ReferenceCellPosition
    -- actual value roundTripTime = (IE value * 0.0625) + 876
    roundTripTime
        INTEGER (0..32766)
    ue-positioning-IPDL-Parameters
        UE-Positioning-IPDL-Parameters
}

UE-Positioning-OTDOA-ReferenceCellInfo-UEB-ext ::= SEQUENCE {
    -- actual value roundTripTimeExtension = (IE value * 0.0625)
    roundTripTimeExtension
        INTEGER (0..70274)
}

UE-Positioning-OTDOA-ReferenceCellInfo-r7 ::= SEQUENCE {
    sfn
        INTEGER (0..4095)
    modeSpecificInfo
        CHOICE {
            fdd
                SEQUENCE {
                    primaryCPICH-Info
                },
            tdd
                SEQUENCE{
                    cellAndChannelIdentity
                }
        },
    frequencyInfo
        FrequencyInfo
    positioningMode
        CHOICE {
            ueBased
                SEQUENCE {
                    cellPosition
                        ReferenceCellPosition
                    -- actual value roundTripTime = (IE value * 0.0625) + 876
                    roundTripTime
                        INTEGER (0..32766)
                    -- actual value roundTripTimeExtension = (IE value * 0.0625)
                    roundTripTimeExtension
                        INTEGER (0..70274)
                },
            ueAssisted
                SEQUENCE {}
        },
    ue-positioning-IPDL-Parameters
        UE-Positioning-IPDL-Parameters
}

UE-Positioning-PositionEstimateInfo ::= SEQUENCE {
    referenceTime
        CHOICE {
            utran-GPSReferenceTimeResult
                UTRAN-GPSReferenceTimeResult,
            gps-ReferenceTimeOnly
                GPS-TOW-1msec,
            cell-Timing
                SEQUENCE {
                    sfn
                        INTEGER (0..4095),
                    modeSpecificInfo
                        CHOICE {
                            fdd
                                SEQUENCE {
                                    primaryCPICH-Info
                                },
                            tdd
                                SEQUENCE{
                                    cellAndChannelIdentity
                                }
                        }
                }
        },
    positionEstimate
        PositionEstimate
}

UE-Positioning-PositionEstimateInfo-v770ext ::= SEQUENCE {
    referenceTimeOptions
        CHOICE {
            -- If 'earlier-than-r7', IE 'UE-Positioning-PositionEstimateInfo' shall be included.

```

```

earlier-than-r7                NULL,
-- If 'r7', the corresponding IE 'UE-Positioning-PositionEstimateInfo' shall be excluded.
r7                               SEQUENCE {
    referenceTime                 CHOICE {
        utran-GANSSReferenceTimeResult    UTRAN-GANSSReferenceTime,
        ganssReferenceTimeOnly           GANSSReferenceTimeOnly
    },
    positionEstimate              PositionEstimate
},
positionData                     BIT STRING (SIZE (16)),
velocityEstimate                 VelocityEstimate                                OPTIONAL,
ue-Positioning-GPS-ReferenceTimeUncertainty    UE-Positioning-GPS-ReferenceTimeUncertainty OPTIONAL
}

UE-Positioning-ReportCriteria ::= CHOICE {
    ue-positioning-ReportingCriteria    UE-Positioning-EventParamList,
    periodicalReportingCriteria        PeriodicalReportingCriteria,
    noReporting                         NULL
}

UE-Positioning-ReportCriteria-r7 ::= CHOICE {
    ue-positioning-ReportingCriteria    UE-Positioning-EventParamList-r7,
    periodicalReportingCriteria        PeriodicalReportingCriteria,
    noReporting                         NULL
}

UE-Positioning-ReportingQuantity ::= SEQUENCE {
    methodType                     UE-Positioning-MethodType,
    positioningMethod              PositioningMethod,
    -- dummy1 is not used in this version of specification and it should
    -- be ignored.
    dummy1                         UE-Positioning-ResponseTime,
    horizontal-Accuracy             UE-Positioning-Accuracy                                OPTIONAL,
    gps-TimingOfCellWanted          BOOLEAN,
    -- dummy2 is not used in this version of specification and it should
    -- be ignored.
    dummy2                         BOOLEAN,
    additionalAssistanceDataRequest  BOOLEAN,
    environmentCharacterisation      EnvironmentCharacterisation                                OPTIONAL
}

UE-Positioning-ReportingQuantity-v390ext ::= SEQUENCE {
    vertical-Accuracy               UE-Positioning-Accuracy
}

UE-Positioning-ReportingQuantity-r4 ::= SEQUENCE {
    methodType                     UE-Positioning-MethodType,
    positioningMethod              PositioningMethod,
    horizontalAccuracy              UE-Positioning-Accuracy                                OPTIONAL,
    verticalAccuracy                UE-Positioning-Accuracy                                OPTIONAL,
    gps-TimingOfCellWanted          BOOLEAN,
    additionalAssistanceDataReq     BOOLEAN,
    environmentCharacterisation      EnvironmentCharacterisation                                OPTIONAL
}

UE-Positioning-ReportingQuantity-r7 ::= SEQUENCE {
    methodType                     UE-Positioning-MethodType,
    positioningMethod              PositioningMethod,
    horizontalAccuracy              UE-Positioning-Accuracy                                OPTIONAL,
    verticalAccuracy                UE-Positioning-Accuracy                                OPTIONAL,
    gps-TimingOfCellWanted          BOOLEAN,
    additionalAssistanceDataReq     BOOLEAN,
    environmentCharacterisation      EnvironmentCharacterisation                                OPTIONAL,
    velocityRequested               ENUMERATED { true }                                OPTIONAL,
    gANSSPositioningMethods        BIT STRING (SIZE (16))                                OPTIONAL,
    gANSSTimingOfCellWanted        BIT STRING (SIZE (8))                                OPTIONAL,
    gANSSCarrierPhaseMeasurementRequested    BIT STRING (SIZE (8))                                OPTIONAL
}

UE-Positioning-ResponseTime ::= ENUMERATED {
    s1, s2, s4, s8, s16,
    s32, s64, s128 }

-- SPARE: UTRA-CarrierRSSI, Max = 76
-- Values above Max are spare

```

```

UTRA-CarrierRSSI ::=
    INTEGER (0..127)

UTRAN-GANSSReferenceTime ::=
    SEQUENCE {
        ue-GANSSTimingOfCellFrames
            SEQUENCE {
                -- Actual value [ns] = (ms-Part * 4294967296 + ls-Part) * 250
                -- Actual values [ns] > 8639999999750 are reserved and are considered a protocol error
                ms-Part
                    INTEGER (0..80),
                ls-Part
                    INTEGER (0..4294967295)
            },
        gANSS-TimeId
            INTEGER (0..7)
            OPTIONAL,
        gANSS-TimeUncertainty
            INTEGER (0..127)
            OPTIONAL,
        mode
            CHOICE {
                fdd
                    SEQUENCE {
                        primary-CPICH-Info
                            PrimaryCPICH-Info
                    },
                tdd
                    SEQUENCE {
                        cellParameters
                            CellParametersID
                    }
            },
        referenceSfn
            INTEGER (0..4095)
    }

UTRAN-GPS-DriftRate ::=
    ENUMERATED {
        utran-GPSDrift0, utran-GPSDrift1, utran-GPSDrift2,
        utran-GPSDrift5, utran-GPSDrift10, utran-GPSDrift15,
        utran-GPSDrift25, utran-GPSDrift50, utran-GPSDrift-1,
        utran-GPSDrift-2, utran-GPSDrift-5, utran-GPSDrift-10,
        utran-GPSDrift-15, utran-GPSDrift-25, utran-GPSDrift-50}

UTRAN-GPSReferenceTime ::=
    SEQUENCE {
        -- For utran-GPSTimingOfCell values above 2322431999999 are not
        -- used in this version of the specification
        -- Actual value utran-GPSTimingOfCell = (ms-part * 4294967296) + ls-part
        utran-GPSTimingOfCell
            SEQUENCE {
                ms-part
                    INTEGER (0..1023),
                ls-part
                    INTEGER (0..4294967295)
            },
        modeSpecificInfo
            CHOICE {
                fdd
                    SEQUENCE {
                        referenceIdentity
                            PrimaryCPICH-Info
                    },
                tdd
                    SEQUENCE {
                        referenceIdentity
                            CellParametersID
                    }
            }
            OPTIONAL,
        sfn
            INTEGER (0..4095)
    }

UTRAN-GPSReferenceTimeResult ::=
    SEQUENCE {
        -- For ue-GPSTimingOfCell values above 37158911999999 are not
        -- used in this version of the specification
        -- Actual value ue-GPSTimingOfCell = (ms-part * 4294967296) + ls-part
        ue-GPSTimingOfCell
            SEQUENCE {
                ms-part
                    INTEGER (0.. 16383),
                ls-part
                    INTEGER (0..4294967295)
            },
        modeSpecificInfo
            CHOICE {
                fdd
                    SEQUENCE {
                        referenceIdentity
                            PrimaryCPICH-Info
                    },
                tdd
                    SEQUENCE {
                        referenceIdentity
                            CellParametersID
                    }
            },
        sfn
            INTEGER (0..4095)
    }

VarianceOfRLC-BufferPayload ::=
    ENUMERATED {
        plv0, plv4, plv8, plv16, plv32, plv64,
        plv128, plv256, plv512, plv1024,
        plv2k, plv4k, plv8k, plv16k, spare2, spare1 }

VelocityEstimate ::=
    CHOICE {
        horizontalVelocity
            HorizontalVelocity,
        horizontalWithVerticalVelocity
            HorizontalWithVerticalVelocity,
        horizontalVelocityWithUncertainty
            HorizontalVelocityWithUncertainty,
        horizontalWithVerticalVelocityAndUncertainty
            HorizontalWithVerticalVelocityAndUncertainty
    }

```

```

-- Actual value W = IE value * 0.1
W ::= INTEGER (0..20)

-- *****
--
-- OTHER INFORMATION ELEMENTS (10.3.8)
-- *****

BCC ::= INTEGER (0..7)

BCCH-ModificationInfo ::= SEQUENCE {
    mib-ValueTag MIB-ValueTag,
    bcch-ModificationTime BCCH-ModificationTime OPTIONAL
}

-- Actual value BCCH-ModificationTime = IE value * 8
BCCH-ModificationTime ::= INTEGER (0..511)

BSIC ::= SEQUENCE {
    ncc NCC,
    bcc BCC
}

CBS-DRX-Level1Information ::= SEQUENCE {
    ctch-AllocationPeriod INTEGER (1..256),
    cbs-FrameOffset INTEGER (0..255)
}

CBS-DRX-Level1Information-extension-r6 ::= ENUMERATED {p8, p16, p32, p64, p128, p256}

CDMA2000-Message ::= SEQUENCE {
    msg-Type BIT STRING (SIZE (8)),
    payload BIT STRING (SIZE (1..512))
}

CDMA2000-MessageList ::= SEQUENCE (SIZE (1..maxInterSysMessages)) OF
    CDMA2000-Message

CDMA2000-UMTS-Frequency-List ::= SEQUENCE (SIZE (1..maxNumCDMA2000Freqs)) OF
    FrequencyInfoCDMA2000

CellValueTag ::= INTEGER (1..4)

DeferredMeasurementControlReadingSupport ::= SEQUENCE {
    -- If modeSpecificInfo is not present, deferred SIB11, SIB11bis and SIB12 reading
    -- with default measurement quantities applies
    modeSpecificInfo CHOICE {
        fdd SEQUENCE {
            intraFreqMeasQuantity-FDD IntraFreqMeasQuantity-FDD-sib3
        },
        tdd SEQUENCE {
            intraFreqMeasQuantity-TDDList IntraFreqMeasQuantity-TDD-sib3List
        }
    } OPTIONAL
}

--Actual value = 2^(IE value)
ExpirationTimeFactor ::= INTEGER (1..8)

-- For each extended SIB type the value tag information is added at the end
ExtSIBTypeInfoSchedulingInfo-List ::= SEQUENCE (SIZE (1..maxSIB)) OF
    ExtSIBTypeInfoSchedulingInfo

ExtSIBTypeInfoSchedulingInfo ::= SEQUENCE {
    extensionSIB-Type SIB-TypeExt,
    schedulingInfo SchedulingInformation,
    valueTagInfo ValueTagInfo
}

FDD-UMTS-Frequency-List ::= SEQUENCE (SIZE (1..maxNumFDDFreqs)) OF
    -- NOTE1: The IE "UARFCN (Nlow)" corresponds to
    -- "uarfcn-DL" in FrequencyInfoFDD.
    -- NOTE2: The IE "UARFCN (Nupper)" corresponds to
    -- "uarfcn-UL" in FrequencyInfoFDD.
    FrequencyInfoFDD

```



```

FrequencyInfoCDMA2000 ::=
    SEQUENCE {
        band-Class          BIT STRING (SIZE (5)),
        cdma-Freq           BIT STRING (SIZE(11))
    }

GERAN-SystemInfoBlock ::=
    OCTET STRING (SIZE (1..23))

GERAN-SystemInformation ::=
    SEQUENCE (SIZE (1..maxGERAN-SI)) OF GERAN-SystemInfoBlock

GSM-BA-Range ::=
    SEQUENCE {
        gsmLowRangeUARFCN    UARFCN,
        gsmUpRangeUARFCN    UARFCN
    }

GSM-BA-Range-List ::=
    SEQUENCE (SIZE (1..maxNumGSMFreqRanges)) OF
        GSM-BA-Range

-- This IE is formatted as 'TLV' and is coded in the same way as the Mobile Station Classmark 2
-- information element in [5]. The first octet is the Mobile station classmark 2 IEI and its value
-- shall be set to 33H. The second octet is the Length of mobile station classmark 2 and its value
-- shall be set to 3. The octet 3 contains the first octet of the value part of the Mobile Station
-- Classmark 2 information element, the octet 4 contains the second octet of the value part of the
-- Mobile Station Classmark 2 information element and so on. For each of these octets, the first/
-- leftmost/ most significant bit of the octet contains b8 of the corresponding octet of the Mobile
-- Station Classmark 2.
GSM-Classmark2 ::=
    OCTET STRING (SIZE (5))

-- This IE is formatted as 'V' and is coded in the same way as the value part in the Mobile station
-- classmark 3 information element in [5]
-- The value part is specified by means of CSN.1, which encoding results in a bit string, to which
-- final padding may be appended upto the next octet boundary [5]. The first/ leftmost bit of the
-- CSN.1 bit string is placed in the first/ leftmost/ most significant bit of the first
-- octet. This continues until the last bit of the CSN.1 bit string, which is placed in the last/
-- rightmost/ least significant bit of the last octet.
GSM-Classmark3 ::=
    OCTET STRING (SIZE (1..32))

GSM-MessageList ::=
    SEQUENCE (SIZE (1..maxInterSysMessages)) OF
        BIT STRING (SIZE (1..512))

GSM-MS-RadioAccessCapability ::=
    OCTET STRING (SIZE (1..64))

GsmSecurityCapability ::=
    BIT STRING {
        -- For each bit value "0" means false/ not supported
        a5-7(0),
        a5-6(1),
        a5-5(2),
        a5-4(3),
        a5-3(4),
        a5-2(5),
        a5-1(6)
    } (SIZE (7))

GSM-TargetCellInfoList ::=
    SEQUENCE (SIZE (1..maxGSMTargetCells)) OF
        GSM-TargetCellInfo

GSM-TargetCellInfo ::=
    SEQUENCE {
        bcch-ARFCN          BCCH-ARFCN,
        frequency-band      Frequency-Band,
        bsic                 BSIC          OPTIONAL
    }

IdentificationOfReceivedMessage ::= SEQUENCE {
    rrc-TransactionIdentifier    RRC-TransactionIdentifier,
    receivedMessageType          ReceivedMessageType
}

InterRAT-ChangeFailureCause ::=
    CHOICE {
        configurationUnacceptable    NULL,
        physicalChannelFailure      NULL,
        protocolError                ProtocolErrorInformation,
        unspecified                  NULL,
        spare4                       NULL,
        spare3                       NULL,
        spare2                       NULL,
        spare1                       NULL
    }

```

```

GERANIu-MessageList ::= SEQUENCE (SIZE (1..maxInterSysMessages)) OF
                        BIT STRING (SIZE (1..32768))

GERANIu-RadioAccessCapability ::= BIT STRING (SIZE (1..170))

InterRAT-UE-RadioAccessCapability ::= CHOICE {
    gsm SEQUENCE {
        gsm-Classmark2 GSM-Classmark2,
        gsm-Classmark3 GSM-Classmark3
    },
    cdma2000 SEQUENCE {
        cdma2000-MessageList CDMA2000-MessageList
    }
}

InterRAT-UE-RadioAccessCapabilityList ::= SEQUENCE (SIZE(1..maxInterSysMessages)) OF
InterRAT-UE-RadioAccessCapability

InterRAT-UE-RadioAccessCapability-v590ext ::= SEQUENCE {
    geraniu-RadioAccessCapability GERANIu-RadioAccessCapability
}

InterRAT-UE-RadioAccessCapability-v690ext ::= SEQUENCE {
    supportOfInter-RAT-PS-Handover ENUMERATED { doesSupporInter-RAT-PS-Handover } OPTIONAL,
    gsm-MS-RadioAccessCapability GSM-MS-RadioAccessCapability
}

InterRAT-UE-SecurityCapability ::= CHOICE {
    gsm SEQUENCE {
        gsmSecurityCapability GsmSecurityCapability
    }
}

InterRAT-UE-SecurityCapList ::= SEQUENCE (SIZE(1..maxInterSysMessages)) OF
InterRAT-UE-SecurityCapability

InterRAT-HO-FailureCause ::= CHOICE {
    configurationUnacceptable NULL,
    physicalChannelFailure NULL,
    protocolError ProtocolErrorInformation,
    interRAT-ProtocolError NULL,
    unspecified NULL,
    spare11 NULL,
    spare10 NULL,
    spare9 NULL,
    spare8 NULL,
    spare7 NULL,
    spare6 NULL,
    spare5 NULL,
    spare4 NULL,
    spare3 NULL,
    spare2 NULL,
    spare1 NULL
}

MasterInformationBlock ::= SEQUENCE {
    mib-ValueTag MIB-ValueTag,
    -- TABULAR: The PLMN identity and ANSI-41 core network information
    -- are included in PLMN-Type.
    plmn-Type PLMN-Type,
    sibSb-ReferenceList SIBSb-ReferenceList,
    -- Extension mechanism for non- release99 information
    v690NonCriticalExtensions SEQUENCE {
        masterInformationBlock-v690ext MasterInformationBlock-v690ext,
        v6b0NonCriticalExtensions SEQUENCE {
            masterInformationBlock-v6b0ext MasterInformationBlock-v6b0ext-IEs,
            nonCriticalExtensions SEQUENCE {} OPTIONAL
        } OPTIONAL
    } OPTIONAL
}

MasterInformationBlock-v690ext ::= SEQUENCE {
    multiplePLMN-List MultiplePLMN-List-r6 OPTIONAL
}

MasterInformationBlock-v6b0ext-IEs ::= SEQUENCE {
    extSIBTypeInfoSchedulingInfo-List ExtSIBTypeInfoSchedulingInfo-List OPTIONAL
}

```

```

}
MIB-ValueTag ::= INTEGER (1..8)
NCC ::= INTEGER (0..7)
PLMN-ValueTag ::= INTEGER (1..256)

PredefinedConfigIdentityAndValueTag ::= SEQUENCE {
    predefinedConfigIdentity      PredefinedConfigIdentity,
    predefinedConfigValueTag      PredefinedConfigValueTag
}

ProtocolErrorInformation ::= SEQUENCE {
    diagnosticsType               CHOICE {
        type1                     SEQUENCE {
            protocolErrorCause     ProtocolErrorCause
        },
        spare                      NULL
    }
}

ReceivedMessageType ::= ENUMERATED {
    activeSetUpUpdate,
    cellChangeOrderFromUTRAN,
    cellUpdateConfirm,
    counterCheck,
    downlinkDirectTransfer,
    interRATHandoverCommand,
    measurementControl,
    pagingType2,
    physicalChannelReconfiguration,
    physicalSharedChannelAllocation,
    radioBearerReconfiguration,
    radioBearerRelease,
    radioBearerSetup,
    rrcConnectionRelease,
    rrcConnectionReject,
    rrcConnectionSetup,
    securityModeCommand,
    signallingConnectionRelease,
    transportChannelReconfiguration,
    transportFormatCombinationControl,
    ueCapabilityEnquiry,
    ueCapabilityInformationConfirm,
    uplinkPhysicalChannelControl,
    uraUpdateConfirm,
    utranMobilityInformation,
    assistanceDataDelivery,
    spare6, spare5, spare4, spare3, spare2,
    spare1
}

Rplmn-Information ::= SEQUENCE {
    gsm-BA-Range-List             GSM-BA-Range-List             OPTIONAL,
    fdd-UMTS-Frequency-List       FDD-UMTS-Frequency-List       OPTIONAL,
    tdd-UMTS-Frequency-List       TDD-UMTS-Frequency-List       OPTIONAL,
    cdma2000-UMTS-Frequency-List  CDMA2000-UMTS-Frequency-List  OPTIONAL
}

Rplmn-Information-r4 ::= SEQUENCE {
    gsm-BA-Range-List             GSM-BA-Range-List             OPTIONAL,
    fdd-UMTS-Frequency-List       FDD-UMTS-Frequency-List       OPTIONAL,
    -- the option is the same for 7.68 Mcps TDD as for 3.84 Mcps TDD
    -- i.e. TDD-UMTS-Frequency-List applies
    tdd384-UMTS-Frequency-List    TDD-UMTS-Frequency-List       OPTIONAL,
    tdd128-UMTS-Frequency-List    TDD-UMTS-Frequency-List       OPTIONAL,
    cdma2000-UMTS-Frequency-List  CDMA2000-UMTS-Frequency-List  OPTIONAL
}

SchedulingInformation ::= SEQUENCE {
    scheduling                     SEQUENCE {
        segCount                   SegCount                       DEFAULT 1,
        sib-Pos                     CHOICE {
            -- The element name indicates the repetition period and the value
            -- (multiplied by two) indicates the position of the first segment.
            rep4                     INTEGER (0..1),
        }
    }
}

```

```

        rep8                INTEGER (0..3),
        rep16               INTEGER (0..7),
        rep32               INTEGER (0..15),
        rep64               INTEGER (0..31),
        rep128              INTEGER (0..63),
        rep256              INTEGER (0..127),
        rep512              INTEGER (0..255),
        rep1024             INTEGER (0..511),
        rep2048             INTEGER (0..1023),
        rep4096             INTEGER (0..2047)
    },
    sib-PosOffsetInfo      SibOFF-List                OPTIONAL
}
}

SchedulingInformationSIB ::= SEQUENCE {
    sib-Type                SIB-TypeAndTag,
    scheduling              SchedulingInformation
}

SchedulingInformationSIBSb ::= SEQUENCE {
    sibSb-Type              SIBSb-TypeAndTag,
    scheduling              SchedulingInformation
}

SegCount ::= INTEGER (1..16)

SegmentIndex ::= INTEGER (1..15)

-- Actual value SFN-Prime = 2 * IE value
SFN-Prime ::= INTEGER (0..2047)

SIB-Data-fixed ::= BIT STRING (SIZE (222))

SIB-Data-variable ::= BIT STRING (SIZE (1..214))

SIBOccurIdentity ::= INTEGER (0..15)

SIBOccurrenceIdentityAndValueTag ::= SEQUENCE {
    sibOccurIdentity        SIBOccurIdentity,
    sibOccurValueTag        SIBOccurValueTag
}

SIBOccurValueTag ::= INTEGER (0..15)

SIB-ReferenceList ::= SEQUENCE (SIZE (1..maxSIB)) OF
    SchedulingInformationSIB

SIBSb-ReferenceList ::= SEQUENCE (SIZE (1..maxSIB)) OF
    SchedulingInformationSIBSb

SIB-ReferenceListFACH ::= SEQUENCE (SIZE (1..maxSIB-FACH)) OF
    SchedulingInformationSIB

SIB-Type ::= ENUMERATED {
    masterInformationBlock,
    systemInformationBlockType1,
    systemInformationBlockType2,
    systemInformationBlockType3,
    systemInformationBlockType4,
    systemInformationBlockType5,
    systemInformationBlockType6,
    systemInformationBlockType7,
    -- dummy, dummy2 and dummy3 are not used in this version of the specification,
    -- they should not be sent. If they are received they should be ignored
    dummy,
    dummy2,
    dummy3,
    systemInformationBlockType11,
    systemInformationBlockType12,
    systemInformationBlockType13,
    systemInformationBlockType13-1,
    systemInformationBlockType13-2,
    systemInformationBlockType13-3,
    systemInformationBlockType13-4,
    systemInformationBlockType14,

```

```

systemInformationBlockType15,
systemInformationBlockType15-1,
systemInformationBlockType15-2,
systemInformationBlockType15-3,
systemInformationBlockType16,
systemInformationBlockType17,
systemInformationBlockType15-4,
systemInformationBlockType18,
schedulingBlock1,
schedulingBlock2,
systemInformationBlockType15-5,
systemInformationBlockType5bis,
extensionType }

SIB-TypeAndTag ::=
  sysInfoType1
  sysInfoType2
  sysInfoType3
  sysInfoType4
  sysInfoType5
  sysInfoType6
  sysInfoType7
  -- dummy, dummy2 and dummy3 are not used in this version of the specification,
  -- they should not be sent. If they are received the UE behaviour is not specified.
  dummy
  dummy2
  dummy3
  sysInfoType11
  sysInfoType12
  sysInfoType13
  sysInfoType13-1
  sysInfoType13-2
  sysInfoType13-3
  sysInfoType13-4
  sysInfoType14
  sysInfoType15
  sysInfoType16
  sysInfoType17
  sysInfoType15-1
  sysInfoType15-2
  sysInfoType15-3
  sysInfoType15-4
  sysInfoType18
  sysInfoType15-5
  sysInfoType5bis
  spare4
  spare3
  spare2
  spare1
}

CHOICE {
  PLMN-ValueTag,
  CellValueTag,
  CellValueTag,
  CellValueTag,
  CellValueTag,
  NULL,
  CellValueTag,
  CellValueTag,
  CellValueTag,
  CellValueTag,
  CellValueTag,
  NULL,
  CellValueTag,
  PredefinedConfigIdentityAndValueTag,
  NULL,
  CellValueTag,
  SIBOccurrenceIdentityAndValueTag,
  SIBOccurrenceIdentityAndValueTag,
  CellValueTag,
  CellValueTag,
  CellValueTag,
  CellValueTag,
  NULL,
  NULL,
  NULL,
  NULL
}

SIBSb-TypeAndTag ::=
  sysInfoType1
  sysInfoType2
  sysInfoType3
  sysInfoType4
  sysInfoType5
  sysInfoType6
  sysInfoType7
  -- dummy, dummy2 and dummy3 are not used in this version of the specification,
  -- they should not be sent. If they are received the UE behaviour is not specified.
  dummy
  dummy2
  dummy3
  sysInfoType11
  sysInfoType12
  sysInfoType13
  sysInfoType13-1
  sysInfoType13-2
  sysInfoType13-3
  sysInfoType13-4
  sysInfoType14
  sysInfoType15
  sysInfoType16
  sysInfoType17
  sysInfoTypeSB1
  sysInfoTypeSB2
  sysInfoType15-1
}

CHOICE {
  PLMN-ValueTag,
  CellValueTag,
  CellValueTag,
  CellValueTag,
  CellValueTag,
  CellValueTag,
  NULL,
  CellValueTag,
  CellValueTag,
  CellValueTag,
  CellValueTag,
  CellValueTag,
  NULL,
  CellValueTag,
  PredefinedConfigIdentityAndValueTag,
  NULL,
  CellValueTag,
  CellValueTag,
  CellValueTag,
  CellValueTag,
  NULL,
  NULL,
  NULL,
  NULL
}

```

```

sysInfoType15-2           SIBOccurrenceIdentityAndValueTag,
sysInfoType15-3           SIBOccurrenceIdentityAndValueTag,
sysInfoType15-4           CellValueTag,
sysInfoType15-4           CellValueTag,
sysInfoType15-5           CellValueTag,
sysInfoType15-5bis        CellValueTag,
spare2                     NULL,
spare1                     NULL
}

SIB-TypeExt ::= CHOICE {
  systemInfoType11bis      NULL,
  systemInfoType15bis      NULL,
  systemInfoType15-1bis    NULL,
  systemInfoType15-2bis    NULL,
  systemInfoType15-3bis    NULL,
  systemInfoType15-6       NULL,
  systemInfoType15-7       NULL,
  systemInfoType15-8       NULL
}

SibOFF ::= ENUMERATED {
  so2, so4, so6, so8, so10,
  so12, so14, so16, so18,
  so20, so22, so24, so26,
  so28, so30, so32 }

SibOFF-List ::= SEQUENCE (SIZE (1..15)) OF
  SibOFF

SysInfoType1 ::= SEQUENCE {
  -- Core network IEs
  cn-CommonGSM-MAP-NAS-SysInfo  NAS-SystemInformationGSM-MAP,
  cn-DomainSysInfoList          CN-DomainSysInfoList,
  -- User equipment IEs
  ue-ConnTimersAndConstants      UE-ConnTimersAndConstants          OPTIONAL,
  ue-IdleTimersAndConstants      UE-IdleTimersAndConstants          OPTIONAL,
  -- Extension mechanism for non-release99 information
  v3a0NonCriticalExtensions      SEQUENCE {
    sysInfoType1-v3a0ext         SysInfoType1-v3a0ext-IEs,
    nonCriticalExtensions        SEQUENCE {} OPTIONAL
  }
}

SysInfoType1-v3a0ext-IEs ::= SEQUENCE {
  ue-ConnTimersAndConstants-v3a0ext  UE-ConnTimersAndConstants-v3a0ext,
  ue-IdleTimersAndConstants-v3a0ext  UE-IdleTimersAndConstants-v3a0ext
}

SysInfoType2 ::= SEQUENCE {
  -- UTRAN mobility IEs
  ura-IdentityList              URA-IdentityList,
  -- Extension mechanism for non-release99 information
  nonCriticalExtensions          SEQUENCE {} OPTIONAL
}

SysInfoType3 ::= SEQUENCE {
  sib4indicator                 BOOLEAN,
  -- UTRAN mobility IEs
  cellIdentity                  CellIdentity,
  cellSelectReselectInfo        CellSelectReselectInfoSIB-3-4,
  cellAccessRestriction         CellAccessRestriction,
  -- Extension mechanism for non-release99 information
  v4b0NonCriticalExtensions      SEQUENCE {
    sysInfoType3-v4b0ext         SysInfoType3-v4b0ext-IEs,
    v590NonCriticalExtension      SEQUENCE {
      sysInfoType3-v590ext       SysInfoType3-v590ext,
      v5c0NoncriticalExtension    SEQUENCE {
        sysInfoType3-v5c0ext     SysInfoType3-v5c0ext-IEs,
        v670NonCriticalExtension SEQUENCE {
          sysInfoType3-v670ext    SysInfoType3-v670ext,
          v770NonCriticalExtension SEQUENCE {
            sysInfoType3-v770ext  SysInfoType3-v770ext-IEs,
            nonCriticalExtensions SEQUENCE {} OPTIONAL
          }
        }
      }
    }
  }
}
OPTIONAL
OPTIONAL
OPTIONAL

```

```

    }
    OPTIONAL
}

SysInfoType3-v4b0ext-IEs ::= SEQUENCE {
    mapping-LCR                               Mapping-LCR-r4                               OPTIONAL
}

SysInfoType3-v590ext ::= SEQUENCE {
    cellSelectReselectInfo-v590ext            CellSelectReselectInfo-v590ext            OPTIONAL
}

SysInfoType3-v5c0ext-IEs ::= SEQUENCE {
    cellSelectReselectInfoTreselectionScaling-v5c0ext
                                                CellSelectReselectInfoTreselectionScaling-v5c0ext  OPTIONAL
}

SysInfoType3-v670ext ::= SEQUENCE {
    domainSpecificAccessRestrictionParametersForPLMNOfMIB
                                                DomainSpecificAccessRestrictionParam-v670ext    OPTIONAL,
    domainSpecificAccessRestrictionForSharedNetwork
                                                DomainSpecificAccessRestrictionForSharedNetwork-v670ext  OPTIONAL
}

SysInfoType3-v770ext-IEs ::= SEQUENCE {
    deferredMeasurementControlReadingSupport
                                                DeferredMeasurementControlReadingSupport    OPTIONAL,
    q-QualMin-Offset                           Q-QualMin-Offset                           OPTIONAL,
    q-RxlevMin-Offset                          Q-RxlevMin-Offset                          OPTIONAL,
    mbsfnOnlyService                           MBSFNOnlyService                           OPTIONAL
}

SysInfoType4 ::= SEQUENCE {
    -- UTRAN mobility IEs
    cellIdentity                               CellIdentity,
    cellSelectReselectInfo                     CellSelectReselectInfoSIB-3-4,
    cellAccessRestriction                     CellAccessRestriction,
    -- Extension mechanism for non- release99 information
    v4b0NonCriticalExtensions                  SEQUENCE {
        sysInfoType4-v4b0ext                  SysInfoType4-v4b0ext-IEs,
        v590NonCriticalExtension              SEQUENCE {
            sysInfoType4-v590ext              SysInfoType4-v590ext,
            v5b0NonCriticalExtension          SEQUENCE {
                sysInfoType4-v5b0ext          SysInfoType4-v5b0ext-IEs,
                v5c0NonCriticalExtension      SEQUENCE {
                    sysInfoType4-v5c0ext      SysInfoType4-v5c0ext-IEs,
                    nonCriticalExtensions     SEQUENCE {}
                }
            }
        }
    }
    OPTIONAL
}
OPTIONAL
}
OPTIONAL
}

SysInfoType4-v4b0ext-IEs ::= SEQUENCE {
    mapping-LCR                               Mapping-LCR-r4                               OPTIONAL
}

SysInfoType4-v590ext ::= SEQUENCE {
    cellSelectReselectInfo-v590ext            CellSelectReselectInfo-v590ext            OPTIONAL
}

SysInfoType4-v5b0ext-IEs ::= SEQUENCE {
    cellSelectReselectInfoPCHFACH-v5b0ext     CellSelectReselectInfoPCHFACH-v5b0ext     OPTIONAL
}

SysInfoType4-v5c0ext-IEs ::= SEQUENCE {
    cellSelectReselectInfoTreselectionScaling-v5c0ext
                                                CellSelectReselectInfoTreselectionScaling-v5c0ext  OPTIONAL
}

SysInfoType5 ::= SEQUENCE {
    sib6indicator                              BOOLEAN,
    -- Physical channel IEs
    pich-PowerOffset                           PICH-PowerOffset,
    modeSpecificInfo                           CHOICE {
        fdd                                     SEQUENCE {
            aich-PowerOffset                   AICH-PowerOffset
        },

```

```

    tdd
        SEQUENCE {
-- If PDSCH/PUSCH is configured for 1.28Mcps or 7.68Mcps TDD, the following IEs should be absent
-- and the info included in the respective tdd128SpecificInfo or tdd768SpecificInfo instead.
-- If PDSCH/PUSCH is configured for 3.84Mcps TDD in R5, HCR-r5-SpecificInfo should also be
-- included.
            pusch-SysInfoList-SFN          PUSCH-SysInfoList-SFN          OPTIONAL,
            pdsch-SysInfoList-SFN         PDSCH-SysInfoList-SFN         OPTIONAL,
            openLoopPowerControl-TDD      OpenLoopPowerControl-TDD
        }
    },
    primaryCCPCH-Info                    PrimaryCCPCH-Info              OPTIONAL,
    prach-SystemInformationList           PRACH-SystemInformationList,
    sCCPCH-SystemInformationList          SCCPCH-SystemInformationList,
-- cbs-DRX-Level1Information is conditional on any of the CTCH indicator IEs in
-- sCCPCH-SystemInformationList
    cbs-DRX-Level1Information             CBS-DRX-Level1Information     OPTIONAL,
-- Extension mechanism for non- release99 information
    v4b0NonCriticalExtensions             SEQUENCE {
        sysInfoType5-v4b0ext             SysInfoType5-v4b0ext-IEs     OPTIONAL,
-- Extension mechanism for non- rel-4 information
    v590NonCriticalExtensions             SEQUENCE {
        sysInfoType5-v590ext             SysInfoType5-v590ext-IEs     OPTIONAL,
        v650NonCriticalExtensions         SEQUENCE {
            sysInfoType5-v650ext         SysInfoType5-v650ext-IEs     OPTIONAL,
            v680NonCriticalExtensions     SEQUENCE {
                sysInfoType5-v680ext     SysInfoType5-v680ext-IEs     OPTIONAL,
                v690NonCriticalExtensions SEQUENCE {
                    sysInfoType5-v690ext SysInfoType5-v690ext-IEs,
                    v770NonCriticalExtensions SEQUENCE {
                        sysInfoType5-v770ext SysInfoType5-v770ext-IEs,
                        nonCriticalExtensions SEQUENCE {} OPTIONAL
                    }
                } OPTIONAL
            }
        } OPTIONAL
    }
} OPTIONAL
} OPTIONAL
}
}
}

SysInfoType5-v4b0ext-IEs ::= SEQUENCE {
--The following IE PNBSCH-Allocation-r4 shall be used for 3.84Mcps TDD only.
    pNBSCH-Allocation-r4                PNBSCH-Allocation-r4          OPTIONAL,
-- In case of TDD, the following IE is included instead of the
-- IE up-IPDL-Parameter in up-OTDOA-AssistanceData.
    openLoopPowerControl-IPDL-TDD       OpenLoopPowerControl-IPDL-TDD-r4 OPTIONAL,
-- If SysInfoType5 is sent to describe a 1.28Mcps TDD cell, the IE PRACH-RACH-Info included in
-- PRACH-SystemInformationList shall be ignored, the IE PRACH-Partitioning and the
-- IE rach-TransportFormatSet shall be absent and the corresponding IE in the following
-- PRACH-SystemInformationList-LCR-r4 shall be used
    prach-SystemInformationList-LCR-r4   PRACH-SystemInformationList-LCR-r4 OPTIONAL,
    tdd128SpecificInfo                   SEQUENCE {
        pusch-SysInfoList-SFN           PUSCH-SysInfoList-SFN-LCR-r4  OPTIONAL,
        pdsch-SysInfoList-SFN           PDSCH-SysInfoList-SFN-LCR-r4  OPTIONAL,
        pCCPCH-LCR-Extensions            PrimaryCCPCH-Info-LCR-r4-ext   OPTIONAL,
        sCCPCH-LCR-ExtensionsList        SCCPCH-SystemInformationList-LCR-r4-ext
    }
    frequencyBandIndicator                RadioFrequencyBandFDD          OPTIONAL
}

SysInfoType5-v590ext-IEs ::= SEQUENCE {
    hcr-r5-SpecificInfo                   SEQUENCE {
        pusch-SysInfoList-SFN           PUSCH-SysInfoList-SFN-HCR-r5  OPTIONAL,
        pdsch-SysInfoList-SFN           PDSCH-SysInfoList-SFN-HCR-r5  OPTIONAL
    }
}

SysInfoType5-v650ext-IEs ::= SEQUENCE {
    frequencyBandIndicator2                RadioFrequencyBandFDD2
}

SysInfoType5-v680ext-IEs ::= SEQUENCE {
-- TABULAR: HSDPA Cell Indicator is MD in tabular description
-- Default value is 'HSDPA Capability not indicated'
    hsdpa-CellIndicator                    ENUMERATED { hsdpa-CapableCell } OPTIONAL
}

SysInfoType5-v690ext-IEs ::= SEQUENCE {
-- TABULAR: E-DCH Cell Indicator is MD in tabular description

```



```

-- Default value is 'E-DCH Capability not indicated'
edch-CellIndicator          ENUMERATED { edch-CapableCell }      OPTIONAL,
sccpch-SystemInformation-MBMS CHOICE {
    mcchOnSCCPCHusedForNonMBMS      MBMS-MCCH-ConfigurationInfo-r6,
    mcchOnSCCPCHusedOnlyForMBMS     SCCPCH-SystemInformation-MBMS-r6
}
OPTIONAL,
additionalPRACH-TF-and-TFCS-CCCH-List AdditionalPRACH-TF-and-TFCS-CCCH-List OPTIONAL,
cBS-DRX-Level1Information-extension CBS-DRX-Level1Information-extension-r6 OPTIONAL
}

SysInfoType5-v770ext-IEs ::= SEQUENCE {
    modeSpecificInfo CHOICE {
        fdd SEQUENCE {
            hs-dsch-CommonSystemInformation HS-DSCH-CommonSystemInformation,
            hs-dsch-PagingSystemInformation HS-DSCH-PagingSystemInformation OPTIONAL
        },
        tdd768 SEQUENCE {
            pusch-SysInfoList-SFN PUSCH-SysInfoList-SFN-VHCR OPTIONAL,
            pdsch-SysInfoList-SFN PDSCH-SysInfoList-VHCR-r7 OPTIONAL,
            -- If SysInfoType5 is sent to configure a 7.68Mcps TDD cell, the 'prach-RACH-Info' in
            -- IE PRACH-SystemInformationList shall be ignored, 'prach-Partitioning' shall be absent
            -- and the corresponding IE in the following IE PRACH-SystemInformationList-VHCR-r7
            -- shall be used instead.
            prach-SystemInformationList PRACH-SystemInformationList-VHCR-r7 OPTIONAL
        },
        tdd128 SEQUENCE {
            prach-SystemInformationList PRACH-SystemInformationList-LCR-v770ext OPTIONAL
        }
    }
    OPTIONAL,
    -- If SysInfoType5 is sent to configure a 7.68 Mcps TDD cell (in any mode) or a 3.84 Mcps TDD
    -- cell operating in MBSFN mode, IE SCCPCH-SystemInformationList-HCR-VHCR-r7 is used, otherwise
    -- IE SCCPCH-SystemInformationList-r6 is used.
    sccpch-SystemInformationList SCCPCH-SystemInformationList-HCR-VHCR-r7 OPTIONAL,
    sccpch-SystemInformation-MBMS CHOICE {
        -- If choice is 'mcchOnSCCPCHusedForNonMBMS', IE MBMS-MCCH-ConfigurationInfo-r6 is used.
        -- If choice is 'mcchOnSCCPCHusedOnlyForMBMS', IE MBMS-MCCH-ConfigurationInfo-r7 is used
        -- to configure a 7.68Mcps TDD cell or a cell operating in MBSFN mode, otherwise IE
        -- SCCPCH-SystemInformation-MBMS-r6 is used.
        mcchOnSCCPCHusedOnlyForMBMS SCCPCH-SystemInformation-MBMS-r7
    }
    OPTIONAL,
    tDD-MBSFNInformation TDD-MBSFNInformation OPTIONAL
}

-- SysInfoType5bis uses the same structure as SysInfoType5
SysInfoType5bis ::= SysInfoType5

SysInfoType6 ::= SEQUENCE {
    -- Physical channel IEs
    pich-PowerOffset PICH-PowerOffset,
    modeSpecificInfo CHOICE {
        fdd SEQUENCE {
            aich-PowerOffset AICH-PowerOffset,
            -- dummy is not used in this version of specification, it should
            -- not be sent and if received it should be ignored.
            dummy CSICH-PowerOffset OPTIONAL
        },
        tdd SEQUENCE {
            -- If PDSCH/PUSCH is configured for 1.28Mcps TDD, pusch-SysInfoList-SFN,
            -- pdsch-SysInfoList-SFN and openLoopPowerControl-TDD should be absent
            -- and the info included in the tdd128SpecificInfo instead.
            -- If PDSCH/PUSCH is configured for 7.68Mcps TDD, pusch-SysInfoList-SFN
            -- and pdsch-SysInfoList-SFN should be absent and the info included in the
            -- tdd768SpecificInfo instead.
            -- If PDSCH/PUSCH is configured for 3.84Mcps TDD in R5, HCR-r5-SpecificInfo should
            -- also be included.
            pusch-SysInfoList-SFN PUSCH-SysInfoList-SFN OPTIONAL,
            pdsch-SysInfoList-SFN PDSCH-SysInfoList-SFN OPTIONAL,
            openLoopPowerControl-TDD OpenLoopPowerControl-TDD
        }
    },
    primaryCCPCH-Info PrimaryCCPCH-Info OPTIONAL,
    prach-SystemInformationList PRACH-SystemInformationList OPTIONAL,
    sCCPCH-SystemInformationList SCCPCH-SystemInformationList OPTIONAL,
    cbs-DRX-Level1Information CBS-DRX-Level1Information OPTIONAL,
    -- Conditional on any of the CTCH indicator IEs in
    -- sCCPCH-SystemInformationList
    -- Extension mechanism for non- release99 information
}

```

```

v4b0NonCriticalExtensions SEQUENCE {
  sysInfoType6-v4b0ext SysInfoType6-v4b0ext-IEs OPTIONAL,
  -- Extension mechanism for non-rel-4 information
  v590NonCriticalExtensions SEQUENCE {
    sysInfoType6-v590ext SysInfoType6-v590ext-IEs OPTIONAL,
    v650nonCriticalExtensions SEQUENCE {
      sysInfoType6-v650ext SysInfoType6-v650ext-IEs OPTIONAL,
      v690nonCriticalExtensions SEQUENCE {
        sysInfoType6-v690ext SysInfoType6-v690ext-IEs,
        v770NonCriticalExtensions SEQUENCE {
          sysInfoType6-v770ext SysInfoType6-v770ext-IEs,
          nonCriticalExtensions SEQUENCE {} OPTIONAL
        } OPTIONAL
      } OPTIONAL
    } OPTIONAL
  } OPTIONAL
} OPTIONAL
} OPTIONAL
} OPTIONAL
}

SysInfoType6-v4b0ext-IEs ::= SEQUENCE {
  -- openLoopPowerControl-IPDL-TDD is present only if IPDLs are applied for TDD
  openLoopPowerControl-IPDL-TDD OpenLoopPowerControl-IPDL-TDD-r4 OPTIONAL,
  -- If SysInfoType6 is sent to describe a 1.28Mcps TDD cell, the IE PRACH-RACH-Info included
  -- in PRACH-SystemInformationList shall be ignored, the IE PRACH-Partitioning and the
  -- IE rach-TransportFormatSet shall be absent and the corresponding IEs in the following
  -- PRACH-SystemInformationList-LCR-r4 shall be used
  prach-SystemInformationList-LCR-r4 PRACH-SystemInformationList-LCR-r4 OPTIONAL,
  tdd128SpecificInfo SEQUENCE {
    pusch-SysInfoList-SFN PUSCH-SysInfoList-SFN-LCR-r4 OPTIONAL,
    pdsch-SysInfoList-SFN PDSCH-SysInfoList-SFN-LCR-r4 OPTIONAL,
    pCCPCH-LCR-Extensions PrimaryCCPCH-Info-LCR-r4-ext OPTIONAL,
    sCCPCH-LCR-ExtensionsList SCCPCH-SystemInformationList-LCR-r4-ext OPTIONAL
  } OPTIONAL,
  frequencyBandIndicator RadioFrequencyBandFDD OPTIONAL
}

SysInfoType6-v590ext-IEs ::= SEQUENCE {
  hcr-r5-SpecificInfo SEQUENCE {
    pusch-SysInfoList-SFN PUSCH-SysInfoList-SFN-HCR-r5 OPTIONAL,
    pdsch-SysInfoList-SFN PDSCH-SysInfoList-SFN-HCR-r5 OPTIONAL
  } OPTIONAL
}

SysInfoType6-v650ext-IEs ::= SEQUENCE {
  frequencyBandIndicator2 RadioFrequencyBandFDD2
}

SysInfoType6-v690ext-IEs ::= SEQUENCE {
  additionalPRACH-TF-and-TFCS-CCCH-List AdditionalPRACH-TF-and-TFCS-CCCH-List OPTIONAL
}

SysInfoType6-v770ext-IEs ::= SEQUENCE {
  tdd768SpecificInfo SEQUENCE {
    pusch-SysInfoList-SFN PUSCH-SysInfoList-SFN-VHCR OPTIONAL,
    pdsch-SysInfoList-SFN PDSCH-SysInfoList-SFN-VHCR-r7 OPTIONAL,
    -- If SysInfoType6 is sent to configure a 7.68Mcps TDD cell, the 'prach-RACH-Info' in
    -- IE PRACH-SystemInformationList shall be ignored, 'prach-Partitioning' shall be absent
    -- and the corresponding IE in the following IE PRACH-SystemInformationList-VHCR-r7
    -- shall be used instead.
    prach-SystemInformationList PRACH-SystemInformationList-VHCR-r7 OPTIONAL
  } OPTIONAL,
  -- If SysInfoType6 is sent to configure a 7.68 Mcps TDD cell,
  -- IE SCCPCH-SystemInformationList-HCR-VHCR-r7 is used, otherwise
  -- IE SCCPCH-SystemInformationList-r6 is used.
  sccpch-SystemInformationList SCCPCH-SystemInformationList-HCR-VHCR-r7 OPTIONAL
}

SysInfoType7 ::= SEQUENCE {
  -- Physical channel IEs
  modeSpecificInfo CHOICE {
    fdd SEQUENCE {
      ul-Interference UL-Interference
    },
    tdd NULL
  },
  prach-Information-SIB5-List DynamicPersistenceLevelList,
  prach-Information-SIB6-List DynamicPersistenceLevelList OPTIONAL,
  expirationTimeFactor ExpirationTimeFactor OPTIONAL
}

```

```

-- Extension mechanism for non- release99 information
    nonCriticalExtensions          SEQUENCE {}                               OPTIONAL
}

-- This IE is not used in this version of the specification.
-- It was kept only for backwards compatibility reasons
SysInfoType8 ::=                   SEQUENCE {
-- User equipment IEs
-- dummy1, dummy2, dummy3 are not used in this version of the specification and
-- they should be ignored by the receiver.
    dummy1                        CPCH-Parameters,
-- Physical channel IEs
    dummy2                         CPCH-SetInfoList,
    dummy3                         CSICH-PowerOffset,
-- Extension mechanism for non- release99 information
    nonCriticalExtensions          SEQUENCE {}                               OPTIONAL
}

-- This IE is not used in this version of the specification.
-- It was kept only for backwards compatibility reasons
SysInfoType9 ::=                   SEQUENCE {
-- Physical channel IEs
-- dummy is not used in this version of the specification and
-- it should be ignored by the receiver.
    dummy                          CPCH-PersistenceLevelsList,
-- Extension mechanism for non- release99 information
    nonCriticalExtensions          SEQUENCE {}                               OPTIONAL
}

-- This IE is not used in this version of the specification.
-- It was kept only for backwards compatibility reasons
SysInfoType10 ::=                  SEQUENCE {
-- User equipment IEs
-- dummy is not used in this version of the specification, it should
-- not be sent and if received it should be ignored.
    dummy                          DRAC-SysInfoList,
-- Extension mechanism for non- release99 information
    nonCriticalExtensions          SEQUENCE {}                               OPTIONAL
}

SysInfoType11 ::=                  SEQUENCE {
    sib12indicator                 BOOLEAN,
-- Measurement IEs
    fach-MeasurementOccasionInfo  FACH-MeasurementOccasionInfo      OPTIONAL,
    measurementControlSysInfo     MeasurementControlSysInfo,
-- Extension mechanism for non- release99 information
    v4b0NonCriticalExtensions      SEQUENCE {
        sysInfoType11-v4b0ext      SysInfoType11-v4b0ext-IEs      OPTIONAL,
        v590NonCriticalExtension    SEQUENCE {
            sysInfoType11-v590ext  SysInfoType11-v590ext-IEs,
            v690NonCriticalExtensions SEQUENCE {
                sysInfoType11-v690ext SysInfoType11-v690ext-IEs,
                v6b0NonCriticalExtensions SEQUENCE {
                    sysInfoType11-v6b0ext SysInfoType11-v6b0ext-IEs,
                    v770NonCriticalExtensions SEQUENCE {
                        sysInfoType11-v770ext SysInfoType11-v770ext-IEs,
                        v7b0NonCriticalExtensions SEQUENCE {
                            sysInfoType11-v7b0ext SysInfoType11-v7b0ext-IEs,
                            nonCriticalExtensions SEQUENCE {}          OPTIONAL
                        }
                    }
                }
            }
        }
    }
}
}
}
}
}
}
}
}
}
}
}
}
}
}
}
}

SysInfoType11-v4b0ext-IEs ::= SEQUENCE {
    fach-MeasurementOccasionInfo-LCR-Ext FACH-MeasurementOccasionInfo-LCR-r4-ext OPTIONAL,
    measurementControlSysInfo-LCR      MeasurementControlSysInfo-LCR-r4-ext
}

SysInfoType11-v590ext-IEs ::= SEQUENCE {
--The order of the list corresponds to the order of cell in newIntraFrequencyCellInfoList
newIntraFrequencyCellInfoList-v590ext SEQUENCE (SIZE (1..maxCellMeas)) OF
    CellSelectReselectInfo-v590ext      OPTIONAL,
--The order of the list corresponds to the order of cell in newInterFrequencyCellInfoList
newInterFrequencyCellInfoList-v590ext SEQUENCE (SIZE (1..maxCellMeas)) OF

```

```

        CellSelectReselectInfo-v590ext OPTIONAL,
--The order of the list corresponds to the order of cell in newInterRATCellInfoList
newInterRATCellInfoList-v590ext SEQUENCE (SIZE (1..maxCellMeas)) OF
        CellSelectReselectInfo-v590ext OPTIONAL,
intraFreqEventCriteriaList-v590ext Intra-FreqEventCriteriaList-v590ext OPTIONAL,
intraFreqReportingCriteria-1b-r5 IntraFreqReportingCriteria-1b-r5 OPTIONAL,
intraFreqEvent-1d-r5 IntraFreqEvent-1d-r5 OPTIONAL
}

SysInfoType11-v690ext-IEs ::= SEQUENCE {
-- dummy is not used in this version of the specification. If received, the UE behaviour
-- is not specified.
dummy Dummy-InterFreqRACHReportingInfo OPTIONAL
}

SysInfoType11-v6b0ext-IEs ::= SEQUENCE {
-- Measurement IEs
interFreqRACHReportingInfo InterFreqRACHReportingInfo OPTIONAL
}

SysInfoType11-v770ext-IEs ::= SEQUENCE {
-- Measurement IEs
mbsfnFrequencyList MBSFNFrequencyList OPTIONAL
}

SysInfoType11-v7b0ext-IEs ::= SEQUENCE {
-- Measurement IEs
newInterFreqCellList NewInterFreqCellList-v7b0ext OPTIONAL
}

SysInfoType11bis ::= SEQUENCE {
-- Measurement IEs
measurementControlSysInfo MeasurementControlSysInfoExtension OPTIONAL,
measurementControlSysInfo-LCR MeasurementControlSysInfoExtension-LCR-r4 OPTIONAL,
measurementControlSysInfoExtensionAddOn-r5 MeasurementControlSysInfoExtensionAddOn-r5 OPTIONAL,
-- Extension mechanism for non-release99 information
v7b0NonCriticalExtensions SEQUENCE {
sysInfoType11bis-v7b0ext SysInfoType11bis-v7b0ext-IEs,
nonCriticalExtensions SEQUENCE {} OPTIONAL
} OPTIONAL
}

SysInfoType11bis-v7b0ext-IEs ::= SEQUENCE {
-- Measurement IEs
newInterFreqCellList NewInterFreqCellList-v7b0ext OPTIONAL
}

SysInfoType12 ::= SEQUENCE {
-- Measurement IEs
fach-MeasurementOccasionInfo FACH-MeasurementOccasionInfo OPTIONAL,
measurementControlSysInfo MeasurementControlSysInfo,
-- Extension mechanism for non- release99 information
v4b0NonCriticalExtensions SEQUENCE {
sysInfoType12-v4b0ext SysInfoType12-v4b0ext-IEs OPTIONAL,
v590NonCriticalExtension SEQUENCE {
sysInfoType12-v590ext SysInfoType12-v590ext-IEs,
v690NonCriticalExtensions SEQUENCE {
sysInfoType12-v690ext SysInfoType12-v690ext-IEs,
v6b0NonCriticalExtensions SEQUENCE {
sysInfoType12-v6b0ext SysInfoType12-v6b0ext-IEs,
v7b0NonCriticalExtensions SEQUENCE {
sysInfoType12-v7b0ext SysInfoType12-v7b0ext-IEs,
nonCriticalExtensions SEQUENCE {} OPTIONAL
} OPTIONAL
} OPTIONAL
} OPTIONAL
} OPTIONAL
} OPTIONAL
} OPTIONAL
}

SysInfoType12-v4b0ext-IEs ::= SEQUENCE {
fach-MeasurementOccasionInfo-LCR-Ext FACH-MeasurementOccasionInfo-LCR-r4-ext OPTIONAL,
measurementControlSysInfo-LCR MeasurementControlSysInfo-LCR-r4-ext
}

SysInfoType12-v590ext-IEs ::= SEQUENCE {
--The order of the list corresponds to the order of cell in newIntraFrequencyCellInfoList

```

```

newIntraFrequencyCellInfoList-v590ext SEQUENCE (SIZE (1..maxCellMeas)) OF
    CellSelectReselectInfo-v590ext OPTIONAL,
--The order of the list corresponds to the order of cell in newInterFrequencyCellInfoList
newInterFrequencyCellInfoList-v590ext SEQUENCE (SIZE (1..maxCellMeas)) OF
    CellSelectReselectInfo-v590ext OPTIONAL,
--The order of the list corresponds to the order of cell in newInterRATCellInfoList
newInterRATCellInfoList-v590ext SEQUENCE (SIZE (1..maxCellMeas)) OF
    CellSelectReselectInfo-v590ext OPTIONAL,
intraFreqEventCriteriaList-v590ext Intra-FreqEventCriteriaList-v590ext OPTIONAL,
intraFreqReportingCriteria-1b-r5 IntraFreqReportingCriteria-1b-r5 OPTIONAL,
intraFreqEvent-1d-r5 IntraFreqEvent-1d-r5 OPTIONAL
}

SysInfoType12-v690ext-IEs ::= SEQUENCE {
    -- dummy is not used in this version of the specification. If received, the UE behaviour
    -- is not specified.
    dummy Dummy-InterFreqRACHReportingInfo OPTIONAL
}

SysInfoType12-v6b0ext-IEs ::= SEQUENCE {
    -- Measurement IEs
    interFreqRACHReportingInfo InterFreqRACHReportingInfo OPTIONAL
}

SysInfoType12-v7b0ext-IEs ::= SEQUENCE {
    -- Measurement IEs
    newInterFreqCellList NewInterFreqCellList-v7b0ext OPTIONAL
}

SysInfoType13 ::= SEQUENCE {
    -- Core network IEs
    cn-DomainSysInfoList CN-DomainSysInfoList,
    -- User equipment IEs
    ue-IdleTimersAndConstants UE-IdleTimersAndConstants OPTIONAL,
    capabilityUpdateRequirement CapabilityUpdateRequirement OPTIONAL,
    -- Extension mechanism for non- release99 information
    v3a0NonCriticalExtensions SEQUENCE {
        sysInfoType13-v3a0ext SysInfoType13-v3a0ext-IEs,
        v4b0NonCriticalExtensions SEQUENCE {
            sysInfoType13-v4b0ext SysInfoType13-v4b0ext-IEs,
            -- Extension mechanism for non- release99 information
            v770NonCriticalExtensions SEQUENCE {
                sysInfoType13-v770ext SysInfoType13-v770ext-IEs,
                nonCriticalExtensions SEQUENCE {} OPTIONAL
            }
        }
    } OPTIONAL
}

SysInfoType13-v3a0ext-IEs ::= SEQUENCE {
    ue-IdleTimersAndConstants-v3a0ext UE-IdleTimersAndConstants-v3a0ext
}

SysInfoType13-v4b0ext-IEs ::= SEQUENCE {
    capabilityUpdateRequirement-r4Ext CapabilityUpdateRequirement-r4-ext OPTIONAL
}

SysInfoType13-v770ext-IEs ::= SEQUENCE {
    capabilityUpdateRequirement CapabilityUpdateRequirement-v770ext OPTIONAL
}

SysInfoType13-1 ::= SEQUENCE {
    -- ANSI-41 IEs
    ansi-41-RAND-Information ANSI-41-RAND-Information,
    -- Extension mechanism for non- release99 information
    nonCriticalExtensions SEQUENCE {} OPTIONAL
}

SysInfoType13-2 ::= SEQUENCE {
    -- ANSI-41 IEs
    ansi-41-UserZoneID-Information ANSI-41-UserZoneID-Information,
    -- Extension mechanism for non- release99 information
    nonCriticalExtensions SEQUENCE {} OPTIONAL
}

SysInfoType13-3 ::= SEQUENCE {
    -- ANSI-41 IEs
    ansi-41-PrivateNeighbourListInfo ANSI-41-PrivateNeighbourListInfo,

```

```

-- Extension mechanism for non- release99 information
nonCriticalExtensions          SEQUENCE {}          OPTIONAL
}

SysInfoType13-4 ::=
-- ANSI-41 IEs
ansi-41-GlobalServiceRedirectInfo
ANSI-41-GlobalServiceRedirectInfo,
-- Extension mechanism for non- release99 information
nonCriticalExtensions          SEQUENCE {}          OPTIONAL
}

SysInfoType14 ::=
-- Physical channel IEs
individualTS-InterferenceList  IndividualTS-InterferenceList,
expirationTimeFactor           ExpirationTimeFactor          OPTIONAL,
-- Extension mechanism for non- release99 information
nonCriticalExtensions          SEQUENCE {}          OPTIONAL
}

SysInfoType15 ::=
-- Measurement IEs
ue-positioning-GPS-CipherParameters  UE-Positioning-CipherParameters  OPTIONAL,
ue-positioning-GPS-ReferenceLocation  ReferenceLocation,
ue-positioning-GPS-ReferenceTime      UE-Positioning-GPS-ReferenceTime,
ue-positioning-GPS-Real-timeIntegrity BadSatList          OPTIONAL,
-- Extension mechanism for non- release99 information
v4b0NonCriticalExtensions          SEQUENCE {
  sysInfoType15-v4b0ext            SysInfoType15-v4b0ext-IEs,
  -- Extension mechanism for non- release4 information
  v770NonCriticalExtensions        SEQUENCE {
    sysInfoType15-v770ext          SysInfoType15-v770ext-IEs,
    nonCriticalExtensions          SEQUENCE {}          OPTIONAL
  } OPTIONAL
} OPTIONAL
}

SysInfoType15-v4b0ext-IEs ::= SEQUENCE {
  up-IPDL-Parameters-TDD           UE-Positioning-IPDL-Parameters-TDD-r4-ext  OPTIONAL
}

SysInfoType15-v770ext-IEs ::= SEQUENCE {
  -- Measurement IEs
  ue-Positioning-GPS-ReferenceTime  UE-Positioning-GPS-ReferenceTime-v770ext
}

SysInfoType15bis ::=
-- Measurement IEs
ue-positioning-GANSS-ReferencePosition  ReferenceLocationGANSS,
ue-positioning-GANSS-ReferenceTime      UE-Positioning-GANSS-ReferenceTime,
ue-positioning-GANSS-IonosphericModel  UE-Positioning-GANSS-IonosphericModel  OPTIONAL,
-- Extension mechanism for non-release99 information
nonCriticalExtensions          SEQUENCE {}          OPTIONAL
}

SysInfoType15-1 ::=
-- DGPS corrections
ue-positioning-GPS-DGPS-Corrections    UE-Positioning-GPS-DGPS-Corrections,
-- Extension mechanism for non- release99 information
nonCriticalExtensions          SEQUENCE {}          OPTIONAL
}

SysInfoType15-1bis ::=
-- Measurement IEs
ue-positioning-GANSS-DGANSS-Corrections UE-Positioning-DGANSSCorrections,
-- Extension mechanism for non-release99 information
nonCriticalExtensions          SEQUENCE {}          OPTIONAL
}

SysInfoType15-2 ::=
-- Ephemeris and clock corrections
transmissionTOW                   GPS-TOW-1sec,
satID                              SatID,
ephemerisParameter                EphemerisParameter,
-- Extension mechanism for non- release99 information
nonCriticalExtensions          SEQUENCE {}          OPTIONAL
}

```

```

SysInfoType15-2bis ::= SEQUENCE {
  -- Measurement IEs
  ue-positioning-GANSS-navigationModel  UE-Positioning-GANSS-NavigationModel,
  -- Extension mechanism for non-release99 information
  nonCriticalExtensions SEQUENCE {} OPTIONAL
}

SysInfoType15-3 ::= SEQUENCE {
  -- Almanac and other data
  transmissionTOW GPS-TOW-1sec,
  ue-positioning-GPS-Almanac UE-Positioning-GPS-Almanac
OPTIONAL,
  ue-positioning-GPS-IonosphericModel UE-Positioning-GPS-IonosphericModel
OPTIONAL,
  ue-positioning-GPS-UTC-Model UE-Positioning-GPS-UTC-Model
OPTIONAL,
  satMask BIT STRING (SIZE (1..32)) OPTIONAL,
  lsbTOW BIT STRING (SIZE (8)) OPTIONAL,
  -- Extension mechanism for non- release99 information
  nonCriticalExtensions SEQUENCE {} OPTIONAL
}

SysInfoType15-3bis ::= SEQUENCE {
  -- Measurement IEs
  ue-positioning-GANSS-Almanac UE-Positioning-GANSS-Almanac OPTIONAL,
  ue-positioning-GANSS-TimeModels UE-Positioning-GANSS-TimeModels OPTIONAL,
  ue-positioning-GANSS-UTC-Model UE-Positioning-GANSS-UTCModel OPTIONAL,
  -- Extension mechanism for non-release99 information
  nonCriticalExtensions SEQUENCE {} OPTIONAL
}

SysInfoType15-4 ::= SEQUENCE {
  -- Measurement IEs
  ue-positioning-OTDOA-CipherParameters UE-Positioning-CipherParameters OPTIONAL,
  ue-positioning-OTDOA-AssistanceData UE-Positioning-OTDOA-AssistanceData,
  v3a0NonCriticalExtensions SEQUENCE {
    sysInfoType15-4-v3a0ext SysInfoType15-4-v3a0ext,
    -- Extension mechanism for non- release99 information
    v4b0NonCriticalExtensions SEQUENCE {
      sysInfoType15-4-v4b0ext SysInfoType15-4-v4b0ext,
      nonCriticalExtensions SEQUENCE {} OPTIONAL
    } OPTIONAL
  } OPTIONAL
}

SysInfoType15-4-v3a0ext ::= SEQUENCE {
  sfn-Offset-Validity SFN-Offset-Validity OPTIONAL
}

SysInfoType15-4-v4b0ext ::= SEQUENCE {
  ue-Positioning-OTDOA-AssistanceData-r4ext UE-Positioning-OTDOA-AssistanceData-r4ext OPTIONAL
}

SysInfoType15-5 ::= SEQUENCE {
  -- Measurement IEs
  ue-positioning-OTDOA-AssistanceData-UEB UE-Positioning-OTDOA-AssistanceData-UEB,
  v3a0NonCriticalExtensions SEQUENCE {
    sysInfoType15-5-v3a0ext SysInfoType15-5-v3a0ext,
    -- Extension mechanism for non- release99 information
    v770NonCriticalExtensions SEQUENCE {
      sysInfoType15-5-v770ext SysInfoType15-5-v770ext-IEs,
      nonCriticalExtensions SEQUENCE {} OPTIONAL
    } OPTIONAL
  } OPTIONAL
}

SysInfoType15-5-v3a0ext ::= SEQUENCE {
  sfn-Offset-Validity SFN-Offset-Validity OPTIONAL
}

SysInfoType15-5-v770ext-IEs ::= SEQUENCE {
  ue-Positioning-OTDOA-AssistanceData-UEB-ext
  UE-Positioning-OTDOA-AssistanceData-UEB-ext OPTIONAL
}

SysInfoType15-6 ::= SEQUENCE {
  -- Measurement IEs
  ue-positioning-GANSS-TOD INTEGER (0..86399),

```

```

        ue-positioning-GANSS-ReferenceMeasurementInformation
            UE-Positioning-GANSS-ReferenceMeasurementInfo,
    -- Extension mechanism for non-release99 information
        nonCriticalExtensions          SEQUENCE {}          OPTIONAL
    }

SysInfoType15-7 ::=          SEQUENCE {
    -- Measurement IEs
        ue-positioning-GANSS-DataBitAssistance UE-Positioning-GANSS-Data-Bit-Assistance,
    -- Extension mechanism for non-release99 information
        nonCriticalExtensions          SEQUENCE {}          OPTIONAL
    }

SysInfoType15-8 ::=          SEQUENCE {
    -- Measurement IEs
        ue-positioning-GANSS-DataCipheringInfo UE-Positioning-CipherParameters OPTIONAL,
        ue-positioning-GANSS-realTimeIntegrity UE-Positioning-GANSS-RealTimeIntegrity OPTIONAL,
    -- Extension mechanism for non-release99 information
        nonCriticalExtensions          SEQUENCE {}          OPTIONAL
    }

SysInfoType16 ::=          SEQUENCE {
    -- Radio bearer IEs
        preDefinedRadioConfiguration PreDefRadioConfiguration,
    -- Extension mechanism for non- release99 information
        v770NonCriticalExtensions      SEQUENCE {
            sysInfoType16-v770ext      SysInfoType16-v770ext-IEs,
            nonCriticalExtensions      SEQUENCE {}          OPTIONAL
        } OPTIONAL
    }

SysInfoType16-v770ext-IEs ::= SEQUENCE {
        preDefinedRadioConfiguration PreDefRadioConfiguration-v770ext
    }

SysInfoType17 ::=          SEQUENCE {
    -- Physical channel IEs
    -- If PDSCH/PUSCH is configured for 1.28Mcps or 7.68Mcps TDD, pusch-SysInfoList and
    -- pdsch-SysInfoList should be absent and the info included in the respective
    -- tdd128SpecificInfo or tdd768SpecificInfo instead.
    -- If PDSCH/PUSCH is configured for 3.84Mcps TDD in R5, HCR-r5-SpecificInfo should also be
    -- included.
        pusch-SysInfoList                PUSCH-SysInfoList          OPTIONAL,
        pdsch-SysInfoList                PDSCH-SysInfoList          OPTIONAL,
    -- Extension mechanism for non- release99 information
        v4b0NonCriticalExtensions        SEQUENCE {
            sysInfoType17-v4b0ext        SysInfoType17-v4b0ext-IEs,
            v590NonCriticalExtensions    SEQUENCE {
                sysInfoType17-v590ext    SysInfoType17-v590ext-IEs    OPTIONAL,
                v770NonCriticalExtensions SEQUENCE {
                    sysInfoType17-v770ext SysInfoType17-v770ext-IEs,
                    nonCriticalExtensions SEQUENCE {}          OPTIONAL
                }
            } OPTIONAL
        } OPTIONAL
    }

SysInfoType17-v4b0ext-IEs ::= SEQUENCE {
        tdd128SpecificInfo              SEQUENCE {
            pusch-SysInfoList            PUSCH-SysInfoList-LCR-r4    OPTIONAL,
            pdsch-SysInfoList            PDSCH-SysInfoList-LCR-r4    OPTIONAL
        } OPTIONAL
    }

SysInfoType17-v590ext-IEs ::= SEQUENCE {
        hcr-r5-SpecificInfo              SEQUENCE {
            pusch-SysInfoList            PUSCH-SysInfoList-HCR-r5    OPTIONAL,
            pdsch-SysInfoList            PDSCH-SysInfoList-HCR-r5    OPTIONAL
        } OPTIONAL
    }

SysInfoType17-v770ext-IEs ::= SEQUENCE {
        tdd768SpecificInfo              SEQUENCE {
            pusch-SysInfoList-SFN        PUSCH-SysInfoList-SFN-VHCR    OPTIONAL,
            pdsch-SysInfoList-SFN        PDSCH-SysInfoList-VHCR-r7    OPTIONAL
        } OPTIONAL
    }

```



```

SysInfoType18 ::=
    SEQUENCE {
        idleModePLMNIde ntities          PLMNIdentitiesOfNeighbourCells          OPTIONAL,
        connectedModePLMNIde ntities PLMNIdentitiesOfNeighbourCells          OPTIONAL,
        -- Extension mechanism for non- release99 information
        v6b0NonCriticalExtensions          SEQUENCE {
            sysInfoType18-v6b0ext          SysInfoType18-v6b0ext,
            nonCriticalExtensions          SEQUENCE {}          OPTIONAL
        }          OPTIONAL
    }

SysInfoType18-v6b0ext ::=
    SEQUENCE {
        idleModePLMNIde ntitiesSIB11bis    PLMNIdentitiesOfNeighbourCells    OPTIONAL,
        connectedModePLMNIde ntitiesSIB11bis PLMNIdentitiesOfNeighbourCells    OPTIONAL
    }

SysInfoTypeSB1 ::=
    SEQUENCE {
        -- Other IEs
        sib-ReferenceList                  SIB-ReferenceList,
        -- Extension mechanism for non- release99 information
        v6b0NonCriticalExtensions          SEQUENCE {
            sysInfoTypeSB1-v6b0ext        SysInfoTypeSB1-v6b0ext,
            nonCriticalExtensions          SEQUENCE {}          OPTIONAL
        }          OPTIONAL
    }

SysInfoTypeSB1-v6b0ext ::=
    SEQUENCE {
        extSIBTypeInfoSchedulingInfo-List  ExtSIBTypeInfoSchedulingInfo-List  OPTIONAL
    }

SysInfoTypeSB2 ::=
    SEQUENCE {
        -- Other IEs
        sib-ReferenceList                  SIB-ReferenceList,
        -- Extension mechanism for non- release99 information
        v6b0NonCriticalExtensions          SEQUENCE {
            sysInfoTypeSB2-v6b0ext        SysInfoTypeSB2-v6b0ext,
            nonCriticalExtensions          SEQUENCE {}          OPTIONAL
        }          OPTIONAL
    }

SysInfoTypeSB2-v6b0ext ::=
    SEQUENCE {
        extSIBTypeInfoSchedulingInfo-List  ExtSIBTypeInfoSchedulingInfo-List  OPTIONAL
    }

TDD-UMTS-Frequency-List ::=
    SEQUENCE (SIZE (1..maxNumTDDFreqs)) OF
        FrequencyInfoTDD

-- For systemInformationBlockType11bis the Value Tag Info "CellValueTag" is used
ValueTagInfo ::= CHOICE {
    none                NULL,
    cellValueTag        CellValueTag,
    plmn-ValueTag       PLMN-ValueTag,
    sIBOccurrenceIdentityAndValueTag SIBOccurrenceIdentityAndValueTag
}

-- *****
--
-- ANSI-41 INFORMATION ELEMENTS (10.3.9)
--
-- *****

ANSI-41-GlobalServiceRedirectInfo ::= ANSI-41-NAS-Parameter
ANSI-41-PrivateNeighbourListInfo ::= ANSI-41-NAS-Parameter
ANSI-41-RAND-Information ::= ANSI-41-NAS-Parameter
ANSI-41-UserZoneID-Information ::= ANSI-41-NAS-Parameter
ANSI-41-NAS-Parameter ::= BIT STRING (SIZE (1..2048))

Min-P-REV ::= BIT STRING (SIZE (8))

NAS-SystemInformationANSI-41 ::= ANSI-41-NAS-Parameter
NID ::= BIT STRING (SIZE (16))

P-REV ::= BIT STRING (SIZE (8))

SID ::= BIT STRING (SIZE (15))

-- *****
--
-- MBMS INFORMATION ELEMENTS (10.3.9a)

```

```

--
-- *****
MBMS-AccessProbabilityFactor ::=      ENUMERATED {
    apf0, apf32, apf64, apf96, apf128, apf160, apf192,
    apf224, apf256, apf288, apf320, apf352, apf384, apf416,
    apf448, apf480, apf512, apf544, apf576, apf608, apf640,
    apf672, apf704, apf736, apf768, apf800, apf832, apf864,
    apf896, apf928, apf960, apf1000 }

MBMS-CellGroupIdentity-r6 ::=        BIT STRING (SIZE (12))

MBMS-CommonCCTrChIdentity ::=        INTEGER (1..32)

MBMS-CommonPhyChIdentity ::=         INTEGER (1..32)

MBMS-CommonRBIdentity ::=            INTEGER (1..32)

MBMS-CommonRBInformation-r6 ::=      SEQUENCE {
    commonRBIdentity                MBMS-CommonRBIdentity,
    pdcp-Info                       PDCP-Info-r4,
    rlc-Info                        RLC-Info-MTCH-r6
}

MBMS-CommonRBInformationList-r6 ::=  SEQUENCE (SIZE (1..maxMBMS-CommonRB)) OF
    MBMS-CommonRBInformation-r6

MBMS-CommonTrChIdentity ::=          INTEGER (1..32)

MBMS-ConnectedModeCountingScope ::= SEQUENCE {
    countingForUraPCH                BOOLEAN,
    countingForCellPCH               BOOLEAN,
    countingForCellFACH               BOOLEAN
}

MBMS-CurrentCell-SCCPCH-r6 ::=       SEQUENCE {
    sccpchIdentity                   MBMS-SCCPCHIdentity                OPTIONAL,
    secondaryCCPCH-Info              MBMS-CommonPhyChIdentity,
    softComb-TimingOffset             MBMS-SoftComb-TimingOffset        OPTIONAL,
    -- If the IE transpCh-InfoCommonForAllTrCh is absent, the default TFCS as specified
    -- in 14.10.1 applies
    transpCh-InfoCommonForAllTrCh    MBMS-CommonCCTrChIdentity        OPTIONAL,
    transpChInformation               MBMS-TrCHInformation-CurrList
}

MBMS-CurrentCell-SCCPCHList-r6 ::=   SEQUENCE (SIZE (1..maxSCCPCH)) OF
    MBMS-CurrentCell-SCCPCH-r6

MBMS-FACHCarryingMTCH-List ::=       SEQUENCE (SIZE (1..maxFACHPCH)) OF
    TransportFormatSet

MBMS-JoinedInformation-r6 ::=         SEQUENCE {
    p-TMSI                           P-TMSI-GSM-MAP                OPTIONAL
}

MBMS-L1CombiningSchedule-32 ::=      SEQUENCE {
    -- Actual L1 combining schedule values (offset, start, duration) = IE value * 4
    cycleOffset                       INTEGER (0..7)                    OPTIONAL,
    mtch-L1CombiningPeriodList        SEQUENCE (SIZE (1..maxMBMS-L1CP)) OF SEQUENCE {
        periodStart                   INTEGER (0..7),
        periodDuration                 INTEGER (1..8)
    }
}

MBMS-L1CombiningSchedule-64 ::=      SEQUENCE {
    -- Actual L1 combining schedule values (offset, start, duration) = IE value * 4
    cycleOffset                       INTEGER (0..15)                   OPTIONAL,
    mtch-L1CombiningPeriodList        SEQUENCE (SIZE (1..maxMBMS-L1CP)) OF SEQUENCE {
        periodStart                   INTEGER (0..15),
        periodDuration                 INTEGER (1..16)
    }
}

MBMS-L1CombiningSchedule-128 ::=     SEQUENCE {
    -- Actual L1 combining schedule values (offset, start, duration) = IE value * 4
    cycleOffset                       INTEGER (0..31)                    OPTIONAL,
    mtch-L1CombiningPeriodList        SEQUENCE (SIZE (1..maxMBMS-L1CP)) OF SEQUENCE {
        periodStart                   INTEGER (0..31),
}

```

```

    periodDuration                INTEGER (1..32)
  }
}

MBMS-L1CombiningSchedule-256 ::= SEQUENCE {
  -- Actual L1 combining schedule values (offset, start, duration) = IE value * 4
  cycleOffset                    INTEGER (0..63) OPTIONAL,
  mtch-L1CombiningPeriodList    SEQUENCE (SIZE (1..maxMBMS-L1CP)) OF SEQUENCE {
    periodStart                  INTEGER (0..63),
    periodDuration               INTEGER (1..64)
  }
}

MBMS-L1CombiningSchedule-512 ::= SEQUENCE {
  -- Actual L1 combining schedule values (offset, start, duration) = IE value * 4
  cycleOffset                    INTEGER (0..127) OPTIONAL,
  mtch-L1CombiningPeriodList    SEQUENCE (SIZE (1..maxMBMS-L1CP)) OF SEQUENCE {
    periodStart                  INTEGER (0..127),
    periodDuration               INTEGER (1..128)
  }
}

MBMS-L1CombiningSchedule-1024 ::= SEQUENCE {
  -- Actual L1 combining schedule values (offset, start, duration) = IE value * 4
  cycleOffset                    INTEGER (0..255) OPTIONAL,
  mtch-L1CombiningPeriodList    SEQUENCE (SIZE (1..maxMBMS-L1CP)) OF SEQUENCE {
    periodStart                  INTEGER (0..255),
    periodDuration               INTEGER (1..256)
  }
}

MBMS-L1CombiningSchedule ::= CHOICE {
  cycleLength-32                 MBMS-L1CombiningSchedule-32,
  cycleLength-64                 MBMS-L1CombiningSchedule-64,
  cycleLength-128                MBMS-L1CombiningSchedule-128,
  cycleLength-256                MBMS-L1CombiningSchedule-256,
  cycleLength-512                MBMS-L1CombiningSchedule-512,
  cycleLength-1024              MBMS-L1CombiningSchedule-1024
}

MBMS-L1CombiningTransmTimeDiff ::= INTEGER (0..3)

MBMS-L23Configuration ::= CHOICE {
  sameAsCurrent                  SEQUENCE {
    currentCell-SCCPCH           MBMS-SCCPCHIdentity,
    msch-ConfigurationInfo       MBMS-MSCH-ConfigurationInfo-r6 OPTIONAL
  },
  different                       SEQUENCE {
    -- If the IE transpCh-InfoCommonForAllTrCh is absent, the default TFCS as specified
    -- in 14.10.1 applies
    transpCh-InfoCommonForAllTrCh MBMS-CommonCCTrChIdentity OPTIONAL,
    transpChInformation            MBMS-TrCHInformation-NeighbList
  }
}

MBMS-LogicalChIdentity ::= INTEGER (1..15)

MBMS-MCCH-ConfigurationInfo-r6 ::= SEQUENCE {
  accessInfoPeriodCoefficient    INTEGER (0..3),
  repetitionPeriodCoefficient    INTEGER (0..3),
  modificationPeriodCoefficient  INTEGER (7..10),
  rlc-Info                       RLC-Info-MCCH-r6,
  tctf-Presence                  MBMS-TCTF-Presence OPTIONAL
}

MBMS-MICHConfigurationInfo-r6 ::= SEQUENCE {
  michPowerOffset                MBMS-MICHPowerOffset,
  mode                            CHOICE {
    fdd                            SEQUENCE {
      channelisationCode256        ChannelisationCode256,
      ni-CountPerFrame             MBMS-NI-CountPerFrame,
      sttd-Indicator                BOOLEAN
    },
    -- The CHOICE tdd384 is used for both tdd384 and tdd768. If IE
    -- 'MBMS-MICHConfigurationInfo-v770ext' is not present, tdd384 applies.
    tdd384                          SEQUENCE {
      timeslot                      TimeslotNumber,
      midambleShiftAndBurstType      MidambleShiftAndBurstType,

```

```

        channelisationCode          DL-TS-ChannelisationCode,
        repetitionPeriodLengthOffset RepPerLengthOffset-MICH   OPTIONAL,
        mbmsNotificationIndLength    MBMS-MICHNotificationIndLength DEFAULT mn4
    },
    tdd128                            SEQUENCE {
        timeslot                      TimeslotNumber-LCR-r4,
        midambleShiftAndBurstType     MidambleShiftAndBurstType-LCR-r4,
        channelisationCodeList        SEQUENCE (SIZE (1..2)) OF
            DL-TS-ChannelisationCode,
        repetitionPeriodLengthOffset  RepPerLengthOffset-MICH   OPTIONAL,
        mbmsNotificationIndLength     MBMS-MICHNotificationIndLength DEFAULT mn4
    }
}

MBMS-MICHConfigurationInfo-v770ext ::= SEQUENCE {
    mode                               CHOICE {
        -- For tdd384, IE 'MidambleShiftAndBurstType-r7' replaces IE 'MidambleShiftAndBurstType'
        -- in IE 'MBMS-MICHConfigurationInfo-r6'. IE 'MidambleShiftAndBurstType' shall be ignored.
        tdd384                          SEQUENCE {
            midambleShiftAndBurstType    MidambleShiftAndBurstType-r7
        },
        -- For tdd768, the CHIOCE tdd384 in IE 'MBMS-MICHConfigurationInfo-r6' applies, except
        -- that IE 'MidambleShiftAndBurstType-VHCR' replaces IE 'MidambleShiftAndBurstType'. IE
        -- 'MidambleShiftAndBurstType' shall be ignored.
        tdd768                          SEQUENCE {
            midambleShiftAndBurstType    MidambleShiftAndBurstType-VHCR
        },
        tdd128                          SEQUENCE {
            mbsfnSpecialTimeSlot         TimeSlotLCR-ext                OPTIONAL
        }
    }
}

MBMS-MICHNotificationIndLength ::= ENUMERATED { mn4, mn8, mn16 }

MBMS-MICHPowerOffset ::= INTEGER (-10..5)

MBMS-ModifedService-r6 ::= SEQUENCE {
    mbms-TransmissionIdentity          MBMS-TransmissionIdentity,
    mbms-RequiredUEAction              MBMS-RequiredUEAction-Mod,
    mbms-PreferredFrequency            CHOICE {
        mcch                            MBMS-PFLIndex,
        dcch                            MBMS-PFLInfo
    } OPTIONAL,
    --dummy is not used. If received it shall be ignored.
    dummy                              ENUMERATED { true }                OPTIONAL,
    continueMCCHReading                BOOLEAN
}

MBMS-ModifedServiceList-r6 ::= SEQUENCE (SIZE (1..maxMBMSservModif)) OF
    MBMS-ModifedService-r6

MBMS-ModifiedService-v770ext ::= SEQUENCE {
    mbsfnClusterFrequency              MBSFN-ClusterFrequency-r7        OPTIONAL
}

MBMS-ModifiedService-LCR-v7c0ext ::= SEQUENCE {
    rbReleaseCause                    MBMS-PTM-RBReleaseCause-LCR-r7    OPTIONAL
}

-- IE 'MBMS-ModifiedServiceList-v770ext' contains a list of extension data
-- associated with the MBMS transmission identities at the corresponding
-- positions in IE 'MBMS-ModifedServiceList-r6'
MBMS-ModifiedServiceList-v770ext ::= SEQUENCE (SIZE (1..maxMBMSservModif)) OF
    MBMS-ModifiedService-v770ext

-- IE 'MBMS-ModifiedServiceList-v7c0ext' contains a list of extension data
-- associated with the MBMS transmission identities at the corresponding
-- positions in IE 'MBMS-ModifedServiceList-r6'
MBMS-ModifiedServiceList-LCR-v7c0ext ::= SEQUENCE (SIZE (1..maxMBMSservModif)) OF
    MBMS-ModifiedService-LCR-v7c0ext

MBMS-MSCH-ConfigurationInfo-r6 ::= SEQUENCE {
    mschSchedulingInfo                MBMS-MSCHSchedulingInfo          OPTIONAL,
    rlc-Info                          RLC-Info-MSCH-r6                OPTIONAL,
    tctf-Presence                      MBMS-TCTF-Presence              OPTIONAL
}

```

```

MBMS-MSCHSchedulingInfo ::= CHOICE {
    schedulingPeriod-32-Offset      INTEGER (0..31),
    schedulingPeriod-64-Offset      INTEGER (0..63),
    schedulingPeriod-128-Offset     INTEGER (0..127),
    schedulingPeriod-256-Offset     INTEGER (0..255),
    schedulingPeriod-512-Offset     INTEGER (0..511),
    schedulingPeriod-1024-Offset    INTEGER (0..1023)
}

MBMS-NeighbouringCellSCCPCH-r6 ::= SEQUENCE {
    secondaryCCPCH-Info             MBMS-CommonPhyChIdentity,
    secondaryCCPCHPwrOffsetDiff    MBMS-SCCPCHPwrOffsetDiff      OPTIONAL,
    layer1Combining                 CHOICE {
        fdd                         SEQUENCE {
            softComb-TimingOffset    MBMS-SoftComb-TimingOffset,
            mbms-L1CombiningTransmTimeDiff MBMS-L1CombiningTransmTimeDiff,
            mbms-L1CombiningSchedule MBMS-L1CombiningSchedule  OPTIONAL
        },
        tdd                         NULL
    } OPTIONAL,
    mbms-L23Configuration           MBMS-L23Configuration
}

MBMS-NeighbouringCellSCCPCH-v770ext ::= SEQUENCE {
    secondaryCCPCH-Info             MBMS-CommonPhyChIdentity      OPTIONAL,
    secondaryCCPCH-InfoDiff        SecondaryCCPCHInfoDiff-MBMS,
    secondaryCCPCHPwrOffsetDiff    MBMS-SCCPCHPwrOffsetDiff  OPTIONAL,
    layer1Combining                 CHOICE {
        fdd                         SEQUENCE {
            softComb-TimingOffset    MBMS-SoftComb-TimingOffset,
            mbms-L1CombiningTransmTimeDiff MBMS-L1CombiningTransmTimeDiff,
            mbms-L1CombiningSchedule MBMS-L1CombiningSchedule  OPTIONAL
        },
        tdd                         NULL
    } OPTIONAL,
    mbms-L23Configuration           MBMS-L23Configuration
}

MBMS-NeighbouringCellSCCPCHList-r6 ::= SEQUENCE (SIZE (1..maxSCCPCH)) OF
    MBMS-NeighbouringCellSCCPCH-r6

-- IE "MBMS-NeighbouringCellSCCPCHList-v770ext" may be received as an extension of the IE
-- "MBMS-NeighbouringCellSCCPCHList-r6". When both lists are received in the same message
-- and the total number of list elements is greater than constant value 'maxSCCPCH', the
-- UE behaviour is unspecified.
MBMS-NeighbouringCellSCCPCHList-v770ext ::= SEQUENCE (SIZE (1..maxSCCPCH)) OF
    MBMS-NeighbouringCellSCCPCH-v770ext

MBMS-NI-CountPerFrame ::= ENUMERATED { ni18, ni36, ni72, ni144 }

MBMS-NumberOfNeighbourCells-r6 ::= INTEGER (0..32)

MBMS-PFLIndex ::= INTEGER (1..maxMBMS-Freq)

MBMS-PFLInfo ::= FrequencyInfo

MBMS-PhyChInformation-r6 ::= SEQUENCE {
    mbms-CommonPhyChIdentity       MBMS-CommonPhyChIdentity,
    secondaryCCPCHInfo-MBMS        SecondaryCCPCHInfo-MBMS-r6
}

MBMS-PhyChInformation-r7 ::= SEQUENCE {
    mbms-CommonPhyChIdentity       MBMS-CommonPhyChIdentity,
    secondaryCCPCHInfo-MBMS        SecondaryCCPCHInfo-MBMS-r7
}

MBMS-PhyChInformationList-r6 ::= SEQUENCE (SIZE (1..maxMBMS-CommonPhyCh)) OF
    MBMS-PhyChInformation-r6

MBMS-PhyChInformationList-r7 ::= SEQUENCE (SIZE (1..maxMBMS-CommonPhyCh)) OF
    MBMS-PhyChInformation-r7

MBMS-PL-ServiceRestrictInfo-r6 ::= ENUMERATED { true }

MBMS-PreferredFrequencyInfo-r6 ::= SEQUENCE {
    mbmsPreferredFrequency          INTEGER (1..maxMBMS-Freq)      OPTIONAL,
    layerConvergenceInformation     CHOICE {

```

```

        mbms-Qoffset                MBMS-Qoffset,
        mbms-HCSoffset              INTEGER (0..7)
    },
    mbms-PL-ServiceRestrictInfo      MBMS-PL-ServiceRestrictInfo-r6    OPTIONAL
}

MBMS-PreferredFrequencyList-r6 ::= SEQUENCE (SIZE (1..maxMBMS-Freq)) OF
    MBMS-PreferredFrequencyInfo-r6

MBMS-PTMActivationTime-r6 ::= INTEGER (0..2047)

MBMS-PTM-RBInformation-C ::= SEQUENCE {
    rbInformation                MBMS-CommonRBIdentity,
    shortTransmissionID          MBMS-ShortTransmissionID,
    logicalChIdentity            MBMS-LogicalChIdentity
}

MBMS-PTM-RBInformation-CList ::= SEQUENCE (SIZE (1..maxRBperTrCh)) OF
    MBMS-PTM-RBInformation-C

MBMS-PTM-RBInformation-N ::= SEQUENCE {
    shortTransmissionID          MBMS-ShortTransmissionID,
    logicalChIdentity            MBMS-LogicalChIdentity,
    layer1-CombiningStatus       BOOLEAN
}

MBMS-PTM-RBInformation-NList ::= SEQUENCE (SIZE (1..maxRBperTrCh)) OF
    MBMS-PTM-RBInformation-N

MBMS-PTM-RBReleaseCause-LCR-r7 ::= ENUMERATED {
    normalRelease, outOfMBMSServiceCoverageInRAN,
    networkAbnormalRelease,
    spare5, spare4, spare3, spare2, spare1 }

MBMS-Qoffset ::= ENUMERATED { q4, q8, q12, q16, q20, q30, q40, qInfinity }

MBMS-RequiredUEAction-Mod ::= ENUMERATED {
    none,
    acquireCountingInfo,
    acquireCountingInfoPTM-RBsUnmodified,
    acquirePTM-RBInfo,
    requestPTPRB,
    releasePTM-RB }

MBMS-RequiredUEAction-UMod ::= ENUMERATED {
    none,
    acquirePTM-RBInfo,
    requestPTPRB }

MBMS-SCCPCHIdentity ::= INTEGER (1..maxSCCPCH)

MBMS-SCCPCHPwrOffsetDiff ::= ENUMERATED { mcpo-minus6, mcpo-minus3, mcpo-plus3, mcpo-plus6 }

MBMS-SelectedServiceInfo ::= SEQUENCE {
    status                       CHOICE {
        none                      NULL,
        some                      MBMS-SelectedServicesListFull
    }
}

MBMS-SelectedServicesListFull ::= SEQUENCE (SIZE (1..maxMBMSservSelect)) OF
    MBMS-ServiceIdentity-r6

MBMS-SelectedServicesListShort ::= SEQUENCE (SIZE (1..maxMBMSservSelect)) OF
    MBMS-ShortTransmissionID

MBMS-SelectedServicesShort ::= SEQUENCE {
    mbms-SelectedServicesList    MBMS-SelectedServicesListShort,
    modificationPeriodIdentity   INTEGER (0..1)
}

MBMS-ServiceAccessInfo-r6 ::= SEQUENCE {
    shortTransmissionID          MBMS-ShortTransmissionID,
    accessprobabilityFactor-Idle MBMS-AccessProbabilityFactor,
    accessprobabilityFactor-Connected MBMS-AccessProbabilityFactor    OPTIONAL,
    mbms-ConnectedModeCountingScope MBMS-ConnectedModeCountingScope
}

MBMS-ServiceAccessInfoList-r6 ::= SEQUENCE (SIZE (1..maxMBMSservCount)) OF

```

```

        MBMS-ServiceAccessInfo-r6

MBMS-ServiceIdentity-r6 ::= SEQUENCE {
    serviceIdentity      OCTET STRING (SIZE (3)),
    plmn-Identity        CHOICE {
        -- The 'sameAsMIB-PLMN-Id' choice refers to the 'PLMN Identity' (R99) in MIB.
        sameAsMIB-PLMN-Id  NULL,
        other                CHOICE {
            -- The 'sameAsMIB-MultiPLMN-Id' choice refers to one of the (1..5) PLMN Identities
            -- provided in the 'Multiple PLMN List' (REL-6) in MIB.
            sameAsMIB-MultiPLMN-Id  INTEGER (1..5),
            explicitPLMN-Id          PLMN-Identity
        }
    }
}

MBMS-ServiceSchedulingInfo-r6 ::= SEQUENCE {
    mbms-TransmissionIdentity  MBMS-TransmissionIdentity,
    mbms-ServiceTransmInfoList  MBMS-ServiceTransmInfoList OPTIONAL,
    nextSchedulingperiod        INTEGER (0..31)
}

MBMS-ServiceSchedulingInfoList-r6 ::= SEQUENCE (SIZE (1..maxMBMsservSched)) OF
    MBMS-ServiceSchedulingInfo-r6

MBMS-ServiceTransmInfo ::= SEQUENCE {
    -- Actual values (start, duration) = IE values * 4
    start          INTEGER (0..255),
    duration        INTEGER (1..256)
}

MBMS-ServiceTransmInfoList ::= SEQUENCE (SIZE (1..maxMBMSTransmis)) OF
    MBMS-ServiceTransmInfo

MBMS-SessionIdentity ::= OCTET STRING (SIZE (1))

MBMS-ShortTransmissionID ::= INTEGER (1..maxMBMsservUnmodif)

MBMS-SIBType5-SCCPCH-r6 ::= SEQUENCE {
    sccpchIdentity      MBMS-SCCPCHIdentity,
    transpCHInformation  MBMS-TrCHInformation-SIB5List
}

MBMS-SIBType5-SCCPCHList-r6 ::= SEQUENCE (SIZE (1..maxSCCPCH)) OF
    MBMS-SIBType5-SCCPCH-r6

MBMS-SoftComb-TimingOffset ::= ENUMERATED { ms0, ms10, ms20, ms40 }

MBMS-TCTF-Presence ::= ENUMERATED { false }

MBMS-TimersAndCounters-r6 ::= SEQUENCE {
    t-318              T-318                                DEFAULT ms1000
}

MBMS-TransmissionIdentity ::= SEQUENCE {
    mbms-ServiceIdentity  MBMS-ServiceIdentity-r6,
    mbms-SessionIdentity  MBMS-SessionIdentity            OPTIONAL
}

MBMS-TranspChInfoForCCTrCh-r6 ::= SEQUENCE {
    commonCCTrChIdentity  MBMS-CommonCCTrChIdentity,
    transportFormatCombinationSet  TFCS
}

MBMS-TranspChInfoForEachCCTrCh-r6 ::= SEQUENCE (SIZE (1..maxMBMS-CommonCCTrCh)) OF
    MBMS-TranspChInfoForCCTrCh-r6

MBMS-TranspChInfoForEachTrCh-r6 ::= SEQUENCE (SIZE (1..maxMBMS-CommonTrCh)) OF
    MBMS-TranspChInfoForTrCh-r6

MBMS-TranspChInfoForTrCh-r6 ::= SEQUENCE {
    commonTrChIdentity    MBMS-CommonTrChIdentity,
    transportFormatSet     TransportFormatSet
}

MBMS-TrCHInformation-Curr ::= SEQUENCE {
    transpCh-Info         MBMS-CommonTrChIdentity,

```

```

    rbInformation                MBMS-PTM-RBInformation-CList        OPTIONAL,
    msch-ConfigurationInfo       MBMS-MSCH-ConfigurationInfo-r6  OPTIONAL
  }

MBMS-TrCHInformation-CurrList ::= SEQUENCE (SIZE (1..maxFACHPCH)) OF
    MBMS-TrCHInformation-Curr

MBMS-TrCHInformation-Neighb ::= SEQUENCE {
    transpCh-Info                MBMS-CommonTrChIdentity,
    transpCh-CombiningStatus     BOOLEAN,
    rbInformation                MBMS-PTM-RBInformation-NList    OPTIONAL,
    msch-ConfigurationInfo       MBMS-MSCH-ConfigurationInfo-r6  OPTIONAL
  }

MBMS-TrCHInformation-NeighbList ::= SEQUENCE (SIZE (1..maxFACHPCH)) OF
    MBMS-TrCHInformation-Neighb

MBMS-TrCHInformation-SIB5 ::= SEQUENCE {
    transpCh-Identity            INTEGER (1..maxFACHPCH),
    rbInformation                MBMS-PTM-RBInformation-CList        OPTIONAL,
    msch-ConfigurationInfo       MBMS-MSCH-ConfigurationInfo-r6  OPTIONAL
  }

MBMS-TrCHInformation-SIB5List ::= SEQUENCE (SIZE (1..maxFACHPCH)) OF
    MBMS-TrCHInformation-SIB5

MBMS-UnmodifiedService-r6 ::= SEQUENCE {
    mbms-TransmissionIdentity    MBMS-TransmissionIdentity,
    mbms-RequiredUEAction        MBMS-RequiredUEAction-UMod,
    mbms-PreferredFrequency      MBMS-PFLIndex                OPTIONAL
  }

MBMS-UnmodifiedServiceList-r6 ::= SEQUENCE (SIZE (1..maxMBMsservUnmodif)) OF
    MBMS-UnmodifiedService-r6

MBMS-UnmodifiedService-v770ext ::= SEQUENCE {
    mbsfnClusterFrequency        MBSFN-ClusterFrequency-r7    OPTIONAL
  }

-- IE 'MBMS-UnmodifiedServiceList-v770ext' contains a list of extension data
-- associated with the MBMS transmission identities at the corresponding
-- positions in IE 'MBMS-UnmodifiedServiceList-r6'
MBMS-UnmodifiedServiceList-v770ext ::= SEQUENCE (SIZE (1..maxMBMsservUnmodif)) OF
    MBMS-UnmodifiedService-v770ext

MBSFN-ClusterFrequency-r7 ::= INTEGER (1..maxMBSFNClusters)

MBSFNFrequency ::= SEQUENCE {
    frequencyInfo                FrequencyInfo,
    -- IE "cellParameterID" is used only for MBSFN clusters operating in 1.28 Mcps TDD mode.
    cellParametersID             CellParametersID                OPTIONAL
  }

MBSFNFrequencyList ::= SEQUENCE (SIZE (0..maxMBSFNClusters)) OF
    MBSFNFrequency

MBSFNOnlyService ::= ENUMERATED {true}

MBSFNservicesNotNotified-r7 ::= SEQUENCE {
    notificationOfAllMBSFNservicesInTheBand
    ENUMERATED { true }                OPTIONAL
  }

MBSFNInterFrequencyNeighbour-r7 ::= SEQUENCE {
    mbsfnFrequency                FrequencyInfo,
    mbsfnServicesNotification      CHOICE {
        mbsfnServicesNotified      NULL,
        mbsfnServicesNotNotified    MBSFNservicesNotNotified-r7
    }
  }

MBSFN-InterFrequencyNeighbourList-r7 ::= SEQUENCE (SIZE (1.. maxMBSFNClusters)) OF
    MBSFNInterFrequencyNeighbour-r7

MBSFN-TDDTimeSlotInfo ::= SEQUENCE {
    timeSlotNumber                TimeslotNumber-LCR-r4,
    cellParametersID             CellParametersID
  }

```



```

MBSFN-TDDTimeSlotInfo-LCR ::= SEQUENCE {
    frequencyIndex      INTEGER (1..maxMBSFNClusters),
    timeSlotList        MBSFN-TDDInformation
}

MBSFN-TDDInformation ::= SEQUENCE (SIZE (1..maxTS)) OF
    MBSFN-TDDTimeSlotInfo

MBSFN-TDDInformation-LCR ::= SEQUENCE (SIZE (1..maxMBSFNClusters)) OF
    MBSFN-TDDTimeSlotInfo-LCR

MBSFN-TDM-Info ::= SEQUENCE {
    shortTransmissionID MBMS-ShortTransmissionID,
    tDMPeriod            INTEGER (2..9),
    tDMOffset            INTEGER (0..8),
    tDMLength            INTEGER (1..8)
}

MBSFN-TDM-Info-List ::= SEQUENCE (SIZE (1..maxMBMSservUnmodif)) OF
    MBSFN-TDM-Info

END

```

11.4 Constant definitions

Constant-definitions DEFINITIONS AUTOMATIC TAGS ::=

BEGIN

```

hiPDSCHidentities      INTEGER ::= 64
hiPUSCHidentities      INTEGER ::= 64
hiRM                    INTEGER ::= 256
maxAC                   INTEGER ::= 16
maxAdditionalMeas       INTEGER ::= 4
maxASC                  INTEGER ::= 8
maxASCmap               INTEGER ::= 7
maxASCpersist          INTEGER ::= 6
maxCCTrCH               INTEGER ::= 8
maxCellMeas            INTEGER ::= 32
maxCellMeas-1          INTEGER ::= 31
maxCNDomains            INTEGER ::= 4
maxCommonHRNTI         INTEGER ::= 4
maxCommonQueueID       INTEGER ::= 2
maxCPCHsets            INTEGER ::= 16
maxDPCH-DLchan         INTEGER ::= 8
maxDPDCH-UL            INTEGER ::= 6
maxDRACclasses         INTEGER ::= 8
maxE-DCHMACdFlow       INTEGER ::= 8
maxE-DCHMACdFlow-1    INTEGER ::= 7
maxEDCHRL              INTEGER ::= 4
maxFACHPCH             INTEGER ::= 8
maxFreq                INTEGER ::= 8
maxFreqBandsFDD        INTEGER ::= 8
maxFreqBandsFDD-ext    INTEGER ::= 15 -- maxFreqBandsFDD-ext ::= 22 - (maxFreqBandsFDD - 1)
maxFreqBandsTDD        INTEGER ::= 4
maxFreqBandsGSM        INTEGER ::= 16
maxGANSS                INTEGER ::= 8
maxGANSS-1             INTEGER ::= 7
maxGANSSSat            INTEGER ::= 64
maxGANSSSat-1          INTEGER ::= 63
maxGERAN-SI            INTEGER ::= 8
maxGSMTTargetCells    INTEGER ::= 32
maxHProcesses          INTEGER ::= 8
maxHS-SCCHLessTrBlk   INTEGER ::= 4
maxHSDSCHTBIndex      INTEGER ::= 64
maxHSDSCHTBIndex-tdd384 INTEGER ::= 512
maxHSSCCHs             INTEGER ::= 4
maxInterSysMessages   INTEGER ::= 4
maxLoChperRLC          INTEGER ::= 2
maxMAC-d-PDUsizes      INTEGER ::= 8
maxMBMS-CommonCCTrCh  INTEGER ::= 32
maxMBMS-CommonPhyCh   INTEGER ::= 32
maxMBMS-CommonRB      INTEGER ::= 32
maxMBMS-CommonTrCh    INTEGER ::= 32
maxMBMS-Freq           INTEGER ::= 4
maxMBMS-L1CP           INTEGER ::= 4

```

```

maxMBMSSservCount          INTEGER ::= 8
maxMBMSSservModif         INTEGER ::= 32
maxMBMSSservSched         INTEGER ::= 16
maxMBMSSservSelect       INTEGER ::= 8
maxMBMSSservUnmodif      INTEGER ::= 64
maxMBMSTransmis          INTEGER ::= 4
maxMBSFNClusters         INTEGER ::= 16
maxMeasEvent              INTEGER ::= 8
maxMeasIntervals         INTEGER ::= 3
maxMeasParEvent          INTEGER ::= 2
maxNumCDMA2000Freqs      INTEGER ::= 8
maxNumE-AGCH             INTEGER ::= 4
maxNumE-HICH             INTEGER ::= 4
maxNumGSMFreqRanges      INTEGER ::= 32
maxNumFDDFreqs           INTEGER ::= 8
maxNumTDDFreqs           INTEGER ::= 8
maxNoOfMeas              INTEGER ::= 16
maxOtherRAT              INTEGER ::= 15
maxOtherRAT-16           INTEGER ::= 16
maxPage1                 INTEGER ::= 8
maxPCPCH-APsig           INTEGER ::= 16
maxPCPCH-APsubCh         INTEGER ::= 12
maxPCPCH-CDsig           INTEGER ::= 16
maxPCPCH-CDsubCh         INTEGER ::= 12
maxPCPCH-SF              INTEGER ::= 7
maxPCPCHs                INTEGER ::= 64
maxPDCPAlgoType          INTEGER ::= 8
maxPDSCH                 INTEGER ::= 8
maxPDSCH-TFCIgroups      INTEGER ::= 256
maxPRACH                 INTEGER ::= 16
maxPRACH-FPACH           INTEGER ::= 8
maxPredefConfig          INTEGER ::= 16
maxPUSCH                 INTEGER ::= 8
maxQueueIDs              INTEGER ::= 8
maxRABsetup              INTEGER ::= 16
maxRAT                   INTEGER ::= 16
maxRB                    INTEGER ::= 32
maxRBallRABs             INTEGER ::= 27
maxRBMuxOptions          INTEGER ::= 8
maxRBperRAB              INTEGER ::= 8
maxRBperTrCh             INTEGER ::= 16
maxReportedGSMCells      INTEGER ::= 8
maxRL                     INTEGER ::= 8
maxRL-1                  INTEGER ::= 7
maxRLCPDUsizesPerLogChan INTEGER ::= 32
maxRFC3095-CID           INTEGER ::= 16384
maxROHC-PacketSizes-r4   INTEGER ::= 16
maxROHC-Profile-r4       INTEGER ::= 8
maxSat                   INTEGER ::= 16
maxSatClockModels        INTEGER ::= 4
maxSCCPCH                INTEGER ::= 16
maxSgnType               INTEGER ::= 8
maxSIB                   INTEGER ::= 32
maxSIB-FACH              INTEGER ::= 8
maxSIBperMsg             INTEGER ::= 16
maxSRBsetup              INTEGER ::= 8
maxSystemCapability       INTEGER ::= 16
maxTDD128Carrier         INTEGER ::= 6
maxTF                     INTEGER ::= 32
maxTF-CPCH               INTEGER ::= 16
maxTFC                   INTEGER ::= 1024
maxTFCsub                INTEGER ::= 1024
maxTFCI-2-Combs          INTEGER ::= 512
maxTGPS                  INTEGER ::= 6
maxTrCH                  INTEGER ::= 32
-- maxTrCHpreconf should be 16 but has been set to 32 for compatibility
maxTrCHpreconf           INTEGER ::= 32
maxTS                    INTEGER ::= 14
maxTS-1                  INTEGER ::= 13
maxTS-2                  INTEGER ::= 12
maxTS-LCR                INTEGER ::= 6
maxTS-LCR-1              INTEGER ::= 5
maxURA                   INTEGER ::= 8
maxURNTI-Group           INTEGER ::= 8

```

END

11.5 RRC information between network nodes

Internode-definitions DEFINITIONS AUTOMATIC TAGS ::=

BEGIN

IMPORTS

HandoverToUTRANCommand,
MeasurementReport,
PhysicalChannelReconfiguration,
RadioBearerReconfiguration,
RadioBearerRelease,
RadioBearerSetup,
RRCConnectionSetupComplete-r3-add-ext-IEs,
RRC-FailureInfo,
TransportChannelReconfiguration,
UECapabilityInformation-r3-add-ext-IEs

FROM PDU-definitions

```
-- Core Network IEs :
  CN-DomainIdentity,
  CN-DomainInformationList,
  CN-DomainInformationListFull,
  CN-DRX-CycleLengthCoefficient,
  NAS-SystemInformationGSM-MAP,
-- UTRAN Mobility IEs :
  CellIdentity,
  URA-Identity,
-- User Equipment IEs :
  AccessStratumReleaseIndicator,
  C-RNTI,
  ChipRateCapability,
  DL-CapabilityWithSimultaneousHS-DSCHConfig,
  DL-PhysChCapabilityFDD-v380ext,
  DL-PhysChCapabilityTDD,
  DL-PhysChCapabilityTDD-LCR-r4,
  GSM-Measurements,
  HSDSCH-physical-layer-category,
  FailureCauseWithProtErr,
  MaxHcContextSpace,
  MaximumAM-EntityNumberRLC-Cap,
  MaximumRLC-WindowSize,
  MaxNoPhysChBitsReceived,
  MaxNoDPDCH-BitsTransmitted,
  MaxPhysChPerFrame,
  MaxPhysChPerSubFrame-r4,
  MaxPhysChPerTS,
  MaxROHC-ContextSessions-r4,
  MaxTS-PerFrame,
  MaxTS-PerSubFrame-r4,
  MinimumSF-DL,
  MultiModeCapability,
  MultiRAT-Capability,
  NetworkAssistedGPS-Supported,
  PhysicalChannelCapability-edch-r6,
  RadioFrequencyBandTDDList,
  RLC-Capability,
  RRC-MessageSequenceNumber,
  SecurityCapability,
  SimultaneousSCCPCH-DPCH-Reception,
  STARTList,
  STARTSingle,
  START-Value,
  SupportOfDedicatedPilotsForChEstimation,
  T-305,
  TransportChannelCapability,
  TxRxFrequencySeparation,
  U-RNTI,
  UE-CapabilityContainer-IEs,
  UE-GANSSPositioning-Capability,
  UE-MultiModeRAT-Capability,
  UE-PowerClassExt,
  UE-RadioAccessCapabBandFDDList,
  UE-RadioAccessCapabBandFDDList2,
  UE-RadioAccessCapabBandFDDList-ext,
  UE-RadioAccessCapability,
```

```

UE-RadioAccessCapability-v370ext,
UE-RadioAccessCapability-v380ext,
UE-RadioAccessCapability-v3a0ext,
UE-RadioAccessCapability-v3g0ext,
UE-RadioAccessCapability-v4b0ext,
UE-RadioAccessCapability-v590ext,
UE-RadioAccessCapability-v5c0ext,
UE-RadioAccessCapability-v7e0ext,
UE-RadioAccessCapability-v7f0ext,
UL-PhysChCapabilityFDD,
UL-PhysChCapabilityFDD-r6,
UL-PhysChCapabilityTDD,
UL-PhysChCapabilityTDD-LCR-r4,
-- Radio Bearer IEs :
  PredefinedConfigStatusList,
  PredefinedConfigValueTag,
  RAB-InformationSetupList,
  RAB-InformationSetupList-r4,
  RAB-InformationSetupList-r5,
  RAB-InformationSetupList-r6-ext,
  RAB-InformationSetupList-r6,
  RAB-InformationSetupList-v6b0ext,
  RAB-InformationSetupList-r7,
  RB-Identity,
  SRB-InformationSetupList,
  SRB-InformationSetupList-r5,
  SRB-InformationSetupList-r6,
  SRB-InformationSetupList-r7,
-- Transport Channel IEs :
  CPCH-SetID,
  DL-CommonTransChInfo,
  DL-CommonTransChInfo-r4,
  DL-AddReconfTransChInfoList,
  DL-AddReconfTransChInfoList-r4,
  DL-AddReconfTransChInfoList-r5,
  DL-AddReconfTransChInfoList-r7,
  DRAC-StaticInformationList,
  UL-CommonTransChInfo,
  UL-CommonTransChInfo-r4,
  UL-AddReconfTransChInfoList,
  UL-AddReconfTransChInfoList-r6,
  UL-AddReconfTransChInfoList-r7,
-- Physical Channel IEs :
  PrimaryCPICH-Info,
  TPC-CombinationIndex,
  ScramblingCodeChange,
  TGCFN,
  TGPSI,
  TGPS-ConfigurationParams,
-- Measurement IEs :
  Event1j-r6,
  Hysteresis,
  Inter-FreqEventCriteriaList-v590ext,
  Intra-FreqEventCriteriaList-v590ext,
  IntraFreqEvent-1d-r5,
  IntraFreqReportingCriteria-1b-r5,
  InterRATCellInfoIndication,
  MeasuredResultsOnRACHinterFreq,
  MeasurementIdentity,
  MeasurementReportingMode,
  MeasurementType,
  MeasurementType-r4,
  MeasurementType-r6,
  MeasurementType-r7,
  AdditionalMeasurementID-List,
  PositionEstimate,
  ReportingCellStatus,
  ThresholdSFN-GPS-TOW-us,
  TimeToTrigger,
-- MBMS IEs :
  MBMS-JoinedInformation-r6,
  MBMS-SelectedServiceInfo,
-- Other IEs :
  GERANIu-RadioAccessCapability,
  GSM-MS-RadioAccessCapability,
  InterRAT-UE-RadioAccessCapabilityList,
  InterRAT-UE-RadioAccessCapability-v590ext,
  InterRAT-UE-RadioAccessCapability-v690ext,

```

```

UESpecificBehaviourInformationIdle,
UESpecificBehaviourInformationInterRAT

FROM InformationElements

    maxCNDomains,
    maxGANSs,
    maxNoOfMeas,
    maxRB,
    maxRBallRABs,
    maxRFC3095-CID,
    maxSRBsetup,
    maxRL,
    maxTGPS
FROM Constant-definitions;

-- Part 1: Class definitions similar to what has been defined in 11.1 for RRC messages
-- Information that is transferred in the same direction and across the same path is grouped

-- *****
--
-- RRC information, to target RNC
--
-- *****
-- RRC Information to target RNC sent either from source RNC or from another RAT

ToTargetRNC-Container ::= CHOICE {
    interRATHandoverInfo          InterRATHandoverInfoWithInterRATCapabilities-r3,
    srncRelocation                SRNC-RelocationInfo-r3,
    rfc3095-ContextInfo           RFC3095-ContextInfo-r5,
    extension                     NULL
}

-- *****
--
-- RRC information, target RNC to source RNC
--
-- *****

TargetRNC-ToSourceRNC-Container ::= CHOICE {
    radioBearerSetup              RadioBearerSetup,
    radioBearerReconfiguration    RadioBearerReconfiguration,
    radioBearerRelease            RadioBearerRelease,
    transportChannelReconfiguration TransportChannelReconfiguration,
    physicalChannelReconfiguration PhysicalChannelReconfiguration,
    rrc-FailureInfo               RRC-FailureInfo,
    -- IE dl-DCCHmessage consists of an octet string that includes the IE DL-DCCH-Message
    dl-DCCHmessage                OCTET STRING,
    extension                     NULL
}

-- Part 2: Container definitions, similar to the PDU definitions in 11.2 for RRC messages
-- In alphabetical order

-- *****
--
-- Handover to UTRAN information
--
-- *****

InterRATHandoverInfoWithInterRATCapabilities-r3 ::= CHOICE {
    r3                             SEQUENCE {
        -- IE InterRATHandoverInfoWithInterRATCapabilities-r3-IEs also
        -- includes non critical extensions
        interRATHandoverInfo-r3    InterRATHandoverInfoWithInterRATCapabilities-r3-IEs,
        v390NonCriticalExtensions  SEQUENCE {
            interRATHandoverInfoWithInterRATCapabilities-v390ext
            InterRATHandoverInfoWithInterRATCapabilities-v390ext-IEs,
        -- Reserved for future non critical extension
        v690NonCriticalExtensions SEQUENCE {
            interRATHandoverInfoWithInterRATCapabilities-v690ext
            InterRATHandoverInfoWithInterRATCapabilities-v690ext-IEs,
        nonCriticalExtensions     SEQUENCE {} OPTIONAL
        }
    } OPTIONAL
},

```

```

    criticalExtensions          SEQUENCE {}
}

InterRATHandoverInfoWithInterRATCapabilities-r3-IEs ::= SEQUENCE {
    -- The order of the IEs may not reflect the tabular format
    -- but has been chosen to simplify the handling of the information in the BSC
    -- Other IEs
    ue-RATSpecificCapability    InterRAT-UE-RadioAccessCapabilityList OPTIONAL,
    -- interRATHandoverInfo, Octet string is used to obtain 8 bit length field prior to
    -- actual information. This makes it possible for BSS to transparently handle information
    -- received via GSM air interface even when it includes non critical extensions.
    -- The octet string shall include the InterRATHandoverInfo information
    -- The BSS can re-use the 44.018 length field received from the MS
    interRATHandoverInfo       OCTET STRING (SIZE (0..255))
}

InterRATHandoverInfoWithInterRATCapabilities-v390ext-IEs ::= SEQUENCE {
    -- User equipment IEs
    failureCauseWithProtErr    FailureCauseWithProtErr          OPTIONAL
}

InterRATHandoverInfoWithInterRATCapabilities-v690ext-IEs ::= SEQUENCE {
    -- Other IEs
    ue-RATSpecificCapability-v690ext    InterRAT-UE-RadioAccessCapability-v690ext    OPTIONAL
}

-- *****
--
-- RFC3095 context, source RNC to target RNC
--
-- *****

RFC3095-ContextInfo-r5 ::= CHOICE {
    r5
        SEQUENCE {
            RFC3095-ContextInfoList-r5    RFC3095-ContextInfoList-r5,
            -- Reserved for future non critical extension
            nonCriticalExtensions         SEQUENCE {} OPTIONAL
        },
    criticalExtensions          SEQUENCE {}
}

RFC3095-ContextInfoList-r5 ::= SEQUENCE (SIZE (1..maxRBallRABs)) OF
    RFC3095-ContextInfo

-- *****
--
-- SRNC Relocation information
--
-- *****

SRNC-RelocationInfo-r3 ::= CHOICE {
    r3
        SEQUENCE {
            sRNC-RelocationInfo-r3        SRNC-RelocationInfo-r3-IEs,
            v380NonCriticalExtensions     SEQUENCE {
                sRNC-RelocationInfo-v380ext SRNC-RelocationInfo-v380ext-IEs,
                -- Reserved for future non critical extension
                v390NonCriticalExtensions  SEQUENCE {
                    sRNC-RelocationInfo-v390ext    SRNC-RelocationInfo-v390ext-IEs,
                    v3a0NonCriticalExtensions     SEQUENCE {
                        sRNC-RelocationInfo-v3a0ext    SRNC-RelocationInfo-v3a0ext-IEs,
                        v3b0NonCriticalExtensions     SEQUENCE {
                            sRNC-RelocationInfo-v3b0ext    SRNC-RelocationInfo-v3b0ext-IEs,
                            v3c0NonCriticalExtensions     SEQUENCE {
                                sRNC-RelocationInfo-v3c0ext    SRNC-RelocationInfo-v3c0ext-IEs,
                                laterNonCriticalExtensions SEQUENCE {
                                    sRNC-RelocationInfo-v3d0ext    SRNC-RelocationInfo-v3d0ext-IEs,
                                    -- Container for additional R99 extensions
                                    sRNC-RelocationInfo-r3-add-ext    BIT STRING
                                        (CONTAINING SRNC-RelocationInfo-v3h0ext-IEs)    OPTIONAL,
                                    v3g0NonCriticalExtensions     SEQUENCE {
                                        sRNC-RelocationInfo-v3g0ext    SRNC-RelocationInfo-v3g0ext-IEs,
                                        v4b0NonCriticalExtensions     SEQUENCE {
                                            sRNC-RelocationInfo-v4b0ext    SRNC-RelocationInfo-v4b0ext-IEs,
                                            v590NonCriticalExtensions     SEQUENCE {
                                                sRNC-RelocationInfo-v590ext
                                                    SRNC-RelocationInfo-v590ext-IEs,
                                                v5a0NonCriticalExtensions     SEQUENCE {

```

```

SRNC-RelocationInfo-v5a0ext
v5b0NonCriticalExtensions SEQUENCE {
  SRNC-RelocationInfo-v5b0ext
  SRNC-RelocationInfo-v5b0ext-IEs,
v5c0NonCriticalExtensions SEQUENCE {
  SRNC-RelocationInfo-v5c0ext
  SRNC-RelocationInfo-v5c0ext-IEs,
v690NonCriticalExtensions SEQUENCE {
  SRNC-RelocationInfo-v690ext
  SRNC-RelocationInfo-v690ext-IEs,
v6b0NonCriticalExtensions SEQUENCE {
  SRNC-RelocationInfo-v6b0ext
  SRNC-RelocationInfo-v6b0ext-IEs,
v770NonCriticalExtensions SEQUENCE {
  SRNC-RelocationInfo-v770ext
  SRNC-RelocationInfo-v770ext-IEs,
v7e0NonCriticalExtensions SEQUENCE {
  SRNC-RelocationInfo-v7e0ext
  SRNC-RelocationInfo-v7e0ext-IEs,
v7f0NonCriticalExtensions SEQUENCE {
  SRNC-RelocationInfo-v7f0ext
  SRNC-RelocationInfo-v7f0ext-IEs,
  nonCriticalExtensions SEQUENCE {} OPTIONAL
} OPTIONAL
} OPTIONAL
} OPTIONAL
} OPTIONAL
} OPTIONAL
} OPTIONAL
} OPTIONAL
} OPTIONAL
} OPTIONAL
},
later-than-r3 CHOICE {
r4 SEQUENCE {
  SRNC-RelocationInfo-r4 SRNC-RelocationInfo-r4-IEs,
v4d0NonCriticalExtensions SEQUENCE {
  SRNC-RelocationInfo-v4d0ext SRNC-RelocationInfo-v4d0ext-IEs,
  -- Container for adding non critical extensions after freezing REL-5
  SRNC-RelocationInfo-r4-add-ext BIT STRING OPTIONAL,
v590NonCriticalExtensions SEQUENCE {
  SRNC-RelocationInfo-v590ext SRNC-RelocationInfo-v590ext-IEs,
v5a0NonCriticalExtensions SEQUENCE {
  SRNC-RelocationInfo-v5a0ext SRNC-RelocationInfo-v5a0ext-IEs,
v5b0NonCriticalExtensions SEQUENCE {
  SRNC-RelocationInfo-v5b0ext SRNC-RelocationInfo-v5b0ext-IEs,
v5c0NonCriticalExtensions SEQUENCE {
  SRNC-RelocationInfo-v5c0ext SRNC-RelocationInfo-v5c0ext-IEs,
v690NonCriticalExtensions SEQUENCE {
  SRNC-RelocationInfo-v690ext SRNC-RelocationInfo-v690ext-IEs,
v6b0NonCriticalExtensions SEQUENCE {
  SRNC-RelocationInfo-v6b0ext SRNC-RelocationInfo-v6b0ext-IEs,
v770NonCriticalExtensions SEQUENCE {
  SRNC-RelocationInfo-v770ext SRNC-RelocationInfo-v770ext-IEs,
v7e0NonCriticalExtensions SEQUENCE {
  SRNC-RelocationInfo-v7e0ext SRNC-RelocationInfo-v7e0ext-IEs,
v7f0NonCriticalExtensions SEQUENCE {
  SRNC-RelocationInfo-v7f0ext SRNC-RelocationInfo-v7f0ext-IEs,
  nonCriticalExtensions SEQUENCE {} OPTIONAL
} OPTIONAL
} OPTIONAL
} OPTIONAL
} OPTIONAL
} OPTIONAL
} OPTIONAL
} OPTIONAL
} OPTIONAL
}

```

```

    } OPTIONAL
  } OPTIONAL
} OPTIONAL
},
criticalExtensions CHOICE {
  r5 SEQUENCE {
    sRNC-RelocationInfo-r5 SRNC-RelocationInfo-r5-IEs,
    sRNC-RelocationInfo-r5-add-ext BIT STRING OPTIONAL,
    v5a0NonCriticalExtensions SEQUENCE {
      sRNC-RelocationInfo-v5a0ext SRNC-RelocationInfo-v5a0ext-IEs,
      v5b0NonCriticalExtensions SEQUENCE {
        sRNC-RelocationInfo-v5b0ext SRNC-RelocationInfo-v5b0ext-IEs,
        v5c0NonCriticalExtensions SEQUENCE {
          sRNC-RelocationInfo-v5c0ext SRNC-RelocationInfo-v5c0ext-IEs,
          v690NonCriticalExtensions SEQUENCE {
            sRNC-RelocationInfo-v690ext SRNC-RelocationInfo-v690ext-IEs,
            v6b0NonCriticalExtensions SEQUENCE {
              sRNC-RelocationInfo-v6b0ext SRNC-RelocationInfo-v6b0ext-IEs,
              v770NonCriticalExtensions SEQUENCE {
                sRNC-RelocationInfo-v770ext
                SRNC-RelocationInfo-v770ext-IEs,
                v7e0NonCriticalExtensions SEQUENCE {
                  sRNC-RelocationInfo-v7e0ext
                  SRNC-RelocationInfo-v7e0ext-IEs,
                  v7f0NonCriticalExtensions SEQUENCE {
                    sRNC-RelocationInfo-v7f0ext
                    SRNC-RelocationInfo-v7f0ext-IEs,
                    nonCriticalExtensions SEQUENCE {} OPTIONAL
                  } OPTIONAL
                } OPTIONAL
              } OPTIONAL
            } OPTIONAL
          } OPTIONAL
        } OPTIONAL
      } OPTIONAL
    } OPTIONAL
  } OPTIONAL
},
criticalExtensions CHOICE {
  r6 SEQUENCE {
    sRNC-RelocationInfo-r6 SRNC-RelocationInfo-r6-IEs,
    sRNC-RelocationInfo-r6-add-ext BIT STRING
      (CONTAINING SRNC-RelocationInfo-r6-add-ext-IEs) OPTIONAL,
    v6b0NonCriticalExtensions SEQUENCE {
      sRNC-RelocationInfo-v6b0ext SRNC-RelocationInfo-v6b0ext-IEs,
      v770NonCriticalExtensions SEQUENCE {
        sRNC-RelocationInfo-v770ext SRNC-RelocationInfo-v770ext-IEs,
        nonCriticalExtensions SEQUENCE {} OPTIONAL
      } OPTIONAL
    } OPTIONAL
  },
  criticalExtensions CHOICE {
    r7 SEQUENCE {
      sRNC-RelocationInfo-r7 SRNC-RelocationInfo-r7-IEs,
      sRNC-RelocationInfo-r7-add-ext BIT STRING
        (CONTAINING SRNC-RelocationInfo-r7-add-ext-IEs) OPTIONAL,
      nonCriticalExtensions SEQUENCE {} OPTIONAL
    },
    criticalExtensions SEQUENCE {}
  }
}
}
}
}
}
}

```

```

SRNC-RelocationInfo-r3-IEs ::= SEQUENCE {
  -- Non-RRC IEs
  stateOfRRC StateOfRRC,
  stateOfRRC-Procedure StateOfRRC-Procedure,
  -- Ciphering related information IEs
  -- If the extension v380 is included use the extension for the ciphering status per CN domain
  cipheringStatus CipheringStatus,
  -- If ciphering status is started and the IE latestConfiguredCN-Domain should be included,
  -- the IE cn-DomainIdentity (in SRNC-RelocationInfo-v380ext-IEs) shall be used instead.
  calculationTimeForCiphering CalculationTimeForCiphering OPTIONAL,
  -- The order of occurrence in the IE cipheringInfoPerRB-List is the
  -- same as the RBs in SRB-InformationSetupList in RAB-InformationSetupList.
}

```



```

-- The signalling RBs are supposed to be listed
-- first. Only UM and AM RBs that are ciphered are listed here
cipheringInfoPerRB-List      CipheringInfoPerRB-List      OPTIONAL,
count-C-List                 COUNT-C-List                 OPTIONAL,
integrityProtectionStatus    IntegrityProtectionStatus,
-- In the IE srb-SpecificIntegrityProtInfo, the first information listed corresponds to
-- signalling radio bearer RB0 and after the order of occurrence is the same as the SRBs in
-- SRB-InformationSetupList
-- The target RNC may ignore the IE srb-SpecificIntegrityProtInfo if the
-- IE integrityProtectionStatus has the value "not started".
srb-SpecificIntegrityProtInfo SRB-SpecificIntegrityProtInfoList,
implementationSpecificParams ImplementationSpecificParams    OPTIONAL,
-- User equipment IEs
u-RNTI                       U-RNTI,
c-RNTI                       C-RNTI                       OPTIONAL,
ue-RadioAccessCapability     UE-RadioAccessCapability,
ue-Positioning-LastKnownPos  UE-Positioning-LastKnownPos  OPTIONAL,
-- Other IEs
ue-RATSpecificCapability     InterRAT-UE-RadioAccessCapabilityList  OPTIONAL,
-- UTRAN mobility IEs
ura-Identity                 URA-Identity                 OPTIONAL,
-- Core network IEs
cn-CommonGSM-MAP-NAS-SysInfo NAS-SystemInformationGSM-MAP,
cn-DomainInformationList     CN-DomainInformationList     OPTIONAL,
-- Measurement IEs
ongoingMeasRepList          OngoingMeasRepList          OPTIONAL,
-- Radio bearer IEs
predefinedConfigStatusList   PredefinedConfigStatusList,
srb-InformationList          SRB-InformationSetupList,
rab-InformationList          RAB-InformationSetupList     OPTIONAL,
-- Transport channel IEs
ul-CommonTransChInfo        UL-CommonTransChInfo        OPTIONAL,
ul-TransChInfoList          UL-AddReconfTransChInfoList  OPTIONAL,
modeSpecificInfo            CHOICE {
    fdd                       SEQUENCE {
        -- dummy and dummy2 are not used in this version of the specification, they should
        -- not be sent and if received they should be ignored.
        dummy                  CPCH-SetID                    OPTIONAL,
        dummy2                 DRAC-StaticInformationList  OPTIONAL
    },
    tdd                       NULL
},
dl-CommonTransChInfo        DL-CommonTransChInfo        OPTIONAL,
dl-TransChInfoList          DL-AddReconfTransChInfoList  OPTIONAL,
-- Measurement report
measurementReport            MeasurementReport            OPTIONAL
}

SRNC-RelocationInfo-v380ext-IEs ::= SEQUENCE {
-- Ciphering related information IEs
-- In the SRNC-RelocationInfo-r3-IEs, the IE 'cn-DomainIdentity' is used to represent the
-- IE 'Latest configured CN domain' in the tabular.
cn-DomainIdentity           CN-DomainIdentity,
cipheringStatusList         CipheringStatusList
}

SRNC-RelocationInfo-v390ext-IEs ::= SEQUENCE {
cn-DomainInformationList-v390ext  CN-DomainInformationList-v390ext  OPTIONAL,
ue-RadioAccessCapability-v370ext  UE-RadioAccessCapability-v370ext  OPTIONAL,
ue-RadioAccessCapability-v380ext  UE-RadioAccessCapability-v380ext  OPTIONAL,
dl-PhysChCapabilityFDD-v380ext    DL-PhysChCapabilityFDD-v380ext,
failureCauseWithProtErr          FailureCauseWithProtErr           OPTIONAL
}

SRNC-RelocationInfo-v3a0ext-IEs ::= SEQUENCE {
cipheringInfoForSRB1-v3a0ext      CipheringInfoPerRB-List-v3a0ext,
ue-RadioAccessCapability-v3a0ext  UE-RadioAccessCapability-v3a0ext  OPTIONAL,
-- cn-domain identity for IE startValueForCiphering-v3a0ext is specified
-- in subsequent extension (SRNC-RelocationInfo-v3b0ext-IEs)
startValueForCiphering-v3a0ext    START-Value
}

SRNC-RelocationInfo-v3b0ext-IEs ::= SEQUENCE {
-- cn-domain identity for IE startValueForCiphering-v3a0ext included in previous extension
cn-DomainIdentity                CN-DomainIdentity,
-- the IE startValueForCiphering-v3b0ext contains the start values for each CN Domain. The
-- value of start indicated by the IE startValueForCiphering-v3a0ext should be set to the
-- same value as the start-Value for the corresponding cn-DomainIdentity in the IE

```

```

    -- startValueForCiphering-v3b0ext
    startValueForCiphering-v3b0ext          STARTList2          OPTIONAL
}

SRNC-RelocationInfo-v3c0ext-IEs ::= SEQUENCE {
    -- IE rb-IdentityForHOMessage includes the identity of the RB used by the source SRNC
    -- to send the message contained in the IE "TargetRNC-ToSourceRNC-Container".
    -- Only included if type is "UE involved"
    rb-IdentityForHOMessage                RB-Identity          OPTIONAL
}

SRNC-RelocationInfo-v3d0ext-IEs ::= SEQUENCE {
    -- User equipment IEs
    uESpecificBehaviourInformationIdle     UESpecificBehaviourInformationIdle     OPTIONAL,
    uESpecificBehaviourInformationInterRAT UESpecificBehaviourInformationInterRAT
    OPTIONAL
}

SRNC-RelocationInfo-v3g0ext-IEs ::= SEQUENCE {
    ue-RadioAccessCapability-v3g0ext      UE-RadioAccessCapability-v3g0ext      OPTIONAL
}

SRNC-RelocationInfo-v3h0ext-IEs ::= SEQUENCE {
    tpc-CombinationInfoList                TPC-CombinationInfoList                OPTIONAL,
    nonCriticalExtension                    SEQUENCE {}                            OPTIONAL
}

SRNC-RelocationInfo-v4d0ext-IEs ::= SEQUENCE {
    tpc-CombinationInfoList                TPC-CombinationInfoList                OPTIONAL
}

TPC-CombinationInfoList ::= SEQUENCE (SIZE (1..maxRL)) OF
    TPC-Combination-Info

STARTList2 ::=
    SEQUENCE (SIZE (2..maxCNdomains)) OF
    STARTSingle

SRNC-RelocationInfo-v4b0ext-IEs ::= SEQUENCE {
    ue-RadioAccessCapability-v4b0ext      UE-RadioAccessCapability-v4b0ext      OPTIONAL
}

SRNC-RelocationInfo-v590ext-IEs ::= SEQUENCE {
    ue-RadioAccessCapability-v590ext      UE-RadioAccessCapability-v590ext      OPTIONAL,
    ue-RATSpecificCapability-v590ext      InterRAT-UE-RadioAccessCapability-v590ext OPTIONAL
}

SRNC-RelocationInfo-v5a0ext-IEs ::= SEQUENCE {
    storedCompressedModeInfo              StoredCompressedModeInfo              OPTIONAL
}

SRNC-RelocationInfo-v5b0ext-IEs ::= SEQUENCE {
    interRATCellInfoIndication            InterRATCellInfoIndication            OPTIONAL
}

SRNC-RelocationInfo-v5c0ext-IEs ::= SEQUENCE {
    ue-RadioAccessCapability-v5c0ext      UE-RadioAccessCapability-v5c0ext      OPTIONAL
}

CipheringInfoPerRB-List-v3a0ext ::= SEQUENCE {
    dl-UM-SN                               BIT STRING (SIZE (7))
}

CipheringStatusList ::=
    SEQUENCE (SIZE (1..maxCNdomains)) OF
    CipheringStatusCNdomain

CipheringStatusCNdomain ::=
    SEQUENCE {
        cn-DomainIdentity                  CN-DomainIdentity,
        cipheringStatus                    CipheringStatus
    }

CodeChangeStatusList ::= SEQUENCE (SIZE (1..maxRL)) OF
    CodeChangeStatus

CodeChangeStatus ::= SEQUENCE {
    primaryCPICH-Info                      PrimaryCPICH-Info,
    scramblingCodeChange                    ScramblingCodeChange
}

```

```

StoredCompressedModeInfo ::= SEQUENCE {
    storedTGP-SequenceList      StoredTGP-SequenceList,
    codeChangeStatusList       CodeChangeStatusList    OPTIONAL
}

StoredTGP-SequenceList ::= SEQUENCE (SIZE (1..maxTGPS)) OF
    StoredTGP-Sequence

StoredTGP-Sequence ::= SEQUENCE {
    tgpsi                      TGPSI,
    current-tgps-Status        CHOICE {
        active                  SEQUENCE {
            tgcfn                TGCFN
        },
        inactive                NULL
    },
    tgps-ConfigurationParams    TGPS-ConfigurationParams    OPTIONAL
}

SRNC-RelocationInfo-r4-IEs ::= SEQUENCE {
    -- Non-RRC IEs
    -- IE rb-IdentityForHOMessage includes the identity of the RB used by the source SRNC
    -- to send the message contained in the IE "TargetRNC-ToSourceRNC-Container".
    -- Only included if type is "UE involved"
    rb-IdentityForHOMessage     RB-Identity                OPTIONAL,
    stateOfRRC                  StateOfRRC,
    stateOfRRC-Procedure        StateOfRRC-Procedure,
    -- Ciphering related information IEs
    cipheringStatusList         CipheringStatusList-r4,
    latestConfiguredCN-Domain   CN-DomainIdentity,
    calculationTimeForCiphering CalculationTimeForCiphering    OPTIONAL,
    count-C-List                COUNT-C-List                OPTIONAL,
    cipheringInfoPerRB-List     CipheringInfoPerRB-List-r4    OPTIONAL,
    -- Integrity protection related information IEs
    integrityProtectionStatus    IntegrityProtectionStatus,
    -- The target RNC may ignore the IE srb-SpecificIntegrityProtInfo if the
    -- IE integrityProtectionStatus has the value "not started".
    srb-SpecificIntegrityProtInfo SRB-SpecificIntegrityProtInfoList,
    implementationSpecificParams ImplementationSpecificParams    OPTIONAL,
    -- User equipment IEs
    u-RNTI                      U-RNTI,
    c-RNTI                      C-RNTI                OPTIONAL,
    ue-RadioAccessCapability     UE-RadioAccessCapability-r4,
    ue-RadioAccessCapability-ext UE-RadioAccessCapabBandFDDList    OPTIONAL,
    ue-Positioning-LastKnownPos  UE-Positioning-LastKnownPos    OPTIONAL,
    uESpecificBehaviourInformationIdle UESpecificBehaviourInformationIdle    OPTIONAL,
    uESpecificBehaviourInformationInterRAT UESpecificBehaviourInformationInterRAT    OPTIONAL,
    -- Other IEs
    ue-RATSpecificCapability     InterRAT-UE-RadioAccessCapabilityList    OPTIONAL,
    -- UTRAN mobility IEs
    ura-Identity                 URA-Identity                OPTIONAL,
    -- Core network IEs
    cn-CommonGSM-MAP-NAS-SysInfo NAS-SystemInformationGSM-MAP,
    cn-DomainInformationList     CN-DomainInformationListFull    OPTIONAL,
    -- Measurement IEs
    ongoingMeasRepList           OngoingMeasRepList-r4        OPTIONAL,
    -- Radio bearer IEs
    predefinedConfigStatusList   PredefinedConfigStatusList,
    srb-InformationList          SRB-InformationSetupList,
    rab-InformationList          RAB-InformationSetupList-r4    OPTIONAL,
    -- Transport channel IEs
    ul-CommonTransChInfo        UL-CommonTransChInfo-r4        OPTIONAL,
    ul-TransChInfoList          UL-AddReconfTransChInfoList    OPTIONAL,
    -- 'dummy', 'dummy1' and 'dummy2' are not used in this version of the specification,
    -- they should not be sent and if received they should be ignored.
    dummy                        CHOICE {
        fdd                      SEQUENCE {
            dummy1                CPCH-SetID                OPTIONAL,
            dummy2                DRAC-StaticInformationList    OPTIONAL
        },
        tdd                      NULL
    }
    dl-CommonTransChInfo        DL-CommonTransChInfo-r4        OPTIONAL,
    dl-TransChInfoList          DL-AddReconfTransChInfoList-r4    OPTIONAL,
    -- Measurement report
    measurementReport            MeasurementReport            OPTIONAL,
    failureCause                 FailureCauseWithProtErr        OPTIONAL
}

```

```

}

SRNC-RelocationInfo-r5-IEs ::= SEQUENCE {
  -- Non-RRC IEs
  -- IE rb-IdentityForHOMessage includes the identity of the RB used by the source SRNC
  -- to send the message contained in the IE "TargetRNC-ToSourceRNC-Container".
  -- Only included if type is "UE involved"
  rb-IdentityForHOMessage      RB-Identity      OPTIONAL,
  stateOfRRC                  StateOfRRC,
  stateOfRRC-Procedure        StateOfRRC-Procedure,
  -- Ciphering related information IEs
  cipheringStatusList         CipheringStatusList-r4,
  latestConfiguredCN-Domain   CN-DomainIdentity,
  calculationTimeForCiphering CalculationTimeForCiphering OPTIONAL,
  count-C-List                COUNT-C-List   OPTIONAL,
  cipheringInfoPerRB-List     CipheringInfoPerRB-List-r4 OPTIONAL,
  -- Integrity protection related information IEs
  integrityProtectionStatus   IntegrityProtectionStatus,
  srb-SpecificIntegrityProtInfo SRB-SpecificIntegrityProtInfoList OPTIONAL,
  implementationSpecificParams ImplementationSpecificParams OPTIONAL,
  -- User equipment IEs
  u-RNTI                      U-RNTI,
  c-RNTI                      C-RNTI      OPTIONAL,
  ue-RadioAccessCapability    UE-RadioAccessCapability-r5,
  ue-RadioAccessCapability-ext UE-RadioAccessCapabBandFDDList OPTIONAL,
  ue-Positioning-LastKnownPos UE-Positioning-LastKnownPos  OPTIONAL,
  uESpecificBehaviourInformationIdle
                              UESpecificBehaviourInformationIdle  OPTIONAL,
  uESpecificBehaviourInformationInterRAT
                              UESpecificBehaviourInformationInterRAT  OPTIONAL,
  -- Other IEs
  ue-RATSpecificCapability    InterRAT-UE-RadioAccessCapabilityList-r5  OPTIONAL,
  -- UTRAN mobility IEs
  ura-Identity                URA-Identity      OPTIONAL,
  -- Core network IEs
  cn-CommonGSM-MAP-NAS-SysInfo NAS-SystemInformationGSM-MAP,
  cn-DomainInformationList    CN-DomainInformationListFull  OPTIONAL,
  -- Measurement IEs
  ongoingMeasRepList         OngoingMeasRepList-r5      OPTIONAL,
  -- Radio bearer IEs
  predefinedConfigStatusList  PredefinedConfigStatusList,
  srb-InformationList         SRB-InformationSetupList-r5,
  rab-InformationList         RAB-InformationSetupList-r5  OPTIONAL,
  -- Transport channel IEs
  ul-CommonTransChInfo       UL-CommonTransChInfo-r4      OPTIONAL,
  ul-TransChInfoList         UL-AddReconfTransChInfoList  OPTIONAL,
  -- 'dummy', 'dummy1' and 'dummy2' are not used in this version of the specification,
  -- they should not be sent and if received they should be ignored.
  dummy                       CHOICE {
    fdd                       SEQUENCE {
      dummy1                  CPCH-SetID      OPTIONAL,
      dummy2                  DRAC-StaticInformationList  OPTIONAL
    },
    tdd                       NULL
  }
  dl-CommonTransChInfo       DL-CommonTransChInfo-r4      OPTIONAL,
  dl-TransChInfoList         DL-AddReconfTransChInfoList-r5  OPTIONAL,
  -- PhyCH IEs
  tpc-CombinationInfoList     TPC-CombinationInfoList     OPTIONAL,
  -- Measurement report
  measurementReport          MeasurementReport      OPTIONAL,
  -- Other IEs
  failureCause               FailureCauseWithProtErr  OPTIONAL
}

SRNC-RelocationInfo-v690ext-IEs ::= SEQUENCE {
  -- User equipment IEs
  -- IE ueCapabilityContainer is used for the transparent transfer of capability information
  -- received from the UE
  ueCapabilityContainer       BIT STRING
                              (CONTAINING UE-CapabilityContainer-IEs) OPTIONAL,
  -- IE ueCapabilityContainer-RSC and IE ueCapabilityContainer-UCI are used for the
  -- transparent transfer of capability information received from the UE that was introduced
  -- in a release independent manner, i.e., transferred within a VLEC. These UE capabilities
  -- are included both in the RRC CONNECTION SETUP COMPLETE and the UE CAPABILITY INFORMATION
  -- messages. Only the VLEC of one message needs to be included i.e. the one from these
  -- messages that was last received.
  -- Case 1: If the last received message was a RRC CONNECTION SETUP COMPLETE (RSC)

```

```

    ueCapabilityContainer-RSC          BIT STRING
                                     (CONTAINING RRCConnectionSetupComplete-r3-add-ext-IEs) OPTIONAL,
    -- Case 2: If the last received message was a UE CAPABILITY INFORMATION (UCI)
    ueCapabilityContainer-UCI          BIT STRING
                                     (CONTAINING UECapabilityInformation-r3-add-ext-IEs)    OPTIONAL,
-- Radio bearer IEs
  rab-InformationSetupList            RAB-InformationSetupList-r6-ext          OPTIONAL,
-- Measurement report
  measuredResultsOnRACHinterFreq      MeasuredResultsOnRACHinterFreq        OPTIONAL,
-- MBMS IEs
  mbms-JoinedInformation              MBMS-JoinedInformation-r6          OPTIONAL,
-- Measurement IEs
  intraFreqReportingCriteria          IntraFreqReportingCriteria-r6-ext    OPTIONAL
}

SRNC-RelocationInfo-r6-IEs ::= SEQUENCE {
-- Non-RRC IEs
  -- IE rb-IdentityForHOMessage includes the identity of the RB used by the source SRNC
  -- to send the message contained in the IE "TargetRNC-ToSourceRNC-Container".
  -- Only included if type is "UE involved"
  rb-IdentityForHOMessage             RB-Identity                          OPTIONAL,
  stateOfRRC                          StateOfRRC,
  stateOfRRC-Procedure                StateOfRRC-Procedure,
-- Ciphering related information IEs
  cipheringStatusList                CipheringStatusList-r4,
  latestConfiguredCN-Domain           CN-DomainIdentity,
  calculationTimeForCiphering         CalculationTimeForCiphering          OPTIONAL,
  count-C-List                        COUNT-C-List                          OPTIONAL,
  cipheringInfoPerRB-List             CipheringInfoPerRB-List-r4          OPTIONAL,
-- Integrity protection related information IEs
  integrityProtectionStatus           IntegrityProtectionStatus,
  srb-SpecificIntegrityProtInfo       SRB-SpecificIntegrityProtInfoList   OPTIONAL,
  implementationSpecificParams        ImplementationSpecificParams        OPTIONAL,
-- User equipment IEs
  u-RNTI                              U-RNTI,
  c-RNTI                              C-RNTI                              OPTIONAL,
  ue-RadioAccessCapability            UE-RadioAccessCapability-r6,
  ue-RadioAccessCapability-ext        UE-RadioAccessCapabBandFDDList     OPTIONAL,
  ue-Positioning-LastKnownPos         UE-Positioning-LastKnownPos        OPTIONAL,
  uESpecificBehaviourInformationIdle   UESpecificBehaviourInformationIdle  OPTIONAL,
  uESpecificBehaviourInformationInterRAT
                                     UESpecificBehaviourInformationInterRAT OPTIONAL,
  -- IE ueCapabilityContainer is used for the transparent transfer of capability information
  -- received from the UE
  ueCapabilityContainer                BIT STRING
                                     (CONTAINING UE-CapabilityContainer-IEs) OPTIONAL,
  -- IE ueCapabilityContainer-RSC and IE ueCapabilityContainer-UCI are used for the
  -- transparent transfer of capability information received from the UE that was introduced
  -- in a release independent manner, i.e., transferred within a VLEC. These UE capabilities
  -- are included both in the RRC CONNECTION SETUP COMPLETE and the UE CAPABILITY INFORMATION
  -- messages. Only the VLEC of one message needs to be included i.e. the one from these
  -- messages that was last received.
  -- Case 1: If the last received message was a RRC CONNECTION SETUP COMPLETE (RSC)
  ueCapabilityContainer-RSC           BIT STRING
                                     (CONTAINING RRCConnectionSetupComplete-r3-add-ext-IEs) OPTIONAL,
  -- Case 2: If the last received message was a UE CAPABILITY INFORMATION (UCI)
  ueCapabilityContainer-UCI           BIT STRING
                                     (CONTAINING UECapabilityInformation-r3-add-ext-IEs)    OPTIONAL,
-- Other IEs
  ue-RATSpecificCapability            InterRAT-UE-RadioAccessCapabilityList-r5 OPTIONAL,
-- UTRAN mobility IEs
  ura-Identity                        URA-Identity                          OPTIONAL,
-- Core network IEs
  cn-CommonGSM-MAP-NAS-SysInfo       NAS-SystemInformationGSM-MAP,
  cn-DomainInformationList            CN-DomainInformationListFull        OPTIONAL,
-- Measurement IEs
  ongoingMeasRepList                 OngoingMeasRepList-r6              OPTIONAL,
  interRATCellInfoIndication          InterRATCellInfoIndication          OPTIONAL,
-- Radio bearer IEs
  predefinedConfigStatusList          PredefinedConfigStatusList,
  srb-InformationList                 SRB-InformationSetupList-r6,
  rab-InformationList                 RAB-InformationSetupList-r6          OPTIONAL,
-- Transport channel IEs
  ul-CommonTransChInfo               UL-CommonTransChInfo-r4            OPTIONAL,
  ul-TransChInfoList                 UL-AddReconfTransChInfoList-r6     OPTIONAL,
  dl-CommonTransChInfo               DL-CommonTransChInfo-r4            OPTIONAL,
  dl-TransChInfoList                 DL-AddReconfTransChInfoList-r5     OPTIONAL,

```

```

-- PhyCH IEs
  tpc-CombinationInfoList      TPC-CombinationInfoList      OPTIONAL,
  storedCompressedModeInfo     StoredCompressedModeInfo     OPTIONAL,
-- Measurement report
  measurementReport           (CONTAINING MeasurementReport)     OPTIONAL,
-- Other IEs
  failureCause                FailureCauseWithProtErr      OPTIONAL,
-- MBMS IEs
  mbms-JoinedInformation      MBMS-JoinedInformation-r6    OPTIONAL
}

SRNC-RelocationInfo-r6-add-ext-IEs ::= SEQUENCE {
  sRNC-RelocationInfo-v7e0ext  SRNC-RelocationInfo-v7e0ext-IEs,
  v7f0NonCriticalExtensions    SEQUENCE {
    sRNC-RelocationInfo-v7f0ext  SRNC-RelocationInfo-v7f0ext-IEs,
    nonCriticalExtensions        SEQUENCE {} OPTIONAL
  } OPTIONAL
}

SRNC-RelocationInfo-v6b0ext-IEs ::= SEQUENCE {
  -- The order of the RABs in IE rab-InformationSetupListExt is the same as
  -- in IE rab-InformationSetupList that is included in this message
  rab-InformationSetupListExt  RAB-InformationSetupList-v6b0ext  OPTIONAL,
  mbmsSelectedServiceInfo     MBMS-SelectedServiceInfo
}

SRNC-RelocationInfo-r7-IEs ::= SEQUENCE {
  -- Non-RRC IEs
  -- IE rb-IdentityForHOMessage includes the identity of the RB used by the source SRNC
  -- to send the message contained in the IE "TargetRNC-ToSourceRNC-Container".
  -- Only included if type is "UE involved"
  rb-IdentityForHOMessage     RB-Identity                        OPTIONAL,
  stateOfRRC                  StateOfRRC,
  stateOfRRC-Procedure        StateOfRRC-Procedure,
  -- Ciphering related information IEs
  cipheringStatusList         CipheringStatusList-r4,
  latestConfiguredCN-Domain   CN-DomainIdentity,
  calculationTimeForCiphering CalculationTimeForCiphering     OPTIONAL,
  count-C-List                COUNT-C-List                       OPTIONAL,
  cipheringInfoPerRB-List     CipheringInfoPerRB-List-r4        OPTIONAL,
  -- Integrity protection related information IEs
  integrityProtectionStatus    IntegrityProtectionStatus,
  srb-SpecificIntegrityProtInfo SRB-SpecificIntegrityProtInfoList  OPTIONAL,
  implementationSpecificParams ImplementationSpecificParams     OPTIONAL,
  -- User equipment IEs
  u-RNTI                       U-RNTI,
  c-RNTI                       C-RNTI                        OPTIONAL,
  -- IE 'UE-RadioAccessCapability-r6' includes the Rel-5 radio access capability extensions
  -- and earlier. Rel-6 and later extensions are included in IE 'UE-CapabilityContainer-IEs'.
  ue-RadioAccessCapability     UE-RadioAccessCapability-r6,
  ue-RadioAccessCapability-ext UE-RadioAccessCapabBandFDDList    OPTIONAL,
  ue-Positioning-LastKnownPos  UE-Positioning-LastKnownPos      OPTIONAL,
  ueSpecificBehaviourInformationIdle UESpecificBehaviourInformationIdle  OPTIONAL,
  ueSpecificBehaviourInformationInterRAT UESpecificBehaviourInformationInterRAT  OPTIONAL,
  -- IE ueCapabilityContainer is used for the transparent transfer of capability information
  -- received from the UE
  ueCapabilityContainer        BIT STRING
                                (CONTAINING UE-CapabilityContainer-IEs) OPTIONAL,
  -- IE ueCapabilityContainer-RSC and IE ueCapabilityContainer-UCI are used for the
  -- transparent transfer of capability information received from the UE that was introduced
  -- in a release independent manner, i.e., transferred within a VLEC. These UE capabilities
  -- are included both in the RRC CONNECTION SETUP COMPLETE and the UE CAPABILITY INFORMATION
  -- messages. Only the VLEC of one message needs to be included i.e. the one from these
  -- messages that was last received.
  -- Case 1: If the last received message was a RRC CONNECTION SETUP COMPLETE (RSC)
  ueCapabilityContainer-RSC    BIT STRING
                                (CONTAINING RRCConnectionSetupComplete-r3-add-ext-IEs) OPTIONAL,
  -- Case 2: If the last received message was a UE CAPABILITY INFORMATION (UCI)
  ueCapabilityContainer-UCI    BIT STRING
                                (CONTAINING UECapabilityInformation-r3-add-ext-IEs) OPTIONAL,
  -- Other IEs
  ue-RATSpecificCapability     InterRAT-UE-RadioAccessCapabilityList-r5  OPTIONAL,
  -- UTRAN mobility IEs
  ura-Identity                 URA-Identity                        OPTIONAL,
  srns-t-305                   T-305                                OPTIONAL,

```

```

-- Core network IEs
  cn-CommonGSM-MAP-NAS-SysInfo      NAS-SystemInformationGSM-MAP,
  cn-DomainInformationList          CN-DomainInformationListFull      OPTIONAL,
-- Measurement IEs
  ongoingMeasRepList                OngoingMeasRepList-r7          OPTIONAL,
  interRATCellInfoIndication        InterRATCellInfoIndication      OPTIONAL,
-- Radio bearer IEs
  predefinedConfigStatusList        PredefinedConfigStatusList,
  srb-InformationList                SRB-InformationSetupList-r7,
  rab-InformationList                RAB-InformationSetupList-r7    OPTIONAL,
-- Transport channel IEs
  ul-CommonTransChInfo              UL-CommonTransChInfo-r4        OPTIONAL,
  ul-TransChInfoList                UL-AddReconfTransChInfoList-r7  OPTIONAL,
  dl-CommonTransChInfo              DL-CommonTransChInfo-r4        OPTIONAL,
  dl-TransChInfoList                DL-AddReconfTransChInfoList-r7  OPTIONAL,
-- PhyCH IEs
  tpc-CombinationInfoList           TPC-CombinationInfoList        OPTIONAL,
  storedCompressedModeInfo          StoredCompressedModeInfo        OPTIONAL,
-- Measurement report
  measurementReport                  BIT STRING
                                     (CONTAINING MeasurementReport)    OPTIONAL,
-- Other IEs
  failureCause                       FailureCauseWithProtErr         OPTIONAL,
-- MBMS IEs
  mbms-JoinedInformation             MBMS-JoinedInformation-r6      OPTIONAL,
  mbmsSelectedServiceInfo           MBMS-SelectedServiceInfo       OPTIONAL,
}

SRNC-RelocationInfo-r7-add-ext-IEs ::= SEQUENCE {
  sRNC-RelocationInfo-v7e0ext      SRNC-RelocationInfo-v7e0ext-IEs,
  v7f0NonCriticalExtensions         SEQUENCE {
    sRNC-RelocationInfo-v7f0ext     SRNC-RelocationInfo-v7f0ext-IEs,
    nonCriticalExtensions            SEQUENCE {} OPTIONAL
  } OPTIONAL
}

SRNC-RelocationInfo-v770ext-IEs ::= SEQUENCE {
  thresholdSFN-GPS-TOW-us          ThresholdSFN-GPS-TOW-us        OPTIONAL,
  srns-t-305                        T-305                          OPTIONAL
}

SRNC-RelocationInfo-v7e0ext-IEs ::= SEQUENCE {
  -- User equipment IEs
  ue-RadioAccessCapability          UE-RadioAccessCapability-v7e0ext
}

SRNC-RelocationInfo-v7f0ext-IEs ::= SEQUENCE {
  -- User equipment IEs
  ue-RadioAccessCapability          UE-RadioAccessCapability-v7f0ext  OPTIONAL
}

-- IE definitions

CalculationTimeForCipherring ::= SEQUENCE {
  cell-Id                           CellIdentity,
  sfn                                INTEGER (0..4095)
}

CipherringInfoPerRB ::= SEQUENCE {
  dl-HFN                             BIT STRING (SIZE (20..25)),
  ul-HFN                             BIT STRING (SIZE (20..25))
}

CipherringInfoPerRB-r4 ::= SEQUENCE {
  rb-Identity                         RB-Identity,
  dl-HFN                             BIT STRING (SIZE (20..25)),
  dl-UM-SN                           BIT STRING (SIZE (7))          OPTIONAL,
  ul-HFN                             BIT STRING (SIZE (20..25))
}

-- TABULAR: CipherringInfoPerRB-List, multiplicity value numberOfRadioBearers
-- has been replaced with maxRB.
CipherringInfoPerRB-List ::= SEQUENCE (SIZE (1..maxRB)) OF
  CipherringInfoPerRB

CipherringInfoPerRB-List-r4 ::= SEQUENCE (SIZE (1..maxRB)) OF
  CipherringInfoPerRB-r4

```

```

CipheringStatus ::= ENUMERATED {
    started, notStarted }

CipheringStatusList-r4 ::= SEQUENCE (SIZE (1..maxCNdomains)) OF
    CipheringStatusCNdomain-r4

CipheringStatusCNdomain-r4 ::= SEQUENCE {
    cn-DomainIdentity CN-DomainIdentity,
    cipheringStatus CipheringStatus,
    start-Value START-Value
}

CN-DomainInformation-v390ext ::= SEQUENCE {
    cn-DRX-CycleLengthCoeff CN-DRX-CycleLengthCoefficient
}

CN-DomainInformationList-v390ext ::= SEQUENCE (SIZE (1..maxCNdomains)) OF
    CN-DomainInformation-v390ext

CompressedModeMeasCapability-r4 ::= SEQUENCE {
    fdd-Measurements BOOLEAN,
    -- TABULAR: The IEs tdd-Measurements, gsm-Measurements and multiCarrierMeasurements
    -- are made optional since they are conditional based on another information element.
    -- Their absence corresponds to the case where the condition is not true.
    tdd384-Measurements BOOLEAN OPTIONAL,
    tdd128-Measurements BOOLEAN OPTIONAL,
    gsm-Measurements GSM-Measurements OPTIONAL,
    multiCarrierMeasurements BOOLEAN OPTIONAL
}

COUNT-C-List ::= SEQUENCE (SIZE (1..maxCNdomains)) OF
    COUNT-CSingle

COUNT-CSingle ::= SEQUENCE {
    cn-DomainIdentity CN-DomainIdentity,
    count-C BIT STRING (SIZE (32))
}

DL-PhysChCapabilityFDD-r4 ::= SEQUENCE {
    -- The IE "maxNoDPCH-PDSCH-Codes" only gives information on the maximum number of DPCH Codes.
    maxNoDPCH-PDSCH-Codes INTEGER (1..8),
    maxNoPhysChBitsReceived MaxNoPhysChBitsReceived,
    supportForSF-512 BOOLEAN,
    -- dummy, dummy2 and dummy3 are not used in this version of the specification
    -- and if received they should be ignored.
    dummy BOOLEAN,
    dummy2 SimultaneousSCCPCH-DPCH-Reception,
    dummy3 SupportOfDedicatedPilotsForChEstimation OPTIONAL
}

DL-PhysChCapabilityFDD-r5 ::= SEQUENCE {
    -- The IE "maxNoDPCH-PDSCH-Codes" only gives information on the maximum number of DPCH Codes.
    maxNoDPCH-PDSCH-Codes INTEGER (1..8),
    maxNoPhysChBitsReceived MaxNoPhysChBitsReceived,
    supportForSF-512 BOOLEAN,
    -- dummy, dumy2 and dummy3 are not used in this version of the specification
    -- and if received they should be ignored.
    dummy BOOLEAN,
    dummy2 SimultaneousSCCPCH-DPCH-Reception,
    dummy3 SupportOfDedicatedPilotsForChEstimation OPTIONAL,
    fdd-hspdsch CHOICE {
        supported SEQUENCE {
            hsdSCH-physical-layer-category HSDSCH-physical-layer-category,
            -- dummy and dummy2 are not used in this version of the specification
            -- and if received they should be ignored.
            dummy BOOLEAN,
            dummy2 BOOLEAN
        },
        unsupported NULL
    }
}

DL-PhysChCapabilityTDD-r5 ::= SEQUENCE {
    maxTS-PerFrame MaxTS-PerFrame,
    maxPhysChPerFrame MaxPhysChPerFrame,
    minimumSF MinimumSF-DL,

```



```

supportOfPDSCH          BOOLEAN,
maxPhysChPerTS         MaxPhysChPerTS,
tdd384-hspdsch        CHOICE {
    supported           HSDSCH-physical-layer-category,
    unsupported        NULL
}
}

DL-PhysChCapabilityTDD-LCR-r5 ::= SEQUENCE {
    maxTS-PerSubFrame    MaxTS-PerSubFrame-r4,
    maxPhysChPerSubFrame MaxPhysChPerSubFrame-r4,
    minimumSF           MinimumSF-DL,
    supportOfPDSCH      BOOLEAN,
    maxPhysChPerTS      MaxPhysChPerTS,
    supportOf8PSK       BOOLEAN,
    tdd128-hspdsch     CHOICE {
        supported       HSDSCH-physical-layer-category,
        unsupported    NULL
    }
}

DL-RFC3095-Context ::= SEQUENCE {
    rfc3095-Context-Identity INTEGER (0..16383),
    dl-mode                 ENUMERATED {u, o, r},
    dl-ref-ir              OCTET STRING (SIZE (1..3000)),
    dl-ref-time            INTEGER (0..4294967295) OPTIONAL,
    dl-curr-time           INTEGER (0..4294967295) OPTIONAL,
    dl-syn-offset-id      INTEGER (0..65535) OPTIONAL,
    dl-syn-slope-ts       INTEGER (0..4294967295) OPTIONAL,
    dl-dyn-changed        BOOLEAN
}

ImplementationSpecificParams ::= BIT STRING (SIZE (1..512))

IntegrityProtectionStatus ::= ENUMERATED {
    started, notStarted }

InterRAT-UE-RadioAccessCapabilityList-r5 ::= SEQUENCE {
    interRAT-UE-RadioAccessCapability InterRAT-UE-RadioAccessCapabilityList,
    geranIu-RadioAccessCapability     GERANIu-RadioAccessCapability OPTIONAL
}

IntraFreqReportingCriteria-r6-ext ::= SEQUENCE {
    -- The content of the v690 non-critical extension should be
    -- considered as an extension of IE IntraFreqEventCriteriaList
    event           Event1j-r6,
    hysteresis      Hysteresis,
    timeToTrigger  TimeToTrigger,
    reportingCellStatus ReportingCellStatus OPTIONAL
}

-- dummy is not used in this version of the specification, it should
-- not be sent and if received it should be ignored.
MaxHcContextSpace-r5 ::= ENUMERATED {
    dummy, by1024, by2048, by4096, by8192,
    by16384, by32768, by65536, by131072 }

MeasurementCapability-r4 ::= SEQUENCE {
    downlinkCompressedMode CompressedModeMeasCapability-r4,
    uplinkCompressedMode   CompressedModeMeasCapability-r4
}

MeasurementCommandWithType ::= CHOICE {
    setup      MeasurementType,
    modify     NULL,
    release    NULL
}

MeasurementCommandWithType-r4 ::= CHOICE {
    setup      MeasurementType-r4,
    modify     NULL,
    release    NULL
}

MeasurementCommandWithType-r6 ::= CHOICE {
    setup      MeasurementType-r6,
    modify     NULL,
}

```

```

    release                NULL
}

MeasurementCommandWithType-r7 ::= CHOICE {
    setup                MeasurementType-r7,
    modify              NULL,
    release             NULL
}

OngoingMeasRep ::= SEQUENCE {
    measurementIdentity    MeasurementIdentity,
    -- TABULAR: The CHOICE Measurement in the tabular description is included
    -- in MeasurementCommandWithType
    measurementCommandWithType    MeasurementCommandWithType,
    measurementReportingMode      MeasurementReportingMode            OPTIONAL,
    additionalMeasurementID-List   AdditionalMeasurementID-List    OPTIONAL
}

OngoingMeasRep-r4 ::= SEQUENCE {
    measurementIdentity    MeasurementIdentity,
    -- TABULAR: The CHOICE Measurement in the tabular description is included
    -- in MeasurementCommandWithType-r4.
    measurementCommandWithType    MeasurementCommandWithType-r4,
    measurementReportingMode      MeasurementReportingMode            OPTIONAL,
    additionalMeasurementID-List   AdditionalMeasurementID-List    OPTIONAL
}

OngoingMeasRep-r5 ::= SEQUENCE {
    measurementIdentity    MeasurementIdentity,
    -- TABULAR: The CHOICE Measurement in the tabular description is included
    -- in MeasurementCommandWithType-r4.
    measurementCommandWithType    MeasurementCommandWithType-r4,
    measurementReportingMode      MeasurementReportingMode            OPTIONAL,
    additionalMeasurementID-List   AdditionalMeasurementID-List    OPTIONAL,
    measurementCommand-v590ext    CHOICE {
        -- the choice "intra-frequency" shall be used for the case of intra-frequency measurement,
        -- as well as when intra-frequency events are configured for inter-frequency measurement
        intra-frequency          Intra-FreqEventCriteriaList-v590ext,
        inter-frequency          Inter-FreqEventCriteriaList-v590ext
    } OPTIONAL,
    intraFreqReportingCriteria-1b-r5    IntraFreqReportingCriteria-1b-r5    OPTIONAL,
    intraFreqEvent-1d-r5              IntraFreqEvent-1d-r5            OPTIONAL
}

OngoingMeasRep-r6 ::= SEQUENCE {
    measurementIdentity    MeasurementIdentity,
    measurementCommandWithType    MeasurementCommandWithType-r6,
    measurementReportingMode      MeasurementReportingMode            OPTIONAL,
    additionalMeasurementID-List   AdditionalMeasurementID-List    OPTIONAL
}

OngoingMeasRep-r7 ::= SEQUENCE {
    measurementIdentity    MeasurementIdentity,
    measurementCommandWithType    MeasurementCommandWithType-r7,
    measurementReportingMode      MeasurementReportingMode            OPTIONAL,
    additionalMeasurementID-List   AdditionalMeasurementID-List    OPTIONAL
}

OngoingMeasRepList ::= SEQUENCE (SIZE (1..maxNoOfMeas)) OF
    OngoingMeasRep

OngoingMeasRepList-r4 ::= SEQUENCE (SIZE (1..maxNoOfMeas)) OF
    OngoingMeasRep-r4

OngoingMeasRepList-r5 ::= SEQUENCE (SIZE (1..maxNoOfMeas)) OF
    OngoingMeasRep-r5

OngoingMeasRepList-r6 ::= SEQUENCE (SIZE (1..maxNoOfMeas)) OF
    OngoingMeasRep-r6

OngoingMeasRepList-r7 ::= SEQUENCE (SIZE (1..maxNoOfMeas)) OF
    OngoingMeasRep-r7

PDCP-Capability-r4 ::= SEQUENCE {
    losslessSRNS-RelocationSupport    BOOLEAN,
    supportForRfc2507                 CHOICE {
        notSupported                NULL,
        supported                    MaxHcContextSpace
    }
}

```

```

    },
    supportForRfc3095 CHOICE {
        notSupported NULL,
        supported SEQUENCE {
            maxROHC-ContextSessions MaxROHC-ContextSessions-r4 DEFAULT s16,
            reverseCompressionDepth INTEGER (0..65535) DEFAULT 0
        }
    }
}

PDCP-Capability-r5 ::= SEQUENCE {
    losslessSRNS-RelocationSupport BOOLEAN,
    supportForRfc2507 CHOICE {
        notSupported NULL,
        supported MaxHcContextSpace-r5
    },
    supportForRfc3095 CHOICE {
        notSupported NULL,
        supported SEQUENCE {
            maxROHC-ContextSessions MaxROHC-ContextSessions-r4 DEFAULT s16,
            reverseCompressionDepth INTEGER (0..65535) DEFAULT 0,
            supportForRfc3095ContextRelocation BOOLEAN
        }
    }
}

PDCP-Capability-r6 ::= SEQUENCE {
    losslessSRNS-RelocationSupport BOOLEAN,
    losslessDLRLC-PDUSizeChange ENUMERATED { true } OPTIONAL,
    supportForRfc2507 CHOICE {
        notSupported NULL,
        supported MaxHcContextSpace-r5
    },
    supportForRfc3095 CHOICE {
        notSupported NULL,
        supported SEQUENCE {
            maxROHC-ContextSessions MaxROHC-ContextSessions-r4 DEFAULT s16,
            reverseCompressionDepth INTEGER (0..65535) DEFAULT 0,
            supportForRfc3095ContextRelocation BOOLEAN
        }
    }
}

PhysicalChannelCapability-r4 ::= SEQUENCE {
    fddPhysChCapability SEQUENCE {
        downlinkPhysChCapability DL-PhysChCapabilityFDD-r4,
        uplinkPhysChCapability UL-PhysChCapabilityFDD
    } OPTIONAL,
    tdd384-PhysChCapability SEQUENCE {
        downlinkPhysChCapability DL-PhysChCapabilityTDD,
        uplinkPhysChCapability UL-PhysChCapabilityTDD
    } OPTIONAL,
    tdd128-PhysChCapability SEQUENCE {
        downlinkPhysChCapability DL-PhysChCapabilityTDD-LCR-r4,
        uplinkPhysChCapability UL-PhysChCapabilityTDD-LCR-r4
    } OPTIONAL
}

PhysicalChannelCapability-r5 ::= SEQUENCE {
    fddPhysChCapability SEQUENCE {
        downlinkPhysChCapability DL-PhysChCapabilityFDD-r5,
        uplinkPhysChCapability UL-PhysChCapabilityFDD
    } OPTIONAL,
    tdd384-PhysChCapability SEQUENCE {
        downlinkPhysChCapability DL-PhysChCapabilityTDD-r5,
        uplinkPhysChCapability UL-PhysChCapabilityTDD
    } OPTIONAL,
    tdd128-PhysChCapability SEQUENCE {
        downlinkPhysChCapability DL-PhysChCapabilityTDD-LCR-r5,
        uplinkPhysChCapability UL-PhysChCapabilityTDD-LCR-r4
    } OPTIONAL
}

RF-Capability-r4 ::= SEQUENCE {
    fddRF-Capability SEQUENCE {
        ue-PowerClass UE-PowerClassExt,
        txRxFrequencySeparation TxRxFrequencySeparation
    } OPTIONAL,
}

```

```

tdd384-RF-Capability          SEQUENCE {
  ue-PowerClass                UE-PowerClassExt,
  radioFrequencyBandTDDList    RadioFrequencyBandTDDList,
  chipRateCapability           ChipRateCapability
}                               OPTIONAL,
tdd128-RF-Capability          SEQUENCE {
  ue-PowerClass                UE-PowerClassExt,
  radioFrequencyBandTDDList    RadioFrequencyBandTDDList,
  chipRateCapability           ChipRateCapability
}                               OPTIONAL
}

RFC3095-ContextInfo ::=      SEQUENCE {
  rb-Identity                  RB-Identity,
  rfc3095-Context-List        RFC3095-Context-List
}

RFC3095-Context-List ::=    SEQUENCE (SIZE (1..maxRFC3095-CID)) OF SEQUENCE {
  dl-RFC3095-Context          DL-RFC3095-Context    OPTIONAL,
  ul-RFC3095-Context          UL-RFC3095-Context    OPTIONAL
}

RLC-Capability-r5 ::=      SEQUENCE {
  totalRLC-AM-BufferSize      TotalRLC-AM-BufferSize-r5,
  maximumRLC-WindowSize       MaximumRLC-WindowSize,
  maximumAM-EntityNumber      MaximumAM-EntityNumberRLC-Cap
}

SRB-SpecificIntegrityProtInfo ::= SEQUENCE {
  ul-RRC-HFN                  BIT STRING (SIZE (28)),
  dl-RRC-HFN                  BIT STRING (SIZE (28)),
  ul-RRC-SequenceNumber       RRC-MessageSequenceNumber,
  dl-RRC-SequenceNumber       RRC-MessageSequenceNumber
}

SRB-SpecificIntegrityProtInfoList ::= SEQUENCE (SIZE (4..maxSRBsetup)) OF
SRB-SpecificIntegrityProtInfo

StateOfRRC ::=              ENUMERATED {
  cell-DCH, cell-FACH,
  cell-PCH, ura-PCH }

StateOfRRC-Procedure ::=    ENUMERATED {
  awaitNoRRC-Message,
  awaitRB-ReleaseComplete,
  awaitRB-SetupComplete,
  awaitRB-ReconfigurationComplete,
  awaitTransportCH-ReconfigurationComplete,
  awaitPhysicalCH-ReconfigurationComplete,
  awaitActiveSetUpdateComplete,
  awaitHandoverComplete,
  sendCellUpdateConfirm,
  sendUraUpdateConfirm,
  -- dummy is not used in this version of specification
  -- It should not be sent
  dummy,
  otherStates
}

TotalRLC-AM-BufferSize-r5 ::= ENUMERATED {
  kb10, kb50, kb100, kb150, kb200,
  kb300, kb400, kb500, kb750, kb1000 }

TPC-Combination-Info ::= SEQUENCE {
  primaryCPICH-Info           PrimaryCPICH-Info,
  tpc-CombinationIndex        TPC-CombinationIndex
}

UE-MultiModeRAT-Capability-r5 ::= SEQUENCE {
  multiRAT-CapabilityList     MultiRAT-Capability,
  multiModeCapability         MultiModeCapability,
  supportOfUTRAN-ToGERAN-NACC BOOLEAN
}

UE-Positioning-Capability-r4 ::= SEQUENCE {
  standaloneLocMethodsSupported BOOLEAN,
  ue-BasedOTDOA-Supported     BOOLEAN,

```

```

networkAssistedGPS-Supported      NetworkAssistedGPS-Supported,
supportForUE-GPS-TimingOfCellFrames  BOOLEAN,
supportForIPDL                    BOOLEAN,
rx-tx-TimeDifferenceType2Capable    BOOLEAN,
validity-CellPCH-UraPCH            ENUMERATED { true }    OPTIONAL,
sfn-sfnType2Capability             ENUMERATED { true }    OPTIONAL
}

UE-Positioning-LastKnownPos ::= SEQUENCE {
    sfn                INTEGER (0..4095),
    cell-id            CellIdentity,
    positionEstimate   PositionEstimate
}

UE-RadioAccessCapability-r4 ::= SEQUENCE {
    accessStratumReleaseIndicator  AccessStratumReleaseIndicator,
    pdcp-Capability                PDCP-Capability-r4,
    rlc-Capability                 RLC-Capability,
    transportChannelCapability     TransportChannelCapability,
    rf-Capability                  RF-Capability-r4,
    physicalChannelCapability      PhysicalChannelCapability-r4,
    ue-MultiModeRAT-Capability     UE-MultiModeRAT-Capability,
    securityCapability             SecurityCapability,
    ue-positioning-Capability      UE-Positioning-Capability-r4,
    measurementCapability          MeasurementCapability-r4    OPTIONAL
}

UE-RadioAccessCapability-r5 ::= SEQUENCE {
    accessStratumReleaseIndicator  AccessStratumReleaseIndicator,
    dl-CapabilityWithSimultaneousHS-DSCHConfig  DL-CapabilityWithSimultaneousHS-DSCHConfig  OPTIONAL,
    pdcp-Capability                PDCP-Capability-r5,
    rlc-Capability                 RLC-Capability-r5,
    transportChannelCapability     TransportChannelCapability,
    rf-Capability                  RF-Capability-r4,
    physicalChannelCapability      PhysicalChannelCapability-r5,
    ue-MultiModeRAT-Capability     UE-MultiModeRAT-Capability-r5,
    securityCapability             SecurityCapability,
    ue-positioning-Capability      UE-Positioning-Capability-r4,
    measurementCapability          MeasurementCapability-r4    OPTIONAL
}

UE-RadioAccessCapability-r6 ::= SEQUENCE {
    accessStratumReleaseIndicator  AccessStratumReleaseIndicator,
    dl-CapabilityWithSimultaneousHS-DSCHConfig  DL-CapabilityWithSimultaneousHS-DSCHConfig  OPTIONAL,
    pdcp-Capability                PDCP-Capability-r6,
    rlc-Capability                 RLC-Capability-r5,
    transportChannelCapability     TransportChannelCapability,
    rf-Capability                  RF-Capability-r4,
    physicalChannelCapability      PhysicalChannelCapability-r5,
    ue-MultiModeRAT-Capability     UE-MultiModeRAT-Capability-r5,
    securityCapability             SecurityCapability,
    ue-positioning-Capability      UE-Positioning-Capability-r4,
    measurementCapability          MeasurementCapability-r4    OPTIONAL
}

UL-RFC3095-Context ::= SEQUENCE {
    rfc3095-Context-Identity      INTEGER (0..16383),
    ul-mode                       ENUMERATED {u, o, r},
    ul-ref-ir                     OCTET STRING ( SIZE (1..3000)),
    ul-ref-time                   INTEGER (0..4294967295)    OPTIONAL,
    ul-curr-time                  INTEGER (0..4294967295)    OPTIONAL,
    ul-syn-offset-id              INTEGER (0..65535)         OPTIONAL,
    ul-syn-slope-ts               INTEGER (0..4294967295)    OPTIONAL,
    ul-ref-sn-1                   INTEGER (0..65535)         OPTIONAL
}
END

```

12 Message transfer syntax

Transfer syntax for RRC PDUs is derived from their ASN.1 definitions by use of Packed Encoding Rules, unaligned as specified in X.691 [49], and with adapted final padding. If special encoding is used, it is indicated in the ECN module defined for each ASN.1 module. The use of special encoding is defined in [14].

The following encoding rules apply in addition to what has been specified in X.691 [49]:

- When a bit string value is placed in a bit-field as specified in 15.6 to 15.11 in [11], the leading bit of the bit string value shall be placed in the leading bit of the bit-field, and the trailing bit of the bit string value shall be placed in the trailing bit of the bit-field.

NOTE: The terms "leading bit" and "trailing bit" are defined in ITU-T Rec. X.680 | ISO/IEC 8824-1. When using the "bstring" notation, the leading bit of the bit string value is on the left, and the trailing bit of the bit string value is on the right.

12.1 Structure of encoded RRC messages

An RRC PDU, which is the bit string that is exchanged between peer entities/ across the radio interface, is the concatenation of a basic production, an extension and padding, in that order.

RRC PDUs shall be mapped to and from RLC SDUs upon transmission and reception as follows:

- when delivering an RRC PDU as an RLC SDU to the RLC layer for transmission, the first bit of the RRC PDU shall be represented as the first bit in the RLC SDU and onwards; and
- upon reception of an RLC SDU from the RLC layer, the first bit of the RLC SDU shall represent the first bit of the RRC PDU and onwards.

12.1.1 Basic production

The 'basic production' is obtained by applying UNALIGNED PER to the abstract syntax value (the ASN.1 description) as specified in X.691, except for the 0 to 7 bits added at the end to produce a multiple of 8 bits. The basic production can have any positive number of bits, not necessarily a multiple of 8 bits.

12.1.2 Extension

Emitters compliant with this version of the specification of the protocol shall, unless indicated otherwise on a PDU type basis, set the extension part empty. Emitters compliant with a later version might send non-empty extensions.

12.1.3 Padding

Emitters compliant with this version of the specification of the protocol shall, unless indicated otherwise on a PDU type basis, pad the basic production with the smallest number of bits required to meet the size constraints of the lower layers. Padding bits shall be set to 0.

Receivers compliant with this version of the specification have no need to distinguish the extension and padding parts, and shall, unless indicated otherwise on a PDU type basis, accept RRC PDUs with any bit string in the extension and padding parts.

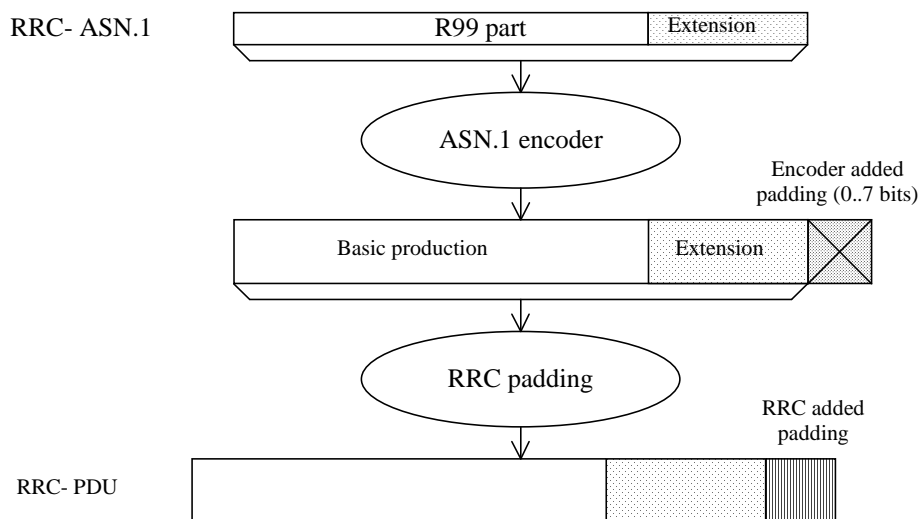

Figure 12.1.3-1: Padding

When using AM or UM mode, RLC requires that the RRC PDU length is a multiple of 8 bits.

When using Tr mode, RLC does neither impose size requirements nor perform padding. This implies that RRC has to take into account the transport format set defined for the transport channel across which the message is to be sent. RRC shall add the lowest number of padding bits required to fit the size specified for the selected transport format.

For paging type 1 messages, in case the PCCH is mapped on HS-DSCH, padding needs to apply only to ensure octet alignment.

For SYSTEM INFORMATION CHANGE INDICATION message, in case the BCCH is mapped on HS-DSCH, padding needs to apply only to ensure octet alignment.

For system information blocks, building the PDU involves two steps. The first step is the building of the System Information Blocks, in which step padding is not applied (the rules for extension apply). The second step is the building of the RRC PDUs, involving segmentation and concatenation of System Information Blocks, and then padding as described above for Tr mode if the BCCH carrying the System Information Blocks is mapped on BCH. The procedure is shown by means of an example as described in Figure 12.1.3-2. The example includes two System Information Blocks, SIB_n and SIB_{n+1}, of which only SIB_n includes a protocol extension. The two System Information Blocks used in the example do not require segmentation and are concatenated into one SYSTEM INFORMATION message.

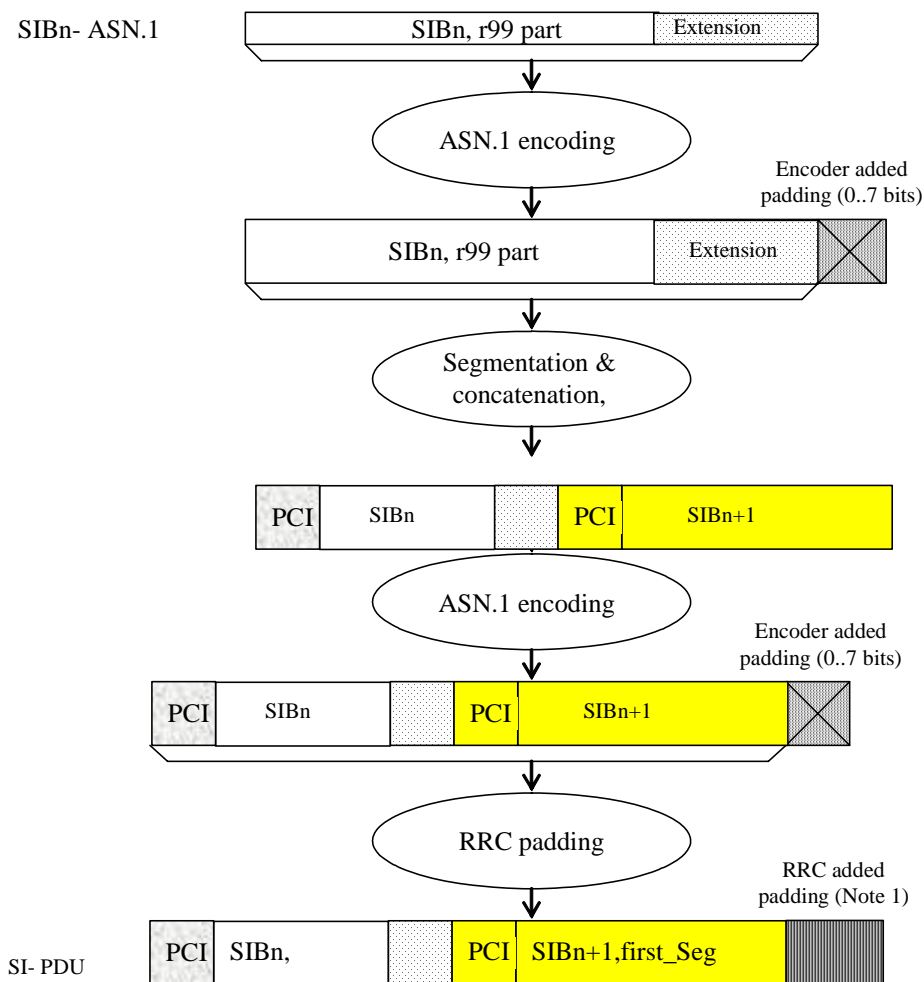

Note 1: RRC padding needs to be added only to octet align BCCH blocks which are mapped onto HS-DSCH

Figure 12.1.3-2: Padding for System Information

PCI: Protocol control information at SYSTEM INFORMATION message level

SI: SYSTEM INFORMATION message

For system information blocks, RRC may also add padding information at the end of IE "SIB data fixed", used both within IE "Last segment" and IE "Complete SIB". The IE "SIB data fixed" has a fixed length i.e. no length denominator used. In case the remaining amount of "SIB data" information is insufficient to fill the IE completely, RRC includes padding bits.

Since no length denominator is included, the receiving RRC cannot remove the padding added by the sender. However, since the padding used is the same as the padding added by the PER encoder to achieve octet alignment, the receiver can handle it.

NOTE 1 The mechanism described above implies that the PDU provided to the ASN.1 decoder may have more than 7 padding bits included. For a complete System Information Block of length 215 bits, 11 padding bits are added by RRC. Since the decoder requires an octet aligned input, 6 additional bits need to be added. In this (worst) case, a total of 17 padding bits is included.

NOTE 2 For the above cases, use of padding bits is possible and more efficient than including a length denominator.

When using the RRC padding described above, the segment has a fixed length, which completely fills the transport block. Therefore, in this case no RRC padding is added within the SYSTEM INFORMATION message. This is illustrated by means of the following figure.

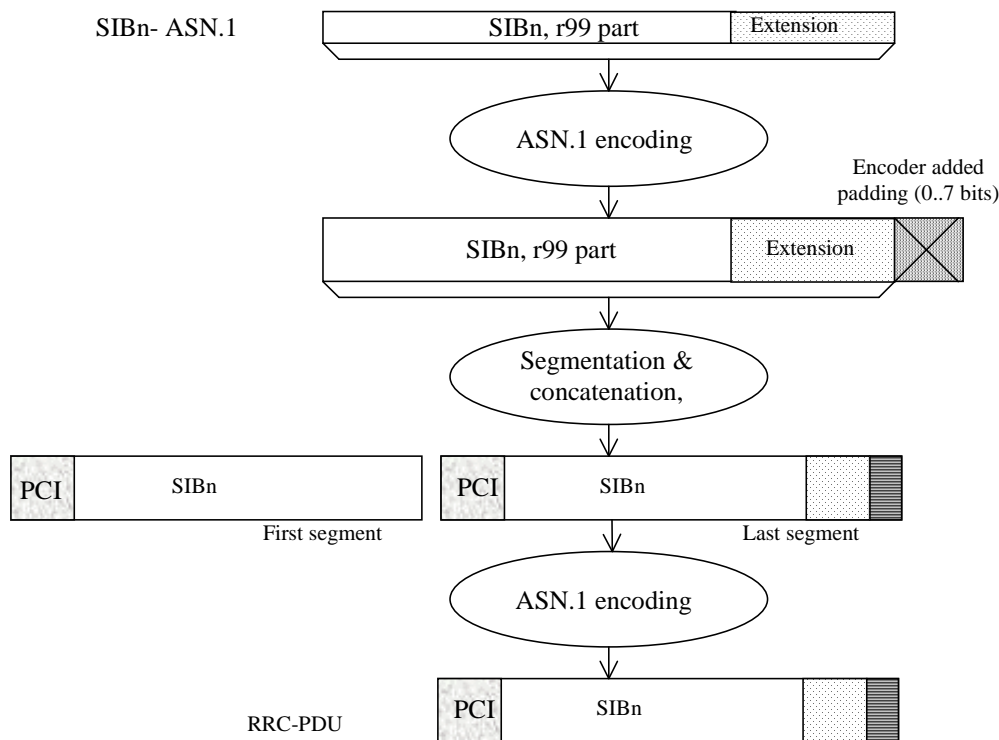

Figure 12.1.3-3: No RRC padding for System Information

12.2 ECN link module for RRC

```

RRC-ECN-Link-Module LINK-DEFINITIONS ::=
BEGIN

IMPORTS
    RRC-encodings          -- Encoding objects for RRC messages
FROM RRC-Encoding-Definitions;

ENCODE Class-definitions
    WITH RRC-encodings
    COMPLETED BY PER-BASIC-UNALIGNED

ENCODE PDU-definitions
    WITH RRC-encodings
    COMPLETED BY PER-BASIC-UNALIGNED

ENCODE InformationElements
    WITH RRC-encodings
    COMPLETED BY PER-BASIC-UNALIGNED

ENCODE Internode-definitions
    WITH RRC-encodings
    COMPLETED BY PER-BASIC-UNALIGNED

END

```

12.3 ECN modules for RRC

The encoding definition module "RRC-Encoding-Definitions" contains definition of the encoding object set "RRC-encodings". The encoding object set contains all the specialized encoding for RRC.

```

RRC-Encoding-Definitions ENCODING-DEFINITIONS ::=

```

```

BEGIN
EXPORTS
    RRC-encodings;

RRC-encodings #ENCODINGS ::= {
    -- Trailing bits
    outer-encoding
}

--*****
--
-- The trailing bits in all RRC messages shall be ignored
-- (including unknown message contents & unknown extensions).
-- This overrides the default PER behaviour which pads the last
-- octet with zero bits.
--
--*****

outer-encoding #OUTER ::= {
    ENCODER-DECODER {
    }
    DECODE AS IF {
        POST-PADDING    encoder-option
    }
}

END

Class-definitions-ECN-Module ENCODING-DEFINITIONS ::=
BEGIN
END

PDU-definitions-ECN-Module ENCODING-DEFINITIONS ::=
BEGIN
END

InformationElements-ECN-Module ENCODING-DEFINITIONS ::=
BEGIN
END

Internode-definitions-ECN-Module ENCODING-DEFINITIONS ::=
BEGIN
END

```

12.4 RRC messages encoded otherwise

NOTE: The messages included in this section are not specified by means of ASN.1.

12.4.1 Messages using tabular encoding specification

The encoding of the message is specified by means of a table listing the information elements known in the message and their order of their appearance in the message.

When a field extends over more than one octet, the order of bit values progressively decreases as the octet number increases. The least significant bit of the field is represented by the lowest numbered bit of the highest numbered octet of the field.

12.4.1.1 TRANSPORT FORMAT COMBINATION CONTROL using transparent DCCH

12.4.1.1.1 TRANSPORT FORMAT COMBINATION CONTROL, 3 bit format

The 3 bit format is as follows:

3	2	1	Transport Format Combination Set Identity value
0	0	0	0
0	0	1	1
0	1	0	2
1	1	1	7

12.4.1.1.2 Void

12.4.1.1.3 Void

13 Protocol timers, counters, other parameters and default configurations

The information provided in subclauses 13.1 and 13.2 shall be treated as informative. The normative text is specified in the relevant subclauses in clause 8 and clause 8 shall prevail.

13.1 Timers for UE

Timer	Start	Stop	At expiry
T300	Transmission of RRC CONNECTION REQUEST in case of connection establishment for reasons other than MBMS reception	Reception of RRC CONNECTION SETUP	Retransmit RRC CONNECTION REQUEST if V300 =< N300, else go to Idle mode
T302	Transmission of CELL UPDATE/URA UPDATE	Reception of CELL UPDATE CONFIRM/URA UPDATE CONFIRM	Retransmit CELL UPDATE/URA UPDATE if V302 =< N302, else, go to Idle mode
T304	Transmission of UE CAPABILITY INFORMATION	Reception of UE CAPABILITY INFORMATION CONFIRM	Retransmit UE CAPABILITY INFORMATION if V304 =< N304, else initiate a cell update procedure
T305	Entering CELL_FACH or URA_PCH or CELL_PCH state. Reception of CELL UPDATE CONFIRM/URA UPDATE CONFIRM.	Entering another state.	Transmit CELL UPDATE if T307 is not activated and the UE detects "in service area". Otherwise, if T307 is not active, start T307.
T307	When the timer T305 has expired and the UE detects "out of service area".	When the UE detects "in service area".	Transit to idle mode
T308	Transmission of RRC CONNECTION RELEASE COMPLETE	Not stopped	Transmit RRC CONNECTION RELEASE COMPLETE if V308 <=N308, else go to idle mode.
T309	Upon reception of CELL CHANGE ORDER FROM UTRAN message	Successful response to a connection establishment request in the new cell.	Resume the connection to UTRAN
T310	Transmission of PUSCH CAPACITY REQUEST	Reception of PHYSICAL SHARED CHANNEL ALLOCATION	Transmit PUSCH CAPACITY REQUEST if V310 =< N310, else procedure stops.
T311	Reception of PHYSICAL SHARED CHANNEL ALLOCATION message with the CHOICE "PUSCH allocation" set to "PUSCH allocation pending".	Reception of PHYSICAL SHARED CHANNEL ALLOCATION message with CHOICE "PUSCH allocation" set to "PUSCH allocation assignment".	UE may initiate a PUSCH capacity request procedure.
T312	When the UE starts to establish dedicated CH	When the UE detects N312 "in sync" indication from L1.	The criteria for physical channel establishment failure is fulfilled
T313	When the UE detects consecutive N313 "out of sync" indication from L1.	When the UE detects consecutive N315 "in sync" indication from L1.	The criteria for Radio Link failure is fulfilled.
T314	When the criteria for radio link failure are fulfilled. The timer is started if radio bearer(s) that are associated with T314 exist or if only RRC connection exists only to the CS domain.	When the Cell Update procedure has been completed.	See subclause 8.3.1.13.

Timer	Start	Stop	At expiry
T315	When the criteria for radio link failure are fulfilled. The timer is started only if radio bearer(s) that are associated with T315 exist or if RRC connection exists to PS domain.	When the Cell Update procedure has been completed.	See subclause 8.3.1.14.
T316	When the UE detects "out of service area" in URA_PCH or CELL_PCH state	When the UE detects "in service area".	Initiate cell update procedure if in service area is detected. Otherwise start timer T317, transit to CELL_FACH state and initiate cell update procedure when the UE detects "in service area".
T317	When the T316 expires or when in CELL_FACH state, the UE detects "out of service area".	When the UE detects "in service area".	T317 never expires.
T318	Transmission of RRC CONNECTION REQUEST in case of connection establishment for MBMS reception	Reception of RRC CONNECTION SETUP	Enter idle mode
T319	When entering CELL_PCH or URA_PCH.	When leaving CELL_PCH or URA_PCH state.	The UE activates starts the DRX cycle based on "DRX cycle length coefficient".
T320	When receiving the CELL UPDATE CONFIRM message with IE "Wait time" and IE "RRC State Indicator" set to the value "CELL_PCH" or "URA_PCH".	When initiating the cell update or URA update procedure, see subclause 8.3.1.2.	See subclause 8.3.1.16.

13.2 Counters for UE

Counter	Reset	Incremented	When reaching max value
V300	When initiating the procedure RRC connection establishment	Upon expiry of T300.	When V300 > N300, the UE enters idle mode.
V302	When initiating the procedure Cell update or URA update	Upon expiry of T302	When V302 > N302 the UE enters idle mode.
V304	When sending the first UE CAPABILITY INFORMATION message.	Upon expiry of T304	When V304 > N304 the UE initiates the Cell update procedure
V308	When sending the first RRC CONNECTION RELEASE COMPLETE message in a RRC connection release procedure.	Upon expiry of T308	When V308 > N308 the UE stops re-transmitting the RRC CONNECTION RELEASE COMPLETE message.
V310	When sending the first PUSCH CAPACITY REQUEST message in a PUSCH capacity request procedure	Upon expiry of T310	When V310 > N310 the UE stops re-transmitting the PUSCH CAPACITY REQUEST message.

13.3 UE constants and parameters

Constant	Usage
N300	Maximum number of retransmissions of the RRC CONNECTION REQUEST message
N302	Maximum number of retransmissions of the CELL UPDATE / URA UPDATE message
N304	Maximum number of retransmissions of the UE CAPABILITY INFORMATION message
N308	Maximum number of retransmissions of the RRC CONNECTION RELEASE COMPLETE message
N310	Maximum number of retransmission of the PUSCH CAPACITY REQUEST message
N312	Maximum number of "in sync" received from L1.
N313	Maximum number of successive "out of sync" received from L1.
N315	Maximum number of successive "in sync" received from L1 during T313 is activated.

13.4 UE variables

13.4.ob AM_RLC_ERROR_PENDING_RB234

This variable indicates whether an AM RLC unrecoverable error has been detected during the current cell update procedure on RB 2, 3, or 4.

Information Element/Group name	Need	Multi	Type and reference	Semantics description
AM RLC error pending	MP		Boolean	TRUE means an unrecoverable error was detected on AM RLC during the current cell update procedure.. Set to FALSE when the cell update procedure is completed.

13.4.oc AM_RLC_ERROR_PENDING_RB5_AND_UP

This variable indicates whether an AM RLC unrecoverable error has been detected during the current cell update procedure on RB 5 or above.

Information Element/Group name	Need	Multi	Type and reference	Semantics description
AM RLC error pending	MP		Boolean	TRUE means an unrecoverable error was detected on AM RLC during the current cell update procedure.. Set to FALSE when the cell update procedure is completed.

13.4.0 CELL_INFO_LIST

This variable contains cell information on intra-frequency, inter-frequency and inter-RAT cells, as received in messages System Information Block Type 11, System Information Block Type 12, and MEASUREMENT CONTROL.

The first position in Intra-frequency cell info list corresponds to Intra-frequency cell id 0, the second to Intra-frequency cell id 1, etc.

The first position in Inter-frequency cell info list corresponds to Inter-frequency cell id 0, the second to Inter-frequency cell id 1, etc.

The first position in Inter-RAT cell info list corresponds to Inter-RAT cell id 0, the second to Inter-RAT cell id 1, etc.

This variable shall be cleared at cell re-selection, when leaving UTRA RRC connected mode, when switched off as well as at selection of a new PLMN.

Information Element/Group name	Need	Multi	Type and reference	Semantics description	Version
Intra-frequency cell info	OP	1..<maxCel IMeas>			
>CHOICE <i>position status</i>	MP				
>>Occupied					
>>>Cell info	MP		Cell info 10.3.7.2		
>>Vacant				No data	
Inter-frequency cell info	OP	1..<maxCel IMeas>			
>CHOICE <i>position status</i>	MP				
>>Occupied					
>>>Frequency info	MP		Frequency info 10.3.6.36		
>>>Cell info	MP		Cell info 10.3.7.2		
>>Vacant				No data	
Inter-RAT cell info list	OP				REL-5
>Inter-RAT cell info	OP	1..<maxCel IMeas>			
>>CHOICE <i>position status</i>	MP				
>>>Occupied					
>>>>CHOICE <i>Radio Access Technology</i>					
>>>>>GSM					
>>>>>>Cell selection and re- selection info	MP		Cell selection and re- selection info for SIB11/12 10.3.2.4		
>>>>>>BSIC	MP		BSIC 10.3.8.2		
>>>>>>BCCH ARFCN	MP		Integer (0..1023)	[43]	
>>>>>>IS-2000					
>>>>>>>System specific measurement info			enumerated (frequency, timeslot, colour code, output power, PN offset)	For IS-2000, use fields from TIA/EIA/IS-2000.5, subclause 3. 7.3.3.2.27, <i>Candidate Frequency Neighbour List Message</i>	
>>>Vacant				No data	
>CHOICE <i>indication status</i>	MP				REL-5
>>Present					REL-5
>>>Inter-RAT cell info indication	OP		Integer (0..3)		REL-5
>>Not present				No data	REL-5

13.4.00 Void

13.4.0a CELL_UPDATE_STARTED

This variable indicates whether a cell update or URA update procedure is in progress.

Information Element/Group name	Need	Multi	Type and reference	Semantics description
Cell update started	MP		Boolean	TRUE means a cell or URA update procedure is in progress. Set to FALSE when entering UTRA RRC connected mode. Set to FALSE when leaving UTRA RRC connected mode.

13.4.1 CIPHERING_STATUS

This variable contains information about the current status of ciphering in the UE.

Information Element/Group name	Need	Multi	Type and reference	Semantics description
Status for each CN domain	MP	<1 to maxCNDomains>		
>CN domain identity	MP		CN domain identity 10.3.1.1	
>Status	MP		Enumerated(Not started, Started)	Set to "Not started" when entering UTRA RRC connected mode. Set to "Not started" when leaving UTRA RRC connected mode.
Reconfiguration	MP		Boolean	TRUE means an RRC procedure performing reconfiguration of ciphering is ongoing. Set to FALSE when entering UTRA RRC connected mode. Set to FALSE when leaving UTRA RRC connected mode.

13.4.2 Void

13.4.2a CONFIGURATION_INCOMPLETE

This variable indicates whether a received measurement control message contains invalid an incomplete measurement configuration.

Information Element/Group name	Need	Multi	Type and reference	Semantics description
Configuration incomplete	MP		Boolean	TRUE: An incomplete configuration has been detected. Set to FALSE when entering UTRA RRC connected mode. Set to FALSE when leaving UTRA RRC connected mode.

13.4.3 C_RNTI

This variable stores the assigned C-RNTI for this UE when in CELL_FACH state. For FDD, this variable stores the assigned C-RNTI for this UE in CELL_PCH state, if in CELL_PCH state a HS-DSCH transport channel has been allocated.

Information Element/Group name	Need	Multi	Type and reference	Semantics description
C-RNTI	OP		C-RNTI 10.3.3.8	Cleared when entering UTRA RRC connected mode when not otherwise stated in the procedure. Cleared when leaving UTRA RRC connected mode.

13.4.3a DEFERRED_MEASUREMENT_STATUS

Information Element/Group name	Need	Multi	Type and reference	Semantics description	Version
Deferred measurement status	MP		Boolean	If TRUE, the UE can transmit RRC messages on RACH and receive RRC messages commanding it to enter CELL_DCH without having read and acted on SIB11, SIB11bis and 12.	REL-7

13.4.3b DTX_DRX_PARAMS

NOTE: For FDD only.

Information Element/Group name	Need	Multi	Type and reference	Semantics description	Version
UE parameters for DTX-DRX	MD		DTX-DRX Information in 10.3.6.34a		REL-7

13.4.3c DTX_DRX_STATUS

NOTE: For FDD only.

This variable indicates whether discontinuous UL DPCCH transmission and discontinuous reception of F-DPCH and HSPA DL channel procedures are ongoing. See subclause 8.5.34 for actions related to the setting of this variable.

Information Element/Group name	Need	Multi	Type and reference	Semantics description	Version
DTX_DRX_STATUS	MP		Boolean	TRUE: discontinuous transmission and reception is ongoing. Set to FALSE when entering UTRA RRC connected mode when not otherwise stated in the procedure. Set to FALSE when leaving UTRA RRC connected mode.	REL-7

13.4.3d DSAC_PARAM

This variable contains Domain Specific Access Restriction Parameters during the connected mode.

Information Element/Group name	Need	Multi	Type and reference	Semantics description	Version
CS Domain Specific Access Restriction	MP		Domain Access Restriction 10.3.1.3b	This IE contains CS Domain Specific Access Restriction Parameters	REL-6
PS Domain Specific Access Restriction	MP		Domain Access Restriction 10.3.1.3b	This IE contains PS Domain Specific Access Restriction Parameters	REL-6

13.4.3e DSCH_RNTI

In TDD this variable stores the assigned DSCH-RNTI for this UE when in CELL_DCH state.

Information Element/Group name	Need	Multi	Type and reference	Semantics description
DSCH-RNTI	OP		DSCH-RNTI 10.3.3.9a	Cleared when entering UTRA RRC connected mode when not otherwise stated in the procedure. Cleared when leaving UTRA RRC connected mode.

13.4.4 Void

13.4.4o E_DCH_TRANSMISSION

This variable indicates whether E-DPDCH and E-DPCCH transmission procedures are ongoing. See subclause 8.5.28 for actions related to the setting of this variable.

Information Element/Group name	Need	Multi	Type and reference	Semantics description	Version
E-DCH transmission	MP		Boolean	TRUE: E-DCH transmission is ongoing. Set to FALSE when entering UTRA RRC connected mode when not otherwise stated in the procedure. Set to FALSE when leaving UTRA RRC connected mode.	REL-6

13.4.4a E_RNTI

Information Element/Group name	Need	Multi	Type and reference	Semantics description	Version
Primary E-RNTI	OP		E-RNTI 10.3.3.10a	Cleared when entering UTRA RRC connected mode when not otherwise stated in the procedure. Cleared when leaving UTRA RRC connected mode.	REL-6
Secondary E-RNTI	OP		E-RNTI 10.3.3.10a	Cleared when entering UTRA RRC connected mode when not otherwise stated in the procedure. Cleared when leaving UTRA RRC connected mode.	REL-6

13.4.5 ESTABLISHED_RABS

This variable is used to store information about the established radio access bearers and signalling radio bearers in the UE.

Information Element/Group name	Need	Multi	Type and reference	Semantics description
RAB information	OP	1 to <maxRABsetup>		For each RAB established. Cleared when entering UTRA RRC connected mode when not otherwise stated in the procedure. Cleared when leaving UTRA RRC connected mode.
>RAB info	MP		RAB info 10.3.4.8	
>RB information	MP	1 to <maxRBper RAB>		For each RB belonging to the RAB
>>RB identity	MP		RB identity 10.3.4.16	
>>Subflow	MP		Integer(0..<maxSubflow count>)	Reference to the RAB subflow implemented by this RB
>>RB started	MD		Enumerated(stopped, started)	Default value is started
Signalling radio bearer information	OP	1 to <maxSRBsetup>		In the order of RB0 and upwards. Cleared when leaving UTRA RRC connected mode.
>RB started	MD		Enumerated(stopped, started)	Default value is started

13.4.5a ESTABLISHED_SIGNALLING_CONNECTIONS

This variable is used to store information about established signalling connections.

Information Element/Group name	Need	Multi	Type and reference	Semantics description
Signalling connection list	OP	1 to <maxCNdo mains>		For each established signalling connection. Cleared when entering UTRA RRC connected mode when not otherwise stated in the procedure. Cleared when leaving UTRA RRC connected mode.
>Signalling connection identity	MP		CN domain identity 10.3.1.1	

13.4.6 ESTABLISHMENT_CAUSE

This variable is used to store the cause for establishment of a signalling connection received by upper layers, to be used at RRC connection establishment or Initial Direct Transfer.

Information Element/Group name	Need	Multi	Type and reference	Semantics description
Establishment cause	OP		Establishment cause 10.3.3.11	Cleared when leaving UTRA RRC connected mode.

13.4.7 FAILURE_CAUSE

This variable contains the cause for failure of a UE initiated procedure, to be reported in a retransmitted message.

Information Element/Group name	Need	Multi	Type and reference	Semantics description
Failure cause	OP		Failure cause 10.3.3.13	Cleared when entering UTRA RRC connected mode. Cleared when leaving UTRA RRC connected mode.

13.4.8 FAILURE_INDICATOR

This variable indicates whether the procedure has failed for a UE initiated procedure.

Information Element/Group name	Need	Multi	Type and reference	Semantics description
Failure indicator	MP		Boolean	TRUE: Procedure has failed. Set to FALSE when entering UTRA RRC connected mode. Set to FALSE when leaving UTRA RRC connected mode.

13.4.8o H_RNTI

This variable stores the assigned H-RNTI for this UE when in CELL-DCH, CELL_FACH (FDD only) or CELL_PCH (FDD only) state, and when an HS-DSCH transport channel has been allocated.

Information Element/Group name	Need	Multi	Type and reference	Semantics description	Version
H-RNTI	OP		H-RNTI 10.3.3.14a	Cleared when entering UTRA RRC connected mode when not otherwise stated in the procedure. Cleared when leaving UTRA RRC connected mode.	REL-5

13.4.800 HS_DSCH_RECEPTION

This variable indicates whether HS-SCCH and HS-DSCH reception procedures are ongoing. See subclause 8.5.25 for actions related to the setting of this variable.

Information Element/Group name	Need	Multi	Type and reference	Semantics description	Version
HS-DSCH reception	MP		Boolean	TRUE: HS-DSCH reception is ongoing. Set to FALSE when entering UTRA RRC connected mode when not otherwise stated in the procedure. Set to FALSE when leaving UTRA RRC connected mode.	REL-5

13.4.80a HS_DSCH_RECEPTION_CELL_FACH_STATE

This variable indicates whether HS-SCCH and HS-DSCH reception procedures are ongoing in CELL_FACH for BCCH, DCCH and, if configured, DTCH reception. See subclause 8.5.36 for actions related to the setting of this variable.

NOTE: FDD only.

Information Element/Group name	Need	Multi	Type and reference	Semantics description	Version
HS-DSCH reception in CELL_FACH state	MP		Boolean	TRUE: HS-DSCH reception in CELL_FACH is ongoing. Set to FALSE when entering UTRA RRC connected mode, CELL_PCH, URA_PCH and CELL_DCH. Set to FALSE when leaving UTRA RRC connected mode,	REL-7

13.4.8ob HS_DSCH_RECEPTION_OF_CCCH_ENABLED

This variable indicates whether HS-SCCH and HS-DSCH reception procedures are enabled for CCCH and BCCH, and for SRB1 if the UE is in CELL_FACH state. See subclause 8.5.37 for actions related to the setting of this variable.

NOTE: For FDD only.

Information Element/Group name	Need	Multi	Type and reference	Semantics description	Version
HS-DSCH reception of CCCH	MP		Boolean	TRUE: HS-DSCH reception for the CCCH is enabled. Set to FALSE when leaving UTRA RRC connected mode. Set to FALSE when entering CELL_PCH, URA_PCH and CELL_DCH.	REL-7

13.4.8oc HS_DSCH_RECEPTION_GENERAL

This variable indicates whether HS-SCCH and HS-DSCH reception procedures are ongoing in CELL_DCH, CELL_FACH, CELL_PCH, or URA_PCH. See subclause 8.5.37a for actions related to the setting of this variable.

NOTE: FDD only.

Information Element/Group name	Need	Multi	Type and reference	Semantics description	Version
HS-DSCH reception in all states	MP		Boolean	TRUE: HS-DSCH reception in CELL_DCH, FACH, CELL_PCH or URA_PCH is ongoing. Set to FALSE when entering UTRA RRC connected mode when not otherwise stated in the procedure. Set to FALSE when leaving UTRA RRC connected mode	REL-7

13.4.8ooo HS_SCCH_LESS_PARAMS

NOTE: For FDD only.

This variable contains the parameters for UE operation in HS-SCCH less mode. The parameters are listed in subclause 10.3.6.36ab.

Information Element/Group name	Need	Multi	Type and reference	Semantics description	Version
UE parameters for HS-SCCH less	MD		HS-SCCH less Information in 10.3.6.36ab		REL-7

13.4.80000 HS_SCCH_LESS_STATUS

NOTE: For FDD only.

This variable indicates whether HS-SCCH less HS-DSCH transmission procedures are ongoing. See subclause 8.5.35 for actions related to the setting of this variable.

Information Element/Group name	Need	Multi	Type and reference	Semantics description	Version
HS_SCCH_LESS_STATUS	MP		Boolean	TRUE: HS-SCCH less HS-DSCH transmission is ongoing. Set to FALSE when entering UTRA RRC connected mode when not otherwise stated in the procedure. Set to FALSE when leaving UTRA RRC connected mode.	REL-7

13.4.8a INCOMPATIBLE_SECURITY_RECONFIGURATION

This variable indicates whether an incompatible simultaneous reconfiguration of a security function has been received.

Information Element/Group name	Need	Multi	Type and reference	Semantics description
Incompatible security reconfiguration	MP		Boolean	TRUE: An incompatible simultaneous security reconfiguration has been detected. Set to FALSE when entering UTRA RRC connected mode. Set to FALSE when leaving UTRA RRC connected mode.

13.4.8b Void

13.4.8c Void

13.4.9 INITIAL_UE_IDENTITY

In this variable the identity used by the UE when establishing an RRC connection is stored.

Information Element/Group name	Need	Multi	Type and reference	Semantics description
Initial UE identity	OP		Initial UE identity 10.3.3.15	Cleared when leaving UTRA RRC connected mode.

13.4.9a INTEGRITY_PROTECTION_ACTIVATION_INFO

This variable contains information to be sent to UTRAN about when a new integrity protection configuration shall be activated in the uplink for signalling radio bearers in case of modification of integrity protection.

Information Element/Group name	Need	Multi	Type and reference	Semantics description
Uplink Integrity protection activation info	OP		Integrity protection activation info 10.3.3.17	Cleared when entering UTRA RRC connected mode. Cleared when leaving UTRA RRC connected mode.

13.4.10 INTEGRITY_PROTECTION_INFO

This variable contains information about the current status of the integrity protection in the UE.

Information Element/Group name	Need	Multi	Type and reference	Semantics description
Status	MP		Enumerated(Not started, Started)	Set to "Not started" when entering UTRA RRC connected mode. Set to "Not started" when leaving UTRA RRC connected mode.
Reconfiguration	MP		Boolean	TRUE means a reconfiguration of integrity protection is ongoing. Set to FALSE when entering UTRA RRC connected mode. Set to FALSE when leaving UTRA RRC connected mode.
Signalling radio bearer specific integrity protection information	OP	1 to <maxSRBs etup>		When integrity protection is started, status information for RB0- RB4 in that order. Cleared when entering UTRA RRC connected mode. Cleared when leaving UTRA RRC connected mode.
>Uplink RRC HFN	MP		Bit string (28)	
>Downlink RRC HFN	MP		Bit string (28)	
>Uplink RRC Message sequence number	MP		Integer (0..15)	
>Downlink RRC Message sequence number	OP		Integer (0..15)	

13.4.10a INTER_RAT_HANDBOVER_INFO_TRANSFERRED

This variable stores information about the inter RAT handover info that has been transferred to another RAT.

Information Element/Group name	Need	Multi	Type and reference	Semantics description	Version
Predefined configuration status information	OP		Predefined configuration status information 10.3.4.5a	Cleared upon entering connected mode in another RAT	
Predefined configuration status information compressed	OP		Predefined configuration status information compressed 10.3.4.5b	Cleared upon entering connected mode in another RAT	REL-5
UE security information	OP		UE security information 10.3.3.4 2b	Cleared upon entering connected mode in another RAT	
UE security information2	OP		UE security information2 10.3.3.4 2c	Cleared upon entering connected mode in another RAT	REL-6
UE radio access capability	OP		UE radio access capability 10.3.3.4 2	Cleared upon entering connected mode in another RAT	
UE radio access capability extension	OP		UE radio access capability extension 10.3.3.4 2a	Cleared upon entering connected mode in another RAT	
UE radio access capability compressed	OP		UE radio access capability compressed 10.3.3.4 2o		REL-5
UE system specific capability	OP	1 to <maxSystemCapability>	Inter-RAT UE radio access capability 10.3.8.7	Cleared upon entering connected mode in another RAT	
>Inter-RAT UE radio access capability	MP		Inter-RAT UE radio		

			access capability 10.3.8.7		
--	--	--	-------------------------------	--	--

13.4.11 INVALID_CONFIGURATION

This variable indicates whether a received message contained an invalid configuration, by means of invalid values or invalid combinations of information elements.

Information Element/Group name	Need	Multi	Type and reference	Semantics description
Invalid configuration	MP		Boolean	TRUE: An invalid configuration has been detected. Set to FALSE when entering UTRA RRC connected mode. Set to FALSE when leaving UTRA RRC connected mode.

13.4.11a LATEST_CONFIGURED_CN_DOMAIN

This variable stores the CN-domain that was most recently configured to be used for ciphering and integrity protection.

Information Element/Group name	Need	Multi	Type and reference	Semantics description
Latest configured CN domain	OP		CN domain identity 10.3.1.1	Cleared when entering UTRA RRC connected mode when not stated otherwise in the procedure. Cleared when leaving UTRA RRC connected mode.

13.4.11b LATEST_CONFIGURED_SRB_DELAY_AND_PC_PREAMBLE

This variable stores the SRB delay and PC preamble to be used for establishing the DPCH after failure of hard handover, inter-RAT handover from UTRAN, or cell change order from UTRAN.

Information Element/Group name	Need	Multi	Type and reference	Semantics description
SRB delay	OP		Integer (0..7)	Cleared when entering UTRA RRC connected mode when not stated otherwise in the procedure.
PC preamble	OP		Integer (0..7)	Cleared when entering UTRA RRC connected mode when not stated otherwise in the procedure.

13.4.11c MBMS_ACTIVATED_SERVICES

This variable stores the MBMS multicast services the UE has joined as well as the MBMS broadcast services the UE is interested to receive. Whenever the list of joined multicast services and/ or interested broadcast services changes, upper layers provide an indication upon which the UE shall update the variable accordingly. In case upper layers de-select an MBMS Selected Services, the UE shall remove the concerned service from the variable. Likewise, when upper layers select an MBMS Selected Services, the UE shall add the concerned service to the variable.

Information Element/Group name	Need	Multi	Type and reference	Semantics description
Activated service list	OP	1 to <maxMBMS-Services>		
>Service Identity	MP		MBMS Service identity 10.3.9a.8	
>Service type	MP		Enumerated (Multicast, Broadcast)	
>MBMS Selected Services Indicator	CV- <i>Broadcast</i>		Boolean	TRUE means that the service is currently a MBMS Selected Service

Condition	Explanation
<i>Broadcast</i>	This IE is mandatory present if the IE "Service type" is set to 'Broadcast' and not needed otherwise.

NOTE: An independent instance of the variable MBMS_ACTIVATED_SERVICES is used by UEs supporting reception of MBMS services from cells operating in MBSFN mode and will contain the services available in MBSFN mode only as indicated by higher layers.

13.4.11d MBMS_PREV_FREQUENCY_INFO

This variable stores the frequency information of the cell the UE is camped on, upon moving to the MBMS preferred layer indicated MBMS FLC preferred frequency information.

Information Element/Group name	Need	Multi	Type and reference	Semantics description	Version
PREV Frequency Information					
CHOICE <i>mode</i>					
>FDD cell					
>>UARFCN downlink (Nd)	MP		Integer(0 .. 16383)	[21]	
>3.84 Mcps TDD cell					
>>UARFCN (Nt)	MP		Integer(0 .. 16383)	[22]	
>1.28 Mcps TDD cell list					
>>UARFCN (Nt)	MP		Integer(0 .. 16383)	[22]	

13.4.11e MBMS_PL_SERVICE_RESTRICTION_INFO_DEDICATED

This variable stores the value of the IE "MBMS PL Service Restriction Information" restriction applicable to preferred frequency received in the latest Radio Bearer Control or Cell Update Confirm message.

Information Element/Group name	Need	Multi	Type and reference	Semantics description	Version
MBMS_PL_SERVICE_RESTRICTION_INFO_DEDICATED	MP		Enumerated(TRUE, FALSE)	Set to FALSE when entering UTRA connected mode.	REL-6

13.4.12 MEASUREMENT_IDENTITY

This variable stores the measurements configured in the UE. For each configured measurement, the information below shall be stored.

Information Element/Group name	Need	Multi	Type and reference	Semantics description
MEASUREMENT CONTROL	OP		MEASUREMENT CONTROL 10.2.17, System Information Block type 11 10.2.48.8.12, System Information Block type 12 10.2.48.8.13	Information as contained in these messages. Cleared when entering UTRA RRC connected mode when not stated otherwise in the procedure (8.4.1.8-8.4.1.9). Cleared when leaving UTRA RRC connected mode when not stated otherwise in the procedure (8.4.1.9a).

13.4.13 Void

13.4.13a MIMO_PARAMS

This variable indicates the values of the parameters for operation in MIMO mode. See subclause 8.5.xx for actions related to the setting of this variable.

Information Element/Group name	Need	Multi	Type and reference	Semantics description	Version
MIMO N_cqi_typeA/M_cqi ratio	OP		Enumerated(1/2, 2/3, 3/4, 4/5, 5/6, 6/7, 7/8, 8/9, 9/10, 1/1)		
MIMO pilot configuration	OP		MIMO pilot configuration 10.3.6.41b		
Precoding weight set restriction	OP		Enumerated (TRUE)	If present, UE applies precoding weight set restriction.	REL-7

13.4.13b MIMO_STATUS

This variable indicates whether the UE is operating in MIMO mode. See subclause 8.5.wv for actions related to the setting of this variable.

Information Element/Group name	Need	Multi	Type and reference	Semantics description	Version
MIMO status	MP		Boolean	TRUE means the UE is operating in MIMO mode. Cleared when leaving CELL_DCH state.	

13.4.14 ORDERED_RECONFIGURATION

This variable stores information about an ongoing Reconfiguration procedure.

Information Element/Group name	Need	Multi	Type and reference	Semantics description
Ordered reconfiguration	MP		Boolean	TRUE means that a Reconfiguration procedure is ongoing. Set to FALSE when entering UTRA RRC connected mode. Set to FALSE when leaving UTRA RRC connected mode.

13.4.14a PDCP_ROHC_TARGET_MODE

This variable contains the ROHC target mode.

Information Element/Group name	Need	Multi	Type and reference	Semantics description	Version
Target Mode	OP		Enumerated (O-mode, R-mode)	The UE shall only transit to the signalled mode for operation of ROHC as described in [36].	REL-5

13.4.15 PDCP_SN_INFO

This variable contains PDCP receive sequence numbers for one or several radio bearers to be included in a response message to UTRAN.

Information Element/Group name	Need	Multi	Type and reference	Semantics description
RB with PDCP information list	OP	1 to <maxRBall RABs>		Cleared when entering UTRA RRC connected mode. Cleared when leaving UTRA RRC connected mode.
>RB with PDCP information	MP		RB with PDCP information 10.3.4.22	

13.4.15a PHYSICAL_SHARED_CHANNEL_CONFIGURATION

This variable is used only for TDD to store information about the physical shared channel configuration in the UE.

Information Element/Group name	Need	Multi	Type and reference	Semantics description
PUSCH configuration	OP			Cleared when entering and leaving UTRA RRC connected mode.
>PUSCH info	MP		PUSCH info 10.3.6.63	
>PUSCH Identity	OP		Integer(1..hiPUSCHidentities)	
>PUSCH power control info	OP		PUSCH power control info 10.3.6.65	
PDSCH configuration	OP			Cleared when entering and leaving UTRA RRC connected mode.
>PDSCH Info	MP		PDSCH Info 10.3.6.44	
>PDSCH Identity	OP		Integer(1..hiPDSCHidentities)	
>PDSCH power control info	OP		PDSCH power control info 10.3.6.45	
ISCP Timeslot list	OP	1 to maxTS		Cleared when entering and leaving UTRA RRC connected mode.
>Timeslot number	MP		Timeslot number 10.3.6.84	Timeslot numbers, for which the UE shall report the timeslot ISCP in PUSCH CAPACITY REQUEST message

13.4.16 PROTOCOL_ERROR_INDICATOR

This variable indicates whether there exist a protocol error that is to be reported to UTRAN.

Information Element/Group name	Need	Multi	Type and reference	Semantics description
Protocol error indicator	MP		Protocol error indicator 10.3.3.27	Set to FALSE when entering UTRA RRC connected mode. Set to FALSE when leaving UTRA RRC connected mode.

13.4.17 PROTOCOL_ERROR_INFORMATION

This variable contains diagnostics to be reported to UTRAN for a message that was not completely understood.

Information Element/Group name	Need	Multi	Type and reference	Semantics description
Protocol error information	OP		Protocol error information 10.3.8.12	Cleared when entering UTRA RRC connected mode. Cleared when leaving UTRA RRC connected mode.

13.4.18 PROTOCOL_ERROR_REJECT

This variable indicates whether there has occurred a severe protocol error causing the ongoing procedure to fail.

Information Element/Group name	Need	Multi	Type and reference	Semantics description
Protocol error reject	MP		Boolean	TRUE: a severe protocol error has occurred. Set to FALSE when entering UTRA RRC connected mode. Set to FALSE when leaving UTRA RRC connected mode.

13.4.19 RB_TIMER_INDICATOR

This variable contains information to be sent to UTRAN if any of the timers T314 or T315 has expired when the UE sends a cell update with cause RL failure.

Information Element/Group name	Need	Multi	Type and reference	Semantics description
RB timer indicator	OP		RB timer indicator 10.3.3.28	Cleared when entering UTRA RRC connected mode. Cleared when leaving UTRA RRC connected mode.

13.4.20 RB_UPLINK_CIPHERING_ACTIVATION_TIME_INFO

This variable contains information to be sent to UTRAN about when a new ciphering configuration shall be activated in the uplink for radio bearers using RLC-AM or RLC-UM.

Information Element/Group name	Need	Multi	Type and reference	Semantics description
RB uplink ciphering activation time info	OP		RB activation time info 10.3.4.13	Cleared when entering UTRA RRC connected mode. Cleared when leaving UTRA RRC connected mode.

13.4.20o RNC_CAPABILITY_CHANGE_SUPPORT

This variable indicates whether the serving RNC supports changes of UE capability in connected mode.

Information Element/Group name	Need	Multi	Type and reference	Semantics description
RNC support for change of UE capability	MP		Boolean	Cleared when leaving UTRA RRC connected mode.

13.4.20a SECURITY_MODIFICATION

This variable contains information on which CN domain is affected by the ongoing security reconfiguration.

Information Element/Group name	Need	Multi	Type and reference	Semantics description
Status for each CN domain	MP	<1 to maxCNDo mains>		
>CN domain identity	MP		CN domain identity 10.3.1.1	
>Status	MP		Enumerated(Affected, Not Affected)	

13.4.21 Void

13.4.22 START_THRESHOLD

This variable contains information about the maximum allowed value of the START for a CN domain.

Information Element/Group name	Need	Multi	Type and reference	Semantics description
THRESHOLD	OP		Integer (0..1048576)	20 bits. Cleared when entering UTRA RRC connected mode when not stated otherwise in the procedure. Cleared when leaving UTRA RRC connected mode.

13.4.23 START_VALUE_TO_TRANSMIT

This variable contains the value of START for new radio bearer(s) to be transmitted in a response message.

Information Element/Group name	Need	Multi	Type and reference	Semantics description
START	OP		START 10.3.3.38	Cleared when entering UTRA RRC connected mode. Cleared when leaving UTRA RRC connected mode.

13.4.24 TFC_SUBSET

This variable contains information about the TFC subset(s) applicable to the UE.

Information Element/Group name	Need	Multi	Type and reference	Semantics description	Version
CHOICE <i>mode</i>	MP				
>FDD					
>>Current TFC subset	MP		Transport Format Combination Subset 10.3.5.22	Set to "Full transport format set" when entering UTRA RRC connected mode when not stated otherwise in the procedure.	
>>Duration	OP		TFC Control duration 10.3.6.80	Cleared when entering UTRA RRC connected mode. Cleared when leaving UTRA RRC connected mode.	
>>Default TFC subset	OP		Transport Format Combination Subset 10.3.5.22	The TFC subset to go back to when any temporary limitation is released. Cleared when entering UTRA RRC connected mode. Cleared when leaving UTRA RRC connected mode.	

Information Element/Group name	Need	Multi	Type and reference	Semantics description	Version
>>TFC subset list	MP	1 to <maxTF Csub>			REL-4
>>>TFC subset	MP		Transport Format Combination Subset 10.3.5.22		REL-4
>TDD					
>>TFCS list	MP	1 to <maxCCT rCH >		One TFCS is created when entering UTRA RRC connected mode when not stated otherwise in the procedure.	
>>>TFCS identity	MP		Transport Format Combination Set Identity 10.3.5.21	"TFCS ID" is set to 1 when entering UTRA RRC connected mode when not stated otherwise in the procedure. "Shared channel indicator" is set to FALSE when entering UTRA RRC connected mode when not stated otherwise in the procedure.	
>>>>Current TFC subset	MP		Transport Format Combination Subset 10.3.5.22	Set to "Full transport format set" when entering UTRA RRC connected mode when not stated otherwise in the procedure.	
>>>>Duration	OP		TFC Control duration 10.3.6.80	Cleared when entering UTRA RRC connected mode. Cleared when leaving UTRA RRC connected mode.	
>>>>Default TFC subset	OP		Transport Format Combination Subset 10.3.5.22	The TFC subset to go back to when any temporary limitation is released. Cleared when entering UTRA RRC connected mode. Cleared when leaving UTRA RRC connected mode.	
>>TFC subset list	MP	1 to <maxTF Csub2>			REL-4
>>>TFCS identity	MP		Transport Format Combination Set Identity 10.3.5.21		REL-4
>>>>TFC subset	MP		Transport Format Combination Subset 10.3.5.22		REL-4

13.4.25 TGPS_IDENTITY

This variable contains the configuration parameters of all the configured compressed mode transmission gap pattern sequences.

Information Element/Group name	Need	Multi	Type and reference	Semantics description
Transmission gap pattern sequence	OP	1 to <maxTGP S>		Cleared when entering UTRA RRC connected mode. Cleared when leaving UTRA RRC connected mode.
>TGPSI	MP		TGPSI 10.3.6.82	
>TGPS Status Flag	MP		Enumerated(activate, deactivate)	This flag indicates whether the Transmission Gap Pattern Sequence shall be activated or deactivated.
> Current TGPS Status Flag	MP		Enumerated(active, inactive)	This flag indicates the current status of the Transmission Gap Pattern Sequence, whether it is active or inactive
>TGCFN	CV-Active		Integer (0..255)	Connection Frame Number of the first frame of the first pattern within the Transmission Gap Pattern Sequence.
>Transmission gap pattern sequence configuration parameters	MP			Information as contained in the IE group "Transmission gap pattern sequence configuration parameters" in IE "DPCH compressed mode info" 10.3.6.33.

Condition	Explanation
<i>Active</i>	This IE is mandatory present when the value of the IE "TGPS Status Flag" is "Activate" and not needed otherwise.

13.4.26 TGSN_REPORTED

This variable specifies whether an IE "Proposed TGSN" was reported to the UTRAN

Information Element/Group name	Need	Multi	Type and reference	Semantics description
Proposed TGSN reported	MP		Boolean	Set to FALSE when entering UTRA RRC connected mode. Set to FALSE when leaving UTRA RRC connected mode.

13.4.26a TIMERS_AND_CONSTANTS

This variable contains the values for all timers and constants used in connected mode.

Information Element/Group name	Need	Multi	Type and reference	Semantics description
UE Timers and constants in connected mode	MD		UE Timers and constants in connected mode 10.3.3.43	Default value means that for all timers and constants - for parameters with need MD, the defaults specified in 10.3.3.43 apply and - for parameters with need OP, the parameters are absent. All parameters are set to the default value when leaving UTRA RRC connected mode to another RAT.

13.4.27 TRANSACTIONS

This variable stores the identifications of the ongoing RRC procedure transactions.

Information Element/Group name	Need	Multi	Type and reference	Semantics description
Accepted transactions	OP	1 to <maxtrans actions>		Cleared when leaving UTRA RRC connected mode.
>Message type	MP		Message Type	
>RRC transaction identifier	MP		RRC transaction identifier 10.3.3.36	
Rejected transactions	OP	1 to <maxtrans actions>		Cleared when leaving UTRA RRC connected mode.
>Message type	MP		Message Type	
>RRC transaction identifier	MP		RRC transaction identifier 10.3.3.36	

13.4.27o TRIGGERED_MEASUREMENT_REPORT

This variable indicates that the measurement procedure has to be started to notify UTRAN that the UE has entered CELL_FACH after detecting the value of its variable H_RNTI in the HS-SCCH reception procedure while being in CELL_PCH state, as specified in subclause 8.5.40.

NOTE: For FDD only.

Information Element/Group name	Need	Multi	Type and reference	Semantics description	Version
Triggered measurement report	MP		Boolean	Set to FALSE when entering CELL_PCH and URA_PCH.	REL-7

13.4.27a TRIGGERED_1A_EVENT

This variable contains information about a 1a event that has been triggered in the UE. There is one such variable per 1a event configured in the UE.

Information Element/Group name	Need	Multi	Type and reference	Semantics description
Cells triggered	OP	1 to < maxCellMeas>		Cleared when entering UTRA RRC connected mode. Cleared when leaving UTRA RRC connected mode.
>primary CPICH	MP		Primary CPICH info 10.3.6.60	
>sent reports	MP		Integer(1..Infinity)	Number of reports sent to UTRAN in case of event triggered periodical reporting
Cells recently triggered	OP	1 to < maxCellMeas>		
>primary CPICH	MP		Primary CPICH info 10.3.6.60	
>sent reports	MP		Integer(1..Infinity)	Number of reports sent to UTRAN in case of event triggered periodical reporting
Periodical reporting running	MP		Boolean	

13.4.27b TRIGGERED_1B_EVENT

This variable contains information about a 1b event that has been triggered in the UE. There is one such variable per 1b event configured in the UE.

Information Element/Group name	Need	Multi	Type and reference	Semantics description	Version
Cells triggered	OP	1 to < maxCellMeas>		Cleared when entering UTRA RRC connected mode. Cleared when leaving UTRA RRC connected mode.	
>primary CPICH	MP		Primary CPICH info 10.3.6.60		
>sent reports	MP		Integer(1..Infinity)	Number of reports sent to UTRAN in case of event triggered periodical reporting	REL-5
Cells recently triggered	OP	1 to < maxCellMeas>			REL-5
>primary CPICH	MP		Primary CPICH info 10.3.6.60		REL-5
>sent reports	MP		Integer(1..Infinity)	Number of reports sent to UTRAN in case of event triggered periodical reporting.	REL-5
Periodical reporting running	MP		Boolean		REL-5

13.4.27c TRIGGERED_1C_EVENT

This variable contains information about a 1c event that has been triggered in the UE. There is one such variable per 1c event configured in the UE.

Information Element/Group name	Need	Multi	Type and reference	Semantics description
Cells triggered	OP	1 to < maxCellMeas>		Cleared when entering UTRA RRC connected mode. Cleared when leaving UTRA RRC connected mode.
>primary CPICH	MP		Primary CPICH info 10.3.6.60	
>sent reports	MP		Integer(1..Infinity)	Number of reports sent to UTRAN in case of event triggered periodical reporting
Cells recently triggered	OP	1 to < maxCellMeas>		
>primary CPICH	MP		Primary CPICH info 10.3.6.60	
>sent reports	MP		Integer(1..Infinity)	Number of reports sent to UTRAN in case of event triggered periodical reporting
Periodical reporting running	MP		Boolean	

13.4.27d BEST_CELL_1D_EVENT

This variable contains information about a 1d event that has been triggered in the UE. There is one such variable per 1d event configured in the UE.

Information Element/Group name	Need	Multi	Type and reference	Semantics description
Best cell	OP		Primary CPICH info 10.3.6.60	Cleared when entering UTRA RRC connected mode. Cleared when leaving UTRA RRC connected mode.

13.4.27e TRIGGERED_1E_EVENT

This variable contains information about a 1e event that has been triggered in the UE. There is one such variable per 1e event configured in the UE.

Information Element/Group name	Need	Multi	Type and reference	Semantics description
Cells triggered	OP	1 to < maxCellMeas>		Cleared when entering UTRA RRC connected mode. Cleared when leaving UTRA RRC connected mode.
>primary CPICH	MP		Primary CPICH info 10.3.6.60	
Cells recently triggered	OP	1 to < maxCellMeas>		
>primary CPICH	MP		Primary CPICH info 10.3.6.60	

13.4.27f TRIGGERED_1F_EVENT

This variable contains information about a 1f event that has been triggered in the UE. There is one such variable per 1f event configured in the UE.

Information Element/Group name	Need	Multi	Type and reference	Semantics description
Cells triggered	OP	1 to < maxCellMeas>		Cleared when entering UTRA RRC connected mode. Cleared when leaving UTRA RRC connected mode.
>primary CPICH	MP		Primary CPICH info 10.3.6.60	
Cells recently triggered	OP	1 to < maxCellMeas>		
>primary CPICH	MP		Primary CPICH info 10.3.6.60	

13.4.27f1 TRIGGERED_1G_EVENT

This variable contains information about a 1g event that has been triggered in the UE.

Information Element/Group name	Need	Multi	Type and reference	Semantics description
Cells triggered	OP	1 to < maxCellMeas>		
>Primary CCPCH info	MP		Primary CCPCH info 10.3.6.57	

13.4.27f2 TRIGGERED_1H_EVENT

This variable contains information about a 1h event that has been triggered in the UE.

Information Element/Group name	Need	Multi	Type and reference	Semantics description
Cells triggered	OP	1 to < maxCellMeas>		
>Primary CCPCH info	MP		Primary CCPCH info 10.3.6.57	

13.4.27f3 TRIGGERED_1I_EVENT

This variable contains information about a 1i event that has been triggered in the UE.

Information Element/Group name	Need	Multi	Type and reference	Semantics description
Cells triggered	OP	1 to < maxCellMeas>		
>Primary CCPCH info	MP		Primary CCPCH info 10.3.6.57	

13.4.27f4 BEST_FREQUENCY_2A_EVENT

This variable contains information about a 2a event that has been configured in the UE. There is one such variable per 2a event configured in the UE.

Information Element/Group name	Need	Multi	Type and reference	Semantics description
Best frequency	MP		Frequency info 10.3.6.36	

13.4.27f5 TRIGGERED_2B_EVENT

This variable contains information about a 2b event that has been configured in the UE. There is one such variable per 2b event configured in the UE.

Information Element/Group name	Need	Multi	Type and reference	Semantics description
Frequency triggered	OP	1 to <maxCellMeas>		
>Frequency	MP	Frequency info 10.3.6.36		

13.4.27f6 TRIGGERED_2C_EVENT

This variable contains information about a 2c event that has been configured in the UE. There is one such variable per 2c event configured in the UE.

Information Element/Group name	Need	Multi	Type and reference	Semantics description
Frequency triggered	OP	1 to <maxCellMeas>		
>Frequency	MP	Frequency info 10.3.6.36		

13.4.27f7 TRIGGERED_2D_EVENT

This variable contains information about a 2d event that has been configured in the UE. There is one such variable per 2d event configured in the UE.

Information Element/Group name	Need	Multi	Type and reference	Semantics description
Event triggered	OP		Boolean	

13.4.27f8 TRIGGERED_2E_EVENT

This variable contains information about a 2e event that has been configured in the UE. There is one such variable per 2e event configured in the UE.

Information Element/Group name	Need	Multi	Type and reference	Semantics description
Frequency triggered	OP	1 to <maxCellMeas>		
>Frequency	MP	Frequency info 10.3.6.36		

13.4.27f9 TRIGGERED_2F_EVENT

This variable contains information about a 2f event that have been configured in the UE. There is one such variable per 2f event configured in the UE.

Information Element/Group name	Need	Multi	Type and reference	Semantics description
Event triggered	OP		Boolean	

13.4.27f10 TRIGGERED_3A_EVENT

This variable contains information about a 3a event that has been configured in the UE. There is one such variable per event 3a configured in the UE.

Information Element/Group name	Need	Multi	Type and reference	Semantics description
CHOICE <i>system</i>	OP			
>GSM				
>>CHOICE <i>BSIC</i>	MP			
>>>Verified BSIC		0 to <maxCellMeas>		
>>>>Inter-RAT cell id	MP		Integer(0..<maxCellMeas>-1)	
>>>Non verified BSIC		0 to <maxCellMeas>		
>>>>BCCH ARFCN	MP		Integer (0..1023)	

13.4.27f11 TRIGGERED_3B_EVENT

This variable contains information about a 3b event that has been configured in the UE. There is one such variable per event 3b configured in the UE.

Information Element/Group name	Need	Multi	Type and reference	Semantics description
CHOICE <i>system</i>	OP			
>GSM				
>>CHOICE <i>BSIC</i>	MP			
>>>Verified BSIC		0 to <maxCellMeas>		
>>>>Inter-RAT cell id	MP		Integer(0..<maxCellMeas>-1)	
>>>Non verified BSIC		0 to <maxCellMeas>		
>>>>BCCH ARFCN	MP		Integer (0..1023)	

13.4.27f12 TRIGGERED_3C_EVENT

This variable contains information about a 3c event that has been configured in the UE. There is one such variable per event 3c configured in the UE.

Information Element/Group name	Need	Multi	Type and reference	Semantics description
CHOICE <i>system</i>	OP			
>GSM				
>>CHOICE <i>BSIC</i>	MP			
>>>Verified BSIC		0 to <maxCellMeas>		
>>>>Inter-RAT cell id	MP		Integer(0..<maxCellMeas>-1)	
>>>Non verified BSIC		0 to <maxCellMeas>		
>>>>BCCH ARFCN	MP		Integer (0..1023)	

13.4.27f13 BEST_CELL_3D_EVENT

This variable contains information about a 3d event that has been configured in the UE. There is one such variable per event 3a configured in the UE.

Information Element/Group name	Need	Multi	Type and reference	Semantics description
CHOICE <i>system</i>				
>GSM				
>>CHOICE <i>BSIC</i>	MP			
>>>Verified BSIC				
>>>>Inter-RAT cell id	MP		Integer(0..<maxCellMeas>-1)	
>>>Non verified BSIC				
>>>>BCCH ARFCN	MP		Integer (0..1023)	

13.4.27f14 TRIGGERED_6A_EVENT

This variable contains information about a 6a event that has been configured in the UE. There is one such variable per 6a event configured in the UE.

Information Element/Group name	Need	Multi	Type and reference	Semantics description
Event triggered	OP		Boolean	

13.4.27f15 TRIGGERED_6B_EVENT

This variable contains information about a 6b event that has been configured in the UE. There is one such variable per 6b event configured in the UE.

Information Element/Group name	Need	Multi	Type and reference	Semantics description
Event triggered	OP		Boolean	

13.4.27f16 TRIGGERED_6C_EVENT

This variable contains information about a 6c event that has been configured in the UE. There is one such variable per 6c event configured in the UE.

Information Element/Group name	Need	Multi	Type and reference	Semantics description
Event triggered	OP		Boolean	

13.4.27f17 TRIGGERED_6D_EVENT

This variable contains information about a 6d event that has been configured in the UE. There is one such variable per 6d event configured in the UE.

Information Element/Group name	Need	Multi	Type and reference	Semantics description
Event triggered	OP		Boolean	

13.4.27f18 TRIGGERED_6E_EVENT

This variable contains information about a 6e event that has been configured in the UE. There is one such variable per 6e event configured in the UE.

Information Element/Group name	Need	Multi	Type and reference	Semantics description
Event triggered	OP		Boolean	

13.4.27f19 TRIGGERED_6F_EVENT

This variable contains information about a 6f event that has been configured in the UE. There is one such variable per 6f event configured in the UE.

Information Element/Group name	Need	Multi	Type and reference	Semantics description	Version
CHOICE mode					
>FDD					
Event triggered_RL	OP	<maxRL >	Boolean		
>1.28 Mcps TDD					REL-4
>>T _{ADV}	MP		TADV info 10.3.7.11 2		REL-4

13.4.27f20 TRIGGERED_6G_EVENT

This variable contains information about a 6g event that has been configured in the UE. There is one such variable per 6g event configured in the UE.

Information Element/Group name	Need	Multi	Type and reference	Semantics description
Event triggered_RL	OP	<maxRL>	Boolean	

13.4.27f21 TRIGGERED_1J_EVENT

This variable contains information about a 1j event that has been triggered in the UE. There is one such variable per 1j event configured in the UE.

Information Element/Group name	Need	Multi	Type and reference	Semantics description	Version
Cells triggered	OP	1 to < maxCellMe as>		Cleared when entering UTRA RRC connected mode. Cleared when leaving UTRA RRC connected mode.	REL-6
>primary CPICH	MP		Primary CPICH info 10.3.6.60		REL-6
>sent reports	MP		Integer(1..Inf inity)	Number of reports sent to UTRAN in case of event triggered periodical reporting	REL-6
Cells recently triggered	OP	1 to < maxCellMe as>			REL-6
>primary CPICH	MP		Primary CPICH info 10.3.6.60		REL-6
>sent reports	MP		Integer(1..Inf inity)	Number of reports sent to UTRAN in case of event triggered periodical reporting	REL-6
Periodical reporting running	MP		Boolean		REL-6

13.4.27g UE_CAPABILITY_REQUESTED

This variable stores information about the UE capabilities that have been requested by UTRAN but that have not yet been transferred to UTRAN.

Information Element/Group name	Need	Multi	Type and reference	Semantics description
UE radio access capability	OP		UE radio access capability 10.3.3.42	Cleared when entering UTRA RRC connected mode. Cleared when leaving UTRA RRC connected mode.
UE radio access capability extension	OP		UE radio access capability extension 10.3.3.42a	Cleared when entering UTRA RRC connected mode. Cleared when leaving UTRA RRC connected mode.
UE system specific capability	OP	1 to <maxInterSystemMessages>		
>Inter-RAT UE radio access capability	MP		Inter-RAT UE radio access capability 10.3.8.7	Includes inter-RAT classmark. Cleared when entering UTRA RRC connected mode. Cleared when leaving UTRA RRC connected mode.

13.4.28 UE_CAPABILITY_TRANSFERRED

This variable stores information about which UE capabilities that have been transferred to UTRAN.

Information Element/Group name	Need	Multi	Type and reference	Semantics description	Version
UE radio access capability	OP		UE radio access capability 10.3.3.42	Cleared when entering UTRA RRC connected mode when not stated otherwise in the procedure. Cleared when leaving UTRA RRC connected mode.	
UE radio access capability extension	OP		UE radio access capability extension 10.3.3.42a	Cleared when entering UTRA RRC connected mode when not stated otherwise in the procedure. Cleared when leaving UTRA RRC connected mode.	
UE system specific capability	OP	1 to <maxSystemCapability>			
>Inter-RAT UE radio access capability	MP		Inter-RAT UE radio access capability 10.3.8.7	Includes inter-RAT classmark. Cleared when entering UTRA RRC connected mode when not stated otherwise in the procedure. Cleared when leaving UTRA RRC connected mode.	
UE radio access capability compressed	OP		UE radio access capability compressed 10.3.3.42o		REL-5
Security capability	OP		Security capability 10.3.3.37		REL-5

13.4.28a UE_POSITIONING_GPS_DATA

Information Element/Group name	Need	Multi	Type and reference	Semantics description
GPS Data ciphering info	OP		UE positioning Ciphering info 10.3.7.86	
GPS Deciphering Keys	OP			
>Current deciphering key	MP		Bit string(56)	
>Next deciphering key	MP		Bit string(56)	
UE positioning GPS reference time	OP		UE positioning GPS reference time 10.3.7.96	
UE positioning GPS reference UE position	OP		Ellipsoid point with altitude and uncertainty ellipsoid 10.3.8.4c	A priori knowledge of UE 3-D position.
UE positioning GPS DGPS corrections	OP		UE positioning GPS DGPS corrections 10.3.7.91	
UE positioning GPS navigation model	OP	1 to <maxSat>		
>SatID	MP		Enumerated(0..63)	Satellite ID
>GPS Ephemeris and Clock Correction parameters	MP		UE positioning GPS Ephemeris and Clock Correction parameters 10.3.7.91a	
UE positioning GPS ionospheric model	OP		UE positioning GPS ionospheric model 10.3.7.92	
UE positioning GPS UTC model	OP		UE positioning GPS UTC model 10.3.7.97	
UE positioning GPS almanac	OP			
>SatID	MP	1 to <maxSatAlmanacStorage>		
>>WN _a	MP			Same as IE in 10.3.7.89
>>DataID	MP			Same as IE in 10.3.7.89
>>e	MP			Same as IE in 10.3.7.89
>>t _{oa}	MP			Same as IE in 10.3.7.89
>>δI	MP			Same as IE in 10.3.7.89
>>OMEGADOT	MP			Same as IE in 10.3.7.89
>>SV Health	MP			Same as IE in 10.3.7.89
>>A ^{1/2}	MP			Same as IE in 10.3.7.89
>>OMEGA ₀	MP			Same as IE in 10.3.7.89
>>M ₀	MP			Same as IE in 10.3.7.89

Information Element/Group name	Need	Multi	Type and reference	Semantics description
>>ω	MP			Same as IE in 10.3.7.89
>>af ₀	MP			Same as IE in 10.3.7.89
>>af ₁	MP			Same as IE in 10.3.7.89
>SV Global Health	OP			Same as IE in 10.3.7.89
UE positioning GPS acquisition assistance	OP		UE positioning GPS acquisition assistance 10.3.7.88	
UE positioning GPS real-time integrity	OP		UE positioning GPS real-time integrity 10.3.7.95	

13.4.28b UE_POSITIONING_OTDOA_DATA_UE_ASSISTED

Information Element/Group name	Need	Multi	Type and reference	Semantics description
UE positioning OTDOA reference cell info for UE-assisted	OP		UE positioning OTDOA reference cell info 10.3.7.108	
UE positioning OTDOA neighbour cell list for UE-assisted	OP	1 to <maxCellMEas>		
>UE positioning OTDOA neighbour cell info for UE-assisted	MP		UE positioning OTDOA neighbour cell info 10.3.7.106	

13.4.28c UE_POSITIONING_OTDOA_DATA_UE_BASED

Information Element/Group name	Need	Multi	Type and reference	Semantics description
OTDOA Deciphering Keys	OP			
>Current deciphering key	MP		Bit string(56)	
>Next deciphering key	MP		Bit string(56)	
OTDOA Data ciphering info	OP		UE positioning Ciphering info 10.3.7.86	
UE positioning OTDOA reference cell info for UE-based	OP		UE positioning OTDOA reference cell info for UE-based 10.3.7.108a	
UE positioning OTDOA neighbour cell list for UE-based	OP	1 to <maxCellMeas>		
>UE positioning OTDOA neighbour cell info for UE-based	MP		UE positioning OTDOA neighbour cell info for UE-based 10.3.7.106	

13.4.28d UE_POSITIONING_GANSS_DATA

Information Element/Group name	Need	Multi	Type and reference	Semantics description	Version
GANSS Data ciphering info	OP		UE positioning Ciphering info 10.3.7.86		REL-7
GANSS Deciphering Keys	OP				REL-7
>Current deciphering key	MP		Bit string(56)		REL-7
>Next deciphering key	MP		Bit string(56)		REL-7
UE positioning GANSS reference time	OP		UE positioning GANSS reference time 10.3.7.96o		REL-7
UE positioning GANSS reference UE position	OP		Ellipsoid point with altitude and uncertainty ellipsoid 10.3.8.4c	A priori knowledge of UE 3-D position.	REL-7
UE positioning GANSS ionospheric model	OP		UE positioning GANSS ionospheric model 10.3.7.92a		REL-7
GANSS Generic DataList	OP	1 to <maxGANSS>			REL-7

Information Element/Group name	Need	Multi	Type and reference	Semantics description	Version
>GANSS ID	OP		Integer (0..7)	Same as IE in 10.3.7.90a	REL-7
>GANSS Time Models List		1 to <maxG ANSS- 1>			REL-7
>>Positioning GANSS Time Model	OP		UE positioning GANSS time model 10.3.7.97a		
>UE positioning DGANSS corrections	OP		UE positioning DGANSS corrections 10.3.7.91b		REL-7
>UE positioning GANSS navigation model	OP		UE positioning GANSS navigation model 10.3.7.94a		REL-7
>UE positioning GANSS real-time integrity	OP		UE positioning GANSS real-time integrity 10.3.7.95a		REL-7
>UE positioning GANSS data bit assistance	OP		UE positioning GANSS data bit assistance 10.3.7.97b		REL-7
>UE positioning GANSS reference measurement information	OP		UE positioning GANSS reference measurement information 10.3.7.88b		REL-7
>UE positioning GANSS almanac	OP		UE positioning GANSS almanac 10.3.7.89a		REL-7
>UE positioning GANSS UTC model	OP		UE positioning GANSS UTC model 10.3.7.97c		REL-7

13.4.29 UNSUPPORTED_CONFIGURATION

This variable indicates whether a received message contained a configuration that is not supported by the UE.

Information Element/Group name	Need	Multi	Type and reference	Semantics description
Unsupported configuration	MP		Boolean	TRUE: An unsupported configuration has been detected. Set to FALSE when entering UTRA RRC connected mode. Set to FALSE when leaving UTRA RRC connected mode.

13.4.30 URA_IDENTITY

This variable stores the assigned URA identity for this UE when in URA_PCH state.

Information Element/Group name	Need	Multi	Type and reference	Semantics description
URA identity	OP		URA identity 10.3.2.6	Cleared when entering UTRA RRC connected mode. Cleared when leaving UTRA RRC connected mode.

13.4.31 U_RNTI

This variable stores the assigned U-RNTI for this UE.

Information Element/Group name	Need	Multi	Type and reference	Semantics description
U-RNTI	OP		U-RNTI 10.3.3.47	Cleared when leaving UTRA RRC connected mode.

13.4.32 VALUE_TAG

This variable contains information about the value tag for the last received system information block of a given type, for all system information blocks using value tags. The UE shall maintain one instance of this variable for the current selected cell. The UE may store several instances of this variable, one for each cell, to be used if the UE returns to these cells.

All IEs in this variable shall be cleared when switched off. All IEs in this variable except for the IE "SIB 16 value tag list" shall be cleared at selection of a new cell and this cell broadcasts an IE "PLMN Identity" in the MIB which is different from the IE "PLMN Identity" broadcast in the MIB in the previously selected cell. The IE "SIB 16 value tag list" is cleared when NAS informs AS about a new selected PLMN.

Information Element/Group name	Need	Multi	Type and reference	Semantics description	Version
MIB value tag	OP		MIB value tag 10.3.8.9	Value tag for the master information block	
SB 1 value tag	OP		Cell value tag 10.3.8.4	Value tag for the scheduling block type 1	
SB 2 value tag	OP		Cell value tag 10.3.8.4	Value tag for the scheduling block type 2	
SIB 1 value tag	CV-GSM		PLMN value tag 10.3.8.10	Value tag for the system information block type 1 Note: IE 'PLMN value tag' is used for SIB1 but the area scope for	

Information Element/Group name	Need	Multi	Type and reference	Semantics description	Version
				SIB 1 is Cell.	
SIB 2 value tag	OP		Cell value tag 10.3.8.4	Value tag for the system information block type 2	
SIB 3 value tag	OP		Cell value tag 10.3.8.4	Value tag for the system information block type 3	
SIB 4 value tag	OP		Cell value tag 10.3.8.4	Value tag for the system information block type 4	
SIB 5 value tag	OP		Cell value tag 10.3.8.4	Value tag for the system information block type 5 or 5bis	
SIB 6 value tag	OP		Cell value tag 10.3.8.4	Value tag for the system information block type 6	
CHOICE <i>mode</i>	MP				
>FDD					
>TDD				(no data)	
SIB 11 value tag	OP		Cell value tag 10.3.8.4	Value tag for the system information block type 11	
SIB 11bis value tag	OP		Cell value tag 10.3.8.4	Value tag for the system information block type 11bis	REL-6
SIB 12 value tag	OP		Cell value tag 10.3.8.4	Value tag for the system information block type 12	
SIB 13 value tag	CV-ANSI		Cell value tag 10.3.8.4	Value tag for the system information block type 13	
SIB 13.1 value tag	CV-ANSI		Cell value tag 10.3.8.4	Value tag for the system information block type 13.1	
SIB 13.2 value tag	CV-ANSI		Cell value tag 10.3.8.4	Value tag for the system information block type 13.2	
SIB 13.3 value tag	CV-ANSI		Cell value tag 10.3.8.4	Value tag for the system information block type 13.3	
SIB 13.4 value tag	CV-ANSI		Cell value tag 10.3.8.4	Value tag for the system information block type 13.4	
SIB 15 value tag	OP		Cell value tag 10.3.8.4	Value tag for the system information block type 15	
SIB 15.1 value tag	OP		Cell value tag 10.3.8.4	Value tag for the system information block type 15.1	
SIB 15.2 value tag list	OP	1 to		List of value tags	

Information Element/Group name	Need	Multi	Type and reference	Semantics description	Version
		<maxSat>		for all stored occurrences of system information block type 15.2	
>SIB 15.2 value tag	MP		Cell value tag 10.3.8.4		
>SIB occurrence identity and value tag	MP		SIB occurrence identity and value tag 10.3.8.20b		
SIB 15.3 value tag list	OP	1 to <maxSat>		List of value tags for all stored occurrences of system information block type 15.3	
>SIB 15.3 value tag	MP		PLMN value tag 10.3.8.10	Value tag for the system information block type 15.3	
>SIB occurrence identity and value tag	MP		SIB occurrence identity and value tag 10.3.8.20b		
SIB 15.4 value tag	OP		Cell value tag 10.3.8.4	Value tag for the system information block type 15.4	

Information Element/Group name	Need	Multi	Type and reference	Semantics description	Version
SIB 15.5 value tag	OP		Cell value tag 10.3.8.4	Value tag for the system information block type 15.5	
GANSS SIBs	OP	1 to <maxGANSS>			REL-7
>GANSS ID	MD		Integer(0..7)	Identifier for GANSS, absence of this IE means Galileo	REL-7
>SIB 15bis value tag	OP		Cell value tag 10.3.8.4	Value tag for the system information block type 15bis	REL-7
>SIB 15.1bis value tag	OP		Cell value tag 10.3.8.4	Value tag for the system information block type 15.1bis	REL-7
>SIB 15.2bis value tag list	OP	1 to <maxSat>		List of value tags for all stored occurrences of system information block type 15.2bis	REL-7
>>SIB 15.2bis value tag	MP		Cell value tag 10.3.8.4		REL-7
>>SIB occurrence identity and value tag	MP		SIB occurrence identity and value tag 10.3.8.20b		REL-7
>SIB 15.3bis value tag list	OP	1 to <maxSat>		List of value tags for all stored occurrences of system information block type 15.3bis	REL-7
>>SIB 15.3bis value tag	MP		PLMN value tag 10.3.8.10	Value tag for the system information block type 15.3bis	REL-7
>>SIB occurrence identity and value tag	MP		SIB occurrence identity and value tag 10.3.8.20b		REL-7
>SIB 15.6 value tag	OP		Cell value tag 10.3.8.4	Value tag for the system information block type 15.6	REL-7
>SIB 15.7 value tag	OP		Cell value tag 10.3.8.4	Value tag for the system information block type 15.7	REL-7
>SIB 15.8 value tag	OP		Cell value tag 10.3.8.4	Value tag for the system information block type 15.8	REL-7
SIB 16 value tag list	OP	1 to <maxPred efConfig>		List of value tags for all stored occurrences of the system information block type 16	

Information Element/Group name	Need	Multi	Type and reference	Semantics description	Version
>Predefined configuration identity and value tag	MP		Predefined configuration identity and value tag 10.3.8.11		
SIB 18 value tag	OP		Cell value tag 10.3.8.4	Value tag for the system information block type 18	

Condition	Explanation
GSM	This information is optional when the UE is operating in "GSM-MAP mode" and never stored otherwise.
ANSI	This information is optional when the UE is operating in "ANSI-41 mode" and never stored otherwise.

13.5 UE RRC Procedure Performance

This subclause defines the performance requirements related to RRC procedures in the UE. Where the total delay is impacted by processing of variable length on the physical layer (e.g. physical layer synchronisation), references to appropriate specifications are given.

13.5.1 Definitions

The following definitions of N1 and N2 are valid only for this UE RRC Procedure Performance specification.

N1 = upper limit on the time required to execute modifications in UE after the reception of a UTRAN -> UE message has been completed. Where applicable (e.g. the physical layer transmission is impacted), the changes shall be adopted in the beginning of the next TTI starting after N1. N1 is specified as a multiple of 10 ms.

N2 = number of 10 ms radio frames from end of reception of UTRAN -> UE message on UE physical layer before the transmission of the UE -> UTRAN response message must be ready to start on a transport channel with no access delay other than the TTI alignment (e.g. DCH, therefore excluding delays caused by RACH procedure etc). The UE response message transmission from the physical layer shall begin at the latest $(N2*10)+TTI$ ms after completion of the reception of the last TTI carrying the triggering UTRAN -> UE message. When Target State is CELL_DCH, the UE response message transmission from the physical layer may be additionally delayed by the value of IE "SRB delay".

N1 and N2 are independent (e.g. $N2-N1$ is not restricted to being less than or equal to 10ms).

13.5.2 RRC procedure performance values

NOTE: Times indicated in the table do not include cell reselection.

Procedure title:	UTRAN -> UE	UE -> UTRAN	N1	N2	Notes
RRC Connection Management Procedures					
Broadcast of system information	SYSTEM INFORMATION				N2 is not applicable for any system information messages, because there is no response message from the UE.

Procedure title:	UTRAN -> UE	UE -> UTRAN	N1	N2	Notes
Master Information Block	SYSTEM INFORMATION		5	NA	No system information data shall be lost due to processing of a MIB received with no detectable errors. This means that the UE shall buffer all system information data received after the MIB until the data can be processed according to the information in the MIB, unless the MIB was received erroneously.
System Information Block type 1	SYSTEM INFORMATION		10	NA	
System Information Block type 2	SYSTEM INFORMATION		10	NA	
System Information Block type 3	SYSTEM INFORMATION		10	NA	
System Information Block type 4	SYSTEM INFORMATION		10	NA	
System Information Block type 5 or System Information Block type 5bis	SYSTEM INFORMATION		10	NA	
System Information Block type 6	SYSTEM INFORMATION		10	NA	
System Information Block type 7	SYSTEM INFORMATION		5	NA	
System Information Block type 11 or System Information Block type 11bis	SYSTEM INFORMATION		10	NA	
System Information Block type 12	SYSTEM INFORMATION		10	NA	
System Information Block type 13	SYSTEM INFORMATION		10	NA	
System Information Block type 14	SYSTEM INFORMATION		10	NA	
System Information Block type 15	SYSTEM INFORMATION		10	NA	
System Information Block type 16	SYSTEM INFORMATION		10	NA	
System Information Block type 18	SYSTEM INFORMATION		10	NA	
RRC connection establishment <i>Target state CELL_DCH</i>	RRC CONNECTION SETUP	RRC CONNECTION SETUP COMPLETE	10	NA	N1 measures time to the start of tx / rx on DPCH. N2 cannot be specified, because RRC CONNECTION SETUP COMPLETE message is transmitted only after physical layer synchronisation, which also depends on the Node B. The performance of the physical layer synchronisation procedure is specified in [19] and [20]
RRC connection establishment <i>Target state CELL_FACH</i>	RRC CONNECTION SETUP	RRC CONNECTION SETUP COMPLETE	10	11	N1 and N2 applicable as defined (N2 can be tested from the initiation of the power ramp on RACH).

Procedure title:	UTRAN -> UE	UE -> UTRAN	N1	N2	Notes
RRC connection release <i>From CELL_DCH state</i>	RRC CONNECTION RELEASE	RRC CONNECTION RELEASE COMPLETE	5	8	N1 sets the requirement for the time from the completion of the last repetition of the RRC CONNECTION RELEASE COMPLETE message to the release of the physical channel. N2 sets the requirement from the end of successful reception of the RRC CONNECTION RELEASE message to the start of the first transmission of the RRC CONNECTION RELEASE COMPLETE message.
RRC connection release <i>From CELL_FACH state</i>	RRC CONNECTION RELEASE	RRC CONNECTION RELEASE COMPLETE	NA	11	N1 represents UE internal configuration that cannot be externally observed.
Paging	PAGING TYPE 1	CELL UPDATE	10	11+ T	T is the repetition period of SIB7 (applicable for FDD) and SIB14 (applicable for TDD)
UE capability enquiry	UE CAPABILITY ENQUIRY	UE CAPABILITY INFORMATION	NA	8	N1 is not applicable because the UE configuration does not change.
Security mode control	SECURITY MODE COMMAND	SECURITY MODE COMPLETE	5	8	
Signalling connection release procedure	SIGNALLING CONNECTION RELEASE		5	NA	N2 is not applicable because there is no response message.
Counter check	COUNTER CHECK	COUNTER CHECK RESPONSE	NA	8	N1 is not applicable because the UE configuration does not change.
Radio Bearer control procedures					
Radio bearer establishment <i>Target state CELL_DCH</i>	RADIO BEARER SETUP	RADIO BEARER SETUP COMPLETE / FAILURE	10	NA	N2 cannot be specified, because the RADIO BEARER SETUP COMPLETE / FAILURE message is transmitted only after physical layer synchronisation, which depends also on Node B.
Radio bearer establishment <i>From state CELL_FACH to state CELL_FACH</i>	RADIO BEARER SETUP	RADIO BEARER SETUP COMPLETE / FAILURE	10	11	
Radio bearer establishment <i>From CELL_DCH to CELL_FACH</i>	RADIO BEARER SETUP	RADIO BEARER SETUP COMPLETE	NA	NA	N1 and N2 cannot be specified, because UE need to read SIBs on BCH before sending RADIO BEARER SETUP COMPLETE
Radio bearer reconfiguration <i>Target state CELL_DCH</i>	RADIO BEARER RECONFIGURATION	RADIO BEARER RECONFIGURATION COMPLETE / FAILURE	5 or 10	NA	N2 cannot be specified, because the RADIO BEARER RECONFIGURATION COMPLETE / FAILURE message is transmitted only after physical layer synchronisation, which depends also on Node B. NOTE 1
Radio bearer reconfiguration <i>From state CELL_FACH to state CELL_FACH</i>	RADIO BEARER RECONFIGURATION	RADIO BEARER RECONFIGURATION COMPLETE / FAILURE	10	11	

Procedure title:	UTRAN -> UE	UE -> UTRAN	N1	N2	Notes
Radio bearer reconfiguration <i>From state CELL_DCH to state CELL_FACH</i>	RADIO BEARER RECONFIGURATION	RADIO BEARER RECONFIGURATION COMPLETE	NA	NA	N1 and N2 cannot be specified, because UE need to read SIBs on BCH before sending RADIO BEARER RECONFIGURATION COMPLETE
Radio bearer release <i>Target state CELL_DCH</i>	RADIO BEARER RELEASE	RADIO BEARER RELEASE COMPLETE / FAILURE	10	11	
Radio bearer release <i>From state CELL_FACH to state CELL_FACH</i>	RADIO BEARER RELEASE	RADIO BEARER RELEASE COMPLETE / FAILURE	10	11	
Radio bearer release <i>From state CELL_DCH to state CELL_FACH</i>	RADIO BEARER RELEASE	RADIO BEARER RELEASE COMPLETE	NA	NA	N1 and N2 cannot be specified, because UE need to read SIBs on BCH before sending RADIO BEARER RECONFIGURATION COMPLETE
Transport channel reconfiguration <i>Target state CELL_DCH</i>	TRANSPORT CHANNEL RECONFIGURATION	TRANSPORT CHANNEL RECONFIGURATION COMPLETE / FAILURE	5 or 10	NA	N2 cannot be specified, because the TRANSPORT CHANNEL RECONFIGURATION COMPLETE / FAILURE message is transmitted only after physical layer synchronisation, which depends also on Node B. NOTE 1
Transport channel reconfiguration <i>From state CELL_FACH to state CELL_FACH</i>	TRANSPORT CHANNEL RECONFIGURATION	TRANSPORT CHANNEL RECONFIGURATION COMPLETE / FAILURE	10	11	
Transport channel reconfiguration <i>From state CELL_DCH to state CELL_FACH</i>	TRANSPORT CHANNEL RECONFIGURATION	TRANSPORT CHANNEL RECONFIGURATION COMPLETE	NA	NA	N1 and N2 cannot be specified, because UE need to read SIBs on BCH before sending TRANSPORT CHANNEL RECONFIGURATION COMPLETE
Transport format combination control <i>AM or UM RLC mode</i>	TRANSPORT FORMAT COMBINATION CONTROL	TRANSPORT FORMAT COMBINATION CONTROL FAILURE	5	8	
Transport format combination control <i>Transparent mode</i>	TRANSPORT FORMAT COMBINATION CONTROL		5	NA	N2 is not applicable because no response message is defined.
Physical channel reconfiguration <i>Target state CELL_DCH</i>	PHYSICAL CHANNEL RECONFIGURATION	PHYSICAL CHANNEL RECONFIGURATION COMPLETE / FAILURE	5 or 8	NA	N2 cannot be specified, because the PHYSICAL CHANNEL RECONFIGURATION COMPLETE / FAILURE message is transmitted only after physical layer synchronisation, which depends also on Node B. NOTE 1
Physical channel reconfiguration <i>From state CELL_FACH to state CELL_FACH</i>	PHYSICAL CHANNEL RECONFIGURATION	PHYSICAL CHANNEL RECONFIGURATION COMPLETE / FAILURE	8	9	

Procedure title:	UTRAN -> UE	UE -> UTRAN	N1	N2	Notes
Physical channel reconfiguration <i>From state CELL_DCH to state CELL_FACH</i>	PHYSICAL CHANNEL RECONFIGURATION	PHYSICAL CHANNEL RECONFIGURATION COMPLETE	NA	NA	N1 and N2 cannot be specified, because UE need to read SIBs on BCH before sending PHYSICAL CHANNEL RECONFIGURATION COMPLETE
Physical Shared Channel Allocation [TDD only]	PHYSICAL SHARED CHANNEL ALLOCATION		5	NA	N2 is not applicable because no response message is defined.
Uplink Physical Channel Control [TDD only]	UPLINK PHYSICAL CHANNEL CONTROL		8	NA	Requirements for outer loop and timing advance adjustments are defined in [22] and [20]. N2 is not applicable because there is no response message.
RRC connection mobility procedures					
Cell update	CELL UPDATE CONFIRM	UTRAN MOBILITY INFORMATION CONFIRM	5	8	
		PHYSICAL CHANNEL RECONFIGURATION COMPLETE <i>Target state CELL_FACH</i>	8	9	
		PHYSICAL CHANNEL RECONFIGURATION COMPLETE <i>Target state CELL_DCH</i>	8	NA	N2 cannot be specified, because the PHYSICAL CHANNEL RECONFIGURATION COMPLETE / FAILURE message is transmitted only after physical layer synchronisation, which depends also on Node B.
		TRANSPORT CHANNEL RECONFIGURATION COMPLETE <i>Target state CELL_FACH</i>	10	11	
		TRANSPORT CHANNEL RECONFIGURATION COMPLETE <i>Target state CELL_DCH</i>	10	NA	N2 cannot be specified, because the PHYSICAL CHANNEL RECONFIGURATION COMPLETE / FAILURE message is transmitted only after physical layer synchronisation, which depends also on Node B.
		RADIO BEARER RECONFIGURATION COMPLETE <i>Target state CELL_FACH</i>	10	11	
		RADIO BEARER RECONFIGURATION COMPLETE <i>Target state CELL_DCH</i>	10	NA	N2 cannot be specified, because the PHYSICAL CHANNEL RECONFIGURATION COMPLETE / FAILURE message is transmitted only after physical layer synchronisation, which depends also on Node B.

Procedure title:	UTRAN -> UE	UE -> UTRAN	N1	N2	Notes
		RADIO BEARER RELEASE COMPLETE <i>Target state</i> <i>CELL_DCH</i>	10	11	
URA update	URA UPDATE CONFIRM	UTRAN MOBILITY INFORMATION CONFIRM	5	8	
UTRAN mobility information	UTRAN MOBILITY INFORMATION	UTRAN MOBILITY INFORMATION CONFIRM / FAILURE	5	8	
Active set update	ACTIVE SET UPDATE	ACTIVE SET UPDATE COMPLETE / FAILURE	NA	5	The requirements on UE combining and power control performance for both UL and DL are specified by RAN WG4 in [21] and [19]. Also in case of branch addition the COMPLETE / FAILURE message is transmitted without waiting for the new branch to stabilise, therefore N2 is specified.
Inter-RAT handover to UTRAN	HANDOVER TO UTRAN COMMAND (other system)	HANDOVER TO UTRAN COMPLETE	NA	NA	The performance of this procedure is specified in 05.10.
Inter-RAT handover from UTRAN	HANDOVER FROM UTRAN COMMAND	HANDOVER FROM UTRAN FAILURE	NA	NA	The performance of this procedure is specified in [19] and [20].
Measurement procedures					
Measurement control	MEASUREMENT CONTROL	MEASUREMENT CONTROL FAILURE	5	8	Response to measurement inquiry depends on physical layer measurement. Response time is defined in [19] and [20]. N1 and N2 only define the processing of the message.

NOTE 1: The lower value applies when the UE is ordered to do a serving HS-DSCH cell change, changing no other information than contained in the IE "H-RNTI", the IE "Downlink HS-PDSCH information", the IE "Uplink DPCH power control info" and/or the IE "Serving HS-DSCH radio link indicator" (FDD only).

13.6 RB information parameters for signalling radio bearer RB 0

The following Radio Bearer parameter values apply for signalling radio bearer RB0 for TDD and for FDD, if either UE or UTRAN do not support common channel mapping on HS-DSCH:

Information element/ Group name	Value	Comment
RLC info		
>Uplink RLC mode	TM	
>>Transmission RLC discard	omitted	Neither discard is used, nor will there be a reset
>>Segmentation indication	FALSE	
>Downlink RLC mode	UM	
>>DL UM RLC LI size	7	
RB mapping info		Single multiplexing option
>Uplink mapping info		
>>UL transport channel	RACH	RACH corresponding with selected PRACH
>>RLC size list	N/A	If available the size in the IE "Additional Dynamic Transport Format Information for CCCH" for the transport channel used. Else the first TF defined in the Transport Format Set for the transport channel is used.
>>MAC logical channel priority	1	
>Downlink mapping info		
>>DL transport channel	FACH	

Procedure descriptions in subclause 8.6.4.8 shall not be applied for the IE "RB mapping info" that is used for signalling radio bearer RB0.

13.6a RB information parameters for SHCCH

The following Radio Bearer parameter values apply for SHCCH:

Information element/ Group name	Value	Comment
RLC info		
>Uplink RLC mode	TM	
>>Transmission RLC discard	omitted	Neither discard is used, nor will there be a reset
>>Segmentation indication	FALSE	
>Downlink RLC mode	UM	
RB mapping info		
>Uplink mapping info		Option 1
>>UL transport channel	RACH	RACH corresponding with selected PRACH
>>RLC size list	N/A	The first TF defined in the Transport Format Set for the transport channel that is used
>>MAC logical channel priority	1	
>Downlink mapping info		
>>DL transport channel	FACH	
>Uplink mapping info		Option 2
>>UL transport channel	USCH	
>>UL Transport Channel Identity	1	
>>MAC logical channel priority	1	
>>RLC size list	N/A	The first TF defined in the Transport Format Set for the transport channel that is used
>Downlink mapping info		
>>DL transport channel	DSCH	
>>DL Transport Channel Identity	1	

13.6b RB information parameters for BCCH mapped to FACH

The following Radio Bearer parameter values apply for BCCH mapped to FACH:

Information element/ Group name	Value	Comment
Downlink RLC mode	TM	
Segmentation indication	FALSE	

13.6c RB information parameters for PCCH mapped to PCH

The following Radio Bearer parameter values apply for PCCH mapped to PCH:

Information element/ Group name	Value	Comment
Downlink RLC mode	TM	
Segmentation indication	FALSE	

13.6d Parameters for BCCH mapped to BCH

The transport format parameters for BCH are specified in [34].

13.6e RB information parameters for signalling radio bearer RB 0 mapped on HS-DSCH and RACH

The following Radio Bearer parameter values apply for signalling radio bearer RB0, if UE and UTRAN support common channel mapping on HS-DSCH:

NOTE: FDD only.

Information element/ Group name	Value	Comment
RLC info		
>Uplink RLC mode	TM	
>>Transmission RLC discard	omitted	Neither discard is used, nor will there be a reset
>>Segmentation indication	FALSE	
>Downlink RLC mode	UM	
>>Length indicator size	7	
RB mapping info		Single multiplexing option
>Uplink mapping info		
>>UL transport channel	RACH	RACH corresponding with selected PRACH
>>RLC size list	N/A	If available the size in the IE "Additional Dynamic Transport Format Information for CCCH" for the transport channel used. Else the first TF defined in the Transport Format Set for the transport channel is used.
>>MAC logical channel priority	1	
>Downlink mapping info		
>>DL transport channel	HS-DSCH	

13.6f RB information parameters for BCCH mapped to HS-DSCH

The following Radio Bearer parameter values apply for BCCH mapped to HS-DSCH:

NOTE: FDD only.

Information element/ Group name	Value	Comment
Downlink RLC mode	TM	
Segmentation indication	FALSE	
MAC-ehs reordering queue	N/A	No MAC-ehs reordering queue is configured for BCCH reception.

13.6g RB information parameters for PCCH mapped to HS-DSCH

The following Radio Bearer parameter values apply for PCCH mapped to HS-DSCH:

NOTE: FDD only.

Information element/ Group name	Value	Comment
Downlink RLC mode	TM	
Segmentation indication	FALSE	
MAC-ehs reordering queue	N/A	No MAC-ehs reordering queue is configured for PCCH reception.

13.7 Parameter values for default radio configurations

The UE shall support the use of the default radio configurations that are specified in the following.

NOTE 1: These configurations are based on [41] and cover a number of RAB and signalling connection configurations.

In the table that is used to specify the parameter values for these default configurations, the following principles are used:

- Optional IEs that are not used are omitted;
- In case no parameter value is specified in a column, this means the value given the previous (left side) column applies.

NOTE 2: If needed, signalling radio bearer RB4 is established after the completion of handover.

NOTE 3: For each default configuration, the value of FDD, 3.84 Mcps TDD, 7.68 Mcps TDD and 1.28 Mcps TDD parameters are specified. All parameters apply to FDD, 3.84 Mcps TDD, 7.68 Mcps and 1.28 Mcps TDD modes, unless explicitly stated otherwise. It should be noted that in this respect default configurations differ from pre-defined configurations, which only include parameter values for one mode.

NOTE 4: The transport format sizes, indicated in the following table, concern the RLC PDU size, since all configurations concern dedicated channels. The transport block sizes indicated in TS 34.108 are different since these include the size of the MAC header.

NOTE 5: The tabular values included in this subclause, represent the actual IE values as in clause 10, and not the ASN.1 representation of these values.

NOTE 5A: For TDD, default configurations 0, 1, 5, 6, 7 and 22 are incorrect and they should not be used in this version of the specification.

Configuration	3.4 kbps signalling	13.6 kbps signalling	Unused configuration	12.2 kbps speech + 3.4 kbps signalling
Ref 34.108	2	3		4
Default configuration identity	0	1	2	3
RB INFORMATION				
rb-Identity	RB1: 1, RB2: 2, RB3: 3	RB1: 1, RB2: 2, RB3: 3		RB1: 1, RB2: 2, RB3: 3, RB5: 5, RB6: 6, RB7: 7
rlc-InfoChoice	Rlc-info	Rlc-info		Rlc-info
>ul-RLC-Mode	RB1: UM RB2- RB3: AM	RB1: UM RB2- RB3: AM		RB1: UM RB2- RB3: AM RB5- RB7: TM
>>transmissionRLC-DiscardMode	RB1: N/A RB2- RB3: NoDiscard	RB1: N/A RB2- RB3: NoDiscard		RB1: N/A RB2- RB3: NoDiscard RB5- RB7: N/A

Configuration	3.4 kbps signalling	13.6 kbps signalling	Unused configuration	12.2 kbps speech + 3.4 kbps signalling
>>>maxDat	RB1: N/A RB2- RB3: 15	RB1: N/A RB2- RB3: 15		RB1: N/A RB2- RB3: 15 RB5- RB7: N/A
>>transmissionWindowSize	RB1: N/A RB2- RB3: 128 for UEs with more than 10 kbyte "total RLC AM buffer size" and 32 otherwise	RB1: N/A RB2- RB3: 128 for UEs with more than 10 kbyte "total RLC AM buffer size" and 32 otherwise		RB1: N/A RB2- RB3: 128 for UEs with more than 10 kbyte "total RLC AM buffer size" and 32 otherwise RB5- RB7: N/A
>>timerRST	RB1: N/A RB2- RB3: 300	RB1: N/A RB2- RB3: 300		RB1: N/A RB2- RB3: 300 RB5- RB7: N/A
>>max-RST	RB1: N/A RB2- RB3: 1	RB1: N/A RB2- RB3: 1		RB1: N/A RB2- RB3: 1 RB5- RB7: N/A
>>pollingInfo	RB1: N/A RB2- RB3: as below	RB1: N/A RB2- RB3: as below		RB1: N/A RB2- RB3: as below RB5- RB7: N/A
>>>lastTransmissionPDU-Poll	RB2- RB3: FALSE	RB2- RB3: FALSE		RB2- RB3: FALSE
>>>lastRetransmissionPDU-Poll	RB2- RB3: FALSE	RB2- RB3: FALSE		RB2- RB3: FALSE
>>>timerPollPeriodic	RB2- RB3: 300	RB2- RB3: 100		RB2- RB3: 300
>>segmentationIndication	RB1- RB3: N/A	RB1- RB3: N/A		RB1- RB3: N/A RB5- RB7: FALSE
>dl-RLC-Mode	RB1: UM RB2- RB3: AM	RB1: UM RB2- RB3: AM		RB1: UM RB2- RB3: AM RB5- RB7: TM
>>inSequenceDelivery	RB1: N/A RB2- RB3: TRUE	RB1: N/A RB2- RB3: TRUE		RB1: N/A RB2- RB3: TRUE RB5- RB7: N/A
>>receivingWindowSize	RB1: N/A RB2- RB3: 128 for UEs with more than 10 kbyte "total RLC AM buffer size" and 32 otherwise	RB1: N/A RB2- RB3: 128 for UEs with more than 10 kbyte "total RLC AM buffer size" and 32 otherwise		RB1: N/A RB2- RB3: 128 for UEs with more than 10 kbyte "total RLC AM buffer size" and 32 otherwise RB5- RB7: N/A
>>dl-RLC-StatusInfo	RB1: N/A RB2- RB3: as below	RB1: N/A RB2- RB3: as below		RB1: N/A RB2- RB3: as below RB5- RB7: N/A
>>>timerStatusProhibit	RB2- RB3: 100	RB2- RB3: 100		RB2- RB3: 100
>>>missingPDU-Indicator	RB2- RB3: FALSE	RB2- RB3: FALSE		RB2- RB3: FALSE
>>>timerStatusPeriodic	RB2- RB3: 300	RB2- RB3: 100		RB2- RB3: 300
>>segmentationIndication	RB1- RB3: N/A	RB1- RB3: N/A		RB1- RB3: N/A RB5- RB7: FALSE
rb-MappingInfo				
>UL-LogicalChannelMappings	OneLogicalChannel	OneLogicalChannel		OneLogicalChannel
>>ul-TransportChannelType	Dch	Dch		Dch
>>>transportChannelIdentity	RB1- RB3: 1	RB1- RB3: 1		RB1- RB3: 4 RB5: 1, RB6: 2, RB7: 3
>>logicalChannelIdentity	RB1: 1, RB2: 2, RB3: 3	RB1: 1, RB2: 2, RB3: 3		RB1: 1, RB2: 2, RB3: 3 RB5- RB7: N/A
>>rlc-SizeList	RB1- RB3: configured	RB1- RB3: configured		RB1- RB3: configured RB5- RB7: N/A

Configuration	3.4 kbps signalling	13.6 kbps signalling	Unused configuration	12.2 kbps speech + 3.4 kbps signalling
>>mac-LogicalChannelPriority	RB1: 1, RB2: 2, RB3: 3	RB1: 1, RB2: 2, RB3: 3		RB1: 1, RB2: 2, RB3: 3 RB5- RB7: 5
>DL-logicalChannelMappingList				
>>Mapping option 1	One mapping option	One mapping option		One mapping option
>>>dl-TransportChannelType	Dch	Dch		Dch
>>>>transportChannelIdentity	RB1- RB3: 1	RB1- RB3: 1		RB1- RB3: 4 RB5: 1, RB6: 2, RB7: 3
>>>>logicalChannelIdentity	RB1: 1, RB2: 2, RB3: 3	RB1: 1, RB2: 2, RB3: 3		RB1: 1, RB2: 2, RB3: 3 RB5- RB7: N/A
TrCH INFORMATION PER TrCH				
UL-AddReconfTransChInfoList				
>Uplink transport channel type	dch	dch		dch
>transportChannelIdentity	TrCH1: 1	TrCH1: 1		TrCH1: 1, TrCH2: 2, TrCH3: 3, TrCH4: 4
>transportFormatSet	DedicatedTransChTFS	DedicatedTransChTFS		DedicatedTransChTFS
>>dynamicTF-information				
>>>>tf0/ tf0,1	TrCH1: (0x144, 1x144)	TrCH1: (0x144, 1x144)		TrCH1: (0x81) TrCH2: (0x 103, 1x103) TrCH3: (0x 60, 1x60) TrCH4: (0x144, 1x144)
>>>>>rlcSize	BitMode	BitMode		BitMode
>>>>>>sizeType	TrCH1: type 2, part1= 2, part2= 0 (144)	TrCH1: type 2, part1= 2, part2= 0 (144)		TrCH1: type 1: 81 TrCH2: type 1: 103 TrCH3: type 1: 60 TrCH4: 2: type 2, part1= 2, part2= 0 (144)
>>>>>>numberOfTbSizeList	TrCH1: Zero, one	TrCH1: Zero, one		TrCH1: Zero TrCH2-4: Zero, one
>>>>>>logicalChannelList	All	All		All
>>>>>>>tf 1	N/A	N/A		TrCH1: (1x39) TrCH2- TrCH4: N/A
>>>>>>>>numberOfTransportBlocks				TrCH1: One
>>>>>>>>rlc-Size				TrCH1: BitMode
>>>>>>>>>sizeType				TrCH1: 1: 39
>>>>>>>>>>numberOfTbSizeList				TrCH1: One
>>>>>>>>>>>logicalChannelList				TrCH1: all
>>>>>>>>>>>>tf 2	N/A	N/A		TrCH1: (1x81) TrCH2- TrCH4: N/A
>>>>>>>>>>>>>numberOfTransportBlocks				TrCH1: One
>>>>>>>>>>>>>>rlc-Size				TrCH1: BitMode
>>>>>>>>>>>>>>>sizeType				TrCH1: type 1: 81
>>>>>>>>>>>>>>>>numberOfTbSizeList				TrCH1: One
>>>>>>>>>>>>>>>>>logicalChannelList				TrCH1: all
>>>>>>>>>>>>>>>>>>semistaticTF-Information				
>>>>>>>>>>>>>>>>>>>tti	TrCH1: 40	TrCH1: 10		TrCH1- TrCH3: 20 TrCH4: 40
>>>>>>>>>>>>>>>>>>>>channelCodingType	Convolutional	Convolutional		Convolutional

Configuration	3.4 kbps signalling	13.6 kbps signalling	Unused configuration	12.2 kbps speech + 3.4 kbps signalling
>>>>codingRate	TrCH1: Third	TrCH1: Third		TrCH1- TrCH2: Third TrCH3: Half TrCH4: Third
>>>rateMatchingAttribute	TrCH1: 160	TrCH1: 160		TrCH1: 200 TrCH2: 190 TrCH3: 235 TrCH4: 160
>>>crc-Size	TrCH1: 16	TrCH1: 16		TrCH1: 12 TrCH2- TrCH3: 0 TrCH4: 16
DL-AddReconfTransChInfoList				
>Downlink transport channel type	dch	dch		dch
>dl-TransportChannelIdentity (should be as for UL)	TrCH1: 1	TrCH1: 1		TrCH1: 1, TrCH2: 2, TrCH3: 3, TrCH4: 4
>tfcs-SignallingMode	SameAsUL	SameAsUL		Explicit <Only tf0 on TrCH1 is different and shown below>
>>transportFormatSet				DedicatedTransChTFS
>>>dynamicTF-information				
>>>>tf0/ tf0,1				TrCH1: (1x0)
>>>>rlcSize				bitMode
>>>>>sizeType				TrCH1: type 1: 0
>>>>>numberOfTbSizeList				TrCH1: One
>>>>>logicalChannelList				All
>>ULTrCH-Id	TrCH1: 1	TrCH1: 1		TrCH1: 1, TrCH2: 2, TrCH3: 3, TrCH4: 4
>dch-QualityTarget				
>>bler-QualityValue	TrCH1: 5×10^{-2}	TrCH1: 5×10^{-2}		TrCH1: 7×10^{-3} TrCH2- TrCH4: Absent
TrCH INFORMATION, COMMON				
ul-CommonTransChInfo				
>tfcs-ID (TDD only)	1	1		1
>sharedChannelIndicator (TDD only)	FALSE	FALSE		FALSE
>tfcs-Subset	Absent, not required	Absent, not required		Absent, not required
>ul-TFCS	Normal TFCS signalling	Normal TFCS signalling		Normal TFCS signalling
>>explicitTFCS-ConfigurationMode	Complete	Complete		Complete
>>>ctfcSize	Ctfc2Bit	Ctfc2Bit		Ctfc6Bit
>>>>TFCS representation	Addition	Addition		Addition
>>>>>TFCS list				
>>>>>>TFCS 1	(TF0)	(TF0)		(TF0, TF0, TF0, TF0)
>>>>>>>ctfc	0	0		0
>>>>>>>gainFactorInformation	Computed	Computed		Computed
>>>>>>>referenceTFCSId	0	0		0
>>>>>>>TFCS 2	(TF1)	(TF1)		(TF1, TF0, TF0, TF0)
>>>>>>>ctfc	1	1		1
>>>>>>>gainFactorInformation	Signalled	Signalled		Computed

Configuration	3.4 kbps signalling	13.6 kbps signalling	Unused configuration	12.2 kbps speech + 3.4 kbps signalling
>>>>>>> β c (FDD only)	11	11		N/A
>>>>>>> β d	15	15		N/A
>>>>>>>referenceTFCId	0	0		0
>>>>>>>TFCS 3				(TF2, TF1, TF1, TF0)
>>>>>>>ctfc				11
>>>>>>>gainFactorInformation				Computed
>>>>>>>referenceTFCId				0
>>>>>>>TFCS 4				(TF0, TF0, TF0, TF1)
>>>>>>>ctfc				12
>>>>>>>gainFactorInformation				Computed
>>>>>>> β c (FDD only)				N/A
>>>>>>> β d				N/A
>>>>>>>referenceTFCId				0
>>>>>>>TFCS 5				(TF1, TF0, TF0, TF1)
>>>>>>>ctfc				13
>>>>>>>gainFactorInformation				Computed
>>>>>>>referenceTFCId				0
>>>>>>>TFCS 6				(TF2, TF1, TF1, TF1)
>>>>>>>ctfc				23
>>>>>>>gainFactorInformation				Signalled
>>>>>>> β c (FDD only)				11
>>>>>>> β d				15
>>>>>>>referenceTFCId				0
>dl-CommonTransChInfo				
>tfc-SignallingMode	Same as UL	Same as UL		Same as UL
PhyCH INFORMATION FDD				
UL-DPCH-InfoPredef				
>ul-DPCH-PowerControlInfo				
>>powerControlAlgorithm	Algorithm 1	Algorithm 1		Algorithm 1
>>>tpcStepSize	1 dB	1 dB		1 dB
>tfc-Existence	TRUE	TRUE		TRUE
>puncturingLimit	1	1		0.88
DL-CommonInformationPredef				
>dl-DPCH-InfoCommon				
>>spreadingFactor	256	128		128
>>tfc-Existence	FALSE	FALSE		FALSE
>>pilotBits	4	4		4
>>positionFixed	N/A	N/A		Fixed
PhyCH INFORMATION 3.84/7.68 Mcps TDD				
UL-DPCH-InfoPredef				
>ul-DPCH-PowerControlInfo				
>>dpcch-ConstantValue	0	0		0
>commonTimeslotInfo				
>>secondInterleavingMode	frameRelated	frameRelated		frameRelated
>>tfc-Coding	4	4		16
>>puncturingLimit	1	0.92		0.88

Configuration	3.4 kbps signalling	13.6 kbps signalling	Unused configuration	12.2 kbps speech + 3.4 kbps signalling
>>repetitionPeriodAndLength	repetitionPeriod1	repetitionPeriod1		repetitionPeriod1
DL-CommonInformationPredef				
>dl-DPCH-InfoCommon				
>>commonTimeslotInfo				
>>>secondInterleavingMode	frameRelated	frameRelated		frameRelated
>>>tfc-Coding	4	4		16
>>>puncturingLimit	1	0.92		0.92
>>>repetitionPeriodAndLength	repetitionPeriod1	repetitionPeriod1		repetitionPeriod1
PhyCH INFORMATION 1.28 Mcps TDD				
UL-DPCH-InfoPredef				
>commonTimeslotInfo				
>>secondInterleavingMode	frameRelated	frameRelated		frameRelated
>>tfc-Coding	4	4		16
>>puncturingLimit	1	0.64		0.60
>>repetitionPeriodAndLength	repetitionPeriod1	repetitionPeriod1		repetitionPeriod1
DL-CommonInformationPredef				
>dl-DPCH-InfoCommon				
>>commonTimeslotInfo				
>>>secondInterleavingMode	frameRelated	frameRelated		frameRelated
>>>tfc-Coding	4	4		16
>>>puncturingLimit	1	0.64		0.60
>>>repetitionPeriodAndLength	repetitionPeriod1	repetitionPeriod1		repetitionPeriod1

Configuration	28.8 kbps conv. CS- data + 3.4 kbps signalling	32 kbps conv. CS- data + 3.4 kbps signalling	64kbps conv. CS- data + 3.4 kbps signalling	14.4 kbps streaming CS- data + 3.4 kbps signalling
Ref 34.108	12	14	13	15
Default configuration identity	4	5	6	7
RB INFORMATION				
rb-Identity	RB1: 1, RB2: 2, RB3: 3, RB5: 5	RB1: 1, RB2: 2, RB3: 3, RB5: 5	RB1: 1, RB2: 2, RB3: 3, RB5: 5	RB1: 1, RB2: 2, RB3: 3, RB5: 5
rlc-InfoChoice	Rlc-info	Rlc-info	Rlc-info	Rlc-info
>ul-RLC-Mode	RB1: UM RB2- RB3: AM RB5: TM	RB1: UM RB2- RB3: AM RB5: TM	RB1: UM RB2- RB3: AM RB5: TM	RB1: UM RB2- RB3: AM RB5: TM
>>transmissionRLC-DiscardMode	RB1: N/A RB2- RB3: NoDiscard RB5: N/A	RB1: N/A RB2- RB3: NoDiscard RB5: N/A	RB1: N/A RB2- RB3: NoDiscard RB5: N/A	RB1: N/A RB2- RB3: NoDiscard RB5: N/A
>>>maxDat	RB1: N/A RB2- RB3: 15 RB5: N/A	RB1: N/A RB2- RB3: 15 RB5: N/A	RB1: N/A RB2- RB3: 15 RB5: N/A	RB1: N/A RB2- RB3: 15 RB5: N/A
>>transmissionWindowSize	RB1: N/A RB2- RB3: 128 for UEs with more than 10 kbyte "total RLC AM buffer size" and 32 otherwise RB5: N/A	RB1: N/A RB2- RB3: 128 for UEs with more than 10 kbyte "total RLC AM buffer size" and 32 otherwise RB5: N/A	RB1: N/A RB2- RB3: 128 for UEs with more than 10 kbyte "total RLC AM buffer size" and 32 otherwise RB5: N/A	RB1: N/A RB2- RB3: 128 for UEs with more than 10 kbyte "total RLC AM buffer size" and 32 otherwise RB5: N/A

Configuration	28.8 kbps conv. CS- data + 3.4 kbps signalling	32 kbps conv. CS- data + 3.4 kbps signalling	64kbps conv. CS- data + 3.4 kbps signalling	14.4 kbps streaming CS- data + 3.4 kbps signalling
>>timerRST	RB1: N/A RB2- RB3: 300 RB5: N/A	RB1: N/A RB2- RB3: 300 RB5: N/A	RB1: N/A RB2- RB3: 300 RB5: N/A	RB1: N/A RB2- RB3: 300 RB5: N/A
>>max-RST	RB1: N/A RB2- RB3: 1 RB5: N/A	RB1: N/A RB2- RB3: 1 RB5: N/A	RB1: N/A RB2- RB3: 1 RB5: N/A	RB1: N/A RB2- RB3: 1 RB5: N/A
>>pollingInfo	RB1: N/A RB2- RB3: as below RB5: N/A	RB1: N/A RB2- RB3: as below RB5: N/A	RB1: N/A RB2- RB3: as below RB5: N/A	RB1: N/A RB2- RB3: as below RB5: N/A
>>>lastTransmissionPDU-Poll	RB2- RB3: FALSE	RB2- RB3: FALSE	RB2- RB3: FALSE	RB2- RB3: FALSE
>>>lastRetransmissionPDU-Poll	RB2- RB3: FALSE	RB2- RB3: FALSE	RB2- RB3: FALSE	RB2- RB3: FALSE
>>>timerPollPeriodic	RB2- RB3: 300	RB2- RB3: 300	RB2- RB3: 300	RB2- RB3: 300
>>segmentationIndication	RB1- RB3: N/A RB5: FALSE	RB1- RB3: N/A RB5: FALSE	RB1- RB3: N/A RB5: FALSE	RB1- RB3: N/A RB5: FALSE
>dl-RLC-Mode	RB1: UM RB2- RB3: AM RB5: TM	RB1: UM RB2- RB3: AM RB5: TM	RB1: UM RB2- RB3: AM RB5: TM	RB1: UM RB2- RB3: AM RB5: TM
>>inSequenceDelivery	RB1: N/A RB2- RB3: TRUE RB5: N/A	RB1: N/A RB2- RB3: TRUE RB5: N/A	RB1: N/A RB2- RB3: TRUE RB5: N/A	RB1: N/A RB2- RB3: TRUE RB5: N/A
>>receivingWindowSize	RB1: N/A RB2- RB3: 128 for UEs with more than 10 kbyte "total RLC AM buffer size" and 32 otherwise RB5: N/A	RB1: N/A RB2- RB3: 128 for UEs with more than 10 kbyte "total RLC AM buffer size" and 32 otherwise RB5: N/A	RB1: N/A RB2- RB3: 128 for UEs with more than 10 kbyte "total RLC AM buffer size" and 32 otherwise RB5: N/A	RB1: N/A RB2- RB3: 128 for UEs with more than 10 kbyte "total RLC AM buffer size" and 32 otherwise RB5: N/A
>>>dl-RLC-StatusInfo	RB1: N/A RB2- RB3: as below RB5: N/A	RB1: N/A RB2- RB3: as below RB5: N/A	RB1: N/A RB2- RB3: as below RB5: N/A	RB1: N/A RB2- RB3: as below RB5: N/A
>>>timerStatusProhibit	RB2- RB3: 100	RB2- RB3: 100	RB2- RB3: 100	RB2- RB3: 100
>>>missingPDU-Indicator	RB2- RB3: FALSE	RB2- RB3: FALSE	RB2- RB3: FALSE	RB2- RB3: FALSE
>>>timerStatusPeriodic	RB2- RB3: 300	RB2- RB3: 300	RB2- RB3: 300	RB2- RB3: 300
>>segmentationIndication	RB1- RB3: N/A RB5: FALSE	RB1- RB3: N/A RB5: FALSE	RB1- RB3: N/A RB5: FALSE	RB1- RB3: N/A RB5: FALSE
rb-MappingInfo				
>UL-LogicalChannelMappings	OneLogicalChannel	OneLogicalChannel	OneLogicalChannel	OneLogicalChannel
>>ul-TransportChannelType	Dch	Dch	Dch	Dch
>>>transportChannelIdentity	RB1- RB3: 2 RB5: 1	RB1- RB3: 2 RB5: 1	RB1- RB3: 2 RB5: 1	RB1- RB3: 2 RB5: 1
>>logicalChannelIdentity	RB1: 1, RB2: 2, RB3: 3 RB5: N/A	RB1: 1, RB2: 2, RB3: 3 RB5: N/A	RB1: 1, RB2: 2, RB3: 3 RB5: N/A	RB1: 1, RB2: 2, RB3: 3 RB5: N/A
>>rlc-SizeList	RB1- RB3: configured RB5: N/A	RB1- RB3: configured RB5: N/A	RB1- RB3: configured RB5: N/A	RB1- RB3: configured RB5: N/A
>>mac-LogicalChannelPriority	RB1: 1, RB2: 2, RB3: 3 RB5: 5	RB1: 1, RB2: 2, RB3: 3 RB5: 5	RB1: 1, RB2: 2, RB3: 3 RB5: 5	RB1: 1, RB2: 2, RB3: 3 RB5: 5
>DL-logicalChannelMappingList				
>>Mapping option 1	One mapping option	One mapping option	One mapping option	One mapping option
>>>dl-TransportChannelType	Dch	Dch	Dch	Dch
>>>>transportChannelIdentity	RB1- RB3: 2 RB5: 1	RB1- RB3: 2 RB5: 1	RB1- RB3: 2 RB5: 1	RB1- RB3: 2 RB5: 1

Configuration	28.8 kbps conv. CS- data + 3.4 kbps signalling	32 kbps conv. CS- data + 3.4 kbps signalling	64kbps conv. CS- data + 3.4 kbps signalling	14.4 kbps streaming CS- data + 3.4 kbps signalling
>>>logicalChannelIdentity	RB1: 1, RB2: 2, RB3: 3 RB5: N/A	RB1: 1, RB2: 2, RB3: 3 RB5: N/A	RB1: 1, RB2: 2, RB3: 3 RB5: N/A	RB1: 1, RB2: 2, RB3: 3 RB5: N/A
TrCH INFORMATION PER TrCH				
UL-AddReconfTransChInfoList				
>Uplink transport channel type	dch	dch	dch	dch
>transportChannelIdentity	TrCH1: 1, TrCH2: 2	TrCH1: 1, TrCH2: 2	TrCH1: 1, TrCH2: 2	TrCH1: 1, TrCH2: 2
>transportFormatSet	DedicatedTransChTFS	DedicatedTransChTFS	DedicatedTransChTFS	DedicatedTransChTFS
>>dynamicTF-information				
>>>tf0/ tf0,1	TrCH1: (0x576, 1x576, 2x576) TrCH2: (0x144, 1x144)	TrCH1: (0x640, 1x640) TrCH2: (0x144, 1x144)	TrCH1: (0x640, 2x640) TrCH2: (0x144, 1x144)	TrCH1: (0x576, 1x576) TrCH2: (0x144, 1x144)
>>>>rlcSize	TrCH1: OctetMode TrCH2: BitMode	TrCH1: OctetMode TrCH2: BitMode	TrCH1: OctetMode TrCH2: BitMode	TrCH1: OctetMode TrCH2: BitMode
>>>>>sizeType	TrCH1: type 2, part1= 9, part2= 2 (576) TrCH2: type 2, part1= 2, part2= 0 (144)	TrCH1: type 2, part1= 11, part2= 2 (640) TrCH2: type 2, part1= 2, part2= 0 (144)	TrCH1: type 2, part1= 11, part2= 2 (640) TrCH2: type 2, part1= 2, part2= 0 (144)	TrCH1: type 2, part1= 9, part2= 2 (576) TrCH2: type 2, part1= 2, part2= 0 (144)
>>>>numberOfTbSizeList	TrCH1: Zero, 1, 2 TrCH2: Zero, one	TrCH1: Zero, one TrCH2: Zero, one	TrCH1: Zero, 2 TrCH2: Zero, one	TrCH1: Zero, one, TrCH2: Zero, one
>>>>logicalChannelList	All	All	All	All
>>semiStaticTF-Information				
>>>tTi	TrCH1: 40 TrCH2: 40	TrCH1: 20 TrCH2: 40	TrCH1: 20 TrCH2: 40	TrCH1: 40 TrCH2: 40
>>>channelCodingType	TrCH1: Turbo TrCH2: Convolutional	TrCH1: Turbo TrCH2: Convolutional	TrCH1: Turbo TrCH2: Convolutional	TrCH1: Turbo TrCH2: Convolutional
>>>>codingRate	TrCH1: N/A TrCH2: Third	TrCH1: N/A TrCH2: Third	TrCH1: N/A TrCH2: Third	TrCH1: N/A TrCH2: Third
>>>>rateMatchingAttribute	TrCH1: 180 TrCH2: 160	TrCH1: 185 TrCH2: 160	TrCH1: 170 TrCH2: 160	TrCH1: 165 TrCH2: 160
>>>>crc-Size	TrCH1: 16 TrCH2: 16	TrCH1: 16 TrCH2: 16	TrCH1: 16 TrCH2: 16	TrCH1: 16 TrCH2: 16
DL-AddReconfTransChInfoList				
>Downlink transport channel type	dch	dch	dch	dch
>dl-TransportChannelIdentity (should be as for UL)	TrCH1: 1, TrCH2: 2	TrCH1: 1, TrCH2: 2	TrCH1: 1, TrCH2: 2	TrCH1: 1, TrCH2: 2
>dfs-SignallingMode	SameAsUL	SameAsUL	SameAsUL	SameAsUL
>>transportFormatSet				
>>>dynamicTF-information				
>>>>tf0/ tf0,1				
>>>>>rlcSize				
>>>>>>sizeType				
>>>>>>>numberOfTbSizeList				
>>>>>>>logicalChannelList				
>>ULTrCH-Id	TrCH1: 1, TrCH2: 2	TrCH1: 1, TrCH2: 2	TrCH1: 1, TrCH2: 2	TrCH1: 1, TrCH2: 2
>dch-QualityTarget				
>>bler-QualityValue	TrCH1: 2×10^{-3} TrCH2: Absent	TrCH1: 2×10^{-3} TrCH2: Absent	TrCH1: 2×10^{-3} TrCH2: Absent	TrCH1: 1×10^{-2} TrCH2: Absent

Configuration	28.8 kbps conv. CS- data + 3.4 kbps signalling	32 kbps conv. CS- data + 3.4 kbps signalling	64kbps conv. CS- data + 3.4 kbps signalling	14.4 kbps streaming CS- data + 3.4 kbps signalling
TrCH INFORMATION, COMMON				
ul-CommonTransChInfo				
>tfc-ID (TDD only)	1	1	1	1
>sharedChannellIndicator (TDD only)	FALSE	FALSE	FALSE	FALSE
>tfc-Subset	Absent, not required	Absent, not required	Absent, not required	Absent, not required
>ul-TFCS	Normal TFCl signalling	Normal TFCl signalling	Normal TFCl signalling	Normal TFCl signalling
>>explicitTFCS-ConfigurationMode	Complete	Complete	Complete	Complete
>>>ctfcSize	Ctfc4Bit	Ctfc2Bit	Ctfc2Bit	Ctfc4Bit
>>>>TFCS representation	Addition	Addition	Addition	Addition
>>>>>TFCS list				
>>>>>>TFCS 1	(TF0, TF0)	(TF0, TF0)	(TF0, TF0)	(TF0, TF0)
>>>>>>>ctfc	0	0	0	0
>>>>>>>>gainFactorInformation	Computed	Computed	Computed	Computed
>>>>>>>>>referenceTFClId	0	0	0	0
>>>>>>>>>TFCS 2	(TF1, TF0)	(TF1, TF0)	(TF1, TF0)	(TF1, TF0)
>>>>>>>>>>ctfc	1	1	1	1
>>>>>>>>>>>gainFactorInformation	Computed	Computed	Computed	Computed
>>>>>>>>>>>> β_c (FDD only)	N/A	N/A	N/A	N/A
>>>>>>>>>>>> β_d	N/A	N/A	N/A	N/A
>>>>>>>>>>>>>referenceTFClId	0	0	0	0
>>>>>>>>>>>>>TFCS 3	(TF2, TF0)	(TF0, TF1)	(TF0, TF1)	(TF0, TF1)
>>>>>>>>>>>>>>ctfc	2	2	2	2
>>>>>>>>>>>>>>>gainFactorInformation	Computed	Computed	Computed	Computed
>>>>>>>>>>>>>>>>referenceTFClId	0	0	0	0
>>>>>>>>>>>>>>>>TFCS 4	(TF0, TF1)	(TF1, TF1)	(TF1, TF1)	(TF1, TF1)
>>>>>>>>>>>>>>>>>ctfc	3	3	3	3
>>>>>>>>>>>>>>>>>>gainFactorInformation	Computed	Signalled	Signalled	Signalled
>>>>>>>>>>>>>>>>>>> β_c (FDD only)	N/A	8	8	11
>>>>>>>>>>>>>>>>>>>> β_d	N/A	15	15	15
>>>>>>>>>>>>>>>>>>>>>referenceTFClId	0	0	0	0
>>>>>>>>>>>>>>>>>>>>>>TFCS 5	(TF1, TF1)	N/A	N/A	
>>>>>>>>>>>>>>>>>>>>>>>ctfc	4			
>>>>>>>>>>>>>>>>>>>>>>>>gainFactorInformation	Computed			
>>>>>>>>>>>>>>>>>>>>>>>>>referenceTFClId	0			
>>>>>>>>>>>>>>>>>>>>>>>>>>TFCS 6	(TF2, TF1)	N/A	N/A	
>>>>>>>>>>>>>>>>>>>>>>>>>>>ctfc	5			
>>>>>>>>>>>>>>>>>>>>>>>>>>>>gainFactorInformation	Signalled			
>>>>>>>>>>>>>>>>>>>>>>>>>>>>> β_c (FDD only)	8			
>>>>>>>>>>>>>>>>>>>>>>>>>>>>>> β_d	15			
>>>>>>>>>>>>>>>>>>>>>>>>>>>>>>>referenceTFClId	0			
>>>>>>>>>>>>>>>>>>>>>>>>>>>>>>>>TFCS 7				
>>>>>>>>>>>>>>>>>>>>>>>>>>>>>>>>>ctfc				
>>>>>>>>>>>>>>>>>>>>>>>>>>>>>>>>>>gainFactorInformation				
>>>>>>>>>>>>>>>>>>>>>>>>>>>>>>>>>>>referenceTFClId				
>>>>>>>>>>>>>>>>>>>>>>>>>>>>>>>>>>>>TFCS 8				
>>>>>>>>>>>>>>>>>>>>>>>>>>>>>>>>>>>>>ctfc				
>>>>>>>>>>>>>>>>>>>>>>>>>>>>>>>>>>>>>>gainFactorInformation				
>>>>>>>>>>>>>>>>>>>>>>>>>>>>>>>>>>>>>>>referenceTFClId				

Configuration	28.8 kbps conv. CS- data + 3.4 kbps signalling	32 kbps conv. CS- data + 3.4 kbps signalling	64kbps conv. CS- data + 3.4 kbps signalling	14.4 kbps streaming CS- data + 3.4 kbps signalling
>>>>>TFCS 9				
>>>>>>ctfc				
>>>>>>>gainFactorInform ation				
>>>>>>>referenceTFCId				
>>>>>TFCS 10				
>>>>>>ctfc				
>>>>>>>gainFactorInform ation				
>>>>>>> β c (FDD only)				
>>>>>>> β d				
>>>>>>>referenceTFCId				
dI-CommonTransChInfo				
>tfc-SignallingMode	Same as UL	Same as UL	Same as UL	Same as UL
PhyCH INFORMATION FDD				
UL-DPCH-InfoPredef				
>ul-DPCH- PowerControlInfo				
>>powerControlAlgorithm	Algorithm 1	Algorithm 1	Algorithm 1	Algorithm 1
>>>tpcStepSize	1 dB	1 dB	1 dB	1 dB
>tfc-Existence	TRUE	TRUE	TRUE	TRUE
>puncturingLimit	0.92	0.8	0.92	1
DL- CommonInformationPrede f				
>dI-DPCH-InfoCommon				
>>spreadingFactor	64	64	32	128
>>tfc-Existence	TRUE	TRUE	TRUE	TRUE
>>pilotBits	8	8	8	8
>>positionFixed	Flexible	Flexible	Flexible	Flexible
PhyCH INFORMATION 3.84/7.68 Mcps TDD				
UL-DPCH-InfoPredef				
>ul-DPCH- PowerControlInfo				
>>dpch-ConstantValue	0	0	0	0
>commonTimeslotInfo				
>>secondInterleavingMod e	frameRelated	frameRelated	frameRelated	frameRelated
>>tfc-Coding	16	8	8	8
>>puncturingLimit	0.44	0.8	0.56	0.8
>>repetitionPeriodAndLen gth	repetitionPeriod1	repetitionPeriod1	repetitionPeriod1	repetitionPeriod1
DL- CommonInformationPrede f				
>dI-DPCH-InfoCommon				
>>commonTimeslotInfo				
>>>secondInterleavingMo de	frameRelated	frameRelated	frameRelated	frameRelated
>>>tfc-Coding	16	8	8	8
>>>puncturingLimit	0.44	0.64	0.56	0.8
>>>repetitionPeriodAndLe ngth	repetitionPeriod1	repetitionPeriod1	repetitionPeriod1	repetitionPeriod1
PhyCH INFORMATION 1.28 Mcps TDD				
UL-DPCH-InfoPredef				
>commonTimeslotInfo				

Configuration	28.8 kbps conv. CS-data + 3.4 kbps signalling	32 kbps conv. CS-data + 3.4 kbps signalling	64kbps conv. CS-data + 3.4 kbps signalling	14.4 kbps streaming CS-data + 3.4 kbps signalling
>>secondInterleavingMode	frameRelated	frameRelated	frameRelated	frameRelated
>>tfc-Coding	16	8	8	8
>>puncturingLimit	0.64	0.60	0.64	1
>>repetitionPeriodAndLength	repetitionPeriod1	repetitionPeriod1	repetitionPeriod1	repetitionPeriod1
DL-CommonInformationPredef				
>dl-DPCH-InfoCommon				
>>commonTimeslotInfo				
>>>secondInterleavingMode	frameRelated	frameRelated	frameRelated	frameRelated
>>>tfc-Coding	16	8	8	8
>>>puncturingLimit	0.64	0.60	0.64	0.88
>>>repetitionPeriodAndLength	repetitionPeriod1	repetitionPeriod1	repetitionPeriod1	repetitionPeriod1

Configuration	28.8 kbps streaming CS-data + 3.4 kbps signalling	57.6 kbps streaming CS-data + 3.4 kbps signalling	12.2/7.95/5.9/4.75 kbps speech + 3.4 kbps signalling
Ref 34.108	16	17	4a
Default configuration identity	8	9	10
RB INFORMATION			
rb-Identity	RB1: 1, RB2: 2, RB3: 3, RB5: 5	RB1: 1, RB2: 2, RB3: 3, RB5: 5	RB1: 1, RB2: 2, RB3: 3, RB5: 5, RB6: 6, RB7: 7
rlc-InfoChoice	Rlc-info	Rlc-info	Rlc-info
>ul-RLC-Mode	RB1: UM RB2- RB3: AM RB5: TM	RB1: UM RB2- RB3: AM RB5: TM	RB1: UM RB2- RB3: AM RB5-RB7: TM
>>transmissionRLC-DiscardMode	RB1: N/A RB2- RB3: NoDiscard RB5: N/A	RB1: N/A RB2- RB3: NoDiscard RB5: N/A	RB1: N/A RB2- RB3: NoDiscard RB5- RB7: N/A
>>>maxDat	RB1: N/A RB2- RB3: 15 RB5: N/A	RB1: N/A RB2- RB3: 15 RB5: N/A	RB1: N/A RB2- RB3: 15 RB5- RB7: N/A
>>transmissionWindowSize	RB1: N/A RB2- RB3: 128 for UEs with more than 10 kbyte "total RLC AM buffer size" and 32 otherwise RB5: N/A	RB1: N/A RB2- RB3: 128 for UEs with more than 10 kbyte "total RLC AM buffer size" and 32 otherwise RB5: N/A	RB1: N/A RB2- RB3: 128 for UEs with more than 10 kbyte "total RLC AM buffer size" and 32 otherwise RB5- RB7: N/A
>>timerRST	RB1: N/A RB2- RB3: 300 RB5: N/A	RB1: N/A RB2- RB3: 300 RB5: N/A	RB1: N/A RB2- RB3: 300 RB5- RB7: N/A
>>max-RST	RB1: N/A RB2- RB3: 1 RB5: N/A	RB1: N/A RB2- RB3: 1 RB5: N/A	RB1: N/A RB2- RB3: 1 RB5- RB7: N/A
>>pollingInfo	RB1: N/A RB2- RB3: as below RB5: N/A	RB1: N/A RB2- RB3: as below RB5: N/A	RB1: N/A RB2- RB3: as below RB5- RB7: N/A
>>>lastTransmissionPDU-Poll	RB2- RB3: FALSE	RB2- RB3: FALSE	RB2- RB3: FALSE
>>>lastRetransmissionPDU-Poll	RB2- RB3: FALSE	RB2- RB3: FALSE	RB2- RB3: FALSE
>>>timerPollPeriodic	RB2- RB3: 300	RB2- RB3: 300	RB2- RB3: 300

Configuration	28.8 kbps streaming CS-data + 3.4 kbps signalling	57.6 kbps streaming CS-data + 3.4 kbps signalling	12.2/7.95/5.9/4.75 kbps speech + 3.4 kbps signalling
>>segmentationIndication	RB1- RB3: N/A RB5: FALSE	RB1- RB3: N/A RB5: FALSE	RB1- RB3: N/A RB5- RB7: FALSE
>dl-RLC-Mode	RB1: UM RB2- RB3: AM RB5: TM	RB1: UM RB2- RB3: AM RB5: TM	RB1: UM RB2- RB3: AM RB5- RB7: TM
>>inSequenceDelivery	RB1: N/A RB2- RB3: TRUE RB5: N/A	RB1: N/A RB2- RB3: TRUE RB5: N/A	RB1: N/A RB2- RB3: TRUE RB5- RB7: N/A
>>receivingWindowSize	RB1: N/A RB2- RB3: 128 for UEs with more than 10 kbyte "total RLC AM buffer size" and 32 otherwise RB5: N/A	RB1: N/A RB2- RB3: 128 for UEs with more than 10 kbyte "total RLC AM buffer size" and 32 otherwise RB5: N/A	RB1: N/A RB2- RB3: 128 for UEs with more than 10 kbyte "total RLC AM buffer size" and 32 otherwise RB5- RB7: N/A
>>dl-RLC-StatusInfo	RB1: N/A RB2- RB3: as below RB5: N/A	RB1: N/A RB2- RB3: as below RB5: N/A	RB1: N/A RB2- RB3: as below RB5- RB7: N/A
>>>timerStatusProhibit	RB2- RB3: 100	RB2- RB3: 100	RB2- RB3: 100
>>>missingPDU-Indicator	RB2- RB3: FALSE	RB2- RB3: FALSE	RB2- RB3: FALSE
>>>timerStatusPeriodic	RB2- RB3: 300	RB2- RB3: 300	RB2- RB3: 300
>>segmentationIndication	RB1- RB3: N/A RB5: FALSE	RB1- RB3: N/A RB5: FALSE	RB1- RB3: N/A RB5- RB7: FALSE
rb-MappingInfo			
>UL-LogicalChannelMappings	OneLogicalChannel	OneLogicalChannel	OneLogicalChannel
>>ul-TransportChannelType	Dch	Dch	Dch
>>>transportChannelIdentity	RB1- RB3: 2 RB5: 1	RB1- RB3: 2 RB5: 1	RB1- RB3: 4 RB5: 1, RB6: 2, RB7: 3
>>logicalChannelIdentity	RB1: 1, RB2: 2, RB3: 3 RB5: N/A	RB1: 1, RB2: 2, RB3: 3 RB5: N/A	RB1: 1, RB2: 2, RB3: 3 RB5- RB7: N/A
>>rlc-SizeList	RB1- RB3: configured RB5: N/A	RB1- RB3: configured RB5: N/A	RB1- RB3: configured RB5- RB7: N/A
>>mac-LogicalChannelPriority	RB1: 1, RB2: 2, RB3: 3 RB5: 5	RB1: 1, RB2: 2, RB3: 3 RB5: 5	RB1: 1, RB2: 2, RB3: 3 RB5- RB7: 5
>DL-logicalChannelMappingList			
>>Mapping option 1	One mapping option	One mapping option	One mapping option
>>>dl-TransportChannelType	Dch	Dch	Dch
>>>>transportChannelIdentity	RB1- RB3: 2 RB5: 1	RB1- RB3: 2 RB5: 1	RB1- RB3: 4 RB5: 1, RB6: 2, RB7: 3
>>>>logicalChannelIdentity	RB1: 1, RB2: 2, RB3: 3 RB5: N/A	RB1: 1, RB2: 2, RB3: 3 RB5: N/A	RB1: 1, RB2: 2, RB3: 3 RB5- RB7: N/A
TrCH INFORMATION PER TrCH			
UL-AddReconfTransChInfoList			
>Uplink transport channel type	dch	dch	dch
>transportChannelIdentity	TrCH1: 1, TrCH2: 2	TrCH1: 1, TrCH2: 2	TrCH1: 1, TrCH2: 2, TrCH3: 3, TrCH4: 4
>transportFormatSet	DedicatedTransChTFS	DedicatedTransChTFS	DedicatedTransChTFS

Configuration	28.8 kbps streaming CS-data + 3.4 kbps signalling	57.6 kbps streaming CS-data + 3.4 kbps signalling	12.2/7.95/5.9/4.75 kbps speech + 3.4 kbps signalling
>>dynamicTF-information			
>>>tf0/ tf0,1	TrCH1: (0x576, 1x576, 2x576) TrCH2: (0x144, 1x144)	TrCH1: (0x576, 1x576, 2x576, 3x576, 4x576) TrCH2: (0x144, 1x144)	TrCH1: (0x81) TrCH2: (0x 103) TrCH3: (0x 60) TrCH4: (0x144)
>>>>rlcSize	TrCH1: OctetMode TrCH2:BitMode	TrCH1: OctetMode TrCH2:BitMode	BitMode
>>>>>sizeType	TrCH1: type 2, part1= 9, part2= 2 (576) TrCH2: type 2, part1= 2, part2= 0 (144)	TrCH1: type 2, part1= 9, part2= 2 (576) TrCH2: type 2, part1= 2, part2= 0 (144)	TrCH1: type 1: 81 TrCH2: type 1: 103 TrCH3: type 1: 60 TrCH4: type 2, part1= 2, part2= 0 (144)
>>>>numberOfTbSizeList	TrCH1: Zero, one, 2 TrCH2: Zero, one	TrCH1: Zero, one, 2, 3, 4 TrCH2: Zero, one	TrCH1-4: Zero
>>>>logicalChannelList	All	All	All
>>>>tf 1			TrCH1: (1x39) TrCH2: (1x53) TrCH3: (1x60) TrCH4: (1x144)
>>>>numberOfTransportBlocks			TrCH1-4: One
>>>>rlc-Size			TrCH1-3: BitMode
>>>>>sizeType			TrCH1: type 1: 39 TrCH2: type 1: 53 TrCH3: type 1: 60 TrCH4: type 2, part1= 2, part2= 0 (144)
>>>>numberOfTbSizeList			TrCH1-4: One
>>>>logicalChannelList			TrCH1-4: all
>>>>tf 2			TrCH1: (1x42) TrCH2: (1x63) TrCH3- TrCH4: N/A
>>>>numberOfTransportBlocks			TrCH1-2: One
>>>>rlc-Size			TrCH1: BitMode
>>>>>sizeType			TrCH1: type 1: 42 TrCH2: type 1: 63
>>>>numberOfTbSizeList			TrCH1-2: One
>>>>logicalChannelList			TrCH1: all
>>>>tf 3			TrCH1: (1x55) TrCH2: (1x84) TrCH3- TrCH4: N/A
>>>>numberOfTransportBlocks			TrCH1-2: One
>>>>rlc-Size			TrCH1: BitMode
>>>>>sizeType			TrCH1: type 1: 55 TrCH2: type 1: 84
>>>>numberOfTbSizeList			TrCH1-2: One
>>>>logicalChannelList			TrCH1: all
>>>>tf 4			TrCH1: (1x75) TrCH2: (1x103) TrCH3- TrCH4: N/A
>>>>numberOfTransportBlocks			TrCH1-2: One
>>>>rlc-Size			TrCH1: BitMode
>>>>>sizeType			TrCH1: type 1: 75 TrCH2: type 1: 103
>>>>numberOfTbSizeList			TrCH1-2: One

Configuration	28.8 kbps streaming CS- data + 3.4 kbps signalling	57.6 kbps streaming CS- data + 3.4 kbps signalling	12.2/7.95/5.9/4.75 kbps speech + 3.4 kbps signalling
>>>>logicalChannelList			TrCH1: all
>>>>tf 5			TrCH1: (1x81) TrCH2- TrCH4: N/A
>>>>numberOfTransportBlocks			TrCH1: One
>>>>rlc-Size			TrCH1: BitMode
>>>>>sizeType			TrCH1: type 1: 81
>>>>>numberOfTbSizeList			TrCH1: One
>>>>>logicalChannelList			TrCH1: all
>>semiStaticTF-Information			
>>>tti	TrCH1: 40 TrCH2: 40	TrCH1: 40 TrCH2: 40	TrCH1- TrCH3: 20 TrCH4: 40
>>>channelCodingType	TrCH1: Turbo TrCH2: Convolutional	TrCH1: Turbo TrCH2: Convolutional	Convolutional
>>>>codingRate	TrCH1: N/A TrCH2: Third	TrCH1: N/A TrCH2: Third	TrCH1- TrCH2: Third TrCH3: Half TrCH4: Third
>>>rateMatchingAttribute	TrCH1: 155 TrCH2: 160	TrCH1: 145 TrCH2: 160	TrCH1: 200 TrCH2: 190 TrCH3: 235 TrCH4: 160
>>>>crc-Size	TrCH1: 16 TrCH2: 16	TrCH1: 16 TrCH2: 16	TrCH1: 12 TrCH2- TrCH3: 0 TrCH4: 16
DL-AddReconfTransChInfoList			
>Downlink transport channel type	dch	dch	dch
>dl-TransportChannelIdentity (should be as for UL)	TrCH1: 1, TrCH2: 2	TrCH1: 1, TrCH2: 2	TrCH1: 1, TrCH2: 2, TrCH3: 3, TrCH4: 4
>tfs-SignallingMode	SameAsUL	SameAsUL	Independent <Only tf0 on TrCH1 is different and shown below>
>>transportFormatSet			DedicatedTransChTFS
>>>dynamicTF-information			
>>>>tf0/ tf0,1			TrCH1: (1x0)
>>>>rlcSize			bitMode
>>>>>sizeType			TrCH1: type 1: 0
>>>>>numberOfTbSizeList			TrCH1: One
>>>>>logicalChannelList			All
>>ULTrCH-Id	TrCH1: 1, TrCH2: 2	TrCH1: 1, TrCH2: 2	TrCH1: 1, TrCH2: 2, TrCH3: 3, TrCH4: 4
>dch-QualityTarget			
>>bler-QualityValue	TrCH1: 1×10^{-2} TrCH2: Absent	TrCH1: 1×10^{-2} TrCH2: Absent	TrCH1: 7×10^{-3} TrCH2- TrCH4: Absent
TrCH INFORMATION, COMMON			
ul-CommonTransChInfo			
>tfc-ID (TDD only)	1	1	1
>sharedChannelIndicator (TDD only)	FALSE	FALSE	FALSE
>tfc-Subset	Absent, not required	Absent, not required	Absent, not required
>ul-TFCS	Normal TFCI signalling	Normal TFCI signalling	Normal TFCI signalling

Configuration	28.8 kbps streaming CS-data + 3.4 kbps signalling	57.6 kbps streaming CS-data + 3.4 kbps signalling	12.2/7.95/5.9/4.75 kbps speech + 3.4 kbps signalling
>>explicitTFCS-ConfigurationMode	Complete	Complete	Complete
>>>ctfcSize	Ctfc4Bit	Ctfc4Bit	Ctfc8Bit
>>>>TFCS representation	Addition	Addition	Addition
>>>>>TFCS list			
>>>>>>TFCS 1	(TF0, TF0)	(TF0, TF0)	(TF0, TF0, TF0, TF0)
>>>>>>>ctfc	0	0	0
>>>>>>>>gainFactorInformation	Computed	Computed	Computed
>>>>>>>>referenceTFClId	0	0	0
>>>>>>>>>TFCS 2	(TF1, TF0)	(TF1, TF0)	(TF1, TF0, TF0, TF0)
>>>>>>>>>>ctfc	1	1	1
>>>>>>>>>>>gainFactorInformation	Computed	Computed	Computed
>>>>>>>>>>>> β_c (FDD only)	N/A	N/A	N/A
>>>>>>>>>>>> β_d	N/A	N/A	N/A
>>>>>>>>>>>>>referenceTFClId	0	0	0
>>>>>>>>>>>>>>TFCS 3	(TF2, TF0)	(TF2, TF0)	(TF2, TF1, TF0, TF0)
>>>>>>>>>>>>>>>ctfc	2	2	8
>>>>>>>>>>>>>>>>gainFactorInformation	Computed	Computed	Computed
>>>>>>>>>>>>>>>>>referenceTFClId	0	0	0
>>>>>>>>>>>>>>>>>>TFCS 4	(TF0, TF1)	(TF3, TF0)	(TF3, TF2, TF0, TF0)
>>>>>>>>>>>>>>>>>>>ctfc	3	3	15
>>>>>>>>>>>>>>>>>>>>gainFactorInformation	Computed	Computed	Computed
>>>>>>>>>>>>>>>>>>>>>> β_c (FDD only)	N/A	N/A	N/A
>>>>>>>>>>>>>>>>>>>>>> β_d	N/A	N/A	N/A
>>>>>>>>>>>>>>>>>>>>>>>referenceTFClId	0	0	0
>>>>>>>>>>>>>>>>>>>>>>>>TFCS 5	(TF1, TF1)	(TF4, TF0)	(TF4, TF3, TF0, TF0)
>>>>>>>>>>>>>>>>>>>>>>>>>ctfc	4	4	22
>>>>>>>>>>>>>>>>>>>>>>>>>>>gainFactorInformation	Computed	Computed	Computed
>>>>>>>>>>>>>>>>>>>>>>>>>>>>referenceTFClId	0	0	0
>>>>>>>>>>>>>>>>>>>>>>>>>>>>>TFCS 6	(TF2, TF1)	(TF0, TF1)	(TF5, TF4, TF1, TF0)
>>>>>>>>>>>>>>>>>>>>>>>>>>>>>>>ctfc	5	5	59
>>>>>>>>>>>>>>>>>>>>>>>>>>>>>>>>gainFactorInformation	Signalled	Computed	Computed
>>>>>>>>>>>>>>>>>>>>>>>>>>>>>>>>>> β_c (FDD only)	8	N/A	N/A
>>>>>>>>>>>>>>>>>>>>>>>>>>>>>>>>>>>> β_d	15	N/A	N/A
>>>>>>>>>>>>>>>>>>>>>>>>>>>>>>>>>>>>>>referenceTFClId	0	0	0
>>>>>>>>>>>>>>>>>>>>>>>>>>>>>>>>>>>>>>>TFCS 7		(TF1, TF1)	(TF0,TF0,TF0,TF1)
>>ctfc		6	60
>>>gainFactorInformation		Computed	Computed
>>referenceTFClId		0	0
>>>TFCS 8		(TF2, TF1)	(TF1,TF0,TF0,TF1)
>>ctfc		7	61
>>>gainFactorInformation		Computed	Computed
>>referenceTFClId		0	0
>>>TFCS 9		(TF3, TF1)	(TF2,TF1,TF0,TF1)
>>ctfc		8	68

Configuration	28.8 kbps streaming CS-data + 3.4 kbps signalling	57.6 kbps streaming CS-data + 3.4 kbps signalling	12.2/7.95/5.9/4.75 kbps speech + 3.4 kbps signalling
>>>>>>gainFactorInformation		Computed	Computed
>>>>>>referenceTFCLd		0	0
>>>>>TFCS 10		(TF4, TF1)	(TF3,TF2,TF0,TF1)
>>>>>>ctfc		9	75
>>>>>>gainFactorInformation		Signalled	Computed
>>>>>> β c (FDD only)		8	N/A
>>>>>> β d		15	N/A
>>>>>>referenceTFCLd		0	0
>>>>>TFCS 11			(TF4,TF3,TF0,TF1)
>>>>>>ctfc			82
>>>>>>gainFactorInformation			Computed
>>>>>>referenceTFCLd			0
>>>>>TFCS 12			(TF5,TF4,TF1,TF1)
>>>>>>ctfc			119
>>>>>>gainFactorInformation			Signalled
>>>>>> β c (FDD only)			11
>>>>>> β d			15
>>>>>>referenceTFCLd			0
dl-CommonTransChInfo			
>tfcs-SignallingMode	Same as UL	Same as UL	Same as UL
PhyCH INFORMATION FDD			
UL-DPCH-InfoPredef			
>ul-DPCH-PowerControlInfo			
>>powerControlAlgorithm	Algorithm 1	Algorithm 1	Algorithm 1
>>tpcStepSize	1 dB	1 dB	1 dB
>tfci-Existence	TRUE	TRUE	TRUE
>puncturingLimit	1	1	0.88
DL-CommonInformationPredef			
>dl-DPCH-InfoCommon			
>>spreadingFactor	64	32	128
>>tfci-Existence	TRUE	TRUE	FALSE
>>pilotBits	8	8	4
>>positionFixed	Flexible	Flexible	Fixed
PhyCH INFORMATION 3.84/7.68 Mcps TDD			
UL-DPCH-InfoPredef			
>ul-DPCH-PowerControlInfo			
>>dpch-ConstantValue	0	0	0
>commonTimeslotInfo			
>>secondInterleavingMode	frameRelated	frameRelated	frameRelated
>>tfci-Coding	16	16	16
>>puncturingLimit	0.44	0.48	0.88
>>repetitionPeriodAndLength	repetitionPeriod1	repetitionPeriod1	repetitionPeriod1
DL-CommonInformationPredef			
>dl-DPCH-InfoCommon			
>>commonTimeslotInfo			

Configuration	28.8 kbps streaming CS- data + 3.4 kbps signalling	57.6 kbps streaming CS- data + 3.4 kbps signalling	12.2/7.95/5.9/4.75 kbps speech + 3.4 kbps signalling
>>>secondInterleavingMode	frameRelated	frameRelated	frameRelated
>>>tfc-Coding	16	16	16
>>>puncturingLimit	0.44	0.48	0.92
>>>repetitionPeriodAndLength	repetitionPeriod1	repetitionPeriod1	repetitionPeriod1
PhyCH INFORMATION 1.28 Mcps TDD			
UL-DPCH-InfoPredef			
>commonTimeslotInfo			
>>secondInterleavingMode	frameRelated	frameRelated	
>>tfc-Coding	16	16	
>>puncturingLimit	0.64	0.72	
>>repetitionPeriodAndLength	repetitionPeriod1	repetitionPeriod1	
DL- CommonInformationPredef			
>dl-DPCH-InfoCommon			
>>commonTimeslotInfo			
>>>secondInterleavingMode	frameRelated	frameRelated	frameRelated
>>>tfc-Coding	16	16	16
>>>puncturingLimit	0.64	0.72	0.92
>>>repetitionPeriodAndLength	repetitionPeriod1	repetitionPeriod1	repetitionPeriod1

Configuration	10.2/6.7/5.9/4.75 kbps speech + 3.4 kbps signalling + 0.15 kbps SRB#5	7.4/6.7/5.9/4.75 kbps speech + 3.4 kbps signalling + 0.15 kbps SRB#5
Ref 34.108	5a	7a
Default configuration identity	11	12
RB INFORMATION		
rb-Identity	RB1: 1, RB2: 2, RB3: 3, RB5: 5, RB6: 6, RB7: 7, RB8: 8	RB1: 1, RB2: 2, RB3: 3, RB5: 5, RB6: 6, RB7: 7
rlc-InfoChoice	Rlc-info	Rlc-info
>ul-RLC-Mode	RB1: UM RB2- RB3: AM RB5-RB7: TM	RB1: UM RB2- RB3: AM RB5-RB6: TM
>>transmissionRLC-DiscardMode	RB1: N/A RB2- RB3: NoDiscard RB5- RB7: N/A	RB1: N/A RB2- RB3: NoDiscard RB5- RB6: N/A
>>>maxDat	RB1: N/A RB2- RB3: 15 RB5- RB7: N/A	RB1: N/A RB2- RB3: 15 RB5- RB6: N/A
>>transmissionWindowSize	RB1: N/A RB2- RB3: 128 for UEs with more than 10 kbyte "total RLC AM buffer size" and 32 otherwise RB5- RB7: N/A	RB1: N/A RB2- RB3: 128 for UEs with more than 10 kbyte "total RLC AM buffer size" and 32 otherwise RB5- RB6: N/A
>>timerRST	RB1: N/A RB2- RB3: 300 RB5- RB7: N/A	RB1: N/A RB2- RB3: 300 RB5- RB6: N/A
>>max-RST	RB1: N/A RB2- RB3: 1 RB5- RB7: N/A	RB1: N/A RB2- RB3: 1 RB5- RB6: N/A
>>pollingInfo	RB1: N/A RB2- RB3: as below RB5- RB7: N/A	RB1: N/A RB2- RB3: as below RB5- RB6: N/A
>>>lastTransmissionPDU-Poll	RB2- RB3: FALSE	RB2- RB3: FALSE
>>>lastRetransmissionPDU-Poll	RB2- RB3: FALSE	RB2- RB3: FALSE
>>>timerPollPeriodic	RB2- RB3: 300	RB2- RB3: 300
>>segmentationIndication	RB1- RB3: N/A RB5- RB7: FALSE	RB1- RB3: N/A RB5- RB6: FALSE
>dl-RLC-Mode	RB1: UM RB2- RB3: AM RB5- RB7: TM RB8: TM	RB1: UM RB2- RB3: AM RB5- RB6: TM RB7: TM
>>inSequenceDelivery	RB1: N/A RB2- RB3: TRUE RB5- RB8: N/A	RB1: N/A RB2- RB3: TRUE RB5- RB7: N/A
>>receivingWindowSize	RB1: N/A RB2- RB3: 128 for UEs with more than 10 kbyte "total RLC AM buffer size" and 32 otherwise RB5- RB8: N/A	RB1: N/A RB2- RB3: 128 for UEs with more than 10 kbyte "total RLC AM buffer size" and 32 otherwise RB5- RB7: N/A
>>dl-RLC-StatusInfo	RB1: N/A RB2- RB3: as below RB5- RB8: N/A	RB1: N/A RB2- RB3: as below RB5- RB7: N/A
>>>timerStatusProhibit	RB2- RB3: 100	RB2- RB3: 100
>>>missingPDU-Indicator	RB2- RB3: FALSE	RB2- RB3: FALSE
>>>timerStatusPeriodic	RB2- RB3: 300	RB2- RB3: 300

>>segmentationIndication	RB1- RB3: N/A RB5- RB8: FALSE	RB1- RB3: N/A RB5- RB7: FALSE
rb-MappingInfo		
>UL-LogicalChannelMappings	OneLogicalChannel	OneLogicalChannel
>>ul-TransportChannelType	Dch	Dch
>>>transportChannelIdentity	RB1- RB3: 4 RB5: 1, RB6: 2, RB7: 3,	RB1- RB3: 3 RB5: 1, RB6: 2
>>logicalChannelIdentity	RB1: 1, RB2: 2, RB3: 3 RB5- RB7: N/A	RB1: 1, RB2: 2, RB3: 3 RB5- RB6: N/A
>>rlc-SizeList	RB1- RB3: configured RB5- RB7: N/A	RB1- RB3: configured RB5- RB6: N/A
>>mac-LogicalChannelPriority	RB1: 1, RB2: 2, RB3: 3 RB5- RB7: 5	RB1: 1, RB2: 2, RB3: 3 RB5- RB6: 5
>DL-logicalChannelMappingList		
>>Mapping option 1	One mapping option	One mapping option
>>>dl-TransportChannelType	Dch	Dch
>>>>transportChannelIdentity	RB1- RB3: 4 RB5: 1, RB6: 2, RB7: 3, RB8: 5	RB1- RB3: 3 RB5: 1, RB6: 2, RB7:4
>>>logicalChannelIdentity	RB1: 1, RB2: 2, RB3: 3 RB5- RB8: N/A	RB1: 1, RB2: 2, RB3: 3 RB5- RB7: N/A
TrCH INFORMATION PER TrCH		
UL-AddReconfTransChInfoList		
>Uplink transport channel type	dch	dch
>transportChannelIdentity	TrCH1: 1, TrCH2: 2, TrCH3: 3, TrCH4: 4	TrCH1: 1, TrCH2: 2, TrCH3: 3
>transportFormatSet	DedicatedTransChTFS	DedicatedTransChTFS
>>dynamicTF-information		
>>>tf0/ tf0,1	TrCH1: (0x65) TrCH2: (0x 99) TrCH3: (0x 40, 1x40) TrCH4: (0x144, 1x144)	TrCH1: (0x61) TrCH2: (0x 87) TrCH3: (0x 144, 1x144)
>>>>rlcSize	BitMode	BitMode
>>>>>sizeType	TrCH1: type 1: 65 TrCH2: type 1: 99 TrCH3: type 1: 40 TrCH4: 2: type 2, part1= 2, part2= 0 (144)	TrCH1: type 1: 61 TrCH2: type 1: 87 TrCH3: 2: type 2, part1= 2, part2= 0 (144)
>>>>numberOfTbSizeList	TrCH1-2: Zero TrCH3-4: Zero, one	TrCH1-2: Zero TrCH3: Zero, one
>>>>logicalChannelList	All	All
>>>>tf 1	TrCH1: (1x39) TrCH2: (1x 53) TrCH3- TrCH4: N/A	TrCH1: (1x39) TrCH2: (1x53) TrCH3: N/A
>>>>>numberOfTransportBlocks	TrCH1: One TrCH2: One	TrCH1: One TrCH2: One
>>>>>rlc-Size	TrCH1-2: BitMode	TrCH1-2: BitMode
>>>>>>sizeType	TrCH1: 1: 39 TrCH2: 1: 53	TrCH1: 1: 39 TrCH1: 1: 53
>>>>>>numberOfTbSizeList	TrCH1-2: One	TrCH1-2: One

>>>>logicalChannelList	TrCH1: all	TrCH1: all
>>>tf 2	TrCH1: (1x42) TrCH2: (1x63) TrCH3- TrCH4: N/A	TrCH1: (1x42) TrCH2: (1x63) TrCH3: N/A
>>>>numberOfTransportBlocks	TrCH1: One TrCh2: One	TrCH1: One TrCh2: One
>>>>rlc-Size	TrCH1: BitMode	TrCH1: BitMode
>>>>>sizeType	TrCH1: type 1: 42 TrCH2: type 1: 63	TrCH1: type 1: 42 TrCH2: type 1: 63
>>>>numberOfTbSizeList	TrCH1: One TrCH2: One	TrCH1: One TrCH2: One
>>>>logicalChannelList	TrCH1: all TrCH2: all	TrCH1: all TrCH2: all
>>>tf 3	TrCH1: (1x55) TrCH2: (1x76) TrCH3- TrCH4: N/A	TrCH1: (1x55) TrCH2: (1x76) TrCH3: N/A
>>>>numberOfTransportBlocks	TrCH1: One TrCh2: One	TrCH1: One TrCh2: One
>>>>rlc-Size	TrCH1: BitMode	TrCH1: BitMode
>>>>>sizeType	TrCH1: type 1: 55 TrCH2: type 1: 76	TrCH1: type 1: 55 TrCH2: type 1: 76
>>>>numberOfTbSizeList	TrCH1: One TrCH2: One	TrCH1: One TrCH2: One
>>>>logicalChannelList	TrCH1: all TrCH2: all	TrCH1: all TrCH2: all
>>>tf 4	TrCH1: (1x58) TrCH2: (1x99) TrCH3- TrCH4: N/A	TrCH1: (1x58) TrCH2: (1x87) TrCH3: N/A
>>>>numberOfTransportBlocks	TrCH1: One TrCh2: One	TrCH1: One TrCh2: One
>>>>rlc-Size	TrCH1: BitMode	TrCH1: BitMode
>>>>>sizeType	TrCH1: type 1: 58 TrCH2: type 1: 99	TrCH1: type 1: 58 TrCH2: type 1: 87
>>>>numberOfTbSizeList	TrCH1: One TrCH2: One	TrCH1: One TrCH2: One
>>>>logicalChannelList	TrCH1: all TrCH2: all	TrCH1: all TrCH2: all
>>>tf 5	TrCH1: (1x65) TrCH2- TrCH4: N/A	TrCH1: (1x61) TrCH2- TrCH4: N/A
>>>>numberOfTransportBlocks	TrCH1: One	TrCH1: One
>>>>rlc-Size	TrCH1: BitMode	TrCH1: BitMode
>>>>>sizeType	TrCH1: type 1: 65	TrCH1: type 1: 61
>>>>numberOfTbSizeList	TrCH1: One	TrCH1: One
>>>>logicalChannelList	TrCH1: all	TrCH1: all
>>semistaticTF-Information		
>>>tfti	TrCH1- TrCH3: 20 TrCH4: 40	TrCH1- TrCH2: 20 TrCH3: 40
>>>channelCodingType	Convolutional	Convolutional
>>>>codingRate	TrCH1- TrCH2: Third TrCH3: Half TrCH4: Third	TrCH1- TrCH2: Third TrCH3: Third
>>>rateMatchingAttribute	TrCH1: 200 TrCH2: 190 TrCH3: 235 TrCH4: 160	TrCH1: 200 TrCH2: 190 TrCH3: 160
>>>crc-Size	TrCH1: 12 TrCH2- TrCH3: 0 TrCH4: 16	TrCH1: 12 TrCH2: 0 TrCH3: 16
DL-AddReconfTransChInfoList		
>Downlink transport channel type	dch	dch

>dl-TransportChannelIdentity	TrCH1: 1, TrCH2: 2, TrCH3: 3, TrCH4: 4, TrCH5: 5	TrCH1: 1, TrCH2: 2, TrCH3: 3, TrCH4: 4
>tfs-SignallingMode	Independent <Only tf0 on TrCH1 and tf0/1 on TrCH5 are different and shown below>	Independent <Only tf0 on TrCH1 and tf0/1 on TrCH4 are different and shown below>
>>transportFormatSet		
>>>dynamicTF-information		
>>>>tf0/ tf0,1	TrCH1: (1x0) TrCH5: (0x3, 1x3)	TrCH1: (1x0) TrCH4: (0x3, 1x3)
>>>>rlcSize	BitMode	bitMode
>>>>>sizeType	TrCH1: type 1: 0 TrCH5: type 1: 3	TrCH1: type 1: 0 TrCH4: type 1: 3
>>>>numberOfTbSizeList	TrCH1: One TrCH5: Zero, one	TrCH1: One TrCH4: Zero, one
>>>>logicalChannelList	All	All
>>>semistaticTF-Information	same as UL except for TrCH5	same as UL except for TrCH4
>>>>tti	TrCH5: 20	TrCH4: 20
>>>>channelCodingType	Convolutional	Convolutional
>>>>>codingRate	TrCH5: Third	TrCH4: Third
>>>>rateMatchingAttribute	TrCH5: 200	TrCH4: 200
>>>>crc-Size	TrCH5: 12	TrCH4: 12
>>ULTrCH-Id	TrCH1: 1, TrCH2: 2, TrCH3: 3, TrCH4: 4,	TrCH1: 1, TrCH2: 2, TrCH3: 3
>dch-QualityTarget		
>>bler-QualityValue	TrCH1: 7×10^{-3} TrCH2- TrCH5: Absent	TrCH1: 7×10^{-3} TrCH2- TrCH4: Absent
TrCH INFORMATION, COMMON		
ul-CommonTransChInfo		
>tfc-ID (TDD only)	1	1
>sharedChannelIndicator (TDD only)	FALSE	FALSE
> tfc-Subset	Absent, not required	Absent, not required
>ul-TFCS	Normal TFCl signalling	Normal TFCl signalling
>>explicitTFCS-ConfigurationMode	Complete	Complete
>>>ctfcSize	Ctfc8Bit	Ctfc6Bit
>>>>TFCS representation	Addition	Addition
>>>>>TFC list		
>>>>>>TFC 1	(TF0, TF0, TF0, TF0)	(TF0, TF0, TF0)
>>>>>>>ctfc	0	0
>>>>>>>>gainFactorInformation	Computed	Computed
>>>>>>>>referenceTFClId	0	0
>>>>>>>>TFC 2	(TF1, TF0, TF0, TF0)	(TF1, TF0, TF0)
>>>>>>>>ctfc	1	1
>>>>>>>>>gainFactorInformation	Computed	Computed
>>>>>>>>>> β_c (FDD only)	N/A	N/A
>>>>>>>>>> β_d	N/A	N/A
>>>>>>>>>>referenceTFClId	0	0
>>>>>>>>>>TFC 3	(TF2, TF1, TF0, TF0)	(TF2, TF1, TF0)
>>>>>>>>>>>ctfc	8	8
>>>>>>>>>>>>gainFactorInformation	Computed	Computed
>>>>>>>>>>>>referenceTFClId	0	0

>>>>>>TFC 4	(TF3, TF2, TF0, TF0)	(TF3, TF2, TF0)
>>>>>>>ctfc	15	15
>>>>>>>gainFactorInform ation	Computed	Computed
>>>>>>> β c (FDD only)		
>>>>>>> β d		
>>>>>>>referenceTFCId	0	0
>>>>>>TFC 5	(TF4, TF3, TF0, TF0)	(TF4, TF3, TF0)
>>>>>>>ctfc	22	22
>>>>>>>gainFactorInform ation	Computed	Computed
>>>>>>>referenceTFCId	0	0
>>>>>>TFC 6	(TF5, TF4, TF1, TF0)	(TF5, TF4, TF0)
>>>>>>>ctfc	59	29
>>>>>>>gainFactorInform ation	Computed	Computed
>>>>>>> β c (FDD only)		
>>>>>>> β d		
>>>>>>>referenceTFCId	0	0
>>>>>>TFC 7	(TF0, TF0, TF0, TF1)	(TF0, TF0, TF1)
>>>>>>>ctfc	60	30
>>>>>>>gainFactorInform ation	Computed	Computed
>>>>>>>referenceTFCId	0	0
>>>>>>TFC 8	(TF1, TF0, TF0, TF1)	(TF1, TF0, TF1)
>>>>>>>ctfc	61	31
>>>>>>>gainFactorInform ation	computed	computed
>>>>>>> β c (FDD only)		
>>>>>>> β d		
>>>>>>>referenceTFCId	0	0
>>>>>>TFC 9	(TF2, TF1, TF0, TF1)	(TF2, TF1, TF1)
>>>>>>>ctfc	68	38
>>>>>>>gainFactorInform ation	computed	computed
>>>>>>>referenceTFCId	0	0
>>>>>>TFC 10	(TF3, TF2, TF0, TF1)	(TF3, TF2, TF1)
>>>>>>>ctfc	75	45
>>>>>>>gainFactorInform ation	computed	computed
>>>>>>> β c (FDD only)		
>>>>>>> β d		
>>>>>>>referenceTFCId	0	0
>>>>>>TFC 11	(TF4, TF3, TF0, TF1)	(TF4, TF3, TF1)
>>>>>>>ctfc	82	52
>>>>>>>gainFactorInform ation	computed	computed
>>>>>>>referenceTFCId	0	0
>>>>>>TFC 12	(TF5, TF4, TF1, TF1)	(TF5, TF4, TF1)
>>>>>>>ctfc	119	59
>>>>>>>gainFactorInform ation	signalled	signalled
>>>>>>> β c (FDD only)	11	11
>>>>>>> β d	15	15

>>>>>>referenceTFCId	0	0
> TFC subset list		
>>TFC subset 1	(speech rate 10.2)	(speech rate 7.4)
>>> Allowed transport format combination list	(TFC1, TFC2, TFC3, TFC4, TFC5, TFC7, TFC8, TFC6, TFC9, TFC10, TFC11, TFC12)	(TFC1, TFC2, TFC3, TFC4, TFC5, TFC7, TFC8, TFC6, TFC9, TFC10, TFC11, TFC12)
>>TFC subset 2	(speech rate 6.7)	(speech rate 6.7)
>>> Allowed transport format combination list	(TFC1, TFC2, TFC3, TFC4, TFC7, TFC8, TFC5, TFC9, TFC10, TFC11)	(TFC1, TFC2, TFC3, TFC4, TFC7, TFC8, TFC5, TFC9, TFC10, TFC11)
>>TFC subset 3	(speech rate 5.9)	(speech rate 5.9)
>>> Allowed transport format combination list	(TFC1, TFC2, TFC3, TFC7, TFC8, TFC4, TFC9, TFC10)	(TFC1, TFC2, TFC3, TFC7, TFC8, TFC4, TFC9, TFC10)
>>TFC subset 4	(speech rate 4.75)	(speech rate 4.75)
>>> Allowed transport format combination list	(TFC1, TFC2, TFC7, TFC8, TFC3, TFC9)	(TFC1, TFC2, TFC7, TFC8, TFC3, TFC9)
dl-CommonTransChInfo		
>tfc-SignallingMode	Independent	Independent
>tfc-ID (TDD only)	1	1
>sharedChannelIndicator (TDD only)	FALSE	FALSE
> tfc-Subset	Absent, not required	Absent, not required
>dl-TFCS	Normal TFCI signalling	Normal TFCI signalling
>>explicitTFCS-ConfigurationMode	Complete	Complete
>>>ctfcSize	Ctfc8Bit	Ctfc8Bit
>>>>TFCS representation	Addition	Addition
>>>>>TFCS list		
>>>>>>TFC 1	(TF0, TF0, TF0, TF0, TF0)	(TF0, TF0, TF0, TF0)
>>>>>>>ctfc	0	0
>>>>>>>TFC 2	(TF1, TF0, TF0, TF0, TF0)	(TF1, TF0, TF0, TF0)
>>>>>>>>ctfc	1	1
>>>>>>>>TFC 3	(TF2, TF1, TF0, TF0, TF0)	(TF2, TF1, TF0, TF0)
>>>>>>>>>ctfc	8	8
>>>>>>>>>TFC 4	(TF3, TF2, TF0, TF0, TF0)	(TF3, TF2, TF0, TF0)
>>>>>>>>>>ctfc	15	15
>>>>>>>>>>TFC 5	(TF4, TF3, TF0, TF0, TF0)	(TF4, TF3, TF0, TF0)
>>>>>>>>>>>ctfc	22	22
>>>>>>>>>>>TFC 6	(TF5, TF4, TF1, TF0, TF0)	(TF5, TF4, TF0, TF0)
>>>>>>>>>>>>ctfc	59	29
>>>>>>>>>>>>TFC 7	(TF0, TF0, TF0, TF1, TF0)	(TF0, TF0, TF1, TF0)
>>>>>>>>>>>>>ctfc	60	30
>>>>>>>>>>>>>TFC 8	(TF1, TF0, TF0, TF1, TF0)	(TF1, TF0, TF1, TF0)
>>>>>>>>>>>>>>ctfc	61	31
>>>>>>>>>>>>>>TFC 9	(TF2, TF1, TF0, TF1, TF0)	(TF2, TF1, TF1, TF0)
>>>>>>>>>>>>>>>ctfc	68	38
>>>>>>>>>>>>>>>>TFC 10	(TF3, TF2, TF0, TF1, TF0)	(TF3, TF2, TF1, TF0)
>>>>>>>>>>>>>>>>>ctfc	75	45

>>>>>TFC 11	(TF4, TF3, TF0, TF1, TF0)	(TF4, TF3, TF1, TF0)
>>>>>>ctfc	82	52
>>>>>TFC 12	(TF5, TF4, TF1, TF1, TF0)	(TF5, TF4, TF1, TF0)
>>>>>>ctfc	119	59
>>>>>TFC 13	(TF0, TF0, TF0, TF0, TF1)	(TF0, TF0, TF0, TF1)
>>>>>>ctfc	120	60
>>>>>TFC 14	(TF1, TF0, TF0, TF0, TF1)	(TF1, TF0, TF0, TF1)
>>>>>>ctfc	121	61
>>>>>TFC 15	(TF2, TF1, TF0, TF0, TF1)	(TF2, TF1, TF0, TF1)
>>>>>>ctfc	128	68
>>>>>TFC 16	(TF3, TF2, TF0, TF0, TF1)	(TF3, TF2, TF0, TF1)
>>>>>>ctfc	135	75
>>>>>TFC 17	(TF4, TF3, TF0, TF0, TF1)	(TF4, TF3, TF0, TF1)
>>>>>>ctfc	142	82
>>>>>TFC 18	(TF5, TF4, TF1, TF0, TF1)	(TF5, TF4, TF0, TF1)
>>>>>>ctfc	179	89
>>>>>TFC 19	(TF0, TF0, TF0, TF1, TF1)	(TF0, TF0, TF1, TF1)
>>>>>>ctfc	180	90
>>>>>TFC 20	(TF1, TF0, TF0, TF1, TF1)	(TF1, TF0, TF1, TF1)
>>>>>>ctfc	181	91
>>>>>TFC 21	(TF2, TF1, TF0, TF1, TF1)	(TF2, TF1, TF1, TF1)
>>>>>>ctfc	188	98
>>>>>TFC 22	(TF3, TF2, TF0, TF1, TF1)	(TF3, TF2, TF1, TF1)
>>>>>>ctfc	195	105
>>>>>TFC 23	(TF4, TF3, TF0, TF1, TF1)	(TF4, TF3, TF1, TF1)
>>>>>>ctfc	202	112
>>>>>TFC 24	(TF5, TF4, TF1, TF1, TF1)	(TF5, TF4, TF1, TF1)
>>>>>>ctfc	239	119
PhyCH INFORMATION FDD		
UL-DPCH-InfoPredef		
>ul-DPCH- PowerControllInfo		
>>powerControlAlgorithm	Algorithm 1	Algorithm 1
>>>tpcStepSize	1 dB	1 dB
>tfc-Existence	TRUE	TRUE
>puncturingLimit	0.88	0.88
DL- CommonInformationPredef		
>dl-DPCH-InfoCommon		
>>spreadingFactor	128	128
>>tfc-Existence	FALSE	FALSE
>>pilotBits	4	4
>>positionFixed	Fixed	Fixed
PhyCH INFORMATION 3.84/7.68 Mcps TDD		
UL-DPCH-InfoPredef		
>ul-DPCH- PowerControllInfo		
>>dpch-ConstantValue	0	0

>commonTimeslotInfo		
>>secondInterleavingMode	frameRelated	frameRelated
>>tfc-Coding	16	16
>>puncturingLimit	0.60	0.60
>>repetitionPeriodAndLength	repetitionPeriod1	repetitionPeriod1
DL-CommonInformationPredef		
>dl-DPCH-InfoCommon		
>>commonTimeslotInfo		
>>>secondInterleavingMode	frameRelated	frameRelated
>>>tfc-Coding	16	16
>>>puncturingLimit	0.60	0.60
>>>repetitionPeriodAndLength	repetitionPeriod1	repetitionPeriod1
PhyCH INFORMATION 1.28 Mcps TDD		
UL-DPCH-InfoPredef		
>commonTimeslotInfo		
>>secondInterleavingMode	frame Related	frame Related
>>tfc-Coding	16	16
>>puncturingLimit	0.64	0.64
>>repetitionPeriodAndLength	repetitionPeriod1	repetitionPeriod1
DL-CommonInformationPredef		
>dl-DPCH-InfoCommon		
>>commonTimeslotInfo		
>>>secondInterleavingMode	frame Related	frame Related
>>>tfc-Coding	16	16
>>>puncturingLimit	0.64	0.64
>>>repetitionPeriodAndLength	repetitionPeriod1	repetitionPeriod1

NOTE : Default configuration identity 11 can not be used with release 4 UEs.

Configuration	12.65/8.85/6.6 kbps speech + 3.4 kbps signalling + 0.15 kbps SRB#5
Ref 34.108	62
Default configuration identity	13
RB INFORMATION	
rb-Identity	RB1: 1, RB2: 2, RB3: 3, RB5: 5, RB6: 6, RB7: 7, RB8: 8
rlc-InfoChoice	Rlc-info
>ul-RLC-Mode	RB1: UM RB2- RB3: AM RB5-RB7: TM
>>transmissionRLC- DiscardMode	RB1: N/A RB2- RB3: NoDiscard RB5- RB7: N/A
>>>maxDat	RB1: N/A RB2- RB3: 15 RB5- RB7: N/A
>>transmissionWindowSiz e	RB1: N/A RB2- RB3: 128 for UEs with more than 10 kbyte "total RLC AM buffer size" and 32 otherwise RB5- RB7: N/A
>>timerRST	RB1: N/A RB2- RB3: 300 RB5- RB7: N/A
>>max-RST	RB1: N/A RB2- RB3: 1 RB5- RB7: N/A
>>pollingInfo	RB1: N/A RB2- RB3: as below RB5- RB7: N/A
>>>lastTransmissionPDU- Poll	RB2- RB3: FALSE
>>>lastRetransmissionPD U-Poll	RB2- RB3: FALSE
>>>timerPollPeriodic	RB2- RB3: 300
>>segmentationIndication	RB1- RB3: N/A RB5- RB7: FALSE
>dl-RLC-Mode	RB1: UM RB2- RB3: AM RB5- RB7: TM RB8: TM
>>inSequenceDelivery	RB1: N/A RB2- RB3: TRUE RB5- RB7: N/A RB8: N/A
>>receivingWindowSize	RB1: N/A RB2- RB3: 128 for UEs with more than 10 kbyte "total RLC AM buffer size" and 32 otherwise RB5- RB7: N/A RB8: N/A
>>dl-RLC-StatusInfo	RB1: N/A RB2- RB3: as below RB5- RB7: N/A RB8: N/A

>>>timerStatusProhibit	RB2- RB3: 100
>>>missingPDU-Indicator	RB2- RB3: FALSE
>>>timerStatusPeriodic	RB2- RB3: 300
>>segmentationIndication	RB1- RB3: N/A RB5- RB7: FALSE RB8: FALSE
rb-MappingInfo	
>UL-LogicalChannelMappings	OneLogicalChannel
>>ul-TransportChannelType	Dch
>>>transportChannelIdentity	RB1- RB3: 4 RB5: 1, RB6: 2, RB7: 3.
>>logicalChannelIdentity	RB1: 1, RB2: 2, RB3: 3 RB5- RB7: N/A
>>rlc-SizeList	RB1- RB3: configured RB5- RB7: N/A
>>mac-LogicalChannelPriority	RB1: 1, RB2: 2, RB3: 3 RB5- RB7: 5
>DL-logicalChannelMappingList	
>>Mapping option 1	One mapping option
>>>dl-TransportChannelType	Dch
>>>>transportChannelIdentity	RB1- RB3: 4 RB5: 1, RB6: 2, RB7: 3, RB8: 5
>>>logicalChannelIdentity	RB1: 1, RB2: 2, RB3: 3 RB5- RB7: N/A RB8: N/A
TrCH INFORMATION PER TrCH	
UL-AddReconfTransChInfoList	
>Uplink transport channel type	dch
>transportChannelIdentity	TrCH1: 1, TrCH2: 2, TrCH3: 3, TrCH4: 4
>transportFormatSet	DedicatedTransChTFS
>>dynamicTF-information	
>>>tf0/ tf0,1	TrCH1: (0x72) TrCH2: (0x 181) TrCH3: (0x60) TrCH4: (0x144, 1x144)
>>>>rlcSize	BitMode
>>>>>sizeType	TrCH1: type 1: 72 TrCH2: type 2: part1= 6, part2= 5 TrCH3: type1: 60 TrCH4: 2: type 2, part1= 2, part2= 0 (144)
>>>>numberOfTbSizeList	TrCH1-3: Zero TrCH4: Zero, one
>>>>logicalChannelList	All
>>>tf 1	TrCH1: (1x40) TrCH2: (1x 78) TrCH3: N/A TrCH4: N/A

>>>>numberOfTransportBlocks	TrCH1: One TrCH2: One
>>>>rlc-Size	TrCH1-2: BitMode
>>>>>sizeType	TrCH1: 1: 40 TrCH2: 1: 78
>>>>numberOfTbSizeList	TrCH1-2: One
>>>>logicalChannelList	TrCH1: all
>>>tf 2	TrCH1: (1x54) TrCH2: (1x113) TrCH3: N/A TrCH4: N/A
>>>>numberOfTransportBlocks	TrCH1: One TrCh2: One
>>>>rlc-Size	TrCH1: BitMode
>>>>>sizeType	TrCH1: type 1: 54 TrCH2: type 1: 113
>>>>numberOfTbSizeList	TrCH1: One TrCH2: One
>>>>logicalChannelList	TrCH1: all TrCH2: all
>>>tf 3	TrCH1: (1x64) TrCH2: (1x181) TrCH3: N/A TrCH4: N/A
>>>>numberOfTransportBlocks	TrCH1: One TrCh2: One
>>>>rlc-Size	TrCH1: BitMode
>>>>>sizeType	TrCH1: type 1: 64 TrCH2: type 2: part1=6, part2= 5
>>>>numberOfTbSizeList	TrCH1: One TrCH2: One
>>>>logicalChannelList	TrCH1: all TrCH2: all
>>>tf 4	TrCH1: (1x72) TrCH2: N/A TrCH3: N/A TrCH4: N/A
>>>>numberOfTransportBlocks	TrCH1: One
>>>>rlc-Size	TrCH1: BitMode
>>>>>sizeType	TrCH1: type 1: 72
>>>>numberOfTbSizeList	TrCH1: One
>>>>logicalChannelList	TrCH1: all
>>semistaticTF-Information	
>>>tti	TrCH1- TrCH3: 20 TrCH4: 40
>>>channelCodingType	Convolutional
>>>>codingRate	TrCH1- TrCH3: Third TrCH4: Third
>>>>rateMatchingAttribute	TrCH1: 200 TrCH2: 190 TrCH3: 256 TrCH4: 170
>>>>crc-Size	TrCH1: 12 TrCH2: 0 TrCH3: 0 TrCH4: 16
DL-AddReconfTransChInfoList	
>Downlink transport channel type	dch
>dl-TransportChannelIdentity	TrCH1: 1, TrCH2: 2, TrCH3: 3, TrCH4: 4, TrCH5: 5

>fs-SignallingMode	Independent <Only tf0 on TrCH1 and tf0/ff1 on TrCH5 are different and shown below>
>>transportFormatSet	
>>>dynamicTF-information	
>>>>tf0/ ff0,1	TrCH1: (1x0) TrCH5: (0x3, 1x3)
>>>>rlcSize	BitMode
>>>>>sizeType	TrCH1: type 1: 0 TrCH5: type 1: 3
>>>>>numberOfTbSizeList	TrCH1: One TrCH5: Zero, one
>>>>>logicalChannelList	All
>>>semistaticTF-Information	same as UL except for TrCH5
>>>>tqi	TrCH5: 20
>>>>>channelCodingType	Convolutional
>>>>>>codingRate	TrCH5: Third
>>>>>>rateMatchingAttribute	TrCH5: 205
>>>>>>crc-Size	TrCH5: 8
>>ULTrCH-Id	TrCH1: 1, TrCH2: 2, TrCH3: 3, TrCH4: 4,
>dch-QualityTarget	
>>bler-QualityValue	TrCH1: 7×10^{-3} TrCH2: Absent TrCH3: Absent TrCH4- TrCH5: Absent
TrCH INFORMATION, COMMON	
ul-CommonTransChInfo	
>tfcs-ID (TDD only)	1
>sharedChannelIndicator (TDD only)	FALSE
> tfc-Subset	Absent, not required
>ul-TFCS	Normal TFCI signalling
>>explicitTFCS-ConfigurationMode	Complete
>>>ctfcSize	Ctfc6Bit
>>>>TFCS representation	Addition
>>>>>TFC list	
>>>>>>TFC 1	(TF0, TF0, TF0, TF0)
>>>>>>>ctfc	0
>>>>>>>>gainFactorInformation	Computed
>>>>>>>>referenceTFCId	0
>>>>>>TFC 2	(TF1, TF0, TF0, TF0)
>>>>>>>ctfc	1
>>>>>>>>gainFactorInformation	Computed
>>>>>>>>> β_c (FDD only)	N/A
>>>>>>>>> β_d	N/A
>>>>>>>>>referenceTFCId	0
>>>>>>TFC 3	(TF2, TF1, TF0, TF0)
>>>>>>>ctfc	7
>>>>>>>>gainFactorInformation	Computed
>>>>>>>>>referenceTFCId	0

>>>>>>TFC 4	(TF3, TF2, TF0, TF0)
>>>>>>>ctfc	13
>>>>>>>gainFactorInformation	Computed
>>>>>>> β c (FDD only)	
>>>>>>> β d	
>>>>>>>referenceTFCId	0
>>>>>>TFC 5	(TF4, TF3, TF0, TF0)
>>>>>>>ctfc	19
>>>>>>>gainFactorInformation	Computed
>>>>>>>referenceTFCId	0
>>>>>>TFC 6	(TF0, TF0, TF0, TF1)
>>>>>>>ctfc	20
>>>>>>>gainFactorInformation	Computed
>>>>>>> β c (FDD only)	
>>>>>>> β d	
>>>>>>>referenceTFCId	0
>>>>>>TFC 7	(TF1, TF0, TF0, TF1)
>>>>>>>ctfc	21
>>>>>>>gainFactorInformation	Computed
>>>>>>>referenceTFCId	0
>>>>>>TFC 8	(TF2, TF1, TF0, TF1)
>>>>>>>ctfc	27
>>>>>>>gainFactorInformation	computed
>>>>>>> β c (FDD only)	
>>>>>>> β d	
>>>>>>>referenceTFCId	0
>>>>>>TFC 9	(TF3, TF2, TF0, TF1)
>>>>>>>ctfc	33
>>>>>>>gainFactorInformation	computed
>>>>>>>referenceTFCId	0
>>>>>>TFC 10	(TF4, TF3, TF0, TF1)
>>>>>>>ctfc	39
>>>>>>>gainFactorInformation	signalled
>>>>>>> β c (FDD only)	11
>>>>>>> β d	15
>>>>>>>referenceTFCId	0
> TFC subset list	
>>TFC subset 1	(speech rate 6.6)
>>> Allowed transport format combination list	(TFC1, TFC2, TFC3, TFC6, TFC7, TFC8)
>>TFC subset 2	(speech rate 8.85)
>>> Allowed transport format combination list	(TFC1, TFC2, TFC3, TFC4, TFC6, TFC7, TFC8, TFC9)
>>TFC subset 3	(speech rate 12.65)
>>> Allowed transport format combination list	(TFC1, TFC2, TFC3, TFC4, TFC5, TFC6, TFC7, TFC8, TFC9, TFC10)

dl-CommonTransChInfo	
>tfc-SignallingMode	Independent
ul-CommonTransChInfo	
>tfc-ID (TDD only)	1
>sharedChannelIndicator (TDD only)	FALSE
> tfc-Subset	Absent, not required
>dl-TFCS	Normal TFCI signalling
>>explicitTFCS-ConfigurationMode	Complete
>>>ctfcSize	Ctfc8Bit
>>>>TFCS representation	Addition
>>>>>TFCS list	
>>>>>>TFC 1	(TF0, TF0, TF0, TF0, TF0)
>>>>>>>ctfc	0
>>>>>>>TFC 2	(TF1, TF0, TF0, TF0, TF0)
>>>>>>>ctfc	1
>>>>>>>TFC 3	(TF2, TF1, TF0, TF0, TF0)
>>>>>>>ctfc	7
>>>>>>>TFC 4	(TF3, TF2, TF0, TF0, TF0)
>>>>>>>ctfc	13
>>>>>>>TFC 5	(TF4, TF3, TF0, TF0, TF0)
>>>>>>>ctfc	19
>>>>>>>TFC 6	(TF0, TF0, TF0, TF1, TF0)
>>>>>>>ctfc	20
>>>>>>>TFC 7	(TF1, TF0, TF0, TF1, TF0)
>>>>>>>ctfc	21
>>>>>>>TFC 8	(TF2, TF1, TF0, TF1, TF0)
>>>>>>>ctfc	27
>>>>>>>TFC 9	(TF3, TF2, TF0, TF1, TF0)
>>>>>>>ctfc	33
>>>>>>>TFC 10	(TF4, TF3, TF0, TF1, TF0)
>>>>>>>ctfc	39
>>>>>>>TFC 11	(TF0, TF0, TF0, TF0, TF1)
>>>>>>>ctfc	40
>>>>>>>TFC 12	(TF1, TF0, TF0, TF0, TF1)
>>>>>>>ctfc	41
>>>>>>>TFC 13	(TF2, TF1, TF0, TF0, TF1)
>>>>>>>ctfc	47
>>>>>>>TFC 14	(TF3, TF2, TF0, TF0, TF1)
>>>>>>>ctfc	53
>>>>>>>TFC 15	(TF4, TF3, TF0, TF0, TF1)
>>>>>>>ctfc	59
>>>>>>>TFC 16	(TF0, TF0, TF0, TF1, TF1)
>>>>>>>ctfc	60
>>>>>>>TFC 17	(TF1, TF0, TF0, TF1, TF1)
>>>>>>>ctfc	61

>>>>>TFC 18	(TF2, TF1, TF0, TF1, TF1)
>>>>>ctfc	67
>>>>>TFC 19	(TF3, TF2, TF0, TF1, TF1)
>>>>>ctfc	73
>>>>>TFC 20	(TF4, TF3, TF0, TF1, TF1)
>>>>>ctfc	79
PhyCH INFORMATION FDD	
UL-DPCH-InfoPredef	
>ul-DPCH- PowerControlInfo	
>>powerControlAlgorithm	Algorithm 1
>>>tpcStepSize	1 dB
>tfc-Existence	TRUE
>puncturingLimit	0.84
DL- CommonInformationPredef	
>dl-DPCH-InfoCommon	
>>spreadingFactor	128
>>tfc-Existence	FALSE
>>pilotBits	4
>>positionFixed	Fixed

Configuration	12.2/7.4/5.9/4.75 kbps speech + 3.4 kbps signalling + 0.15 kbps SRB#5
Ref 34.108	4b
Default configuration identity	14
RB INFORMATION	
rb-Identity	RB1: 1, RB2: 2, RB3: 3, RB5: 5, RB6: 6, RB7: 7, RB8: 8
rlc-InfoChoice	Rlc-info
>ul-RLC-Mode	RB1: UM RB2- RB3: AM RB5-RB7: TM
>>transmissionRLC- DiscardMode	RB1: N/A RB2- RB3: NoDiscard RB5- RB7: N/A
>>>maxDat	RB1: N/A RB2- RB3: 25 RB5- RB7: N/A
>>transmissionWindowSiz e	RB1: N/A RB2- RB3: 32 RB5- RB7: N/A
>>timerRST	RB1: N/A RB2- RB3: 200 RB5- RB7: N/A
>>max-RST	RB1: N/A RB2- RB3: 1 RB5- RB7: N/A
>>pollingInfo	RB1: N/A RB2- RB3: as below RB5- RB7: N/A
>>>TimerPoll	RB2- RB3: 200
>>>PollPDU	RB2- RB3: n/a
>>>PollSDU	RB2- RB3: 1

Configuration	12.2/7.4/5.9/4.75 kbps speech + 3.4 kbps signalling + 0.15 kbps SRB#5
>>>lastTransmissionPDU-Poll	RB2- RB3: FALSE
>>>lastRetransmissionPDU-Poll	RB2- RB3: TRUE
>>>PollWindow	RB2- RB3: 99
>>segmentationIndication	RB1- RB3: N/A RB5- RB7: FALSE
>dl-RLC-Mode	RB1: UM RB2- RB3: AM RB5- RB7: TM RB8: TM
>>inSequenceDelivery	RB1: N/A RB2- RB3: TRUE RB5- RB8: N/A
>>receivingWindowSize	RB1: N/A RB2- RB3: 32 RB5- RB8: N/A
>>dl-RLC-StatusInfo	RB1: N/A RB2- RB3: as below RB5- RB8: N/A
>>>timerStatusProhibit	RB2- RB3: 100
>>>missingPDU-Indicator	RB2- RB3: TRUE
>>segmentationIndication	RB1- RB3: N/A RB5- RB8: FALSE
rb-MappingInfo	
>UL-LogicalChannelMappings	OneLogicalChannel
>>ul-TransportChannelType	Dch
>>>transportChannelIdentity	RB1- RB3: 9 RB5: 1, RB6: 2, RB7: 3.
>>logicalChannelIdentity	RB1: 1, RB2: 2, RB3: 3 RB5- RB7: N/A
>>rlc-SizeList	RB1- RB3: configured RB5- RB7: N/A
>>mac-LogicalChannelPriority	RB1: 1, RB2: 2, RB3: 3 RB5- RB7: 5
>DL-logicalChannelMappingList	
>>Mapping option 1	One mapping option
>>>dl-TransportChannelType	Dch
>>>>transportChannelIdentity	RB1- RB3: 9 RB5: 1, RB6: 2, RB7: 3, RB8: 5
>>>logicalChannelIdentity	RB1: 1, RB2: 2, RB3: 3 RB5- RB8: N/A
TrCH INFORMATION PER TrCH	
UL-AddReconfTransChInfoList	
>Uplink transport channel type	dch
>transportChannelIdentity	TrCH1: 1, TrCH2: 2, TrCH3: 3, TrCH4: 9

Configuration	12.2/7.4/5.9/4.75 kbps speech + 3.4 kbps signalling + 0.15 kbps SRB#5
>transportFormatSet	DedicatedTransChTFS
>>dynamicTF-information	
>>>tf0/ tf0,1	TrCH1: (0x81) TrCH2: (0x 103) TrCH3: (0x60) TrCH4: (0x144, 1x144)
>>>>rlcSize	BitMode
>>>>>sizeType	TrCH1: type 1: 81 TrCH2: type 1: 103 TrCH3: type1: 60 TrCH4: 2: type 2, part1= 2, part2= 0 (144)
>>>>numberOfTbSizeList	TrCH1-3: Zero TrCH4: Zero, one
>>>>logicalChannelList	All
>>>tf 1	TrCH1: (1x39) TrCH2: (1x53) TrCH3: (1x60) TrCH4: (1x144)
>>>>numberOfTransportBlocks	TrCH1-3: One
>>>>rlc-Size	TrCH1-3: BitMode
>>>>>sizeType	TrCH1: 1: 39 TrCH2: 1: 53 TrCH3: 1: 60
>>>>numberOfTbSizeList	TrCH1-3: One
>>>>logicalChannelList	TrCH1-3: all
>>>tf 2	TrCH1: (1x42) TrCH2: (1x63) TrCH3- TrCH4: N/A
>>>>numberOfTransportBlocks	TrCH1-2: One
>>>>rlc-Size	TrCH1: BitMode
>>>>>sizeType	TrCH1: type 1: 42 TrCH2: type 1: 63
>>>>numberOfTbSizeList	TrCH1-2: One
>>>>logicalChannelList	TrCH1: all
>>>tf 3	TrCH1: (1x55) TrCH2: (1x87) TrCH3- TrCH4: N/A
>>>>numberOfTransportBlocks	TrCH1-2: One
>>>>rlc-Size	TrCH1: BitMode
>>>>>sizeType	TrCH1: type 1: 55 TrCH2: type 1: 87
>>>>numberOfTbSizeList	TrCH1-2: One
>>>>logicalChannelList	TrCH1: all
>>>tf 4	TrCH1: (1x61) TrCH2: (1x103) TrCH3- TrCH4: N/A
>>>>numberOfTransportBlocks	TrCH1-2: One
>>>>rlc-Size	TrCH1: BitMode
>>>>>sizeType	TrCH1: type 1: 61 TrCH2: type 1: 103
>>>>numberOfTbSizeList	TrCH1-2: One
>>>>logicalChannelList	TrCH1: all
>>>tf 5	TrCH1: (1x81) TrCH2- TrCH4: N/A

Configuration	12.2/7.4/5.9/4.75 kbps speech + 3.4 kbps signalling + 0.15 kbps SRB#5
>>>>numberOfTransportBlocks	TrCH1: One
>>>>rlc-Size	TrCH1: BitMode
>>>>>sizeType	TrCH1: type 1: 81
>>>>numberOfTbSizeList	TrCH1: One
>>>>logicalChannelList	TrCH1: all
>>semiStaticTF-Information	
>>>tti	TrCH1- TrCH3: 20 TrCH4: 40
>>>channelCodingType	Convolutional
>>>>codingRate	TrCH1- TrCH2: Third TrCH3: Half TrCH4: Third
>>>rateMatchingAttribute	TrCH1: 200 TrCH2: 190 TrCH3: 235 TrCH4: 160
>>>crc-Size	TrCH1: 12 TrCH2- TrCH3: 0 TrCH4: 16
DL-AddReconfTransChInfoList	
>Downlink transport channel type	
>dl-TransportChannelIdentity	TrCH1: 1, TrCH2: 2, TrCH3: 3, TrCH4: 9, TrCH5: 5
>tfs-SignallingMode	Independent <Only tf0 on TrCH1 and tf0/1 on TrCH5 are different and shown below>
>>transportFormatSet	
>>>dynamicTF-information	
>>>>tf0/ tf0,1	TrCH1: (1x0) TrCH5: (0x3, 1x3)
>>>>rlcSize	bitMode
>>>>>sizeType	TrCH1: type 1: 0 TrCH5: type 1: 3
>>>>numberOfTbSizeList	TrCH1: One TrCH5: Zero, one
>>>>logicalChannelList	all
>>>semistaticTF-Information	same as UL except for TrCH5
>>>>tti	TrCH5: 20
>>>>channelCodingType	Convolutional
>>>>>codingRate	TrCH5: Third
>>>>rateMatchingAttribute	TrCH5: 205
>>>>crc-Size	TrCH5: 8
>>ULTrCH-Id	TrCH1: 1, TrCH2: 2, TrCH3: 3, TrCH4: 9
>dch-QualityTarget	
>>bler-QualityValue	TrCH1: 7×10^{-3} TrCH2: Absent TrCH3: Absent TrCH4- TrCH5: Absent
TrCH INFORMATION, COMMON	

Configuration	12.2/7.4/5.9/4.75 kbps speech + 3.4 kbps signalling + 0.15 kbps SRB#5
ul-CommonTransChInfo	
>tfc-ID (TDD only)	1
>sharedChannelIndicator (TDD only)	FALSE
>tfc-Subset	Absent, not required
>ul-TFCS	Normal TFCI signalling
>>explicitTFCS-ConfigurationMode	Complete
>>>ctfcSize	Ctfc8Bit
>>>>TFCS representation	Addition
>>>>>TFCS list	
>>>>>>TFCS 1	(TF0, TF0, TF0, TF0)
>>>>>>>ctfc	0
>>>>>>>gainFactorInformation	Computed
>>>>>>>referenceTFCId	0
>>>>>>>>TFCS 2	(TF1, TF0, TF0, TF0)
>>>>>>>>ctfc	1
>>>>>>>>gainFactorInformation	Computed
>>>>>>>>> β c (FDD only)	N/A
>>>>>>>>>> β d	N/A
>>>>>>>>>>>referenceTFCId	0
>>>>>>>>>>>>TFCS 3	(TF2, TF1, TF0, TF0)
>>>>>>>>>>>>ctfc	8
>>>>>>>>>>>>gainFactorInformation	Computed
>>>>>>>>>>>>>referenceTFCId	0
>>>>>>>>>>>>>>TFCS 4	(TF3, TF2, TF0, TF0)
>>>>>>>>>>>>>>ctfc	15
>>>>>>>>>>>>>>gainFactorInformation	Computed
>>>>>>>>>>>>>>> β c (FDD only)	N/A
>>>>>>>>>>>>>>>> β d	N/A
>>>>>>>>>>>>>>>>>referenceTFCId	0
>>>>>>>>>>>>>>>>>>TFCS 5	(TF4, TF3, TF0, TF0)
>>>>>>>>>>>>>>>>>>ctfc	22
>>>>>>>>>>>>>>>>>>gainFactorInformation	Computed
>>>>>>>>>>>>>>>>>>>referenceTFCId	0
>>>>>>>>>>>>>>>>>>>>TFCS 6	(TF5, TF4, TF1, TF0)
>>>>>>>>>>>>>>>>>>>>>ctfc	59
>>>>>>>>>>>>>>>>>>>>>gainFactorInformation	Computed
>>>>>>>>>>>>>>>>>>>>>> β c (FDD only)	N/A
>>>>>>>>>>>>>>>>>>>>>>> β d	N/A
>>>>>>>>>>>>>>>>>>>>>>>>referenceTFCId	0
>>>>>>>>>>>>>>>>>>>>>>>>>TFCS 7	(TF0, TF0, TF0, TF1)
>>>>>>>>>>>>>>>>>>>>>>>>>>ctfc	60
>>>>>>>>>>>>>>>>>>>>>>>>>>gainFactorInformation	Computed
>>>>>>>>>>>>>>>>>>>>>>>>>>>referenceTFCId	0
>>>>>>>>>>>>>>>>>>>>>>>>>>>>TFCS 8	(TF1, TF0, TF0, TF1)

Configuration	12.2/7.4/5.9/4.75 kbps speech + 3.4 kbps signalling + 0.15 kbps SRB#5
>>>>>>ctfc	61
>>>>>>gainFactorInformation	Computed
>>>>>>referenceTFClid	0
>>>>>TFCS 9	(TF2,TF1,TF0,TF1)
>>>>>>ctfc	68
>>>>>>gainFactorInformation	Computed
>>>>>>referenceTFClid	0
>>>>>TFCS 10	(TF3,TF2,TF0,TF1)
>>>>>>ctfc	75
>>>>>>gainFactorInformation	Computed
>>>>>> β c (FDD only)	N/A
>>>>>> β d	N/A
>>>>>>referenceTFClid	0
>>>>>TFCS 11	(TF4,TF3,TF0,TF1)
>>>>>>ctfc	82
>>>>>>gainFactorInformation	Computed
>>>>>>referenceTFClid	0
>>>>>TFCS 12	(TF5,TF4,TF1,TF1)
>>>>>>ctfc	119
>>>>>>gainFactorInformation	Signalled
>>>>>> β c (FDD only)	11
>>>>>> β d	15
>>>>>>referenceTFClid	0
> TFC subset list	
>>TFC subset 1	(speech rate 4.75)
>>> Allowed transport format combination list	(TFC1, TFC2, TFC3, TFC7, TFC8, TFC9)
>>TFC subset 2	(speech rate 5.9)
>>> Allowed transport format combination list	(TFC1, TFC2, TFC3, TFC4, TFC7, TFC8, TFC9, TFC10)
>>TFC subset 3	(speech rate 7.4)
>>> Allowed transport format combination list	(TFC1, TFC2, TFC3, TFC4, TFC5, TFC7, TFC8, TFC9, TFC10, TFC11)
>>TFC subset 4	(speech rate 12.2)
>>> Allowed transport format combination list	(TFC1, TFC2, TFC3, TFC4, TFC5, TFC6, TFC7, TFC8, TFC9, TFC10, TFC11, TFC12)
dl-CommonTransChInfo	
>tfcs-SignallingMode	Independent
ul-CommonTransChInfo	
>tfcs-ID (TDD only)	1
>sharedChannelIndicator (TDD only)	FALSE
> tfc-Subset	Absent, not required
>dl-TFCS	Normal TFCI signalling
>>explicitTFCS-ConfigurationMode	Complete
>>>ctfcSize	Ctfc8Bit

Configuration	12.2/7.4/5.9/4.75 kbps speech + 3.4 kbps signalling + 0.15 kbps SRB#5
>>>>TFCS representation	Addition
>>>>>TFCS list	
>>>>>>TFC 1	(TF0, TF0, TF0, TF0, TF0)
>>>>>>>ctfc	0
>>>>>>>TFC 2	(TF1, TF0, TF0, TF0, TF0)
>>>>>>>ctfc	1
>>>>>>>TFC 3	(TF2, TF1, TF0, TF0, TF0)
>>>>>>>ctfc	8
>>>>>>>TFC 4	(TF3, TF2, TF0, TF0, TF0)
>>>>>>>ctfc	15
>>>>>>>TFC 5	(TF4, TF3, TF0, TF0, TF0)
>>>>>>>ctfc	22
>>>>>>>TFC 6	(TF5,TF4,TF1,TF0, TF0)
>>>>>>>ctfc	59
>>>>>>>TFC 7	(TF0, TF0, TF0, TF1, TF0)
>>>>>>>ctfc	60
>>>>>>>TFC 8	(TF1, TF0, TF0, TF1, TF0)
>>>>>>>ctfc	61
>>>>>>>TFC 9	(TF2, TF1, TF0, TF1, TF0)
>>>>>>>ctfc	68
>>>>>>>TFC 10	(TF3, TF2, TF0, TF1, TF0)
>>>>>>>ctfc	75
>>>>>>>TFC 11	(TF4, TF3, TF0, TF1, TF0)
>>>>>>>ctfc	82
>>>>>>>TFC 12	(TF5,TF4,TF1,TF1, TF0)
>>>>>>>ctfc	119
>>>>>>>TFC 13	(TF0, TF0, TF0, TF0, TF1)
>>>>>>>ctfc	120
>>>>>>>TFC 14	(TF1, TF0, TF0, TF0, TF1)
>>>>>>>ctfc	121
>>>>>>>TFC 15	(TF2, TF1, TF0, TF0, TF1)
>>>>>>>ctfc	128
>>>>>>>TFC 16	(TF3, TF2, TF0, TF0, TF1)
>>>>>>>ctfc	135
>>>>>>>TFC 17	(TF4, TF3, TF0, TF0, TF1)
>>>>>>>ctfc	142
>>>>>>>TFC 18	(TF5,TF4,TF1,TF0, TF1)
>>>>>>>ctfc	179
>>>>>>>TFC 19	(TF0, TF0, TF0, TF1, TF1)
>>>>>>>ctfc	180
>>>>>>>TFC 20	(TF1, TF0, TF0, TF1, TF1)

Configuration	12.2/7.4/5.9/4.75 kbps speech + 3.4 kbps signalling + 0.15 kbps SRB#5
>>>>>>ctfc	181
>>>>>>TFC 21	(TF2, TF1, TF0, TF1, TF1)
>>>>>>ctfc	188
>>>>>>TFC 22	(TF3, TF2, TF0, TF1, TF1)
>>>>>>ctfc	195
>>>>>>TFC 23	(TF4, TF3, TF0, TF1, TF1)
>>>>>>ctfc	202
>>>>>>TFC 24	(TF5,TF4,TF1,TF1, TF1)
>>>>>>ctfc	239
PhyCH INFORMATION FDD	
UL-DPCH-InfoPredef	
>ul-DPCH-PowerControllInfo	
>>powerControlAlgorithm	Algorithm 1
>>>tpcStepSize	1 dB
>tfci-Existence	TRUE
>puncturingLimit	0.84
DL-CommonInformationPredef	
>dl-DPCH-InfoCommon	
>>spreadingFactor	128
>>>tfci-Existence	FALSE
>>pilotBits	4
>>positionFixed	Fixed
PhyCH INFORMATION 3.84/7.68 Mcps TDD	
UL-DPCH-InfoPredef	
>ul-DPCH-PowerControllInfo	
>>dpch-ConstantValue	
>commonTimeslotInfo	
>>secondInterleavingMode	
>>>tfci-Coding	
>>puncturingLimit	
>>repetitionPeriodAndLength	
DL-CommonInformationPredef	
>dl-DPCH-InfoCommon	
>>commonTimeslotInfo	
>>>secondInterleavingMode	
>>>>tfci-Coding	
>>>puncturingLimit	
>>>repetitionPeriodAndLength	
PhyCH INFORMATION 1.28 Mcps TDD	
UL-DPCH-InfoPredef	
>commonTimeslotInfo	
>>secondInterleavingMode	
>>>tfci-Coding	

Configuration	12.2/7.4/5.9/4.75 kbps speech + 3.4 kbps signalling + 0.15 kbps SRB#5
>>puncturingLimit	
>>repetitionPeriodAndLength	
DL-CommonInformationPredef	
>dl-DPCH-InfoCommon	
>>commonTimeslotInfo	
>>>secondInterleavingMode	
>>>tfc-Coding	
>>>puncturingLimit	
>>>repetitionPeriodAndLength	

Configuration	7.95 kbps speech + 3.4 kbps signalling
Ref 34.108	6
Default configuration identity	15
RB INFORMATION	
rb-Identity	RB1: 1, RB2: 2, RB3: 3, RB5: 5, RB6: 6, RB7: 7
rlc-InfoChoice	Rlc-info
>ul-RLC-Mode	RB1: UM RB2- RB3: AM RB5-RB7: TM
>>transmissionRLC-DiscardMode	RB1: N/A RB2- RB3: NoDiscard RB5- RB7: N/A
>>>maxDat	RB1: N/A RB2- RB3: 25 RB5- RB7: N/A
>>transmissionWindowSize	RB1: N/A RB2- RB3: 32 RB5- RB7: N/A
>>timerRST	RB1: N/A RB2- RB3: 200 RB5- RB7: N/A
>>max-RST	RB1: N/A RB2- RB3: 1 RB5- RB7: N/A
>>pollingInfo	RB1: N/A RB2- RB3: as below RB5- RB7: N/A
>>>TimerPoll	RB2- RB3: 200
>>>PollPDU	RB2- RB3: n/a
>>>PollSDU	RB2- RB3: 1
>>>lastTransmissionPDU-Poll	RB2- RB3: FALSE
>>>lastRetransmissionPDU-Poll	RB2- RB3: TRUE
>>>PollWindow	RB2- RB3: 99
>>segmentationIndication	RB1- RB3: N/A RB5- RB7: FALSE

Configuration	7.95 kbps speech + 3.4 kbps signalling
>dl-RLC-Mode	RB1: UM RB2- RB3: AM RB5- RB7: TM
>>inSequenceDelivery	RB1: N/A RB2- RB3: TRUE RB5- RB7: N/A
>>receivingWindowSize	RB1: N/A RB2- RB3: 32 RB5- RB7: N/A
>>dl-RLC-StatusInfo	RB1: N/A RB2- RB3: as below RB5- RB7: N/A
>>>timerStatusProhibit	RB2- RB3: 100
>>>missingPDU-Indicator	RB2- RB3: TRUE
>>segmentationIndication	RB1- RB3: N/A RB5- RB7: FALSE
rb-MappingInfo	
>UL-LogicalChannelMappings	OneLogicalChannel
>>ul-TransportChannelType	Dch
>>>transportChannelIdentity	RB1- RB3: 9 RB5: 1, RB6: 2, RB7: 3
>>logicalChannelIdentity	RB1: 1, RB2: 2, RB3: 3 RB5- RB7: N/A
>>rlc-SizeList	RB1- RB3: configured RB5- RB7: N/A
>>mac-LogicalChannelPriority	RB1: 1, RB2: 2, RB3: 3 RB5- RB7: 5
>DL-logicalChannelMappingList	
>>Mapping option 1	One mapping option
>>>dl-TransportChannelType	Dch
>>>>transportChannelIdentity	RB1- RB3: 9 RB5: 1, RB6: 2, RB7: 3
>>>logicalChannelIdentity	RB1: 1, RB2: 2, RB3: 3 RB5- RB7: N/A
TrCH INFORMATION PER TrCH	
UL-AddReconfTransChInfoList	
>Uplink transport channel type	dch
>transportChannelIdentity	TrCH1: 1, TrCH2: 2, TrCH3:3, TrCH4: 9
>transportFormatSet	DedicatedTransChTFS
>>dynamicTF-information	
>>>tf0/ tf0,1	TrCH1: (0x75) TrCH2: (0x 84 1x84) TrCH3: (0x 60) TrCH4: (0x144, 1x144)
>>>>rlcSize	BitMode

Configuration	7.95 kbps speech + 3.4 kbps signalling
>>>>sizeType	TrCH1: type 1: 75 TrCH2: type 1: 84 TrCH3: type 1: 60 TrCH4: 2: type 2, part1= 2, part2= 0 (144)
>>>>numberOfTbSizeList	TrCH1: Zero TrCH2-4: Zero, one
>>>>logicalChannelList	All
>>>tf 1	TrCH1: (1x39) TrCH2- TrCH4: N/A
>>>>numberOfTransportBlocks	TrCH1: One
>>>>rlc-Size	TrCH1: BitMode
>>>>sizeType	TrCH1: 1: 39
>>>>numberOfTbSizeList	TrCH1: One
>>>>logicalChannelList	TrCH1: all
>>>tf 2	TrCH1: (1x75) TrCH2- TrCH4: N/A
>>>>numberOfTransportBlocks	TrCH1: One
>>>>rlc-Size	TrCH1: BitMode
>>>>sizeType	TrCH1: type 1: 75
>>>>numberOfTbSizeList	TrCH1: One
>>>>logicalChannelList	TrCH1: all
>>semistaticTF-Information	
>>>tti	TrCH1- TrCH3: 20 TrCH4: 40
>>>channelCodingType	Convolutional
>>>>codingRate	TrCH1- TrCH2: Third TrCH3: Half TrCH4: Third
>>>>rateMatchingAttribute	TrCH1: 200 TrCH2: 190 TrCH3: 235 TrCH4: 160
>>>>crc-Size	TrCH1: 12 TrCH2-TrCH3: 0 TrCH4: 16
DL- AddReconfTransChInfoList	
>Downlink transport channel type	Dch
>dl- TransportChannelIdentity (should be as for UL)	TrCH1: 1, TrCH2: 2, TrCH3: 3, TrCH4: 9
>tfs-SignallingMode	Explicit <Only tf0 on TrCH1 is different and shown below>
>>transportFormatSet	DedicatedTransChT FS
>>>dynamicTF-information	
>>>>tf0/ tf0,1	TrCH1: (1x0)
>>>>rlcSize	BitMode
>>>>sizeType	TrCH1: type 1: 0
>>>>numberOfTbSizeList	TrCH1: One
>>>>logicalChannelList	All
>>ULTrCH-Id	TrCH1: 1, TrCH2: 2, TrCH3:3, TrCH4: 9
>dch-QualityTarget	

Configuration	7.95 kbps speech + 3.4 kbps signalling
>>bler-QualityValue	TrCH1: 7x10-3 TrCH2- TrCH4: Absent
TrCH INFORMATION, COMMON	
ul-CommonTransChInfo	
>tfc-ID (TDD only)	1
>sharedChannelIndicator (TDD only)	FALSE
>tfc-Subset	Absent, not required
>ul-TFCS	Normal TFCI signalling
>>explicitTFCS- ConfigurationMode	Complete
>>>ctfcSize	Ctfc4Bit
>>>>TFCS representation	Addition
>>>>>TFCS list	
>>>>>>TFCS 1	(TF0, TF0, TF0, TF0)
>>>>>>>ctfc	0
>>>>>>>gainFactorInform ation	Computed
>>>>>>>referenceTFCId	0
>>>>>>>TFCS 2	(TF1, TF0, TF0, TF0)
>>>>>>>ctfc	1
>>>>>>>gainFactorInform ation	Computed
>>>>>>>> β c (FDD only)	N/A
>>>>>>>> β d	N/A
>>>>>>>>referenceTFCId	0
>>>>>>>>TFCS 3	(TF2, TF1, TF0, TF0)
>>>>>>>>ctfc	5
>>>>>>>>gainFactorInform ation	Computed
>>>>>>>>referenceTFCId	0
>>>>>>>>TFCS 4	(TF0, TF0, TF0, TF1)
>>>>>>>>ctfc	6
>>>>>>>>gainFactorInform ation	Computed
>>>>>>>>> β c (FDD only)	N/A
>>>>>>>>> β d	N/A
>>>>>>>>>referenceTFCId	0
>>>>>>>>>TFCS 5	(TF1, TF0, TF0, TF1)
>>>>>>>>>ctfc	7
>>>>>>>>>gainFactorInform ation	Computed
>>>>>>>>>referenceTFCId	0
>>>>>>>>>TFCS 6	(TF2, TF1, TF0, TF1)
>>>>>>>>>ctfc	11
>>>>>>>>>gainFactorInform ation	Signalled
>>>>>>>>>> β c (FDD only)	11
>>>>>>>>>> β d	15
>>>>>>>>>>referenceTFCId	0
dl-CommonTransChInfo	

Configuration	7.95 kbps speech + 3.4 kbps signalling
>tfcs-SignallingMode	Same as UL
PhyCH INFORMATION FDD	
UL-DPCH-InfoPredef	
>ul-DPCH- PowerControlInfo	
>>powerControlAlgorithm	Algorithm 1
>>>tpcStepSize	1 dB
>tfci-Existence	TRUE
>puncturingLimit	0.96
DL- CommonInformationPredef	
>dl-DPCH-InfoCommon	
>>spreadingFactor	128
>>tfci-Existence	FALSE
>>pilotBits	4
>>positionFixed	Fixed
PhyCH INFORMATION 3.84/7.68 Mcps TDD	
UL-DPCH-InfoPredef	
>ul-DPCH- PowerControlInfo	
>>dpch-ConstantValue	0
>commonTimeslotInfo	
>>secondInterleavingMode	frameRelated
>>tfci-Coding	16
>>puncturingLimit	0.52
>>repetitionPeriodAndLeng th	repetitionPeriod1
DL- CommonInformationPredef	
>dl-DPCH-InfoCommon	
>>commonTimeslotInfo	
>>>secondInterleavingMod e	frameRelated
>>>tfci-Coding	16
>>>puncturingLimit	0.52
>>>repetitionPeriodAndLe ngth	repetitionPeriod1
PhyCH INFORMATION 1.28 Mcps TDD	
UL-DPCH-InfoPredef	
>commonTimeslotInfo	
>>secondInterleavingMode	frameRelated
>>tfci-Coding	16
>>puncturingLimit	0.80
>>repetitionPeriodAndLeng th	repetitionPeriod1
DL- CommonInformationPredef	
>dl-DPCH-InfoCommon	
>>commonTimeslotInfo	
>>>secondInterleavingMod e	frameRelated
>>>tfci-Coding	16
>>>puncturingLimit	0.80
>>>repetitionPeriodAndLe ngth	repetitionPeriod1

Configuration	12.65/8.85/6.6 kbps speech + 3.4 kbps signalling (without SRB#5)
Ref 25.993	7.1.106
Default configuration identity	16
RB INFORMATION	
rb-Identity	RB1: 1, RB2: 2, RB3: 3, RB5: 5, RB6: 6, RB7: 7,
rlc-InfoChoice	Rlc-info
>ul-RLC-Mode	RB1: UM RB2- RB3: AM RB5-RB7: TM
>>transmissionRLC- DiscardMode	RB1: N/A RB2- RB3: NoDiscard RB5- RB7: N/A
>>>maxDat	RB1: N/A RB2- RB3: 25 RB5- RB7: N/A
>>transmissionWindowSiz e	RB1: N/A RB2- RB3: 32 RB5- RB7: N/A
>>timerRST	RB1: N/A RB2- RB3: 200 RB5- RB7: N/A
>>max-RST	RB1: N/A RB2- RB3: 1 RB5- RB7: N/A
>>pollingInfo	RB1: N/A RB2- RB3: as below RB5- RB7: N/A
>>>TimerPoll	RB2- RB3: 200
>>>PollPDU	RB2- RB3: n/a
>>>PollSDU	RB2- RB3: 1
>>>lastTransmissionPDU- Poll	RB2- RB3: FALSE
>>>lastRetransmissionPD U-Poll	RB2- RB3: TRUE
>>>PollWindow	RB2- RB3: 99
>>segmentationIndication	RB1- RB3: N/A RB5- RB7: FALSE
>dl-RLC-Mode	RB1: UM RB2- RB3: AM RB5- RB7: TM
>>inSequenceDelivery	RB1: N/A RB2- RB3: TRUE RB5- RB7: N/A
>>receivingWindowSize	RB1: N/A RB2- RB3: 32 RB5- RB7: N/A
>>dl-RLC-StatusInfo	RB1: N/A RB2- RB3: as below RB5- RB7: N/A
>>>timerStatusProhibit	RB2- RB3: 100
>>>missingPDU-Indicator	RB2- RB3: TRUE
>>segmentationIndication	RB1- RB3: N/A RB5- RB7: FALSE
rb-MappingInfo	
>UL- LogicalChannelMappings	OneLogicalChannel
>>ul- TransportChannelType	Dch

>>>transportChannelIdentity	RB1- RB3: 9 RB5: 1, RB6: 2, RB7: 3.
>>logicalChannelIdentity	RB1: 1, RB2: 2, RB3: 3 RB5- RB7: N/A
>>rlc-SizeList	RB1- RB3: configured RB5- RB7: N/A
>>mac-LogicalChannelPriority	RB1: 1, RB2: 2, RB3: 3 RB5- RB7: 5
>DL-logicalChannelMappingList	
>>Mapping option 1	One mapping option
>>>dl-TransportChannelType	Dch
>>>>transportChannelIdentity	RB1- RB3: 9 RB5: 1, RB6: 2, RB7: 3,
>>>logicalChannelIdentity	RB1: 1, RB2: 2, RB3: 3 RB5- RB7: N/A
TrCH INFORMATION PER TrCH	
UL-AddReconfTransChInfoList	
>Uplink transport channel type	Dch
>transportChannelIdentity	TrCH1: 1, TrCH2: 2, TrCH3: 3, TrCH4: 9
>transportFormatSet	DedicatedTransChTFS
>>dynamicTF-information	
>>>tf0/ tf0,1	TrCH1: (0x72) TrCH2: (0x 181) TrCH3: (0x60) TrCH4: (0x144, 1x144)
>>>>rlcSize	BitMode
>>>>>sizeType	TrCH1: type 1: 72 TrCH2: type 2: part1= 6, part2= 5 TrCH3: type1: 60 TrCH4: 2: type 2, part1= 2, part2= 0 (144)
>>>>numberOfTbSizeList	TrCH1-3: Zero TrCH4: Zero, one
>>>>logicalChannelList	All
>>>tf 1	TrCH1: (1x40) TrCH2: (1x 78) TrCH3: N/A TrCH4: N/A
>>>>numberOfTransportBlocks	TrCH1: One TrCH2: One
>>>>rlc-Size	TrCH1-2: BitMode
>>>>>sizeType	TrCH1: 1: 40 TrCH2: 1: 78
>>>>numberOfTbSizeList	TrCH1-2: One
>>>>logicalChannelList	TrCH1: all
>>>tf 2	TrCH1: (1x54) TrCH2: (1x113) TrCH3: N/A TrCH4: N/A

>>>>numberOfTransportBlocks	TrCH1: One TrCh2: One
>>>>rlc-Size	TrCH1: BitMode
>>>>>sizeType	TrCH1: type 1: 54 TrCH2: type 1: 113
>>>>numberOfTbSizeList	TrCH1: One TrCH2: One
>>>>logicalChannelList	TrCH1: all TrCH2: all
>>>tf 3	TrCH1: (1x64) TrCH2: (1x181) TrCH3: N/A TrCH4: N/A
>>>>numberOfTransportBlocks	TrCH1: One TrCh2: One
>>>>rlc-Size	TrCH1: BitMode
>>>>>sizeType	TrCH1: type 1: 64 TrCH2: type 2: part1=6, part2= 5
>>>>numberOfTbSizeList	TrCH1: One TrCH2: One
>>>>logicalChannelList	TrCH1: all TrCH2: all
>>>tf 4	TrCH1: (1x72) TrCH2: N/A TrCH3: N/A TrCH4: N/A
>>>>numberOfTransportBlocks	TrCH1: One
>>>>rlc-Size	TrCH1: BitMode
>>>>>sizeType	TrCH1: type 1: 72
>>>>numberOfTbSizeList	TrCH1: One
>>>>logicalChannelList	TrCH1: all
>>semistaticTF-Information	
>>>tfti	TrCH1- TrCH3: 20 TrCH4: 40
>>>channelCodingType	Convolutional
>>>>codingRate	TrCH1- TrCH3: Third TrCH4: Third
>>>rateMatchingAttribute	TrCH1: 200 TrCH2: 190 TrCH3: 256 TrCH4: 170
>>>crc-Size	TrCH1: 12 TrCH2: 0 TrCH3: 0 TrCH4: 16
DL-AddReconfTransChInfoList	
>Downlink transport channel type	Dch
>dl-TransportChannelIdentity	
>tfs-SignallingMode	Independent <Only tf0 on TrCH1 is different and shown below>
>>transportFormatSet	
>>>dynamicTF-information	
>>>>tf0/ tf0,1	TrCH1: (1x0)
>>>>rlcSize	BitMode
>>>>>sizeType	TrCH1: type 1: 0
>>>>numberOfTbSizeList	TrCH1: One
>>>>logicalChannelList	All

>>>semistaticTF-Information	same as UL
>>ULTrCH-Id	TrCH1: 1, TrCH2: 2, TrCH3: 3, TrCH4: 9,
>dch-QualityTarget	
>>bler-QualityValue	TrCH1: 7×10^{-3} TrCH2: Absent TrCH3: Absent TrCH4: Absent
TrCH INFORMATION, COMMON	
ul-CommonTransChInfo	
>tfc-ID (TDD only)	1
>sharedChannelIndicator (TDD only)	FALSE
> tfc-Subset	Absent, not required
>ul-TFCS	Normal TFCI signalling
>>explicitTFCS- ConfigurationMode	Complete
>>>ctfcSize	Ctfc6Bit
>>>>TFCS representation	Addition
>>>>>TFC list	
>>>>>>TFC 1	(TF0, TF0, TF0, TF0)
>>>>>>>ctfc	0
>>>>>>>gainFactorInform ation	Computed
>>>>>>>referenceTFCId	0
>>>>>>>TFC 2	(TF1, TF0, TF0, TF0)
>>>>>>>ctfc	1
>>>>>>>gainFactorInform ation	Computed
>>>>>>>> β c (FDD only)	N/A
>>>>>>>> β d	N/A
>>>>>>>>referenceTFCId	0
>>>>>>>>TFC 3	(TF2, TF1, TF0, TF0)
>>>>>>>>ctfc	7
>>>>>>>>gainFactorInform ation	Computed
>>>>>>>>referenceTFCId	0
>>>>>>>>TFC 4	(TF3, TF2, TF0, TF0)
>>>>>>>>ctfc	13
>>>>>>>>gainFactorInform ation	Computed
>>>>>>>>> β c (FDD only)	
>>>>>>>>> β d	
>>>>>>>>>referenceTFCId	0
>>>>>>>>>TFC 5	(TF4, TF3, TF0, TF0)
>>>>>>>>>ctfc	19
>>>>>>>>>gainFactorInform ation	Computed
>>>>>>>>>referenceTFCId	0
>>>>>>>>>TFC 6	(TF0, TF0, TF0, TF1)
>>>>>>>>>ctfc	20
>>>>>>>>>gainFactorInform ation	Computed
>>>>>>>>>> β c (FDD only)	
>>>>>>>>>> β d	

>>>>>>referenceTFCId	0
>>>>>TFC 7	(TF1, TF0, TF0, TF1)
>>>>>>ctfc	21
>>>>>>gainFactorInformation	Computed
>>>>>>referenceTFCId	0
>>>>>TFC 8	(TF2, TF1, TF0, TF1)
>>>>>>ctfc	27
>>>>>>gainFactorInformation	computed
>>>>>> β c (FDD only)	
>>>>>> β d	
>>>>>>referenceTFCId	0
>>>>>TFC 9	(TF3, TF2, TF0, TF1)
>>>>>>ctfc	33
>>>>>>gainFactorInformation	computed
>>>>>>referenceTFCId	0
>>>>>TFC 10	(TF4, TF3, TF0, TF1)
>>>>>>ctfc	39
>>>>>>gainFactorInformation	signalled
>>>>>> β c (FDD only)	11
>>>>>> β d	15
>>>>>>referenceTFCId	0
> TFC subset list	
>>TFC subset 1	(speech rate 6.6)
>>> Allowed transport format combination list	(TFC1, TFC2, TFC3, TFC6, TFC7, TFC8)
>>TFC subset 2	(speech rate 8.85)
>>> Allowed transport format combination list	(TFC1, TFC2, TFC3, TFC4, TFC6, TFC7, TFC8, TFC9)
>>TFC subset 3	(speech rate 12.65)
>>> Allowed transport format combination list	(TFC1, TFC2, TFC3, TFC4, TFC5, TFC6, TFC7, TFC8, TFC9, TFC10)
dl-CommonTransChInfo	
>tfc-SignallingMode	Same as UL
ul-CommonTransChInfo	
>tfc-ID (TDD only)	1
>sharedChannelIndicator (TDD only)	FALSE
PhyCH INFORMATION FDD	
UL-DPCH-InfoPredef	
>ul-DPCH-PowerControlInfo	
>>powerControlAlgorithm	Algorithm 1
>>>tpcStepSize	1 dB
>tfc-Existence	TRUE
>puncturingLimit	0.84
DL-CommonInformationPredef	
>dl-DPCH-InfoCommon	
>>spreadingFactor	128
>>tfc-Existence	FALSE
>>pilotBits	4

>>positionFixed	Fixed
-----------------	-------

Configuration	Signalling on E-DCH on UL depending based on minimum E-DCH UE category + Signalling on HS-DSCH based minimum HS-DSCH UE category
Ref 25.993	7.5.10
Default configuration identity	17
RB INFORMATION	
rb-Identity	RB1: 1, RB2: 2, RB3: 3
rlc-InfoChoice	Rlc-info
>ul-RLC-Mode	RB1: UM RB2- RB3: AM
>>transmissionRLC-DiscardMode	RB1: N/A RB2- RB3: NoDiscard
>>>maxDat	RB1: N/A RB2- RB3: 25
>>transmissionWindowSize	RB1: N/A RB2- RB3: 128
>>timerRST	RB1: N/A RB2- RB3: 200
>>max-RST	RB1: N/A RB2- RB3: 1
>>pollingInfo	RB1: N/A RB2- RB3: as below
>>>TimerPoll	RB2- RB3: 100
>>>PollPDU	RB2- RB3: n/a
>>>PollSDU	RB2- RB3: 1
>>>lastTransmissionPDU-Poll	RB2- RB3: FALSE
>>>lastRetransmissionPDU-Poll	RB2- RB3: FALSE
>>>PollWindow	RB2- RB3: 99
>>segmentationIndication	RB1- RB3: N/A
>dl-RLC-Mode	RB1: UM RB2- RB3: AM
>>DL RLC PDU size	RB1-RB3: 144
>>inSequenceDelivery	RB1: N/A RB2- RB3: TRUE
>>receivingWindowSize	RB1: N/A RB2- RB3: 128
>>dl-RLC-StatusInfo	RB1: N/A RB2- RB3: as below
>>>timerStatusProhibit	RB2- RB3: 100
>>>missingPDU-Indicator	RB2- RB3: TRUE
>>segmentationIndication	RB1- RB3: N/A
>>dl-UM-RLC-LI-size	7
Rb-MappingInfo	
>UL-LogicalChannelMappings	OneLogicalChannel
>>UplinkTransportChannelTypeChoice	
>>ul-TransportChannelType	E-DCH
>>>logicalChannelIdentity	RB1: 1, RB2: 2, RB3: 3
>>>E-DCH MAC-d flow identity	RB1-RB3:0
>>>DDI	RB1: 1, RB2: 2, RB3: 3
>>>>RLC PDU size	144
>>mac-LogicalChannelPriority	RB1: 1, RB2: 2, RB3: 3

Configuration	Signalling on E-DCH on UL depending based on minimum E-DCH UE category + Signalling on HS-DSCH based minimum HS-DSCH UE category
>DL-logicalChannelMappings	OneLogicalChannel
>>Mapping option 1	One mapping option
>>>dl-TransportChannelType	HS-DSCH
>>>>Mac-d flow identity	RB1- RB3: 0
>>>>logicalChannelIdentity	RB1: 1, RB2: 2, RB3: 3
TrCH INFORMATION PER TrCH	
UL-AddReconfTransChInfoList	
>Uplink transport channel type	E-DCH
>UL Transport channel identity	
> UL-ParametersChoice	
>> E-DCH Transmission Time Interval	10
>> HARQ info for E-DCH	
>>> HARQ RV Configuration	Rvtable
>> Added or reconfigured E-DCH MAC-d flow	One MAC-d flow
>>> E-DCH MAC-d flow identity	0
>>> E-DCH MAC-d flow power offset	4
>>> E-DCH MAC-d flow maximum number of retransmissions	5
>>> E-DCH MAC-d flow multiplexing list	0
>>> transmission grant typeChoice	
>>>> Non-scheduled transmission grant info	Non-scheduled
>>>>> Max MAC-e PDU contents size	162
DL-AddReconfTransChInfoList	
>Downlink transport channel type	HS-DSCH
>DL-ParametersChoice	
>>HARQ Info	
>>>Number of Processes	6
>>>Memory PartitioningChoice	
>>>>Implicit	
>>Added or reconfigured MAC-d flow	
>>> MAC-hs queue to add or reconfigure list	
>>>>MAC-hs queue Id	0
>>>>MAC-d Flow Identity	0
>>>>T1	100
>>>>MAC-hs window size	12
>>>>MAC-d PDU size info	
>>>>>MAC-d PDU size	148
>>>>>MAC-d PDU size index	0

Configuration	Signalling on E-DCH on UL depending based on minimum E-DCH UE category + Signalling on HS-DSCH based minimum HS-DSCH UE category
TrCH INFORMATION, COMMON	<i>Null</i>

Configuration	12.2 kbps speech + 13.6 kbps signalling	12.2/7.95/5.9/4.75 kbps speech + 13.6 kbps signalling
Ref 25.993	7.1.131	7.1.132
Default configuration identity	18	19
RB INFORMATION		
rb-Identity	RB1: 1, RB2: 2, RB3: 3, RB5: 5, RB6: 6, RB7: 7	RB1: 1, RB2: 2, RB3: 3, RB5: 5, RB6: 6, RB7: 7
rlc-InfoChoice	Rlc-info	Rlc-info
>ul-RLC-Mode	RB1: UM RB2- RB3: AM RB5-RB7: TM	RB1: UM RB2- RB3: AM RB5-RB7: TM
>>transmissionRLC-DiscardMode	RB1: N/A RB2- RB3: NoDiscard RB5- RB7: N/A	RB1: N/A RB2- RB3: NoDiscard RB5- RB7: N/A
>>>maxDat	RB1: N/A RB2- RB3: 15 RB5- RB7: N/A	RB1: N/A RB2- RB3: 15 RB5- RB7: N/A
>>transmissionWindowSize	RB1: N/A RB2- RB3: 32 RB5- RB7: N/A	RB1: N/A RB2- RB3: 32 RB5- RB7: N/A
>>timerRST	RB1: N/A RB2- RB3: 200 RB5- RB7: N/A	RB1: N/A RB2- RB3: 200 RB5- RB7: N/A
>>max-RST	RB1: N/A RB2- RB3: 1 RB5- RB7: N/A	RB1: N/A RB2- RB3: 1 RB5- RB7: N/A
>>pollingInfo	RB1: N/A RB2- RB3: as below RB5- RB7: N/A	RB1: N/A RB2- RB3: as below RB5- RB7: N/A
>>>TimerPoll	RB2- RB3: 100	RB2- RB3: 100
>>>PollPDU	RB2- RB3: n/a	RB2- RB3: n/a
>>>PollSDU	RB2- RB3: 1	RB2- RB3: 1
>>>lastTransmissionPDU-Poll	RB2- RB3: FALSE	RB2- RB3: FALSE
>>>lastRetransmissionPDU-Poll	RB2- RB3: TRUE	RB2- RB3: TRUE
>>>PollWindow	RB2- RB3: 99	RB2- RB3: 99
>>>timerPollPeriodic	RB2- RB3: n/a	RB2- RB3: n/a
>>segmentationIndication	RB1- RB3: N/A RB5- RB7: FALSE	RB1- RB3: N/A RB5- RB7: FALSE
>dl-RLC-Mode	RB1: UM RB2- RB3: AM RB5- RB7: TM	RB1: UM RB2- RB3: AM RB5- RB7: TM
>>inSequenceDelivery	RB1: N/A RB2- RB3: TRUE RB5- RB7: N/A	RB1: N/A RB2- RB3: TRUE RB5- RB7: N/A

Configuration	12.2 kbps speech + 13.6 kbps signalling	12.2/7.95/5.9/4.75 kbps speech + 13.6 kbps signalling
>>receivingWindowSize	RB1: N/A RB2- RB3: 32 RB5- RB7: N/A	RB1: N/A RB2- RB3: 32 RB5- RB7: N/A
>>dl-RLC-StatusInfo	RB1: N/A RB2- RB3: as below RB5- RB7: N/A	RB1: N/A RB2- RB3: as below RB5- RB7: N/A
>>>timerStatusProhibit	RB2- RB3: 100	RB2- RB3: 100
>>>missingPDU-Indicator	RB2- RB3: TRUE	RB2- RB3: TRUE
>>>timerStatusPeriodic	RB2- RB3: n/a	RB2- RB3: n/a
>>segmentationIndication	RB1- RB3: N/A RB5- RB7: FALSE	RB1- RB3: N/A RB5- RB7: FALSE
rb-MappingInfo		
>UL- LogicalChannelMappings	OneLogicalChannel	OneLogicalChannel
>>ul- TransportChannelType	Dch	Dch
>>>transportChannelIdentity	RB1- RB3: 9 RB5: 1, RB6: 2, RB7: 3	RB1- RB3: 9 RB5: 1, RB6: 2, RB7: 3
>>logicalChannelIdentity	RB1: 1, RB2: 2, RB3: 3 RB5- RB7: N/A	RB1: 1, RB2: 2, RB3: 3 RB5- RB7: N/A
>>rlc-SizeList	RB1- RB3: configured RB5- RB7: N/A	RB1- RB3: configured RB5- RB7: N/A
>>mac- LogicalChannelPriority	RB1: 1, RB2: 2, RB3: 3 RB5- RB7: 5	RB1: 1, RB2: 2, RB3: 3 RB5- RB7: 5
>DL- logicalChannelMappingList		
>>Mapping option 1	One mapping option	One mapping option
>>>dl- TransportChannelType	Dch	Dch
>>>>transportChannelIdentity	RB1- RB3: 9 RB5: 1, RB6: 2, RB7: 3	RB1- RB3: 9 RB5: 1, RB6: 2, RB7: 3
>>>logicalChannelIdentity	RB1: 1, RB2: 2, RB3: 3 RB5- RB7: N/A	RB1: 1, RB2: 2, RB3: 3 RB5- RB7: N/A
TrCH INFORMATION PER TrCH		
UL- AddReconfTransChInfoList		
>Uplink transport channel type	dch	dch
>transportChannelIdentity	TrCH1: 1, TrCH2: 2, TrCH3: 3, TrCH4: 9	TrCH1: 1, TrCH2: 2, TrCH3: 3, TrCH4: 9
>transportFormatSet	DedicatedTransChT FS	DedicatedTransChT FS
>>dynamicTF-information		
>>>tf0/ tf0,1	TrCH1: (0x81) TrCH2: (0x 103, 1x103) TrCH3: (0x 60, 1x60) TrCH4: (0x144, 1x144, 2x144, 3x144, 4x144)	TrCH1: (0x 81) TrCH2: (0x 103) TrCH3: (0x 60) TrCH4: (0x144)
>>>>rlcSize	BitMode	BitMode

Configuration	12.2 kbps speech + 13.6 kbps signalling	12.2/7.95/5.9/4.75 kbps speech + 13.6 kbps signalling
>>>>>sizeType	TrCH1: type 1: 81 TrCH2: type 1: 103 TrCH3: type 1: 60 TrCH4: 2: type 2, part1= 2, part2= 0 (144)	TrCH1: type 1: 81 TrCH2: type 1: 103 TrCH3: type 1: 60 TrCH4: 2: type 2, part1= 2, part2= 0 (144)
>>>>numberOfTbSizeList	TrCH1: Zero TrCH2-3: Zero, One TrCH4: Zero, one, 2, 3, 4	TrCH1-4: Zero
>>>>logicalChannelList	All	All
>>>>tf 1	TrCH1: (1x39) TrCH2- TrCH4: N/A	TrCH1: (1x39) TrCH2: (1x53) TrCH3: (1x60) TrCH4: (1x144, 2x144, 3x144, 4x144)
>>>>numberOfTransportBlocks	TrCH1: One	TrCH1-3: One TrCH4: One, 2, 3, 4
>>>>rlc-Size	TrCH1: BitMode	TrCH1: BitMode
>>>>>sizeType	TrCH1: 1: 39	TrCH1: 1: 39 TrCH2: 1: 53 TrCH3: 1: 60 TrCH4: 2: type 2, part1= 2, part2= 0 (144)
>>>>numberOfTbSizeList	TrCH1: One	TrCH1: One
>>>>logicalChannelList	TrCH1: all	TrCH1: all
>>>>tf 2	TrCH1: (1x81) TrCH2- TrCH4: N/A	TrCH1: (1x42) TrCH2: (1x63) TrCH3- TrCH4: N/A
>>>>numberOfTransportBlocks	TrCH1: One	TrCH1-2: One
>>>>rlc-Size	TrCH1: BitMode	TrCH1: BitMode
>>>>>sizeType	TrCH1: type 1: 81	TrCH1: type 1: 42 TrCH2: type 1: 63
>>>>numberOfTbSizeList	TrCH1: One	TrCH1: One
>>>>logicalChannelList	TrCH1: all	TrCH1: all
>>>>tf 3		TrCH1: (1x55) TrCH2: (1x84) TrCH3- TrCH4: N/A
>>>>numberOfTransportBlocks		TrCH1-2: One
>>>>rlc-Size		TrCH1: BitMode
>>>>>sizeType		TrCH1: type 1: 55 TrCH2: type 1: 84
>>>>numberOfTbSizeList		TrCH1-2: One
>>>>logicalChannelList		TrCH1: all
>>>>tf 4		TrCH1: (1x75) TrCH2: (1x103) TrCH3- TrCH4: N/A
>>>>numberOfTransportBlocks		TrCH1-2: One
>>>>rlc-Size		TrCH1: BitMode
>>>>>sizeType		TrCH1: type 1: 75 TrCH2: type 1: 103
>>>>numberOfTbSizeList		TrCH1-2: One
>>>>logicalChannelList		TrCH1: all
>>>>tf 5		TrCH1: (1x81) TrCH2- TrCH4: N/A

Configuration	12.2 kbps speech + 13.6 kbps signalling	12.2/7.95/5.9/4.75 kbps speech + 13.6 kbps signalling
>>>>numberOfTransportBlocks		TrCH1: One
>>>>rlc-Size		TrCH1: BitMode
>>>>>sizeType		TrCH1: type 1: 81
>>>>numberOfTbSizeList		TrCH1: One
>>>>logicalChannelList		TrCH1: all
>>semistaticTF-Information		
>>>tti	TrCH1- TrCH3: 20 TrCH4: 40	TrCH1- TrCH3: 20 TrCH4: 40
>>>channelCodingType	Convolutional	Convolutional
>>>>codingRate	TrCH1- TrCH2: Third TrCH3: Half TrCH4: Third	TrCH1- TrCH2: Third TrCH3: Half TrCH4: Third
>>>rateMatchingAttribute	TrCH1: 200 TrCH2: 190 TrCH3: 235 TrCH4: 160	TrCH1: 200 TrCH2: 190 TrCH3: 235 TrCH4: 160
>>>crc-Size	TrCH1: 12 TrCH2- TrCH3: 0 TrCH4: 16	TrCH1: 12 TrCH2- TrCH3: 0 TrCH4: 16
DL- AddReconfTransChInfoList		
>Downlink transport channel type	dch	
>dl- TransportChannelIdentity (should be as for UL)	TrCH1: 1, TrCH2: 2, TrCH3: 3, TrCH4: 9	TrCH1: 1, TrCH2: 2, TrCH3: 3, TrCH4: 9
>tf0-SignallingMode	Explicit <Only tf0 on TrCH1 is different and shown below>	Explicit <Only tf0 on TrCH1 is different and shown below>
>>transportFormatSet	DedicatedTransChT FS	DedicatedTransChT FS
>>>dynamicTF-information		
>>>>tf0/ tf0,1	TrCH1: (1x0)	TrCH1: (1x0)
>>>>rlcSize	bitMode	bitMode
>>>>>sizeType	TrCH1: type 1: 0	TrCH1: type 1: 0
>>>>numberOfTbSizeList	TrCH1: One	TrCH1: One
>>>>logicalChannelList	All	All
>>ULTrCH-Id	TrCH1: 1, TrCH2: 2, TrCH3: 3, TrCH4: 9	TrCH1: 1, TrCH2: 2, TrCH3: 3, TrCH4: 9
>dch-QualityTarget		
>>bler-QualityValue	TrCH1: 7×10^{-3} TrCH2- TrCH4: Absent	TrCH1: 7×10^{-3} TrCH2- TrCH4: Absent
TrCH INFORMATION, COMMON		
ul-CommonTransChInfo		
>tfcs-ID (TDD only)	1	1
>sharedChannelIndicator (TDD only)	FALSE	FALSE
>tf0-Subset	Absent, not required	Absent, not required
>ul-TFCS	Normal TFCS signalling	Normal TFCS signalling
>>explicitTFCS- ConfigurationMode	Complete	Complete
>>>ctfcSize	Ctfc6Bit	Ctfc8Bit
>>>>TFCS representation	Addition	Addition
>>>>>TFCS list		

Configuration	12.2 kbps speech + 13.6 kbps signalling	12.2/7.95/5.9/4.75 kbps speech + 13.6 kbps signalling
>>>>>TFC 1	(TF0, TF0, TF0, TF0)	(TF0, TF0, TF0, TF0)
>>>>>>ctfc	0	0
>>>>>>>gainFactorInformation	Computed	Computed
>>>>>>>referenceTFCId	0	0
>>>>>TFC 2	(TF1, TF0, TF0, TF0)	(TF1, TF0, TF0, TF0)
>>>>>>ctfc	1	1
>>>>>>>gainFactorInformation	Computed	Computed
>>>>>>>referenceTFCId	0	0
>>>>>TFC 3	(TF2, TF1, TF1, TF0)	(TF2, TF1, TF0, TF0)
>>>>>>ctfc	11	8
>>>>>>>gainFactorInformation	Computed	Computed
>>>>>>>referenceTFCId	0	0
>>>>>TFC 4	(TF0, TF0, TF0, TF1)	(TF3, TF2, TF0, TF0)
>>>>>>ctfc	12	15
>>>>>>>gainFactorInformation	Computed	Computed
>>>>>>>referenceTFCId	0	0
>>>>>TFC 5	(TF1, TF0, TF0, TF1)	(TF4, TF3, TF0, TF0)
>>>>>>ctfc	13	22
>>>>>>>gainFactorInformation	Computed	Computed
>>>>>>>referenceTFCId	0	0
>>>>>TFC 6	(TF2, TF1, TF1, TF1)	(TF5, TF4, TF1, TF0)
>>>>>>ctfc	23	59
>>>>>>>gainFactorInformation	Signalled	Computed
>>>>>>> β_c (FDD only)	10	N/A
>>>>>>> β_d	15	N/A
>>>>>>>referenceTFCId	0	0
>>>>>TFC 7	(TF0, TF0, TF0, TF2)	(TF0, TF0, TF0, TF1)
>>>>>>ctfc	24	60
>>>>>>>gainFactorInformation	Computed	Computed
>>>>>>>referenceTFCId	0	0
>>>>>TFC 8	(TF1, TF0, TF0, TF2)	(TF1, TF0, TF0, TF1)
>>>>>>ctfc	25	61
>>>>>>>gainFactorInformation	Computed	Computed
>>>>>>>referenceTFCId	0	0
>>>>>TFC 9	(TF0, TF0, TF0, TF3)	(TF2, TF1, TF0, TF1)
>>>>>>ctfc	36	68
>>>>>>>gainFactorInformation	Computed	Computed
>>>>>>>referenceTFCId	0	0
>>>>>TFC 10	(TF1, TF0, TF0, TF3)	(TF3, TF2, TF0, TF1)
>>>>>>ctfc	37	75

Configuration	12.2 kbps speech + 13.6 kbps signalling	12.2/7.95/5.9/4.75 kbps speech + 13.6 kbps signalling
>>>>>>gainFactorInformation	Computed	Computed
>>>>>>referenceTFCId	0	0
>>>>>>TFC 11	(TF0, TF0, TF0, TF4)	(TF4,TF3,TF0,TF1)
>>>>>>ctfc	48	82
>>>>>>gainFactorInformation	Computed	Computed
>>>>>>referenceTFCId	0	0
>>>>>>TFC 12		(TF5,TF4,TF1,TF1)
>>>>>>ctfc		119
>>>>>>gainFactorInformation		Signalled
>>>>>> β_c (FDD only)		10
>>>>>> β_d		15
>>>>>>referenceTFCId		0
>>>>>>TFC 13		(TF0,TF0,TF0,TF2)
>>>>>>ctfc		120
>>>>>>gainFactorInformation		Computed
>>>>>>referenceTFCId		0
>>>>>>TFC 14		(TF1, TF0, TF0, TF2)
>>>>>>ctfc		121
>>>>>>gainFactorInformation		Computed
>>>>>>referenceTFCId		0
>>>>>>TFC 15		(TF0,TF0,TF0,TF3)
>>>>>>ctfc		180
>>>>>>gainFactorInformation		Computed
>>>>>>referenceTFCId		0
>>>>>>TFC 16		(TF1, TF0, TF0, TF3)
>>>>>>ctfc		181
>>>>>>gainFactorInformation		Computed
>>>>>>referenceTFCId		0
dl-CommonTransChInfo		
>tfc-SignallingMode	Same as UL	Same as UL
PhyCH INFORMATION FDD		
UL-DPCH-InfoPredef		
>ul-DPCH- PowerControlInfo		
>>powerControlAlgorithm	Algorithm 1	Algorithm 1
>>>tpcStepSize	1 dB	1 dB
>tfc-Existence	TRUE	TRUE
>puncturingLimit	0.84	0.84
DL- CommonInformationPredef		
>dl-DPCH-InfoCommon		
>>spreadingFactor	128	128
>>tfc-Existence	TRUE	TRUE
>>pilotBits	4	4

Configuration	12.2 kbps speech + 13.6 kbps signalling	12.2/7.95/5.9/4.75 kbps speech + 13.6 kbps signalling
>>positionFixed	Flexible	Flexible

Configuration	64kbps conv. CS-data + 13.6 kbps signalling	12.65/8.85/6.6 kbps speech + 13.6 kbps signalling (without SRB#5)
Ref 25.993	7.1.133	7.1.134
Default configuration identity	20	21
RB INFORMATION		
Rb-Identity	RB1: 1, RB2: 2, RB3: 3, RB5: 5	RB1: 1, RB2: 2, RB3: 3, RB5: 5, RB6: 6, RB7: 7,
rlc-InfoChoice	Rlc-info	Rlc-info
>ul-RLC-Mode	RB1: UM RB2- RB3: AM RB5: TM	RB1: UM RB2- RB3: AM RB5-RB7: TM
>>transmissionRLC-DiscardMode	RB1: N/A RB2- RB3: NoDiscard RB5: N/A	RB1: N/A RB2- RB3: NoDiscard RB5- RB7: N/A
>>>maxDat	RB1: N/A RB2- RB3: 25 RB5: N/A	RB1: N/A RB2- RB3: 25 RB5- RB7: N/A
>>transmissionWindowSize	RB1: N/A RB2- RB3: 32 RB5: N/A	RB1: N/A RB2- RB3: 32 RB5- RB7: N/A
>>timerRST	RB1: N/A RB2- RB3: 200 RB5: N/A	RB1: N/A RB2- RB3: 200 RB5- RB7: N/A
>>max-RST	RB1: N/A RB2- RB3: 1 RB5: N/A	RB1: N/A RB2- RB3: 1 RB5- RB7: N/A
>>pollingInfo	RB1: N/A RB2- RB3: as below RB5: N/A	RB1: N/A RB2- RB3: as below RB5- RB7: N/A
>>>TimerPoll	RB2- RB3: 100	RB2- RB3: 100
>>>PollPDU	RB2- RB3: n/a	RB2- RB3: n/a
>>>PollSDU	RB2- RB3: 1	RB2- RB3: 1
>>>lastTransmissionPDU-Poll	RB2- RB3: FALSE	RB2- RB3: FALSE
>>>lastRetransmissionPDU-Poll	RB2- RB3: TRUE	RB2- RB3: TRUE
>>>PollWindow	RB2- RB3: 99	RB2- RB3: 99
>>segmentationIndication	RB1- RB3: N/A RB5: FALSE	RB1- RB3: N/A RB5- RB7: FALSE
>dl-RLC-Mode	RB1: UM RB2- RB3: AM RB5: TM	RB1: UM RB2- RB3: AM RB5- RB7: TM
>>inSequenceDelivery	RB1: N/A RB2- RB3: TRUE RB5: N/A	RB1: N/A RB2- RB3: TRUE RB5- RB7: N/A
>>receivingWindowSize	RB1: N/A RB2- RB3: 32 RB5: N/A	RB1: N/A RB2- RB3: 32 RB5- RB7: N/A
>>dl-RLC-StatusInfo	RB1: N/A RB2- RB3: as below RB5: N/A	RB1: N/A RB2- RB3: as below RB5- RB7: N/A
>>>timerStatusProhibit	RB2- RB3: 100	RB2- RB3: 100
>>>missingPDU-Indicator	RB2- RB3: TRUE	RB2- RB3: TRUE
>>segmentationIndication	RB1- RB3: N/A RB5: FALSE	RB1- RB3: N/A RB5- RB7: FALSE
rb-MappingInfo		
>UL-LogicalChannelMappings	OneLogicalChannel	OneLogicalChannel
>>ul-TransportChannelType	Dch	Dch
>>>transportChannelIdentity	RB1- RB3: 9 RB5: 1	RB1- RB3: 9 RB5: 1, RB6: 2, RB7: 3.
>>logicalChannelIdentity	RB1: 1, RB2: 2, RB3: 3 RB5: N/A	RB1: 1, RB2: 2, RB3: 3 RB5- RB7: N/A

>>rlc-SizeList	RB1- RB3: configured RB5: N/A	RB1- RB3: configured RB5- RB7: N/A
>>>mac-LogicalChannelPriority	RB1: 1, RB2: 2, RB3: 3 RB5: 5	RB1: 1, RB2: 2, RB3: 3 RB5- RB7: 5
>DL-logicalChannelMappingList		
>>Mapping option 1	One mapping option	One mapping option
>>>dl-TransportChannelType	Dch	Dch
>>>>transportChannelIdentity	RB1- RB3: 9 RB5: 1	RB1- RB3: 9 RB5: 1, RB6: 2, RB7: 3,
>>>>logicalChannelIdentity	RB1: 1, RB2: 2, RB3: 3 RB5: N/A	RB1: 1, RB2: 2, RB3: 3 RB5- RB7: N/A
TrCH INFORMATION PER TrCH		
UL-AddReconfTransChInfoList		
>Uplink transport channel type	dch	Dch
>transportChannelIdentity	TrCH1: 1, TrCH2: 9	TrCH1: 1, TrCH2: 2, TrCH3: 3, TrCH4: 9
>transportFormatSet	DedicatedTransChTF S	DedicatedTransChTF S
>>>dynamicTF-information		
>>>>tf0/ tf0,1,2,3,4	TrCH1: (0x640, 2x640) TrCH2: (0x144, 1x144, 2x144, 3x144, 4x144)	TrCH1: (0x72) TrCH2: (0x 181) TrCH3: (0x60) TrCH4: (0x144, 1x144, 2x144, 3x144, 4x144)
>>>>>rlcSize	TrCH1: OctetMode TrCH2:BitMode	BitMode
>>>>>>sizeType	TrCH1: type 2, part1= 11, part2= 2 (640) TrCH2: type 2, part1= 2, part2= 0 (144)	TrCH1: type 1: 72 TrCH2: type 2: part1= 6, part2= 5 TrCH3: type1: 60 TrCH4: 2: type 2, part1= 2, part2= 0 (144)
>>>>>>numberOfTbSizeList	TrCH1: Zero, 2 TrCH2: Zero, one, 2, 3, 4	TrCH1-3: Zero TrCH4: Zero, one, 2, 3, 4
>>>>>>logicalChannelList	All	All
>>>>tf 1		TrCH1: (1x40) TrCH2: (1x 78) TrCH3: N/A TrCH4: N/A
>>>>>>numberOfTransportBlocks		TrCH1: One TrCH2: One
>>>>>>>rlc-Size		TrCH1-2: BitMode
>>>>>>>>sizeType		TrCH1: 1: 40 TrCH2: 1: 78
>>>>>>>>numberOfTbSizeList		TrCH1-2: One
>>>>>>>>logicalChannelList		TrCH1: all
>>>>tf 2		TrCH1: (1x54) TrCH2: (1x113) TrCH3: N/A TrCH4: N/A
>>>>>>>>numberOfTransportBlocks		TrCH1: One TrCh2: One
>>>>>>>>>rlc-Size		TrCH1: BitMode
>>>>>>>>>>sizeType		TrCH1: type 1: 54 TrCH2: type 1: 113
>>>>>>>>>>numberOfTbSizeList		TrCH1: One TrCH2: One
>>>>>>>>>>logicalChannelList		TrCH1: all TrCH2: all

>>>tf 3		TrCH1: (1x64) TrCH2: (1x181) TrCH3: N/A TrCH4: N/A
>>>>numberOfTransportBlocks		TrCH1: One TrCh2: One
>>>>rlc-Size		TrCH1: BitMode
>>>>>sizeType		TrCH1: type 1: 64 TrCH2: type 2: part1=6, part2= 5
>>>>numberOfTbSizeList		TrCH1: One TrCH2: One
>>>>logicalChannelList		TrCH1: all TrCH2: all
>>>tf 4		TrCH1: (1x72) TrCH2: N/A TrCH3: N/A TrCH4: N/A
>>>>numberOfTransportBlocks		TrCH1: One
>>>>rlc-Size		TrCH1: BitMode
>>>>>sizeType		TrCH1: type 1: 72
>>>>numberOfTbSizeList		TrCH1: One
>>>>logicalChannelList		TrCH1: all
>>semistaticTF-Information		
>>>tti	TrCH1: 20 TrCH2: 40	TrCH1- TrCH3: 20 TrCH4: 40
>>>channelCodingType	TrCH1: Turbo TrCH2: Convolutional	Convolutional
>>>>codingRate	TrCH1: N/A TrCH2: Third	TrCH1- TrCH3: Third TrCH4: Third
>>>>rateMatchingAttribute	TrCH1: 170 TrCH2: 160	TrCH1: 200 TrCH2: 190 TrCH3: 256 TrCH4: 170
>>>>crc-Size	TrCH1: 16 TrCH2: 16	TrCH1: 12 TrCH2: 0 TrCH3: 0 TrCH4: 16
DL-AddReconfTransChInfoList		
>Downlink transport channel type	dch	Dch
>dl-TransportChannelIdentity	TrCH1: 1, TrCH2: 9	
>dfs-SignallingMode	SameAsUL	Independent <Only tf0 on TrCH1 is different and shown below>
>>transportFormatSet		
>>>dynamicTF-information		
>>>>tf0/ tf0,1		TrCH1: (1x0)
>>>>rlcSize		BitMode
>>>>>sizeType		TrCH1: type 1: 0
>>>>numberOfTbSizeList		TrCH1: One
>>>>logicalChannelList		All
>>>semistaticTF-Information		same as UL
>>ULTrCH-Id	TrCH1: 1, TrCH2: 9	TrCH1: 1, TrCH2: 2, TrCH3: 3, TrCH4: 9,
>dch-QualityTarget		
>>bler-QualityValue	TrCH1: 2×10^{-3} TrCH2: Absent	TrCH1: 7×10^{-3} TrCH2: Absent TrCH3: Absent TrCH4: Absent
TrCH INFORMATION, COMMON		
ul-CommonTransChInfo		

>tfc-ID (TDD only)	1	1
>sharedChannelIndicator (TDD only)	FALSE	FALSE
> tfc-Subset	Absent, not required	Absent, not required
>ul-TFCS	Normal TFCI signalling	Normal TFCI signalling
>>explicitTFCS-ConfigurationMode	Complete	Complete
>>>ctfcSize	Ctfc4Bit	Ctfc6Bit
>>>>TFCS representation	Addition	Addition
>>>>>TFC list		
>>>>>>TFC 1	(TF0, TF0)	(TF0, TF0, TF0, TF0)
>>>>>>>ctfc	0	0
>>>>>>>gainFactorInformation	Computed	Computed
>>>>>>>referenceTFCId	0	0
>>>>>>>TFC 2	(TF1, TF0)	(TF1, TF0, TF0, TF0)
>>>>>>>>ctfc	1	1
>>>>>>>>gainFactorInformation	Computed	Computed
>>>>>>>>> β c (FDD only)	N/A	N/A
>>>>>>>>>> β d	N/A	N/A
>>>>>>>>>>referenceTFCId	0	0
>>>>>>>>>>>TFC 3	(TF0, TF1)	(TF2, TF1, TF0, TF0)
>>>>>>>>>>>>ctfc	2	7
>>>>>>>>>>>>gainFactorInformation	Computed	Computed
>>>>>>>>>>>>referenceTFCId	0	0
>>>>>>>>>>>>>TFC 4	(TF1, TF1)	(TF3, TF2, TF0, TF0)
>>>>>>>>>>>>>>ctfc	3	13
>>>>>>>>>>>>>>gainFactorInformation	Signalled	Computed
>>>>>>>>>>>>>>> β c (FDD only)	8	N/A
>>>>>>>>>>>>>>>> β d	15	N/A

>>>>>>referenceTFCId	0	0
>>>>>TFC 5	(TF0, TF2)	(TF4, TF3, TF0, TF0)
>>>>>ctfc	4	19
>>>>>gainFactorInformation	Computed	Computed
>>>>>>referenceTFCId	0	0
>>>>>TFC 6	(TF0, TF3)	(TF0, TF0, TF0, TF1)
>>>>>ctfc	6	20
>>>>>gainFactorInformation	Computed	Computed
>>>>>>referenceTFCId	0	0
>>>>>TFC 7	(TF0, TF4)	(TF1, TF0, TF0, TF1)
>>>>>ctfc	8	21
>>>>>gainFactorInformation	Computed	Computed
>>>>>>referenceTFCId	0	0
>>>>>TFC 8		(TF2, TF1, TF0, TF1)
>>>>>ctfc		27
>>>>>gainFactorInformation		computed
>>>>>>referenceTFCId		0
>>>>>TFC 9		(TF3, TF2, TF0, TF1)
>>>>>ctfc		33
>>>>>gainFactorInformation		computed
>>>>>>referenceTFCId		0
>>>>>TFC 10		(TF4, TF3, TF0, TF1)
>>>>>ctfc		39
>>>>>gainFactorInformation		signalled
>>>>>> β c (FDD only)		10
>>>>>> β d		15
>>>>>>>referenceTFCId		0
>>>>>TFC 11		(TF0, TF0, TF0, TF2)
>>>>>ctfc		40
>>>>>gainFactorInformation		Computed
>>>>>>referenceTFCId		0
>>>>>TFC 12		(TF1, TF0, TF0, TF2)
>>>>>ctfc		41
>>>>>gainFactorInformation		Computed
>>>>>>referenceTFCId		0
>>>>>TFC 13		(TF0, TF0, TF0, TF3)
>>>>>ctfc		60
>>>>>gainFactorInformation		Computed
>>>>>>referenceTFCId		0
>>>>>TFC 14		(TF1, TF0, TF0, TF3)
>>>>>ctfc		61
>>>>>gainFactorInformation		Computed
>>>>>>referenceTFCId		0
>>>>>TFC 15		(TF0, TF0, TF0, TF4)
>>>>>ctfc		80
>>>>>gainFactorInformation		Computed
>>>>>>referenceTFCId		0
dl-CommonTransChInfo		
>tfc-SignallingMode	Same as UL	Same as UL
ul-CommonTransChInfo		
>tfc-ID (TDD only)		1
>sharedChannelIndicator (TDD only)		FALSE
> tfc-Subset		Absent, not required
PhyCH INFORMATION FDD		
UL-DPCH-InfoPredef		
>ul-DPCH-PowerControlInfo		
>>powerControlAlgorithm	Algorithm 1	Algorithm 1
>>>tpcStepSize	1 dB	1 dB
>tfc-Existence	TRUE	TRUE
>puncturingLimit	0.88	0.84
DL-CommonInformationPredef		
>dl-DPCH-InfoCommon		
>>spreadingFactor	32	128

>>tfc-Existence	TRUE	TRUE
>>pilotBits	8	4
>>positionFixed	Flexible	Flexible
PhyCH INFORMATION 3.84 Mcps TDD		
UL-DPCH-InfoPredef		
>ul-DPCH-PowerControllInfo		
>>dpch-ConstantValue		
>commonTimeslotInfo		
>>secondInterleavingMode		
>>tfc-Coding		
>>puncturingLimit		
>>repetitionPeriodAndLength		
DL-CommonInformationPredef		
>dl-DPCH-InfoCommon		
>>commonTimeslotInfo		
>>>secondInterleavingMode		
>>>tfc-Coding		
>>>puncturingLimit		
>>>repetitionPeriodAndLength		
PhyCH INFORMATION 1.28 Mcps TDD		
UL-DPCH-InfoPredef		
>commonTimeslotInfo		
>>secondInterleavingMode		
>>tfc-Coding		
>>puncturingLimit		
>>repetitionPeriodAndLength		
DL-CommonInformationPredef		
>dl-DPCH-InfoCommon		
>>commonTimeslotInfo		
>>>secondInterleavingMode		
>>>tfc-Coding		
>>>puncturingLimit		
>>>repetitionPeriodAndLength		

Configuration	13.6 kbps signalling
Ref 34.108	3
Default configuration identity	22
RB INFORMATION	
rb-Identity	RB1: 1, RB2: 2, RB3: 3
rlc-InfoChoice	Rlc-info
>ul-RLC-Mode	RB1: UM RB2- RB3: AM
>>transmissionRLC-DiscardMode	RB1: N/A RB2- RB3: NoDiscard
>>>maxDat	RB1: N/A RB2- RB3: 25
>>transmissionWindowSize	RB1: N/A RB2- RB3: 32
>>timerRST	RB1: N/A RB2- RB3: 200
>>max-RST	RB1: N/A RB2- RB3: 1
>>pollingInfo	RB1: N/A RB2- RB3: as below
>>>TimerPoll	RB2- RB3: 100
>>>PollPDU	RB2- RB3: n/a
>>>PollSDU	RB2- RB3: 1

Configuration	13.6 kbps signalling
>>>lastTransmissionPDU-Poll	RB2- RB3: FALSE
>>>lastRetransmissionPDU-Poll	RB2- RB3: TRUE
>>>PollWindow	RB2- RB3: 99
>>segmentationIndication	RB1- RB3: N/A
>dl-RLC-Mode	RB1: UM RB2- RB3: AM
>>inSequenceDelivery	RB1: N/A RB2- RB3: TRUE
>>receivingWindowSize	RB1: N/A RB2- RB3: 32
>>dl-RLC-StatusInfo	RB1: N/A RB2- RB3: as below
>>>timerStatusProhibit	RB2- RB3: 100
>>>missingPDU-Indicator	RB2- RB3: TRUE
>>segmentationIndication	RB1- RB3: N/A
rb-MappingInfo	
>UL-LogicalChannelMappings	OneLogicalChannel
>>ul-TransportChannelType	Dch
>>>transportChannelIdentity	RB1- RB3:9
>>logicalChannelIdentity	RB1: 1, RB2: 2, RB3: 3
>>rlc-SizeList	RB1- RB3: configured
>>mac-LogicalChannelPriority	RB1: 1, RB2: 2, RB3: 3
>DL-logicalChannelMappingList	
>>Mapping option 1	One mapping option
>>>dl-TransportChannelType	Dch
>>>>transportChannelIdentity	RB1- RB3: 9
>>>logicalChannelIdentity	RB1: 1, RB2: 2, RB3: 3
TrCH INFORMATION PER TrCH	
UL-AddReconfTransChInfoList	
>Uplink transport channel type	Dch
>transportChannelIdentity	TrCH1: 9
>transportFormatSet	DedicatedTransChTFS
>>dynamicTF-information	
>>>tf0/ tf0,1	TrCH1: (0x144, 1x144)
>>>>rlcSize	BitMode
>>>>>sizeType	TrCH1: type 2, part1= 2, part2= 0 (144)
>>>>>numberOfTbSizeList	TrCH1: Zero, one
>>>>logicalChannelList	All
>>>tf 1	N/A
>>>>numberOfTransportBlocks	
>>>>rlc-Size	
>>>>>sizeType	
>>>>>numberOfTbSizeList	

Configuration	13.6 kbps signalling
>>>>logicalChannellist	
>>>tf 2	N/A
>>>>numberOfTransportBlocks	
>>>>rlc-Size	
>>>>>sizeType	
>>>>>numberOfTbSizeList	
>>>>logicalChannellist	
>>semistaticTF-Information	
>>>tfti	TrCH1: 10
>>>channelCodingType	Convolutional
>>>>codingRate	TrCH1: Third
>>>>rateMatchingAttribute	TrCH1: 160
>>>>crc-Size	TrCH1: 16
DL-AddReconfTransChInfoList	
>Downlink transport channel type	Dch
>dl-TransportChannelIdentity (should be as for UL)	TrCH1: 9
>tfs-SignallingMode	SameAsUL
>>transportFormatSet	
>>>dynamicTF-information	
>>>>tf0/ tf0,1	
>>>>>rlcSize	
>>>>>>sizeType	
>>>>>>numberOfTbSizeList	
>>>>>logicalChannellist	
>>ULTrCH-Id	TrCH1: 9
>dch-QualityTarget	
>>bler-QualityValue	TrCH1: 1×10^{-2}
TrCH INFORMATION, COMMON	
ul-CommonTransChInfo	
>tfc-ID (TDD only)	1
>sharedChannelIndicator (TDD only)	FALSE
>tfc-Subset	Absent, not required
>ul-TFCS	Normal TFCI signalling
>>explicitTFCS-ConfigurationMode	Complete
>>>ctfcSize	Ctfc2Bit
>>>>TFCS representation	Addition
>>>>>TFCS list	
>>>>>>TFCS 1	(TF0)
>>>>>>>ctfc	0
>>>>>>>>gainFactorInformation	Computed
>>>>>>>>referenceTFCId	0
>>>>>>>>TFCS 2	(TF1)
>>>>>>>>>ctfc	1
>>>>>>>>>>gainFactorInformation	Signalled
>>>>>>>>>>> β c (FDD only)	11
>>>>>>>>>>> β d	15
>>>>>>>>>>>>referenceTFCId	0
dl-CommonTransChInfo	
>tfs-SignallingMode	Same as UL
PhyCH INFORMATION FDD	

Configuration	13.6 kbps signalling
UL-DPCH-InfoPredef	
>ul-DPCH-PowerControlInfo	
>>powerControlAlgorithm	Algorithm 1
>>>tpcStepSize	1 dB
>tfci-Existence	TRUE
>puncturingLimit	1
DL-CommonInformationPredef	
>dl-DPCH-InfoCommon	
>>spreadingFactor	128
>>tfci-Existence	FALSE
>>pilotBits	4
>>positionFixed	N/A
PhyCH INFORMATION 3.84 / 7.68 Mcps TDD	
UL-DPCH-InfoPredef	
>ul-DPCH-PowerControlInfo	
>>dpch-ConstantValue	0
>commonTimeslotInfo	
>>secondInterleavingMode	frameRelated
>>tfci-Coding	4
>>puncturingLimit	0.92
>>repetitionPeriodAndLength	repetitionPeriod1
DL-CommonInformationPredef	
>dl-DPCH-InfoCommon	
>>commonTimeslotInfo	
>>>secondInterleavingMode	frameRelated
>>>tfci-Coding	4
>>>puncturingLimit	0.92
>>>repetitionPeriodAndLength	repetitionPeriod1
PhyCH INFORMATION 1.28 Mcps TDD	
UL-DPCH-InfoPredef	
>commonTimeslotInfo	
>>secondInterleavingMode	frameRelated
>>tfci-Coding	4
>>puncturingLimit	0.64
>>repetitionPeriodAndLength	repetitionPeriod1
DL-CommonInformationPredef	
>dl-DPCH-InfoCommon	
>>commonTimeslotInfo	
>>>secondInterleavingMode	frameRelated
>>>tfci-Coding	4
>>>puncturingLimit	0.64
>>>repetitionPeriodAndLength	repetitionPeriod1

NOTE: the difference between default configuration #22 and default configuration #1 (13.6 kbps signalling) resides in the RLC configuration and the DCH quality target.

14 Specific functions

14.1 Intra-frequency measurements

14.1.1 Intra-frequency measurement quantities

A measurement quantity is used to evaluate whether an intra-frequency event has occurred or not. It can be:

- 1 Downlink E_c/N_0 .
- 2 Downlink path loss.

For FDD:

Pathloss in dB = Primary CPICH Tx power - CPICH RSCP.

For Primary CPICH Tx power the IE "Primary CPICH Tx power" shall be used. The unit is dBm.

CPICH RSCP is the result of the CPICH RSCP measurement. The unit is dBm.

For TDD:

Pathloss in dB = Primary CCPCH TX power - Primary CCPCH RSCP.

For Primary CCPCH TX power the IE "Primary CCPCH TX Power" shall be used. The unit is dBm.

Primary CCPCH RSCP is the result of the Primary CCPCH RSCP measurement. The unit is dBm.

If necessary Pathloss shall be rounded up to the next higher integer.

Results higher than 158 shall be reported as 158.

Results lower than 46 shall be reported as 46.

- 3 Downlink received signal code power (RSCP) after despreading.
- 4 ISCP measured on Timeslot basis.

A description of those values can be found in [7] and [8].

14.1.2 Intra-frequency reporting events for FDD

Within the measurement reporting criteria field in the Measurement Control message the UTRAN notifies the UE which events should trigger a measurement report. The listed events are the toolbox from which the UTRAN can choose the reporting events that are needed for the implemented handover evaluation function, or other radio network functions.

All the specified events are measured with respect to any of the measurement quantities given in subclause 14.1.1. The measurement quantities are measured on the monitored primary common pilot channels (CPICH) of the cell defined in the measurement object.

Special mechanisms for the events are illustrated in subclause 14.1.4 and 14.1.5.

NOTE: The events below are numbered 1A, 1B, 1C,... since all intra-frequency reporting events would be labelled 1X, inter-frequency reporting events would be labelled 2X, and so on for the other measurement types.

When one intra-frequency measurement identity corresponds to multiple intra-frequency events with identical event identities, the UE behaviour is not specified.

14.1.2.1 Reporting event 1A: A Primary CPICH enters the reporting range

When an intra-frequency measurement configuring event 1a is set up, the UE shall:

- 1> create a variable TRIGGERED_1A_EVENT related to that measurement, which shall initially be empty;
- 1> delete this variable when the measurement is released.

When event 1A is configured in the UE, the UE shall:

- 1> if "Measurement quantity" is "pathloss" and Equation 1 below is fulfilled for one or more primary CPICHs, or if "Measurement quantity" is "CPICH Ec/N0" or "CPICH RSCP", and Equation 2 below is fulfilled for one or more primary CPICHs, for each of these primary CPICHs:
 - 2> if all required reporting quantities are available for that cell; and
 - 2> if the equations have been fulfilled for a time period indicated by "Time to trigger", and if that primary CPICH is part of cells allowed to trigger the event according to "Triggering condition 2", and if that primary CPICH is not included in the "cells triggered" in the variable TRIGGERED_1A_EVENT:
 - 3> include that primary CPICH in the "cells recently triggered" in the variable TRIGGERED_1A_EVENT.
- 1> if the value of "Reporting deactivations threshold" for this event is greater than or equal to the current number of cells in the active set or equal to 0 and any primary CPICHs are stored in the "cells recently triggered" in the variable TRIGGERED_1A_EVENT:
 - 2> if "Reporting interval" for this event is not equal to 0:
 - 3> if the IE "Periodical reporting running" in the variable TRIGGERED_1A_EVENT is set to FALSE:
 - 4> start a timer with the value of "Reporting interval" for this event and set the IE "Periodical reporting running" in the variable TRIGGERED_1A_EVENT to TRUE;
 - 3> set "sent reports" for the primary CPICHs in "cells recently triggered" in the variable TRIGGERED_1A_EVENT to 1.
 - 2> send a measurement report with IEs set as below:
 - 3> set in "intra-frequency measurement event results": "Intrafrequency event identity" to "1a"; and
 - 3> include in "cell measurement event results" all entries of the "cells recently triggered" in the variable TRIGGERED_1A_EVENT in descending order according to the configured measurement quantity taking into account the cell individual offset for each of those cells;
 - 3> set the IE "measured results" and the IE "additional measured results" according to subclause 8.4.2, not taking into account the cell individual offset for each cell.
 - 2> move all entries from "cells recently triggered" to "cells triggered" in the variable TRIGGERED_1A_EVENT.
- 1> if the timer for the periodical reporting has expired:
 - 2> if any primary CPICH is included in the "cells triggered" in the variable TRIGGERED_1A_EVENT:
 - 3> if "Reporting interval" for this event is not equal to 0, and if "Amount of reporting" is greater than "sent reports" stored for any of these primary CPICHs, in "cells triggered" in the variable TRIGGERED_1A_EVENT:
 - 4> increment the stored counter "sent reports" for all CPICHs in "cell triggered" in variable TRIGGERED_1A_EVENT;
 - 4> start a timer with the value of "Reporting interval" for this event;
 - 4> send a measurement report with IEs set as below:
 - 5> set in "intra-frequency measurement event results": "Intrafrequency event identity" to "1a"; and
 - 5> include in "cell measurement event results" all entries of the variable TRIGGERED_1A_EVENT with value of IE "sent reports" equal to or smaller than value of "Amount of reporting" in descending order according to the configured measurement quantity taking into account the cell individual offset for each of those cells;

- 5> set the IE "measured results" and the IE "additional measured results" according to subclause 8.4.2, not taking into account the cell individual offset for each cell.
- 4> if "sent reports" in variable TRIGGERED_1A_EVENT is equal to "Amount of reporting" for all entries:
 - 5> set the IE "Periodical Reporting running" in the variable TRIGGERED_1A_EVENT to FALSE and disable the timer for the periodical reporting.
- 1> if "Measurement quantity" is "pathloss" and Equation 3 below is fulfilled for a primary CPICH, or if "Measurement quantity" is "CPICH Ec/N0" or "CPICH RSCP", and Equation 4 below is fulfilled for a primary CPICH; or
- 1> if a primary CPICH is no longer part of the cells allowed to trigger the event according to the "Triggering condition 2":
 - 2> if that primary CPICH is included in the "cells triggered" or "cells recently triggered" in the variable TRIGGERED_1A_EVENT:
 - 3> remove the entry of that primary CPICH from "cells triggered" or "cells recently triggered" in the variable TRIGGERED_1A_EVENT.
 - 3> if no entry in the variable TRIGGERED_1A_EVENT has a value of "sent reports" smaller than "Amount of reporting"; or
 - 3> if there is no entry in the variable TRIGGERED_1A_EVENT:
 - 4> if the reporting interval timer is running:
 - 5> stop the reporting interval timer;
 - 5> set the IE "Periodical reporting running" in the variable TRIGGERED_1A_EVENT to FALSE.

This event is only applicable to the CELL_DCH state. When the measurement is setup in CELL_DCH or upon transition to CELL_DCH the UE shall:

- 1> if the "Triggering condition 2" includes active set cells:
 - 2> include the primary CPICH of all cells in the current active set into the "cells triggered" in the variable TRIGGERED_1A_EVENT with the counter "sent reports" set to "Amount of reporting".

Equation 1 (Triggering condition for pathloss)

$$10 \cdot \text{Log}M_{New} + CIO_{New} \leq W \cdot 10 \cdot \text{Log} \left(\frac{1}{\sum_{i=1}^{N_A} (1/M_i)} \right) + (1-W) \cdot 10 \cdot \text{Log}M_{Best} + (R_{1a} - H_{1a} / 2),$$

Equation 2 (Triggering condition for all the other measurement quantities)

$$10 \cdot \text{Log}M_{New} + CIO_{New} \geq W \cdot 10 \cdot \text{Log} \left(\sum_{i=1}^{N_A} M_i \right) + (1-W) \cdot 10 \cdot \text{Log}M_{Best} - (R_{1a} - H_{1a} / 2),$$

Equation 3 (Leaving triggering condition for pathloss)

$$10 \cdot \text{Log}M_{New} + CIO_{New} > W \cdot 10 \cdot \text{Log} \left(\frac{1}{\sum_{i=1}^{N_A} (1/M_i)} \right) + (1-W) \cdot 10 \cdot \text{Log}M_{Best} + (R_{1a} + H_{1a} / 2),$$

Equation 4 (Leaving triggering condition for all the other measurement quantities)

$$10 \cdot \text{Log}M_{New} + CIO_{New} < W \cdot 10 \cdot \text{Log} \left(\sum_{i=1}^{N_A} M_i \right) + (1-W) \cdot 10 \cdot \text{Log}M_{Best} - (R_{1a} + H_{1a} / 2),$$

The variables in the formula are defined as follows:

M_{New} is the measurement result of the cell entering the reporting range.

CIO_{New} is the individual cell offset for the cell entering the reporting range if an individual cell offset is stored for that cell. Otherwise it is equal to 0.

M_i is a measurement result of a cell not forbidden to affect reporting range in the active set.

N_A is the number of cells not forbidden to affect reporting range in the current active set.

For pathloss

M_{Best} is the measurement result of the cell not forbidden to affect reporting range in the active set with the lowest measurement result, not taking into account any cell individual offset.

for other measurements quantities.

M_{Best} is the measurement result of the cell not forbidden to affect reporting range in the active set with the highest measurement result, not taking into account any cell individual offset.

W is a parameter sent from UTRAN to UE.

R_{Ia} is the reporting range constant.

H_{Ia} is the hysteresis parameter for the event 1a.

If the measurement results are pathloss or CPICH-Ec/No then M_{New} , M_i and M_{Best} are expressed as ratios.

If the measurement result is CPICH-RSCP then M_{New} , M_i and M_{Best} are expressed in mW.

14.1.2.2 Reporting event 1B: A primary CPICH leaves the reporting range

When an intra-frequency measurement configuring event 1b is set up, the UE shall:

- 1> create a variable TRIGGERED_1B_EVENT related to that measurement, which shall initially be empty;
- 1> delete this variable when the measurement is released.

When event 1B is configured in the UE, the UE shall:

- 1> if "Measurement quantity" is "pathloss" and Equation 1 below is fulfilled for one or more primary CPICHs, or if "Measurement quantity" is "CPICH Ec/No" or "CPICH RSCP", and Equation 2 below is fulfilled for one or more primary CPICHs, for each of these primary CPICHs:
 - 2> if all required reporting quantities are available for that cell, and if the equations have been fulfilled for a time period indicated by "Time to trigger", and if that primary CPICH is part of cells allowed to trigger the event according to "Triggering condition 1", and if that primary CPICH is not included in the "cells triggered" in the variable TRIGGERED_1B_EVENT:
 - 3> include that primary CPICH in the "cells recently triggered" in the variable TRIGGERED_1B_EVENT.
- 1> if any primary CPICHs are stored in the "cells recently triggered" in the variable TRIGGERED_1B_EVENT:
 - 2> if "Periodic reporting info-1b" is present, and "Reporting interval" for this event is not equal to 0:
 - 3> if the IE "Periodical reporting running" in the variable TRIGGERED_1B_EVENT is set to FALSE:
 - 4> start a timer with the value of "Reporting interval" for this event and set the IE "Periodical reporting running" in the variable TRIGGERED_1B_EVENT to TRUE;
 - 3> set "sent reports" for the primary CPICHs in "cells recently triggered" in the variable TRIGGERED_1B_EVENT to 1.
 - 2> send a measurement report with IEs set as below:
 - 3> set in "intra-frequency measurement event results": "Intrafrequency event identity" to "1b"; and
 - 3> include in "cell measurement event results" all entries of "cells recently triggered" in the variable TRIGGERED_1B_EVENT in ascending order according to the configured measurement quantity taking into account the cell individual offset for each of those cells;

- 3> set the IE "measured results" and the IE "additional measured results" according to subclause 8.4.2, not taking into account the cell individual offset for each cell.
- 2> move all entries from IE "cells recently triggered" to "cells triggered" in the variable TRIGGERED_1B_EVENT.
- 1> if the timer for the periodical reporting has expired:
 - 2> if any primary CPICH is included in the "cells triggered" in the variable TRIGGERED_1B_EVENT:
 - 3> if "Periodic reporting info-1b" is present:
 - 4> if "Reporting interval" is not equal to 0, and if "Amount of reporting" is greater than "sent reports" stored for any of these primary CPICHs, in "cells triggered" in the variable TRIGGERED_1B_EVENT:
 - 5> increment the stored counter "sent reports" for all CPICHs in "cell triggered" in variable TRIGGERED_1B_EVENT;
 - 5> start a timer with the value of "Reporting interval-1b" for this event;
 - 5> send a measurement report with IEs set as below:
 - 6> set in "intra-frequency measurement event results": "Intrafrequency event identity" to "1b"; and
 - 6> include in "cell measurement event results" all entries of the variable TRIGGERED_1B_EVENT with value of IE "sent reports" equal to or smaller than value of "Amount of reporting" in ascending order according to the configured measurement quantity taking into account the cell individual offset for each of those cells;
 - 6> set the IE "measured results" and the IE "additional measured results" according to subclause 8.4.2, not taking into account the cell individual offset for each cell.
 - 5> if "sent reports" in variable TRIGGERED_1B_EVENT is equal to "Amount of reporting" for all entries:
 - 6> set the IE "Periodical Reporting running" in the variable TRIGGERED_1B_EVENT to FALSE and disable the timer for the periodical reporting.
- 1> if "Measurement quantity" is "pathloss" and Equation 3 below is fulfilled for a primary CPICH, or if "Measurement quantity" is "CPICH Ec/N0" or "CPICH RSCP", and Equation 4 below is fulfilled for a primary CPICH; or
- 1> if a primary CPICH is no longer part of the cells allowed to trigger the event according to the "Triggering condition 1":
 - 2> if that primary CPICH is included in the "cells triggered" in the variable TRIGGERED_1B_EVENT:
 - 3> remove the entry of that primary CPICH from "cells triggered" in the variable TRIGGERED_1B_EVENT;
 - 3> if there is no entry in the variable TRIGGERED_1B_EVENT:
 - 4> if the reporting interval timer is running:
 - 5> stop the reporting interval timer;
 - 5> set the IE "Periodical reporting running" in the variable TRIGGERED_1B_EVENT to FALSE.

Equation 1 (Triggering condition for pathloss)

$$10 \cdot \text{Log}M_{\text{Oid}} + CIO_{\text{Oid}} \geq W \cdot 10 \cdot \text{Log} \left(1 / \sum_{i=1}^{N_A} (1/M_i) \right) + (1-W) \cdot 10 \cdot \text{Log}M_{\text{Best}} + (R_{1b} + H_{1b} / 2),$$

Equation 2 (Triggering condition for all the other measurement quantities)

$10 \cdot \text{Log}M_{Old} + CIO_{Old} \leq W \cdot 10 \cdot \text{Log} \left(\sum_{i=1}^{N_A} M_i \right) + (1-W) \cdot 10 \cdot \text{Log}M_{Best} - (R_{1b} + H_{1b} / 2)$, Equation 3 (Leaving triggering condition for pathloss)

$10 \cdot \text{Log}M_{Old} + CIO_{Old} < W \cdot 10 \cdot \text{Log} \left(1 / \sum_{i=1}^{N_A} (1/M_i) \right) + (1-W) \cdot 10 \cdot \text{Log}M_{Best} + (R_{1b} - H_{1b} / 2)$, Equation 4 (Leaving triggering condition for all the other measurement quantities)

$10 \cdot \text{Log}M_{Old} + CIO_{Old} > W \cdot 10 \cdot \text{Log} \left(\sum_{i=1}^{N_A} M_i \right) + (1-W) \cdot 10 \cdot \text{Log}M_{Best} - (R_{1b} - H_{1b} / 2)$, The variables in the formula are defined as follows:

M_{Old} is the measurement result of the cell leaving the reporting range.

CIO_{Old} is the individual cell offset for the cell leaving the reporting range if an individual cell offset is stored for that cell. Otherwise it is equal to 0.

M_i is a measurement result of a cell not forbidden to affect reporting range in the active set.

N_A is the number of cells not forbidden to affect reporting range in the current active set.

For pathloss

M_{Best} is the measurement result of the cell not forbidden to affect reporting range in the active set with the lowest measurement result, not taking into account any cell individual offset.

for other measurements quantities.

M_{Best} is the measurement result of the cell not forbidden to affect reporting range in the active set with the highest measurement result, not taking into account any cell individual offset.

W is a parameter sent from UTRAN to UE.

R_{1b} is the reporting range constant.

H_{1b} is the hysteresis parameter for the event 1b.

If the measurement results are pathloss or CPICH-Ec/No then M_{Old} , M_i and M_{Best} are expressed as ratios.

If the measurement result is CPICH-RSCP then M_{Old} , M_i and M_{Best} are expressed in mW.

14.1.2.3 Reporting event 1C: A non-active primary CPICH becomes better than an active primary CPICH

When an intra-frequency measurement configuring event 1c is set up, the UE shall:

- 1> create a variable TRIGGERED_1C_EVENT related to that measurement, which shall initially be empty;
- 1> delete this variable when the measurement is released.

When event 1C is configured in the UE, the UE shall:

- 1> if "Measurement quantity" is "pathloss" and Equation 1 below is fulfilled for one or more primary CPICHs, or if "Measurement quantity" is "CPICH Ec/No" or "CPICH RSCP", and Equation 2 below is fulfilled for one or more primary CPICHs, for each of these primary CPICHs:
 - 2> if all required reporting quantities are available for that cell; and
 - 2> if the equations have been fulfilled for a time period indicated by "Time to trigger", and if the primary CPICH that is better is not included in the active set but the other primary CPICH is any of the primary CPICHs included in the active set, and if that first primary CPICH is not included in the "cells triggered" in the variable TRIGGERED_1C_EVENT:
- 3> include that primary CPICH in the "cells recently triggered" in the variable TRIGGERED_1C_EVENT.

- 1> if the value of "Replacement activation threshold" for this event is less than or equal to the current number of cells in the active set or equal to 0 and if any primary CPICHs are stored in the "cells recently triggered" in the variable TRIGGERED_1C_EVENT:
 - 2> if "Reporting interval" for this event is not equal to 0:
 - 3> if the IE "Periodical reporting running" in the variable TRIGGERED_1C_EVENT is set to FALSE:
 - 4> start a timer for with the value of "Reporting interval" for this event and set the IE "Periodical reporting running" in the variable TRIGGERED_1C_EVENT to TRUE.
 - 3> set "sent reports" for that primary CPICH in the variable TRIGGERED_1C_EVENT to 1.
 - 2> send a measurement report with IEs set as below:
 - 3> set in "intra-frequency measurement event results": "Intrafrequency event identity" to "1c"; and
 - 3> include in "cell measurement event results" all entries of the "cells recently triggered" in the variable TRIGGERED_1C_EVENT not in the active set as well as the "primary CPICH info" of all the primary CPICHs in the active set for which the measured value is worse (i.e. greater for pathloss and less for the other measurement quantities) than the one of the entry in "cell recently triggered" that has the best measured value taking into account their cell individual offset. The "primary CPICH info" for those cells shall be ordered according to their measured value taking into account their cell individual offset, beginning with the best cell to the worst one;
 - 3> set the IE "measured results" and the IE "additional measured results" according to subclause 8.4.2, not taking into account the cell individual offset for each cell.
 - 2> move all entries from "cells recently triggered" to "cells triggered" in the variable TRIGGERED_1C_EVENT.
- 1> if the timer for the periodical reporting has expired:
 - 2> if any primary CPICH is included in the "cells triggered" in the variable TRIGGERED_1C_EVENT, and not included in the current active set:
 - 3> if "Reporting interval" for this event is not equal to 0, and if "Amount of reporting" is greater than "sent reports" stored for that primary CPICH, in "cells triggered" in the variable TRIGGERED_1C_EVENT:
 - 4> increment the stored counter "sent reports" for all CPICH in "cell triggered" in variable TRIGGERED_1C_EVENT;
 - 4> start a timer with the value of "Reporting interval" for this event;
 - 4> send a measurement report with IEs set as below:
 - 5> set in "intra-frequency measurement event results": "Intrafrequency event identity" to "1c"; and
 - 5> include in "cell measurement event results" all entries of the variable TRIGGERED_1C_EVENT with value of IE "sent report" equal to or smaller than value of "Amount of reporting" and that are not part of the active set as well as the "primary CPICH info" of all the primary CPICHs in the active set for which the measured value is worse (i.e. greater for pathloss and less for the other measurement quantities) than the one of the entry in "cell triggered" that has the best measured value, ordering the "primary CPICH info" according to their measured value beginning with the best cell to the worst one, taking into account the cell individual offset for each cell;
 - 5> set the IE "measured results" and the IE "additional measured results" according to subclause 8.4.2, not taking into account the cell individual offset for each cell.
 - 4> if "sent reports" in variable TRIGGERED_1C_EVENT is equal to "Amount of reporting" for all entries:
 - 5> set the IE "Periodical Reporting running" in the variable TRIGGERED_1C_EVENT to FALSE and disable the timer for the periodical reporting.

- 1> if "Measurement quantity" is "pathloss" and Equation 3 below is fulfilled for a primary CPICH, or if "Measurement quantity" is "CPICH Ec/N0" or "CPICH RSCP", and Equation 4 below is fulfilled for a primary CPICH or;
- 1> if a primary CPICH is added to the active set:
- 2> if that primary CPICH is included in the "cells triggered" or "cells recently triggered" in the variable TRIGGERED_1C_EVENT:
- 3> remove the entry of that primary CPICH from "cells triggered" or "cells recently triggered" in the variable TRIGGERED_1C_EVENT.
- 3> if no entry in the variable TRIGGERED_1C_EVENT has a value of "sent reports" smaller than "Amount of reporting" or
- 3> if there is no entry in the variable TRIGGERED_1C_EVENT:
- 4> if the reporting interval timer is running:
- 5> stop the reporting interval timer;
- 5> set the IE "Periodical reporting running" in the variable TRIGGERED_1C_EVENT to FALSE.

Equation 1 (Triggering condition for pathloss)

$$10 \log M_{New} + CIO_{New} \leq 10 \log M_{inAS} + CIO_{inAS} - H_{lc} / 2$$

Equation 2 (Triggering condition for all the other measurement quantities)

$$10 \log M_{New} + CIO_{New} \geq 10 \log M_{inAS} + CIO_{inAS} + H_{lc} / 2$$

Equation 3 (Leaving triggering condition for pathloss)

$$10 \log M_{New} + CIO_{New} > 10 \log M_{inAS} + CIO_{inAS} + H_{lc} / 2$$

Equation 4 (Leaving triggering condition for all the other measurement quantities)

$$10 \log M_{New} + CIO_{New} < 10 \log M_{inAS} + CIO_{inAS} - H_{lc} / 2$$

The variables in the formula are defined as follows:

M_{New} is the measurement result of the cell not included in the active set.

CIO_{New} is the individual cell offset for the cell becoming better than the cell in the active set if an individual cell offset is stored for that cell. Otherwise it is equal to 0.

For pathloss:

M_{inAS} is the measurement result of the cell in the active set with the highest measurement result.

For other measurement quantities:

M_{inAS} is the measurement result of the cell in the active set with the lowest measurement result.

CIO_{inAS} is the individual cell offset for the cell in the active set that is becoming worse than the new cell.

H_{lc} is the hysteresis parameter for the event 1c.

If the measurement results are pathloss or CPICH-Ec/No then M_{New} and M_{inAS} are expressed as ratios.

If the measurement result is CPICH-RSCP then M_{New} and M_{inAS} are expressed in mW.

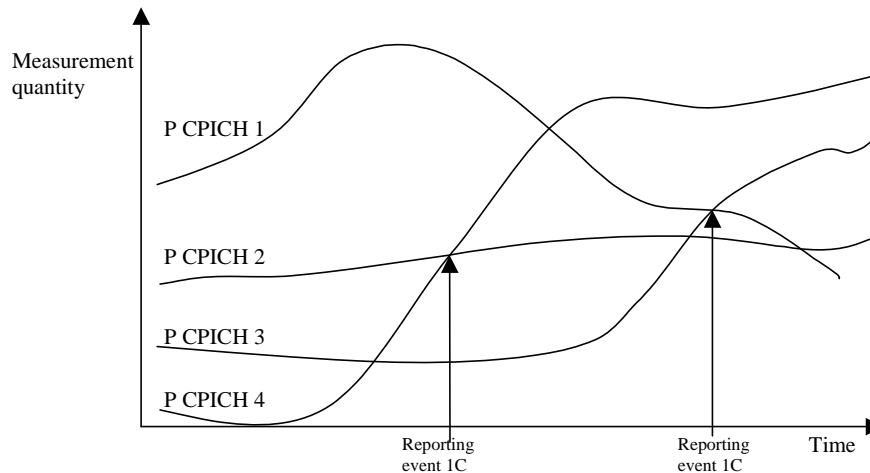

Figure 14.1.2.3-1 [Informative]: A primary CPICH that is not included in the active set becomes better than a primary CPICH that is in the active set

In this figure, the parameters hysteresis and time to trigger, as well as the cell individual offsets for all cells are equal to 0. In this example the cells belonging to primary CPICH 1 and 2 are in the active set, but the cells transmitting primary CPICH 3 and CPICH 4 are not (yet) in the active set.

The first measurement report is sent when primary CPICH 4 becomes better than primary CPICH 2. The "cell measurement event result" of the measurement report contains the information of primary CPICH 4 and CPICH 2.

Assuming that the active set has been updated after the first measurement report (active set is now primary CPICH 1 and primary CPICH 4), the second report is sent when primary CPICH 3 becomes better than primary CPICH 1. The "cell measurement event result" of the second measurement report contains the information of primary CPICH 3 and primary CPICH 1.

14.1.2.4 Reporting event 1D: Change of best cell

When an intra-frequency measurement configuring event 1d is set up, the UE shall:

- 1> create a variable TRIGGERED_1D_EVENT related to that measurement, which shall initially contain the best cell in the active set when the measurement is initiated;
- 1> delete this variable when the measurement is released.
- 1> As soon as the best cell in the active set has been evaluated by the UE (and stored in the TRIGGERED_1D_EVENT variable) and provided that there is more than one cell in the active set, trigger an immediate measurement report with IEs set as below:
 - 2> set in "intra-frequency measurement event results"; "Intrafrequency event identity" to "1d" and "cell measurement event results" to the CPICH info of the primary CPICH stored in the TRIGGERED_1D_EVENT variable;
 - 2> set the IE "measured results" and the IE "additional measured results" according to subclause 8.4.2

When event 1D is configured in the UE, the UE shall:

- 1> if IE "useCIO" is present and its value is TRUE, take into account the Cell Individual Offset for evaluation of the Equation 1 and 2, otherwise do not take it into account.
- 1> if "Measurement quantity" is "pathloss" and Equation 1 below is fulfilled for a primary CPICH that is not stored in "Best cell" in variable BEST_CELL_1D_EVENT, or if "Measurement quantity" is "CPICH Ec/N0" or "CPICH RSCP", and Equation 2 below is fulfilled for a primary CPICH that is not stored in "Best cell" in variable BEST_CELL_1D_EVENT:

NOTE: If the equations are simultaneously fulfilled for more than one primary CPICH, the UE should report only one event 1D, triggered by the best primary CPICH.

- 2> if all required reporting quantities are available for that cell, and if the equations have been fulfilled for a time period indicated by "Time to trigger" and if IE "Triggering condition 2" is absent or if it is present and that primary CPICH is part of cells allowed to trigger the event according to "Triggering condition 2":
- 3> set "best cell" in the variable BEST_CELL_1D_EVENT to that primary CPICH that triggered the event;
- 3> send a measurement report with IEs set as below:
 - 4> set in "intra-frequency measurement event results"; "Intrafrequency event identity" to "1d" and "cell measurement event results" to the CPICH info of the primary CPICH that triggered the report.
 - 4> set the IE "measured results" and the IE "additional measured results" according to subclause 8.4.2.

This event is only applicable to the CELL_DCH state. Upon transition to CELL_DCH the UE shall:

- 1> set "best cell" in the variable BEST_CELL_1D_EVENT to the best cell of the primary CPICHs included in the active set.

Equation 1 (Triggering condition for pathloss)

$$10 \text{Log}M_{NotBest} + CIO_{NotBest} \leq 10 \text{Log}M_{Best} + CIO_{Best} - H_{1d} / 2$$

Equation 2 (Triggering condition for all the other measurement quantities)

$$10 \text{Log}M_{NotBest} + CIO_{NotBest} \geq 10 \text{Log}M_{Best} + CIO_{Best} + H_{1d} / 2$$

The variables in the formula are defined as follows:

$M_{NotBest}$ is the measurement result of a cell not stored in "best cell" in the variable BEST_CELL_1D_EVENT.

$CIO_{NotBest}$ is the cell individual offset of a cell not stored in "best cell" in the variable BEST_CELL_1D_EVENT.

M_{Best} is the measurement result of the cell stored in "best cell" in variable BEST_CELL_1D_EVENT.

CIO_{Best} is the cell individual offset of a cell stored in "best cell" in the variable BEST_CELL_1D_EVENT.

H_{1d} is the hysteresis parameter for the event 1d.

If the measurement results are pathloss or CPICH-Ec/No then $M_{NotBest}$ and M_{Best} are expressed as ratios.

If the measurement result is CPICH-RSCP then $M_{NotBest}$ and M_{Best} are expressed in mW.

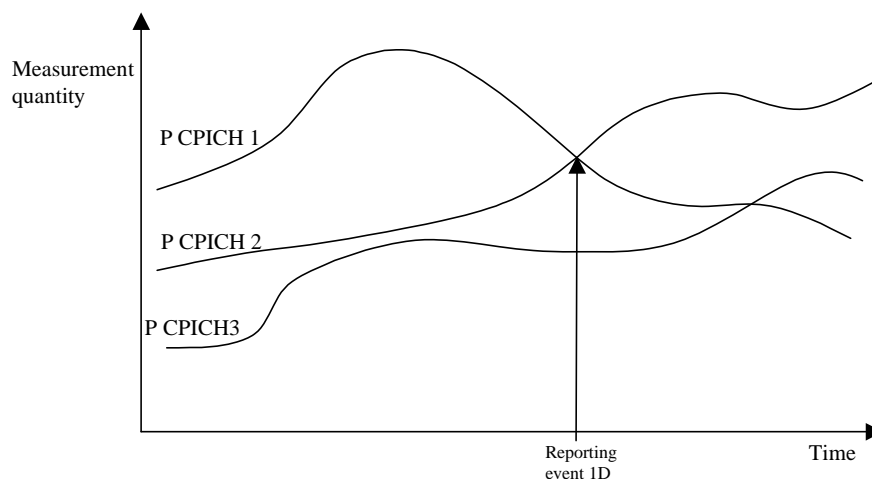

Figure 14.1.2.4-1 [Informative]: A primary CPICH becomes better than the previously best primary CPICH

In this figure, the parameters hysteresis and time to trigger, as well as the cell individual offsets for all cells are equal to 0.

14.1.2.5 Reporting event 1E: A Primary CPICH becomes better than an absolute threshold

When an intra-frequency measurement configuring event 1e is set up, the UE shall:

- 1> create a variable TRIGGERED_1E_EVENT related to that measurement, which shall initially be empty;
- 1> delete this variable when the measurement is released.

When event 1E is configured in the UE, the UE shall:

- 1> if "Measurement quantity" is "pathloss" and Equation 1 below is fulfilled for a primary CPICH, or if "Measurement quantity" is "CPICH Ec/N0" or "CPICH RSCP", and Equation 2 below is fulfilled for one or more primary CPICHs, for each of these primary CPICHs:
 - 2> if all required reporting quantities are available for that cell, and if the equations have been fulfilled for a time period indicated by "Time to trigger", and if that primary CPICH is part of cells allowed to trigger the event according to "Triggering condition 2", and that primary CPICH is not included in the "cells triggered" in the variable TRIGGERED_1E_EVENT:
 - 3> include that primary CPICH in the "cells recently triggered" in the variable TRIGGERED_1E_EVENT.
- 1> if any primary CPICHs are stored in the "cells recently triggered" in the variable TRIGGERED_1E_EVENT:
 - 2> send a measurement report with IEs set as below:
 - 3> set in "intra-frequency measurement event results": "Intrafrequency event identity" to "1e"; and
 - 3> include in "cell measurement event results" all entries of the "cells recently triggered" in the variable TRIGGERED_1E_EVENT in descending order according to the configured measurement quantity taking into account the cell individual offset for each of those cells;
 - 3> set the IE "measured results" and the IE "additional measured results" according to subclause 8.4.2, not taking into account the cell individual offset for each cell.
 - 2> move all entries from "cells recently triggered" to "cells triggered" in the variable TRIGGERED_1E_EVENT.
- 1> if "Measurement quantity" is "pathloss" and Equation 3 below is fulfilled for a primary CPICH, or if "Measurement quantity" is "CPICH Ec/N0" or "CPICH RSCP", and Equation 4 below is fulfilled for a primary CPICH; or
- 1> if a primary CPICH is no longer part of the cells allowed to trigger the event according to the "Triggering condition 2":
 - 2> if that primary CPICH is included in the "cells triggered" in the variable TRIGGERED_1E_EVENT:
 - 3> remove that primary CPICH and sent reports from "cells triggered" in the variable TRIGGERED_1E_EVENT.

This event is only applicable to the CELL_DCH state. When the measurement is setup in CELL_DCH or upon transition to CELL_DCH the UE shall:

- 1> if the "Triggering condition 2" includes active set cells:
 - 2> include the primary CPICH of all cells in the current active set that fulfil the equations 1 or 2 according to the "Measurement quantity" of event 1e into the "cells triggered" in the variable TRIGGERED_1E_EVENT.

Equation 1 (Triggering condition for pathloss)

$$10 \log M_{New} + CIQ_{New} \leq T_{1e} - H_{1e} / 2,$$

Equation 2 (Triggering condition for all the other measurement quantities)

$$10 \log M_{New} + CIQ_{New} \geq T_{1e} + H_{1e} / 2,$$

Equation 3 (Leaving triggering condition for pathloss)

$$10 \text{Log}M_{New} + CIO_{New} > T_{le} + H_{le}/2,$$

Equation 4 (Leaving triggering condition for all the other measurement quantities)

$$10 \text{Log}M_{New} + CIO_{New} < T_{le} - H_{le}/2,$$

The variables in the formula are defined as follows:

M_{New} is the measurement result of a cell that becomes better than an absolute threshold.

CIO_{New} is the individual cell offset for the cell becoming better than the absolute threshold. Otherwise it is equal to 0.

T_{le} is an absolute threshold.

H_{le} is the hysteresis parameter for the event 1e.

If the measurement results are pathloss or CPICH-Ec/No then M_{New} is expressed as ratios.

If the measurement result is CPICH-RSCP then M_{New} is expressed in mW.

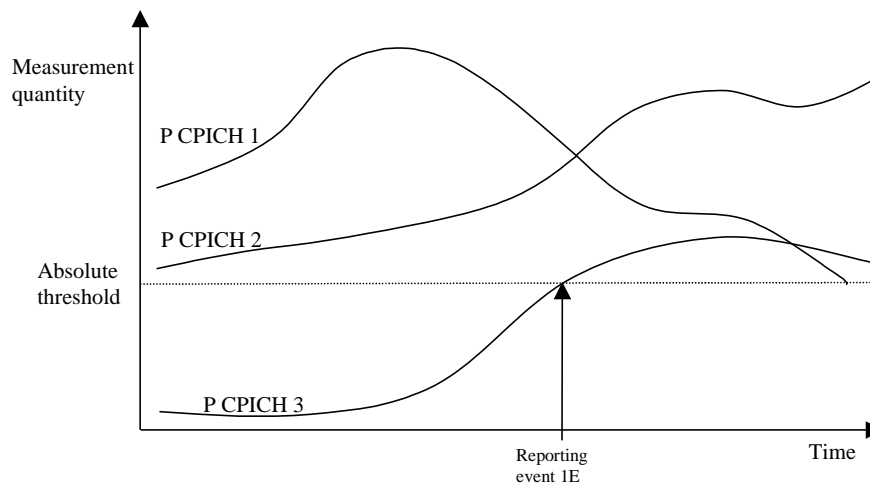

Figure 14.1.2.5-1 [Informative]: Event-triggered report when a Primary CPICH becomes better than an absolute threshold

In this figure, the parameters hysteresis and time to trigger, as well as the cell individual offsets for all cells are equal to 0.

14.1.2.6 Reporting event 1F: A Primary CPICH becomes worse than an absolute threshold

When an intra-frequency measurement configuring event 1F is set up, the UE shall:

- 1> create a variable TRIGGERED_1F_EVENT related to that measurement, which shall initially be empty;
- 1> delete this variable when the measurement is released.

When event 1F is configured in the UE, the UE shall:

- 1> if "Measurement quantity" is "pathloss" and Equation 1 below is fulfilled for one or more primary CPICHs, or if "Measurement quantity" is "CPICH Ec/N0" or "CPICH RSCP", and Equation 2 below is fulfilled for one or more primary CPICHs, for each of these primary CPICHs:
 - 2> if all required reporting quantities are available for that cell, and if the equations have been fulfilled for a time period indicated by "Time to trigger", and if that primary CPICH is part of cells allowed to trigger the event

according to "Triggering condition 1", and that primary CPICH is not included in the "cells triggered" in the variable TRIGGERED_1F_EVENT:

- 3> include that primary CPICH in the "cells recently triggered" in the variable TRIGGERED_1F_EVENT.
- 1> if any primary CPICHs are stored in the "cells recently triggered" in the variable TRIGGERED_1F_EVENT:
 - 2> send a measurement report with IEs set as below:
 - 3> set in "intra-frequency event measurement results": "Intrafrequency event identity" to "1f"; and
 - 3> include in "cell measurement event results" all entries of the "cells recently triggered" in the variable TRIGGERED_1F_EVENT in descending order according to the configured measurement quantity taking into account the cell individual offset for each of those cells;
 - 3> set the IE "measured results" and the IE "additional measured results" according to subclause 8.4.2, not taking into account the cell individual offset for each cell;
 - 2> move all entries from "cells recently triggered" to "cells triggered" in the variable TRIGGERED_1F_EVENT.
- 1> if "Measurement quantity" is "pathloss" and Equation 3 below is fulfilled for a primary CPICH, or if "Measurement quantity" is "CPICH Ec/N0" or "CPICH RSCP", and Equation 4 below is fulfilled for a primary CPICH; or
- 1> if a primary CPICH is no longer part of the cells allowed to trigger the event according to the "Triggering condition 1":
 - 2> if that primary CPICH is included in the "cells triggered" in the variable TRIGGERED_1F_EVENT:
 - 3> remove that primary CPICH from "cells triggered" in the variable TRIGGERED_1F_EVENT.

Equation 1 (Triggering condition for pathloss)

$$10 \text{Log}M_{Oid} + CIO_{Oid} \geq T_{If} + H_{If}/2$$

Equation 2 (Triggering condition for all the other measurement quantities)

$$10 \text{Log}M_{Oid} + CIO_{Oid} \leq T_{If} - H_{If}/2$$

Equation 3 (Leaving triggering condition for pathloss)

$$10 \text{Log}M_{Oid} + CIO_{Oid} < T_{If} - H_{If}/2$$

Equation 4 (Leaving triggering condition for all the other measurement quantities)

$$10 \text{Log}M_{Oid} + CIO_{Oid} > T_{If} + H_{If}/2$$

The variables in the formula are defined as follows:

M_{Oid} is the measurement result of a cell that becomes worse than an absolute threshold

CIO_{Oid} is the individual cell offset for the cell becoming worse than the absolute threshold. Otherwise it is equal to 0.

T_{If} is an absolute threshold

H_{If} is the hysteresis parameter for the event 1f.

If the measurement results are pathloss or CPICH-Ec/No then M_{Oid} is expressed as ratios.

If the measurement result is CPICH-RSCP then M_{Oid} is expressed in mW.

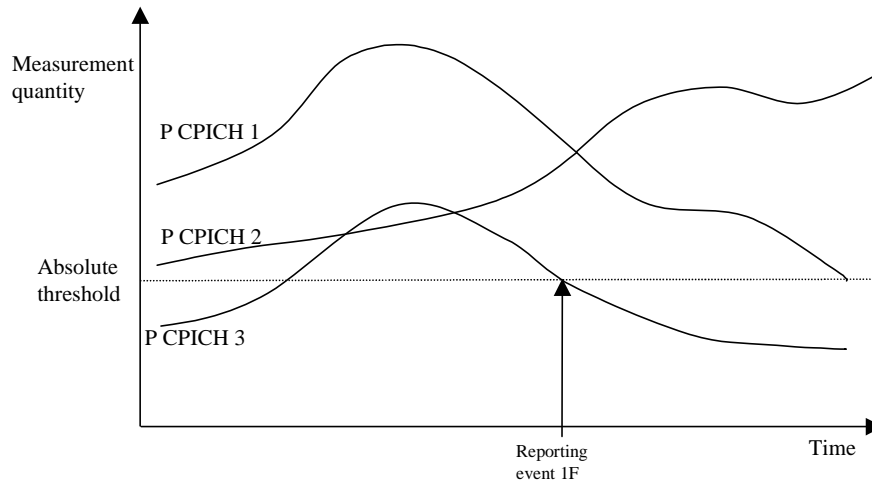

Figure 14.1.2.6-1 [Informative]: Event-triggered report when a Primary CPICH becomes worse than an absolute threshold

In this figure, the parameters hysteresis and time to trigger, as well as the cell individual offsets for all cells are equal to 0.

14.1.2.7 Reporting event 1J: A non-active E-DCH but active DCH primary CPICH becomes better than an active E-DCH primary CPICH

When an intra-frequency measurement configuring event 1j is set up, the UE shall:

- 1> create a variable TRIGGERED_1J_EVENT related to that measurement, which shall initially be empty;
- 1> delete this variable when the measurement is released.

When event 1J is configured in the UE, the UE shall:

- 1> if "Measurement quantity" is "pathloss" and Equation 1 below is fulfilled for one or more primary CPICHs, or if "Measurement quantity" is "CPICH Ec/N0" or "CPICH RSCP", and Equation 2 below is fulfilled for one or more primary CPICHs, for each of these primary CPICHs:
 - 2> if all required reporting quantities are available for that cell; and
 - 2> if the equations have been fulfilled for a time period indicated by "Time to trigger", and if the primary CPICH that is better is not included in the E-DCH active set but included in DCH active set and the other primary CPICH is any of the primary CPICHs included in the E-DCH active set, and if that first primary CPICH is not included in the "cells triggered" in the variable TRIGGERED_1J_EVENT:
 - 3> include that primary CPICH in the "cells recently triggered" in the variable TRIGGERED_1J_EVENT.
- 1> if the value of "Replacement activation threshold" for this event is less than or equal to the current number of cells in the E-DCH active set or equal to 0 and if any primary CPICHs are stored in the "cells recently triggered" in the variable TRIGGERED_1J_EVENT:
 - 2> if "Reporting interval" for this event is not equal to 0:
 - 3> if the IE "Periodical reporting running" in the variable TRIGGERED_1J_EVENT is set to FALSE:
 - 4> start a timer for with the value of "Reporting interval" for this event and set the IE "Periodical reporting running" in the variable TRIGGERED_1J_EVENT to TRUE.
 - 3> set "sent reports" for that primary CPICH in the variable TRIGGERED_1J_EVENT to 1.
 - 2> send a measurement report with IEs set as below:
 - 3> set in "intra-frequency measurement event results": "Intrafrequency event identity" to "1J"; and

- 3> include in "cell measurement event results" all entries of the "cells recently triggered" in the variable TRIGGERED_1J_EVENT not in the E-DCH active set but included in DCH active set as well as the "primary CPICH info" of all the primary CPICHs in the E-DCH active set for which the measured value is worse (i.e. greater for pathloss and less for the other measurement quantities) than the one of the entry in "cell recently triggered" that has the best measured value taking into account their cell individual offset. The "primary CPICH info" for those cells shall be ordered according to their measured value taking into account their cell individual offset, beginning with the best cell to the worst one;
 - 3> set the IE "measured results" and the IE "additional measured results" according to subclause 8.4.2, not taking into account the cell individual offset for each cell.
- 2> move all entries from "cells recently triggered" to "cells triggered" in the variable TRIGGERED_1J_EVENT.
- 1> if the timer for the periodical reporting has expired:
 - 2> if any primary CPICH is included in the "cells triggered" in the variable TRIGGERED_1J_EVENT, and not included in the current E-DCH active set but included in DCH active set:
 - 3> if "Reporting interval" for this event is not equal to 0, and if "Amount of reporting" is greater than "sent reports" stored for that primary CPICH, in "cells triggered" in the variable TRIGGERED_1J_EVENT:
 - 4> increment the stored counter "sent reports" for all CPICH in "cell triggered" in variable TRIGGERED_1J_EVENT;
 - 4> start a timer with the value of "Reporting interval" for this event;
 - 4> send a measurement report with IEs set as below:
 - 5> set in "intra-frequency measurement event results": "Intrafrequency event identity" to "1J"; and
 - 5> include in "cell measurement event results" all entries of the variable TRIGGERED_1J_EVENT with value of IE "sent report" equal to or smaller than value of "Amount of reporting" and that are not part of the E-DCH active set but included in DCH active set as well as the "primary CPICH info" of all the primary CPICHs in the E-DCH active set for which the measured value is worse (i.e. greater for pathloss and less for the other measurement quantities) than the one of the entry in "cell triggered" that has the best measured value, ordering the "primary CPICH info" according to their measured value beginning with the best cell to the worst one, taking into account the cell individual offset for each cell;
 - 5> set the IE "measured results" and the IE "additional measured results" according to subclause 8.4.2, not taking into account the cell individual offset for each cell.
 - 4> if "sent reports" in variable TRIGGERED_1J_EVENT is equal to "Amount of reporting" for all entries:
 - 5> set the IE "Periodical Reporting running" in the variable TRIGGERED_1J_EVENT to FALSE and disable the timer for the periodical reporting.
 - 1> if "Measurement quantity" is "pathloss" and Equation 3 below is fulfilled for a primary CPICH, or if "Measurement quantity" is "CPICH Ec/N0" or "CPICH RSCP", and Equation 4 below is fulfilled for a primary CPICH or;
 - 1> if a primary CPICH is added to the E-DCH active set:
 - 2> if that primary CPICH is included in the "cells triggered" or "cells recently triggered" in the variable TRIGGERED_1J_EVENT:
 - 3> remove the entry of that primary CPICH from "cells triggered" or "cells recently triggered" in the variable TRIGGERED_1J_EVENT.
 - 3> if no entry in the variable TRIGGERED_1J_EVENT has a value of "sent reports" smaller than "Amount of reporting" or
 - 3> if there is no entry in the variable TRIGGERED_1J_EVENT:
 - 4> if the reporting interval timer is running:

5> stop the reporting interval timer;

5> set the IE "Periodical reporting running" in the variable TRIGGERED_1J_EVENT to FALSE.

Equation 1 (Triggering condition for pathloss)

$$10 \log M_{New} + CIO_{New} \leq 10 \log M_{inAS} + CIO_{inAS} - H_{1j} / 2$$

Equation 2 (Triggering condition for all the other measurement quantities)

$$10 \log M_{New} + CIO_{New} \geq 10 \log M_{inAS} + CIO_{inAS} + H_{1j} / 2$$

Equation 3 (Leaving triggering condition for pathloss)

$$10 \log M_{New} + CIO_{New} > 10 \log M_{inAS} + CIO_{inAS} + H_{1j} / 2$$

Equation 4 (Leaving triggering condition for all the other measurement quantities)

$$10 \log M_{New} + CIO_{New} < 10 \log M_{inAS} + CIO_{inAS} - H_{1j} / 2$$

The variables in the formula are defined as follows:

M_{New} is the measurement result of the cell not included in the E-DCH active set but included in DCH active set.

CIO_{New} is the individual cell offset for the cell not included in the E-DCH active set but included in DCH active set becoming better than the cell in the E-DCH active set if an individual cell offset is stored for that cell. Otherwise it is equal to 0.

For pathloss:

M_{inAS} is the measurement result of the cell in the E-DCH active set with the highest measurement result.

For other measurement quantities:

M_{inAS} is the measurement result of the cell in the E-DCH active set with the lowest measurement result.

CIO_{inAS} is the individual cell offset for the cell in the E-DCH active set that is becoming worse than the new cell.

H_{1j} is the hysteresis parameter for the event 1J.

If the measurement results are pathloss or CPICH-Ec/No then M_{New} and M_{inAS} are expressed as ratios.

If the measurement result is CPICH-RSCP then M_{New} and M_{inAS} are expressed in mW.

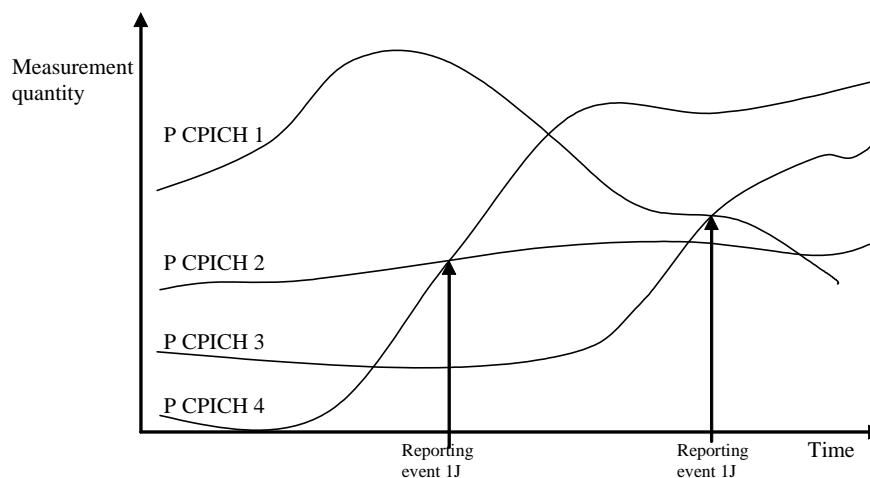

Figure 14.1.2.7-1 [Informative]: A primary CPICH that is not included in the E-DCH active set but included in DCH active set becomes better than a primary CPICH that is in the E-DCH active set

In this figure, the parameters hysteresis and time to trigger, as well as the cell individual offsets for all cells are equal to 0 and replacement activation threshold is equal to 0 or 1 or 2. In this example the cells belonging to primary CPICH 1 and 2 are in the E-DCH active set, but the cells transmitting primary CPICH 3 and CPICH 4 are not (yet) in the E-DCH active set but included in DCH active set.

The first measurement report is sent when primary CPICH 4 becomes better than primary CPICH 2. The "cell measurement event result" of the measurement report contains the information of primary CPICH 4 and CPICH 2.

Assuming that the E-DCH active set has been updated after the first measurement report (E-DCH active set is now primary CPICH 1 and primary CPICH 4), the second report is sent when primary CPICH 3 becomes better than primary CPICH 1. The "cell measurement event result" of the second measurement report contains the information of primary CPICH 3 and primary CPICH 1.

14.1.3 Intra-frequency reporting events for TDD

14.1.3.1 Reporting event 1G: Change of best cell (TDD)

When an intra-frequency measurement configuring event 1g is set up, the UE shall

- 1> create a variable TRIGGERED_1G_EVENT related to that measurement, which shall initially be empty.
- 1> store the P-CCPCH of the serving cell in the variable TRIGGERED_1G_EVENT as the best cell .
- 1> delete this variable when the measurement is released.

When event 1G is configured in the UE, the UE shall:

- 1> if the equation 1 is fulfilled for one or more P-CCPCHs during the time "Time to trigger"
 - 2> if those P-CCPCHs are not included in the "primary CCPCH info" in the variable TRIGGERED_1G_EVENT:
 - 3> include those P-CCPCHs in "cells triggered" in the variable TRIGGERED_1G_EVENT;
 - 2> update the prebest cell to the best P-CCPCH and for each cell in the variable TRIGGERED_1G_EVENT:
 - 3> if Equation 2 below is fulfilled for a primary CCPCH:
 - 4> remove the entry of that primary CCPCH from "cells triggered" in the variable TRIGGERED_1G_EVENT;
- 2> send a measurement report with IEs set as below:
 - 3> set in "intra-frequency measurement event results": "Intrafrequency event identity" to "1g";
 - 3> set the first entry in "cell measurement event results" to the "Cell parameters ID" of the P-CCPCH which was stored in the variable TRIGGERED_1G_EVENT;
 - 3> include all entries in "cells triggered" in variable TRIGGERED_1G_EVENT in "cell measurement event results" in the measurement report in descending order according to:

$$10 \cdot \text{Log}M + O$$

where M is the P-CCPCH RSCP and O the individual offset of a cell;

- 3> set the IE "measured results" and the IE "additional measured results" according to subclause 8.4.2, not taking into account the cell individual offset for each cell.
- 1> if Equation 2 below is fulfilled for a primary CCPCH:
 - 2> if a primary CCPCH is included in the "cells triggered" in the variable TRIGGERED_1G_EVENT:
 - 3> remove the entry of that primary CCPCH from "cells triggered" in the variable TRIGGERED_1G_EVENT;

The UE shall use the equations below for evaluation of reporting event 1g:

Equation 1

$$10 \cdot \text{Log}M_i + O_i - H_{1g} > 10 \cdot \text{Log}M_{\text{previous_best}} + O_{\text{previous_best}}$$

The variables in the formula are defined as follows:

$M_{\text{previous_best}}$ is the current P-CCPCH RSCP of the previous best cell expressed in mW

$O_{\text{previous_best}}$ is the cell individual offset of the previous best cell

M_i is the current P-CCPCH RSCP of the currently evaluated cell i expressed in mW

O_i is the cell individual offset of the currently evaluated cell i

H_{1g} is the hysteresis parameter for the event 1g.

Equation 2

$$10 \cdot \text{Log}M_i + O_i + H_{1g} < 10 \cdot \text{Log}M_{\text{previous_best}} + O_{\text{previous_best}}$$

The variables in the formula are defined as follows:

$M_{\text{previous_best}}$ is the current P-CCPCH RSCP of the previous best cell expressed in mW

$O_{\text{previous_best}}$ is the cell individual offset of the previous best cell

M_i is the current P-CCPCH RSCP of the currently evaluated cell i expressed in mW

O_i is the cell individual offset of the currently evaluated cell i

H_{1g} is the hysteresis parameter for the event 1g.

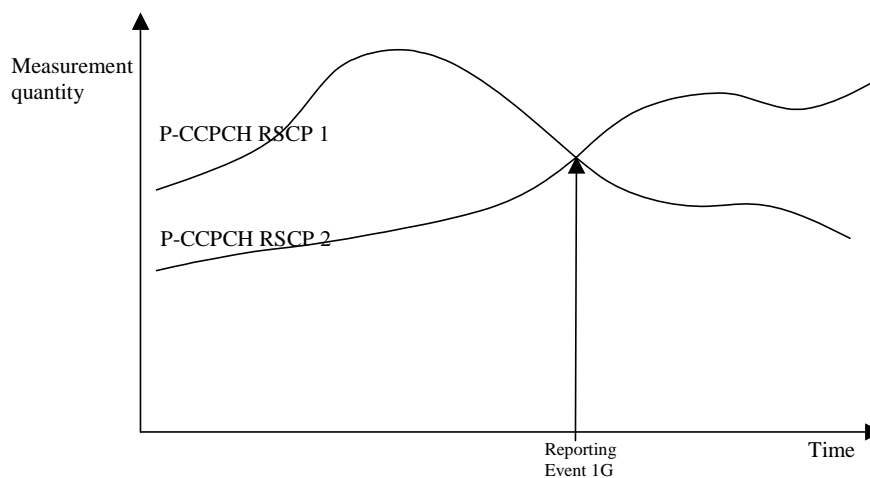

Figure 14.1.3.1-1: A P-CCPCH RSCP becomes better than the previous best P-CCPCH RSCP

14.1.3.2 Reporting event 1H: Timeslot ISCP below a certain threshold (TDD)

When an intra-frequency measurement configuring event 1h is set up, the UE shall:

- 1> create a variable TRIGGERED_1H_EVENT related to that measurement, which shall initially be empty;
- 1> delete this variable when the measurement is released.

When event 1h is configured in the UE, the UE shall:

- 1> if equation 1 is fulfilled for a time period indicated by "Time to trigger" and if that P-CCPCH is not included in the IE "cells triggered" in the variable TRIGGERED_1H_EVENT:

- 2> include that P-CCPCH in the IE "cells triggered" in the variable TRIGGERED_1H_EVENT;
- 2> send a measurement report with the IEs set as below:
 - 3> set in "intra-frequency measurement event results": "Intrafrequency event identity" to "1h" and in "cell measurement event results" the "Cell parameters ID" of the P-CCPCH that triggered the report;
 - 3> include in "Cell measured results" the "Timeslot ISCP" of those cells that are included in the variable TRIGGERED_1H_EVENT and "additional measured results" according to subclause 8.4.2, not taking into account the cell individual offset for each cell.
- 1> if Equation 2 below is fulfilled for a primary CCPCH:
 - 2> if a primary CCPCH is included in the "cells triggered" in the variable TRIGGERED_1H_EVENT:
 - 3> remove the entry of that primary CCPCH from "cells triggered" in the variable TRIGGERED_1H_EVENT.

The UE shall use the equations below for evaluation of reporting event 1h:

Equation 1

$$10 \cdot \text{Log}M_i + H_{1h} + O_i < T_{1h},$$

Equation 2

$$10 \cdot \text{Log}M_i - H_{1h} + O_i > T_{1h},$$

The variables in the formula are defined as follows:

M_i is the Timeslot ISCP of the currently evaluated cell i expressed in mW

O_i is the cell individual offset of the currently evaluated cell i

T_{1h} is the Threshold for event 1h

H_{1h} is the hysteresis parameter for the event 1h.

Before any evaluation is done, the Timeslot ISCP expressed in mW is filtered according to subclause 8.6.7.2.

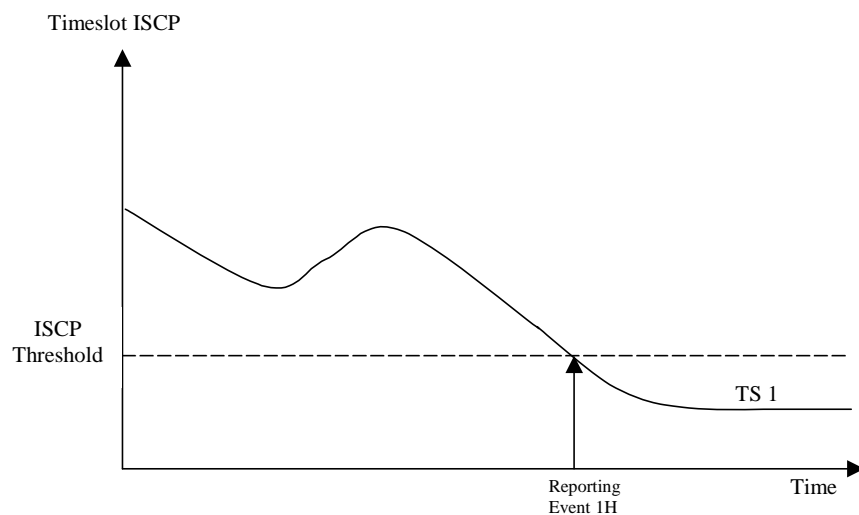

Figure 14.1.3.2-1: An ISCP value of a timeslot drops below an absolute threshold

14.1.3.3 Reporting event 1l: Timeslot ISCP above a certain threshold (TDD)

When an intra-frequency measurement configuring event 1l is set up, the UE shall:

- 1> create a variable TRIGGERED_1I_EVENT related to that measurement, which shall initially be empty;
- 1> delete this variable when the measurement is released.

When event 1i is configured in the UE, the UE shall:

- 1> if equation 1 is fulfilled for a time period indicated by "Time to trigger" and if that P-CCPCH is not included in the IE "cells triggered" in the variable TRIGGERED_1I_EVENT:
 - 2> include that P-CCPCH in the IE "cells triggered" in the variable TRIGGERED_1I_EVENT;
 - 2> send a measurement report with the IEs set as below:
 - 3> set in "intra-frequency measurement event results": "Intrafrequency event identity" to "1i" and in "cell measurement event results" to the "Cell parameters ID" of the P-CCPCH that triggered the report;
 - 3> include in "measured results" the "Timeslot ISCP" of those cells that are included in the variable TRIGGERED_1I_EVENT and "additional measured results" according to 8.4.2, not taking into account the cell individual offset for each cell.
- 1> if Equation 2 below is fulfilled for a primary CCPCH:
 - 2> if a primary CCPCH is included in the "cells triggered" in the variable TRIGGERED_1I_EVENT:
 - 3> remove the entry of that primary CCPCH from "cells triggered" in the variable TRIGGERED_1I_EVENT.

The UE shall use the equation below for evaluation of reporting event 1i:

Equation 1

$$10 \cdot \text{Log}M_i - H_{1i} + O_i > T_{1i},$$

Equation 2

$$10 \cdot \text{Log}M_i - H_{1i} + O_i < T_{1i},$$

The variables in the formula are defined as follows:

M_i is the Timeslot ISCP of the currently evaluated cell i expressed in mW

O_i is the cell individual offset of the currently evaluated cell i

T_{1i} is the Threshold for event 1i

H_{1i} is the hysteresis parameter for the event 1i.

Before any evaluation is done, the Timeslot ISCP expressed in mW is filtered according to subclause 8.6.7.2.

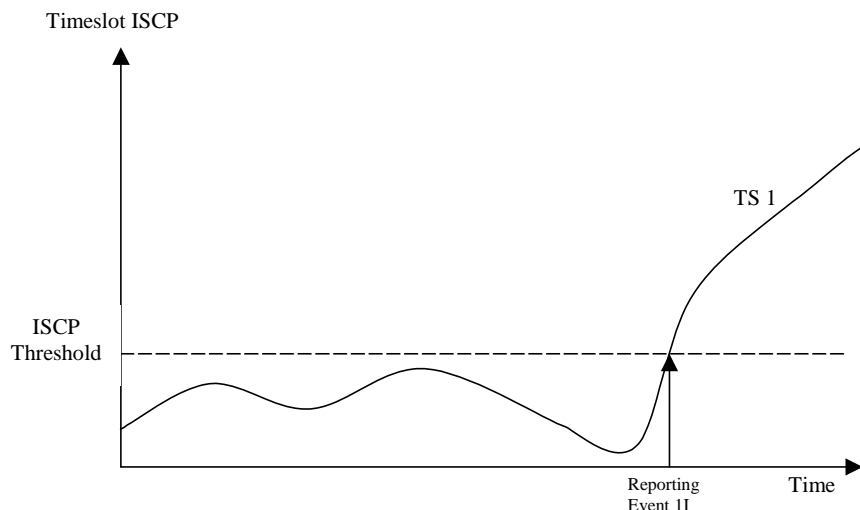

Figure 14.1.3.3-1: An ISCP value of a timeslot exceeds a certain threshold

14.1.4 Event-triggered periodic intra-frequency measurement reports (informative)

14.1.4.1 Cell addition failure (FDD only)

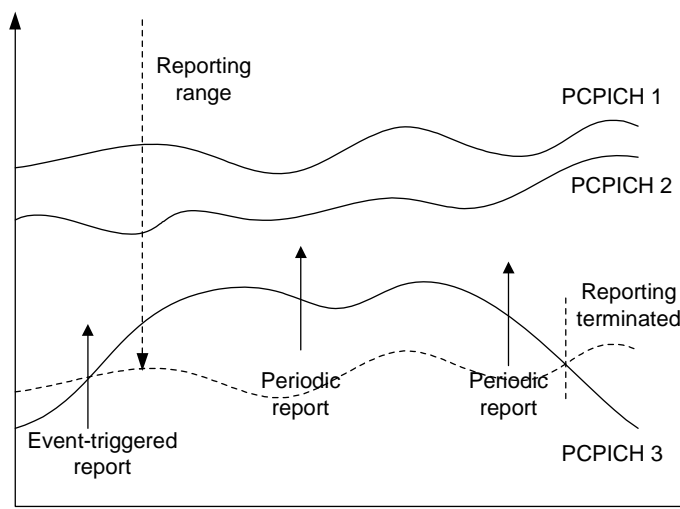

Figure 14.1.4.1-1: Periodic reporting triggered by event 1A

When a cell enters the reporting range and triggers event 1A, the UE shall transmit a MEASUREMENT REPORT to the UTRAN and typically this may result in an update of the active set. However, in some situations the UTRAN may be unable to add a strong cell to the active set typically due to capacity shortage for example.

The UE shall continue reporting after the initial report by reverting to periodical measurement reporting if the reported cell is not added to the active set. This is illustrated in Figure 14.1.4.1-1. During periodic reporting the UE shall transmit MEASUREMENT REPORT messages to the UTRAN at predefined intervals. The reports shall include reporting information of the cells in the current active set and of the monitored cell(s) in the reporting range.

Event-triggered periodic measurement reporting shall be terminated if:

- 1> there are no longer any monitored cell(s) within the reporting range; or
- 1> the UTRAN has added cells to the active set so that it includes the maximum number of cells (defined by the **reporting deactivation threshold** parameter), which are allowed for event 1A to be triggered; or

1> the UE has sent the maximum number of MEASUREMENT REPORT messages (defined by the **amount of reporting** parameter).

The reporting period is assigned by the UTRAN (with the **Reporting interval** parameter). If the reporting interval is set to zero event-triggered periodic measurement reporting shall not be applied.

14.1.4.1a Cell removal failure (FDD only)

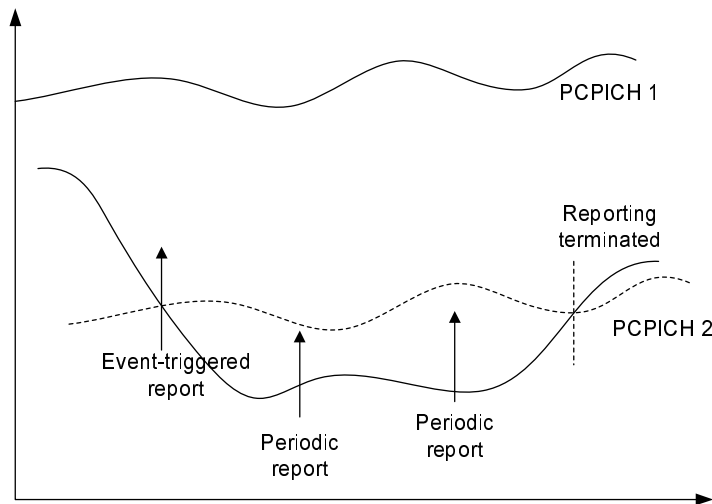

Figure 14.1.4.1a: Periodic reporting triggered by event 1B

When a cell enters the removal range and triggers event 1B, the UE shall transmit a MEASUREMENT REPORT to the UTRAN and typically this may result in the removal of the weakest active cell. If the UTRAN is unable to receive MEASUREMENT REPORT after the maximum retransmission, it is beneficial to receive continuous reports in this case as well.

The UE shall revert to periodical measurement reporting if the UTRAN does not update the active set after the transmission of the measurement report. This is illustrated in Figure 14.1.4.1a. During periodic reporting the UE shall transmit MEASUREMENT REPORT messages to the UTRAN at predefined intervals.

Event-triggered periodic measurement reporting shall be terminated if:

- 1> there are no longer any monitored cell(s) within the removal range; or
- 1> the UTRAN has removed cells from the active set so that there are no longer the minimum amount of active cells for event 1B to be triggered; or
- 1> the UE has sent the maximum number of MEASUREMENT REPORT messages (defined by the "amount of reporting" parameter).

The reporting period is assigned by the UTRAN (with the "Reporting interval" parameter). If the reporting interval is set to zero, event-triggered periodic measurement reporting shall not be applied.

14.1.4.2 Cell replacement failure (FDD only)

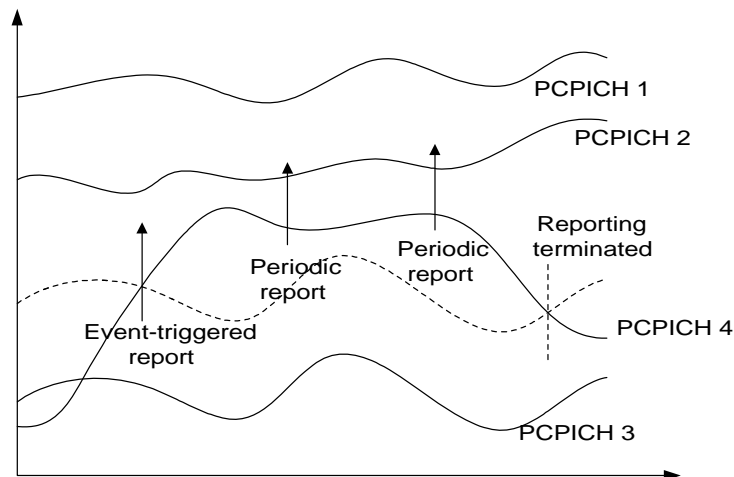

Figure 14.1.4.1-2: Periodic reporting triggered by event 1C

When a cell enters the replacement range and triggers event 1C, the UE shall transmit a MEASUREMENT REPORT to the UTRAN and typically this may result in the replacement of the weakest active cell. If the UTRAN is unable to replace the cell due to for example capacity shortage, it is beneficial to receive continuous reports in this case as well.

The UE shall revert to periodical measurement reporting if the UTRAN does not update the active set after the transmission of the measurement report. This is illustrated in Figure 14.1.4.1-2. During periodic reporting the UE shall transmit MEASUREMENT REPORT messages to the UTRAN at predefined intervals. The reports shall include reporting information of the cells in the current active set and of the monitored cell(s) in the replacement range.

Event-triggered periodic measurement reporting shall be terminated if:

- 1> there are no longer any monitored cell(s) within the replacement range; or
- 1> the UTRAN has removed cells from the active set so that there are no longer the minimum amount of active cells for event 1C to be triggered (as defined by the **replacement activation threshold** parameter); or
- 1> the UE has sent the maximum number of MEASUREMENT REPORT messages (defined by the **amount of reporting** parameter).

The reporting period is assigned by the UTRAN (with the **Reporting interval** parameter). If the reporting interval is set to zero, event-triggered periodic measurement reporting shall not be applied.

14.1.5 Mechanisms available for modifying intra-frequency measurement reporting behaviour (informative)

14.1.5.1 Hysteresis

To limit the amount of event-triggered reports, a hysteresis parameter may be connected with each reporting event given above. The value of the hysteresis is given to the UE in the Reporting criteria field of the Measurement Control message.

In the example in Figure 14.1.5.1-1, the hysteresis ensures that the event 1D (FDD) or IG(TDD) (primary CPICH(FDD)/CCPCH(TDD) 2 becomes the best cell) is not reported until the difference is equal to the hysteresis value. The fact that primary CPICH(FDD)/CCPCH(TDD) 1 becomes best afterwards is not reported at all in the example since the primary CPICH(FDD)/CCPCH(TDD) 1 does not become sufficiently better than the primary CPICH(FDD)/CCPCH(TDD) 2.

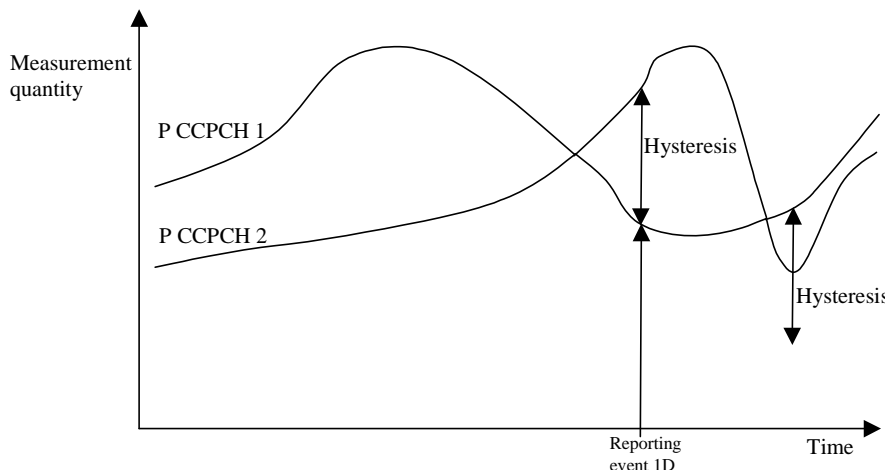

Figure 14.1.5.1-1: Hysteresis limits the amount of measurement reports

14.1.5.2 Time-to-trigger

To limit the measurement signalling load, a time-to-trigger parameter could be connected with each reporting event given above. The value of the time-to-trigger is given to the UE in the Reporting criteria field of the Measurement Control message.

The effect of the time-to-trigger is that the report is triggered only after the conditions for the event have existed for the specified time-to-trigger. In the following FDD example in Figure 14.1.5.2-1, the use of time-to-trigger means that the event (primary CPICH 3 enters the reporting range) is not reported until it has been within the range for the time given by the time-to-trigger parameter.

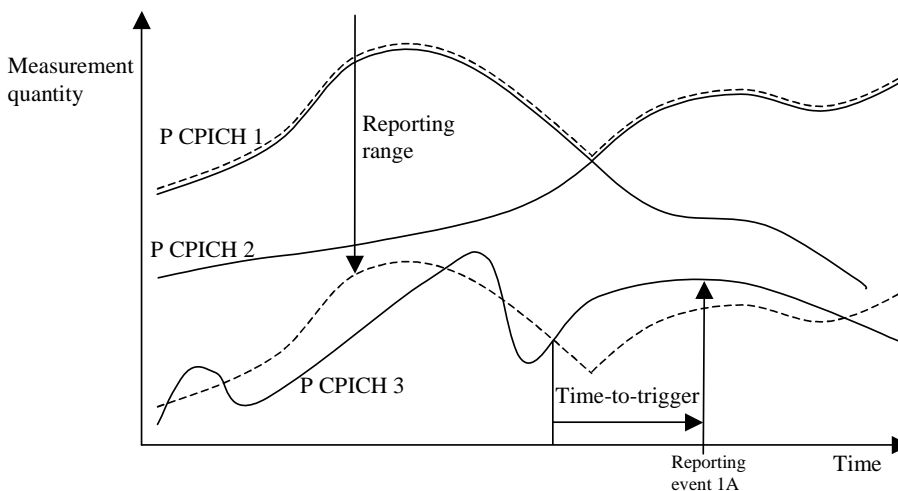

Figure 14.1.5.2-1: Time-to-trigger limits the amount of measurement reports

In the following TDD example in Figure 14.1.5.2-2, the use of time-to-trigger means that the event (Timeslot ISCP upon certain threshold) is not reported until it has been upon the threshold for the time given by the time-to trigger parameter.

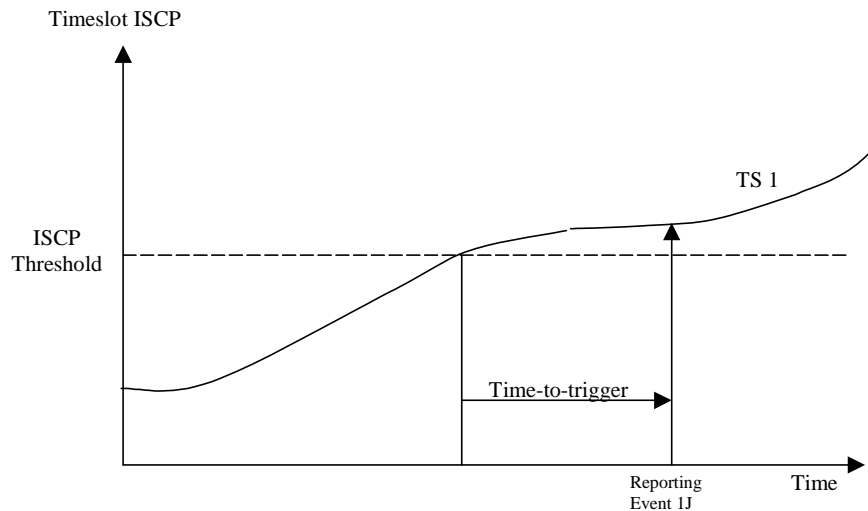

Figure 14.1.5.2-2: Time-to-trigger limits the amount of measurement reports

NOTE: The time-to-trigger could be combined with hysteresis, i.e. a hysteresis value is added to the measurement quantity before evaluating if the time-to-trigger timer should be started.

14.1.5.3 Cell individual offsets

For each cell that is monitored, an offset can be assigned with inband signalling. The offset can be either positive or negative. The offset is added to the measurement quantity before the UE evaluates if an event has occurred. The UE receives the cell individual offsets for each primary CPICH(FDD)/CCPCH(TDD) in the IE "Cell individual offset" included in the IE "Cell info" associated with each measurement object included in the MEASUREMENT CONTROL message.

For the FDD example, in Figure 14.1.5.3-1, since an offset is added to primary CPICH 3, it is the dotted curve that is used to evaluate if an event occurs. Hence, this means that measurement reports from UE to UTRAN are triggered when primary CPICH plus the corresponding offset, i.e. the dotted curve, leaves and enters the reporting range and when it gets better than primary CPICH 1 (if these events have been ordered by UTRAN). This offset mechanism provides the network with an efficient tool to change the reporting of an individual primary CPICH.

By applying a positive offset, as in Figure 14.1.5.3-1, the UE will send measurement reports as if the primary CPICH is offset x dB better than what it really is. This could be useful if the operator knows that a specific cell is interesting to monitor more carefully, even though it is not so good for the moment. In the example in Figure 14.1.5.3-1, the operator might know by experience that in this area primary CPICH 3 can become good very quickly (e.g. due to street corners) and therefore that it is worth reporting more intensively. Depending on the implemented handover evaluation algorithm, this may result in the cell with primary CPICH 3 being included in the active set earlier than would have been the case without the positive offset.

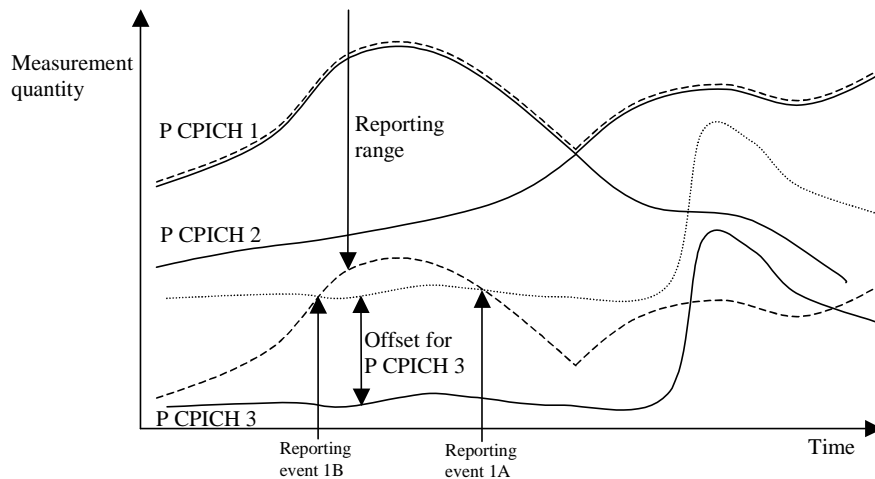

Figure 14.1.5.3-1: A positive offset is applied to primary CPICH 3 before event evaluation in the UE

For the TDD example, in Figure 14.1.5.3-2, an offset is added to primary CCPCH2, it is the dotted curve that is used to evaluate if the primary CCPCH2 becomes better than primary CCPCH1 (ordered by the UTRAN).

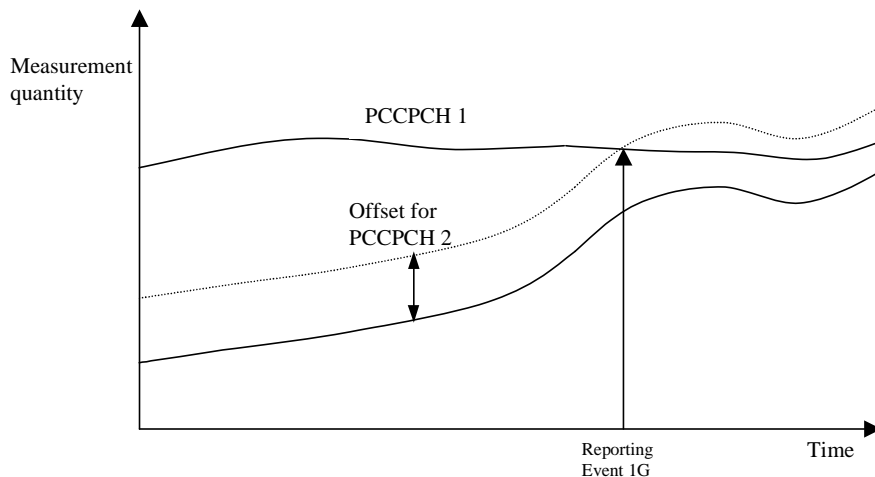

Figure 14.1.5.3-2: A positive offset is applied to primary CCPCH 2

Correspondingly, the operator can choose to apply a negative offset to a primary CCPCH. Then the reporting on that primary CCPCH is limited and the corresponding cell may be, at least temporarily excluded from the active set or as a target cell for handover.

It is important to note that the offset is added before triggering events, i.e. the offset is added by the UE before evaluating if a measurement report should be sent as opposed to offsets that are applied in the network and used for the actual handover evaluation. It should also be noted that the cell individual offset is not used in all measurement reporting events, and that it is not applied to all events in the same way.

14.1.5.4 Forbid a Primary CPICH to affect the reporting range (FDD only)

The reporting range affects the reporting events 1A and 1B presented above. The reporting range is defined as a function of all the Primary CPICHs in the active set (see 14.1.2.1 and 14.1.2.2). If the parameter W is set to 0, the reporting range is defined relative to the best Primary CPICH. However, there could be cases where it is good to forbid a specific Primary CPICH to affect the reporting range. For example in Figure 14.1.5.4-1 the network has requested the UE to not let Primary CPICH 3 affect the reporting range. This mechanism could be effective if the operator knows by experience that the quality of Primary CPICH 3 is very unstable in a specific area and therefore should not affect the reporting of the other Primary CPICHs.

The UE shall ignore that a Primary CPICH is forbidden to affect the reporting range if all of the following conditions are fulfilled:

- the Primary CPICH is included in active set; and
- all cells in active set are defined as Primary CPICHs forbidden to affect the reporting range.

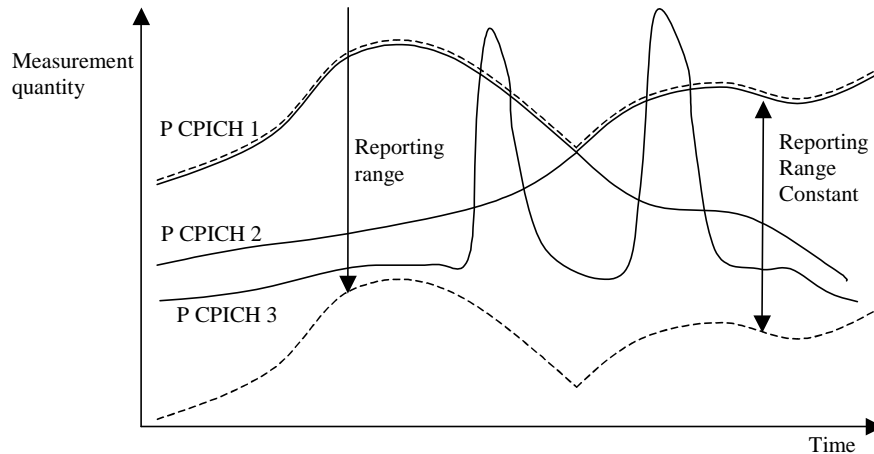

Figure 14.1.5.4-1: Primary CPICH 3 is forbidden to affect the reporting range

14.1.6 Report quantities in intra-frequency measurements

The quantities that the UE shall report to UTRAN when the event is triggered for an intra-frequency measurement are given by the IE "Intra-frequency reporting quantity" stored for this measurement and can be the following:

- 1 SFN-SFN observed time difference
- 2 Cell synchronisation information
- 3 Cell Identity
- 4 Downlink E_c/N_0 (FDD).
- 5 Downlink path loss.

For FDD:

$$\text{Pathloss in dB} = \text{Primary CPICH Tx power} - \text{CPICH RSCP.}$$

- For Primary CPICH Tx power the IE "Primary CPICH Tx power" shall be used. The unit is dBm.
- CPICH RSCP is the result of the CPICH RSCP measurement. The unit is dBm.

For TDD:

$$\text{Pathloss in dB} = \text{Primary CCPCH TX power} - \text{Primary CCPCH RSCP.}$$

- For Primary CCPCH TX power the IE "Primary CCPCH TX Power" shall be used. The unit is dBm.
- Primary CCPCH RSCP is the result of the Primary CCPCH RSCP measurement. The unit is dBm.

If necessary Pathloss shall be rounded up to the next higher integer.

Results higher than 158 shall be reported as 158.

Results lower than 46 shall be reported as 46.

- 6 Downlink received signal code power (RSCP) after despreading (of a primary CPICH for FDD, and of a primary CCPCH for TDD).
- 7 ISCP measured on Timeslot basis. (TDD)

8 Proposed TGSN (TDD)

A description of those values can be found in [7] and [8].

14.2 Inter-frequency measurements

14.2.0a Inter-frequency measurement quantities

The two first measurement quantities listed below are used by the UE to evaluate whether an inter-frequency measurement event has occurred or not, through the computation of a frequency quality estimate. The quantity to use to compute the frequency quality estimate for an inter-frequency measurement is given in the "Inter-frequency measurement quantity" stored for that measurement.

- 1 Downlink Ec/No (FDD)
- 2 Downlink received signal code power (RSCP) after despreading.
- 3 Downlink path loss.

For FDD:

$$\text{Pathloss in dB} = \text{Primary CPICH Tx power} - \text{CPICH RSCP.}$$

- For Primary CPICH Tx power the IE "Primary CPICH Tx power" shall be used. The unit is dBm.
- CPICH RSCP is the result of the CPICH RSCP measurement. The unit is dBm.

For TDD:

$$\text{Pathloss in dB} = \text{Primary CCPCH TX power} - \text{Primary CCPCH RSCP.}$$

- For Primary CCPCH TX power the IE "Primary CCPCH TX Power" shall be used. The unit is dBm.
- Primary CCPCH RSCP is the result of the Primary CCPCH RSCP measurement. The unit is dBm.

A description of those values can be found in [7] and [8].

14.2.0b Frequency quality estimate

14.2.0b.1 FDD cells

The frequency quality estimate used in events 2a, 2b 2c, 2d, 2e and 2f is defined as:

$$Q_{\text{frequency } j} = 10 \cdot \text{Log} M_{\text{frequency } j} = W_j \cdot 10 \cdot \text{Log} \left(\sum_{i=1}^{N_{A_j}} M_{i j} \right) + (1 - W_j) \cdot 10 \cdot \text{Log} M_{\text{Best } j},$$

The variables in the formula are defined as follows ("the virtual active set on frequency j" should be understood as the active set if frequency j is the used frequency. If frequency j is a non-used frequency, the way the virtual active set is initiated and updated is described in subclause 14.11):

$Q_{\text{frequency } j}$ is the estimated quality of the virtual active set on frequency j.

$M_{\text{frequency } j}$ is the estimated quality of the virtual active set on frequency j.

$M_{i j}$ is a measurement result of cell i in the virtual active set on frequency j.

N_{A_j} is the number of cells in the virtual active set on frequency j.

$M_{\text{Best } j}$ is the measurement result of the cell in the virtual active set on frequency j with the highest measurement result.

W_j is a parameter sent from UTRAN to UE and used for frequency j .

If the measurement result is CPICH-Ec/No then $M_{Frequency}$, M_{ij} and M_{Best} are expressed as ratios.

If the measurement result is CPICH-RSCP or PCCPCH-RSCP then $M_{Frequency}$, M_{ij} and M_{Best} are expressed in mW.

14.2.0b.2 TDD cells

$$Q_{i,frequency j} = 10 \cdot \text{Log}M_i + O_{i,j},$$

$Q_{i,frequency j}$ is the estimated quality of cell i on frequency j .

M_i is the measurement result for Primary CCPCH RSCP of cell i on the primary frequency expressed in mW.

O_{ij} is the cell individual offset of the currently evaluated cell i on frequency j . O_{ij} is set by IE "Cell individual offset"

14.2.0c Inter-frequency reporting quantities

The quantities that the UE shall report for each cell to UTRAN when the event is triggered for an inter-frequency measurement is given by the "Inter-frequency reporting quantity" IE stored for this measurement and can be the following, from 1 to 8. The quantity number 9 can be reported for each frequency that triggered the report.

- 1 Cell identity
- 2 SFN-SFN observed time difference
- 3 Cell synchronisation information
- 4 Downlink Ec/No (FDD)
- 5 Downlink path loss.

For FDD:

$$\text{Pathloss in dB} = \text{Primary CPICH Tx power} - \text{CPICH RSCP.}$$

- For Primary CPICH Tx power the IE "Primary CPICH Tx power" shall be used. The unit is dBm.
- CPICH RSCP is the result of the CPICH RSCP measurement. The unit is dBm.

For TDD:

$$\text{Pathloss in dB} = \text{Primary CCPCH TX power} - \text{Primary CCPCH RSCP.}$$

- For Primary CCPCH TX power the IE "Primary CCPCH TX Power" shall be used. The unit is dBm.
- Primary CCPCH RSCP is the result of the Primary CCPCH RSCP measurement. The unit is dBm.

If necessary Pathloss shall be rounded up to the next higher integer.

Results higher than 158 shall be reported as 158.

Results lower than 46 shall be reported as 46.

- 6 Downlink received signal code power (RSCP) after despreading (of a primary CPICH for FDD, and of a primary CCPCH for TDD).
- 7 ISCP measured on Timeslot basis. (TDD)
- 8 Proposed TGSN (TDD)
- 9 UTRA carrier RSSI

A description of those values can be found in [7] and [8].

14.2.1 Inter-frequency reporting events

Within the measurement reporting criteria field in the MEASUREMENT CONTROL message UTRAN notifies the UE which events should trigger the UE to send a MEASUREMENT REPORT message. The listed events are the toolbox from which the UTRAN can choose the reporting events that are needed for the implemented handover evaluation function, or other radio network functions.

All events are evaluated with respect to one of the measurement quantities given in subclause 14.2.0a. The measurement quantities are measured on the monitored primary common pilot channels (CPICH) in FDD mode and the monitored primary common control channels (PCCPCH) in TDD mode of the cell defined in the measurement object. A "non-used frequency" is a frequency that the UE has been ordered to measure upon but is not used for the connection. A "used frequency" is a frequency that the UE has been ordered to measure upon and is also currently used for the connection.

The "monitored set on non-used frequency" consists of cells in "cells for measurement" (or all cells in CELL_INFO_LIST if "cells for measurement" is not present) that are not part of the virtual active set on that non-used frequency.

When one inter-frequency measurement identity corresponds to multiple inter-frequency events with identical event identities, the UE behaviour is not specified.

14.2.1.1 Event 2a: Change of best frequency.

When event 2a is configured in the UE within a measurement, the UE shall:

- 1> when the measurement is initiated or resumed:
 - 2> store the used frequency in the variable BEST_FREQUENCY_2A_EVENT.
- 1> if equation 1 below has been fulfilled for a time period indicated by "Time to trigger" for a frequency included for that event and which is not stored in the variable BEST_FREQUENCY_2A_EVENT:
 - 2> send a measurement report with IEs set as below:
 - 3> set in "inter-frequency measurement event results":
 - 4> "inter-frequency event identity" to "2a"; and
 - 4> "Frequency info" to the frequency that triggered the event; and
 - 4> "Non frequency related measurement event results" to the "Primary CPICH info" of the best primary CPICH for FDD cells or "Primary CCPCH info" to the "Cells parameters ID" of the best primary CCPCH for TDD cells on that frequency, not taking into account the cell individual offset.
 - 3> if a non-used frequency triggered the measurement report:
 - 4> include in IE "Inter-frequency measured results list" the measured results for the non-used frequency that triggered the event, not taking into account the cell individual offset.
 - 3> if the used frequency triggered the measurement report:
 - 4> do not include the IE "Inter-frequency measured results list" in the measurement report.
 - 3> set the IE "additional measured results" according to subclause 8.4.2, not taking into account the cell individual offset;
 - 2> update the variable BEST_FREQUENCY_2A_EVENT with that frequency.

Equation 1:

$$Q_{NotBest} \geq Q_{Best} + H_{2a} / 2$$

The variables in the formula are defined as follows:

$Q_{Not\ Best}$ is the quality estimate of a frequency not stored the "best frequency" in the variable BEST_FREQUENCY_2A_EVENT.

Q_{Best} is the quality estimate of the frequency stored in "best frequency" in the variable BEST_FREQUENCY_2A_EVENT.

H_{2a} is the hysteresis parameter for the event 2a in that measurement.

14.2.1.2 Event 2b: The estimated quality of the currently used frequency is below a certain threshold **and** the estimated quality of a non-used frequency is above a certain threshold.

When an inter-frequency measurement configuring event 2b is set up, the UE shall:

- 1> create a variable TRIGGERED_2B_EVENT related to that measurement, which shall initially be empty;
- 1> delete this variable when the measurement is released.

When event 2b is configured in the UE within a measurement, the UE shall:

- 1> if equations 1 and 2 below have been fulfilled for a time period indicated by "Time to Trigger" from the same instant, respectively for one or several non-used frequencies included for that event and for the used frequency:
 - 2> if any of those non-used frequency is not stored in the variable TRIGGERED_2B_EVENT:
 - 3> store the non-used frequencies that triggered the event and that were not previously stored in the variable TRIGGERED_2B_EVENT into that variable;
 - 3> send a measurement report with IEs set as below:
 - 4> set in "inter-frequency measurement event results":
 - 5> "inter-frequency event identity" to "2b"; and
 - 5> for each non-used frequency that triggered the event, beginning with the best frequency:
 - 6> "Frequency info" to that non-used frequency; and
 - 6> "Non frequency related measurement event results" to the "Primary CPICH info" of the best primary CPICH for FDD cells or "Primary CCPCH info" to the "Cell parameters ID" of the best primary CCPCH for TDD cells on that non-used frequency, not taking into account the cell individual offset.
 - 4> include in IE "Inter-frequency measured results list" the measured results for each non-used frequency that triggered the event, not taking into account the cell individual offset;
 - 4> set the IE "additional measured results" according to subclause 8.4.2, not taking into account the cell individual offset.
 - 1> if equation 3 below is fulfilled for a non-used frequency stored in the variable TRIGGERED_2B_EVENT:
 - 2> remove that non-used frequency from the variable TRIGGERED_2B_EVENT.
 - 1> if equation 4 below is fulfilled for the used frequency:
 - 2> clear the variable TRIGGERED_2B_EVENT.

Triggering conditions:

Equation 1:

$$Q_{Non\ used} \geq T_{Non\ used\ 2b} + H_{2b}/2$$

The variables in the formula are defined as follows:

$Q_{Non\ used}$ is the quality estimate of a non-used frequency that becomes better than an absolute threshold.

$T_{Non\ used\ 2b}$ is the absolute threshold that applies for this non-used frequency in that measurement.

H_{2b} is the hysteresis parameter for the event 2b.

Equation 2:

$$Q_{Used} \leq T_{Used\ 2b} - H_{2b}/2$$

The variables in the formula are defined as follows:

Q_{Used} is the quality estimate of the used frequency.

$T_{Used\ 2b}$ is the absolute threshold that applies for the used frequency in that measurement.

H_{2b} is the hysteresis parameter for the event 2b.

Leaving triggered state condition:

Equation 3:

$$Q_{Nonused} < T_{Nonused\ 2b} - H_{2b}/2$$

The variables in the formula are defined as follows:

$Q_{Non\ used}$ is the quality estimate of a non-used frequency that is stored in the variable TRIGGERED_2B_EVENT.

$T_{Non\ used\ 2b}$ is the absolute threshold that applies for this non-used frequency in that measurement.

H_{2b} is the hysteresis parameter for the event 2b.

Equation 4:

$$Q_{Used} > T_{Used\ 2b} + H_{2b}/2$$

The variables in the formula are defined as follows:

Q_{Used} is the quality estimate of the used frequency.

$T_{Used\ 2b}$ is the absolute threshold that applies for the used frequency in that measurement.

H_{2b} is the hysteresis parameter for the event 2b.

14.2.1.3 Event 2c: The estimated quality of a non-used frequency is above a certain threshold

When an inter-frequency measurement configuring event 2c is set up, the UE shall:

- 1> create a variable TRIGGERED_2C_EVENT related to that measurement, which shall initially be empty;
- 1> delete this variable when the measurement is released.

When event 2c is configured in the UE within a measurement, the UE shall:

- 1> if equation 1 below has been fulfilled for one or several non-used frequencies included for that event during the time "Time to trigger":
 - 2> if any of those non-used frequencies is not stored in the variable TRIGGERED_2C_EVENT:
 - 3> store the non-used frequencies that triggered the event and that were not previously stored in the variable TRIGGERED_2C_EVENT into that variable;
 - 3> send a measurement report with IEs set as below:
 - 4> set in "inter-frequency measurement event results":
 - 5> "inter-frequency event identity" to "2c"; and

- 5> for each non-used frequency that triggered the event, beginning with the best frequency:
 - 6> "Frequency info" to that non-used frequency; and
 - 6> "Non frequency related measurement event results" to the "Primary CPICH info" of the best primary CPICH for FDD cells or "Primary CCPCH info" to the "Cell parameters ID" of the best primary CCPCH for TDD cells on that non-used frequency, not taking into account the cell individual offset.
 - 4> include in IE "Inter-frequency measured results list" the measured results for each non-used frequency that triggered the event, not taking into account the cell individual offset;
 - 4> set the IE "additional measured results" according to subclause 8.4.2 not taking into account the cell individual offset.
- 1> if equation 2 below is fulfilled for a non-used frequency stored in the variable TRIGGERED_2C_EVENT:
 - 2> remove that non-used frequency from the variable TRIGGERED_2C_EVENT.

Triggering condition:

Equation 1:

$$Q_{Non\ used} \geq T_{Non\ used\ 2c} + H_{2c}/2$$

The variables in the formula are defined as follows:

$Q_{Non\ used}$ is the quality estimate of a non-used frequency that becomes better than an absolute threshold.

$T_{Non\ used\ 2c}$ is the absolute threshold that applies for this non-used frequency in that measurement.

H_{2c} is the hysteresis parameter for the event 2c.

Leaving triggered state condition:

Equation 2:

$$Q_{Non\ used} < T_{Non\ used\ 2c} - H_{2c}/2$$

The variables in the formula are defined as follows:

$Q_{Non\ used}$ is the quality estimate of a non-used frequency stored in the variable TRIGGERED_2C_EVENT.

$T_{Non\ used\ 2c}$ is the absolute threshold that applies for this non-used frequency in that measurement.

H_{2c} is the hysteresis parameter for the event 2c.

14.2.1.4 Event 2d: The estimated quality of the currently used frequency is below a certain threshold

A UE shall be able to perform this measurement and the corresponding event reporting without requiring compressed mode.

When an inter-frequency measurement configuring event 2d is set up, the UE shall:

- 1> create a variable TRIGGERED_2D_EVENT related to that measurement, which shall initially be set to FALSE;
- 1> delete this variable when the measurement is released.

When event 2d is configured in the UE within a measurement, the UE shall:

- 1> if equation 1 below has been fulfilled for the used frequency during the time "Time to trigger":
 - 2> if the variable TRIGGERED_2D_EVENT is set to FALSE:
 - 3> set the variable TRIGGERED_2D_EVENT to TRUE;

3> send a measurement report with IEs set as below:

4> set in "inter-frequency event results": "inter-frequency event identity" to "2d" and no IE "Inter-frequency cells", not taking into account the cell individual offset;

4> include in IE "Inter-frequency measured results list" the measured results for the used frequency, not taking into account the cell individual offset;

4> set the IE "additional measured results" according to subclause 8.4.2, not taking into account the cell individual offset.

1> if the variable TRIGGERED_2D_EVENT is set to TRUE and if equation 2 is fulfilled for the used frequency:

2> set the variable TRIGGERED_2D_EVENT to FALSE.

Triggering condition:

Equation 1:

$$Q_{Used} \leq T_{Used2d} - H_{2d}/2$$

The variables in the formula are defined as follows:

Q_{Used} is the quality estimate of the used frequency.

T_{Used2d} is the absolute threshold that applies for the used frequency and event 2d.

H_{2d} is the hysteresis parameter for the event 2d.

Leaving triggered state condition:

Equation 2:

$$Q_{Used} > T_{Used2d} + H_{2d}/2$$

The variables in the formula are defined as follows:

Q_{Used} is the quality estimate of the used frequency.

T_{Used2d} is the absolute threshold that applies for the used frequency and event 2d.

H_{2d} is the hysteresis parameter for the event 2d.

14.2.1.5 Event 2e: The estimated quality of a non-used frequency is below a certain threshold

When an inter-frequency measurement configuring event 2e is set up, the UE shall:

1> create a variable TRIGGERED_2E_EVENT related to that measurement, which shall initially be empty;

1> delete this variable when the measurement is released.

When event 2e is configured in the UE within a measurement, the UE shall:

1> if equation 1 below has been fulfilled for one or several non-used frequencies included for that event during the time "Time to trigger":

2> if any of those non-used frequencies is not stored in the variable TRIGGERED_2E_EVENT:

3> store the non-used frequencies that triggered the event and that were not previously stored in the variable TRIGGERED_2E_EVENT into that variable;

3> send a measurement report with IEs set as below:

4> set in "inter-frequency measurement event results":

- 5> "inter-frequency event identity" to "2e"; and
- 5> for each non-used frequency that triggered the event, beginning with the best frequency:
 - 6> "Frequency info" to that non-used frequency; and
 - 6> "Non frequency related measurement event results" to the "Primary CPICH info" of the best primary CPICH for FDD cells or "Primary CCPCH info" to the "Cell parameters ID" of the best primary CCPCH for TDD cells on that non-used frequency, not taking into account the cell individual offset.
- 4> include in the IE "Inter-frequency measured results list" the measured results for each non-used frequency that triggered the event, not taking into account the cell individual offset;
- 4> set the IE "additional measured results" according to subclause 8.4.2, not taking into account the cell individual offset.
- 1> if equation 2 below is fulfilled for a non-used frequency stored in the variable TRIGGERED_2E_EVENT:
 - 2> remove that non-used frequency from the variable TRIGGERED_2E_EVENT.

Triggering condition:

Equation 1:

$$Q_{Nonused} \leq T_{Nonused2e} - H_{2e} / 2$$

The variables in the formula are defined as follows:

$Q_{Non used}$ is the quality estimate of a non-used frequency that becomes worse than an absolute threshold.

$T_{Non used 2e}$ is the absolute threshold that applies for that non-used frequency for that event.

H_{2e} is the hysteresis parameter for the event 2e.

Leaving triggered state condition:

Equation 2:

$$Q_{Nonused} > T_{Nonused2e} + H_{2e} / 2$$

The variables in the formula are defined as follows:

$Q_{Non used}$ is the quality estimate of a non-used frequency stored in the variable TRIGGERED_2E_EVENT.

$T_{Non used 2e}$ is the absolute threshold that applies for that non-used frequency for that event.

H_{2e} is the hysteresis parameter for the event 2e.

14.2.1.6 Event 2 f: The estimated quality of the currently used frequency is above a certain threshold

A UE shall be able to perform this measurement and the corresponding event reporting without requiring compressed mode.

When an inter-frequency measurement configuring event 2f is set up, the UE shall:

- 1> create a variable TRIGGERED_2F_EVENT related to that measurement, which shall initially be set to FALSE;
- 1> delete this variable when the measurement is released.

When event 2f is configured in the UE within a measurement, the UE shall:

- 1> if equation 1 below has been fulfilled for the used frequency during the time "Time to trigger":
 - 2> if the variable TRIGGERED_2F_EVENT is set to FALSE:

3> set the variable TRIGGERED_2F_EVENT to TRUE;

3> send a measurement report with IEs set as below:

4> set in "inter-frequency event results": "inter-frequency event identity" to "2f", and no IE "Inter-frequency cells";

4> include in IE "Inter-frequency measured results list" the measured results for the used frequency, not taking into account the cell individual offset;

4> set the IE "additional measured results" according to subclause 8.4.2, not taking into account the cell individual offset.

1> if the variable TRIGGERED_2F_EVENT is set to TRUE and if equation 2 is fulfilled for the used frequency:

2> set the variable TRIGGERED_2F_EVENT to FALSE.

Triggering condition:

Equation 1:

$$Q_{Used} \geq T_{Used2f} + H_{2f}/2$$

The variables in the formula are defined as follows:

Q_{Used} is the quality estimate of the used frequency.

T_{Used2f} is the absolute threshold that applies for the used frequency and event 2f.

H_{2f} is the hysteresis parameter for the event 2f.

Leaving triggered state condition:

Equation 2:

$$Q_{Used} < T_{Used2f} - H_{2f}/2$$

The variables in the formula are defined as follows:

Q_{Used} is the quality estimate of the used frequency.

T_{Used2f} is the absolute threshold that applies for the used frequency and event 2f.

H_{2f} is the hysteresis parameter for the event 2f.

14.3 Inter-RAT measurements

14.3.0a Inter-RAT measurement quantities

A measurement quantity is used by the UE to evaluate whether an inter-RAT measurement event has occurred or not.

The measurement quantity for UTRAN is used to compute the frequency quality estimate for the active set, as described in the next subclause, and can be:

- 1 Downlink Ec/No.
- 2 Downlink received signal code power (RSCP) after despreading.

The measurement quantity for GSM can be:

- 1 GSM Carrier RSSI

A description of those values can be found in [7] and [8].

14.3.0b Frequency quality estimate of the UTRAN frequency

The estimated quality of the active set in UTRAN in event 3a is defined as:

$$Q_{UTRAN} = 10 \cdot \text{Log} M_{UTRAN} = W \cdot 10 \cdot \text{Log} \left(\sum_{i=1}^{N_A} M_i \right) + (1 - W) \cdot 10 \cdot \text{Log} M_{Best},$$

The variables in the formula are defined as follows:

Q_{UTRAN} is the estimated quality of the active set on the currently used UTRAN frequency.

M_{UTRAN} is the estimated quality of the active set on currently used UTRAN frequency expressed in another unit.

M_i is the measurement result of cell i in the active set, according to what is indicated in the IE "Measurement quantity for UTRAN quality estimate".

N_A is the number of cells in the active set.

M_{Best} is the measurement result of the cell in the active set with the highest measurement result.

W is a parameter sent from UTRAN to UE.

If the measurement result is CPICH-Ec/No M_{UTRAN} , M_i and M_{Best} are expressed as ratios.

If the measurement result is CPICH-RSCP or PCCPCH-RSCP, M_{UTRAN} , M_i and M_{Best} are expressed in mW.

14.3.0c Inter-RAT reporting quantities

The quantities that the UE shall report to UTRAN when the event is triggered for an inter-RAT measurement are given by the IE "Inter-RAT reporting quantity" stored for that measurement, and can be the following:

In the case the other RAT is GSM:

- 1 GSM carrier RSSI

A description of those values can be found in [7] and [8].

14.3.1 Inter-RAT reporting events

Within the measurement reporting criteria field in the MEASUREMENT CONTROL message the UTRAN notifies the UE which events should trigger the UE to send a MEASUREMENT REPORT message. The listed events are the toolbox from which the UTRAN can choose the reporting events that are needed for the implemented handover evaluation function, or other radio network functions.

All events are measured with respect to one of the measurement quantities given in subclause 14.3.0a, and of the frequency quality estimate given in subclause 14.3.0b. For UTRAN the measurement quantities are measured on the monitored primary common pilot channels (CPICH) in FDD mode and the monitored primary common control channels (PCCPCH) in TDD mode of the cell defined in the measurement object. For other RATs the measurement quantities are system-specific. A "used UTRAN frequency" is a frequency that the UE have been ordered to measure upon and is also currently used for the connection to UTRAN. "Other system" is e.g. GSM.

In the text below describing the events:

- "The BCCH ARFCN and BSIC combinations considered in that inter-RAT measurement" shall be understood as the BCCH ARFCN and BSIC combinations of the inter-RAT cells pointed at in the IE "Cells for measurement" if it has been received for that inter-RAT measurement, or otherwise of the cells included in the "inter-RAT cell info" part of the variable CELL_INFO LIST.
- "The BCCH ARFCNs considered in that inter-RAT measurement" shall be understood as the BCCH ARFCNs of the inter-RAT cells pointed at in the IE "Cells for measurement" if it has been received for that inter-RAT measurement, or otherwise of the cells included in the "inter-RAT cell info" part of the variable CELL_INFO LIST.

When one inter-RAT measurement identity corresponds to multiple inter-RAT events with identical event identities, the UE behaviour is not specified.

14.3.1.1 Event 3a: The estimated quality of the currently used UTRAN frequency is below a certain threshold **and** the estimated quality of the other system is above a certain threshold.

When an inter-RAT measurement configuring event 3a is set up, the UE shall:

- 1> create a variable TRIGGERED_3A_EVENT related to that measurement, which shall initially be empty;
- 1> delete this variable when the measurement is released.

When event 3a is configured in the UE within a measurement, the UE shall:

- 1> if the other RAT is GSM, and if IE "BSIC verification required" is set to "required":
 - 2> if equations 1 and 2 below have both been fulfilled for a time period indicated by "Time to trigger" from the same instant, respectively for the used UTRAN frequency and for one or several GSM cells that match any of the BCCH ARFCN and BSIC combinations considered in that inter-RAT measurement:
 - 3> if the Inter-RAT cell id of any of those GSM cells is not stored in the variable TRIGGERED_3A_EVENT:
 - 4> store the Inter-RAT cell ids of the GSM cells that triggered the event and that were not previously stored in the variable TRIGGERED_3A_EVENT into that variable.
 - 4> send a measurement report with IEs set as below:
 - 5> in "inter-RAT measurement event result": "inter-RAT event identity" to "3a", "CHOICE BSIC" to "verified BSIC" and "Inter-RAT cell id" to the GSM cells that triggered the event (best one first), taking into account the cell individual offset of the GSM cells;
 - 5> "measured results" and possible "additional measured results" according to subclause 8.6.7.5 and 8.4.2, respectively, not taking into account the cell individual offset.
 - 2> if equation 4 is fulfilled for a GSM cell whose inter-RAT cell id is stored in the variable TRIGGERED_3A_EVENT:
 - 3> remove the inter-RAT cell id of that GSM cell from the variable TRIGGERED_3A_EVENT.
 - 2> if equation 3 is fulfilled for the used frequency in UTRAN:
 - 3> clear the variable TRIGGERED_3A_EVENT.- 1> if the other RAT is GSM, and if IE "BSIC verification required" is set to "not required":
 - 2> if equations 1 and 2 below have been fulfilled for a time period indicated by "Time to trigger" from the same instant, respectively for the used UTRAN frequency and for one or several BCCH ARFCNs considered in that inter-RAT measurement:
 - 3> if any of those BCCH ARFCNs is not stored into the variable TRIGGERED_3A_EVENT:
 - 4> store the BCCH ARFCNs that triggered the event and that were not previously stored in the variable TRIGGERED_3A_EVENT into that variable;
 - 4> send a measurement report with IEs set as below:
 - 5> in "inter-RAT measurement event result": "inter-RAT event identity" to "3a", "CHOICE BSIC" to "non verified BSIC" and "BCCH ARFCN" to BCCH ARFCNs that triggered the event (best one first), taking into account the cell individual offset of the GSM cells;
 - 5> "measured results" and possible "additional measured results" according to subclause 8.6.7.5 and 8.4.2, respectively, not taking into account the cell individual offset.
 - 2> if equation 4 is fulfilled for a BCCH ARFCN that is stored in the variable TRIGGERED_3A_EVENT:

3> remove that BCCH ARFCN from the variable TRIGGERED_3A_EVENT.

2> if equation 3 is fulfilled for the used frequency in UTRAN:

3> clear the variable TRIGGERED_3A_EVENT.

Triggering conditions:

Equation 1:

$$Q_{Used} \leq T_{Used} - H_{3a} / 2$$

The variables in the formula are defined as follows:

Q_{Used} is the quality estimate of the used UTRAN frequency.

T_{Used} is the absolute threshold that applies for the used frequency in that measurement.

H_{3a} is the hysteresis parameter for event 3a.

Equation 2:

$$M_{Other RAT} + CIO_{Other RAT} \geq T_{Other RAT} + H_{3a} / 2$$

The variables in the formula are defined as follows:

$M_{Other RAT}$ is the measurement quantity for the cell of the other system.

$CIO_{Other RAT}$ is the cell individual offset for the cell of the other system.

$T_{Other RAT}$ is the absolute threshold that applies for the other system in that measurement.

H_{3a} is the hysteresis parameter for event 3a.

Leaving triggered state conditions:

Equation 3:

$$Q_{Used} > T_{Used} + H_{3a} / 2$$

The variables in the formula are defined as follows:

Q_{Used} is the quality estimate of the used UTRAN frequency.

T_{Used} is the absolute threshold that applies for the used frequency in that measurement.

H_{3a} is the hysteresis parameter for event 3a.

Equation 4:

$$M_{Other RAT} + CIO_{Other RAT} < T_{Other RAT} - H_{3a} / 2$$

The variables in the formula are defined as follows:

$M_{Other RAT}$ is the measurement quantity for the cell of the other system. $M_{Other RAT}$ is expressed in dBm.

$CIO_{Other RAT}$ is the cell individual offset for the cell of the other system.

$T_{Other RAT}$ is the absolute threshold that applies for the other system in that measurement.

H_{3a} is the hysteresis parameter for event 3a.

14.3.1.2 Event 3b: The estimated quality of other system is below a certain threshold

When an inter-RAT measurement configuring event 3b is set up, the UE shall:

- 1> create a variable TRIGGERED_3B_EVENT related to that measurement, which shall initially be empty;
- 1> delete this variable when the measurement is released.

When event 3b is configured in the UE within a measurement, the UE shall:

- 1> if the other RAT is GSM, and if IE "BSIC verification required" is set to "required":
 - 2> if equation 1 below has been fulfilled for a time period indicated by "time to trigger" for one or several GSM cells that match any of the BCCH ARFCN and BSIC combinations considered in that inter-RAT measurement:
 - 3> if the inter-RAT cell id of any of those GSM cell is not stored in the variable TRIGGERED_3B_EVENT:
 - 4> store the inter-RAT cell ids of the GSM cells that triggered the event and that were not previously stored in the variable TRIGGERED_3B_EVENT into that variable;
 - 4> send a measurement report with IEs set as below:
 - 5> set in "inter-RAT measurement event result": "inter-RAT event identity" to "3b", "CHOICE BSIC" to "verified BSIC" and "Inter-RAT cell id" to the GSM cells that triggered the event (worst one first), taking into account the cell individual offset of the GSM cells;
 - 5> set the IE "measured results" and the IE "additional measured results" according to subclause 8.6.7.5 and 8.4.2, respectively, not taking into account the cell individual offset.
 - 2> if equation 2 below is fulfilled for a GSM cell whose inter-RAT cell id is stored in the variable TRIGGERED_3B_EVENT:
 - 3> remove the inter-RAT cell id of that GSM cell from the variable TRIGGERED_3B_EVENT.
- 1> if the other RAT is GSM, and if IE "BSIC verification required" is set to "not required":
 - 2> if equation 1 below has been fulfilled for a time period indicated by "time to trigger" for one or several of the BCCH ARFCNs considered in that inter-RAT measurement:
 - 3> if any of those BCCH ARFCN is not stored into the variable TRIGGERED_3B_EVENT:
 - 4> store the BCCH ARFCNs that triggered the event and that were not previously stored in the variable TRIGGERED_3B_EVENT into that variable;
 - 4> send a measurement report with IEs set as below:
 - 5> set in "inter-RAT measurement event result": "inter-RAT event identity" to "3b", "CHOICE BSIC" to "non verified BSIC" and "BCCH ARFCN" to BCCH ARFCNs that triggered the event (worst one first), taking into account the cell individual offset of the GSM cells;
 - 5> set the IE "measured results" and the IE "additional measured results" according to subclause 8.6.7.5 and 8.4.2, respectively, not taking into account the cell individual offset.
 - 2> if equation 2 below is fulfilled for a BCCH ARFCN that is stored in the variable TRIGGERED_3B_EVENT:
 - 3> remove that BCCH ARFCN from the variable TRIGGERED_3B_EVENT.

Triggering condition:

Equation 1:

$$M_{Other\ RAT} + CIO_{Other\ RAT} \leq T_{Other\ RAT} - H_{3b} / 2$$

The variables in the formula are defined as follows:

$M_{Other\ RAT}$ is the measurement quantity for the cell of the other system.

$CIO_{Other\ RAT}$ is the cell individual offset for the cell of the other system.

$T_{Other\ RAT}$ is the absolute threshold that applies for the other system in that measurement.

H_{3b} is the hysteresis parameter for event 3b.

Leaving triggered state condition:

Equation 2:

$$M_{Other\ RAT} + CIO_{Other\ RAT} > T_{Other\ RAT} + H_{3b}/2$$

The variables in the formula are defined as follows:

$M_{Other\ RAT}$ is the measurement quantity for the cell of the other system. $M_{Other\ RAT}$ is expressed in dBm.

$CIO_{Other\ RAT}$ is the cell individual offset for the cell of the other system.

$T_{Other\ RAT}$ is the absolute threshold that applies for the other system in that measurement.

H_{3b} is the hysteresis parameter for event 3b.

14.3.1.3 Event 3c: The estimated quality of other system is above a certain threshold

When an inter-RAT measurement configuring event 3c is set up, the UE shall:

- 1> create a variable TRIGGERED_3C_EVENT related to that measurement, which shall initially be empty;
- 1> delete this variable when the measurement is released.

When event 3c is configured in the UE within a measurement, the UE shall:

- 1> if the other RAT is GSM, and if IE "BSIC verification required" is set to "required":
 - 2> if equation 1 below has been fulfilled for a time period indicated by "time to trigger" for one or several GSM cells that match any of the BCCH ARFCN and BSIC combinations considered in that inter-RAT measurement:
 - 3> if the inter-RAT cell id of any of those GSM cell is not stored in the variable TRIGGERED_3C_EVENT:
 - 4> store the Inter-RAT cell ids of the GSM cells that triggered the event and that were not previously stored in the variable TRIGGERED_3C_EVENT into that variable;
 - 4> send a measurement report with IEs set as below:
 - 5> set in "inter-RAT measurement event result": "inter-RAT event identity" to "3c", "CHOICE BSIC" to "verified BSIC" and "Inter-RAT cell id" to the GSM cells that triggered the event (best one first), taking into account the cell individual offset of the GSM cells;
 - 5> set the IE "measured results" and the IE "additional measured results" according to subclause 8.6.7.5 and 8.4.2, respectively, not taking into account the cell individual offset.
 - 2> if equation 2 below is fulfilled for a GSM cell whose inter-RAT cell id is stored in the variable TRIGGERED_3C_EVENT:
 - 3> remove the inter-RAT cell id of that GSM cell from the variable TRIGGERED_3C_EVENT.
- 1> if the other RAT is GSM, and if IE "BSIC verification required" is set to "not required":
 - 2> if equation 1 below has been fulfilled for a time period indicated by "time to trigger" for one or several of the BCCH ARFCNs considered in that inter-RAT measurement:
 - 3> if any of those BCCH ARFCN is not stored into the variable TRIGGERED_3C_EVENT:
 - 4> store the BCCH ARFCNs that triggered the event and that were not previously stored in the variable TRIGGERED_3C_EVENT into that variable;
 - 4> send a measurement report with IEs set as below:

5> set in "inter-RAT measurement event result": "inter-RAT event identity" to "3c", "CHOICE BSIC" to "non verified BSIC" and "BCCH ARFCN" to BCCH ARFCNs that triggered the event (best one first), taking into account the cell individual offset of the GSM cells;

5> set the IE "measured results" and the IE "additional measured results" according to subclause 8.6.7.5 and 8.4.2, respectively, not taking into account the cell individual offset.

2> if equation 2 is fulfilled for a BCCH ARFCN that is stored in the variable TRIGGERED_3C_EVENT:

3> remove that BCCH ARFCN from the variable TRIGGERED_3C_EVENT.

Triggering condition:

Equation 1:

$$M_{Other\ RAT} + CIO_{Other\ RAT} \geq T_{Other\ RAT} + H_{3c}/2$$

The variables in the formula are defined as follows:

$M_{Other\ RAT}$ is the measurement quantity for the cell of the other system. $M_{Other\ RAT}$ is expressed in dBm.

$CIO_{Other\ RAT}$ is the cell individual offset for the cell of the other system.

$T_{Other\ RAT}$ is the absolute threshold that applies for the other system in that measurement.

H_{3c} is the hysteresis parameter for event 3c.

Leaving triggered state condition:

Equation 2:

$$M_{Other\ RAT} + CIO_{Other\ RAT} < T_{Other\ RAT} - H_{3c}/2$$

The variables in the formula are defined as follows:

$M_{Other\ RAT}$ is the measurement quantity for the cell of the other system. $M_{Other\ RAT}$ is expressed in dBm.

$CIO_{Other\ RAT}$ is the cell individual offset for the cell of the other system.

$T_{Other\ RAT}$ is the absolute threshold that applies for the other system in that measurement.

H_{3c} is the hysteresis parameter for event 3c.

14.3.1.4 Event 3d: Change of best cell in other system

When an inter-RAT measurement configuring event 3d is set up, the UE shall:

- 1> create a variable BEST_CELL_3D_EVENT related to that measurement;
- 1> delete this variable when the measurement is released.

When event 3d is configured in the UE within a measurement, the UE shall:

- 1> if the other RAT is GSM, and if IE "BSIC verification required" is set to "required":
 - 2> when the measurement is initiated or resumed:
 - 3> store in the variable BEST_CELL_3D_EVENT the Inter-RAT cell id of the GSM cell that has the best measured quantity among the GSM cells that match any of the BCCH ARFCN and BSIC combinations considered in that inter-RAT measurement, not taking into account the cell individual offset of the GSM cells;
 - 3> send a measurement report with IE set as below:

- 4> set in "inter-RAT measurement event result": "inter-RAT event identity" to "3d", "CHOICE BSIC" to "verified BSIC" and "Inter-RAT cell id" to the GSM cell that is stored in the variable BEST_CELL_3D_EVENT;
 - 4> set the IE "measured results" and the IE "additional measured results" according to subclause 8.6.7.5 and 8.4.2, respectively, not taking into account the cell individual offset.
- 2> if equation 1 has been fulfilled for a time period indicated by "time to trigger" for a GSM cell that is different from the one stored in BEST_CELL_3D_EVENT and that matches any of the BCCH ARFCN and BSIC combinations considered in that inter-RAT measurement:
- 3> store the Inter-RAT cell id of that GSM cell in the variable BEST_CELL_3D_EVENT;
 - 3> send a measurement report with IEs set as below:
 - 4> set in "inter-RAT measurement event result": "inter-RAT event identity" to "3d", "CHOICE BSIC" to "verified BSIC" and "Inter-RAT cell id" to the GSM cell is now stored in BEST_CELL_3D_EVENT;
 - 4> set the IE "measured results" and the IE "additional measured results" according to subclause 8.6.7.5 and 8.4.2, respectively, not taking into account the cell individual offset.
- 1> if the other RAT is GSM, and if IE "BSIC verification required" is set to "not required":
- 2> when the measurement is initiated or resumed:
 - 3> store in the variable BEST_CELL_3D_EVENT the BCCH ARFCN of the GSM cell that has the best measured quantity among the BCCH ARFCNs considered in that inter-RAT measurement;
 - 3> send a measurement report with IE set as below:
 - 4> set in "inter-RAT measurement event result": "inter-RAT event identity" to "3d", "CHOICE BSIC" to "non verified BSIC" and "BCCH ARFCN" to the BCH ARFCN that is stored in the variable BEST_CELL_3D_EVENT;
 - 4> set the IE "measured results" and the IE "additional measured results" according to subclause 8.6.7.5 and 8.4.2, respectively, not taking into account the cell individual offset.
 - 2> if equation 1 below has been fulfilled for a time period indicated by "time to trigger" for one of the BCCH ARFCNs considered in that inter-RAT measurement and different from the one stored in BEST_CELL_3D_EVENT:
 - 3> store the BCCH ARFCN of that GSM cell in the variable BEST_CELL_3D_EVENT;
 - 3> send a measurement report with IEs set as below:
 - 4> set in "inter-RAT measurement event result": "inter-RAT event identity" to "3d", "CHOICE BSIC" to "non verified BSIC" and "BCCH ARFCN" to the BCCH ARFCN that is now stored in the variable BEST_CELL_3D_EVENT;
 - 4> set the IE "measured results" and the IE "additional measured results" according to subclause 8.4.2, not taking into account the cell individual offset.

Equation 1:

$$M_{New} \geq M_{Best} + H_{3d} / 2$$

The variables in the formula are defined as follows:

M_{New} is the measurement quantity for a GSM cell that is not stored in the variable BEST_CELL_3D_EVENT.

M_{Best} is the measurement quantity for a GSM cell that is stored in the variable BEST_CELL_3D_EVENT.

H_{3d} is the hysteresis parameter for event 3d.

14.3.2 GSM measurements in compressed mode

14.3.2.1 GSM RSSI measurements

The UE shall perform GSM RSSI measurements in the gaps of compressed mode pattern sequence specified for GSM RSSI measurement purpose.

14.3.2.2 Initial BSIC identification

The UE shall perform Initial BSIC identification in compressed mode pattern sequence specified for Initial BSIC identification measurement purpose.

The parameter "N identify abort" in the IE "DPCH compressed mode info" indicates the maximum number of patterns that the UE shall use to attempt to decode the unknown BSIC of the GSM cell in the initial BSIC identification procedure.

The BSIC identification procedure is defined in detail in [19].

14.3.2.3 BSIC re-confirmation

The UE shall perform BSIC re-confirmation in compressed mode pattern sequence specified for BSIC re-confirmation measurement purpose.

The parameter "T reconfirm abort" in the IE "DPCH compressed mode info" indicates the maximum time allowed for the re-confirmation of the BSIC of one GSM cell in the BSIC re-confirmation procedure.

The BSIC re-confirmation procedure is defined in detail in [19].

14.4 Traffic Volume Measurements

14.4.1 Traffic Volume Measurement Quantity

Traffic volume measurements may be configured by RRC to assist with dynamic radio bearer control. The reported quantities that can be configured are:

- 1 Buffer Occupancy.
- 2 Average of Buffer Occupancy.
- 3 Variance of Buffer Occupancy.

A description of these values can be found in [15].

When a report is triggered, the UE shall provide the requested quantities for the acknowledged and unacknowledged mode RBs mapped onto the transport channels identified.

When the RLC buffer payload, Average of RLC buffer payload or Variance of RLC buffer payload is reported, the measured quantity shall be rounded upwards to the closest higher value possible to report. When the measured quantity is over the highest value possible to report, it shall be set to the highest value.

14.4.2 Traffic Volume reporting triggers

Traffic volume measurement reports can be triggered using two different mechanisms, periodical and event triggered. The reporting criteria are specified in the measurement control message.

All the specified events are evaluated with respect to the Transport Channel Traffic Volume (TCTV). This quantity is equal to the sum of the Buffer Occupancy for all logical channels mapped onto a transport channel. The events on a given transport channel shall be evaluated at least at every TTI (may be more often) as described in [15].

When one traffic volume measurement identity corresponds to multiple traffic volume events with identical event identities for the same transport channel, the UE behaviour is not specified.

When a traffic volume measurement is set up, the UE shall:

- 1> if the IE "report criteria" is set to "Traffic volume measurement reporting criteria":
 - 2> for each IE "Parameters sent for each transport channel":
 - 3> if the IE "Uplink transport channel type" is not included; or
 - 3> if the IE "Uplink Transport Channel Type" has the value "DCH" or "USCH" and the IE "UL transport channel id" is not included:
 - 4> for each IE "Parameters required for each Event":
 - 5> for each uplink transport channel on which the UE is supposed to report (see below):
 - 6> configure an event trigger defined by the values in the IEs "Measurement Identity", "Traffic volume event identity", "Reporting threshold", "Time to trigger", "Pending time after trigger" and "Tx Interruption after trigger".
 - 3> else:
 - 4> for each IE "Parameters required for each Event":
 - 5> for the uplink transport channel defined by the IEs "Uplink transport channel type" and "UL transport channel id":
 - 6> configure an event trigger defined by the values in the IEs "Measurement Identity", "Traffic volume event identity", "Reporting threshold", "Time to trigger", "Pending time after trigger" and "Tx Interruption after trigger".
 - 1> else:
 - 2> if the IE "report criteria" is set to "Periodical reporting criteria":
 - 2> configure periodical triggers with period equal to the value in the IE "Reporting Interval" and with number of transmissions equal to the value in the IE "Amount of reporting" for the measurement identified by the IE "Measurement Identity".

For each transport channel for which an event trigger has been configured, the UE shall:

- 1> for each event configured for this transport channel:
 - 2> if the TCTV is larger than the threshold in IE "Reporting threshold" at TVM setup or modify; or
 - 2> if the TCTV becomes larger than the threshold in IE "Reporting threshold" while the event is configured:
 - 3> if the IE "Traffic volume event identity" has value "4a":
 - 4> if the IE "Time to trigger" is not present; and
 - 4> if the Pending-time-after-trigger timer for this event is not active:
 - 5> if the IE "Pending time after trigger" is included:
 - 6> start the Pending-time-after-trigger timer for this event with the value in this IE.
 - 5> trigger a report for the measurement identified by the IE "Measurement Identity".
 - 4> else:
 - 5> start the Time-to-trigger timer for this event with the value in the IE "Time to trigger".
 - 3> if the IE "Traffic volume event identity" has value "4b":
 - 4> if the Time-to-trigger timer for this event is active:
 - 5> stop this timer.

- 2> if the TCTV is smaller than the threshold in IE "Reporting threshold" at TVM setup or modify; or
- 2> if the TCTV becomes smaller than the threshold in IE "Reporting threshold" while the event is configured:
 - 3> if the IE "Traffic volume event identity" has value "4a":
 - 4> if the Time-to-trigger timer for this event is active:
 - 5> stop this timer.
 - 3> if the IE "Traffic volume event identity" has value "4b":
 - 4> if the IE "Time to trigger" is not present; and
 - 4> if the Pending-time-after-trigger timer for this event is not active:
 - 5> if the IE "Pending time after trigger" is included:
 - 6> start the Pending-time-after-trigger timer for this event with the value in this IE.
 - 5> trigger a report for the measurement identified by the IE "Measurement Identity".
 - 4> else:
 - 5> start the Time-to-trigger timer for this event with the value in the IE "Time to trigger".

When the Time-to-trigger timer for an event elapses:

- 1> if the Pending-time-after-trigger timer for this event is not active:
 - 2> trigger a report for the measurement identified by the IE "Measurement Identity" corresponding to this event;
- 2> if the IE "Pending time after trigger" is included:
 - 3> start the Pending-time-after-trigger timer for this event with the value in this IE.

When the Pending-time-after-trigger for an event elapses:

- 1> if the IE "Traffic volume event identity" has value "4a":
 - 2> if the TCTV is larger than the threshold in IE "Reporting threshold":
 - 3> if the IE "Time to trigger" is not present:
 - 4> trigger a report for the measurement identified by the IE "Measurement Identity" corresponding to this event;
 - 4> start the Pending-time-after-trigger timer for this event with the value in the IE "Pending time after trigger".
 - 3> else:
 - 4> start the Time-to-trigger timer for this event with the value in the IE "Time to trigger".
- 1> if the IE "Traffic volume event identity" has value "4b":
 - 2> if the TCTV is smaller than the threshold in IE "Reporting threshold":
 - 3> if the IE "Time to trigger" is not present:
 - 4> trigger a report for the measurement identified by the IE "Measurement Identity" corresponding to this event;
 - 4> start the Pending-time-after-trigger timer for this event with the value in the IE "Pending time after trigger".
 - 3> else:
 - 4> start the Time-to-trigger timer for this event with the value in the IE "Time to trigger".

When a periodical trigger elapses, the UE shall:

- 1> trigger a report for the measurement identified by the IE "Measurement Identity";
- 1> if the number of reports triggered by this periodical trigger reaches the value in the IE "Amount of reporting":
 - 2> disable this periodical trigger.

When a report is triggered for a given IE "Measurement Identity", the UE shall:

- 1> consider the variable MEASUREMENT_IDENTITY corresponding to this measurement identity;
- 1> if the report is triggered by an event trigger:
 - 2> include the IE "Event results";
 - 2> set the IE "Uplink transport channel type causing the event" to the type of the transport channel which triggered the report;
 - 2> if the transport channel type is "DCH" or "USCH":
 - 3> include the IE "UL Transport Channel identity" and set it to the identity of the transport channel which triggered the report.
 - 2> else:
 - 3> not include the IE "UL Transport Channel identity".
 - 2> set the IE "Traffic volume event identity" to the identity of the event that triggered the report;
 - 2> if the IE "Tx interruption after trigger" for the event that triggered the report is included:
 - 3> if the UE is in CELL_FACH state:
 - 4> prohibit DTCH transmissions on the RACH;
 - 4> if the Tx interruption timer is not running; or
 - 4> if the Tx interruption timer is running and still has a value larger than the IE "Tx interruption after trigger" for the event, i.e. it was started earlier by another event with a larger value in IE "Tx interruption after trigger":
 - 5> start the Tx interruption timer with the value in the IE "Tx interruption after trigger" for this event.
 - 4> when it receives from the UTRAN a message causing the transition to CELL_DCH state; or
 - 4> when the Tx interruption timer elapses:
 - 5> stop the timer;
 - 5> resume these transmissions.
- 1> if the IE "Traffic volume measurement object" is not included:
 - 2> report on all the uplink transport channels as specified below.
- 1> if the IE "Traffic volume measurement object" is included:
 - 2> report on the uplink transport channels identified in this IE as specified below.
- 1> for each UM or AM RB mapped onto a transport channel on which the UE is expected to report:
 - 2> add an element in the IE "Traffic volume measurement results";
 - 2> set the value of the IE "RB Identity" to the identity of the considered radio bearer;
 - 2> if the RB is mapped onto one logical channel:
 - 3> if the IE "RLC Buffer Payload for each RB" is set to TRUE:

- 4> include the IE "RLC Buffers Payload" and set it to the Buffer Occupancy value for this logical channel, rounded up to the next allowed value.
- 3> if the IE "Average of RLC Buffer Payload for each RB" is set to TRUE:
 - 4> include and set the IE "Average of RLC Buffer Payload" to the Buffer Occupancy for this logical channel averaged over the interval specified in the IE "Time Interval to take an average or a variance" (see [15]), rounded up to the next allowed value.
- 3> if the IE "Variance of RLC Buffer Payload for each RB" is set to TRUE:
 - 4> include and set the IE "Variance of RLC Buffer Payload" to the variance of the Buffer Occupancy for this logical channel computed over the interval specified in the IE "Time Interval to take an average or a variance" (see [15]), rounded up to the next allowed value.
- 2> if the RB is mapped onto two logical channels:
 - 3> if one logical channel is mapped onto transport channels on which the UE is supposed to report:
 - 4> if the IE "RLC Buffer Payload for each RB" is set to TRUE:
 - 5> include and set the IE "RLC Buffers Payload" to the Buffer Occupancy value for this logical channel, rounded up to the next allowed value.
 - 4> if the IE "Average of RLC Buffer Payload for each RB" is set to TRUE:
 - 5> include and set the IE "Average of RLC Buffer Payload" to the Buffer Occupancy for this logical channel averaged over the interval specified in the IE "Time Interval to take an average or a variance" (see [15]), rounded up to the next allowed value.
 - 4> if the IE "Variance of RLC Buffer Payload for each RB" is set to TRUE:
 - 5> include and set the IE "Variance of RLC Buffer Payload" to the variance of the Buffer Occupancy for this logical channel computed over the interval specified in the IE "Time Interval to take an average or a variance" (see [15]), rounded up to the next allowed value.
 - 3> if both logical channels are mapped onto transport channels on which the UE is supposed to report:
 - 4> if the IE "RLC Buffer Payload for each RB" is set to TRUE:
 - 5> include and set the IE "RLC Buffers Payload" to the sum of the Buffer Occupancy values for the two logical channels, rounded up to the next allowed value.
 - 4> if the IE "Average of RLC Buffer Payload for each RB" is set to TRUE:
 - 5> include and set the IE "Average of RLC Buffer Payload" to the sum of the Buffer Occupancy for the two logical channels averaged over the interval specified in the IE "Time Interval to take an average or a variance" (see [15]) and rounded up to the next allowed value.
 - 4> if the IE "Variance of RLC Buffer Payload for each RB" is set to TRUE:
 - 5> include and set the IE "Variance of RLC Buffer Payload" to the variance of the sum of the Buffer Occupancy for the two logical channels, computed over the interval specified in the IE "Time Interval to take an average or a variance" (see [15]) and rounded up to the next allowed value.

14.4.2.1 Reporting event 4 A: Transport Channel Traffic Volume becomes larger than an absolute threshold

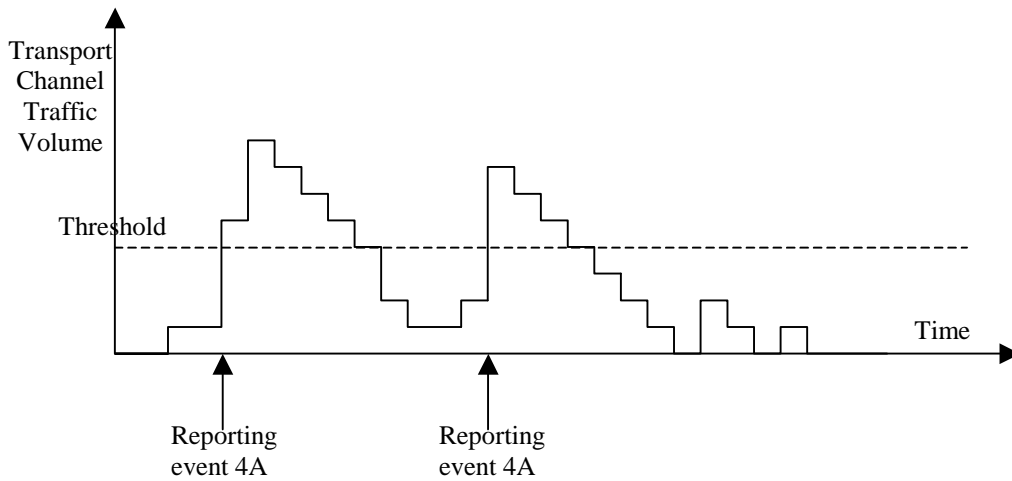

Figure 14.4.2.1-1: Event triggered report when Transport Channel Traffic Volume becomes larger than a certain threshold

If the monitored Transport Channel Traffic Volume (TCTV) [15] is larger than an absolute threshold at TVM setup or modify, or is larger at activation of the monitored transport channel, or becomes larger than an absolute threshold while the event is configured i.e. if $TCTV > \text{Reporting threshold}$, this event could trigger a report. The event could be triggered again only if TCTV becomes smaller than the Reporting threshold and later $TCTV > \text{Reporting threshold}$ is verified again.

14.4.2.2 Reporting event 4 B: Transport Channel Traffic Volume becomes smaller than an absolute threshold

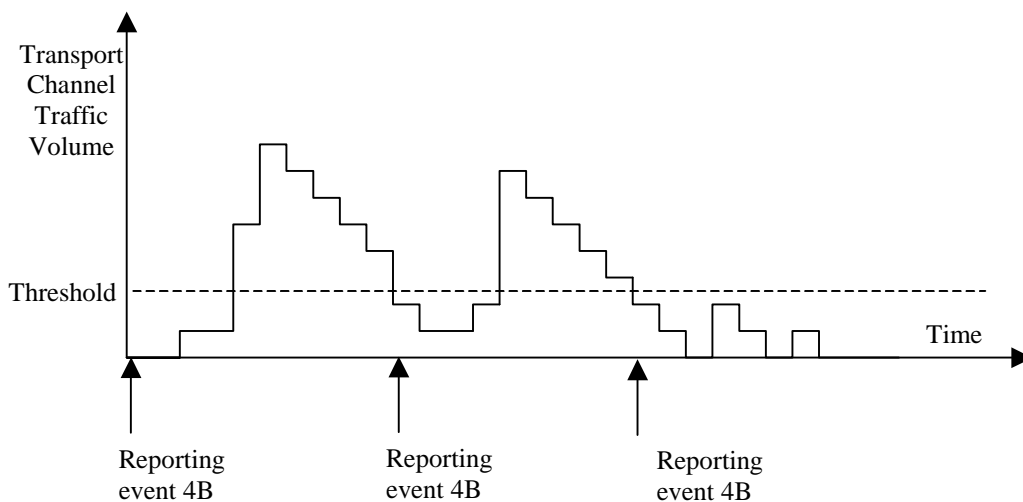

Figure 14.4.2.1-2: Event triggered report when Transport Channel Traffic Volume becomes smaller than certain threshold

If the monitored Transport Channel Traffic Volume (TCTV) [15] is smaller than an absolute threshold at TVM setup or modify, or is smaller at activation of the monitored transport channel, or becomes smaller than an absolute threshold while the event is configured i.e. if $TCTV < \text{Reporting threshold}$, this event could trigger a report. The event could be triggered again only if TCTV becomes bigger than the Reporting threshold and later $TCTV < \text{Reporting threshold}$ is verified again.

14.4.3 Traffic volume reporting mechanisms

Traffic volume measurement triggering could be associated with both a *time-to-trigger* and a *pending time after trigger*. The time-to-trigger is used to get time domain hysteresis, i.e. the condition must be fulfilled during the time-to-trigger time before a report is sent. Pending time after trigger is used to limit consecutive reports when one traffic volume measurement report already has been sent and enables periodic reporting while the TCTV remains above(4a) or below(4b) the threshold. This is described in detail below.

14.4.3.1 Pending time after trigger

This timer is started in the UE when a measurement report has been triggered by a given event. The UE is then forbidden to send new measurement reports triggered by the same event during this time period. Instead the UE waits until the timer has expired. If the Transport Channel Traffic Volume [15] is still above the threshold for event 4a, or below the threshold for event 4b when the timer expires, the UE sends a new measurement report, and the timer is restarted. Otherwise it waits for a new triggering.

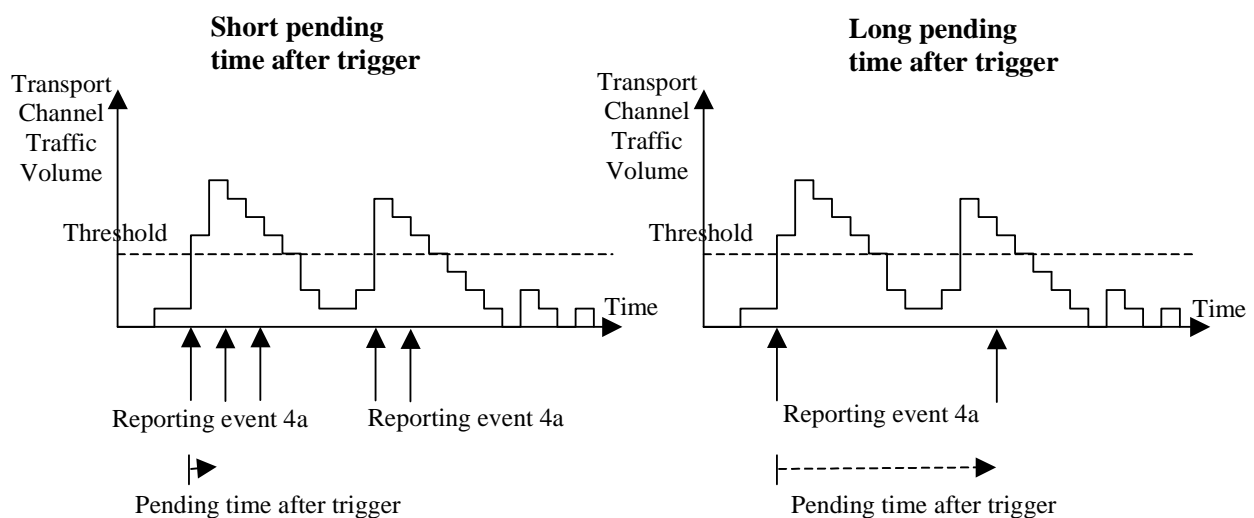

Figure 14.4.3.1-1: Pending time after trigger limits the amount of consecutive measurement reports

Figure 14.4.3.1-1 shows that by increasing the pending time after trigger a triggered second event does not result in a measurement report. The figure assumes absence of the IE "Time to trigger".

14.4.3.2 Time-to-trigger

The timer is started in the UE when the Transport Channel Traffic Volume triggers the event. If the TCTV crosses the threshold before the timer expires, the timer is stopped. If the timer expires then a report is triggered.

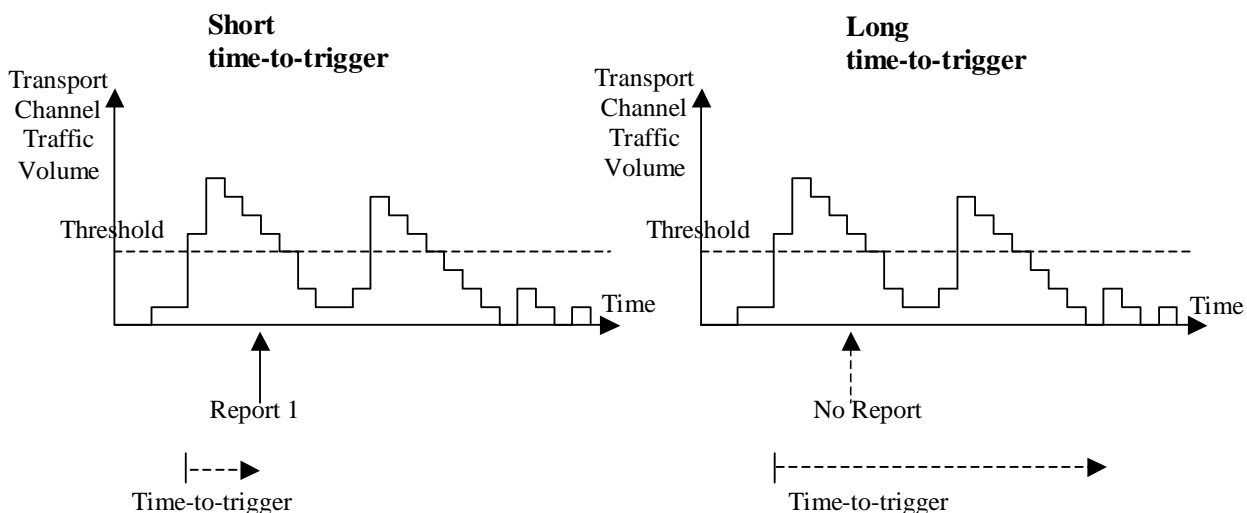

Figure 14.4.3.1-2: Time-to-trigger is used to achieve time hysteresis

Figure 14.4.3.1-2 shows that by increasing the time-to-trigger the report is not triggered.

14.4.4 Interruption of user data transmission

By including the IE "Tx Interruption after trigger", a UE in CELL_FACH state may be instructed by the UTRAN to prohibit transmission of user data on the RACH temporarily after a measurement report has been triggered.

The UE shall only resume transmission of user data, when:

- 1> it receives from the UTRAN a message allocating a dedicated physical channel, leading to the transition to CELL_DCH state; or
- 1> the time period indicated by the IE "Tx Interruption after trigger" elapses.

The transmission on signalling radio bearers shall not be interrupted.

14.5 Quality Measurements

14.5.1 Quality reporting measurement quantities

For quality measurements, the following measurement quantities are used:

1. Downlink transport channel BLER
2. Timeslot SIR (TDD only)

14.5.2 Quality reporting events

When one measurement identity corresponds to multiple quality events for the same transport channel, the UE behaviour is not specified.

14.5.2.1 Reporting event 5A: A predefined number of bad CRCs is exceeded

When this event is ordered by UTRAN in a measurement control message, the UE shall send a measurement report when the amount of bad CRCs during a predefined sliding window exceeds a predefined number.

The following three parameters are used in the scheme:

- **Total CRC** = the length of the sliding window over which the number of bad CRCs are counted.

- **Bad CRC** = the number of bad CRC that is required within the latest "Total CRC" received CRCs for the event to be triggered.
- **Pending after trigger** = a new event can not be triggered until "Pending after trigger" CRCs have been received,

When a DCH is established, the UE shall begin to count the number of bad CRCs within the last "Total CRC" received CRCs. No event can be triggered until at least "Total CRC" CRCs have been received. For each new received CRC, the UE shall compare the number of bad CRCs within the latest "Total CRC" received CRCs with the parameter "Bad CRC". An event shall be triggered if the number of bad CRCs is equal or larger than "Bad CRC".

At the time when the event is triggered a pending time after trigger timer is started with the length of "Pending after trigger" CRCs. A new event can not be triggered until "Pending after trigger" CRCs have been received. When "Pending after trigger" CRCs have been received the event evaluation start again and a new event can be triggered.

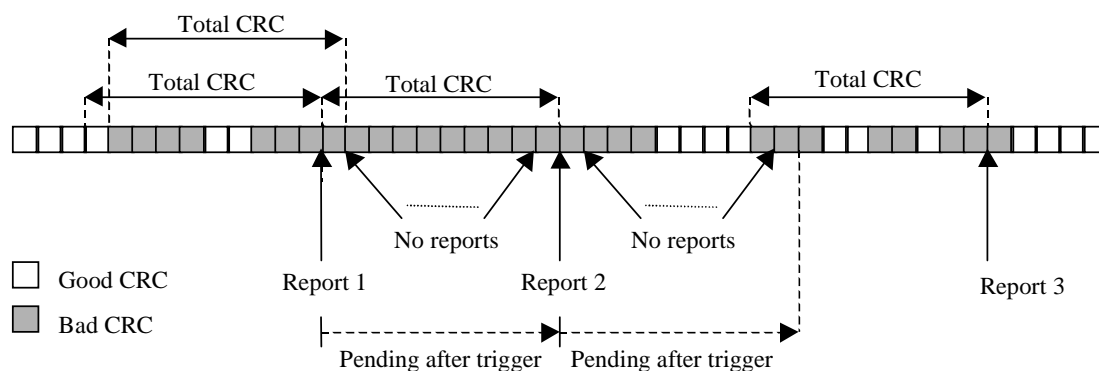

Figure 14.5.2.1-1: Event triggered CRC error reporting

14.6 UE internal measurements

14.6.1 UE internal measurement quantities

For UE internal measurements the following measurement quantities exist:

1. UE transmission (Tx) power, for TDD measured on a timeslot basis.
2. UE received signal strength power (RSSI).
3. UE Rx-Tx time difference (FDD only).
4. T_{ADV} (1.28 Mcps TDD).

14.6.2 UE internal measurement reporting events

In the Measurement reporting criteria field in the Measurement Control messages, the UTRAN notifies the UE of which events should trigger a measurement report. UE internal measurement reporting events that can trigger a report are given below. The reporting events are marked with vertical arrows in the figures below. All events can be combined with time-to-trigger.

NOTE: The reporting events are numbered 6A, 6B, 6C,... where 6 denotes that the event belongs to the type UE internal measurements.

When one measurement identity corresponds to multiple internal events with identical event identities, the UE behaviour is not defined.

14.6.2.1 Reporting event 6A: The UE Tx power becomes larger than an absolute threshold

When a UE internal measurement configuring event 6a is set up, the UE shall:

- 1> create a variable TRIGGERED_6A_EVENT related to that measurement, which shall initially be set to FALSE;
- 1> delete this variable when the measurement is released.

When this event is ordered by UTRAN in a measurement control message, the UE shall:

- 1> if the UE Tx power (for TDD within a single TS) is greater than the value in IE "UE Transmitted Power Tx power threshold" stored for this event in the variable MEASUREMENT_IDENTITY for a time period indicated by the IE "time_to_trigger":
 - 2> if the variable TRIGGERED_6A_EVENT is set to FALSE:
 - 3> set the variable TRIGGERED_6A_EVENT to TRUE;
 - 3> send a measurement report with IEs set as below:
 - 4> set in "UE internal measurement event results": "UE internal event identity" to "6a";
 - 4> set the IE "measured results" and the IE "additional measured results" according to 8.4.2.
 - 1> if the variable TRIGGERED_6A_EVENT is set to TRUE and if the UE Tx power (for TDD within a single TS) is less or equal the value in IE "UE Transmitted Power Tx power threshold" stored for this event in the variable MEASUREMENT_IDENTITY:
 - 2> set the variable TRIGGERED_6A_EVENT to FALSE.

14.6.2.2 Reporting event 6B: The UE Tx power becomes less than an absolute threshold

When a UE internal measurement configuring event 6b is set up, the UE shall:

- 1> create a variable TRIGGERED_6B_EVENT related to that measurement, which shall initially be set to FALSE;
- 1> delete this variable when the measurement is released.

When this event is ordered by UTRAN in a measurement control message, the UE shall:

- 1> if the UE Tx power (for TDD within a single TS) is less than the value in IE "UE Transmitted Power Tx power threshold" stored for this event in the variable MEASUREMENT_IDENTITY for a time period indicated by the IE "time_to_trigger":
 - 2> if the variable TRIGGERED_6B_EVENT is set to FALSE:
 - 3> set the variable TRIGGERED_6B_EVENT to TRUE;
 - 3> send a measurement report with IEs set as below:
 - 4> set in "UE internal measurement event results": "UE internal event identity" to "6b";
 - 4> set the IE "measured results" and the IE "additional measured results" according to 8.4.2.
 - 1> if the variable TRIGGERED_6B_EVENT is set to TRUE and if the UE Tx power (for TDD within a single TS) is greater or equal the value in IE "UE Transmitted Power Tx power threshold" stored for this event in the variable MEASUREMENT_IDENTITY:
 - 2> set the variable TRIGGERED_6B_EVENT to FALSE.

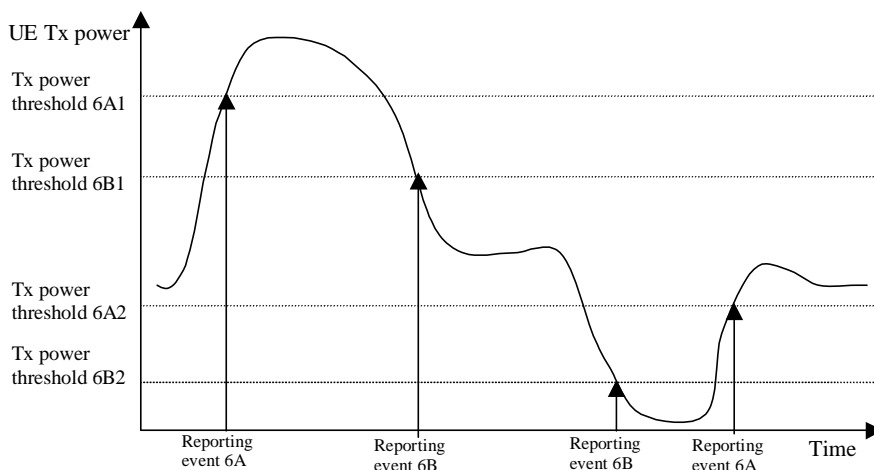

Figure 14.6.2.2-1: Event-triggered measurement reports when the UE Tx power becomes larger or less than absolute thresholds

14.6.2.3 Reporting event 6C: The UE Tx power reaches its minimum value

When a UE internal measurement configuring event 6c is set up, the UE shall:

- 1> create a variable TRIGGERED_6C_EVENT related to that measurement, which shall initially be set to FALSE;
- 1> delete this variable when the measurement is released.

When this event is ordered by UTRAN in a measurement control message, the UE shall:

- 1> if the UE Tx power is equal its minimum value (for TDD its minimum value on a single TS) for a time period indicated by the IE "time_to_trigger":
 - 2> if the variable TRIGGERED_6C_EVENT is set to FALSE:
 - 3> set the variable TRIGGERED_6C_EVENT to TRUE;
 - 3> send a measurement report with IEs set as below:
 - 4> set in "UE internal measurement event results": "UE internal event identity" to "6c";
 - 4> set the IE "measured results" and the IE "additional measured results" according to 8.4.2.
- 1> if the variable TRIGGERED_6C_EVENT is set to TRUE and if the UE Tx power is greater than its minimum value:
 - 2> set the variable TRIGGERED_6C_EVENT to FALSE.

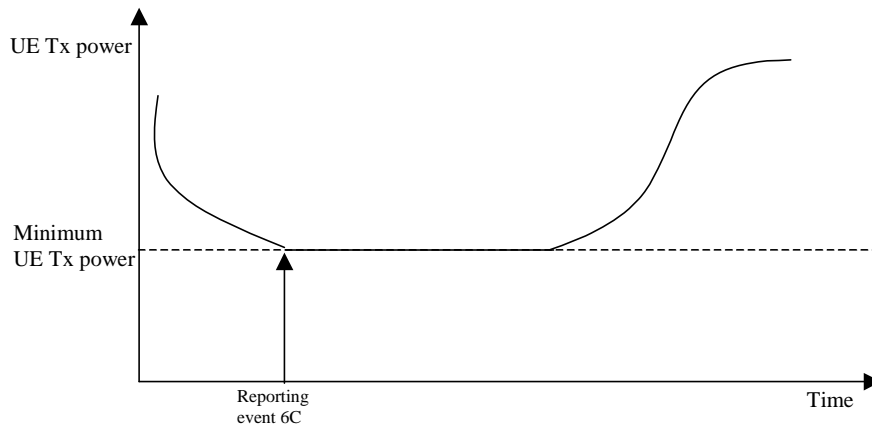

Figure 14.6.2.3-1: Event-triggered measurement report when the UE Tx power reaches its minimum value

14.6.2.4 Reporting event 6D: The UE Tx power reaches its maximum value

When a UE internal measurement configuring event 6d is set up, the UE shall:

- 1> create a variable TRIGGERED_6D_EVENT related to that measurement, which shall initially be set to FALSE;
- 1> delete this variable when the measurement is released.

When this event is ordered by UTRAN in a measurement control message, the UE shall:

- 1> if the UE Tx power equals the maximum power the UE can transmit, i.e. the maximum UE TX power reduced by the power reduction used by the UE (for TDD its maximum value on a single TS) for a time period indicated by the IE "time_to_trigger":
 - 2> if the variable TRIGGERED_6D_EVENT is set to FALSE:
 - 3> set the variable TRIGGERED_6D_EVENT to TRUE;
 - 3> send a measurement report with IEs set as below:
 - 4> set in "UE internal measurement event results": "UE internal event identity" to "6d";
 - 4> set the IE "measured results" and the IE "additional measured results" according to 8.4.2.
 - 1> if the variable TRIGGERED_6D_EVENT is set to TRUE and if the UE Tx power is less than the maximum UE TX power:
 - 2> set the variable TRIGGERED_6D_EVENT to FALSE.

NOTE: The maximum UE TX power is defined in subclause 8.6.6.8 and the maximum allowed power reduction is defined in subclause 6.2.2 in [21].

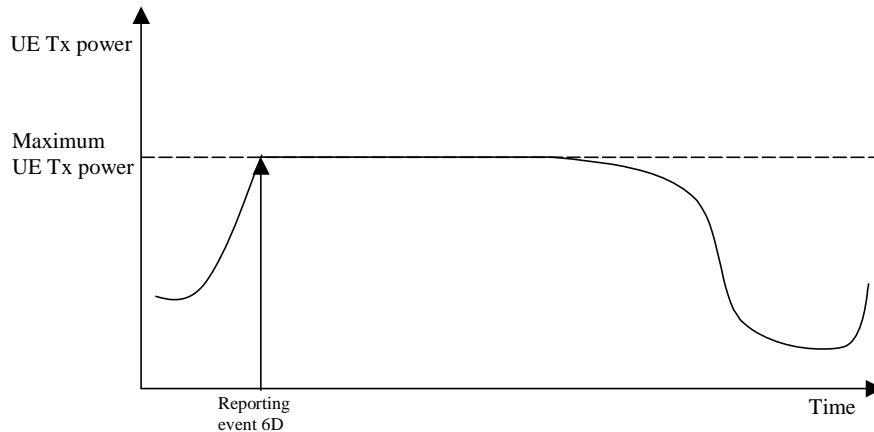

Figure 14.6.2.4-1: Event-triggered report when the UE Tx power reaches its maximum value

14.6.2.5 Reporting event 6E: The UE RSSI reaches the UE's dynamic receiver range

When a UE internal measurement configuring event 6e is set up, the UE shall:

- 1> create a variable TRIGGERED_6E_EVENT related to that measurement, which shall initially be set to FALSE;
- 1> delete this variable when the measurement is released.

When this event is ordered by UTRAN in a measurement control message, the UE shall:

- 1> if the UE RSSI is greater or equal the UE's dynamic receiver range for a time period indicated by the IE "time_to_trigger":
 - 2> if the variable TRIGGERED_6E_EVENT is set to FALSE:
 - 3> set the variable TRIGGERED_6E_EVENT to TRUE;
 - 3> send a measurement report with IEs set as below:
 - 4> set in "UE internal measurement event results": "UE internal event identity" to "6e";
 - 4> set the IE "measured results" and the IE "additional measured results" according to subclause 8.4.2.
- 1> if the variable TRIGGERED_6E_EVENT is set to TRUE and if the UE RSSI is less than the UE's dynamic receiver range:
 - 2> set the variable TRIGGERED_6E_EVENT to FALSE.

14.6.2.6 Reporting event 6F (FDD): The UE Rx-Tx time difference for a RL included in the active set becomes larger than an absolute threshold

When a UE internal measurement configuring event 6f is set up, the UE shall:

- 1> create a variable TRIGGERED_6F_EVENT related to that measurement, which shall initially be set to FALSE for each RL;
- 1> delete this variable when the measurement is released.

When this event is ordered by UTRAN in a measurement control message, the UE shall:

- 1> if the UE Rx-Tx time difference for a RL included in the active set is greater than the value in the IE "UE Rx-Tx time difference threshold" stored for this event in the variable MEASUREMENT_IDENTITY for a time period indicated by the IE "time_to_trigger":
 - 2> if the variable TRIGGERED_6F_EVENT is set to FALSE for this RL:

- 3> set the variable TRIGGERED_6F_EVENT to TRUE for this RL;
- 3> send a measurement report with IEs set as below:
 - 4> set in "UE internal measurement event results": "UE internal event identity" to "6f";
 - 4> set the IE "measured results" and the IE "additional measured results" according to subclause 8.4.2.
- 1> if the variable TRIGGERED_6F_EVENT is set to TRUE for a RL and if the UE RX-Tx time difference for this RL included in the active set is less than or equal to the value in the IE "UE Rx-Tx time difference threshold" stored for this event in the variable MEASUREMENT_IDENTITY:
- 2> set the variable TRIGGERED_6F_EVENT to FALSE for this RL.

14.6.2.6a Reporting event 6F (1.28 Mcps TDD): The time difference indicated by T_{ADV} becomes larger than an absolute threshold

When a UE internal measurement configuring event 6f is set up, the UE shall:

- 1> create a variable TRIGGERED_6F_EVENT related to that measurement, which shall initially be set to the currently measured T_{ADV} ;
- 1> delete this variable when the measurement is released.

When this event is ordered by UTRAN in a measurement control message, the UE shall:

- 1> if the absolute value of the difference between the measured T_{ADV} and the T_{ADV} stored in the variable TRIGGERED_6F_EVENT is greater than the predefined threshold configured with the IE "T_{ADV} Threshold" for this event in the variable MEASUREMENT_IDENTITY for a time period indicated by the IE "time_to_trigger":
- 2> set the variable TRIGGERED_6F_EVENT to the currently measured T_{ADV} ;
- 2> send a measurement report with IEs set as below:
 - 3> set the IE "T_{ADV}" to the measured value, and the IE "SFN" to the SFN during which the latest measurement was performed, in the IE "T_{ADV} Info";
 - 3> set the IE "measured results" and the IE "additional measured results" according to subclause 8.4.2.

14.6.2.7 Reporting event 6G: The UE Rx-Tx time difference for a RL included in the active set becomes less than an absolute threshold

When a UE internal measurement configuring event 6g is set up, the UE shall:

- 1> create a variable TRIGGERED_6G_EVENT related to that measurement, which shall initially be set to FALSE for each RL;
- 1> delete this variable when the measurement is released.

When this event is ordered by UTRAN in a measurement control message, the UE shall:

- 1> if the UE Rx-Tx time difference for a RL included in the active set is less than the value in IE "UE Rx-Tx time difference threshold" stored for this event in the variable MEASUREMENT_IDENTITY for a time period indicated by the IE "time_to_trigger":
- 2> if the variable TRIGGERED_6G_EVENT is set to FALSE for this RL:
 - 3> set the variable TRIGGERED_6G_EVENT to TRUE for this RL;
 - 3> send a measurement report with IEs set as below:
 - 4> set in "UE internal measurement event results": "UE internal event identity" to "6g";
 - 4> set the IE "measured results" and the IE "additional measured results" according to subclause 8.4.2.

1> if the variable TRIGGERED_6G_EVENT is set to TRUE for a RL and if the UE RX-Tx time difference for this RL included in the active set is greater or equal the value in IE "UE Rx-Tx time difference threshold" stored for this event in the variable MEASUREMENT_IDENTITY:

2> set the variable TRIGGERED_6G_EVENT to FALSE for this RL.

14.7 UE positioning measurements

14.7.1 UE positioning measurement quantities

The quantity to measure for UE positioning is dependent on the positioning method and the method type requested in the IE "UE positioning reporting quantity".

- 1 SFN-SFN observed time difference type 2, optional.
- 2 Rx-Tx time difference type 2, optional.
- 3 GPS timing of cell frames, optional.

The definition of other GPS measurements is not within the scope of this specification.

14.7.2 Void

14.7.3 UE positioning reporting events

In the IE "UE positioning reporting criteria" in the Measurement Control messages, the UTRAN notifies the UE of which events should trigger a measurement report. UE positioning reporting events that can trigger a report are given below. The content of the measurement report is dependant on the positioning method and method type requested in the IE "UE positioning reporting quantity" of the Measurement Control message and is described in detail in [18].

When one measurement identity corresponds to multiple positioning events with identical event identities, the UE behaviour is not defined.

14.7.3.1 Reporting Event 7a: The UE position changes more than an absolute threshold

This event is used for UE-based methods only.

When this event is ordered by UTRAN in a measurement control message, the UE shall:

- 1> if the UE changes its position compared to the last reported position by more than the threshold defined by the IE "Threshold position change"; or
- 1> if no position has been reported since the event was configured and the UE changes its position compared to the first position estimate obtained after the event was configured by more than the threshold defined by the IE "Threshold position change":
 - 2> send a measurement report as specified in subclause 8.6.7.19.1b;
 - 2> if the value of IE "Amount of Reporting" in variable MEASUREMENT_IDENTITY for this event is greater than zero:
 - 3> decrease IE "Amount of Reporting" in variable MEASUREMENT_IDENTITY for this event by one.
 - 2> if the value of IE "Amount of Reporting" in variable MEASUREMENT_IDENTITY for this event is equal to zero:
 - 3> delete this event from the list of events in variable MEASUREMENT_IDENTITY.
- 1> if the UE is unable to evaluate the event because a position measurement is not available:
 - 2> not send a report.

14.7.3.2 Reporting Event 7b: SFN-SFN measurement changes more than an absolute threshold

When this event is ordered by UTRAN in a measurement control message, the UE shall:

- 1> send a measurement report when the SFN-SFN time difference measurement type 2 of any measured cell changes more than the threshold defined by the IE "Threshold SFN-SFN change"; and
- 1> if UTRAN set IE "Method Type" in "UE positioning reporting quantity" in the MEASUREMENT CONTROL message to "UE-based":
 - 2> act as specified in subclause 8.6.7.19.1b.
- 1> if UTRAN set IE "Method Type" in "UE positioning reporting quantity" in the MEASUREMENT CONTROL message to "UE-assisted":
 - 2> act as specified in subclause 8.6.7.19.1a.
- 1> if UTRAN set IE "Method Type" in "UE positioning reporting quantity" in the MEASUREMENT CONTROL message to "UE-assisted preferred but UE-based allowed" or "UE-based preferred but UE-assisted allowed":
 - 2> the UE may choose to act according to either subclause 8.6.7.19.1a or 8.6.7.19.1b.
- 1> if the value of IE "Amount of Reporting" in variable MEASUREMENT_IDENTITY for this event is greater than zero:
 - 2> decrease IE "Amount of Reporting" in variable MEASUREMENT_IDENTITY for this event by one.
- 1> if the value of IE "Amount of Reporting" in variable MEASUREMENT_IDENTITY for this event is equal to zero:
 - 2> delete this event from the list of events in variable MEASUREMENT_IDENTITY.

14.7.3.3 Reporting Event 7c: GPS time and SFN time have drifted apart more than an absolute threshold

When this event is ordered by UTRAN in a measurement control message, the UE shall:

- 1> send a measurement report when the GPS Time Of Week and the SFN timer have drifted apart more than the threshold defined by the IE "Threshold SFN-GPS TOW"; and
- 1> if UTRAN set IE "Method Type" in "UE positioning reporting quantity" in the MEASUREMENT CONTROL message to "UE based":
 - 2> act as specified in subclause 8.6.7.19.1b.
- 1> if UTRAN set IE "Method Type" in "UE positioning reporting quantity" in the MEASUREMENT CONTROL message to "UE assisted":
 - 2> act as specified in subclause 8.6.7.19.1a.
- 1> if UTRAN set IE "Method Type" in "UE positioning reporting quantity" in the MEASUREMENT CONTROL message to "UE assisted preferred but UE based allowed" or "UE based preferred but UE assisted allowed":
 - 2> act as specified in subclause 8.6.7.19.1a or in subclause 8.6.7.19.1b depending on the method type chosen by the UE.
- 1> if the value of IE "Amount of Reporting" in variable MEASUREMENT_IDENTITY for this event is greater than zero:
 - 2> decrease IE "Amount of Reporting" in variable MEASUREMENT_IDENTITY for this event by one.
- 1> if the value of IE "Amount of Reporting" in variable MEASUREMENT_IDENTITY for this event is equal to zero:
 - 2> delete this event from the list of events in variable MEASUREMENT_IDENTITY.

14.7.3.4 Reporting Event 7d: GANSS time and SFN time have drifted apart more than an absolute threshold

When this event is ordered by UTRAN in a measurement control message, the UE shall:

- 1> send a measurement report when the GANSS Time Of Week and the SFN timer have drifted apart more than the threshold defined by the IE "Threshold SFN-GANSS TOW"; and
- 1> if UTRAN set IE "Method Type" in "UE positioning reporting quantity" in the MEASUREMENT CONTROL message to "UE based":
 - 2> act as specified in subclause 8.6.7.19.1b.
- 1> if UTRAN set IE "Method Type" in "UE positioning reporting quantity" in the MEASUREMENT CONTROL message to "UE assisted":
 - 2> act as specified in subclause 8.6.7.19.1a.
- 1> if UTRAN set IE "Method Type" in "UE positioning reporting quantity" in the MEASUREMENT CONTROL message to "UE assisted preferred but UE based allowed" or "UE based preferred but UE assisted allowed":
 - 2> act as specified in subclause 8.6.7.19.1a or in subclause 8.6.7.19.1b depending on the method type chosen by the UE.
- 1> if the value of IE "Amount of Reporting" in variable MEASUREMENT_IDENTITY for this event is greater than zero:
 - 2> decrease IE "Amount of Reporting" in variable MEASUREMENT_IDENTITY for this event by one.
- 1> if the value of IE "Amount of Reporting" in variable MEASUREMENT_IDENTITY for this event is equal to zero:
 - 2> delete this event from the list of events in variable MEASUREMENT_IDENTITY.

14.8 Void

14.9 Downlink power control

14.9.1 Generalities

This function is implemented in the UE in order to set the SIR target value on each CCTrCH used for the downlink power control. This SIR value shall be adjusted according to an autonomous function in the UE in order to achieve the same measured quality as the quality target set by UTRAN. The quality target is set as the transport channel BLER value for each transport channel as signalled by UTRAN.

When transport channel BLER is used the UE shall run a quality target control loop such that the quality requirement is met for each transport channel, which has been assigned a BLER target.

The UE shall set the SIR target when the physical channel has been set up or reconfigured. It shall not increase the SIR target value before the power control has converged on the current value. The UE may estimate whether the power control has converged on the current value, by comparing the averaged measured SIR to the SIR target value.

NOTE: The power control function for F-DPCH is specified in [29].

14.9.2 Downlink power control in compressed mode

In compressed mode, the target SIR needs to be changed in several frames compared to normal mode. For this purpose, four values DeltaSIR1, DeltaSIRafter1, DeltaSIR2 and DeltaSIRafter2 are signalled by the UTRAN to the UE (see subclause 10.3.6.33).

For each frame, the target SIR offset during compressed mode, compared to normal mode is:

$$\Delta\text{SIR} = \max(\Delta\text{SIR1_compression}, \dots, \Delta\text{SIRn_compression}) + \Delta\text{SIR1_coding} + \Delta\text{SIR2_coding}$$

where n is the number of TTI lengths for all TrChs of the CCTrCh, F_i is the length in number of frames of the i -th TTI and where $\Delta\text{SIR_coding}$ fulfils:

- $\Delta\text{SIR1_coding} = \Delta\text{SIR1}$ if the start of the first transmission gap in the transmission gap pattern is within the current frame.
- $\Delta\text{SIR1_coding} = \Delta\text{SIRafter1}$ if the current frame just follows a frame containing the start of the first transmission gap in the transmission gap pattern.
- $\Delta\text{SIR2_coding} = \Delta\text{SIR2}$ if the start of the second transmission gap in the transmission gap pattern is within the current frame.
- $\Delta\text{SIR2_coding} = \Delta\text{SIRafter2}$ if the current frame just follows a frame containing the start of the second transmission gap in the transmission gap pattern.
- $\Delta\text{SIR1_coding} = 0$ and $\Delta\text{SIR2_coding} = 0$ otherwise.

and $\Delta\text{SIRi_compression}$ is defined by :

- $\Delta\text{SIRi_compression} = 3$ dB for downlink frames compressed by reducing the spreading factor by 2.
- $\Delta\text{SIRi_compression} = 0$ dB in all other cases.

Several compressed mode patterns applying to the same frames should be avoided as much as possible.

In case several compressed mode patterns are used simultaneously, a ΔSIR offset is computed for each compressed mode pattern and the sum of all ΔSIR offsets is applied to the frame.

14.10 Calculated Transport Format Combination

The Calculated Transport Format Combination (CTFC) is a tool for efficient signalling of transport format combinations.

Let I be the number of transport channels that are included in the transport format combination. For DCHs, all configured DCHs are included in the transport format combination. Each transport channel TrCH_i , $i = 1, 2, \dots, I$, has L_i transport formats, i.e. the transport format indicator TFI_i can take L_i values, $\text{TFI}_i \in \{0, 1, 2, \dots, L_i - 1\}$.

Define $P_i = \prod_{j=0}^{i-1} L_j$, where $i = 1, 2, \dots, I$, and $L_0 = 1$.

Let $\text{TFC}(\text{TFI}_1, \text{TFI}_2, \dots, \text{TFI}_I)$ be the transport format combination for which TrCH_1 has transport format TFI_1 , TrCH_2 has transport format TFI_2 , etc. The corresponding $\text{CTFC}(\text{TFI}_1, \text{TFI}_2, \dots, \text{TFI}_I)$ is then computed as:

$$\text{CTFC}(\text{TFI}_1, \text{TFI}_2, \dots, \text{TFI}_I) = \sum_{i=1}^I \text{TFI}_i \cdot P_i.$$

For FACH and PCH transport channels, "TrCH₁" corresponds to the transport channel listed at the first position in IE "FACH/PCH information" in IE "Secondary CCPCCH System Information", "TrCH₂" corresponds to the transport channel listed at the second position in IE "FACH/PCH information" and so on.

For all other transport channels in FDD and for all configured transport channels of the same transport channel type (i.e. DCH, DSCH, USCH) in TDD, "TrCH₁" corresponds to the transport channel having the lowest transport channel identity in the transport format combination mapped to the TFCI field. "TrCH₂" corresponds to the transport channel having the next lowest transport channel identity, and so on.

14.10.1 Default TFCS for MBMS

14.10.1.1 S-CCPCH configuration including a FACH carrying MSCH

In case the S-CCPCH configuration includes a FACH carrying MSCH, the default TFCS is defined according to the following:

Let TrCH 1 be the FACH carrying MSCH, TrCH 2 be the first TrCH carrying MTCH listed in the IE "TrCh information list", TrCH 3 be the second TrCH carrying MTCH listed in the IE "TrCh information list" etc. and let TrCH I be the last TrCH carrying MTCH listed in the IE "TrCh information list".

Each transport channel TrCH_{*i*}, *i* = 1, 2, ..., *I*, has *L_i* transport formats, i.e. the transport format indicator TFI_{*i*} can take *L_i* values.

Each transport format combination set is defined by the transport formats of each transport channel mapped on this S-CCPCH:

TFC = (TFI₁, TFI₂, ..., TFI_{*I*}).

The "MBMS implicit TFCS" contains then the following set of TFCs:

$$\text{TFCS} = \{(0,0,\dots,0), (0,1,\dots,0), \dots, (0,L_2,\dots,0), (0,0,1,\dots,0), \dots, (0,0,L_3,\dots,0), \dots, (0,0,0,\dots,1), \dots, (0,0,0,\dots,L_I), \\ (1,0,\dots,0), (1,1,\dots,0), \dots, (1,L_2,\dots,0), (1,0,1,\dots,0), \dots, (1,0,L_3,\dots,0), \dots, (1,0,0,\dots,1), \dots, (1,0,0,\dots,L_I), \\ (2,0,\dots,0), \dots, (L_1,0,\dots,0)\}$$

14.10.1.2 S-CCPCH configuration not including a FACH carrying MSCH

In case the S-CCPCH configuration does not include a FACH carrying MSCH, the default TFCS is defined according to the following:

Let TrCH 1 be the first TrCH listed in the IE "TrCh information list", TrCH 2 be the second TrCH listed in the IE "TrCh information list" etc. and let TrCH I be the last TrCH listed in the IE "TrCh information list".

Each transport channel TrCH_{*i*}, *i* = 1, 2, ..., *I*, has *L_i* transport formats, i.e. the transport format indicator TFI_{*i*} can take *L_i* values.

Each transport format combination set is defined by the transport formats of each transport channel mapped on this S-CCPCH:

TFC = (TFI₁, TFI₂, ..., TFI_{*I*}).

The "MBMS implicit TFCS" contains then the following set of TFCs:

$$\text{TFCS} = \{(0,\dots,0), (1,\dots,0), \dots, (L_1,\dots,0), (0,1,\dots,0), \dots, (0,L_2,\dots,0), \dots, (0,0,\dots,1), \dots, (0,0,\dots,L_I)\}$$

14.11 UE autonomous update of virtual active set on non-used frequency (FDD only)

In the text that follows:

- a "non-used frequency" is a frequency that the UE has been ordered to measure upon but is not used for the connection. A "used frequency" is a frequency that the UE has been ordered to measure upon and is also currently used for the connection;
- a "non-used frequency (resp. cell) considered in an inter-frequency measurement" shall be understood as a non-used frequency (resp. cell) included in the list of cells pointed at in the IE "cells for measurement" if it was received for that measurement, or otherwise as a non-used frequency (resp. cell) included in the "Inter-frequency cell info" part of the variable CELL_INFO_LIST.

For event-triggered inter frequency measurements it is possible to use intra-frequency measurement reporting events for support of maintenance of an active set associated with a non-used frequency considered in that measurement, a "virtual

active set" and used in the evaluation of the frequency quality estimates. The "initial virtual active set" for a frequency is the virtual active set that is associated to that frequency just after a message was received that sets up or modifies the inter-frequency measurement.

The way the virtual active sets are initiated and updated for the non-used frequencies considered in an inter-frequency measurement is described in the two subclauses below.

The UE shall support a single virtual active set per non-used frequency.

The virtual active set is not initialised and maintained for an inter frequency measurement with periodic reporting. A virtual active set initialised and maintained by another inter-frequency measurement does not affect reporting of the periodic inter-frequency measurement.

14.11.1 Initial virtual active set

If the UE receives a MEASUREMENT CONTROL message that sets up or modifies an inter-frequency measurement and includes the IE "Inter-frequency set update"; or

If at least one cell can be measured on a non-used frequency for which the current virtual active set is empty (see subclause 14.11.2), the UE shall:

- 1> for each non-used frequency F_i considered in the measurement where cells can be measured:
 - 2> if event 1a is configured for the used frequency in an intra-frequency measurement:
 - 3> include in the initial virtual active set the N_i cells that have either the greatest downlink E_c/N_0 or the greatest downlink RSCP after despreading or the lowest pathloss (the measurement quantity to be used is determined by the IE "intra-frequency measurement quantity" of the intra-frequency measurement from which the event 1a configuration is taken), among the cells on frequency F_i considered in that inter-frequency measurement, where:

$$N_i = \min(N_{1a}, N_{Cells\ F_i}) \text{ if } N_{1a} \neq 0 \text{ and } N_i = N_{Cells\ F_i} \text{ otherwise.}$$

where:

N_{1a} is the "Reporting deactivation threshold" included in the intra-frequency measurement for the first event 1a defined in the intra-frequency measurement with the lowest identity at the time the inter-frequency measurement was received with the IE "Inter-frequency set update" present.

$N_{Cells\ F_i}$ is the number of cells on frequency F_i considered in that inter-frequency measurement.

2> else:

$$N_i = N_{Cells\ F_i}$$

where:

$N_{Cells\ F_i}$ is the number of cells on frequency F_i considered in that inter-frequency measurement.

NOTE1: The UE initialises the virtual active set with up to the maximum number of inter-frequency cells supported by the UE as defined in [19].

NOTE2: If the UTRAN configures more than one measurement using events 2A, 2B, 2C or 2E the UE measurement capabilities may be exceeded due to the necessary copying of 1A, 1B, 1C criteria. To avoid this the UTRAN may configure one measurement to apply to multiple frequencies so that the 1A, 1B, and 1C criteria will only be copied once.

NOTE3: After a hard handover (see subclause 8.3.5), if the MEASUREMENT CONTROL message that restarts an inter-frequency measurement using the virtual active set does not include the IE "Inter-frequency set update", the UE behaviour regarding the virtual active set is not specified.

14.11.2 Virtual active set update during an inter-frequency measurement

For an inter-frequency measurement, the UE shall:

- 1> apply the events of type 1a, 1b and 1c that were defined for the used frequency in other stored measurements of type "intra-frequency" at the time the inter-frequency measurement was last received with the IE "Inter-frequency set update" present; and
- 1> update the virtual active set for the non-used frequencies considered in that measurement according to the following rules:
 - 2> if several events of type 1a (resp. 1b,1c) were defined for the used frequency when the inter-frequency measurement was last received with the IE "Inter-frequency set update" present, only the first 1a event (resp 1b, 1c) that was defined in the measurement with the lowest measurement identity shall apply to the non-used frequencies;
 - 2> all the cells considered in the inter-frequency measurements shall be able to affect the reporting range for event 1a and 1b. (i.e. the IE "Cells forbidden to affect reporting range" possibly stored for the intra-frequency measurements on the used frequency does not apply to the non-used frequencies considered in the inter-frequency measurement);
 - 2> the IEs "amount of reporting" and "reporting interval" that were stored for the intra-frequency measurements on the used frequency shall not be considered if reports of the virtual active set updates are needed.
 - 2> the measurement quantity and filter coefficient to be used is determined by the IE "intra-frequency measurement quantity" of the intra-frequency measurement from which the intra-frequency event configuration configuration is taken.

NOTE: If the measurement quantity and filter coefficients to be used differ for the 1a, 1b, and 1c events applied then the UE behaviour is unspecified.

- 1> if event 1a is applicable to the non-used frequencies considered in the inter-frequency measurement, always only consider monitored cells that are not in the virtual active set for this event, and:
 - 2> when this event is triggered (according to the criteria described in subclause 14.1.2.1) by a cell for a non-used frequency considered in that measurement:
 - 3> if the "Reporting deactivation threshold" is equal to 0, or if the "Reporting deactivation threshold" is different from 0 and the number of cells included in the virtual active set for that frequency is less than or equal to the "Reporting deactivation threshold":
 - 4> add the primary CPICH that enters the reporting range to the "virtual active set".
 - 2> if event 1b is applicable for the non-used frequencies considered in that inter-frequency measurement, always only consider cells in the virtual active set for this event, and when this event is triggered (according to the criteria described in subclause 14.1.2.2) by a cell for a non-used frequency considered in that measurement:
 - 3> if the number of cells included in the virtual active set is greater than 1:
 - 4> remove the primary CPICH that leaves the reporting range from the "virtual active set".
 - 2> if event 1c is applicable for the non-used frequencies considered in that inter-frequency measurement, always only consider monitored cells for this event, and when this event is triggered (according to the criteria described in subclause 14.1.2.3) by a cell for a non-used frequency considered in that measurement:
 - 3> if the "Reporting activation threshold" is equal to 0, or if the "Reporting activation threshold" is different from 0 and the number of cells included in the virtual active set for that frequency is greater than or equal to the "Reporting activation threshold":
 - 4> rank all active and non-active primary CPICHs and take the n best cells to create a new "virtual active set", where n is the number of active primary CPICHs in the "virtual active set".
- 1> if Event 1a is not defined for the used frequency in other stored measurements of type "intra-frequency" at the time the inter-frequency measurement was set up:

- 2> the UE shall continuously update the virtual active set to consist of all cells on frequency F_i considered in that inter-frequency measurement.

NOTE: The UE needs to only update the virtual active set with up to the maximum number of interfrequency cells supported by the UE as defined in [19].

If none of the cells that are considered in the measurement on this frequency were measured, the UE may treat the virtual active set as empty and follow the appropriate initialisation procedure in subclause 14.11.1 when any relevant cell can first be measured.

If a cell is a member of the virtual active set and is removed from the variable CELL_INFO_LIST or removed from the list of cells pointed at by the IE "Cells for measurement" for the inter-frequency measurement then the UE shall remove the cell from the virtual active set.

If an inter-frequency measurement that initialised a virtual active set is released, then any virtual active set associated with this measurement shall also be released.

14.12 Provision and reception of RRC information between network nodes

14.12.0 General

In certain cases, e.g., when performing handover to UTRAN or when performing SRNC relocation, RRC information may need to be transferred between UTRAN nodes, between UTRAN and another RAT, between nodes within another RAT or between the UE and another RAT.

The RRC information exchanged between network nodes or between the UE and another RAT is typically transferred by means of RRC information containers. An RRC information container is a self-contained and extensible RRC information unit that may be used to transfer a number of different RRC messages, one at a time. As stated before, RRC information containers may be used to transfer RRC messages across interfaces other than the Uu interface. The RRC messages that may be included in RRC information containers have similar characteristics as the RRC messages that are transferred across the Uu interface.

The RRC messages that are sent to/ from the UE, e.g., HANDOVER TO UTRAN COMMAND, INTER RAT HANDOVER INFO are covered by (sub)clauses 8, 9, 10, 11.0-11.4 and 12 of this specification. The following subclauses concern RRC messages exchanged between network nodes.

In future versions of this specification, it is possible to extend the RRC messages transferred across interfaces other than Uu. For these RRC messages the same extension mechanism applies as defined for RRC messages transferred across the Uu interface, as is specified in subclause 10.1, i.e., both critical and non-critical extensions may be added.

The transfer syntax for RRC information containers and RRC messages transferred between network nodes is derived from their ASN.1 definitions by use of Packed Encoding Rules, unaligned (X.691). It should be noted that the encoder adds final padding to achieve octet alignment. The resulting octet string is, carried in a container, transferred between the network nodes.

When using a separate RRC information container for each endpoint, the receiving RRC protocol entity is able to interpret the received container; this means that the receiver need not take into account information about the (network interface) message used in transferring the container.

The following encoding rules apply in addition to what has been specified in X.691 [49]:

- 1> When a bit string value is placed in a bit-field as specified in 15.6 to 15.11 in [11], the leading bit of the bit string value shall be placed in the leading bit of the bit-field, and the trailing bit of the bit string value shall be placed in the trailing bit of the bit-field.

NOTE: The terms "leading bit" and "trailing bit" are defined in ITU-T Rec. X.680 | ISO/IEC 8824-1. When using the "bstring" notation, the leading bit of the bit string value is on the left, and the trailing bit of the bit string value is on the right.

14.12.0a General error handling for RRC messages exchanged between network nodes

The error handling for RRC messages that are exchanged between network nodes applies the same principles as defined for other RRC messages.

Although the same principles apply for network nodes receiving unknown, unforeseen and erroneous RRC messages received in RRC information containers, the notification of the error should be done in a different manner, as specified in the following:

The network node receiving an invalid RRC message from another network node should:

- 1> if the received RRC message was unknown, unforeseen or erroneous:
 - 2> prepare an RRC FAILURE INFO message, including the IE "Failure cause" set to "Protocol error" and the IE "Protocol error information" including an IE "Protocol error cause" which should be set as follows:
 - 3> to "ASN.1 violation or encoding error" upon receiving an RRC message for which the encoded message does not result in any valid abstract syntax value;
 - 3> to "Message type non-existent or not implemented" upon receiving an unknown RRC message type;
 - 3> to "Message extension not comprehended" upon receiving an RRC message including an undefined critical message extension;
 - 3> to "Information element value not comprehended" upon receiving an RRC message including an mandatory IE for which no default value is defined and for which either the value is set to spare or for which the encoded IE does not result in a valid transfer syntax. The same applies for conditional IEs, for which the conditions for presence are met, the IE is present but has a value set to spare or for which the encoded IE does not result in a valid transfer syntax;
 - 3> to "Information element missing" upon receiving an RRC information container with an absent conditional IE for which the conditions for presence are met.
 - 2> prepare an RRC FAILURE INFO message, including the IE "Failure cause" set to a value that reflects the failure cause.
- 1> send the RRC FAILURE INFO message to the network node from which the invalid RRC protocol information was received.

NOTE 1: The appropriate (failure) messages used across the network interfaces may not support the inclusion of a RRC information container. In this case, the information contained in the RRC FAILURE INFO message may need to be transferred otherwise e.g. by mapping to a cause value (e.g. a cause value in the RR-HANDOVER FAILURE message when there is a error associated with the RRC-HANDOVER TO UTRAN COMMAND message).

NOTE 2 In case the RRC procedure used to perform SRNS relocation fails e.g. due to non comprehension, the source RNC may notify the target RNC by including the diagnostics information (IEs "Protocol error" and "Protocol error information") in the "RRC message "SRNS Relocation" Info sent in the RRC information container" used for a subsequent relocation request.

14.12.1 RRC Information to target RNC

The RRC information container "RRC Information to target RNC" may either be sent from source RNC or from another RAT. In case of handover to UTRAN, this information originates from another RAT, while in case of SRNC relocation the RRC information originates from the source RNC. In case of handover to UTRAN, the RRC information transferred may provide UTRAN specific information, as defined in the INTER RAT HANDOVER INFO WITH INTER RAT CAPABILITIES message, that the target RNC needs when preparing the handover command message. In case of SRNC relocation and handover/cell reselection from GERAN *Iu mode*, the RRC information transferred specifies the configuration of RRC and the lower layers it controls, e.g., including the radio bearer and transport channel configuration. It is used by the target RNC to initialise RRC and the lower layer protocols to facilitate SRNC relocation and handover/cell reselection from GERAN *Iu mode* in a manner transparent to the UE.

RFC 3095 CONTEXT INFO is used to transfer the compressor and decompressor context information of the RFC 3095 protocol from source RNC to target RNC.

Information Element/Group Name	Need	Multi	Type and reference	Semantics description	Version
CHOICE <i>case</i>	MP			At least one spare choice, Criticality: Reject, is needed	
>Handover to UTRAN			INTER RAT HANDOVER INFO WITH INTER RAT CAPABILITIES 14.12.4.1		
>SRNC relocation			SRNS RELOCATION INFO 14.12.4.2		
>RFC 3095 context info			RFC 3095 CONTEXT INFO 14.12.4.4		REL-5

14.12.2 RRC information, target RNC to source RNC

There are 2 possible cases for RNC relocation:

1. The UE is already under control of target RNC; and
2. The SRNC Relocation with Hard Handover (UE still under control of SRNC), but UE is moving to a location controlled by the target RNC (based on measurement information).

In case 1 the relocation is transparent to the UE and there is no "reverse" direction container. The SRNC just assigns the 'serving' function to the target RNC, which then becomes the Serving RNC.

In case 2 the relocation is initiated by SRNC, which also provides the RRC Initialisation Information to the target RNC. Base on this information, the target RNC prepares the Hard Handover Message ("Physical channel reconfiguration" (subclause 8.2.6), "radio bearer establishment" (subclause 8.2.1), "Radio bearer reconfiguration" (subclause 8.2.2), "Radio bearer release" (subclause 8.2.3) or "Transport channel reconfiguration" (subclause 8.2.4).

In case 2 two possibilities are defined in order to transmit the relocation message from the target RNC to the source RNC which can be chosen by the source RNC by including or not including the IE "RB Id for handover message" in the IE "SRNS Relocation Info".

In case the IE "RB Id for handover message" has been received by the target RNC in the IE "SRNS Relocation Info", the target RNC should choose the IE "DL DCCCH message" and include the DL DCCCH message that should be transmitted transparently to the UE by the source RNC. In that case, the target RNC is integrity protecting the message if applicable.

If the target RNC did not receive the IE "RB Id for handover message" in the IE "SRNS Relocation Info" the target RNC should use another choice. In that case, the source RNC should integrity protect the message before transmitting it to the UE if applicable.

The source RNC then transmits the Handover Message to the UE, which then performs the handover.

In the successful case, the UE transmits an XXX COMPLETE message, using the new configuration, to the target RNC.

In case of failure, the UE transmits an XXX FAILURE, using the old configuration, to the source RNC and the RRC context remains unchanged (has to be confirmed and checked with the SRNS relocation procedure).

Information Element/Group name	Need	Multi	Type and reference	Semantics description
CHOICE <i>RRC message</i>	MP			At least one spare choice, Criticality: Reject, is needed

Information Element/Group name	Need	Multi	Type and reference	Semantics description
>RADIO BEARER SETUP			RADIO BEARER SETUP 10.2.31	
>RADIO BEARER RECONFIGURATION			RADIO BEARER RECONFIGURATION 10.2.25	
>RADIO BEARER RELEASE			RADIO BEARER RELEASE 10.2.28	
>TRANSPORT CHANNEL RECONFIGURATION			TRANSPORT CHANNEL RECONFIGURATION 10.2.51	
>PHYSICAL CHANNEL RECONFIGURATION			PHYSICAL CHANNEL RECONFIGURATION 10.2.20	
>RRC FAILURE INFO			RRC FAILURE INFO 10.2.41 a	
>DL DCCH message			OCTET STRING	

14.12.3 Void

14.12.4 RRC messages exchanged between network nodes

14.12.4.0 HANDOVER TO UTRAN COMMAND

This RRC message is sent between network nodes to transfer the actual handover command including the details of the radio configuration to be used upon handover to UTRAN as compiled by the target RNC.

Direction: target RNC →source RAT

The message is exactly the same as the HANDOVER TO UTRAN COMMAND defined in subclause 10.2.16a.

14.12.4.0a INTER RAT HANDOVER INFO

This RRC message is sent between network nodes to transfer information relevant for the target RNC when preparing for handover to UTRAN.

Direction: source RNC/RAT→target RAT

The message is exactly the same as the INTER RAT HANDOVER INFO defined in subclause 10.2.16d

14.12.4.1 INTER RAT HANDOVER INFO WITH INTER RAT CAPABILITIES

This RRC message is sent between network nodes when preparing for an inter RAT handover to UTRAN.

Direction: source RAT→target RNC

Information Element/Group Name	Need	Multi	Type and reference	Semantics description
UE Information elements				
Predefined configuration status information	OP		Predefined configuration status information 10.3.4.5a	
Predefined configuration status information compressed	OP		Predefined configuration status information compressed 10.3.4.5b	REL-5
UE security information	OP		UE security information 10.3.3.42b	
UE security information2	OP		UE security information2 10.3.3.42c	REL-6
UE Specific Behaviour Information 1 interRAT	OP		UE Specific Behaviour Information 1 interRAT 10.3.3.52	This IE shall not be included in this version of the protocol
UE capability container	OP			
>UE radio access capability	MP		UE radio access capability 10.3.3.42	
>UE radio access capability extension	MP		UE radio access capability extension 10.3.3.42a	Although this IE is not always required, the need has been set to MP to align with the ASN.1
UE radio access capability compressed	OP		UE radio access capability compressed 10.3.3.42o	REL-5
UE radio access capability comp 2	OP		UE radio access capability comp 2 10.3.3.42oa	REL-6
Other Information elements				
UE system specific capability	OP	1 to <maxSystemCapability>		
>Inter-RAT UE radio access capability	MP		Inter-RAT UE radio access capability 10.3.8.7	
Failure cause	OP		Failure cause 10.3.3.13	Diagnostics information related to an earlier handover to UTRAN request
Protocol error information	CV-ProtErr		Protocol error information 10.3.8.12	

Condition	Explanation
<i>ProtErr</i>	This IE is mandatory present if the IE "Protocol error indicator" is included and has the value TRUE. Otherwise it is not needed.

NOTE1: To facilitate that network nodes can transparently forward the RRC information received, the INTER RAT HANDOVER INFO WITH INTER RAT CAPABILITIES should include the entire INTER RAT HANDOVER INFO message. The network node, which may not be able to decode the information received, may only append some information to what was received.

NOTE2: The above table does not need to reflect the order of the information elements in the actual encoded message. The order, that is reflected in the ASN.1, should be chosen in a manner that avoids that network nodes need to perform reordering of information elements.

14.12.4.2 SRNS RELOCATION INFO

This RRC message is sent between network nodes when preparing for an SRNS relocation or a handover/cell reselection from GERAN *Iu mode*.

With the presence or absence of the IE "RB identity for Hard Handover message" the source RNC indicates to the target SRNC whether the source RNC expects to receive the choice "DL DCCH message" in the IE "RRC information, target RNC to source RNC" in case the SRNS relocation is of type "UE involved". Furthermore the target RNC uses this information for the calculation of the MAC-I.

Direction: source RNC/RAT→target RNC

Information Element/Group Name	Need	Multi	Type and reference	Semantics description	Version
Non RRC IEs					
>RB identity for Handover message	OP		RB identity 10.3.4.16	Gives the id of the radio bearer on which the source RNC will transmit the RRC message in the case the relocation is of type "UE involved". In handover from GERAN <i>Iu mode</i> this IE is always set to 2.	
>State of RRC	MP		RRC state indicator, 10.3.3.35a		
>State of RRC procedure	MP		Enumerated (await no RRC message, await RB Release Complete, await RB Setup Complete, await RB Reconfiguration Complete, await Transport CH Reconfiguration Complete, await Physical CH Reconfiguration Complete, await Active		

Information Element/Group Name	Need	Multi	Type and reference	Semantics description	Version
			Set Update Complete, await Handover Complete, send Cell Update Confirm, send URA Update Confirm, , others)		
Ciphering related information					
>Ciphering status for each CN domain	MP	<1 to maxCNdo mains>			
>>CN domain identity	MP		CN domain identity 10.3.1.1		
>>Ciphering status	MP		Enumerated(Not started, Started)		
>>START	MP		START 10.3.3.38	START value to be used in this CN domain.	
>Latest configured CN domain	MP		CN domain identity 10.3.1.1	Value contained in the variable of the same name. In case this variable is empty, the source RNC can set any CN domain identity. In that case, the Ciphering status and the Integrity protection status should be Not started and the target RNC should not initialise the variable Latest configured CN domain.	
>Calculation time for ciphering related information	CV- <i>Ciphering</i>			Time when the ciphering information of the message were calculated, relative to a cell of the target RNC. In handover and cell reselection from GERAN <i>lu mode</i> this field is not present.	
>>Cell Identity	MP		Cell Identity 10.3.2.2	Identity of one of the cells under the target RNC and included in the active set of the current call	
>>SFN	MP		Integer(0..4095)		
>COUNT-C list	OP	1 to <maxCNdo mains>		COUNT-C values for radio bearers using transparent mode RLC	
>>CN domain identity	MP		CN domain identity 10.3.1.1		
>>COUNT-C	MP		Bit string(32)		
>Ciphering info per radio bearer	OP	1 to <maxRB>		For signalling radio bearers this IE is mandatory.	
>>RB identity	MP		RB identity 10.3.4.16		
>>Downlink HFN	MP		Bit string(20..25)	This IE is either RLC AM HFN (20 bits) or RLC UM HFN (25 bits)	
>>Downlink SN	CV- <i>SRB1</i>		Bit String(7)	VT(US) of RLC UM	
>>Uplink HFN	MP		Bit string(20..25)	This IE is either RLC AM HFN (20 bits) or RLC UM HFN (25	

Information Element/Group Name	Need	Multi	Type and reference	Semantics description	Version
)	bits)	
Integrity protection related information					
>Integrity protection status	MP		Enumerated(Not started, Started)		
>Signalling radio bearer specific integrity protection information	CV-IP	4 to <maxSRBs etup>			
>>Uplink RRC HFN	MP		Bit string (28)	For each SRB, in the case activation times for the next IP configuration to be applied on this SRB have already been reached this IE corresponds to the last value used. Else this value corresponds to the value the source would have initialized the HFN to at the activation time, not considering any increment of HFN due to RRC SN roll over. Increment of HFN due to RRC SN roll over is taken care of by target based on value sent by the source.	
>>Downlink RRC HFN	MP		Bit string (28)	For each SRB, in the case activation times for the next IP configuration to be applied on this SRB have already been reached this IE corresponds to the last value used. Else this value corresponds to the value the source would have initialized the HFN to at the activation time, not considering any increment of HFN due to RRC SN roll over. Increment of HFN due to RRC SN roll over is taken care of by target based on value sent by the source. In particular, for SRB2, this IE should not take into account the RRC message that will trigger the relocation. NOTE: In order to have the possibility of sending downlink messages after the construction of the IE "SRNS RELOCATION INFO", the source may choose a value ahead of the last value used.	
>>Uplink RRC Message sequence number	MP		Integer (0..15)	For each SRB, this IE corresponds to the last value received or in the case activation time was not reached for a configuration the value equals (activation time - 1).	
>>Downlink RRC Message sequence number	MP		Integer (0..15)	For each SRB, this IE corresponds to the last value used or in the case activation time was not reached for a configuration the value equals (activation time -1). In particular, for SRB2, this IE should not take into account	

Information Element/Group Name	Need	Multi	Type and reference	Semantics description	Version
				the RRC message that will trigger the relocation. NOTE: In order to have the possibility of sending downlink messages after the construction of the IE "SRNS RELOCATION INFO", the source may choose a value ahead of the last value used for SRB3 and SRB4.	
>Implementation specific parameters	OP		Bit string (1..512)		
RRC IEs					
UE Information elements					
>U-RNTI	MP		U-RNTI 10.3.3.47	G-RNTI is placed in this field when performing handover or cell reselection from GERAN <i>lu mode</i> .	
>C-RNTI	OP		C-RNTI 10.3.3.8		
>UE radio access Capability	MP		UE radio access capability 10.3.3.42		
>UE radio access capability extension	OP		UE radio access capability extension 10.3.3.42a		
>Last known UE position	OP				
>>SFN	MP		Integer (0..4095)	Time when position was estimated	
>>Cell ID	MP		Cell identity; 10.3.2.2	Indicates the cell, the SFN is valid for.	
>>>CHOICE <i>Position estimate</i>	MP				
>>>>Ellipsoid Point			Ellipsoid Point; 10.3.8.4a		
>>>>Ellipsoid point with uncertainty circle			Ellipsoid point with uncertainty circle 10.3.8.4d		
>>>>Ellipsoid point with uncertainty ellipse			Ellipsoid point with uncertainty ellipse 10.3.8.4e		
>>>>Ellipsoid point with altitude			Ellipsoid point with altitude 10.3.8.4b		
>>>>Ellipsoid point with altitude and uncertainty ellipsoid			Ellipsoid point with altitude and uncertainty ellipsoid 10.3.8.4c		

Information Element/Group Name	Need	Multi	Type and reference	Semantics description	Version
>UE Specific Behaviour Information 1 idle	OP		UE Specific Behaviour Information 1 idle 10.3.3.51	This IE should be included if received via the "INTER RAT HANDOVER INFO", the "RRC CONNECTION REQUEST", the IE "SRNS RELOCATION INFO" or the "Inter RAT Handover Info with Inter RAT Capabilities"	
>UE Specific Behaviour Information 1 interRAT	OP		UE Specific Behaviour Information 1 interRAT 10.3.3.52	This IE should be included if received via the "INTER RAT HANDOVER INFO", the "RRC CONNECTION REQUEST", the IE "SRNS RELOCATION INFO" or the "Inter RAT Handover Info with Inter RAT Capabilities"	
Other Information elements					
>UE system specific capability	OP	1 to <maxSystemCapability>			
>>Inter-RAT UE radio access capability	MP		Inter-RAT UE radio access capability 10.3.8.7		
UTRAN Mobility Information elements					
>URA Identifier	OP		URA identity 10.3.2.6		
>T305	OP		Integer (5, 10, 30, 60, 120, 360, 720, infinity)	If UE is in CELL_FACH state, this information element shall be included. Value in minutes. Infinity means no update.	REL-7
CN Information Elements					
>CN common GSM-MAP NAS system information	MP		NAS system information (GSM-MAP) 10.3.1.9		
>CN domain related information	OP	1 to <MaxCNdomains>		CN related information to be provided for each CN domain	
>>CN domain identity	MP				
>>CN domain specific GSM-MAP NAS system info	MP		NAS system information (GSM-MAP) 10.3.1.9		
>>CN domain specific DRX cycle length coefficient	MP		CN domain specific DRX cycle length coefficient, 10.3.3.6		
Measurement Related Information elements					
>For each ongoing measurement reporting	OP	1 to <MaxNoOfMeas>		The source RNC should include the measurement IEs for each measurement configured and ongoing in the UE.	
>>Measurement Identity	MP		Measurement identity 10.3.7.48		
>>Measurement Command	MP		Measurement command 10.3.7.46	This IE should have the value Setup.	
>>Measurement Type	CV-Setup		Measurement		

Information Element/Group Name	Need	Multi	Type and reference	Semantics description	Version
			t type 10.3.7.50		
>>Measurement Reporting Mode	OP		Measurement reporting mode 10.3.7.49		
>>Additional Measurements list	OP		Additional measurements list 10.3.7.1		
>>CHOICE <i>Measurement</i>	<i>CV-Setup</i>				
>>>Intra-frequency					
>>>>Intra-frequency cell info	OP		Intra-frequency cell info list 10.3.7.33		
>>>>Intra-frequency measurement quantity	OP		Intra-frequency measurement quantity 10.3.7.38		
>>>>Intra-frequency reporting quantity	OP		Intra-frequency reporting quantity 10.3.7.41		
>>>>Reporting cell status	OP		Reporting cell status 10.3.7.61		
>>>>Measurement validity	OP		Measurement validity 10.3.7.51		
>>>>CHOICE <i>report criteria</i>	OP				
>>>>>Intra-frequency measurement reporting criteria			Intra-frequency measurement reporting criteria 10.3.7.39		
>>>>>Periodical reporting			Periodical reporting criteria 10.3.7.53		
>>>>>No reporting			NULL		
>>>Inter-frequency					
>>>>Inter-frequency cell info	OP		Inter-frequency cell info list 10.3.7.13		
>>>>Inter-frequency measurement quantity	OP		Inter-frequency measurement quantity 10.3.7.18		
>>>>Inter-frequency reporting quantity	OP		Inter-frequency reporting quantity 10.3.7.21		
>>>>Reporting cell status	OP		Reporting cell status 10.3.7.61		
>>>>Measurement validity	OP		Measurement validity 10.3.7.51		

Information Element/Group Name	Need	Multi	Type and reference	Semantics description	Version
>>>>Inter-frequency set update	OP		Inter-frequency set update 10.3.7.22		
>>>>CHOICE <i>report criteria</i>	OP				
>>>>>Intra-frequency measurement reporting criteria			Intra-frequency measurement reporting criteria 10.3.7.39		
>>>>>Inter-frequency measurement reporting criteria			Inter-frequency measurement reporting criteria 10.3.7.19		
>>>>>Periodical reporting			Periodical reporting criteria 10.3.7.53		
>>>>>No reporting			NULL		
>>>Inter-RAT					
>>>>Inter-RAT cell info	OP		Inter-RAT cell info list 10.3.7.23		
>>>>Inter-RAT measurement quantity	OP		Inter-RAT measurement quantity 10.3.7.29		
>>>>Inter-RAT reporting quantity	OP		Inter-RAT reporting quantity 10.3.7.32		
>>>>Reporting cell status	OP		Reporting cell status 10.3.7.61		
>>>>Measurement validity	OP		Measurement validity 10.3.7.51		
>>>>CHOICE <i>report criteria</i>	OP				
>>>>>Inter-RAT measurement reporting criteria			Inter-RAT measurement reporting criteria 10.3.7.30		
>>>>>Periodical reporting			Periodical reporting criteria 10.3.7.53		
>>>>>No reporting			NULL		
>>>Traffic Volume					
>>>>Traffic volume measurement Object	OP		Traffic volume measurement object 10.3.7.70		
>>>>Traffic volume measurement quantity	OP		Traffic volume measurement quantity 10.3.7.71		
>>>>Traffic volume reporting quantity	OP		Traffic volume reporting		

Information Element/Group Name	Need	Multi	Type and reference	Semantics description	Version
			quantity 10.3.7.74		
>>>>Measurement validity	OP		Measurement validity 10.3.7.51		
>>>>CHOICE <i>report criteria</i>	OP				
>>>>Traffic volume measurement reporting criteria			Traffic volume measurement reporting criteria 10.3.7.72		
>>>>Periodical reporting			Periodical reporting criteria 10.3.7.53		
>>>>No reporting			NULL		
>>>Quality					
>>>>Quality measurement quantity	OP		Quality measurement quantity 10.3.7.59		
>>>>CHOICE <i>report criteria</i>	OP				
>>>>Quality measurement reporting criteria			Quality measurement reporting criteria 10.3.7.58		
>>>>Periodical reporting			Periodical reporting criteria 10.3.7.53		
>>>>No reporting			NULL		
>>>UE internal					
>>>>UE internal measurement quantity	OP		UE internal measurement quantity 10.3.7.79		
>>>>UE internal reporting quantity	OP		UE internal reporting quantity 10.3.7.82		
>>>>CHOICE <i>report criteria</i>	OP				
>>>>UE internal measurement reporting criteria			UE internal measurement reporting criteria 10.3.7.80		
>>>>Periodical reporting			Periodical reporting criteria 10.3.7.53		
>>>>No reporting			NULL		
>>>UE positioning					
>>>>LCS reporting quantity	OP		LCS reporting quantity 10.3.7.111		
>>>>CHOICE <i>report criteria</i>	OP				
>>>>LCS reporting criteria			LCS reporting criteria 10.3.7.110		
>>>>Periodical reporting			Periodical reporting		

Information Element/Group Name	Need	Multi	Type and reference	Semantics description	Version
			criteria 10.3.7.53		
>>>>No reporting					
Radio Bearer Information Elements					
>Predefined configuration status information	OP		Predefined configuration status information 10.3.4.5a		
>Signalling RB information list	MP	1 to <maxSRBs etup>		For each signalling radio bearer	
>>Signalling RB information	MP		Signalling RB information to setup 10.3.4.24		
>RAB information list	OP	1 to <maxRABs etup>		Information for each RAB	
>>RAB information	MP		RAB information to setup 10.3.4.10		
Transport Channel Information Elements					
Uplink transport channels					
>UL Transport channel information common for all transport channels	OP		UL Transport channel information common for all transport channels 10.3.5.24		
>UL transport channel information list	OP	1 to <MaxTrCH >			
>>UL transport channel information	MP		Added or reconfigured UL TrCH information 10.3.5.2		
Downlink transport channels					
>DL Transport channel information common for all transport channels	OP		DL Transport channel information common for all transport channels 10.3.5.6		
>DL transport channel information list	OP	1 to <MaxTrCH >			
>>DL transport channel information	MP		Added or reconfigured DL TrCH information 10.3.5.1		

Information Element/Group Name	Need	Multi	Type and reference	Semantics description	Version
PhyCH information elements					
>TPC Combination Info list	OP	1 to <maxRL>			
>>Primary CPICH info	MP		Primary CPICH info 10.3.6.60		
>>TPC combination index	MP		TPC combination index 10.3.6.85		
>Transmission gap pattern sequence	OP	1 to <maxTGP S>			REL-5
>>TGPSI	MP		TGPSI 10.3.6.82		REL-5
>> Current TGPS Status Flag	MP		Enumerated(active, inactive)	This flag indicates the current status of the Transmission Gap Pattern Sequence, whether it is active or inactive	REL-5
>>TGCFN	CV-Active		Integer (0..255)	Connection Frame Number of the latest past frame of the first pattern within the Transmission Gap Pattern Sequence.	REL-5
>>Transmission gap pattern sequence configuration parameters	OP				REL-5
>>>TGMP	MP		Enumerated(TDD measurement, FDD measurement, GSM carrier RSSI measurement, GSM Initial BSIC identification, GSM BSIC re-confirmation, Multi-carrier measurement)	Transmission Gap pattern sequence Measurement Purpose.	REL-5
>>>TGPRC	MP		Integer (1..511, Infinity)	The number of remaining transmission gap patterns within the Transmission Gap Pattern Sequence.	REL-5
>>>TGSN	MP		Integer (0..14)	Transmission Gap Starting Slot Number The slot number of the first transmission gap slot within the TGCFN.	REL-5
>>>TGL1	MP		Integer(1..14)	The length of the first Transmission Gap within the transmission gap pattern expressed in number of slots	REL-5
>>>TGL2	MD		Integer (1..14)	The length of the second Transmission Gap within the transmission gap pattern. If omitted, then TGL2=TGL1. The value of TGL2 shall be ignored if TGD is set to "undefined"	REL-5
>>>TGD	MP		Integer(15..269,	Transmission gap distance indicates the number of slots	REL-5

Information Element/Group Name	Need	Multi	Type and reference	Semantics description	Version
			undefined)	between starting slots of two consecutive transmission gaps within a transmission gap pattern. If there is only one transmission gap in the transmission gap pattern, this parameter shall be set to undefined.	
>>>TGPL1	MP		Integer (1..144)	The duration of transmission gap pattern 1.	REL-5
>>>RPP	MP		Enumerated (mode 0, mode 1).	Recovery Period Power control mode during the frame after the transmission gap within the compressed frame. Indicates whether normal PC mode or compressed PC mode is applied	REL-5
>>>ITP	MP		Enumerated (mode 0, mode 1).	Initial Transmit Power is the uplink power control method to be used to compute the initial transmit power after the compressed mode gap.	REL-5
>>>CHOICE <i>UL/DL mode</i>	MP				REL-5
>>>>DL only				Compressed mode used in DL only	REL-5
>>>>>Downlink compressed mode method	MP		Enumerated (SF/2, higher layer scheduling)	Method for generating downlink compressed mode gap	REL-5
>>>>>UL only				Compressed mode used in UL only	REL-5
>>>>>Uplink compressed mode method	MP		Enumerated (SF/2, higher layer scheduling)	Method for generating uplink compressed mode gap	REL-5
>>>>>UL and DL				Compressed mode used in UL and DL	REL-5
>>>>>Downlink compressed mode method	MP		Enumerated (SF/2, higher layer scheduling)	Method for generating downlink compressed mode gap	REL-5
>>>>>Uplink compressed mode method	MP		Enumerated (SF/2, higher layer scheduling)	Method for generating uplink compressed mode gap	REL-5
>>>Downlink frame type	MP		Enumerated (A, B)		REL-5
>>>DeltaSIR1	MP		Real(0..3 by step of 0.1)	Delta in DL SIR target value to be set in the UE during the frame containing the start of the first transmission gap in the transmission gap pattern (without including the effect of the bit-rate increase)	REL-5
>>>DeltaSIRafter1	MP		Real(0..3 by step of 0.1)	Delta in DL SIR target value to be set in the UE one frame after the frame containing the start of the first transmission gap in the transmission gap pattern.	REL-5
>>>DeltaSIR2	OP		Real(0..3 by step of 0.1)	Delta in DL SIR target value to be set in the UE during the frame containing the start of the second transmission gap in the transmission gap pattern	REL-5

Information Element/Group Name	Need	Multi	Type and reference	Semantics description	Version
				(without including the effect of the bit-rate increase) When omitted, DeltaSIR2 = DeltaSIR1.	
>>>DeltaSIRafter2	OP		Real(0..3 by step of 0.1)	Delta in DL SIR target value to be set in the UE one frame after the frame containing the start of the second transmission gap in the transmission gap pattern. When omitted, DeltaSIRafter2 = DeltaSIRafter1.	REL-5
>>>N Identify abort	<i>CV-Initial BSIC</i>		Integer(1..128)	Indicates the maximum number of repeats of patterns that the UE shall use to attempt to decode the unknown BSIC of the GSM cell in the initial BSIC identification procedure	REL-5
>>>T Reconfirm abort	<i>CV-Re-confirm BSIC</i>		Real(0.5..10.0 by step of 0.5)	Indicates the maximum time allowed for the re-confirmation of the BSIC of one GSM cell in the BSIC re-confirmation procedure. The time is given in steps of 0.5 seconds.	REL-5
>Scrambling Code Change List	CH-SF/2	1 to <maxRL>			REL-5
>>Primary CPICH info	MP		Primary CPICH info 10.3.6.60		REL-5
>>Scrambling code change	MP		Enumerated (code change, no code change)	Indicates whether the alternative scrambling code is used for compressed mode method 'SF/2'.	REL-5
Other Information elements					
>Measurement report	OP		MEASUREMENT REPORT 10.2.19	The source RNC should include the Measurement report the UE sent that triggered the SRNS relocation. This information could e.g. be used by the target RNC to set initial power when establishing a DCH.	
>Failure cause	OP		Failure cause 10.3.3.13	Diagnostics information related to an earlier SRNC Relocation request (see NOTE 2 in 14.12.0a)	
>Protocol error information	<i>CV-ProtErr</i>		Protocol error information 10.3.8.12		
MBMS joined information	OP			Included if the UE has joined one or more MBMS services	REL-6
>P-TMSI	OP		P-TMSI (GSM-MAP) 10.3.1.13	In case the UE is in PMM-Idle	REL-6
MBMS Selected Service Info	OP		MBMS Selected Services Info 10.3.9a.7b		REL-6

Multi Bound	Explanation
MaxNoOfMeas	Maximum number of active measurements, upper limit 16

Condition	Explanation
<i>Setup</i>	The IE is mandatory present when the IE Measurement command has the value "Setup", otherwise the IE is not needed.
<i>Ciphering</i>	The IE is mandatory present when the IE Ciphering Status has the value "started" and the ciphering counters need not be reinitialised, otherwise the IE is not needed.
<i>IP</i>	The IE is mandatory present when the IE Integrity protection status has the value "started" and the integrity protection counters need not be reinitialised, otherwise the IE is not needed.
<i>ProtErr</i>	This IE is mandatory present if the IE "Protocol error indicator" is included and has the value TRUE. Otherwise it is not needed.
<i>SRB1</i>	The IE is mandatory present for RB1. Otherwise it is not needed.
<i>Active</i>	This IE is mandatory present when the value of the IE "Current TGPS Status Flag" is "Active" and not needed otherwise.
<i>Initial BSIC</i>	This IE is mandatory present when the value of the IE "TGMP" is set to "GSM Initial BSIC identification" and not needed otherwise.
<i>Re-confirm BSIC</i>	This IE is mandatory present when the value of the IE "TGMP" is set to "GSM BSIC re-confirmation" and not needed otherwise.
<i>SF/2</i>	The IE is mandatory present if the IE "Transmission Gap Pattern Sequence" is included and has the value "SF/2" as the compressed mode method, and already sent the UE the IE "Scrambling Code Change" for each RL in the active set. Otherwise the IE is not needed.

14.12.4.3 Void

14.12.4.4 RFC 3095 CONTEXT INFO

This RRC message is sent between network nodes in SRNS relocation. It is used to transfer the compressor and decompressor context information of the RFC 3095 protocol.

Direction: source RNC →target RNC

Information Element/Group name	Need	Multi	Type and reference	Semantics description	Version
RFC 3095 context	MP	1 to <maxRBall RABs>			REL-5
>RB identity	MP		RB identity 10.3.4.16		REL-5
>RFC 3095 context list	MP	1 to <maxRFC3095-CID>			REL-5
>>Downlink RFC 3095 context	OP				REL-5
>>>Downlink RFC 3095 context identity	MP		Integer (0..16383)		REL-5
>>>DL_MODE	MP		Enumerated (u, o, r)	RFC 3095 mode in downlink before SRNS relocation.	REL-5
>>>REF_IR	MP		Octet string (1..3000)	The RTP IR header (see section 5.7.7 of RFC3095 for detailed format) corresponding to the oldest header in the compressor sliding window.	REL-5
>>>REF_TIME	OP		Integer (0..4294967295)	Arrival time (at the compressor) of REF_IR in milliseconds. See sections 4.5.4 and 6.5.1 of RFC3095.	REL-5
>>>CURR_TIME	OP		Integer (0..4294967295)	Current time in milliseconds. See section 6.5.1 of RFC3095.	REL-5
>>>SYN_OFFSET_ID	OP		Integer (0..65535)	Last synchronized offset of IP-ID. See section 4.5.5 and 6.5.1 of RFC3095 (termed "Offset_I"). It is related to the compression and decompression of IP-ID and is the synchronized offset between the IP-ID value and the SN value (in the same header) during the last SO state before the relocation procedure.	REL-5
>>>SYN_SLOPE_TS	OP		Integer (0..4294967295)	Last synchronized slope of TS. See sections 5.5.1.2 and 5.7 of RFC3095. In SO state, $TS(n) = TS(m) + (n-m) * SYN_SLOPE_TS$, where n and m are, the RTP SN of the current and	REL-5

				the reference packet, respectively. The unit of SYN_SLOPE_TS depends on whether TS is scaled before compression or not.	
>>>DYN_CHANGED	MP		Boolean	Information whether dynamic fields other than RTP SN, RTP TS and IP-ID have changed in the headers that are stored in the sliding window. Set to TRUE if changed and FALSE if not changed.	REL-5
>>Uplink RFC 3095 context	OP				REL-5
>>>Uplink RFC 3095 context identity	MP		Integer (0..16383)		REL-5
>>>UL_MODE	MP		Enumerated (u, o, r)	RFC 3095 mode in uplink	REL-5
>>>REF_IR	MP		Octet string (1..3000)	The RTP IR header (see section 5.7.7 of IETF RFC3095 for detailed format) corresponding to the last correctly decompressed header.	REL-5
>>>REF_TIME	OP		Integer (0..4294967 295)	Arrival time (at the decompressor) of REF_IR in milliseconds. See sections 4.5.4 and 6.5.1 of RFC3095.	REL-5
>>>CURR_TIME	OP		Integer (0..4294967 295)	Current time in milliseconds. See section 6.5.1 of RFC3095.	REL-5
>>>SYN_OFFSET_ID	OP		Integer (0..65535)	Last synchronized offset of IP-ID. See sections 4.5.5 and 6.5.1 of RFC3095 (termed "Offset_I") It is related to the compression and decompression of IP-ID and is the synchronized offset between the IP-ID value and the SN value (in the same header) during the last SO state before the relocation	REL-5

>>>SYN_SLOPE_TS	OP		Integer (0..4294967 295)	<p>procedure.</p> <p>Last synchronized slope of TS. See sections 5.5.1.2 and 5.7 of RFC3095.</p> <p>In SO state, $TS(n) = TS(m) + (n-m) * SYN_SLOPE_TS$, where n and m are, the RTP SN of the current and the reference packet, respectively. The unit of SYN_SLOPE_TS depends on whether TS is scaled before compression or not.</p>	REL-5
>>>REF_SN_1	OP		Integer (0..65535)	Corresponds to the RTP Sequence Number of the predecessor of the latest RTP packet. This could be used to perform local repair of context by decompressor in U or O mode (see "ref - 1" in section 5.3.2.2.5 in IETF RFC3095 for further explanation).	REL-5

14.13 Void

14.14 Void

Annex A (informative): USIM parameters

A.1 Introduction

This annex contains recommendations about the RRC parameters to be stored in the USIM.

A.2 Cipherring information

Information Element/Group name	Need	Multi	Type and reference	Semantics description
Cipher key for each CN domain	MP	<1 to maxCNDo mains>		Cipher key is described in [40].
>CK	MP		Bit string (128)	
Integrity key for each CN domain	MP	<1 to maxCNDo mains>		Integrity key is described in [40].
>IK	MP		Bit string (128)	
THRESHOLD	MP		Bit string (20)	
START value for each CN domain	MP	<1 to maxCNDo mains>		START value is described in [40].
>START	MP		Bit string (20)	
KSI, Key set identifier for each CN domain	MP	<1 to maxCNDo mains>		Key set identifier is described in [40].
>KSI	MP		Bit string (3)	

A.3 Frequency information

Neighbour cell list.

Information Element/Group name	Need	Multi	Type and reference	Semantics description	Version
FDD cell list	OP	<1 to maxFDDFr eqList>			
>UARFCN downlink (Nd)	MP		Integer(0 .. 16383)	[21]	
>Primary scrambling code	OP	<1 to maxFDDFr eqCellList>	Primary CPICH info 10.3.6.60		
3.84 Mcps TDD cell list	OP	<1 to maxTDDFr eqList>			
>UARFCN (Nt)	MP		Integer(0 .. 16383)	[22]	
>Cell parameters ID	OP	<1 to maxTDDFr eqCellList>	Integer (0..127)	The Cell parameters ID is described in [32].	
1.28 Mcps TDD cell list	OP	<1 to maxTDDFr eqList>			REL-4
>UARFCN (Nt)	MP		Integer(0 ..	[22]	REL-4

Information Element/Group name	Need	Multi	Type and reference	Semantics description	Version
			16383)		
>Cell parameters ID	OP	<1 to maxTDDFreqCellList>	Integer (0..127)	The Cell parameters ID is described in [32].	REL-4
GSM Neighbour cell list	OP				
>GSM neighbour cell info	MP	<1 to maxGSMCellList>			
>>BSIC	MP				
>>BCCH ARFCN	MP				

A.4 Multiplicity values and type constraint values

Constant	Explanation	Value
Ciphering information		
maxCNDomains	Maximum number of CN domains	4
Frequency information		
maxFDDFreqList	Maximum number of FDD carrier frequencies to be stored in USIM	4
maxTDDFreqList	Maximum number of TDD carrier frequencies to be stored in USIM	4
maxFDDFreqCellList	Maximum number of neighbouring FDD cells on one carrier to be stored in USIM	32
maxTDDFreqCellList	Maximum number of neighbouring TDD cells on one carrier to be stored in USIM	32
maxGSMCellList	Maximum number of GSM cells to be stored in USIM	32

Annex B (informative): Description of RRC state transitions

This annex contains Stage 2 description of RRC states and state transitions.

B.1 RRC states and state transitions including GSM

After power on, the UE stays in Idle Mode until it transmits a request to establish an RRC Connection. In Idle Mode the connection of the UE is closed on all layers of the access stratum. In Idle Mode the UE is identified by non-access stratum identities such as IMSI, TMSI and P-TMSI. In addition, the UTRAN has no own information about the individual Idle Mode UEs, and it can only address e.g. all UEs in a cell or all UEs monitoring a paging occasion. The UE behaviour within this mode is described in [4].

The UTRA RRC Connected Mode is entered when the RRC Connection is established. The UE is assigned a radio network temporary identity (RNTI) to be used as UE identity on common transport channels.

The RRC states within UTRA RRC Connected Mode reflect the level of UE connection and which transport channels that can be used by the UE.

For inactive stationary data users the UE may fall back to PCH on both the Cell and URA levels. That is, upon the need for paging, the UTRAN checks the current level of connection of the given UE, and decides whether the paging message is sent within the URA, or should it be sent via a specific cell.

B.2 Transition from Idle Mode to UTRA RRC Connected Mode

The transition to the UTRA RRC Connected Mode from the Idle Mode can only be initiated by the UE by transmitting a request for an RRC Connection. The event is triggered either by a paging request from the network or by a request from upper layers in the UE.

When the UE receives a message from the network that confirms the RRC connection establishment, the UE enters the CELL_FACH or CELL_DCH state of UTRA RRC Connected Mode.

In the case of a failure to establish the RRC Connection the UE goes back to Idle Mode. Possible causes are radio link failure, a received reject response from the network or lack of response from the network (timeout).

B.2.1 Transitions for Emergency Calls

Refer to [4] for all states and procedures referred to in this subclause. When UE leaves idle mode from state *Camped on any cell* in order to make an emergency call, moving to state *Connected mode (emergency calls only)*, the UE shall attempt to access the current serving cell. If the access attempt to the serving cell fails the UE shall use the *Cell Reselection* procedure. If no acceptable cell is found, the UE shall use the *Any cell selection*. When returning to idle mode, the UE shall use the procedure *Cell selection when leaving connected mode* in order to find an acceptable cell to camp on, state *Camped on any cell*.

B.3 UTRA RRC Connected Mode States and Transitions

B.3.1 CELL_DCH state

The CELL_DCH state is characterised by

- For TDD: A dedicated physical channel is allocated to the UE in uplink and downlink or a dedicated physical channel is allocated to the UE in the uplink and HS_DSCH_RECEPTION is set to TRUE.

- A dedicated physical channel is allocated to the UE in uplink and downlink.
- For TDD:
 - E_DCH_TRANSMISSION is set to TRUE and HS_DSCH_RECEPTION is set to TRUE.
 - E_DCH_TRANSMISSION is set to TRUE and a dedicated physical channel is allocated to the UE in the downlink.
- The UE is known on cell level according to its current active set.
- Dedicated transport channels, downlink and uplink (TDD) shared transport channels, and a combination of these transport channels can be used by the UE.

The CELL_DCH-state is entered from the Idle Mode through the setup of an RRC connection, or by establishing a dedicated physical channel from the CELL_FACH state.

In TDD a PDSCH may be assigned to the UE in this state, to be used for a DSCH. A PUSCH may also be assigned to the UE in this state, to be used for a USCH. If PDSCH or PUSCH are used for TDD, a FACH transport channel may be assigned to the UE for reception of physical shared channel allocation messages.

B.3.1.1 Transition from CELL_DCH to Idle Mode

Transition to Idle Mode is realised through the release of the RRC connection.

B.3.1.2 Transition from CELL_DCH to CELL_FACH state

Transition to CELL_FACH state occurs when all dedicated channels have been released, which may be

- a) via explicit signalling (e.g. PHYSICAL CHANNEL RECONFIGURATION, RADIO BEARER RECONFIGURATION, RADIO BEARER RELEASE, RADIO BEARER SETUP, TRANSPORT CHANNEL RECONFIGURATION, etc.).

at the end of the time period for which the dedicated channel was allocated (TDD)

B.3.1.3 Transition from CELL_DCH to CELL_PCH state

Transition to CELL_PCH state occurs via explicit signalling (e.g. PHYSICAL CHANNEL RECONFIGURATION, RADIO BEARER RECONFIGURATION, RADIO BEARER RELEASE, RADIO BEARER SETUP, TRANSPORT CHANNEL RECONFIGURATION, etc.).

B.3.1.4 Transition from CELL_DCH to URA_PCH state

Transition to URA_PCH state occurs via explicit signalling (e.g. PHYSICAL CHANNEL RECONFIGURATION, RADIO BEARER RECONFIGURATION, RADIO BEARER RELEASE, RADIO BEARER SETUP, TRANSPORT CHANNEL RECONFIGURATION, etc.).

B.3.1.5 Radio Resource Allocation tasks (CELL_DCH)

For the DCH, several physical channel allocation strategies may be applied. The allocations can be either permanent (needing a DCH release message) or based on time or amount-of-data.

Resource allocation can be done separately for each packet burst with fast signalling on the DCH

For each radio frame the UE and the network indicate the current data rate (in uplink and downlink respectively) using the transport format combination indicator (TFCI). However, in TDD, DCH and DSCH or USCH may be mapped on different CCTrCHs, their TFCI are totally independent. DCH transmission is not modified by the simultaneous existence of DSCH/USCH. If the configured set of combinations (i.e. transport format set for one transport channel) are found to be insufficient to retain the QoS requirements for a transport channel, the network initiates a reconfiguration of the transport format set (TFS) for that transport channel. This reconfiguration can be done during or in between data transmission. Further, the network can reconfigure the physical channel allowing an increase or decrease of the peak data rate.

For the uplink data transmission, the UE reports the observed traffic volume to the network in order for the network to re-evaluate the current allocation of resources. This report contains e.g. the amount of data to be transmitted or the buffer status in the UE.

B.3.1.6 RRC Connection mobility tasks (CELL_DCH)

Depending on the amount and frequency of data macrodiversity (soft handover) may or may not be applied.

The RRC Connection mobility is handled by measurement reporting, soft handover and Timing re-initialised or Timing-maintained hard handover procedures.

B.3.1.7 UE Measurements (CELL_DCH)

The UE performs measurements and transmit measurement reports according to the measurement control information.

The UE uses the connected mode measurement control information received in other states until new measurement control information has been assigned to the UE.

B.3.1.8 Acquisition of system information (CELL_DCH)

FDD UEs with certain capabilities reads system information broadcast on FACH.

TDD UEs reads the BCH to acquire valid system information. For each acquisition, the UE may need different combinations of system information broadcast on BCH. The scheduling on the broadcast channel is done in such way that the UE knows when the requested information can be found.

B.3.2 CELL_FACH state

The CELL_FACH state is characterised by:

- No dedicated physical channel is allocated to the UE.
- The UE continuously monitors in the downlink:
 - In TDD mode:
 - a FACH.
 - In FDD mode:
 - a FACH; or
 - an HS-DSCHs and optionally a FACH for MBMS reception.
- The UE is assigned a default common or shared transport channel in the uplink (e.g. RACH) that it can use anytime according to the access procedure for that transport channel.
- The position of the UE is known by UTRAN on cell level according to the cell where the UE last made a cell update.
- In TDD mode, one or several USCH or DSCH transport channels may have been established.

B.3.2.1 Transition from CELL_FACH to CELL_DCH state

A transition occurs, when a dedicated physical channel is established via explicit signalling (e.g. PHYSICAL CHANNEL RECONFIGURATION, RADIO BEARER RECONFIGURATION, RADIO BEARER RELEASE, RADIO BEARER SETUP, TRANSPORT CHANNEL RECONFIGURATION, etc.).

B.3.2.2 Transition from CELL_FACH to CELL_PCH state

The transition occurs when UTRAN orders the UE to move to CELL_PCH state, which is done via explicit signalling (e.g. CELL UPDATE CONFIRM, RADIO BEARER RECONFIGURATION, etc.).

B.3.2.3 Transition from CELL_FACH to Idle Mode

Upon release of the RRC connection, the UE moves to the idle mode.

B.3.2.4 Transition from CELL_FACH to URA_PCH State

The transition occurs when UTRAN orders the UE to move to URA_PCH state, which is done via explicit signalling (e.g. URA UPDATE CONFIRM, RADIO BEARER RECONFIGURATION, etc.).

B.3.2.5 Radio Resource Allocation Tasks (CELL_FACH)

For TDD, in the CELL_FACH state the UE will monitor a FACH.

For FDD in the CELL_FACH state the UE will monitor a FACH, if the UE does not support HS-DSCH reception in CELL_FACH state or IE "HS-DSCH common system information" is not included in the system information. Otherwise the UE will monitor the common HS-DSCH(s), and FACH monitoring is restricted to MBMS reception.

The UE is enabled to transmit uplink control signals and it may be able to transmit small data packets on the RACH.

The network can assign the UE transport channel parameters (e.g. transport format sets) in advance, to be used when a DCH is used. Upon assignment of the physical channel for DCH, the UE moves to CELL_DCH state and uses the pre-assigned TFS for the DCH.

If no UE dedicated physical channel or transport channel configuration has been assigned, the UE uses the common physical channel and transport channel configuration according to the system information.

For the uplink data transmission, the UE reports the observed traffic volume to the network in order for the network to re-evaluate the current allocation of resources. This report contains e.g. the amount of data to be transmitted or the buffer status in the UE.

When there is either user or control data to transmit, a selection procedure determines whether the data should be transmitted on a common transport channel, or if a transition to CELL_DCH should be executed. The selection is dynamic and depends on e.g. traffic parameters (amount of data, packet burst frequency).

In the TDD mode, the UTRAN can assign USCH / DSCH resources to the UE in CELL_FACH state. When USCH / DSCH resources are assigned, the UE will continue to monitor FACHs, depending on the UE capability. The UE may use the USCH / DSCH to transmit signalling messages or user data in the uplink and / or the downlink using USCH and / or DSCH when resources are allocated to cell and UE is assigned use of those USCH / DSCH.

For the uplink data transmission on USCH the UE reports to the network the traffic volume (current size of RLC data buffers), The UTRAN can use these measurement reports to re-evaluate the current allocation of the USCH / DSCH resources.

B.3.2.6 RRC Connection mobility tasks (CELL_FACH)

In this state the location of the UE is known on cell level. A cell update procedure is used to report to the UTRAN, when the UE selects a new cell to observe the common downlink channels of a new cell. Downlink data transmission on the FACH can be started without prior paging.

The UE monitors the broadcast channel and system information on BCCH of its own and neighbour cells and from this the need for the updating of cell location is identified.

The UE performs cell reselection and upon selecting a new UTRA cell, it initiates a cell update procedure. Upon selecting a new cell belonging to another radio access system than UTRA, the UE enters idle mode and makes an access to that system according to its specifications.

B.3.2.7 UE Measurements (CELL_FACH)

The UE performs measurements and transmit measurement reports according to the measurement control information.

By default, the UE uses the measurement control information broadcast within the system information. However, for measurements for which the network also provides measurement control information within a MEASUREMENT CONTROL message, the latter information takes precedence.

B.3.2.8 Transfer and update of system information (CELL_FACH)

The UE reads the BCH to acquire valid system information. For each acquisition, the UE may need different combinations of system information broadcast on BCH. The scheduling on the broadcast channel is done in such way that the UE knows when the requested information can be found.

When the system information is modified, the scheduling information is updated to reflect the changes in system information transmitted on BCH. The new scheduling information is broadcast on FACH and/or on the common HS-DSCH(s) (FDD only) in order to inform UEs about the changes. If the changes are applicable for the UE, the modified system information is read on BCH.

B.3.3 CELL_PCH state

The CELL_PCH state is characterised by:

- For FDD, if "HS-DSCH paging system information" is not included in System Information or the UE does not support HS-DSCH reception in CELL_PCH and URA_PCH state, and for TDD, no dedicated physical channel is allocated to the UE.

For FDD, if "HS-DSCH paging system information" is included in System Information and the UE does support HS-DSCH reception in CELL_PCH and URA_PCH state, dedicated physical channel may be allocated to the UE.
- For FDD, if "HS-DSCH paging system information" is not included in System Information or the UE does not support HS-DSCH reception in CELL_PCH and URA_PCH state, and for TDD, the UE selects a PCH with the algorithm specified in subclause 8.5.19, and uses DRX for monitoring the selected PCH via an associated PICH.
- For FDD, if "HS-DSCH paging system information" is included in System Information and the UE supports HS-DSCH reception in CELL_PCH and URA_PCH state, the UE selects a HS-DSCH mapped on the HS-PDSCH with algorithms specified in 8.5.41, 8.5.39 and 8.5.40, and uses DRX for monitoring the selected HS-DSCH via an associated PICH.
- No uplink activity is possible.
- The position of the UE is known by UTRAN on cell level according to the cell where the UE last made a cell update in CELL_FACH state.

The DCCH and DTCH logical channels can only be used in this state if HS-DSCH is used and a dedicated H-RNTI is configured. Otherwise, if the network wants to initiate any activity, it needs to make a paging request on the PCCH logical channel in the known cell to initiate any downlink activity.

B.3.3.1 Transition from CELL_PCH to CELL_FACH state

The UE is transferred to CELL_FACH state:

- a) by paging from UTRAN (PAGING TYPE1 message)
- b) through any uplink access

B.3.3.2 Radio Resource Allocation Tasks (CELL_PCH)

In CELL_PCH state no resources have been granted for data transmission. For this purpose, a transition to another state has to be executed.

The UE may use Discontinuous Reception (DRX) in order to reduce power consumption. When DRX is used the UE needs only to receive at one paging occasion per DRX cycle. The UE may be instructed to use specific DRX cycle lengths by the network. The UE determines its paging occasions in the same way as for Idle Mode, see [4].

B.3.3.3 RRC Connection mobility tasks (CELL_PCH)

In the CELL_PCH state, the UE mobility is performed through cell reselection procedures, which may differ from the one defined in [4].

The UE performs cell reselection and upon selecting a new UTRA cell, it moves to CELL_FACH state and initiates a cell update procedure in the new cell. After the cell update procedure has been performed, the UE changes its state back to CELL_PCH state if neither the UE nor the network has any more data to transmit.

Upon selecting a new cell belonging to another radio access system than UTRA, the UE enters idle mode and make an access to that system according to its specifications.

In case of low UE activity, UTRAN may want to reduce the cell-updating overhead by ordering the UE to move to the URA_PCH State. This transition is made via the CELL_FACH state. UTRAN may apply an inactivity timer, and optionally, a counter, which counts the number of cell updates e.g. UTRAN orders the UE to move to URA_PCH when the number of cell updates has exceeded certain limits (network parameter).

B.3.3.4 UE Measurements (CELL_PCH)

The UE performs measurements and transmit measurement reports according to the measurement control information.

The UE uses the measurement control information according to the system information when no UE dedicated measurement control information has been assigned.

B.3.3.5 Transfer and update of system information (CELL_PCH)

The UE reads the BCH to acquire valid system information. For each acquisition, the UE may need different combinations of system information broadcast on BCH. The scheduling on the broadcast channel is done in such way that the UE knows when the requested information can be found.

B.3.4 URA_PCH State

The URA_PCH state is characterised by:

- No dedicated channel is allocated to the UE.
- For FDD, if "HS-DSCH paging system information" is not included in System Information or the UE does not support HS-DSCH reception in CELL_PCH and URA_PCH state, and for TDD, the UE selects a PCH with the algorithm specified in subclause 8.5.19, and uses DRX for monitoring the selected PCH via an associated PICH.
- For FDD, if "HS-DSCH paging system information" is included in System Information and the UE supports HS-DSCH reception in CELL_PCH and URA_PCH state, the UE selects a HS-DSCH mapped on the HS-PDSCH with algorithms specified in 8.5.41, 8.5.39 and 8.5.40, and uses DRX for monitoring the selected HS-DSCH via an associated PICH.
- No uplink activity is possible.
- The location of the UE is known on UTRAN Registration area level according to the URA assigned to the UE during the last URA update in CELL_FACH state.

The DCCH logical channel cannot be used in this state. If the network wants to initiate any activity, it needs to make a paging request on the PCCH logical channel within the URA where the location of the UE is known. If the UE needs to transmit anything to the network, it goes to the CELL_FACH state. The transition to URA_PCH State can be controlled

with an inactivity timer, and optionally, with a counter that counts the number of cell updates. When the number of cell updates has exceeded certain limits (a network parameter), then the UE changes to the URA_PCH State.

URA updating is initiated by the UE, which, upon the detection of the Registration area, sends the network the Registration area update information on the RACH of the new cell.

B.3.4.1 Transition from URA_PCH State to CELL_FACH State (URA_PCH)

Any activity causes the UE to be transferred to CELL_FACH State.

- a) Uplink access is performed by RACH.
- b) by paging from UTRAN (PAGING TYPE1 message).

NOTE: The release of an RRC connection is possible in the URA_PCH state. UE in URA_PCH is able to go to idle when triggered by paging type 1 message in case "Release indicator" has the value "Release".

B.3.4.2 Radio Resource Allocation Tasks (URA_PCH)

In URA_PCH State no resources have been granted for data transmission. For this purpose, a transition to CELL_FACH State has to be executed.

The UE may use Discontinuous Reception (DRX) in order to reduce power consumption. When DRX is used the UE needs only to receive at one paging occasion per DRX cycle. The UE may be instructed to use specific DRX cycle lengths by the network. The UE determines its paging occasions in the same way as for Idle Mode, see [4].

B.3.4.3 RRC Connection mobility tasks (URA_PCH)

In URA_PCH State the location of a UE is known on UTRAN Registration area level.

In this state, the UE mobility is performed through URA reselection procedures, which may differ from the definitions in [4]. The UE performs cell reselection and upon selecting a new UTRA cell belonging to a URA that does not match the URA used by the UE, the UE moves to CELL_FACH state and initiates a URA update towards the network. After the URA update procedure has been performed, the UE changes its state back to URA_PCH state if neither the UE nor the network has any more data to transmit.

Upon selecting a new cell belonging to another radio access system than UTRA, the UE enters idle mode and makes an access to that system according to its specifications.

B.3.4.4 UE Measurements (URA_PCH)

The UE performs measurements and transmit measurement reports according to the measurement control information.

The UE uses the measurement control information according to the system information when no UE dedicated measurement control information has been assigned.

B.3.4.5 Transfer and update of system information (URA_PCH)

The same mechanisms to transfer and update system information as for state CELL_PCH are applicable for UEs in URA_PCH state.

B.3.5 States and Transitions for Cell Reselection in URA_PCH, CELL_PCH, and CELL_FACH

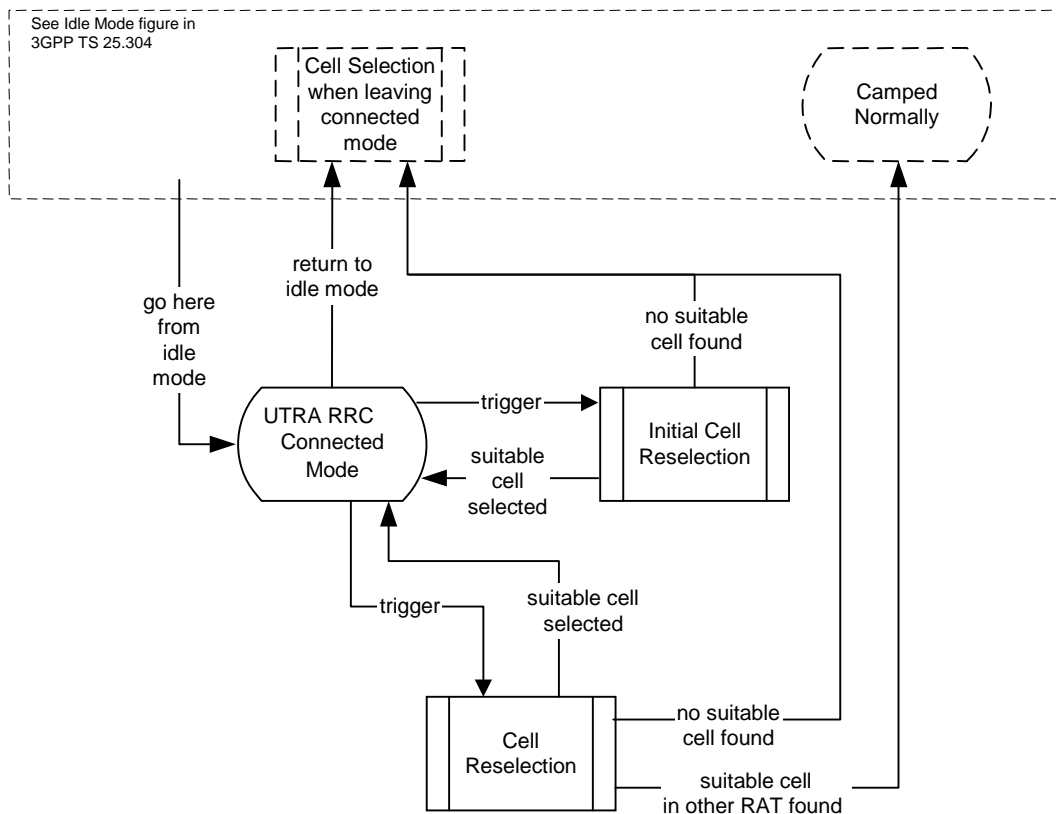

Figure B.3.5-1: UTRA RRC Connected mode cell reselection for URA_PCH, CELL_PCH, and CELL_FACH

In some states the UE performs cell reselection procedures. The UE selects a suitable cell (defined in [4]) and radio access technology based on connected mode radio measurements and cell reselection criteria.

Figure B.3.5-1 shows the states and procedures in the cell reselection process in connected mode.

When a cell reselection is triggered, the UE evaluates the cell reselection criteria based on radio measurements, and if a better cell is found that cell is selected, procedure Cell reselection (see [4]). If the change of cell implies a change of radio access technology, the RRC connection is released, and the UE enters idle mode of the other RAT. If no suitable cell is found in the cell reselection procedure, the UE eventually enters idle mode.

When an Initial cell reselection is triggered, the UE shall use the Initial cell reselection procedure (see [4]) to find a suitable cell. One example where this procedure is triggered is at radio link failure, where the UE may trigger an initial cell reselection in order to request re-establishment of the RRC connection. If the UE is unable to find a suitable cell, the UE eventually enters idle mode.

B.4 Inter-RAT handover with CS domain services

When using CS domain services, UTRAN is using an Inter-Radio access system Handover Procedure and GSM is using a Handover procedure for the transition from UTRA RRC Connected Mode to GSM Connected Mode.

B.5 Inter-RAT handover with PS domain services

When using PS domain services, the UE can initiate cell reselection from a GSM/GPRS cell to a UTRAN cell and then uses the RRC Connection Establishment procedure for the transition to UTRA RRC Connected mode. It is also possible for the BSS to initiate a UTRA Inter-RAT Handover to seamlessly relocate the UE to UTRAN. In this latter case there is no need to return the UE to Idle Mode (GPRS Packet Idle Mode) and the UE immediately moves to RRC connected state in the UTRAN.

In the case that cell reselection is used, when the RRC Connection is established from Idle Mode (GPRS Packet Idle Mode) the RRC CONNECTION REQUEST message contains an indication, that UTRAN needs to continue an already established GPRS UE context from the CN. This indication allows UTRAN to e.g. prioritise the RRC CONNECTION REQUEST from the UE.

In UTRA RRC connected mode UTRAN may use UE or network initiated cell reselection to change from a UTRAN cell to a GSM/GPRS cell. If the cell reselection was successful the UE enters Idle Mode (GPRS Packet Idle Mode). The UE sends a packet channel request from Idle Mode (GPRS Packet Idle mode) to establish a Temporary Block flow and enter GPRS Packet Transfer Mode. In the GPRS Packet Transfer Mode the UE sends a RA Update request message. The RA Update Request message sent from the UE contains an indication that GSM/GPRS need to continue an already established UTRAN UE context from the CN. This means that the RA Update request is always sent for the transition from UTRA RRC Connected Mode to GSM/GPRS regardless if the RA is changed or not.

Alternatively, the UTRAN may use an Inter-System Relocation (PS Handover) to relocate a UTRA RRC connected UE directly to GPRS Packet Transfer Mode in GERAN.

NOTE: The reason for using RA update instead of a new message is to reduce the impact on the existing GSM/GPRS specification.

B.6 Inter-RAT handover with simultaneous PS and CS domain services

B.6.1 Inter-RAT handover UTRAN to GSM / BSS

For a UE in CELL_DCH state using both CS and PS Domain services the Inter-RAT handover procedure is based on measurement reports from the UE but initiated from UTRAN.

The UE performs the Inter-RAT handover from UTRA RRC Connected Mode to GSM Connected Mode first. When the UE has sent handover complete message to GSM / BSS the UE initiates a temporary block flow towards GPRS and sends a RA update request.

If the Inter-RAT handover from UTRA RRC Connected Mode to GSM Connected Mode was successful the handover is considered as successful regardless if the UE was able to establish a temporary block flow or not towards GPRS.

In case of Inter-RAT handover failure the UE has the possibility to go back to UTRA RRC Connected Mode and re-establish the connection in the state it originated from.

B.6.2 Inter-RAT handover GSM / BSS to UTRAN

For a UE in GSM Connected Mode using both CS and PS domain services the Inter-RAT handover procedure is based on measurement reports from the UE but initiated from GSM / BSS.

The UE performs the Inter-RAT handover from GSM Connected Mode to UTRA RRC Connected Mode.

In UTRA RRC Connected Mode both services are established in parallel.

If the Inter-RAT handover from GSM Connected mode to UTRA RRC Connected Mode was successful the handover is considered as successful.

In case of Inter-RAT handover failure the UE has the possibility to go back to GSM Connected Mode and re-establish the connection in the state it originated from.

Annex C (informative): Description for the Compressed Coding of Pre-defined configurations included in the INTER RAT HANDOVER INFO message

This annex contains a description of the compressed coding of the IE "Predefined configuration status information compressed" (see subclause 10.3.4.5b) included in the INTER RAT HANDOVER INFO message.

C.1 Definitions

Pre-defined configuration set with different value tags: This is a set of consecutive positions for which pre-defined configurations are stored with different value tags. The set cannot include positions for which no pre-defined configuration is stored.

Pre-defined configuration list with variable size: This is the variable sized list consisting of the value tags corresponding to the remaining positions after the "Pre-defined configuration sets with different value tags" have been formed. This will also indicate not stored pre-defined configurations, either explicitly or implicitly (i.e. in the case that there are no more stored configurations until the end of the variable sized list). This is highlighted in figures C.2-1 and C.2-2.

C.2 Examples of the methodology

From figure C.2-1 it can be seen that there are two "Pre-defined configuration sets with different value tags".

The start position of Set1 is "1" with a list of 7 pre-defined configurations {1, 2, 3, 4, 5, 6, 7}.

The start position of Set2 is "10" with a list of 6 pre-defined configurations {10, 11, 12, 13, 14, 15}.

The "Pre-defined configurations list with variable size" has a start position of 0, and includes all of the pre-defined configurations not included in the sets {0, 8, 9}. The value tag at position 9 is not stored. This does not need to be explicitly indicated in the coding as "not stored" because there are no stored pre-defined configurations positioned after this in the list.

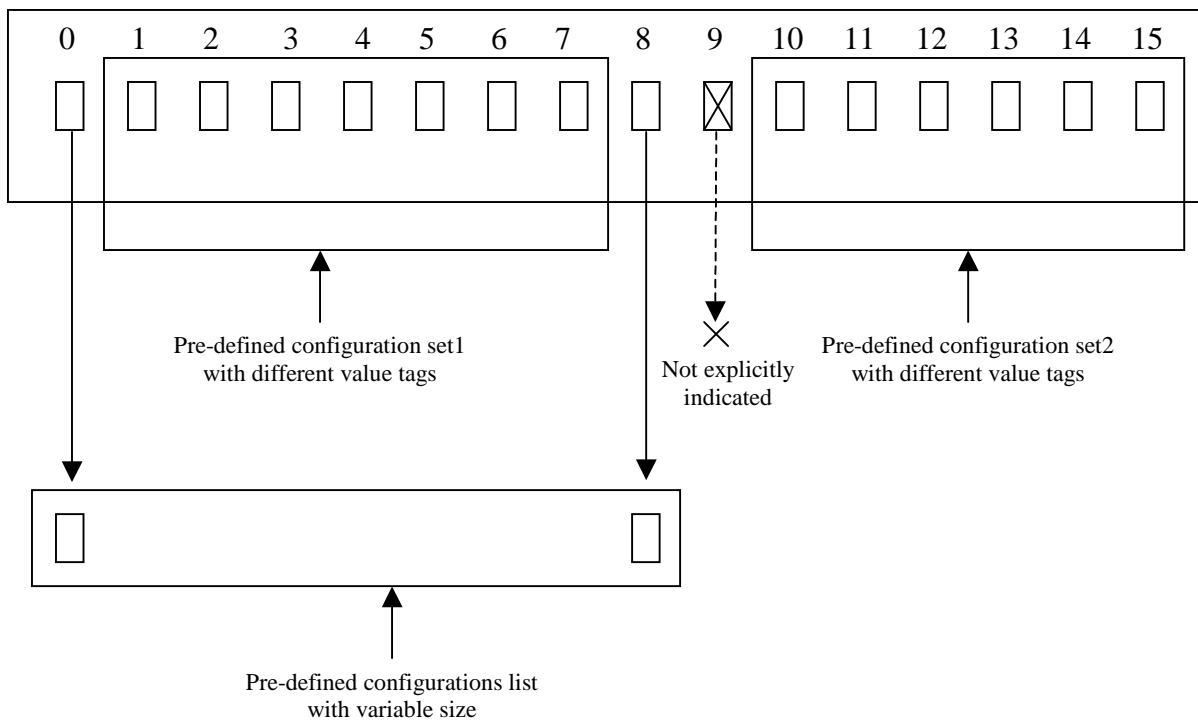

Figure C.2-1: Example scenario where non-stored pre-defined configurations do not need to be explicitly indicated

Figure C.2-2 is similar to Figure C.2-1. However in this case for the "Pre-defined configurations list with variable size", the pre-defined configuration in position 8 is not stored. This needs to be explicitly indicated in the coding as "not stored" because there is a stored pre-defined configuration (position 9) positioned after this in the list.

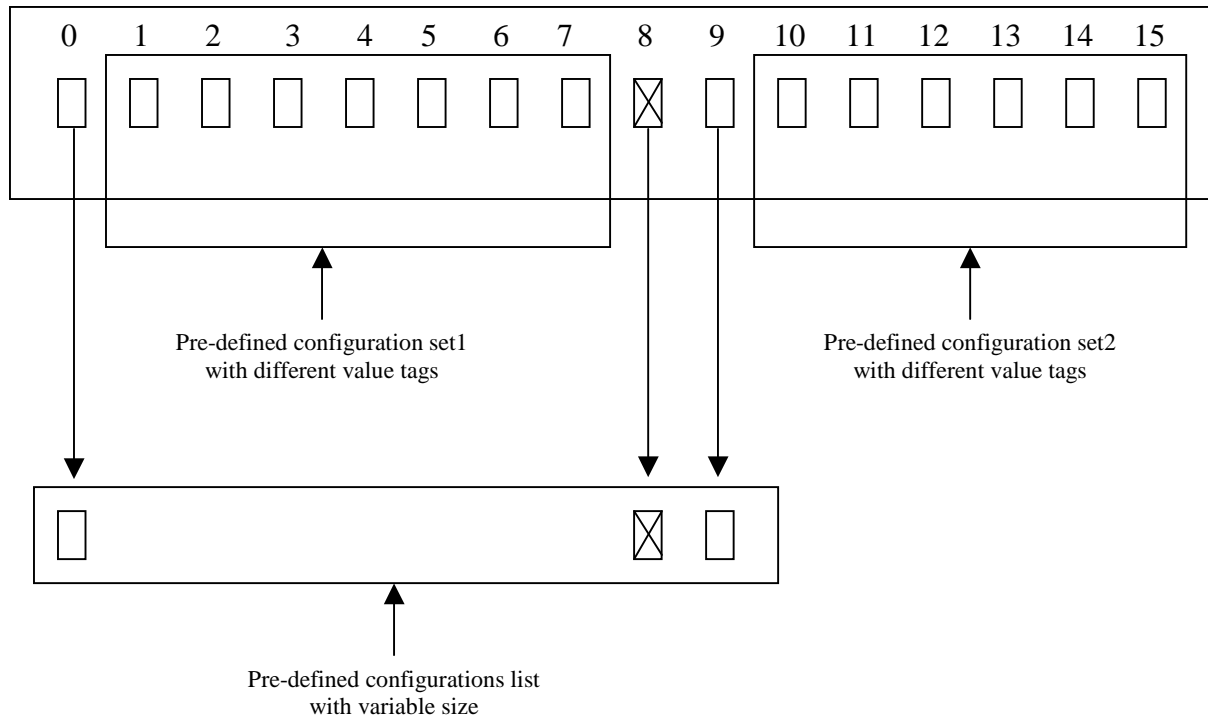

Figure C.2-2: Example scenario where non-stored pre-defined configurations need to be explicitly indicated

Annex D (Normative): Implementation of Domain Specific Access Control (DSAC) in UEs of 3GPP Release 5

UEs of 3GPP Release 5 implementing the domain specific access class control feature but not implementing the network sharing feature shall act on the domain specific access class restriction indicated by the IE "Domain Specific Access Restriction Parameters For PLMN Of MIB" if present, and otherwise apply the access restrictions indicated by the IE "Cell Access Restriction".

Annex E (informative): Change history

Change history							
Date	TSG #	TSG Doc.	CR	Rev	Subject/Comment	Old	New
10/1999	RP-05	RP-99524	-		Approved at TSG-RAN #5 and placed under Change Control	-	3.0.0
12/1999	RP-06	RP-99650	001		Modification of RRC procedure specifications	3.0.0	3.1.0
	RP-06	RP-99654	005	1	Introduction of Information Element for Power Control Algorithm	3.0.0	3.1.0
	RP-06	RP-99654	007	1	RRC parameters for SSdT	3.0.0	3.1.0
	RP-06	RP-99656	009	1	Inclusion of information elements for integrity protection	3.0.0	3.1.0
	RP-06	RP-99656	010	2	Security mode control procedure	3.0.0	3.1.0
	RP-06	RP-99656	011	3	Updates of the system information procedure	3.0.0	3.1.0
	RP-06	RP-99656	012	2	Inter-frequency measurements and reporting	3.0.0	3.1.0
	RP-06	RP-99656	013	1	Inter-system measurements and reporting	3.0.0	3.1.0
	RP-06	RP-99656	014	1	Additional measurements in RRC measurement messages	3.0.0	3.1.0
	RP-06	RP-99656	015	3	Value range for Measurement Information Elements	3.0.0	3.1.0
	RP-06	RP-99656	016	2	Message contents for inter system handover to UTRAN	3.0.0	3.1.0
	RP-06	RP-99652	017		Inclusion of ciphering information elements	3.0.0	3.1.0
	RP-06	RP-99651	018		Corrections and editorial changes	3.0.0	3.1.0
	RP-06	RP-99654	019	1	Algorithm for CTCF Calculation	3.0.0	3.1.0
	RP-06	RP-99651	025		Logical CH for RRC Connection Re-establishment (RRC Connection Re-establishment deleted in RAN_10, RP-000715)	3.0.0	3.1.0
	RP-06	RP-99719	026	1	Gain Factors	3.0.0	3.1.0
	RP-06	RP-99654	027	1	Parameters for CELL UPDATE CONFIRM message	3.0.0	3.1.0
	RP-06	RP-99651	028		Cell Update Cause	3.0.0	3.1.0
	RP-06	RP-99654	029	1	RRC Initialisation Information	3.0.0	3.1.0
	RP-06	RP-99656	034	1	Open loop power control for PRACH	3.0.0	3.1.0
	RP-06	RP-99652	038		Addition of the UE controlled AMR mode adaptation	3.0.0	3.1.0
	RP-06	RP-99651	039		Information elements for RLC reset	3.0.0	3.1.0
	RP-06	RP-99656	040		Support for DS-41 Initial UE Identity	3.0.0	3.1.0
	RP-06	RP-99656	042	2	Integration of Cell Broadcast Service (CBS)	3.0.0	3.1.0
	RP-06	RP-99654	044	1	Gated transmission of DPCH	3.0.0	3.1.0
	RP-06	RP-99656	045		Modification to the Transport Format Combination Control message	3.0.0	3.1.0
	RP-06	RP-99656	046		New Information elements and modifications to messages required in order to support configuration and re-configuration of the DSCH in FDD mode	3.0.0	3.1.0
	RP-06	RP-99654	047	1	Editorial Corrections and Alignments with Layer 1 specifications	3.0.0	3.1.0
	RP-06	RP-99654	048	1	Information elements for TDD shared channel operation	3.0.0	3.1.0
	RP-06	RP-99656	049		Description of CN dependent IEs in Master Information Block	3.0.0	3.1.0
	RP-06	RP-99650	050		UE capability information elements	3.0.0	3.1.0
	RP-06	RP-99656	051	1	UTRAN response time to uplink feedback commands of TX diversity control	3.0.0	3.1.0
	RP-06	RP-99654	052		New and corrected CPCH parameters	3.0.0	3.1.0
	RP-06	RP-99654	053	2	Compressed mode parameters without gating	3.0.0	3.1.0
	RP-06	RP-99654	054		Transport format combination set and transport format combination subset	3.0.0	3.1.0
	RP-06	RP-99656	055	1	Information elements for cell selection and reselection	3.0.0	3.1.0
	RP-06	RP-99654	056		Corrections and Alignments of the RRC to the L1 for TDD	3.0.0	3.1.0
	RP-06	RP-99656	057	1	Introduction of a SCCH procedure	3.0.0	3.1.0
	RP-06	RP-99656	061		Support for DS-41 Paging UE Identity	3.0.0	3.1.0
	RP-06	RP-99656	062	2	Support for cdma2000 Hard Handover	3.0.0	3.1.0
	RP-06	RP-99656	063	1	Provide necessary signalling to support FDD DSCH	3.0.0	3.1.0
	RP-06	RP-99654	064		RRC procedure interactions	3.0.0	3.1.0
	RP-06	RP-99654	066	1	Transfer of UE capabilities	3.0.0	3.1.0
	RP-06	RP-99654	067		Selection of initial UE identity	3.0.0	3.1.0
	RP-06	RP-99657	069		UE capability verification in the security mode control procedure	3.0.0	3.1.0
	RP-06	RP-99657	070	1	DPCH initial power	3.0.0	3.1.0
	RP-06	RP-99657	071		Actions when entering idle mode	3.0.0	3.1.0

Change history							
Date	TSG #	TSG Doc.	CR	Rev	Subject/Comment	Old	New
	RP-06	RP-99657	072		Specification of inter-frequency and inter-system reporting events for FDD	3.0.0	3.1.0
	RP-06	RP-99657	073	1	Signalling radio bearers	3.0.0	3.1.0
	RP-06	RP-99654	074		CN information elements	3.0.0	3.1.0
	RP-06	RP-99654	076		UE information elements	3.0.0	3.1.0
	RP-06	RP-99657	077	1	Radio bearer, transport channel and physical channel information elements	3.0.0	3.1.0
	RP-06	RP-99654	078		Other information elements	3.0.0	3.1.0
	RP-06	RP-99657	079	2	RRC signalling for PDCP	3.0.0	3.1.0
	RP-06	RP-99654	080		Content of Measurement Control Messages	3.0.0	3.1.0
	RP-06	RP-99654	081		RRC Information Elements to support Block STTD transmission diversity in TDD	3.0.0	3.1.0
	RP-06	RP-99657	082	1	Signalling connection release	3.0.0	3.1.0
	RP-06	RP-99657	083	1	Addition of cell access restriction information elements to System Information	3.0.0	3.1.0
	RP-06	RP-99655	085	1	RRC Connection Establishment parameters	3.0.0	3.1.0
	RP-06	RP-99657	092	1	Support of UE autonomous update of a active set on a non-used frequency	3.0.0	3.1.0
	RP-06	RP-99657	095	1	TPC combining for power control	3.0.0	3.1.0
	RP-06	RP-99653	096	1	Editorial Modification of IEs in RRC messages	3.0.0	3.1.0
	RP-06	RP-99655	097		Selection of SCCPCH	3.0.0	3.1.0
	RP-06	RP-99655	098	1	RRC Initialisation Information	3.0.0	3.1.0
	RP-06	RP-99657	100	1	Support of physical channel establishment and failure criteria in the UE	3.0.0	3.1.0
	RP-06	RP-99655	102	1	RRC Connection Re-establishment (Message deleted in RAN_10, RP-000715)	3.0.0	3.1.0
	RP-06	RP-99657	106	1	System information on FACH	3.0.0	3.1.0
	RP-06	RP-99657	108	1	SAPs and Primitives for DS-41 mode	3.0.0	3.1.0
	RP-06	RP-99655	109	1	TX Diversity Mode for Dedicated Channel	3.0.0	3.1.0
	RP-06	RP-99657	110	1	RACH message length signalling on System Information	3.0.0	3.1.0
	RP-06	RP-99657	113	1	Routing of NAS messages in UTRAN	3.0.0	3.1.0
	RP-06	RP-99655	116	3	TBS Identification in TFS	3.0.0	3.1.0
	RP-06	RP-99657	117	1	Merging the hard handover and some radio bearer control procedures	3.0.0	3.1.0
	RP-06	RP-99653	120	1	Selected RRC message transfer syntax	3.0.0	3.1.0
	RP-06	RP-99657	121		Efficient rate command signalling	3.0.0	3.1.0
03/2000	RP-07	RP-000043	122		TDD Mode BCH Reception in Cell DCH State	3.1.0	3.2.0
	RP-07	RP-000043	123		Uplink Outer Loop Power Control in TDD Mode	3.1.0	3.2.0
	RP-07	RP-000043	124	1	TFS TB Size Calculation with Bit Aligned TDD MAC Headers	3.1.0	3.2.0
	RP-07	RP-000043	125		Grouping of DRAC IEs, and detailed definitions of these IEs	3.1.0	3.2.0
	RP-07	RP-000043	126		Correction of specifications for the 'Dynamic Resource Allocation Control of Uplink DCH' Procedure	3.1.0	3.2.0
	RP-07	RP-000043	131	2	Clarification of PDCP info and PDCP capability IEs	3.1.0	3.2.0
	RP-07	RP-000043	132		Editorial change to "Specification of system information block characteristics"	3.1.0	3.2.0
	RP-07	RP-000043	133		Additions of CBS related Information Elements	3.1.0	3.2.0
	RP-07	RP-000043	134		Signalling for computed gain factors	3.1.0	3.2.0
	RP-07	RP-000043	137	1	General error handling procedures	3.1.0	3.2.0
	RP-07	RP-000043	138	1	RRC message extensions	3.1.0	3.2.0
	RP-07	RP-000043	139		Padding of RRC messages using RLC transparent mode	3.1.0	3.2.0
	RP-07	RP-000043	140	2	UE information elements	3.1.0	3.2.0
	RP-07	RP-000043	141		Other information elements	3.1.0	3.2.0
	RP-07	RP-000043	142	3	Integrity protection function	3.1.0	3.2.0
	RP-07	RP-000043	143	4	RAB-RB relations	3.1.0	3.2.0
	RP-07	RP-000043	144	1	Inter-system handover from UTRAN	3.1.0	3.2.0
	RP-07	RP-000043	145	3	Handover to UTRAN including procedure for pre- configuration	3.1.0	3.2.0
	RP-07	RP-000043	146	2	RRC measurement filtering parameters	3.1.0	3.2.0
	RP-07	RP-000043	147		New event "RL out of UE Rx window"	3.1.0	3.2.0
	RP-07	RP-000044	148	1	Access control on RACH	3.1.0	3.2.0
	RP-07	RP-000044	149	2	cdma2000 Hard Handover	3.1.0	3.2.0

Change history							
Date	TSG #	TSG Doc.	CR	Rev	Subject/Comment	Old	New
	RP-07	RP-000044	150	1	CPCH parameters with corrections	3.1.0	3.2.0
	RP-07	RP-000044	152		U-plane AM RLC reconfiguration by cell update procedure	3.1.0	3.2.0
	RP-07	RP-000044	154	3	CPCH	3.1.0	3.2.0
	RP-07	RP-000044	155	1	Information elements for ASC in TDD	3.1.0	3.2.0
	RP-07	RP-000044	156		Addition of timing advance value in handover related messages	3.1.0	3.2.0
	RP-07	RP-000044	157	2	Physical channel description for TDD	3.1.0	3.2.0
	RP-07	RP-000044	159		Message contents for the intersystem command message to UTRAN operating in TDD mode	3.1.0	3.2.0
	RP-07	RP-000044	160		Corrections on use of PUSCH power control info and minor corrections	3.1.0	3.2.0
	RP-07	RP-000044	162	2	UE individual DRX cycles in CELL_PCH and URA_PCH states	3.1.0	3.2.0
	RP-07	RP-000044	163		Correction to Transport Format Combination Control procedure	3.1.0	3.2.0
	RP-07	RP-000044	164	3	Downlink outer loop power control	3.1.0	3.2.0
	RP-07	RP-000044	165	2	Redirection of RRC connection setup	3.1.0	3.2.0
	RP-07	RP-000044	166	2	Inter-frequency measurements in CELL_FACH state	3.1.0	3.2.0
	RP-07	RP-000044	167		List of found editorial mistakes in the Dec99 version of 25.331 (V3.1.0)	3.1.0	3.2.0
	RP-07	RP-000044	168	1	Transport block size	3.1.0	3.2.0
	RP-07	RP-000044	169	1	Cell Access Restriction	3.1.0	3.2.0
	RP-07	RP-000044	170		Editorial modification	3.1.0	3.2.0
	RP-07	RP-000044	171		Modification of DPCH info	3.1.0	3.2.0
	RP-07	RP-000045	172	1	Measurement control message	3.1.0	3.2.0
	RP-07	RP-000045	173	2	Reporting cell status	3.1.0	3.2.0
	RP-07	RP-000045	174		Additional IE for RB release	3.1.0	3.2.0
	RP-07	RP-000045	175		Available SF in PRACH info	3.1.0	3.2.0
	RP-07	RP-000045	176		Traffic volume measurement event	3.1.0	3.2.0
	RP-07	RP-000045	177		Report of multiple cells on an event result	3.1.0	3.2.0
	RP-07	RP-000045	178		Editorial modification on Direct Transfer	3.1.0	3.2.0
	RP-07	RP-000045	179		Correction of the Security Mode Control procedure	3.1.0	3.2.0
	RP-07	RP-000045	180	1	Maximum calculated Transport Format Combination	3.1.0	3.2.0
	RP-07	RP-000045	183		Additional DPCH IEs to align 25.331 with 25.214	3.1.0	3.2.0
	RP-07	RP-000045	184	1	RB – DCH mapping	3.1.0	3.2.0
	RP-07	RP-000045	188	1	Modifications related to FDD mode DSCH	3.1.0	3.2.0
	RP-07	RP-000045	189	1	Identification of Shared Channel Physical Configuration in TDD Mode	3.1.0	3.2.0
	RP-07	RP-000045	192	1	Uplink Outer Loop Power Control During Hard Handover	3.1.0	3.2.0
	RP-07	RP-000045	193		Support of Multiple CCTrCH's in TDD Mode	3.1.0	3.2.0
	RP-07	RP-000045	194	1	Uplink Physical Channel Control in TDD Mode	3.1.0	3.2.0
	RP-07	RP-000045	201	1	Transfer of initial information from UE to target RNC prior to handover to UTRAN	3.1.0	3.2.0
	RP-07	RP-000045	202	1	CN information elements	3.1.0	3.2.0
	RP-07	RP-000045	203		UTRAN mobility information elements	3.1.0	3.2.0
	RP-07	RP-000045	204	1	RB information elements	3.1.0	3.2.0
	RP-07	RP-000046	205	1	Physical channel information elements	3.1.0	3.2.0
	RP-07	RP-000046	206	1	UE capability information elements	3.1.0	3.2.0
	RP-07	RP-000046	207		UE variables	3.1.0	3.2.0
	RP-07	RP-000046	208	1	Actions when entering idle mode	3.1.0	3.2.0
	RP-07	RP-000046	209		Usage of pilot bits	3.1.0	3.2.0
	RP-07	RP-000046	210		System information procedure corrections	3.1.0	3.2.0
	RP-07	RP-000046	212		Reconfiguration of ciphering	3.1.0	3.2.0
	RP-07	RP-000046	213	1	Enhancements to RRC connection re-establishment procedure (Message subsequently deleted in RAN_I), RP-000715)	3.1.0	3.2.0
	RP-07	RP-000046	215		Updates to RRC Initialisation Information transparent container and addition of reverse direction container description	3.1.0	3.2.0
	RP-07	RP-000046	220	1	Changes in RRC messages to support lossless SRNC relocation	3.1.0	3.2.0
	RP-07	RP-000046	229	1	Measurements of unlisted neighbouring cells	3.1.0	3.2.0
	RP-07	RP-000046	234	2	Inclusion of Location Services	3.1.0	3.2.0
	RP-07	RP-000046	236	1	Application of Access Service Classes and relation to Access Classes	3.1.0	3.2.0

Change history							
Date	TSG #	TSG Doc.	CR	Rev	Subject/Comment	Old	New
	RP-07	RP-000046	252	1	DRX indicator presence and state entering mechanism at the end of a procedure	3.1.0	3.2.0
	RP-07	RP-000046	254	1	Physical shared channel allocation procedure	3.1.0	3.2.0
	RP-07	RP-000046	255		Corrections to TDD specific parameters in PICH info	3.1.0	3.2.0
	RP-07	RP-000046	256		Editorial modifications	3.1.0	3.2.0
	RP-07	RP-000046	259	2	Introduction of mapping function information in Cell selection and	3.1.0	3.2.0
	RP-07	RP-000046	263		Ciphering and integrity HFN	3.1.0	3.2.0
	RP-07	RP-000046	267		New SIB for UP	3.1.0	3.2.0
	RP-07	RP-000047	268		Removal of synchronization Case 3	3.1.0	3.2.0
	RP-07	RP-000047	271		TX Diversity	3.1.0	3.2.0
	RP-07	RP-000047	272		Update of tabular format clause 10	3.1.0	3.2.0
	RP-07	RP-000047	273		ASN.1 description	3.1.0	3.2.0
06/2000	RP-08	RP-000222	228	5	Downlink power control in compressed mode	3.2.0	3.3.0
	RP-08	RP-000222	260	1	Clarification on physical channel allocations in TDD	3.2.0	3.3.0
	RP-08	RP-000222	261	4	TDD Measurements and Reporting	3.2.0	3.3.0
	RP-08	RP-000222	262	4	Signalling of IEs related to System Information on FACH	3.2.0	3.3.0
	RP-08	RP-000222	265	3	Transport Format Combination Control	3.2.0	3.3.0
	RP-08	RP-000222	269	1	Signalling of partial failure in radio bearer related procedures	3.2.0	3.3.0
	RP-08	RP-000222	275		Clarification on PDCP info	3.2.0	3.3.0
	RP-08	RP-000222	279		Editorial modification on Transport Ch capability	3.2.0	3.3.0
	RP-08	RP-000222	280		Editorial modification on CN IE	3.2.0	3.3.0
	RP-08	RP-000222	281	3	Editorial modification on Physical CH IE	3.2.0	3.3.0
	RP-08	RP-000222	282	1	Editorial modification on ASN.1 description	3.2.0	3.3.0
	RP-08	RP-000222	283	1	IEs on SIB5/6	3.2.0	3.3.0
	RP-08	RP-000222	285	2	Re-establishment timer	3.2.0	3.3.0
	RP-08	RP-000222	286	1	CN DRX cycle coefficient	3.2.0	3.3.0
	RP-08	RP-000222	287	1	Cell Access Restriction	3.2.0	3.3.0
	RP-08	RP-000222	288	1	Cell selection and re-selection parameters	3.2.0	3.3.0
	RP-08	RP-000222	289	2	Modification on Measurement IE	3.2.0	3.3.0
	RP-08	RP-000222	291	1	RACH Transmission parameters	3.2.0	3.3.0
	RP-08	RP-000222	292	1	SCCPCH System Info	3.2.0	3.3.0
	RP-08	RP-000222	293	1	Addition of HFN for RRC CONNECTION RE-ESTABLISHMENT COMPLETE	3.2.0	3.3.0
	RP-08	RP-000223	294	1	RLC reconfiguration indicator	3.2.0	3.3.0
	RP-08	RP-000223	296	3	RLC Info	3.2.0	3.3.0
	RP-08	RP-000223	297	1	Usage of Transport CH ID	3.2.0	3.3.0
	RP-08	RP-000223	298	2	Transport format combination set	3.2.0	3.3.0
	RP-08	RP-000223	300	1	Usage of U-RNTI and C-RNTI in DL DCCH message	3.2.0	3.3.0
	RP-08	RP-000223	301		Description of Cell Update Procedure	3.2.0	3.3.0
	RP-08	RP-000223	304	1	System information modification procedure	3.2.0	3.3.0
	RP-08	RP-000223	305		Functional descriptions of the RRC messages	3.2.0	3.3.0
	RP-08	RP-000223	306		Clarification of CTFC calculation	3.2.0	3.3.0
	RP-08	RP-000223	307	3	Compressed mode parameters	3.2.0	3.3.0
	RP-08	RP-000223	309	2	Signalling procedure for periodic local authentication	3.2.0	3.3.0
	RP-08	RP-000223	310	5	Editorial corrections on security	3.2.0	3.3.0
	RP-08	RP-000223	311	2	Security capability	3.2.0	3.3.0
	RP-08	RP-000223	312	1	Corrections on ASN.1 definitions	3.2.0	3.3.0
	RP-08	RP-000223	313	2	DRX cycle lower limit	3.2.0	3.3.0
	RP-08	RP-000223	314	1	Removal of CPICH SIR measurement quantity	3.2.0	3.3.0
	RP-08	RP-000223	315	1	Signalling connection release request	3.2.0	3.3.0
	RP-08	RP-000223	318	1	Change to IMEI coding from BCD to hexadecimal	3.2.0	3.3.0
	RP-08	RP-000223	319	1	Removal of RLC sequence numbers from RRC initialisation information	3.2.0	3.3.0
	RP-08	RP-000223	320	3	Addition of the length of PDCP sequence numbers into PDCP info	3.2.0	3.3.0
	RP-08	RP-000224	323	1	BSIC verification of GSM cells	3.2.0	3.3.0
	RP-08	RP-000224	324		Reporting cell status	3.2.0	3.3.0
	RP-08	RP-000224	325		RRC measurement filtering parameters	3.2.0	3.3.0

Change history							
Date	TSG #	TSG Doc.	CR	Rev	Subject/Comment	Old	New
	RP-08	RP-000224	326		Cell-reselection parameter signalling	3.2.0	3.3.0
	RP-08	RP-000224	328	3	Multiplicity values	3.2.0	3.3.0
	RP-08	RP-000224	329		Quality measurements	3.2.0	3.3.0
	RP-08	RP-000224	330	4	CPCH Status Indication mode correction	3.2.0	3.3.0
	RP-08	RP-000224	331	4	End of CPCH transmission	3.2.0	3.3.0
	RP-08	RP-000224	332		Handover to UTRAN procedure	3.2.0	3.3.0
	RP-08	RP-000224	333		Harmonization of access service classes in FDD and TDD	3.2.0	3.3.0
	RP-08	RP-000224	334	1	Correction to usage of primary CCPCH info and primary CPICH info	3.2.0	3.3.0
	RP-08	RP-000224	335		Corrections and clarifications on system information handling	3.2.0	3.3.0
	RP-08	RP-000224	336		Editorial corrections	3.2.0	3.3.0
	RP-08	RP-000224	337	1	Editorial corrections on uplink timing advance	3.2.0	3.3.0
	RP-08	RP-000224	339		Correction of Transport Format Combination tabular format and ASN.1	3.2.0	3.3.0
	RP-08	RP-000224	340	1	UE variables	3.2.0	3.3.0
	RP-08	RP-000224	342	1	General error handling	3.2.0	3.3.0
	RP-08	RP-000224	344	1	System Information extensibility in ASN.1 definitions	3.2.0	3.3.0
	RP-08	RP-000224	345		Usage of pilot bits	3.2.0	3.3.0
	RP-08	RP-000224	346	3	RRC connection release procedure	3.2.0	3.3.0
	RP-08	RP-000225	347	1	Alignment of Section 10.3 on methodology defined in 25.921	3.2.0	3.3.0
	RP-08	RP-000225	348		Modifications of cell (re)selection parameters	3.2.0	3.3.0
	RP-08	RP-000225	350	1	GPS time-of-week represented as seconds and fractions of seconds	3.2.0	3.3.0
	RP-08	RP-000225	351	2	CPCH corrections	3.2.0	3.3.0
	RP-08	RP-000225	352		PLMN type selection	3.2.0	3.3.0
	RP-08	RP-000225	353	3	Paging and establishment cause values	3.2.0	3.3.0
	RP-08	RP-000225	354		Common channel configurations	3.2.0	3.3.0
	RP-08	RP-000225	355	2	Clarification of prioritization of logical channels in UE	3.2.0	3.3.0
	RP-08	RP-000225	357	2	UE capability corrections	3.2.0	3.3.0
	RP-08	RP-000225	358	2	Clarification of HFN	3.2.0	3.3.0
	RP-08	RP-000225	359	3	Clarification of Integrity Protection	3.2.0	3.3.0
	RP-08	RP-000225	360	1	RRC message size optimization regarding TrCH parameters	3.2.0	3.3.0
	RP-08	RP-000225	361		Protocol extensions in ASN	3.2.0	3.3.0
	RP-08	RP-000225	362	1	Downloading of pre- defined configurations via SIB 16	3.2.0	3.3.0
	RP-08	RP-000225	363	1	Optimization of System Information	3.2.0	3.3.0
	RP-08	RP-000225	364	1	CPCH gain factor	3.2.0	3.3.0
	RP-08	RP-000225	368	2	SFN Transmission Rate in TDD Mode	3.2.0	3.3.0
	RP-08	RP-000225	371	1	Integrity Control	3.2.0	3.3.0
	RP-08	RP-000225	372		Modification to measurement event evaluation	3.2.0	3.3.0
	RP-08	RP-000225	373		System Information related parameters	3.2.0	3.3.0
	RP-08	RP-000226	375	1	Changes in RB mapping info	3.2.0	3.3.0
	RP-08	RP-000226	377		Editorial corrections to PRACH system information and Cell info	3.2.0	3.3.0
	RP-08	RP-000226	378		Editorial Corrections to 25.331 Procedures and Tabular Format	3.2.0	3.3.0
	RP-08	RP-000226	379	1	Corrections to figures and procedures for the failure cases	3.2.0	3.3.0
	RP-08	RP-000226	380		Corrections on use of ORDERED_CONFIG	3.2.0	3.3.0
	RP-08	RP-000226	382	1	Corrections to Transport Channel and RB Reconfiguration procedures	3.2.0	3.3.0
	RP-08	RP-000226	383	1	Corrections to INITIAL DIRECT TRANSFER and UE CAPABILITY INFORMATION CONFIRM procedures	3.2.0	3.3.0
	RP-08	RP-000226	384		Corrections to Transparent mode signalling info Tabular format and ASN.1	3.2.0	3.3.0
	RP-08	RP-000226	385		Corrections to Soft Handover messages and procedures	3.2.0	3.3.0
	RP-08	RP-000226	387		Corrections to RRC CONNECTION REJECT procedures	3.2.0	3.3.0
	RP-08	RP-000226	388	1	Transport format combination in TDD and Transport channel ID	3.2.0	3.3.0
	RP-08	RP-000226	389	1	Signalling for dynamic TTI in TDD	3.2.0	3.3.0
	RP-08	RP-000226	390	1	Usage of DCCH for Shared Channel Allocation message	3.2.0	3.3.0
	RP-08	RP-000226	391	1	Correction to physical channel IEs in TDD	3.2.0	3.3.0
	RP-08	RP-000226	392	1	TDD preconfiguration for Handover to UTRAN	3.2.0	3.3.0

Change history							
Date	TSG #	TSG Doc.	CR	Rev	Subject/Comment	Old	New
	RP-08	RP-000226	393		Corrections to measurement control descriptions and messages	3.2.0	3.3.0
	RP-08	RP-000226	394	1	Corrections on ASN.1 definitions	3.2.0	3.3.0
	RP-08	RP-000226	395		Addition of the Segmentation indication field for transparent mode RLC in the RLC Info	3.2.0	3.3.0
	RP-08	RP-000226	396	1	Radio Bearer identity for CCCH	3.2.0	3.3.0
	RP-08	RP-000226	397	1	ASN.1 definitions for RRC information between network nodes	3.2.0	3.3.0
	RP-08	RP-000227	398	1	NAS Routing	3.2.0	3.3.0
	RP-08	RP-000227	399		DPCCH power control preamble	3.2.0	3.3.0
	RP-08	RP-000227	400	2	Modifications of Assisted GPS Messages	3.2.0	3.3.0
	RP-08	RP-000227	401		Choice of Initial UE Identity	3.2.0	3.3.0
	RP-08	RP-000227	402		ANSI-41 information elements	3.2.0	3.3.0
	RP-08	RP-000227	404	1	RLC value ranges	3.2.0	3.3.0
	RP-08	RP-000227	408	1	HFN Reset	3.2.0	3.3.0
	RP-08	RP-000227	409	1	Clarification on ciphering parameters and integrity protection procedure in case of SRNS relocation	3.2.0	3.3.0
	RP-08	RP-000227	410	1	Clarification of compressed mode activation and configuration failure	3.2.0	3.3.0
	RP-08	RP-000227	412	1	Modification of the RLC Size IE	3.2.0	3.3.0
	RP-08	RP-000227	414		CPCH DL Power control	3.2.0	3.3.0
	RP-08	RP-000227	415	1	SFN measurements in TDD	3.2.0	3.3.0
09/2000	RP-09	RP-000361	356	3	Clarification on multiplicity of PCH and PICH and S-CCPCH selection	3.3.0	3.4.0
	RP-09	RP-000361	403	3	Parameters to be stored in the USIM	3.3.0	3.4.0
	RP-09	RP-000361	413	3	Optimization of Inter-system handover message	3.3.0	3.4.0
	RP-09	RP-000361	416	2	Timing Advance in Handover Procedures	3.3.0	3.4.0
	RP-09	RP-000361	417	2	Synchronization of Timing Advance and Timing Deviation Measurement	3.3.0	3.4.0
	RP-09	RP-000361	418		Downlink Physical Channels Per Timeslot	3.3.0	3.4.0
	RP-09	RP-000361	419		TDD Mode DCH Reception in Cell DCH State	3.3.0	3.4.0
	RP-09	RP-000361	420	2	Downlink Power Control During DTX in TDD Mode	3.3.0	3.4.0
	RP-09	RP-000361	421	1	Paging Indicator Length Definition	3.3.0	3.4.0
	RP-09	RP-000361	422		Updating & alignment of RRC containers & handover to UTRAN information transfer	3.3.0	3.4.0
	RP-09	RP-000361	424		Default values for UE timers and counters	3.3.0	3.4.0
	RP-09	RP-000361	425	1	Security mode control	3.3.0	3.4.0
	RP-09	RP-000361	426	1	Corrections and Editorial updates to chapter 8	3.3.0	3.4.0
	RP-09	RP-000361	427		Corrections and editorial updates to chapter 10	3.3.0	3.4.0
	RP-09	RP-000361	428		Transition from CELL_DCH to CELL_PCH and URA_PCH state	3.3.0	3.4.0
	RP-09	RP-000361	430		Assisted GPS Messaging and Procedures	3.3.0	3.4.0
	RP-09	RP-000361	431	2	Corrections to Activation Time use	3.3.0	3.4.0
	RP-09	RP-000361	432		Editorial Corrections to measurement reporting range	3.3.0	3.4.0
	RP-09	RP-000361	434	4	Default DPCH offset value and DPCH offset	3.3.0	3.4.0
	RP-09	RP-000361	435	3	RLC info	3.3.0	3.4.0
	RP-09	RP-000362	437		Clarification of the description of IE semantics in "RB with PDCP information"	3.3.0	3.4.0
	RP-09	RP-000362	438	1	Editorial corrections on security	3.3.0	3.4.0
	RP-09	RP-000362	439		Editorial correction to RB mapping info	3.3.0	3.4.0
	RP-09	RP-000362	440	1	Compressed mode configuration failure	3.3.0	3.4.0
	RP-09	RP-000362	441		Gain factors for TDD	3.3.0	3.4.0
	RP-09	RP-000362	442		Introduction of Default DPCH Offset Value in TDD	3.3.0	3.4.0
	RP-09	RP-000362	444	1	Optimization of handover to UTRAN command	3.3.0	3.4.0
	RP-09	RP-000362	445		Editorial corrections	3.3.0	3.4.0
	RP-09	RP-000362	448	1	Mapping of channelisation code	3.3.0	3.4.0
	RP-09	RP-000362	449	2	DL TFCS Limitation	3.3.0	3.4.0
	RP-09	RP-000362	450		SIB offset	3.3.0	3.4.0
	RP-09	RP-000362	451		RRC CONNECTION RELEASE cause	3.3.0	3.4.0
	RP-09	RP-000362	452		Addition of RACH TFCS	3.3.0	3.4.0
	RP-09	RP-000362	453	2	Cell Identity	3.3.0	3.4.0
	RP-09	RP-000362	454		Editorial Modifications	3.3.0	3.4.0

Change history							
Date	TSG #	TSG Doc.	CR	Rev	Subject/Comment	Old	New
	RP-09	RP-000362	455	1	TDD PRACH Power Control for Spreading Factor 8/16	3.3.0	3.4.0
	RP-09	RP-000362	456		TDD CCTrCH Repetition Length Definition	3.3.0	3.4.0
	RP-09	RP-000362	457	1	Reporting threshold of traffic volume measurements	3.3.0	3.4.0
	RP-09	RP-000362	459	2	UP GPS assistance data for SIB	3.3.0	3.4.0
	RP-09	RP-000362	461	1	Support of cell update confirm on CCCH	3.3.0	3.4.0
	RP-09	RP-000363	462	1	Max Window Size in RLC capabilities	3.3.0	3.4.0
	RP-09	RP-000363	463	3	UE handling of CFN	3.3.0	3.4.0
	RP-09	RP-000363	464	1	Correction of padding description in clause 12	3.3.0	3.4.0
	RP-09	RP-000363	465	1	Window size in RLC info	3.3.0	3.4.0
	RP-09	RP-000363	466	1	TFC Control Duration	3.3.0	3.4.0
	RP-09	RP-000363	467		System Information Block Tabular Information	3.3.0	3.4.0
	RP-09	RP-000363	469	1	Frequency encoding in inter-system handover messages	3.3.0	3.4.0
	RP-09	RP-000363	470		RRC message size optimization regarding TFS parameters	3.3.0	3.4.0
	RP-09	RP-000363	471	2	RACH selection	3.3.0	3.4.0
	RP-09	RP-000363	472		DRX cycle lower limit	3.3.0	3.4.0
	RP-09	RP-000363	474		Rx window size in RLC info	3.3.0	3.4.0
	RP-09	RP-000363	476	1	Corrections & optimizations regarding system information blocks of length 215..221	3.3.0	3.4.0
	RP-09	RP-000363	477	1	Corrections on 8.1.1 resulting from RRC review at R2#14	3.3.0	3.4.0
	RP-09	RP-000363	478	1	Corrections to the RRC connection release procedure	3.3.0	3.4.0
	RP-09	RP-000363	479	1	New release cause for signalling connection re-establishment	3.3.0	3.4.0
	RP-09	RP-000363	480	1	Correction to IE midamble shift and burst type	3.3.0	3.4.0
	RP-09	RP-000363	481	1	Correction in RLC info	3.3.0	3.4.0
	RP-09	RP-000363	483		Description of CTCH occasions	3.3.0	3.4.0
	RP-09	RP-000363	485	1	TDD CCTrCH UL/DL Pairing for Inner Loop Power Control	3.3.0	3.4.0
	RP-09	RP-000363	486	1	DCCH and BCCH Signalling of TDD UL OL PC Information	3.3.0	3.4.0
	RP-09	RP-000364	487	1	Broadcast SIBs for TDD UL OL PC Information	3.3.0	3.4.0
	RP-09	RP-000364	490	1	CPCH corrections	3.3.0	3.4.0
	RP-09	RP-000364	492	3	Corrections to Security IEs	3.3.0	3.4.0
	RP-09	RP-000364	494	1	Corrections to parameters to be stored in the USIM	3.3.0	3.4.0
	RP-09	RP-000364	496		Editorial corrections	3.3.0	3.4.0
	RP-09	RP-000364	497	2	Physical Shared Channel Allocation procedure	3.3.0	3.4.0
	RP-09	RP-000364	498		Correction to Transport Format Combination Control Message	3.3.0	3.4.0
	RP-09	RP-000364	499	1	Usage of Cell Parameter ID	3.3.0	3.4.0
	RP-09	RP-000364	500		RB description for SHCCH	3.3.0	3.4.0
	RP-09	RP-000364	501	1	Use of LI in UM	3.3.0	3.4.0
	RP-09	RP-000364	502	1	Minor Corrections to RRC Protocol Specification	3.3.0	3.4.0
	RP-09	RP-000364	503	1	Correction to Cell Update Cause	3.3.0	3.4.0
	RP-09	RP-000364	504		Correction on T307 definition	3.3.0	3.4.0
	RP-09	RP-000364	505		Corrections to relative priorities in RRC Protocol	3.3.0	3.4.0
	RP-09	RP-000364	506		Unification of Reconfiguration Procedures	3.3.0	3.4.0
	RP-09	RP-000364	507	1	Changes to section 8.2 proposed at Paris RRC Ad Hoc	3.3.0	3.4.0
	RP-09	RP-000364	508		Establishment Cause	3.3.0	3.4.0
	RP-09	RP-000364	509	1	PRACH partitioning	3.3.0	3.4.0
	RP-09	RP-000364	510		Editorial Correction on Active Set Update	3.3.0	3.4.0
	RP-09	RP-000364	511		Editorial Correction regarding system information	3.3.0	3.4.0
	RP-09	RP-000365	512	1	Clarification on Reporting Cell Status	3.3.0	3.4.0
	RP-09	RP-000365	513	1	Editorial corrections on RRC Connection Establishment and Release procedures NOTE: In subclause 8.1.4.6, the change from "decrease" to "increase" for V308 was decided to be incorrect after discussion on the TSG-RAN WG2 reflector and was not implemented	3.3.0	3.4.0
	RP-09	RP-000365	514		Gated Transmission Control Info	3.3.0	3.4.0
	RP-09	RP-000365	515	1	Cell selection/reselection parameters for SIB 3/4	3.3.0	3.4.0
	RP-09	RP-000365	516		Implementation of Ec/N0 parameters and optimization of SIB 11/12	3.3.0	3.4.0
	RP-09	RP-000365	517		PRACH Info	3.3.0	3.4.0
	RP-09	RP-000365	518	1	Uplink DPCH power control info	3.3.0	3.4.0

Change history								
Date	TSG #	TSG Doc.	CR	Re v	Subject/Comment	Old	New	
	RP-09	RP-000365	519		AICH power offset value range	3.3.0	3.4.0	
	RP-09	RP-000365	520		Direct paging of RRC connected UE in CELL_PCH/URA_PCH NOTE: This CR was postponed in TSG-RAN #9 and was wrongly included in v3.4.0. This was corrected in v3.4.1	3.3.0	3.4.0	
	RP-09	RP-000365	521		Corrections to Sections 1-7	3.3.0	3.4.0	
	RP-09	RP-000365	522		Error handling for Uplink Physical Channel Control procedure	3.3.0	3.4.0	
	RP-09	RP-000365	523		Corrections to downlink outer loop power control in compressed mode	3.3.0	3.4.0	
	RP-09	RP-000365	524	1	Clarification on measurement procedure using compressed mode	3.3.0	3.4.0	
	RP-09	RP-000365	525	1	Updates to cell and URA update procedures based on RRC Ad Hoc	3.3.0	3.4.0	
	RP-09	RP-000365	526	1	Updates to RNTI allocation procedure based on RRC Ad Hoc	3.3.0	3.4.0	
	RP-09	RP-000365	528		PRACH constant value	3.3.0	3.4.0	
	RP-09	RP-000365	530	1	Corrections to the paging procedure	3.3.0	3.4.0	
	RP-09	RP-000365	532	1	Moving of text from 25.304	3.3.0	3.4.0	
	RP-09	RP-000365	533	1	Message extensibility	3.3.0	3.4.0	
	RP-09	RP-000365	534	1	Additions to "State of RRC Procedure" in RRC Initialisation information, source RNC to target RNC	3.3.0	3.4.0	
	RP-09	RP-000365	535	1	Support of codec negotiation	3.3.0	3.4.0	
	-	-	-		Removal of contents of CR 520 from v3.4.0, because it was postponed at TSG-RAN #9 and by accident included anyway.	3.4.0	3.4.1	
12/2000	RP-10	RP-000570	536		Downlink outer-loop power control in compressed mode	3.4.1	3.5.0	
	RP-10	RP-000570	537	1	Correction in the use of "U-RNTI Short"	3.4.1	3.5.0	
	RP-10	RP-000570	538		Corrections related to UE Timing	3.4.1	3.5.0	
	RP-10	RP-000570	539		Corrections to SFN-SFN definition	3.4.1	3.5.0	
	RP-10	RP-000570	541	1	Corrections to definition and use of Activation Time	3.4.1	3.5.0	
	RP-10	RP-000570	542		Corrections to logical channel priorities	3.4.1	3.5.0	
	RP-10	RP-000570	543	1	Correction to codec negotiation	3.4.1	3.5.0	
	RP-10	RP-000570	544	1	CFN-SFN observed time difference measurement	3.4.1	3.5.0	
	RP-10	RP-000570	545	1	Correction to timing indication for hard handover	3.4.1	3.5.0	
	RP-10	RP-000570	546	1	UE Radio Access Capability Corrections	3.4.1	3.5.0	
	RP-10	RP-000570	548	1	RRC establishment and paging causes for NAS signalling	3.4.1	3.5.0	
	RP-10	RP-000570	549		Corrections to Intra-frequency measurements and Traffic volume measurements	3.4.1	3.5.0	
	RP-10	RP-000570	551	1	PRACH/RACH System information	3.4.1	3.5.0	
	RP-10	RP-000570	553	1	GSM Measurement reporting	3.4.1	3.5.0	
	RP-10	RP-000570	554	1	BLER measurement and quality target	3.4.1	3.5.0	
	RP-10	RP-000570	556	1	Clarification of PDCP sequence number window terminology	3.4.1	3.5.0	
	RP-10	RP-000570	559	1	Clarification on Error Handling	3.4.1	3.5.0	
	RP-10	RP-000570	560		Removal of compressed mode measurement purpose "other"	3.4.1	3.5.0	
	RP-10	RP-000570	561		Clarification of compressed mode measurement purpose "GSM"	3.4.1	3.5.0	
	RP-10	RP-000570	564	2	Reporting multiple GSM cells	3.4.1	3.5.0	
	RP-10	RP-000571	566	1	Number of RLS that can be removed in Active Set update	3.4.1	3.5.0	
	RP-10	RP-000571	568	1	Clarification on Segment Index	3.4.1	3.5.0	
	RP-10	RP-000571	571	3	RRC procedure performance requirements	3.4.1	3.5.0	
	RP-10	RP-000571	572	1	Correction of newInterSystemCellList and MeasurementControlSysInfo in ASN.1	3.4.1	3.5.0	
	RP-10	RP-000571	573	4	Removal of Flow Id concept while maintaining lu interface flexibility	3.4.1	3.5.0	
	RP-10	RP-000571	574	2	Ciphering and reset	3.4.1	3.5.0	
	RP-10	RP-000571	575	1	Corrections and clarifications concerning inter-RAT change procedures	3.4.1	3.5.0	
	RP-10	RP-000571	576	1	General Security Clarifications	3.4.1	3.5.0	
	RP-10	RP-000571	577		Clarification on RB 0	3.4.1	3.5.0	
	RP-10	RP-000571	578		Clarification on the transition of RRC state	3.4.1	3.5.0	
	RP-10	RP-000571	580	1	UP measurements for RRC information to target RNC	3.4.1	3.5.0	
	RP-10	RP-000571	581		Correction on LCS reporting criteria	3.4.1	3.5.0	
	RP-10	RP-000574	583	1	CSICH Corrections	3.4.1	3.5.0	
	RP-10	RP-000571	584	1	Clarification to handling of satellite health issues	3.4.1	3.5.0	
	RP-10	RP-000571	585		Clarification on activation time	3.4.1	3.5.0	

Change history							
Date	TSG #	TSG Doc.	CR	Rev	Subject/Comment	Old	New
	RP-10	RP-000571	586		Clarification on activation time for ciphering in TM	3.4.1	3.5.0
	RP-10	RP-000571	587	2	Measurement procedures and messages	3.4.1	3.5.0
	RP-10	RP-000571	590	1	Inter-RAT UE radio access capability	3.4.1	3.5.0
	RP-10	RP-000571	592	1	Clarification on cell update/URA update procedures	3.4.1	3.5.0
	RP-10	RP-000571	595	4	Protocol States and Process	3.4.1	3.5.0
	RP-10	RP-000571	596	1	System Information	3.4.1	3.5.0
	RP-10	RP-000715	597	5	RRC Connection Management Procedures, Generic procedures and actions	3.4.1	3.5.0
	RP-10	RP-000572	598	1	Paging Procedures	3.4.1	3.5.0
	RP-10	RP-000572	599		NAS signalling Procedures	3.4.1	3.5.0
	RP-10	RP-000572	600	3	Radio Bearer Control Procedures	3.4.1	3.5.0
	RP-10	RP-000572	601	1	Corrections to the Counter Check Procedure	3.4.1	3.5.0
	RP-10	RP-000572	602		Tabular Information and ASN.1	3.4.1	3.5.0
	RP-10	RP-000572	604	2	Corrections to Measurement Occasion concept	3.4.1	3.5.0
	RP-10	RP-000572	606		Corrections concerning optimisation of RB information	3.4.1	3.5.0
	RP-10	RP-000572	608	1	Corrections to security	3.4.1	3.5.0
	RP-10	RP-000572	609	1	Ciphering activation time for DPCH	3.4.1	3.5.0
	RP-10	RP-000572	610		Confirmation of signalling connection establishment	3.4.1	3.5.0
	RP-10	RP-000572	611	2	RACH Sub-channel signalling	3.4.1	3.5.0
	RP-10	RP-000572	613	2	Assistance data delivery for UP	3.4.1	3.5.0
	RP-10	RP-000572	614	1	Clarification of LCS measurements	3.4.1	3.5.0
	RP-10	RP-000572	615	2	Configuration of RLC PDU sizes for logical channels	3.4.1	3.5.0
	RP-10	RP-000574	616		PICH power offset for TDD	3.4.1	3.5.0
	RP-10	RP-000572	617		Correction for PDSCH power control for TDD	3.4.1	3.5.0
	RP-10	RP-000574	618		Usage of dynamic spreading factor in uplink	3.4.1	3.5.0
	RP-10	RP-000572	619		Correction of Midamble Shift for Burst Type 3	3.4.1	3.5.0
	RP-10	RP-000572	621		Correction of text concerning Scheduling of System Information	3.4.1	3.5.0
	RP-10	RP-000572	622	1	Alignment of GSM'99 BA Range concept and its inclusion in UTRA	3.4.1	3.5.0
	RP-10	RP-000572	623	1	Clarification of RB mapping info	3.4.1	3.5.0
	RP-10	RP-000572	624	1	Correction to UE multi-RAT capability	3.4.1	3.5.0
	RP-10	RP-000573	625		Correction to PDCP sequence number exchange during hard handover	3.4.1	3.5.0
	RP-10	RP-000573	628	2	DCH Quality Target	3.4.1	3.5.0
	RP-10	RP-000573	629	1	Simultaneous release of RBs and signalling connection	3.4.1	3.5.0
	RP-10	RP-000573	630		Correction on Transport Channel Reconfiguration	3.4.1	3.5.0
	RP-10	RP-000573	631		Limitation of DRX cycle length	3.4.1	3.5.0
	RP-10	RP-000574	632		Signalling of the alpha value in TDD for open loop power control	3.4.1	3.5.0
	RP-10	RP-000573	633		Support for improved compressed mode handling for TDD measurements	3.4.1	3.5.0
	RP-10	RP-000573	636		Usage of secondary CPICH and secondary scrambling code	3.4.1	3.5.0
	RP-10	RP-000573	639		Expiration time of SIB type 7, 14	3.4.1	3.5.0
	RP-10	RP-000573	640		Correction to integrity protection	3.4.1	3.5.0
	RP-10	RP-000684	641		Downlink Outer Loop Control	3.4.1	3.5.0
03/2001	RP-11	RP-010029	642	2	RL Failure in cell update procedure	3.5.0	3.6.0
	RP-11	RP-010029	645	1	Clarification on COUNTER CHECK	3.5.0	3.6.0
	RP-11	RP-010029	646	2	Traffic Volume Measurement corrections	3.5.0	3.6.0
	RP-11	RP-010029	650	2	Reserved TFCI for the TDD Special Burst	3.5.0	3.6.0
	RP-11	RP-010029	653		Correction to description of RRC state transitions	3.5.0	3.6.0
	RP-11	RP-010029	657		RLC re-establish correction	3.5.0	3.6.0
	RP-11	RP-010029	658	1	Removal of RLC logical channel mapping indicator	3.5.0	3.6.0
	RP-11	RP-010029	659		New paging and establishment cause "Unknown"	3.5.0	3.6.0
	RP-11	RP-010029	660	1	Miscellaneous procedure corrections	3.5.0	3.6.0
	RP-11	RP-010029	661		Corrections to compressed mode pattern sequence handling	3.5.0	3.6.0
	RP-11	RP-010029	662		Inter-system change clarifications	3.5.0	3.6.0
	RP-11	RP-010029	663	1	RLC status transmission in CELL_PCH and URA_PCH	3.5.0	3.6.0
	RP-11	RP-010029	665	1	Clarification of RB information parameter values for SRB0	3.5.0	3.6.0
	RP-11	RP-010029	666		Encoding for RRC- container	3.5.0	3.6.0

Change history							
Date	TSG #	TSG Doc.	CR	Rev	Subject/Comment	Old	New
	RP-11	RP-010029	667	2	Update of message extension and encoding descriptions	3.5.0	3.6.0
	RP-11	RP-010032	668	4	Introduction of default pre-defined configurations	3.5.0	3.6.0
	RP-11	RP-010029	669	2	Security corrections	3.5.0	3.6.0
	RP-11	RP-010029	670		Clarifications on Blind Handover Support	3.5.0	3.6.0
	RP-11	RP-010029	671	1	Missing descriptions of UE actions	3.5.0	3.6.0
	RP-11	RP-010029	672	2	Corrections on UE Positioning information	3.5.0	3.6.0
	RP-11	RP-010029	674	1	Security related corrections to SRNS	3.5.0	3.6.0
	RP-11	RP-010032	675	2	Downlink power offsets	3.5.0	3.6.0
	RP-11	RP-010274	676	2	Checking the integrity of UE security capabilities	3.5.0	3.6.0
	RP-11	RP-010030	678	1	Clarification to Secondary CCPCH info	3.5.0	3.6.0
	RP-11	RP-010030	679	1	Miscellaneous corrections	3.5.0	3.6.0
	RP-11	RP-010030	680		Removal of Layer 3 filtering for RACH	3.5.0	3.6.0
	RP-11	RP-010030	681	2	Correction of compressed mode parameters	3.5.0	3.6.0
	RP-11	RP-010030	682		Removal of immediate cell evaluation	3.5.0	3.6.0
	RP-11	RP-010030	684	2	Scheduling of SIB 15.2 and SIB 15.3	3.5.0	3.6.0
	RP-11	RP-010030	685	1	Correction to ECN modules	3.5.0	3.6.0
	RP-11	RP-010030	686	1	Improvement of the description of timing advance for TDD	3.5.0	3.6.0
	RP-11	RP-010030	687		Correction on timing advance and allocation for shared channels	3.5.0	3.6.0
	RP-11	RP-010030	688	1	Clarification on SF 1 signalling	3.5.0	3.6.0
	RP-11	RP-010030	689	1	Correction to power control in TDD	3.5.0	3.6.0
	RP-11	RP-010030	690		Midamble - Channelisation code association for TDD	3.5.0	3.6.0
	RP-11	RP-010030	691		Network requested reporting for physical shared channel allocation	3.5.0	3.6.0
	RP-11	RP-010030	693		System Information	3.5.0	3.6.0
	RP-11	RP-010030	694	1	Clarification on Transport Channel Identity	3.5.0	3.6.0
	RP-11	RP-010030	696	1	Editorial Correction	3.5.0	3.6.0
	RP-11	RP-010030	698	2	Correction to add coding of intra domain NAS node selector	3.5.0	3.6.0
	RP-11	RP-010030	700	1	Corrections to system information block characteristics in TDD	3.5.0	3.6.0
	RP-11	RP-010030	701	2	ASN.1 corrections	3.5.0	3.6.0
	RP-11	RP-010030	702	2	Measurement related corrections	3.5.0	3.6.0
	RP-11	RP-010031	703	1	Clarifications on TFC Control procedure	3.5.0	3.6.0
	RP-11	RP-010031	704	2	Association of PLMN ID to neighbour cells	3.5.0	3.6.0
	RP-11	RP-010031	705	1	TFCS Selection Guidelines	3.5.0	3.6.0
	RP-11	RP-010031	710		Special Burst Scheduling During DTX in TDD	3.5.0	3.6.0
	RP-11	RP-010031	711	1	Radio Link Failure Criteria in TDD	3.5.0	3.6.0
	RP-11	RP-010031	712	1	Correction & Clarification to TDD RACH Subchannels	3.5.0	3.6.0
	RP-11	RP-010031	713	1	Number of retransmission of RRC CONNECTION REQUEST	3.5.0	3.6.0
	RP-11	RP-010031	714		Uplink Frequency Notification	3.5.0	3.6.0
	RP-11	RP-010031	715		Clarification of Radio Bearer Mapping for DCH/DSCH Transport Channels	3.5.0	3.6.0
	RP-11	RP-010031	716		Correction of mismatches between tabular and ASN.1	3.5.0	3.6.0
	RP-11	RP-010031	717		Correction to discontinuous reception in TDD	3.5.0	3.6.0
	RP-11	RP-010031	718		Power control preamble	3.5.0	3.6.0
	RP-11	RP-010031	719		Maximum number of AM entity	3.5.0	3.6.0
	RP-11	RP-010031	720	1	Real-time Integrity Broadcast	3.5.0	3.6.0
	RP-11	RP-010031	721	3	Moving Real-time Integrity description to different chapter	3.5.0	3.6.0
	RP-11	RP-010031	723	1	Removal of the payload unit concept	3.5.0	3.6.0
	RP-11	RP-010031	724		Security related corrections to SRNS	3.5.0	3.6.0
	RP-11	RP-010031	725		Periodic PLMN selection correction	3.5.0	3.6.0
	RP-11	RP-010042	683	1	Modification of "SSDT Information" IE parameters to indicate if SSDT is used in the UL only	3.6.0	4.0.0
	RP-11	RP-010041	692	1	Idle allocation for Node B synchronisation	3.6.0	4.0.0
	RP-11	RP-010037	706	1	Physical channel configuration information elements for 1.28 Mcps TDD	3.6.0	4.0.0
	RP-11	RP-010037	707	2	Changes to Measurement Related Signalling and Introduction of Cell (Re)selection Parameters for 1.28Mcps TDD	3.6.0	4.0.0
	RP-11	RP-010037	708	1	Introduction of RACH Parameters for 1.28 Mcps TDD	3.6.0	4.0.0
	RP-11	RP-010037	709		Introduction of UE radio access capability Parameters for 1.28	3.6.0	4.0.0

Change history							
Date	TSG #	TSG Doc.	CR	Re v	Subject/Comment	Old	New
					Mcps TDD		
	RP-11	RP-010040	722	1	Introduction of IPDLs for TDD	3.6.0	4.0.0
	RP-11	RP-010039	726	1	ROHC updates to RRC	3.6.0	4.0.0
06/2001	RP-12	RP-010311	731		Clarification of the IE 'spreading factor' in Uplink DPCH info for FDD mode	4.0.0	4.1.0
	RP-12	RP-010311	733		Correction of UE Radio Access Capability depending on UTRAN FDD bands	4.0.0	4.1.0
	RP-12	RP-010311	735		Clarification on Security mode control	4.0.0	4.1.0
	RP-12	RP-010311	738		Correction of TrCH parameter handling	4.0.0	4.1.0
	RP-12	RP-010311	740		TFC Subsets in TDD	4.0.0	4.1.0
	RP-12	RP-010311	746		RRC containers	4.0.0	4.1.0
	RP-12	RP-010311	748		Various corrections	4.0.0	4.1.0
	RP-12	RP-010311	750		General error handling for system information	4.0.0	4.1.0
	RP-12	RP-010311	752		Order of elements in strings	4.0.0	4.1.0
	RP-12	RP-010311	754		Configuration consistency checks	4.0.0	4.1.0
	RP-12	RP-010312	756		Compressed mode corrections	4.0.0	4.1.0
	RP-12	RP-010312	758		Correction concerning inter-RAT procedures	4.0.0	4.1.0
	RP-12	RP-010312	762		Measurement corrections	4.0.0	4.1.0
	RP-12	RP-010312	764		RLC Tr Discard	4.0.0	4.1.0
	RP-12	RP-010312	766		Annex B CPCH Correction	4.0.0	4.1.0
	RP-12	RP-010312	768		SIB Correction for CSICH Power Offset	4.0.0	4.1.0
	RP-12	RP-010312	770		Transfer of Last known position in case of SRNS relocation	4.0.0	4.1.0
	RP-12	RP-010312	772		Corrections to UE Positioning measurements	4.0.0	4.1.0
	RP-12	RP-010312	779		GSM measurements in compressed mode	4.0.0	4.1.0
	RP-12	RP-010312	781		Correction of Activation Time in Inter-Rat HO Commands	4.0.0	4.1.0
	RP-12	RP-010313	785		Clarification of FRESH in SRNS relocation	4.0.0	4.1.0
	RP-12	RP-010313	789		Correction to UE timers and constants in idle mode	4.0.0	4.1.0
	RP-12	RP-010313	793		Clarification on multiframe allocation in TDD	4.0.0	4.1.0
	RP-12	RP-010313	795		Predefined parameters for logical channels	4.0.0	4.1.0
	RP-12	RP-010313	797		Pathloss calculation	4.0.0	4.1.0
	RP-12	RP-010313	799		Clarification on periodic measurement reporting	4.0.0	4.1.0
	RP-12	RP-010313	803	1	Handling of IE PRACH TFCS and Primary CPICH/Primary CCPCH info	4.0.0	4.1.0
	RP-12	RP-010313	805		Correction to FACH measurement occasion in TDD	4.0.0	4.1.0
	RP-12	RP-010313	807		Clarification of L1 synchronization procedures	4.0.0	4.1.0
	RP-12	RP-010313	809		Correction of Activation Time definition	4.0.0	4.1.0
	RP-12	RP-010314	813		Corrections to RRC procedure performance	4.0.0	4.1.0
	RP-12	RP-010314	815		Removal of mapping function	4.0.0	4.1.0
	RP-12	RP-010314	817		Security clarifications	4.0.0	4.1.0
	RP-12	RP-010314	819		Corrections to UE Positioning	4.0.0	4.1.0
	RP-12	RP-010314	825		Definition of DPCH numbering	4.0.0	4.1.0
	RP-12	RP-010314	827		Corrections to System Information Procedure	4.0.0	4.1.0
	RP-12	RP-010314	829		Relation between DOFF and DPCH Frame Offset	4.0.0	4.1.0
	RP-12	RP-010314	831		Procedures for "same as UL"	4.0.0	4.1.0
	RP-12	RP-010314	837		Editorial and minor corrections	4.0.0	4.1.0
	RP-12	RP-010314	839		Editorial Correction	4.0.0	4.1.0
	RP-12	RP-010315	843		Corrections on OTDOA-IPDL specific burst parameter semantic description	4.0.0	4.1.0
	RP-12	RP-010315	845		Error handling for messages sent from another RAT	4.0.0	4.1.0
	RP-12	RP-010315	849		Needed TFC in the TFCS for TDD	4.0.0	4.1.0
	RP-12	RP-010315	855		Clarification of TFCS selection guidelines	4.0.0	4.1.0
	RP-12	RP-010315	861		Clarification of Traffic Volume measurements	4.0.0	4.1.0
	RP-12	RP-010315	863		CFN synchronisation problems at timing re-initialised hard handover	4.0.0	4.1.0
	RP-12	RP-010315	866		Corrections on UP Assistance Message Descriptions	4.0.0	4.1.0
	RP-12	RP-010315	868		Correction on Area Scope of SIB 15.3	4.0.0	4.1.0
	RP-12	RP-010315	872		Correction to AICH power offset	4.0.0	4.1.0
	RP-12	RP-010316	875		Clarification on IE 'Downlink rate matching restriction information'	4.0.0	4.1.0

Change history							
Date	TSG #	TSG Doc.	CR	Re v	Subject/Comment	Old	New
	RP-12	RP-010316	877		Corrections on Tabular/ASN.1	4.0.0	4.1.0
	RP-12	RP-010316	879		Corrections on Tabular and ASN.1 inconsistencies	4.0.0	4.1.0
	RP-12	RP-010316	881		Editorial corrections on Tabular and ASN.1 inconsistencies	4.0.0	4.1.0
	RP-12	RP-010316	883		UE Positioning corrections to ASN.1 and tabular	4.0.0	4.1.0
	RP-12	RP-010316	885		Corrections to resolve inconsistencies between Tabular and ASN.1	4.0.0	4.1.0
	RP-12	RP-010316	887		UE positioning OTDOA Neighbour Cell Info	4.0.0	4.1.0
	RP-12	RP-010316	889		DRAC corrections	4.0.0	4.1.0
	RP-12	RP-010316	893		ASN.1 Correction of IE TFCS ID	4.0.0	4.1.0
	RP-12	RP-010316	895		Correction of IE IODE range in AGPS Positioning	4.0.0	4.1.0
	RP-12	RP-010317	897		Correction to BurstModeParameters in IPDL	4.0.0	4.1.0
	RP-12	RP-010317	899		Corrections on inconsistencies between Tabular and ASN.1	4.0.0	4.1.0
	RP-12	RP-010317	901		Naming of message abstract types in ASN.1	4.0.0	4.1.0
	RP-12	RP-010317	904		Information elements outside the extension container	4.0.0	4.1.0
	RP-12	RP-010317	906		Correction concerning DRX cycle upon inter-RAT change towards UTRAN	4.0.0	4.1.0
	RP-12	RP-010323	773		Corrections to IPDLs for TDD	4.0.0	4.1.0
	RP-12	RP-010323	850	2	Correction to 1.28Mcps TDD RACH parameters and operation	4.0.0	4.1.0
	RP-12	RP-010323	851		TFCI coding in case of 8PSK	4.0.0	4.1.0
	RP-12	RP-010323	902	1	Structure and naming of information elements	4.0.0	4.1.0
09/2001	RP-13	RP-010544	0870		UL Transport Channel Type Correction	4.1.0	4.2.0
	RP-13	RP-010544	0908		Guidelines concerning conditions, spares, defaults and correction of inconsistencies	4.1.0	4.2.0
	RP-13	RP-010544	0910		Correction to TDD DL DPCH Common Timeslot Info	4.1.0	4.2.0
	RP-13	RP-010544	0912		TDD System Information Update in Cell_DCH	4.1.0	4.2.0
	RP-13	RP-010544	0914		Editorial Corrections	4.1.0	4.2.0
	RP-13	RP-010544	0916		UL DPCH Power Control Info in TDD	4.1.0	4.2.0
	RP-13	RP-010544	0918		CN-originated paging in CELL_PCH and URA_PCH state	4.1.0	4.2.0
	RP-13	RP-010544	0920		Corrections to UE variable handling	4.1.0	4.2.0
	RP-13	RP-010544	0922		Inter-frequency measurements	4.1.0	4.2.0
	RP-13	RP-010544	0924		Inter-RAT measurements	4.1.0	4.2.0
	RP-13	RP-010671	0926	1	Intra-frequency measurements	4.1.0	4.2.0
	RP-13	RP-010545	0928		Multiplexing configuration corrections	4.1.0	4.2.0
	RP-13	RP-010545	0930		Reception of non-dedicated control channels mapped on FACH in CELL_FACH state	4.1.0	4.2.0
	RP-13	RP-010545	0932		Removal of C-RNTI when entering CELL_DCH	4.1.0	4.2.0
	RP-13	RP-010545	0935		TF and TFC set definition	4.1.0	4.2.0
	RP-13	RP-010545	0937		Correction of remaining ASN.1/Tabular inconsistencies	4.1.0	4.2.0
	RP-13	RP-010545	0939		CPICH Ec/N0 Range	4.1.0	4.2.0
	RP-13	RP-010545	0941		Priorities for IDNNS coding	4.1.0	4.2.0
	RP-13	RP-010545	0943		Dedicated pilots and S-CPICH specification related to UE specific beamforming	4.1.0	4.2.0
	RP-13	RP-010545	0945		Security corrections	4.1.0	4.2.0
	RP-13	RP-010546	0953		Intra-frequency measurement events for TDD corrections	4.1.0	4.2.0
	RP-13	RP-010546	0955		Inconsistencies between ASN.1 and tabular format	4.1.0	4.2.0
	RP-13	RP-010546	0957		TDD PICH corrections and clarifications	4.1.0	4.2.0
	RP-13	RP-010546	0959		Messages on CCCH	4.1.0	4.2.0
	RP-13	RP-010546	0961		Clarification of Parameter Values for Default Radio Configurations	4.1.0	4.2.0
	RP-13	RP-010546	0963		Clarification to usage of default values in "Cell Selection and Reselection for SIB11/12Info"	4.1.0	4.2.0
	RP-13	RP-010546	0965		Clarification of handling of System information block 14	4.1.0	4.2.0
	RP-13	RP-010546	0967		Description of UE behaviour when receiving UE positioning related information	4.1.0	4.2.0
	RP-13	RP-010546	0982		Clarification on periodic measurement reporting	4.1.0	4.2.0
	RP-13	RP-010546	0984		Corrections and clarifications on Measurement procedures description	4.1.0	4.2.0
	RP-13	RP-010547	0986		Lossless Criteria in PDCP Info	4.1.0	4.2.0
	RP-13	RP-010547	0988		Corrections to cell reselection parameter values	4.1.0	4.2.0
	RP-13	RP-010547	0990		Correction to signalling connection release	4.1.0	4.2.0

Change history							
Date	TSG #	TSG Doc.	CR	Re v	Subject/Comment	Old	New
	RP-13	RP-010547	0992		Corrections to cell update procedures	4.1.0	4.2.0
	RP-13	RP-010547	0994		PDCP configuration and PS domain configuration checks	4.1.0	4.2.0
	RP-13	RP-010547	0996		Correction to handling of RRC transaction identifier for Cell Update, URA Update and RRC connection setup	4.1.0	4.2.0
	RP-13	RP-010547	0998	1	Correction of UE capabilities regarding Rx-Tx time difference type 2 measurement	4.1.0	4.2.0
	RP-13	RP-010547	1000		Correction to handling of IE 'Downlink info for each radio link'	4.1.0	4.2.0
	RP-13	RP-010547	1004		Redundant IE in Traffic volume measurement system information	4.1.0	4.2.0
	RP-13	RP-010547	1006		Editorial corrections	4.1.0	4.2.0
	RP-13	RP-010548	1008		MAC logical channel priority added to definition of RB0 and SHCCH	4.1.0	4.2.0
	RP-13	RP-010548	1010		Control of primary CCPCCH RSCP measurement in PUSCH CAPACITY REQUEST message	4.1.0	4.2.0
	RP-13	RP-010548	1014		Various minor corrections	4.1.0	4.2.0
	RP-13	RP-010548	1016		Range of T312	4.1.0	4.2.0
	RP-13	RP-010548	1018		Bitstring of channelisationCodeIndices	4.1.0	4.2.0
	RP-13	RP-010548	1020		Transmission of UE CAPABILITY INFORMATION message	4.1.0	4.2.0
	RP-13	RP-010548	1022		Multiple UE capabilities procedures	4.1.0	4.2.0
	RP-13	RP-010548	1024		Corrections to information elements outside the extension container	4.1.0	4.2.0
	RP-13	RP-010548	1026		SFN reporting	4.1.0	4.2.0
	RP-13	RP-010548	1028		TFCl combining indicator	4.1.0	4.2.0
	RP-13	RP-010549	1030		RLC reset on a Signalling Radio Bearer	4.1.0	4.2.0
	RP-13	RP-010549	1034		Quality Indication for UE Positioning Parameters	4.1.0	4.2.0
	RP-13	RP-010549	1036		Editorial Correction for UE Positioning	4.1.0	4.2.0
	RP-13	RP-010549	1038		Clarification on the current status of ciphering	4.1.0	4.2.0
	RP-13	RP-010549	1048		Clarification on HFN initialization at SRB and RB setup	4.1.0	4.2.0
	RP-13	RP-010549	1050		Clarification on Inter-RAT measurement	4.1.0	4.2.0
	RP-13	RP-010549	1052		Clarification on re-assembly of segments	4.1.0	4.2.0
	RP-13	RP-010549	1062		Minor Corrections	4.1.0	4.2.0
	RP-13	RP-010549	1066		Support of dedicated pilots for channel estimation	4.1.0	4.2.0
	RP-13	RP-010549	1068		Correction to SRNS relocation handling	4.1.0	4.2.0
	RP-13	RP-010550	1076		Correction to RLC state variables	4.1.0	4.2.0
	RP-13	RP-010550	1082		Reading of CN information in SIB 1 inRRC Connected Mode	4.1.0	4.2.0
	RP-13	RP-010550	1086		Restricting the maximum amount of preconfigurations in case of equivalent PLMNs	4.1.0	4.2.0
	RP-13	RP-010554	0933		Order of bits in bitstrings	4.1.0	4.2.0
	RP-13	RP-010554	0946		Selection of the RFC3095 CID transmission	4.1.0	4.2.0
	RP-13	RP-010554	0970		Correction of IPDL parameters for TDD enhancements in ASN.1 description	4.1.0	4.2.0
	RP-13	RP-010554	0971	1	1.28 Mcps TDD PICH, Midamble and UL timing advance control corrections	4.1.0	4.2.0
	RP-13	RP-010554	0972		Introduction of 1.28 Mcps TDD Mode in clause 13.7	4.1.0	4.2.0
	RP-13	RP-010554	0973		Tadv in 1.28 Mcps TDD	4.1.0	4.2.0
	RP-13	RP-010554	0974		Correction and clarification to PRACH in 1.28 Mcps TDD	4.1.0	4.2.0
10/2001	-	-	-		Replacement of incorrect (R'99) version of ASN.1 by correct (Rel-4) version of ASN.1.	4.2.0	4.2.1
12/2001	RP-14	RP-010763	1088		Corrections to RRC information containers	4.2.1	4.3.0
	RP-14	RP-010763	1090		Removal of Block SSTD	4.2.1	4.3.0
	RP-14	RP-010763	1098		COUNT-C-SFN frame difference measurement	4.2.1	4.3.0
	RP-14	RP-010763	1100		Trigger for deletion of ciphering and integrity keys	4.2.1	4.3.0
	RP-14	RP-010763	1102		Correction to P_compensation calculation for GSM neighbour cells	4.2.1	4.3.0
	RP-14	RP-010763	1104		Preconfigurations in case of equivalent PLMNs	4.2.1	4.3.0
	RP-14	RP-010763	1109		Handling of DRX cycle and U-RNTI in RRC connection setup and handling of TrCH information	4.2.1	4.3.0
	RP-14	RP-010763	1111		Correction to Information Element names	4.2.1	4.3.0
	RP-14	RP-010763	1113		Correction of Description of IE "SSDT Information"	4.2.1	4.3.0
	RP-14	RP-010763	1115		Clarification on Cell Identity and correction to reference to BAND_INDICATOR	4.2.1	4.3.0
	RP-14	RP-010764	1117		Clarification to Measured Results on RACH and Measurement Events	4.2.1	4.3.0

Change history							
Date	TSG #	TSG Doc.	CR	Rev	Subject/Comment	Old	New
	RP-14	RP-010764	1119		Inconsistency between ASN.1 and tabular wrt. RPLMN information	4.2.1	4.3.0
	RP-14	RP-010764	1124		General clarification on Establishment of Access Service Classes	4.2.1	4.3.0
	RP-14	RP-010764	1126		Clarification on TX diversity indicator IE and STTD indicator IE	4.2.1	4.3.0
	RP-14	RP-010764	1132		Different diversity modes used in the same active set	4.2.1	4.3.0
	RP-14	RP-010764	1134		Issues regarding signalling connection establishment and RRC connection release	4.2.1	4.3.0
	RP-14	RP-010764	1136		Presence of AC to ASC mapping in SIB5 and SIB6	4.2.1	4.3.0
	RP-14	RP-010764	1138		RRC establishment cause at inter-RAT cell change order to UTRAN	4.2.1	4.3.0
	RP-14	RP-010764	1142		Start of timers at radio link failure	4.2.1	4.3.0
	RP-14	RP-010765	1144		Handling of the number of FBI bits sent in Uplink DPCH info	4.2.1	4.3.0
	RP-14	RP-010765	1146		Bit string order when using PER	4.2.1	4.3.0
	RP-14	RP-010765	1148		Clarification on DRX cycle length in connected mode	4.2.1	4.3.0
	RP-14	RP-010765	1152		Correction to error condition on downlink information for each radio link	4.2.1	4.3.0
	RP-14	RP-010765	1154		Correction of inconsistencies between tabular and ASN.1	4.2.1	4.3.0
	RP-14	RP-010765	1156		Measurement related corrections	4.2.1	4.3.0
	RP-14	RP-010765	1158		Inconsistency between hard-coded preconfigurations parameters and procedure text	4.2.1	4.3.0
	RP-14	RP-010765	1166		PLMN search in CELL_PCH/URA_PCH states with 80ms DRX cycle	4.2.1	4.3.0
	RP-14	RP-010765	1168		Correction to CFN calculation for FDD	4.2.1	4.3.0
	RP-14	RP-010765	1170		Correction to radio bearer control	4.2.1	4.3.0
	RP-14	RP-010766	1172		Handling of IE "frequency info"	4.2.1	4.3.0
	RP-14	RP-010766	1174		Correction to Radio Bearer Release	4.2.1	4.3.0
	RP-14	RP-010940	1178	1	Correction to RACH reporting	4.2.1	4.3.0
	RP-14	RP-010766	1180		Correction to URA/Cell update and other minor corrections	4.2.1	4.3.0
	RP-14	RP-010766	1182		Correction to Active Set Update	4.2.1	4.3.0
	RP-14	RP-010766	1184		Correction of Traffic Volume Measurement Criteria	4.2.1	4.3.0
	RP-14	RP-010941	1186	1	Correction of UE Positioning	4.2.1	4.3.0
	RP-14	RP-010766	1203		Invalid RRC CONNECTION REJECT	4.2.1	4.3.0
	RP-14	RP-010766	1214		Security baseline for corrections	4.2.1	4.3.0
	RP-14	RP-010766	1220		Pending integrity protection activation time for UL RB0	4.2.1	4.3.0
	RP-14	RP-010767	1222		Correction of rate matching restriction function	4.2.1	4.3.0
	RP-14	RP-010773	1096		Usage of UM RLC Special Length Indicator	4.2.1	4.3.0
	RP-14	RP-010773	1120		Corrections to REL-4 LCR Tabular Description and ASN1 Code	4.2.1	4.3.0
	RP-14	RP-010773	1199		Correction of FPACH parameter definition for 1.28Mcps TDD	4.2.1	4.3.0
	RP-14	RP-010773	1200		Correction of 1.28Mcps TDD	4.2.1	4.3.0
	RP-14	RP-010773	1201		Correction and Clarification to Open Loop Power Control in 1.28 Mcps TDD	4.2.1	4.3.0
	RP-14	RP-010773	1206		Extensions of IE value ranges in tabular	4.2.1	4.3.0
03/2002	RP-15	RP-020070	1229		Constant value range correction for DPCH and PUSCH in TDD mode	4.3.0	4.4.0
	RP-15	RP-020070	1231		Corrections to open loop power control for TDD and RB information parameters for SHCCH	4.3.0	4.4.0
	RP-15	RP-020070	1233		Removal of unnecessary replication of TFCS ID in Physical Shared Channel Allocation message	4.3.0	4.4.0
	RP-15	RP-020070	1237		Correction to TF selection when using UL RLC TM	4.3.0	4.4.0
	RP-15	RP-020070	1239		Correction to the UE behaviour in case of SRNS relocation	4.3.0	4.4.0
	RP-15	RP-020070	1241		Header Compression protocols re-initialisation during SRNS Relocation	4.3.0	4.4.0
	RP-15	RP-020070	1243		Misalignments between tabular and ASN.1 related to UE Positioning, tabular correction	4.3.0	4.4.0
	RP-15	RP-020070	1245		Corrections to comments in ASN.1	4.3.0	4.4.0
	RP-15	RP-020070	1247		Correction to restarting of T308	4.3.0	4.4.0
	RP-15	RP-020070	1249		Clarification of the use of T309 during inter-RAT cell reselections	4.3.0	4.4.0
	RP-15	RP-020071	1251		Measurement Corrections	4.3.0	4.4.0
	RP-15	RP-020239	1253	1	Existence of TFCl bits	4.3.0	4.4.0
	RP-15	RP-020071	1258		Corrections of inconsistency between procedural description, tabular and ASN.1	4.3.0	4.4.0
	RP-15	RP-020071	1260		Corrections to Expiration Time Factor and Expiration Time formula	4.3.0	4.4.0

Change history								
Date	TSG #	TSG Doc.	CR	Re v	Subject/Comment	Old	New	
					for SIB 7 and SIB 14			
	RP-15	RP-020071	1262		Corrections to Reporting Cell Status	4.3.0	4.4.0	
	RP-15	RP-020071	1268		Correction to inter frequency measurements	4.3.0	4.4.0	
	RP-15	RP-020071	1271		Actions at reception of system information block type 1	4.3.0	4.4.0	
	RP-15	RP-020071	1273		Tx diversity and no diversity in the same active set	4.3.0	4.4.0	
	RP-15	RP-020071	1275		Correction to cell update	4.3.0	4.4.0	
	RP-15	RP-020071	1277		Successful and unsuccessful procedures	4.3.0	4.4.0	
	RP-15	RP-020072	1279		Measurement related corrections	4.3.0	4.4.0	
	RP-15	RP-020072	1281		Clarifications on Event 1D	4.3.0	4.4.0	
	RP-15	RP-020205	1283	1	Security corrections	4.3.0	4.4.0	
	RP-15	RP-020072	1285		Transition from CELL_DCH to CELL_FACH state	4.3.0	4.4.0	
	RP-15	RP-020072	1287		Corrections and clarifications of Radio link timing	4.3.0	4.4.0	
	RP-15	RP-020072	1289		Spare values in ASN.1	4.3.0	4.4.0	
	RP-15	RP-020072	1294		Actions on reception of measurement related IEs	4.3.0	4.4.0	
	RP-15	RP-020231	1296	1	Removal of channel coding option "no coding" for FDD and 3.84 Mcps TDD	4.3.0	4.4.0	
	RP-15	RP-020072	1298		Timing Indication when moving to CELL_DCH state	4.3.0	4.4.0	
	RP-15	RP-020072	1307		Correction to processing RB mapping info	4.3.0	4.4.0	
	RP-15	RP-020072	1313		RRC Connection Release following network authentication failure	4.3.0	4.4.0	
	RP-15	RP-020072	1317		Clarification on serving cell in SIB11	4.3.0	4.4.0	
	RP-15	RP-020073	1319		Treatment of optional elements in RB control messages	4.3.0	4.4.0	
	RP-15	RP-020073	1323		Procedure Performance for TDD UL physical Channel Control	4.3.0	4.4.0	
	RP-15	RP-020250	1331	1	Clarification to physical channel establishment criteria	4.3.0	4.4.0	
	RP-15	RP-020249	1333	1	OTDOA Assistance Data	4.3.0	4.4.0	
	RP-15	RP-020073	1337		Retransmission of uplink direct transfer at RLC re-establishment and inter-RAT change	4.3.0	4.4.0	
	RP-15	RP-020073	1339		Correction to IE "UL interference" for UTRA TDD	4.3.0	4.4.0	
	RP-15	RP-020074	1343		Corrections of UE Positioning requirements	4.3.0	4.4.0	
	RP-15	RP-020074	1345		Multimode speech in default configurations	4.3.0	4.4.0	
	RP-15	RP-020073	1347		Correction to UE Id for DSCH	4.3.0	4.4.0	
	RP-15	RP-020073	1349		Corrections to support combined Cell/URA update and SRNS relocation	4.3.0	4.4.0	
	RP-15	RP-020073	1351		Number of UTRAN and Inter-RAT frequencies	4.3.0	4.4.0	
	RP-15	RP-020073	1353		Abortion of signalling connection establishment	4.3.0	4.4.0	
	RP-15	RP-020073	1358		Modification of GPS timing representation to avoid large integers	4.3.0	4.4.0	
	RP-15	RP-020074	1360		Additional TFCS selection guidelines	4.3.0	4.4.0	
	RP-15	RP-020074	1362		Clarification of layer 3 filtering of measurements in the UE	4.3.0	4.4.0	
	RP-15	RP-020210	1364		Improved readability of procedural text	4.3.0	4.4.0	
	RP-15	RP-020228	1366		Clarification on ICS version within UE radio access capabilities	4.3.0	4.4.0	
	RP-15	RP-020233	1368		Clarification of Maximum number of TFC in the TFCS	4.3.0	4.4.0	
	RP-15	RP-020238	1370		Support of UP measurement reporting in CELL_PCH/URA_PCH	4.3.0	4.4.0	
	RP-15	RP-020082	1122	2	Correction to include Cell ID for Cell_DCH state	4.3.0	4.4.0	
	RP-15	RP-020082	1187	2	Correction of Transparent mode signalling for UL rate control	4.3.0	4.4.0	
	RP-15	RP-020082	1188	2	Introduction of default radio configurations for UMTS_AMR2 with four speech modes	4.3.0	4.4.0	
	RP-15	RP-020082	1223	1	Acquisition of PLMN identity of neighbour cells via SIB 18	4.3.0	4.4.0	
	RP-15	RP-020082	1254		Various ASN.1 Corrections	4.3.0	4.4.0	
	RP-15	RP-020082	1290		Handover from UTRAN failure	4.3.0	4.4.0	
	RP-15	RP-020082	1335		Corrections to indicate that SIB 14 is not used by 1.28 TDD	4.3.0	4.4.0	
	RP-15	RP-020084	1129	2	Support of flexible hard split mode	4.4.0	5.0.0	
	RP-15	RP-020090	1225	1	Introduction of the parameters of OTDOA with IPDL for 1.28 Mcps TDD	4.4.0	5.0.0	
	RP-15	RP-020085	1291	1	Radio link timing	4.4.0	5.0.0	
	RP-15	RP-020094	1305	2	Introduction of HSDPA	4.4.0	5.0.0	
06/2002	RP-16	RP-020330	1373		ASN.1 Corrections	5.0.0	5.1.0	
	RP-16	RP-020330	1376		Clarification of unnecessary MP IEs in RADIO BEARER RECONFIGURATION	5.0.0	5.1.0	
	RP-16	RP-020330	1379		Correction on SIB type	5.0.0	5.1.0	

Change history							
Date	TSG #	TSG Doc.	CR	Rev	Subject/Comment	Old	New
	RP-16	RP-020330	1382		Clarification to the handling of IE "Cells for measurement" received in SIB 11/12	5.0.0	5.1.0
	RP-16	RP-020330	1385	1	Correction to Cell Update procedure	5.0.0	5.1.0
	RP-16	RP-020330	1388		Correction to handling of FACH measurement occasion info in SIB12	5.0.0	5.1.0
	RP-16	RP-020331	1392		Actions when optional IE "Maximum allowed UL TX power" is missing	5.0.0	5.1.0
	RP-16	RP-020331	1395		Corrections concerning default configurations	5.0.0	5.1.0
	RP-16	RP-020331	1398		Correction concerning when hard handover specific handling applies	5.0.0	5.1.0
	RP-16	RP-020331	1401		Handling of variables CELL_INFO_LIST and MEASUREMENT_IDENTITY	5.0.0	5.1.0
	RP-16	RP-020331	1404		IE "Cell Synchronisation Information"	5.0.0	5.1.0
	RP-16	RP-020331	1407		Corrections to Cell Individual Offset	5.0.0	5.1.0
	RP-16	RP-020332	1410		Clarification to Compressed Mode Status Info	5.0.0	5.1.0
	RP-16	RP-020332	1413		Clarification of OTDOA quality figure	5.0.0	5.1.0
	RP-16	RP-020332	1416		Correction to Cell Access Restriction for SIB4	5.0.0	5.1.0
	RP-16	RP-020332	1419		Corrections concerning spare values and comments	5.0.0	5.1.0
	RP-16	RP-020332	1423		Variable for shared channel configurations	5.0.0	5.1.0
	RP-16	RP-020332	1426	1	Integrity protection on RB0	5.0.0	5.1.0
	RP-16	RP-020333	1429	1	Periodic cell update clarifications	5.0.0	5.1.0
	RP-16	RP-020333	1432		Multiple cells triggering event 1D	5.0.0	5.1.0
	RP-16	RP-020333	1435		Disjoint Active Sets in the Active Set Update procedure	5.0.0	5.1.0
	RP-16	RP-020333	1438		Deletion on compressed mode patterns when moving to CELL_FACH state	5.0.0	5.1.0
	RP-16	RP-020333	1441		TDD C-RNTI in Cell DCH	5.0.0	5.1.0
	RP-16	RP-020333	1444	1	CCTrCH Release in TDD	5.0.0	5.1.0
	RP-16	RP-020334	1447		Layer 3 retransmission of SIGNALLING CONNECTION RELEASE INDICATION	5.0.0	5.1.0
	RP-16	RP-020334	1450		Alignment of tabular and ASN.1 for UTRAN GPS timing of cell frames resolution	5.0.0	5.1.0
	RP-16	RP-020334	1453		Correction to Default Radio Configuration Timers	5.0.0	5.1.0
	RP-16	RP-020334	1456		Clarification to number of L3 filters	5.0.0	5.1.0
	RP-16	RP-020334	1459	1	Correction to 3G to 2G Inter-RAT handover for multi-domain RABs	5.0.0	5.1.0
	RP-16	RP-020334	1462		DCH quality target	5.0.0	5.1.0
	RP-16	RP-020335	1465		Correction to RB Mapping Info	5.0.0	5.1.0
	RP-16	RP-020335	1468	1	Ciphering activation for TM bearers	5.0.0	5.1.0
	RP-16	RP-020335	1471		TFCS selection guideline correction	5.0.0	5.1.0
	RP-16	RP-020382	1480	1	Clarification of Measurement Validity and Valid Measurement Objects	5.0.0	5.1.0
	RP-16	RP-020363	1483		Remaining clarification of Measurement Validity and Valid Measurement Objects	5.0.0	5.1.0
	RP-16	RP-020381	1486	1	Traffic Volume Measurement clarifications	5.0.0	5.1.0
	RP-16	RP-020335	1489		Correction to handling of IE 'Downlink information for each RL'	5.0.0	5.1.0
	RP-16	RP-020336	1492		Corrections to Security procedure on Missing integrity protection reset on relocation and counter check response actions for asymmetric bearer configurations	5.0.0	5.1.0
	RP-16	RP-020336	1495		Corrections to cell update interactions with security and SRNS Relocation	5.0.0	5.1.0
	RP-16	RP-020336	1498		"Out of service" area definition	5.0.0	5.1.0
	RP-16	RP-020339	1473		RRC connection release procedure in CELL_DCH state	5.0.0	5.1.0
	RP-16	RP-020339	1475		Correction to DL TM DCCH TF size for Default Configurations	5.0.0	5.1.0
	RP-16	RP-020339	1477		Corrections in ASN.1 related to SRNS relocation	5.0.0	5.1.0
	RP-16	RP-020341	1499		HS-DSCH related corrections	5.0.0	5.1.0
	RP-16	RP-020341	1500		Removal of BLER threshold from IE "Measurement Feedback info"	5.0.0	5.1.0
	RP-16	RP-020345	1501		RFC 3095 context relocation	5.0.0	5.1.0
09/2002	RP-17	RP-020541	1504	1	UE behaviour when active set cells are not included in CELL_INFO_LIST	5.1.0	5.2.0
	RP-17	RP-020541	1507	1	Corrections to handling of IE "Cells for measurement"	5.1.0	5.2.0
	RP-17	RP-020541	1510		Clarification on the use of UE radio access capability extensions within the INTER RAT HANDOVER INFO message	5.1.0	5.2.0
	RP-17	RP-020541	1513		Correction to RRC connection procedure	5.1.0	5.2.0

Change history							
Date	TSG #	TSG Doc.	CR	Re v	Subject/Comment	Old	New
	RP-17	RP-020541	1516		Correction to the variable TGPS_IDENTITY	5.1.0	5.2.0
	RP-17	RP-020541	1522		Missing IEs in RLC info	5.1.0	5.2.0
	RP-17	RP-020542	1528	1	Corrections of UE internal measurement reporting events	5.1.0	5.2.0
	RP-17	RP-020542	1531	2	UE behaviour upon reception of reconfiguration	5.1.0	5.2.0
	RP-17	RP-020542	1534		Application of integrity keys in case of a pending CN domain switch during a SRNS relocation	5.1.0	5.2.0
	RP-17	RP-020542	1537	1	Clarifications on Quality Measurements	5.1.0	5.2.0
	RP-17	RP-020542	1540		Correction of DPCH constant value in TDD default radio configurations	5.1.0	5.2.0
	RP-17	RP-020542	1543		Handling of UE internal measurement information in broadcast	5.1.0	5.2.0
	RP-17	RP-020543	1546		Observed time difference to GSM reporting indicator	5.1.0	5.2.0
	RP-17	RP-020543	1551		Corrections on Security relative to cipherring of TM bearers and to SRNS relocation	5.1.0	5.2.0
	RP-17	RP-020543	1554		Coding of IE NC mode	5.1.0	5.2.0
	RP-17	RP-020543	1557		Clarification to filtered measurement quantities	5.1.0	5.2.0
	RP-17	RP-020543	1560		Inconsistencies in triggering and reporting for events 1a, 1b,1c, 1e and 1f	5.1.0	5.2.0
	RP-17	RP-020543	1563	1	Optional and Mandatory fields in Measurement Control	5.1.0	5.2.0
	RP-17	RP-020544	1566		Clarifications to Reporting Cell Status	5.1.0	5.2.0
	RP-17	RP-020544	1569		Clarification to minimum SF	5.1.0	5.2.0
	RP-17	RP-020544	1572		Clarifications to inter-frequency measurements	5.1.0	5.2.0
	RP-17	RP-020544	1578	2	Cipherring when HO to UMTS of signalling only connection	5.1.0	5.2.0
	RP-17	RP-020544	1581		Inter RAT handover from UTRAN	5.1.0	5.2.0
	RP-17	RP-020544	1584		Correction to Cell Update procedure with cause "Radio link failure"	5.1.0	5.2.0
	RP-17	RP-020545	1587		Correction to the handling of IE "UTRAN DRX cycle length coefficient" in CELL/URA UPDATE procedure	5.1.0	5.2.0
	RP-17	RP-020545	1590		Correction to RLC unrecoverable error occurs in CELL_DCH state	5.1.0	5.2.0
	RP-17	RP-020545	1593		Use of scrambling change when activating CM pattern using SF/2 by MEASUREMENT CONTROL	5.1.0	5.2.0
	RP-17	RP-020545	1596		Actions when optional IE "Maximum allowed UL TX power" is missing	5.1.0	5.2.0
	RP-17	RP-020630	1599	1	IP_offset correction	5.1.0	5.2.0
	RP-17	RP-020545	1602		Clarification on the IE "Frequency Info"	5.1.0	5.2.0
	RP-17	RP-020546	1605		Correction of RNTI used in PUSCH capacity request and physical shared channel allocation	5.1.0	5.2.0
	RP-17	RP-020546	1608		Correction to allowed logical channel list choice for RACH transport channels	5.1.0	5.2.0
	RP-17	RP-020654	1611	1	Clarification of SRNS Relocation Info	5.1.0	5.2.0
	RP-17	RP-020546	1614		DCH quality target	5.1.0	5.2.0
	RP-17	RP-020546	1617		Handling of variables CELL_INFO_LIST and MEASUREMENT_IDENTITY(2)	5.1.0	5.2.0
	RP-17	RP-020546	1620	1	Correction of secondary CCPCH selection and PRACH selection	5.1.0	5.2.0
	RP-17	RP-020547	1623		RRC TVM Corrections	5.1.0	5.2.0
	RP-17	RP-020547	1626		Correction of Transmission Gap Distance semantics description	5.1.0	5.2.0
	RP-17	RP-020547	1629		Corrections to Active Set Update and simultaneous reconfiguration	5.1.0	5.2.0
	RP-17	RP-020547	1632		UE behaviour following RLC size change	5.1.0	5.2.0
	RP-17	RP-020547	1635		RRC SN in uplink	5.1.0	5.2.0
	RP-17	RP-020547	1638		Multiplexing of Tr mode RBs of different CN domains on the same transport channel	5.1.0	5.2.0
	RP-17	RP-020548	1641		Security clarifications	5.1.0	5.2.0
	RP-17	RP-020548	1644		Correction to the actions of "out of service area" and "in service area"	5.1.0	5.2.0
	RP-17	RP-020548	1647		TVM: pending time after trigger and initial conditions	5.1.0	5.2.0
	RP-17	RP-020548	1650	1	Handling of Downlink information for each RL in reconfiguration messages	5.1.0	5.2.0
	RP-17	RP-020548	1655		Corrections to Cell Update/URA Update Procedure in case of nested cell updates and simultaneous SRNS relocation	5.1.0	5.2.0
	RP-17	RP-020548	1670		Corrections to security	5.1.0	5.2.0
	RP-17	RP-020631	1673	1	SRNS relocation with integrity	5.1.0	5.2.0
	RP-17	RP-020549	1676		Reception of MEASUREMENT CONTROL in state CELL_FACH	5.1.0	5.2.0
	RP-17	RP-020549	1679		Unsupported configuration	5.1.0	5.2.0
	RP-17	RP-020549	1682		Handover corrections	5.1.0	5.2.0

Change history								
Date	TSG #	TSG Doc.	CR	Re v	Subject/Comment	Old	New	
	RP-17	RP-020558	1575	1	Correction of SFN-SFN Measurement	5.1.0	5.2.0	
	RP-17	RP-020559	1661		Corrections to Synchronisation for 1.28 Mcps TDD	5.1.0	5.2.0	
	RP-17	RP-020553	1657		Corrections on Power Control for 1.28 Mcps TDD	5.1.0	5.2.0	
	RP-17	RP-020553	1659		Correction to RLC entity re-establishment during SRNS relocation	5.1.0	5.2.0	
	RP-17	RP-020553	1663		Reintroduction of IE "SRB delay" in Rel-4 ASN.1	5.1.0	5.2.0	
	RP-17	RP-020553	1665		Corrections to ASN.1 for SRNC relocation container	5.1.0	5.2.0	
	RP-17	RP-020553	1667		Unused elements in ASN.1	5.1.0	5.2.0	
	RP-17	RP-020557	1547		Correction on Radio link timing	5.1.0	5.2.0	
	RP-17	RP-020662	1651	2	Physical layer IEs for HSDPA	5.1.0	5.2.0	
	RP-17	RP-020557	1652		Transport channel information elements for HSDPA	5.1.0	5.2.0	
	RP-17	RP-020590	1683		TX diversity on radio links in the active set	5.1.0	5.2.0	
	RP-17	RP-020557	1684		Mandatory Support of dedicated pilots for channel estimation	5.1.0	5.2.0	
12/2002	RP-18	RP-020721	1687		Corrections to IEs "Ellipsoid point with Altitude and uncertainty Ellipsoid" and "Ellipsoid point with uncertainty Ellipse"	5.2.0	5.3.0	
	RP-18	RP-020721	1690	1	Handling of Ciphering and integrity protection activation times	5.2.0	5.3.0	
	RP-18	RP-020721	1693		Handling of measurements at state transitions to/from DCH state.	5.2.0	5.3.0	
	RP-18	RP-020721	1696	2	Measurement related corrections	5.2.0	5.3.0	
	RP-18	RP-020721	1699		ASN.1 of the SRNS relocation info	5.2.0	5.3.0	
	RP-18	RP-020721	1710	1	Corrections to PRACH selection	5.2.0	5.3.0	
	RP-18	RP-020722	1713		TDD Downlink Path Loss for interfrequency measurement	5.2.0	5.3.0	
	RP-18	RP-020892	1716	1	Correction on coding of GSM Classmark 2 and 3	5.2.0	5.3.0	
	RP-18	RP-020722	1719		Correction on Frame Allocation Calculation	5.2.0	5.3.0	
	RP-18	RP-020722	1722		Inter-frequency measurements	5.2.0	5.3.0	
	RP-18	RP-020722	1725		Maximum Allowed UL TX Power	5.2.0	5.3.0	
	RP-18	RP-020722	1728		START values for the initialisation of SRB counters and UTRAN incorrect actions	5.2.0	5.3.0	
	RP-18	RP-020723	1731		Correction to the RRC transaction table management	5.2.0	5.3.0	
	RP-18	RP-020723	1803		Use of DCH Quality Target with Blind Transport Format Detection	5.2.0	5.3.0	
	RP-18	RP-020723	1742		Correction to storing current TFC subset in variable TFC_SUBSET for TDD	5.2.0	5.3.0	
	RP-18	RP-020723	1745		Security at inter-RAT handover	5.2.0	5.3.0	
	RP-18	RP-020723	1748		Integrity protection activations times	5.2.0	5.3.0	
	RP-18	RP-020723	1751		Additional measurements	5.2.0	5.3.0	
	RP-18	RP-020724	1754		DPCH compressed mode info in Downlink information common for all RLS	5.2.0	5.3.0	
	RP-18	RP-020724	1757	1	Handling of RB mapping	5.2.0	5.3.0	
	RP-18	RP-020724	1766		RLC window size in default configurations	5.2.0	5.3.0	
	RP-18	RP-020724	1769		Corrections to Activation time	5.2.0	5.3.0	
	RP-18	RP-020724	1772		Numbering of "ASC Setting" IEs included in "PRACH partitioning" IE	5.2.0	5.3.0	
	RP-18	RP-020724	1779	2	Correction on support for compressed mode	5.2.0	5.3.0	
	RP-18	RP-020903	1734	3	Introduction of backwards compatible correction mechanism	5.2.0	5.3.0	
	RP-18	RP-020727	1776		Signalling of the timing adjustment mode for closed loop Tx diversity	5.2.0	5.3.0	
	RP-18	RP-020893	1810		Handling of hyper frame numbers	5.2.0	5.3.0	
	RP-18	RP-020726	1760	2	Early UE Specific Behaviour Information in RRC Connection Request / interRAT info	5.2.0	5.3.0	
	RP-18	RP-020858	1701		Correction of ASN1 IE "InterFreqCellInfoList-r4"	5.2.0	5.3.0	
	RP-18	RP-020858	1703		Correction of Special Burst Scheduling for TDD	5.2.0	5.3.0	
	RP-18	RP-020858	1705		Correction of measurement reporting event 6f for 1.28 Mcps TDD	5.2.0	5.3.0	
	RP-18	RP-020858	1781		Ciphering during SRNS relocation without reuse of COUNT-C	5.2.0	5.3.0	
	RP-18	RP-020858	1783		Correction to IE "Intra Domain NAS Node Selector"	5.2.0	5.3.0	
	RP-18	RP-020858	1785		Correction to PRACH selection	5.2.0	5.3.0	
	RP-18	RP-020859	1787		Correction to reporting event 6f for FDD	5.2.0	5.3.0	
	RP-18	RP-020859	1802		ASN.1 corrections	5.2.0	5.3.0	
	RP-18	RP-020859	1805		Asymmetric ROHC Configuration	5.2.0	5.3.0	
	RP-18	RP-020859	1807		Reference Cell for GSM OTD Measurement	5.2.0	5.3.0	
	RP-18	RP-020736	1707		RRC container for RFC3095 context	5.2.0	5.3.0	

Change history							
Date	TSG #	TSG Doc.	CR	Rev	Subject/Comment	Old	New
	RP-18	RP-020736	1791		Correction to IE "Access stratum release indicator"	5.2.0	5.3.0
	RP-18	RP-020736	1792		RLC capability for HSDPA	5.2.0	5.3.0
	RP-18	RP-020736	1794		Dedicated pilot bits for HS-DSCH	5.2.0	5.3.0
	RP-18	RP-020736	1795		Expansion of CPICH RSCP range	5.2.0	5.3.0
	RP-18	RP-020736	1796		L3 Retransmission of event 1b	5.2.0	5.3.0
	RP-18	RP-020736	1797		DPC mode change in ACTIVE SET UPDATE message	5.2.0	5.3.0
	RP-18	RP-020736	1798		Correction to handling of IE 'Downlink information for each RL'	5.2.0	5.3.0
	RP-18	RP-020896	1793	2	HSDPA parameter value ranges	5.2.0	5.3.0
03/2003	RP-19	RP-030103	1813		ASN.1 of the SRNS relocation Info	5.3.0	5.4.0
	RP-19	RP-030103	1816		Correction to procedural text for Physical Shared Channel Allocation (TDD only)	5.3.0	5.4.0
	RP-19	RP-030103	1819	1	CM and state transition related to measurements, additional measurements, virtual active set and periodic measurements	5.3.0	5.4.0
	RP-19	RP-030103	1822		Physical channel failure and radio link re-establishment	5.3.0	5.4.0
	RP-19	RP-030103	1825		Correction concerning bit numbering convention	5.3.0	5.4.0
	RP-19	RP-030104	1831		Additional Measurement reporting list	5.3.0	5.4.0
	RP-19	RP-030104	1834	2	Correction on RRC integrity protection procedure	5.3.0	5.4.0
	RP-19	RP-030104	1837		Reporting Cell Status and Event 2A	5.3.0	5.4.0
	RP-19	RP-030104	1840		Correction to the handling of variable TGPS_IDENTITY and IE "Triggering condition 1/2"	5.3.0	5.4.0
	RP-19	RP-030104	1843	1	Hard handover with pending ciphering activation times	5.3.0	5.4.0
	RP-19	RP-030105	1846		Correction of default configurations	5.3.0	5.4.0
	RP-19	RP-030105	1849		Correction to UE behaviour on entering RRC Connected mode	5.3.0	5.4.0
	RP-19	RP-030105	1855		Update of Start values in USIM on inter-RAT transitions and transitions to idle mode	5.3.0	5.4.0
	RP-19	RP-030082	1858		Corrections to Channelisation Code TFCI Mapping for TDD	5.3.0	5.4.0
	RP-19	RP-030111	1860		Correction of PNBSCH for 1.28Mcps TDD	5.3.0	5.4.0
	RP-19	RP-030111	1862		Correction of SFN-SFN observed time difference for 1.28Mcps TDD	5.3.0	5.4.0
	RP-19	RP-030111	1864	3	ASN.1 corrections concerning missing UE capability extensions	5.3.0	5.4.0
	RP-19	RP-030111	1866		Extensions for 1.28 Mcps specific elements in system information	5.3.0	5.4.0
	RP-19	RP-030111	1868		Corrections to power control parameter signalling for 1.28 Mcps TDD	5.3.0	5.4.0
	RP-19	RP-030117	1872		TDD HS-SICH Power Control	5.3.0	5.4.0
	RP-19	RP-030117	1873		Usage of separate scrambling code for HSDPA	5.3.0	5.4.0
	RP-19	RP-030119	1874		TDD HS-DSCH midamble shift and burst type	5.3.0	5.4.0
	RP-19	RP-030117	1875		Corrections to the IE "Added or Reconfigured MAC-d flow" and the associated table in 10.3.10	5.3.0	5.4.0
	RP-19	RP-030117	1877	1	Network Assisted Cell Change from UTRAN to GERAN	5.3.0	5.4.0
	RP-19	RP-030117	1878	1	Defining more than one DSCH / USCH transport channel in PDSCH and PUSCH system information (TDD only)	5.3.0	5.4.0
	RP-19	RP-030117	1879		Introducing the use of pre-defined configurations within UTRA	5.3.0	5.4.0
	RP-19	RP-030120	1880		Group release (without security)	5.3.0	5.4.0
	RP-19	RP-030105	1884		Correction to Inter-RAT Measurement Report	5.3.0	5.4.0
	RP-19	RP-030106	1887		Correction of signalling of transport block size for DSCH	5.3.0	5.4.0
	RP-19	RP-030106	1890		PS service continuity when moving between 3G and 2G	5.3.0	5.4.0
	RP-19	RP-030106	1893	1	Multiple activations of the same compressed mode pattern	5.3.0	5.4.0
	RP-19	RP-030106	1896		Setting of ciphering activation time for TM bearers	5.3.0	5.4.0
	RP-19	RP-030117	1897		Correction of shadow CR implementation	5.3.0	5.4.0
	RP-19	RP-030111	1899		Removal of MRRU parameter in PDCP info	5.3.0	5.4.0
	RP-19	RP-030117	1900		Measurement event for evaluation of best HS-DSCH cel	5.3.0	5.4.0
	RP-19	RP-030105	1902	1	NAS and Integrity procedure interaction	5.3.0	5.4.0
	RP-19	RP-030117	1903		Correction to USBI	5.3.0	5.4.0
	RP-19	RP-030187	1909		GPS navigation model update mechanism	5.3.0	5.4.0
	RP-19	RP-030201	1910		Layer 3 filtering definition	5.3.0	5.4.0
	RP-20	RP-030293	1913		Handling of UP Assistance Data	5.4.0	5.5.0
	RP-20	RP-030293	1916	1	Concerns on Procedures for Cell-ID Positioning Method	5.4.0	5.5.0
	RP-20	RP-030293	1919		Inconsistency between Procedural, ASN.1, and Tabular Aspects of UE Positioning Error	5.4.0	5.5.0

Change history								
Date	TSG #	TSG Doc.	CR	Rev	Subject/Comment	Old	New	
	RP-20	RP-030293	1922		Removal of FFS (For further Study) and references to other working groups	5.4.0	5.5.0	
	RP-20	RP-030293	1926		Key handling when entering idle mode and coding of security capabilities	5.4.0	5.5.0	
	RP-20	RP-030293	1929		Security actions when SIM is present on RRC Connection Request	5.4.0	5.5.0	
	RP-20	RP-030294	1932		Update of interfrequency measurement cell info list, reading of SIB11/12, inclusion of Measured Results on RACH	5.4.0	5.5.0	
	RP-20	RP-030294	1937		Additional measurements without measurement validity	5.4.0	5.5.0	
	RP-20	RP-030294	1940		Handover to UTRAN in macrodiversity	5.4.0	5.5.0	
	RP-20	RP-030294	1943	1	TVM Reporting in CELL_PCH state	5.4.0	5.5.0	
	RP-20	RP-030294	1946	1	Initialisation of the Virtual Active Set	5.4.0	5.5.0	
	RP-20	RP-030295	1949		IE "Tx diversity mode" in ACTIVE SET UPDATE message	5.4.0	5.5.0	
	RP-20	RP-030295	1952	1	Correction to transport channel traffic volume measurement events 4a and 4b	5.4.0	5.5.0	
	RP-20	RP-030295	1955		Maximum Number of GPS Almanac Messages to be Stored in UE_POSITIONING_GPS_DATA	5.4.0	5.5.0	
	RP-20	RP-030374	1958	2	Stopping of RLC entities at relocation	5.4.0	5.5.0	
	RP-20	RP-030369	1978	4	Ciphering Mode info IE in 2G-3G Handover	5.4.0	5.5.0	
	RP-20	RP-030295	1981		START values on 2G-3G handover	5.4.0	5.5.0	
	RP-20	RP-030298	1983		ROHC profile signalling	5.4.0	5.5.0	
	RP-20	RP-030298	1959	1	Optimisation of the INTER RAT HANDOVER INFO message	5.4.0	5.5.0	
	RP-20	RP-030350	1987	2	Corrections to security procedures in case of pending security configurations at SRNS Relocation	5.4.0	5.5.0	
	RP-20	RP-030371	1990		Setting of T317 to infinity and out of service behaviour	5.4.0	5.5.0	
	RP-20	RP-030303	1960		Correction to the IE 'HS-DSCH capability class'	5.4.0	5.5.0	
	RP-20	RP-030303	1961		Correction of "RB mapping info" in case HS-DSCH + DCH	5.4.0	5.5.0	
	RP-20	RP-030303	1963		Explanation of CV-UE for the IE MidambleShift in the tabular	5.4.0	5.5.0	
09/2003	RP-21	RP-030484	1993		Handling of key sets at Inter-RAT Handover to UTRAN	5.5.0	5.6.0	
	RP-21	RP-030484	1996		Correction to UE Positioning privacy procedures	5.5.0	5.6.0	
	RP-21	RP-030520	2003	2	START calculation in connected mode	5.5.0	5.6.0	
	RP-21	RP-030506	2000	1	Reconfiguration with state transition to an indicated cell on a different frequency	5.5.0	5.6.0	
	RP-21	RP-030484	2006		PRACH channelisation code list limitation to align with TS 25.221	5.5.0	5.6.0	
	RP-21	RP-030484	2009		Handling of transport channel information at radio bearer release	5.5.0	5.6.0	
	RP-21	RP-030485	2015		Corrections for TDD for the IEs "Downlink DPCH info common for all radio links"	5.5.0	5.6.0	
	RP-21	RP-030485	2018		TFCS selection guidelines for TFC Subset	5.5.0	5.6.0	
	RP-21	RP-030485	2025		Value range of UE Rx-Tx time difference type 2 measurement	5.5.0	5.6.0	
	RP-21	RP-030485	2033		Activation Time for DSCH	5.5.0	5.6.0	
	RP-21	RP-030485	2044		Correction of PDCP Configuration for RFC 2507	5.5.0	5.6.0	
	RP-21	RP-030486	2048		Corrections to event list handling	5.5.0	5.6.0	
	RP-21	RP-030486	2051		Corrections to RACH reporting	5.5.0	5.6.0	
	RP-21	RP-030486	2054		Corrections to modification of Additional Measurement lists	5.5.0	5.6.0	
	RP-21	RP-030486	2057		UE positioning support in the UE	5.5.0	5.6.0	
	RP-21	RP-030478	2064		Elimination of EPC mechanism	5.5.0	5.6.0	
	RP-21	RP-030486	2069		UE behaviour in transition from CELL_DCH to CELL_FACH/CELL_PCH/URA_PCH and Out of Service is detected	5.5.0	5.6.0	
	RP-21	RP-030505	2072	1	Radio link failure during reconfiguration procedure	5.5.0	5.6.0	
	RP-21	RP-030491	2020		Ciphering of TM SRBs	5.5.0	5.6.0	
	RP-21	RP-030491	2022	1	Correction on PDCP Header compression Configuration	5.5.0	5.6.0	
	RP-21	RP-030491	2027		Corrections for TDD PUSCH	5.5.0	5.6.0	
	RP-21	RP-030495	1997		Correction to UE behaviour on T317 expiry	5.5.0	5.6.0	
	RP-21	RP-030495	2029		Correcting value range of MAC-hs buffer ID	5.5.0	5.6.0	
	RP-21	RP-030495	2030		Correction of handling of IE "MAC-hs reset indicator" in Added or Reconfigured DL TrCH information	5.5.0	5.6.0	
	RP-21	RP-030495	2035	1	UE capability signalling for UMTS1800	5.5.0	5.6.0	
	RP-21	RP-030495	2039		Handover between UTRAN and GERAN lu mode	5.5.0	5.6.0	
	RP-21	RP-030495	2040		Updated references to the RRC State Indicator IE	5.5.0	5.6.0	
	RP-21	RP-030495	2041		Corrections to Event 1D	5.5.0	5.6.0	

Change history							
Date	TSG #	TSG Doc.	CR	Re v	Subject/Comment	Old	New
	RP-21	RP-030449	2028		Reconfiguration of MAC-d flow	5.5.0	5.6.0
	RP-21	RP-030462	2061		HS-SCCH transmit diversity mode	5.5.0	5.6.0
	RP-21	RP-030503	2066		Scrambling code & phase reference combinations for HS-DSCH (solution 2)	5.5.0	5.6.0
12/2003	RP-22	RP-030617	2075		Unsuccessful security mode control procedure and Integrity Protection	5.6.0	5.7.0
	RP-22	RP-030625	2076		START value calculation for RLC size change	5.6.0	5.7.0
	RP-22	RP-030617	2079		UE Positioning UE based assisted GPS	5.6.0	5.7.0
	RP-22	RP-030617	2085		Handling of zero-rate TrCHs in TFCS	5.6.0	5.7.0
	RP-22	RP-030617	2091	3	Measurement control for A-GPS	5.6.0	5.7.0
	RP-22	RP-030621	2093		Corrections to 1.28 Mcps TDD power control: ASN1/Tabular consistency, correction of omissions	5.6.0	5.7.0
	RP-22	RP-030621	2095		UpPCH power control for 1.28Mcps	5.6.0	5.7.0
	RP-22	RP-030617	2102	1	Interaction between compressed mode pattern activation and message activation time	5.6.0	5.7.0
	RP-22	RP-030625	2103		Initialisation of virtual active set	5.6.0	5.7.0
	RP-22	RP-030611	2106	1	Correction to Redirection procedure at RRC Connection Setup	5.6.0	5.7.0
	RP-22	RP-030610	2112	2	SFN associated with GPS timing of cell frame	5.6.0	5.7.0
	RP-22	RP-030618	2115		Correction to Handling SIB1	5.6.0	5.7.0
	RP-22	RP-030618	2118		Measurement Handling In State Transition for UE Positioning	5.6.0	5.7.0
	RP-22	RP-030618	2124		Corrections to UE positioning reporting for UE assisted and UE based methods	5.6.0	5.7.0
	RP-22	RP-030662	2127	1	SIB 7 reading	5.6.0	5.7.0
	RP-22	RP-030662	2130		HFN initialisation in case of pending security configurations	5.6.0	5.7.0
	RP-22	RP-030621	2132	1	General protocol error handling failure for DL CCCH messages due to ASN.1 error	5.6.0	5.7.0
	RP-22	RP-030621	2136		Corrections relating to 1.28 Mcps TDD	5.6.0	5.7.0
	RP-22	RP-030621	2138		Missing CHOICE RLC Info type in the ASN.1 IE 'RB-InformationSetup-r4'	5.6.0	5.7.0
	RP-22	RP-030625	2139	1	RRM in PCH/FACH	5.6.0	5.7.0
	RP-22	RP-030625	2140		Correction of operating band reference	5.6.0	5.7.0
	RP-22	RP-030713	2141	1	Re-ordering Queue and HARQ Ids	5.6.0	5.7.0
	RP-22	RP-030625	2142		Correction to the procedural description: Reconfiguration of MAC-d flow	5.6.0	5.7.0
	RP-22	RP-030625	2143	1	Enhancement of RRC transaction identifier for measurement control message	5.6.0	5.7.0
	RP-22	RP-030629	2144		Inclusion of a default configuration identity for AMR-WB	5.6.0	5.7.0
	RP-22	RP-030625	2145		TDD C-RNTI in Cell DCH	5.6.0	5.7.0
	RP-22	RP-030662	2148		Additional Measurements List Modify	5.6.0	5.7.0
	RP-22	RP-030625	2149		IP activation time for RB0	5.6.0	5.7.0
	RP-22	RP-030722	2152	3	Minimum UE capability class	5.6.0	5.7.0
	RP-22	RP-030612	2158	4	Measured results on RACH	5.6.0	5.7.0
	RP-22	RP-030625	2159		COUNT-I reverting in case Security Mode Control procedure failure	5.6.0	5.7.0
	RP-21	RP-030548	2034	1	Maintaining the RRC Connection while Emergency camped on a F-PLMN during OOS (note: it was decided that this CR would not be implemented until the Rel-6 would be created)	5.5.0	6.0.0
	RP-22	RP-030630	2133		Introduction of UMTS800	5.7.0	6.0.0
	RP-22	RP-030721	2134	1	AS capability indication	5.7.0	6.0.0
	RP-22	RP-030630	2160		Introduction of new bands	5.7.0	6.0.0
		Editorial			Repair of corrupted figures	6.0.0	6.0.1
03/2004	RP-23	RP-040095	2168	2	Response on SRNS Relocation with Cell Update	6.0.1	6.1.0
	RP-23	RP-040095	2172		TPC Combination Index in SRNC relocation	6.0.1	6.1.0
	RP-23	RP-040107	2176	1	Correction to "Current TGPS Status Flag"	6.0.1	6.1.0
	RP-23	RP-040095	2180	1	Invalidation of START value in USIM/UE.	6.0.1	6.1.0
	RP-23	RP-040095	2184	1	Uplink Integrity protection handling in case of N302 increment	6.0.1	6.1.0
	RP-23	RP-040095	2188	1	Amount of reporting for UE-based and UE assisted A-GPS	6.0.1	6.1.0
	RP-23	RP-040101	2191	1	Ensuring decoding possibility related to Introduction of new bands	6.0.1	6.1.0
	RP-23	RP-040101	2197	2	Clarification to multimode indication	6.0.1	6.1.0
	RP-23	RP-040101	2200		Correction for 1.28 Mcps TDD Power Control	6.0.1	6.1.0
	RP-23	RP-040101	2203		Missing "pdcP-SN-info" in ASN.1 IE "RB-InformationReconfig-r4"	6.0.1	6.1.0

Change history								
Date	TSG #	TSG Doc.	CR	Re v	Subject/Comment	Old	New	
	RP-23	RP-040107	2207		Correction to HS-SCCH info	6.0.1	6.1.0	
	RP-23	RP-040107	2209		Correction to HS-SCCH info	6.0.1	6.1.0	
	RP-23	RP-040107	2213		Correction to activation time for HS-DSCH reconfiguration in TDD	6.0.1	6.1.0	
	RP-23	RP-040131	2217	3	Connected mode handling IE 'CN domain system information' in SIB1	6.0.1	6.1.0	
	RP-23	RP-040096	2221		Correction to event 6D	6.0.1	6.1.0	
	RP-23	RP-040096	2225	1	Correction to UE positioning reporting for GPS standalone operation mode	6.0.1	6.1.0	
	RP-23	RP-040092	2229		Frequency band alignment with 25.101	6.0.1	6.1.0	
	RP-23	RP-040096	2235		UTRAN setting of the activation time for TM bearers in Ciphering Mode info IE	6.0.1	6.1.0	
	RP-23	RP-040096	2239		Corrections to "Entered parameter"	6.0.1	6.1.0	
	RP-23	RP-040097	2243		Corrections to TFC Subset Functionality	6.0.1	6.1.0	
	RP-23	RP-040097	2247	1	Waiting for RLC-ACK on UMI	6.0.1	6.1.0	
	RP-23	RP-040105	2249		Invalid Simultaneous Reconfiguration Criteria	6.0.1	6.1.0	
	RP-23	RP-040101	2252	1	General correction and alignment of the ASN.1 and tabular	6.0.1	6.1.0	
	RP-23	RP-040121	2253	1	Introduction of UMTS1700/2100 (Band IV)	6.0.1	6.1.0	
	RP-23	RP-040091	2254		Introduction of UMTS850 (Band V)	6.0.1	6.1.0	
	RP-23	RP-040101	2257		Introduction of VLEC in every message branch	6.0.1	6.1.0	
	RP-23	RP-040107	2259		Simultaneous Reception of S-CCPCH and HS-DSCH	6.0.1	6.1.0	
	RP-23	RP-040107	2261		Cell reselection between UTRAN and GERAN Iu mode	6.0.1	6.1.0	
	RP-23	RP-040108	2263		HSDPA related corrections on buffer flushing on state transitions, RAT transitions, error cases, MAC-hs reconfiguration and readiness to receive HS-PDSCH	6.0.1	6.1.0	
	RP-23	RP-040106	2265	2	Signalling of MAC-hs Reset	6.0.1	6.1.0	
	RP-23	RP-040131	2267	2	Modification of Inter-frequency CELL_INFO_LIST	6.0.1	6.1.0	
	RP-23	RP-040131	2269	1	[VAS] 1B-1C conflicts when 1A is not configured	6.0.1	6.1.0	
	RP-23	RP-040131	2271	1	Handling of wait time in RRC connection reject	6.0.1	6.1.0	
	RP-23	RP-040108	2274		Misalignments between R'99 and Rel-5 procedures	6.0.1	6.1.0	
	RP-23	RP-040097	2281		Issues related to Inter-RAT and Inter-frequency handovers	6.0.1	6.1.0	
	RP-23	RP-040097	2285	1	Corrections to reconfiguration scenarios and ciphering of TM RBs	6.0.1	6.1.0	
	RP-23	RP-040110	2286	4	Addition of "cell selection indication" for cell selection at release of RRC connection and RRC connection reject with re-direction	6.0.1	6.1.0	
	RP-23	RP-040129	2288		HSDPA capability for multimode FDD-TDD terminals	6.0.1	6.1.0	
	RP-23	RP-040095	2168	2	Response on SRNS Relocation with Cell Update	6.0.1	6.1.0	
06/2004	RP-24	RP-040203	2292		Empty non-critical extensions	6.1.0	6.2.0	
	RP-24	RP-040211	2294	1	Missing "v3g0" extension in the UE CAPABILITY INFORMATION	6.1.0	6.2.0	
	RP-24	RP-040203	2303		Correction on System Information in TDD	6.1.0	6.2.0	
	RP-24	RP-040236	2305		Corrections to Cell Change Order from UTRAN procedure	6.1.0	6.2.0	
	RP-24	RP-040206	2308		Correction on SFN-SFN time difference misalignment in 1.28 Mcps TDD	6.1.0	6.2.0	
	RP-24	RP-040207	2311		ASN.1 correction leftovers	6.1.0	6.2.0	
	RP-24	RP-040210	2313		Closing the REL-5 extensions in the ASN.1	6.1.0	6.2.0	
	RP-24	RP-040207	2316		Incorrect presence of UE-RadioAccessCapability extension in RRC CONNECTION SETUP COMPLETE	6.1.0	6.2.0	
	RP-24	RP-040210	2318		Unnecessary MAC-d flow identity in the IE "DL-TrCH-Type-r5"	6.1.0	6.2.0	
	RP-24	RP-040211	2320	1	UE capability enquiry for GERAN Iu mode	6.1.0	6.2.0	
	RP-24	RP-040207	2323		Clean up of SRNS Relocation Info REL-4 version	6.1.0	6.2.0	
	RP-24	RP-040210	2325		Tabular correction for RADIO BEARER RELEASE message	6.1.0	6.2.0	
	RP-24	RP-040210	2327		Misalignments between R'99 and Rel-5 procedures	6.1.0	6.2.0	
	RP-24	RP-040210	2329		Erroneous setting of Re-establish Indicator in case of SRNS relocation	6.1.0	6.2.0	
	RP-24	RP-040207	2332		Correction to IE "Cell Info"	6.1.0	6.2.0	
	RP-24	RP-040210	2334		Correction Concerning UE Positioning Measurement	6.1.0	6.2.0	
	RP-24	RP-040236	2336		Pending compressed mode reconfigurations	6.1.0	6.2.0	
		RP-040236	2338		Active compressed mode patterns with same measurement purpose	6.1.0	6.2.0	
	RP-24	RP-040211	2340		Correction to Information Elements for UE Rx-Tx time difference	6.1.0	6.2.0	
	RP-24	RP-040210	2342		Naming correction in the HS-DSCH IE Measurement Feedback Information	6.1.0	6.2.0	

Change history							
Date	TSG #	TSG Doc.	CR	Re v	Subject/Comment	Old	New
	RP-24	RP-040206	2345		Clarification about open loop power control in 1.28Mcps TDD	6.1.0	6.2.0
	RP-24	RP-040206	2348		Clarification about measurement control system information in TDD mode	6.1.0	6.2.0
	RP-24	RP-040211	2350		Correction to timing-maintained hard handover regarding the UL transmission timing	6.1.0	6.2.0
	RP-24	RP-040236	2354	2	Selection of suitable cell	6.1.0	6.2.0
	RP-24	RP-040236	2356		Check of the PLMN identity in the MIB when selecting a new cell	6.1.0	6.2.0
	RP-24	RP-040211	2358		Compressed INTER RAT HANDOVER INFO message modifications/corrections	6.1.0	6.2.0
	RP-24	RP-040215	2359		The ASN.1 definition of IE "SysInfoType5bis"	6.1.0	6.2.0
	RP-24	RP-040224	2361		RLC size handling and RLC re-establishment	6.1.0	6.2.0
	RP-24	RP-040212	2363		Restrict operation of the virtual active set	6.1.0	6.2.0
	RP-24	RP-040213	2365		Usage of different RB mapping info	6.1.0	6.2.0
	RP-24	RP-040256	2367	1	Clarification on UE procedure in case of HHO failure	6.1.0	6.2.0
09/2004	RP-25	RP-040327	2373		TDD misalignment between tabular and ASN.1 definitions of UL Transport channel information common for all transport channels and special burst scheduling	6.2.0	6.3.0
	RP-25	RP-040327	2377		Definition of parameters for UE-assisted A-GPS	6.2.0	6.3.0
	RP-25	RP-040339	2378	2	Addition of UMTS850 (Band V) in the tabular	6.2.0	6.3.0
	RP-25	RP-040360	2381		Default Configurations for multiple AMR Rate Configurations	6.2.0	6.3.0
	RP-25	RP-040319	2384		Correction on PRACH selection in 1.28Mcps TDD	6.2.0	6.3.0
	RP-25	RP-040334	2386		Inconsistency in UE action for HFN initialisation	6.2.0	6.3.0
	RP-25	RP-040334	2388		Usage of different RB mapping info for TDD	6.2.0	6.3.0
	RP-25	RP-040334	2390		TDD HS-DSCH Corrections	6.2.0	6.3.0
	RP-25	RP-040334	2392		Alignment of Tabular Definition with ASN.1 for HS-SCCH Info	6.2.0	6.3.0
	RP-25	RP-040348	2394	1	Correction to HS-DSCH reception conditions	6.2.0	6.3.0
	RP-25	RP-040334	2396		Correction to RB mapping check	6.2.0	6.3.0
	RP-25	RP-040334	2398		Position Timestamp for A-GPS	6.2.0	6.3.0
	RP-25	RP-040334	2400		Pending compressed mode reconfigurations	6.2.0	6.3.0
	RP-25	RP-040335	2402		Predefined configurations for the RRC connection request	6.2.0	6.3.0
	RP-25	RP-040335	2404		Cell update during reconfiguration from CELL_FACH to CELL_PCH	6.2.0	6.3.0
	RP-25	RP-040335	2406		UE actions for Delta_ACK/NACK and repetition factor	6.2.0	6.3.0
	RP-25	RP-040335	2408		Calculation of UL transmit power for HS-SICH (TDD)	6.2.0	6.3.0
	RP-25	RP-040335	2410		Handling of Timer T302 Expiry	6.2.0	6.3.0
	RP-25	RP-040335	2412		Correct naming for HS-DSCH with DCH multiplexing option	6.2.0	6.3.0
	RP-25	RP-040335	2414		Compressed Pre-defined configurations description in new Annex C	6.2.0	6.3.0
	RP-25	RP-040335	2416		Integration between integrity protection and the sending of downlink messages during SRNS relocation	6.2.0	6.3.0
	RP-25	RP-040328	2418		Corrections to restrictions of operation of the virtual active set	6.2.0	6.3.0
	RP-25	RP-040336	2420		UE actions for received new keys	6.2.0	6.3.0
	RP-25	RP-040336	2422	1	Scrambling Code Change	6.2.0	6.3.0
	RP-25	RP-040328	2428		Clarifications to VAS functionality	6.2.0	6.3.0
	RP-25	RP-040336	2430		UE security capability in INTER_RAT handover	6.2.0	6.3.0
	RP-25	RP-040336	2432		Correction to the Radio Link Failure behaviour	6.2.0	6.3.0
12/2004	RP-26	RP-040481	2434		Correction to measured results on RACH	6.3.0	6.4.0
	RP-26	RP-040481	2436		T305 handling upon a state transition	6.3.0	6.4.0
	RP-26	RP-040481	2438		Handling of pending AM RLC unrecoverable errors signalled by cell update	6.3.0	6.4.0
	RP-26	RP-040476	2442		Correction to maximum length of CTCH period	6.3.0	6.4.0
	RP-26	RP-040481	2444		TPC step size in default configurations	6.3.0	6.4.0
	RP-26	RP-040474	2448		References to ITU-T Recommendations on ASN.1	6.3.0	6.4.0
	RP-26	RP-040477	2451		ASN.1 clarification on Measurement Report for 1.28 Mcps TDD	6.3.0	6.4.0
	RP-26	RP-040481	2453		Correction to HS-DSCH reception conditions	6.3.0	6.4.0
	RP-26	RP-040481	2455	1	MAC-hs Reset procedure	6.3.0	6.4.0
	RP-26	RP-040526	2457	2	Cell selection and reselection parameters	6.3.0	6.4.0
	RP-26	RP-040482	2459	1	Clarification the PDCP capability- Max HC context space	6.3.0	6.4.0

Change history								
Date	TSG #	TSG Doc.	CR	Re v	Subject/Comment	Old	New	
	RP-26	RP-040482	2461		Corrections to IE "WAIT TIME" = 0	6.3.0	6.4.0	
	RP-26	RP-040482	2463	1	RRC transaction identifier in the MEASUREMENT CONTROL message	6.3.0	6.4.0	
	RP-26	RP-040482	2465		Correction to intra-frequency measurement handling in SIB11	6.3.0	6.4.0	
	RP-26	RP-040477	2468	1	Missing OTDOA TDD related v4b0 extension in MEASUREMENT CONTROL	6.3.0	6.4.0	
	RP-26	RP-040482	2470	2	Clarification of Radio Bearer Downlink Ciphering Activation Time Info	6.3.0	6.4.0	
	RP-26	RP-040520	2472	2	TFC Subset Variable Usage and Application of Transport Format Combination Subset	6.3.0	6.4.0	
	RP-26	RP-040505	2474		Use of preconfiguration in the RADIO BEARER RECONFIGURATION message	6.3.0	6.4.0	
	RP-26	RP-040505	2476		UTRAN setting of ciphering activation time for SRB2	6.3.0	6.4.0	
	RP-26	RP-040505	2478		Correction to ASN1 IE "srb-SpecificIntegrityProtInfo"	6.3.0	6.4.0	
	RP-26	RP-040522	2480	2	Criteria for initiating cell update on receiving "Frequency info" IE in CELL UPDATE CONFIRM message	6.3.0	6.4.0	
	RP-26	RP-040505	2482		Traffic volume measurements in PCH states	6.3.0	6.4.0	
	RP-26	RP-040505	2484		Failure cause indication on Cell Update	6.3.0	6.4.0	
	RP-26	RP-040495	2487	1	Network Sharing and multiple PLMN identities	6.3.0	6.4.0	
	RP-26	RP-040505	2493		Inter-RAT measurement control information used	6.3.0	6.4.0	
	RP-26	RP-040491	2494		ASN.1 update for the introduction of MBMS	6.3.0	6.4.0	
	RP-26	RP-040491	2495	1	Introduction of MBMS	6.3.0	6.4.0	
	RP-26	RP-040543	2496	2	Preamble and Postamble to reduce HS-DPCCH transmit power	6.3.0	6.4.0	
	RP-26	RP-040507	2497		Introduction of E-DCH	6.3.0	6.4.0	
03/2005	RP-27	RP-050038	2491	2	Removal of TGPL2	6.4.0	6.5.0	
	RP-27	RP-050069	2499		Minor HSDPA related corrections	6.4.0	6.5.0	
	RP-27	RP-050169	2501		Integrity protection related information in the SRNS relocation info	6.4.0	6.5.0	
	RP-27	RP-050069	2503		Number of timeslots that can be used for HS-PDSCH resource for 3.84 Mcps TDD	6.4.0	6.5.0	
	RP-27	RP-050089	2504		HS-DSCH operation without a DL DPCH for 3.84 Mcps TDD	6.4.0	6.5.0	
	RP-27	RP-050114	2506		Removal of unnecessary cell updates on receiving "Frequency info" IE in CELL UPDATE CONFIRM message	6.4.0	6.5.0	
	RP-27	RP-050069	2508		ASN.1 clarification on Cell and Channel Identity info for 1.28 Mcps TDD	6.4.0	6.5.0	
	RP-27	RP-050070	2510		Handling of TM SRB's at radio link failure	6.4.0	6.5.0	
	RP-27	RP-050070	2513		Removal of the UARFCN uplink (Nu) in the informative Annex A.3	6.4.0	6.5.0	
	RP-27	RP-050070	2515	1	Correction on PRACH selection	6.4.0	6.5.0	
	RP-27	RP-050067	2517	3	Lossless DL RLC PDU size change	6.4.0	6.5.0	
	RP-27	RP-050069	2519		Clarification of GERAN (P)SI message coding in NACC	6.4.0	6.5.0	
	RP-27	RP-050070	2521		Unsupported RLC mode reconfigurations	6.4.0	6.5.0	
	RP-27	RP-050070	2523		Correction to Inter RAT cell info indication	6.4.0	6.5.0	
	RP-27	RP-050086	2524		Correction to network sharing functionality	6.4.0	6.5.0	
	RP-27	RP-050086	2525		Network sharing corrections	6.4.0	6.5.0	
	RP-27	RP-050110	2526	1	CN domain specific Access Class Barring	6.4.0	6.5.0	
	RP-27	RP-050081	2527		Corrections to "selected PLMN" in access stratum	6.4.0	6.5.0	
	RP-27	RP-050074	2528		Introduction of F-DPCH	6.4.0	6.5.0	
	RP-27	RP-050084	2529		Minor E-DCH related corrections	6.4.0	6.5.0	
	RP-27	RP-050079	2530	2	Miscellaneous MBMS corrections	6.4.0	6.5.0	
	RP-27	RP-050087	2532		Additional Frequency Bands	6.4.0	6.5.0	
	RP-27	RP-050084	2534		Introduction of E-DCH in the ASN.1	6.4.0	6.5.0	
	RP-27	RP-050097	2535		Improvements to uplink closed loop power control for 1.28 Mcps TDD	6.4.0	6.5.0	
	RP-27	RP-050079	2536	1	MBMS Corrections to 25.331 ASN.1	6.4.0	6.5.0	
	RP-27	RP-050128	2538	1	Correction to cell selection and reselection parameters to enable enhanced cell reselection	6.4.0	6.5.0	
06/2005	RP-28	RP-050253	2539	3	Faster L1 DCH synchronization	6.5.0	6.6.0	
	RP-28	RP-050339	2540	3	Timing maintained hard handover	6.5.0	6.6.0	
	RP-28	RP-050320	2541	1	Removal of unnecessary Start values	6.5.0	6.6.0	
	RP-28	RP-050329	2542		Merged CR alignment w.r.t. network sharing functionality	6.5.0	6.6.0	

Change history							
Date	TSG #	TSG Doc.	CR	Re v	Subject/Comment	Old	New
	RP-28	RP-050302	2545		Timing Reinitialized Handover & Radio Link Timing Adjustmen	6.5.0	6.6.0
	RP-28	RP-050302	2547		Addition of omitted IE "report criteria" in MEASUREMENT CONTROL message "modify" command	6.5.0	6.6.0
	RP-28	RP-050316	2548	2	Miscellaneous MBMS corrections (set II)	6.5.0	6.6.0
	RP-28	RP-050316	2549	1	Correction to MBMS notification procedure	6.5.0	6.6.0
	RP-28	RP-050316	2550	1	FACH Measurement Occasion when UE receives MBMS	6.5.0	6.6.0
	RP-28	RP-050316	2551		Frequency layer dispersion	6.5.0	6.6.0
	RP-28	RP-050303	2553	2	Signalling of target mode for ROHC operation	6.5.0	6.6.0
	RP-28	RP-050320	2554	2	Introduction of inter-frequency RACH measurement reporting	6.5.0	6.6.0
	RP-28	RP-050324	2555		Closed-Loop Power Control Improvements for 1.28 Mcps TDD – ASN1 Corrections	6.5.0	6.6.0
	RP-28	RP-050322	2556		Release 6 HS-DSCH operation without a DL DPCH for 3.84 Mcps TDD – Setting of Dhs-sync	6.5.0	6.6.0
	RP-28	RP-050320	2557	1	Correction to the Amount of Reporting	6.5.0	6.6.0
	RP-28	RP-050320	2558		Measurement report message definition when Inter-RAT cell info indication is used	6.5.0	6.6.0
	RP-28	RP-050320	2559		Direct transition to DCH	6.5.0	6.6.0
	RP-28	RP-050316	2560	1	Addition of the number of MBMS Neighbour Cell PTM Information messages to the MBMS Modified Services Information message	6.5.0	6.6.0
	RP-28	RP-050316	2561	1	Addition of MBMS counting for UEs in Cell_PCH and Cell_FACH states and addition of UE requested p-t-p bearer establishmen	6.5.0	6.6.0
	RP-28	RP-050320	2562		Introduction of IE "RB information to reconfigure" in RB SETUP, RB RELEASE messages	6.5.0	6.6.0
	RP-28	RP-050320	2564		Including HS-DSCH serving cell change in ASU	6.5.0	6.6.0
	RP-28	RP-050320	2566	1	Detection of Activation CFN wraparound in the UE during HS-DSCH cell change	6.5.0	6.6.0
	RP-28	RP-050304	2568		Correction to handling of keys at inter-RAT handove	6.5.0	6.6.0
	RP-28	RP-050302	2572		CTFC calculation for DCH	6.5.0	6.6.0
	RP-28	RP-050302	2574		Default RB identity in IE 'Signalling RB information to setup	6.5.0	6.6.0
	RP-28	RP-050302	2576		Default configuration 13	6.5.0	6.6.0
	RP-28	RP-050320	2577		UE L3 requirements for HS-DSCH mobility	6.5.0	6.6.0
	RP-28	RP-050374	2579	3	Support for out-of-sequence PDUs in RLC-UM	6.5.0	6.6.0
	RP-28	RP-050305	2581		Feature Clean Up: Removal of 80 ms TTI for DCH for all other cases but when the UE supports SF512	6.5.0	6.6.0
	RP-28	RP-050306	2583		Feature Clean Up: Removal of observed time difference to GSM cell	6.5.0	6.6.0
	RP-28	RP-050307	2585		Feature Clean Up: Removal of SSDT	6.5.0	6.6.0
	RP-28	RP-050308	2586		Feature Clean-up: Removal of DSCH (FDD)	6.5.0	6.6.0
	RP-28	RP-050309	2589		Feature Clean Up: Removal of CPCH	6.5.0	6.6.0
	RP-28	RP-050310	2591		Feature Clean Up: Removal of dedicated pilot as sole phase reference	6.5.0	6.6.0
	RP-28	RP-050311	2593		Feature Clean Up: Removal of DRAC	6.5.0	6.6.0
	RP-28	RP-050312	2595		Feature Clean Up: Removal of TX diversity closed loop mode 2	6.5.0	6.6.0
	RP-28	RP-050313	2597		Feature Clean Up: Removal of Compressed mode by puncturing	6.5.0	6.6.0
	RP-28	RP-050327	2598	2	Alignment of EUDCH RRC Stage-3 to Stage-2 status, including handling of 2 E-RNTIs	6.5.0	6.6.0
	RP-28	RP-050336	2599		Radio link failure in F-DPCH	6.5.0	6.6.0
	RP-28	RP-050323	2600	1	Setting up F-DPCH and E-DCH in RRC connection setup	6.5.0	6.6.0
	RP-28	RP-050316	2601	1	Validity of PtM configurations	6.5.0	6.6.0
	RP-28	RP-050392	2602	1	CCCH message enhancements	6.5.0	6.6.0
	RP-28	RP-050320	2604		Quality measurement corrections	6.5.0	6.6.0
	RP-28	RP-050328	2605		Clean-up of R6 ASN.1 leftovers	6.5.0	6.6.0
	RP-28	RP-050346	2607	2	UE behaviour for DCH SIR target setting for Downlink power control	6.5.0	6.6.0
	RP-28	RP-050317	2608		RLC LI Optimization for VoIP	6.5.0	6.6.0
	RP-28	RP-050316	2609	2	Introduction of an S-CCPCH power offset difference in order to improve cell selection for soft and selective combining	6.5.0	6.6.0
	RP-28	RP-050320	2610		Erroneous implementation of CR#2501 in RRC specification v6.5.0.	6.5.0	6.6.0
	RP-28	RP-050329	2611		Correction to network sharing	6.5.0	6.6.0
	RP-28	RP-050316	2613		MBMS asn1 issues	6.5.0	6.6.0

Change history							
Date	TSG #	TSG Doc.	CR	Rev	Subject/Comment	Old	New
	RP-28	RP-050316	2614		SCCPCH timing offset information for FDD MBMS soft combining	6.5.0	6.6.0
	RP-28	RP-050316	2615		MBMS corrections on signalling optimization	6.5.0	6.6.0
09/2005	RP-29	RP-050486	2616		Support of Domain Specific Access control in Rel-5 Ues	6.6.0	6.7.0
	RP-29	RP-050465	2619		ASN1 update for InterRATReportingQuantity	6.6.0	6.7.0
	RP-29	RP-050465	2621	1	IE "RB information to reconfigure" for RADIO BEARER RECONFIGURATION message	6.6.0	6.7.0
	RP-29	RP-050465	2623		Size of TFC Subset List for Transport Format Combination Control	6.6.0	6.7.0
	RP-29	RP-050465	2626		RB mapping rules	6.6.0	6.7.0
	RP-29	RP-050587	2628	3	Rules for triggering hard handover	6.6.0	6.7.0
	RP-29	RP-050465	2630		RSCP value range extension	6.6.0	6.7.0
	RP-29	RP-050465	2632		H-RNTI validity	6.6.0	6.7.0
	RP-29	RP-050482	2633		Removal RLC-SDU alignment capability	6.6.0	6.7.0
	RP-29	RP-050458	2635		Feature Clean Up: Removal of DRAC	6.6.0	6.7.0
	RP-29	RP-050458	2637		DRAC & Dedicated pilots removal leftovers (asn1)	6.6.0	6.7.0
	RP-29	RP-050458	2639		DRAC & CPCH removal leftovers (sib8,9,10)	6.6.0	6.7.0
	RP-29	RP-050458	2641	1	Feature remove (Tabular/asn1 alignment)	6.6.0	6.7.0
	RP-29	RP-050482	2642		Correction to UE L3 requirements for HS-DSCH mobility	6.6.0	6.7.0
	RP-29	RP-050482	2643		Rate Control Correction	6.6.0	6.7.0
	RP-29	RP-050482	2644		Introduction of container to facilitate transparent transfer of UE capabilities	6.6.0	6.7.0
	RP-29	RP-050482	2645		Minor ASN.1 correction for TDD IEs Beacon PL Est and DHS-Sync	6.6.0	6.7.0
	RP-29	RP-050482	2646		Addition of ongoing reconfiguration indicator in cell update	6.6.0	6.7.0
	RP-29	RP-050482	2648		Faster L1 DCH synchronization	6.6.0	6.7.0
	RP-29	RP-050482	2649		Direct transition to DCH	6.6.0	6.7.0
	RP-29	RP-050482	2650		PSI messages in CELL CHANGE ORDER FROM UTRAN	6.6.0	6.7.0
	RP-29	RP-050482	2651		SRNS relocation info	6.6.0	6.7.0
	RP-29	RP-050482	2652		Correction to UE-assisted OTDOA support	6.6.0	6.7.0
	RP-29	RP-050482	2653		Correction to undefined UE behaviour in case of Cell-ID positioning with method type UE-based	6.6.0	6.7.0
	RP-29	RP-050482	2654		Receiving "Frequency info" IE in CELL UPDATE CONFIRM message	6.6.0	6.7.0
	RP-29	RP-050483	2655		Re-entry in service in CELL_PCH before T316 expiry	6.6.0	6.7.0
	RP-29	RP-050483	2656		ASN.1 alignment to Rel-5 of InterRATCellInfoIndication	6.6.0	6.7.0
	RP-29	RP-050483	2657		Addition of Inter-frequency measurements reporting on RACH reporting in the ASN.1 of RRC CONNECTION REQUEST and CELL UPDATE messages	6.6.0	6.7.0
	RP-29	RP-050483	2658		Correction to the Amount of Reporting	6.6.0	6.7.0
	RP-29	RP-050483	2659		Minor correction of HS-DSCH/ E-DCH capability indication	6.6.0	6.7.0
	RP-29	RP-050476	2660		Modification of TPC command error rate granularity and range	6.6.0	6.7.0
	RP-29	RP-050473	2661	1	Introduction of PS handover between UTRAN and GERAN	6.6.0	6.7.0
	RP-29	RP-050483	2662		Including HS-DPCCH power offset and HARQ preamble mode in active set update	6.6.0	6.7.0
	RP-29	RP-050468	2663		Minor MBMS corrections (set IV)	6.6.0	6.7.0
	RP-29	RP-050468	2664		Clarification on MBMS modified services information IE	6.6.0	6.7.0
	RP-29	RP-050468	2665		MBMS correction for recounting	6.6.0	6.7.0
	RP-29	RP-050468	2666	1	MBMS asn1 issues	6.6.0	6.7.0
	RP-29	RP-050471	2667		E-DCH corrections and additions	6.6.0	6.7.0
	RP-29	RP-050471	2668		E-DCH corrections	6.6.0	6.7.0
	RP-29	RP-050472	2669	4	E-DCH additions to active set update	6.6.0	6.7.0
	RP-29	RP-050471	2670	1	UE capabilities for E-DCH in 25.331	6.6.0	6.7.0
	RP-29	RP-050468	2671		Conditional suspension of CELL_FACH measurements to enable reception of MCCH	6.6.0	6.7.0
	RP-29	RP-050468	2672		MBMS message order on MCCH	6.6.0	6.7.0
	RP-29	RP-050468	2673		MSCH configuration information in case of soft combining Timing Offset	6.6.0	6.7.0
	RP-29	RP-050469	2674	1	Removal of fixed position for S-CCPCHs carrying MBMS channels	6.6.0	6.7.0
	RP-29	RP-050467	2675		Introduction of Band VII	6.6.0	6.7.0
	RP-29	RP-050483	2676		Introducing pre- configuration upon radio bearer establishment	6.6.0	6.7.0

Change history							
Date	TSG #	TSG Doc.	CR	Rev	Subject/Comment	Old	New
	RP-29	RP-050484	2677	1	Introduction of the device type indication in UE capability	6.6.0	6.7.0
	RP-29	RP-050471	2680		E-DCH TTI Reconfiguration	6.6.0	6.7.0
	RP-29	RP-050483	2681		Maximum number of reference ETFCI's	6.6.0	6.7.0
	RP-29	RP-050561	2682		F-DPCH power control	6.6.0	6.7.0
12/2005	RP-30	RP-050801	2617	2	Introduction of UMTS1700	6.7.0	6.8.0
	RP-30	RP-050787	2683	4	Introduction of the HSDPA and E-DCH Capable Cell Indicator	6.7.0	6.8.0
	RP-30	RP-050785	2685	1	PRACH for CCCH in SIB 6	6.7.0	6.8.0
	RP-30	RP-050796	2686	1	Tx/Rx frequency separation capability (FDD)	6.7.0	6.8.0
	RP-30	RP-050827	2687	1	E-DCH mobility corrections and multi-step handling for E-RGCH	6.7.0	6.8.0
	RP-30	RP-050797	2688	1	L1 synchronisation at HHO	6.7.0	6.8.0
	RP-30	RP-050786	2690		Correction to UE positioning measurements in CELL_PCH/URA_PCH state	6.7.0	6.8.0
	RP-30	RP-050785	2692		Clarification of Delta in Inter/Intra-frequency measurement reporting criteria	6.7.0	6.8.0
	RP-30	RP-050785	2694		Clarification of the usage of "Ack-Nack Power Offset" in HSDPA for TDD	6.7.0	6.8.0
	RP-30	RP-050785	2696		Modification of WB-AMR default configuration	6.7.0	6.8.0
	RP-30	RP-050785	2698		Serving E-DCH radio link indication	6.7.0	6.8.0
	RP-30	RP-050800	2699		Introduction of UMTS 900 (Band VIII)	6.7.0	6.8.0
	RP-30	RP-050788	2700		MCCH configuration information	6.7.0	6.8.0
	RP-30	RP-050788	2701		Correction of default TFCS for MBMS	6.7.0	6.8.0
	RP-30	RP-050797	2702		Unidirectional RLC reconfiguration	6.7.0	6.8.0
	RP-30	RP-050793	2703	1	Misalignments for E-DCH	6.7.0	6.8.0
	RP-30	RP-050793	2704		Update for E-DCH Serving Grant IE value range	6.7.0	6.8.0
	RP-30	RP-050793	2705		Clarification on MAC-d flow multiplexing list	6.7.0	6.8.0
	RP-30	RP-050793	2706		Addition of E-DCH power offsets to active set update	6.7.0	6.8.0
	RP-30	RP-050793	2707		E-RNTI validity	6.7.0	6.8.0
	RP-30	RP-050793	2708		Clarification of bit strings for EUL	6.7.0	6.8.0
	RP-30	RP-050793	2709	1	Modification of SI periodicity	6.7.0	6.8.0
	RP-30	RP-050793	2710		E-DCH PO signalling	6.7.0	6.8.0
	RP-30	RP-050793	2711	1	MAC es/e reset indicator	6.7.0	6.8.0
	RP-30	RP-050788	2714	1	MBMS corrections on default TFCS, service identity and PL Service Information	6.7.0	6.8.0
	RP-30	RP-050831	2717	1	Corrections of inconsistencies in Rel-6 RRC messages (ASN.1 review)	6.7.0	6.8.0
	RP-30	RP-050861	2718	1	Introduction of Support of Handover to GAN	6.7.0	6.8.0
03/2006	RP-31	RP-060087	2716	5	E-DCH Measurement Event 1J	6.8.0	6.9.0
	RP-31	RP-060083	2720	-	Default configuration 11 for multirate AMR with SRB5	6.8.0	6.9.0
	RP-31	RP-060081	2722	1	Addition of synchronization parameters in RRC for HS-SICH in 1.28Mcps TDD	6.8.0	6.9.0
	RP-31	RP-060091	2723	-	Integrity Protection check for NAS messages	6.8.0	6.9.0
	RP-31	RP-060087	2724	-	E-DCH radio link addition using ASU of RL already in DCH active set	6.8.0	6.9.0
	RP-31	RP-060087	2725	-	Addition of SF128 and SF256 in E-DCH maximum channelisation codes	6.8.0	6.9.0
	RP-31	RP-060087	2726	2	RRC signaling efficiency changes for E-DCH	6.8.0	6.9.0
	RP-31	RP-060087	2727	-	E-DCH HARQ Info signalling	6.8.0	6.9.0
	RP-31	RP-060087	2728	-	Secondary Scrambling Code in F-DPCH RL information	6.8.0	6.9.0
	RP-31	RP-060087	2729	-	Correction to E-DCH IEs	6.8.0	6.9.0
	RP-31	RP-060087	2730	-	Non-scheduled grant	6.8.0	6.9.0
	RP-31	RP-060087	2731	-	IE handling for E-DCH	6.8.0	6.9.0
	RP-31	RP-060087	2732	-	E-RNTI handling in Active Set Update procedure	6.8.0	6.9.0
	RP-31	RP-060087	2733	-	Editorial correction on "E-DCH information"	6.8.0	6.9.0
	RP-31	RP-060120	2734	1	Corrections of inconsistencies in Rel-6 RRC messages (ASN.1 review)	6.8.0	6.9.0
	RP-31	RP-060091	2735	-	Correction to Modifying Integrity Protection Configuration for TM SRB	6.8.0	6.9.0
	RP-31	RP-060091	2736	-	Correction to Security Mode Control Procedure	6.8.0	6.9.0
	RP-31	RP-060091	2737	-	Resolving problems from CR implementation	6.8.0	6.9.0

Change history							
Date	TSG #	TSG Doc.	CR	Re v	Subject/Comment	Old	New
	RP-31	RP-060093	2738	-	Removal of GPRS encryption algorithm info	6.8.0	6.9.0
	RP-31	RP-060092	2739	1	Default configurations for Multi-mode AMR	6.8.0	6.9.0
	RP-31	RP-060091	2740	-	Periodic URA Update in OOS	6.8.0	6.9.0
	RP-31	RP-060091	2741	-	Correction in IE UE positioning capability	6.8.0	6.9.0
	RP-31	RP-060091	2742	-	F-DPCH, HSDPA and E-DCH in HANDOVER TO UTRAN COMMAND (Rel-6 ASN.1 review issue 013)	6.8.0	6.9.0
	RP-31	RP-060091	2743	-	Representation of IE "latestConfiguredCN-Domain" in the r3 branch of SRNS Relocation Info	6.8.0	6.9.0
	RP-31	RP-060083	2746	1	7.95kbps NB AMR Default Configuration removal	6.8.0	6.9.0
	RP-31	RP-060091	2747	-	Periodic BMC Schedule Message	6.8.0	6.9.0
	RP-31	RP-060092	2748	1	Introduction of additional Default configuration identities	6.8.0	6.9.0
	RP-31	RP-060095	2749	1	PS default configurations	6.8.0	6.9.0
	RP-31	RP-060091	2751	-	Configuration of DL TFCS as 'Same as UL'	6.8.0	6.9.0
	RP-31	RP-060091	2752	-	NAS synchronization indicator in RB setup	6.8.0	6.9.0
	RP-31	RP-060088	2753	-	General error handling in case of ASN.1 violation and for MBMS channels	6.8.0	6.9.0
	RP-31	RP-060091	2754	-	Clarification of UE action upon receiving the IE RB information to change list	6.8.0	6.9.0
	RP-31	RP-060091	2755	-	Removal of unnecessary checking for HS-DSCH and E-DCH configuration	6.8.0	6.9.0
	RP-31	RP-060091	2756	-	Introduction of WB-AMR default configuration without SRB#5	6.8.0	6.9.0
	RP-31	RP-060091	2757	-	Initial DPCH frame offset for F-DPCH	6.8.0	6.9.0
	RP-31	RP-060086	2760	1	Support for different E-DCH and HS-DSCH serving cells	6.8.0	6.9.0
	RP-31	RP-060088	2761	-	Correction to S-CCPCH power offset for MBMS	6.8.0	6.9.0
	RP-31	RP-060093	2764	-	Inter-RAT PS Handover capability	6.8.0	6.9.0
	RP-31	RP-060095	2765	-	Indication of HSPA capability and conversation call type for CS	6.8.0	6.9.0
	RP-31	RP-060097	2713	3	Enabling the Providing of Velocity	6.9.0	7.0.0
	RP-31	RP-060096	2758	-	Release 7 HS-DSCH operation without a DL DPCH for 1.28 Mcps TDD – synchronisation and power control of UL DPCH via PLCCCH	6.9.0	7.0.0
	RP-31	RP-060098	2759	-	7.68 Mcps TDD Option (Release 7)	6.9.0	7.0.0
	RP-31	RP-060099	2762	-	Introduction of REL-7 access stratum release indicator	6.9.0	7.0.0
06/2006	RP-32	RP-060374	2769	1	RoHC Segmentation, padding and Packet_sizes_allowed parameter removal	7.0.0	7.1.0
	RP-32	RP-060360	2772	1	Corrections of procedures dealing with "Serving HS-DSCH radio link indicator" and "Serving E-DCH radio link indicator"	7.0.0	7.1.0
	RP-32	RP-060361	2774	1	MAC-HS handling for "return in case of failure"	7.0.0	7.1.0
	RP-32	RP-060383	2776	1	"RB" terminology in security procedures	7.0.0	7.1.0
	RP-32	RP-060368	2778	-	Clarification on IE "MBMS re-acquire MCCH"	7.0.0	7.1.0
	RP-32	RP-060368	2780	-	Clarification on MCCH Acquisition Initiation	7.0.0	7.1.0
	RP-32	RP-060368	2782	-	Clarification of encoding of TB size for FDD common transport channels	7.0.0	7.1.0
	RP-32	RP-060368	2784	-	HCS parameters for MBMS cell reselection	7.0.0	7.1.0
	RP-32	RP-060354	2786	-	Clarification on MAC-e/es reset	7.0.0	7.1.0
	RP-32	RP-060361	2788	-	Modification to the "BLER target" configuration method in RRC spec for 3.84Mcps TDD	7.0.0	7.1.0
	RP-32	RP-060361	2790	-	Add some IEs regarding HS-SICH power control parameter updating in UPLINK PHYSICAL CHANNEL CONTROL message in 1.28Mcps TDD mode	7.0.0	7.1.0
	RP-32	RP-060364	2792	-	Corrections on Inter-RAT cell info indication	7.0.0	7.1.0
	RP-32	RP-060364	2794	-	Clarifications regarding virtual active set	7.0.0	7.1.0
	RP-32	RP-060358	2796	-	PS Handover Capability	7.0.0	7.1.0
	RP-32	RP-060364	2798	-	Handling of System Information Block type 5bis.	7.0.0	7.1.0
	RP-32	RP-060364	2800	-	Introducing container for Measurement Report informaton within SRNS relocation	7.0.0	7.1.0
	RP-32	RP-060364	2802	-	Removal of GSM OTD reference cell	7.0.0	7.1.0
	RP-32	RP-060364	2804	-	Error handling of 'dummy' IEs introduced in ASN.1 by recent feature removal	7.0.0	7.1.0
	RP-32	RP-060365	2806	-	START value in Cell Update	7.0.0	7.1.0
	RP-32	RP-060365	2808	-	Default configurations 10 and 13	7.0.0	7.1.0
	RP-32	RP-060365	2810	-	Inter-frequency measurement reporting on RACH	7.0.0	7.1.0
	RP-32	RP-060365	2812	-	Radio bearer mapping for SRBs	7.0.0	7.1.0

Change history								
Date	TSG #	TSG Doc.	CR	Re v	Subject/Comment	Old	New	
	RP-32	RP-060365	2814	-	Correction to RLC default configuration	7.0.0	7.1.0	
	RP-32	RP-060366	2816	-	New standalone SRB default configuration	7.0.0	7.1.0	
	RP-32	RP-060366	2818	-	Introduction of default configurations with 'flexible TFCS'	7.0.0	7.1.0	
	RP-32	RP-060366	2820	-	Small IE corrections: "RB information to change list", "Access Class Barred"	7.0.0	7.1.0	
	RP-32	RP-060366	2822	-	Correction to IE Default Configuration Identity	7.0.0	7.1.0	
	RP-32	RP-060366	2824	-	Correction to TFC subset for default configurations 11&12	7.0.0	7.1.0	
	RP-32	RP-060366	2826	-	HSDPA/E-DCH info in INTER RAT HANDOVER INFO WITH INTER RAT CAPABILITIES	7.0.0	7.1.0	
	RP-32	RP-060373	2827	1	Adding CS Call Type to Cell Update Message	7.0.0	7.1.0	
	RP-32	RP-060359	2829	-	Correct indication of Rel-7 tabular entries	7.0.0	7.1.0	
	RP-32	RP-060359	2830	-	Corrections to REL-7 ASN.1	7.0.0	7.1.0	
	RP-32	RP-060362	2831	-	Measurement control ASN.1 error	7.0.0	7.1.0	
	RP-32	RP-060368	2833	-	Clarification on MBMS Radio Bearer Release	7.0.0	7.1.0	
	RP-32	RP-060354	2835	-	Correction on E-DCH DL Scrambling Code	7.0.0	7.1.0	
	RP-32	RP-060366	2837	-	Reinstatement of missing IE "Periodical reporting information-1b" in ASN.1	7.0.0	7.1.0	
	RP-32	RP-060366	2839	-	SRB2 suspension	7.0.0	7.1.0	
	RP-32	RP-060369	2842	-	Release 7 Timing Advance (3.84 Mcps and 7.68 Mcps TDD)	7.0.0	7.1.0	
	RP-32	RP-060369	2843	-	Introduction of REL-7 access stratum release indicator	7.0.0	7.1.0	
	RP-32	RP-060369	2844	-	Positioning velocity ASN.1	7.0.0	7.1.0	
	RP-32	RP-060386	2845	1	Correction of positioning confidence reporting inconsistencies	7.0.0	7.1.0	
09/2006	RP-33	RP-060573	2848	-	Removal of CID indication in PDCP PID	7.1.0	7.2.0	
	RP-33	RP-060574	2852	-	Correction to the tabulars for Serving Grant value	7.1.0	7.2.0	
	RP-33	RP-060575	2854	-	Range of the encoding of E-DCH physical layer category and HS-DSCH physical layer category	7.1.0	7.2.0	
	RP-33	RP-060574	2856	-	3-index step 2-index step clarifications	7.1.0	7.2.0	
	RP-33	RP-060597	2858	2	Introduction of SIB 11bis	7.1.0	7.2.0	
	RP-33	RP-060581	2859	-	Power class for UMTS2600 (VII) internal / 900 (VIII)	7.1.0	7.2.0	
	RP-33	RP-060576	2861	-	Corrections to MBMS Downlink Timeslots and Codes for TDD	7.1.0	7.2.0	
	RP-33	RP-060576	2865	-	Clarification on MBMS notification for UEs in CELL_DCH state	7.1.0	7.2.0	
	RP-33	RP-060576	2867	-	Clarification on MBMS p-t-m activation time IE	7.1.0	7.2.0	
	RP-33	RP-060576	2869	-	Access probability factor	7.1.0	7.2.0	
	RP-33	RP-060575	2871	-	Modification to the HS-SCCH set configuration method in RRC spec for 1.28Mcps TDD	7.1.0	7.2.0	
	RP-33	RP-060575	2873	-	Correction to tabular for IE "Delay restriction Flag"	7.1.0	7.2.0	
	RP-33	RP-060575	2877	-	Correction on 3G-2G Handover	7.1.0	7.2.0	
	RP-33	RP-060575	2879	-	Pending security configuration for SRB2	7.1.0	7.2.0	
	RP-33	RP-060593	2881	-	UE radio access capability for Single-band UE	7.1.0	7.2.0	
	RP-33	RP-060593	2883	-	Inter-RAT handover to UTRAN (HSPA)	7.1.0	7.2.0	
	RP-33	RP-060593	2885	-	Tabular & reference corrections	7.1.0	7.2.0	
	RP-33	RP-060593	2887	-	F-DPCH Tx Diversity	7.1.0	7.2.0	
	RP-33	RP-060593	2889	1	Expiration of RRC timer T314/T315 associated to CS/PS RABs	7.1.0	7.2.0	
	RP-33	RP-060583	2892	-	Clarification on Exceeding Variance in Traffic Volume Measurement	7.1.0	7.2.0	
	RP-33	RP-060573	2897	1	Use of CM_PATTERN_ACTIVATION_ABORTED	7.1.0	7.2.0	
	RP-33	RP-060573	2900	1	Corrections of procedures dealing with Hard Handover	7.1.0	7.2.0	
	RP-33	RP-060585	2901	-	Correction to spreading factors used for 7.68 Mcps TDD PRACH	7.1.0	7.2.0	
	RP-33	RP-060583	2902	-	Corrections to ASN.1 (3.84 Mcps and 7.68 Mcps TDD)	7.1.0	7.2.0	
	RP-33	RP-060586	2903	-	Introduction of 3.84 Mcps and 7.68 Mcps TDD E-DCH	7.1.0	7.2.0	
	RP-33	RP-060582	2904	-	Support of 2570 – 2620 MHz band for TDD	7.1.0	7.2.0	
	RP-33	RP-060593	2907	-	ASN1 correction on Inter-frequency RACH measurement reporting, backward compatible solution	7.1.0	7.2.0	
	RP-33	RP-060584	2908	-	CS Call type indication in CELL_FACH	7.1.0	7.2.0	
	RP-33	RP-060584	2910	1	UE behaviour in RRC Connection Re-establishment scenarios	7.1.0	7.2.0	
	RP-33	RP-060624	2911	2	Enhancing MBMS support for Mobile TV	7.1.0	7.2.0	
	RP-33	RP-060574	2913	-	E-DCH gain factor computation	7.1.0	7.2.0	
	RP-33	RP-060593	2915	-	Correction to default configuration #22	7.1.0	7.2.0	
	RP-33	RP-060622	2917	-	Correction to coding of PLCCH for 1.28Mcps TDD	7.1.0	7.2.0	
	RP-33	RP-060578	2919	-	MAC-hs reset	7.1.0	7.2.0	
12/2006	RP-34	RP-060722	2916	2	UE based OTDOA positioning in WCDMA cells with extended range	7.2.0	7.3.0	

Change history							
Date	TSG #	TSG Doc.	CR	Rev	Subject/Comment	Old	New
	RP-34	RP-060717	2922	1	Correction on acceptable configurations for compression entities	7.2.0	7.3.0
	RP-34	RP-060715	2923	-	Introduction of Band X (Extended UMTS 1.7/2.1 GHz) in 25.331	7.2.0	7.3.0
	RP-34	RP-060716	2925	-	Grant and MAC-e/es headers for E-DCH and References	7.2.0	7.3.0
	RP-34	RP-060804	2927	2	Correction to E-DCH reconfiguration	7.2.0	7.3.0
	RP-34	RP-060718	2931	-	Removal of MSCH configuration information from S-CCPCH system information	7.2.0	7.3.0
	RP-34	RP-060718	2933	-	Correction relating to the formation of a list of services	7.2.0	7.3.0
	RP-34	RP-060718	2935	-	Indentation error in handling MBMS establishment cause values	7.2.0	7.3.0
	RP-34	RP-060718	2936	-	MSCH configuration information	7.2.0	7.3.0
	RP-34	RP-060719	2938	-	Tabular/ASN.1 mismatch for IE "UE radio access capability comp 2"	7.2.0	7.3.0
	RP-34	RP-060716	2940	-	Correction to Radio Bearer Mapping for UE in CELL_DCH state	7.2.0	7.3.0
	RP-34	RP-060726	2941	1	State transition diagram from URA_PCH/Cell_PCH to idle	7.2.0	7.3.0
	RP-34	RP-060719	2943	-	Usage of Band Indicator in Inter-RAT cell info list	7.2.0	7.3.0
	RP-34	RP-060716	2945	-	Correction for support of HS-DSCH in RRC Connection Setup	7.2.0	7.3.0
	RP-34	RP-060720	2947	-	Corrections related to 3.84 and 7.68 Mcps TDD E-DCH and the support of TDD at 2.6 GHz	7.2.0	7.3.0
	RP-34	RP-060712	2948	1	Introduction of the UE speed information at the CELL_DCH transition	7.2.0	7.3.0
	RP-34	RP-060713	2949	2	Introduction of the new security algorithms UEA2 and UIA2.	7.2.0	7.3.0
	RP-34	RP-060718	2951	-	RAB ID for mobile TV	7.2.0	7.3.0
	RP-34	RP-060718	2953	-	MBMS PL Service Restriction Information and preferred frequency layer	7.2.0	7.3.0
	RP-34	RP-060724	2954	2	Introduction of inter-RAT DTM Handover	7.2.0	7.3.0
	RP-34	RP-060718	2956	-	MBMS short transmission ID and Mobile TV	7.2.0	7.3.0
03/2007	RP-35	RP-070159	2957	2	Deferred SIB11/12 reading and acting	7.3.0	7.4.0
	RP-35	RP-070159	2958	-	UE Positioning Fine Time Assistance for GPS	7.3.0	7.4.0
	RP-35	RP-070159	2959	-	Correction of "Threshold SFN-GPS TOW"	7.3.0	7.4.0
	RP-35	RP-070159	2960	1	Correction to standalone UE positioning	7.3.0	7.4.0
	RP-35	RP-070159	2961	-	Clarification on introduction of the new security algorithms	7.3.0	7.4.0
	RP-35	RP-070159	2962	-	Change to area scope of SIB1 value tag	7.3.0	7.4.0
	RP-35	RP-070159	2963	-	Correction of the tabular description of the IE Downlink information for each radio link Post	7.3.0	7.4.0
	RP-35	RP-070159	2964	-	Removal of redundant ASN1 element DL-CCTrChTPCList	7.3.0	7.4.0
	RP-35	RP-070151	2966	-	Correction of MBMS MODIFICATION REQUEST	7.3.0	7.4.0
	RP-35	RP-070151	2968	-	Wording of MBMS PL Service Restriction Information and preferred frequency layer	7.3.0	7.4.0
	RP-35	RP-070151	2970	-	maxMBMS-Services definition	7.3.0	7.4.0
	RP-35	RP-070151	2972	1	MBMS selected services indication	7.3.0	7.4.0
	RP-35	RP-070151	2973	1	Correction of RAB release procedure for Mobile TV	7.3.0	7.4.0
	RP-35	RP-070153	2975	-	Tabular Alignment for Uplink DPCH Info	7.3.0	7.4.0
	RP-35	RP-070151	2977	1	Update the IE" RAB information to reconfigure" for Mobile TV	7.3.0	7.4.0
	RP-35	RP-070154	2979	-	Absence of MS Classmark 2 and 3 in IE "Inter-RAT UE radio access capability"	7.3.0	7.4.0
	RP-35	RP-070153	2981	-	Handling of TFCS with no DCH configured	7.3.0	7.4.0
	RP-35	RP-070163	2983	1	Introducing 64QAM downlink support	7.3.0	7.4.0
	RP-35	RP-070157	2984	-	Introduction of 1.28 Mcps TDD E-DCH	7.3.0	7.4.0
	RP-35	RP-070161	2985	1	Introducing MIMO in RRC specification	7.3.0	7.4.0
	RP-35	RP-070172	2986	-	Alignment of Tabular with ASN.1	7.3.0	7.4.0
	RP-35	RP-070160	2987	-	Corrections to Tabular for 3.84 and 7.68 McpsTDD E-DCH	7.3.0	7.4.0
	RP-35	RP-070151	2989	1	MICH reception for services scheduled with MSCH	7.3.0	7.4.0
	RP-35	RP-070158	2990	-	Introduction of DTX-DRX and HS-SCCH less in RRC	7.3.0	7.4.0
06/2007	RP-36	RP-070402	2982	6	Introducing 16QAM uplink support	7.4.0	7.5.0
	RP-36	RP-070407	2992	-	Use of Integrity protection algorithm UIA/2: removal of a 'shall' in a note	7.4.0	7.5.0
	RP-36	RP-070407	2993	-	RRC Cellid encoding alignment on RANAP	7.4.0	7.5.0
	RP-36	RP-070407	2994	-	Signalling connection release at T314/315 expiry	7.4.0	7.5.0
	RP-36	RP-070408	2995	-	Cell Update Confirm with RLC re-establish indicator	7.4.0	7.5.0
	RP-36	RP-070408	2996	-	Correction of STTD Indicator for F-DPCH Tx Diversity	7.4.0	7.5.0
	RP-36	RP-070395	2997	-	Introduction of GAN PS handover	7.4.0	7.5.0
	RP-36	RP-070408	2998	-	Feature Clean Up leftover: Removal of DRAC leftover	7.4.0	7.5.0
	RP-36	RP-070408	2999	-	Initialisation of CFN calculation for CELL_FACH	7.4.0	7.5.0

Change history								
Date	TSG #	TSG Doc.	CR	Rev	Subject/Comment	Old	New	
	RP-36	RP-070408	3000		PLMN selection ping-pong control	7.4.0	7.5.0	
	RP-36	RP-070408	3001		Optimization of switching between MBMS broadcast TV channels transmitted on ptp bearers (MBMS for Mobile TV)	7.4.0	7.5.0	
	RP-36	RP-070408	3002		Alignment of tabular to ASN.1 for SIB11/SIB12 and event 1J	7.4.0	7.5.0	
	RP-36	RP-070403	3003	2	Introduction of HS-DSCH reception in CELL_FACH, URA_PCH and CELL_PCH	7.4.0	7.5.0	
	RP-36	RP-070408	3004	1	Introduction two DRX schemes in URA_PCH and CELL_PCH	7.4.0	7.5.0	
	RP-36	RP-070416	3008		Maintenance of PMM connection for MBMS PTP reception	7.4.0	7.5.0	
	RP-36	RP-070401	3010		Content of MSI message when sent on DCCH	7.4.0	7.5.0	
	RP-36	RP-070401	3012		Relative ordering of MBMS Selected Services when indicated to the network	7.4.0	7.5.0	
	RP-36	RP-070416	3013		Background scan during MBMS PTM reception	7.4.0	7.5.0	
	RP-36	RP-070401	3015		Default MBMS activation time and 'MBMS all unmodified p-t-m services'	7.4.0	7.5.0	
	RP-36	RP-070401	3017		Problem with the IE 'MBMS service identity' included in the IE 'RAB info'	7.4.0	7.5.0	
	RP-36	RP-070406	3019		Correction of SRB delay	7.4.0	7.5.0	
	RP-36	RP-070406	3021		Incorrect reference to 25.993 for default configuration 17	7.4.0	7.5.0	
	RP-36	RP-070416	3022		Removal of redundant IE 'MBMS-PreferredFreqRequest-r6'	7.4.0	7.5.0	
	RP-36	RP-070406	3024		Correction to CTFC for default configuration 12	7.4.0	7.5.0	
	RP-36	RP-070404	3025	1	Introduction of Improved L2 support for high data rates	7.4.0	7.5.0	
	RP-36	RP-070400	3026		MBMS TDD and FDD Physical Layer Improvements	7.4.0	7.5.0	
	RP-36	RP-070408	3027		Introduction of Wait time to Cell Update Confirm	7.4.0	7.5.0	
	RP-36	RP-070415	3028		Removing the limitation of SRNC identity size	7.4.0	7.5.0	
	RP-36	RP-070408	3029		Using special value of HE field to indicate end of an SDU for RLC AM	7.4.0	7.5.0	
	RP-36	RP-070408	3030	1	T305 timer in RRC container at SRNS relocation	7.4.0	7.5.0	
	RP-36	RP-070408	3031		Support for signalling of F-DPCH slot formats	7.4.0	7.5.0	
	RP-36	RP-070398	3032	1	A-GNSS in UTRAN (RRC)	7.4.0	7.5.0	
	RP-36	RP-070397	3034		Addition of E-DCH Scheduling Information Power Offset in TDD mode	7.4.0	7.5.0	
	RP-36	RP-070397	3035	1	Corrections to tabular for non-scheduled transmission for LCR TDD	7.4.0	7.5.0	
	RP-36	RP-070397	3036		Introduction of PRACH configuration in messages triggering E-DCH serving cell change in LCR TDD mode	7.4.0	7.5.0	
	RP-36	RP-070417	3037		Correction to definition of maxNumE-AGCH for TDD	7.4.0	7.5.0	
	RP-36	RP-070394	3038		Correction to definition of Power Resource Related Information (TDD only)	7.4.0	7.5.0	
	RP-36	RP-070401	3039		MBMS Scheduling Information	7.4.0	7.5.0	
	RP-36	RP-070401	3040		MBMS Notification	7.4.0	7.5.0	
	RP-36	RP-070401	3041		Minor correction on text	7.4.0	7.5.0	
	RP-36	RP-070504	3043	2	Indication for F-DPCH support status	7.4.0	7.5.0	
09/2007	RP-37	RP-070623	3047	1	Correction to E-DCH STTD operation	7.5.0	7.6.0	
	RP-37	RP-070625	3048	1	Requirement on MICH reading	7.5.0	7.6.0	
	RP-37	RP-070624	3050		START values in cell update before security is enabled	7.5.0	7.6.0	
	RP-37	RP-070671	3053	1	Clarification on Enhanced CELL_FACH State	7.5.0	7.6.0	
	RP-37	RP-070671	3054		Correction of UTRAN MOBILITY INFORMATION extension	7.5.0	7.6.0	
	RP-37	RP-070626	3055	1	Lossless reconfiguration between fixed and flexible RLC PDU size	7.5.0	7.6.0	
	RP-37	RP-070630	3056		Restriction on the number of MIMO processes	7.5.0	7.6.0	
	RP-37	RP-070670	3057		Correction on 16 QAM Category	7.5.0	7.6.0	
	RP-37	RP-070632	3058	1	Correction to MBSFN TDM	7.5.0	7.6.0	
	RP-37	RP-070631	3059		Corrections to Tabular (alignment with ASN.1)	7.5.0	7.6.0	
	RP-37	RP-070631	3060		CR implementation issues 25.331 v7.4.0 (2007-03)	7.5.0	7.6.0	
	RP-37	RP-070636	3061		Incomplete exception description in UE-based OTDOA	7.5.0	7.6.0	
	RP-37	RP-070636	3062		Correction of inconsistency in 25.331 related to UE-sending of capabilities	7.5.0	7.6.0	
	RP-37	RP-070625	3064	1	MBMS Counting completion in RRC	7.5.0	7.6.0	
	RP-37	RP-070625	3066	1	MBMS ptp service change	7.5.0	7.6.0	
	RP-37	RP-070623	3068	1	Clarification on logical channel multiplexing	7.5.0	7.6.0	
	RP-37	RP-070625	3072		Integrity Protection and MBMS: Correction to Procedural Text (alignment with ASN.1)	7.5.0	7.6.0	
	RP-37	RP-070625	3074		MBMS services naming	7.5.0	7.6.0	

Change history								
Date	TSG #	TSG Doc.	CR	Re v	Subject/Comment	Old	New	
	RP-37	RP-070671	3077		Removal of RRC padding on BCCH and PCCH carried on HS-DSCH	7.5.0	7.6.0	
	RP-37	RP-070671	3078		Periodic MAC-ehs reset	7.5.0	7.6.0	
	RP-37	RP-070671	3079		Correction to UE behavior to disable HS-DSCH operation when HS-DSCH reception is unavailable	7.5.0	7.6.0	
	RP-37	RP-070671	3080		Cell reselection issues during RRC connection establishment procedure	7.5.0	7.6.0	
	RP-37	RP-070671	3081		Additional cases of MAC-ehs reset for UEs operating in Enhanced CELL_FACH	7.5.0	7.6.0	
	RP-37	RP-070634	3082	2	UE Capabilities for Rel-7, with 'improved L2' optional	7.5.0	7.6.0	
	RP-37	RP-070627	3083		Correction to CPC UL DTX for addition of a new cell in the active set.	7.5.0	7.6.0	
	RP-37	RP-070627	3084	1	Handling of DPCH Slot Format 4	7.5.0	7.6.0	
	RP-37	RP-070627	3085		Correction to the related IEs of DTX-DRX operation in RRC	7.5.0	7.6.0	
	RP-37	RP-070627	3086	1	Restriction of HS-SCCH less operation and MIMO	7.5.0	7.6.0	
	RP-37	RP-070627	3087	1	HS-SCCH less virtual IR buffer size	7.5.0	7.6.0	
	RP-37	RP-070629	3088		Timing Advance Corrections for 3.84/7.68 Mcps TDD E-DCH	7.5.0	7.6.0	
	RP-37	RP-070631	3089		3.84/7.68 Mcps TDD EDCH Sending Scheduling Information Periodically	7.5.0	7.6.0	
	RP-37	RP-070670	3090		Correction on 64QAM and MIMO UE capability in RRC	7.5.0	7.6.0	
	RP-37	RP-070670	3092	1	Starting and stopping operation in 16QAM mode	7.5.0	7.6.0	
	RP-37	RP-070623	3093		The range of E-TFCI _{ed,switch}	7.5.0	7.6.0	
	RP-37	RP-070650	3094		Introduction of multi-frequency operation for LCR TDD	7.5.0	7.6.0	
	RP-37	RP-070624	3096		F-DPCH TPC error rate target	7.5.0	7.6.0	
	RP-37	RP-070624	3098		Correction to CTFC for default configuration 14	7.5.0	7.6.0	
	RP-37	RP-070624	3100		Correction to default configuration 16	7.5.0	7.6.0	
	RP-37	RP-070624	3102		Security correction on PS handover to UTRAN	7.5.0	7.6.0	
	RP-37	RP-070626	3103		IE Common RB mapping info	7.5.0	7.6.0	
	RP-37	RP-070626	3104		Common-MAC-ehs-ReorderingQueues	7.5.0	7.6.0	
	RP-37	RP-070627	3105	2	Correction to CPC Parameters	7.5.0	7.6.0	
	RP-37	RP-070632	3107		Change Request for 25.331 ASN.1 for MBMS TDD and FDD Physical Layer Improvements	7.5.0	7.6.0	
	RP-37	RP-070628	3108		Update of GANSS elements improving GANSS ambiguity resolution	7.5.0	7.6.0	
	RP-37	RP-070636	3109		Corrections to DRX schemes in URA_PCH and CELL_PCH	7.5.0	7.6.0	
	RP-37	RP-070636	3112		Clarification on reconfiguration of T305	7.5.0	7.6.0	
	RP-37	RP-070628	3113		Introduction of SIB type extension for SIB type 15.8	7.5.0	7.6.0	
	RP-37	RP-070636	3114		Correction for configuration of RFC2507 header compression	7.5.0	7.6.0	
	RP-37	RP-070636	3115		Correction for CS call type	7.5.0	7.6.0	
	RP-37	RP-070636	3116		Add the frequency info for to identify the neighbour cells when report the OTDOA measurement results	7.5.0	7.6.0	
	RP-37	RP-070624	3120		Corrections in the default radio configurations 11/12/13	7.5.0	7.6.0	
	RP-37	RP-070624	3122		Miscellaneous corrections in the default radio configurations	7.5.0	7.6.0	
12/2007	RP-38	RP-071011	3125	2	UE setting for the "Extension indicator" in the frequency band IEs	7.6.0	7.7.0	
	RP-38	RP-070898	3132	-	Correction to Measurement Report Initiation Procedure with UEs in CELL_PCH	7.6.0	7.7.0	
	RP-38	RP-070899	3134	-	START value and reconfiguration from fixed to flexible	7.6.0	7.7.0	
	RP-38	RP-070900	3136	-	UE DTX capability in RRC Connection Request	7.6.0	7.7.0	
	RP-38	RP-070903	3140	1	Introduction of an additional UE category for 1.28Mcps TDD E-DCH	7.6.0	7.7.0	
	RP-38	RP-070905	3142	2	UE Waiting during Cell Update Procedure	7.6.0	7.7.0	
	RP-38	RP-070905	3144	1	Correction for radio bearer mapping for FDD	7.6.0	7.7.0	
	RP-38	RP-070903	3146	-	Add E-RUCCH SYNC-UL info for handover procedure for LCR TDD	7.6.0	7.7.0	
	RP-38	RP-070895	3150	-	Correction on MMSI reception on DCCH	7.6.0	7.7.0	
	RP-38	RP-070894	3153	2	RADIO BEARER SETUP using default configurations	7.6.0	7.7.0	
	RP-38	RP-070895	3156	-	Correction of integrity protection and checking of MBMS MODIFIED SERVICES INFORMATION message on DCCH	7.6.0	7.7.0	
	RP-38	RP-070892	3161	-	Use of default configuration 12	7.6.0	7.7.0	
	RP-38	RP-070903	3163	-	A Correction about SNPL for 1.28 Mcps TDD	7.6.0	7.7.0	
	RP-38	RP-070903	3165	-	Support of SRB transmission on HSPA for 1.28Mcps TDD	7.6.0	7.7.0	
	RP-38	RP-070902	3168	-	More improvement on Dedicated frequency for 1.28 Mcps TDD MBMS	7.6.0	7.7.0	

Change history							
Date	TSG #	TSG Doc.	CR	Rev	Subject/Comment	Old	New
	RP-38	RP-070903	3170	-	Clarification of gain factor Beta-e in LCR TDD EUL	7.6.0	7.7.0
	RP-38	RP-070898	3172	2	lur backward compatibility problem	7.6.0	7.7.0
	RP-38	RP-070898	3174	-	BCCH reception on HS-DSCH for CELL_PCH UE	7.6.0	7.7.0
	RP-38	RP-070898	3176	-	Cell_PCH UE behaviour upon reception of activation time in reconfiguration message	7.6.0	7.7.0
	RP-38	RP-070899	3178	-	CQI Table usage	7.6.0	7.7.0
	RP-38	RP-070938	3180	-	Scheduled Grant setting in DTX Cycle 2 during CPC operation	7.6.0	7.7.0
	RP-38	RP-070894	3183	-	Wrong UL Puncturing Limits for default configurations #15, #18, #19, #20 and #21	7.6.0	7.7.0
	RP-38	RP-070906	3185	1	Change of UE capability during an RRC connection	7.6.0	7.7.0
	RP-38	RP-070901	3187	-	Correction to HS-SCCH numbering assumption for 64QAM encoding	7.6.0	7.7.0
	RP-38	RP-070905	3189	-	Clarification that "Default DPCH offset value" is required for FACH->DCH reconfiguration	7.6.0	7.7.0
	RP-38	RP-070895	3191	-	Error in Rel-7 shadow CR concerning MBMS preferred frequency information	7.6.0	7.7.0
	RP-38	RP-070905	3195	-	Correction to Control Information transmission with two logical channels	7.6.0	7.7.0
	RP-38	RP-070905	3197	-	Some editorial corrections on Multi-carriers for LCR TDD	7.6.0	7.7.0
	RP-38	RP-070895	3200	-	Procedure text concerning MBMS offsets and tabular/ASN.1 description are not aligned	7.6.0	7.7.0
	RP-38	RP-070905	3202	1	MBMS Common Physical Channels limitation	7.6.0	7.7.0
	RP-38	RP-070895	3205	1	Correction on MBMS Frequency Layer Dispersion (FLD)	7.6.0	7.7.0
	RP-38	RP-070897	3207	1	Replacement of the almanac Sat Mask by SV ID	7.6.0	7.7.0
	RP-38	RP-070911	3209	-	Clarification on E-DPDCH power extrapolation/interpolation	7.6.0	7.7.0
	RP-38	RP-070895	3211	-	BCCH / MCCH consistency for MBMS reception	7.6.0	7.7.0
	RP-38	RP-070910	3213	-	Introduction of CS voice over HSPA	7.6.0	7.7.0
	RP-38	RP-070905	3216	-	Disable reselection to the original RAT when UE receives RRC CONNECTION REJECT	7.6.0	7.7.0
	RP-38	RP-070904	3218	-	Corrections due to the ASN.1 R7 review (main CR)	7.6.0	7.7.0
	RP-38	RP-070904	3220	-	Signalling of Rel-7 UE capabilities (ASN.1 R7 review)	7.6.0	7.7.0
	RP-38	RP-070912	3222	-	Augmentation of GANSS Signal ID field	7.6.0	7.7.0
	RP-38	RP-070905	3224	-	Delta T2TP Parameter	7.6.0	7.7.0

Change history								
Date	TSG #	TSG Doc.	CR	Re v	Subject/Comment	Old	New	
03/2008	RP-39	RP-080178	3230	-	Clarification on MAX_CID	7.7.0	7.8.0	
	RP-39	RP-080189	3232	-	FACH measurement occasion Calculation	7.7.0	7.8.0	
	RP-39	RP-080189	3234	-	Clarification on "Default DPCH offset value"	7.7.0	7.8.0	
	RP-39	RP-080189	3236	-	Synchronised modification of system information blocks	7.7.0	7.8.0	
	RP-39	RP-080189	3238	-	Clarification on "Measured Results on RACH" in enhanced CELL_FACH	7.7.0	7.8.0	
	RP-39	RP-080186	3240	-	Correction to conditions for setting MIMO_STATUS variable	7.7.0	7.8.0	
	RP-39	RP-080188	3242	-	Correction to HS-SCCH numbering assumption for 64QAM encoding	7.7.0	7.8.0	
	RP-39	RP-080181	3244	-	Use of cell selection and reslection info in the case that a cell is providing MBSFN only service	7.7.0	7.8.0	
	RP-39	RP-080191	3246	-	Corrections due to the RRC Rel-7 ASN.1 review	7.7.0	7.8.0	
	RP-39	RP-080177	3249	-	L2-combining in MBMS CURRENT CELL P-T-M RB INFORMATION message	7.7.0	7.8.0	
	RP-39	RP-080189	3252	-	Traffic volum measurement for CELL_PCH UE	7.7.0	7.8.0	
	RP-39	RP-080190	3254	-	Support of octet aligned HS-DSCH transport block sizes for non-64QAM	7.7.0	7.8.0	
	RP-39	RP-080186	3256	1	Correction to MIMO with the message PHYSICAL CHANNEL RECONFIGURATION	7.7.0	7.8.0	
	RP-39	RP-080182	3258	-	Supporting multi-frequency for 1.28 Mcps TDD MBMS	7.7.0	7.8.0	
	RP-39	RP-080185	3260	-	Modification of variable E_DCH_TRANSMISSION setting	7.7.0	7.8.0	
	RP-39	RP-080185	3262	-	Correction and Clarification of non-scheduled E-PUCH allocation for LCR TDD	7.7.0	7.8.0	
	RP-39	RP-080185	3264	-	Modifications on the values of T-RUCCH timer for LCR TDD	7.7.0	7.8.0	
	RP-39	RP-080184	3266	-	Persistence scaling values for 3.84/7.68 Mcps TDD E-DCH	7.7.0	7.8.0	
	RP-39	RP-080178	3269	-	Correction to default configuration 17	7.7.0	7.8.0	
05/2008	RP-40	RP-080390	3281	1	Interpretation of the "Neighbouring cell identity" in MBMS NEIGHBOURING CELL PTM RB INFO	7.8.0	7.9.0	
	RP-40	RP-080390	3284	-	Clarification on MBMS dispersion	7.8.0	7.9.0	
	RP-40	RP-080403	3286	-	Minor ASN.1 corrections due errors detected during v780 implementation	7.8.0	7.9.0	
	RP-40	RP-080396	3290	-	Correction on the attribute of Treset in system information	7.8.0	7.9.0	
	RP-40	RP-080396	3292	-	Editorial correction to reconfigure MAC-ehs reordering queue	7.8.0	7.9.0	
	RP-40	RP-080403	3294	-	Editorial correction to variable description of CELL_INFO_LIST	7.8.0	7.9.0	
	RP-40	RP-080393	3297	-	Correction to the calcuration of DPCH frame offset for F-DPCH on timing re-initialised hard handover	7.8.0	7.9.0	
	RP-40	RP-080403	3299	-	Handling of TRANSPORT FORMAT COMBINATION CONTROL	7.8.0	7.9.0	
	RP-40	RP-080404	3301	-	Completion of the mechanism for Scheduling Information transmission on MAC-e PDU alone for 1.28 Mcps TDD in EUL	7.8.0	7.9.0	
	RP-40	RP-080443	3303	1	Counter and timers for Scheduling Information Reporting of LCR TDD	7.8.0	7.9.0	
	RP-40	RP-080398	3305	-	Clarification of the definition of PRRI for TDD	7.8.0	7.9.0	
	RP-40	RP-080400	3307	1	Correction and Clarification of E-RUCCH Info for LCR TDD	7.8.0	7.9.0	
	RP-40	RP-080395	3311	-	Re-establishment condition for RLC reconfiguration to fixed from flexible PDU size	7.8.0	7.9.0	
	RP-40	RP-080402	3314	-	MBSFN Corrections	7.8.0	7.9.0	
	RP-40	RP-080403	3318	-	Correction of missing Rel-7 VLEC in the Radio Bearer Reconfiguration message	7.8.0	7.9.0	
	RP-40	RP-080396	3320	-	RRC connection release for Cell_PCH	7.8.0	7.9.0	
	RP-40	RP-080396	3323	-	Correction of CELL_PCH in Reconfiguration Procedure	7.8.0	7.9.0	
	RP-40	RP-080401	3328	-	Extended power control gap for E-PUCH in LCR TDD	7.8.0	7.9.0	
	RP-40	RP-080300	3331	-	GANSS corrections	7.8.0	7.9.0	
	RP-40	RP-080403	3333	-	Various ASN.1 corrections	7.8.0	7.9.0	
	RP-40	RP-080403	3334	-	Uncorrect way to delete MAC-ehs re-ordering queue	7.8.0	7.9.0	
	RP-40	RP-080442	3339	-	Correction to note on reference E-TFCI configuration	7.8.0	7.9.0	
	RP-40	RP-080394	3341	-	Correction to relation between DTX-DRX timing and DTX-DRX configuration	7.8.0	7.9.0	
	RP-40	RP-080400	3343	1	Clarification on Number of E-UCCH for LCR TDD	7.8.0	7.9.0	
	RP-40	RP-080400	3345	1	Presence clarification of E-HICH Information per radio link for TDD	7.8.0	7.9.0	
	RP-40	RP-080400	3347	-	Correction on the non-scheduled E-PUCH configuration	7.8.0	7.9.0	
	RP-40	RP-080394	3351	-	Correction to signaling of Uplink DPCCCH slot format information	7.8.0	7.9.0	
	RP-40	RP-080442	3354	1	Indication for E-DPCCH Power Boosting support status	7.8.0	7.9.0	

Change history							
Date	TSG #	TSG Doc.	CR	Rev	Subject/Comment	Old	New
08/2008	-	-	-	-	Fix Word problem	7.9.0	7.9.1
09/2008	RP-41	RP-080681	3357	-	Correct the description of UE behaviour during HS-DSCH Reception in CELL_PCH and URA_PCH	7.9.1	7.10.0
	RP-41	RP-080679	3359	-	Correction on the non-scheduled E-PUCH configuration for 1.28Mcps TDD	7.9.1	7.10.0
	RP-41	RP-080680	3361	2	MBSFN Corrections	7.9.1	7.10.0
	RP-41	RP-080681	3364	-	Deletion of Duplicate Definition of CELL_FACH HS-DSCH Variables	7.9.1	7.10.0
	RP-41	RP-080684	3366	-	Modification of GANSS timing representation to avoid large integers	7.9.1	7.10.0
	RP-41	RP-080678	3375	-	Clarification of the UE behavior on DSAC	7.9.1	7.10.0
	RP-41	RP-080685	3385	2	Reconfiguration of inactive RABs to DCH	7.9.1	7.10.0
	RP-41	RP-080682	3388	-	Correction to MIMO parameters	7.9.1	7.10.0
	RP-41	RP-080679	3390	-	Persistence value (Pi) completion for E-RUCCH in LCR TDD	7.9.1	7.10.0
	RP-41	RP-080679	3394	-	Introduce E-DCH Traffic volume measurement for LCR TDD	7.9.1	7.10.0
	RP-41	RP-080685	3396	-	Introduce QrxlevminOffset in 25.331 for TDD	7.9.1	7.10.0
	RP-41	RP-080679	3399	1	Correction of E-RUCCH configuration for LCR TDD EUL	7.9.1	7.10.0
12/2008	RP-42	RP-080999	3418	-	Typo in IE 'Domain Specific Access Restriction'	7.10.0	7.11.0
	RP-42	RP-081005	3420	-	Misplaced IEs in RADIO BEARER RECONFIGURATION	7.10.0	7.11.0
	RP-42	RP-081004	3423	1	Resetting the periodic cell update timer T305 after autonomous state transition to CELL_FACH in Enhanced CELL_FACH	7.10.0	7.11.0
	RP-42	RP-081003	3429	1	Clarification to the scope of Uplink DPCH slot format 4 feature	7.10.0	7.11.0
	RP-42	RP-081007	3431	-	Introduce Intra-Secondary Frequency Indicator for LCR TDD	7.10.0	7.11.0
	RP-42	RP-081004	3434	2	correct the description of UE behaviour during HS-DSCH Reception in CELL_PCH	7.10.0	7.11.0
	RP-42	RP-081003	3437	-	Modification of the conditions for disabling HS-SCCH less operation	7.10.0	7.11.0
	RP-42	RP-081005	3443	-	Corrections related to the cell update wait timer T320	7.10.0	7.11.0
	RP-42	RP-081000	3465	1	MBMS frequency selection	7.10.0	7.11.0
	RP-42	RP-081003	3467	-	Correction to DRX and CQI reporting	7.10.0	7.11.0
	RP-42	RP-081003	3477	-	Clarification to the use of 'F-DPCH slot format' IE	7.10.0	7.11.0
	RP-42	RP-081005	3488	-	Correction to IDT procedure	7.10.0	7.11.0
	RP-42	RP-081006	3491	-	Clarification for 16QAM UL E-AGCH table mapping	7.10.0	7.11.0
	RP-42	RP-080998	3498	-	Correction of measurement event 1l	7.10.0	7.11.0
	RP-42	RP-081007	3500	-	Clarification of Persistence Value (Pi) for E-RUCCH in LCR TDD	7.10.0	7.11.0
	RP-42	RP-081005	3508	-	Correction to "DL RLC PDU size" explicit configuration to prevent security issue	7.10.0	7.11.0
	RP-42	RP-081003	3510	-	Clarification to the use of 'DTX-DRX timing information' for hard handover	7.10.0	7.11.0
	RP-42	RP-081005	3513	1	Correction of measurement event 1H	7.10.0	7.11.0
	RP-42	RP-081005	3517	-	Support of Enhanced F-DPCH in RRC CONNECTION REQUEST	7.10.0	7.11.0
02/2009	RP-43	RP-090115	3534	1	UMTS frequency information in IE "Rplmn information"	7.11.0	7.12.0
	RP-43	RP-090115	3537	-	CN system information after PS HO	7.11.0	7.12.0
	RP-43	RP-090119	3539	-	Correction to the UE behaviour when entering URA_PCH state	7.11.0	7.12.0
	RP-43	RP-090117	3541	1	Condition to set the 'Security capability indication' flag	7.11.0	7.12.0
	RP-43	RP-090117	3543	2	Ciphering for intra-UTRAN Radio Bearer Setup - Rel 7	7.11.0	7.12.0
	RP-43	RP-090118	3568	-	Clarification of scope of signaled transport block sizes for HS-SCCH less operation	7.11.0	7.12.0
	RP-43	RP-090117	3574	-	25.331 Rel 7 CR UE restrictions on E-TFCl	7.11.0	7.12.0
	RP-43	RP-090115	3579	-	Correction to handling of CELL_INFO_LIST when 'Inter-frequency cell info list' is received in System Information Block Type 11bis	7.11.0	7.12.0
	RP-43	RP-090115	3582	-	Corrections for PS handover to UTRAN	7.11.0	7.12.0
	RP-43	RP-090121	3584	1	Correction to RRC handling of AG and SG tables when 16QAM UL is configured	7.11.0	7.12.0
	RP-43	RP-090118	3586	1	Correction to handling of DTX-DRX information	7.11.0	7.12.0
	RP-43	RP-090122	3616	1	Clarification of 64QAM TB Table applicability	7.11.0	7.12.0
	RP-43	RP-090117	3621	-	Adding the MBMS PTM RB release cause in the MCCH message when releasing the MBMS service for 1.28Mcps TDD	7.11.0	7.12.0
04/2009	-	-	-	-	Problem of delay in opening the specification was solved. No contents change.	7.12.0	7.12.1
06/2009	RP-44	RP-090498	3628	1	Removal of description of CPCH feature	7.12.1	7.13.0
	RP-44	RP-090505	3630	1	Error in UE capability update procedure	7.12.1	7.13.0

Change history							
Date	TSG #	TSG Doc.	CR	Re v	Subject/Comment	Old	New
	RP-44	RP-090505	3632	1	Correction on deferredMeasurementControlReading	7.12.1	7.13.0
	RP-44	RP-090500	3634	-	Clarification for setting the HS_SCCH_LESS_STATUS variable	7.12.1	7.13.0
	RP-44	RP-090505	3644	-	Correction on UE Mobility State Indicator	7.12.1	7.13.0
	RP-44	RP-090500	3646	-	Correction to CPC activation/deactivation	7.12.1	7.13.0
	RP-44	RP-090606	3655	3	Specification of CPC restored state upon physical layer failure	7.12.1	7.13.0
	RP-44	RP-090501	3657	2	Correction to non-scheduled transmission for 1.28 Mcps TDD	7.12.1	7.13.0
	RP-44	RP-090503	3659	-	Clarification of CQI reporting for 1.28Mcps TDD	7.12.1	7.13.0
	RP-44	RP-090503	3661	-	Correction to Improved L2 support for high data rates for TDD	7.12.1	7.13.0
	RP-44	RP-090499	3670	-	Clarification to the support of 2 different layer 3 filters per measurement type	7.12.1	7.13.0
	RP-44	RP-090505	3672	1	Clarification to handling of IE "Use special value of HE field"	7.12.1	7.13.0
	RP-44	RP-090500	3674	-	Removal of slot format 3 from IE "Uplink DPCCH slot format information" in "DTX-DRX information"	7.12.1	7.13.0
	RP-44	RP-090504	3682	-	Correction to Enhanced CELL_FACH Capability	7.12.1	7.13.0
	RP-44	RP-090500	3689	1	Corrections to CPC when E-DCH TTI is reconfigured	7.12.1	7.13.0
	RP-44	RP-090505	3691	2	Call Type Inclusion condition	7.12.1	7.13.0
	RP-44	RP-090502	3696	-	Correction on p-t-m bearer release in MBSFN	7.12.1	7.13.0
09/2009	RP-45	RP-090901	3703	-	Missing RRC messages in RRC procedure performance values section	7.13.0	7.14.0
	RP-45	RP-090905	3707	-	Correction to HS-SCCH less operation (Rel-7)	7.13.0	7.14.0
	RP-45	RP-090908	3716	1	E-DCH TTI restriction for 16QAM	7.13.0	7.14.0
	RP-45	RP-090902	3724	-	Making feature "Using special value of HE field to indicate end of an SDU for RLC AM" optional and octet aligned HS-DSCH transport block table optional for non-64QAM UEs	7.13.0	7.14.0
	RP-45	RP-090901	3748	-	Clarification of multi-frequency info for 1.28Mcps TDD	7.13.0	7.14.0
	RP-45	RP-090904	3753	-	Correction to the description of MIMO parameters	7.13.0	7.14.0
	RP-45	RP-090902	3758	-	Making features "F-DPCH" and "Introduction of Wait time to Cell Update Confirm" optional	7.13.0	7.14.0
	RP-45	RP-090898	3763	2	Making features "Two DRX schemes in URA_PCH and CELL_PCH" and "E-DPDCH power interpolation formula" optional	7.13.0	7.14.0
	RP-45	RP-090897	3770	1	CS voice over HSPA UE capability in RRC CONNECTION REQUEST	7.13.0	7.14.0
	RP-45	RP-090903	3777	-	Clarification on the Power Resource Related Information of 1.28Mcps TDD	7.13.0	7.14.0
	RP-45	RP-090903	3779	-	Clarification on the configuration of T-SI-NST for 1.28Mcps TDD	7.13.0	7.14.0
	RP-45	RP-090900	3802	-	Clarification on Inter-frequency RACH reporting quantity for TDD	7.13.0	7.14.0
	RP-45	RP-090900	3806	-	E-AGCH channel and E_RNTI variable corrections	7.13.0	7.14.0
	RP-45	RP-090901	3812	-	Enhancing the Category Handling in UMTS	7.13.0	7.14.0
	RP-45	RP-090902	3815	-	Making the bit of feature "UEA2/UIA2" reformulated	7.13.0	7.14.0
	RP-45	RP-090900	3817	-	RLC Size - SizeInfoType2 correction	7.13.0	7.14.0
12/2009	RP-46	RP-091307	3818	-	Adding missing reference for HS_SCCH_LESS_STATUS variable	7.14.0	7.15.0
	RP-46	RP-091306	3822	-	Clarification on deferred measurement control reading	7.14.0	7.15.0
	RP-46	RP-091310	3832	1	Clarification of Power Offset for Scheduling Info for 1.28Mcps TDD (change 1)	7.14.0	7.15.0
	RP-46	RP-091312	3854	1	MAC-es/e reset when 16QAM operation starts or stops(REL-7)	7.14.0	7.15.0
	RP-46	RP-091306	3869	-	Corrections to the Frequency quality estimate in 1.28Mcps TDD	7.14.0	7.15.0
	RP-46	RP-091305	3877	1	UE behaviour upon a removal of the serving HS-DSCH/E-DCH radio link	7.14.0	7.15.0
	RP-46	RP-091305	3881	-	Maximum Power Reduction (MPR) and event 6D reporting	7.14.0	7.15.0
	RP-46	RP-091308	3884	1	RRC Signaling of S-CPICH power offset for MIMO UEs	7.14.0	7.15.0
	RP-46	RP-091306	3918	2	Modification of inter RAT handover info for 1.28 Mcps TDD	7.14.0	7.15.0
	RP-46	RP-091308	3945	1	Optional support of Tx diversity on DL control channels for MIMO capable UEs	7.14.0	7.15.0
	RP-46	RP-091306	3984	1	Correction to the reference in section 14.9.2	7.14.0	7.15.0
03/2010	RP-47	RP-100199	4008	1	Indication of MIMO codebook restriction	7.15.0	7.16.0
	RP-47	RP-100284	4011	-	Traffic volume measurement in CELL_PCH state	7.15.0	7.16.0
	RP-47	RP-100284	4071	1	Corrections to HS-DSCH reception in CELL-PCH and CELL-FACH	7.15.0	7.16.0
	RP-47	RP-100283	4077	1	Corrections to the Delta Primary CCPCH RSCP for 1.28Mcps TDD	7.15.0	7.16.0
06/2010	RP-48	RP-100532	4132	-	Handling of RRC Unrecoverable Error in Enhanced CELL_FACH	7.16.0	7.17.0
	RP-48	RP-100534	4147	-	Clarification on UE radio access capability in ASN1 for LCR TDD	7.16.0	7.17.0
	RP-48	RP-100532	4159	-	Clarification on the HS-DSCH reception in enhanced CELL_FACH	7.16.0	7.17.0

Change history							
Date	TSG #	TSG Doc.	CR	Re v	Subject/Comment	Old	New
					state		
	RP-48	RP-100532	4184	-	Clarification on the traffic volume measurement in CELL_PCH state	7.16.0	7.17.0
09/2010	RP-49	RP-100844	4191	-	Incorrect inconsistency check on MAC-ehs reordering queue	7.17.0	7.18.0
	RP-49	RP-100841	4237	-	Flexible RLC only applies to user RB, not SRB	7.17.0	7.18.0
	RP-49	RP-100883	4242	-	LI size for CCCH(SRB#0) in enhanced CELL_FACH operation	7.17.0	7.18.0
	RP-49	RP-100844	4272	-	Clarifications to the intra-frequency measurement event for 1.28Mcps TDD	7.17.0	7.18.0
	RP-49	RP-100844	4279	-	Correction to default radio configuration #20	7.17.0	7.18.0
	RP-49	RP-100842	4298	-	Clarification of when to clear IE Precoding weight set restriction" from MIMO_PARAMS"	7.17.0	7.18.0
03/2011	RP-51	RP-110264	4454	-	PCI Weight set restriction logic	7.18.0	7.19.0
	RP-51	RP-110264	4462	-	Use of New H-RNTI in UMI message in CELL_DCH state	7.18.0	7.19.0
	RP-51	RP-110264	4473	1	Reconfiguration messages and HS-SSCH orders interaction for DTX/DRX	7.18.0	7.19.0
06/2011	RP-52	RP-110826	4603	-	Handling of START value due to an RLC reestablishment when DL RLC PDU size is reconfigured from fixed to flexible with 15-bit LI	7.19.0	7.20.0
	RP-52	RP-110826	4623	-	Clarification to the number of HARQ processes in HSDPA when switching between MIMO and non-MIMO	7.19.0	7.20.0
	RP-52	RP-110827	4663	1	Informative note of UE behaviour when change of the value of Use special value of HE field without downlink RLC entity re-establishment	7.19.0	7.20.0
12/2011	RP-54	RP-111701	4819	-	Correction to Default Radio Configurations for TDD: invalidation of identities 0, 1, 5, 6, 7, 22	7.20.0	7.21.0
	RP-54	RP-111703	4861	1	Clarification to the handling of HS-DSCH TB size table	7.20.0	7.21.0
	RP-54	RP-111705	4865	1	Clarify the total number of soft channel bits of HSDSCH physical layer category 19 and 20	7.20.0	7.21.0
	RP-54	RP-111704	4870	1	Correction of BCCH mapping on HS-DSCH	7.20.0	7.21.0

History

Document history		
V7.0.0	March 2006	Publication
V7.1.0	June 2006	Publication
V7.2.0	September 2006	Publication
V7.3.0	December 2006	Publication
V7.4.0	March 2007	Publication
V7.5.0	June 2007	Publication
V7.6.0	October 2007	Publication
V7.7.0	January 2008	Publication
V7.8.0	April 2008	Publication
V7.9.0	July 2008	Publication (Withdrawn)
V7.9.1	October 2008	Publication
V7.10.0	October 2008	Publication
V7.11.0	February 2009	Publication
V7.12.1	April 2009	Publication
V7.13.0	July 2009	Publication
V7.14.0	October 2009	Publication
V7.15.0	February 2010	Publication
V7.16.0	May 2010	Publication
V7.17.0	July 2010	Publication
V7.18.0	October 2010	Publication
V7.19.0	May 2011	Publication
V7.20.0	July 2011	Publication
V7.21.0	January 2012	Publication