

ETSI TS 125 331 V8.23.0 (2013-07)



**Universal Mobile Telecommunications System (UMTS);
Radio Resource Control (RRC);
Protocol specification
(3GPP TS 25.331 version 8.23.0 Release 8)**



Reference

RTS/TSGR-0225331v8n0

Keywords

UMTS

ETSI

650 Route des Lucioles
F-06921 Sophia Antipolis Cedex - FRANCE

Tel.: +33 4 92 94 42 00 Fax: +33 4 93 65 47 16

Siret N° 348 623 562 00017 - NAF 742 C
Association à but non lucratif enregistrée à la
Sous-Préfecture de Grasse (06) N° 7803/88

Important notice

Individual copies of the present document can be downloaded from:

<http://www.etsi.org>

The present document may be made available in more than one electronic version or in print. In any case of existing or perceived difference in contents between such versions, the reference version is the Portable Document Format (PDF). In case of dispute, the reference shall be the printing on ETSI printers of the PDF version kept on a specific network drive within ETSI Secretariat.

Users of the present document should be aware that the document may be subject to revision or change of status. Information on the current status of this and other ETSI documents is available at

<http://portal.etsi.org/tb/status/status.asp>

If you find errors in the present document, please send your comment to one of the following services:

http://portal.etsi.org/chaicor/ETSI_support.asp

Copyright Notification

No part may be reproduced except as authorized by written permission.
The copyright and the foregoing restriction extend to reproduction in all media.

© European Telecommunications Standards Institute 2013.
All rights reserved.

DECT™, **PLUGTESTS™**, **UMTS™** and the ETSI logo are Trade Marks of ETSI registered for the benefit of its Members.
3GPP™ and **LTE™** are Trade Marks of ETSI registered for the benefit of its Members and
of the 3GPP Organizational Partners.
GSM® and the GSM logo are Trade Marks registered and owned by the GSM Association.

Intellectual Property Rights

IPRs essential or potentially essential to the present document may have been declared to ETSI. The information pertaining to these essential IPRs, if any, is publicly available for **ETSI members and non-members**, and can be found in ETSI SR 000 314: *"Intellectual Property Rights (IPRs); Essential, or potentially Essential, IPRs notified to ETSI in respect of ETSI standards"*, which is available from the ETSI Secretariat. Latest updates are available on the ETSI Web server (<http://ipr.etsi.org>).

Pursuant to the ETSI IPR Policy, no investigation, including IPR searches, has been carried out by ETSI. No guarantee can be given as to the existence of other IPRs not referenced in ETSI SR 000 314 (or the updates on the ETSI Web server) which are, or may be, or may become, essential to the present document.

Foreword

This Technical Specification (TS) has been produced by ETSI 3rd Generation Partnership Project (3GPP).

The present document may refer to technical specifications or reports using their 3GPP identities, UMTS identities or GSM identities. These should be interpreted as being references to the corresponding ETSI deliverables.

The cross reference between GSM, UMTS, 3GPP and ETSI identities can be found under <http://webapp.etsi.org/key/queryform.asp>.

Contents

Intellectual Property Rights	2
Foreword.....	2
Foreword.....	34
1 Scope	35
2 References	35
3 Definitions and abbreviations.....	38
3.1 Definitions	38
3.2 Abbreviations	39
4 General	42
4.1 Overview of the specification.....	42
4.2 RRC Layer Model	43
4.3 Protocol specification principles	46
5 RRC Functions and Services provided to upper layers	46
5.1 RRC Functions	46
5.2 RRC Services provided to upper layers.....	47
5.3 Primitives between RRC and upper layers	47
6 Services expected from lower layers.....	47
6.1 Services expected from Layer 2	47
6.2 Services expected from Layer 1	47
6.3 Signalling Radio Bearers.....	47
7 Protocol states	48
7.1 Overview of RRC States and State Transitions including GSM and E-UTRA	48
7.2 Processes in UE modes/states.....	49
7.2.1 UE Idle mode.....	49
7.2.2 UTRA RRC Connected mode.....	49
7.2.2.1 URA_PCH or CELL_PCH state	49
7.2.2.2 CELL_FACH state.....	50
7.2.2.3 CELL_DCH state.....	51
8 RRC procedures	52
8.1 RRC Connection Management Procedures	53
8.1.1 Broadcast of system information	53
8.1.1.1 General	53
8.1.1.1.1 System information structure.....	53
8.1.1.1.2 System information blocks	54
8.1.1.1.3 Segmentation and concatenation of system information blocks	60
8.1.1.1.4 Re-assembly of segments	61
8.1.1.1.5 Scheduling of system information	62
8.1.1.2 Initiation.....	62
8.1.1.3 Reception of SYSTEM INFORMATION messages by the UE.....	62
8.1.1.4 Void.....	63
8.1.1.5 Actions upon reception of the Master Information Block and Scheduling Block(s).....	63
8.1.1.6 Actions upon reception of system information blocks	67
8.1.1.6.1 System Information Block type 1	68
8.1.1.6.2 System Information Block type 2.....	69
8.1.1.6.3 System Information Block type 3.....	69
8.1.1.6.4 System Information Block type 4.....	74
8.1.1.6.5 System Information Block type 5 and 5bis.....	74
8.1.1.6.6 System Information Block type 6.....	78
8.1.1.6.7 System Information Block type 7.....	81
8.1.1.6.8 Void.....	81
8.1.1.6.9 Void.....	81

8.1.1.6.10	Void.....	81
8.1.1.6.11	System Information Block type 11.....	81
8.1.1.6.11a	System Information Block type 11bis.....	83
8.1.1.6.12	System Information Block type 12.....	83
8.1.1.6.13	System Information Block type 13.....	85
8.1.1.6.14	System Information Block type 14.....	85
8.1.1.6.15	System Information Block type 15.....	85
8.1.1.6.15.0	System Information Block type 15bis.....	85
8.1.1.6.15.1	System Information Block type 15.1.....	86
8.1.1.6.15.1a	System Information Block type 15.1bis.....	86
8.1.1.6.15.2	System Information Block type 15.2.....	86
8.1.1.6.15.2a	System Information Block type 15.2bis.....	87
8.1.1.6.15.2b	System Information Block type 15.2ter.....	87
8.1.1.6.15.3	System Information Block type 15.3.....	87
8.1.1.6.15.3a	System Information Block type 15.3bis.....	88
8.1.1.6.15.4	System Information Block type 15.4.....	89
8.1.1.6.15.5	System Information Block type 15.5.....	89
8.1.1.6.15.6	System Information Block type 15.6.....	89
8.1.1.6.15.7	System Information Block type 15.7.....	89
8.1.1.6.15.8	System Information Block type 15.8.....	89
8.1.1.6.16	System Information Block type 16.....	90
8.1.1.6.17	System Information Block type 17.....	90
8.1.1.6.18	System Information Block type 18.....	90
8.1.1.6.19	System Information Block type 19.....	92
8.1.1.6.20	System Information Block type 20.....	92
8.1.1.7	Modification of system information.....	92
8.1.1.7.1	Modification of system information blocks using a value tag.....	92
8.1.1.7.2	Synchronised modification of system information blocks.....	93
8.1.1.7.3	Actions upon system information change.....	93
8.1.1.7.4	Actions upon expiry of a system information expiry timer.....	94
8.1.2	Paging.....	94
8.1.2.1	General.....	94
8.1.2.2	Initiation.....	94
8.1.2.3	Reception of a PAGING TYPE 1 message by the UE.....	95
8.1.3	RRC connection establishment.....	97
8.1.3.1	General.....	97
8.1.3.2	Initiation.....	97
8.1.3.3	RRC CONNECTION REQUEST message contents to set.....	98
8.1.3.4	Reception of an RRC CONNECTION REQUEST message by the UTRAN.....	100
8.1.3.5	Cell re-selection, T300 or T318 timeout.....	101
8.1.3.5a	Abortion of RRC connection establishment.....	102
8.1.3.6	Reception of an RRC CONNECTION SETUP message by the UE.....	102
8.1.3.7	Physical channel failure or cell re-selection.....	105
8.1.3.8	Invalid RRC CONNECTION SETUP message, unsupported configuration or invalid configuration.....	106
8.1.3.9	Reception of an RRC CONNECTION REJECT message by the UE.....	107
8.1.3.10	Invalid RRC CONNECTION REJECT message.....	110
8.1.4	RRC connection release.....	111
8.1.4.1	General.....	111
8.1.4.2	Initiation.....	111
8.1.4.3	Reception of an RRC CONNECTION RELEASE message by the UE.....	112
8.1.4.4	Invalid RRC CONNECTION RELEASE message.....	113
8.1.4.5	Cell re-selection or radio link failure.....	114
8.1.4.6	Expiry of timer T308, unacknowledged mode transmission.....	114
8.1.4.7	Void.....	115
8.1.4.8	Reception of an RRC CONNECTION RELEASE COMPLETE message by UTRAN.....	115
8.1.4.9	Unsuccessful transmission of the RRC CONNECTION RELEASE COMPLETE message, acknowledged mode transmission.....	115
8.1.4.10	Detection of loss of dedicated physical channel by UTRAN in CELL_DCH state.....	115
8.1.4.11	Failure to receive RRC CONNECTION RELEASE COMPLETE message by UTRAN.....	115
8.1.4a	RRC connection release requested by upper layers.....	116
8.1.4a.1	General.....	116

8.1.4a.2	Initiation.....	116
8.1.5	Void.....	116
8.1.6	Transmission of UE capability information.....	116
8.1.6.1	General.....	116
8.1.6.2	Initiation.....	116
8.1.6.3	Reception of a UE CAPABILITY INFORMATION message by the UTRAN.....	118
8.1.6.4	Reception of the UE CAPABILITY INFORMATION CONFIRM message by the UE.....	118
8.1.6.5	Invalid UE CAPABILITY INFORMATION CONFIRM message.....	119
8.1.6.6	T304 timeout.....	119
8.1.7	UE capability enquiry.....	120
8.1.7.1	General.....	120
8.1.7.2	Initiation.....	120
8.1.7.3	Reception of a UE CAPABILITY ENQUIRY message by the UE.....	120
8.1.7.4	Invalid UE CAPABILITY ENQUIRY message.....	120
8.1.8	Initial Direct transfer.....	121
8.1.8.1	General.....	121
8.1.8.2	Initiation of Initial direct transfer procedure in the UE.....	121
8.1.8.2a	RLC re-establishment or inter-RAT change.....	123
8.1.8.2ab	Inter-RAT handover from UTRAN to GERAN <i>Iu mode</i>	124
8.1.8.2b	Abortion of signalling connection establishment.....	124
8.1.8.2c	Inter-RAT handover from UTRAN to E-UTRAN.....	124
8.1.8.3	Reception of INITIAL DIRECT TRANSFER message by the UTRAN.....	124
8.1.9	Downlink Direct transfer.....	124
8.1.9.1	General.....	124
8.1.9.2	Initiation of downlink direct transfer procedure in the UTRAN.....	125
8.1.9.3	Reception of a DOWNLINK DIRECT TRANSFER message by the UE.....	125
8.1.9.3a	No signalling connection exists.....	125
8.1.9.4	Invalid DOWNLINK DIRECT TRANSFER message.....	126
8.1.10	Uplink Direct transfer.....	126
8.1.10.1	General.....	126
8.1.10.2	Initiation of uplink direct transfer procedure in the UE.....	126
8.1.10.2a	RLC re-establishment or inter-RAT change.....	127
8.1.10.2b	Inter-RAT handover from UTRAN to GERAN <i>Iu mode</i>	127
8.1.10.2c	Inter-RAT handover from UTRAN to E-UTRAN.....	127
8.1.10.3	Reception of UPLINK DIRECT TRANSFER message by the UTRAN.....	128
8.1.11	UE dedicated paging.....	128
8.1.11.1	General.....	128
8.1.11.2	Initiation.....	128
8.1.11.3	Reception of a PAGING TYPE 2 message by the UE.....	128
8.1.11.4	Invalid PAGING TYPE 2 message.....	128
8.1.12	Security mode control.....	129
8.1.12.1	General.....	129
8.1.12.2	Initiation.....	129
8.1.12.2.1	Ciphering configuration change.....	129
8.1.12.2.2	Integrity protection configuration change.....	130
8.1.12.3	Reception of SECURITY MODE COMMAND message by the UE.....	132
8.1.12.3.1	New ciphering and integrity protection keys.....	136
8.1.12.4	Void.....	138
8.1.12.4a	Incompatible simultaneous security reconfiguration.....	138
8.1.12.4b	Cell update procedure during security reconfiguration.....	138
8.1.12.4c	Invalid configuration.....	139
8.1.12.5	Reception of SECURITY MODE COMPLETE message by the UTRAN.....	140
8.1.12.6	Invalid SECURITY MODE COMMAND message.....	142
8.1.13	Signalling connection release procedure.....	142
8.1.13.1	General.....	142
8.1.13.2	Initiation of SIGNALLING CONNECTION RELEASE by the UTRAN.....	142
8.1.13.3	Reception of SIGNALLING CONNECTION RELEASE by the UE.....	143
8.1.13.4	Invalid SIGNALLING CONNECTION RELEASE message.....	143
8.1.13.5	Invalid configuration.....	143
8.1.14	Signalling connection release indication procedure.....	144
8.1.14.1	General.....	144
8.1.14.2	Initiation.....	144

8.1.14.2a	RLC re-establishment or inter-RAT change	146
8.1.14.3	Reception of SIGNALLING CONNECTION RELEASE INDICATION by the UTRAN	146
8.1.14.4	Expiry of timer T323.....	146
8.1.15	Counter check procedure	146
8.1.15.1	General	147
8.1.15.2	Initiation.....	147
8.1.15.3	Reception of a COUNTER CHECK message by the UE.....	147
8.1.15.4	Reception of the COUNTER CHECK RESPONSE message by UTRAN	148
8.1.15.5	Cell re-selection	148
8.1.15.6	Invalid COUNTER CHECK message.....	148
8.1.16	Inter RAT handover information transfer	148
8.1.16.1	General	149
8.1.16.2	Initiation.....	149
8.1.16.3	INTER RAT HANDOVER INFO message contents to set	149
8.1.17	ETWS primary notification with security procedure	151
8.1.17.1	General	151
8.1.17.2	Initiation.....	151
8.1.17.3	Void.....	151
8.1.17.4	Reception of the ETWS PRIMARY NOTIFICATION WITH SECURITY message	151
8.1.17.5	Forward of the ETWS primary notification to the upper layers	151
8.1.17.6	Void.....	151
8.2	Radio Bearer control procedures	152
8.2.1	Radio bearer establishment	152
8.2.2	Reconfiguration procedures	152
8.2.2.1	General	154
8.2.2.2	Initiation.....	154
8.2.2.2a	Initiation of handover from GERAN <i>Iu mode</i>	156
8.2.2.3	Reception of RADIO BEARER SETUP or RADIO BEARER RECONFIGURATION or RADIO BEARER RELEASE or TRANSPORT CHANNEL RECONFIGURATION or PHYSICAL CHANNEL RECONFIGURATION message or Target cell HS-SCCH order by the UE	156
8.2.2.3a	Reception of RADIO BEARER RECONFIGURATION message by the UE performing handover from GERAN <i>Iu mode</i>	173
8.2.2.4	Transmission of a response message by the UE, normal case.....	174
8.2.2.5	Reception of a response message by the UTRAN, normal case.....	176
8.2.2.5a	Rejection by the UE	177
8.2.2.6	Unsupported configuration in the UE	178
8.2.2.7	Physical channel failure	178
8.2.2.8	Cell re-selection	179
8.2.2.9	Transmission of a response message by the UE, failure case	179
8.2.2.10	Reception of a response message by the UTRAN, failure case	180
8.2.2.11	Invalid configuration.....	180
8.2.2.12	Incompatible simultaneous reconfiguration	181
8.2.2.12a	Incompatible simultaneous security reconfiguration.....	181
8.2.2.12b	Cell update procedure during security reconfiguration	181
8.2.2.13	Invalid received message	182
8.2.2.14	Radio link failure	182
8.2.3	Radio bearer release.....	183
8.2.4	Transport channel reconfiguration.....	184
8.2.5	Transport format combination control	184
8.2.5.1	General	184
8.2.5.2	Initiation.....	184
8.2.5.3	Reception of a TRANSPORT FORMAT COMBINATION CONTROL message by the UE	184
8.2.5.4	Invalid configuration.....	186
8.2.5.5	Invalid TRANSPORT FORMAT COMBINATION CONTROL message	187
8.2.6	Physical channel reconfiguration.....	187
8.2.7	Physical Shared Channel Allocation [TDD only].....	188
8.2.7.1	General	188
8.2.7.2	Initiation.....	188
8.2.7.3	Reception of a PHYSICAL SHARED CHANNEL ALLOCATION message by the UE	188
8.2.7.4	Invalid PHYSICAL SHARED CHANNEL ALLOCATION message	190
8.2.8	PUSCH capacity request [TDD only].....	191

8.2.8.1	General	191
8.2.8.2	Initiation	191
8.2.8.3	PUSCH CAPACITY REQUEST message contents to set	192
8.2.8.4	Reception of a PUSCH CAPACITY REQUEST message by the UTRAN	193
8.2.8.5	T310 expiry	193
8.2.9	Void	193
8.2.10	Uplink Physical Channel Control [TDD only]	193
8.2.10.1	General	193
8.2.10.2	Initiation	193
8.2.10.3	Reception of UPLINK PHYSICAL CHANNEL CONTROL message by the UE	193
8.2.10.4	Invalid UPLINK PHYSICAL CHANNEL CONTROL message	194
8.2.11	Physical channel reconfiguration failure	194
8.2.11.1	General	195
8.2.11.2	Runtime error due to overlapping compressed mode configurations	195
8.2.11.3	Void	195
8.3	RRC connection mobility procedures	195
8.3.1	Cell and URA update procedures	195
8.3.1.1	General	198
8.3.1.2	Initiation	199
8.3.1.3	CELL UPDATE / URA UPDATE message contents to set	207
8.3.1.4	T305 expiry and the UE detects "out of service area"	211
8.3.1.4.1	Re-entering "in service area"	211
8.3.1.4.2	Expiry of timer T307	212
8.3.1.5	Reception of an CELL UPDATE/URA UPDATE message by the UTRAN	212
8.3.1.6	Reception of the CELL UPDATE CONFIRM/URA UPDATE CONFIRM message by the UE	213
8.3.1.7	Transmission of a response message to UTRAN	223
8.3.1.7a	Physical channel failure	226
8.3.1.8	Unsupported configuration by the UE	228
8.3.1.9	Invalid configuration	229
8.3.1.9a	Incompatible simultaneous reconfiguration	230
8.3.1.9b	Security reconfiguration during Cell update procedure	231
8.3.1.10	Confirmation error of URA ID list	232
8.3.1.11	Invalid CELL UPDATE CONFIRM/URA UPDATE CONFIRM message	233
8.3.1.12	T302 expiry or cell reselection	233
8.3.1.13	T314 expiry	237
8.3.1.14	T315 expiry	237
8.3.1.15	Reception of the UTRAN MOBILITY INFORMATION CONFIRM message by the UTRAN	238
8.3.1.16	T320 Expiry	238
8.3.2	URA update	239
8.3.3	UTRAN mobility information	239
8.3.3.1	General	239
8.3.3.2	Initiation	239
8.3.3.3	Reception of UTRAN MOBILITY INFORMATION message by the UE	239
8.3.3.4	Reception of an UTRAN MOBILITY INFORMATION CONFIRM message by the UTRAN	243
8.3.3.5	Cell re-selection	243
8.3.3.5a	Incompatible simultaneous security reconfiguration	243
8.3.3.6	Invalid UTRAN MOBILITY INFORMATION message	244
8.3.3.7	T322 expiry	244
8.3.4	Active set update	245
8.3.4.1	General	245
8.3.4.2	Initiation	245
8.3.4.3	Reception of an ACTIVE SET UPDATE message by the UE	246
8.3.4.4	Unsupported configuration in the UE	249
8.3.4.5	Invalid configuration	249
8.3.4.5a	Void	250
8.3.4.5b	Incompatible simultaneous reconfiguration	250
8.3.4.6	Reception of the ACTIVE SET UPDATE COMPLETE message by the UTRAN	250
8.3.4.7	Reception of the ACTIVE SET UPDATE FAILURE message by the UTRAN	250
8.3.4.8	Invalid ACTIVE SET UPDATE message	251
8.3.4.9	Reception of an ACTIVE SET UPDATE message in wrong state	251
8.3.5	Hard handover	251
8.3.5.1	Timing re-initialised hard handover	252

8.3.5.1.1	General	252
8.3.5.1.2	Initiation (FDD only).....	252
8.3.5.2	Timing-maintained hard handover	253
8.3.5.2.1	General	253
8.3.5.2.2	Initiation (FDD only).....	253
8.3.6	Inter-RAT handover to UTRAN	254
8.3.6.1	General	254
8.3.6.2	Initiation.....	254
8.3.6.3	Reception of HANDOVER TO UTRAN COMMAND message by the UE	255
8.3.6.4	Invalid Handover to UTRAN command message.....	260
8.3.6.4a	Unsupported configuration in HANDOVER TO UTRAN COMMAND message.....	260
8.3.6.5	UE fails to perform handover.....	260
8.3.6.6	Reception of message HANDOVER TO UTRAN COMPLETE by the UTRAN	261
8.3.7	Inter-RAT handover from UTRAN	261
8.3.7.1	General	261
8.3.7.2	Initiation.....	261
8.3.7.3	Reception of a HANDOVER FROM UTRAN COMMAND message by the UE.....	261
8.3.7.4	Successful completion of the inter-RAT handover	263
8.3.7.5	UE fails to complete requested handover.....	264
8.3.7.6	Invalid HANDOVER FROM UTRAN COMMAND message	264
8.3.7.7	Reception of an HANDOVER FROM UTRAN FAILURE message by UTRAN	265
8.3.7.8	Unsupported configuration in HANDOVER FROM UTRAN COMMAND message.....	265
8.3.7.8a	Reception of HANDOVER FROM UTRAN COMMAND message by UE in CELL_FACH.....	266
8.3.8	Inter-RAT cell reselection to UTRAN.....	266
8.3.8.1	General	266
8.3.8.2	Initiation.....	266
8.3.8.2a	Initiation of inter-RAT cell reselection from GERAN <i>Iu mode</i>	267
8.3.8.3	UE fails to complete an inter-RAT cell reselection.....	267
8.3.8.3a	UE fails to complete an inter-RAT cell reselection from GERAN <i>Iu mode</i>	267
8.3.9	Inter-RAT cell reselection from UTRAN	268
8.3.9.1	General	268
8.3.9.2	Initiation.....	268
8.3.9.2a	Initiation of inter-RAT cell reselection to GERAN <i>Iu mode</i>	268
8.3.9.3	Successful cell reselection.....	268
8.3.9.4	UE fails to complete an inter-RAT cell reselection.....	268
8.3.10	Inter-RAT cell change order to UTRAN	269
8.3.10.1	General	269
8.3.10.2	Initiation.....	269
8.3.10.3	UE fails to complete an inter-RAT cell change order	269
8.3.11	Inter-RAT cell change order from UTRAN.....	269
8.3.11.1	General	270
8.3.11.2	Initiation.....	270
8.3.11.3	Reception of an CELL CHANGE ORDER FROM UTRAN message by the UE	270
8.3.11.4	Successful completion of the cell change order	271
8.3.11.5	Expiry of timer T309 or UE fails to complete requested cell change order	271
8.3.11.6	Unsupported configuration in CELL CHANGE ORDER FROM UTRAN message	273
8.3.11.7	Invalid CELL CHANGE ORDER FROM UTRAN message	273
8.4	Measurement procedures.....	273
8.4.0	Measurement related definitions	273
8.4.1	Measurement control	275
8.4.1.1	General	275
8.4.1.2	Initiation.....	275
8.4.1.3	Reception of MEASUREMENT CONTROL by the UE	276
8.4.1.4	Unsupported measurement in the UE.....	283
8.4.1.4a	Configuration Incomplete	283
8.4.1.5	Invalid MEASUREMENT CONTROL message.....	283
8.4.1.6	Measurements after transition from CELL_DCH to CELL_FACH/CELL_PCH/URA_PCH state ..	284
8.4.1.6.1	Intra-frequency measurement	284
8.4.1.6.2	Inter-frequency measurement	285
8.4.1.6.3	Inter-RAT measurement	285
8.4.1.6.4	Quality measurement	286
8.4.1.6.5	UE internal measurement	286

8.4.1.6.6	Traffic volume measurement	286
8.4.1.6.7	UE positioning measurement	287
8.4.1.6a	Actions in CELL_FACH/CELL_PCH/URA_PCH state upon cell re-selection	289
8.4.1.7	Measurements after transition from CELL_FACH to CELL_DCH state	289
8.4.1.7.1	Intra-frequency measurement	289
8.4.1.7.2	Inter-frequency measurement	290
8.4.1.7.3	Inter-RAT measurement	290
8.4.1.7.4	Traffic volume measurement	290
8.4.1.7.5	UE positioning measurement	291
8.4.1.8	Measurements after transition from idle mode to CELL_DCH state	292
8.4.1.8.1	Intra-frequency measurement	292
8.4.1.8.2	Inter-frequency measurement	292
8.4.1.8.3	Inter-RAT measurement	292
8.4.1.8.4	Traffic volume measurement	292
8.4.1.8.5	UE positioning measurement	292
8.4.1.9	Measurements after transition from idle mode to CELL_FACH state	293
8.4.1.9.1	Intra-frequency measurement	293
8.4.1.9.2	Inter-frequency measurement	293
8.4.1.9.3	Inter-RAT measurement	293
8.4.1.9.4	Traffic volume measurement	293
8.4.1.9.5	UE positioning measurement	294
8.4.1.9a	Measurements after transition from connected mode to idle mode	294
8.4.1.9a.1	Intra-frequency measurement	294
8.4.1.9a.2	Inter-frequency measurement	294
8.4.1.9a.3	Inter-RAT measurement	294
8.4.1.9a.4	UE positioning measurement	295
8.4.1.9b	Measurements after transition from CELL_FACH to CELL_PCH/URA_PCH	295
8.4.1.9b.1	Traffic volume measurement	295
8.4.1.9b.2	UE positioning measurement	295
8.4.1.9b.3	Inter-RAT measurement	296
8.4.1.9b.4	Intra-frequency measurement	296
8.4.1.9b.5	Inter-frequency measurement	296
8.4.1.9c	Measurements after transition from CELL_PCH/URA_PCH to CELL_FACH	296
8.4.1.9c.1	Traffic volume measurement	296
8.4.1.9c.2	UE positioning measurement	297
8.4.1.9c.3	Inter-RAT measurement	297
8.4.1.10	Changes in measurement objects	297
8.4.1.10.1	Traffic volume measurement	297
8.4.1.10.2	Quality measurement	298
8.4.1.10.3	Intra-frequency, Inter-frequency and Inter-RAT measurements	298
8.4.1.11	Cell Reselection (FDD only and 1.28 Mcps TDD only)	298
8.4.1.11.1	Traffic volume measurement	298
8.4.2	Measurement report	299
8.4.2.1	General	299
8.4.2.2	Initiation	299
8.4.3	Assistance Data Delivery	301
8.4.3.1	General	301
8.4.3.2	Initiation	301
8.4.3.3	Reception of ASSISTANCE DATA DELIVERY message by the UE	302
8.4.3.4	Invalid ASSISTANCE DATA DELIVERY message	302
8.5	General procedures	302
8.5.1	Selection of initial UE identity	302
8.5.2	Actions when entering idle mode from connected mode	303
8.5.3	Open loop power control upon establishment of DPCCCH	304
8.5.4	Physical channel establishment criteria in CELL_DCH state	305
8.5.4A	Physical channel establishment criteria for Enhanced Uplink in CELL_FACH state and Idle mode	305
8.5.5	Actions in "out of service area" and "in service area"	305
8.5.5.1	Detection of "out of service" area	305
8.5.5.1.1	Actions following detection of "out of service" area in URA_PCH or CELL_PCH state	305
8.5.5.1.2	Actions following detection of "out of service" area in CELL_FACH state	306
8.5.5.1.3	Actions following detection of "out of service" area on transition from CELL_DCH to URA_PCH or CELL_PCH	306

8.5.5.1.4	Actions following detection of "out of service" area on transition from CELL_DCH to CELL_FACH	306
8.5.5.2	Detection of "in service" area.....	306
8.5.5.2.1	Actions following Re-entry into "in service area" in URA_PCH or CELL_PCH state	306
8.5.5.2.2	Actions following re-entry into "in service area" in CELL_FACH state	307
8.5.5.3	T316 expiry	307
8.5.5.4	T317 expiry	307
8.5.6	Radio link failure criteria and actions upon radio link failure	307
8.5.7	Open loop power control	308
8.5.8	Maintenance of Hyper Frame Numbers.....	313
8.5.9	START value calculation.....	313
8.5.10	Integrity protection	314
8.5.10.1	Integrity protection in downlink.....	315
8.5.10.2	Integrity protection in uplink.....	316
8.5.10.3	Calculation of message authentication code	317
8.5.11	FACH measurement occasion calculation	317
8.5.12	Establishment of Access Service Classes	319
8.5.13	Mapping of Access Classes to Access Service Classes	320
8.5.14	PLMN Type Selection	320
8.5.14a	Neighbour cells list narrowing for cell reselection	320
8.5.15	CFN calculation	320
8.5.15.1	Initialisation for CELL_DCH state after state transition.....	320
8.5.15.2	Initialisation in CELL_DCH state at hard handover	321
8.5.15.3	Initialisation for CELL_FACH	321
8.5.15.4	Initialisation after intersystem handover to UTRAN	321
8.5.15.5	Initialisation for MTCH and/or MSCH carried on S-CCPCH that may be soft combined	322
8.5.16	Configuration of CTCH occasions.....	322
8.5.17	PRACH selection.....	322
8.5.18	Selection of RACH TTI.....	323
8.5.18.1	FDD.....	323
8.5.18.2	1.28 Mcps TDD.....	324
8.5.19	Secondary CCPCH selection	325
8.5.19a	Secondary CCPCH and FACH selection for MCCH reception.....	325
8.5.20	Unsupported configuration	326
8.5.21	Actions related to Radio Bearer mapping	326
8.5.22	Actions when entering another RAT from connected mode.....	334
8.5.23	Measured results on RACH	334
8.5.24	Change of PLMN while in RRC connected mode	336
8.5.25	Actions related to HS_DSCH_RECEPTION variable.....	337
8.5.26	Service prioritisation.....	339
8.5.27	MBMS frequency selection	339
8.5.28	Actions related to E_DCH_TRANSMISSION variable	341
8.5.29	MBMS modification period identity calculation	344
8.5.30	Detecting MBMS service reception inability.....	344
8.5.31	Actions related to DEFERRED_MEASUREMENT_STATUS variable	344
8.5.32	Actions related to MIMO_PARAMS variable.....	345
8.5.33	Actions related to MIMO_STATUS variable	346
8.5.34	Actions related to DTX_DRX_STATUS variable (FDD only)	346
8.5.35	Actions related to HS_SCCH_LESS_STATUS variable (FDD only).....	347
8.5.36	Actions related to HS_DSCH_RECEPTION_CELL_FACH_STATE variable (FDD and 1.28 Mcps TDD only).....	348
8.5.37	Actions related to HS_DSCH_RECEPTION_OF_CCCH_ENABLED variable (FDD and 1.28 Mcps TDD only).....	350
8.5.37a	Actions related to HS_DSCH_RECEPTION_GENERAL	351
8.5.38	Common H-RNTI selection (FDD and 1.28 Mcps TDD only).....	351
8.5.39	PICH selection for HSDPA based paging (FDD and 1.28 Mcps TDD only)	351
8.5.40	HS_DSCH Reception in CELL_PCH and URA_PCH (FDD only)	352
8.5.40a	HS_DSCH Reception in CELL_PCH and URA_PCH (1.28 Mcps TDD only)	353
8.5.41	HS-PDSCH channelisation codes selection for paging reception (FDD and 1.28 Mcps TDD only)	354
8.5.42	Autonomous UTRAN DRX Cycle length coefficient change	355
8.5.43	Reception of MBMS from a cell operating in MBSFN mode	355
8.5.44	HS-DSCH CQI reporting tables.....	355

8.5.45	Enhanced Uplink in CELL_FACH state and Idle mode (FDD only)	356
8.5.45a	Enhanced Uplink in CELL_FACH state and Idle mode (1.28 Mcps TDD only)	357
8.5.46	Actions related to COMMON_E_DCH_TRANSMISSION variable (FDD and 1.28 Mcps TDD only).....	357
8.5.47	Actions related to READY_FOR_COMMON_EDCH variable (FDD and 1.28 Mcps TDD only)	359
8.5.48	Actions related to HS_DSCH_DRX_CELL_FACH_STATUS variable (FDD and 1.28 Mcps TDD only).....	361
8.5.49	CELL_FACH HS-DSCH DRX operation (FDD only).....	361
8.5.49a	CELL_FACH HS-DSCH DRX operation (1.28Mcps TDD only).....	362
8.5.50	Common E-RNTI selection (1.28 Mcps TDD only).....	362
8.5.51	Actions related to SECONDARY_CELL_HS_DSCH_RECEPTION variable (FDD only)	363
8.5.52	Actions related to TARGET_CELL_PRECONFIGURATION variable (FDD only)	364
8.5.53	Actions related to CONTROL_CHANNEL_DRX_STATUS variable (1.28 Mcps TDD only).....	364
8.5.54	Actions related to E_DCH_SPS_STATUS variable (1.28 Mcps TDD only)	365
8.5.55	Actions related to HS_DSCH_SPS_STATUS variable (1.28 Mcps TDD only)	365
8.5.56	Actions related to HSPA_RNTI_STORED_CELL_PCH variable (FDD and 1.28 Mcps TDD only)	366
8.6	Generic actions on receipt and absence of an information element.....	367
8.6.1	CN information elements.....	367
8.6.1.1	Void.....	367
8.6.1.2	CN information info	367
8.6.1.3	Signalling connection release indication.....	367
8.6.2	UTRAN mobility information elements	368
8.6.2.1	URA identity	368
8.6.2.2	Mapping info.....	369
8.6.2.3	RNC support for change of UE capability	369
8.6.2.4	CSG PSC Split Information	369
8.6.2.5	E-UTRA detection	369
8.6.3	UE information elements	369
8.6.3.1	Activation time.....	369
8.6.3.1a	CN domain specific DRX cycle length coefficient	371
8.6.3.1b	H-RNTI	371
8.6.3.2	UTRAN DRX Cycle length coefficient	372
8.6.3.3	Generic state transition rules depending on received information elements	372
8.6.3.4	Ciphering mode info	373
8.6.3.5	Integrity protection mode info.....	376
8.6.3.5.1	Initialisation of Integrity Protection.....	376
8.6.3.5.2	Integrity Protection Re-configuration for SRNS Relocation, intra-RAT SR-VCC and handover from GERAN Iu mode.....	377
8.6.3.5.3	Integrity Protection modification in case of new keys or initialisation of signalling connection	378
8.6.3.6	Void.....	379
8.6.3.7	Void.....	379
8.6.3.8	Integrity check info	379
8.6.3.9	New C-RNTI.....	379
8.6.3.9a	New DSCH-RNTI.....	380
8.6.3.10	New U-RNTI.....	380
8.6.3.11	RRC transaction identifier.....	380
8.6.3.12	Capability Update Requirement	384
8.6.3.13	Group release information.....	385
8.6.3.14	New E-RNTI.....	386
8.6.3.15	SR-VCC Info.....	387
8.6.4	Radio bearer information elements	387
8.6.4.1	Signalling RB information to setup list.....	387
8.6.4.2	RAB information for setup.....	388
8.6.4.2a	RAB information to reconfigure	390
8.6.4.3	RB information to setup	390
8.6.4.4	RB information to be affected	393
8.6.4.4a	Void.....	393
8.6.4.5	RB information to reconfigure	393
8.6.4.6	RB information to release	393
8.6.4.7	RB with PDCP information	394
8.6.4.8	RB mapping info	394
8.6.4.9	RLC Info	397

8.6.4.10	PDCP Info	401
8.6.4.11	PDCP SN Info	402
8.6.4.12	NAS Synchronisation Indicator	402
8.6.4.13	PDCP context relocation info	402
8.6.4.14	RLC Info MBMS	402
8.6.4.15	RAB information for MBMS ptp bearer	403
8.6.5	Transport channel information elements	403
8.6.5.1	Transport Format Set	403
8.6.5.2	Transport format combination set	405
8.6.5.3	Transport format combination subset	406
8.6.5.4	DCH quality target	408
8.6.5.5	Added or Reconfigured UL TrCH information	408
8.6.5.5a	Added or reconfigured MAC-d flow	409
8.6.5.6	Added or Reconfigured DL TrCH information	410
8.6.5.6a	Void	410
8.6.5.6b	HARQ Info	410
8.6.5.7	Deleted UL TrCH information	411
8.6.5.8	Deleted DL TrCH information	411
8.6.5.9	UL Transport channel information common for all transport channels	412
8.6.5.10	DL Transport channel information common for all transport channels	412
8.6.5.11	Void	413
8.6.5.12	TFCS Reconfiguration/Addition Information	413
8.6.5.12a	Additional RACH TFCS for CCCH	414
8.6.5.13	TFCS Removal Information	414
8.6.5.14	Void	414
8.6.5.15	TFCS Explicit Configuration	414
8.6.5.16	E-DCH Transmission Time Interval (FDD only)	414
8.6.5.17	HARQ Info for E-DCH	415
8.6.5.18	Added or reconfigured E-DCH MAC-d flow	415
8.6.5.19	SRB1 mapping info (FDD and 1.28 Mcps TDD only)	416
8.6.5.20	HARQ System Info (FDD and 1.28 Mcps TDD only)	416
8.6.5.21	CCCH mapping info (FDD and 1.28 Mcps TDD only)	417
8.6.5.22	Common MAC-ehs reordering queue (FDD and 1.28 Mcps TDD only)	417
8.6.5.23	Added or reconfigured MAC-ehs reordering queue	417
8.6.5.24	Common E-DCH MAC-d flows (FDD and 1.28 Mcps TDD only)	418
8.6.6	Physical channel information elements	418
8.6.6.1	Frequency info	418
8.6.6.2	Void	419
8.6.6.2a	PNBSCH allocation	420
8.6.6.3	Void	420
8.6.6.3a	Downlink information per radio link list	420
8.6.6.4	Downlink information for each radio link	421
8.6.6.5	Void	423
8.6.6.6	Uplink DPCH info	423
8.6.6.7	Void	424
8.6.6.8	Maximum allowed UL TX power	424
8.6.6.9	Void	425
8.6.6.10	Void	425
8.6.6.11	Uplink DPCH power control info	425
8.6.6.12	Secondary CPICH info	426
8.6.6.13	Primary CPICH usage for channel estimation	426
8.6.6.14	DPCH frame offset (FDD Only)	426
8.6.6.15	DPCH Compressed mode info	428
8.6.6.16	Repetition period, Repetition length, Offset (TDD only)	431
8.6.6.16a	Repetition period, Repetition length, Offset _{sub} (1.28 Mcps TDD non-scheduled transmission only)	432
8.6.6.17	Primary CCPCH info	433
8.6.6.18	Primary CPICH info	433
8.6.6.19	Void	433
8.6.6.20	Void	433
8.6.6.21	Void	433
8.6.6.22	Secondary Scrambling Code, Code Number	433

8.6.6.23	PDSCH Power Control info	433
8.6.6.24	Tx Diversity Mode	434
8.6.6.25	Void.....	435
8.6.6.26	UL Timing Advance Control (TDD only)	435
8.6.6.26a	Uplink synchronisation parameters (TDD only)	436
8.6.6.27	Downlink information common for all radio links.....	436
8.6.6.28	Downlink DPCH info common for all radio links	436
8.6.6.28a	Downlink F-DPCH info common for all radio links	438
8.6.6.29	ASC setting	438
8.6.6.30	SRB delay, PC preamble (FDD only)	440
8.6.6.31	Void.....	440
8.6.6.32	Void.....	440
8.6.6.33	HS-SCCH Info	440
8.6.6.34	Measurement Feedback Info	442
8.6.6.35	DPC Mode.....	442
8.6.6.36	Downlink HS-PDSCH Information	442
8.6.6.36a	DL Multi-carrier information (1.28 Mcps TDD only)	442
8.6.6.37	E-DCH Info.....	443
8.6.6.38	DTX-DRX timing information (FDD only).....	445
8.6.6.39	DTX-DRX information (FDD only)	445
8.6.6.40	HS-SCCH less information (FDD only)	446
8.6.6.41	MIMO parameters.....	446
8.6.6.42	UL 16QAM settings	446
8.6.6.43	Multi-frequency Info (1.28 Mcps TDD only)	447
8.6.6.44	Void.....	447
8.6.6.45	Downlink Secondary Cell Info FDD.....	447
8.6.6.46	Control Channel DRX information (1.28 Mcps TDD only)	448
8.6.6.47	SPS information (1.28 Mcps TDD only).....	448
8.6.7	Measurement information elements.....	450
8.6.7.1	Measurement validity.....	450
8.6.7.2	Filter coefficient	450
8.6.7.3	Intra-frequency/Inter-frequency/Inter-RAT cell info list	452
8.6.7.3a	UTRA priority info list.....	459
8.6.7.3b	GSM priority info list.....	460
8.6.7.3c	E-UTRA frequency and priority info list	461
8.6.7.3d	E-UTRA frequency list	462
8.6.7.4	Intra-frequency measurement quantity.....	462
8.6.7.5	Inter-RAT measurement quantity.....	462
8.6.7.6	Inter-RAT reporting quantity	464
8.6.7.7	Cell Reporting Quantities.....	464
8.6.7.8	Periodical Reporting Criteria	465
8.6.7.9	Reporting Cell Status	466
8.6.7.10	Traffic Volume Measurement	466
8.6.7.11	Traffic Volume Measurement Reporting Criteria	467
8.6.7.12	FACH measurement occasion info	467
8.6.7.13	Measurement Reporting Mode.....	469
8.6.7.14	Inter-frequency measurement.....	469
8.6.7.15	Inter-RAT measurement.....	470
8.6.7.16	Intra-frequency measurement.....	470
8.6.7.17	Quality measurement	471
8.6.7.18	UE internal measurement.....	471
8.6.7.18a	Void.....	471
8.6.7.19	UE positioning	471
8.6.7.19.0	UE positioning reporting criteria.....	471
8.6.7.19.1	UE positioning reporting quantity	472
8.6.7.19.1a	UE positioning reporting for UE assisted methods.....	473
8.6.7.19.1b	UE positioning reporting for UE based methods.....	476
8.6.7.19.2	UE positioning OTDOA assistance data for UE-assisted.....	478
8.6.7.19.2a	UE positioning OTDOA assistance data for UE-based	479
8.6.7.19.3	UE positioning GPS assistance data	481
8.6.7.19.3.1	UE positioning GPS acquisition assistance.....	481
8.6.7.19.3.2	UE positioning GPS Almanac.....	481

8.6.7.19.3.3	UE positioning D-GPS Corrections	482
8.6.7.19.3.3a	UE positioning GPS Navigation Model.....	482
8.6.7.19.3.4	UE positioning GPS Ephemeris and Clock Correction Parameters	482
8.6.7.19.3.5	UE positioning GPS ionospheric model	482
8.6.7.19.3.6	UE positioning GPS real-time integrity	483
8.6.7.19.3.7	UE positioning GPS reference time	483
8.6.7.19.3.8	UE positioning GPS reference UE position	484
8.6.7.19.3.9	UE positioning UTC model	484
8.6.7.19.4	UE positioning Ciphering info	484
8.6.7.19.5	UE positioning Error	486
8.6.7.19.6	Void.....	487
8.6.7.19.7	UE positioning GANSS assistance data	487
8.6.7.19.7.1	UE positioning GANSS reference measurement information	487
8.6.7.19.7.2	UE positioning GANSS Almanac	487
8.6.7.19.7.3	UE positioning D-GANSS Corrections	487
8.6.7.19.7.4	UE positioning GANSS Navigation Model	488
8.6.7.19.7.4a	UE positioning GANSS Clock Model	488
8.6.7.19.7.4b	UE positioning GANSS Orbit Model	488
8.6.7.19.7.5	UE positioning GANSS ionospheric model.....	488
8.6.7.19.7.6	UE positioning GANSS real-time integrity	489
8.6.7.19.7.7	UE positioning GANSS reference time	489
8.6.7.19.7.8	UE positioning GANSS reference UE position	490
8.6.7.19.7.9	UE positioning GANSS time model	490
8.6.7.19.7.10	UE positioning GANSS UTC model	490
8.6.7.19.7.11	UE positioning GANSS data bit assistance	490
8.6.7.19.7.12	UE positioning GANSS additional ionospheric model.....	490
8.6.7.19.7.13	UE positioning GANSS Earth orientation parameters.....	490
8.6.7.19.7.14	UE positioning GANSS additional navigation models.....	491
8.6.7.19.7.14a	UE positioning GANSS additional clock models	491
8.6.7.19.7.14b	UE positioning GANSS additional orbit models	491
8.6.7.19.7.15	UE positioning GANSS additional UTC models.....	491
8.6.7.19.7.16	UE positioning GANSS auxiliary information	491
8.6.7.20	Void.....	492
8.6.7.21	Intra-frequency reporting quantity for RACH reporting	492
8.6.7.22	Additional Measurement List.....	492
8.6.7.23	Dedicated Priority Information	493
8.6.7.24	Adjacent frequency index	494
8.6.7.25	Idle Interval Information (TDD only)	494
8.6.8	Void.....	494
8.6.8a	Other Information elements	494
8.6.8a.1	ETWS information	494
8.6.9	MBMS specific information elements	495
8.6.9.1	Continue MCCH Reading	495
8.6.9.1a	MBMS dynamic persistence level.....	495
8.6.9.2	MBMS PL Service Restriction Information.....	495
8.6.9.3	MBMS L1 combining schedule	495
8.6.9.3a	MBMS Number of neighbour cells.....	496
8.6.9.4	MBMS Preferred frequency information	496
8.6.9.4a	Void.....	496
8.6.9.4b	MBMS p-t-m activation time	496
8.6.9.5	MBMS RB list released to change transfer mode	497
8.6.9.6	MBMS Required UE action	497
8.6.9.6a	MBMS re- acquire MCCH.....	498
8.6.9.7	MBMS Service transmissions info list.....	498
8.6.9.8	MBMS Short transmission ID.....	498
8.6.9.9	MBMS Transmission identity	499
8.6.9.9a	MBMS transmission time difference	499
8.6.9.9ab	MBSFN cluster frequency.....	499
8.6.9.9ac	MBSFN frequency list	500
8.6.9.9ad	MBSFN inter frequency neighbour list.....	500
8.6.9.9ae	MBSFN TDM Information	501
8.6.9.9b	MCCH configuration information.....	501

8.6.9.10	Next scheduling period	501
8.6.9.11	TDD MBSFN Information.....	501
8.6.9.12	Network Standard Time Information	502
8.7	MBMS specific procedures	502
8.7.1	Reception of MBMS control information.....	502
8.7.1.1	General	502
8.7.1.2	Initiation.....	503
8.7.1.3	UE requirements on reading of MCCH information.....	503
8.7.1.4	UE requirements on reading of MSCH information	504
8.7.2	MCCH acquisition	504
8.7.2.1	General	504
8.7.2.2	Initiation.....	505
8.7.2.3	MCCH information to be acquired by the UE.....	505
8.7.2.4	Reception of the MBMS MODIFIED SERVICES INFORMATION and the MBMS UNMODIFIED SERVICES INFORMATION by the UE.....	505
8.7.2.5	Reception of the other MBMS messages by the UE	506
8.7.3	MBMS Notification	506
8.7.3.1	General	507
8.7.3.2	Initiation.....	507
8.7.3.3	Receiving the MBMS Notification information.....	507
8.7.3.3.1	Reception via MCCH	507
8.7.3.3.2	Void.....	508
8.7.3.3.3	Reception via DCCH.....	508
8.7.3.4	UE action upon receiving MBMS MODIFIED SERVICES INFORMATION message.....	508
8.7.3.5	UE fails to receive MBMS Notification information	510
8.7.4	MBMS counting	510
8.7.4.1	General	510
8.7.4.2	Initiation.....	510
8.7.4.3	Reception of the MBMS ACCESS INFORMATION.....	510
8.7.4.4	Termination of the MBMS counting procedure	512
8.7.4.5	Failure of the counting response procedure.....	512
8.7.5	MBMS p-t-m radio bearer configuration	512
8.7.5.1	General	512
8.7.5.2	Initiation.....	512
8.7.5.3	Reception of the MBMS Current Cell PTM RB information	513
8.7.5.4	Reception of the MBMS Neighbouring Cell PTM RB information.....	513
8.7.6	MBMS modification request.....	513
8.7.6.1	General	513
8.7.6.2	Initiation.....	514
8.7.6.2a	MBMS MODIFICATION REQUEST message contents to set.....	514
8.7.6.3	Reception of a MBMS MODIFICATION REQUEST message by the UTRAN.....	515
8.7.7	MBMS service scheduling.....	515
8.7.7.1	General	515
8.7.7.2	Initiation.....	515
8.7.7.3	Reception of the MBMS scheduling information	515
9	Handling of unknown, unforeseen and erroneous protocol data	516
9.1	General	516
9.2	ASN.1 violation or encoding error	516
9.3	Unknown or unforeseen message type	517
9.3a	Unsolicited received message.....	517
9.3b	Unexpected critical message extension	517
9.4	Unknown or unforeseen information element value, mandatory information element	518
9.5	Conditional information element error.....	518
9.6	Unknown or unforeseen information element value, conditional information element	519
9.7	Unknown or unforeseen information element value, optional information element	520
9.8	Unexpected non-critical message extension.....	520
9.9	Handling of errors in nested information elements	520
10	Message and information element functional definition and content.....	521
10.1	General	521
10.1.1	Protocol extensions	522

10.1.1.1	Non-critical extensions.....	524
10.1.1.1.1	Extension of an information element with additional values or choices	524
10.1.1.1.2	Extension of a message with additional information elements.....	524
10.1.1.2	Critical extensions.....	525
10.1.1.2.1	Extension of an information element with additional values or choices	525
10.1.1.2.2	Extension of a message with additional information elements.....	525
10.2	Radio Resource Control messages	525
10.2.1	ACTIVE SET UPDATE.....	525
10.2.2	ACTIVE SET UPDATE COMPLETE.....	527
10.2.3	ACTIVE SET UPDATE FAILURE	528
10.2.4	ASSISTANCE DATA DELIVERY	528
10.2.5	CELL CHANGE ORDER FROM UTRAN	529
10.2.6	CELL CHANGE ORDER FROM UTRAN FAILURE.....	530
10.2.7	CELL UPDATE.....	530
10.2.8	CELL UPDATE CONFIRM.....	533
10.2.9	COUNTER CHECK	537
10.2.10	COUNTER CHECK RESPONSE	538
10.2.11	DOWNLINK DIRECT TRANSFER.....	538
10.2.12	Void.....	539
10.2.12a	ETWS PRIMARY NOTIFICATION WITH SECURITY.....	539
10.2.13	Void.....	539
10.2.14	Void.....	539
10.2.15	HANDOVER FROM UTRAN COMMAND.....	539
10.2.16	HANDOVER FROM UTRAN FAILURE	542
10.2.16a	HANDOVER TO UTRAN COMMAND.....	543
10.2.16b	HANDOVER TO UTRAN COMPLETE.....	546
10.2.16c	INITIAL DIRECT TRANSFER.....	546
10.2.16d	INTER RAT HANDOVER INFO	548
10.2.16e	MBMS Access Information.....	549
10.2.16f	MBMS Common p-t-m rb Information	550
10.2.16g	MBMS Current Cell p-t-m rb Information	552
10.2.16h	MBMS General Information.....	554
10.2.16i	MBMS Modification request.....	555
10.2.16j	MBMS Modified services Information.....	556
10.2.16k	MBMS Neighbouring Cell p-t-m rb Information.....	559
10.2.16L	MBMS Scheduling Information	562
10.2.16m	MBMS Unmodified services Information	563
10.2.17	MEASUREMENT CONTROL	564
10.2.18	MEASUREMENT CONTROL FAILURE	566
10.2.19	MEASUREMENT REPORT.....	567
10.2.20	PAGING TYPE 1	568
10.2.21	PAGING TYPE 2	568
10.2.22	PHYSICAL CHANNEL RECONFIGURATION	569
10.2.23	PHYSICAL CHANNEL RECONFIGURATION COMPLETE	572
10.2.24	PHYSICAL CHANNEL RECONFIGURATION FAILURE	573
10.2.25	PHYSICAL SHARED CHANNEL ALLOCATION	574
10.2.26	PUSCH CAPACITY REQUEST.....	575
10.2.27	RADIO BEARER RECONFIGURATION	576
10.2.28	RADIO BEARER RECONFIGURATION COMPLETE	580
10.2.29	RADIO BEARER RECONFIGURATION FAILURE	582
10.2.30	RADIO BEARER RELEASE.....	582
10.2.31	RADIO BEARER RELEASE COMPLETE.....	586
10.2.32	RADIO BEARER RELEASE FAILURE.....	588
10.2.33	RADIO BEARER SETUP.....	588
10.2.34	RADIO BEARER SETUP COMPLETE.....	592
10.2.35	RADIO BEARER SETUP FAILURE	594
10.2.36	RRC CONNECTION REJECT	595
10.2.37	RRC CONNECTION RELEASE.....	596
10.2.38	RRC CONNECTION RELEASE COMPLETE.....	597
10.2.39	RRC CONNECTION REQUEST.....	597
10.2.40	RRC CONNECTION SETUP	600
10.2.41	RRC CONNECTION SETUP COMPLETE	603

10.2.41a	RRC FAILURE INFO	604
10.2.42	RRC STATUS	605
10.2.43	SECURITY MODE COMMAND	605
10.2.44	SECURITY MODE COMPLETE	606
10.2.45	SECURITY MODE FAILURE	607
10.2.46	SIGNALLING CONNECTION RELEASE	607
10.2.47	SIGNALLING CONNECTION RELEASE INDICATION	607
10.2.48	SYSTEM INFORMATION	608
10.2.48.1	First Segment	610
10.2.48.2	First Segment (short)	610
10.2.48.3	Subsequent Segment	610
10.2.48.4	Last Segment	611
10.2.48.5	Last Segment (short)	611
10.2.48.6	Complete SIB	611
10.2.48.7	Complete SIB (short)	612
10.2.48.8	System Information Blocks	612
10.2.48.8.1	Master Information Block	613
10.2.48.8.2	Scheduling Block 1	613
10.2.48.8.3	Scheduling Block 2	614
10.2.48.8.4	System Information Block type 1	614
10.2.48.8.5	System Information Block type 2	614
10.2.48.8.6	System Information Block type 3	614
10.2.48.8.7	System Information Block type 4	617
10.2.48.8.8	System Information Block type 5 and 5bis	618
10.2.48.8.9	System Information Block type 6	622
10.2.48.8.10	System Information Block type 7	624
10.2.48.8.11	Void	624
10.2.48.8.12	Void	624
10.2.48.8.13	Void	624
10.2.48.8.14	System Information Block type 11	624
10.2.48.8.14a	System Information Block type 11bis	625
10.2.48.8.15	System Information Block type 12	625
10.2.48.8.16	System Information Block type 13	626
10.2.48.8.16.1	System Information Block type 13.1	626
10.2.48.8.16.2	System Information Block type 13.2	626
10.2.48.8.16.3	System Information Block type 13.3	626
10.2.48.8.16.4	System Information Block type 13.4	627
10.2.48.8.17	System Information Block type 14	627
10.2.48.8.18	System Information Block type 15	627
10.2.48.8.18.0	System Information Block type 15bis	628
10.2.48.8.18.1a	System Information Block type 15.1bis	629
10.2.48.8.18.2	System Information Block type 15.2	629
10.2.48.8.18.2a	System Information Block type 15.2bis	629
10.2.48.8.18.2b	System Information Block type 15.2ter	630
10.2.48.8.18.3	System Information Block type 15.3	630
10.2.48.8.18.3a	System Information Block type 15.3bis	631
10.2.48.8.18.4	System Information Block type 15.4	631
10.2.48.8.18.4a	System Information Block type 15.5	631
10.2.48.8.18.5	System Information Block type 15.6	632
10.2.48.8.18.6	System Information Block type 15.7	632
10.2.48.8.18.7	System Information Block type 15.8	632
10.2.48.8.19	System Information Block type 16	633
10.2.48.8.20	System Information Block type 17	633
10.2.48.8.21	System Information Block type 18	634
10.2.48.8.22	System Information Block type 19	634
10.2.48.8.23	System Information Block type 20	634
10.2.49	SYSTEM INFORMATION CHANGE INDICATION	634
10.2.50	TRANSPORT CHANNEL RECONFIGURATION	635
10.2.51	TRANSPORT CHANNEL RECONFIGURATION COMPLETE	638
10.2.52	TRANSPORT CHANNEL RECONFIGURATION FAILURE	640
10.2.53	TRANSPORT FORMAT COMBINATION CONTROL	640
10.2.54	TRANSPORT FORMAT COMBINATION CONTROL FAILURE	641

10.2.55	UE CAPABILITY ENQUIRY	642
10.2.56	UE CAPABILITY INFORMATION.....	642
10.2.57	UE CAPABILITY INFORMATION CONFIRM	643
10.2.58	UPLINK DIRECT TRANSFER.....	644
10.2.59	UPLINK PHYSICAL CHANNEL CONTROL.....	644
10.2.60	URA UPDATE	646
10.2.61	URA UPDATE CONFIRM	647
10.2.62	UTRAN MOBILITY INFORMATION	649
10.2.63	UTRAN MOBILITY INFORMATION CONFIRM	650
10.2.64	UTRAN MOBILITY INFORMATION FAILURE.....	651
10.3	Information element functional definitions	652
10.3.1	CN Information elements.....	652
10.3.1.1	CN domain identity	652
10.3.1.2	CN Domain System Information.....	652
10.3.1.3	CN Information info.....	653
10.3.1.3a	CN Information info full	653
10.3.1.3b	Domain Specific Access Restriction	654
10.3.1.3c	Domain Specific Access Restriction Parameters	654
10.3.1.4	IMEI.....	654
10.3.1.5	IMSI (GSM-MAP).....	654
10.3.1.6	Intra Domain NAS Node Selector.....	655
10.3.1.7	Location Area Identification	656
10.3.1.7oa	Location/Registration Parameters	657
10.3.1.7a	Multiple PLMN List.....	657
10.3.1.8	NAS message	657
10.3.1.9	NAS system information (GSM-MAP).....	658
10.3.1.10	Paging record type identifier	658
10.3.1.10a	Paging Permission with Access Control Parameters.....	658
10.3.1.11	PLMN identity	658
10.3.1.11a	PLMN identity with Optional MCC.....	659
10.3.1.12	PLMN Type	659
10.3.1.13	P-TMSI (GSM-MAP)	659
10.3.1.14	RAB identity	659
10.3.1.15	Routing Area Code.....	660
10.3.1.16	Routing Area Identification.....	660
10.3.1.17	TMSI (GSM-MAP).....	660
10.3.2	UTRAN mobility Information elements	661
10.3.2.1	Cell Access Restriction	661
10.3.2.2	Cell identity.....	661
10.3.2.3	Cell selection and re-selection info for SIB3/4	662
10.3.2.4	Cell selection and re-selection info for SIB11/12	666
10.3.2.5	Mapping Info.....	667
10.3.2.6	URA identity.....	668
10.3.2.7	Dedicated priority Information.....	669
10.3.2.8	CSG Identity	671
10.3.2.9	CSG PSC Split Information	671
10.3.3	UE Information elements	672
10.3.3.1	Activation time.....	672
10.3.3.2	Capability Update Requirement	672
10.3.3.3	Cell update cause	672
10.3.3.4	Ciphering Algorithm	673
10.3.3.5	Ciphering mode info	673
10.3.3.6	CN domain specific DRX cycle length coefficient	673
10.3.3.7	Void.....	674
10.3.3.7a	Common E-RNTI info	674
10.3.3.8	C-RNTI	674
10.3.3.9	Void.....	674
10.3.3.9a	DSCH-RNTI	674
10.3.3.10	Void.....	675
10.3.3.10a	E-RNTI	675
10.3.3.11	Establishment cause	676
10.3.3.12	Expiration Time Factor	677

10.3.3.13	Failure cause	677
10.3.3.14	Failure cause and error information	677
10.3.3.14o	Group release information.....	678
10.3.3.14a	H-RNTI.....	678
10.3.3.15	Initial UE identity.....	678
10.3.3.16	Integrity check info	679
10.3.3.17	Integrity protection activation info.....	679
10.3.3.18	Integrity protection Algorithm	680
10.3.3.19	Integrity protection mode info.....	680
10.3.3.19a	Void.....	680
10.3.3.20	Void.....	681
10.3.3.21	Measurement capability	681
10.3.3.21a	Measurement capability extension	683
10.3.3.21b	Measurement capability TDD	686
10.3.3.22	Paging cause.....	687
10.3.3.23	Paging record	687
10.3.3.24	PDCCP capability	688
10.3.3.25	Physical channel capability	689
10.3.3.25a	Pre-redirectioin info	694
10.3.3.26	Protocol error cause.....	695
10.3.3.27	Protocol error indicator	695
10.3.3.28	RB timer indicator.....	695
10.3.3.29	Redirectioin info.....	696
10.3.3.30	Re-establishment timer.....	696
10.3.3.31	Rejection cause	696
10.3.3.32	Release cause	696
10.3.3.32a	RF Capability Compressed	697
10.3.3.33	RF capability FDD	697
10.3.3.33a	RF capability FDD extension	698
10.3.3.33b	RF capability TDD.....	698
10.3.3.33c	RF capability TDD 1.28 Mcps.....	699
10.3.3.34	RLC capability	699
10.3.3.35	RLC re-establish indicator	699
10.3.3.35o	RRC connection release information	699
10.3.3.35a	RRC State Indicator	700
10.3.3.36	RRC transaction identifier.....	700
10.3.3.37	Security capability.....	701
10.3.3.37a	Signalling Connection Release Indication Cause.....	701
10.3.3.38	START	701
10.3.3.39	Void.....	702
10.3.3.40	Transport channel capability	702
10.3.3.41	UE multi-mode/multi-RAT capability	704
10.3.3.42	UE radio access capability	705
10.3.3.42o	UE radio access capability compressed.....	709
10.3.3.42oa	UE radio access capability comp 2	710
10.3.3.42ob	UE radio access capability comp for 1.28 Mcps TDD	712
10.3.3.42a	UE radio access capability extension	713
10.3.3.42b	UE security information	714
10.3.3.42c	UE security information2.....	714
10.3.3.43	UE Timers and Constants in connected mode.....	714
10.3.3.44	UE Timers and Constants in idle mode.....	716
10.3.3.45	UE positioning capability.....	718
10.3.3.45a	GANSS Signal Id.....	720
10.3.3.46	URA update cause.....	720
10.3.3.47	U-RNTI	721
10.3.3.47a	U-RNTI group.....	721
10.3.3.48	U-RNTI Short	722
10.3.3.49	UTRAN DRX cycle length coefficient	722
10.3.3.50	Wait time.....	722
10.3.3.51	UE Specific Behaviour Information 1 idle.....	722
10.3.3.52	UE Specific Behaviour Information 1 interRAT.....	723
10.3.4	Radio Bearer Information elements	723

10.3.4.0a	Common RB mapping info	723
10.3.4.0	Default configuration identity	723
10.3.4.0a	Default configuration for CELL_FACH	724
10.3.4.1	Downlink RLC STATUS info.....	724
10.3.4.1a	PDCP context relocation info.....	724
10.3.4.2	PDCP info	725
10.3.4.2a	PDCP ROHC target mode.....	727
10.3.4.3	PDCP SN info	727
10.3.4.4	Polling info.....	728
10.3.4.5	Predefined configuration identity	728
10.3.4.5a	Predefined configuration status information	728
10.3.4.5b	Predefined configuration status information compressed	729
10.3.4.6	Predefined configuration value tag	729
10.3.4.7	Predefined RB configuration.....	730
10.3.4.8	RAB info	730
10.3.4.9	RAB info Post	731
10.3.4.9a	RAB information for MBMS ptp bearers.....	731
10.3.4.10	RAB information for setup.....	732
10.3.4.11	RAB information to reconfigure	733
10.3.4.11a	RAB info to replace	733
10.3.4.12	NAS Synchronization indicator	733
10.3.4.13	RB activation time info	734
10.3.4.14	RB COUNT-C MSB information	734
10.3.4.15	RB COUNT-C information.....	734
10.3.4.16	RB identity	734
10.3.4.17	RB information to be affected.....	735
10.3.4.18	RB information to reconfigure	735
10.3.4.19	RB information to release	735
10.3.4.20	RB information to setup	735
10.3.4.21	RB mapping info	736
10.3.4.22	RB with PDCP information	739
10.3.4.23	RLC info	740
10.3.4.23a	RLC info MBMS	742
10.3.4.24	Signalling RB information to setup.....	742
10.3.4.24a	SR-VCC Info.....	742
10.3.4.25	Transmission RLC Discard	743
10.3.4.26	UM Duplication Avoidance and Reordering info	744
10.3.4.27	UM Out of sequence delivery info	744
10.3.5	Transport CH Information elements	745
10.3.5.1	Added or Reconfigured DL TrCH information.....	745
10.3.5.1a	Added or reconfigured MAC-d flow.....	746
10.3.5.1b	Added or reconfigured E-DCH MAC-d flow.....	747
10.3.5.1c	Added or reconfigured MAC-ehs reordering queue.....	749
10.3.5.2	Added or Reconfigured UL TrCH information.....	750
10.3.5.2a	Additional Dynamic Transport Format Information for CCCH.....	750
10.3.5.2b	Additional RACH TFCS for CCCH.....	751
10.3.5.3	Void.....	751
10.3.5.3a	Common MAC-ehs reordering queue list	751
10.3.5.3b	Common E-DCH MAC-d flows	751
10.3.5.4	Deleted DL TrCH information.....	753
10.3.5.5	Deleted UL TrCH information.....	753
10.3.5.6	DL Transport channel information common for all transport channels	754
10.3.5.7	Void.....	754
10.3.5.7a	HARQ Info.....	755
10.3.5.7b	Void.....	756
10.3.5.7c	MAC-d Flow Identity.....	756
10.3.5.7d	HARQ Info for E-DCH.....	756
10.3.5.7e	E-DCH MAC-d Flow Identity.....	756
10.3.5.7f	MAC-ehs Queue Id	756
10.3.5.8	Power Offset Information	756
10.3.5.9	Predefined TrCH configuration.....	758
10.3.5.10	Quality Target	758

10.3.5.11	Semi-static Transport Format Information.....	758
10.3.5.12	Void.....	759
10.3.5.13	TFCFS Explicit Configuration	759
10.3.5.14	Void.....	759
10.3.5.15	TFCFS Reconfiguration/Addition Information	760
10.3.5.16	TFCFS Removal Information.....	761
10.3.5.17	Void.....	761
10.3.5.18	Transport channel identity.....	761
10.3.5.19	Transport Format Combination (TFC).....	761
10.3.5.20	Transport Format Combination Set.....	761
10.3.5.21	Transport Format Combination Set Identity	761
10.3.5.22	Transport Format Combination Subset	762
10.3.5.23	Transport Format Set.....	762
10.3.5.24	UL Transport channel information common for all transport channels	764
10.3.6	Physical CH Information elements	765
10.3.6.1	AC-to-ASC mapping.....	765
10.3.6.2	AICH Info	766
10.3.6.3	AICH Power offset.....	766
10.3.6.4	Allocation period info	766
10.3.6.5	Alpha.....	766
10.3.6.6	ASC setting	766
10.3.6.7	Void.....	768
10.3.6.8	CCTrCH power control info	769
10.3.6.8a	Cell and Channel Identity info	769
10.3.6.9	Cell parameters Id	769
10.3.6.9a	Common E-DCH system info	769
10.3.6.10	Common timeslot info.....	772
10.3.6.10a	Common timeslot info MBMS.....	773
10.3.6.11	Constant value.....	773
10.3.6.11a	Constant value TDD.....	773
10.3.6.12	Void.....	773
10.3.6.13	Void.....	773
10.3.6.14	Void.....	773
10.3.6.15	Void.....	774
10.3.6.16	Default DPCH Offset Value.....	774
10.3.6.17	Downlink channelisation codes.....	774
10.3.6.17a	Downlink channelisation codes VHCR.....	775
10.3.6.18	Downlink DPCH info common for all RL	776
10.3.6.19	Downlink DPCH info common for all RL Post	778
10.3.6.20	Downlink DPCH info common for all RL Pre	778
10.3.6.21	Downlink DPCH info for each RL.....	778
10.3.6.22	Downlink DPCH info for each RL Post.....	781
10.3.6.23	Downlink DPCH power control information	782
10.3.6.23oa	Downlink F-DPCH info common for all RL.....	782
10.3.6.23ob	Downlink F-DPCH info for each RL	782
10.3.6.23a	Downlink HS-PDSCH Information	784
10.3.6.24	Downlink information common for all radio links.....	785
10.3.6.25	Downlink information common for all radio links Post.....	786
10.3.6.26	Downlink information common for all radio links Pre	786
10.3.6.27	Downlink information for each radio link.....	787
10.3.6.28	Downlink information for each radio link Post.....	787
10.3.6.28a	DL Multi-Carrier Information (1.28 Mcps TDD only)	789
10.3.6.29	Void.....	790
10.3.6.30	Void.....	790
10.3.6.31	Downlink rate matching restriction information	790
10.3.6.31a	Downlink secondary cell info FDD	790
10.3.6.32	Downlink Timeslots and Codes	792
10.3.6.32a	Downlink Timeslots and Codes VHCR	792
10.3.6.33	DPCH compressed mode info	793
10.3.6.34	DPCH Compressed Mode Status Info.....	796
10.3.6.34a	DTX-DRX information	797
10.3.6.34b	DTX-DRX timing information.....	799

10.3.6.35	Dynamic persistence level.....	799
10.3.6.35a	FPACH info	799
10.3.6.35b	Frequency band indicator	800
10.3.6.35c	Frequency band indicator 2	800
10.3.6.36	Frequency info	800
10.3.6.36oo	HS-PDSCH Midamble Configuration.....	800
10.3.6.36o	HS-PDSCH Timeslot Configuration	801
10.3.6.36oa	HS-PDSCH Timeslot Configuration VHCR.....	802
10.3.6.36a	HS-SCCH Info	803
10.3.6.36ab	HS-SCCH less information	807
10.3.6.36b	HS-SICH Power Control Info	807
10.3.6.36c	HS-DSCH common system information	808
10.3.6.36ca	HS-DSCH common system information 1.28Mcps TDD	808
10.3.6.36d	HS-DSCH paging system information	809
10.3.6.36da	HS-DSCH paging system information 1.28Mcps TDD	810
10.3.6.36e	HS-SCCH system info	812
10.3.6.36ea	HS-SCCH system info 1.28Mcps TDD	812
10.3.6.36f	Void.....	814
10.3.6.36g	HS-DSCH DRX in CELL_FACH information.....	814
10.3.6.36h	HS-DSCH DRX in CELL_FACH information 1.28Mcps TDD	815
10.3.6.37	Individual timeslot info	815
10.3.6.38	Individual Timeslot interference	816
10.3.6.39	Maximum allowed UL TX power	816
10.3.6.39a	Multi-frequency Info (1.28 Mcps TDD only)	816
10.3.6.40	Void.....	816
10.3.6.40a	Measurement Feedback Info	817
10.3.6.41	Midamble shift and burst type.....	817
10.3.6.41a	MIMO parameters	819
10.3.6.41b	MIMO pilot configuration.....	819
10.3.6.41c	Non-scheduled transmission grant info (TDD only)	820
10.3.6.42	PDSCH Capacity Allocation info	822
10.3.6.43	Void.....	822
10.3.6.44	PDSCH info	822
10.3.6.45	PDSCH Power Control info	823
10.3.6.46	PDSCH system information	823
10.3.6.47	Void.....	824
10.3.6.48	Persistence scaling factors.....	824
10.3.6.49	PICH Info.....	824
10.3.6.50	PICH Power offset	825
10.3.6.50a	PLCCH Info	825
10.3.6.51	PRACH Channelisation Code List.....	825
10.3.6.51a	PRACH Channelisation Code 1.28 Mcps TDD	826
10.3.6.51b	PRACH Channelisation Code List VHCR.....	826
10.3.6.52	PRACH info (for RACH).....	827
10.3.6.53	PRACH partitioning.....	829
10.3.6.54	PRACH power offset	829
10.3.6.54a PRACH preamble control parameters (for Enhanced Uplink)	829
10.3.6.55	PRACH system information list.....	832
10.3.6.56	Predefined PhyCH configuration	833
10.3.6.57	Primary CCPCH info	834
10.3.6.58	Primary CCPCH info post.....	834
10.3.6.59	Primary CCPCH TX Power	835
10.3.6.60	Primary CPICH info.....	835
10.3.6.61	Primary CPICH Tx power.....	835
10.3.6.62	Primary CPICH usage for channel estimation	835
10.3.6.63	PUSCH info	835
10.3.6.63a	PUSCH info VHCR	835
10.3.6.64	PUSCH Capacity Allocation info	836
10.3.6.65	PUSCH power control info	836
10.3.6.66	PUSCH system information	837
10.3.6.66a	PUSCH system information VHCR	838
10.3.6.67	RACH transmission parameters.....	839

10.3.6.68	Radio link addition information	839
10.3.6.69	Radio link removal information	840
10.3.6.69a	E-DCH reconfiguration information	840
10.3.6.69b	E-DCH reconfiguration information same serving cell.....	842
10.3.6.70	Void.....	842
10.3.6.70a	SCTD indicator	842
10.3.6.71	Secondary CCPCH info	844
10.3.6.71a	Secondary CCPCH info MBMS	846
10.3.6.71b	Secondary CCPCH info MBMS Diff.....	848
10.3.6.72	Secondary CCPCH system information.....	849
10.3.6.72a	Secondary CCPCH system information MBMS	850
10.3.6.73	Secondary CPICH info.....	850
10.3.6.74	Secondary scrambling code.....	850
10.3.6.74a	Serving HS-DSCH cell information.....	851
10.3.6.74b	Serving Cell Change Parameters.....	851
10.3.6.75	SFN Time info	852
10.3.6.75a	Special Burst Scheduling	852
10.3.6.76	Void.....	852
10.3.6.77	Void.....	852
10.3.6.78	STTD indicator	852
10.3.6.78o	SYNC_UL codes bitmap.....	852
10.3.6.78a	SYNC_UL info	853
10.3.6.78b	TDD MBSFN Information.....	853
10.3.6.78c	LCR TDD MBSFN Information	854
10.3.6.78d	SYNC_UL info for E-RUCCH	854
10.3.6.79	TDD open loop power control	855
10.3.6.79a	Target cell preconfiguration information	856
10.3.6.80	TFC Control duration.....	856
10.3.6.81	Void.....	856
10.3.6.82	TGPSI	857
10.3.6.83	Time info.....	857
10.3.6.83a	Time Slot LCR Extension	857
10.3.6.84	Timeslot number	857
10.3.6.85	TPC combination index.....	857
10.3.6.85a	TSTD indicator	858
10.3.6.86	TX Diversity Mode	858
10.3.6.86o	UL 16QAM configuration.....	858
10.3.6.86a	UL 16QAM settings.....	859
10.3.6.87	UL interference	859
10.3.6.87a	UL interference TDD	859
10.3.6.87b	Uplink DPCH code info for Common E-DCH.....	860
10.3.6.88	Uplink DPCH info	861
10.3.6.89	Uplink DPCH info Post.....	863
10.3.6.90	Uplink DPCH info Pre	864
10.3.6.91	Uplink DPCH power control info	864
10.3.6.91a	Uplink DPCH power control info for Common E-DCH.....	866
10.3.6.92	Uplink DPCH power control info Post	866
10.3.6.93	Uplink DPCH power control info Pre	867
10.3.6.94	Uplink Timeslots and Codes	868
10.3.6.94a	Uplink Timeslots and Codes LCR	869
10.3.6.94b	Uplink Timeslots and Codes VHCR.....	870
10.3.6.95	Uplink Timing Advance.....	872
10.3.6.95a	Extended Uplink Timing Advance.....	872
10.3.6.96	Uplink Timing Advance Control.....	872
10.3.6.97	E-DCH Info.....	875
10.3.6.98	E-DPCCH Info.....	876
10.3.6.99	E-DPDCH Info.....	877
10.3.6.100	E-AGCH Info.....	878
10.3.6.100a	E-AGCH Info 1.28Mcps TDD	881
10.3.6.101	E-HICH Info	881
10.3.6.101a	E-HICH Info 1.28Mcps TDD.....	883
10.3.6.102	E-RGCH Info (FDD only)	883

10.3.6.103	E-RUCCH Info (TDD only).....	885
10.3.6.103a	E-RUCCH Info 1.28Mcps TDD.....	888
10.3.6.104	E-PUCH Info (TDD only).....	890
10.3.6.104a	E-PUCH Info 1.28Mcps TDD.....	894
10.3.6.105	E-TFCS info (TDD only).....	895
10.3.6.106	E-TFC Boost Info.....	895
10.3.6.107	Control Channel DRX information 1.28Mcps TDD.....	895
10.3.6.108	HS-SCCH DRX information 1.28 Mcps TDD.....	896
10.3.6.109	E-AGCH DRX information 1.28 Mcps TDD.....	896
10.3.6.110	SPS information 1.28 Mcps TDD.....	897
10.3.6.111	E-DCH SPS information 1.28 Mcps TDD.....	897
10.3.6.112	HS-DSCH SPS information 1.28 Mcps TDD.....	899
10.3.6.113	Downlink channelisation codes MBSFN IMB.....	901
10.3.6.114	Secondary CCPCH frame type 2 info.....	902
10.3.6.115	E-RGCH Info for Common E-DCH.....	902
10.3.6.116	E-HICH Info for Common E-DCH.....	902
10.3.7	Measurement Information elements.....	903
10.3.7.1	Additional measurements list.....	903
10.3.7.2	Cell info.....	903
10.3.7.3	Cell measured results.....	905
10.3.7.4	Cell measurement event results.....	906
10.3.7.5	Cell reporting quantities.....	906
10.3.7.6	Cell synchronisation information.....	907
10.3.7.6a	E-UTRA event results.....	907
10.3.7.6b	E-UTRA frequency list.....	908
10.3.7.6c	E-UTRA measured results.....	909
10.3.7.7	Event results.....	909
10.3.7.8	FACH measurement occasion info.....	910
10.3.7.9	Filter coefficient.....	911
10.3.7.9a	GSM cell group.....	911
10.3.7.10	HCS Cell re-selection information.....	912
10.3.7.11	HCS neighbouring cell information.....	912
10.3.7.12	HCS Serving cell information.....	912
10.3.7.12a	Idle Interval Information.....	913
10.3.7.13	Inter-frequency cell info list.....	913
10.3.7.14	Inter-frequency event identity.....	915
10.3.7.15	Inter-frequency measured results list.....	915
10.3.7.16	Inter-frequency measurement.....	915
10.3.7.17	Inter-frequency measurement event results.....	916
10.3.7.18	Inter-frequency measurement quantity.....	916
10.3.7.19	Inter-frequency measurement reporting criteria.....	917
10.3.7.20	Inter-frequency measurement system information.....	920
10.3.7.20a	Inter-frequency RACH reporting information.....	920
10.3.7.21	Inter-frequency reporting quantity.....	920
10.3.7.22	Inter-frequency SET UPDATE.....	921
10.3.7.23	Inter-RAT cell info list.....	921
10.3.7.24	Inter-RAT event identity.....	922
10.3.7.25	Inter-RAT info.....	922
10.3.7.26	Inter-RAT measured results list.....	923
10.3.7.27	Inter-RAT measurement.....	924
10.3.7.28	Inter-RAT measurement event results.....	924
10.3.7.29	Inter-RAT measurement quantity.....	925
10.3.7.30	Inter-RAT measurement reporting criteria.....	926
10.3.7.31	Inter-RAT measurement system information.....	927
10.3.7.32	Inter-RAT reporting quantity.....	927
10.3.7.33	Intra-frequency cell info list.....	928
10.3.7.34	Intra-frequency event identity.....	929
10.3.7.35	Intra-frequency measured results list.....	929
10.3.7.36	Intra-frequency measurement.....	929
10.3.7.37	Intra-frequency measurement event results.....	930
10.3.7.38	Intra-frequency measurement quantity.....	930
10.3.7.39	Intra-frequency measurement reporting criteria.....	931

10.3.7.40	Intra-frequency measurement system information	934
10.3.7.41	Intra-frequency reporting quantity	935
10.3.7.42	Intra-frequency reporting quantity for RACH reporting	935
10.3.7.43	Maximum number of reported cells on RACH	936
10.3.7.43a	MBMS preferred frequency information	936
10.3.7.43b	MBSFN inter frequency neighbour list	937
10.3.7.44	Measured results	937
10.3.7.45	Measured results on RACH	938
10.3.7.46	Measurement Command	940
10.3.7.47	Measurement control system information	941
10.3.7.47a	Measurement control system information extension	942
10.3.7.48	Measurement Identity	943
10.3.7.49	Measurement reporting mode	943
10.3.7.50	Measurement Type	943
10.3.7.51	Measurement validity	944
10.3.7.52	Void	944
10.3.7.53	Periodical reporting criteria	944
10.3.7.53aa	Periodical reporting info-1b	944
10.3.7.53a	PLMN identities of neighbour cells	944
10.3.7.54	Primary CCPCH RSCP info	945
10.3.7.54a	Qhcs	946
10.3.7.55	Quality measured results list	947
10.3.7.56	Quality measurement	948
10.3.7.57	Quality measurement event results	948
10.3.7.58	Quality measurement reporting criteria	948
10.3.7.59	Quality reporting quantity	949
10.3.7.60	Reference time difference to cell	949
10.3.7.61	Reporting Cell Status	950
10.3.7.62	Reporting information for state CELL_DCH	952
10.3.7.63	SFN-SFN observed time difference	952
10.3.7.64	Time to trigger	953
10.3.7.65	Timeslot ISCP info	953
10.3.7.66	Traffic volume event identity	953
10.3.7.67	Traffic volume measured results list	953
10.3.7.68	Traffic volume measurement	954
10.3.7.69	Traffic volume measurement event results	954
10.3.7.70	Traffic volume measurement object	955
10.3.7.71	Traffic volume measurement quantity	955
10.3.7.72	Traffic volume measurement reporting criteria	957
10.3.7.73	Traffic volume measurement system information	958
10.3.7.74	Traffic volume reporting quantity	958
10.3.7.75	UE internal event identity	959
10.3.7.76	UE internal measured results	959
10.3.7.77	UE internal measurement	960
10.3.7.78	UE internal measurement event results	960
10.3.7.79	UE internal measurement quantity	960
10.3.7.80	UE internal measurement reporting criteria	961
10.3.7.81	Void	962
10.3.7.82	UE Internal reporting quantity	962
10.3.7.83	UE Rx-Tx time difference type 1	962
10.3.7.84	UE Rx-Tx time difference type 2	963
10.3.7.85	UE Transmitted Power info	963
10.3.7.86	UE positioning Ciphering info	963
10.3.7.87	UE positioning Error	964
10.3.7.88	UE positioning GPS acquisition assistance	965
10.3.7.88a	UE positioning GPS Additional Assistance Data Request	966
10.3.7.88b UE positioning GANSS reference measurement information	968
10.3.7.88c	UE positioning GANSS additional assistance data request	971
10.3.7.88d	DGANSS Signal Id	974
10.3.7.89	UE positioning GPS almanac	976
10.3.7.89a	UE positioning GANSS almanac	977
10.3.7.90	UE positioning GPS assistance data	979

10.3.7.90a	Void.....	980
10.3.7.90b	UE positioning GANSS assistance data.....	980
10.3.7.91	UE positioning GPS DGPS corrections.....	983
10.3.7.91a	UE positioning GPS Ephemeris and Clock Correction parameters.....	984
10.3.7.91b	UE positioning DGANSS corrections.....	985
10.3.7.91c	UE positioning GANSS orbit model.....	987
10.3.7.91d	UE positioning GANSS clock model.....	988
10.3.7.91e	UE positioning GANSS additional orbit models.....	988
10.3.7.91f	UE positioning GANSS additional clock models.....	992
10.3.7.92	UE positioning GPS ionospheric model.....	993
10.3.7.92a	UE positioning GANSS ionospheric model.....	994
10.3.7.92b	UE positioning GANSS additional ionospheric model.....	994
10.3.7.92c	UE positioning GANSS Earth orientation parameters.....	994
10.3.7.93	UE positioning GPS measured results.....	995
10.3.7.93a	UE positioning GANSS measured results.....	996
10.3.7.94	UE positioning GPS navigation model.....	999
10.3.7.94a	UE positioning GANSS navigation model.....	1000
10.3.7.94b	UE positioning GANSS additional navigation models.....	1000
10.3.7.95	UE positioning GPS real-time integrity.....	1001
10.3.7.95a	Void.....	1002
10.3.7.95b	UE positioning GANSS real-time integrity.....	1002
10.3.7.96	UE positioning GPS reference time.....	1002
10.3.7.96o	UE positioning GANSS reference time.....	1004
10.3.7.96a	UE positioning GPS reference time uncertainty.....	1005
10.3.7.97	UE positioning GPS UTC model.....	1005
10.3.7.97a	UE positioning GANSS time model.....	1005
10.3.7.97b	UE positioning GANSS data bit assistance.....	1006
10.3.7.97c	UE positioning GANSS UTC model.....	1008
10.3.7.97d	UE positioning GANSS additional UTC models.....	1008
10.3.7.97e	UE positioning GANSS SBAS ID.....	1010
10.3.7.97f	UE positioning GANSS auxiliary information.....	1010
10.3.7.98	UE positioning IPDL parameters.....	1012
10.3.7.99	UE positioning measured results.....	1013
10.3.7.100	UE positioning measurement.....	1013
10.3.7.101	UE positioning measurement event results.....	1014
10.3.7.102	Void.....	1014
10.3.7.103	UE positioning OTDOA assistance data for UE-assisted.....	1015
10.3.7.103a	UE positioning OTDOA assistance data for UE-based.....	1015
10.3.7.104	Void.....	1015
10.3.7.105	UE positioning OTDOA measured results.....	1015
10.3.7.106	UE positioning OTDOA neighbour cell info.....	1016
10.3.7.106a	UE positioning OTDOA neighbour cell info for UE-based.....	1018
10.3.7.107	UE positioning OTDOA quality.....	1018
10.3.7.108	UE positioning OTDOA reference cell info.....	1020
10.3.7.108a	UE positioning OTDOA reference cell info for UE-based.....	1021
10.3.7.109	UE positioning position estimate info.....	1021
10.3.7.109a	UE positioning Relative Time Difference quality.....	1024
10.3.7.110	UE positioning reporting criteria.....	1024
10.3.7.111	UE positioning reporting quantity.....	1025
10.3.7.112	T _{ADV} info.....	1028
10.3.7.113	UTRA priority info list.....	1028
10.3.7.114	GSM priority info list.....	1029
10.3.7.115	E-UTRA frequency and priority info list.....	1030
10.3.8	Other Information elements.....	1032
10.3.8.1	BCCH modification info.....	1032
10.3.8.2	BSIC.....	1032
10.3.8.3	CBS DRX Level 1 information.....	1032
10.3.8.4	Cell Value tag.....	1032
10.3.8.4a	Ellipsoid point.....	1033
10.3.8.4b	Ellipsoid point with Altitude.....	1033
10.3.8.4c	Ellipsoid point with Altitude and uncertainty ellipsoid.....	1033

10.3.8.4d	Ellipsoid point with uncertainty Circle	1034
10.3.8.4e	Ellipsoid point with uncertainty Ellipse	1035
10.3.8.4ea	ETWS information	1035
10.3.8.4eb	Void.....	1035
10.3.8.4f	GERAN system information	1035
10.3.8.4g	GSM Target Cell Info	1036
10.3.8.4h	Horizontal Velocity	1036
10.3.8.4i	Horizontal with Vertical Velocity	1036
10.3.8.4j	Horizontal Velocity with Uncertainty	1037
10.3.8.4k	Horizontal with Vertical Velocity and Uncertainty	1037
10.3.8.4L	E-UTRA Target Info	1038
10.3.8.4m	HNB Name.....	1038
10.3.8.5	Inter-RAT change failure	1039
10.3.8.6	Inter-RAT handover failure.....	1039
10.3.8.7	Inter-RAT UE radio access capability.....	1040
10.3.8.8	Void.....	1041
10.3.8.8a	Inter-RAT UE security capability	1041
10.3.8.9	MIB Value tag.....	1041
10.3.8.10	PLMN Value tag	1041
10.3.8.10a	PNBSCH allocation	1041
10.3.8.11	Predefined configuration identity and value tag.....	1042
10.3.8.12	Protocol error information.....	1042
10.3.8.13	References to other system information blocks.....	1043
10.3.8.14	References to other system information blocks and scheduling blocks	1045
10.3.8.15	Rplmn information	1046
10.3.8.16	Scheduling information	1047
10.3.8.17	SEG COUNT	1048
10.3.8.18	Segment index.....	1048
10.3.8.18a	SIB and SB type	1048
10.3.8.18b	SIB type extension	1049
10.3.8.18c	SIB type extension2	1049
10.3.8.18d	GANSS SIB type	1050
10.3.8.19	SIB data fixed.....	1050
10.3.8.20	SIB data variable	1050
10.3.8.20a	SIB occurrence identity	1050
10.3.8.20b	SIB occurrence identity and value tag.....	1051
10.3.8.20c	SIB occurrence value tag	1051
10.3.8.21	SIB type	1051
10.3.8.22	SIB type SIBs only.....	1052
10.3.8.23	UE History Information	1053
10.3.8.24	Data volume history	1054
10.3.9	ANSI-41 Information elements.....	1054
10.3.9.1	ANSI-41 Core Network Information	1054
10.3.9.2	ANSI-41 Global Service Redirection information	1054
10.3.9.3	ANSI-41 NAS parameter	1055
10.3.9.4	ANSI-41 NAS system information	1055
10.3.9.5	ANSI-41 Private Neighbour List information	1055
10.3.9.6	ANSI-41 RAND information	1055
10.3.9.7	ANSI-41 User Zone Identification information	1055
10.3.9.8	MIN_P_REV.....	1056
10.3.9.9	NID	1056
10.3.9.10	P_REV	1056
10.3.9.11	SID	1056
10.3.9a	MBMS Information elements	1057
10.3.9a.1	MBMS Common CCTrCH identity	1057
10.3.9a.2	MBMS Common PhyCh identity	1057
10.3.9a.3	MBMS Common RB identity	1057
10.3.9a.4	MBMS Common TrCh identity	1057
10.3.9a.5	MBMS Current cell S-CCPCH identity	1057
10.3.9a.6	Void.....	1057
10.3.9a.7	MBMS L1 combining schedule	1058
10.3.9a.7o	MBMS p-t-m activation time	1058

10.3.9a.7a	MBMS p-t-m RB information.....	1059
10.3.9a.7b	MBMS Selected Service Info.....	1059
10.3.9a.7c	MBMS Selected Services Full	1060
10.3.9a.7d	MBMS Selected Services Short	1060
10.3.9a.8	MBMS Service identity.....	1060
10.3.9a.8a	MBMS Service ID	1061
10.3.9a.9	MBMS Session identity	1061
10.3.9a.10	MBMS Short transmission identity.....	1061
10.3.9a.10a	MBMS Soft Combining Timing Offset.....	1061
10.3.9a.11	MBMS specific timers and counters	1062
10.3.9a.12	MBMS Transmission identity	1062
10.3.9a.12a	MBSFN frequency list	1062
10.3.9a.12b	MBSFN TDM Information List	1063
10.3.9a.13	MCCH configuration information.....	1063
10.3.9a.14	MICH configuration information	1064
10.3.9a.15	MICH Power offset	1065
10.3.9a.16	MSCH configuration information	1066
10.3.9a.17	Network Standard Time Information	1066
10.3.10	Multiplicity values and type constraint values.....	1067
11	Message and Information element abstract syntax (with ASN.1).....	1070
11.0	General	1071
11.1	General message structure.....	1071
11.2	PDU definitions.....	1076
11.3	Information element definitions	1186
11.4	Constant definitions.....	1424
11.5	RRC information between network nodes.....	1426
12	Message transfer syntax	1447
12.1	Structure of encoded RRC messages.....	1447
12.1.1	Basic production	1447
12.1.2	Extension	1447
12.1.3	Padding	1448
12.2	ECN link module for RRC	1450
12.3	ECN modules for RRC.....	1450
12.4	RRC messages encoded otherwise	1451
12.4.1	Messages using tabular encoding specification	1451
12.4.1.1	TRANSPORT FORMAT COMBINATION CONTROL using transparent DCCH.....	1451
12.4.1.1.1	TRANSPORT FORMAT COMBINATION CONTROL, 3 bit format.....	1451
12.4.1.1.2	Void.....	1452
12.4.1.1.3	Void.....	1452
13	Protocol timers, counters, other parameters and default configurations	1453
13.1	Timers for UE.....	1453
13.2	Counters for UE	1455
13.3	UE constants and parameters.....	1456
13.4	UE variables	1456
13.4.ob	AM_RLC_ERROR_PENDING_RB234	1456
13.4.oc	AM_RLC_ERROR_PENDING_RB5_AND_UP.....	1456
13.4.0	CELL_INFO_LIST.....	1456
13.4.00	Void.....	1457
13.4.0a	CELL_UPDATE_STARTED.....	1457
13.4.1	CIPHERING_STATUS	1458
13.4.1a	COMMON_E_DCH_TRANSMISSION.....	1458
13.4.2	Void	1458
13.4.2a	CONFIGURATION_INCOMPLETE	1458
13.4.3	C_RNTI	1459
13.4.3a	DEFERRED_MEASUREMENT_STATUS	1459
13.4.3b	DTX_DRX_PARAMS	1459
13.4.3c	DTX_DRX_STATUS.....	1459
13.4.3d	DSAC_PARAM	1460
13.4.3e	DSCH_RNTI	1460
13.4.4	Void.....	1460

13.4.4o	E_DCH_TRANSMISSION	1460
13.4.4a	E_RNTI	1461
13.4.5	ESTABLISHED_RABS	1461
13.4.5a	ESTABLISHED_SIGNALLING_CONNECTIONS	1462
13.4.6	ESTABLISHMENT_CAUSE	1462
13.4.6a	EUTRA_FREQUENCY_INFO_LIST	1462
13.4.6b	ETWS_DUPLICATE_DETECT_PARAM	1463
13.4.6c	ETWS_INFO_IN_PROGRESS	1463
13.4.7	FAILURE_CAUSE	1464
13.4.8	FAILURE_INDICATOR	1464
13.4.8o	H_RNTI	1464
13.4.8oo	HS_DSCH_RECEPTION	1464
13.4.8oa	HS_DSCH_RECEPTION_CELL_FACH_STATE	1465
13.4.8ob	HS_DSCH_RECEPTION_OF_CCCH_ENABLED	1465
13.4.8oc	HS_DSCH_RECEPTION_GENERAL	1466
13.4.8od	SECONDARY_CELL_HS_DSCH_RECEPTION	1466
13.4.8oe	HS_DSCH_DRX_CELL_FACH_STATUS	1466
13.4.8of	HS_DSCH_RECEPTION_OF_ETWS_ENABLED	1467
13.4.8ooo	HS_SCCH_LESS_PARAMS	1467
13.4.8oooo	HS_SCCH_LESS_STATUS	1467
13.4.8a	INCOMPATIBLE_SECURITY_RECONFIGURATION	1467
13.4.8b	Void	1468
13.4.8c	Void	1468
13.4.8d	HSPA_RNTI_STORED_CELL_PCH	1468
13.4.9	INITIAL_UE_IDENTITY	1468
13.4.9a	INTEGRITY_PROTECTION_ACTIVATION_INFO	1468
13.4.10	INTEGRITY_PROTECTION_INFO	1469
13.4.10a	INTER_RAT_HANDOVER_INFO_TRANSFERRED	1469
13.4.11	INVALID_CONFIGURATION	1471
13.4.11a	LATEST_CONFIGURED_CN_DOMAIN	1471
13.4.11b	LATEST_CONFIGURED_SRB_DELAY_AND_PC_PREAMBLE	1471
13.4.11c	MBMS_ACTIVATED_services	1471
13.4.11d	MBMS_PREV_FREQUENCY_INFO	1472
13.4.11e	MBMS_PL_Service_Restriction_Info_dedicated	1472
13.4.12	MEASUREMENT_IDENTITY	1473
13.4.13	Void	1473
13.4.13a	MIMO_PARAMS	1473
13.4.13b	MIMO_STATUS	1474
13.4.14	ORDERED_RECONFIGURATION	1474
13.4.14a	PDCP_ROHC_TARGET_MODE	1475
13.4.15	PDCP_SN_INFO	1475
13.4.15a	PHYSICAL_SHARED_CHANNEL_CONFIGURATION	1475
13.4.15b	PPAC_PARAM	1476
13.4.15c	PRIORITY_INFO_LIST	1476
13.4.16	PROTOCOL_ERROR_INDICATOR	1479
13.4.17	PROTOCOL_ERROR_INFORMATION	1480
13.4.18	PROTOCOL_ERROR_REJECT	1480
13.4.19	RB_TIMER_INDICATOR	1480
13.4.20	RB_UPLINK_CIPHERING_ACTIVATION_TIME_INFO	1480
13.4.20o	RNC_CAPABILITY_CHANGE_SUPPORT	1480
13.4.20oo	READY_FOR_COMMON_EDCH	1481
13.4.20a	SECURITY_MODIFICATION	1481
13.4.21	Void	1481
13.4.22	START_THRESHOLD	1481
13.4.23	START_VALUE_TO_TRANSMIT	1481
13.4.23a	TARGET_CELL_PRECONFIGURATION	1482
13.4.24	TFC_SUBSET	1482
13.4.25	TGPS_IDENTITY	1484
13.4.26	TGSN_REPORTED	1484
13.4.26a	TIMERS_AND_CONSTANTS	1484
13.4.27	TRANSACTIONS	1485
13.4.27o	Void	1485

13.4.27a	TRIGGERED_1A_EVENT	1485
13.4.27b	TRIGGERED_1B_EVENT	1486
13.4.27c	TRIGGERED_1C_EVENT	1487
13.4.27d	BEST_CELL_1D_EVENT	1487
13.4.27e	TRIGGERED_1E_EVENT	1487
13.4.27f	TRIGGERED_1F_EVENT	1488
13.4.27f1	TRIGGERED_1G_EVENT	1488
13.4.27f2	TRIGGERED_1H_EVENT	1488
13.4.27f3	TRIGGERED_1I_EVENT	1488
13.4.27f4	BEST_FREQUENCY_2A_EVENT	1489
13.4.27f5	TRIGGERED_2B_EVENT	1489
13.4.27f6	TRIGGERED_2C_EVENT	1489
13.4.27f7	TRIGGERED_2D_EVENT	1489
13.4.27f8	TRIGGERED_2E_EVENT	1490
13.4.27f9	TRIGGERED_2F_EVENT	1490
13.4.27f10	TRIGGERED_3A_EVENT	1490
13.4.27f11	TRIGGERED_3B_EVENT	1491
13.4.27f12	TRIGGERED_3C_EVENT	1491
13.4.27f13	BEST_CELL_3D_EVENT	1492
13.4.27f14	TRIGGERED_6A_EVENT	1492
13.4.27f15	TRIGGERED_6B_EVENT	1493
13.4.27f16	TRIGGERED_6C_EVENT	1493
13.4.27f17	TRIGGERED_6D_EVENT	1493
13.4.27f18	TRIGGERED_6E_EVENT	1493
13.4.27f19	TRIGGERED_6F_EVENT	1493
13.4.27f20	TRIGGERED_6G_EVENT	1493
13.4.27f21	TRIGGERED_1J_EVENT	1494
13.4.27g	UE_CAPABILITY_REQUESTED	1494
13.4.28	UE_CAPABILITY_TRANSFERRED	1494
13.4.28a	UE_POSITIONING_GPS_DATA	1495
13.4.28b	UE_POSITIONING_OTDOA_DATA_UE_ASSISTED	1497
13.4.28c	UE_POSITIONING_OTDOA_DATA_UE_BASED	1497
13.4.28d	UE_POSITIONING_GANSS_DATA	1498
13.4.29	UNSUPPORTED_CONFIGURATION	1499
13.4.30	URA_IDENTITY	1500
13.4.31	U_RNTI	1500
13.4.32	VALUE_TAG	1500
13.4.33	CONTROL_CHANNEL_DRX_PARAMS	1504
13.4.34	CONTROL_CHANNEL_DRX_STATUS	1505
13.4.35	E_DCH_SPS_PARAMS	1505
13.4.36	E_DCH_SPS_STATUS	1505
13.4.37	HS_DSCH_SPS_PARAMS	1506
13.4.38	HS_DSCH_SPS_STATUS	1506
13.5	UE RRC Procedure Performance	1506
13.5.1	Definitions	1507
13.5.2	RRC procedure performance values	1507
13.6	RB information parameters for signalling radio bearer RB 0	1512
13.6a	RB information parameters for SHCCH	1513
13.6b	RB information parameters for BCCH mapped to FACH	1513
13.6c	RB information parameters for PCCH mapped to PCH	1513
13.6d	Parameters for BCCH mapped to BCH	1513
13.6e	RB information parameters for signalling radio bearer RB 0 mapped on HS-DSCH and RACH	1513
13.6f	RB information parameters for BCCH mapped to HS-DSCH	1514
13.6g	RB information parameters for PCCH mapped to HS-DSCH	1514
13.6h	RB information parameters for signalling radio bearer RB 0 mapped on HS-DSCH and common E-DCH	1514
13.7	Parameter values for default radio configurations	1515
13.8	Parameter values for default radio configurations in CELL_FACH	1583
14	Specific functions	1583
14.1	Intra-frequency measurements	1583
14.1.1	Intra-frequency measurement quantities	1583

14.1.2	Intra-frequency reporting events for FDD	1583
14.1.2.1	Reporting event 1A: A Primary CPICH enters the reporting range	1584
14.1.2.2	Reporting event 1B: A primary CPICH leaves the reporting range	1586
14.1.2.3	Reporting event 1C: A non-active primary CPICH becomes better than an active primary CPICH	1588
14.1.2.4	Reporting event 1D: Change of best cell.....	1591
14.1.2.5	Reporting event 1E: A Primary CPICH becomes better than an absolute threshold.....	1593
14.1.2.6	Reporting event 1F: A Primary CPICH becomes worse than an absolute threshold	1595
14.1.2.7	Reporting event 1J: A non-active E-DCH but active DCH primary CPICH becomes better than an active E-DCH primary CPICH	1597
14.1.3	Intra-frequency reporting events for TDD	1599
14.1.3.1	Reporting event 1G: Change of best cell (TDD).....	1599
14.1.3.2	Reporting event 1H: Timeslot ISCP below a certain threshold (TDD).....	1601
14.1.3.3	Reporting event 1I: Timeslot ISCP above a certain threshold (TDD).....	1602
14.1.4	Event-triggered periodic intra-frequency measurement reports (informative)	1604
14.1.4.1	Cell addition failure (FDD only)	1604
14.1.4.1a	Cell removal failure (FDD only)	1605
14.1.4.2	Cell replacement failure (FDD only)	1606
14.1.5	Mechanisms available for modifying intra-frequency measurement reporting behaviour (informative)	1606
14.1.5.1	Hysteresis	1606
14.1.5.2	Time-to-trigger	1607
14.1.5.3	Cell individual offsets	1608
14.1.5.4	Forbid a Primary CPICH to affect the reporting range (FDD only).....	1609
14.1.6	Report quantities in intra-frequency measurements.....	1610
14.2	Inter-frequency measurements	1611
14.2.0a	Inter-frequency measurement quantities	1611
14.2.0b	Frequency quality estimate	1611
14.2.0b.1	FDD cells	1611
14.2.0b.2	TDD cells	1612
14.2.0c	Inter-frequency reporting quantities	1612
14.2.1	Inter-frequency reporting events	1613
14.2.1.1	Event 2a: Change of best frequency.....	1613
14.2.1.2	Event 2b: The estimated quality of the currently used frequency is below a certain threshold and the estimated quality of a non-used frequency is above a certain threshold.....	1614
14.2.1.3	Event 2c: The estimated quality of a non-used frequency is above a certain threshold	1615
14.2.1.4	Event 2d: The estimated quality of the currently used frequency is below a certain threshold.....	1616
14.2.1.5	Event 2e: The estimated quality of a non-used frequency is below a certain threshold	1617
14.2.1.6	Event 2 f: The estimated quality of the currently used frequency is above a certain threshold	1618
14.3	Inter-RAT measurements	1619
14.3.0a	Inter-RAT measurement quantities.....	1619
14.3.0b	Frequency quality estimate of the UTRAN frequency	1620
14.3.0c	Inter-RAT reporting quantities	1620
14.3.1	Inter-RAT reporting events.....	1620
14.3.1.1	Event 3a: The estimated quality of the currently used UTRAN frequency is below a certain threshold and the estimated quality of the other system is above a certain threshold.....	1621
14.3.1.2	Event 3b: The estimated quality of other system is below a certain threshold.....	1623
14.3.1.3	Event 3c: The estimated quality of other system is above a certain threshold	1625
14.3.1.4	Event 3d: Change of best cell in other system	1626
14.3.2	GSM measurements in compressed mode	1628
14.3.2.1	GSM RSSI measurements.....	1628
14.3.2.2	Initial BSIC identification	1628
14.3.2.3	BSIC re-confirmation.....	1629
14.3.3	E-UTRA measurements in compressed mode	1629
14.3.3.1	E-UTRA RSRP measurements.....	1629
14.3.3.2	E-UTRA RSRQ measurements.....	1629
14.4	Traffic Volume Measurements.....	1629
14.4.1	Traffic Volume Measurement Quantity	1629
14.4.2	Traffic Volume reporting triggers.....	1629
14.4.2.1	Reporting event 4 A: Transport Channel Traffic Volume becomes larger than an absolute threshold.....	1634
14.4.2.2	Reporting event 4 B: Transport Channel Traffic Volume becomes smaller than an absolute threshold.....	1635

14.4.3	Traffic volume reporting mechanisms	1635
14.4.3.1	Pending time after trigger.....	1635
14.4.3.2	Time-to-trigger.....	1636
14.4.4	Interruption of user data transmission.....	1636
14.5	Quality Measurements.....	1637
14.5.1	Quality reporting measurement quantities	1637
14.5.2	Quality reporting events.....	1637
14.5.2.1	Reporting event 5A: A predefined number of bad CRCs is exceeded	1637
14.6	UE internal measurements.....	1638
14.6.1	UE internal measurement quantities	1638
14.6.2	UE internal measurement reporting events.....	1638
14.6.2.1	Reporting event 6A: The UE Tx power becomes larger than an absolute threshold.....	1638
14.6.2.2	Reporting event 6B: The UE Tx power becomes less than an absolute threshold	1638
14.6.2.3	Reporting event 6C: The UE Tx power reaches its minimum value	1639
14.6.2.4	Reporting event 6D: The UE Tx power reaches its maximum value	1640
14.6.2.5	Reporting event 6E: The UE RSSI reaches the UE's dynamic receiver range	1641
14.6.2.6	Reporting event 6F (FDD): The UE Rx-Tx time difference for a RL included in the active set becomes larger than an absolute threshold.....	1641
14.6.2.6a	Reporting event 6F (1.28 Mcps TDD): The time difference indicated by T _{ADV} becomes larger than an absolute threshold	1642
14.6.2.7	Reporting event 6G: The UE Rx-Tx time difference for a RL included in the active set becomes less than an absolute threshold	1642
14.7	UE positioning measurements.....	1643
14.7.1	UE positioning measurement quantities	1643
14.7.2	Void	1643
14.7.3	UE positioning reporting events	1643
14.7.3.1	Reporting Event 7a: The UE position changes more than an absolute threshold.....	1643
14.7.3.2	Reporting Event 7b: SFN-SFN measurement changes more than an absolute threshold.....	1644
14.7.3.3	Reporting Event 7c: GPS time and SFN time have drifted apart more than an absolute threshold ..	1644
14.7.3.4	Reporting Event 7d: GANSS time and SFN time have drifted apart more than an absolute threshold.....	1645
14.8	Void.....	1645
14.9	Downlink power control.....	1645
14.9.1	Generalities	1645
14.9.2	Downlink power control in compressed mode	1645
14.10	Calculated Transport Format Combination	1646
14.10.1	Default TFCS for MBMS	1647
14.10.1.1	S-CCPCH configuration including a FACH carrying MSCH.....	1647
14.10.1.2	S-CCPCH configuration not including a FACH carrying MSCH.....	1647
14.11	UE autonomous update of virtual active set on non-used frequency (FDD only)	1647
14.11.1	Initial virtual active set	1648
14.11.2	Virtual active set update during an inter-frequency measurement.....	1649
14.12	Provision and reception of RRC information between network nodes.....	1650
14.12.0	General.....	1650
14.12.0a	General error handling for RRC messages exchanged between network nodes	1651
14.12.1	RRC Information to target RNC	1651
14.12.2	RRC information, target RNC to source RNC.....	1652
14.12.3	Void	1653
14.12.4	RRC messages exchanged between network nodes.....	1653
14.12.4.0	HANDOVER TO UTRAN COMMAND	1653
14.12.4.0a	INTER RAT HANDOVER INFO	1653
14.12.4.1	INTER RAT HANDOVER INFO WITH INTER RAT CAPABILITIES.....	1653
14.12.4.2	SRNS RELOCATION INFO	1655
14.12.4.3	Void.....	1668
14.12.4.4	RFC 3095 CONTEXT INFO	1668
14.13	Void.....	1671
14.14	Void.....	1671
Annex A (informative): USIM parameters		1672
A.1	Introduction	1672
A.2	Ciphering information	1672
A.3	Frequency information	1672

A.4	Multiplicity values and type constraint values	1673
Annex B (informative):	Description of RRC state transitions including GSM and E-UTRA.....	1674
B.1	RRC states and state transitions	1674
B.2	Transition from Idle Mode to UTRA RRC Connected Mode	1674
B.2.1	Transitions for Emergency Calls	1674
B.3	UTRA RRC Connected Mode States and Transitions.....	1674
B.3.1	CELL_DCH state.....	1674
B.3.1.1	Transition from CELL_DCH to Idle Mode.....	1675
B.3.1.2	Transition from CELL_DCH to CELL_FACH state	1675
B.3.1.3	Transition from CELL_DCH to CELL_PCH state	1675
B.3.1.4	Transition from CELL_DCH to URA_PCH state.....	1675
B.3.1.5	Radio Resource Allocation tasks (CELL_DCH).....	1675
B.3.1.6	RRC Connection mobility tasks (CELL_DCH).....	1676
B.3.1.7	UE Measurements (CELL_DCH)	1676
B.3.1.8	Acquisition of system information (CELL_DCH)	1676
B.3.2	CELL_FACH state	1676
B.3.2.1	Transition from CELL_FACH to CELL_DCH state	1677
B.3.2.2	Transition from CELL_FACH to CELL_PCH state	1677
B.3.2.3	Transition from CELL_FACH to Idle Mode	1677
B.3.2.4	Transition from CELL_FACH to URA_PCH State.....	1677
B.3.2.5	Radio Resource Allocation Tasks (CELL_FACH)	1677
B.3.2.6	RRC Connection mobility tasks (CELL_FACH).....	1678
B.3.2.7	UE Measurements (CELL_FACH).....	1678
B.3.2.8	Transfer and update of system information (CELL_FACH).....	1678
B.3.3	CELL_PCH state	1678
B.3.3.1	Transition from CELL_PCH to CELL_FACH state	1679
B.3.3.2	Radio Resource Allocation Tasks (CELL_PCH).....	1679
B.3.3.3	RRC Connection mobility tasks (CELL_PCH).....	1679
B.3.3.4	UE Measurements (CELL_PCH).....	1679
B.3.3.5	Transfer and update of system information (CELL_PCH)	1679
B.3.4	URA_PCH State	1679
B.3.4.1	Transition from URA_PCH State to CELL_FACH State (URA_PCH)	1680
B.3.4.2	Radio Resource Allocation Tasks (URA_PCH).....	1680
B.3.4.3	RRC Connection mobility tasks (URA_PCH)	1680
B.3.4.4	UE Measurements (URA_PCH)	1680
B.3.4.5	Transfer and update of system information (URA_PCH).....	1680
B.3.5	States and Transitions for Cell Reselection in URA_PCH, CELL_PCH, and CELL_FACH	1681
B.4	Inter-RAT handover with CS domain services.....	1681
B.5	Inter-RAT handover with PS domain services	1682
B.6	Inter-RAT handover with simultaneous PS and CS domain services.....	1682
B.6.1	Inter-RAT handover UTRAN to GSM / BSS	1682
B.6.2	Inter-RAT handover GSM / BSS to UTRAN	1682
Annex C (informative):	Description for the Compressed Coding of Pre-defined configurations included in the INTER RAT HANDOVER INFO message	1684
C.1	Definitions	1684
C.2	Examples of the methodology	1684
Annex D (Normative):	Implementation of Domain Specific Access Control (DSAC) in UEs of 3GPP Release 5.....	1687
Annex E (Normative):	EUTRA Feature group indicators.....	1688
Annex F (informative):	Change history	1690
History		1733

Foreword

This Technical Specification has been produced by the 3rd Generation Partnership Project (3GPP).

The contents of the present document are subject to continuing work within the TSG and may change following formal TSG approval. Should the TSG modify the contents of the present document, it will be re-released by the TSG with an identifying change of release date and an increase in version number as follows:

Version x.y.z

where:

- x the first digit:
 - 1 presented to TSG for information;
 - 2 presented to TSG for approval;
 - 3 or greater indicates TSG approved document under change control.
- y the second digit is incremented for all changes of substance, i.e. technical enhancements, corrections, updates, etc.
- z the third digit is incremented when editorial only changes have been incorporated in the document.

1 Scope

The present document specifies the Radio Resource Control protocol for the UE-UTRAN radio interface.

The scope of the present document also includes:

- the information to be transported in a transparent container between source RNC and target RNC in connection with SRNC relocation;
- the information to be transported in a transparent container between a target RNC and another system.

2 References

The following documents contain provisions which, through reference in this text, constitute provisions of the present document.

- References are either specific (identified by date of publication, edition number, version number, etc.) or non-specific.
- For a specific reference, subsequent revisions do not apply.
- For a non-specific reference, the latest version applies. In the case of a reference to a 3GPP document (including a GSM document), a non-specific reference implicitly refers to the latest version of that document *in the same Release as the present document*.

- [1] 3GPP TR 21.905: "Vocabulary for 3GPP Specifications".
- [2] 3GPP TS 25.301: "Radio Interface Protocol Architecture".
- [3] 3GPP TS 25.303: "Interlayer Procedures in Connected Mode".
- [4] 3GPP TS 25.304: "UE Procedures in Idle Mode and Procedures for Cell Reselection in Connected Mode".
- [5] 3GPP TS 24.008: "Mobile radio interface layer 3 specification; Core Network Protocols; Stage 3".
- [6] 3GPP TS 25.103: "RF parameters in support of RRM".
- [7] 3GPP TS 25.215: "Physical layer – Measurements (FDD)".
- [8] 3GPP TS 25.225: "Physical layer – Measurements (TDD)".
- [9] 3GPP TS 25.401: "UTRAN overall description".
- [10] 3GPP TS 25.402: "Synchronization in UTRAN; Stage 2".
- [11] 3GPP TS 23.003: "Numbering, addressing and identification".
- [12] ICD-GPS-200: "Navstar GPS Space Segment/Navigation User Interface".
- [13] RTCM-SC104: "RTCM Recommended Standards for Differential GNSS Service (v.2.2)".
- [14] 3GPP TR 25.921: "Guidelines and principles for protocol description and error handling".
- [15] 3GPP TS 25.321: "Medium Access Control (MAC) protocol specification".
- [16] 3GPP TS 25.322: "Radio Link Control (RLC) protocol specification".
- [17] 3GPP TS 24.007: "Mobile radio interface signalling layer 3; General aspects".
- [18] 3GPP TS 25.305: "Stage 2 Functional Specification of UE Positioning in UTRAN".
- [19] 3GPP TS 25.133: "Requirements for Support of Radio Resource Management (FDD)".

- [20] 3GPP TS 25.123: "Requirements for Support of Radio Resource Management (TDD)".
- [21] 3GPP TS 25.101: "UE Radio Transmission and Reception (FDD)".
- [22] 3GPP TS 25.102: "UE Radio Transmission and Reception (TDD)".
- [23] 3GPP TS 23.060: "General Packet Radio Service (GPRS); Service description; Stage 2".
- [24] 3GPP TS 23.032: "Universal Geographical Area Description (GAD)".
- [25] 3GPP TS 23.122: "Non-Access-Stratum functions related to Mobile Station (MS) in idle mode".
- [26] 3GPP TS 25.211: "Physical channels and mapping of transport channels onto physical channels (FDD)".
- [27] 3GPP TS 25.212: "Multiplexing and channel coding (FDD)".
- [28] 3GPP TS 25.213: "Spreading and modulation (FDD)".
- [29] 3GPP TS 25.214: "Physical layer procedures (FDD)".
- [30] 3GPP TS 25.221: "Physical channels and mapping of transport channels onto physical channels (TDD)".
- [31] 3GPP TS 25.222: "Multiplexing and channel coding (TDD)".
- [32] 3GPP TS 25.223: "Spreading and modulation (TDD)".
- [33] 3GPP TS 25.224: "Physical Layer Procedures (TDD)".
- [34] 3GPP TS 25.302: "Services provided by the physical layer".
- [35] 3GPP TS 25.306 "UE Radio Access Capabilities".
- [36] 3GPP TS 25.323: "Packet Data Convergence Protocol (PDCP) Specification".
- [37] 3GPP TS 25.324: "Broadcast/Multicast Control BMC".
- [38] 3GPP TR 25.922: "Radio resource management strategies".
- [39] 3GPP TR 25.925: "Radio interface for broadcast/multicast services".
- [40] 3GPP TS 33.102: "3G Security; Security Architecture".
- [41] 3GPP TS 34.108: "Common Test Environments for User Equipment (UE) Conformance Testing".
- [42] 3GPP TS 34.123-2: "User Equipment (UE) conformance specification; Part 2: Implementation Conformance Statement (ICS) proforma specification".
- [43] 3GPP TS 44.018: "Mobile radio interface layer 3 specification; Radio Resource Control Protocol".
- [44] 3GPP TS 44.060: "General Packet Radio Service (GPRS); Mobile Station (MS) - Base Station System (BSS) interface; Radio Link Control/Medium Access Control (RLC/MAC) protocol".
- [45] 3GPP TS 45.005: "Radio transmission and reception".
- [46] 3GPP TS 45.008: "Radio subsystem link control".
- [47] ITU-T Recommendation X.680 (07/2002) "Information Technology - Abstract Syntax Notation One (ASN.1): Specification of basic notation".
- [48] ITU-T Recommendation X.681 (07/2002) "Information Technology - Abstract Syntax Notation One (ASN.1): Information object specification".
- [49] ITU-T Recommendation X.691 (07/2002) "Information technology - ASN.1 encoding rules: Specification of Packed Encoding Rules (PER)".
- [50] 3GPP TS 31.102: "Characteristics of the USIM Application".

- [51] 3GPP TS 25.308: "High Speed Downlink Packet Access (HSDPA): Overall Description; Stage 2".
- [52] IANA ROHC profile identifier definition (<http://www.iana.org/assignments/rohc-pro-ids>).
- [53] 3GPP TS 44.118: "Mobile radio interface layer 3 specification; Radio Resource Control Protocol, Iu Mode".
- [54] 3GPP TS 23.246: "Multimedia Broadcast Multicast Service; Architecture and Functional Description".
- [55] 3GPP TS 25.346: " Introduction of the Multimedia Broadcast Multicast Service (MBMS) in the Radio Access Network (Stage-2)".
- [56] 3GPP TR 25.992: "Multimedia Broadcast Multicast Service (MBMS); UTRAN/GERAN Requirements".
- [57] 3GPP TS 25.413: "UTRAN Iu Interface RANAP Signalling".
- [58] 3GPP TS 25.309: "FDD Enhanced Uplink; Overall Description; Stage 2".
- [59] 3GPP TS 25.319: "Enhanced Uplink; Overall Description; Stage 2".
- [60] 3GPP TR 25.827: "1.28Mcps TDD Enhanced Uplink; Physical Layer Aspects".
- [61] Galileo OS Signal in Space ICD (OS SIS ICD), Draft 0, Galileo Joint Undertaking, May 23rd, 2006.
- [62] 3GPP TS 26.101: "Adaptive Multi-Rate (AMR) speech codec frame structure".
- [63] 3GPP TS 26.201: "Adaptive Multi Rate – Wideband (AMR-WB) speech codec frame structure".
- [64] 3GPP TS 36.101: "Evolved Universal Terrestrial Radio Access (E-UTRA); User Equipment (UE) radio transmission and reception".
- [65] 3GPP TS 36.104: "Evolved Universal Terrestrial Radio Access (E-UTRA); Base Station (BS) radio transmission and reception".
- [66] 3GPP TS 36.304: "Evolved Universal Terrestrial Radio Access (E-UTRA); User Equipment (UE) procedures in idle mode".
- [67] 3GPP TS 36.331: "Evolved Universal Terrestrial Radio Access (E-UTRA); Radio Resource Control (RRC); Protocol Specification".
- [68] IS-GPS-200, Revision D, Navstar GPS Space Segment/Navigation User Interfaces, March 7th, 2006.
- [69] IS-GPS-705, Navstar GPS Space Segment/User Segment L5 Interfaces, September 22, 2005.
- [70] IS-GPS-800, Navstar GPS Space Segment/User Segment L1C Interfaces, March 31, 2008.
- [71] Specification for the Wide Area Augmentation System (WAAS), US Department of Transportation, Federal Aviation Administration, DTFA01-96-C-00025, 2001.
- [72] IS-QZSS, Quasi Zenith Satellite System Navigation Service Interface Specifications for QZSS, Ver.1.0, June 17, 2008.
- [73] Global Navigation Satellite System GLONASS Interface Control Document, Version 5, 2002.
- [74] 3GPP TS 36.133: "Evolved Universal Terrestrial Radio Access (E-UTRA); Requirements for support of radio resource management".
- [75] 3GPP TS 22.011: "Service accessibility".
- [76] 3GPP TS 23.003: "Numbering, addressing and identification".
- [77] 3GPP TS 23.041: "Technical realization of Cell Broadcast Service (CBS)".

- [78] 3GPP TS 33.401: "3GPP System Architecture Evolution (SAE): Security architecture".
- [79] 3GPP TS 24.301: " Non-Access-Stratum (NAS) protocol for Evolved Packet System (EPS)".

3 Definitions and abbreviations

3.1 Definitions

For the purposes of the present document, the terms and definitions given in [1] apply, together as:

Adjacent Frequency: A frequency whose centre is within 5 MHz of the centre of the currently used frequency and belongs to the same frequency band as that of the currently used frequency.

Common E-DCH resource: In FDD, common E-DCH resources are under direct control of the Node B and are shared by UEs in CELL_FACH state and IDLE mode. In 1.28 Mcps TDD, common E-DCH resources used by UEs in CELL_FACH and IDLE mode are under direct control of Node B and are shared by UEs in the CELL_DCH state.

Current Frequency (FDD only): The frequency that is currently used by the UE. In case of dual cell configured, the serving HS-DSCH cell frequency is treated as current frequency.

Data Description Indicator (DDI): MAC-e header field used to identify the logical channel, MAC-d flow and the size of the MAC-d PDUs concatenated into a MAC-es PDU.

E-DCH active set (FDD only): The set of cells which carry the E-DCH for one UE. Only radio links for which an E-HICH configuration is stored are considered part of the E-DCH active set.

Enhanced Uplink in CELL_FACH state and Idle mode: In FDD, combines the REL99 random access power ramping phase with E-DCH transmission. The procedure can be started in idle mode and RRC Connected mode, but not in CELL_DCH state. In 1.28 Mcps TDD, the REL7 enhanced random access procedure for E-DCH in CELL_DCH is used in idle mode and CELL_FACH state.

HARQ profile: One HARQ profile consists of a power offset attribute and maximum number of transmissions.

MBMS activated services: the MBMS multicast services the UE has joined as well as the broadcast services the UE is interested in.

MCCH acquisition: the procedure for acquiring all MCCH information relevant for the UE ie. includes reception of the RB information for the UE's MBMS activated services.

MBMS controlling cell: the cell from which the UE receives MCCH.

MBMS notification: a notification provided by UTRAN indicating a change in the provision of one or more MBMS services.

MBMS Selected Services: a subset of the MBMS activated services of the Broadcast type for which the UE applies RRC procedures to inform UTRAN that the service has been selected (by upper layers).

MBMS transmission: a possibly repeated session of an MBMS service. An MBMS transmission is uniquely identified by the combination of the MBMS service identity and the MBMS session identity.

MBSFN cluster: Set of cells operating in MBSFN mode providing only MBMS service in PtM mode and seen as one cell by a UE.

MBSFN mode: Transmission mode where a set of synchronized cells transmit exactly the same data for provision of MBMS service.

Primary Absolute Grant (FDD only): Absolute Grant received with the primary E-RNTI.

Secondary Absolute Grant (FDD only): Absolute Grant received with the secondary E-RNTI.

Serving E-DCH cell: Cell from which the UE receives Absolute Grants from the Node-B scheduler. A UE has one Serving E-DCH cell.

Serving E-DCH RLS or Serving RLS (FDD only): Set of cells which contains at least the Serving E-DCH cell and from which the UE can receive and combine one Relative Grant. The UE has only one Serving E-DCH RLS.

Non-serving E-DCH RL or Non-serving RL (FDD only): Cell which belongs to the E-DCH active set but does not belong to the Serving E-DCH RLS and from which the UE in CELL_DCH can receive one Relative Grant. The UE can have zero, one or several Non-serving E-DCH RL(s).

SR-VCC: Single Radio Voice Call Continuity, Voice call continuity between IMS over PS access and CS access for calls that are anchored in IMS when the UE is capable of transmitting/receiving on only one of those access networks at a given time.

Target Cell Pre-Configuration (FDD only): HS-DSCH Cell configuration provided to UE in Active Set Update for which HS-DSCH serving Cell Change may be initiated by HS-SCCH order sent from target cell.

Target cell HS-SCCH order: A HS-DSCH serving cell change command signaled to an UE by using HS-SCCH order in the target cell for which a measurement report was triggered by an Event 1d intra frequency event.

3.2 Abbreviations

For the purposes of the present document, the following abbreviations apply:

ACK	Acknowledgement
AG	Absolute Grant
AICH	Acquisition Indicator CHannel
AM	Acknowledged Mode
AS	Access Stratum
ASC	Access Service Class
ASN.1	Abstract Syntax Notation.1
BCCH	Broadcast Control Channel
BCFE	Broadcast Control Functional Entity
BER	Bit Error Rate
BLER	Block Error Rate
BSS	Base Station Sub-system
CCCH	Common Control Channel
CCPCH	Common Control Physical CHannel
CH	Conditional on history
CM	Connection Management
CN	Core Network
C-RNTI	Cell RNTI
CTCH	Common Traffic CHannel
CTFC	Calculated Transport Format Combination
CV	Conditional on value
DCA	Dynamic Channel Allocation
DCCH	Dedicated Control Channel
DCFE	Dedicated Control Functional Entity
DCH	Dedicated Channel
DC-SAP	Dedicated Control SAP
DDI	Data Description Indicator
DGANSS	Differential GANSS
DGPS	Differential Global Positioning System
DL	Downlink
DSCH	Downlink Shared Channel
DTCH	Dedicated Traffic Channel
DTM	Dual Transfer Mode
E-AGCH	E-DCH Absolute Grant Channel
ECEF	Earth-Centered, Earth-Fixed
ECI	Earth-Centered-Inertial
E-DCH	Enhanced uplink DCH
E-DPCCH	E-DCH Dedicated Physical Control Channel (FDD Only)
E-DPDCH	E-DCH Dedicated Physical Data Channel (FDD Only)
EGNOS	European Geostationary Navigation Overlay Service
E-HICH	E-DCH HARQ Acknowledgement Indicator Channel

E-PUCH	Enhanced Uplink Physical Channel (TDD only)
E-RGCH	E-DCH Relative Grant Channel (FDD only)
E-RNTI	E-DCH RNTI
E-RUCCH	E-DCH Random Access Uplink Control Channel (TDD only)
E-TFCI	E-DCH Transport Format Combination Indicator
ETWS	Earthquake and Tsunami Warning System
E-UCCH	E-DCH Uplink Control Channel (TDD only)
E-UTRA	Evolved Universal Terrestrial Radio Access
E-UTRAN	Evolved Universal Terrestrial Radio Access Network
FACH	Forward Access Channel
FDD	Frequency Division Duplex
F-DPCH	Fractional DPCH
GAGAN	GPS Aided Geo Augmented Navigation
GANSS	Galileo and Additional Navigation Satellite Systems
GC-SAP	General Control SAP
GERAN	GSM/EDGE Radio Access Network
GLONASS	GLObal'naya NAVigatsionnaya Sputnikovaya Sistema (Engl.: Global Navigation Satellite System)
GNSS	Global Navigation Satellite System
GRA	GERAN Registration Area
G-RNTI	GERAN Radio Network Temporary Identity
HARQ	Hybrid Automatic Repeat Request
HCS	Hierarchical Cell Structure
HFN	Hyper Frame Number
H-RNTI	HS-DSCH RNTI
HS-DSCH	High Speed Downlink Shared Channel
ICD	Interface Control Document
ID	Identifier
IDNNS	Intra Domain NAS Node Selector
IE	Information element
IETF	Internet Engineering Task Force
IMB	Integrated Mobile Broadcast
IMEI	International Mobile Equipment Identity
IMSI	International Mobile Subscriber Identity
IP	Internet Protocol
ISCP	Interference on Signal Code Power
L1	Layer 1
L2	Layer 2
L3	Layer 3
LAI	Location Area Identity
MAC	Media Access Control
MBMS	Multimedia Broadcast Multicast Service
MBSFN	MBMS over a Single Frequency Network
MCC	Mobile Country Code
MCCH	MBMS point-to-multipoint Control Channel
MD	Mandatory default
MICH	MBMS notification Indicator Channel
MM	Mobility Management
MNC	Mobile Network Code
MP	Mandatory present
MTCH	MBMS point-to-multipoint Traffic Channel
MSAS	Multi-functional Satellite Augmentation System
MSCH	MBMS point-to-multipoint Scheduling Channel
NACC	Network Assisted Cell Change
NAS	Non Access Stratum
Nt-SAP	Notification SAP
NW	Network
OP	Optional
PCCH	Paging Control Channel
PCH	Paging Channel
PDCP	Packet Data Convergence Protocol
PDSCH	Physical Downlink Shared Channel
PDU	Protocol Data Unit

PLMN	Public Land Mobile Network
PNFE	Paging and Notification Control Functional Entity
PRACH	Physical Random Access CHannel
PRN	Pseudo-Random Noise
PSI	Packet System Information
p-t-m	Point-to-Multipoint
P-TMSI	Packet Temporary Mobile Subscriber Identity
p-t-p	Point-to-Point
PUSCH	Physical Uplink Shared Channel
QoS	Quality of Service
QZSS	Quasi-Zenith Satellite System
RAB	Radio access bearer
RACH	Random Access CHannel
RAI	Routing Area Identity
RAT	Radio Access Technology
RB	Radio Bearer
RFE	Routing Functional Entity
RG	Relative Grant
RL	Radio Link
RLC	Radio Link Control
RLS	Radio Link Set
RNC	Radio Network Controller
RNTI	Radio Network Temporary Identifier
RRC	Radio Resource Control
RSCP	Received Signal Code Power
RSN	Retransmission Sequence Number
RSRP	Reference Signal Received Power
RSRQ	Reference Signal Received Quality
RSSI	Received Signal Strength Indicator
SAP	Service Access Point
SBAS	Satellite Based Augmentation System
SCFE	Shared Control Function Entity
SCTD	Space Code Transmit Diversity
SCTO	Soft Combining Timing Offset (MBMS)
SF	Spreading Factor
SG	Serving grant
SHCCH	Shared Control Channel
SI	System Information
SIR	Signal to Interference Ratio
SPS	Semi-Persistent Scheduling
S-RNTI	SRNC - RNTI
SV	Space Vehicle
TDD	Time Division Duplex
TF	Transport Format
TFCS	Transport Format Combination Set
TFS	Transport Format Set
TM	Transparent Mode
TME	Transfer Mode Entity
TMSI	Temporary Mobile Subscriber Identity
Tr	Transparent
TSN	Transmission Sequence Number
Tx	Transmission
UE	User Equipment
UL	Uplink
UM	Unacknowledged Mode
URA	UTRAN Registration Area
U-RNTI	UTRAN-RNTI
USCH	Uplink Shared Channel
UTC	Universal Coordinated Time
UTRAN	Universal Terrestrial Radio Access Network
WAAS	Wide Area Augmentation System
WGS-84	World Geodetic System 1984

4 General

If not specified differently, descriptions are relevant for both FDD and TDD. Descriptions for TDD only are relevant for both 1.28 Mcps TDD and 3.84 Mcps TDD and 7.68 Mcps TDD if not specified differently.

4.1 Overview of the specification

This specification is organised as follows:

- subclause 4.2 contains the description of the model of the RRC protocol layer;
- clause 5 lists the RRC functions and the services provided to upper layers;
- clause 6 lists the services expected from the lower layers and specifies the radio bearers available for usage by the RRC messages;
- clause 7 specifies the UE states for the Access Stratum, and also specifies the processes running in the UE in the respective states;
- clause 8 specifies RRC procedures, including UE state transitions;
- clause 9 specifies the procedures for the handling of unknown, unforeseen, and erroneous protocol data by the receiving entity;
- clause 10 describes the message in a Tabular format; these messages descriptions are referenced in clause 8;
- clause 11 specifies the encoding of the messages of the RRC protocol. This is based on the Tabular description in clause 10.
- clause 12 specifies the transfer syntax for RRC PDUs derived from the encoding definition;
- clause 13 lists the protocol timers, counters, constants and variables to be used by the UE;
- clause 14 specifies some of the processes applicable in UTRA RRC connected mode e.g. measurement processes, and also the RRC information to be transferred between network nodes. Note that not all the processes applicable in UTRA RRC connected mode are specified here i.e. some UTRA RRC connected mode processes are described in [4] e.g. cell re-selection;
- Annex A contains recommendations about the network parameters to be stored on the USIM;
- Annex B contains informative Stage 2 description of the RRC protocol states and state transitions.

The following figure summarises the mapping of UE states, including states in GSM and E-UTRA, to the appropriate UTRA, GSM and E-UTRA specifications that specify the UE behaviour.

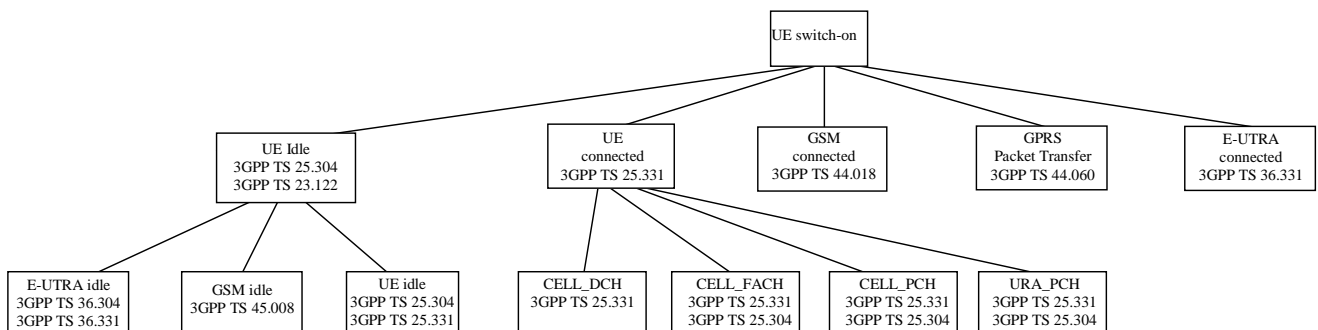

Figure 4.1-1: Mapping of UE state to 3GPP Specifications

4.2 RRC Layer Model

The functional entities of the RRC layer are described below:

- Routing of higher layer messages to different MM/CM entities (UE side) or different core network domains (UTRAN side) is handled by the Routing Function Entity (**RFE**).
- Broadcast functions are handled in the broadcast control function entity (**BCFE**). The BCFE is used to deliver the RRC services, which are required at the GC-SAP. The BCFE can use the lower layer services provided by the Tr-SAP and UM-SAP.
- Paging of UEs that do not have an RRC connection is controlled by the paging and notification control function entity (**PNFE**). The PNFE is used to deliver the RRC services that are required at the Nt-SAP. The PNFE can use the lower layer services provided by the Tr-SAP and UM-SAP.
- The Dedicated Control Function Entity (**DCFE**) handles all functions specific to one UE. The DCFE is used to deliver the RRC services that are required at the DC-SAP and can use lower layer services of UM/AM-SAP and Tr-SAP depending on the message to be sent and on the current UE service state.
- In TDD mode, the DCFE is assisted by the Shared Control Function Entity (SCFE) location in the C-RNC, which controls the allocation of the PDSCH and PUSCH using lower layers services of UM-SAP and Tr-SAP.
- The Transfer Mode Entity (TME) handles the mapping between the different entities inside the RRC layer and the SAPs provided by RLC.

NOTE 1: Logical information exchange is necessary also between the RRC sublayer functional entities. Most of that is implementation dependent and not necessary to present in detail in a specification.

Figure 4.2-1 shows the RRC model for the UE and Figure 4.2-2 and Figure 4.2-3 show the RRC model for the UTRAN.

NOTE 2: The figure shows only the types of SAPs that are used. Multiple instances of Tr-SAP, UM-SAP and AM-SAP are possible. Especially, different functional entities usually use different instances of SAP types.

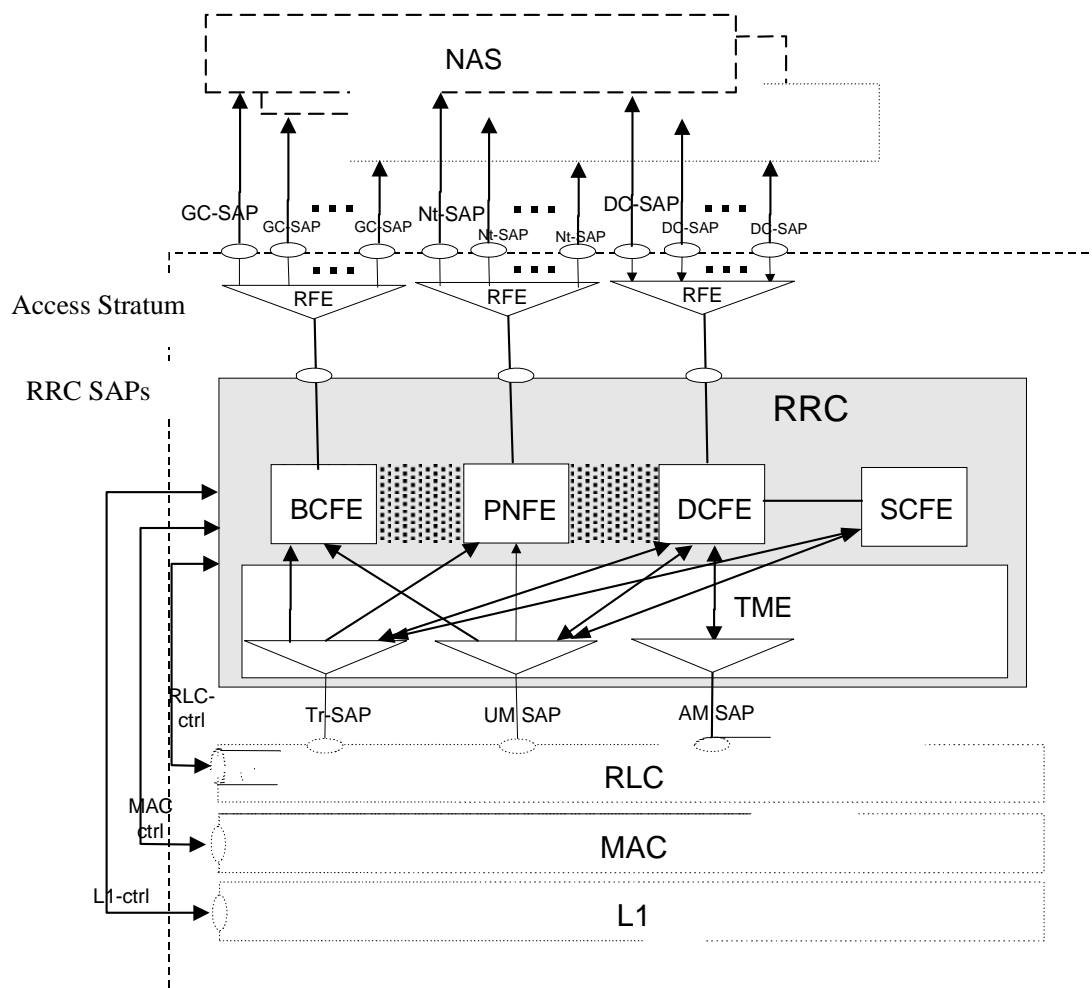

Figure 4.2-1: UE side model of RRC

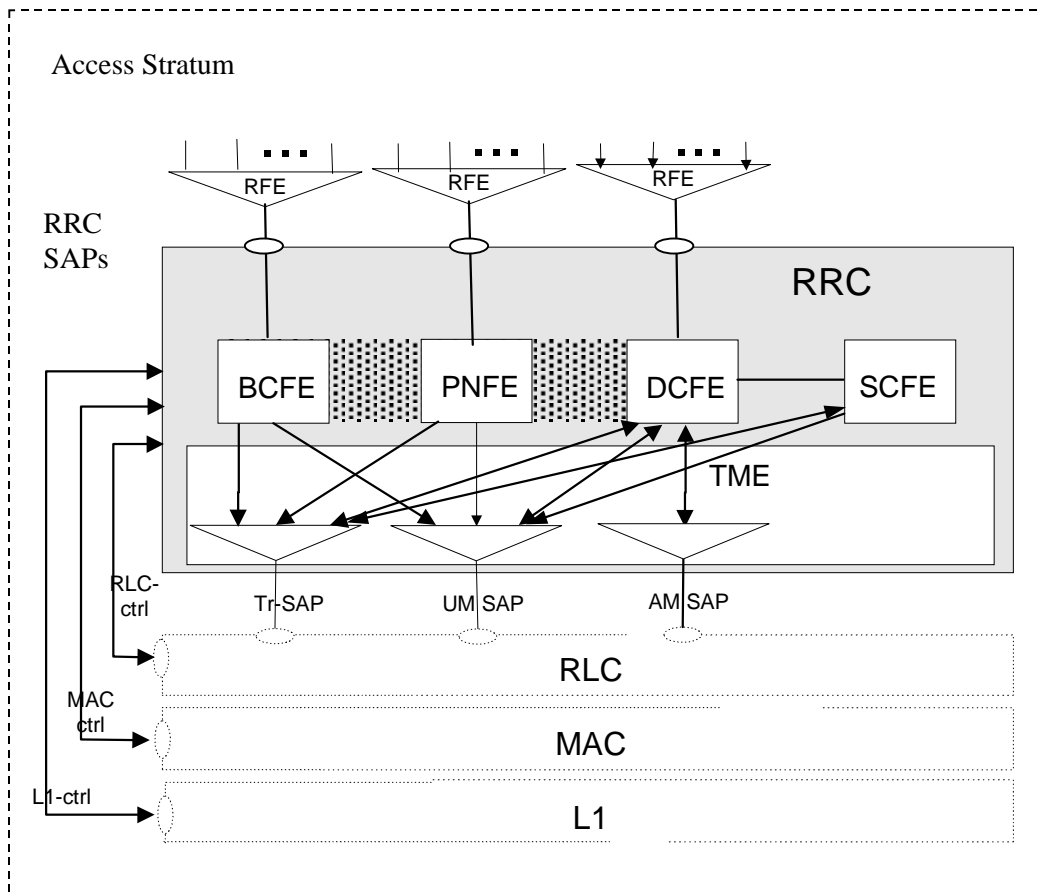

Figure 4.2-2: UTRAN side RRC model (DS-MAP system)

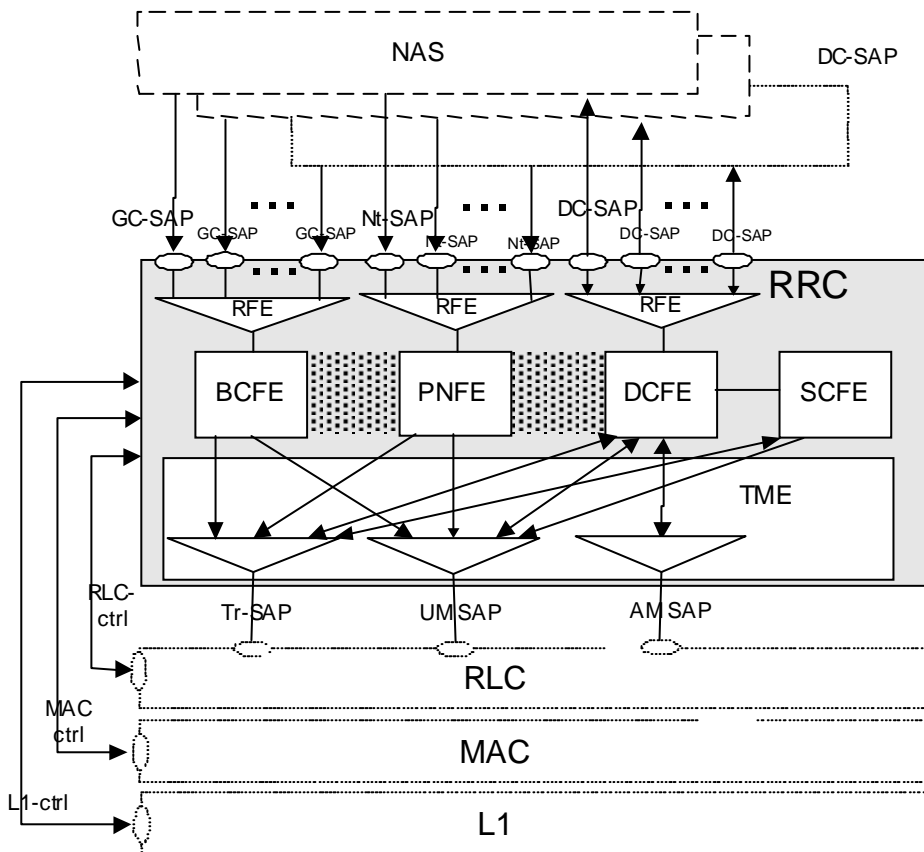

Figure 4.2-3: UTRAN side RRC model (DS-41 System)

4.3 Protocol specification principles

This protocol specification is based on the applicable general guidelines given in [14].

In this specification, a notation of variables is used. The variables are defined in subclause 13.4. Variables are typically used to represent a status or a result of an action, such as reception of an information element in a message, which is used to specify a behaviour somewhere else in the specification, such as when setting the value of an information element in a transmitted message. The variables only serve the purpose of specifying the protocol, and do not therefore impose any particular implementation.

When specifying the UE behaviour at reception of messages, the behaviour that is tied to reception or non-reception of individual information elements, and in some cases combinations of information elements, is specified in one location (subclause 8.6).

5 RRC Functions and Services provided to upper layers

5.1 RRC Functions

The RRC performs the functions listed below. A more detailed description of these functions is provided in [2]:

- Broadcast of information related to the non-access stratum (Core Network);
- Broadcast of information related to the access stratum;
- Establishment, maintenance and release of an RRC connection between the UE and UTRAN;
- Establishment, reconfiguration and release p-t-p of Radio Bearers;
- Establishment, reconfiguration and release of p-t-m Radio Bearers;
- Assignment, reconfiguration and release of radio resources for the RRC connection;
- RRC connection mobility functions;
- Control of requested QoS;
- UE measurement reporting and control of the reporting;
- Outer loop power control;
- Control of ciphering;
- Slow DCA (TDD mode);
- Paging;
- Initial cell selection and cell re-selection;
- Arbitration of radio resources on uplink DCH;
- RRC message integrity protection;
- Timing advance (TDD mode);
- CBS control;
- MBMS control.

5.2 RRC Services provided to upper layers

The RRC offers the following services to upper layers, a description and primitives of these services are provided in [2] and [17].

- General Control;
- Notification;
- Dedicated control.

The RRC layer provides the UE-UTRAN portion of signalling connections to the upper layers to support the exchange of upper layer's information flow. The signalling connection is used between the user equipment and the core network to transfer upper layer information. For each core network domain, at most one signalling connection may exist at the same time. The RRC layer maps the signalling connections for one UE on a single RRC connection. For the upper layer data transfer on signalling connections, the RRC layer supports the discrimination between two different classes, named "High priority" (corresponding to "SAPI 0" for a GSM-MAP based core network) and "Low priority" (corresponding to "SAPI 3" for a GSM-MAP based core network).

5.3 Primitives between RRC and upper layers

The primitives between RRC and the upper layers are described in [17].

6 Services expected from lower layers

6.1 Services expected from Layer 2

The services provided by layer 2 are described in [2], [15] and [16].

6.2 Services expected from Layer 1

The services provided by layer 1 are described in [2].

6.3 Signalling Radio Bearers

The Radio Bearers (RB) available for transmission of RRC messages are defined as "signalling radio bearers" and are specified in the following. The UE and UTRAN shall select the signalling radio bearers for RRC messages using RLC-TM, RLC-UM or RLC-AM on the DCCH and CCCH, according to the following:

- Signalling radio bearer RB0 shall be used for all messages sent on the CCCH (UL: RLC-TM, DL: RLC-UM).
- Signalling radio bearer RB1 shall be used for all messages sent on the DCCH, when using RLC unacknowledged mode (RLC-UM).
- Signalling radio bearer RB2 shall be used for all messages sent on the DCCH, when using RLC acknowledged mode (RLC-AM), except for the RRC messages carrying higher layer (NAS) signalling.
- Signalling radio bearer RB3 and optionally Signalling radio bearer RB4 shall be used for the RRC messages carrying higher layer (NAS) signalling and sent on the DCCH in RLC acknowledged mode (RLC-AM), as specified in subclauses 8.1.8., 8.1.9 and 8.1.10.
- Additionally, RBs whose identities shall be set between 5 and 32 may be used as signalling radio bearer for the RRC messages on the DCCH sent in RLC transparent mode (RLC-TM).
- RRC messages on the SHCCH are mapped either on RACH or on the USCH in the uplink using TM and either on FACH or on the DSCH using RLC-UM. These messages are only specified for TDD mode.

- RRC messages on the MCCH are mapped on FACH using RLC-UM. The transport channel configuration for MCCH is indicated on BCCH. For this signalling radio bearer no identity is applied.
- RRC messages on the MSCH are mapped on FACH using RLC-UM. The transport channel configuration for MSCH is indicated on MCCH. For this signalling radio bearer no identity is applied.

The Radio Bearer configuration for signalling radio bearer RB0, SHCCH, BCCH on FACH, PCCH on PCH, BCCH mapped to BCH, RB0 mapped on HS-DSCH (FDD only) and RACH, BCCH mapped on HS-DSCH (FDD and 1.28 Mcps TDD only), PCCH mapped to HS-DSCH (FDD and 1.28 Mcps TDD only) and RB0 mapped on HS-DSCH and common E-DCH (FDD and 1.28 Mcps TDD only) are specified in subclauses 13.6, 13.6a, 13.6b, 13.6c, 13.6e, 13.6f, 13.6g and 13.6h.

Ciphering is never applied to signalling radio bearer RB0 or signalling radio bearers using RLC TM.

7 Protocol states

7.1 Overview of RRC States and State Transitions including GSM and E-UTRA

Figure 7.1-1 shows the RRC states in UTRA RRC Connected Mode, including transitions between UTRA RRC connected mode and GSM connected mode for CS domain services, and between UTRA RRC connected mode and GSM/GPRS packet modes or E-UTRA RRC connected mode for PS domain services. It also shows the transitions between Idle Mode and UTRA RRC Connected Mode and furthermore the transitions within UTRA RRC connected mode.

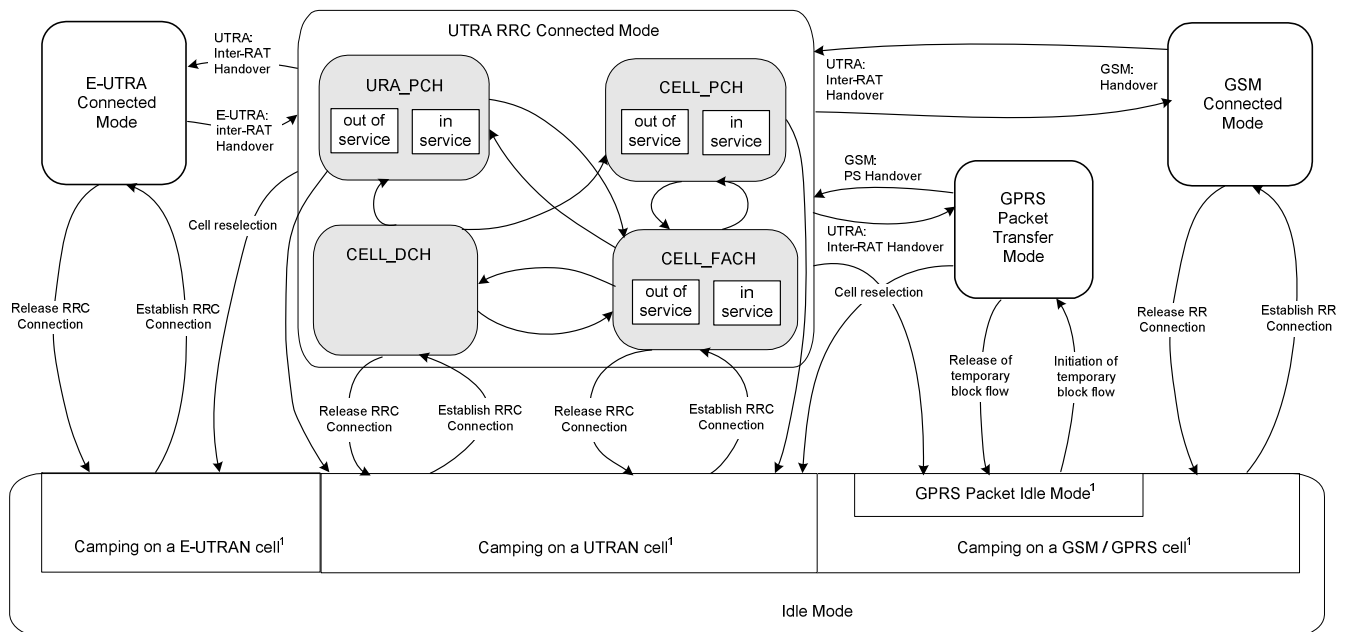

NOTE: ¹: The indicated division within Idle Mode is only included for clarification and shall not be interpreted as states.

NOTE: Transitions between GSM/GPRS and E-UTRA are not shown.

Figure 7.1-1: RRC States and State Transitions including GSM and E-UTRA

The RRC connection is defined as a point-to-point bi-directional connection between RRC peer entities in the UE and the UTRAN characterised by the allocation of a U-RNTI. A UE has either zero or one RRC connection.

If NAS informs AS about a new selected PLMN, registered PLMN or equivalent PLMN list while being in connected mode, the UE shall perform the actions according to subclause 8.5.24.

NOTE: The state transitions are specified in clause 8.

7.2 Processes in UE modes/states

NOTE: This subclause specifies what processes shall be active in the UE in the different RRC modes/states. The related procedures and the conditions on which they are triggered are specified either in clause 8 or elsewhere in the relevant process definition.

7.2.1 UE Idle mode

UE processes that are active in UE Idle mode are specified in [4].

The UE shall perform a periodic search for higher priority PLMNs as specified in [25], unless the UE is receiving MBMS services via p-t-m radio bearers.

A UE that is capable of receiving MBMS services on cells operating in MBSFN mode as specified in subclause 8.1.1.6.3 is operating in idle mode and acts on RRC messages and system information received from this cell operating in MBSFN mode independently from messages received from cells not operating in MBSFN mode. This implies that procedures executed based on messages and system information received from a cell operating in MBSFN mode shall not interact with messages and system information received from a cell not operating in MBSFN mode unless explicitly specified otherwise.

NOTE 1: This implies that the UE is operating an independent stack for the reception of MBMS services on cells operating in MBSFN mode as specified in subclause 8.1.1.6.3.

NOTE 2: For 1.28 Mcps TDD, if the cell is operating in MBSFN mode, system information and MCCH messages are transmitted on the MBSFN Special Timeslot [30].

7.2.2 UTRA RRC Connected mode

In this specification unless otherwise mentioned "connected mode" shall refer to "UTRA RRC connected mode".

7.2.2.1 URA_PCH or CELL_PCH state

In the URA_PCH or CELL_PCH state the UE shall perform the following actions:

NOTE: For 3.84 Mcps TDD and 7.68 Mcps TDD, neither DCCH nor DTCH are available in these states. For FDD and 1.28 Mcps TDD, DCCH and DTCH reception on HS-DSCH may be configured in CELL_PCH state, if the UE supports HS-DSCH reception in CELL_PCH and URA_PCH state. Otherwise, neither DCCH nor DTCH are available in CELL_PCH state. In URA_PCH, neither DCCH nor DTCH are available.

1> if the UE is "in service area":

- 2> maintain up-to-date system information as broadcast by the serving cell as specified in the subclause 8.1.1;
- 2> perform cell reselection process as specified in [4];
- 2> perform a periodic search for higher priority PLMNs as specified in [25], unless the UE is receiving MBMS services via p-t-m radio bearers;

NOTE: If the DRX cycle length is 80ms, then a search for higher priority PLMNs may not identify all the available PLMNs due to the paging occasion on the current serving cell coinciding with the MIB of the cell of interest.

- 2> for 3.84 Mcps TDD and 7.68 Mcps TDD; or
- 2> for FDD and 1.28 Mcps TDD, if the UE does not support HS-DSCH reception in CELL_PCH and URA_PCH state; or
- 2> if the IE "HS-DSCH paging system information" is not included in System Information Block type 5 or System Information Block type 5bis; or

- 2> for 1.28 Mcps TDD, if variable H_RNTI or variable C_RNTI is not set, and the IE "PICH info" is included in IE "Secondary CCPCH system information" in System Information Block type 5 or System Information Block type 6:
 - 3> monitor the paging occasions and PICH monitoring occasions determined according to subclauses 8.6.3.1a, 8.6.3.2 and 8.5.42 and receive paging information on the PCH mapped on the S-CCPCH selected by the UE according to the procedure in subclause 8.5.19;
 - 2> else:
 - 3> monitor the paging occasions and PICH monitoring occasions determined according to subclauses 8.6.3.1a, 8.6.3.2 and 8.5.39 and receive PCCH on the HS-DSCH mapped on the HS-PDSCH, or DCCH and DTCH on the HS-DSCH mapped on the HS-PDSCH and the associated HS-SCCH selected by the UE according to the procedure in subclause 8.5.40 for FDD and 8.5.40a for 1.28 Mcps TDD.
 - 2> act on RRC messages received on PCCH, BCCH, and DCCH (FDD only);
 - 2> perform measurements process according to measurement control information as specified in subclause 8.4 and in subclause 14.4;
 - 2> maintain up-to-date BMC data if it supports Cell Broadcast Service (CBS) as specified in [37];
 - 2> act on RRC messages received on MCCH if it supports MBMS and has activated an MBMS service as specified in subclause 8.7;
 - 2> run timer T305 for periodical URA update if the UE is in URA_PCH or for periodical cell update if the UE is in CELL_PCH.
- 1> if the UE is "out of service area":
- 2> perform cell selection process as specified in [4];
 - 2> run timer T316;
 - 2> run timer T305 or T307;
 - 2> if the cell selection process fails to find a suitable cell after a complete scan of all RATs and all frequency bands supported by the UE, the UE shall after a minimum of TimerOutOfService time (default value 30 s) of being "out of service area":
 - 3> indicate all available PLMNs to NAS to enable the selection of a new PLMN;
 - 3> if an acceptable cell is found then the UE shall camp on that cell to obtain limited service as defined in [4] and, perform actions according to subclause 8.5.24;
 - 3> else if no acceptable cell is found, the UE shall continue looking for an acceptable cell as defined in [4].

7.2.2.2 CELL_FACH state

In the CELL_FACH state the UE shall perform the following actions:

NOTE: DCCH and, if configured, DTCH are available in this state.

- 1> if the UE is "in service area":
- 2> maintain up-to-date system information as broadcast by the serving cell as specified in subclause 8.1.1;
 - 2> perform cell reselection process as specified in [4];
 - 2> perform measurements process according to measurement control information as specified in subclause 8.4 and in subclause 14.4;
 - 2> run timer T305 (periodical cell update);
 - 2> select and configure the RB multiplexing options applicable for the transport channels to be used in this RRC state;

- 2> for 3.84 Mcps and 7.68 Mcps TDD; or
- 2> for FDD and 1.28 Mcps TDD, if the UE does not support HS-DSCH reception in CELL_FACH state; or
- 2> if the IE "HS-DSCH common system information" is not included in System Information Block type 5 or System Information Block type 5bis; or
- 2> for 1.28 Mcps TDD, if the IE "common E-DCH system info" is not included in System Information Block type 5:
 - 3> listen to all FACH transport channels mapped on the S-CCPCH selected by the UE according to the procedure in subclause 8.5.19.
- 2> else:
 - 3> if variable H_RNTI is set:
 - 4> receive physical channels HS-SCCH(s) using the value of the variable H_RNTI as UE identity and parameters given by the IE(s) "HS-DSCH common system information" according to the procedure in subclause 8.5.36.
 - 3> else:
 - 4> if the variable HS_DSCH_RECEPTION_OF_CCCH_ENABLED is set to TRUE:
 - 5> receive physical channel(s) of type HS-SCCH with selected common H-RNTI using parameters given by the IE(s) "HS-DSCH common system information" according to the procedure in subclause 8.5.37.
- 2> act on RRC messages received on BCCH, CCCH and DCCH;
- 2> act on RRC messages received on MCCH if it supports MBMS and has activated an MBMS service as specified in subclause 8.7;
- 2> act on RRC messages received on, if available, SHCCH (TDD only).
- 1> if the UE is "out of service area":
 - 2> perform cell selection process as specified in [4];
 - 2> run timers T305 (periodical cell update), and T317 (cell update when re-entering "in service") or T307 (transition to Idle mode), if started;
 - 2> run timers T314 and/or T315, if started;
 - 2> if the cell selection process fails to find a suitable cell after a complete scan of all RATs and all frequency bands supported by the UE, the UE shall after a minimum of TimerOutOfService time (default value 30 seconds) of being "out of service area":
 - 3> indicate all available PLMNs to NAS to enable the selection of a new PLMN;
 - 3> if an acceptable cell is found then the UE shall camp on that cell to obtain limited service as defined in [4] and perform actions according to subclause 8.5.24;
 - 3> else if no acceptable cell is found, the UE shall continue looking for an acceptable cell as defined in [4].

7.2.2.3 CELL_DCH state

In the CELL_DCH state the UE shall perform the following actions:

NOTE: DCCH and, if configured, DTCH are available in this state.

- 1> read the system information as specified in subclause 8.1.1 (for UEs in TDD mode);
- 1> perform measurements process according to measurement control information as specified in subclause 8.4 and in clause 14;

- 1> select and configure the RB multiplexing options applicable for the transport channels to be used in this RRC state;
- 1> act on RRC messages received on DCCH;
- 1> act on RRC messages received on BCCH (applicable only to UEs with certain capabilities and in FDD mode);
- 1> act on RRC messages received on MCCH if it supports MBMS and has activated an MBMS service as specified in subclause 8.7 (applicable only to UEs supporting MBMS with certain capabilities);
- 1> act on RRC messages received on BCCH (TDD only) and, if available, SHCCH (TDD only).

NOTE: If any of the above procedures results in different HS-DSCH and E-DCH serving cells, the UE behaviour is unspecified.

8 RRC procedures

The UE shall be able to process several simultaneous RRC procedures. After the reception of a message which invoked a procedure, the UE shall be prepared to receive and act on another message which may invoke a second procedure. Whether this second invocation of a procedure (transaction) is accepted or rejected by the UE is specified in the subclauses of this clause, and in particular in subclause 8.6.3.11 (RRC transaction identifier).

On receiving a message the UE shall:

- 1> check that the message is addressed to the UE (e.g. by checking the IE "Initial UE identity" or the IE "U-RNTI" for messages on CCCH);
- 1> discard the messages addressed to other UEs.

and then the UE shall:

- 1> apply integrity check as appropriate;
- 1> proceed with error handling as specified in clause 9;
- 1> act upon the IE "RRC transaction identifier";
- 1> continue with the procedure as specified in the relevant subclause.

NOTE: Due to an error in the Release '99 ASN.1, a Release '99 UE is unable to determine which UE is addressed by a downlink CCCH message corresponding to a protocol version later than Release '99. As a result, the Release '99 UE will not be able to return a protocol error according to subclause 9.3a. Therefore, the UTRAN should only send a Release '99 message version towards UEs that have indicated conformance to Release '99 in the IE "Access stratum release indicator".

The RRC entity in the UE shall consider PDUs to have been transmitted when they are submitted to the lower layers. If the RRC entity in the UE submits a message for transmission using AM RLC, it shall consider the message successfully transmitted when UTRAN reception of all relevant PDUs is acknowledged by RLC. In the UE, timers are started when the PDUs are sent on the radio interface in the case of the transmission using the CCCH.

8.1 RRC Connection Management Procedures

8.1.1 Broadcast of system information

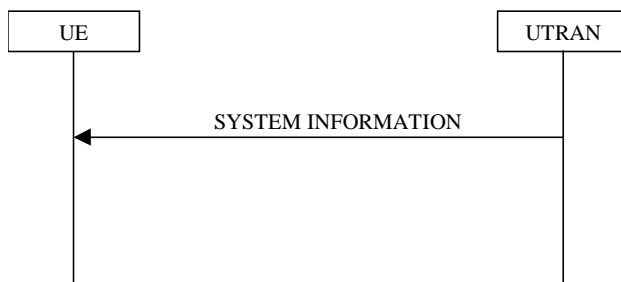

Figure 8.1.1-1: Broadcast of system information

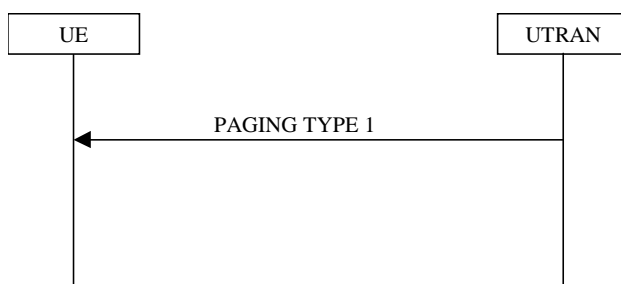

Figure 8.1.1-2: Notification of system information modification for UEs in idle mode, CELL_PCH state and URA_PCH state

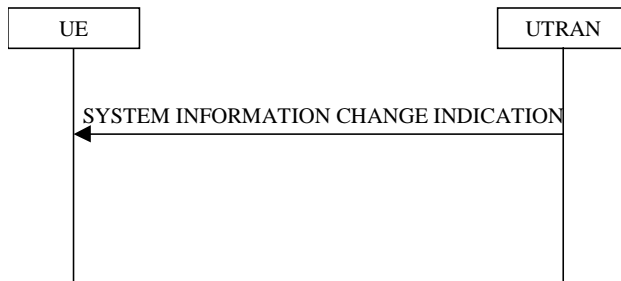

Figure 8.1.1-3: Notification of system information modification for UEs in CELL_FACH and CELL_DCH (TDD only) state

8.1.1.1 General

The purpose of this procedure is to broadcast system information from the UTRAN to UEs in a cell.

8.1.1.1.1 System information structure

The system information elements are broadcast in *system information blocks*. A system information block groups together system information elements of the same nature. Different system information blocks may have different characteristics, e.g. regarding their repetition rate and the requirements on UEs to re-read the system information blocks.

The system information is organised as a tree. A *master information block* gives references and scheduling information to a number of system information blocks in a cell. The system information blocks contain the actual system information. The master information block may optionally also contain reference and scheduling information to one or two *scheduling blocks*, which give references and scheduling information for additional system information blocks. Scheduling information for a system information block may only be included in either the master information block or one of the scheduling blocks.

For all system information blocks except System Information Block types 15.2, 15.3 and 16, the content is the same in each occurrence for system information blocks using value tag. System Information Block types 15.2, 15.3 and 16 may occur more than once with different content. In this case scheduling information is provided for each such occurrence of the system information block. System information blocks that do not use value tag may have different content for each occurrence.

8.1.1.1.2 System information blocks

Table 8.1.1 specifies all system information blocks and their characteristics.

The *area scope column* in table 8.1.1 specifies the area where a system information block's value tag is valid. If the area scope is *cell*, the UE shall consider the system information block to be valid only in the cell in which it was read. If system information blocks have been previously stored for this cell, the UE shall check whether the value tag for the system information block in the entered cell is different compared to the stored value tag. If the area scope is *PLMN* or *Equivalent PLMN*, the UE shall check the value tag for the system information block when a new cell is selected. If the value tag for the system information block in the new cell is different compared to the value tag for the system information block stored in the UE, the UE shall re-read the system information block. If the area scope is *PLMN*, the UE shall consider the system information block to be valid only within the PLMN in which it was read. If the area scope is *Equivalent PLMN*, the UE shall consider the system information block to be valid within the PLMN in which it was received and all PLMNs which are indicated by higher layers to be equivalent.

For System information block types 15.2, 15.2bis, 15.2ter, 15.3, 15.3bis and 16, which may have multiple occurrences, each occurrence has its own independent value tag. The UE shall re-read a particular occurrence if the value tag of this occurrence has changed compared to that stored in the UE.

The *UE mode/state column when block is valid* in Table 8.1.1 specifies in which UE mode or UE state the IEs in a system information block shall be regarded as valid by the UE. In other words, the indicated system information block becomes invalid upon change to a mode/state that is not included in this column. System Information Block Type 16 remains also valid upon transition to or from GSM/GPRS. In some cases, the states are inserted in brackets to indicate that the validity is dependent on the broadcast of the associated System Information Blocks by the network as explained in the relevant procedure subclause.

The *UE mode/state column when block is read* in Table 8.1.1 specifies in which UE mode or UE state the IEs in a system information block may be read by the UE. The UE shall have the necessary information prior to execution of any procedure requiring information to be obtained from the appropriate system information block. The requirements on the UE in terms of when to read the system information may therefore be derived from the procedure specifications that specify which IEs are required in the different UE modes/states in conjunction with the different performance requirements that are specified.

The UE shall:

- 1> if variable DEFERRED_MEASUREMENT_STATUS is set to FALSE:
 - 2> if System Information Block type 11 is referenced in the master information block or in the scheduling blocks:
 - 3> if System Information Block type 12 is not referenced in the master information block or in the scheduling blocks, or broadcast of System Information Block type 12 is not indicated in System Information Block type 11:
 - 4> have read and acted upon System Information Block type 11 and System Information Block type 11bis, if scheduled on BCH, in a cell when the UE transmits an RRC message on RACH.
 - 3> else:
 - 4> have read and acted upon System Information Block type 11 and System Information Block type 11bis, if scheduled on BCH, in a cell before the UE transmits the RRC CONNECTION REQUEST message.
 - 4> have read and acted upon both System Information Block type 11 and System Information Block type 11bis, if scheduled on BCH, and System Information Block type 12 in a cell when:
 - 5> the UE transmits an RRC message on RACH in RRC connected mode; or

5> the UE receives a message commanding to enter Cell_DCH state.

1> else:

2> the UE may transmit an RRC message on RACH before having read and acted upon System Information Block type 11, System Information Block type 11bis and System Information Block type 12, if scheduled on BCH.

NOTE 1: There are a number of system information blocks that include the same IEs while the UE mode/state in which the information is valid differs. This approach is intended to allow the use of different IE values in different UE mode/states.

NOTE 2: System Information Block Type 16 is also obtained by a UE while in GSM/GPRS. The details of this are not within the scope of this specification.

The *Scheduling information* column in table 8.1.1 specifies the position and repetition period for the System Information Block.

The *modification of system information* column in table 8.1.1 specifies the update mechanisms applicable for a certain system information block. For system information blocks with a value tag, the UE shall update the information according to subclause 8.1.1.7.1 or 8.1.1.7.2. For system information blocks with an expiration timer, the UE shall, when the timer expires, perform an update of the information according to subclause 8.1.1.7.4.

Table 8.1.1: Specification of system information block characteristics

System information block	Area scope	UE mode/state when block is valid	UE mode/state when block is read	Scheduling information	Modification of system information	Additional comment
Master information block	Cell	Idle mode, CELL_FACH, CELL_PCH, URA_PCH, CELL_DCH (TDD only)	Idle mode, CELL_FACH, CELL_PCH, URA_PCH, CELL_DCH (TDD only)	SIB_POS = 0 SIB_REP = 8 (FDD) SIB_REP = 8, 16, 32 (TDD) SIB_OFF=2	Value tag	
Scheduling block 1	Cell	Idle mode, CELL_FACH, CELL_PCH, URA_PCH, CELL_DCH (TDD only)	Idle mode, CELL_FACH, CELL_PCH, URA_PCH, CELL_DCH (TDD only)	Specified by the IE "Scheduling information" in MIB	Value tag	See Note 3
Scheduling block 2	Cell	Idle mode, CELL_FACH, CELL_PCH, URA_PCH, CELL_DCH (TDD only)	Idle mode, CELL_FACH, CELL_PCH, URA_PCH, CELL_DCH (TDD only)	Specified by the IE "Scheduling information" in MIB	Value tag	See Note 3
System information block type 1	Cell	Idle mode, CELL_FACH, CELL_PCH, URA_PCH, CELL_DCH	Idle, CELL_FACH, CELL_PCH, URA_PCH	Specified by the IE "Scheduling information"	Value tag	Note: The area scope of SIB1 is Cell but for compliance to earlier versions of the specification the coding of the scheduling information for SIB1 contains the "PLMN value tag" information element. See Note 3
System information block type 2	Cell	URA_PCH	URA_PCH	Specified by the IE "Scheduling information"	Value tag	See Note 3
System information block type 3	Cell	Idle mode, (CELL_FACH, CELL_PCH, URA_PCH)	Idle mode, (CELL_FACH, CELL_PCH, URA_PCH)	Specified by the IE "Scheduling information"	Value tag	
System information block type 4	Cell	CELL_FACH, CELL_PCH, URA_PCH	CELL_FACH, CELL_PCH, URA_PCH	Specified by the IE "Scheduling information"	Value tag	If System information block type 4 is not broadcast in a cell, the connected mode UE shall apply information in System information block type 3 in connected mode. See Note 3
System information block type 5 and 5bis	Cell	Idle mode, (CELL_FACH, CELL_PCH, URA_PCH, CELL_DCH (TDD only))	Idle mode, (CELL_FACH, CELL_PCH, URA_PCH, CELL_DCH (TDD only))	Specified by the IE "Scheduling information"	Value tag	System information block type 5bis is sent instead of system information block type 5 in cells that use Band IV or Band IX or Band X.

System information block	Area scope	UE mode/state when block is valid	UE mode/state when block is read	Scheduling information	Modification of system information	Additional comment
System information block type 6	Cell	CELL_FACH, CELL_PCH, URA_PCH, CELL_DCH (TDD only)	CELL_FACH, CELL_PCH, URA_PCH, CELL_DCH (TDD only)	Specified by the IE "Scheduling information"	Value tag	<p>If system information block type 6 is not broadcast in a cell, the connected mode UE shall read System information block type 5 or System information block type 5bis.</p> <p>If some of the optional IEs are not included in System information block type 6, the UE shall read the corresponding IEs in System information block type 5 or System information block type 5bis.</p> <p>In TDD mode system information block 6 shall only be read in CELL_DCH if required for open loop power control as specified in subclause 8.5.7 and/or if shared transport channels are assigned to the UE. If in these cases system information block type 6 is not broadcast the UE shall read system information block type 5. See Note 3</p>
System information block type 7	Cell	Idle mode, CELL_FACH, CELL_PCH, URA_PCH, CELL_DCH (TDD only)	Idle mode, CELL_FACH, CELL_PCH, URA_PCH, CELL_DCH (TDD only)	Specified by the IE "Scheduling information"	Expiration timer = MAX(32 , SIB_REP * ExpirationTimeFactor)	In TDD mode system information block type 7 shall only be read in CELL_DCH if shared transport channels are assigned to the UE. See Note 3
System information block type 11	Cell	Idle mode (CELL_FACH, CELL_PCH, URA_PCH, CELL_DCH)	Idle mode (CELL_FACH, CELL_PCH, URA_PCH)	Specified by the IE "Scheduling information"	Value tag	
System information block type 11bis	Cell	Idle mode (CELL_FACH, CELL_PCH, URA_PCH, CELL_DCH)	Idle mode (CELL_FACH, CELL_PCH, URA_PCH)	Specified by the IE "Scheduling information"	Value tag	See Note 3

System information block	Area scope	UE mode/state when block is valid	UE mode/state when block is read	Scheduling information	Modification of system information	Additional comment
System information block type 12	Cell	CELL_FACH, CELL_PCH, URA_PCH, CELL_DCH	Idle mode, CELL_FACH, CELL_PCH, URA_PCH	Specified by the IE "Scheduling information"	Value tag	If system information block type 12 is not broadcast in a cell, the connected mode UE shall read System information block type 11. If some of the optional IEs are not included in System information block type 12, the UE shall read the corresponding IEs in System information block type 11. See Note 3
System information block type 13	Cell	Idle Mode, CELL_FACH, CELL_PCH, URA_PCH	Idle Mode, CELL_FACH, CELL_PCH, URA_PCH	Specified by the IE "Scheduling information"	Value tag	See Note 3
System information block type 13.1	Cell	Idle Mode, CELL_FACH, CELL_PCH, URA_PCH	Idle Mode, CELL_FACH, CELL_PCH, URA_PCH	Specified by the IE "Scheduling information"	Value tag	See Note 3
System information block type 13.2	Cell	Idle Mode, CELL_FACH, CELL_PCH, URA_PCH	Idle Mode, CELL_FACH, CELL_PCH, URA_PCH	Specified by the IE "Scheduling information"	Value tag	See Note 3
System information block type 13.3	Cell	Idle Mode, CELL_FACH, CELL_PCH, URA_PCH	Idle Mode, CELL_FACH, CELL_PCH, URA_PCH	Specified by the IE "Scheduling information"	Value tag	See Note 3
System information block type 13.4	Cell	Idle Mode, CELL_FACH, CELL_PCH, URA_PCH	Idle Mode, CELL_FACH, CELL_PCH, URA_PCH	Specified by the IE "Scheduling information"	Value tag	See Note 3
System information block type 14	Cell	Idle Mode, CELL_FACH, CELL_PCH, URA_PCH, CELL_DCH	Idle Mode, CELL_FACH, CELL_PCH, URA_PCH, CELL_DCH	Specified by the IE "Scheduling information"	Expiration timer = MAX(32 , SIB_REP * ExpirationTimeFactor)	This system information block is used in 3.84 Mcps TDD and 7.68 Mcps TDD mode only. System information block type 14 shall only be read in CELL_DCH if required for open loop power control as specified in subclause 8.5.7. See Note 3
System information block type 15	Cell	Idle Mode, CELL_FACH, CELL_PCH, URA_PCH	Idle Mode, CELL_FACH, CELL_PCH, URA_PCH	Specified by the IE "Scheduling information"	Value tag	See Note 3
System information block type 15bis		Idle Mode, CELL_FACH, CELL_PCH, URA_PCH	Idle Mode, CELL_FACH, CELL_PCH, URA_PCH	Specified by the IE "Scheduling information"	Value tag	See Note 3
System information block type 15.1	Cell	Idle Mode, CELL_FACH, CELL_PCH, URA_PCH	Idle Mode, CELL_FACH, CELL_PCH, URA_PCH	Specified by the IE "Scheduling information"	Value tag	See Note 3
System information block type 15.1bis		Idle Mode, CELL_FACH, CELL_PCH, URA_PCH	Idle Mode, CELL_FACH, CELL_PCH, URA_PCH	Specified by the IE "Scheduling information"	Value tag	See Note 3

System information block	Area scope	UE mode/state when block is valid	UE mode/state when block is read	Scheduling information	Modification of system information	Additional comment
System information block type 15.2	Cell	Idle Mode, CELL_FACH, CELL_PCH, URA_PCH	Idle Mode, CELL_FACH, CELL_PCH, URA_PCH	Specified by the IE "Scheduling information"	Value tag	For this system information block there may be multiple occurrences See Note 3
System information block type 15.2bis	Cell	Idle Mode, CELL_FACH, CELL_PCH, URA_PCH	Idle Mode, CELL_FACH, CELL_PCH, URA_PCH	Specified by the IE "Scheduling information"	Value tag	For this system information block there may be multiple occurrences See Note 3
System information block type 15.2ter	Cell	Idle Mode, CELL_FACH, CELL_PCH, URA_PCH	Idle Mode, CELL_FACH, CELL_PCH, URA_PCH	Specified by the IE "Scheduling information"	Value tag	For this system information block there may be multiple occurrences See Note 3
System information block type 15.3	PLMN	Idle Mode, CELL_FACH, CELL_PCH, URA_PCH	Idle Mode, CELL_FACH, CELL_PCH, URA_PCH	Specified by the IE "Scheduling information"	Value tag	For this system information block there may be multiple occurrences See Note 3
System information block type 15.3bis	PLMN	Idle Mode, CELL_FACH, CELL_PCH, URA_PCH	Idle Mode, CELL_FACH, CELL_PCH, URA_PCH	Specified by the IE "Scheduling information"	Value tag	For this system information block there may be multiple occurrences See Note 3
System information block type 15.4	Cell	Idle Mode, CELL_FACH, CELL_PCH, URA_PCH	Idle Mode, CELL_FACH, CELL_PCH, URA_PCH	Specified by the IE "Scheduling information"	Value tag	See Note 3
System information block type 15.5	Cell	Idle Mode, CELL_FACH, CELL_PCH, URA_PCH	Idle Mode, CELL_FACH, CELL_PCH, URA_PCH	Specified by the IE "Scheduling information"	Value tag	See Note 3
System information block type 15.6	Cell	Idle Mode, CELL_FACH, CELL_PCH, URA_PCH	Idle Mode, CELL_FACH, CELL_PCH, URA_PCH	Specified by the IE "Scheduling information"	Value tag	See Note 3
System information block type 15.7	Cell	Idle Mode, CELL_FACH, CELL_PCH, URA_PCH	Idle Mode, CELL_FACH, CELL_PCH, URA_PCH	Specified by the IE "Scheduling information"	Value tag	See Note 3
System information block type 15.8	Cell	Idle Mode, CELL_FACH, CELL_PCH, URA_PCH	Idle Mode, CELL_FACH, CELL_PCH, URA_PCH	Specified by the IE "Scheduling information"	Value tag	See Note 3
System information block type 16	Equivalent PLMN	Idle Mode, CELL_FACH, CELL_PCH, URA_PCH, CELL_DCH	Idle Mode, CELL_FACH, CELL_PCH, URA_PCH	Specified by the IE "Scheduling information"	Value tag	For this system information block there may be multiple occurrences. This system information block is also valid while in GSM/GPRS. See Note 3
System information block type 17	Cell	CELL_FACH, CELL_PCH, URA_PCH, CELL_DCH	CELL_FACH, CELL_PCH, URA_PCH, CELL_DCH	Specified by the IE "Scheduling information"	Expiration timer = SIB_REP	This system information block is used in TDD mode only. System information block type 17 shall only be read if shared transport channels are assigned to the UE. See Note 3

System information block	Area scope	UE mode/state when block is valid	UE mode/state when block is read	Scheduling information	Modification of system information	Additional comment
System Information Block type 18	Cell	Idle mode, CELL_FACH, CELL_PCH, URA_PCH, CELL_DCH	Idle mode, CELL_FACH, CELL_PCH, URA_PCH	Specified by the IE "Scheduling information"	Value tag	See Note 3
System Information Block type 19	Cell	Idle mode, CELL_FACH, CELL_PCH, URA_PCH	Idle mode, CELL_FACH, CELL_PCH, URA_PCH	Specified by the IE "Scheduling information"	Value tag	See Note 3
System Information Block type 20	Cell	Idle mode, CELL_PCH, URA_PCH	Idle mode, CELL_PCH, URA_PCH	Specified by the IE "Scheduling information"	Value tag	See Note 3

NOTE 3: The UE behaviour is unspecified if this system information block is received on a cell operating in MBSFN mode as indicated in subclause 8.1.1.6.3. A network should not send these system information blocks on a cell operating in MBSFN mode.

NOTE 4: For 1.28 Mcps TDD, if a cell is operating in MBSFN mode, system information blocks are transmitted on the MBSFN Special Timeslot [30].

8.1.1.1.3 Segmentation and concatenation of system information blocks

A generic SYSTEM INFORMATION message is used to convey the system information blocks on the BCCH. A given BCCH may be mapped onto either a BCH or a FACH transport channel according to subclause 8.1.1.1.2. The size of the SYSTEM INFORMATION message shall fit the size of a BCH or a FACH transport block.

The RRC layer in UTRAN performs segmentation and concatenation of encoded system information blocks. If the encoded system information block is larger than the size of a SYSTEM INFORMATION message, it will be segmented and transmitted in several messages. If the encoded system information block is smaller than a SYSTEM INFORMATION message, UTRAN may concatenate several system information blocks, or the first segment or the last segment into the same message as specified in the remainder of this clause.

Four different segment types are defined:

- First segment;
- Subsequent segment;
- Last segment;
- Complete.

Each of the types - *First*, *Subsequent* and *Last segment* - is used to transfer segments of a master information block, scheduling block or a system information block. The segment type, *Complete*, is used to transfer a complete master information block, complete scheduling block or a complete system information block.

Each segment consists of a header and a data field. The data field carries the encoded system information elements. The header contains the following parameters:

- The number of segments in the system information block (SEG_COUNT). This parameter is only included in the header if the segment type is "First segment".
- SIB type. The SIB type uniquely identifies the master information block, scheduling block or a system information block.
- Segment index. This parameter is only included in the header if the segment type is "Subsequent segment" or "Last segment".

UTRAN may combine one or several segments of variable length in the same SYSTEM INFORMATION message. The following combinations are allowed:

1. No segment;
2. First segment;
3. Subsequent segment;
4. Last segment;
5. Last segment + First segment;
6. Last segment + one or several Complete;
7. Last segment + one or several Complete + First segment;
8. One or several Complete;
9. One or several Complete + First segment;
10. One Complete of size 215 to 226;
11. Last segment of size 215 to 222.

The "No segment" combination is used when there is no master information block, scheduling block or system information block scheduled for a specific BCH transport block.

UEs are not required to support the reception of multiple occurrences of the same system information block type within one SYSTEM INFORMATION message.

NOTE: Since the SIB type is the same for each occurrence of the system information block, the UE does not know the order in which the occurrences, scheduled for this SYSTEM INFORMATION message, appear. Therefore, the UE is unable to determine which scheduling information, e.g., value tag relates to which occurrence of the system information block.

8.1.1.1.4 Re-assembly of segments

The RRC layer in the UE shall perform re-assembly of segments. All segments belonging to the same master information block, scheduling block or system information block shall be assembled in ascending order with respect to the segment index. When all segments of the master information block, scheduling block or a system information block have been received, the UE shall perform decoding of the complete master information block, scheduling block or system information block. For System Information Block types 15.2, 15.3 and 16, which may have multiple occurrences, each occurrence shall be re-assembled independently.

The UE shall discard system information blocks of which segments were missing, of which segments were received out of sequence and/or for which duplicate segments were received. The only valid sequence is an ascending one with the sequence starting with the First Segment of the associated System Information Block.

If the UE receives a Subsequent segment or Last segment where the index in IE "Segment index" is equal to or larger than the number of segments stated in IE "SEG_COUNT" in the scheduling information for that scheduling block or system information block:

- 1> the UE may:
 - 2> read all the segments to create a system information block as defined by the scheduling information read by the UE;
 - 2> store the content of the system information block with a value tag set to the value NULL; and
 - 2> consider the content of the scheduling block or system information block as valid:
 - 3> until it receives the same type of scheduling block or system information block in a position according to its scheduling information; or
 - 3> at most for 6 hours after reception.

- 1> and the UE shall:

2> re-read scheduling information for that scheduling block or system information block.

If the UE receives a Subsequent segment or Last segment where the index in IE "Segment index" is equal to or larger than the number of segments stated in IE "SEG_COUNT" in the First segment, the UE shall

- 1> discard all segments for that master information block, scheduling block or system information block; and
- 1> re-read the scheduling information for that system information block;
- 1> then re-read all segments for that system information block.

8.1.1.1.5 Scheduling of system information

Scheduling of system information blocks is performed by the RRC layer in UTRAN. If segmentation is used, it should be possible to schedule each segment separately.

To allow the mixing of system information blocks with short repetition period and system information blocks with segmentation over many frames, UTRAN may multiplex segments from different system information blocks. Multiplexing and de-multiplexing is performed by the RRC layer.

The scheduling of each system information block broadcast on a BCH transport channel is defined by the following parameters:

- the number of segments (SEG_COUNT);
- the repetition period (SIB_REP). The same value applies to all segments;
- the position (phase) of the first segment within one cycle of the Cell System Frame Number (SIB_POS(0)). Since system information blocks are repeated with period SIB_REP, the value of SIB_POS(i), $i = 0, 1, 2, \dots, \text{SEG_COUNT}-1$ must be less than SIB_REP for all segments;
- the offset of the subsequent segments in ascending index order (SIB_OFF(i), $i = 1, 2, \dots, \text{SEG_COUNT}-1$). The position of the subsequent segments is calculated using the following: $\text{SIB_POS}(i) = \text{SIB_POS}(i-1) + \text{SIB_OFF}(i)$.

The scheduling is based on the Cell System Frame Number (SFN). The SFN of a frame at which a particular segment, i , with $i = 0, 1, 2, \dots, \text{SEG_COUNT}-1$ of a system information block occurs, fulfils the following relation:

$$\text{SFN mod SIB_REP} = \text{SIB_POS}(i)$$

In FDD and TDD the scheduling of the master information block is fixed as defined in table 8.1.1. For TDD, UTRAN may apply one of the values allowed for the master information block's repetition period. The value that UTRAN is using in TDD is not signalled; UEs have to determine it by trial and error.

8.1.1.2 Initiation

The system information is continuously broadcast on a regular basis in accordance with the scheduling defined for each system information block.

8.1.1.3 Reception of SYSTEM INFORMATION messages by the UE

The UE shall read SYSTEM INFORMATION messages broadcast on a BCH transport channel in idle mode and in the connected mode in states CELL_FACH, CELL_PCH, URA_PCH and CELL_DCH (TDD only).

In idle mode and connected mode different combinations of system information blocks are valid. The UE shall acquire the system information blocks that are needed according to table 8.1.1. However, when the variable READY_FOR_COMMON_EDCH is set to TRUE and IE "UL interference for common E-DCH" is included in SIB 5/5bis, the UE shall acquire the system information block 7 upon entering a new cell and shall consider the content of the system information block 7 as always valid and ignore any system information expiry timer.

The UE may store system information blocks with *cell*, *PLMN* or *Equivalent PLMN* area scope (including their value tag if applicable) for different cells and different PLMNs, to be used if the UE returns to these cells.

The UE shall consider all stored system information blocks as invalid after it has been switched off. Some information obtained from system information may be stored by the UE or in the USIM for use in a stored information cell selection.

When selecting a new cell the UE shall consider all current system information blocks with area scope cell to be invalid. If the UE has stored valid system information blocks for the newly selected cell, the UE may set those as current system information blocks.

After selecting a new cell and this cell broadcasts an IE "PLMN Identity" in the MIB which is different from the IE "PLMN Identity" broadcast in the MIB in the previously selected cell, the UE shall consider all current system information blocks with area scope *PLMN* to be invalid. If the UE has previously stored valid system information blocks for the selected cell of the new PLMN, the UE may set those as current system information blocks.

When NAS informs AS about a new selected PLMN, the UE shall consider all stored system information blocks with area scope *Equivalent PLMN* to be invalid.

8.1.1.4 Void

8.1.1.5 Actions upon reception of the Master Information Block and Scheduling Block(s)

When selecting a new cell, the UE shall read the master information block. The UE may use the pre-defined scheduling information to locate the master information block in the cell.

Upon reception of the master information block, the UE shall:

- 1> if the IE "Multiple PLMN List" is not present in the Master Information Block:
 - 2> consider the IE "PLMN identity" in the Master Information Block as the PLMN identity of the cell.
- 1> else:
 - 2> consider the PLMN identities in the IE "Multiple PLMN List" as the PLMN identities of the cell;
 - 2> when reading the "Multiple PLMN List", read all the PLMN identities in the list as follows:
 - 3> if the IE "MIB PLMN Identity" is set to TRUE:
 - 4> read the "PLMN identity" IE in the MIB and consider it as a part of the "Multiple PLMN List".
 - 3> if the IE "MIB PLMN Identity" is set to FALSE:
 - 4> not consider the "PLMN identity" IE in the MIB as a part of the "Multiple PLMN List";
 - 4> not consider the IE "PLMN identity" in the MIB as a PLMN identity of the cell;
 - 4> not forward the PLMN in the IE "PLMN identity" of the MIB to upper layers.
 - 3> if the MCC is not present when reading a IE "PLMN identity with Optional MCC" in the IE "Multiple PLMN List":
 - 4> set the MCC of this PLMN identity equal to the MCC of the closest preceding "PLMN identity with Optional MCC" in the "Multiple PLMN List" that includes an MCC;
 - 4> or, if no such "PLMN identity with Optional MCC" exists, the UE shall set the MCC of this PLMN identity to the MCC of the "PLMN identity" IE in the Master Information Block irrespective of the value of the IE "MIB PLMN Identity".
- 1> if the UE is operating in "ANSI-41 mode" and the IE "PLMN Type" has the value "ANSI-41" or "GSM-MAP and ANSI-41":
 - 2> store the ANSI-41 Information elements contained in the master information block and perform initial process for ANSI-41.

- 1> compare the value tag in the master information block with the value tag stored for this cell and this PLMN in the variable VALUE_TAG;
- 1> if the value tags differ, or if no IEs for the master information block are stored:
 - 2> store the value tag into the variable VALUE_TAG for the master information block;
 - 2> read and store scheduling information included in the master information block.
- 1> if the value tags are the same the UE may use stored system information blocks and scheduling blocks using value tag that were stored for this cell and this PLMN as valid system information.

For all system information blocks or scheduling blocks that are supported by the UE referenced in the master information block or the scheduling blocks, the UE shall perform the following actions:

- 1> for all system information blocks with area scope "PLMN" or "Equivalent PLMN" that use value tags:
 - 2> compare the value tag read in scheduling information for that system information block with the value stored within the variable VALUE_TAG for that system information block;
 - 2> if the value tags differ, or if no IEs for the corresponding system information block are stored:
 - 3> store the value tag read in scheduling information for that system information block into the variable VALUE_TAG;
 - 3> read and store the IEs of that system information block.
 - 2> if the value tags are the same the UE may use stored system information blocks using value tag that were stored in this PLMN as valid system information.
- 1> for all system information blocks or scheduling blocks with area scope cell that use value tags:
 - 2> compare the value tag read in scheduling information for that system information block or scheduling block with the value stored within the variable VALUE_TAG for that system information block or scheduling block;
 - 2> if the value tags differ, or if no IEs for the corresponding system information block or scheduling block are stored:
 - 3> store the value tag read in scheduling information for that system information block or scheduling block into the variable VALUE_TAG;
 - 3> read and store the IEs of that system information block or scheduling block.
 - 2> if the value tags are the same the UE may use stored system information blocks using value tags that were stored for this cell and this PLMN as valid system information.
- 1> for system information blocks which may have multiple occurrences:
 - 2> compare the value tag and the configuration or multiple occurrence identity for the occurrence of the system information blocks read in scheduling information with the value tag and configuration or multiple occurrence identity stored within the variable VALUE_TAG:
 - 3> if the value tags differ, or if no IEs from the occurrence with that configuration or multiple occurrence identity of the system information block are stored:
 - 4> store the value tag read in scheduling information for that system information block and the occurrence with that configuration or multiple occurrence identity into the variable VALUE_TAG;
 - 4> read and store the IEs of that system information block.
 - 3> if the value tags and the configuration or multiple occurrence identity are identical to those stored, the UE may use stored occurrences of system information blocks that were stored for this cell and this PLMN as valid system information.

For system information blocks, not supported by the UE, but referenced either in the master information block or in the scheduling blocks, the UE may:

- 1> skip reading this system information block;
- 1> skip monitoring changes to this system information block.

If the UE:

- 1> receives a scheduling block at a position different from its position according to the scheduling information for the scheduling block; or
- 1> receives a scheduling block for which scheduling information has not been received:

the UE may:

- 1> store the content of the scheduling block with a value tag set to the value NULL; and
- 1> consider the content of the scheduling block as valid until it receives the same type of scheduling block in a position according to its scheduling information or at most for 6 hours after reception.

If the UE does not find a scheduling block in a position where it should be according to its scheduling information, but a transport block with correct CRC was found at that position, the UE shall:

- 1> read the scheduling information for this scheduling block.

If the UE does not find the master information block in a position fulfilling:

$$\text{SFN mod } 32 = 0$$

but a transport block with correct CRC was found at that position), the UE shall:

- 1> consider the master information block as not found; and
- 1> consider the cell to be barred according to [4]; and
- 1> consider the barred cell as using the value "allowed" in the IE "Intra-frequency cell re-selection indicator", and the maximum value in the IE "T_{barred}".

NOTE: This permits a different repetition for the MIB in later versions for FDD. In TDD it allows for a variable SIB_REP in this and future releases.

If the cell is not operating in MBSFN mode (according to Section 8.1.1.6.3) then:

- 1> If system information block type 1 is not scheduled on BCH, and system information block type 13 is not scheduled on BCH, the UE shall:
 - 2> consider the cell to be barred according to [4]; and
 - 2> consider the barred cell as using the value "allowed" in the IE "Intra-frequency cell re-selection indicator", and the maximum value in the IE "T_{barred}".
- 1> If the UE only supports GSM-MAP but finds a cell that broadcasts System Information Block type 13 but not System Information Block type 1, the UE shall:
 - 2> consider the cell barred.
- 1> If system information block type 1 is not scheduled on BCH; and
- 1> if the UE is operating in "GSM-MAP mode"; and
- 1> if the IE "PLMN type" in the Master Information Block has the value "GSM-MAP" or "GSM-MAP and ANSI-41", the UE shall:
 - 2> indicate to upper layers that no CN system information is available.
- 1> If in idle mode and System Information Block type 3 is not scheduled on BCH, the UE shall:
 - 2> consider the cell to be barred according to [4]; and

- 2> consider the barred cell as using the value "allowed" in the IE "Intra-frequency cell re-selection indicator", and the maximum value in the IE " T_{barred} ".
- 1> If in connected mode and System Information Block type 3 is not scheduled on BCH, and System Information Block type 4 is not scheduled on BCH, the UE shall:
 - 2> consider the cell to be barred according to [4]; and
 - 2> consider the barred cell as using the value "allowed" in the IE "Intra-frequency cell re-selection indicator", and the maximum value in the IE " T_{barred} ".
- 1> If in idle mode and neither System Information Block type 5 nor type 5bis is scheduled on BCH, or System Information Block type 5 or type 5bis is scheduled but IE "AICH info" (FDD) or IE "PICH info" is not present, the UE shall:
 - 2> consider the cell to be barred according to [4]; and
 - 2> consider the barred cell as using the value "allowed" in the IE "Intra-frequency cell re-selection indicator", and the maximum value in the IE " T_{barred} ".
- 1> If in connected mode and neither System Information Block type 5 nor type 5bis is scheduled on BCH, and System Information Block type 6 is not scheduled on BCH, or any of System Information Block type 5, type 5bis or type 6 is scheduled but IE "AICH info" (FDD) or IE "PICH info" is not present, the UE shall:
 - 2> consider the cell to be barred according to [4]; and
 - 2> consider the barred cell as using the value "allowed" in the IE "Intra-frequency cell re-selection indicator", and the maximum value in the IE " T_{barred} ".
- 1> If System Information Block type 7 is not scheduled on BCH, the UE shall:
 - 2> consider the cell to be barred according to [4]; and
 - 2> consider the barred cell as using the value "allowed" in the IE "Intra-frequency cell re-selection indicator", and the maximum value in the IE " T_{barred} ".
- 1> In 3.84 Mcps TDD and 7.68 Mcps TDD, if System Information Block type 14 is not scheduled on BCH, the UE shall:
 - 2> consider the cell to be barred according to [4]; and
 - 2> consider the barred cell as using the value "allowed" in the IE "Intra-frequency cell re-selection indicator", and the maximum value in the IE " T_{barred} ".

If the cell is operating in MBSFN mode (according to section 8.1.1.6.3) then:

- 1> If neither System Information block type 5 nor System Information Block type 5bis is scheduled on the BCH the UE shall:
 - 2> not consider this MBSFN cluster as candidate during the MBSFN cluster selection and MBSFN cluster re-selection procedures [4]. The UE may choose to not recheck the status of this MBSFN cluster during the time corresponding to the maximum value for T_{barred} .
- 1> If System Information Block type 11 is not scheduled on the BCH the UE shall:
 - 2> not consider this MBSFN cluster as candidate during the MBSFN cluster selection and MBSFN cluster re-selection procedures [4]. The UE may choose to not recheck the status of this MBSFN cluster during the time corresponding to the maximum value for T_{barred} .

If System Information Block type 5 and System Information Block type 5bis are both scheduled on BCH:

- 1> the UE behaviour is unspecified.

8.1.1.6 Actions upon reception of system information blocks

The UE may use the scheduling information included within the master information block and the scheduling blocks to locate each system information block to be acquired. For System Information Block type 15.1bis, 15.2bis, 15.2ter, 15.3bis, 15.6, 15.7 and 15.8 the scheduling information shall be used to associate a system information block with a GNSS.

The UE should only expect one occurrence of the scheduling information for a system information block in the master information block and any of the scheduling blocks except for System Information Block type 16, System Information Block type 15.2 and System Information Block type 15.3, which may have multiple occurrences. System Information Blocks 15.1bis, 15.6, 15.7 and 15.8 have one occurrence for each GNSS supported while System Information Blocks 15.2bis, 15.2ter and 15.3bis may have multiple occurrences for each GNSS. However, to enable future introduction of new system information blocks, the UE shall also be able to receive system information blocks other than the ones indicated within the scheduling information. The UE may ignore contents of such system information block.

If the UE:

- 1> receives a system information block in a position according to the scheduling information for the system information block; and
- 1> this system information block uses a value tag; or
- 1> this system information block uses a value tag and configuration or multiple occurrence identity:

the UE shall:

- 1> store the content of the system information block together with the value of its value tag or the values of configuration and multiple occurrence identity and the associated value tag in the scheduling information for the system information block; and
- 1> consider the content of the system information block valid until, if used, the value tag in the scheduling information for the system information block is changed or at most for 6 hours after reception.

If the UE:

- 1> receives a system information block in a position according to the scheduling information for the system information block; and
- 1> this system information block does not use a value tag according to the system information block type:

the UE shall:

- 1> store the content of the system information block;
- 1> if HS_DSCH_DRX_CELL_FACH_STATUS is set to TRUE and if the system information block corresponds to System Information Block type 7:
 - 2> start an expiration timer using a value set to 800.
- 1> else:
 - 2> start an expiration timer using a value as defined in Table 8.1.1 for that system information block type,
- 1> consider the content of the system information block valid until, the expiration timer expires.

If the UE:

- 1> receives a system information block at a position different from its position according to the scheduling information for the system information block; or
- 1> receives a system information block for which scheduling information has not been received; and
- 1> this system information block uses a value tag:

the UE may:

- 1> store the content of the system information block with a value tag set to the value NULL; and

- 1> consider the content of the system information block as valid until it receives the same type of system information block in a position according to its scheduling information or at most for 6 hours after reception.

If the UE:

- 1> receives a system information block with multiple occurrences at a position different from its position according to the scheduling information for the system information block; or
- 1> receives a system information block with multiple occurrences for which scheduling information has not been received; and
- 1> this system information block uses a value tag and configuration or multiple occurrence identity:

the UE shall:

- 1> ignore this information.

If the UE does not find a system information block in a position where it should be according to its scheduling information, but a transport block with correct CRC was found at that position, the UE shall read the scheduling information for this system information block.

The UE shall act upon all received information elements as specified in subclause 8.6 unless specified otherwise in the following subclauses.

8.1.1.6.1 System Information Block type 1

The UE should store all relevant IEs included in this system information block if the UE is operating in "GSM-MAP mode" and the IE "PLMN type" in the Master Information Block has the value "GSM-MAP" or "GSM-MAP and ANSI-41". The UE shall also:

- 1> check that the cell, according to information included in IE "CN common GSM-MAP NAS system information", is suitable [4];
- 1> if in connected mode:
 - 2> not forward the content of the IE "CN common GSM-MAP NAS system information" to upper layers.
- 1> if in idle mode:
 - 2> forward the content of the IE "CN common GSM-MAP NAS system information" to upper layers.
- 1> for the IE "CN domain system information list":
 - 2> for each IE "CN domain system information" that is present:
 - 3> check that the cell, according to information included in IE "CN domain specific NAS system information", is suitable [4];
 - 3> if in connected mode:
 - 4> not forward the content of the IE "CN domain specific NAS system information" to upper layers.
 - 3> if in idle mode:
 - 4> forward the content of the IE "CN domain specific NAS system information" and the IE "CN domain identity" to upper layers;
 - 4> use the IE "CN domain specific DRX cycle length coefficient" to calculate frame number for the Paging Occasions as specified in [4];
 - 4> store the value of the IE "CN domain specific DRX cycle length coefficient" for use in connected mode.
 - 2> if an IE "CN domain system information" is not present for a particular CN domain:
 - 3> if in idle mode:

4> indicate to upper layers that no CN system information is available for that CN domain.

1> if the UE has not yet entered UTRA RRC connected mode:

2> store the values of the IE "UE Timers and constants in connected mode" in the variable TIMERS_AND_CONSTANTS.

2> if the IE "T323" is not present:

3> clear any value of the timer T323 stored in the IE "UE Timers and constants in connected mode" in the variable TIMERS_AND_CONSTANTS.

1> use the values stored in the variable TIMERS_AND_CONSTANTS for the relevant timers and constants.

8.1.1.6.2 System Information Block type 2

If in connected mode the UE should store all relevant IEs included in this system information block. The UE shall:

1> if in state URA_PCH, start to perform URA updates using the information in the IE "URA identity".

If in idle mode, the UE shall not use the values of the IEs in this system information block.

8.1.1.6.3 System Information Block type 3

The UE should store all relevant IEs included in this system information block. The UE shall:

1> if in connected mode, and System Information Block 4 is indicated as used in the cell:

2> read and act on information sent in that block.

1> if IE "Deferred measurement control reading support" is present:

2> set variable DEFERRED_MEASUREMENT_STATUS to TRUE.

1> else:

2> set variable DEFERRED_MEASUREMENT_STATUS to FALSE.

With respect to Domain Specific Access Control and Paging Permission with Access Control, the UE shall:

1> if the IE "Multiple PLMN List" is not included in the Master Information Block:

2> apply the domain specific access restrictions as indicated by the IE "Domain Specific Access Restriction Parameters For PLMN Of MIB", and the paging permission with access control as indicated by the IE "Paging Permission with Access Control Parameters for PLMN Of MIB".

1> else:

2> if the PLMN specified by the IE "PLMN Identity" of the Master Information Block is chosen by the UE:

3> apply the domain specific access restrictions as indicated by the IE "Domain Specific Access Restriction Parameters For PLMN Of MIB", and the paging permission with access control as indicated by the IE "Paging Permission with Access Control Parameters for PLMN Of MIB".

2> else, if N-th (N=1..5) PLMN in the IE "Multiple PLMNs" contained in the IE "Multiple PLMN List" is chosen by the UE:

3> if the IE "Domain Specific Access Restriction List" of the IE "Domain Specific Access Restriction For Shared Network" is indicated:

4> if the IE "Domain Specific Access Restriction Parameters For OperatorN" is indicated:

5> apply the domain specific access restrictions as indicated by the IE "Domain Specific Access Restriction Parameters For OperatorN".

3> else,

- 4> if the IE "Domain Specific Access Restriction Parameters For All" of the IE "Domain Specific Access Restriction For Shared Network" is indicated:
 - 5> apply the domain specific access restrictions as indicated by the IE "Domain Specific Access Restriction Parameters For All".
- 3> if the IE "Paging Permission with Access Control List" of the IE "Paging Permission with Access Control For Shared Network" is indicated:
 - 4> if the IE "Paging Permission with Access Control Parameters For OperatorN" is indicated:
 - 5> apply the paging permission with access control as indicated by the IE "Paging Permission with Access Control Parameters For OperatorN".
- 3> else,
 - 4> if the IE "Paging Permission with Access Control Parameters For All" of the IE "Paging Permission with Access Control For Shared Network" is indicated:
 - 5> apply the paging permission with access control as indicated by the IE "Paging Permission with Access Control Parameters For All".

The UE shall apply the following handling with respect to any Access Class Barring information:

1> if in idle mode:

- 2> if the IE "Paging Permission with Access Control Parameters For PLMN Of MIB", the IE "Paging Permission with Access Control Parameters For OperatorN" or the IE "Paging Permission with Access Control Parameters For All" to be applied according to the requirements above is included in System Information Block Type 3, the UE shall:
 - 3> if Paging Response Restriction Indication is set to "None":
 - 4> when sending a response to any PAGING TYPE 1 message, *Paging* message specified in [67] or CS SERVICE NOTIFICATION message specified in [79], act as if no Access Class is barred in the IE "Access Class Barred List" as specified in [4].
 - 3> if Paging Response Restriction Indication is set to "PS":
 - 4> when sending a response to any PAGING TYPE 1 message, *Paging* message specified in [67] from CS domain or CS SERVICE NOTIFICATION message specified in [79], act as if no Access Class is barred in the IE "Access Class Barred List" as specified in [4];
 - 4> when sending a response to any PAGING TYPE 1 message, *Paging* message specified in [67] from PS domain, act on the IE "Domain Specific Access Class Barred List" if indicated in the IE "PS Domain Specific Access Restriction" (or IE "Access Class Barred list" if IE "Domain Specific Access Class Barred List" is not present) as specified in [4].
 - 3> if Paging Response Restriction Indication is set to "CS":
 - 4> when sending a response to any PAGING TYPE 1 message, *Paging* message specified in [67] or from PS domain, act as if no Access Class is barred in the IE "Access Class Barred List" as specified in [4];
 - 4> when sending a response to any PAGING TYPE 1 message, *Paging* message specified in [67] from CS domain or CS SERVICE NOTIFICATION message specified in [79], act on the IE "Domain Specific Access Class Barred List" if indicated in the IE "CS Domain Specific Access Restriction" (or IE "Access Class Barred list" if IE "Domain Specific Access Class Barred List" is not present) as specified in [4].
 - 3> else (if Paging Response Restriction Indication is set to "All"):
 - 4> when sending a response to any PAGING TYPE 1 message, *Paging* message specified in [67] from CS domain or CS SERVICE NOTIFICATION message specified in [79], act on the IE "Domain Specific Access Class Barred List" if indicated in the IE "CS Domain Specific Access Restriction" as specified in [4];

- 4> when sending a response to any PAGING TYPE 1 message, *Paging* message specified in [67] from PS domain, act on the IE "Domain Specific Access Class Barred List" if indicated in the IE "PS Domain Specific Access Restriction" as specified in [4];
- 4> when sending a response to any PAGING TYPE 1 message, *Paging* message specified in [67] or CS SERVICE NOTIFICATION message specified in [79] from PS or CS domain, act on the IE "Access Class Barred list" if the IE "Domain Specific Access Class Barred List" is not present.
- 3> when initiating a Location/Registration procedure to CS domain, act on the IE "Location/Registration Access Class Barred List" if the IE "Location/Registration Restriction Indicator" is set to "All" or "CS", as specified in [4];
- 3> when initiating an access to CS domain for any other reason, act on the IE "Domain Specific Access Class Barred List" if indicated in the IE "CS Domain Specific Access Restriction" (or IE "Access Class Barred list" if IE "Domain Specific Access Class Barred List" is not present) as specified in [4];
- 3> when initiating a Location/Registration procedure to PS domain, act on the IE "Location/Registration Access Class Barred List" if the IE "Location/Registration Restriction Indicator" is set to "All" or "PS", as specified in [4];
- 3> when initiating an access to PS domain for any other reason, act on the IE "Domain Specific Access Class Barred List" if indicated in the IE "PS Domain Specific Access Restriction" (or IE "Access Class Barred list" if IE "Domain Specific Access Class Barred List" is not present) as specified in [4].
- 3> upon transition to UTRA RRC connected, the UE shall:
 - 4> store that Paging Permission with Access Control Parameters to the variable "PPAC_PARAM" and maintain the variable until it is cleared, the PLMN chosen by the UE is changed or the RRC connection is released;
 - 4> if the IE "Domain Specific Access Restriction Parameters For PLMN Of MIB", the IE "Domain Specific Access Restriction Parameters For OperatorN" or the IE "Domain Specific Access Restriction Parameters For All" to be applied according to the requirements above is included in System Information Block Type 3:
 - 5> store that Domain Specific Access Restriction Parameters to the variable "DSAC_PARAM" and maintain the variable until it is cleared, the PLMN chosen by the UE is changed or the RRC connection is released.
 - 4> act on the stored IE "Paging Response Restriction Indicator" when sending a response to any PAGING TYPE 1 or PAGING TYPE 2 message, *Paging* message specified in [67] or CS SERVICE NOTIFICATION message specified in [79];
 - 4> act on the stored IE "Location/Registration Access Class Barred List" if the IE "Location/Registration Restriction Indicator" is set to "All" or "CS", when initiating a Location/Registration procedure to the CS domain, as specified in [4];
 - 4> act on the stored IE "Location/Registration Access Class Barred List" if the IE "Location/Registration Restriction Indicator" is set to "All" or "PS", when initiating a Location/Registration procedure to the PS domain, as specified in [4];
 - 4> act on the stored IE "Domain Specific Access Class Barred List" if indicated in the IE "CS Domain Specific Access Restriction" when initiating an INITIAL DIRECT TRANSFER message to the CS domain for any other reason, as specified in [4];
 - 4> act on the stored IE "Domain Specific Access Class Barred List" if indicated in the IE "PS Domain Specific Access Restriction" when initiating an INITIAL DIRECT TRANSFER message to the PS domain, for any other reason, as specified in [4].
- 2> if neither the IE "Paging Permission with Access Control Parameters For PLMN Of MIB", the IE "Paging Permission with Access Control Parameters For OperatorN" nor the IE "Paging Permission with Access Control Parameters For All" to be applied according to the requirements above is included in System Information Block Type 3:

- 3> if the IE "Domain Specific Access Restriction Parameters For PLMN Of MIB", the IE "Domain Specific Access Restriction Parameters For OperatorN" or the IE "Domain Specific Access Restriction Parameters For All" to be applied according to the requirements above is included in System Information Block Type 3 the UE shall:
 - 4> act on the IE "Domain Specific Access Class Barred List" if indicated in the IE "CS Domain Specific Access Restriction" when initiating RRC Connection establishment to send an INITIAL DIRECT TRANSFER message to the CS domain, as specified in [4]. If "no restriction" was indicated in restriction status, the UE shall act as if no Access Class is barred in the IE "Domain Specific Access Class Barred List", and ignore the IE "Access Class Barred List" in the IE "Cell Access Restriction";
 - 4> act on the IE "Domain Specific Access Class Barred List" if indicated in the IE "PS Domain Specific Access Restriction" when initiating RRC Connection establishment to send an INITIAL DIRECT TRANSFER message to the PS domain, as specified in [4]. If "no restriction" was indicated in restriction status, the UE shall act as if no Access Class is barred in the IE "Domain Specific Access Class Barred List", and ignore the IE "Access Class Barred List" in the IE "Cell Access Restriction";
 - 4> upon transition to UTRA RRC connected, the UE shall:
 - 5> store that Domain Specific Access Restriction Parameters to the variable "DSAC_PARAM" and maintain the variable until it is cleared, the PLMN chosen by the UE is changed or the RRC connection is released;
 - 5> act on the stored IE "Domain Specific Access Class Barred List" if indicated in the IE "CS Domain Specific Access Restriction" when initiating an INITIAL DIRECT TRANSFER message to the CS domain, as specified in [4];
 - 5> act on the stored IE "Domain Specific Access Class Barred List" if indicated in the IE "PS Domain Specific Access Restriction" when initiating an INITIAL DIRECT TRANSFER message to the PS domain, as specified in [4].
- 3> else:
 - 4> act on the IE "Access Class Barred list" when initiating RRC Connection establishment as specified in [4].
- 1> if in connected mode:
 - 2> for the variable "DSAC_PARAM":
 - 3> if the IE "Domain Specific Access Restriction Parameters For PLMN Of MIB", the IE "Domain Specific Access Restriction Parameters For OperatorN" or the IE "Domain Specific Access Restriction Parameters For All" to be applied according to the requirements above is included in the System Information Block Type 3:
 - 4> if the variable "DSAC_PARAM" is not set, the UE shall:
 - 5> store that Domain Specific Access Restriction Parameters to the variable "DSAC_PARAM" and maintain the variable until it is cleared, the PLMN chosen by the UE is changed or the RRC connection is released.
 - 4> else (the access class barring information is stored) UE shall:
 - 5> update the variable "DSAC_PARAM" with that Domain Specific Access Restriction Parameters;
 - 3> else:
 - 4> if the variable "DSAC_PARAM" is set, the UE shall:
 - 5> clear the variable "DSAC_PARAM".
 - 2> for the variable "PPAC_PARAM":
 - 3> if the IE "Paging Permission with Access Control Parameters For PLMN Of MIB", the IE "Paging Permission with Access Control Parameters For OperatorN" or the IE "Paging Permission with Access

Control Parameters For All" to be applied according to the requirements above is included in the System Information Block Type 3:

4> if the variable "PPAC_PARAM" is not set, the UE shall:

5> store that Paging Permission with Access Control Parameters to the variable "PPAC_PARAM" and maintain the variable until it is cleared, the PLMN chosen by the UE is changed or the RRC connection is released.

4> else (the access class barring information is stored) UE shall:

5> update the variable "PPAC_PARAM" with that Paging Permission with Access Control Parameters.

3> else:

4> if the variable "PPAC_PARAM" is set, the UE shall:

5> clear the variable "PPAC_PARAM".

2> the UE shall:

3> if the variable "DSAC_PARAM" is set:

4> if the variable "PPAC_PARAM" is set:

5> act on the stored IE "Paging Response Restriction Indicator" when sending a response to any PAGING TYPE 1 or PAGING TYPE 2 message, Paging message specified in [67] or CS SERVICE NOTIFICATION message specified in [79];

5> act on the stored IE "Location/Registration Access Class Barred List" if the IE "Location/Registration Restriction Indicator" is set to "All" or "CS", when initiating a Location/Registration procedure to the CS domain, as specified in [4];

5> act on the stored IE "Location/Registration Access Class Barred List" if the IE "Location/Registration Restriction Indicator" is set to "All" or "PS", when initiating a Location/Registration procedure to the PS domain, as specified in [4];

5> act on the stored IE "Domain Specific Access Class Barred List" if indicated in the IE "CS Domain Specific Access Restriction" when initiating an INITIAL DIRECT TRANSFER message to the CS domain for any other reason, as specified in [4];

5> act on the stored IE "Domain Specific Access Class Barred List" if indicated in the IE "PS Domain Specific Access Restriction" when initiating an INITIAL DIRECT TRANSFER message to the PS domain, for any other reason, as specified in [4].

4> if the variable "PPAC_PARAM" is not set:

5> act on the stored IE "Domain Specific Access Class Barred List" if indicated in the IE "CS Domain Specific Access Restriction" when initiating an INITIAL DIRECT TRANSFER message to the CS domain, as specified in [4];

5> act on the stored IE "Domain Specific Access Class Barred List" if indicated in the IE "PS Domain Specific Access Restriction" when initiating an INITIAL DIRECT TRANSFER message to the PS domain, as specified in [4].

3> else:

4> act as if no Access Class is barred.

With respect to "CSG Identity" IE, the UE shall:

1> if the IE "CSG Identity" is present:

2> forward the content of IE "CSG Identity" to the upper layers.

If the IE "MBSFN only service" is set to TRUE the UE shall:

1> consider this cell to operate in MBSFN mode;

1> for TDD consider that all slots operate in MBSFN mode;

1> for FDD, 3.84 Mcps TDD IMB and 3.84/7.68 Mcps TDD if the UE capabilities allow the reception of MBSFN in addition to the normal UE operation the UE may receive MBMS services from this cell in accordance with requirements for selection of a cell providing only MBSFN as specified in [4]. For 1.28 Mcps TDD, if the UE capabilities allow the reception of MBSFN in addition to the normal UE operation the UE may get synchronized to the MBSFN cluster as specified in [4].

8.1.1.6.4 System Information Block type 4

If in connected mode, the UE should store all relevant IEs included in this system information block. The UE shall:

1> if in connected mode:

2> read and act on information sent in this block;

2> read the System Information Block Type 3 for any Access Class Barring information and act on that information as described in subclause 8.1.1.6.3.

If in idle mode, the UE shall not use the values of the IEs included in this system information block.

8.1.1.6.5 System Information Block type 5 and 5bis

The UE should store all relevant IEs included in this system information block. The UE shall:

1> if the IE "Frequency band indicator" is included and if the frequency band indicated in the IE is not part of the frequency bands supported in the UE radio access capability; or

1> if the IE "Frequency band indicator 2" is included and if the frequency band indicated in the IE is not part of the frequency bands supported in the UE radio access capability; or

1> if the IE "Frequency band indicator" is included and set to "extension indicator", and the UE does not support any of the frequency bands that can be indicated by the IE "Frequency band indicator 2" (i.e., Band VIII or beyond); or

1> if the IE "Frequency band indicator" is not included in System Information Block type 5, the DL frequency is in between 2110MHz-2170MHz, and Band I is not part of the frequency bands supported by the UE in the UE radio access capability, or

1> if the IE "Frequency band indicator" is not included in System Information Block type 5, the DL frequency is in between 1805MHz-1880MHz, and Band III is not part of the frequency bands supported by the UE in the UE radio access capability:

2> consider the cell to be barred according to [4]; and

2> consider the barred cell as using the value "not allowed" in the IE "Intra-frequency cell re-selection indicator", and the maximum value in the IE " T_{barred} ".

1> if the cell belongs to any frequency band equal to Band IV or greater and neither the IE "Frequency band indicator" nor the IE "Frequency band indicator 2" are included in System Information Block type 5 or in System Information Block type 5bis:

2> the UE behaviour is not specified.

1> if in connected mode, and System Information Block type 6 is indicated as used in the cell:

2> read and act on information sent in System Information Block type 6.

1> determine the value for the HSPA_RNTI_STORED_CELL_PCH variable and take the corresponding actions as described in subclause 8.5.56;

1> determine the value for the READY_FOR_COMMON_EDCH variable and take the corresponding actions as described in subclause 8.5.47;

- 1> determine the value for the COMMON_E_DCH_TRANSMISSION variable and take the corresponding actions as described in subclause 8.5.46;
- 1> if the UE is in CELL_FACH state or Idle mode; and
- 1> if the UE does support E-DCH transmission in CELL_FACH state and Idle mode; and
- 1> if the IE "HS-DSCH common system information" is included in system information block type 5 or 5bis; and
- 1> if the IE "Common E-DCH system info" is included system information block type 5 or 5bis:
 - 2> for 1.28 Mcps TDD, if the IE "Frequency info" is included in system information block type 5;
 - 3> store and use the frequency indicated by the IE "Frequency info" as the secondary frequency for Enhanced Uplink transmission in CELL_FACH state and Idle mode;
 - 3> if the IE "E-RUCCH Access Service class" and/or "E-RUCCH persistence scaling factor list" and/or "SYNC_UL info" and/or IE " PRACH Information" are included in the IE "E-RUCCH Info" in system information block type 5;
 - 4> store and use the information contained in IE "E-RUCCH info";
 - 3> else:
 - 4> use the same configuration in the IE "PRACH system information list" on the secondary frequency indicated by the IE "Frequency info".
 - 3> if the IE "UpPCH Position Info" is included:
 - 4> store and use the UpPCH position indicated by the IE "UpPCH Position Info";
 - 2> for 1.28 Mcps TDD, if the IE "Frequency info" is not included in system information block type 5;
 - 3> use the primary frequency for Enhanced Uplink transmission in CELL_FACH state and Idle mode;
 - 3> use the same configuration in the IE "PRACH system information list" on the primary frequency for the IE "E-RUCCH Access Service class" and/or "E-RUCCH persistence scaling factor list" and/or "SYNC_UL info" and/or IE " PRACH Information".
 - 2> use the Enhanced Uplink in CELL_FACH state and Idle mode as specified in section 8.5.45 for FDD or 8.5.45a for 1.28 Mcps TDD and [15] for DTCH, DCCH and CCCH transmission.
 - 2> for 1.28 Mcps TDD, if the IE "Treset Usage Indicator" is included:
 - 3> store IE "Treset Usage Indicator";
 - 2> else:
 - 3> clear the stored IE.
- 1> else:
 - 2> if the UE is in CELL_PCH state; and
 - 2> if the UE does support E-DCH transmission in CELL_FACH state and Idle mode; and
 - 2> if the IE "HS-DSCH paging system information" is included in system information block type 5 or 5bis; and
 - 2> if the IE "Common E-DCH system info" is included system information block type 5 or 5bis; and
 - 2> if the variables C_RNTI, E_RNTI and H_RNTI are set:
 - 3> use the Enhanced Uplink in CELL_FACH state and Idle mode as specified in section 8.5.45 for FDD or 8.5.45a for 1.28 Mcps TDD and [15] for DTCH and DCCH transmission.
 - 2> else:
 - 3> replace the TFS of the RACH with the one stored in the UE if any;

- 3> let the physical channel(s) of type PRACH given by the IE(s) "PRACH info" be the default in uplink for the PRACH if UE is in CELL_FACH state;
- 3> start to receive the physical channel of type AICH using the parameters given by the IE "AICH info" (FDD only) when given allocated PRACH is used;
- 3> if the IE "Additional Dynamic Transport Format Information for CCCH" is included for the selected PRACH:
 - 4> use this transport format for transmission of the CCCH.
- 3> else:
 - 4> use the first instance of the list of transport formats as in the IE "RACH TFS" for the used RACH received in the IE "PRACH system information list" when using the CCCH.
- 1> for 3.84 Mcps and 7.68 Mcps TDD; or
- 1> for FDD and 1.28 Mcps TDD, if the UE does not support HS-DSCH reception in CELL_FACH state; or
- 1> if the IE "HS-DSCH common system information" is not included; or
- 1> for 1.28 Mcps TDD, if the IE "Common E-DCH system info" is not included:
 - 2> replace the TFS of the FACH/PCH with the one stored in the UE if any;
 - 2> select a Secondary CCPCH as specified in [4] and in subclause 8.5.19, and start to receive the physical channel of type PICH associated with the PCH carried by the selected Secondary CCPCH using the parameters given by the IE "PICH info" if UE is in Idle mode or in CELL_PCH or URA_PCH state;
 - 2> start to monitor its paging occasions on the selected PICH if UE is in Idle mode or in CELL_PCH or URA_PCH state;
 - 2> start to receive the selected physical channel of type Secondary CCPCH using the parameters given by the IE(s) "Secondary CCPCH info" if UE is in CELL_FACH state;
 - 2> in 3.84 Mcps TDD and 7.68 Mcps TDD:
 - 3> use the IE "TDD open loop power control" as defined in subclause 8.5.7 when allocated PRACH is used.
 - 2> in TDD:
 - 3> if the IE "PDSCH system information" and/or the IE "PUSCH system information" is included:
 - 4> store each of the configurations given there with the associated identity given in the IE "PDSCH Identity" and/or "PUSCH Identity" respectively. For every configuration, for which the IE "SFN Time info" is included, the information shall be stored for the duration given there.
 - 2> take the actions related to the HS_DSCH_RECEPTION_GENERAL variable as described in subclause 8.5.37a.
- 1> else:
 - 2> if the UE is in Idle mode:
 - 3> if the variable HS_DSCH_RECEPTION_OF_CCCH_ENABLED is set to TRUE:
 - 4> for FDD, start to receive HS-DSCH according to the procedure in subclause 8.5.37.
 - 4> for 1.28 Mcps TDD, if the IE "Frequency info" is included in system information block type 5;
 - 5> start to receive HS-DSCH according to the procedure in subclause 8.5.37 at the frequency indicated by the IE "Frequency info";
 - 4> for 1.28 Mcps TDD, if the IE "Frequency info" is not included in system information block type 5;
 - 5> start to receive HS-DSCH according to the procedure in subclause 8.5.37 at the primary frequency;

- 3> else:
 - 4> replace the TFS of the FACH/PCH with the one stored in the UE if any;
 - 4> select a Secondary CCPCH as specified in [4] and in subclause 8.5.19, and start to receive the physical channel of type PICH associated with the PCH carried by the selected Secondary CCPCH using the parameters given by the IE "PICH info";
 - 4> start to monitor its paging occasions on the selected PICH.
- 3> take the actions related to the HS_DSCH_RECEPTION_GENERAL variable as described in subclause 8.5.37a.
- 2> if the UE is in CELL_FACH:
 - 3> if variable H_RNTI is set:
 - 4> start to receive HS-DSCH according to the procedure in subclause 8.5.36.
 - 3> else:
 - 4> if the variable HS_DSCH_RECEPTION_OF_CCCH_ENABLED is set to TRUE:
 - 5> for FDD, start to receive HS-DSCH according to the procedure in subclause 8.5.37.
 - 5> for 1.28 Mcps TDD, if the IE "Frequency info" is included in system information block type 5;
 - 6> start to receive HS-DSCH according to the procedure in subclause 8.5.37 at the frequency indicated by the IE "Frequency info";
 - 5> for 1.28 Mcps TDD, if the IE "Frequency info" is not included in system information block type 5;
 - 6> start to receive HS-DSCH according to the procedure in subclause 8.5.37 at the primary frequency;
 - 3> if the IE "HS-DSCH DRX in CELL_FACH Information" is included:
 - 4> determine the value of the HS_DSCH_DRX_CELL_FACH_STATUS variable according to the procedure in subclause 8.5.48.
- 2> if the UE is in CELL_PCH or URA_PCH state:
 - 3> for FDD and for 1.28 Mcps TDD, if the UE supports HS-DSCH reception in CELL_PCH and URA_PCH state; and
 - 3> if IE "HS-DSCH paging system information" is included:
 - 4> if this IE is not currently stored; and
 - 4> if the value of the IE "SRNC identity" in the variable U_RNTI is not equal to the 12 MSBs of the received IE "Cell identity" in System Information Block type 3; and
 - 4> if the UE is in URA_PCH state:
 - 5> initiate the URA update procedure as specified in subclause 8.3.1, using the cause "periodic URA update".
 - 4> for FDD; or
 - 4> for 1.28 Mcps TDD, if both variable H_RNTI and variable C_RNTI are set:
 - 5> start to monitor the paging occasions and PICH monitoring occasions determined according to subclauses 8.6.3.1a, 8.6.3.2 and 8.5.39 and receive PCCH on the HS-DSCH mapped on the HS-PDSCH, or DCCH and DTCH and BCCH on the HS-DSCH mapped on the HS-PDSCH and the associated HS-PDSCH selected by the UE according to the procedure in subclause 8.5.40 for FDD and 8.5.40a for 1.28 Mcps TDD.

3> else:

- 4> replace the TFS of the FACH/PCH with the one stored in the UE if any;
- 4> select a Secondary CCPCH as specified in [4] and in subclause 8.5.19, and start to receive the physical channel of type PICH associated with the PCH carried by the selected Secondary CCPCH using the parameters given by the IE "PICH info";
- 4> start to monitor its paging occasions on the selected PICH;
- 4> take the actions related to the HS_DSCH_RECEPTION_GENERAL variable as described in subclause 8.5.37a.

If a UE is a 12 kbps class UE according to [35] and the UE has a lower capability than required to support all transport channel configurations mapped on a specific Secondary CCPCH, the UE shall at a certain time instant still be able to decode those transport channels mapped on this Secondary CCPCH that do match the capability supported by the UE. The UE shall use the TFCI bits for that Secondary CCPCH, to distinguish a transport channel configuration that is supported by the UE from a transport channel configuration that is not supported by the UE.

In particular if the UE is a 12 kbps class UE according to [35] and it does not support the processing requirement at a given point in time for a Secondary CCPCH, it shall still be able to decode the same Secondary CCPCH when the processing requirement is consistent with the UE capability. Or if the UE does not support the number of TFs or the coding of a certain transport channel on a Secondary CCPCH, it shall still be able to decode other transport channels mapped on the same Secondary CCPCH that is consistent with what is supported by the UE.

The UE shall:

- 1> if the IE "Secondary CCPCH system information MBMS" is included:
 - 2> apply the Secondary CCPCH and FACH indicated by the IE "FACH carrying MCCH" for receiving MCCH.
- 1> otherwise, if the IE "Secondary CCPCH system information" includes the IE "MCCH configuration information":
 - 2> apply the Secondary CCPCH and FACH indicated by the IE 'MCCH configuration information' for receiving MCCH.
- 1> for TDD, if the IE "TDD MBSFN Information" is included:
 - 2> apply the scrambling codes (as referenced by the "Cell parameters ID") to each timeslot indicated by "TDD MBSFN Information".

8.1.1.6.6 System Information Block type 6

If in connected mode, the UE should store all relevant IEs included in this system information block. The UE shall:

- 1> if the IE "Frequency band indicator" is included:
 - 2> if the frequency band indicated in the IE is not part of the frequency bands supported in the UE radio access capability; or
 - 2> if the IE "Frequency band indicator 2" is included and if the frequency band indicated in the IE is not part of the frequency bands supported in the UE radio access capability; or
 - 2> if the IE "Frequency band indicator" is included and set to "extension indicator", and the UE does not support any of the frequency bands that can be indicated by the IE "Frequency band indicator 2" (i.e., Band VIII or beyond):
 - 3> consider the cell to be barred according to [4]; and
 - 3> consider the barred cell as using the value "not allowed" in the IE "Intra-frequency cell re-selection indicator", and the maximum value in the IE "T_{barred}".
- 1> if the UE is in CELL_FACH state; and
- 1> if the UE does support E-DCH transmission in CELL_FACH state and Idle mode; and

- 1> if the IE "HS-DSCH common system information" is included in system information block type 5 or 5bis; and
- 1> if the IE "Common E-DCH system info" is included system information block type 5 or 5bis:
 - 2> use the Enhanced Uplink in CELL_FACH state and Idle mode as specified in section 8.5.45 for FDD or 8.5.45a for 1.28 Mcps TDD and [15] for DTCH, DCCH and CCCH transmission.
- 1> else:
 - 2> if the UE is in CELL_PCH state; and
 - 2> if the UE does support E-DCH transmission in CELL_FACH state and Idle mode; and
 - 2> if the IE "HS-DSCH paging system information" is included in system information block type 5 or 5bis; and
 - 2> if the IE "Common E-DCH system info" is included system information block type 5 or 5bis; and
 - 2> if the variables C_RNTI, E_RNTI and H_RNTI are set:
 - 3> use the Enhanced Uplink in CELL_FACH state and Idle mode as specified in section 8.5.45 for FDD or 8.5.45a for 1.28 Mcps TDD and [15] for DTCH and DCCH transmission.
 - 2> else:
 - 3> replace the TFS of the RACH with the one stored in the UE if any;
 - 3> let the physical channel(s) of type PRACH given by the IE(s) "PRACH info" be the default in uplink if UE is in CELL_FACH state. If the IE "PRACH info" is not included, the UE shall read the corresponding IE(s) in System Information Block type 5 or System Information Block type 5bis and use that information to configure the PRACH;
 - 3> start to receive the physical channel of type AICH using the parameters given by the IE "AICH info" when associated PRACH is used. If the IE "AICH info" is not included, the UE shall read the corresponding IE in System Information Block type 5 or System Information Block type 5bis and use that information (FDD only);
 - 3> if the IE "Additional Dynamic Transport Format Information for CCCH" is included for the selected PRACH:
 - 4> use this transport format for transmission of the CCCH (FDD only).
 - 3> else:
 - 4> use the first instance of the list of transport formats as in the IE "RACH TFS" for the used RACH received in the IE "PRACH system information list" when using the CCCH (FDD only).
- 1> for 3.84 Mcps and 7.68 Mcps TDD; or
- 1> for FDD and 1.28 Mcps TDD, if the UE does not support HS-DSCH reception in CELL_FACH state; or
- 1> if the IE "HS-DSCH common system information" is not included in System Information Block type 5 or System Information Block type 5bis; or
- 1> for 1.28 Mcps TDD, if the IE "Common E-DCH system info" is not included:
 - 2> replace the TFS of the FACH/PCH with the one stored in the UE if any;
 - 2> select a Secondary CCPCH as specified in [4] and in subclause 8.5.19, and start to receive the physical channel of type PICH associated with the PCH carried by the selected Secondary CCPCH using the parameters given by the IE "PICH info" if the UE is in CELL_PCH or URA_PCH state. If the IE "PICH info" is not included, the UE shall read the corresponding IE in System Information Block type 5 or System Information Block type 5bis and use that information;
 - 2> start to monitor its paging occasions on the selected PICH if the UE is in CELL_PCH or URA_PCH state;
 - 2> start to receive the selected physical channel of type Secondary CCPCH using the parameters given by the IE(s) "Secondary CCPCH info" if the UE is in CELL_FACH state. If the IE "Secondary CCPCH info" is not

included, the UE shall read the corresponding IE(s) in System Information Block type 5 or System Information Block type 5bis and use that information;

- 2> in 3.84 Mcps TDD and 7.68 Mcps TDD: use the IE "TDD open loop power control" as defined in subclause 8.5.7;
- 2> in TDD: if the IE "PDSCH system information" and/or the IE "PUSCH system information" is included, store each of the configurations given there with the associated identity given in the IE "PDSCH Identity" and/or "PUSCH Identity" respectively. For every configuration, for which the IE "SFN Time info" is included, the information shall be stored for the duration given there;
- 2> take the corresponding actions as described in subclause 8.5.37a.

1> else:

2> if the UE is in CELL_FACH:

3> read and use the IE "HS-DSCH common system information" in System Information Block type 5 or System Information Block type 5bis;

3> if variable H_RNTI is set:

4> start to receive HS-DSCH according to the procedure in subclause 8.5.36.

3> else:

4> if the variable HS_DSCH_RECEPTION_OF_CCCH_ENABLED is set to TRUE:

5> start to receive HS-DSCH according to the procedure in subclause 8.5.37.

2> if the UE is in CELL_PCH or URA_PCH state:

3> for FDD and for 1.28 Mcps TDD if the UE supports HS-DSCH reception in CELL_PCH and URA_PCH state; and

3> if IE "HS-DSCH paging system information" is included in System Information Block type 5 or System Information Block type 5bis:

4> read and use the IE "HS-DSCH paging system information" in System Information Block type 5 or System Information Block type 5bis;

4> for FDD; or

4> for 1.28 Mcps TDD, if both variable H_RNTI and variable C_RNTI are set:

5> start to monitor the paging occasions and PICH monitoring occasions determined according to subclauses 8.6.3.1a, 8.6.3.2 and 8.5.39 and receive PCCH or DCCH and DTCH according to the procedure in subclause 8.5.40 for FDD and 8.5.40a for 1.28 Mcps TDD.

3> else:

4> replace the TFS of the FACH/PCH with the one stored in the UE if any;

4> select a Secondary CCPCH as specified in [4] and in subclause 8.5.19, and start to receive the physical channel of type PICH associated with the PCH carried by the selected Secondary CCPCH using the parameters given by the IE "PICH info". If the IE "PICH info" is not included, the UE shall read the corresponding IE in System Information Block type 5 or System Information Block type 5bis and use that information;

4> start to monitor its paging occasions on the selected PICH;

4> take the actions related to the HS_DSCH_RECEPTION_GENERAL variable as described in subclause 8.5.37a.

If in idle mode, the UE shall not use the values of the IEs in this system information block.

If a UE is a 12 kbps class UE according to [35] and the UE has a lower capability than required to support all transport channel configurations mapped on a specific Secondary CCPCH, the UE shall at a certain time instant still be able to decode those transport channels mapped on this Secondary CCPCH that do match the capability supported by the UE. The UE shall use the TFCI bits for that Secondary CCPCH, to distinguish a transport channel configuration that is supported by the UE from a transport channel configuration that is not supported by the UE.

In particular if the UE is a 12 kbps class UE according to [35] and it does not support the processing requirement at a given point in time for a Secondary CCPCH, it shall still be able to decode the same Secondary CCPCH when the processing requirement is consistent with the UE capability. Or if the UE does not support the number of TFs or the coding of a certain transport channel on a Secondary CCPCH, it shall still be able to decode other transport channels mapped on the same Secondary CCPCH that is consistent with what is supported by the UE.

8.1.1.6.7 System Information Block type 7

The UE should store all relevant IEs included in this system information block.

8.1.1.6.8 Void

8.1.1.6.9 Void

8.1.1.6.10 Void

8.1.1.6.11 System Information Block type 11

If the cell is not operating in MBSFN mode according to subclause 8.1.1.6.3 the UE should store all relevant IEs included in this system information block. If the cell is not operating in MBSFN mode according to subclause 8.1.1.6.3 the UE shall:

1> if in idle mode:

2> clear the variable MEASUREMENT_IDENTITY.

1> if IE "FACH measurement occasion info" is included:

2> act as specified in subclause 8.6.7.

1> else:

2> may perform inter-frequency/inter-RAT measurements or inter-frequency/inter-RAT cell re-selection evaluation, if the UE capabilities permit such measurements while simultaneously receiving the S-CCPCH of the serving cell.

1> clear the variable CELL_INFO_LIST;

1> act upon the received IE "Intra-frequency cell info list"/"Inter-frequency cell info list"/"Inter-RAT cell info list" as described in subclause 8.6.7.3;

1> if the IE "Inter-frequency RACH reporting information" is included in the system information block:

2> read the IE and use that information for the inter-frequency measurements as specified in subclause 8.5.23.

1> if in idle mode; or

1> if in connected mode and if System Information Block type 12 is not broadcast in the cell:

2> if no intra-frequency measurement stored in the variable MEASUREMENT_IDENTITY was set up or modified through a MEASUREMENT CONTROL message:

- 3> if included, store the IE "Intra-frequency reporting quantity" and the IE "Intra-frequency measurement reporting criteria" or "Periodical reporting criteria" in order to activate reporting when state CELL_DCH is entered in the variable MEASUREMENT_IDENTITY. The IE "Cells for measurement" is absent for this measurement. The IE "Measurement Validity" is absent for this measurement after a state transition to CELL_DCH;
- 1> if in connected mode and if System Information Block type 12 is not broadcast in the cell:
 - 2> read the IE "Traffic volume measurement system information";
 - 2> if no traffic volume measurement with the measurement identity indicated in the IE "Traffic volume measurement system information" was set up or modified through a MEASUREMENT CONTROL message:
 - 3> update the variable MEASUREMENT_IDENTITY with the measurement information received in that IE.
 - 1> if the IE "Cell selection and reselection info" is not included for a new neighbouring cell in the IE "intra-frequency cell info list", the IE "inter-frequency cell info list" or the IE "inter-RAT cell info list" in System Information Block type 11:
 - 2> use the default values specified for the IE "Cell selection and reselection info" for that cell except for the IE "HCS neighbouring cell information".
 - 1> if the IE "Use of HCS" is set to "used", indicating that HCS is used, do the following:
 - 2> if IE "HCS neighbouring cell information" is not included for the first new cell in the IE "Intra-frequency cell info list", the IE "Inter-frequency cell info list" or the IE "Inter-RAT cell info list" in System Information Block type 11:
 - 3> use the default values specified for the IE "HCS neighbouring cell information" for that cell.
 - 2> if IE "HCS neighbouring cell information" is not included for any other new cell in the IE "Intra-frequency cell info list", the IE "Inter-frequency cell info list" or the IE "Inter-RAT cell info list" in System Information Block type 11:
 - 3> for that cell use the same parameter values as used for the preceding cell in the same cell info list in System Information Block type 11.
 - 1> if the value of the IE "Cell selection and reselection quality measure" is different from the value of the IE "Cell selection and reselection quality measure" obtained from System Information Block type 3 or System Information Block type 4:
 - 2> use the value of the IE from this System Information Block and ignore the value obtained from System Information Block type 3 or System Information Block type 4.
 - 1> if in connected mode, and System Information Block type 12 is indicated as used in the cell:
 - 2> read and act on information sent in System Information Block type 12 as indicated in subclause 8.1.1.6.12.
 - 1> if IE "MBSFN frequency list" is included:
 - 2> act as specified in subclause 8.6.9.9ac.
- For 1.28 Mcps TDD if the cell is operating in MBSFN only mode according to subclause 8.1.1.6.3 the UE shall:
- 1> store the frequencies and their corresponding "cell parameter ID" indicated in the IE "MBSFN LCR TDD frequency list" included in the IE "MBSFN frequency list".
- If the cell is operating in MBSFN mode according to subclause 8.1.1.6.3 the UE may:
- 1> for FDD and 3.84/7.68 Mcps TDD consider the cells indicated in the IE "Intra-frequency cell info list" in the IE "Intra-frequency measurement system information" as candidates for the selection of the MBSFN cluster;
 - 1> for 1.28 Mcps TDD consider there exist MBSFN clusters deployed with the frequencies and their corresponding "cell parameter ID" stored.

For 1.28 Mcps TDD if the cell is not operating in MBSFN only mode but associated with one or more MBSFN clusters the UE shall:

- 1> store the frequencies and their corresponding "cell parameter ID" indicated in the IE "MBSFN LCR TDD frequency list" included in the IE "MBSFN frequency list";
- 1> consider there exist MBSFN clusters deployed with the frequencies and their corresponding 'cell parameter ID' stored;
- 1> search an MBSFN cluster in MBSFN only mode with its frequency and corresponding "cell parameter ID" for monitoring the MBMS services delivered in dedicated MBSFN frequency layer.

NOTE: The IE "Intra-frequency cell info list" may not include information about all neighbouring MBSFN clusters

8.1.1.6.11a System Information Block type 11bis

The UE should store all relevant IEs included in this system information block. The UE shall:

- 1> after reception of SIB 11 act upon the received IEs "Intra-frequency cell info list", "Inter-frequency cell info list" and "Inter-RAT cell info list" as described in subclause 8.6.7.3;
- 1> if the IE "Cell selection and reselection info" is not included for a new neighbouring cell in the IEs "New Intra-frequency cells", "New Inter-frequency cells" or "New Inter-RAT cells" in System Information Block type 11bis:
 - 2> use the default values specified for the IE "Cell selection and reselection info" for that cell except for the IE "HCS neighbouring cell information".
- 1> if the IE "Use of HCS" is set to "used", indicating that HCS is used, do the following:
 - 2> if IE "HCS neighbouring cell information" is not included for the first new cell in the IEs "New Intra-frequency cells", "New Inter-frequency cells" or "New Inter-RAT cells" in System Information Block type 11bis:
 - 3> use the default values specified for the IE "HCS neighbouring cell information" for that cell.
 - 2> if IE "HCS neighbouring cell information" is not included for any other new cell in the IEs "New Intra-frequency cells", "New Inter-frequency cells" or "New Inter-RAT cells" in System Information Block type 11bis:
 - 3> for that cell use the same parameter values as used for the preceding cell in the same cell info list in System Information Block type 11bis.

8.1.1.6.12 System Information Block type 12

If in connected mode, the UE should store all relevant IEs included in this system information block. The UE shall:

- 1> after reception of System Information Block type 11; and
- 1> after reception of System Information Block type 11bis, if broadcast in the cell:
 - 2> update the variable MEASUREMENT_IDENTITY with the measurement information in the received IEs unless specified otherwise.
- 1> if IE "FACH measurement occasion info" is included:
 - 2> act as specified in subclause 8.6.7.
- 1> else:
 - 2> may perform inter-frequency/inter-RAT measurements or inter-frequency/inter-RAT cell re-selection evaluation, if the UE capabilities permit such measurements while simultaneously receiving the S-CCPCH of the serving cell.

- 1> act upon the received IE "Intra-frequency cell info list"/"Inter-frequency cell info list"/"Inter-RAT cell info list" as described in subclause 8.6.7.3;
- 1> if any of the IEs "Intra-frequency measurement quantity", "Intra-frequency reporting quantity for RACH reporting", "Maximum number of reported cells on RACH" or "Reporting information for state CELL_DCH" are not included in the system information block:
 - 2> read the corresponding IE(s) in system information block type 11 and use that information for the intra-frequency measurement.
- 1> if the IE "Inter-frequency RACH reporting information" is included in this system information block or in System Information Block type 11:
 - 2> if the IE is not included in the system information block, read the corresponding IE(s) in System Information Block type 11;
 - 2> use the received information for the inter-frequency measurements as specified in subclause 8.5.23.
- 1> if included in this system information block or in System Information Block type 11:
 - 2> if no intra-frequency measurement in the variable MEASUREMENT_IDENTITY was set up or modified through a MEASUREMENT CONTROL message:
 - 3> store the IE "Intra-frequency reporting quantity" and the IE "Intra-frequency measurement reporting criteria" or "Periodical reporting criteria" in order to activate reporting when state CELL_DCH is entered in the variable MEASUREMENT_IDENTITY. The IE "Cells for measurement" is absent for this measurement. The IE "Measurement Validity" is absent for this measurement after a state transition to CELL_DCH;
- 1> if the IE "Traffic volume measurement system information" is not included in this system information block:
 - 2> read the corresponding IE in System Information Block type 11.
- 1> if the IE "Traffic volume measurement system information" was received either in this system information block or in System Information Block type 11:
 - 2> if no traffic volume measurement with the measurement identity indicated in the IE "Traffic volume measurement system information" was set up or modified through a MEASUREMENT CONTROL message:
 - 3> update the variable MEASUREMENT_IDENTITY with the measurement information received in that IE.
- 1> if in CELL_FACH state:
 - 2> start or continue the traffic volume measurements stored in the variable MEASUREMENT_IDENTITY that are valid in CELL_FACH state.
- 1> if the IE "Cell selection and reselection info" is not included for a new neighbouring cell in the IE "Intra-frequency cell info list", the IE "Inter-frequency cell info list" or the IE "Inter-RAT cell info list" in System Information Block type 12:
 - 2> use the default values specified for the IE "Cell selection and reselection info" for that cell except for the IE "HCS neighbouring cell information".
- 1> if the IE "Use of HCS" is set to "used", indicating that HCS is used, do the following:
 - 2> if IE "HCS neighbouring cell information" is not included for the first new cell in the IE "Intra-frequency cell info list", the IE "Inter-frequency cell info list" or the IE "Inter-RAT cell info list" in System Information Block type 12:
 - 3> use the default values specified for the IE "HCS neighbouring cell information" for that cell.
 - 2> if IE "HCS neighbouring cell information" is not included for any other new cell in the IE "Intra-frequency cell info list", the IE "Inter-frequency cell info list" or the IE "Inter-RAT cell info list" in System Information Block type 12:

3> for that cell use the same parameter values as used for the preceding cell in the same cell info list in System Information Block type 12.

1> if the value of the IE "Cell selection and reselection quality measure" is different from the value of the IE "Cell selection and reselection quality measure" obtained from System Information Block type 3 or System Information Block type 4:

2> use the value of the IE from this System Information Block and ignore the value obtained from System Information Block type 3 or System Information Block type 4.

If in idle mode, the UE shall not use the values of the IEs in this system information block.

8.1.1.6.13 System Information Block type 13

If in idle or connected mode, the UE should store all relevant IEs included in this system information block except for the IEs "CN domain specific DRX cycle length coefficient", "UE timers and constants in idle mode" and "Capability update requirement" which shall be stored only in the idle mode case. The UE shall read System Information Block type 13 and the associated System Information Block types 13.1, 13.2, 13.3 and 13.4 only when the UE is operating in "ANSI-41 mode" and the IE "PLMN type" in the Master Information Block has the value "ANSI-41" or "GSM-MAP and ANSI-41". The UE shall also:

1> forward the content of the IE "CN domain specific NAS system information" to the non-access stratum entity indicated by the IE "CN domain identity";

1> use the IE "CN domain specific DRX cycle length coefficient" to calculate frame number for the Paging Occasions and Page indicator as specified in [4].

Refer to TIA/EIA/IS-2000.5-A for actions on information contained in System Information Block types 13.1, 13.2, 13.3 and 13.4.

8.1.1.6.14 System Information Block type 14

This system information block type is used only in 3.84 Mcps TDD and 7.68 Mcps TDD.

The UE should store all relevant IEs included in this system information block. The UE shall:

1> use the IE "UL Timeslot Interference" to calculate PRACH, DPCH and PUSCH transmit power for TDD uplink open loop power control as defined in subclause 8.5.7.

8.1.1.6.15 System Information Block type 15

If the UE is in idle or connected mode, and supports GPS location services it should store all relevant IEs included in this system information block. The UE shall:

1> if the IE "GPS Data ciphering info" is included:

1> act as specified in the subclause 8.6.7.19.4.- act upon the received IE "Reference position" as specified in subclause 8.6.7.19.3.8;

1> act upon the received IE "GPS reference time" as specified in subclause 8.6.7.19.3.7;

1> if IE "Satellite information" is included:

2> act upon this list of bad satellites as specified in subclause 8.6.7.19.3.6.

NOTE: For efficiency purposes, the UTRAN should broadcast System Information Block type 15 if it is broadcasting System Information Block type 15.2.

8.1.1.6.15.0 System Information Block type 15bis

If the UE is in idle or connected mode, and supports GANSS location services it should store all relevant IEs included in this system information block. The UE shall:

1> act upon the received IE "Reference position" as specified in subclause 8.6.7.19.7.8;

- 1> act upon the received IE "GANSS reference time" as specified in subclause 8.6.7.19.7.7;
- 1> if IE "GANSS ionospheric model" is included:
 - 2> act upon the received IE "GANSS ionospheric model" as specified in subclause 8.6.7.19.7.5.
- 1> if IE "GANSS additional ionospheric model" is included:
 - 2> act upon the received IE "GANSS additional ionospheric model" as specified in subclause 8.6.7.19.7.12.
- 1> if IE "GANSS Earth orientation parameters" is included:
 - 2> act upon the received IE "GANSS Earth orientation parameters" as specified in subclause 8.6.7.19.7.13.

8.1.1.6.15.1 System Information Block type 15.1

The UE should store all the relevant IEs included in this system information block in variable UE_POSITIONING_GPS_DATA. The UE shall:

- 1> act on "DGPS information" in the IE "DGPS Corrections" in a similar manner as specified in [13] except that the scale factors for PRC and RRC are different;
- 1> act upon the received IE "UE Positioning GPS DGPS corrections" as specified in subclause 8.6.7.19.3.3.

In this version of the specification, the UE shall:

- 1> ignore the following IEs: "Delta PRC2", "Delta RRC2", "Delta PRC3" and "Delta RRC3".

8.1.1.6.15.1a System Information Block type 15.1bis

This SIB has one occurrence for each GANSS supported. To identify the different GANSSs, the scheduling information for System Information Block type 15.1bis is associated with IE "GANSS ID". The UE should store all the relevant IEs included in this system information block in variable UE_POSITIONING_GANSS_DATA. The UE shall:

- 1> act on "DGANSS information" in the IE "DGANSS Corrections" in a similar manner as specified in [13] except that the scale factors for PRC and RRC are different;
- 1> act upon the received IE "UE Positioning DGANSS corrections" as specified in subclause 8.6.7.19.7.3.

8.1.1.6.15.2 System Information Block type 15.2

For System Information Block type 15.2 multiple occurrences may be used; one occurrence for one satellite. To identify the different occurrences, the scheduling information for System Information Block type 15.2 includes IE "SIB occurrence identity and value tag". The UE should store all the relevant IEs included in this system information block in variable UE_POSITIONING_GPS_DATA. The UE shall:

- 1> compare for each occurrence the value tag of the stored occurrence, if any, with the occurrence value tag included in the IE "SIB occurrence identity and value tag" for the occurrence of the System Information Block with the same occurrence identity;
- 1> in case the UE has no SIB occurrence stored with the same identity or in case the occurrence value tag is different:
 - 2> store the occurrence information together with its identity and value tag for later use.
- 1> in case an occurrence with the same identity but different value tag was stored:
 - 2> overwrite this one with the new occurrence read via system information for later use.
- 1> interpret IE "Transmission TOW" as a very coarse estimate of the current time, i.e., the approximate GPS time-of-week when the message is broadcast;
- 1> interpret IE "SatID" as the satellite ID of the data from which this message was obtained;
- 1> act upon the received IEs "Sat ID" and "GPS Ephemeris and Clock Corrections Parameter" as specified in subclause 8.6.7.19.3.4.

The IE "Transmission TOW" may be different each time a particular SIB occurrence is transmitted. The UTRAN should not increment the value tag of the SIB occurrence if the IE "Transmission TOW" is the only IE that is changed.

The UE may not need to receive all occurrences before it can use the information from any one occurrence.

8.1.1.6.15.2a System Information Block type 15.2bis

For System Information Block type 15.2bis multiple occurrences may be used; one occurrence for one satellite. To identify for which GANSS the occurrence is related to, the scheduling information for System Information Block type 15.2bis is associated with IE "GANSS ID". To identify the different occurrences within each GANSS, the scheduling information for System Information Block type 15.2bis includes IE "SIB occurrence identity and value tag". The UE should store all the relevant IEs included in this system information block in variable UE_POSITIONING_GANSS_DATA. The UE shall:

- 1> compare for each occurrence the value tag of the stored occurrence, if any, with the occurrence value tag included in the IE "SIB occurrence identity and value tag" for the occurrence of the System Information Block with the same occurrence identity;
- 1> in case the UE has no SIB occurrence stored with the same identity or in case the occurrence value tag is different:
 - 2> store the occurrence information together with its identity and value tag for later use.
- 1> in case an occurrence with the same identity but different value tag was stored:
 - 2> overwrite this one with the new occurrence read via system information for later use.
- 1> act upon the received IEs "GANSS Navigation Model" as specified in subclause 8.6.7.19.7.4.

The UE may not need to receive all occurrences before it can use the information from any one occurrence.

8.1.1.6.15.2b System Information Block type 15.2ter

For System Information Block type 15.2ter multiple occurrences may be used; one occurrence for one satellite. To identify for which GANSS the occurrence is related to, the scheduling information for System Information Block type 15.2ter is associated with IE "GANSS ID". To identify the different occurrences within each GANSS, the scheduling information for System Information Block type 15.2ter includes IE "SIB occurrence identity and value tag". The UE should store all the relevant IEs included in this system information block in variable UE_POSITIONING_GANSS_DATA. The UE shall:

- 1> compare for each occurrence the value tag of the stored occurrence, if any, with the occurrence value tag included in the IE "SIB occurrence identity and value tag" for the occurrence of the System Information Block with the same occurrence identity;
- 1> in case the UE has no SIB occurrence stored with the same identity or in case the occurrence value tag is different:
 - 2> store the occurrence information together with its identity and value tag for later use.
- 1> in case an occurrence with the same identity but different value tag was stored:
 - 2> overwrite this one with the new occurrence read via system information for later use.
- 1> act upon the received IE "GANSS additional navigation models" as specified in subclause 8.6.7.19.7.14.

The UE may not need to receive all occurrences before it can use the information from any one occurrence.

8.1.1.6.15.3 System Information Block type 15.3

For System Information Block type 15.3 multiple occurrences may be used; one occurrence for each set of satellite data. To identify the different occurrences, the scheduling information for System Information Block type 15.3 includes IE "SIB occurrence identity and value tag". The UE should store all the relevant IEs included in this system information block in variable UE_POSITIONING_GPS_DATA. The UE shall:

- 1> compare for each occurrence the value tag of the stored occurrence, if any, with the occurrence value tag included in the IE "SIB occurrence identity and value tag" for the occurrence of the System Information Block with the same occurrence identity;
- 1> in case the UE has no SIB occurrence stored with the same identity or in case the occurrence value tag is different:
 - 2> store the occurrence information together with its identity and value tag for later use.
- 1> in case an occurrence with the same identity but different value tag was stored:
 - 2> overwrite this one with the new occurrence read via system information for later use.
- 1> interpret IE "Transmission TOW" as a very coarse estimate of the current time, i.e., the approximate GPS time-of-week when the message is broadcast;
- 1> if the IE "GPS Almanac and Satellite Health" is included:
 - 2> interpret IE "SatMask" as the satellites that contain the pages being broadcast in this message;
 - 2> interpret IE "LSB TOW" as the least significant 8 bits of the TOW [12];
 - 2> act upon the received IE "GPS Almanac and Satellite Health" as specified in subclause 8.6.7.19.3.2.
- 1> if the IE "GPS ionospheric model" is included:
 - 2> act upon the received IE "GPS ionospheric model" as specified in subclause 8.6.7.19.3.5.
- 1> if the IE "GPS UTC model" is included:
 - 2> act upon the received IE "GPS UTC model" as specified in subclause 8.6.7.19.3.9.

The IE "Transmission TOW" may be different each time a particular SIB occurrence is transmitted. The UTRAN should not increment the value tag of the SIB occurrence if the IE "Transmission TOW" is the only IE that is changed. One SIB occurrence value tag is assigned to the table of subclause 10.2.48.8.18.3.

The UE may not need to receive all occurrences before it can use the information for any one occurrence.

8.1.1.6.15.3a System Information Block type 15.3bis

For System Information Block type 15.3bis multiple occurrences may be used; one occurrence for each set of satellite data. To identify for which GANSS the occurrence is related to, the scheduling information for System Information Block type 15.3bis is associated with IE "GANSS ID". To identify the different occurrences within each GANSS, the scheduling information for System Information Block type 15.3bis includes IE "SIB occurrence identity and value tag". The UE should store all the relevant IEs included in this system information block in variable UE_POSITIONING_GANSS_DATA. The UE shall:

- 1> compare for each occurrence the value tag of the stored occurrence, if any, with the occurrence value tag included in the IE "SIB occurrence identity and value tag" for the occurrence of the System Information Block with the same occurrence identity;
- 1> in case the UE has no SIB occurrence stored with the same identity or in case the occurrence value tag is different:
 - 2> store the occurrence information together with its identity and value tag for later use.
- 1> in case an occurrence with the same identity but different value tag was stored:
 - 2> overwrite this one with the new occurrence read via system information for later use.
- 1> if the IE "GANSS Almanac" is included:
 - 2> act upon the received IE "GANSS Almanac" as specified in subclause 8.6.7.19.7.2.
- 1> if the IE "GANSS time model" is included:
 - 2> act upon the received IE "GANSS time model" as specified in subclause 8.6.7.19.7.9.

1> if the IE "GANSS UTC model" is included:

2> act upon the received IE "GANSS UTC model" as specified in subclause 8.6.7.19.7.10.

1> if the IE "GANSS additional UTC models" is included:

2> act upon the received IE "GANSS additional UTC models" as specified in subclause 8.6.7.19.7.15.

1> if the IE "GANSS auxiliary information" is included:

2> act upon the received IE "GANSS auxiliary information" as specified in subclause 8.6.7.19.7.16.

The UE may not need to receive all occurrences before it can use the information for any one occurrence.

8.1.1.6.15.4 System Information Block type 15.4

If the UE is in idle mode or connected mode, the UE shall:

1> if the IE "OTDOA Data ciphering info" is included:

2> act as specified in subclause 8.6.7.19.4.

If the UE is in connected mode, the UE shall:

1> act as specified in subclause 8.6.7.19.2.

8.1.1.6.15.5 System Information Block type 15.5

If the UE is in idle or connected mode, the UE shall:

1> if the UE supports UE-based OTDOA positioning:

2> act as specified in subclause 8.6.7.19.2a.

8.1.1.6.15.6 System Information Block type 15.6

This SIB has one occurrence for each GANSS supported. To identify the different GANSSs, the scheduling information for System Information Block type 15.6 is associated with IE "GANSS ID". The UE should store all the relevant IEs included in this system information block in variable UE_POSITIONING_GANSS_DATA. The UE shall:

1> use IE "GANSS TOD" as a reference time for the data in IE "GANSS reference measurement information";

1> act upon the received IE "GANSS reference measurement information" as specified in subclause 8.6.7.19.7.1.

8.1.1.6.15.7 System Information Block type 15.7

This SIB has one occurrence for each GANSS supported. To identify the different GANSSs, the scheduling information for System Information Block type 15.7 is associated with IE "GANSS ID". The UE should store all the relevant IEs included in this system information block in variable UE_POSITIONING_GANSS_DATA. The UE shall:

1> act upon the received IE "GANSS data bit assistance" as specified in subclause 8.6.7.19.7.11.

8.1.1.6.15.8 System Information Block type 15.8

This SIB has one occurrence for each GANSS supported. To identify the different GANSSs, the scheduling information for System Information Block type 15.8 is associated with IE "GANSS ID". The UE should store all the relevant IEs included in this system information block in variable UE_POSITIONING_GANSS_DATA. The UE shall:

1> if the IE "GANSS Data ciphering info" is included:

2> act as specified in the subclause 8.6.7.19.4.

1> if the IE "GANSS real-time integrity" is included:

2> act upon the received IE " GANSS real-time integrity" as specified in subclause 8.6.7.19.7.6.

8.1.1.6.16 System Information Block type 16

If the IE "Uplink DPCH info Pre" is included in the PhyCH Information Elements for a predefined configuration the UE shall:

- 1> for FDD:
 - 2> if the IE "Number of TPC bits" is not included:
 - 3> use 2 TPC bits in the Uplink DPCH.
 - 2> else:
 - 3> if F-DPCH is not configured then the UE behaviour is unspecified.

For System Information Block type 16 multiple occurrences may be used; one occurrence for each predefined configuration. To identify the different predefined configurations, the scheduling information for System Information Block type 16 includes IE "Predefined configuration identity and value tag".

The UE should store all relevant IEs included in this system information block. The UE shall:

- 1> compare for each predefined configuration the value tag of the stored predefined configuration with the preconfiguration value tag included in the IE "Predefined configuration identity and value tag" for the occurrence of the System Information Block with the same predefined configuration identity;
- 1> in case the UE has no predefined configuration stored with the same identity:
 - 2> store the predefined configuration information together with its identity and value tag for later use e.g. during handover to UTRAN.
- 1> in case a predefined configuration with the same identity but different value tag was stored:
 - 2> overwrite this one with the new configuration read via system information for later use e.g. during handover to UTRAN.

The above handling applies regardless of whether the previously stored predefined configuration information has been obtained via UTRA or via another RAT.

The UE is not required to complete reading of all occurrences of System Information Block type 16 before initiating RRC connection establishment.

The UE is not required to store more than maxPredefConfig preconfigurations even in the case of multiple equivalent PLMNs.

8.1.1.6.17 System Information Block type 17

This system information block type is used only for TDD.

If in connected mode, the UE should store all relevant IEs included in this system information block. The UE shall:

- 1> if the IE "PDSCH system information" and/or the IE "PUSCH system information" is included, store each of the configurations given there with the associated identity given in the IE "PDSCH Identity" and/or "PUSCH Identity" respectively. This information shall become invalid after the time specified by the repetition period (SIB_REP) for this system information block.

If in idle mode, the UE shall not use the values of the IEs in this system information block.

8.1.1.6.18 System Information Block type 18

If the System Information Block type 18 is present, a UE shall obtain knowledge of the PLMN identity of the neighbour cells to be considered for cell reselection, and shall behave as specified in this subclause and in subclause 8.5.14a.

The UE should store all the relevant IEs included in this system information block.

A UE in idle mode shall act according to the following rules:

- 1> if System Information Block type 11bis is scheduled on BCH; and the IE "Idle mode PLMN identities for SIB 11bis" is present:
 - 2> any PLMN list of a given type (IEs "PLMNs of intra-frequency cells list" or "Multiple PLMNs of intra-frequency cells list", "PLMNs of inter-frequency cells list" or "Multiple PLMNs of inter-frequency cells list", "PLMNs of inter-RAT cell lists") included in the IE "Idle mode PLMN identities for SIB 11bis" is paired with the list of cells of the same type derived from System Information Block type 11 and System Information Block type 11bis.
- 1> else:
 - 2> any PLMN list of a given type (IEs "PLMNs of intra-frequency cells list" or "Multiple PLMNs of intra-frequency cells list", "PLMNs of inter-frequency cells list" or "Multiple PLMNs of inter-frequency cells list", "PLMNs of inter-RAT cell lists") included in the IE "Idle mode PLMN identities" is paired with the list of cells of the same type derived from System Information Block type 11 and System Information Block type 11bis if scheduled on BCH.
- 1> the PLMN identity located at a given rank in the PLMN list is that of the cell with the same ranking in the paired list of cells, the cells being considered in the increasing order of their associated identities ("Intra-frequency cell id", "Inter-frequency cell id", "Inter-RAT cell id");
- 1> if no identity is indicated for the first PLMN in a list, the UE shall assume that the neighbouring cell broadcasts the same PLMN configuration (i.e. IE "PLMN Identity" and IE "Multiple PLMN List") as the current cell;
- 1> if no identity is indicated for another entry in the list, the UE shall assume that the neighbouring cell broadcasts the same PLMN configuration (i.e. IE "PLMN Identity" and IE "Multiple PLMN List") as the previous cell in the list;
- 1> if the number of identities in a PLMN list exceeds the number of neighbour cells in the paired list (if any), the extra PLMN identities are considered as unnecessary and ignored;
- 1> if the number of identities in a PLMN list (if any) is lower than the number of neighbour cells in the paired list, the missing PLMN identities are replaced by the PLMN configuration for the last cell in the list.

A UE in connected mode shall act in the same manner as a UE in idle mode with the following modifications:

- 1> if System Information Block type 11bis is scheduled on BCH:
 - 2> the PLMN lists to be considered are the ones included, when present, in the IE "Connected mode PLMN identities for SIB 11bis";
 - 2> otherwise, the UE shall use, in place of any missing list, when present, the corresponding one in the IE "Idle mode PLMN identities for SIB 11bis";
 - 2> otherwise, the UE shall use, in place of any missing list, when present, the corresponding one in the IE "Connected mode PLMN identities";
 - 2> otherwise, the UE shall use, in place of any missing list, the corresponding one in the IE "Idle mode PLMN identities".
- 1> else:
 - 2> the PLMN lists to be considered are the ones included, when present, in the IE "Connected mode PLMN identities";
 - 2> otherwise, the UE shall use, in place of any missing list, the corresponding one in the IE "Idle mode PLMN identities".
- 1> the paired lists of cells are the ones derived from System Information Block type 11, and System Information Block type 11bis if scheduled on BCH, and System Information Block type 12 if present.
- 1> If both the IEs "PLMNs of intra-frequency cells list" and "Multiple PLMNs of intra-frequency cells list" are included; or

- 1> if both the IEs "PLMNs of inter-frequency cells list" and "Multiple PLMNs of inter-frequency cells list" are included:
- 2> the UE behaviour is not specified.

8.1.1.6.19 System Information Block type 19

If the cell is not operating in MBSFN mode according to subclause 8.1.1.6.3 the UE should store all relevant IEs included in this system information block. If the cell is not operating in MBSFN mode according to subclause 8.1.1.6.3 the UE shall:

- 1> if the value of the IE "Priority status" in the variable PRIORITY_INFO_LIST equals "dedicated_priority":
 - 2> clear every stored value of "Thresh_{x,high}" and "Thresh_{x,low}" in every occurrence of the IE "Priority Info List" in the variable PRIORITY_INFO_LIST.
- 1> otherwise:
 - 2> clear the variable PRIORITY_INFO_LIST.
- 1> clear the variable EUTRA_FREQUENCY_INFO_LIST;
- 1> act upon the received IE "UTRA priority info list" as described in subclause 8.6.7.3a;
- 1> if the IE "GSM priority info list" is present:
 - 2> act upon the received IE as described in subclause 8.6.7.3b.
- 1> if the IE "E-UTRA frequency and priority info list" is present:
 - 2> act upon the received IE as described in subclause 8.6.7.3c.

8.1.1.6.20 System Information Block type 20

If the cell is not operating in MBSFN mode according to subclause 8.1.1.6.3, the UE shall:

- 1> if the IE "HNB Name" is present:
 - 2> forward the content of IE "HNB Name" to the upper layers.

8.1.1.7 Modification of system information

For System Information Block type 15.2, 15.3 and 16 that may have multiple occurrences, the UE shall handle each occurrence independently as specified in the previous; that is each occurrence is handled as a separate system information block.

NOTE: It should be noted that for the proper operation of the BCCH Modification Information sent on a PCH or on an HS-DSCH (FDD and 1.28 Mcps TDD only), the System Information should not be changed more frequently than can be accommodated by mobile stations operating at the maximum DRX cycle length supported by the UTRAN.

8.1.1.7.1 Modification of system information blocks using a value tag

Upon modifications of system information blocks using value tags, UTRAN should notify the new value tag for the master information block in the IE "BCCH modification info", transmitted in the following way:

- 1> to reach UEs in idle mode, and in CELL_PCH state and URA_PCH state with S-CCPCH assigned, the IE "BCCH modification info" is contained in a PAGING TYPE 1 message transmitted on the PCCH in all paging occasions in the cell;
- 1> to reach UEs in CELL_PCH state and URA_PCH state with HS-DSCH assigned and no dedicated H-RNTI assigned, the IE "BCCH modification info" is contained in a PAGING TYPE 1 message transmitted on the PCCH in all paging occasions in the cell;

- 1> to reach UEs in CELL_FACH state or TDD UEs in CELL_DCH with S-CCPCH assigned, the IE "BCCH modification info" is contained in a SYSTEM INFORMATION CHANGE INDICATION message transmitted on the BCCH mapped on at least one FACH on every Secondary CCPCH in the cell;
- 1> for FDD and 1.28 Mcps TDD, to reach UEs in CELL_FACH state with HS-DSCH assigned and in CELL_PCH with HS-DSCH and dedicated H-RNTI assigned, the IE "BCCH modification info" is contained in a SYSTEM INFORMATION CHANGE INDICATION message transmitted on the BCCH mapped on the HS-PDSCH indicated with the first indexed HS-SCCH code by the BCCH specific H-RNTI.

Upon reception of a PAGING TYPE 1 message or a SYSTEM INFORMATION CHANGE INDICATION message containing the IE "BCCH modification info" containing the IE "MIB value tag" but not containing the IE "BCCH modification time", the UE shall perform actions as specified in subclause 8.1.1.7.3.

If the IE "BCCH modification time" is included the UE shall perform actions as specified in subclause 8.1.1.7.2.

8.1.1.7.2 Synchronised modification of system information blocks

For modification of some system information elements, e.g. reconfiguration of the channels, it is important for the UE to know exactly when a change occurs. In such cases, the UTRAN should notify the SFN when the change will occur as well as the new value tag for the master information block in the IE "BCCH modification info" transmitted in the following way:

- 1> To reach UEs in idle mode, CELL_PCH state and URA_PCH state, the IE "BCCH modification info" is contained in a PAGING TYPE 1 message transmitted on the PCCH in all paging occasions in the cell;
- 1> To reach UEs in CELL_FACH state or TDD UEs in CELL_DCH with SCCPCH assigned, the IE "BCCH modification info" is contained in a SYSTEM INFORMATION CHANGE INDICATION message transmitted on the BCCH mapped on at least one FACH on every Secondary CCPCH in the cell;
- 1> for FDD and 1.28 Mcps TDD, to reach UEs in CELL_FACH state with HS-DSCH assigned and in CELL_PCH with HS-DSCH and dedicated H-RNTI assigned, the IE "BCCH modification info" is contained in a SYSTEM INFORMATION CHANGE INDICATION message transmitted on the BCCH mapped on the HS-PDSCH indicated with the first indexed HS-SCCH code by the BCCH specific H-RNTI. For 1.28 Mcps TDD, the BCCH is transmitted on frequencies where CELL_FACH state UEs stay and UE detects the BCCH specific H-RNTI on its working frequency.

Upon reception of a PAGING TYPE 1 message or a SYSTEM INFORMATION CHANGE INDICATION message containing the IE "BCCH modification info" containing the IE "MIB value tag" and containing the IE "BCCH modification time", the UE shall:

- 1> perform the actions as specified in subclause 8.1.1.7.3 at the time, indicated in the IE "BCCH Modification Info".

8.1.1.7.3 Actions upon system information change

The UE shall:

- 1> compare the value of IE "MIB value tag" in the IE "BCCH modification info" with the value tag stored for the master information block in variable VALUE_TAG.
- 1> if the value tags differ:
 - 2> read the master information block on BCH;
 - 2> if the value tag of the master information block in the system information is the same as the value in IE "MIB value tag" in "BCCH modification info" but different from the value tag stored in the variable VALUE_TAG:
 - 3> perform actions as specified in subclause 8.1.1.5.
 - 2> if the value tag of the master information block in the system information is the same as the value tag stored in the variable VALUE_TAG:
 - 3> for the next occurrence of the master information block:

- 4> perform actions as specified in subclause 8.1.1.7.3 again.
- 2> if the value tag of the master information block in the system information is different from the value tag stored in the variable VALUE_TAG, and is different from the value in IE "MIB value tag" in "BCCH modification info":
 - 3> perform actions as specified in subclause 8.1.1.5;
 - 3> if $(VTICI - VTMIB) \bmod 8 < 4$, where VTICI is the value tag in the IE "MIB value tag" in "BCCH modification info" and VTMIB is the value tag of the master information block in the system information:
 - 4> for the next occurrence of the master information block:
 - 5> perform actions as specified in subclause 8.1.1.7.3 again.

8.1.1.7.4 Actions upon expiry of a system information expiry timer

When the expiry timer of a system information block not using a value tag expires

the UE shall:

- 1> consider the content of the system information block invalid;
- 1> re-acquire the system information block again before the content can be used;

In FDD for system information blocks other than System Information Block type 7, or in states other than CELL_FACH, or in TDD for system information blocks other than System Information Block type 14, or in states other than CELL_FACH or CELL_DCH the UE may:

- 1> postpone reading the system information block until the content is needed.

In FDD for System Information Block type 7, while in state CELL_FACH, and in TDD for System Information Block type 14, while in state CELL_FACH or CELL_DCH the UE shall always keep an up to date version of the relevant IEs, unless this is not possible because system information can not be received due to bad radio conditions.

8.1.2 Paging

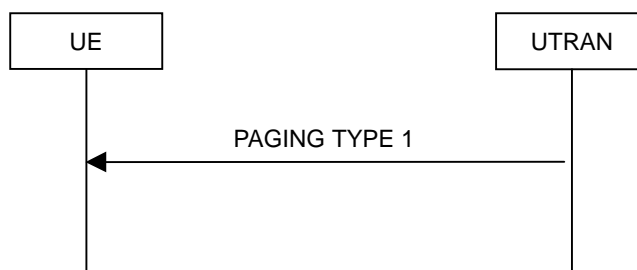

Figure 8.1.2-1: Paging

8.1.2.1 General

This procedure is used to transmit paging information to selected UEs in idle mode, CELL_PCH or URA_PCH state using the paging control channel (PCCH). Upper layers in the network may request paging, to e.g. establish a signalling connection. UTRAN may initiate paging for UEs in CELL_PCH or URA_PCH state to trigger a cell update procedure and for UEs in CELL_PCH when the variable HSPA_RNTI_STORED_CELL_PCH is set to TRUE to trigger a measurement report procedure. In addition, UTRAN may initiate paging for UEs in idle mode, CELL_PCH and URA_PCH state to trigger reading of updated system information. UTRAN may also initiate paging for UEs in CELL_PCH and URA_PCH state to release the RRC connection.

8.1.2.2 Initiation

UTRAN initiates the paging procedure by transmitting a PAGING TYPE 1 message on an appropriate paging occasion on the PCCH.

UTRAN may repeat transmission of a PAGING TYPE 1 message to a UE in several paging occasions to increase the probability of proper reception of a page.

UTRAN may page several UEs in the same paging occasion by including one IE "Paging record" for each UE in the PAGING TYPE 1 message.

For CN originated paging, UTRAN should set the IE "Paging cause" to the cause for paging received from upper layers. If no cause for paging is received from upper layers, UTRAN should set the value "Terminating – cause unknown".

UTRAN may also indicate that system information has been updated, by including the value tag of the master information block in the IE "BCCH modification info" in the PAGING TYPE 1 message. In this case, UTRAN may omit the IEs "Paging record".

UTRAN may also indicate to send Primary Notification for ETWS, by including in the IE "ETWS information" in the PAGING TYPE 1 message. In this case, UTRAN may omit the IEs "Paging record".

8.1.2.3 Reception of a PAGING TYPE 1 message by the UE

A UE in idle mode, CELL_PCH state or URA_PCH state shall receive the paging information for all its monitored paging occasions. For a UE in idle mode, the paging occasions are specified in [4] and depend on the IE "CN domain specific DRX cycle length coefficient", as specified in subclause 8.6.3.1a. For a UE in CELL_PCH state or URA_PCH state, the paging occasions depend also on the IE "UTRAN DRX cycle length coefficient" and the IE "RRC State Indicator", as specified in subclauses 8.6.3.2 and 8.6.3.3 respectively.

When the UE receives a PAGING TYPE 1 message, it shall perform the actions as specified below.

If the UE is in idle mode, for each occurrence of the IE "Paging record" included in the message the UE shall:

- 1> if the IE "Used paging identity" is a CN identity:
 - 2> compare the IE "UE identity" with all of its allocated CN UE identities:
 - 2> if one match is found:
 - 3> indicate reception of paging; and
 - 3> forward the IE "CN domain identity", the IE "UE identity" and the IE "Paging cause" to the upper layers.
- 1> otherwise:
 - 2> ignore that paging record.

If the UE is in connected mode, for each occurrence of the IE "Paging record" included in the message the UE shall:

- 1> if the IE "Used paging identity" is a UTRAN single UE identity and if this U-RNTI is the same as the U-RNTI allocated to the UE stored in the UE variable U_RNTI:
 - 2> if the optional IE "CN originated page to connected mode UE" is included:
 - 3> indicate reception of paging; and
 - 3> forward the IE "CN domain identity", the IE "Paging cause" and the IE "Paging record type identifier" to the upper layers.
 - 2> if the IE "Release indicator" in the IE "RRC connection release information" has the value "Release":
 - 3> release all its radio resources;
 - 3> indicate the release of the established signalling connections (as stored in the variable ESTABLISHED_SIGNALLING_CONNECTIONS) and established radio access bearers (as stored in the variable ESTABLISHED_RABS) to the upper layers;
 - 3> clear the variable ESTABLISHED_SIGNALLING_CONNECTIONS;
 - 3> clear the variable ESTABLISHED_RABS;
 - 3> pass the value of the IE "Release cause" received in the IE "Release information" to upper layers;

- 3> enter idle mode;
- 3> perform the actions specified in subclause 8.5.2 when entering idle mode;
- 3> and the procedure ends.
- 2> otherwise:
 - 3> if variable HSPA_RNTI_STORED_CELL_PCH is set to TRUE:
 - 4> move to CELL_FACH state as specified in subclause 8.5.56.
 - 3> else:
 - 4> perform a cell update procedure with cause "paging response" as specified in subclause 8.3.1.2.
- 2> ignore any other remaining IE "Paging record" that may be present in the message.
- 1> if the IE "Used paging identity" is a UTRAN group identity and there is a group identity match according to subclause 8.6.3.13:
 - 2> if the IE "Release indicator" in the IE "RRC connection release information" has the value "Release":
 - 3> release all its radio resources;
 - 3> indicate the release of the established signalling connections (as stored in the variable ESTABLISHED_SIGNALLING_CONNECTIONS) and established radio access bearers (as stored in the variable ESTABLISHED_RABS) to the upper layers;
 - 3> clear the variable ESTABLISHED_SIGNALLING_CONNECTIONS;
 - 3> clear the variable ESTABLISHED_RABS;
 - 3> pass the value of the IE "Release cause" received in the IE 'Release information' to upper layers;
 - 3> enter idle mode;
 - 3> perform the actions specified in subclause 8.5.2 when entering idle mode;
 - 3> and the procedure ends.
 - 2> otherwise:
 - 3> if variable HSPA_RNTI_STORED_CELL_PCH is set to TRUE:
 - 4> move to CELL_FACH state as specified in subclause 8.5.56.
 - 3> else:
 - 4> perform a cell update procedure with cause "paging response" as specified in subclause 8.3.1.2.
 - 2> ignore any other remaining IE "Paging record" that may be present in the message.
- 1> otherwise:
 - 2> ignore that paging record.

If the IE "BCCH modification info" is included, any UE in idle mode, CELL_PCH or URA_PCH state shall perform the actions as specified in subclause 8.1.1 in addition to any actions caused by the IE "Paging record" occurrences in the message as specified above.

If the IE "ETWS information" is included and RRC is configured to receive ETWS, an ETWS capable UE in idle mode, CELL_PCH or URA_PCH state shall perform the actions as specified in subclause 8.6.8a.1 in addition to any actions caused by the IE "Paging record" or the IE "BCCH modification info" occurrences in the message as specified above.

8.1.3 RRC connection establishment

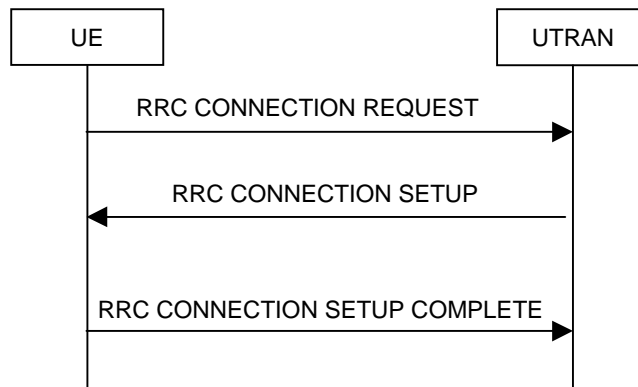

Figure 8.1.3-1: RRC Connection Establishment, network accepts RRC connection

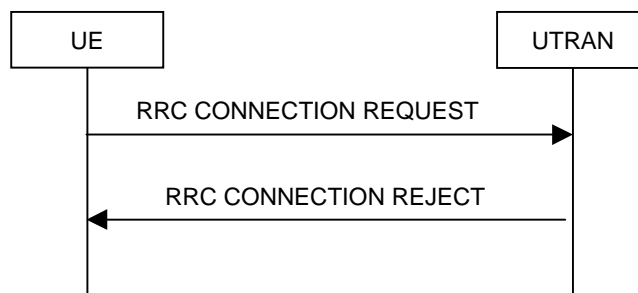

Figure 8.1.3-2: RRC Connection Establishment, network rejects RRC connection

8.1.3.1 General

The purpose of this procedure is to establish an RRC connection.

8.1.3.2 Initiation

The UE shall initiate the procedure when upper layers in the UE requests the establishment of a signalling connection and the UE is in idle mode (no RRC connection exists), as specified in subclause 8.1.8.

Upon initiation of the procedure, the UE shall:

- 1> set the variable `PROTOCOL_ERROR_INDICATOR` to `FALSE`;
- 1> if the USIM is present:
 - 2> set the value of "THRESHOLD" in the variable "START_THRESHOLD" to the 20 MSBs of the value stored in the USIM [50] for the maximum value of `START` for each CN Domain.
- 1> if the SIM is present:
 - 2> set the value of "THRESHOLD" in the variable "START_THRESHOLD" to the default value in [40] for each CN Domain.
- 1> set the IE "Initial UE identity" in the variable `INITIAL_UE_IDENTITY` according to subclause 8.5.1;
- 1> set the contents of the RRC CONNECTION REQUEST message according to subclause 8.1.3.3;
- 1> set CFN in relation to SFN of current cell according to subclause 8.5.15;
- 1> perform the mapping of the Access Class to an Access Service Class as specified in subclause 8.5.13, and apply the given Access Service Class when accessing the RACH or the common E-DCH (for the Enhanced Uplink in CELL_FACH state and Idle mode);

- 1> submit the RRC CONNECTION REQUEST message for transmission on the uplink CCCH;
- 1> set counter V300 to 1; and
- 1> if the variable ESTABLISHMENT_CAUSE is set to "MBMS reception":
 - 2> when the MAC layer indicates success or failure to transmit the message:
 - 3> if the MAC layer indicates failure:
 - 4> enter idle mode;
 - 4> consider the procedure to be unsuccessful;
 - 4> perform other actions when entering idle mode from connected mode as specified in subclause 8.5.2;
 - 4> the procedure ends.
 - 3> else:
 - 4> start timer T318;
 - 4> apply value 0 for counter N300 regardless of the value included in IE "UE Timers and Constants in idle mode".
- 1> otherwise:
 - 2> start timer T300 when the MAC layer indicates success or failure to transmit the message.
- 1> for 3.84 Mcps and 7.68 Mcps TDD; or
- 1> for FDD and 1.28 Mcps TDD, if the UE does not support HS-DSCH reception in CELL_FACH state; or
- 1> if the IE "HS-DSCH common system information" is not included in System Information Block type 5 or System Information Block type 5bis; or
- 1> for 1.28 Mcps TDD, if the IE "Common E-DCH system info" is not included in System Information Block type 5:
 - 2> select a Secondary CCPCH according to [4];
 - 2> start receiving all FACH transport channels mapped on the selected Secondary CCPCH.
- 1> otherwise:
 - 2> set variable HS_DSCH_RECEPTION_OF_CCCH_ENABLED to TRUE; and
 - 2> start receiving the HS-DSCH according to the procedure in subclause 8.5.37.

8.1.3.3 RRC CONNECTION REQUEST message contents to set

The UE shall, in the transmitted RRC CONNECTION REQUEST message:

- 1> set the IE "Establishment cause" to the value of the variable ESTABLISHMENT_CAUSE;
- 1> set the IE "Initial UE identity" to the value of the variable INITIAL_UE_IDENTITY;
- 1> set the IE "Protocol error indicator" to the value of the variable PROTOCOL_ERROR_INDICATOR; and
- 1> include the IE "Predefined configuration status information" and set this IE to TRUE if the UE has all pre-configurations stored with the same value tag as broadcast in the cell in which the RRC connection establishment is initiated.
- 1> if the UE is attempting to establish the signalling connection to PS-domain:
 - 2> include the IE "Domain Indicator" and set it to "PS domain".
- 1> else if the UE is attempting to establish the signalling connection to CS domain:

- 2> include the IE "Domain Indicator" and set it to "CS domain";
 - 2> set the value of the IE "Call type" to "speech", "video" or "other" according to the call being initiated.
 - 1> if the UE only supports HS-DSCH but not E-DCH:
 - 2> include the IE "UE capability indication" and set it to the "HS-DSCH" value.
 - 1> if the UE supports HS-DSCH and E-DCH:
 - 2> include the IE "UE capability indication" and set it to the "HS-DSCH+E-DCH" value.
 - 1> if, according to [4], the High-mobility state is applicable and it has been detected by the UE:
 - 2> include the IE "UE Mobility State Indicator" and set it to the "High-MobilityDetected" value.
 - 1> if the UE performs connection establishment for MBMS ptp radio bearer request as specified in subclause 8.6.9.6; and
 - 1> if one or more of the MBMS services for which the UE initiates the ptp radio bearer request concerns an MBMS Selected Service:
 - 2> for each MBMS Selected Service that is indicated on MCCH and for which the UE initiates the ptp radio bearer request:
 - 3> order the MBMS Selected Services such that those selected with a higher priority are listed in the IE "MBMS Selected Services Short" before those selected with a lower priority;
 - 3> include the IE "MBMS Selected Service ID" within the IE "MBMS Selected Services Short" and set it to a value in accordance with subclause 8.6.9.8.
 - 1> otherwise if the UE performs connection establishment for MBMS counting as specified in subclause 8.7.4; and
 - 1> if one or more of the MBMS services for which the UE initiates the counting response concerns an MBMS Selected Service:
 - 2> for each MBMS Selected Service that is indicated on MCCH and for which the UE initiates the counting response:
 - 3> order the MBMS Selected Services such that those selected with a higher priority are listed in the IE "MBMS Selected Services Short" before those selected with a lower priority;
 - 3> include the IE "MBMS Selected Service ID" within the IE "MBMS Selected Services Short" and set it to a value in accordance with subclause 8.6.9.8.
 - 1> if the UE included one or more "MBMS Selected Service ID" IEs:
 - 2> include the IE "MBMS Modification Period identity" and set it to a value in accordance with subclause 8.5.29.
 - 1> if the UE supports MAC-ehs:
 - 2> include the IE "MAC-ehs support" and set it to TRUE.
 - 1> if the UE supports HS-DSCH reception in CELL_FACH state:
 - 2> include the IE "HS-PDSCH in CELL_FACH" and set it to TRUE.
 - 1> if the UE supports Enhanced Uplink in CELL_FACH state and Idle mode:
 - 2> include the IE "Support of common E-DCH" and set it to TRUE.
- NOTE: In 1.28 Mcps TDD, UE supporting HS-DSCH reception in CELL_FACH state always supports Enhanced Uplink in CELL_FACH state and Idle mode, and vice versa.
- 1> if the UE supports MAC-i/is:
 - 2> include the IE "Support of MAC-i/is" and set it to TRUE.

- 1> if the UE supports E-UTRA:
 - 2> if the variable EUTRA_FREQUENCY_INFO_LIST contains no E-UTRA frequencies:
 - 3> include the IE "Pre-Redirection info";
 - 3> if the UE supports E-UTRA FDD:
 - 4> set the IE "Support of E-UTRA FDD" to TRUE.
 - 3> if the UE supports E-UTRA TDD:
 - 4> set the IE "Support of E-UTRA TDD" to TRUE.
 - 2> if the UE supports any of the bands that the E-UTRA frequencies included in the variable EUTRA_FREQUENCY_INFO_LIST belong to:
 - 3> include the IE "Pre-Redirection info";
 - 3> if the UE supports any of the bands that the E-UTRA FDD frequencies included in the variable EUTRA_FREQUENCY_INFO_LIST belong to:
 - 4> set the IE "Support of E-UTRA FDD" to TRUE.
 - 3> if the UE supports any of the bands that the E-UTRA TDD frequencies included in the variable EUTRA_FREQUENCY_INFO_LIST belong to:
 - 4> set the IE "Support of E-UTRA TDD" to TRUE.
- 1> if the UE supports dual cell operation on adjacent frequencies
 - 2> include the IE "Multi cell support" and set it to TRUE.
- 1> if the UE supports CS voice over HSPA
 - 2> include the IE "Support for CS Voice over HSPA" and set it to TRUE.

The UE shall not include the IE "UE Specific Behaviour Information 1 idle".

8.1.3.4 Reception of an RRC CONNECTION REQUEST message by the UTRAN

Upon receiving an RRC CONNECTION REQUEST message, UTRAN should either:

- 1> accept the request and use a predefined or default radio configuration, in which case it should:
 - 2> include the following information in the RRC CONNECTION SETUP message:
 - 3> the IE "Predefined configuration identity", to indicate which pre-defined configuration of RB and transport channel parameters shall be used; or
 - 3> the IE "Default configuration mode" and IE "Default configuration identity", to indicate which default configuration of RB and transport channel parameters shall be used;
 - 3> PhyCH information elements.
 - 2> submit the RRC CONNECTION SETUP message to the lower layers for transmission on the downlink CCCH.

NOTE 1: UTRAN should only apply a predefined radio configuration in case it orders the UE to enter CELL_DCH. This is because the predefined configuration information included in System Information Block 16 mandatorily includes information only required in CELL_DCH state.

- 1> accept the request without using a predefined or default radio configuration, in which case it should:
 - 2> include in the RRC CONNECTION SETUP message the complete set of RB, TrCH and PhyCH information elements to be used;

- 2> submit the RRC CONNECTION SETUP message to the lower layers for transmission on the downlink CCCH;

NOTE 2: In R'99, the RRC CONNECTION SETUP message always includes the IEs "Added or Reconfigured TrCH information list", both for uplink and downlink transport channels, even if UTRAN orders the UE to move to CELL_FACH and hence need not configure any transport channels. In these cases, UTRAN may include a configuration that adds little to the encoded message size e.g. a DCH with a single zero size transport format. At a later stage, UTRAN may either remove or reconfigure this configuration.

- 1> submit an RRC CONNECTION REJECT message on the downlink CCCH. In the RRC CONNECTION REJECT message, the UTRAN may direct the UE to another UTRA carrier or to another system. The UTRAN may direct the UE to E-UTRAN FDD only if the IE "Pre-Redirection info" is present in the RRC CONNECTION REQUEST message and the IE "Support of E-UTRA FDD" is set to TRUE; the UTRAN may direct the UE to E-UTRAN TDD only if the IE "Pre-Redirection info" is present in the RRC CONNECTION REQUEST message and the IE "Support of E-UTRA TDD" is set to TRUE. After the RRC CONNECTION REJECT message has been sent, all context information for the UE may be deleted in UTRAN.

8.1.3.5 Cell re-selection, T300 or T318 timeout

- 1> if the UE has not yet received an RRC CONNECTION SETUP message with the value of the IE "Initial UE identity" equal to the value of the variable INITIAL_UE_IDENTITY; and

- 1> if cell re-selection or expiry of timer T300 or timer T318 occurs:

the UE shall:

- 1> check the value of V300; and

- 2> if V300 is equal to or smaller than N300:

- 3> if cell re-selection occurred:

- 4> set CFN in relation to SFN of current cell according to subclause 8.5.15.

- 4> for FDD and 1.28 Mcps TDD, if the UE supports HS-DSCH reception in CELL_FACH state and if IE: "HS-DSCH common system information" is included in System Information Block type 5 or System Information Block type 5bis:

- 5> if variable HS_DSCH_RECEPTION_OF_CCCH_ENABLED is set to TRUE:

- 6> reset the MAC-ehs entity [15].

- 5> else:

- 6> set the variable HS_DSCH_RECEPTION_OF_CCCH_ENABLED to TRUE;

- 6> start receiving the HS-DSCH according to the procedure in subclause 8.5.37.

- 3> set the IEs in the RRC CONNECTION REQUEST message according to subclause 8.1.3.3;

- 3> perform the mapping of the Access Class to an Access Service Class as specified in subclause 8.5.13; and

- 3> apply the given Access Service Class when accessing the RACH or the common E-DCH (for the Enhanced Uplink in CELL_FACH state and Idle mode);

- 3> submit a new RRC CONNECTION REQUEST message to lower layers for transmission on the uplink CCCH;

- 3> increment counter V300;

- 3> restart timer T300 when the MAC layer indicates success or failure to transmit the message.

- 2> if V300 is greater than N300:

- 3> enter idle mode.

- 3> consider the procedure to be unsuccessful;
- 3> Other actions the UE shall perform when entering idle mode from connected mode are specified in subclause 8.5.2;
- 3> the procedure ends.

8.1.3.5a Abortion of RRC connection establishment

If the UE has not yet entered UTRA RRC Connected mode and the RRC connection establishment is to be aborted as specified in subclause 8.1.8, the UE shall:

- 1> consider the procedure to be unsuccessful;
- 1> perform the actions when entering idle mode as specified in subclause 8.5.2.

The procedure ends.

8.1.3.6 Reception of an RRC CONNECTION SETUP message by the UE

The UE shall compare the value of the IE "Initial UE identity" in the received RRC CONNECTION SETUP message with the value of the variable INITIAL_UE_IDENTITY.

If the values are different, the UE shall:

- 1> ignore the rest of the message.

If the values are identical, the UE shall:

- 2> if IE "Specification mode" is set to "Preconfiguration" and IE "Preconfiguration mode" is set to "Predefined configuration":
 - 3> initiate the radio bearer and transport channel configuration in accordance with the predefined parameters identified by the IE "Predefined configuration identity" with the following exception;
 - 4> ignore the IE "RB to setup list" and the IE "Re-establishment timer".

NOTE: IE above IEs are mandatory to include in IE 'Predefined RB configuration' that is included in System Information Block 16 but should be ignored since it is not possible to establish a RAB during RRC connection establishment.

- 3> initiate the physical channels in accordance with the received physical channel information elements;
- 2> if IE "Specification mode" is set to "Preconfiguration" and IE "Preconfiguration mode" is set to "Default configuration":
 - 3> initiate the radio bearer and transport channel configuration in accordance with the default parameters identified by the IE "Default configuration mode" and IE "Default configuration identity" with the following exception:
 - 4> ignore the radio bearers other than signalling radio bearers.
- 3> initiate the physical channels in accordance with the received physical channel information elements.

NOTE: IE "Default configuration mode" specifies whether the FDD or TDD version of the default configuration shall be used.

- 2> if IE "Specification mode" is set to "Complete specification":
 - 3> initiate the radio bearer, transport channel and physical channel configuration in accordance with the received radio bearer, transport channel and physical channel information elements.

1> clear the variable ESTABLISHMENT_CAUSE;

1> for FDD and 1.28 Mcps TDD, if the HS_DSCH_RECEPTION_OF_CCCH_ENABLED is set to TRUE:

- 2> set the variable HS_DSCH_RECEPTION_OF_CCCH_ENABLED to FALSE.
- 1> stop timer T300 or T318, whichever one is running, and act upon all received information elements as specified in subclause 8.6, unless specified otherwise in the following:
 - 2> if the UE, according to subclause 8.6.3.3, will be in the CELL_FACH state at the conclusion of this procedure:
 - 3> if the IE "Frequency info" is included:
 - 4> select a suitable UTRA cell according to [4] on that frequency.
 - 4> for 1.28Mcps TDD, decide the working frequency according to subclause 8.6.6.1.
 - 3> else:
 - 4> for 1.28Mcps TDD, continue to use the currently used frequency as working frequency.
 - 3> enter UTRA RRC connected mode;
 - 3> determine the value for the READY_FOR_COMMON_EDCH variable and take the corresponding actions as described in subclause 8.5.47;
 - 3> determine the value for the COMMON_E_DCH_TRANSMISSION variable and take the corresponding actions as described in subclause 8.5.46;
 - 3> if variable READY_FOR_COMMON_EDCH is set to FALSE:
 - 4> select PRACH according to subclause 8.5.17;
 - 3> else:
 - 4> configure the Enhanced Uplink in CELL_FACH state and Idle mode as specified in subclause 8.5.45 for FDD and 8.5.45a for 1.28 Mcps TDD.
 - 3> for 3.84 Mcps and 7.68 Mcps TDD; or
 - 3> for FDD and 1.28 Mcps TDD, if the UE does not support HS-DSCH reception in CELL_FACH state; or
 - 3> if the IE "HS-DSCH common system information" is not included in System Information Block type 5 or System Information Block type 5bis; or
 - 3> for 1.28 Mcps TDD, if the IE "Common E-DCH system info" is not included in System Information Block type 5:
 - 4> select Secondary CCPCCH according to subclause 8.5.19;
 - 3> else:
 - 4> set variable HS_DSCH_RECEPTION_OF_CCCH_ENABLED to FALSE;
 - 4> For FDD if variable READY_FOR_COMMON_EDCH is set to FALSE:
 - 5> if the RBs have the multiplexing option with transport channel type "HS-DSCH" for the DL and transport channel type 'RACH' in the UL; and
 - 5> if "new H-RNTI" and "new C-RNTI" are included:
 - 6> store the "new H-RNTI" according to subclause 8.6.3.1b;
 - 6> store the "new C-RNTI" according to subclause 8.6.3.9;
 - 6> and start to receive HS-DSCH according to the procedure in subclause 8.5.36.
 - 5> else:
 - 6> clear variable C_RNTI and delete any stored C-RNTI value;

- 6> clear variable H_RNTI and delete any stored H-RNTI value;
 - 6> clear any stored IE "HARQ Info";
 - 6> set the variable INVALID_CONFIGURATION to TRUE.
- 4> else:
- 5> if the RBs have the multiplexing option with transport channel type "HS-DSCH" for the DL and transport channel type "E-DCH" in the UL; and
 - 5> if the IEs "new Primary E-RNTI", "new H-RNTI" and "new C-RNTI" are included:
 - 6> store the "new Primary E-RNTI" according to subclause 8.6.3.14;
 - 6> store the "new H-RNTI" according to subclause 8.6.3.1b;
 - 6> store the "new C-RNTI" according to subclause 8.6.3.9;
 - 6> configure Enhanced Uplink in CELL_FACH state and Idle mode according to subclause 8.5.45 for FDD and 8.5.45a for 1.28 Mcps TDD;
 - 6> and start to receive HS-DSCH according to the procedure in subclause 8.5.36.
 - 5> else:
 - 6> clear variable C_RNTI and delete any stored C-RNTI value;
 - 6> clear variable H_RNTI and delete any stored H-RNTI value;
 - 6> clear variable E_RNTI and delete any stored E-RNTI value;
 - 6> clear any stored IE "HARQ Info";
 - 6> set the variable INVALID_CONFIGURATION to TRUE.
- 3> ignore the IE "UTRAN DRX cycle length coefficient" and stop using DRX.
- 1> if the UE, according to subclause 8.6.3.3, will be in the CELL_DCH state at the conclusion of this procedure:
- 2> perform the physical layer synchronisation procedure A as specified in [29] (FDD only);
 - 2> enter UTRA RRC connected mode;
 - 2> ignore the IE "UTRAN DRX cycle length coefficient" and stop using DRX.
- 1> submit an RRC CONNECTION SETUP COMPLETE message to the lower layers on the uplink DCCH after successful state transition per subclause 8.6.3.3, with the contents set as specified below:
- 2> set the IE "RRC transaction identifier" to:
 - 3> the value of "RRC transaction identifier" in the entry for the RRC CONNECTION SETUP message in the table "Accepted transactions" in the variable TRANSACTIONS; and
 - 3> clear that entry.
 - 2> if the USIM or SIM is present:
 - 3> set the "START" for each CN domain in the IE "START list" in the RRC CONNECTION SETUP COMPLETE message with the corresponding START value that is stored in the USIM [50] if present, or as stored in the UE if the SIM is present; and then
 - 3> set the START value stored in the USIM [50] if present, and as stored in the UE if the SIM is present for any CN domain to the value "THRESHOLD" of the variable START_THRESHOLD.
 - 2> if neither the USIM nor SIM is present:

- 3> set the "START" for each CN domain in the IE "START list" in the RRC CONNECTION SETUP COMPLETE message to zero;
- 3> set the value of "THRESHOLD" in the variable "START_THRESHOLD" to the default value [40].
- 2> retrieve its UTRA UE radio access capability information elements from variable UE_CAPABILITY_REQUESTED; and then
- 2> include this in IE "UE radio access capability" and IE "UE radio access capability extension", provided this IE is included in variable UE_CAPABILITY_REQUESTED;
- 2> retrieve its inter-RAT-specific UE radio access capability information elements from variable UE_CAPABILITY_REQUESTED; and then
- 2> include this in IE "UE system specific capability";
- 2> if the variable DEFERRED_MEASUREMENT_STATUS is TRUE:
 - 3> if System Information Block type 11 is scheduled on the BCCH and the UE has not read nor stored the IEs present in this System Information Block, or
 - 3> if System Information Block type 11bis is scheduled on the BCCH and the UE has not read nor stored the IEs present in this System Information Block, or
 - 3> if System Information Block type 12 is scheduled on the BCCH and the UE has not read nor stored the IEs present in this System Information Block:
 - 4> include IE "Deferred measurement control reading".

NOTE: If the "RRC State indicator" is set to the value "CELL_FACH", the UE continues to read and store the IEs in System Information Block type 11, System Information Block type 11bis, and System Information Block type 12, if transmitted, after submitting the RRC Connection Setup Complete message to lower layers (see 8.5.31).

When the RRC CONNECTION SETUP COMPLETE message has been submitted to lower layers for transmission the UE shall:

- 1> if the UE has entered CELL_DCH state:
 - 2> if the IE "Deferred measurement control reading" was included in the RRC CONNECTION SETUP COMPLETE message:
 - 3> clear variable MEASUREMENT_IDENTITY;
 - 3> clear the variable CELL_INFO_LIST.
- 1> if the UE has entered CELL_FACH state:
 - 2> start timer T305 using its initial value if periodical update has been configured by T305 in the IE "UE Timers and constants in connected mode" set to any other value than "infinity" in the variable TIMERS_AND_CONSTANTS.
- 1> store the contents of the variable UE_CAPABILITY_REQUESTED in the variable UE_CAPABILITY_TRANSFERRED;
- 1> initialise variables upon entering UTRA RRC connected mode as specified in subclause 13.4;
- 1> consider the procedure to be successful;

And the procedure ends.

8.1.3.7 Physical channel failure or cell re-selection

- 1> If the UE failed to establish, per subclause 8.5.4, the physical channel(s) indicated in the RRC CONNECTION SETUP message; or

- 1> if the UE performs cell re-selection; or
- 1> if the UE will be in the CELL_FACH state at the conclusion of this procedure; and
- 1> if the received RRC CONNECTION SETUP message included the IE "Frequency info" and the UE could not find a suitable UTRA cell on that frequency but it could find a suitable UTRA cell on another frequency; or
- 1> if the received RRC CONNECTION SETUP message included the IE "Primary CPICH info" (for FDD) or "Primary CCPCH info" (for TDD), and the UE selected another cell than indicated by this IE; or
- 1> if the contents of the variable C_RNTI is empty;
- 1> after having received an RRC CONNECTION SETUP message with the value of the IE "Initial UE identity" equal to the value of the variable INITIAL_UE_IDENTITY; and
- 1> before the RRC CONNECTION SETUP COMPLETE message is delivered to lower layers for transmission:

the UE shall:

- 1> clear the entry for the RRC CONNECTION SETUP message in the table "Accepted transactions" in the variable TRANSACTIONS;
- 1> check the value of V300, and:
 - 2> if V300 is equal to or smaller than N300:
 - 3> set CFN in relation to SFN of current cell according to subclause 8.5.15;
 - 3> set the IEs in the RRC CONNECTION REQUEST message according to subclause 8.1.3.3;
 - 3> perform the mapping of the Access Class to an Access Service Class as specified in subclause 8.5.13, and apply the given Access Service Class when accessing the RACH or the common E-DCH (for the Enhanced Uplink in CELL_FACH and Idle mode);
 - 3> submit a new RRC CONNECTION REQUEST message to the lower layers for transmission on the uplink CCCH;
 - 3> increment counter V300; and
 - 3> restart timer T300 when the MAC layer indicates success or failure in transmitting the message.
 - 2> if V300 is greater than N300:
 - 3> enter idle mode;
 - 3> perform the actions specified in subclause 8.5.2 when entering idle mode from connected mode;
 - 3> consider the RRC establishment procedure to be unsuccessful;
 - 3> the procedure ends.

8.1.3.8 Invalid RRC CONNECTION SETUP message, unsupported configuration or invalid configuration

If the UTRAN instructs the UE to use a configuration, which it does not support e.g., the message includes a pre-defined configuration that the UE has not stored and/or if the received message causes the variable UNSUPPORTED_CONFIGURATION or the variable INVALID_CONFIGURATION to be set to TRUE the UE shall perform procedure specific error handling as specified in this subclause.

If the UE receives an RRC CONNECTION SETUP message which contains an IE "Initial UE identity" with a value which is identical to the value of the variable INITIAL_UE_IDENTITY, but the RRC CONNECTION SETUP message contains a protocol error causing the variable PROTOCOL_ERROR_REJECT to be set to TRUE according to clause 9, the UE shall perform procedure specific error handling as follows. The UE shall:

- 1> stop timer T300 or T318, whichever one is running; and

- 1> clear the entry for the RRC CONNECTION SETUP message in the table "Rejected transactions" in the variable TRANSACTIONS and proceed as below.

If the UE receives an RRC CONNECTION SETUP message which contains an IE "Initial UE identity" with a value which is identical to the value of the variable INITIAL_UE_IDENTITY:

- 1> if the RRC CONNECTION SETUP message contained a configuration the UE does not support; and/or
- 1> if the variable UNSUPPORTED_CONFIGURATION becomes set to TRUE due to the received RRC CONNECTION SETUP message; and/or
- 1> if the variable INVALID_CONFIGURATION becomes set to TRUE due to the received RRC CONNECTION SETUP message:

the UE shall:

- 1> stop timer T300 or T318, whichever one is running; and
- 1> clear the entry for the RRC CONNECTION SETUP message in the table "Accepted transactions" in the variable TRANSACTIONS and proceed as below.

If V300 is equal to or smaller than N300, the UE shall:

- 1> set the variable PROTOCOL_ERROR_INDICATOR to TRUE;
- 1> set the IEs in the RRC CONNECTION REQUEST message according to subclause 8.1.3.3;
- 1> perform the mapping of the Access Class to an Access Service Class as specified in subclause 8.5.13; and
- 1> apply the given Access Service Class when accessing the RACH or the common E-DCH (for the Enhanced Uplink in CELL_FACH and Idle mode);
- 1> submit a new RRC CONNECTION REQUEST message to the lower layers for transmission on the uplink CCCH;
- 1> increment counter V300; and
- 1> restart timer T300 when the MAC layer indicates success or failure in transmitting the message.

If V300 is greater than N300, the UE shall:

- 1> enter idle mode;
- 1> perform the actions specified in subclause 8.5.2 when entering idle mode from connected mode;
- 1> consider the RRC establishment procedure to be unsuccessful;
- 1> the procedure ends.

8.1.3.9 Reception of an RRC CONNECTION REJECT message by the UE

When the UE receives an RRC CONNECTION REJECT message on the downlink CCCH, it shall compare the value of the IE "Initial UE identity" in the received RRC CONNECTION REJECT message with the value of the variable INITIAL_UE_IDENTITY:

If the values are different, the UE shall ignore the rest of the message;

If the values are identical, the UE shall:

- 1> stop timer T300 or T318, whichever one is running; and
- 1> clear the entry for the RRC CONNECTION REJECT message in the table "Accepted transactions" in the variable TRANSACTIONS;
- 1> if the UE has disabled cell reselection to a UTRA carrier due to an earlier RRC CONNECTION REJECT message, the UE shall resume cell reselection to that UTRA carrier;

- 1> if the Rejection Cause is 'unspecified' and the IE "Counting Completion" is present, the UE shall terminate an ongoing MBMS counting procedure according to subclause 8.7.4.4;
- 1> if the IE "wait time" \neq '0'; and
- 1> if the IE "frequency info" is present and:
 - 2> if V300 is equal to or smaller than N300:
 - 3> select a suitable UTRA cell according to [4] on that frequency;
 - 3> after having selected and camped on a suitable cell on the designated UTRA carrier:
 - 4> set CFN in relation to SFN of current cell according to subclause 8.5.15;
 - 4> set the contents of the RRC CONNECTION REQUEST message according to subclause 8.1.3.3;
 - 4> perform the mapping of the Access Class to an Access Service Class as specified in subclause 8.5.13, and apply the given Access Service Class when accessing the RACH or the common E-DCH (for the Enhanced Uplink in CELL_FACH and Idle mode);
 - 4> transmit an RRC CONNECTION REQUEST message on the uplink CCCH;
 - 4> reset counter V300;
 - 4> start timer T300 when the MAC layer indicates success or failure in transmitting the message;
 - 4> disable cell reselection to original UTRA carrier until the time stated in the IE "wait time" has elapsed or until the RRC connection establishment procedure ends, whichever occurs first;
 - 3> if no suitable cell on the designated UTRA carrier is found:
 - 4> wait for at least the time stated in the IE "wait time";
 - 4> set CFN in relation to SFN of current cell according to subclause 8.5.15;
 - 4> set the IEs in the RRC CONNECTION REQUEST message according to subclause 8.1.3.3;
 - 4> perform the mapping of the Access Class to an Access Service Class as specified in subclause 8.5.13, and apply the given Access Service Class when accessing the RACH or the common E-DCH (for the Enhanced Uplink in CELL_FACH and Idle mode);
 - 4> then submit a new RRC CONNECTION REQUEST message to the lower layers for transmission on the uplink CCCH of the original serving cell;
 - 4> increment counter V300;
 - 4> restart timer T300 when the MAC layer indicates success or failure to transmit the message;
 - 2> if V300 is greater than N300:
 - 3> enter idle mode;
 - 3> perform the actions specified in subclause 8.5.2 when entering idle mode from connected mode;
 - 3> consider the RRC establishment procedure to be unsuccessful;
 - 3> the procedure ends.
- 1> if the IE "inter-RAT info" is present:
 - 2> if the IE "wait time" = '0':
 - 3> the UE behaviour is not specified.
 - 2> if V300 is equal to or smaller than N300:
 - 3> if the IE "GSM target cell info" is present:

- 4> attempt to camp on a suitable cell of the list of cells indicated for that RAT;
- 4> if the UE selects and camps on one of the cells indicated for that RAT:
 - 5> disable cell reselection to the original RAT until the time stated in the IE "wait time" has elapsed.
- 4> if the UE cannot find any suitable cell from the indicated ones within 10s, the UE is allowed to camp on any suitable cell on that RAT.
 - 5> after having selected and camped on a suitable cell on the designated RAT:
 - 6> the UE may disable cell reselection to the original RAT until the time stated in the IE "wait time" has elapsed.
- 3> if the IE "E-UTRA target info" is present:
 - 4> attempt to camp on a suitable cell on one of the frequencies indicated for that RAT, excluding any cell indicated in the list of not allowed cells for that RAT (i.e. the "blacklisted cells per freq list" for E-UTRA), if present;
 - 4> if the UE selects and camps on one such cell:
 - 5> disable cell reselection to the original RAT until the time stated in the IE "wait time" has elapsed.
 - 4> if the UE cannot find any suitable cell on the indicated frequencies within 10s, the UE is allowed to camp on any suitable cell on that RAT:
 - 5> after having selected and camped on a suitable cell on the designated RAT:
 - 6> disable cell reselection to the original RAT until the time stated in the IE "wait time" has elapsed.
- 3> if neither the IE "GSM target cell info" nor the IE "E-UTRA target info" is present:
 - 4> select a suitable cell in the designated RAT;
 - 4> after having selected and camped on a suitable cell on the designated RAT:
 - 5> disable cell reselection to the original RAT until the time stated in the IE "wait time" has elapsed or until the UE successfully establishes a connection on the designated RAT, whichever occurs first.
- 3> if no suitable cell in the designated RAT is found:
 - 4> wait at least the time stated in the IE "wait time";
 - 4> set CFN in relation to SFN of current cell according to subclause 8.5.15;
 - 4> set the IEs in the RRC CONNECTION REQUEST message according to subclause 8.1.3.2.
 - 4> perform the mapping of the Access Class to an Access Service Class as specified in subclause 8.5.13, and apply the given Access Service Class when accessing the RACH or the common E-DCH (for the Enhanced Uplink in CELL_FACH and Idle mode);
 - 4> then submit a new RRC CONNECTION REQUEST message to the lower layers for transmission on the uplink CCCH;
 - 4> increment counter V300;
 - 4> restart timer T300 when the MAC layer indicates success or failure to transmit the message;
- 2> if V300 is greater than N300:
 - 3> enter idle mode;
 - 3> perform the actions specified in subclause 8.5.2 when entering idle mode from connected mode;
 - 3> consider the RRC establishment procedure to be unsuccessful;

- 3> the procedure ends.
- 1> if the IE "wait time" <> '0'; and
- 1> if neither the IEs "frequency info" nor "inter-RAT info" are present:
 - 2> if V300 is equal to or smaller than N300:
 - 3> wait at least the time stated in the IE "wait time";
 - 3> set the IEs in the RRC CONNECTION REQUEST message according to subclause 8.1.3.2;
 - 3> perform the mapping of the Access Class to an Access Service Class as specified in subclause 8.5.13, and apply the given Access Service Class when accessing the RACH or the common E-DCH (for the Enhanced Uplink in CELL_FACH and Idle mode);
 - 3> submit a new RRC CONNECTION REQUEST message to the lower layers for transmission on the uplink CCCH;
 - 3> increment counter V300;
 - 3> restart timer T300 when the MAC layer indicates success or failure to transmit the message;
 - 2> if V300 is greater than N300:
 - 3> enter idle mode;
 - 3> perform the actions specified in subclause 8.5.2 when entering idle mode from connected mode;
 - 3> consider the RRC establishment procedure to be unsuccessful;
 - 3> the procedure ends.
- 1> if the IE "wait time" = '0':
 - 2> enter idle mode;
 - 2> perform the actions specified in subclause 8.5.2 when entering idle mode from connected mode;
 - 2> consider the RRC establishment procedure to be unsuccessful;
 - 2> the procedure ends.

8.1.3.10 Invalid RRC CONNECTION REJECT message

If the UE receives an RRC CONNECTION REJECT message which contains an IE "Initial UE identity" with a value which is identical to the value of the IE "Initial UE identity" in the most recent RRC CONNECTION REQUEST message sent by the UE; but the RRC CONNECTION REJECT message contains a protocol error causing the variable PROTOCOL_ERROR_REJECT to be set to TRUE according to clause 9, the UE shall perform procedure specific error handling as follows:

The UE shall:

- 1> stop timer T300 or T318, whichever one is running; and
- 1> clear the entry for the RRC CONNECTION REJECT message in the table "Rejected transactions" in the variable TRANSACTIONS;
- 1> if V300 is equal to or smaller than N300:
 - 2> set the variable PROTOCOL_ERROR_INDICATOR to TRUE;
 - 2> set the IEs in the RRC CONNECTION REQUEST message according to subclause 8.1.3.3;
 - 2> perform the mapping of the Access Class to an Access Service Class as specified in subclause 8.5.13, and apply the given Access Service Class when accessing the RACH or the common E-DCH (for the Enhanced Uplink in CELL_FACH and Idle mode);

- 2> submit a new RRC CONNECTION REQUEST message to the lower layers for transmission on the uplink CCCH;
 - 2> increment counter V300;
 - 2> restart timer T300 when the MAC layer indicates success or failure to transmit the message.
- 1> if V300 is greater than N300:
- 2> enter idle mode;
 - 2> perform the actions specified in subclause 8.5.2 when entering idle mode from connected mode;
 - 2> consider the procedure to be successful;
 - 2> the procedure ends.

8.1.4 RRC connection release

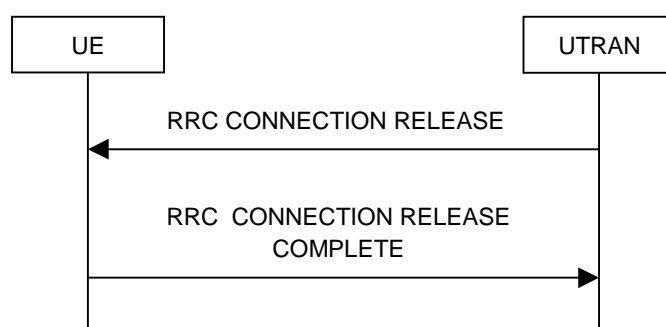

Figure 8.1.4-1: RRC Connection Release procedure on the DCCH



Figure 8.1.4-2: RRC Connection Release procedure on the CCCH

8.1.4.1 General

The purpose of this procedure is to release the RRC connection including all radio bearers and all signalling radio bearers between the UE and the UTRAN. By doing so, all established signalling connections will be released.

8.1.4.2 Initiation

When the UE is in state CELL_DCH or CELL_FACH or CELL_PCH (FDD only), the UTRAN may at anytime initiate an RRC connection release by transmitting an RRC CONNECTION RELEASE message using UM RLC.

When UTRAN transmits an RRC CONNECTION RELEASE message the downlink DCCH should be used, if available. If the downlink DCCH is not available in UTRAN and the UE is in CELL_FACH state, the downlink CCCH may be used.

UTRAN may transmit several RRC CONNECTION RELEASE messages to increase the probability of proper reception of the message by the UE. In such a case, the RRC SN for these repeated messages should be the same. The number of repeated messages and the interval between the messages is a network option.

8.1.4.3 Reception of an RRC CONNECTION RELEASE message by the UE

The UE shall receive and act on an RRC CONNECTION RELEASE message in states CELL_DCH and CELL_FACH and CELL_PCH (FDD only). Furthermore this procedure can interrupt any ongoing procedures with the UE in the above listed states.

When the UE receives the first RRC CONNECTION RELEASE message; and

- 1> if the message is received on the CCCH, and IE "U-RNTI" is present and has the same value as the variable U_RNTI; or
- 1> if the message is received on DCCH:

the UE shall perform the RRC connection release procedure as specified below.

When the UE receives the first RRC CONNECTION RELEASE message; and

- 1> if the message is received on the CCCH, the IE "UTRAN group identity" is present and there is a group identity match according to subclause 8.6.3.13:

the UE shall perform the RRC connection release procedure as specified below.

The UE shall:

- 1> in state CELL_DCH:
 - 2> initialise the counter V308 to zero;
 - 2> set the IE "RRC transaction identifier" in the RRC CONNECTION RELEASE COMPLETE message to the value of "RRC transaction identifier" in the entry for the RRC CONNECTION RELEASE message in the table "Accepted transactions" in the variable TRANSACTIONS;
 - 2> submit an RRC CONNECTION RELEASE COMPLETE message to the lower layers for transmission using UM RLC on the DCCH to the UTRAN;
 - 2> if the IE "Rplmn information" is present:
 - 3> the UE may:
 - 4> store the IE on the ME together with the PLMN id for which it applies;
 - 3> the UE may then:
 - 4> utilise this information, typically indicating where a number of BCCH frequency ranges of a RAT may be expected to be found, during subsequent Rplmn selections of the indicated PLMN.
 - 2> if the IE "UE Mobility State Indicator" is present:
 - 3> consider the High-mobility state to have being detected when entering idle mode.
 - 2> start timer T308 when the RRC CONNECTION RELEASE COMPLETE message is sent on the radio interface.
- 1> in state CELL_FACH:
 - 2> if the RRC CONNECTION RELEASE message was received on the DCCH:
 - 3> set the IE "RRC transaction identifier" in the RRC CONNECTION RELEASE COMPLETE message to the value of "RRC transaction identifier" in the entry for the RRC CONNECTION RELEASE message in the table "Accepted transactions" in the variable TRANSACTIONS;
 - 3> submit an RRC CONNECTION RELEASE COMPLETE message to the lower layers for transmission using AM RLC on the DCCH to the UTRAN.
 - 3> when the successful transmission of the RRC CONNECTION RELEASE COMPLETE message has been confirmed by the lower layers:

- 4> release all its radio resources; and
 - 4> indicate the release of the established signalling connections (as stored in the variable ESTABLISHED_SIGNALLING_CONNECTIONS) and established radio access bearers (as stored in the variable ESTABLISHED_RABS) to upper layers; and
 - 4> clear any entry for the RRC CONNECTION RELEASE message in the tables "Accepted transactions" and "Rejected transactions" in the variable TRANSACTIONS;
 - 4> clear the variable ESTABLISHED_SIGNALLING_CONNECTIONS;
 - 4> clear the variable ESTABLISHED_RABS;
 - 4> pass the value of the IE "Release cause" received in the RRC CONNECTION RELEASE message to upper layers;
 - 4> enter idle mode;
 - 4> perform the actions specified in subclause 8.5.2 when entering idle mode.
- 3> and the procedure ends.
- 2> if the RRC CONNECTION RELEASE message was received on the CCCH:
- 3> release all its radio resources;
 - 3> indicate the release of the established signalling connections (as stored in the variable ESTABLISHED_SIGNALLING_CONNECTIONS) and established radio access bearers (as stored in the variable ESTABLISHED_RABS) to the upper layers;
 - 3> clear any entry for the RRC CONNECTION RELEASE message in the tables "Accepted transactions" and "Rejected transactions" in the variable TRANSACTIONS;
 - 3> clear the variable ESTABLISHED_SIGNALLING_CONNECTIONS;
 - 3> clear the variable ESTABLISHED_RABS;
 - 3> pass the value of the IE "Release cause" received in the RRC CONNECTION RELEASE message to upper layers;
 - 3> enter idle mode;
 - 3> perform the actions specified in subclause 8.5.2 when entering idle mode;
 - 3> and the procedure ends.

8.1.4.4 Invalid RRC CONNECTION RELEASE message

If the RRC CONNECTION RELEASE message contains a protocol error causing the variable PROTOCOL_ERROR_REJECT to be set to TRUE according to clause 9, and if the "protocol error cause" in PROTOCOL_ERROR_INFORMATION is set to any cause value except "ASN.1 violation or encoding error", the UE shall perform procedure specific error handling as follows:

The UE shall:

- 1> ignore any IE(s) causing the error but treat the rest of the RRC CONNECTION RELEASE message as normal according to subclause 8.1.4.3, with an addition of the following actions:
- 2> if the RRC CONNECTION RELEASE message was received on the DCCH:
 - 3> set the IE "RRC transaction identifier" in the RRC CONNECTION RELEASE COMPLETE message to the value of "RRC transaction identifier" in the entry for the RRC CONNECTION RELEASE message in the table "Rejected transactions" in the variable TRANSACTIONS;
 - 3> include the IE "Error indication" in the RRC CONNECTION RELEASE COMPLETE message with:
 - 4> the IE "Failure cause" set to the cause value "Protocol error"; and

- 4> the IE "Protocol error information" set to the value of the variable PROTOCOL_ERROR_INFORMATION.

8.1.4.5 Cell re-selection or radio link failure

If the UE performs cell re-selection or the radio link failure criteria in subclause 8.5.6 are met at any time during the RRC connection release procedure and the UE has not yet entered idle mode, the UE shall:

- 1> if cell re-selection occurred (CELL_FACH state or CELL_PCH (FDD only)):
 - 2> perform a cell update procedure according to subclause 8.3.1 using the cause "Cell reselection".
- 1> if radio link failure occurred (CELL_DCH state):
 - 2> release all its radio resources;
 - 2> indicate the release of the established signalling connections (as stored in the variable ESTABLISHED_SIGNALLING_CONNECTIONS) and established radio access bearers (as stored in the variable ESTABLISHED_RABS) to upper layers;
 - 2> clear the variable ESTABLISHED_SIGNALLING_CONNECTIONS;
 - 2> clear the variable ESTABLISHED_RABS;
 - 2> enter idle mode;
 - 2> perform the actions specified in subclause 8.5.2 when entering idle mode;
 - 2> and the procedure ends.

8.1.4.6 Expiry of timer T308, unacknowledged mode transmission

When in state CELL_DCH and the timer T308 expires, the UE shall:

- 1> increment V308 by one;
- 1> if V308 is equal to or smaller than N308:
 - 2> prior to retransmitting the RRC CONNECTION RELEASE COMPLETE message:
 - 3> if the IE "Status" in the variable INTEGRITY_PROTECTION_INFO has the value "Started":
 - 4> include the same IEs as in the last unsuccessful attempt of this message, except for the IE "Integrity check info", which is set as specified in subclause 8.5.10.
 - 3> else:
 - 4> include the same IEs as in the last unsuccessful attempt of this message.
 - 2> set the IE "RRC transaction identifier" in the RRC CONNECTION RELEASE COMPLETE message retransmitted below to the value of "RRC transaction identifier" in the entry for the RRC CONNECTION RELEASE message in the table "Accepted transactions" in the variable TRANSACTIONS;
 - 2> send the RRC CONNECTION RELEASE COMPLETE message on signalling radio bearer RB1;
 - 2> start timer T308 when the RRC CONNECTION RELEASE COMPLETE message is sent on the radio interface.
- 1> if V308 is greater than N308:
 - 2> release all its radio resources;
 - 2> indicate the release of the established signalling connections (as stored in the variable ESTABLISHED_SIGNALLING_CONNECTIONS) and established radio access bearers (as stored in the variable ESTABLISHED_RABS) to upper layers;

- 2> clear any entry for the RRC CONNECTION RELEASE message in the tables "Accepted transactions" and "Rejected transactions" in the variable TRANSACTIONS;
- 2> clear the variable ESTABLISHED_SIGNALLING_CONNECTIONS;
- 2> clear the variable ESTABLISHED_RABS;
- 2> enter idle mode;
- 2> perform the actions specified in subclause 8.5.2 when entering idle mode;
- 2> and the procedure ends.

8.1.4.7 Void

8.1.4.8 Reception of an RRC CONNECTION RELEASE COMPLETE message by UTRAN

When UTRAN receives an RRC CONNECTION RELEASE COMPLETE message from the UE, it should:

- 1> release all UE dedicated resources and the procedure ends on the UTRAN side.

8.1.4.9 Unsuccessful transmission of the RRC CONNECTION RELEASE COMPLETE message, acknowledged mode transmission

When acknowledged mode was used and RLC does not succeed in transmitting the RRC CONNECTION RELEASE COMPLETE message, the UE shall:

- 1> release all its radio resources;
- 1> indicate the release of the established signalling connections (as stored in the variable ESTABLISHED_SIGNALLING_CONNECTIONS) and established radio access bearers (as stored in the variable ESTABLISHED_RABS) to upper layers;
- 1> clear the variable ESTABLISHED_SIGNALLING_CONNECTIONS;
- 1> clear the variable ESTABLISHED_RABS;
- 1> enter idle mode;
- 1> perform the actions specified in subclause 8.5.2 when entering idle mode;
- 1> and the procedure ends.

8.1.4.10 Detection of loss of dedicated physical channel by UTRAN in CELL_DCH state

If the release is performed from the state CELL_DCH, and UTRAN detects loss of the dedicated physical channel according to subclause 8.5.6, UTRAN may release all UE dedicated resources, even if no RRC CONNECTION RELEASE COMPLETE message has been received.

8.1.4.11 Failure to receive RRC CONNECTION RELEASE COMPLETE message by UTRAN

If UTRAN does not receive any RRC CONNECTION RELEASE COMPLETE message, it should release all UE dedicated resources.

8.1.4a RRC connection release requested by upper layers

8.1.4a.1 General

The purpose of this procedure is to release the RRC connection and bar the current cell or cells. The procedure is requested by upper layers when they determine that the network has failed an authentication check [5].

8.1.4a.2 Initiation

If the upper layers request the release of the RRC connection, the UE shall:

- 1> release all its radio resources;
- 1> enter idle mode;
- 1> perform other actions when entering idle mode from connected mode as specified in subclause 8.5.2;
- 1> if the UE was in CELL_DCH state prior to entering idle mode:
 - 2> consider all cells that were in the active set prior to entering idle mode to be barred according to [4]; and
 - 2> consider the barred cells as using the value "allowed" in the IE "Intra-frequency cell re-selection indicator", and the maximum value in the IE "T_{barred}".
- 1> if the UE was in CELL_FACH or CELL_PCH or URA_PCH state prior to entering idle mode:
 - 2> consider the cell on which the UE was camped prior to entering idle mode to be barred according to [4]; and
 - 2> consider the barred cell as using the value "allowed" in the IE "Intra-frequency cell re-selection indicator", and the maximum value in the IE "T_{barred}".

8.1.5 Void

8.1.6 Transmission of UE capability information

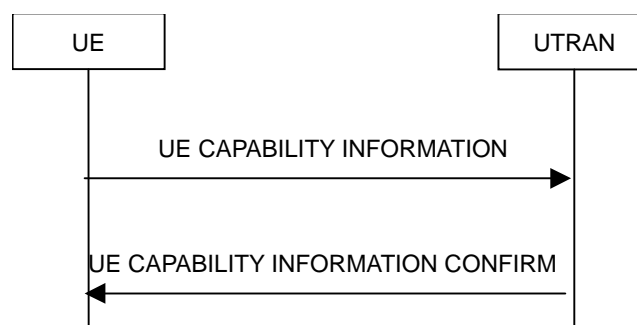

Figure 8.1.6-1: Transmission of UE capability information, normal flow

8.1.6.1 General

The UE capability update procedure is used by the UE to convey UE specific capability information to the UTRAN.

8.1.6.2 Initiation

The UE shall initiate the UE capability update procedure in the following situations:

- 1> the UE receives a UE CAPABILITY ENQUIRY message from the UTRAN;

- 1> while in CELL_DCH or CELL_FACH state, the UE capabilities change compared to those stored in the variable UE_CAPABILITY_TRANSFERRED, and the variable RNC_CAPABILITY_CHANGE_SUPPORT is set to TRUE.

If the UE CAPABILITY INFORMATION message is sent in response to a UE CAPABILITY ENQUIRY message, the UE shall:

- 1> include the IE "RRC transaction identifier"; and
- 1> set it to the value of "RRC transaction identifier" in the entry for the UE CAPABILITY ENQUIRY message in the table "Accepted transactions" in the variable TRANSACTIONS;
- 1> for the UE capabilities defined prior to REL-6:
 - 2> retrieve its UTRA UE radio access capability information elements from variable UE_CAPABILITY_REQUESTED; and
 - 2> include this in IE "UE radio access capability" and in IE "UE radio access capability extension", provided this IE is included in variable UE_CAPABILITY_REQUESTED;
 - 2> retrieve its inter-RAT-specific UE radio access capability information elements from variable UE_CAPABILITY_REQUESTED; and
 - 2> include this in IE "UE system specific capability".
- 1> for the UE capabilities defined in REL-6 or later:
 - 2> include the information elements associated with the capabilities included in the variable UE_CAPABILITY_REQUESTED and the variable UE_CAPABILITY_TRANSFERRED.

If the UE CAPABILITY INFORMATION message is sent because one or more of the UE capabilities change compared to those stored in the variable UE_CAPABILITY_TRANSFERRED while in connected state, the UE shall:

- 1> for the UE capabilities defined prior to REL-6, include the information elements associated with the capabilities that have changed in the UE CAPABILITY INFORMATION message; and
- 1> for the UE capabilities defined in REL-6 or later, include the information elements associated with the capabilities included in the variable UE_CAPABILITY_TRANSFERRED.

If the UE is in CELL_PCH or URA_PCH state, the UE shall:

- 1> if variable READY_FOR_COMMON_EDCH is set to TRUE:
 - 2> move to CELL_FACH state and continue as below.
- 1> else:
 - 2> if variable HSPA_RNTI_STORED_CELL_PCH is set to TRUE:
 - 3> move to CELL_FACH and continue as below.
 - 2> else:
 - 3> if variable H_RNTI and variable C_RNTI are set:
 - 4> continue as below.
 - 3> else:
 - 4> first perform a cell update procedure using the cause "uplink data transmission", see subclause 8.3.1.

The UE RRC shall submit the UE CAPABILITY INFORMATION message to the lower layers for transmission on the uplink DCCH using AM RLC. When the message has been delivered to lower layers for transmission the UE RRC shall start timer T304 and set counter V304 to 1.

A UE in connected mode should only indicate changes of capability in the IEs "DL capability with simultaneous HS-DSCH configuration", "Transport channel capability", "Physical channel capability", "Device type", and the IE "UE power class extension" within "RF capability extension".

The UE should not request a changed capability that would render an existing CS configuration invalid.

A UE with HS-PDSCH configured should not request a changed capability that removes support for HSDPA or HSUPA entirely; it may request reduction of its capabilities to the lowest category, but not to "DCH only".

If the UE is MAC-ehs or dual cell capable, the UE shall signal a value in the "HS-DSCH physical layer category extension" IE.

If the UE signals an "HS-DSCH physical layer category extension" of 13, 15, 17 or 19, it shall signal an "HS-DSCH physical layer category" of 9.

If the UE signals an "HS-DSCH physical layer category extension" of 14, 16, 18 or 20, it shall signal an "HS-DSCH physical layer category" of 10.

If the UE is dual cell capable, the UE shall signal a value in the "HS-DSCH physical layer category extension 2" IE.

If the UE is dual cell capable, then the UE shall support this feature on all the frequency bands supported by the UE.

If the UE signals an "HS-DSCH physical layer category extension 2" of 21, it shall signal an "HS-DSCH physical layer category extension" of 9, 10, 13, 14, 15, 16, 17 or 18.

If the UE signals an "HS-DSCH physical layer category extension 2" of 22, it shall signal an "HS-DSCH physical layer category extension" of 10, 14, 16 or 18.

If the UE signals an "HS-DSCH physical layer category extension 2" of 23, it shall signal an "HS-DSCH physical layer category extension" of 13, 14, 17, 18, 19 or 20.

If the UE signals an "HS-DSCH physical layer category extension 2" of 24, it shall signal an "HS-DSCH physical layer category extension" of 14, 18 or 20.

The UE shall use the "Total number of soft channel bits" (defined in Table 5.1a of [35]) for the category it has signalled, as follows:

- 1> If MAC-hs is configured, the UE uses the category it has signalled in the IE "HS-DSCH physical layer category";
- 1> If MAC-ehs is configured without dual cell operation, the UE uses the category it has signalled in the IE "HS-DSCH physical layer category extension";
- 1> If dual cell operation is configured, the UE uses the category it has signalled in the IE "HS-DSCH physical layer category extension 2".

8.1.6.3 Reception of a UE CAPABILITY INFORMATION message by the UTRAN

Upon reception of a UE CAPABILITY INFORMATION message, the UTRAN should transmit a UE CAPABILITY INFORMATION CONFIRM message on the downlink DCCH using UM or AM RLC. After the UE CAPABILITY INFORMATION CONFIRM message has been submitted to the lower layers for transmission, the procedure is complete.

If the received UE CAPABILITY INFORMATION message indicates capabilities that would be insufficient for the UE to continue in an ongoing service, the UTRAN may reconfigure the bearers for the ongoing service. In such a case, if the UTRAN does not perform such a reconfiguration, it should set the IE "Acceptance of requested change of capability" to "Refused" in the UE CAPABILITY INFORMATION CONFIRM message.

8.1.6.4 Reception of the UE CAPABILITY INFORMATION CONFIRM message by the UE

Upon reception of a UE CAPABILITY INFORMATION CONFIRM message, the UE shall:

- 1> stop timer T304;

- 1> if there is an entry for the UE CAPABILITY ENQUIRY message is present in the table "Accepted transactions" in the variable TRANSACTIONS:
 - 2> clear that entry.
- 1> if the IE "Acceptance of requested change of capability" is included and set to "Accepted":
 - 2> update its variable UE_CAPABILITY_TRANSFERRED with the UE capabilities it has last transmitted to the UTRAN during the current RRC connection.
- 1> if the IE "Acceptance of requested change of capability" is included and set to "Accepted with reconfiguration to follow":
 - 2> when a reconfiguration message with the flag "Reconfiguration in response to requested change of UE capability" set to TRUE, update its variable UE_CAPABILITY_TRANSFERRED with the UE capabilities it has last transmitted to the UTRAN during the current RRC connection;
 - 2> if a reconfiguration message with the flag "Reconfiguration in response to requested change of UE capability" set to TRUE it is not received by the UE within a time determined by the implementation, the UE shall consider the change of capabilities to be refused by the UTRAN.
- 1> if the IE "Acceptance of requested change of capability" is included and set to "Refused":
 - 2> consider the request for a change of capabilities to be refused;
 - 2> wait at least 300 seconds before transmitting another such request.
- 1> clear the variable UE_CAPABILITY_REQUESTED;
- 1> and the procedure ends.

8.1.6.5 Invalid UE CAPABILITY INFORMATION CONFIRM message

If the UE receives a UE CAPABILITY INFORMATION CONFIRM message, which contains a protocol error causing the variable PROTOCOL_ERROR_REJECT to be set to TRUE according to clause 9, the UE shall perform procedure specific error handling as follows:

- 1> stop timer T304;
- 1> transmit an RRC STATUS message on the uplink DCCH using AM RLC;
- 1> include the IE "Identification of received message"; and
- 1> set the IE "Received message type" to UE CAPABILITY INFORMATION CONFIRM; and
- 1> set the IE "RRC transaction identifier" to the value of "RRC transaction identifier" in the entry for the UE CAPABILITY INFORMATION CONFIRM message in the table "Rejected transactions" in the variable TRANSACTIONS; and
- 1> clear that entry;
- 1> include the IE "Protocol error information" with contents set to the value of the variable PROTOCOL_ERROR_INFORMATION;
- 1> when the RRC STATUS message has been submitted to lower layers for transmission:
 - 2> restart timer T304 and continue with any ongoing procedures or processes as if the invalid UE CAPABILITY INFORMATION CONFIRM message has not been received.

8.1.6.6 T304 timeout

Upon expiry of timer T304, the UE shall check the value of V304 and:

- 1> if V304 is smaller than or equal to N304:
 - 2> prior to retransmitting the UE CAPABILITY INFORMATION message:

- 3> if the IE "Status" in the variable INTEGRITY_PROTECTION_INFO has the value "Started":
 - 4> include the same IEs as in the last unsuccessful attempt of this message, except for the IE "Integrity check info", which is set as specified in subclause 8.5.10.
- 3> else:
 - 4> include the same IEs as in the last unsuccessful attempt of this message.
- 2> send the UE CAPABILITY INFORMATION message on signalling radio bearer RB2;
- 2> restart timer T304;
- 2> increment counter V304.
- 1> if V304 is greater than N304:
 - 2> initiate the Cell update procedure as specified in subclause 8.3.1, using the cause "Radio link failure".

8.1.7 UE capability enquiry

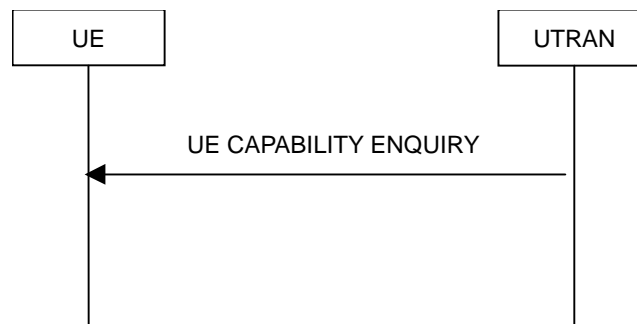

Figure 8.1.7-1: UE capability enquiry procedure, normal flow

8.1.7.1 General

The UE capability enquiry can be used to request the UE to transmit its capability information related to any radio access network that is supported by the UE.

8.1.7.2 Initiation

The UE capability enquiry procedure is initiated by the UTRAN by transmitting a UE CAPABILITY ENQUIRY message on the DCCH using UM or AM RLC.

8.1.7.3 Reception of a UE CAPABILITY ENQUIRY message by the UE

Upon reception of a UE CAPABILITY ENQUIRY message, the UE shall act on the received information elements as specified in subclause 8.6 and initiate the transmission of UE capability information procedure, which is specified in subclause 8.1.6.

8.1.7.4 Invalid UE CAPABILITY ENQUIRY message

If the UE receives a UE CAPABILITY ENQUIRY message, which contains a protocol error causing the variable `PROTOCOL_ERROR_REJECT` to be set to `TRUE` according to clause 9, the UE shall perform procedure specific error handling as follows:

- 1> transmit an RRC STATUS message on the uplink DCCH using AM RLC;
- 1> include the IE "Identification of received message"; and
- 1> set the IE "Received message type" to UE CAPABILITY ENQUIRY; and

- 1> set the IE "RRC transaction identifier" to the value of "RRC transaction identifier" in the entry for the UE CAPABILITY ENQUIRY message in the table "Rejected transactions" in the variable TRANSACTIONS; and
- 1> clear that entry;
- 1> include the IE "Protocol error information" with contents set to the value of the variable PROTOCOL_ERROR_INFORMATION;
- 1> when the RRC STATUS message has been submitted to lower layers for transmission:
 - 2> continue with the ongoing processes and procedures as if the invalid UE CAPABILITY ENQUIRY message has not been received.

8.1.8 Initial Direct transfer

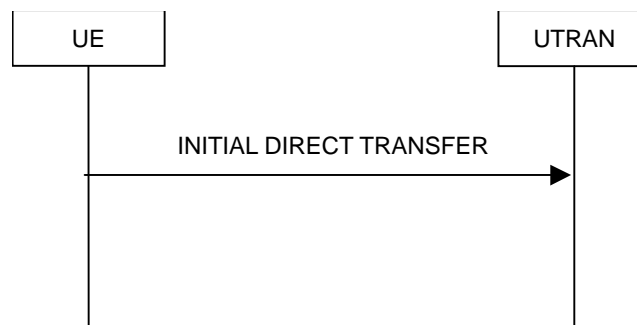

Figure 8.1.8-1: Initial Direct transfer in the uplink, normal flow

8.1.8.1 General

The initial direct transfer procedure is used in the uplink to establish a signalling connection. It is also used to carry an initial upper layer (NAS) message over the radio interface.

8.1.8.2 Initiation of Initial direct transfer procedure in the UE

In the UE, the initial direct transfer procedure shall be initiated, when the upper layers request establishment of a signalling connection. This request also includes a request for the transfer of a NAS message.

Upon initiation of the initial direct transfer procedure the UE shall:

- 1> set the variable ESTABLISHMENT_CAUSE to the cause for establishment indicated by upper layers.

Upon initiation of the initial direct transfer procedure when the UE is in idle mode, the UE shall:

- 1> perform an RRC connection establishment procedure, according to subclause 8.1.3;

NOTE: If an RRC connection establishment is ongoing, this procedure continues unchanged, i.e. it is not interrupted.

- 1> if the RRC connection establishment procedure was not successful:
 - 2> if the establishment cause for the failed RRC connection establishment was set to "MBMS reception" and a different cause value is stored in the variable "ESTABLISHMENT_CAUSE":
 - 3> UE-AS (RRC) initiates a new RRC connection establishment procedure, using the establishment cause as contained in the variable ESTABLISHMENT_CAUSE.
 - 2> otherwise:
 - 3> indicate failure to establish the signalling connection to upper layers and end the procedure.

- 1> when the RRC connection establishment procedure is completed successfully:

2> continue with the initial direct transfer procedure as below.

Upon initiation of the initial direct transfer procedure when the UE is in CELL_PCH or URA_PCH state, the UE shall:

1> if variable READY_FOR_COMMON_EDCH is set to TRUE:

2> move to CELL_FACH state and continue with the initial direct transfer procedure as below.

1> else:

2> if variable HSPA_RNTI_STORED_CELL_PCH is set to TRUE:

3> move to CELL_FACH state and continue with the initial direct transfer procedure as below.

2> else:

3> if variable H_RNTI and variable C_RNTI are set:

4> continue with the initial direct transfer procedure as below.

3> else:

4> perform a cell update procedure, according to subclause 8.3.1, using the cause "uplink data transmission";

4> when the cell update procedure completed successfully:

5> continue with the initial direct transfer procedure as below.

The UE shall, in the INITIAL DIRECT TRANSFER message:

1> set the IE "NAS message" as received from upper layers; and

1> set the IE "CN domain identity" as indicated by the upper layers; and

1> set the IE "Intra Domain NAS Node Selector" as follows:

2> derive the IE "Intra Domain NAS Node Selector" from TMSI/PMTSI, IMSI, or IMEI; and

2> provide the coding of the IE "Intra Domain NAS Node Selector" according to the following priorities:

1. base the routing parameter for IDNNS on TMSI (CS domain) or on PTMSI (PS domain) according to the TMSI/PTMSI provided by upper layers, where the PTMSI may be mapped from a valid GUTI;
2. base the routing parameter for IDNNS on IMSI when no TMSI/PTMSI is provided by upper layers;
3. base the routing parameter for IDNNS on IMEI only if no (U)SIM is inserted in the UE.

1> if the UE, on the existing RRC connection, has received a dedicated RRC message containing the IE "Primary PLMN Identity" in the IE "CN Information Info":

2> set the IE "PLMN identity" in the INITIAL DIRECT TRANSFER message to the latest PLMN information received via dedicated RRC signalling. If NAS has indicated the PLMN towards which a signalling connection is requested, and this PLMN is not in agreement with the latest PLMN information received via dedicated RRC signalling, then the initial direct transfer procedure shall be aborted, and NAS shall be informed.

1> if the UE, on the existing RRC connection, has not received a dedicated RRC message containing the IE "CN Information Info", and if the IE "Multiple PLMN List" was broadcast in the cell where the current RRC connection was established:

2> set the IE "PLMN identity" in the INITIAL DIRECT TRANSFER message to the PLMN chosen by higher layers [5, 25] amongst the PLMNs in the IE "Multiple PLMN List" broadcast in the cell where the RRC connection was established.

1> if the IE "Activated service list" within variable MBMS_ACTIVATED_SERVICES includes one or more MBMS services with the IE "Service type" set to "Multicast" and;

- 1> if the IE "CN domain identity" as indicated by the upper layers is set to "CS domain" and;
- 1> if the variable ESTABLISHED_SIGNALLING_CONNECTIONS does not include the CN domain identity 'PS domain':
 - 2> include the IE "MBMS joined information";
 - 2> include the IE "P-TMSI" within the IE "MBMS joined information" if a valid PTMSI is available.
- 1> if the UE is in CELL_FACH state and the IE "CN domain identity" as indicated by the upper layers is set to "CS domain":
 - 2> if the value of the variable ESTABLISHMENT_CAUSE is set to "Originating Conversational Call" or "Emergency Call":
 - 3> set the value of the IE "Call type" to "speech", "video" or "other" according to the call being initiated.
- 1> if the variable ESTABLISHMENT_CAUSE is initialised:
 - 2> set the IE "Establishment cause" to the value of the variable ESTABLISHMENT_CAUSE;
 - 2> clear the variable ESTABLISHMENT_CAUSE.
- 1> calculate the START according to subclause 8.5.9 for the CN domain as set in the IE "CN Domain Identity"; and
- 1> include the calculated START value for that CN domain in the IE "START".

The UE shall:

- 1> transmit the INITIAL DIRECT TRANSFER message on the uplink DCCH using AM RLC on signalling radio bearer RB3;
- 1> when the INITIAL DIRECT TRANSFER message has been submitted to lower layers for transmission:
 - 2> confirm the establishment of a signalling connection to upper layers; and
 - 2> add the signalling connection with the identity indicated by the IE "CN domain identity" in the variable ESTABLISHED_SIGNALLING_CONNECTIONS.
- 1> when the successful delivery of the INITIAL DIRECT TRANSFER message has been confirmed by RLC:
 - 2> the procedure ends.

When not stated otherwise elsewhere, the UE may also initiate the initial direct transfer procedure when another procedure is ongoing, and in that case the state of the latter procedure shall not be affected.

A new signalling connection request may be received from upper layers during transition to idle mode. In those cases, from the time of the indication of release to upper layers until the UE has entered idle mode, any such upper layer request to establish a new signalling connection shall be queued. This request shall be processed after the UE has entered idle mode.

8.1.8.2a RLC re-establishment or inter-RAT change

If a re-establishment of the transmitting side of the RLC entity on signalling radio bearer RB3 occurs before the successful delivery of the INITIAL DIRECT TRANSFER message has been confirmed by RLC, the UE shall:

- 1> retransmit the INITIAL DIRECT TRANSFER message on the uplink DCCH using AM RLC on signalling radio bearer RB3.

If an Inter-RAT handover from UTRAN to other RAT than E-UTRAN procedure occurs before the successful delivery of the INITIAL DIRECT TRANSFER message has been confirmed by RLC, for messages with the IE "CN domain identity" set to "CS domain", the UE shall:

- 1> retransmit the NAS message as specified in subclause 8.3.7.4.

8.1.8.2ab Inter-RAT handover from UTRAN to GERAN *Iu mode*

If an Inter-RAT handover from UTRAN to GERAN *Iu mode* occurs before the successful delivery of the INITIAL DIRECT TRANSFER message has been confirmed by RLC, for messages for all CN domains, the UE shall:

- 1> retransmit the NAS message as specified in subclause 8.3.7.4.

8.1.8.2b Abortion of signalling connection establishment

If the UE receives a request from upper layers to release (abort) the signalling connection for the CN domain for which the initial direct transfer procedure is ongoing, the UE shall:

- 1> if the UE has not yet entered UTRA RRC connected mode:
 - 2> abort the RRC connection establishment procedure as specified in subclause 8.1.3;

the procedure ends.

8.1.8.2c Inter-RAT handover from UTRAN to E-UTRAN

If an Inter-RAT handover from UTRAN to E-UTRAN occurs before the successful delivery of the INITIAL DIRECT TRANSFER message has been confirmed by RLC, the UE shall:

- 1> discard the NAS message.

8.1.8.3 Reception of INITIAL DIRECT TRANSFER message by the UTRAN

On reception of the INITIAL DIRECT TRANSFER message the NAS message should be routed using the IE "CN Domain Identity". UTRAN may also use the IE "Intra Domain NAS Node Selector" and the IE "PLMN identity" for routing among the CN nodes for the addressed CN domain.

If no signalling connection exists towards the chosen node, then a signalling connection is established.

When the UTRAN receives an INITIAL DIRECT TRANSFER message, it shall not affect the state of any other ongoing RRC procedures, when not stated otherwise elsewhere.

The UTRAN should:

- 1> set the START value for the CN domain indicated in the IE "CN domain identity" to the value of the IE "START".

8.1.9 Downlink Direct transfer



Figure 8.1.9-1: Downlink Direct transfer, normal flow

8.1.9.1 General

The downlink direct transfer procedure is used in the downlink direction to carry upper layer (NAS) messages over the radio interface.

8.1.9.2 Initiation of downlink direct transfer procedure in the UTRAN

In the UTRAN, the direct transfer procedure is initiated when the upper layers request the transfer of a NAS message after the initial signalling connection is established. The UTRAN may also initiate the downlink direct transfer procedure when another RRC procedure is ongoing, and in that case the state of the latter procedure shall not be affected. The UTRAN shall transmit the DOWNLINK DIRECT TRANSFER message on the downlink DCCH using AM RLC on signalling radio bearer RB3 or signalling radio bearer RB4. The UTRAN should:

- 1> if upper layers indicate "low priority" for this message:
 - 2> select signalling radio bearer RB4, if available. Specifically, for a GSM-MAP based CN, signalling radio bearer RB4 should, if available, be selected when "SAPI 3" is requested;
 - 2> select signalling radio bearer RB3 when signalling radio bearer RB4 is not available.
- 1> if upper layers indicate "high priority" for this message:
 - 2> select signalling radio bearer RB3. Specifically, for a GSM-MAP based CN, signalling radio bearer RB3 should be selected when "SAPI 0" is requested.

The UTRAN sets the IE "CN Domain Identity" to indicate, which CN domain the NAS message is originated from.

8.1.9.3 Reception of a DOWNLINK DIRECT TRANSFER message by the UE

Upon reception of the DOWNLINK DIRECT TRANSFER message, the UE RRC shall, using the IE "CN Domain Identity", route the contents of the IE "NAS message" and the value of the IE "CN Domain Identity" to upper layers.

The UE shall clear the entry for the DOWNLINK DIRECT TRANSFER message in the table "Accepted transactions" in the variable TRANSACTIONS.

When the UE receives a DOWNLINK DIRECT TRANSFER message, it shall not affect the state of any other ongoing RRC procedures when not stated otherwise elsewhere.

8.1.9.3a No signalling connection exists

If the UE receives a DOWNLINK DIRECT TRANSFER message, and the signalling connection identified with the IE "CN domain identity" does not exist according to the variable ESTABLISHED_SIGNALLING_CONNECTIONS, the UE shall:

- 1> ignore the content of the DOWNLINK DIRECT TRANSFER message;
- 1> transmit an RRC STATUS message on the uplink DCCH using AM RLC;
- 1> include the IE "Identification of received message"; and
- 1> set the IE "Received message type" to DOWNLINK DIRECT TRANSFER; and
- 1> set the IE "RRC transaction identifier" to the value of "RRC transaction identifier" in the entry for the DOWNLINK DIRECT TRANSFER message in the table "Accepted transactions" in the variable TRANSACTIONS; and
- 1> clear that entry;
- 1> include the IE "Protocol error information" with the IE "Protocol error cause" set to "Message not compatible with receiver state".

When the RRC STATUS message has been submitted to lower layers for transmission, the UE shall:

- 1> continue with any ongoing processes and procedures as if the DOWNLINK DIRECT TRANSFER message has not been received.

8.1.9.4 Invalid DOWNLINK DIRECT TRANSFER message

If the UE receives a DOWNLINK DIRECT TRANSFER message, which contains a protocol error causing the variable `PROTOCOL_ERROR_REJECT` to be set to `TRUE` according to clause 9, the UE shall perform procedure specific error handling as follows:

- 1> transmit an RRC STATUS message on the uplink DCCH using AM RLC;
- 1> include the IE "Identification of received message"; and
- 1> set the IE "Received message type" to DOWNLINK DIRECT TRANSFER; and
- 1> set the IE "RRC transaction identifier" to the value of "RRC transaction identifier" in the entry for the DOWNLINK DIRECT TRANSFER message in the table "Rejected transactions" in the variable TRANSACTIONS; and
- 1> clear that entry;
- 1> include the IE "Protocol error information" with contents set to the value of the variable `PROTOCOL_ERROR_INFORMATION`.

When the RRC STATUS message has been submitted to lower layers for transmission, the UE shall:

- 1> continue with any ongoing processes and procedures as if the invalid DOWNLINK DIRECT TRANSFER message has not been received.

8.1.10 Uplink Direct transfer

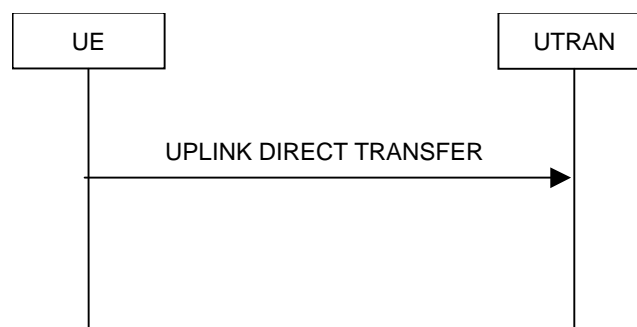

Figure 8.1.10-1: Uplink Direct transfer, normal flow

8.1.10.1 General

The uplink direct transfer procedure is used in the uplink direction to carry all subsequent upper layer (NAS) messages over the radio interface belonging to a signalling connection.

8.1.10.2 Initiation of uplink direct transfer procedure in the UE

In the UE, the uplink direct transfer procedure shall be initiated when the upper layers request a transfer of a NAS message on an existing signalling connection. When not stated otherwise elsewhere, the UE may initiate the uplink direct transfer procedure when another procedure is ongoing, and in that case the state of the latter procedure shall not be affected.

Upon initiation of the uplink direct transfer procedure in `CELL_PCH` or `URA_PCH` state, the UE shall:

- 1> if variable `READY_FOR_COMMON_EDCH` is set to `TRUE`:
 - 2> move to `CELL_FACH` state and continue with the uplink direct transfer procedure as below.
- 1> else:
 - 2> if variable `HSPA_RNTI_STORED_CELL_PCH` is set to `TRUE`:

- 3> move to CELL_FACH and continue with the uplink direct transfer procedure as below.
- 2> else:
 - 3> if variable H_RNTI and variable C_RNTI are set:
 - 4> continue with the uplink direct transfer procedure as below.
 - 3> else:
 - 4> perform a cell update procedure, according to subclause 8.3.1, using the cause "uplink data transmission";
 - 4> when the cell update procedure has been completed successfully:
 - 5> continue with the uplink direct transfer procedure as below.

The UE shall transmit the UPLINK DIRECT TRANSFER message on the uplink DCCH using AM RLC on signalling radio bearer RB3 or signalling radio bearer RB4. The UE shall:

- 1> if upper layers indicate "low priority" for this message:
 - 2> select signalling radio bearer RB4, if available. Specifically, for a GSM-MAP based CN, signalling radio bearer RB4 shall, if available, be selected when "SAPI 3" is requested;
 - 2> select signalling radio bearer RB3 when signalling radio bearer RB4 is not available;
- 1> if upper layers indicate "high priority" for this message:
 - 2> select signalling radio bearer RB3. Specifically, for a GSM-MAP based CN, signalling radio bearer RB3 shall be selected when "SAPI 0" is requested.

The UE shall set the IE "NAS message" as received from upper layers and set the IE "CN domain identity" as indicated by the upper layers.

When the successful delivery of the UPLINK DIRECT TRANSFER message has been confirmed by RLC the procedure ends.

8.1.10.2a RLC re-establishment or inter-RAT change

If signalling radio bearer RB n (where n equals to 3 or 4) was used when transmitting the UPLINK DIRECT TRANSFER message and a re-establishment of the transmitting side of the RLC entity on the same signalling radio bearer RB n occurs before the successful delivery of the UPLINK DIRECT TRANSFER message has been confirmed by RLC, the UE shall:

- 1> retransmit the UPLINK DIRECT TRANSFER message on the uplink DCCH using AM RLC on signalling radio bearer RB n.

If an Inter-RAT handover from UTRAN to other RAT than E-UTRAN procedure occurs before the successful delivery of the UPLINK DIRECT TRANSFER message has been confirmed by RLC, for messages with the IE "CN domain identity" set to "CS domain", the UE shall:

- 1> retransmit the NAS message as specified in subclause 8.3.7.4.

8.1.10.2b Inter-RAT handover from UTRAN to GERAN *Iu mode*

If an Inter-RAT handover from UTRAN to GERAN *Iu mode* occurs before the successful delivery of the UPLINK DIRECT TRANSFER message has been confirmed by RLC, for messages for all CN domains, the UE shall:

- 1> retransmit the NAS message as specified in subclause 8.3.7.4.

8.1.10.2c Inter-RAT handover from UTRAN to E-UTRAN

If an Inter-RAT handover from UTRAN to E-UTRAN occurs before the successful delivery of the UPLINK DIRECT TRANSFER message has been confirmed by RLC, the UE shall:

1> discard the NAS message.

8.1.10.3 Reception of UPLINK DIRECT TRANSFER message by the UTRAN

On reception of the UPLINK DIRECT TRANSFER message the NAS message should be routed using the value indicated in the IE "CN domain identity".

When the UTRAN receives an UPLINK DIRECT TRANSFER message, it shall not affect the state of any other ongoing RRC procedures, when not stated otherwise elsewhere.

8.1.11 UE dedicated paging

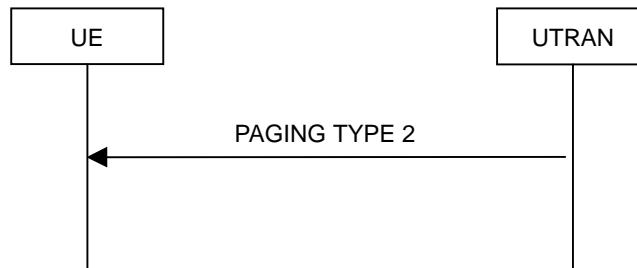

Figure 8.1.11-1: UE dedicated paging

8.1.11.1 General

This procedure is used to transmit dedicated paging information to one UE in connected mode in CELL_DCH, CELL_FACH or CELL_PCH (FDD and 1.28 Mcps TDD only) state. Upper layers in the network may request initiation of paging.

8.1.11.2 Initiation

For a UE in CELL_DCH, CELL_FACH or CELL_PCH (FDD and 1.28 Mcps TDD only) state, UTRAN initiates the procedure by transmitting a PAGING TYPE 2 message on the DCCH using AM RLC. When not stated otherwise elsewhere, the UTRAN may initiate the UE dedicated paging procedure also when another RRC procedure is ongoing, and in that case the state of the latter procedure shall not be affected.

UTRAN should set the IE "Paging cause" to the cause for paging received from upper layers. If no cause for paging is received from upper layers, UTRAN should set the value "Terminating – cause unknown".

8.1.11.3 Reception of a PAGING TYPE 2 message by the UE

When the UE receives a PAGING TYPE 2 message, it shall not affect the state of any other ongoing RRC procedures, when not stated otherwise elsewhere.

The UE shall:

- 1> indicate reception of paging; and
- 1> forward the IE "Paging cause" and the IE "Paging record type identifier" to upper layers.

The UE shall:

- 1> clear the entry for the PAGING TYPE 2 message in the table "Accepted transactions" in the variable TRANSACTIONS.

8.1.11.4 Invalid PAGING TYPE 2 message

If the UE receives a PAGING TYPE 2 message, which contains a protocol error causing the variable PROTOCOL_ERROR_REJECT to be set to TRUE according to clause 9, the UE shall perform procedure specific error handling as follows:

- 1> transmit an RRC STATUS message on the uplink DCCH using AM RLC;
- 1> include the IE "Identification of received message"; and
- 1> set the IE "Received message type" to PAGING TYPE 2; and
- 1> set the IE "RRC transaction identifier" to the value of "RRC transaction identifier" in the entry for the PAGING TYPE 2 message in the table "Rejected transactions" in the variable TRANSACTIONS; and
- 1> clear that entry;
- 1> include the IE "Protocol error information" with contents set to the value of the variable PROTOCOL_ERROR_INFORMATION;
- 1> when the RRC STATUS message has been submitted to lower layers for transmission:
 - 2> continue with any ongoing processes and procedures as if the invalid PAGING TYPE 2 message has not been received.

8.1.12 Security mode control

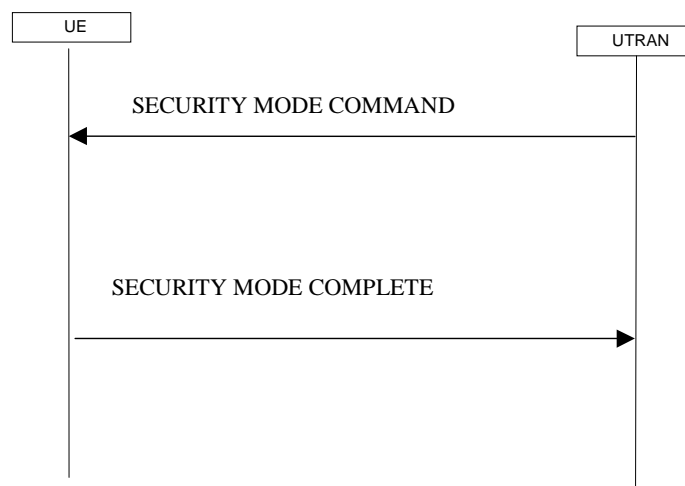

Figure 8.1.12-1: Security mode control procedure

8.1.12.1 General

The purpose of this procedure is to trigger the start of ciphering or to command the restart of the ciphering with a new ciphering configuration, for the radio bearers of one CN domain and for all signalling radio bearers.

It is also used to start integrity protection or to modify the integrity protection configuration for all signalling radio bearers.

8.1.12.2 Initiation

8.1.12.2.1 Ciphering configuration change

To start/restart ciphering, UTRAN sends a SECURITY MODE COMMAND message on the downlink DCCH in AM RLC using the most recent ciphering configuration. If no such ciphering configuration exists then the SECURITY MODE COMMAND is not ciphered. UTRAN should not transmit a SECURITY MODE COMMAND to signal a change in ciphering algorithm.

When configuring ciphering, UTRAN should ensure that the UE needs to store at most two different ciphering configurations (keyset and algorithm) per CN domain, in total over all radio bearers at any given time. For signalling radio bearers the total number of ciphering configurations that need to be stored is at most three. Prior to sending the

SECURITY MODE COMMAND, for the CN domain indicated in the IE "CN domain identity" in the SECURITY MODE COMMAND, UTRAN should:

- 1> suspend all radio bearers using RLC-AM or RLC-UM and all signalling radio bearers using RLC-AM or RLC-UM, except the signalling radio bearer used to send the SECURITY MODE COMMAND message on the downlink DCCH in RLC-AM, and except signalling radio bearer RB0, according to the following:
 - 2> not transmit RLC PDUs with sequence number greater than or equal to the number in IE "Radio bearer downlink ciphering activation time info" on all suspended radio bearers and all suspended signalling radio bearers.
- 1> set, for the signalling radio bearer used to send the SECURITY MODE COMMAND, the "RLC sequence number" in IE "Radio bearer downlink ciphering activation time info" in the IE "Ciphering mode info", at which time the new ciphering configuration shall be applied;

NOTE: The UTRAN should avoid the situation that the UE is aware of more than one pending downlink ciphering activation times for SRB2. In such a case the UE behaviour is unspecified.

- 1> if a transparent mode radio bearer for this CN domain exists:
 - 2> include the IE "Ciphering activation time for DPCH" in IE "Ciphering mode info", at which time the new ciphering configuration shall be applied and specify a CFN value for this IE that is a multiple of 8 frames ($CFN \bmod 8 = 0$).

NOTE: UTRAN should chose the value for the IE "Ciphering activation time for DPCH" such that the new ciphering configuration will occur after all the pending ciphering activation times have been reached for the transparent mode radio bearers of this CN domain.

- 1> consider a ciphering activation time in downlink to be pending until the RLC sequence number of the next RLC PDU to be transmitted for the first time is equal to or larger than the selected activation time;
- 1> set, for each suspended radio bearer and signalling radio bearer that has no pending ciphering activation time set by a previous security mode control procedure, an "RLC sequence number" in IE "Radio bearer downlink ciphering activation time info" in the IE "Ciphering mode info", at which time the new ciphering configuration shall be applied;
- 1> set, for each suspended radio bearer and signalling radio bearer that has a pending ciphering activation time set by a previous security mode control procedure, the "RLC sequence number" in IE "Radio bearer downlink ciphering activation time info" in the IE "Ciphering mode info" to the value used in the previous security mode control procedure, at which time the latest ciphering configuration shall be applied;
- 1> if Integrity protection has already been started for the UE:
 - 2> if for the CN domain indicated in the IE "CN domain identity" in the SECURITY MODE COMMAND, a new security key set (new ciphering and integrity protection keys) has been received from upper layers since the transmission of the last SECURITY MODE COMMAND message for that CN domain:
 - 3> include the IE "Integrity protection mode info" in the SECURITY MODE COMMAND.
 - 2> if the IE "CN domain identity" in the SECURITY MODE COMMAND is different from the IE "CN domain identity" that was sent in the previous SECURITY MODE COMMAND message to the UE:
 - 3> include the IE "Integrity protection mode info" in the SECURITY MODE COMMAND.
- 1> transmit the SECURITY MODE COMMAND message on RB2.

8.1.12.2.2 Integrity protection configuration change

To start or modify integrity protection, UTRAN sends a SECURITY MODE COMMAND message on the downlink DCCH in AM RLC using the new integrity protection configuration. UTRAN should not "modify" integrity protection for a CN domain to which a SECURITY MODE COMMAND configuring integrity protection has been previously sent for an ongoing signalling connection unless the application of new integrity keys needs to be signalled to the UE. UTRAN should not transmit a SECURITY MODE COMMAND to signal a change in integrity protection algorithm.

In case of Inter-RAT handover to UTRAN, after the reception of the HANDOVER TO UTRAN COMPLETE message and a key set is received, UTRAN should transmit a SECURITY MODE COMMAND message containing IE "Integrity protection mode info" in order to initiate integrity protection with the integrity key of the key set used in the other RAT (see subclause 8.3.6.3).

When configuring Integrity protection, UTRAN should:

- 1> ensure that the UE needs to store at most three different Integrity protection configurations (keysets) at any given time. This includes the total number of Integrity protection configurations for all signalling radio bearers;
- 1> if Ciphering has already been started for the UE for the CN domain to be set in the IE "CN domain identity" in the SECURITY MODE COMMAND:
 - 2> if for the CN domain indicated in the IE "CN domain identity" in the SECURITY MODE COMMAND, a new security key set (new ciphering and integrity protection keys) has been received from upper layers since the transmission of the last SECURITY MODE COMMAND message for that CN domain:
 - 3> include the IE "Ciphering mode info" in the SECURITY MODE COMMAND.
- 1> if Ciphering has already been configured for the UE for a CN domain different from the CN domain to be set in the IE "CN domain identity" in the SECURITY MODE COMMAND:
 - 2> include the IE "Ciphering mode info" in the SECURITY MODE COMMAND.

Prior to sending the SECURITY MODE COMMAND, for the CN domain indicated in the IE "CN domain identity" in the SECURITY MODE COMMAND, UTRAN should:

- 1> if this is the first SECURITY MODE COMMAND sent for this RRC connection:
 - 2> if new keys have been received:
 - 3> initialise the hyper frame numbers as follows:
 - 4> set all bits of the hyper frame numbers of the COUNT-I values for all signalling radio bearers to zero.
 - 2> else (if new keys have not been received):
 - 3> use the value "START" in the most recently received IE "START list" or IE "START" that belongs to the CN domain indicated in the IE "CN domain identity" to initialise all hyper frame numbers of COUNT-I for all the signalling radio bearers by:
 - 4> setting the 20 most significant bits of the hyper frame numbers for all signalling radio bearers to the value "START" in the most recently received IE "START list" or IE "START" for that CN domain;
 - 4> setting the remaining bits of the hyper frame numbers equal to zero.
- 1> else (this is not the first SECURITY MODE COMMAND sent for this RRC connection):
 - 2> if new keys have been received:
 - 3> initialise the hyper frame number for COUNT-I for RB2 as follows:
 - 4> set all bits of the HFN of the COUNT-I value for RB2 to zero.
 - 2> if new keys have not been received:
 - 3> initialise the hyper frame number for COUNT-I for RB2 as follows:
 - 4> set the 20 most significant bits of the HFN of the downlink and uplink COUNT-I to the value of the most recently received IE "START" or IE "START list" for the CN domain to be set in the IE "CN Domain Identity";
 - 4> set the remaining bits of the HFN of the downlink and uplink COUNT-I to zero.
- 1> if the IE "Integrity protection mode command" has the value "Start":

- 2> prohibit the transmission of signalling messages with any RRC SN on all signalling radio bearers, except RB2;
 - 2> set the FRESH value in the IE "Integrity protection initialisation number", included in the IE "Integrity protection mode info".
- 1> if the IE "Integrity protection mode command" has the value "Modify":
- 2> for each signalling radio bearer RBn, except RB2:
 - 3> prohibit the transmission of signalling messages with RRC SN greater or equal to the RRC sequence number in entry for signalling radio bearer n in the "RRC message sequence number list" in the IE "Downlink integrity protection activation info", included in the IE "Integrity protection mode info".
 - 2> consider an integrity protection activation time in downlink to be pending until the selected activation time is equal to the next RRC sequence number to be used, which means that the last RRC message using the old integrity protection configuration has been submitted to lower layers;
 - 2> set, for each signalling radio bearer RBn, that has no pending integrity protection activation time set by a previous security mode control procedure, an RRC sequence number in entry for signalling radio bearer n in the "RRC message sequence number list" in the IE "Downlink integrity protection activation info", included in the IE "Integrity protection mode info", at which time the new integrity protection configuration shall be applied;
 - 2> set, for each signalling radio bearer RBn, that has a pending integrity protection activation time set by a previous security mode control procedure, the RRC sequence number in entry for signalling radio bearer n in the "RRC message sequence number list" in the IE "Downlink integrity protection activation info", included in the IE "Integrity protection mode info", to the value used in the previous security mode control procedure, at which time the latest integrity protection configuration shall be applied.
- 1> transmit the SECURITY MODE COMMAND message on RB2 using the new integrity protection configuration.

NOTE1: In the case of re-initialisation of Integrity Protection at HFN wrap around, the network should take into account the UE actions as described in subclauses 8.5.10.1 and 8.5.10.2.

NOTE2: After the SECURITY MODE COMMAND message is transmitted, the network should ensure that it can revert back to old integrity protection until it receives the SECURITY MODE COMPLETE message, to take into account the UE actions when security mode control procedure is unsuccessful. The network should also be aware that the UE may revert to old configuration when waiting for the acknowledgement from L2 for the SECURITY MODE COMPLETE message, and act accordingly.

NOTE3: In the case of the first SECURITY MODE COMMAND message following an SRNS relocation, the network should set the IE "Downlink integrity protection activation info" for SRB3 and SRB4 to at least "the current downlink RRC sequence number +2". As a consequence, at least the first message sent on SRB3 and SRB4 by the Target RNC will use the old integrity protection configuration.

8.1.12.3 Reception of SECURITY MODE COMMAND message by the UE

Upon reception of the SECURITY MODE COMMAND message, the UE shall:

- 1> if neither IE "Ciphering mode info" nor IE "Integrity protection mode info" is included in the SECURITY MODE COMMAND:
 - 2> set the variable INVALID_CONFIGURATION to TRUE.
- 1> if the IE "Security capability" is the same as indicated by variable UE_CAPABILITY_TRANSFERRED, and the IE "GSM security capability" (if included in the SECURITY MODE COMMAND) is the same as indicated by the variable UE_CAPABILITY_TRANSFERRED:
 - 2> set the variable LATEST_CONFIGURED_CN_DOMAIN equal to the IE "CN domain identity";
 - 2> set the IE "Status" in the variable SECURITY_MODIFICATION for the CN domain indicated in the IE "CN domain identity" in the received SECURITY MODE COMMAND to the value "Affected";

- 2> set the IE "Status" in the variable SECURITY_MODIFICATION for all CN domains other than the CN domain indicated in the IE "CN domain identity" to "Not affected";
- 2> set the IE "RRC transaction identifier" in the SECURITY MODE COMPLETE message to the value of "RRC transaction identifier" in the entry for the SECURITY MODE COMMAND message in the table "Accepted transactions" in the variable TRANSACTIONS; and
- 2> clear that entry;
- 2> if the SECURITY MODE COMMAND message contained the IE "Ciphering mode info":
 - 3> perform the actions as specified in subclause 8.6.3.4.
- 2> if the SECURITY MODE COMMAND message contained the IE "Integrity protection mode info":
 - 3> perform the actions as specified in subclause 8.6.3.5.
- 1> prior to sending the SECURITY MODE COMPLETE message:
 - 2> use the old ciphering configuration for this message;
 - 2> if the SECURITY MODE COMMAND message contained the IE "Ciphering mode info":
 - 3> include and set the IE "Radio bearer uplink ciphering activation time info" to the value of the variable RB_UPLINK_CIPHERING_ACTIVATION_TIME_INFO;
 - 3> for each radio bearer and signalling radio bearer that belongs to the CN domain as indicated in the variable LATEST_CONFIGURED_CN_DOMAIN:
 - 4> start or continue incrementing the COUNT-C values for all RLC-AM and RLC-UM signalling radio bearers at the ciphering activation time as specified in the procedure;
 - 4> start or continue incrementing the COUNT-C values common for all transparent mode radio bearers for this CN domain at the ciphering activation time as specified in the procedure;
 - 4> continue incrementing the COUNT-C values for all RLC-AM and RLC-UM radio bearers.
 - 3> if no new security key set (new ciphering and integrity protection keys) has been received from the upper layers [40] for the CN domain as indicated in the variable LATEST_CONFIGURED_CN_DOMAIN:
 - 4> for ciphering on signalling radio bearers using RLC-AM and RLC-UM in the downlink, at the RLC sequence number indicated in IE "Radio bearer downlink ciphering activation time info" in the IE "Ciphering mode info" included in the SECURITY MODE COMMAND, for each signalling radio bearer:
 - 5> set the 20 most significant bits of the HFN component of the downlink COUNT-C to the value "START" in the most recently transmitted IE "START list" or IE "START", at the reception of the SECURITY MODE COMMAND, that belongs to the CN domain as indicated in the variable LATEST_CONFIGURED_CN_DOMAIN;
 - 5> set the remaining bits of the hyper frame numbers to zero.
 - 3> if new keys have been received:
 - 4> perform the actions in subclause 8.1.12.3.1.
 - 2> if the SECURITY MODE COMMAND message contained the IE "Integrity protection mode info":
 - 3> include and set the IE "Uplink integrity protection activation info" to the value of the variable INTEGRITY_PROTECTION_ACTIVATION_INFO for each signalling radio bearer;
 - 3> if no new security key set (new ciphering and integrity protection keys) has been received from the upper layers [40] for the CN domain as indicated in the variable LATEST_CONFIGURED_CN_DOMAIN, for RB2:
 - 4> in the downlink, for the received SECURITY MODE COMMAND message:

- 5> set the 20 most significant bits of the IE "Downlink RRC HFN" in the variable INTEGRITY_PROTECTION_INFO of the downlink COUNT-I to the value "START" in the most recently transmitted IE "START list" or IE "START", at the reception of the SECURITY MODE COMMAND, that belongs to the CN domain as indicated in the variable LATEST_CONFIGURED_CN_DOMAIN;
- 5> set the remaining bits of the IE "Downlink RRC HFN" to zero.
- 4> in the uplink, for the transmitted response message, SECURITY MODE COMPLETE:
 - 5> set the 20 most significant bits of the IE "Uplink RRC HFN" in the variable INTEGRITY_PROTECTION_INFO of the uplink COUNT-I to the value "START" in the most recently transmitted IE "START list" or IE "START", at the reception of the SECURITY MODE COMMAND, that belongs to the CN domain as indicated in the variable LATEST_CONFIGURED_CN_DOMAIN;
 - 5> set the remaining bits of the IE "Uplink RRC HFN" to zero.
- 3> if no new security key set (new ciphering and integrity protection keys) has been received from the upper layers [40] for the CN domain indicated in the variable LATEST_CONFIGURED_CN_DOMAIN, for each signalling radio bearer other than RB2:
 - 4> if the IE "Integrity protection mode command" has the value "start":
 - 5> in the downlink, for this signalling radio bearer:
 - 6> set the 20 most significant bits of IE "Downlink RRC HFN" in the variable INTEGRITY_PROTECTION_INFO of the downlink COUNT-I to the value START transmitted in the most recently transmitted IE "START list" or IE "START", at the reception of the SECURITY MODE COMMAND, that belongs to the CN domain as indicated in the variable LATEST_CONFIGURED_CN_DOMAIN;
 - 6> set the remaining bits of the IE "Downlink RRC HFN" in the variable INTEGRITY_PROTECTION_INFO of the downlink COUNT-I to zero;
 - 4> else:
 - 5> in the downlink, for the first message for which the RRC sequence number in a received RRC message for this signalling radio bearer is equal to or greater than the activation time as indicated in IE "Downlink integrity protection activation info" as included in the IE "Integrity protection mode info", for this signalling radio bearer:
 - 6> set the 20 most significant bits of the IE "Downlink RRC HFN" in the variable INTEGRITY_PROTECTION_INFO of the downlink COUNT-I to the value "START" in the most recently transmitted IE "START list" or IE "START", at the reception of the SECURITY MODE COMMAND, that belongs to the CN domain as indicated in the variable LATEST_CONFIGURED_CN_DOMAIN;
 - 6> set the remaining bits of the IE "Downlink RRC HFN" to zero.
 - 3> if new keys have been received:
 - 4> perform the actions in subclause 8.1.12.3.1.
 - 2> start applying the new integrity protection configuration in the uplink for signalling radio bearer RB2 from and including the transmitted SECURITY MODE COMPLETE message;
 - 2> transmit the SECURITY MODE COMPLETE message on RB2.

NOTE: After submission of the SECURITY MODE COMPLETE message to the lower layers, the UE should accept messages received in the DL which require the new security configuration to be applied on them. If the received message is successfully integrity checked, the UE should not discard the message due to lack of completion of the security procedure, caused by the successful delivery of the SECURITY MODE COMPLETE not having yet been confirmed by lower layers, unless the security configuration to be applied has been aborted and the message received requires integrity protection [5].

- 1> when the successful delivery of the SECURITY MODE COMPLETE message has been confirmed by RLC:
 - 2> if the SECURITY MODE COMMAND message contained the IE "Ciphering mode info":
 - 3> if no new security key set (new ciphering and integrity protection keys) has been received from the upper layers [40] for the CN domain as indicated in the variable LATEST_CONFIGURED_CN_DOMAIN:
 - 4> for ciphering on signalling radio bearers using RLC-AM and RLC-UM in the uplink, at the RLC sequence number indicated in IE "Radio bearer uplink ciphering activation time info" included in the SECURITY MODE COMPLETE, for each signalling radio bearer:
 - 5> set the 20 most significant bits of the HFN component of the uplink COUNT-C to the value "START" in the most recently transmitted IE "START list" or IE "START", at the reception of the SECURITY MODE COMMAND, that belongs to the CN domain as indicated in the variable LATEST_CONFIGURED_CN_DOMAIN;
 - 5> set the remaining bits of the hyper frame numbers to zero.
 - 3> if new keys have been received:
 - 4> perform the actions in subclause 8.1.12.3.1.
 - 3> resume data transmission on any suspended radio bearer and signalling radio bearer mapped on RLC-AM or RLC-UM;
 - 3> set the IE "Reconfiguration" in the variable CIPHERING_STATUS to FALSE; and
 - 3> clear the variable RB_UPLINK_CIPHERING_ACTIVATION_TIME_INFO.
 - 2> if the SECURITY MODE COMMAND message contained the IE "Integrity protection mode info":
 - 3> if no new security key set (new ciphering and integrity protection keys) has been received from the upper layers [40] for the CN domain indicated in the variable LATEST_CONFIGURED_CN_DOMAIN, for each signalling radio bearer other than RB2:
 - 4> if the IE "Integrity protection mode command" has the value "start":
 - 5> in the uplink, for this signalling radio bearer:
 - 6> set the 20 most significant bits of IE "Uplink RRC HFN" in the variable INTEGRITY_PROTECTION_INFO of the uplink COUNT-I to the value START transmitted in the most recently transmitted IE "START list" or IE "START", at the reception of the SECURITY MODE COMMAND, that belongs to the CN domain as indicated in the variable LATEST_CONFIGURED_CN_DOMAIN;
 - 6> set the remaining bits of the IE "Uplink RRC HFN" in the variable INTEGRITY_PROTECTION_INFO of the uplink COUNT-I to zero.
 - 4> else:
 - 5> in the uplink, for the first transmitted RRC message for this signalling radio bearer with RRC sequence number equal to the activation time as indicated in IE "Uplink integrity protection activation info" included in the transmitted SECURITY MODE COMPLETE, for this signalling radio bearer:
 - 6> set the 20 most significant bits of the IE "Uplink RRC HFN" in the variable INTEGRITY_PROTECTION_INFO of the uplink COUNT-I to the value "START" in the most recently transmitted IE "START list" or IE "START", at the reception of the SECURITY MODE COMMAND, that belongs to the CN domain as indicated in the variable LATEST_CONFIGURED_CN_DOMAIN;
 - 6> set the remaining bits of the IE "Uplink RRC HFN" to zero.
 - 3> if new keys have been received:
 - 4> perform the actions in subclause 8.1.12.3.1.

- 3> allow the transmission of RRC messages on all signalling radio bearers with any RRC SN;
- 3> set "Uplink RRC Message sequence number" for signalling radio bearer RB0 in the variable INTEGRITY_PROTECTION_INFO to a value such that next RRC message to be sent on uplink RB0 will use the new integrity protection configuration and the "RRC Message sequence number" in the IE "Integrity check info" in the next RRC message will equal to the activation time for RB0 as indicated in IE "Uplink integrity protection activation info" included in the transmitted SECURITY MODE COMPLETE;
- 3> set the IE "Reconfiguration" in the variable INTEGRITY_PROTECTION_INFO to FALSE; and
- 3> clear the variable INTEGRITY_PROTECTION_ACTIVATION_INFO.
- 2> clear the variable SECURITY_MODIFICATION;
- 2> notify upper layers upon change of the security configuration;
- 2> and the procedure ends.
- 1> if the IE "Security capability" is not the same as indicated by the variable UE_CAPABILITY_TRANSFERRED, or the IE "GSM security capability" (if included in the SECURITY MODE COMMAND) is not the same as indicated by the variable UE_CAPABILITY_TRANSFERRED, or if the IE "GSM security capability" is not included in the SECURITY MODE COMMAND and is included in the variable UE_CAPABILITY_TRANSFERRED:
 - 2> release all its radio resources;
 - 2> indicate the release of the established signalling connections (as stored in the variable ESTABLISHED_SIGNALLING_CONNECTIONS) and established radio access bearers (as stored in the variable ESTABLISHED_RABS) to upper layers;
 - 2> clear the variable ESTABLISHED_SIGNALLING_CONNECTIONS;
 - 2> clear the variable ESTABLISHED_RABS;
 - 2> clear the variable SECURITY_MODIFICATION;
 - 2> enter idle mode;
 - 2> perform actions when entering idle mode as specified in subclause 8.5.2;
 - 2> and the procedure ends.

8.1.12.3.1 New ciphering and integrity protection keys

NOTE: The actions in this subclause are to be performed only if the new keys were received for an ongoing RRC connection while in UTRA.

If a new security key set (new ciphering and integrity protection keys) has been received from the upper layers [40] for the CN domain as indicated in the variable LATEST_CONFIGURED_CN_DOMAIN, the UE shall:

- 1> set the START value for the CN domain indicated in the variable LATEST_CONFIGURED_CN_DOMAIN to zero;
- 1> if the SECURITY MODE COMMAND message contained the IE "Integrity protection mode info":
 - 2> for integrity protection in the downlink on each signalling radio bearer except RB2:
 - 3> if IE "Integrity protection mode command" has the value "start":
 - 4> for the first received message on this signalling radio bearer:
 - 5> start using the new integrity key;
 - 5> for this signalling radio bearer:

- 6> set the IE "Downlink RRC HFN" in the variable INTEGRITY_PROTECTION_INFO of the downlink COUNT-I to zero.
- 3> else:
 - 4> for the first message for which the RRC sequence number in a received RRC message for this signalling radio bearer is equal to or greater than the activation time as indicated in IE "Downlink integrity protection activation info" as included in the IE "Integrity protection mode info":
 - 5> start using the new integrity key;
 - 5> for this signalling radio bearer:
 - 6> set the IE "Downlink RRC HFN" in the variable INTEGRITY_PROTECTION_INFO of the downlink COUNT-I to zero.
- 2> for integrity protection in the uplink on each signalling radio bearer except RB2:
 - 3> for the first message for which the RRC sequence number in a to be transmitted RRC message for this signalling radio bearer is equal to the activation time as indicated in IE "Uplink integrity protection activation info" included in the transmitted SECURITY MODE COMPLETE message:
 - 4> start using the new integrity key;
 - 4> for this signalling radio bearer:
 - 5> set the IE "Uplink RRC HFN" in the variable INTEGRITY_PROTECTION_INFO of the uplink COUNT-I to zero.
- 2> for integrity protection in the downlink on signalling radio bearer RB2:
 - 3> at the received SECURITY MODECOMMAND:
 - 4> start using the new integrity key;
 - 4> set the IE "Downlink RRC HFN" in the variable INTEGRITY_PROTECTION_INFO of the downlink COUNT-I to zero.
- 2> for integrity protection in the uplink on signalling radio bearer RB2 :
 - 3> at the transmitted SECURITY MODE COMPLETE:
 - 4> start using the new integrity key;
 - 4> set the IE "Uplink RRC HFN" in the variable INTEGRITY_PROTECTION_INFO of the uplink COUNT-I to zero.
- 1> if the SECURITY MODE COMMAND message contained the IE "Ciphering mode info":
 - 2> for each signalling radio bearer and for each radio bearer for the CN domain indicated in the variable LATEST_CONFIGURED_CN_DOMAIN:
 - 3> if the IE "Status" in the variable CIPHERING_STATUS has the value "Started" for this CN domain, then for ciphering on radio bearers using RLC-TM:
 - 4> at the CFN as indicated in the IE "Ciphering activation time for DPCH" in the IE "Ciphering mode info":
 - 5> start using the new key in uplink and downlink;
 - 5> set the HFN component of the COUNT-C to zero.
 - 3> if the IE "Status" in the variable CIPHERING_STATUS has the value "Started" for this CN domain, then for ciphering on radio bearers and signalling radio bearers using RLC-AM and RLC-UM:
 - 4> in the downlink, at the RLC sequence number indicated in IE "Radio bearer downlink ciphering activation time info" in the IE "Ciphering mode info":

- 5> start using the new key;
- 5> set the HFN component of the downlink COUNT-C to zero.
- 4> in the uplink, at the RLC sequence number indicated in IE "Radio bearer uplink ciphering activation time info":
 - 5> start using the new key;
 - 5> set the HFN component of the uplink COUNT-C to zero.
- 1> consider the value of the latest transmitted START value to be zero.

8.1.12.4 Void

8.1.12.4a Incompatible simultaneous security reconfiguration

If the variable INCOMPATIBLE_SECURITY_RECONFIGURATION becomes set to TRUE of the received SECURITY MODE COMMAND message, the UE shall:

- 1> transmit a SECURITY MODE FAILURE message on the uplink DCCH using AM RLC, using the ciphering and integrity protection configurations prior to the reception of this SECURITY MODE COMMAND;
- 1> set the IE "RRC transaction identifier" in the SECURITY MODE FAILURE message to the value of "RRC transaction identifier" in the entry for the SECURITY MODE COMMAND message in the table "Accepted transactions" in the variable TRANSACTIONS; and
- 1> clear that entry;
- 1> set the IE "failure cause" to the cause value "incompatible simultaneous reconfiguration";
- 1> when the response message has been submitted to lower layers for transmission:
 - 2> set the variable INCOMPATIBLE_SECURITY_RECONFIGURATION to FALSE;
 - 2> continue with any ongoing processes and procedures as if the invalid SECURITY MODE COMMAND message has not been received;
 - 2> only accept a message on SRB 2, with a COUNT-I that:
 - 3> is higher than the COUNT-I used prior to receiving the SECURITY MODE COMMAND message incremented by one; and
 - 3> does not take into account the HFN from the received SECURITY MODE COMMAND message.
 - 2> and the procedure ends.

8.1.12.4b Cell update procedure during security reconfiguration

If:

- a cell update procedure according to subclause 8.3.1 is initiated; and
- the received SECURITY MODE COMMAND message causes either,
 - the IE "Reconfiguration" in the variable CIPHERING_STATUS to be set to TRUE; and/or
 - the IE "Reconfiguration" in the variable INTEGRITY_PROTECTION_INFO to be set to TRUE:

the UE shall:

- 1> abort the ongoing integrity and/or ciphering reconfiguration;

- 1> resume data transmission on any suspended radio bearer and signalling radio bearer mapped on RLC-AM or RLC-UM;
- 1> allow the transmission of RRC messages on all signalling radio bearers with any RRC SN;
- 1> when the CELL UPDATE message has been submitted to lower layers for transmission:
 - 2> if the SECURITY MODE COMMAND message contained the IE "Ciphering mode info":
 - 3> set the IE "Reconfiguration" in the variable CIPHERING_STATUS to FALSE; and
 - 3> clear the variable RB_UPLINK_CIPHERING_ACTIVATION_TIME_INFO;
 - 2> if the SECURITY MODE COMMAND message contained the IE "Integrity protection mode info":
 - 3> set the IE "Reconfiguration" in the variable INTEGRITY_PROTECTION_INFO to FALSE; and
 - 3> clear the variable INTEGRITY_PROTECTION_ACTIVATION_INFO.
 - 2> continue with any ongoing processes and procedures as if the SECURITY MODE COMMAND message has not been received;
 - 2> only accept a message on SRB 2, with a COUNT-I that:
 - 3> is higher than the COUNT-I used prior to receiving the SECURITY MODE COMMAND message incremented by one; and
 - 3> does not take into account the HFN from the received SECURITY MODE COMMAND message.
 - 2> if the UE has already submitted the SECURITY MODE COMPLETE message, use a COUNT-I value for transmission of the next message on SRB2 as stated below:
 - 3> take the COUNT-I used prior to the transmission of the SECURITY MODE COMPLETE message;
 - 3> increment that COUNT-I with 2;
 - 3> apply that COUNT-I on the next message to transmit.
 - 2> clear the variable SECURITY_MODIFICATION;
 - 2> the procedure ends.

8.1.12.4c Invalid configuration

If the variable INVALID_CONFIGURATION is set to TRUE due to the received SECURITY MODE COMMAND message, the UE shall:

- 1> transmit a SECURITY MODE FAILURE message on the DCCH using AM RLC after setting the IEs as specified below:
 - 2> set the IE "RRC transaction identifier" in the SECURITY MODE FAILURE message to the value of "RRC transaction identifier" in the entry for the SECURITY MODE COMMAND message in the table "Accepted transactions" in the variable TRANSACTIONS; and
 - 2> clear that entry;
 - 2> set the IE "failure cause" to the cause value "invalid configuration".
- 1> when the response message has been submitted to lower layers for transmission:
 - 2> set the variable INVALID_CONFIGURATION to FALSE;
 - 2> set the IE "Reconfiguration" in the variable CIPHERING_STATUS to FALSE;
 - 2> continue with any ongoing processes and procedures as if the invalid SECURITY MODE COMMAND message has not been received;

- 2> only accept a message on SRB 2, with a COUNT-I that:
 - 3> is higher than the COUNT-I used prior to receiving the SECURITY MODE COMMAND message incremented by one; and
 - 3> does not take into account the HFN from the received SECURITY MODE COMMAND message.
- 2> and the procedure ends.

8.1.12.5 Reception of SECURITY MODE COMPLETE message by the UTRAN

UTRAN should apply integrity protection on the received SECURITY MODE COMPLETE message and all subsequent messages with the new integrity protection configuration, if changed. When UTRAN has received a SECURITY MODE COMPLETE message and the integrity protection has successfully been applied, UTRAN should:

- 1> if the IE "Ciphering mode info" was included in the SECURITY MODE COMMAND message:
 - 2> if new keys were received for the CN domain set in the IE "CN Domain Identity" in the SECURITY MODE COMMAND:
 - 3> set, at the downlink and uplink activation time, all the bits of the hyper frame numbers of the downlink and uplink COUNT-C values respectively for all radio bearers for this CN domain and all signalling radio bearers to zero.
 - 2> else (if new keys were not received):
 - 3> use, at the downlink and uplink activation time, the value "START" in the most recently received IE "START list" or IE "START" that belongs to the CN domain as indicated in the IE "CN domain identity" to initialise all hyper frame numbers of the downlink and uplink COUNT-C values respectively for all the signalling radio bearers as follows:
 - 4> set the 20 most significant bits of the hyper frame numbers of the COUNT-C for all signalling radio bearers to the value "START" in the most recently received IE "START list" or IE "START" for that CN domain;
 - 4> set the remaining bits of the hyper frame numbers equal to zero.
- 1> if the IE "Integrity protection mode info" was included in the SECURITY MODE COMMAND message:
 - 2> if this was not the first SECURITY MODE COMMAND message for this RRC connection:
 - 3> if new keys have been received for the CN domain set in the IE "CN Domain Identity" included in the transmitted SECURITY MODE COMMAND message:
 - 4> initialise, at the downlink and uplink activation time, all hyper frame numbers of the downlink and uplink COUNT-I values respectively for all the signalling radio bearers other than RB2 as follows:
 - 5> set all bits of the hyper frame numbers of the uplink and downlink COUNT-I to zero.
 - 3> if no new keys have been received for the CN domain set in the IE "CN Domain Identity" included in the transmitted SECURITY MODE COMMAND message:
 - 4> use, at the downlink and uplink activation time, the value "START" in the most recently received IE "START list" or IE "START" that belongs to the CN domain as indicated in the IE "CN domain identity" to initialise all hyper frame numbers of the downlink and uplink COUNT-I values respectively for all the signalling radio bearers other than RB2 as follows:
 - 5> set the 20 most significant bits of the hyper frame numbers of the downlink and uplink COUNT-I respectively for all signalling radio bearers to the value "START" in the most recently received IE "START list" or IE "START" for that CN domain;
 - 5> set the remaining bits of the hyper frame numbers equal to zero.
- 1> send an indication to upper layers that the new security configuration has been activated;
- 1> resume, in the downlink, all suspended radio bearers and all signalling radio bearers;

- 1> allow the transmission of RRC messages on all signalling radio bearers with any RRC SN;
- 1> if the IE "Integrity protection mode command" included in the SECURITY MODE COMMAND had the value "Start":
 - 2> start applying integrity protection in the downlink for all signalling radio bearers.
- 1> if the IE "Integrity protection mode command" included in the SECURITY MODE COMMAND had the value "Modify":
 - 2> start applying the new integrity protection configuration in the downlink at the RRC sequence number, for each signalling radio bearers RBn, except for signalling radio bearer RB2, indicated by the entry for signalling radio bearer n in the "RRC message sequence number list" in the IE "Downlink integrity protection activation info";
 - 2> continue applying the new integrity configuration for signalling radio bearer RB2;
 - 2> apply the new integrity protection configuration on the received signalling messages with RRC SN greater than or equal to the number associated with the signalling radio bearer in IE "Uplink integrity protection activation info".
- 1> apply the old ciphering configuration for the transmission of RLC PDUs with RLC sequence number less than the number indicated in the IE "Radio bearer downlink ciphering activation time info" included in the IE "Ciphering mode info";
- 1> apply the new ciphering configuration for the transmission of RLC PDUs with RLC sequence number greater than or equal to the number indicated in IE "Radio bearer downlink ciphering activation time info" included in the IE "Ciphering mode info";
- 1> apply the old integrity protection configuration on the received signalling messages with RRC SN smaller than the number associated with the signalling radio bearer in IE "Uplink integrity protection activation info";
- 1> for radio bearers using RLC-AM or RLC-UM:
 - 2> use the old ciphering configuration for received RLC PDUs with RLC sequence number less than the RLC sequence number indicated in the IE "Radio bearer uplink ciphering activation time info" sent by the UE;
 - 2> use the new ciphering configuration for received RLC PDUs with RLC sequence number greater than or equal to the RLC sequence number indicated in the IE "Radio bearer uplink ciphering activation time info" sent by the UE;
 - 2> if an RLC reset or re-establishment of the transmitting side of an RLC entity occurs after the SECURITY MODE COMPLETE message has been received by UTRAN before the downlink activation time for the new ciphering configuration has been reached, ignore the activation time and apply the new ciphering configuration in downlink immediately after the RLC reset or RLC re-establishment;
 - 2> if an RLC reset or re-establishment of the receiving side of an RLC entity occurs after the SECURITY MODE COMPLETE message has been received by UTRAN before the uplink activation time for the new ciphering configuration has been reached, ignore the activation time and apply the new ciphering configuration in uplink immediately after the RLC reset or RLC re-establishment.
- 1> for radio bearers using RLC-TM:
 - 2> use the old ciphering configuration for the received RLC PDUs before the CFN as indicated in the IE "Ciphering activation time for DPCH" in the IE "Ciphering mode info" as included in the SECURITY MODE COMMAND;
 - 2> use the new ciphering configuration for the received RLC PDUs at the CFN as indicated in the IE "Ciphering activation time for DPCH" in the IE "Ciphering mode info" as included in the SECURITY MODE COMMAND.
- 1> and the procedure ends.

8.1.12.6 Invalid SECURITY MODE COMMAND message

If the SECURITY MODE COMMAND message contains a protocol error causing the variable PROTOCOL_ERROR_REJECT to be set to TRUE according to clause 9, the UE shall perform procedure specific error handling as follows:

- 1> transmit a SECURITY MODE FAILURE message on the uplink DCCH using AM RLC;
- 1> set the IE "RRC transaction identifier" in the SECURITY MODE FAILURE message to the value of "RRC transaction identifier" in the entry for the SECURITY MODE COMMAND message in the table "Rejected transactions" in the variable TRANSACTIONS; and
- 1> clear that entry;
- 1> set the IE "failure cause" to the cause value "protocol error";
- 1> include the IE "Protocol error information" with contents set to the value of the variable PROTOCOL_ERROR_INFORMATION;
- 1> when the response message has been submitted to lower layers for transmission:
 - 2> continue with any ongoing processes and procedures as if the invalid SECURITY MODE COMMAND message has not been received;
 - 2> only accept a message on SRB 2, with a COUNT-I that:
 - 3> is higher than the COUNT-I used prior to receiving the SECURITY MODE COMMAND message incremented by one; and
 - 3> does not take into account the HFN from the received SECURITY MODE COMMAND message.
 - 2> and the procedure ends.

8.1.13 Signalling connection release procedure

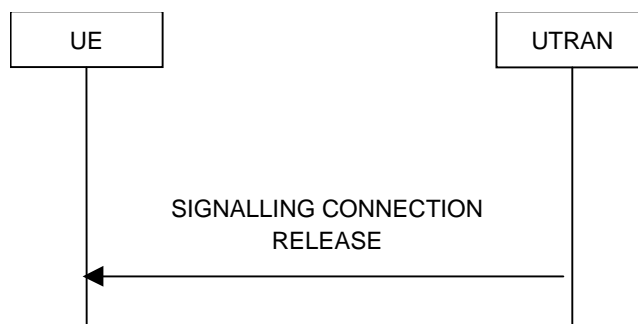

Figure 8.1.13-1: Signalling connection release procedure, normal case

8.1.13.1 General

The signalling connection release procedure is used to notify to the UE that one of its ongoing signalling connections has been released. The procedure does not initiate the release of the RRC connection.

8.1.13.2 Initiation of SIGNALLING CONNECTION RELEASE by the UTRAN

To initiate the procedure, the UTRAN transmits a SIGNALLING CONNECTION RELEASE message on DCCH using AM RLC.

8.1.13.3 Reception of SIGNALLING CONNECTION RELEASE by the UE

Upon reception of a SIGNALLING CONNECTION RELEASE message, the UE shall:

- 1> indicate the release of the signalling connection and pass the value of the IE "CN domain identity" to upper layers;
- 1> remove the signalling connection with the identity indicated by the IE "CN domain identity" from the variable ESTABLISHED_SIGNALLING_CONNECTIONS;
- 1> clear the entry for the SIGNALLING CONNECTION RELEASE message in the table "Accepted transactions" in the variable TRANSACTIONS;
- 1> the procedure ends.

8.1.13.4 Invalid SIGNALLING CONNECTION RELEASE message

If the UE receives a SIGNALLING CONNECTION RELEASE message, which contains a protocol error causing the variable PROTOCOL_ERROR_REJECT to be set to TRUE according to clause 9, the UE shall perform procedure specific error handling as follows:

- 1> include the IE "Identification of received message"; and
 - 2> set the IE "Received message type" to SIGNALLING CONNECTION RELEASE;
 - 2> set the IE "RRC transaction identifier" to the value of "RRC transaction identifier" in the entry for the SIGNALLING CONNECTION RELEASE message in the table "Rejected transactions" in the variable TRANSACTIONS; and
 - 2> clear that entry.
- 1> include the IE "Protocol error information" with contents set to the value of the variable PROTOCOL_ERROR_INFORMATION;
- 1> transmit an RRC STATUS message on the uplink DCCH using AM RLC
- 1> when the RRC STATUS message has been submitted to lower layers for transmission:
 - 2> continue with any ongoing processes and procedures as if the invalid SIGNALLING CONNECTION RELEASE message has not been received.

8.1.13.5 Invalid configuration

If radio access bearers for the CN domain indicated by the IE "CN domain identity" exist in the variable ESTABLISHED_RABS, the UE shall:

- 1> transmit an RRC STATUS message on the uplink DCCH using AM RLC;
- 1> include the IE "Identification of received message"; and
- 1> set the IE "Received message type" to SIGNALLING CONNECTION RELEASE; and
- 1> set the IE "RRC transaction identifier" to the value of "RRC transaction identifier" in the entry for the SIGNALLING CONNECTION RELEASE message in the table "Accepted transactions" in the variable TRANSACTIONS and clear that entry;
- 1> include the IE "Protocol error information" with contents set to the value "Message not compatible with receiver state";
- 1> when the RRC STATUS message has been submitted to lower layers for transmission:
 - 2> continue with any ongoing processes and procedures as if the invalid SIGNALLING CONNECTION RELEASE message has not been received.

8.1.14 Signalling connection release indication procedure

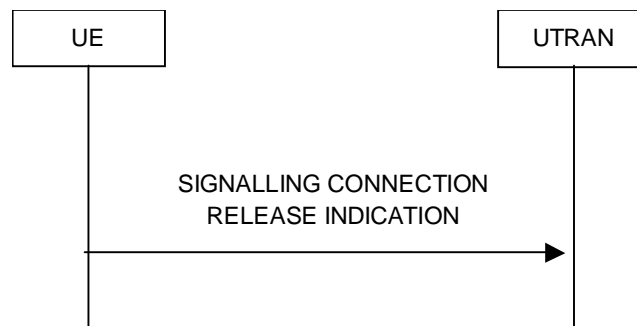

Figure 8.1.14-1: Signalling connection release indication procedure, normal case

8.1.14.1 General

The signalling connection release indication procedure is used by the UE to indicate to the UTRAN that one of its signalling connections has been released or it is used by the UE to request UTRAN to initiate a state transition to a battery efficient RRC state. The procedure may in turn initiate the RRC connection release procedure.

8.1.14.2 Initiation

The UE shall, on receiving a request to release (abort) the signalling connection from upper layers for a specific CN domain:

- 1> if a signalling connection in the variable ESTABLISHED_SIGNALLING_CONNECTIONS for the specific CN domain identified with the IE "CN domain identity" exists:
 - 2> initiate the signalling connection release indication procedure.
- 1> otherwise:
 - 2> abort any ongoing establishment of signalling connection for that specific CN domain as specified in 8.1.3.5a.

Upon initiation of the signalling connection release indication procedure in CELL_PCH or URA_PCH state, the UE shall:

- 1> if variable READY_FOR_COMMON_EDCH is set to TRUE:
 - 2> move to CELL_FACH state and continue with the signalling connection release indication procedure as below.
- 1> else:
 - 2> if variable HSPA_RNTI_STORED_CELL_PCH is set to TRUE:
 - 3> move to CELL_FACH state and continue with the signalling connection release indication procedure as below.
 - 2> else:
 - 3> if variable H_RNTI and variable C_RNTI are set:
 - 4> continue with the signalling connection release indication procedure as below.
 - 3> else:
 - 4> perform a cell update procedure, according to subclause 8.3.1, using the cause "uplink data transmission";
 - 4> when the cell update procedure completed successfully:

5> continue with the signalling connection release indication procedure as below.

The UE shall:

- 1> set the IE "CN Domain Identity" to the value indicated by the upper layers. The value of the IE indicates the CN domain whose associated signalling connection the upper layers are indicating to be released;
- 1> if the UE includes the IE "Signalling Connection Release Indication Cause" and does not set it to "UE Requested PS Data session end";
 - 2> set the IE "Signalling Connection Release Indication Cause" to "any other cause";
- 1> transmit a SIGNALLING CONNECTION RELEASE INDICATION message on DCCH using AM RLC;
- 1> if the SIGNALLING CONNECTION RELEASE INDICATION message did not include the IE "Signalling Connection Release Indication Cause" set to "UE Requested PS Data session end":
 - 2> remove the signalling connection with the identity indicated by upper layers from the variable ESTABLISHED_SIGNALLING_CONNECTIONS.

When the successful delivery of the SIGNALLING CONNECTION RELEASE INDICATION message has been confirmed by RLC the procedure ends.

In addition, if the timer T323 value is stored in the IE "UE Timers and constants in connected mode" in the variable TIMERS_AND_CONSTANTS, and if there is no CS domain connection indicated in the variable ESTABLISHED_SIGNALLING_CONNECTIONS, the UE may:

- 1> if the upper layers indicate that there is no more PS data for a prolonged period:
 - 2> if timer T323 is not running:
 - 3> if the UE is in CELL_DCH state or CELL_FACH state; or
 - 3> if the UE is in CELL_PCH state or URA_PCH state and the DRX cycle length in use is shorter than the shorter CN domain specific DRX cycle length for the PS domain and CS domain; or
 - 3> if the UE is in CELL_PCH state or URA_PCH state and the DRX cycle length in use is equal to or longer than the shorter CN domain specific DRX cycle length for the PS domain and CS domain, and $V316 < 1$:
 - 4> if the UE is in CELL_PCH state or URA_PCH state and the DRX cycle length in use is equal to or longer than the shorter CN domain specific DRX cycle length for the PS domain and CS domain:
 - 5> increment V316 by 1.
 - 4> set the IE "CN Domain Identity" to PS domain;
 - 4> set the IE "Signalling Connection Release Indication Cause" to "UE Requested PS Data session end";
 - 4> transmit a SIGNALLING CONNECTION RELEASE INDICATION message on DCCH using AM RLC;
 - 4> start the timer T323;
- 3> the procedure ends.

The UE shall be inhibited from sending the SIGNALLING CONNECTION RELEASE INDICATION message with the IE "Signalling Connection Release Indication Cause" set to "UE Requested PS Data session end" whilst timer T323 is running.

The UE shall not locally release the PS signalling connection after it has sent the SIGNALLING CONNECTION RELEASE INDICATION message with the IE "Signalling Connection Release Indication Cause" set to "UE Requested PS Data session end".

At transmission or reception of PS data or signalling on SRB3 or upwards, or entering RRC Connected mode, or successful SRNS relocation, the UE shall set V316 to zero.

8.1.14.2a RLC re-establishment or inter-RAT change

If a re-establishment of the transmitting side of the RLC entity on signalling radio bearer RB2 occurs before the successful delivery of the SIGNALLING CONNECTION RELEASE INDICATION message, without the IE "Signalling Connection Release Indication Cause" or with the IE "Signalling Connection Release Indication Cause" set to a value other than "UE Requested PS Data session end", has been confirmed by RLC, the UE shall:

- 1> retransmit the SIGNALLING CONNECTION RELEASE INDICATION message on the uplink DCCH using AM RLC on signalling radio bearer RB2.

If an Inter-RAT handover from UTRAN procedure occurs before the successful delivery of the SIGNALLING CONNECTION RELEASE INDICATION message without the IE "Signalling Connection Release Indication Cause" or with the IE "Signalling Connection Release Indication Cause" set to a value other than "UE Requested PS Data session end", has been confirmed by RLC, the UE shall:

- 1> abort the signalling connection while in the new RAT.

8.1.14.3 Reception of SIGNALLING CONNECTION RELEASE INDICATION by the UTRAN

Upon reception of a SIGNALLING CONNECTION RELEASE INDICATION message, if the IE "Signalling Connection Release Indication Cause" is not included or the IE "Signalling Connection Release Indication Cause" is set to "any other cause", the UTRAN requests the release of the signalling connection from upper layers. Upper layers may then initiate the release of the signalling connection.

If the IE "Signalling Connection Release Indication Cause" is set to "UE Requested PS Data session end" in the SIGNALLING CONNECTION RELEASE INDICATION message the UTRAN may initiate a state transition to an efficient battery consumption RRC state such as IDLE, CELL_PCH, URA_PCH or CELL_FACH state.

8.1.14.4 Expiry of timer T323

When timer T323 expires:

- 1> the UE may determine whether any subsequent indications from upper layers that there is no more PS data for a prolonged period in which case it triggers the transmission of a single SIGNALLING CONNECTION RELEASE INDICATION message according with clause 8.1.14.2;
- 1> the procedure ends.

NOTE: If the UE is in CELL_PCH state or URA_PCH state and the DRX cycle length in use is shorter than the shorter of the CN domain specific DRX cycle lengths for the PS domain and CS domain the UE should limit the number of subsequent SIGNALLING CONNECTION RELEASE INDICATION messages with IE "Signalling Connection Release Indication Cause" set to "UE Requested PS Data session end" in order to not adversely impact the battery lifetime or network signalling load.

8.1.15 Counter check procedure

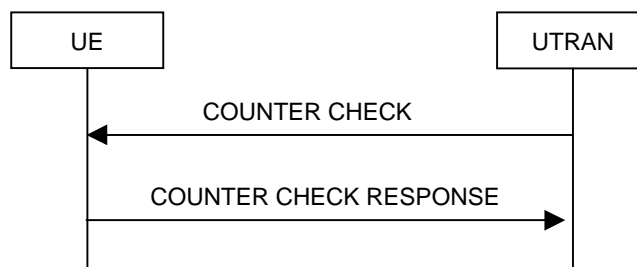

Figure 8.1.15-1: Counter check procedure

8.1.15.1 General

The counter check procedure is used by the UTRAN to perform a local authentication. The purpose of the procedure is to check that the amount of data sent in both directions (uplink and downlink) over the duration of the RRC connection is identical at the UTRAN and at the UE (to detect a possible intruder – a 'man-in-the-middle' – from operating).

This procedure is only applicable to radio bearers, and only to radio bearers using RLC-AM or RLC-UM. It should be noted that this requires that the COUNT-C values for each UL and DL radio bearers using RLC-AM or RLC-UM continue to be incremented even if ciphering is not used. This procedure is not applicable to signalling radio bearers.

8.1.15.2 Initiation

The UTRAN monitors the COUNT-C value associated with each radio bearer using UM or AM RLC. The procedure is triggered whenever any of these values reaches a critical checking value. The granularity of these checking values and the values themselves are defined to the UTRAN by the visited network. The UTRAN initiates the procedure by sending a COUNTER CHECK message on the downlink DCCH.

8.1.15.3 Reception of a COUNTER CHECK message by the UE

When the UE receives a COUNTER CHECK message it shall compare the COUNT-C MSB values received in the IE "RB COUNT-C MSB information" in the COUNTER CHECK message to the COUNT-C MSB values of the corresponding radio bearers.

The UE shall:

- 1> set the IE "RRC transaction identifier" in the COUNTER CHECK RESPONSE message to the value of "RRC transaction identifier" in the entry for the COUNTER CHECK message in the table "Accepted transactions" in the variable TRANSACTIONS; and
- 1> clear that entry.

If:

- there is one or more radio bearer(s) using UM or AM RLC mode stored in the variable ESTABLISHED_RABS, which is (are) not included in the IE "RB COUNT-C MSB information"; or
- there is one or more radio bearer(s) included in the IE "RB COUNT-C MSB information", which is (are) not stored in the variable ESTABLISHED_RABS; or
- for any radio bearer (excluding signalling radio bearers) using UM or AM RLC mode stored in the variable ESTABLISHED_RABS and included in the IE "RB COUNT-C MSB information" with COUNT-C MSB values different from the MSB part of the COUNT-C values in the UE:

the UE shall:

- 1> include these radio bearers in the IE "RB COUNT-C information" in the COUNTER CHECK RESPONSE message. For any RB which is included in the IE "RB COUNT-C MSB information" in the COUNTER CHECK message but not stored in the variable ESTABLISHED_RABS in the UE, the MSB part of COUNT-C values in the COUNTER CHECK RESPONSE message shall be set identical to COUNT-C-MSB values in the COUNTER CHECK message. The LSB part shall be filled with zeroes.

The UE shall:

- 1> if no COUNT-C exists for a radio bearer for a given direction (uplink or downlink) because:
 - 2> it is a uni-directional radio bearer configured only for the other direction (downlink or uplink respectively); or
 - 2> it has been configured to RLC-TM mode in one direction (uplink or downlink) and RLC-UM in the other (downlink or uplink respectively):
- 3> set the COUNT-C in the IE "RB COUNT-C information" in the COUNTER CHECK RESPONSE message, to any value.

- 1> submit a COUNTER CHECK RESPONSE message to lower layers for transmission on the uplink DCCH using AM RLC.

When the COUNTER CHECK RESPONSE message has been submitted to lower layers for transmission the procedure ends.

8.1.15.4 Reception of the COUNTER CHECK RESPONSE message by UTRAN

If the UTRAN receives a COUNTER CHECK RESPONSE message that does not contain any COUNT-C values, the procedure ends.

If the UTRAN receives a COUNTER CHECK RESPONSE message that contains one or several COUNT-C values the UTRAN may release the RRC connection.

8.1.15.5 Cell re-selection

If the UE performs cell re-selection anytime during this procedure it shall, without interrupting the procedure:

- 1> initiate the cell update procedure according to subclause 8.3.1.

8.1.15.6 Invalid COUNTER CHECK message

If the UE receives a COUNTER CHECK message, which contains a protocol error causing the variable `PROTOCOL_ERROR_REJECT` to be set to `TRUE` according to clause 9, the UE shall perform procedure specific error handling as follows. The UE shall:

- 1> transmit an RRC STATUS message on the uplink DCCH using AM RLC;
- 1> include the IE "Identification of received message"; and
- 1> set the IE "Received message type" to COUNTER CHECK; and
- 1> set the IE "RRC transaction identifier" to the value of "RRC transaction identifier" in the entry for the UE COUNTER CHECK message in the table "Rejected transactions" in the variable `TRANSACTIONS`; and
- 1> clear that entry;
- 1> include the IE "Protocol error information" with contents set to the value of the variable `PROTOCOL_ERROR_INFORMATION`;
- 1> when the RRC STATUS message has been submitted to lower layers for transmission:
 - 2> continue with any ongoing processes and procedures as if the invalid COUNTER CHECK message has not been received.

8.1.16 Inter RAT handover information transfer



Figure 8.1.16-1: Inter RAT handover information transfer, normal flow

8.1.16.1 General

The inter RAT handover information transfer procedure is used by the UE to convey RRC information needed for inter RAT handover to UTRAN.

8.1.16.2 Initiation

If:

- a radio access technology other than UTRA, e.g. GSM or E-UTRA, using radio access technology-specific procedures, orders the UE to provide the INTER RAT HANDOVER INFO message; or
- a radio access technology other than UTRA, e.g. GSM or E-UTRA, using radio access technology-specific procedures, configures the UE to send the INTER RAT HANDOVER INFO message upon system specific conditions not involving an explicit order e.g. early classmark sending upon entering connected mode; or
- while in connected mode using another radio access technology, the inter RAT handover info changes compared to what has previously been sent via the other radio access technology:

the UE shall:

- 1> initiate the inter RAT handover information transfer procedure.

To determine if the inter RAT handover info has changed compared to what has previously been sent, the UE shall:

- 1> store the information last sent in the variable INTER_RAT_HANDOVER_INFO_TRANSFERRED;
- 1> if this variable has not yet been set:
 - 2> not initiate the inter RAT handover information transfer procedure due to change of inter RAT handover info.

NOTE: Currently neither the UE security information nor the predefined configuration status information change while in connected mode using GSM radio access technology.

8.1.16.3 INTER RAT HANDOVER INFO message contents to set

The UE shall:

- 1> include the IE "UE security information", and the IE "UE security information2" if inter-RAT PS handover is supported by the UE; and
- 1> not include the IE "UE Specific Behaviour Information 1 interRAT";
- 1> in case support for the compressed version of the inter RAT handover info is indicated via the other radio access technology:
 - 2> if the other radio access technology is not E-UTRA:
 - 3> include of the following IEs the IE that after encoding has the smallest size: IE "Predefined configuration status information compressed" or the IE "Predefined configuration status information".
 - 2> else:
 - 3> exclude the IE "Predefined configuration status information" and "Predefined configuration status information compressed".
 - 2> include the IE "UE radio access capability compressed".
- 1> else:
 - 2> if the other radio access technology is not E-UTRA:
 - 3> include the IE "Predefined configuration status information".
 - 2> else:

- 3> exclude the IE "Predefined configuration status information".
- 2> include the IE "UE capability container", containing the IE "UE radio access capability" and the IE "UE radio access capability extension", in accordance with the following:
 - 3> if the UE supports multiple UTRA FDD Frequency Bands; or
 - 3> if the UE supports a single UTRA FDD Frequency Band different from Band I [21]; or
 - 3> if the UE supports E-UTRA:
 - 4> include the IE "UE radio access capability", excluding IEs "RF capability FDD" and "Measurement capability" for FDD and including the IE "Measurement capability TDD" for TDD;
 - 4> include the IE "UE radio access capability extension", including the IEs "RF capability FDD extension" and the "Measurement capability extension" associated with each supported UTRA FDD frequency band indicated in the IE "Frequency band", but may omit all or part of these IEs for supported inter-RAT bands.
 - 3> else:
 - 4> include the IE "UE radio access capability", including the IEs "RF capability FDD" and "Measurement capability" associated with the Band I [21] for FDD and excluding the IE "Measurement capability TDD" for TDD;
 - 4> include the IE "UE radio access capability extension", including the IEs "RF capability FDD extension" and the "Measurement capability extension" associated with each supported UTRA FDD frequency band indicated in the IE "Frequency band".
- 1> For FDD, include the IE "UE radio access capability comp 2";
- 1> For 1.28 Mcps TDD, include the IE "UE radio access capability comp for 1.28 Mcps TDD";
- 1> initiate the transfer of the INTER RAT HANDOVER INFO message via the other radio access technology, using radio access technology-specific procedures;
- 1> store the following in the variable INTER_RAT_HANDOVER_INFO_TRANSFERRED if they were included in the INTER RAT HANDOVER INFO message:
 - 2> the IE "Predefined configuration status information";
 - 2> the IE "Predefined configuration status information compressed";
 - 2> the IE "UE security information";
 - 2> the IE "UE security information2";
 - 2> the IE "UE radio access capability";
 - 2> the IE "UE radio access capability extension"; and
 - 2> the IE "UE radio access capability compressed";
 - 2> if the IE "UE radio access capability compressed" were included in the INTER RAT HANDOVER INFO message:
 - 3> set the IE "Security Capability" to the mandatory R99 algorithms.
- 1> and the procedure ends.

8.1.17 ETWS primary notification with security procedure

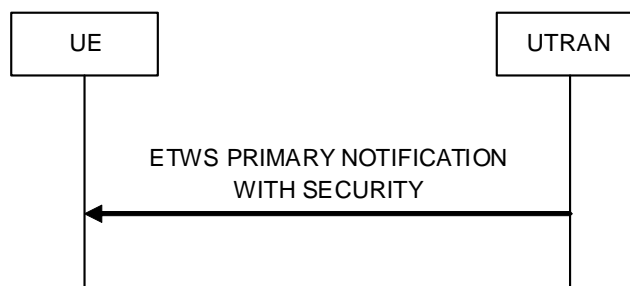

Figure 8.1.17-1: ETWS primary notification with security

8.1.17.1 General

The ETWS primary notification with security procedure is used to transfer an ETWS primary notification to the UE. The ETWS PRIMARY NOTIFICATION WITH SECURITY message is received via the dedicated control channel (DCCH).

The UE may receive the ETWS PRIMARY NOTIFICATION WITH SECURITY message via DCCH, when the UE is in a state where it is configured to receive DCCH. The UTRAN may use this option to send an ETWS primary notification to the UE when RRC is configured from upper layers to receive the ETWS primary notification. The UE behaviour is specified in subclause 8.1.17.4.

8.1.17.2 Initiation

The UTRAN may initiate the ETWS primary notification with security procedure towards UEs in connected mode CELL_DCH state by sending the ETWS PRIMARY NOTIFICATION WITH SECURITY message on DCCH using UM or AM RLC.

8.1.17.3 Void

8.1.17.4 Reception of the ETWS PRIMARY NOTIFICATION WITH SECURITY message

If the UE receives the ETWS PRIMARY NOTIFICATION WITH SECURITY message on DCCH, the ETWS capable UE shall:

- 1> forward the ETWS primary notification to upper layers as specified in subclause 8.1.17.5.

If the UE receives the ETWS PRIMARY NOTIFICATION WITH SECURITY message, an ETWS incapable UE shall ignore this message.

8.1.17.5 Forward of the ETWS primary notification to the upper layers

If the UE has received the ETWS PRIMARY NOTIFICATION WITH SECURITY message on DCCH, the ETWS capable UE shall:

- 1> forward the content of the IE "ETWS information" received in the ETWS PRIMARY NOTIFICATION WITH SECURITY message to upper layers.

8.1.17.6 Void

8.2 Radio Bearer control procedures

8.2.1 Radio bearer establishment

See subclause 8.2.2 Reconfiguration procedures.

8.2.2 Reconfiguration procedures

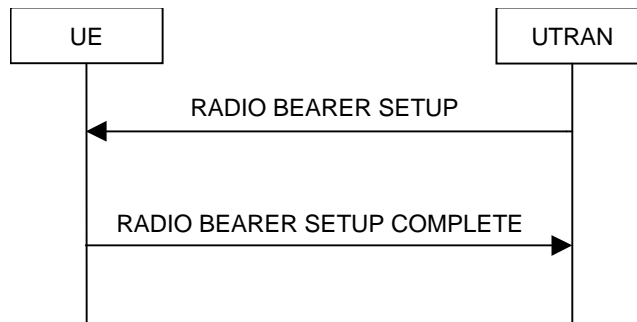

Figure 8.2.2-1: Radio Bearer Establishment, normal case

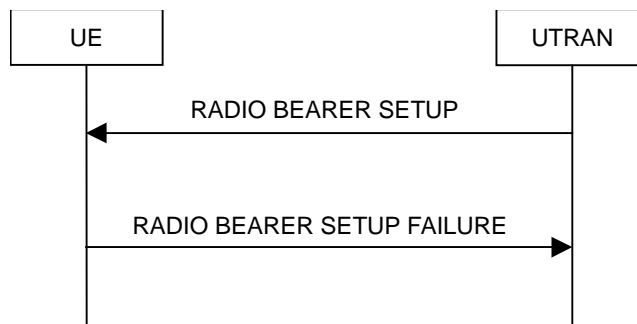

Figure 8.2.2-2: Radio Bearer Establishment, failure case

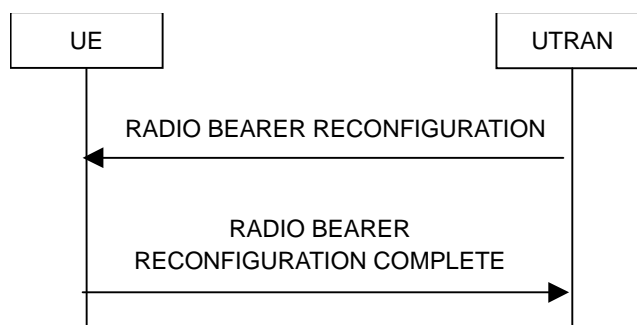

Figure 8.2.2-3: Radio bearer reconfiguration, normal flow

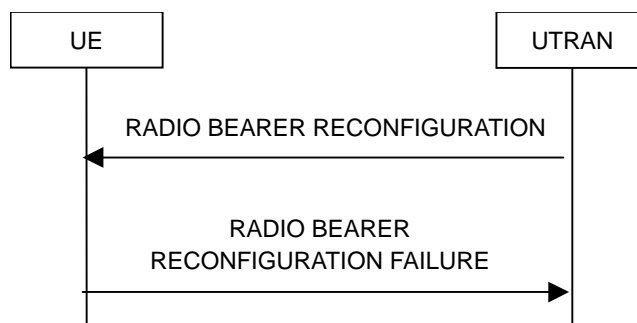

Figure 8.2.2-4: Radio bearer reconfiguration, failure case

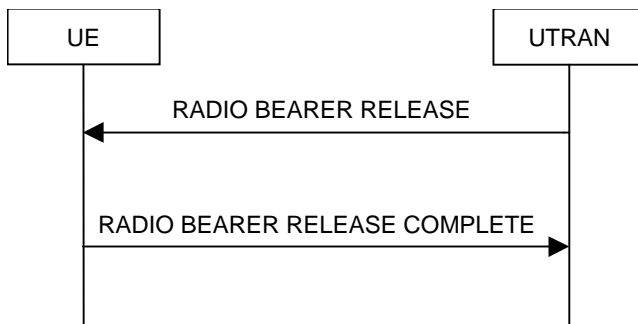

Figure 8.2.2-5: Radio Bearer Release, normal case

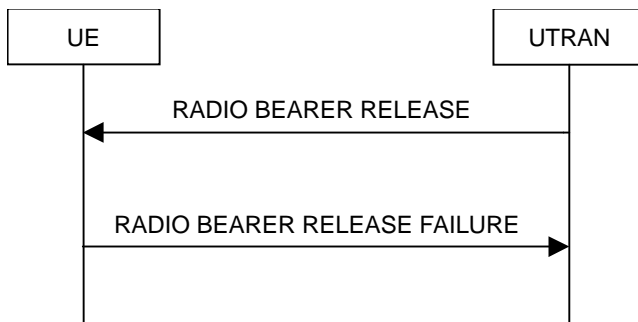

Figure 8.2.2-6: Radio Bearer Release, failure case

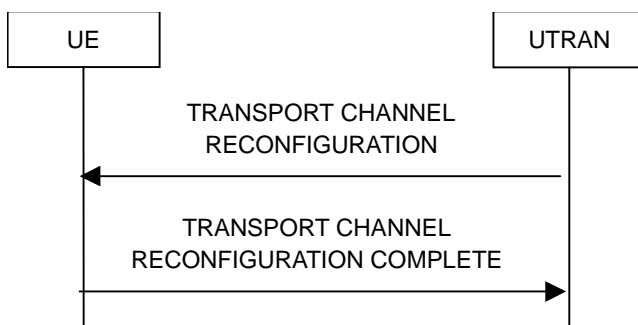

Figure 8.2.2-7: Transport channel reconfiguration, normal flow

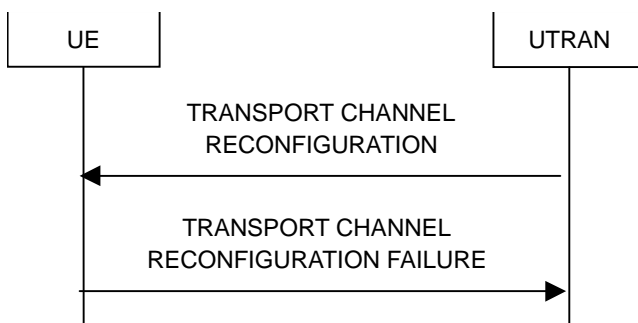

Figure 8.2.2-8: Transport channel reconfiguration, failure case

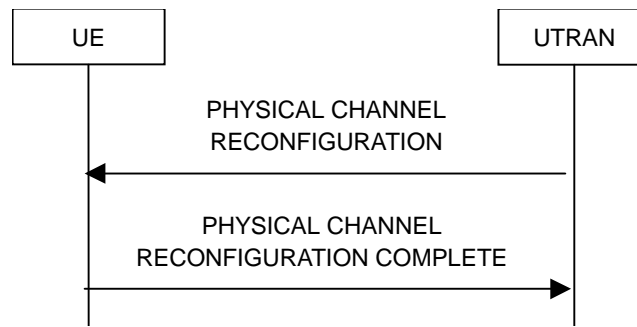

Figure 8.2.2-9: Physical channel reconfiguration, normal flow

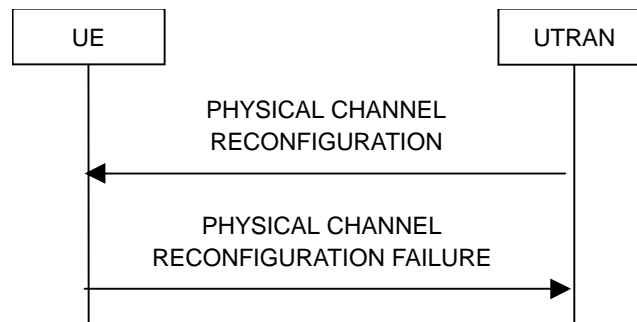

Figure 8.2.2-10: Physical channel reconfiguration, failure case

8.2.2.1 General

Reconfiguration procedures include the following procedures:

- the radio bearer establishment procedure;
- radio bearer reconfiguration procedure;
- the radio bearer release procedure;
- the transport channel reconfiguration procedure; and
- the physical channel reconfiguration procedure.

The radio bearer establishment procedure is used to establish new radio bearer(s).

The radio bearer reconfiguration procedure is used to reconfigure parameters for a radio bearer.

The radio bearer release procedure is used to release radio bearer(s).

The transport channel reconfiguration procedure is used to reconfigure transport channel parameters.

The physical channel reconfiguration procedure is used to establish, reconfigure and release physical channels.

While performing any of the above procedures, these procedures may perform a hard handover (subclause 8.3.5) and/or an HS-DSCH cell change and/or a serving E-DCH cell change. The reconfiguration procedures are also used to change the feedback configuration for HS-DSCH.

8.2.2.2 Initiation

To initiate any one of the reconfiguration procedures, UTRAN should:

- 1> configure new radio links in any new physical channel configuration;
- 1> start transmission and reception on the new radio links;
- 1> for a radio bearer establishment procedure:

- 2> transmit a RADIO BEARER SETUP message on the downlink DCCH using AM or UM RLC;
- 2> if signalling radio bearer RB4 is setup with this procedure and signalling radio bearers RB1-RB3 were already established prior to the procedure:
 - 3> if the variable "LATEST_CONFIGURED_CN_DOMAIN" has been initialised:
 - 4> connect any radio bearers setup by the same message as signalling radio bearer RB4 to the CN domain indicated in the variable "LATEST_CONFIGURED_CN_DOMAIN".
- 1> for a radio bearer reconfiguration procedure:
 - 2> transmit a RADIO BEARER RECONFIGURATION message on the downlink DCCH using AM or UM RLC.
- 1> for a radio bearer release procedure:
 - 2> transmit a RADIO BEARER RELEASE message on the downlink DCCH using AM or UM RLC.
- 1> for a transport channel reconfiguration procedure:
 - 2> transmit a TRANSPORT CHANNEL RECONFIGURATION message on the downlink DCCH using AM or UM RLC.
- 1> for a physical channel reconfiguration procedure:
 - 2> transmit a PHYSICAL CHANNEL RECONFIGURATION message on the downlink DCCH using AM or UM RLC.
- 1> if the reconfiguration procedure is simultaneous with SRNS relocation procedure:
 - 2> if the transmitted message is a RADIO BEARER RECONFIGURATION:
 - 3> include the IE "New U-RNTI".
 - 2> else:
 - 3> include the IE "Downlink counter synchronisation info".
 - 2> if ciphering and/or integrity protection are activated:
 - 3> include new ciphering and/or integrity protection configuration information to be used after reconfiguration.
 - 2> use the downlink DCCH using AM RLC.
- 1> if transport channels are added, reconfigured or deleted in uplink and/or downlink:
 - 2> set TFCS according to the new transport channel(s).
- 1> if transport channels are added or deleted in uplink and/or downlink, and RB Mapping Info applicable to the new configuration has not been previously provided to the UE, the UTRAN should:
 - 2> send the RB Mapping Info for the new configuration.

In the Radio Bearer Reconfiguration procedure UTRAN may indicate that uplink transmission shall be stopped or continued on certain radio bearers. Uplink transmission on a signalling radio bearer used by the RRC signalling (signalling radio bearer RB1 or signalling radio bearer RB2) should not be stopped.

NOTE 1: The Release '99 RADIO BEARER RECONFIGURATION message always includes the IE "RB information to reconfigure", even if UTRAN does not require the reconfiguration of any RB. In these cases, UTRAN may include only the IE "RB identity" within the IE "RB information to reconfigure".

NOTE 2: The Release '99 RADIO BEARER RECONFIGURATION message always includes the IE "Downlink information per radio link list", even if UTRAN does not require the reconfiguration of any RL. In these cases, UTRAN may re-send the currently assigned values for the mandatory IEs included within the IE "Downlink information per radio link list".

NOTE 3: The Release '99 RADIO BEARER RECONFIGURATION message always includes the IE "Primary CPICH Info" (FDD) or IE "Primary CCPCH Info" (TDD) within IE "Downlink information per radio link list". This implies that in case UTRAN applies the RADIO BEARER RECONFIGURATION message to move the UE to CELL_FACH state, it has to indicate a cell. However, UTRAN may indicate any cell; the UE anyhow performs cell selection and notifies UTRAN if it selects another cell than indicated by UTRAN.

If the IE "Activation Time" is included, UTRAN should set it to a value taking the UE performance requirements into account.

UTRAN should take the UE capabilities into account when setting the new configuration.

If the message is used to initiate a transition from CELL_DCH to CELL_FACH state, the UTRAN may assign a C-RNTI to be used in that cell by the UE. In FDD and 1.28 Mcps TDD, if a C-RNTI is assigned, then UTRAN may additionally assign an H-RNTI and an E-RNTI to be used in that cell by the UE.

For FDD and 1.28 Mcps TDD, if the message is used to initiate a transition to CELL_PCH state, the UTRAN may assign a C-RNTI, an H-RNTI and an E-RNTI to be used in that cell by the UE.

8.2.2.2a Initiation of handover from GERAN *Iu mode*

To initiate the handover from GERAN *Iu mode*, UTRAN should:

- 1> provide a RADIO BEARER RECONFIGURATION message to be encapsulated in INTERSYSTEM HANDOVER TO UTRAN COMMAND message, sent on the downlink SRB2 in GERAN *Iu mode*, as specified in [53].
- 1> in case UTRAN decides to use a predefined or default radio configuration that is stored in the UE, it should include the following information in the RADIO BEARER RECONFIGURATION message:
 - PhyCH information elements; and
 - either:
 - the IE "Predefined configuration identity", to indicate which pre-defined configuration of RB, transport channel and physical channel parameters shall be used; or
 - the IE "Default configuration mode" and IE "Default configuration identity", to indicate which default configuration of RB, transport channel and physical channel parameters shall be used.

8.2.2.3 Reception of RADIO BEARER SETUP or RADIO BEARER RECONFIGURATION or RADIO BEARER RELEASE or TRANSPORT CHANNEL RECONFIGURATION or PHYSICAL CHANNEL RECONFIGURATION message or Target cell HS-SCCH order by the UE

The UE shall:

- 1> be able to receive any of the following messages:
 - 2> RADIO BEARER SETUP message; or
 - 2> RADIO BEARER RECONFIGURATION message; or
 - 2> RADIO BEARER RELEASE message; or
 - 2> TRANSPORT CHANNEL RECONFIGURATION message; or
 - 2> PHYSICAL CHANNEL RECONFIGURATION message;
- 1> be able to perform a hard handover and apply physical layer synchronisation procedure A as specified in [29], even if no prior UE measurements have been performed on the target cell and/or frequency.

For FDD: in case a measurement report was triggered by intra frequency event 1d and if the table "Target cell preconfigurations" in the variable TARGET_CELL_PRECONFIGURATION includes the cell that triggered the event the UE shall be able to receive:

- 1> Target cell HS-SCCH order.

In case the reconfiguration procedure is used to remove all existing RL(s) in the active set while new RL(s) are established the UE shall:

- 1> For FDD:
 - 2> if the UE has a pending "TGPS reconfiguration CFN" at the activation time received in the reconfiguration message and the reconfiguration requests a timing re-initialised hard handover (see subclause 8.3.5.1), the UE may:
 - 3> abort the pending CM activation;
 - 3> set the CM_PATTERN_ACTIVATION_ABORTED to TRUE.
 - 2> otherwise:
 - 3> set the CM_PATTERN_ACTIVATION_ABORTED to FALSE.

If the UE receives:

- a RADIO BEARER SETUP message; or
- a RADIO BEARER RECONFIGURATION message; or
- a RADIO BEARER RELEASE message; or
- a TRANSPORT CHANNEL RECONFIGURATION message; or
- a PHYSICAL CHANNEL RECONFIGURATION message; or
- a Target cell HS-SCCH order

it shall:

- 1> stop and reset timer T324 if running;
- 1> stop monitoring target cell HS-SCCH;
- 1> set the variable ORDERED_RECONFIGURATION to TRUE;
- 1> if the UE will enter the CELL_DCH state from any state other than CELL_DCH state at the conclusion of this procedure:
 - 2> if COMMON_E_DCH_TRANSMISSION is set to FALSE before entering CELL_DCH state or IE "E-DCH info" is not included in the reconfiguration message:
 - 3> perform the physical layer synchronisation procedure A as specified in [29] (FDD only).
- 1> if the UE has received a Target cell HS-SCCH order:
 - 2> if the IE "Serving Cell Change MAC reset" in the target cell preconfiguration is set to TRUE:
 - 3> reset the MAC-hs/ehs entity [15].
 - 2> else:
 - 3> determine the value for the "TPC combination index" for current cell and the cell in which the Target cell HS-SCCH order is received;
 - 3> if the values of the IE "TPC combination index" for current cell and the cell in which the Target cell HS-SCCH order is received are different:
 - 4> reset the MAC-hs/ehs entity [15].

- 1> act upon all received information elements, or Target cell preconfiguration information in the case of received Target cell HS-SCCH order, as specified in subclause 8.6, unless specified in the following and perform the actions below.

The UE may:

- 1> maintain a list of the set of cells to which the UE has Radio Links if the IE "Cell ID" is present.

The UE may first release the physical channel configuration used at reception of the reconfiguration message. The UE shall then:

- 1> enter a state according to subclause 8.6.3.3.

In case the UE receives a RADIO BEARER RECONFIGURATION message including the IE "RB information to reconfigure" that only includes the IE "RB identity", the UE shall:

- 1> handle the message as if IE "RB information to reconfigure" was absent.

NOTE: The ASN.1 "r3" version of the RADIO BEARER RECONFIGURATION message always includes the IE "RB information to reconfigure". UTRAN has to include it even if it does not require the reconfiguration of any RB.

In case the UE receives a RADIO BEARER RECONFIGURATION message with the IE "Specification mode" set to "Preconfiguration" while the message is not sent through GERAN *Iu mode*, the UE behaviour is unspecified.

In case the UE receives a RADIO BEARER SETUP message with the IE "Specification mode" not set to "Complete Specification", the UE behaviour is unspecified.

For FDD: in CELL_DCH state, in case the UE receives a Target cell HS-SCCH order the UE shall:

- 1> ignore RADIO BEARER SETUP, RADIO BEARER RECONFIGURATION, TRANSPORT CHANNEL RECONFIGURATION or PHYSICAL CHANNEL RECONFIGURATION messages as described in subclause 8.6.3.11.

If after state transition the UE enters CELL_DCH state, the UE shall, after the state transition:

- 1> in FDD; or

- 1> in TDD when "Primary CCPCH Info" is included indicating a new target cell and "New C-RNTI" is not specified:

- 2> remove any C-RNTI from MAC;

- 2> clear the variable C_RNTI.

- 1> determine the value for the READY_FOR_COMMON_EDCH variable and take the corresponding actions as described in subclause 8.5.47;

- 1> determine the value for the COMMON_E_DCH_TRANSMISSION variable and take the corresponding actions as described in subclause 8.5.46;

- 1> if the IE "E-DCH info" was not included in the message:

- 2> for FDD:

- 3> stop any E-AGCH, E-RGCH and E-HICH reception procedures;

- 3> stop any E-DPCCH and E-DPDCH transmission procedures;

- 3> act as if the IE "MAC-es/e reset indicator" was received and set to TRUE;

- 3> release all E-DCH HARQ resources;

- 3> no longer consider any radio link to be the serving E-DCH radio link.

- 2> for 1.28 Mcps TDD:

- 3> stop any E-AGCH and E-HICH reception procedures;
- 3> stop any E-RUCCH and E-PUCH transmission procedure;
- 3> act as if the IE "MAC-es/e reset indicator" was received and set to TRUE;
- 3> release all E-DCH HARQ resources;
- 3> no longer consider any radio link to be the serving E-DCH radio link.

If after state transition the UE leaves CELL_DCH state, the UE shall, before state transition:

- 1> clear any stored IE "E-DCH info";
- 1> determine the value for the E_DCH_TRANSMISSION variable and take the corresponding actions as described in subclause 8.5.28.

If after state transition the UE leaves CELL_DCH state, the UE shall, after the state transition:

- 1> if any IEs related to HS-DSCH are stored in the UE:
 - 2> clear any stored IE "Downlink HS-PDSCH information";
 - 2> clear any stored IE "Downlink Secondary Cell Info FDD";
 - 2> clear all the entries from the variable TARGET_CELL_PRECONFIGURATION;
 - 2> for 1.28Mcps TDD, clear the IE "HS-PDSCH Midamble Configuration" and the IE "HS-SCCH Set Configuration" in the IE "DL Multi Carrier Information";
 - 2> determine the value for the HS_DSCH_RECEPTION variable and take the corresponding actions as described in subclause 8.5.25.
- 1> if any IEs related to E-DCH are stored in the UE:
 - 2> clear any stored IE "E-DCH info";
 - 2> determine the value for the E_DCH_TRANSMISSION variable and take the corresponding actions as described in subclause 8.5.28.
- 1> if any of the IEs "DTX-DRX timing information" or "DTX-DRX information" are stored in the UE:
 - 2> determine the value for the DTX_DRX_STATUS variable and take the corresponding actions as described in subclause 8.5.34.
- 1> if the IE "HS-SCCH less information" is stored in the UE:
 - 2> determine the value for the HS_SCCH_LESS_STATUS variable and take the corresponding actions as described in subclause 8.5.35.
- 1> if any IEs related to MIMO are stored in the UE:
 - 2> determine the value for the MIMO_STATUS variable and take the corresponding actions as described in subclause 8.5.33.
- 1> if the IE "UE Mobility State Indicator" was present in the reconfiguration message:
 - 2> consider the High-mobility state to have being detected.
- 1> for 1.28 Mcps TDD, if the IEs "Control Channel DRX Information" is stored in the UE:
 - 2> determine the value for the CONTROL_CHANNEL_DRX_STATUS variable and take the corresponding actions as described in subclause 8.5.53.
- 1> for 1.28 Mcps TDD, if the IE "SPS information" is stored in the UE:
 - 2> determine the value for the E_DCH_SPS_STATUS variable and take the corresponding actions as described in subclause 8.5.54;

- 2> determine the value for the HS_DSCH_SPS_STATUS variable and take the corresponding actions as described in subclause 8.5.55.

If the UE was in CELL_DCH state upon reception of the reconfiguration message and remains in CELL_DCH state, the UE shall:

- 1> if the IE "Uplink DPCH Info" is absent, not change its current UL Physical channel configuration;
- 1> for FDD:
 - 2> determine the value for the SECONDARY_CELL_HS_DSCH_RECEPTION and the corresponding actions as described in subclause 8.5.51.
- 1> in TDD:
 - 2> if "Primary CCPCH Info" is included indicating a new target cell and "New C-RNTI" is not specified:
 - 3> remove any C-RNTI from MAC;
 - 3> clear the variable C_RNTI.
 - 2> if "Primary CCPCH Info" is included indicating a new target cell and "New H-RNTI" is not specified:
 - 3> remove any H-RNTI from MAC;
 - 3> clear the variable H_RNTI;
 - 3> determine the value for the HS_DSCH_RECEPTION variable and take the corresponding actions as described in subclause 8.5.25.
 - 2> if the reconfiguration message caused a change from FDD mode to 3.84/7.68 Mcps TDD mode and provides for E-DCH/HS-DSCH operation without an uplink DPCH:
 - 3> the UE shall obtain timing advance for the 3.84/7.68 Mcps TDD cell according to [15].
- 1> if "DPCH frame offset" is included for one or more RLS in the active set, and the reconfiguration procedure does not request a timing reinitialized hard handover (see subclause 8.3.5.1):
 - 2> use its value to determine the beginning of the DPCH or F-DPCH frame in accordance with the following:
 - 3> if the received IE "DPCH frame offset" is across the value range border compared to the DPCH or F-DPCH frame offset currently used by the UE:
 - 4> consider it to be a request to adjust the timing with 256 chips across the frame border (e.g. if the UE receives value 0 while the value currently used is 38144 consider this as a request to adjust the timing with +256 chips).
 - 3> if after taking into account value range borders, the received IE "DPCH frame offset" corresponds to a request to adjust the timing with a step exceeding 256 chips:
 - 4> set the variable INVALID_CONFIGURATION to TRUE.
 - 3> and the procedure ends.
- 2> adjust the radio link timing accordingly.

If after state transition the UE enters CELL_FACH state, the UE shall, after the state transition:

- 1> if the UE was in CELL_DCH state upon reception of the reconfiguration message:
 - 2> clear the variable E_RNTI.
- 1> if the IE "new Primary E-RNTI" is included in the received reconfiguration message:
 - 2> store the "new Primary E-RNTI" according to subclause 8.6.3.14.
- 1> determine the value for the READY_FOR_COMMON_EDCH variable and take the corresponding actions as described in subclause 8.5.47;

- 1> determine the value for the COMMON_E_DCH_TRANSMISSION variable and take the corresponding actions as described in subclause 8.5.46;
- 1> if the IE "Frequency info" is included in the received reconfiguration message:
 - 2> select a suitable UTRA cell according to [4] on that frequency;
 - 2> if the UE finds a suitable UTRA cell on that frequency:
 - 3> if the received reconfiguration message included the IE "Primary CPICH info" (for FDD) or "Primary CCPCH info" (for TDD), and the UE selects another cell than indicated by this IE or the received reconfiguration message did not include the IE "Primary CPICH info" (for FDD) or "Primary CCPCH info" (for TDD):
 - 4> initiate a cell update procedure according to subclause 8.3.1 using the cause "Cell reselection";
 - 4> when the cell update procedure completed successfully:
 - 5> if the UE is in CELL_PCH or URA_PCH state:
 - 6> if variable READY_FOR_COMMON_EDCH is set to TRUE:
 - 7> move to CELL_FACH state and proceed as below.
 - 6> else:
 - 7> if variable H_RNTI and variable C_RNTI are set:
 - 8> proceed as below.
 - 7> else:
 - 8> initiate a cell update procedure according to subclause 8.3.1 using the cause "Uplink data transmission" and proceed as below.
 - 3> else:
 - 4> for 1.28Mcps TDD, decide the working frequency according to subclause 8.6.6.1.
 - 2> else, if the UE can not find a suitable UTRA cell on that frequency but it finds a suitable UTRA cell on another frequency:
 - 3> initiate a cell update procedure according to subclause 8.3.1 using the cause "Cell reselection";
 - 3> when the cell update procedure completed successfully:
 - 4> if the UE is in CELL_PCH or URA_PCH state:
 - 5> if variable READY_FOR_COMMON_EDCH is set to TRUE:
 - 6> move to CELL_FACH state and proceed as below.
 - 5> else:
 - 6> if variable H_RNTI and variable C_RNTI are set:
 - 7> proceed as below.
 - 6> else:
 - 7> initiate a cell update procedure according to subclause 8.3.1 using the cause "Uplink data transmission" and proceed as below.
 - 1> if the IE "Frequency info" is not included in the received reconfiguration message:
 - 2> select a suitable UTRA cell according to [4];
 - 2> if the UE finds a suitable UTRA cell on the current frequency:

- 3> if the received reconfiguration message included the IE "Primary CPICH info" (for FDD) or "Primary CCPCH info" (for TDD), and the UE selects another cell than indicated by this IE or the received reconfiguration message did not include the IE "Primary CPICH info" (for FDD) or "Primary CCPCH info" (for TDD):
 - 4> initiate a cell update procedure according to subclause 8.3.1 using the cause "Cell reselection";
 - 4> when the cell update procedure completed successfully:
 - 5> if the UE is in CELL_PCH or URA_PCH state:
 - 6> if variable READY_FOR_COMMON_EDCH is set to TRUE:
 - 7> move to CELL_FACH state and proceed as below.
 - 6> else:
 - 7> if variable H_RNTI and variable C_RNTI are set:
 - 8> proceed as below.
 - 7> else:
 - 8> initiate a cell update procedure according to subclause 8.3.1 using the cause "Uplink data transmission" and proceed as below.
 - 3> else:
 - 4> for 1.28Mcps TDD, decide the working frequency according to subclause 8.6.6.1.
 - 2> else, if the UE can not find a suitable UTRA cell on the current frequency but it finds a suitable UTRA cell on another frequency:
 - 3> initiate a cell update procedure according to subclause 8.3.1 using the cause "Cell reselection";
 - 3> when the cell update procedure completed successfully:
 - 4> if the UE is in CELL_PCH or URA_PCH state:
 - 5> if variable READY_FOR_COMMON_EDCH is set to TRUE:
 - 6> move to CELL_FACH state and proceed as below.
 - 5> else:
 - 6> if variable H_RNTI and variable C_RNTI are set:
 - 7> proceed as below.
 - 6> else:
 - 7> initiate a cell update procedure according to subclause 8.3.1 using the cause "Uplink data transmission" and proceed as below.
 - 1> start timer T305 using its initial value if timer T305 is not running and if periodical update has been configured by T305 in the IE "UE Timers and constants in connected mode" set to any other value than "infinity" in the variable TIMERS_AND_CONSTANTS;
 - 1> if variable READY_FOR_COMMON_EDCH is set to FALSE:
 - 2> select PRACH according to subclause 8.5.17;
 - 1> else:
 - 2> configure the Enhanced Uplink in CELL_FACH state and Idle mode as specified in subclause 8.5.45 for FDD and 8.5.45a for 1.28 Mcps TDD.
 - 1> for 3.84 Mcps and 1.28 Mcps TDD; or

- 1> for FDD, if the UE does not support HS-DSCH reception in CELL_FACH state; or
- 1> if the IE "HS-DSCH common system information" is not included in System Information Block type 5 or System Information Block type 5bis; or
- 1> for 1.28 Mcps TDD, if the IE "Common E-DCH system info" is not included in System Information Block type 5:
 - 2> select Secondary CCPCH according to subclause 8.5.19;
 - 2> use the transport format set given in system information;
 - 2> take the actions related to the HS_DSCH_RECEPTION_GENERAL variable as described in subclause 8.5.37a.
- 1> else:
 - 2> for FDD if variable READY_FOR_COMMON_EDCH is set to FALSE:
 - 3> if the RBs have the multiplexing option with transport channel type "HS-DSCH" for the DL and transport channel type "RACH" in the UL; and
 - 3> if variable H_RNTI and variable C_RNTI are set:
 - 4> start to receive HS-DSCH according to the procedure in subclause 8.5.36.
 - 3> else:
 - 4> clear variable C_RNTI and delete any stored C-RNTI value;
 - 4> clear variable H_RNTI and delete any stored H-RNTI value;
 - 4> clear any stored IE "HARQ Info".
 - 2> else:
 - 3> if the RBs have the multiplexing option with transport channel type "HS-DSCH" for the DL and transport channel type "E-DCH" in the UL; and
 - 3> if variable E_RNTI, variable H_RNTI and variable C_RNTI are set:
 - 4> start to receive HS-DSCH according to the procedure in subclause 8.5.36.
 - 3> else:
 - 4> clear variable C_RNTI and delete any stored C-RNTI value;
 - 4> clear variable H_RNTI and delete any stored H-RNTI value;
 - 4> clear variable E_RNTI and delete any stored E-RNTI value;
 - 4> clear any stored IE "HARQ Info".
- 1> if the IE "UTRAN DRX cycle length coefficient" is included in the same message:
 - 2> ignore that IE and stop using DRX.
- 1> if the contents of the variable C_RNTI is empty:
 - 2> perform a cell update procedure according to subclause 8.3.1 using the cause "Cell reselection";
 - 2> when the cell update procedure completed successfully:
 - 3> if the UE is in CELL_PCH or URA_PCH state:
 - 4> initiate a cell update procedure according to subclause 8.3.1 using the cause "Uplink data transmission";

4> proceed as below.

If the UE was in CELL_FACH state upon reception of the reconfiguration message and remains in CELL_FACH state, the UE shall:

- 1> determine the value for the READY_FOR_COMMON_EDCH variable and take the corresponding actions as described in subclause 8.5.47;
- 1> determine the value for the COMMON_E_DCH_TRANSMISSION variable and take the corresponding actions as described in subclause 8.5.46;
- 1> if the IE "Frequency info" is included in the received reconfiguration message:
 - 2> select a suitable UTRA cell according to [4] on that frequency;
 - 2> if the UE finds a suitable UTRA cell on that frequency:
 - 3> if the received reconfiguration message included the IE "Primary CPICH info" (for FDD) or "Primary CCPCH info" (for TDD), and the UE selected another cell than indicated by this IE or the received reconfiguration message did not include the IE "Primary CPICH info" (for FDD) or "Primary CCPCH info" (for TDD):
 - 4> initiate a cell update procedure according to subclause 8.3.1 using the cause "cell reselection";
 - 4> when the cell update procedure completed successfully:
 - 5> if the UE is in CELL_PCH or URA_PCH state:
 - 6> if variable READY_FOR_COMMON_EDCH is set to TRUE:
 - 7> move to CELL_FACH state and proceed as below.
 - 6> else:
 - 7> if variable H_RNTI and variable C_RNTI are set:
 - 8> proceed as below.
 - 7> else:
 - 8> initiate a cell update procedure according to subclause 8.3.1 using the cause "Uplink data transmission" and proceed as below.
 - 2> else, if the UE can not find a suitable UTRA cell on that frequency but it finds a suitable UTRA cell on another frequency:
 - 3> initiate a cell update procedure according to subclause 8.3.1 using the cause "Cell reselection";
 - 3> when the cell update procedure completed successfully:
 - 4> if the UE is in CELL_PCH or URA_PCH state:
 - 5> if variable READY_FOR_COMMON_EDCH is set to TRUE:
 - 6> move to CELL_FACH state and proceed as below.
 - 5> else:
 - 6> if variable H_RNTI and variable C_RNTI are set:
 - 7> proceed as below.
 - 6> else:
 - 7> initiate a cell update procedure according to subclause 8.3.1 using the cause "Uplink data transmission" and proceed as below.
 - 1> if the IE "Frequency info" is not included in the received reconfiguration message:

- 2> if the IE "Primary CPICH info" (for FDD) or "Primary CCPCH info" (for TDD) is included the UE shall either:
 - 3> ignore the content of the IE "Primary CPICH info" (for FDD) or "Primary CCPCH info" (for TDD) and proceed as below;
- 2> or:
 - 3> if the received reconfiguration message included the IE "Primary CPICH info" (for FDD) or "Primary CPCH info" (for TDD), and it is different from the current cell:
 - 4> initiate a cell update procedure according to subclause 8.3.1 using the cause "Cell reselection";
 - 4> when the cell update procedure completed successfully:
 - 5> if the UE is in CELL_PCH or URA_PCH state:
 - 6> if variable READY_FOR_COMMON_EDCH is set to TRUE:
 - 7> move to CELL_FACH state and proceed as below.
 - 6> else:
 - 7> if variable H_RNTI and variable C_RNTI are set:
 - 8> proceed as below.
 - 7> else:
 - 8> initiate a cell update procedure according to subclause 8.3.1 using the cause "Uplink data transmission" and proceed as below.

If after state transition the UE leaves CELL_FACH state, the UE shall:

- 1> stop timer T305.

If after state transition the UE enters CELL_PCH or URA_PCH state, the UE shall:

- 1> if the UE enters CELL_PCH state:
 - 2> if the UE supports E-DCH transmission in CELL_FACH state and Idle mode and the IE "Common E-DCH system info" is included in system information block type 5 or 5bis:
 - 3> if variable H_RNTI or variable C_RNTI or variable E_RNTI is not set:
 - 4> clear variable C_RNTI and delete any stored C-RNTI value;
 - 4> clear variable H_RNTI and delete any stored H-RNTI value;
 - 4> clear variable E_RNTI and delete any stored E-RNTI value;
 - 4> clear any stored IE "HARQ Info";
 - 4> reset the MAC-ehs entity [15];
 - 4> reset the MAC-i/is entity [15].
- 1> determine the value for the HSPA_RNTI_STORED_CELL_PCH variable and take the corresponding actions as described in subclause 8.5.56;
- 1> determine the value for the READY_FOR_COMMON_EDCH variable and take the corresponding actions as described in subclause 8.5.47;
- 1> determine the value for the COMMON_E_DCH_TRANSMISSION variable and take the corresponding actions as described in subclause 8.5.46;
- 1> if the IE "UTRAN DRX cycle length coefficient" is not included in the same message:

2> set the variable INVALID_CONFIGURATION to TRUE.

The UE shall transmit a response message as specified in subclause 8.2.2.4, setting the information elements as specified below. The UE shall:

- 1> if the received reconfiguration message included the IE "Downlink counter synchronisation info"; or
- 1> if the received reconfiguration message is a RADIO BEARER RECONFIGURATION and the IE "New U-RNTI" is included; or
- 1> if the received reconfiguration message included the IE "SR-VCC Info":
 - 2> if the variable PDCP_SN_INFO is empty:
 - 3> configure the corresponding RLC entity for all AM and UM radio bearers and AM and UM signalling radio bearers except RB2 to "stop".
 - 2> else:
 - 3> configure the RLC entity for signalling radio bearers RB1, RB3 and RB4 to "stop";
 - 3> configure the RLC entity for UM and AM radio bearers for which the IE "PDCP SN Info" is not included to "stop".
 - 2> re-establish the RLC entity for RB2;
 - 2> clear all entries in the table "Processed transactions" in the variable TRANSACTIONS;
 - 2> for the downlink and the uplink, apply the ciphering configuration as follows:
 - 3> if the received re-configuration message included the IE "Ciphering Mode Info":
 - 4> use the ciphering configuration in the received message when transmitting the response message.
 - 3> if the ciphering configuration for RB2 from a previously received SECURITY MODE COMMAND has not yet been applied because the activation times not having been reached:
 - 4> if the previous SECURITY MODE COMMAND was received due to new keys being received:
 - 5> consider the new ciphering configuration to include the received new keys;
 - 5> initialise the HFN component of the uplink COUNT-C and downlink COUNT-C of SRB2 as indicated in subclause 8.1.12.3.1.
 - 4> else if the ciphering configuration for RB2 from a previously received SECURITY MODE COMMAND has not yet been applied because of the corresponding activation times not having been reached and the previous SECURITY MODE COMMAND caused a change in LATEST_CONFIGURED_CN_DOMAIN:
 - 5> consider the new ciphering configuration to include the keys associated with the LATEST_CONFIGURED_CN_DOMAIN;
 - 5> initialise the HFN component of the uplink COUNT-C and downlink COUNT-C of SRB2 to the most recently transmitted IE "START list" or IE "START" for the LATEST_CONFIGURED_CN_DOMAIN at the reception of the previous SECURITY MODE COMMAND.
 - 4> apply the new ciphering configuration immediately following RLC re-establishment.
 - 3> else:
 - 4> continue using the current ciphering configuration.
- 2> set the new uplink and downlink HFN component of COUNT-C of RB2 to MAX(uplink HFN component of COUNT-C of RB2, downlink HFN component of COUNT-C of RB2);
- 2> increment by one the downlink and uplink values of the HFN of COUNT-C for RB2;

- 2> calculate the START value according to subclause 8.5.9;
- 2> include the calculated START values for each CN domain in the IE "START list" in the IE "Uplink counter synchronisation info";
- 2> if timer T323 value is stored in the IE "UE Timers and constants in connected mode" in the variable TIMERS_AND_CONSTANTS:
 - 3> stop and reset timer T323;
 - 3> clear any value of the timer T323 stored in the IE "UE Timers and constants in connected mode" in the variable TIMERS_AND_CONSTANTS.
- 1> if the received reconfiguration message did not include the IE "Downlink counter synchronisation info":
 - 2> if the variable START_VALUE_TO_TRANSMIT is set:
 - 3> include and set the IE "START" to the value of that variable.
 - 2> if the variable START_VALUE_TO_TRANSMIT is not set and the IE "New U-RNTI" is included:
 - 3> calculate the START value according to subclause 8.5.9;
 - 3> include the calculated START values for each CN domain in the IE "START list" in the IE "Uplink counter synchronisation info".
 - 2> if the received reconfiguration message caused a change in the RLC PDU size, a change from flexible to fixed RLC PDU size or a change from fixed to flexible DL RLC PDU size with RLC length indicator set to 15 bits or a change of the RLC LI size for any RB using RLC-AM:
 - 3> calculate the START value according to subclause 8.5.9;
 - 3> include the calculated START values for the CN domain associated with the corresponding RB identity in the IE "START list" in the IE "Uplink counter synchronisation info".
- 1> if the received reconfiguration message contained the IE "Ciphering mode info" or contained the IE "Integrity protection mode info":
 - 2> set the IE "Status" in the variable SECURITY_MODIFICATION for all the CN domains in the variable SECURITY_MODIFICATION to "Affected".
- 1> if the received reconfiguration message contained the IE "Ciphering mode info":
 - 2> if the reconfiguration message is not used to perform an SRNS relocation, an SR-VCC or a handover from GERAN *Iu mode* with change of ciphering algorithm:
 - 3> the UE behaviour is not specified.
 - 2> if the message is used to perform a timing re-initialised hard handover:
 - 3> if IE "Ciphering activation time for DPCH" is included:
 - 4> the UE behaviour is not specified.
 - 2> else:
 - 3> if the reconfiguration message is used to setup radio bearer(s) using RLC-TM; or
 - 3> if radio bearer(s) using RLC-TM already exist:
 - 4> if IE "Ciphering activation time for DPCH" is not included:
 - 5> the UE behaviour is not specified.
- 1> if the received reconfiguration message contained the IE "Integrity Protection mode info":
 - 2> if the reconfiguration message is not used to perform an SRNS relocation, an SR-VCC or a handover from GERAN *Iu mode*:

3> the UE behaviour is not specified.

1> if the received reconfiguration message did not contain the IE "Ciphering activation time for DPCH" in IE "Ciphering mode info":

2> if prior to this procedure there exist no transparent mode RLC radio bearers:

3> if, at the conclusion of this procedure, the UE will be in CELL_DCH state; and

3> if, at the conclusion of this procedure, at least one transparent mode RLC radio bearer exists:

4> include the IE "COUNT-C activation time" and specify a CFN value for this IE that is a multiple of 8 frames ($CFN \bmod 8 = 0$) and lies at least 200 frames ahead of the CFN in which the response message is first transmitted.

NOTE: UTRAN should not include the IE "Ciphering mode info" in any reconfiguration message unless it is also used to perform an SRNS relocation with change of ciphering algorithm or perform an SR-VCC.

1> set the IE "RRC transaction identifier" to the value of "RRC transaction identifier" in the entry for the received message in the table "Accepted transactions" in the variable TRANSACTIONS; and

1> clear that entry;

1> if the variable PDCP_SN_INFO is not empty:

2> include the IE "RB with PDCP information list" and set it to the value of the variable PDCP_SN_INFO.

1> in TDD, if the procedure is used to perform a handover to a cell where timing advance is enabled, and the UE can calculate the timing advance value in the new cell (i.e. in a synchronous TDD network):

2> set the IE "Uplink Timing Advance" according or the IE "Extended UL Timing Advance" to subclause 8.6.6.26.

1> if the IE "Integrity protection mode info" was present in the received reconfiguration message:

2> start applying the new integrity protection configuration in the uplink for signalling radio bearer RB2 from and including the transmitted response message.

1> if IE "RRC state indicator" is set to "CELL_DCH":

2> if the variable DEFERRED_MEASUREMENT_STATUS is set to TRUE:

3> if System Information Block type 11 is scheduled on the BCCH and the UE has not read nor stored the IEs present in this System Information Block, or

3> if System Information Block type 11bis is scheduled on the BCCH and the UE has not read nor stored the IEs present in this System Information Block, or

3> if System Information Block type 12 is scheduled on the BCCH and the UE has not read nor stored the IEs present in this System Information Block:

4> include IE "Deferred measurement control reading".

If after state transition the UE enters CELL_DCH state, the UE shall, after the state transition:

1> if the IE "Deferred measurement control reading" was included in the response message:

2> clear the variable CELL_INFO_LIST.

If after state transition the UE enters URA_PCH state, the UE shall, after the state transition and transmission of the response message:

1> if the IE "Frequency info" is included in the received reconfiguration message:

2> select a suitable UTRA cell according to [4] on that frequency.

- 2> if the UE can not find a suitable UTRA cell on that frequency but it finds a suitable UTRA cell on another frequency:
 - 3> proceed as below.
- 1> if the IE "Frequency info" is not included in the received reconfiguration message:
 - 2> select a suitable UTRA cell according to [4].
- 1> prohibit periodical status transmission in RLC;
- 1> start timer T305 using its initial value if timer T305 is not running and if periodical update has been configured by T305 in the IE "UE Timers and constants in connected mode" set to any other value than "infinity" in the variable TIMERS_AND_CONSTANTS;
- 1> for 3.84 Mcps and 7.68 Mcps TDD; or
- 1> for FDD and 1.28 Mcps TDD, if the UE does not support HS-DSCH reception in CELL_PCH or URA_PCH state; or
- 1> if the IE "HS-DSCH paging system information" is not included in System Information Block type 5 or System Information Block type 5bis:
 - 2> remove any C-RNTI from MAC;
 - 2> clear the variable C_RNTI;
 - 2> select Secondary CCPCH according to subclause 8.5.19;
 - 2> take the actions related to the HS_DSCH_RECEPTION_GENERAL variable as described in subclause 8.5.37a.
- 1> else:
 - 2> clear variable C_RNTI and delete any stored C-RNTI value;
 - 2> clear variable H_RNTI and delete any stored H-RNTI value;
 - 2> clear any stored IE "HARQ Info";
 - 2> reset the MAC-ehs entity [15];
 - 2> for FDD; or
 - 2> for 1.28 Mcps TDD, if the IE "PICH info" isn't included in IE "Secondary CCPCH system information" in System Information Block type 5 or System Information Block type 6:
 - 3> monitor its paging occasions on the selected PICH determined according to subclauses 8.6.3.1a, 8.6.3.2 and 8.5.39 and receive paging on the HS-DSCH mapped on the HS-PDSCH selected by the UE according to the procedures in subclause 8.5.40 for FDD and 8.5.40a for 1.28 Mcps TDD.
- 1> determine the value for the HSPA_RNTI_STORED_CELL_PCH variable and take the corresponding actions as described in subclause 8.5.56;
- 1> determine the value for the READY_FOR_COMMON_EDCH variable and take the corresponding actions as described in subclause 8.5.47;
- 1> determine the value for the COMMON_E_DCH_TRANSMISSION variable and take the corresponding actions as described in subclause 8.5.46;
- 1> if the IE "UTRAN DRX cycle length coefficient" is included in the same message:
 - 2> use the values in the IE "UTRAN DRX Cycle length coefficient" for calculating Paging occasion and PICH Monitoring Occasion as specified in subclause 8.6.3.2.
- 1> if the criteria for URA update caused by "URA reselection" according to subclause 8.3.1 are fulfilled after cell selection:

- 2> initiate a URA update procedure according to subclause 8.3.1 using the cause "URA reselection";
- 2> when the URA update procedure is successfully completed:
 - 3> the procedure ends.

If after state transition the UE enters CELL_PCH state from CELL_DCH state, the UE shall, after the state transition and transmission of the response message:

- 1> if the IE "Frequency info" is included in the received reconfiguration message:
 - 2> select a suitable UTRA cell according to [4] on that frequency.
 - 2> if the UE finds a suitable UTRA cell on that frequency:
 - 3> if the received reconfiguration message included the IE "Primary CPICH info" (for FDD) or "Primary CCPCH info" (for TDD), and the UE selects another cell than indicated by this IE or the received reconfiguration message did not include the IE "Primary CPICH info" (for FDD) or "Primary CCPCH info" (for TDD):
 - 4> initiate a cell update procedure according to subclause 8.3.1 using the cause "Cell reselection";
 - 4> proceed as below.
 - 2> else, if the UE can not find a suitable UTRA cell on that frequency but it finds a suitable UTRA cell on another frequency:
 - 3> initiate a cell update procedure according to subclause 8.3.1 using the cause "Cell reselection";
 - 3> proceed as below.
 - 1> if the IE "Frequency info" is not included in the received reconfiguration message:
 - 2> select a suitable UTRA cell according to [4].
 - 2> if the UE finds a suitable UTRA cell on the current frequency:
 - 3> if the received reconfiguration message included the IE "Primary CPICH info" (for FDD) or "Primary CCPCH info" (for TDD), and the UE selects another cell than indicated by this IE or the received reconfiguration message did not include the IE "Primary CPICH info" (for FDD) or "Primary CCPCH info" (for TDD):
 - 4> initiate a cell update procedure according to subclause 8.3.1 using the cause "Cell reselection";
 - 4> proceed as below.
 - 2> else, if the UE can not find a suitable UTRA cell on the current frequency but it finds a suitable UTRA cell on another frequency:
 - 3> initiate a cell update procedure according to subclause 8.3.1 using the cause "Cell reselection";
 - 3> proceed as below.
 - 1> prohibit periodical status transmission in RLC;
 - 1> start timer T305 using its initial value if timer T305 is not running and if periodical update has been configured by T305 in the IE "UE Timers and constants in connected mode" set to any other value than "infinity" in the variable TIMERS_AND_CONSTANTS;
 - 1> for 3.84 Mcps and 7.68 Mcps TDD; or
 - 1> for FDD and 1.28 Mcps TDD, if the UE does not support HS-DSCH reception in CELL_PCH or URA_PCH state; or
 - 1> if the IE "HS-DSCH paging system information" is not included in System Information Block type 5 or System Information Block type 5bis and the variable HSPA_RNTI_STORED_CELL_PCH is set to FALSE:

- 2> remove any C-RNTI from MAC;
 - 2> clear the variable C_RNTI;
 - 2> select Secondary CCPCH according to subclause 8.5.19;
 - 2> take the actions related to the HS_DSCH_RECEPTION_GENERAL variable as described in subclause 8.5.37a.
- 1> else:
- 2> if IE "New C-RNTI" is not included:
 - 3> clear variable H_RNTI and delete any stored H-RNTI value;
 - 3> clear any stored IE "HARQ Info";
 - 3> reset the MAC-ehs entity [15].
 - 2> if the variable HSPA_RNTI_STORED_CELL_PCH is set to TRUE:
 - 3> select Secondary CCPCH according to subclause 8.5.19;
 - 3> take the actions related to the HS_DSCH_RECEPTION_GENERAL variable as described in subclause 8.5.37a.
 - 2> else:
 - 3> for FDD; or
 - 3> for 1.28 Mcps TDD, if both variable H_RNTI and variable C_RNTI are set:
 - 4> monitor its paging occasions on the selected PICH determined according to subclauses 8.6.3.1a, 8.6.3.2 and 8.5.39 and receive PCCH or DCCH and DTCH on the HS-DSCH according to the procedures in subclause 8.5.40 for FDD and 8.5.40a for 1.28 Mcps TDD.
- 1> determine the value for the READY_FOR_COMMON_EDCH variable and take the corresponding actions as described in subclause 8.5.47;
- 1> determine the value for the COMMON_E_DCH_TRANSMISSION variable and take the corresponding actions as described in subclause 8.5.46;
- 1> if the IE "UTRAN DRX cycle length coefficient" is included in the same message:
 - 2> use the values in the IE "UTRAN DRX Cycle length coefficient" for calculating Paging occasion and PICH Monitoring Occasion as specified in subclause 8.6.3.2.
- 1> the procedure ends.

If after state transition the UE enters CELL_DCH state from CELL_FACH or from CELL_PCH state:

- 1> if the IE "Default DPCH Offset Value" is not included:
 - 2> the UE behaviour is not specified.

If after state transition the UE enters CELL_PCH state from CELL_FACH state, the UE shall, after the state transition and transmission of the response message:

- 1> if the IE "Frequency info" is included in the received reconfiguration message:
 - 2> select a suitable UTRA cell according to [4] on that frequency.
 - 2> if the UE finds a suitable UTRA cell on that frequency:
 - 3> if the received reconfiguration message included the IE "Primary CPICH info" (for FDD) or "Primary CCPCH info" (for TDD), and the UE selected another cell than indicated by this IE or the received reconfiguration message did not include the IE "Primary CPICH info" (for FDD) or "Primary CCPCH info" (for TDD):

- 4> initiate a cell update procedure according to subclause 8.3.1 using the cause "cell reselection";
 - 4> proceed as below.
- 2> else, if the UE can not find a suitable UTRA cell on that frequency but it finds a suitable UTRA cell on another frequency:
- 3> initiate a cell update procedure according to subclause 8.3.1 using the cause "Cell reselection";
 - 3> proceed as below.
- 1> if the IE "Frequency info" is not included in the received reconfiguration message:
- 2> if the IE "Primary CPICH info" (for FDD) or "Primary CCPCH info" (for TDD) is included the UE shall either:
 - 3> ignore the content of the IE "Primary CPICH info" (for FDD) or "Primary CCPCH info" (for TDD) and proceed as below;
 - 2> or:
 - 3> if the received reconfiguration message included the IE "Primary CPICH info" (for FDD) or "Primary CPCH info" (for TDD), and it is different from the current cell:
 - 4> initiate a cell update procedure according to subclause 8.3.1 using the cause "Cell reselection";
 - 4> proceed as below.
- 1> prohibit periodical status transmission in RLC;
- 1> start timer T305 using its initial value if timer T305 is not running and if periodical update has been configured by T305 in the IE "UE Timers and constants in connected mode" set to any other value than "infinity" in the variable TIMERS_AND_CONSTANTS;
- 1> for 3.84 Mcps and 7.68 Mcps TDD; or
- 1> for FDD and 1.28 Mcps TDD, if the UE does not support HS-DSCH reception; or
- 1> if the IE "HS-DSCH paging system information" is not included in System Information Block type 5 or System Information Block type 5bis and the variable HSPA_RNTI_STORED_CELL_PCH is set to FALSE:
- 2> remove any C-RNTI from MAC;
 - 2> clear the variable C_RNTI.
 - 2> select Secondary CCPCH according to subclause 8.5.19;
 - 2> take the actions related to the HS_DSCH_RECEPTION_GENERAL variable as described in subclause 8.5.37a.
- 1> else:
- 2> if IE "New C-RNTI" is not included:
 - 3> clear variable C_RNTI and delete any stored C-RNTI value;
 - 3> clear variable H_RNTI and delete any stored H-RNTI value;
 - 3> clear any stored IE "HARQ Info";
 - 3> reset the MAC-ehs entity [15].
 - 2> if the variable HSPA_RNTI_STORED_CELL_PCH is set to TRUE:
 - 3> select Secondary CCPCH according to subclause 8.5.19;
 - 3> take the actions related to the HS_DSCH_RECEPTION_GENERAL variable as described in subclause 8.5.37a.

- 2> else:
 - 3> for FDD; or
 - 3> for 1.28 Mcps TDD, if both variable H_RNTI and variable C_RNTI are set:
 - 4> monitor its paging occasions on the selected PICH determined according to subclauses 8.6.3.1a, 8.6.3.2 and 8.5.39 and receive PCCH or DCCH and DTCH on the HS-DSCH according to the procedures in subclause 8.5.40 for FDD and 8.5.40a for 1.28 Mcps TDD.
- 1> determine the value for the READY_FOR_COMMON_EDCH variable and take the corresponding actions as described in subclause 8.5.47;
- 1> determine the value for the COMMON_E_DCH_TRANSMISSION variable and take the corresponding actions as described in subclause 8.5.46;
- 1> if the IE "UTRAN DRX cycle length coefficient" is included in the same message:
 - 2> use the values in the IE "UTRAN DRX Cycle length coefficient" for calculating Paging occasion and PICH Monitoring Occasion as specified in subclause 8.6.3.2.
- 1> the procedure ends.

8.2.2.3a Reception of RADIO BEARER RECONFIGURATION message by the UE performing handover from GERAN *Iu mode*

If the UE is performing handover from GERAN *Iu mode*, the UE shall, in addition to the actions in 8.2.2.3:

- 1> if the IE "Specification mode" is set to "Preconfiguration" and the IE "Preconfiguration mode" is set to "Predefined configuration":
 - 2> initiate the radio bearer and transport channel configuration in accordance with the predefined parameters identified by the IE "Predefined configuration identity";
 - 2> initiate the physical channels in accordance with the predefined parameters identified by the IE "Predefined radio configuration identity" and the received physical channel information elements;
 - 2> store information about the established radio access bearers and radio bearers according to the IE "Predefined configuration identity"; and
- 1> if the IE "Specification mode" is set to "Preconfiguration" and the IE "Preconfiguration mode" is set to "Default configuration":
 - 2> initiate the radio bearer and transport channel configuration in accordance with the default parameters identified by the IE "Default configuration mode" and the IE "Default configuration identity";
 - 2> initiate the physical channels in accordance with the default parameters identified by the IE "Default configuration mode" and IE "Default configuration identity" and the received physical channel information elements;

NOTE: The IE "Default configuration mode" specifies whether the FDD or TDD version of the default configuration shall be used.

- 1> if IE "Specification mode" is set to "Complete specification":
 - 2> initiate the radio bearer, transport channel and physical channel configuration in accordance with the received radio bearer, transport channel and physical channel information elements.
- 1> perform an open loop estimation to determine the UL transmission power according to subclause 8.5.3;
- 1> set the following variables equal to the corresponding variables in GERAN *Iu mode*:

CIPHERING_STATUS

ESTABLISHED_RABS

ESTABLISHED_SIGNALLING_CONNECTIONS
 INTEGRITY_PROTECTION_INFO
 INTER_RAT_HANDBOVER_INFO_TRANSFERRED
 LATEST_CONFIGURED_CN_DOMAIN
 START_THRESHOLD
 UE_CAPABILITY_TRANSFERRED.

1> set the new uplink and downlink HFN of RB2 to $MSB_{20}(\text{MAX}(\text{uplink HFN of RB2}, \text{downlink HFN of RB2}))$;

NOTE: $MSB_{20}()$ operation provides the HFN mapping from GERAN *Iu mode* to UTRAN. In GERAN *Iu mode* the length of HFN component of the COUNT-C of RB2 is longer than 20 bits.

1> initialise the variable TIMERS_AND_CONSTANTS to the default values and start to use those timer and constants values.

8.2.2.4 Transmission of a response message by the UE, normal case

In case the procedure was triggered by reception of a RADIO BEARER SETUP message, the UE shall:

1> transmit a RADIO BEARER SETUP COMPLETE as response message on the uplink DCCH using AM RLC.

In case the procedure was triggered by reception of a RADIO BEARER RECONFIGURATION message, the UE shall:

1> transmit a RADIO BEARER RECONFIGURATION COMPLETE as response message on the uplink DCCH using AM RLC.

In case the procedure was triggered by reception of a RADIO BEARER RELEASE message, the UE shall:

1> transmit a RADIO BEARER RELEASE COMPLETE as response message on the uplink DCCH using AM RLC.

In case the procedure was triggered by reception of a TRANSPORT CHANNEL RECONFIGURATION message, the UE shall:

1> transmit a TRANSPORT CHANNEL RECONFIGURATION COMPLETE as response message on the uplink DCCH using AM RLC.

In case the procedure was triggered by reception of a PHYSICAL CHANNEL RECONFIGURATION message, the UE shall:

1> transmit a PHYSICAL CHANNEL RECONFIGURATION COMPLETE as response message on the uplink DCCH using AM RLC.

In case the procedure was triggered by reception of a Target cell HS-SCCH order, the UE shall:

1> determine the corresponding RADIO BEARER SETUP COMPLETE or RADIO BEARER RECONFIGURATION COMPLETE or TRANSPORT CHANNEL RECONFIGURATION COMPLETE or PHYSICAL CHANNEL RECONFIGURATION COMPLETE response message that shall be used given by the IE "Serving Cell Change Message Type" in the stored HS-DSCH cell configuration;

1> set the IE "RRC transaction identifier" in the corresponding response message to the value of "RRC Transaction Identifier" in the entry for the corresponding response message in the table "Accepted transactions" in the variable TRANSACTIONS; and

1> transmit the corresponding RADIO BEARER SETUP COMPLETE or RADIO BEARER RECONFIGURATION COMPLETE or TRANSPORT CHANNEL RECONFIGURATION COMPLETE or PHYSICAL CHANNEL RECONFIGURATION COMPLETE response message on the uplink DCCH using AM RLC;

1> store the IE "Serving Cell Change Message Type" and the IE "Serving Cell Change Transaction Id" in the table "Processed transactions" in the variable TRANSACTIONS.

If the new state is CELL_DCH or CELL_FACH, the response message shall be transmitted using the new configuration after the state transition, and the UE shall:

- 1> if the IE "Downlink counter synchronisation info" was included in the reconfiguration message; or
- 1> if the received reconfiguration message is a RADIO BEARER RECONFIGURATION and the IE "New U-RNTI" is included; or
- 1> if the received reconfiguration message included the IE "SR-VCC Info":
 - 2> when RLC has confirmed the successful transmission of the response message:
 - 3> if the variable PDCP_SN_INFO is empty:
 - 4> configure the RLC entity for all AM and UM radio bearers and AM and UM signalling radio bearers except RB2 to "continue".
 - 3> else:
 - 4> configure the RLC entity for signalling radio bearers RB1, RB3 and RB4 to "continue";
 - 4> configure the RLC entity for UM and AM radio bearers for which the IE "PDCP SN Info" is not included to "continue".
 - 3> re-establish all AM and UM RLC entities with RB identities larger than 4 and set the first 20 bits of all the HFN component of the respective COUNT-C values to the START value included in the response message for the corresponding CN domain;
 - 3> re-establish the RLC entities with RB identities 1, 3 and 4 and set the first 20 bits of all the HFN component of the respective COUNT-C values to the START value included in the response message for the CN domain stored in the variable LATEST_CONFIGURED_CN_DOMAIN;
 - 3> set the remaining bits of the HFN component of COUNT-C values of all UM RLC entities to zero;
 - 3> if the IE "PDCP context relocation info" is not present:
 - 4> re-initialise the PDCP header compression entities of each radio bearer in the variable ESTABLISHED_RABS as specified in [36].
 - 3> if the IE "PDCP context relocation info" is present:
 - 4> perform the actions as specified in subclause 8.6.4.13.
- 1> if the variable PDCP_SN_INFO is empty:
 - 2> if the received reconfiguration message contained the IE "Ciphering mode info":
 - 3> when RLC has confirmed the successful transmission of the response message:
 - 4> notify upper layers upon change of the security configuration;
 - 4> perform the actions below.
 - 2> if the received reconfiguration message did not contain the IE "Ciphering mode info":
 - 3> when RLC has been requested to transmit the response message:
 - 4> perform the actions below.
 - 1> if the variable PDCP_SN_INFO is non-empty:
 - 2> when RLC has confirmed the successful transmission of the response message:
 - 3> for each radio bearer in the variable PDCP_SN_INFO:
 - 4> if the IE "RB started" in the variable ESTABLISHED_RABS is set to "started":
 - 5> configure the RLC entity for that radio bearer to "continue".

3> perform the actions below.

If the new state is CELL_PCH or URA_PCH, the response message shall be transmitted using the old configuration before the state transition, but the new C-RNTI shall be used if the IE "New C-RNTI" was included in the received reconfiguration message, and the UE shall:

- 1> when RLC has confirmed the successful transmission of the response message:
 - 2> for each radio bearer in the variable PDCP_SN_INFO:
 - 3> if the IE "RB started" in the variable ESTABLISHED_RABS is set to "started":
 - 4> configure the RLC entity for that radio bearer to "continue".
 - 2> enter the new state (CELL_PCH or URA_PCH, respectively);
 - 2> perform the actions below.

The UE shall:

- 1> set the variable ORDERED_RECONFIGURATION to FALSE;
- 1> if the received reconfiguration message contained the IE "Ciphering mode info":
 - 2> resume data transmission on any suspended radio bearer and signalling radio bearer mapped on RLC-AM or RLC-UM;
 - 2> set the IE "Reconfiguration" in the variable CIPHERING_STATUS to FALSE; and
 - 2> clear the variable RB_UPLINK_CIPHERING_ACTIVATION_TIME_INFO.
- 1> if the received reconfiguration message contained the IE "Integrity protection mode info":
 - 2> allow the transmission of RRC messages on all signalling radio bearers with any RRC SN;
 - 2> set "Uplink RRC Message sequence number" for signalling radio bearer RB0 in the variable INTEGRITY_PROTECTION_INFO to a value such that next RRC message to be sent on uplink RB0 will use the new integrity protection configuration;
 - 2> set the IE "Reconfiguration" in the variable INTEGRITY_PROTECTION_INFO to FALSE; and
 - 2> clear the variable INTEGRITY_PROTECTION_ACTIVATION_INFO.
- 1> clear the variable PDCP_SN_INFO;
- 1> clear the variable START_VALUE_TO_TRANSMIT;
- 1> clear the variable SECURITY_MODIFICATION.

8.2.2.5 Reception of a response message by the UTRAN, normal case

When UTRAN has received

- the RADIO BEARER SETUP COMPLETE message; or
- the RADIO BEARER RECONFIGURATION COMPLETE message; or
- the RADIO BEARER RELEASE COMPLETE message; or
- the TRANSPORT CHANNEL RECONFIGURATION COMPLETE message; or
- the PHYSICAL CHANNEL RECONFIGURATION COMPLETE message.

UTRAN may:

- 1> delete the old configuration.

If the procedure caused the UE to leave the CELL_FACH state, UTRAN may:

1> delete the C-RNTI of the UE.

If the IE "UL Timing Advance" or the IE "Extended UL Timing Advance" is included in TDD, UTRAN should:

1> evaluate the timing advance value that the UE has to use in the new cell after handover.

If the IE "START" or the IE "START list " is included, UTRAN should:

1> set the START value for each CN domain with the corresponding values as received in this response message;

1> consequently, then use the START values to initialise the hyper frame numbers, in the same way as specified for the UE in subclause 8.2.2.3, for any new radio bearers that are established.

If UTRAN has ordered a ciphering reconfiguration by including the IE "Ciphering mode info", UTRAN should:

1> for radio bearers using RLC-AM or RLC-UM:

2> on the receiving side of an RLC entity apply the new ciphering configuration in uplink immediately;

2> on the transmitting side of an RLC entity apply the new ciphering configuration in downlink immediately.

1> for radio bearers using RLC-TM:

2> begin incrementing the COUNT-C at the CFN only as indicated in:

3> the IE "Ciphering activation time for DPCH" in the IE "Ciphering mode info", if included in the message that triggered the radio bearer control procedure; or

3> the IE "COUNT-C activation time", if included in the response message for this procedure.

1> and the procedure ends on the UTRAN side.

8.2.2.5a Rejection by the UE

If the UTRAN establishes one or more p-t-p radio bearer(s) for the transmission of a session of an MBMS service, identified by the IE "MBMS Session identity", for which upper layers indicate that it has already been received correctly, the UE shall:

1> transmit a failure response as specified in subclause 8.2.2.9, setting the information elements as specified below:

2> include the IE "RRC transaction identifier";

2> set it to the value of "RRC transaction identifier" in the entry for the received message in the table "Accepted transactions" in the variable TRANSACTIONS;

2> clear that entry; and

2> set the IE "failure cause" to "MBMS session already received correctly".

1> set the variable UNSUPPORTED_CONFIGURATION to FALSE;

1> continue with any ongoing processes and procedures as if the reconfiguration message was not received.

1> the procedure ends.

If the UTRAN establishes one or more p-t-p radio bearer(s) for the transmission of a session of an MBMS service, which will inhibit reception of one or more MBMS services which according to upper layers are of higher priority, the UE may:

1> transmit a failure response as specified in subclause 8.2.2.9, setting the information elements as specified below:

2> include the IE "RRC transaction identifier";

2> set it to the value of "RRC transaction identifier" in the entry for the received message in the table "Accepted transactions" in the variable TRANSACTIONS;

2> clear that entry; and

- 2> set the IE "failure cause" to "Lower priority MBMS service".
- 1> set the variable UNSUPPORTED_CONFIGURATION to FALSE;
- 1> continue with any ongoing processes and procedures as if the reconfiguration message was not received.
- 1> the procedure ends.

8.2.2.6 Unsupported configuration in the UE

If the UTRAN instructs the UE to use a configuration, which it does not support and/or if the received message causes the variable UNSUPPORTED_CONFIGURATION to be set to TRUE, the UE shall:

- 1> transmit a failure response as specified in subclause 8.2.2.9, setting the information elements as specified below:
 - 2> include the IE "RRC transaction identifier"; and
 - 2> set it to the value of "RRC transaction identifier" in the entry for the received message in the table "Accepted transactions" in the variable TRANSACTIONS; and
 - 2> clear that entry;
 - 2> set the IE "failure cause" to "configuration unsupported".
- 1> set the variable UNSUPPORTED_CONFIGURATION to FALSE;
- 1> continue with any ongoing processes and procedures as if the reconfiguration message was not received.

The procedure ends.

8.2.2.7 Physical channel failure

If the received message caused the UE to be in CELL_DCH state and the UE according to subclause 8.5.4 failed to establish the dedicated physical channel(s) indicated in the received message or for 3.84 Mcps TDD or 7.68 Mcps TDD failed to establish the physical channel(s) indicated in the received message to which DCCH(s) are mapped the UE shall:

- 1> For TDD or for FDD if the CM_PATTERN_ACTIVATION_ABORTED flag is not set to TRUE:
 - 2> revert to the configuration prior to the reception of the message (old configuration), including any HS-DSCH, E-DCH, DTX, and DRX configuration if existing. If there exists any DTX or DRX configuration, the UE shall instruct the physical layer to consider only the HS-SCCH orders which were acknowledged prior to the activation time of the received message;
 - 2> For FDD: if the UE was in Cell DCH state prior to the reconfiguration:
 - 3> if the variable DTX_DRX_STATUS is set to TRUE, re-configure the physical layer to perform discontinuous uplink DPCCCH transmission and enable or disable discontinuous downlink reception operations according to the variable DTX_DRX_PARAMS at the CFN corresponding to the frame boundary that is offset by the stored value of the IE "Enabling Delay" from the frame boundary where uplink transmission resumes with the old configuration;
 - 3> perform the physical layer synchronisation procedure A as specified in [29];
 - 3> apply power control preamble according to [26] during the number of frames indicated in the IE "PC preamble" in the variable LATEST_CONFIGURED_SRB_DELAY_AND_PC_PREAMBLE; and
 - 3> then not send any data on signalling radio bearers RB0 to RB4 during the number of frames indicated in the IE "SRB delay" in the variable LATEST_CONFIGURED_SRB_DELAY_AND_PC_PREAMBLE or while the physical channel is not considered established;.
- 1> if the old configuration includes dedicated physical channels (CELL_DCH state) and the UE is unable to revert to the old configuration or for FDD if the CM_PATTERN_ACTIVATION_ABORTED flag is set to TRUE:
 - 2> initiate a cell update procedure according to subclause 8.3.1, using the cause "radio link failure";

- 2> after the cell update procedure has completed successfully:
 - 3> proceed as below.
- 1> if the old configuration does not include dedicated physical channels (CELL_FACH state):
 - 2> select a suitable UTRA cell according to [4];
 - 2> if the UE selects another cell than the cell the UE camped on upon reception of the reconfiguration message:
 - 3> initiate a cell update procedure according to subclause 8.3.1, using the cause "Cell reselection";
 - 3> after the cell update procedure has completed successfully:
 - 4> proceed as below.
- 1> transmit a failure response message as specified in subclause 8.2.2.9, setting the information elements as specified below:
 - 2> include the IE "RRC transaction identifier"; and
 - 2> set it to the value of "RRC transaction identifier" in the entry for the received message in the table "Accepted transactions" in the variable TRANSACTIONS; and
 - 2> clear that entry;
 - 2> set the IE "failure cause" to "physical channel failure".
- 1> set the variable ORDERED_RECONFIGURATION to FALSE;
- 1> continue with any ongoing processes and procedures as if the reconfiguration message was not received.

The procedure ends.

8.2.2.8 Cell re-selection

If the UE performs cell re-selection during the reconfiguration procedure, the UE shall:

- 1> initiate a cell update procedure, as specified in subclause 8.3.1;
- 1> continue with the reconfiguration procedure.

NOTE: After the completion of the cell update procedure and completion of the reconfiguration procedure within the UE, the UE will move to the RRC state as indicated in the reconfiguration message.

8.2.2.9 Transmission of a response message by the UE, failure case

The UE shall:

- 1> in case of reception of a RADIO BEARER SETUP message:
 - 2> if the radio bearer establishment procedure affects several radio bearers:
 - 3> (may) include the identities of the radio bearers for which the procedure would have been successful into the RADIO BEARER SETUP FAILURE message.
 - 2> transmit a RADIO BEARER SETUP FAILURE as response message on the DCCH using AM RLC.
- 1> in case of reception of a RADIO BEARER RECONFIGURATION message:
 - 2> if the radio bearer reconfiguration procedure affects several radio bearers:
 - 3> (may) include the identities of the radio bearers for which the procedure would have been successful into the RADIO BEARER RECONFIGURATION FAILURE message.
 - 2> transmit a RADIO BEARER RECONFIGURATION FAILURE as response message on the DCCH using AM RLC.

- 1> in case of reception of a RADIO BEARER RECONFIGURATION message encapsulated in INTERSYSTEM HANDOVER TO UTRAN COMMAND message in GERAN *Iu mode*:
 - 2> perform the actions as specified in [53].
- 1> in case of reception of a RADIO BEARER RELEASE message:
 - 2> if the radio bearer release procedure affects several radio bearers:
 - 3> (may) include the identities of the radio bearers for which the procedure would have been successful into the RADIO BEARER RELEASE FAILURE message.
 - 2> transmit a RADIO BEARER RELEASE FAILURE as response message on the DCCH using AM RLC.
- 1> in case of reception of a TRANSPORT CHANNEL RECONFIGURATION message:
 - 2> transmit a TRANSPORT CHANNEL RECONFIGURATION FAILURE as response message on the DCCH using AM RLC.
- 1> in case of reception of a PHYSICAL CHANNEL RECONFIGURATION message:
 - 2> transmit a PHYSICAL CHANNEL RECONFIGURATION FAILURE as response message on the DCCH using AM RLC.
- 1> when the response message has been submitted to lower layers for transmission:
 - 2> continue with any ongoing processes and procedures as if no reconfiguration attempt had occurred.

8.2.2.10 Reception of a response message by the UTRAN, failure case

When the UTRAN has received:

- the RADIO BEARER SETUP FAILURE message; or
- the RADIO BEARER RECONFIGURATION FAILURE message; or
- the RADIO BEARER RELEASE FAILURE message; or
- the TRANSPORT CHANNEL RECONFIGURATION FAILURE message; or
- the PHYSICAL CHANNEL RECONFIGURATION FAILURE message;

the UTRAN may restore the old and delete the new configuration. Upper layers should be notified of the failure.

The procedure ends on the UTRAN side.

8.2.2.11 Invalid configuration

If the variable INVALID_CONFIGURATION is set to TRUE the UE shall:

- 1> keep the configuration existing before the reception of the message;
- 1> transmit a failure response message as specified in subclause 8.2.2.9, setting the information elements as specified below:
 - 2> include the IE "RRC transaction identifier"; and
 - 3> set it to the value of "RRC transaction identifier" in the entry for the received message in the table "Accepted transactions" in the variable TRANSACTIONS; and
 - 3> clear that entry.
 - 2> set the IE "failure cause" to "invalid configuration".
- 1> set the variable INVALID_CONFIGURATION to FALSE;
- 1> continue with any ongoing processes and procedures as if the reconfiguration message was not received.

The procedure ends.

8.2.2.12 Incompatible simultaneous reconfiguration

If the table "Rejected transactions" in the variable TRANSACTIONS is set due to the received message and the variable PROTOCOL_ERROR_REJECT is set to FALSE, the UE shall:

- 1> not apply the configuration contained in the received reconfiguration message;
- 1> transmit a failure response message as specified in subclause 8.2.2.9, setting the information elements as specified below:
 - 2> include the IE "RRC transaction identifier"; and
 - 2> set it to the value of "RRC transaction identifier" in the entry for the received message in the table "Rejected transactions" in the variable TRANSACTIONS; and
 - 2> clear that entry;
 - 2> set the IE "failure cause" to "incompatible simultaneous reconfiguration".
- 1> continue with any ongoing processes and procedures as if the reconfiguration message was not received.

The procedure ends.

8.2.2.12a Incompatible simultaneous security reconfiguration

If the variable INCOMPATIBLE_SECURITY_RECONFIGURATION is set to TRUE due to the received reconfiguration message, the UE shall:

- 1> transmit a failure response message as specified in subclause 8.2.2.9, setting the information elements as specified below:
 - 2> include the IE "RRC transaction identifier"; and
 - 2> set it to the value of "RRC transaction identifier" in the entry for the received message in the table "Accepted transactions" in the variable TRANSACTIONS; and
 - 2> clear that entry;
 - 2> set the IE "failure cause" to the cause value "incompatible simultaneous reconfiguration".
- 1> set the variable INCOMPATIBLE_SECURITY_RECONFIGURATION to FALSE;
- 1> continue with any ongoing processes and procedures as if the reconfiguration message was not received.

The procedure ends.

8.2.2.12b Cell update procedure during security reconfiguration

If:

- a cell update procedure according to subclause 8.3.1 is initiated; and
- the received reconfiguration message causes either:
 - the IE "Reconfiguration" in the variable CIPHERING_STATUS to be set to TRUE; and/or
 - the IE "Reconfiguration" in the variable INTEGRITY_PROTECTION_INFO to be set to TRUE;

the UE shall:

- 1> release all radio resources;

- 1> indicate the release of the established signalling connections (as stored in the variable ESTABLISHED_SIGNALLING_CONNECTIONS) and established radio access bearers (as stored in the variable ESTABLISHED_RABS) to upper layers; and
- 1> clear any entry for the RRC CONNECTION RELEASE message in the tables "Accepted transactions" and "Rejected transactions" in the variable TRANSACTIONS;
- 1> clear the variable ESTABLISHED_SIGNALLING_CONNECTIONS;
- 1> clear the variable ESTABLISHED_RABS;
- 1> if the received reconfiguration message contained the IE "Ciphering mode info":
 - 2> set the IE "Reconfiguration" in the variable CIPHERING_STATUS to FALSE; and
 - 2> clear the variable RB_UPLINK_CIPHERING_ACTIVATION_TIME_INFO;
 - 2> clear the variable SECURITY_MODIFICATION.
- 1> if the received reconfiguration message contained the IE "Integrity protection mode info":
 - 2> set the IE "Reconfiguration" in the variable INTEGRITY_PROTECTION_INFO to FALSE; and
 - 2> clear the variable INTEGRITY_PROTECTION_ACTIVATION_INFO.
- 1> enter idle mode;
- 1> perform the actions specified in subclause 8.5.2 when entering idle mode;
- 1> and the procedure ends.

NOTE: UTRAN should use RB Control messages to perform an SRNS relocation only in case of state transitions from CELL_DCH to CELL_DCH.

8.2.2.13 Invalid received message

If the received reconfiguration message contains a protocol error causing the variable PROTOCOL_ERROR_REJECT to be set to TRUE according to clause 9, the UE shall perform procedure specific error handling as follows. The UE shall:

- 1> transmit a failure response message as specified in subclause 8.2.2.9, setting the information elements as specified below:
 - 2> include the IE "RRC transaction identifier"; and
 - 2> set it to the value of "RRC transaction identifier" in the entry for the received message in the table "Rejected transactions" in the variable TRANSACTIONS; and
 - 2> clear that entry;
 - 2> set the IE "failure cause" to the cause value "protocol error";
 - 2> include the IE "Protocol error information" with contents set to the value of the variable PROTOCOL_ERROR_INFORMATION.

The procedure ends.

8.2.2.14 Radio link failure

If the criteria for radio link failure are met in the old configuration during the reconfiguration procedure as specified in subclause 8.5.6, the UE shall:

- 1> if UE would have entered CELL_PCH or URA_PCH as a result of this reconfiguration procedure and UE has already submitted a response message to lower layers:
 - 2> act as if the reconfiguration message was not received;

- 2> initiate a cell update procedure according to subclause 8.3.1, using the cause "radio link failure";
- 2> the procedure ends.

NOTE: UTRAN should consider the reconfiguration procedure as unsuccessful in this case even if a success response message had been received.

- 1> if the UE would have remained in CELL_DCH state as a result of this reconfiguration procedure:
 - 2> initiate a cell update procedure according to subclause 8.3.1, using the cause "radio link failure";
 - 2> after the cell update procedure has completed successfully:
 - 3> transmit a failure response message as specified in subclause 8.2.2.9, setting the information elements as specified below:
 - 4> include the IE "RRC transaction identifier"; and
 - 4> set it to the value of "RRC transaction identifier" in the entry for the received message in the table "Accepted transactions" in the variable TRANSACTIONS; and
 - 4> clear that entry;
 - 4> set the IE "failure cause" to "physical channel failure".
 - 3> act as if the reconfiguration message was not received;
 - 3> the procedure ends.

If the criteria for radio link failure are met in the new configuration during the reconfiguration procedure (i.e. while UE is waiting for RLC acknowledgement for a response message.) as specified in subclause 8.5.6, the UE shall:

- 1> if the received reconfiguration causes either:
 - the IE "Reconfiguration" in the variable CIPHERING_STATUS to be set to TRUE; and/or
 - the IE "Reconfiguration" in the variable INTEGRITY_PROTECTION_INFO to be set to TRUE;
- 2> perform the actions specified in subclause 8.2.2.12b.
- 1> else, the UE should:
 - 2> release all its radio resources;
 - 2> indicate the release of the established signalling connections (as stored in the variable ESTABLISHED_SIGNALLING_CONNECTIONS) and established radio access bearers (as stored in the variable ESTABLISHED_RABS) to upper layers;
 - 2> clear any entry for the RRC CONNECTION RELEASE message in the tables "Accepted transactions" and "Rejected transactions" in the variable TRANSACTIONS;
 - 2> clear the variable ESTABLISHED_SIGNALLING_CONNECTIONS;
 - 2> clear the variable ESTABLISHED_RABS;
 - 2> enter idle mode;
 - 2> perform the actions specified in subclause 8.5.2 when entering idle mode; and
 - 2> the procedure ends.

8.2.3 Radio bearer release

See subclause 8.2.2 (Reconfiguration procedures).

8.2.4 Transport channel reconfiguration

See subclause 8.2.2 (Reconfiguration procedures).

8.2.5 Transport format combination control

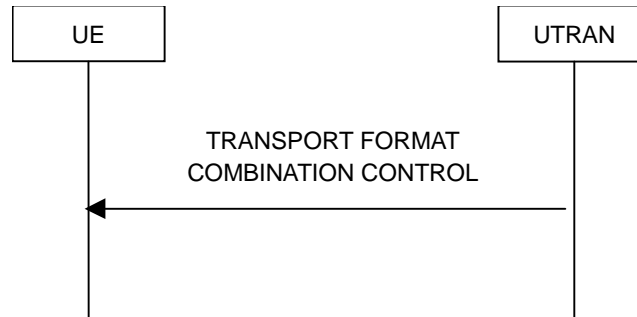

Figure 8.2.5-1: Transport format combination control, normal flow

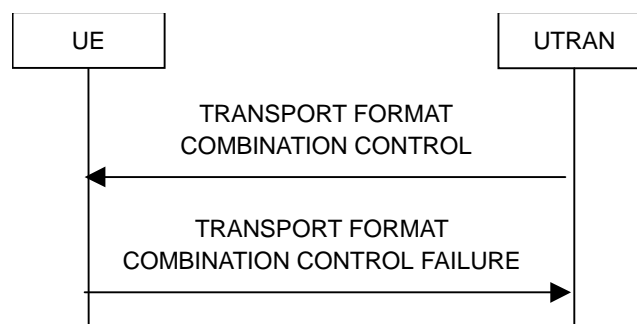

Figure 8.2.5-2: Transport format combination control, failure case

8.2.5.1 General

The transport format combination control procedure is used to control the allowed uplink transport format combinations within the transport format combination set.

8.2.5.2 Initiation

To initiate the transport format combination control procedure, the UTRAN transmits the TRANSPORT FORMAT COMBINATION CONTROL message on the downlink DCCH using AM, UM or TM RLC. When not stated otherwise elsewhere, the UTRAN may initiate the transport format combination control procedure also when another procedure is ongoing, and in that case the state of the latter procedure shall not be affected.

To change the sub-set of allowed transport format combinations, the UTRAN should:

- 1> set the allowed TFCs in the IE "Transport Format Combination subset" ("TFC subset"). The UTRAN may specify the duration for which a new TFC sub-set applies by using the IE "TFC Control duration" and independently may specify the time at which a new TFC sub-set shall be applied using the IE "Activation time for TFC subset".

To remove completely the previous restrictions of allowed transport format combinations, the UTRAN should:

- 1> set the IE "full transport format combination set" in the IE "TFC subset".

8.2.5.3 Reception of a TRANSPORT FORMAT COMBINATION CONTROL message by the UE

If the TRANSPORT FORMAT COMBINATION CONTROL message was received on AM RLC or UM RLC, the UE shall:

- 1> act upon all received information elements as specified in 8.6, unless specified otherwise in the following;
- 1> perform the actions for the transport format combination subset specified in the IE "DPCH/PUSCH TFCS in uplink" according to subclause 8.6.5.3;
- 1> if the IE "UL AMR rate" is included in the message:
 - 2> forward the content of the IE "UL AMR rate" to upper layers.
- 1> if the message is received in CELL_FACH state, and the IE "TFC Control duration" or the IE "Activation time for TFC subset" is present in the message:
 - 2> set the variable INVALID_CONFIGURATION to TRUE.
- 1> if the variable INVALID_CONFIGURATION is set to FALSE:
 - 2> if the IE "TFC Control duration" is included in the message:
 - 3> store the value of the IE "TFC Control duration" in the IE "Duration" in the variable TFC_SUBSET;
 - 3> set the IE "Current TFC subset" (for the CCTrCH indicated by the IE "TFCS Id" in case of TDD) in the variable TFC_SUBSET to the value of the IE "Transport format combination subset";
 - 3> at the CFN indicated by IE "Activation time for TFC subset" apply the transport format combination subset in the IE "Current TFC subset" stored in the variable TFC_SUBSET for the number of (10 ms) frames specified in the IE "Duration";
 - 3> at the end of the time period defined by the IE "Duration" in the variable TFC_SUBSET:
 - 4> if the IE "Current TFC subset" (for the CCTrCH indicated by the IE "TFCS Id" in case of TDD) in the variable TFC_SUBSET has not subsequently been changed by another message:
 - 5> set the value of the IE "Current TFC subset" to the value of the IE "Default TFC subset" in the variable TFC_SUBSET;
 - 5> clear the IE "Duration" in the variable TFC_SUBSET;
 - 5> apply the transport format combination subset in the IE "Current TFC subset" stored in the variable TFC_SUBSET;
 - 2> if the IE "TFC Control duration" is not included in the message:
 - 3> clear the value of the IE "Duration" in the variable TFC_SUBSET;
 - 3> set both the IE "Current TFC subset" and the IE "Default TFC subset" (for the CCTrCH indicated by the IE "TFCS Id" in case of TDD) in the variable TFC_SUBSET to the value of the IE "Transport format combination subset";
 - 3> at the CFN indicated by the IE "Activation time for TFC subset" apply the transport format combination subset in the IE "Current TFC subset" stored in the variable TFC_SUBSET.
 - 2> when the UE enters a state other than CELL_DCH state after the reception of the message:
 - 3> if the CFN indicated by IE "Activation time for TFC subset" has been reached and the time period defined by the IE "Duration" in the variable TFC_SUBSET has not been reached:
 - 4> if the IE "Current TFC subset" (for the CCTrCH indicated by the IE "TFCS Id" in case of TDD) in the variable TFC_SUBSET has not subsequently been changed by another message:
 - 5> set the value of the IE "Current TFC subset" to the value of the IE "Default TFC subset" in the variable TFC_SUBSET;
 - 5> clear the IE "Duration" in the variable TFC_SUBSET;
 - 5> apply the transport format combination subset in the IE "Current TFC subset" stored in the variable TFC_SUBSET.

- 3> if the CFN indicated by IE "Activation time for TFC subset" has not been reached:
 - 4> if the IE "TFC Control duration" is not included in the message:
 - 5> apply the transport format combination subset in the IE "Current TFC subset" stored in the variable TFC_SUBSET.
 - 4> if the IE "TFC Control duration" is included in the message, and if the IE "Current TFC subset" (for the CCTrCH indicated by the IE "TFCS Id" in case of TDD) in the variable TFC_SUBSET has not subsequently been changed by another message:
 - 5> set the value of the IE "Current TFC subset" to the value of the IE "Default TFC subset" in the variable TFC_SUBSET;
 - 5> clear the IE "Duration" in the variable TFC_SUBSET;
 - 5> apply the transport format combination subset in the IE "Current TFC subset" stored in the variable TFC_SUBSET.

If the TRANSPORT FORMAT COMBINATION CONTROL message was received on TM RLC, the UE shall:

- 1> if the IE "TFC subset identity" identifies one of the TFC subsets stored in the IE "TFC subset list" in the variable TFC_SUBSET:
 - 2> perform the actions as specified in subclause 8.6.5.3;
 - 2> if the variable INVALID_CONFIGURATION is set to FALSE:
 - 3> in the variable TFC_SUBSET, set the IE "Current TFC subset" and the IE "default TFC subset" to the value of the IE "TFC subset" in "TFC subset list" which is identified by the IE "TFC subset identity";
 - 3> clear the IE "Duration" in the variable TFC_SUBSET;
 - 3> apply the transport format combination subset in the IE "Current TFC subset" stored in the variable TFC_SUBSET.
- 1> if the IE "TFC subset identity" is greater than the maximum number of TFC subsets stored in the IE "TFC subset list" in the variable TFC_SUBSET:
 - 2> set the variable INVALID_CONFIGURATION to TRUE.

NOTE: The UTRAN should only send the TRANSPORT FORMAT COMBINATION CONTROL message on TM RLC in order to control the rate of TM RBs (for example, carrying multi-rate AMR or WB-AMR) otherwise the UE behaviour is not specified.

The UE shall:

- 1> clear the entry for the TRANSPORT FORMAT COMBINATION CONTROL message in the table "Accepted transactions" in the variable TRANSACTIONS;
- 1> and the procedure ends.

8.2.5.4 Invalid configuration

If the variable INVALID_CONFIGURATION is set to TRUE due to the received TRANSPORT FORMAT COMBINATION CONTROL message the UE shall:

- 1> if the TRANSPORT FORMAT COMBINATION CONTROL message was received on AM RLC:
 - 2> keep the TFC subset existing before the TRANSPORT FORMAT COMBINATION CONTROL message was received;
 - 2> transmit a TRANSPORT FORMAT COMBINATION CONTROL FAILURE message on the DCCH using AM RLC;

- 2> set the IE "RRC transaction identifier" in the TRANSPORT FORMAT COMBINATION CONTROL FAILURE message to the value of "RRC transaction identifier" in the entry for the TRANSPORT FORMAT COMBINATION CONTROL message in the table "Accepted transactions" in the variable TRANSACTIONS; and
 - 2> clear that entry;
 - 2> set the IE "failure cause" to "invalid configuration";
 - 2> when the TRANSPORT FORMAT COMBINATION CONTROL FAILURE message has been submitted to lower layers for transmission the procedure ends.
- 1> if the TRANSPORT FORMAT COMBINATION CONTROL message was received on UM RLC or TM RLC:
 - 2> ignore the TRANSPORT FORMAT COMBINATION CONTROL message;
 - 2> clear the entry for the TRANSPORT FORMAT COMBINATION CONTROL message in the table "Accepted transactions" in the variable TRANSACTIONS.

8.2.5.5 Invalid TRANSPORT FORMAT COMBINATION CONTROL message

If the TRANSPORT FORMAT COMBINATION CONTROL message was received on AM RLC or UM RLC and contains a protocol error causing the variable `PROTOCOL_ERROR_REJECT` to be set to `TRUE` according to clause 9, the UE shall perform procedure specific error handling as follows. The UE shall:

- 1> transmit a TRANSPORT FORMAT COMBINATION CONTROL FAILURE message on the uplink DCCH using AM RLC setting the information elements as specified below:
 - 2> set the IE "RRC transaction identifier" in the TRANSPORT FORMAT COMBINATION CONTROL FAILURE message to the value of "RRC transaction identifier" in the entry for the TRANSPORT FORMAT COMBINATION CONTROL message in the table "Rejected transactions" in the variable TRANSACTIONS; and
 - 2> clear that entry;
 - 2> set the IE "failure cause" to the cause value "protocol error";
 - 2> include the IE "Protocol error information" with contents set to the value of the variable `PROTOCOL_ERROR_INFORMATION`.
- 1> when the TRANSPORT FORMAT COMBINATION CONTROL FAILURE message has been submitted to lower layers for transmission:
 - 2> continue with any ongoing processes and procedures as if the invalid TRANSPORT FORMAT COMBINATION CONTROL message has not been received;
 - 2> and the procedure ends.

If the TRANSPORT FORMAT COMBINATION CONTROL message was received on TM RLC and contains a protocol error causing the variable `PROTOCOL_ERROR_REJECT` to be set to `TRUE` according to clause 9, the UE shall perform procedure specific error handling as follows. The UE shall:

- 1> ignore the invalid TRANSPORT FORMAT COMBINATION CONTROL message as if it has not been received;
- 1> the procedure ends.

8.2.6 Physical channel reconfiguration

See subclause 8.2.2 Reconfiguration procedures.

8.2.7 Physical Shared Channel Allocation [TDD only]



Figure 8.2.7-1: Physical Shared Channel Allocation

8.2.7.1 General

The purpose of this procedure is to allocate radio resources to USCH and/or DSCH transport channels in TDD mode, for use by a UE. This procedure can also be used to indicate to the UE, that a PUSCH allocation is pending, in order to prevent further capacity requests from the UE.

UEs are not required to receive FACH and DSCH simultaneously, i.e. if resources are allocated to DSCH the FACH reception may be suspended.

8.2.7.2 Initiation

To initiate the Physical Shared Channel Allocation procedure, the UTRAN sends the "PHYSICAL SHARED CHANNEL ALLOCATION" message on the downlink SHCCH or on the downlink DCCH using UM RLC. The DSCH-RNTI shall be included for UE identification, if the message is sent on the SHCCH.

8.2.7.3 Reception of a PHYSICAL SHARED CHANNEL ALLOCATION message by the UE

Upon reception of a "PHYSICAL SHARED CHANNEL ALLOCATION" message, if the message is received on the downlink SHCCH the UE shall:

- 1> check the DSCH-RNTI to see if the UE is addressed by the message;
- 1> if the UE is addressed by the message, or if the message is received on the downlink DCCH:
 - 2> perform the following actions.
- 1> otherwise:
 - 2> ignore the message.
- 1> act upon all received information elements as specified in subclause 8.6, unless specified otherwise in the following:
 - 1> if the IE "ISCP Timeslot list" is included:
 - 2> store the timeslot numbers given there for future Timeslot ISCP measurements and reports in the variable PHYSICAL_SHARED_CHANNEL_CONFIGURATION.
 - 1> if the IE "PDSCH capacity allocation info" is included:
 - 2> configure the physical resources used for the downlink CCTrCH given by the IE "TFCS ID" according to the following:
 - 3> if the CHOICE "Configuration" has the value "Old configuration":
 - 4> if the UE has stored a PDSCH configuration in the variable PHYSICAL_SHARED_CHANNEL_CONFIGURATION with the identity given by the IE "PDSCH Identity":
 - 5> configure the physical resources according to that configuration.

- 4> otherwise:
 - 5> ignore the IE "PDSCH capacity allocation info".
- 3> if the CHOICE "Configuration" has the value "New configuration":
 - 4> configure the physical resources according to the information given in IE "PDSCH Info". If IE "Common timeslot info" or IE "PDSCH timeslots and codes" IE are not present in IE "PDSCH Info":
 - 5> reuse the configuration stored in the variable PHYSICAL_SHARED_CHANNEL_CONFIGURATION for this CCTrCH.
 - 4> if the IE "PDSCH Identity" is included:
 - 5> store the new configuration in the variable PHYSICAL_SHARED_CHANNEL_CONFIGURATION using that identity.
- 2> start using the new configuration at the CFN specified by the IE "Allocation activation time", and use that for the duration given by the IE "Allocation duration";
- 2> if the IE "Confirm request" has the value "Confirm PDSCH" and IE "PDSCH Identity" is included in IE "PDSCH capacity allocation info":
 - 3> initiate the PUSCH CAPACITY REQUEST procedure as described in subclause 8.2.8.
- 1> if the IE "PUSCH capacity allocation info" is included:
 - 2> stop the timer T310, if running;
 - 2> if the CHOICE "PUSCH allocation" has the value "PUSCH allocation pending":
 - 3> start the timer T311.
 - 2> if the CHOICE "PUSCH allocation" has the value "PUSCH allocation assignment":
 - 3> stop the timer T311, if running;
 - 3> configure the physical resources used for the uplink CCTrCH given by the IE "TFCS ID" according to the following:
 - 4> if the CHOICE "Configuration" has the value "Old configuration":
 - 5> if the UE has stored a PUSCH configuration with the identity given by the IE "PUSCH Identity" in the variable PHYSICAL_SHARED_CHANNEL_CONFIGURATION:
 - 6> configure the physical resources according to that configuration.
 - 5> otherwise:
 - 6> ignore the IE "PUSCH capacity allocation info".
 - 4> if the CHOICE "Configuration" has the value "New configuration", the UE shall:
 - 5> configure the physical resources according to the information given in IE "PUSCH Info". If IE "Common timeslot info" or IE "PUSCH timeslots and codes" is not present in IE "PUSCH Info":
 - 6> reuse the configuration stored in the variable PHYSICAL_SHARED_CHANNEL_CONFIGURATION for this CCTrCH.
 - 5> if the IE "PUSCH Identity" is included:
 - 6> store the new configuration in the variable PHYSICAL_SHARED_CHANNEL_CONFIGURATION using that identity.
 - 3> if the IE "PUSCH power control info" is present in this message and includes the parameter "UL target SIR" for 3.84 Mcps TDD or 7.68 Mcps TDD, or the parameters "PRX_{PUSCHdes}" and "Beacon PL Est. " and

"TPC Step Size" for 1.28 Mcps TDD, or the parameters are stored in the variable PHYSICAL SHARED CHANNEL CONFIGURATION for this CCTrCH:

- 4> start using the new configuration at the CFN specified by the IE "Allocation activation time", and use that for the duration given by the IE "Allocation duration".
 - 3> otherwise:
 - 4> ignore the IE "PUSCH capacity allocation info".
 - 3> if the IE "PUSCH power control info" is present in this message and includes the parameter "UL target SIR" for 3.84 Mcps TDD or 7.68 Mcps TDD, or the parameters "PRX_{PUSCHdes}" and/or "Beacon PL Est. " and/or "TPC Step Size" for 1.28 Mcps TDD:
 - 4> replace the parameters "UL target SIR" or "PRX_{PUSCHdes}" or "TPC Step Size" stored in the variable PHYSICAL SHARED CHANNEL CONFIGURATION for this CCTrCH with the signalled values.
 - 3> if the IE "Traffic volume report request " is included:
 - 4> initiate the PUSCH CAPACITY REQUEST procedure as described in subclause 8.2.8 at the time indicated by the IE "Traffic volume report request".
 - 3> if the IE "Confirm request" has the value "Confirm PUSCH" and IE "PUSCH Identity" is included in IE "PUSCH capacity allocation info":
 - 4> initiate the PUSCH CAPACITY REQUEST procedure as described in subclause 8.2.8.
 - 3> determine the TFCS subset and hence the TFCI values which are possible given the PUSCH allocation for that CCTrCH;
 - 3> configure the MAC-c/sh in the UE with this TFCS restriction if necessary;
 - 3> transmit USCH Transport Block Sets as required, within the TFCS limits given by the PUSCH allocation.
- NOTE: If the UE has just entered a new cell and System Information Block Type 6 has not yet been scheduled, PUSCH/PDSCH information should be specified in the allocation message.

The UE shall:

- 1> clear the entry for the PHYSICAL SHARED CHANNEL ALLOCATION message in the table "Accepted transactions" in the variable TRANSACTIONS;
- 1> and the procedure ends.

8.2.7.4 Invalid PHYSICAL SHARED CHANNEL ALLOCATION message

If the UE receives a PHYSICAL SHARED CHANNEL ALLOCATION message, which contains a protocol error causing the variable PROTOCOL_ERROR_REJECT to be set to TRUE according to clause 9, the UE shall perform procedure specific error handling as follows. The UE shall:

- 1> ignore the invalid PHYSICAL SHARED CHANNEL ALLOCATION message;
- 1> submit the PUSCH CAPACITY REQUEST message for transmission on the uplink SHCCH, setting the information elements in the message as specified in subclause 8.2.8.3;
- 1> reset counter V310;
- 1> start timer T310;
- 1> proceed as described in subclause 8.2.8.

8.2.8 PUSCH capacity request [TDD only]

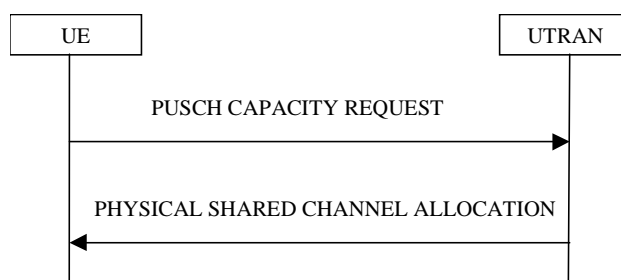

Figure 8.2.8-1: PUSCH Capacity request procedure

8.2.8.1 General

With this procedure, the UE transmits its request for PUSCH resources to the UTRAN. In the normal case, the UTRAN responds with a PHYSICAL SHARED CHANNEL ALLOCATION message, which either allocates the requested PUSCH resources, and/or allocates a PDSCH resource, or may just serve as an acknowledgement, indicating that PUSCH allocation is pending.

This procedure can also be used to acknowledge the reception of a PHYSICAL SHARED CHANNEL ALLOCATION message, or to indicate a protocol error in that message.

With the PUSCH CAPACITY REQUEST message, the UE can request capacity for one or more USCH.

8.2.8.2 Initiation

This procedure is initiated:

- 1> in the CELL_FACH or CELL_DCH state;
- 1> and when at least one RB using USCH has been established;
- 1> and when the UE sees the requirement to request physical resources (PUSCH) for an USCH channel or there is the need to reply to a PHYSICAL SHARED CHANNEL ALLOCATION message as described in clause 8.2.7 (i.e. to confirm the reception of a message, if requested to do so, or to indicate a protocol error).

The procedure can be initiated if:

- Timer T311 is not running.
- The timer T310 (capacity request repetition timer) is not running.

The UE shall:

- 1> set the IEs in the PUSCH CAPACITY REQUEST message according to subclause 8.2.8.3;
- 1> if the procedure is triggered to reply to a previous PHYSICAL SHARED CHANNEL ALLOCATION message by the IE "Confirm request" set to "Confirm PUSCH" and the IE "PUSCH capacity allocation info" is not present:
 - 2> transmit the PUSCH CAPACITY REQUEST message on RACH.
- 1> else:
 - 2> transmit the PUSCH CAPACITY REQUEST message on the uplink SHCCH.
- 1> set counter V310 to 1;
- 1> start timer T310.

8.2.8.3 PUSCH CAPACITY REQUEST message contents to set

With one PUSCH CAPACITY REQUEST message, capacity for one or more USCH can be requested. It shall include these information elements:

- 1> DSCH-RNTI to be used as UE identity if the message is sent on RACH;
- 1> Traffic volume measured results for each radio bearer satisfying the reporting criteria as specified in the MEASUREMENT CONTROL procedure (if no radio bearer satisfies the reporting criteria, traffic volume measured results shall not be included). These results shall include:
 - 2> Radio Bearer ID of the Radio Bearer being reported;
 - 2> RLC buffer payload for these radio bearers, as specified by the MEASUREMENT CONTROL procedure.

The UE shall:

- 1> if the initiation of the procedure is triggered by the IE "Traffic volume report request" in a previously received PHYSICAL SHARED CHANNEL ALLOCATION message:
 - 2> report the traffic volume measurement result for the radio bearer mapped on USCH transport channel specified in the received message. These results shall include:
 - 3> Radio Bearer ID of the Radio Bearer being reported;
 - 3> RLC buffer payload for this radio bearer.
- 1> if the initiation of the procedure is triggered by the IE "Confirm request" set to "Confirm PDSCH" in a previously received PHYSICAL SHARED CHANNEL ALLOCATION message and the IE "PUSCH capacity allocation info" is present in this message:
 - 2> set the CHOICE "Allocation confirmation" to "PDSCH Confirmation" with the value given in the IE "PDSCH Identity" stored in the variable PHYSICAL_SHARED_CHANNEL_CONFIGURATION.
- 1> if the initiation of the procedure is triggered by the IE "Confirm request" set to "Confirm PUSCH" in a previously received PHYSICAL SHARED CHANNEL ALLOCATION message:
 - 2> set the CHOICE "Allocation confirmation" to "PUSCH Confirmation" with the value given in the IE "PUSCH Identity" stored in the variable PHYSICAL_SHARED_CHANNEL_CONFIGURATION.
- 1> if the variable PROTOCOL_ERROR_REJECT is set to TRUE:
 - 2> include the IE "RRC transaction identifier" in the response message transmitted below; and
 - 2> set it to the value of "RRC transaction identifier" in the entry for the PHYSICAL SHARED CHANNEL ALLOCATION message in the table "Rejected transactions" in the variable TRANSACTIONS; and
 - 2> clear that entry;
 - 2> set the IE "protocol error indicator" to TRUE;
 - 2> include the IE "Protocol error information" with contents set to the value of the variable PROTOCOL_ERROR_INFORMATION.
- 1> if the value of the variable PROTOCOL_ERROR_REJECT is FALSE:
 - 2> set the IE "Protocol error indicator" to FALSE.

As an option, the message may include IE "Timeslot ISCP" and IE "Primary CCPCH RSCP".

The timeslots for which "Timeslot ISCP" may be reported shall have been configured with a previous PHYSICAL SHARED CHANNEL ALLOCATION message and stored in the variable PHYSICAL_SHARED_CHANNEL_CONFIGURATION.

"Primary CCPCH RSCP" is reported when requested with a previous PHYSICAL SHARED CHANNEL ALLOCATION message.

8.2.8.4 Reception of a PUSCH CAPACITY REQUEST message by the UTRAN

Upon receiving a PUSCH CAPACITY REQUEST message with traffic volume measurement included for at least one radio bearer, the UTRAN should initiate the PHYSICAL SHARED CHANNEL ALLOCATION procedure, either for allocating PUSCH or PDSCH resources as required, or just as an acknowledgement, indicating a pending PUSCH allocation, as described in subclause 8.2.7.

8.2.8.5 T310 expiry

Upon expiry of timer T310, the UE shall:

- 1> if V310 is smaller than N310:
 - 2> transmit a new PUSCH CAPACITY REQUEST message on the Uplink SHCCH;
 - 2> restart timer T310;
 - 2> increment counter V310;
 - 2> set the IEs in the PUSCH CAPACITY REQUEST message as specified in subclause 8.2.8.3.
- 1> if V310 is greater than or equal to N310:
 - 2> the procedure ends.

8.2.9 Void

8.2.10 Uplink Physical Channel Control [TDD only]

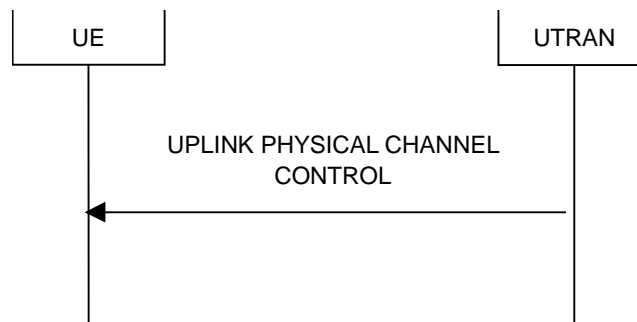

Figure 8.2.10-1: Uplink Physical Channel Control

8.2.10.1 General

The uplink physical channel control procedure is used in TDD to control the uplink outer loop power control and timing advance running in the UE.

8.2.10.2 Initiation

The UTRAN initiates the procedure by transmitting the UPLINK PHYSICAL CHANNEL CONTROL message on the downlink DCCH using AM or UM RLC in order to update parameters for uplink open loop power control in the UE for one CCTrCH or to inform the UE about a new timing advance value to be applied. Especially, uplink interference information measured by the UTRAN can be included for the uplink timeslots used for the CCTrCH.

8.2.10.3 Reception of UPLINK PHYSICAL CHANNEL CONTROL message by the UE

Upon reception of the UPLINK PHYSICAL CHANNEL CONTROL message, the UE shall:

- 1> act upon all received information elements as specified in subclause 8.6.

In 1.28 Mcps TDD, if the IE "Uplink DPCH Power Control Info" and IE "PRX_{HS-SICH}" and IE "TPC step size" are transmitted, this information shall be taken into account by the UE for uplink open loop power control and for uplink closed loop power control as described in subclause 8.6.6.11, and the "PRX_{HS-SICH}" shall be taken into account by the UE for open loop power control as described in subclause 8.5.7 and the "TPC step size" for closed loop power control on HS-SICH.

In 3.84 Mcps TDD or 7.68 Mcps TDD, if the IEs "Uplink DPCH Power Control Info", "PRACH Constant Value", "PUSCH Constant Value", "HS-SICH Power Control Info", "Alpha" or IE group "list of UL Timeslot Interference" are transmitted, this information shall be taken into account by the UE for uplink open loop power control as specified in subclause 8.5.7. If the UE is capable of using IPDLs for UE positioning, the IE "IPDL-Alpha" shall be used instead of the IE "Alpha". If the IE "IPDL-Alpha" parameter is not present, the UE shall use IE "Alpha".

If the IE Special Burst Scheduling is transmitted the UE shall:

- 1> use the new value for the "Special Burst Generation Period".

The UE shall:

- 1> clear the entry for the UPLINK PHYSICAL CHANNEL CONTROL message in the table "Accepted transactions" in the variable TRANSACTIONS;
- 1> and the procedure ends.

8.2.10.4 Invalid UPLINK PHYSICAL CHANNEL CONTROL message

If the UE receives a UPLINK PHYSICAL CHANNEL CONTROL message, which contains a protocol error causing the variable `PROTOCOL_ERROR_REJECT` to be set to TRUE according to clause 9, the UE shall perform procedure specific error handling as follows. The UE shall:

- 1> transmit an RRC STATUS message on the uplink DCCH using AM RLC, setting the information elements as specified below:
 - 2> include the IE "Identification of received message"; and
 - 2> set the IE "Received message type" to UPLINK PHYSICAL CHANNEL CONTROL; and
 - 2> set the IE "RRC transaction identifier" to the value of "RRC transaction identifier" in the entry for the UPLINK PHYSICAL CHANNEL CONTROL message in the table "Rejected transactions" in the variable TRANSACTIONS; and
 - 2> clear that entry;
 - 2> include the IE "Protocol error information" with contents set to the value of the variable `PROTOCOL_ERROR_INFORMATION`.
- 1> when the RRC STATUS message has been submitted to lower layers for transmission:
 - 2> continue with any ongoing processes and procedures as if the invalid UPLINK PHYSICAL CHANNEL CONTROL message has not been received.

8.2.11 Physical channel reconfiguration failure

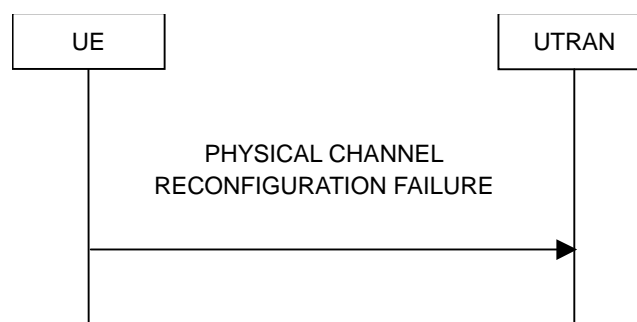

Figure 8.2.11-1: Physical channel reconfiguration failure in case of runtime configuration error

8.2.11.1 General

The physical channel reconfiguration failure procedure is used to indicate to the network a runtime configuration error in the UE.

8.2.11.2 Runtime error due to overlapping compressed mode configurations

When the UE has received from the UTRAN the configurations of several compressed mode transmission gap pattern sequences, and if several of these patterns are to be simultaneously active, the UE shall check to see if these simultaneously active transmission gap pattern sequences create transmission gaps in the same frame. An illegal overlap is created if two or more transmission gap pattern sequences create transmission gaps in the same frame, irrespective of the gaps are created in uplink or downlink.

If the parallel transmission gap pattern sequences create an illegal overlap, the UE shall:

- 1> delete the overlapping transmission gap pattern sequence configuration stored in the variable TGPS_IDENTITY, which is associated with the highest value of IE "TGPSI";
- 1> transmit a PHYSICAL CHANNEL RECONFIGURATION FAILURE message on the DCCH using AM RLC, setting the information elements as specified below:
 - 2> not include the IE "RRC transaction identifier";
 - 2> set the cause value in IE "failure cause" to value "compressed mode runtime error".
- 1> terminate the inter-frequency and/or inter-RAT measurements corresponding to the deleted transmission gap pattern sequence;
- 1> when the PHYSICAL CHANNEL RECONFIGURATION FAILURE message has been submitted to lower layers for transmission:
 - 2> the procedure ends.

8.2.11.3 Void

8.3 RRC connection mobility procedures

8.3.1 Cell and URA update procedures

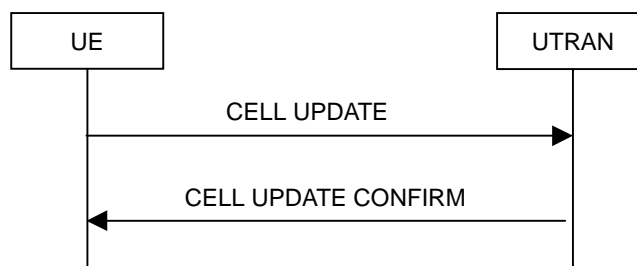

Figure 8.3.1-1: Cell update procedure, basic flow

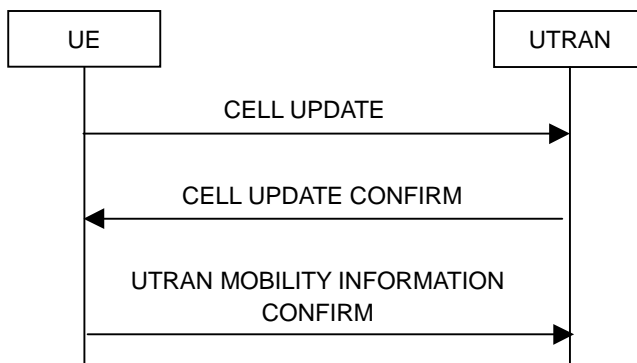

Figure 8.3.1-2: Cell update procedure with update of UTRAN mobility information

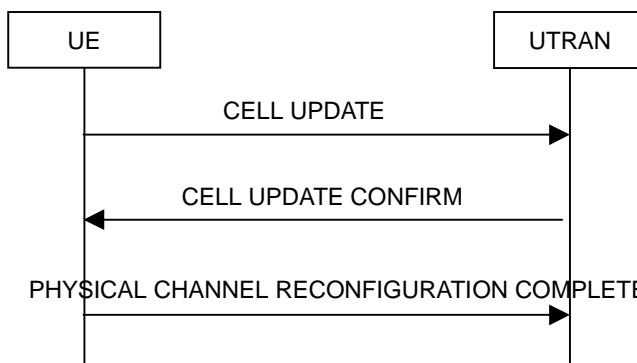

Figure 8.3.1-3: Cell update procedure with physical channel reconfiguration

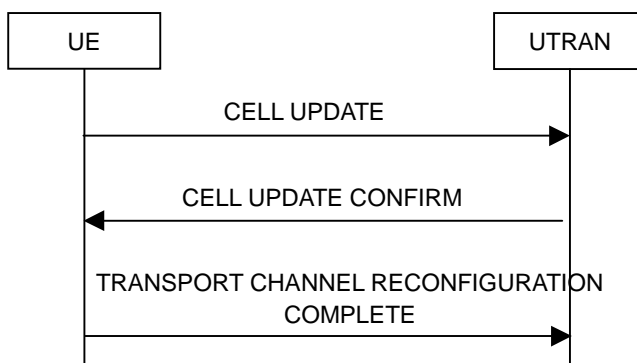

Figure 8.3.1-4: Cell update procedure with transport channel reconfiguration

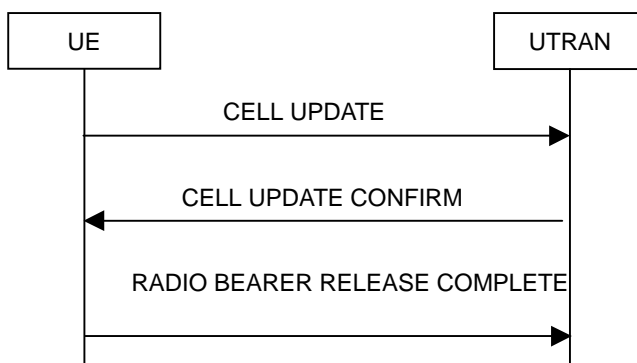

Figure 8.3.1-5: Cell update procedure with radio bearer release

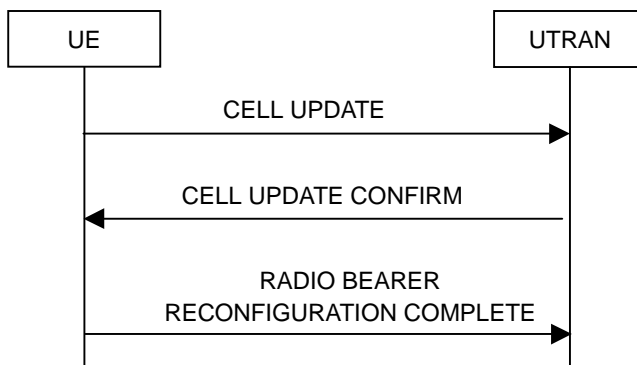

Figure 8.3.1-6: Cell update procedure with radio bearer reconfiguration

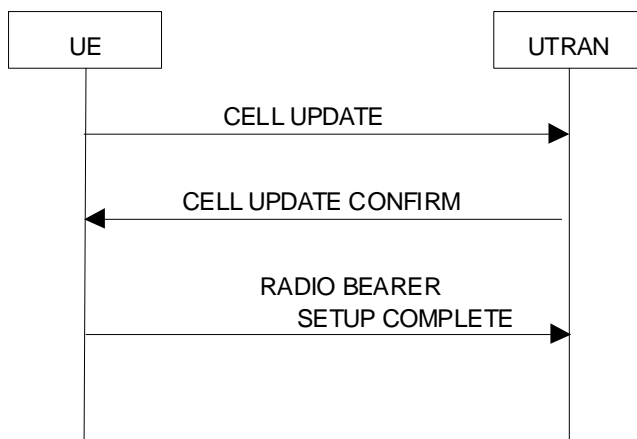

Figure 8.3.1-6a: Cell update procedure with radio bearer setup

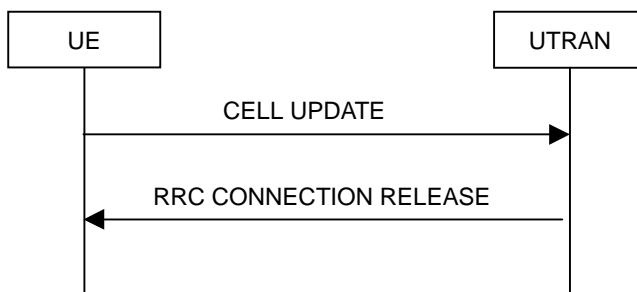

Figure 8.3.1-7: Cell update procedure, failure case

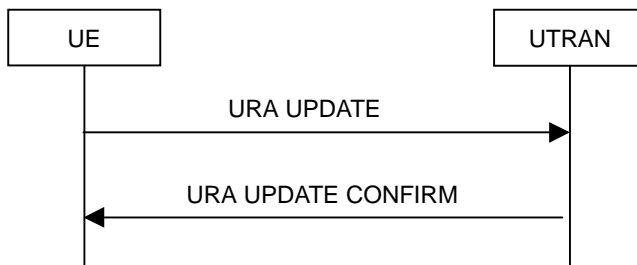

Figure 8.3.1-8: URA update procedure, basic flow

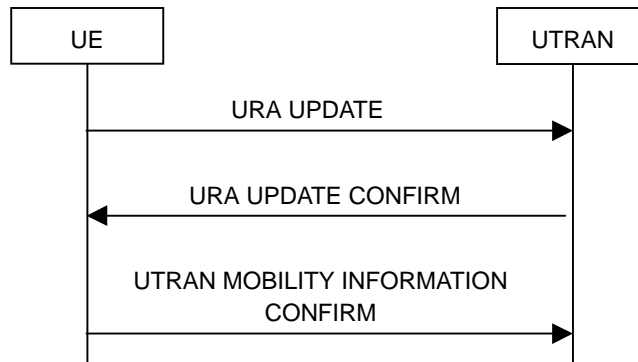

Figure 8.3.1-9: URA update procedure with update of UTRAN mobility information

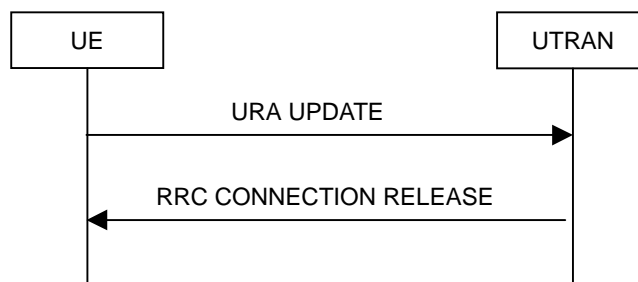

Figure 8.3.1-10: URA update procedure, failure case

8.3.1.1 General

The URA update and cell update procedures serve several main purposes:

- to notify UTRAN after re-entering service area in the URA_PCH or CELL_PCH state;
- to notify UTRAN of an RLC unrecoverable error [16] on an AM RLC entity;
- to be used as a supervision mechanism in the CELL_FACH, CELL_PCH, or URA_PCH state by means of periodical update.

In addition, the URA update procedure also serves the following purpose:

- to retrieve a new URA identity after cell re-selection to a cell not belonging to the current URA assigned to the UE in URA_PCH state.

In addition, the cell update procedure also serves the following purposes:

- to update UTRAN with the current cell the UE is camping on after cell reselection;
- to act on a radio link failure in the CELL_DCH state;
- to act on the transmission failure of the UE CAPABILITY INFORMATION message;
- for FDD and 1.28 Mcps TDD, if the variable H_RNTI is not set, and for 3.84 Mcps TDD and 7.68 Mcps TDD: when triggered in the URA_PCH or CELL_PCH state, to notify UTRAN of a transition to the CELL_FACH state due to the reception of UTRAN originated paging or due to a request to transmit uplink data;
- to count the number of UEs in URA_PCH, CELL_PCH and CELL_FACH that are interested to receive an MBMS transmission;
- when triggered in the URA_PCH, CELL_PCH and CELL_FACH state, to notify UTRAN of the UEs interest to receive an MBMS service;
- to request the MBMS P-T-P RB setup by the UE in CELL_PCH, URA_PCH and CELL_FACH state.

The URA update and cell update procedures may:

1> include an update of mobility related information in the UE;

1> cause a state transition from the CELL_FACH state to the CELL_DCH, CELL_PCH or URA_PCH states or idle mode.

The cell update procedure may also include:

- a re-establish of AM RLC entities;
- a re-establish of UM RLC entities;
- a radio bearer release, radio bearer reconfiguration, transport channel reconfiguration or physical channel reconfiguration.

8.3.1.2 Initiation

A UE shall initiate the cell update procedure in the following cases:

1> Uplink data transmission:

2> for FDD and 1.28 Mcps TDD, if the variable H_RNTI is not set, and for 3.84 Mcps TDD and 7.68 Mcps TDD:

3> if the UE is in URA_PCH or CELL_PCH state; and

3> if timer T320 is not running:

4> if the UE has uplink RLC data PDU or uplink RLC control PDU on RB1 or upwards to transmit:

5> perform cell update using the cause "uplink data transmission".

3> else:

4> if the variable ESTABLISHMENT_CAUSE is set:

5> perform cell update using the cause "uplink data transmission".

1> Paging response:

2> if the criteria for performing cell update with the cause specified above in the current subclause are not met; and

2> if the UE in URA_PCH or CELL_PCH state, receives a PAGING TYPE 1 message fulfilling the conditions for initiating a cell update procedure specified in subclause 8.1.2.3:

3> perform cell update using the cause "paging response".

1> Radio link failure:

2> if none of the criteria for performing cell update with the causes specified above in the current subclause is met:

3> if the UE is in CELL_DCH state and the criteria for radio link failure are met as specified in subclause 8.5.6; or

3> if the transmission of the UE CAPABILITY INFORMATION message fails as specified in subclause 8.1.6.6; or

3> if the UE detects PDCP Unrecoverable Error [36] in a PDCP entity:

4> perform cell update using the cause "radio link failure".

1> MBMS ptp RB request:

2> if none of the criteria for performing cell update with the causes specified above in the current subclause is met; and

- 2> if the UE is in URA_PCH, Cell_PCH or Cell_FACH state; and
- 2> if timer T320 is not running; and
- 2> if the UE should perform cell update for MBMS ptp radio bearer request as specified in subclause 8.6.9.6:
 - 3> perform cell update using the cause "MBMS ptp RB request".
- 1> Re-entering service area:
 - 2> if none of the criteria for performing cell update with the causes specified above in the current subclause is met; and
 - 2> if the UE is in CELL_FACH or CELL_PCH state; and
 - 2> if the UE has been out of service area and re-enters service area before T307 or T317 expires:
 - 3> perform cell update using the cause "re-entering service area".
- 1> RLC unrecoverable error:
 - 2> if none of the criteria for performing cell update with the causes specified above in the current subclause is met; and
 - 2> if the UE detects RLC unrecoverable error [16] in an AM RLC entity:
 - 3> perform cell update using the cause "RLC unrecoverable error".
- 1> Cell reselection:
 - 2> if none of the criteria for performing cell update with the causes specified above in the current subclause is met:
 - 3> if the UE is in CELL_FACH or CELL_PCH state and the UE performs cell re-selection; or
 - 3> if the UE is in CELL_FACH state and the variable C_RNTI is empty:
 - 4> perform cell update using the cause "cell reselection".
- 1> Periodical cell update:
 - 2> if none of the criteria for performing cell update with the causes specified above in the current subclause is met; and
 - 2> if the UE is in CELL_FACH or CELL_PCH state; and
 - 2> if the timer T305 expires; and
 - 2> if the criteria for "in service area" as specified in subclause 8.5.5.2 are fulfilled; and
 - 2> if periodic updating has been configured by T305 in the IE "UE Timers and constants in connected mode" set to any other value than "infinity":
 - 3> for FDD:
 - 4> if the variable COMMON_E_DCH_TRANSMISSION is set to FALSE:
 - 5> perform cell update using the cause "periodical cell update".
 - 4> else:
 - 5> restart the timer T305;
 - 5> and end the procedure.
 - 3> for 1.28 Mcps TDD and 3.84/7.68 Mcps TDD:
 - 4> perform cell update using the cause "periodical cell update".

1> MBMS reception:

- 2> if none of the criteria for performing cell update with the causes specified above in the current subclause is met; and
- 2> if the UE is in URA_PCH, Cell_PCH or Cell_FACH state; and
- 2> if the UE should perform cell update for MBMS counting as specified in subclause 8.7.4:
 - 3> perform cell update using the cause "MBMS reception".

A UE in URA_PCH state shall initiate the URA update procedure in the following cases:

1> URA reselection:

- 2> if the UE detects that the current URA assigned to the UE, stored in the variable URA_IDENTITY, is not present in the list of URA identities in system information block type 2; or
- 2> if the list of URA identities in system information block type 2 is empty; or
- 2> if the system information block type 2 can not be found:
 - 3> perform URA update using the cause "change of URA".

1> Periodic URA update:

- 2> if the criteria for performing URA update with the causes as specified above in the current subclause are not met:
 - 3> if the timer T305 expires and if periodic updating has been configured by T305 in the IE "UE Timers and constants in connected mode" set to any other value than "infinity"; or
 - 3> if the conditions for initiating an URA update procedure specified in subclause 8.1.1.6.5 are fulfilled:
 - 4> perform URA update using the cause "periodic URA update".

When initiating the URA update or cell update procedure, the UE shall:

1> if timer T320 is running:

- 2> stop timer T320;
- 2> if the UE has uplink RLC data PDU or uplink RLC control PDU on RB1 or upwards to transmit:
 - 3> perform cell update using the cause "uplink data transmission".
- 2> else:
 - 3> if the cell update procedure is not triggered due to Paging response or Radio link failure; and
 - 3> if the UE should perform cell update for MBMS ptp radio bearer request as specified in subclause 8.6.9.6:
 - 4> perform cell update using the cause "MBMS ptp RB request".

1> stop timer T319 if it is running;

1> stop timer T305;

1> for FDD and 1.28 Mcps TDD:

- 2> if the UE is in CELL_FACH state; and
- 2> if the IE "HS-DSCH common system information" is included in System Information Block type 5 or System Information Block type 5bis; and
- 2> for 1.28 Mcps TDD, if IE "Common E-DCH system info" in System Information Block type 5; and
- 2> if the UE does support HS-DSCH reception in CELL_FACH state:

- 3> if variable H_RNTI is not set or variable C_RNTI is not set; or
- 3> for FDD, an unrecoverable error [16] in an AM RLC entity is detected:
 - 4> clear variable H_RNTI;
 - 4> clear variable C_RNTI;
 - 4> clear variable E_RNTI;
 - 4> clear any stored IEs "HARQ info";
 - 4> set variable HS_DSCH_RECEPTION_OF_CCCH_ENABLED to TRUE;
 - 4> and start receiving the HS-DSCH transport channels mapped physical channel(s) of type HS-SCCH and HS-PDSCH, by using parameters given by the IE(s) "HS-DSCH common system information" according to the procedure in subclause 8.5.37.
- 3> else:
 - 4> receive the HS-DSCH transport channels mapped physical channel(s) of type HS-SCCH and HS-PDSCH, by using parameters given by the IE(s) "HS-DSCH common system information" according to the procedure in subclause 8.5.36;
 - 4> determine the value for the HSPA_RNTI_STORED_CELL_PCH variable and take the corresponding actions as described in subclause 8.5.56;
 - 4> determine the value for the READY_FOR_COMMON_EDCH variable and take the corresponding actions as described in subclause 8.5.47;
 - 4> determine the value for the COMMON_E_DCH_TRANSMISSION variable and take the corresponding actions as described in subclause 8.5.46;
 - 4> if variable READY_FOR_COMMON_EDCH is set to TRUE:
 - 5> configure the Enhanced Uplink in CELL_FACH state and Idle mode as specified in subclause 8.5.45 for FDD and 8.5.45a for 1.28 Mcps TDD.
- 1> if the UE is in CELL_DCH state:
 - 2> in the variable RB_TIMER_INDICATOR, set the IE "T314 expired" and the IE "T315 expired" to FALSE;
 - 2> if the stored values of the timer T314 and timer T315 are both equal to zero; or
 - 2> if the stored value of the timer T314 is equal to zero and there are no radio bearers associated with any radio access bearers for which in the variable ESTABLISHED_RABS the value of the IE "Re-establishment timer" is set to "useT315" and signalling connection exists only to the CS domain:
 - 3> release all its radio resources;
 - 3> indicate release (abort) of the established signalling connections (as stored in the variable ESTABLISHED_SIGNALLING_CONNECTIONS) and established radio access bearers (as stored in the variable ESTABLISHED_RABS) to upper layers;
 - 3> clear the variable ESTABLISHED_SIGNALLING_CONNECTIONS;
 - 3> clear the variable ESTABLISHED_RABS;
 - 3> enter idle mode;
 - 3> perform other actions when entering idle mode from connected mode as specified in subclause 8.5.2;
 - 3> and the procedure ends.

- 2> if the stored value of the timer T314 is equal to zero:
 - 3> release all radio bearers, associated with any radio access bearers for which in the variable ESTABLISHED_RABS the value of the IE "Re-establishment timer" is set to "useT314";
 - 3> in the variable RB_TIMER_INDICATOR set the IE "T314 expired" to TRUE;
 - 3> if all radio access bearers associated with a CN domain are released:
 - 4> release the signalling connection for that CN domain;
 - 4> remove the signalling connection for that CN domain from the variable ESTABLISHED_SIGNALLING_CONNECTIONS;
 - 4> indicate release (abort) of the signalling connection to upper layers;
- 2> if the stored value of the timer T315 is equal to zero:
 - 3> release all radio bearers associated with any radio access bearers for which in the variable ESTABLISHED_RABS the value of the IE "Re-establishment timer" is set to "useT315";
 - 3> in the variable RB_TIMER_INDICATOR set the IE "T315 expired" to TRUE.
 - 3> if all radio access bearers associated with a CN domain are released:
 - 4> release the signalling connection for that CN domain;
 - 4> remove the signalling connection for that CN domain from the variable ESTABLISHED_SIGNALLING_CONNECTIONS;
 - 4> indicate release (abort) of the signalling connection to upper layers;
- 2> if the stored value of the timer T314 is greater than zero:
 - 3> if there are radio bearers associated with any radio access bearers for which in the variable ESTABLISHED_RABS the value of the IE "Re-establishment timer" is set to "useT314":
 - 4> start timer T314.
 - 3> if there are no radio bearers associated with any radio access bearers for which in the variable ESTABLISHED_RABS the value of the IE "Re-establishment timer" is set to "useT314" or "useT315" and the signalling connection exists to the CS domain:
 - 4> start timer T314.
- 2> if the stored value of the timer T315 is greater than zero:
 - 3> if there are radio bearers associated with any radio access bearers for which in the variable ESTABLISHED_RABS the value of the IE "Re-establishment timer" is set to "useT315"; or
 - 3> if the signalling connection exists to the PS domain:
 - 4> start timer T315.
- 2> for the released radio bearer(s):
 - 3> delete the information about the radio bearer from the variable ESTABLISHED_RABS;
 - 3> when all radio bearers belonging to the same radio access bearer have been released:
 - 4> indicate local end release of the radio access bearer to upper layers using the CN domain identity together with the RAB identity stored in the variable ESTABLISHED_RABS;
 - 4> delete all information about the radio access bearer from the variable ESTABLISHED_RABS.
- 2> if the variable E_DCH_TRANSMISSION is set to TRUE:
 - 3> set the variable E_DCH_TRANSMISSION to FALSE;

- 3> stop any E-AGCH and E-HICH reception procedures;
- 3> for FDD, stop any E-RGCH reception procedures.
- 3> for FDD, stop any E-DPCCH and E-DPDCH transmission procedures.
- 3> for 1.28 Mcps TDD, stop any E-PUCH transmission procedure.
- 3> clear the variable E_RNTI;
- 3> act as if the IE "MAC-es/e reset indicator" was received and set to TRUE;
- 3> release all E-DCH HARQ resources;
- 3> no longer consider any radio link to be the serving E-DCH radio link.
- 2> move to CELL_FACH state;
- 2> select a suitable UTRA cell on the current frequency according to [4];
- 2> clear variable E_RNTI and:
 - 3> determine the value for the HSPA_RNTI_STORED_CELL_PCH variable and take the corresponding actions as described in subclause 8.5.56;
 - 3> determine the value for the READY_FOR_COMMON_EDCH variable and take the corresponding actions as described in subclause 8.5.47;
 - 3> determine the value for the COMMON_E_DCH_TRANSMISSION variable and take the corresponding actions as described in subclause 8.5.46.
- 2> for 3.84 Mcps TDD and 7.68Mcps TDD; or
- 2> for FDD and 1.28 Mcps TDD, if the UE does not support HS-DSCH reception in CELL_FACH state; or
- 2> if the IE "HS-DSCH common system information" is not included in System Information Block type 5 or System Information Block type 5bis; or
- 2> for 1.28 Mcps TDD, if the IE "Common E-DCH system info" is not included in System Information Block type 5:
 - 3> select PRACH according to subclause 8.5.17;
 - 3> select Secondary CCPCH according to subclause 8.5.19;
 - 3> use the transport format set given in system information as specified in subclause 8.6.5.1;
 - 3> take the actions related to the HS_DSCH_RECEPTION_GENERAL variable as described in subclause 8.5.37a.
- 2> else:
 - 3> if variable READY_FOR_COMMON_EDCH is set to TRUE:
 - 4> configure the Enhanced Uplink in CELL_FACH state and Idle mode as specified in subclause 8.5.45.
 - 3> else:
 - 4> select PRACH according to subclause 8.5.17 and:
 - 5> use for the PRACH the transport format set given in system information as specified in subclause 8.6.5.1.
- 3> clear variable H_RNTI;
- 3> clear any stored IEs "HARQ info";
- 3> reset the MAC-ehs entity [15];

- 3> set variable HS_DSCH_RECEPTION_OF_CCCH_ENABLED to TRUE;
- 3> and start receiving the HS-DSCH according to the procedure in subclause 8.5.37.
- 2> set the variable ORDERED_RECONFIGURATION to FALSE.
- 1> set the variables PROTOCOL_ERROR_INDICATOR, FAILURE_INDICATOR, UNSUPPORTED_CONFIGURATION and INVALID_CONFIGURATION to FALSE;
- 1> set the variable CELL_UPDATE_STARTED to TRUE;
- 1> if any IEs related to HS-DSCH are stored in the UE:
 - 2> clear any stored IE "Downlink HS-PDSCH information";
 - 2> clear any stored IE "Downlink Secondary Cell Info FDD";
 - 2> clear all the entries from the variable TARGET_CELL_PRECONFIGURATION;
 - 2> for 1.28Mcps TDD, clear the IE "HS-PDSCH Midamble Configuration" and the IE "HS-SCCH Set Configuration" in the IE "DL Multi Carrier Information";
 - 2> determine the value for the HS_DSCH_RECEPTION variable and take the corresponding actions as described in subclause 8.5.25;
 - 2> determine the value for the SECONDARY_CELL_HS_DSCH_RECEPTION variable and take the corresponding actions as described in subclause 8.5.51.
- 1> if any IEs related to E-DCH are stored in the UE:
 - 2> clear any stored IE "E-DCH info";
 - 2> determine the value for the E_DCH_TRANSMISSION variable and take the corresponding actions as described in subclause 8.5.28.
- 1> if any of the IEs "DTX-DRX timing information" or "DTX-DRX information" are stored in the UE:
 - 2> determine the value for the DTX_DRX_STATUS variable and take the corresponding actions as described in subclause 8.5.34.
- 1> if the IE "HS-SCCH less information" is stored in the UE:
 - 2> determine the value for the HS_SCCH_LESS_STATUS variable and take the corresponding actions as described in subclause 8.5.35.
- 1> if any IEs related to MIMO are stored in the UE:
 - 2> determine the value for the MIMO_STATUS variable and take the corresponding actions as described in subclause 8.5.33.
- 1> for 1.28 Mcps TDD, if the IEs "Control Channel DRX Information" is stored in the UE:
 - 2> determine the value for the CONTROL_CHANNEL_DRX_STATUS variable and take the corresponding actions as described in subclause 8.5.53.
- 1> for 1.28 Mcps TDD, if the IE "SPS information" is stored in the UE:
 - 2> determine the value for the E_DCH_SPS_STATUS variable and take the corresponding actions as described in subclause 8.5.54;
 - 2> determine the value for the HS_DSCH_SPS_STATUS variable and take the corresponding actions as described in subclause 8.5.55.
- 1> if the UE is not already in CELL_FACH state:
 - 2> move to CELL_FACH state;

- 2> determine the value for the HSPA_RNTI_STORED_CELL_PCH variable and take the corresponding actions as described in subclause 8.5.56;
- 2> determine the value for the READY_FOR_COMMON_EDCH variable and take the corresponding actions as described in subclause 8.5.47;
- 2> determine the value for the COMMON_E_DCH_TRANSMISSION variable and take the corresponding actions as described in subclause 8.5.46;
- 2> for 3.84 Mcps TDD and 7.68 Mcps TDD; or
- 2> for FDD and 1.28 Mcps TDD, if the UE does not support HS-DSCH reception in CELL_FACH state; or
- 2> if the IE "HS-DSCH common system information" is not included in System Information Block type 5 or System Information Block type 5bis; or
- 2> for 1.28 Mcps TDD, if the IE "Common E-DCH system info" is not included in System Information Block type 5:
 - 3> select PRACH according to subclause 8.5.17;
 - 3> select Secondary CCPCCH according to subclause 8.5.19;
 - 3> use the transport format set given in system information as specified in subclause 8.6.5.1;
 - 3> take the actions related to the HS_DSCH_RECEPTION_GENERAL variable as described in subclause 8.5.37a.
- 2> else:
 - 3> if variable READY_FOR_COMMON_EDCH is set to TRUE:
 - 4> configure the Enhanced Uplink in CELL_FACH state and Idle mode as specified in subclause 8.5.45.
 - 3> else:
 - 4> select PRACH according to subclause 8.5.17 and:
 - 5> use for the PRACH the transport format set given in system information as specified in subclause 8.6.5.1.
 - 3> if variable H_RNTI is not set or variable C_RNTI is not set:
 - 4> clear variable C_RNTI;
 - 4> clear variable H_RNTI;
 - 4> clear any stored IEs "HARQ info";
 - 4> set variable HS_DSCH_RECEPTION_OF_CCCH_ENABLED to TRUE;
 - 4> and start receiving the HS-DSCH according to the procedure in subclause 8.5.37.
 - 3> else:
 - 4> receive the HS-DSCH according to the procedure in subclause 8.5.36.
- 1> if the UE performs cell re-selection; or
- 1> if the UE re-enters service area and the UE supports HS-DSCH reception in CELL_FACH state and System Information Block type 5 or System Information Block type 5bis includes IE "HS-DSCH common system information", and for 1.28 Mcps TDD, System Information Block type 5 includes IE "Common E-DCH system info":
 - 2> clear the variable C_RNTI; and
 - 2> stop using that C_RNTI just cleared from the variable C_RNTI in MAC;

- 2> for FDD and 1.28 Mcps TDD, if the variable H_RNTI is set:
 - 3> clear the variable H_RNTI; and
 - 3> stop using that H_RNTI just cleared from the variable H_RNTI in MAC;
 - 3> clear any stored IEs "HARQ info";
- 2> for FDD and 1.28 Mcps TDD, if the variable E_RNTI is set:
 - 3> clear the variable E_RNTI.
- 2> determine the value for the HSPA_RNTI_STORED_CELL_PCH variable and take the corresponding actions as described in subclause 8.5.56;
- 2> determine the value for the READY_FOR_COMMON_EDCH variable and take the corresponding actions as described in subclause 8.5.47;
- 2> determine the value for the COMMON_E_DCH_TRANSMISSION variable and take the corresponding actions as described in subclause 8.5.46;
- 2> for FDD and 1.28 Mcps TDD, if the UE does support HS-DSCH reception in CELL_FACH state and IE "HS-DSCH common system information" is included in System Information Block type 5 or System Information Block type 5bis:
 - 3> reset the MAC-ehs entity [15].
 - 3> set variable HS_DSCH_RECEPTION_OF_CCCH_ENABLED to TRUE;
 - 3> and start receiving the HS-DSCH according to the procedure in subclause 8.5.37.
- 2> else:
 - 3> take the actions related to the HS_DSCH_RECEPTION_GENERAL variable as described in subclause 8.5.37a.
- 1> set CFN in relation to SFN of current cell according to subclause 8.5.15;
- 1> in case of a cell update procedure:
 - 2> set the contents of the CELL UPDATE message according to subclause 8.3.1.3;
 - 2> submit the CELL UPDATE message for transmission on the uplink CCCH.
- 1> in case of a URA update procedure:
 - 2> set the contents of the URA UPDATE message according to subclause 8.3.1.3;
 - 2> submit the URA UPDATE message for transmission on the uplink CCCH.
- 1> set counter V302 to 1;
- 1> start timer T302 when the MAC layer indicates success or failure in transmitting the message.

8.3.1.3 CELL UPDATE / URA UPDATE message contents to set

In case of cell update procedure the UE shall transmit a CELL UPDATE message.

In case of URA update procedure the UE shall transmit a URA UPDATE message.

The UE shall set the IEs in the CELL UPDATE message as follows:

- 1> set the IE "Cell update cause" corresponding to the cause specified in subclause 8.3.1.2 that is valid when the CELL UPDATE message is submitted to lower layers for transmission;

NOTE: During the time period starting from when a cell update procedure is initiated by the UE until when the procedure ends, additional CELL UPDATE messages may be transmitted by the UE with different causes.

- 1> if the IE "Cell update cause" is set to "uplink data transmission" and if an event triggered traffic volume measurement has been configured:
 - 2> if the TCTV is larger than the threshold in the IE "Reporting threshold" for a traffic volume measurement stored in the MEASUREMENT_IDENTITY variable and that traffic volume measurement has "measurement identity" equal to 4, "Traffic volume event identity" equal to "4a", "Measurement validity" equal to "all states" or "all states except CELL_DCH":
 - 3> set the IE "Traffic volume indicator" to TRUE.
 - 2> else:
 - 3> set the IE "Traffic volume indicator" to FALSE.
- 1> set the IE "U-RNTI" to the value of the variable U_RNTI;
- 1> if the value of the variable PROTOCOL_ERROR_INDICATOR is TRUE:
 - 2> include the IE "RRC transaction identifier"; and
 - 3> set it to the value of "RRC transaction identifier" in the entry for the CELL UPDATE CONFIRM message in the table "Rejected transactions" in the variable TRANSACTIONS.
 - 2> include and set the IE "failure cause" to the cause value "protocol error";
 - 2> set the IE "Protocol error information" set to the value of the variable PROTOCOL_ERROR_INFORMATION.
- 1> if the value of the variable FAILURE_INDICATOR is TRUE:
 - 2> include the IE "RRC transaction identifier"; and
 - 3> set it to the value of "RRC transaction identifier" in the entry for the CELL UPDATE CONFIRM message in the table "Accepted transactions" in the variable TRANSACTIONS.
 - 2> include and set the IE "failure cause" to the value of the variable FAILURE_CAUSE.
- 1> if the variable "LATEST_CONFIGURED_CN_DOMAIN" has been initialised:
 - 2> for each CN domain for which an entry exists in the variable ESTABLISHED_RABS or which is indicated in the variable LATEST_CONFIGURED_CN_DOMAIN:
 - 3> include the START value calculated according to subclause 8.5.9.
- 1> else:
 - 2> include the START value for either the CS domain or the PS domain, calculated according to subclause 8.5.9.
- 1> if an unrecoverable error [16] in any of the AM RLC entities for the signalling radio bearers RB2, RB3 or RB4 is detected:
 - 2> set the IE "AM_RLC error indication (RB2, RB3 or RB4)" to TRUE;
 - 2> set the variable AM_RLC_ERROR_PENDING_RB234 to TRUE.
- 1> otherwise:
 - 2> if the value of the variable AM_RLC_ERROR_PENDING_RB234 is TRUE:
 - 3> set the IE "AM_RLC error indication (RB2, RB3 or RB4)" to TRUE.
 - 2> otherwise:

- 3> set the IE "AM_RLC error indication (RB2, RB3 or RB4)" to FALSE.
 - 1> if an unrecoverable error [16] in any of the AM RLC entities for the RB5 or upward is detected:
 - 2> set the IE "AM_RLC error indication (RB>4)" to TRUE;
 - 2> set the variable AM_RLC_ERROR_PENDING_RB5_AND_UP to TRUE.
 - 1> otherwise:
 - 2> if the value of the variable AM_RLC_ERROR_PENDING_RB5_AND_UP is TRUE:
 - 3> set the IE "AM_RLC error indication (RB>4)" to TRUE.
 - 2> otherwise:
 - 3> set the IE "AM_RLC error indication (RB>4)" to FALSE.
 - 1> set the IE "RB Timer indicator" to the value of the variable RB_TIMER_INDICATOR;
 - 1> if the variable ESTABLISHMENT_CAUSE is initialised:
 - 2> include the IE "Establishment cause" and set it to the value of the variable ESTABLISHMENT_CAUSE;
 - 2> if the value of the variable ESTABLISHMENT_CAUSE is set to "Originating Conversational Call" or "Emergency Call" and a CS call is being initiated:
 - 3> set the value of the IE "Call type" to "speech", "video" or "other" according to the call being initiated.
 - 1> if the variable ORDERED_RECONFIGURATION is set to TRUE:
 - 2> include the IE "Reconfiguration Status Indicator" and set it to TRUE.
 - 1> if the IE "Cell update cause" is set to "radio link failure" or "RLC Unrecoverable error" and the UE has submitted a reconfiguration response message to RLC and the UE has not received the RLC acknowledgement for the response message:
 - 2> include the IE "Reconfiguration Status Indicator" and set it to TRUE.
 - 1> if the UE supports HS-DSCH reception in CELL_FACH state:
 - 2> include the IE "HS-PDSCH in CELL_FACH" and set it to TRUE.
 - 1> if the UE supports Enhanced Uplink in CELL_FACH state and Idle mode:
 - 2> include the IE "Support of common E-DCH" and set it to TRUE.
 - 1> if the UE supports Two DRX schemes in URA_PCH and CELL_PCH
 - 2> include the IE "Support for Two DRX schemes in URA_PCH and CELL_PCH" and set it to TRUE.
- NOTE: In 1.28 Mcps TDD, UE supporting HS-DSCH reception in CELL_FACH state always supports Enhanced Uplink in CELL_FACH state and Idle mode, and vice versa.
- 1> if the UE supports MAC-i/is:
 - 2> include the IE "Support of MAC-i/is" and set it to TRUE.
 - 1> if the UE supports HS-DSCH DRX operation in CELL_FACH state:
 - 2> include the IE "Support of HS-DSCH DRX operation" and set it to TRUE.
 - 1> if the UE supports SPS operation:
 - 2> include the IE "Support of SPS operation" and set it to TRUE.
 - 1> if the UE supports control channel DRX operation:
 - 2> include the IE "Support of control channel DRX operation" and set it to TRUE.

- 1> if the UE performs cell update for MBMS ptp radio bearer request as specified in subclause 8.6.9.6; and
- 1> if one or more of the MBMS services for which the UE initiates the ptp radio bearer request concerns an MBMS Selected Service:
 - 2> for each MBMS Selected Service that is indicated on MCCH and for which the UE initiates ptp radio bearer request:
 - 3> order the MBMS Selected Services such that those selected with a higher priority are listed in the IE "MBMS Selected Services Short" before those selected with a lower priority;
 - 3> include the IE "MBMS Selected Service ID" within the IE "MBMS Selected Services Short" and set it to a value in accordance with subclause 8.6.9.8.
- 1> otherwise, if the UE performs cell update for MBMS counting as specified in subclause 8.7.4; and
- 1> if one or more of the MBMS services for which the UE initiates the counting response concerns an MBMS Selected Service:
 - 2> for each MBMS Selected Service that is indicated on MCCH and for which the UE initiates the counting response:
 - 3> order the MBMS Selected Services such that those selected with a higher priority are listed in the IE "MBMS Selected Services Short" before those selected with a lower priority;
 - 3> include the IE "MBMS Selected Service ID" within the IE "MBMS Selected Services Short" and set it to a value in accordance with subclause 8.6.9.8.
- 1> if the UE included one or more "MBMS Selected Service ID" IEs:
 - 2> include the IE "MBMS Modification Period identity" and set it to a value in accordance with subclause 8.5.29.
- 1> if, according to [4], the High-mobility state is applicable and it has been detected by the UE:
 - 2> include the IE "UE Mobility State Indicator" and set it to the "High-MobilityDetected" value.

The UE shall:

- 1> if the UE capability has changed compared to the value stored in the variable UE_CAPABILITY_TRANSFERRED and the variable RNC_CAPABILITY_CHANGE_SUPPORT is set to TRUE:
 - 2> include the IE "Capability change indicator".

NOTE: Transmitting the IE "Capability change indicator" does not trigger any actual changed behaviour on the part of the UE. It serves only to inform the network that the UE is requesting an opportunity to send a UE CAPABILITY INFORMATION message.

If the UE needs to include the IE "Failure Cause" and the Cell Update message size exceeds the used transport format size, then the UE may omit the IE "Support for Two DRX schemes in URA_PCH and CELL_PCH" (i.e. omit the cellUpdate-r3-add-ext), and the UE may omit IE "MBMS Selected Services" (i.e. omit the mbmsSelectedServices).

The UE shall set the IEs in the URA UPDATE message as follows:

- 1> set the IE "U-RNTI" to the value of the variable U_RNTI;
- 1> set the IE "URA update cause" corresponding to which cause as specified in subclause 8.3.1.2 that is valid when the URA UPDATE message is submitted to lower layers for transmission;

NOTE: During the time period starting from when a URA update procedure is initiated by the UE until when the procedure ends, additional URA UPDATE messages may be transmitted by the UE with different causes, depending on which causes are valid for the respective URA UPDATE message.

- 1> if the value of the variable PROTOCOL_ERROR_INDICATOR is TRUE:
 - 2 > include the IE "RRC transaction identifier"; and

- 3> set it to the value of "RRC transaction identifier" in the entry for the URA UPDATE CONFIRM message in the table "Rejected transactions" in the variable TRANSACTIONS.
- 2> set the IE "Protocol error indicator" to TRUE;
- 2> include the IE "Protocol error information" set to the value of the variable PROTOCOL_ERROR_INFORMATION.
- 1> if the value of the variable PROTOCOL_ERROR_INDICATOR is FALSE:
 - 2> if the value of the variable INVALID_CONFIGURATION is TRUE:
 - 3> include the IE "RRC transaction identifier"; and
 - 3> set it to the value of "RRC transaction identifier" in the entry for the URA UPDATE CONFIRM message in the table "Accepted transactions" in the variable TRANSACTIONS;
 - 3> set the IE "Protocol error indicator" to TRUE;
 - 3> include the IE "Protocol error information" set to "Information element value not comprehended".
 - 2> if the value of the variable INVALID_CONFIGURATION is FALSE:
 - 3> set the IE "Protocol error indicator" to FALSE.
- 1> if the UE supports HS-DSCH reception in CELL_FACH state:
 - 2> include the IE "HS-PDSCH in CELL_FACH" and set it to TRUE.
- 1> if the UE supports HS-DSCH reception CELL_PCH and URA_PCH state:
 - 2> include the IE "HS-PDSCH in CELL_PCH and URA_PCH" and set it to TRUE.
- 1> if the UE supports Enhanced Uplink in CELL_FACH state and Idle mode:
 - 2> include the IE "Support of common E-DCH" and set it to TRUE.

8.3.1.4 T305 expiry and the UE detects "out of service area"

When the T305 expires and the UE detects that it is "out of service area" as specified in subclause 8.5.5.1, the UE shall

- 1> start timer T307;
- 1> act according to subclause 7.2.2.

8.3.1.4.1 Re-entering "in service area"

If the UE detects "in service area" according to subclause 8.5.5.2 and timer T307 or T317 is running, the UE shall:

- 1> check the value of V302; and
- 1> if V302 is equal to or smaller than N302:
 - 2> in case of a cell update procedure:
 - 3> set the contents of the CELL UPDATE message according to subclause 8.3.1.3;
 - 3> submit the CELL UPDATE message for transmission on the uplink CCCH.
 - 2> in case of a URA update procedure:
 - 3> set the contents of the URA UPDATE message according to subclause 8.3.1.3;
 - 3> submit the URA UPDATE message for transmission on the uplink CCCH.
- 2> increment counter V302;

- 2> restart timer T302 when the MAC layer indicates success or failure to transmit the message.
- 1> if V302 is greater than N302:
 - 2> clear the variable RB_UPLINK_CIPHERING_ACTIVATION_TIME_INFO;
 - 2> clear the variable INTEGRITY_PROTECTION_ACTIVATION_INFO;
 - 2> in case of a cell update procedure:
 - 3> clear the entry for the CELL UPDATE CONFIRM message in the table "Rejected transactions" in the variable TRANSACTIONS.
 - 2> in case of a URA update procedure:
 - 3> clear the entry for the URA UPDATE CONFIRM message in the table "Rejected transactions" in the variable TRANSACTIONS.
 - 2> release all its radio resources;
 - 2> indicate release (abort) of the established signalling connections (as stored in the variable ESTABLISHED_SIGNALLING_CONNECTIONS) and established radio access bearers (as stored in the variable ESTABLISHED_RABS) to upper layers;
 - 2> clear the variable ESTABLISHED_SIGNALLING_CONNECTIONS;
 - 2> clear the variable ESTABLISHED_RABS;
 - 2> enter idle mode;
 - 2> perform other actions when entering idle mode from connected mode as specified in subclause 8.5.2;
 - 2> and the procedure ends.

8.3.1.4.2 Expiry of timer T307

When the T307 expires, the UE shall:

- 1> move to idle mode;
- 1> release all dedicated resources;
- 1> indicate release (abort) of the established signalling connections (as stored in the variable ESTABLISHED_SIGNALLING_CONNECTIONS) and established radio access bearers (as stored in the variable ESTABLISHED_RABS) to upper layers;
- 1> clear the variable ESTABLISHED_SIGNALLING_CONNECTIONS;
- 1> clear the variable ESTABLISHED_RABS;
- 1> perform other actions when entering idle mode from connected mode as specified in subclause 8.5.2;
- 1> and the procedure ends.

8.3.1.5 Reception of an CELL UPDATE/URA UPDATE message by the UTRAN

When the UTRAN receives a CELL UPDATE/URA UPDATE message, the UTRAN should:

- 1> in case the procedure was triggered by reception of a CELL UPDATE:
 - 2> if SRNS relocation was performed:
 - 3> transmit a CELL UPDATE CONFIRM message on the downlink DCCH.
 - 2> otherwise:

- 3> update the START value for each CN domain as maintained in UTRAN (refer to subclause 8.5.9) with "START" in the IE "START list" for the CN domain as indicated by "CN domain identity" in the IE "START list";
 - 3> transmit a CELL UPDATE CONFIRM message on the downlink DCCH or optionally on the CCCH but only if ciphering is not required; and
 - 3> optionally set the IE "RLC re-establish indicator (RB2, RB3 and RB4)" and/or the IE "RLC re-establish indicator (RB5 and upwards)" to TRUE to request a RLC re-establishment in the UE, in which case the corresponding RLC entities should also be re-established in UTRAN; or
- 1> in case the procedure was triggered by reception of a URA UPDATE:
- 2> if SRNS relocation was performed:
 - 3> transmit a URA UPDATE CONFIRM message on the downlink DCCH.
 - 2> otherwise:
 - 3> transmit a URA UPDATE CONFIRM message on the downlink CCCH or DCCH.
 - 2> include the IE "URA identity" in the URA UPDATE CONFIRM message in a cell where multiple URA identifiers are broadcast; or
- 1> initiate an RRC connection release procedure (see subclause 8.1.4) by transmitting an RRC CONNECTION RELEASE message on the downlink CCCH. In particular UTRAN should:
- 2> if the CELL UPDATE message was sent because of an unrecoverable error in RB2, RB3 or RB4:
 - 3> initiate an RRC connection release procedure (subclause 8.1.4) by transmitting an RRC CONNECTION RELEASE message on the downlink CCCH.
- 1> if the radio bearer is connected to a CS domain radio access bearer and the radio bearer uses UM RLC:
- 2> the UM RLC entity should be re-established in UTRAN.

UTRAN may transmit several CELL UPDATE CONFIRM/URA UPDATE CONFIRM messages to increase the probability of proper reception of the message by the UE. In such a case, the RRC SN for these repeated messages should be the same.

8.3.1.6 Reception of the CELL UPDATE CONFIRM/URA UPDATE CONFIRM message by the UE

When the UE receives a CELL UPDATE CONFIRM/URA UPDATE CONFIRM message; and

- if the message is received on the CCCH, and IE "U-RNTI" is present and has the same value as the variable U_RNTI; or
- if the message is received on DCCH:

the UE may:

- 1> maintain a list of the set of cells to which the UE has Radio Links if the IE "Cell ID" is present.

the UE shall:

- 1> stop timer T302;
- 1> set variable HS_DSCH_RECEPTION_OF_CCCH_ENABLED to FALSE;
- 1> in case of a cell update procedure and the CELL UPDATE CONFIRM message:
 - 2> includes "RB information elements"; and/or
 - 2> includes "Transport channel information elements"; and/or
 - 2> includes "Physical channel information elements"; and

2> if the variable ORDERED_RECONFIGURATION is set to FALSE:

3> set the variable ORDERED_RECONFIGURATION to TRUE.

1> act upon all received information elements as specified in subclause 8.6, unless specified otherwise in the following:

2> if the IE "Frequency info" is included in the message:

3> if the IE "RRC State Indicator" is set to the value "CELL_FACH":

4> select a suitable UTRA cell according to [4] on that frequency;

4> if the UE finds a suitable UTRA cell on that frequency:

5> if the received CELL UPDATE CONFIRM message included the IE "Primary CPICH info" (for FDD) or "Primary CCPCH info" (for TDD), and the UE selects another cell than indicated by this IE or the received CELL UPDATE CONFIRM message did not include the IE "Primary CPICH info" (for FDD) or "Primary CCPCH info" (for TDD):

6> act as specified in subclause 8.3.1.12.

5> else:

6> for 1.28Mcps TDD, decide the working frequency according to subclause 8.6.6.1.

4> else, if the UE can not find a suitable UTRA cell on the indicated frequency but it finds a suitable UTRA cell on another frequency:

5> act as specified in subclause 8.3.1.12.

3> if the IE "RRC State Indicator" is set to the value "CELL_PCH" or "URA_PCH":

4> select a suitable UTRA cell according to [4] on that frequency;

4> if the UE finds a suitable UTRA cell on that frequency:

5> if the received CELL UPDATE CONFIRM message included the IE "Primary CPICH info" (for FDD) or "Primary CCPCH info" (for TDD), and the UE in CELL_PCH state selects another cell than indicated by this IE or the received CELL UPDATE CONFIRM message did not include the IE "Primary CPICH info" (for FDD) or "Primary CCPCH info" (for TDD); or

5> if the received CELL UPDATE CONFIRM message included the IE "URA identity", and the UE in URA_PCH state selects cell being part of another URA than indicated by this IE or the received CELL UPDATE CONFIRM message did not include the IE "URA identity":

6> act as specified in subclause 8.3.1.12.

4> else, if the UE can not find a suitable UTRA cell on the indicated frequency but it finds a suitable UTRA cell on another frequency:

5> act as specified in subclause 8.3.1.12.

3> if the IE "RRC State Indicator" is set to the value "CELL_DCH":

4> act on the IE "Frequency info" as specified in subclause 8.6.6.1.

2> if the IE "RRC State Indicator" is set to the value "CELL_PCH" or "URA_PCH":

3> if the IE "Wait time" <> 0 is included in the message and the UE supports timer T320:

4> start timer T320 with value set to the time stated in the IE "wait time".

2> use the transport channel(s) applicable for the physical channel types that is used; and

2> if the IE "TFS" is neither included nor previously stored in the UE for that transport channel(s):

3> use the TFS given in system information.

- 2> if none of the TFS stored is compatible with the physical channel:
 - 3> delete the stored TFS;
 - 3> use the TFS given in system information.
- 2> if the IE "RLC re-establish indicator (RB2, RB3 and RB4)" in the CELL UPDATE CONFIRM message is set to TRUE:
 - 3> re-establish the RLC entities for signalling radio bearer RB2, signalling radio bearer RB3 and signalling radio bearer RB4 (if established);
 - 3> clear all entries in the table "Processed transactions" in the variable TRANSACTIONS;
 - 3> if the value of the IE "Status" in the variable CIPHERING_STATUS of the CN domain stored in the variable LATEST_CONFIGURED_CN_DOMAIN is set to "Started":
 - 4> set the HFN component of the respective COUNT-C values for AM RLC entities with RB identity 2, RB identity 3 and RB identity 4 (if established) equal to the START value included in the latest transmitted CELL UPDATE message for the CN domain stored in the variable LATEST_CONFIGURED_CN_DOMAIN.

NOTE: UTRAN should not send a CELL UPDATE CONFIRM message with a target state CELL_PCH or URA_PCH, and including C-RNTI, and setting the IE "RLC re-establish indicator (RB2, RB3 and RB4)" to TRUE, otherwise the UE behaviour is not specified.

- 2> if the IE "RLC re-establish indicator (RB5 and upwards)" in the CELL UPDATE CONFIRM message is set to TRUE:
 - 3> for radio bearers with RB identity 5 and upwards:
 - 4> re-establish the AM RLC entities;
 - 4> if the value of the IE "Status" in the variable CIPHERING_STATUS of the CN domain as indicated in the IE "CN domain identity" in the IE "RAB info" in the variable ESTABLISHED_RABS is set to "Started":
 - 5> set the HFN component of the respective COUNT-C values for AM RLC entities equal to the START value included in this CELL UPDATE message for the CN domain as indicated in the IE "CN domain identity" in the IE "RAB info" in the variable ESTABLISHED_RABS.

NOTE: UE actions, in case IE "Downlink counter synchronisation info" is included and either IE "RLC re-establish indicator (RB2, RB3 and RB4)" or IE "RLC re-establish indicator (RB5 and upwards)" are set to TRUE, are not defined.

- 1> if the CELL UPDATE CONFIRM / URA UPDATE CONFIRM message contained the IE "Ciphering mode info" or contained the IE "Integrity protection mode info":
 - 2> set the IE "Status" in the variable SECURITY_MODIFICATION for all the CN domains in the variable SECURITY_MODIFICATION to "Affected".
- 1> if the variable ESTABLISHMENT_CAUSE is set:
 - 2> clear the variable ESTABLISHMENT_CAUSE.
- 1> enter a state according to subclause 8.6.3.3 applied on the CELL UPDATE CONFIRM / URA UPDATE CONFIRM message.

If the UE after state transition enters CELL_DCH, CELL_FACH, CELL_PCH or URA_PCH state, the UE shall, after state transition:

- 1> determine the value for the HSPA_RNTI_STORED_CELL_PCH variable and take the corresponding actions as described in subclause 8.5.56;
- 1> determine the value for the READY_FOR_COMMON_EDCH variable and take the corresponding actions as described in subclause 8.5.47;

- 1> determine the value for the COMMON_E_DCH_TRANSMISSION variable and take the corresponding actions as described in subclause 8.5.46.

If the UE after state transition enters CELL_DCH state, it shall:

- 1> perform the physical layer synchronisation procedure A as specified in [29] (FDD only);
- 1> not prohibit periodical status transmission in RLC;
- 1> if the IE "Default DPCH Offset Value" is not included:
 - 2> the UE behaviour is not specified.

If the UE after state transition remains in CELL_FACH state, it shall

- 1> start the timer T305 using its initial value if timer T305 is not running and periodical cell update has been configured by T305 in the IE "UE Timers and constants in connected mode" set to any other value than "infinity";
- 1> if variable READY_FOR_COMMON_EDCH is set to TRUE:
 - 2> configure the Enhanced Uplink in CELL_FACH state and Idle mode as specified in subclause 8.5.45 for FDD and 8.5.45a for 1.28 Mcps TDD.
- 1> else:
 - 2> select PRACH according to subclause 8.5.17;
- 1> for 3.84 Mcps TDD and 7.68 Mcps TDD; or
- 1> for FDD and 1.28 Mcps TDD, if the UE does not support HS-DSCH reception in CELL_FACH state; or
- 1> if the IE "HS-DSCH common system information" is not included in System Information Block type 5 or System Information Block type 5bis; or
- 1> for 1.28 Mcps TDD, if the IE "Common E-DCH system info" is not included in System Information Block type 5:
 - 2> select Secondary CCPCH according to subclause 8.5.19;
 - 2> take the actions related to the HS_DSCH_RECEPTION_GENERAL variable as described in subclause 8.5.37a.
- 1> else:
 - 2> For FDD, if the RBs have the multiplexing option with transport channel type "HS-DSCH" for the DL and transport channel type "RACH" in the UL; and
 - 2> if the UE does not supports E-DCH transmission in CELL_FACH state and Idle mode or the IE "Common E-DCH system info" is not included system information block type 5 or 5bis; and
 - 2> if variable H_RNTI and variable C_RNTI are set:
 - 3> start to receive HS-DSCH according to the procedure in subclause 8.5.36.
 - 2> else:
 - 3> if the RBs have the multiplexing option with transport channel type "HS-DSCH" for the DL and transport channel type "E-DCH" in the UL; and
 - 3> if variable READY_FOR_COMMON_EDCH is set to TRUE; and
 - 3> if variable H_RNTI and variable C_RNTI and variable E-RNTI are set:
 - 4> start to receive HS-DSCH according to the procedure in subclause 8.5.36.
 - 3> else:

- 4> clear variable C_RNTI and delete any stored C-RNTI value;
- 4> clear variable H_RNTI and delete any stored H-RNTI value;
- 4> clear variable E_RNTI and delete any stored E-RNTI value;
- 4> clear any stored IEs "HARQ info";
- 4> set the variable INVALID_CONFIGURATION to TRUE.

1> not prohibit periodical status transmission in RLC;

1> if the IE "UTRAN DRX cycle length coefficient" is included in the same message:

- 2> ignore that IE and stop using DRX.

If the UE after state transition enters URA_PCH or CELL_PCH state, it shall:

1> if the UE enters CELL_PCH state:

- 2> if the UE supports E-DCH transmission in CELL_FACH state and Idle mode and the IE "Common E-DCH system info" is included in system information block type 5 or 5bis:

3> if variable H_RNTI or variable C_RNTI or variable E_RNTI is not set:

- 4> clear variable C_RNTI and delete any stored C-RNTI value;
- 4> clear variable H_RNTI and delete any stored H-RNTI value;
- 4> clear variable E_RNTI and delete any stored E-RNTI value;
- 4> clear any stored IE "HARQ Info";
- 4> reset the MAC-ehs entity [15];
- 4> reset the MAC-i/is entity [15].

1> prohibit periodical status transmission in RLC;

1> for 3.84 Mcps TDD and 7.68 Mcps TDD; or

1> for FDD and 1.28 Mcps TDD, if the UE does not support HS-DSCH reception in CELL_PCH and URA_PCH state; or

1> if the IE "HS-DSCH paging system information" is not included in System Information Block type 5 or System Information Block type 5bis and the variable HSPA_RNTI_STORED_CELL_PCH is set to FALSE:

- 2> clear the variable C_RNTI;
- 2> stop using that C_RNTI just cleared from the variable C_RNTI in MAC.

1> start the timer T305 using its initial value if timer T305 is not running and periodical update has been configured by T305 in the IE "UE Timers and constants in connected mode" set to any other value than "infinity";

1> for 3.84 Mcps TDD and 7.68 Mcps TDD; or

1> for FDD and 1.28 Mcps TDD, if the UE does not support HS-DSCH reception in CELL_PCH and URA_PCH state; or

1> if the IE "HS-DSCH paging system information" is not included in System Information Block type 5 or System Information Block type 5bis and the variable HSPA_RNTI_STORED_CELL_PCH is set to FALSE:

- 2> select Secondary CCPCH according to subclause 8.5.19;
- 2> take the actions related to the HS_DSCH_RECEPTION_GENERAL variable as described in subclause 8.5.37a.

1> else:

2> if the UE is in CELL_PCH:

3> if IE "New C-RNTI" is not included:

4> clear the variable C_RNTI;

4> clear the variable H_RNTI;

4> clear any stored IEs "HARQ info";

4> determine the value for the READY_FOR_COMMON_EDCH variable and take the corresponding actions as described in subclause 8.5.47.

2> if the variable HSPA_RNTI_STORED_CELL_PCH is set to TRUE:

3> select Secondary CCPCH according to subclause 8.5.19;

3> take the actions related to the HS_DSCH_RECEPTION_GENERAL variable as described in subclause 8.5.37a.

2> else:

3> for FDD; or

3> for 1.28 Mcps TDD, if both variable H_RNTI and variable C_RNTI are set:

4> monitor its paging occasions on the selected PICH determined according to subclauses 8.6.3.1a, 8.6.3.2 and 8.5.39 and receive PCCH on the HS-DSCH mapped on the HS-PDSCH, or DCCH and DTCH mapped on the HS-PDSCH and the associated HS-SCCH selected by the UE according to the procedures in subclause 8.5.40 for FDD and 8.5.40a for 1.28 Mcps TDD.

1> if the IE "UTRAN DRX cycle length coefficient" is included in the same message:

2> use the values in the IE "UTRAN DRX Cycle length coefficient" for calculating Paging Occasion and PICH Monitoring Occasion as specified in subclause 8.6.3.2.

NOTE: In the case of a cell update procedure during an ongoing reconfiguration procedure moving the UE into CELL_PCH/URA_PCH then the value of the IE "UTRAN DRX Cycle length coefficient" sent in the CELL UPDATE CONFIRM message should be the same as the value sent in the reconfiguration message.

1> if the IE "UTRAN DRX cycle length coefficient" is not included in the same message:

2> set the variable INVALID_CONFIGURATION to TRUE.

If the UE after the state transition remains in CELL_FACH state; and

1> the contents of the variable C_RNTI are empty:

it shall check the value of V302; and:

1> if V302 is equal to or smaller than N302:

2> if, caused by the received CELL UPDATE CONFIRM or URA UPDATE CONFIRM message:

3> the IE "Reconfiguration" in the variable CIPHERING_STATUS is set to TRUE; and/or

3> the IE "Reconfiguration" in the variable INTEGRITY_PROTECTION_INFO is set to TRUE:

4> abort the ongoing integrity and/or ciphering reconfiguration;

4> if the received CELL UPDATE CONFIRM or URA UPDATE CONFIRM message contained the IE "Ciphering mode info":

5> set the IE "Reconfiguration" in the variable CIPHERING_STATUS to FALSE; and

5> clear the variable RB_UPLINK_CIPHERING_ACTIVATION_TIME_INFO.

- 4> if the received CELL UPDATE CONFIRM or URA UPDATE CONFIRM message contained the IE "Integrity protection mode info":
 - 5> set the IE "Reconfiguration" in the variable INTEGRITY_PROTECTION_INFO to FALSE; and
 - 5> clear the variable INTEGRITY_PROTECTION_ACTIVATION_INFO.
- 2> in case of a URA update procedure:
 - 3> stop the URA update procedure;
 - 3> clear any entry for the URA UPDATE CONFIRM message in the table "Accepted transactions" in the variable TRANSACTIONS; and
 - 3> continue with a cell update procedure.
- 2> set the contents of the CELL UPDATE message according to subclause 8.3.1.3, except for the IE "Cell update cause" which shall be set to "cell reselection";
- 2> submit the CELL UPDATE message for transmission on the uplink CCCH;
- 2> increment counter V302;
- 2> restart timer T302 when the MAC layer indicates success or failure to transmit the message.
- 1> if V302 is greater than N302:
 - 2> clear the variable RB_UPLINK_CIPHERING_ACTIVATION_TIME_INFO;
 - 2> clear the variable INTEGRITY_PROTECTION_ACTIVATION_INFO;
 - 2> in case of a cell update procedure:
 - 3> clear the entry for the CELL UPDATE CONFIRM message in the table "Rejected transactions" in the variable TRANSACTIONS.
 - 2> in case of a URA update procedure:
 - 3> clear the entry for the URA UPDATE CONFIRM message in the table "Rejected transactions" in the variable TRANSACTIONS.
 - 2> release all its radio resources;
 - 2> indicate release (abort) of the established signalling connections (as stored in the variable ESTABLISHED_SIGNALLING_CONNECTIONS) and established radio access bearers (as stored in the variable ESTABLISHED_RABS) to upper layers;
 - 2> clear the variable ESTABLISHED_SIGNALLING_CONNECTIONS;
 - 2> clear the variable ESTABLISHED_RABS;
 - 2> enter idle mode;
 - 2> other actions the UE shall perform when entering idle mode from connected mode are specified in subclause 8.5.2;
 - 2> and the procedure ends.

If the UE after the state transition remains in CELL_FACH state; and

- a C-RNTI is stored in the variable C_RNTI;

or

- the UE after the state transition moves to another state than the CELL_FACH state:

the UE shall:

- 1> in case cell reselection interrupted an ongoing cell update procedure and a CELL UPDATE CONFIRM/URA UPDATE CONFIRM was received with the IE "Downlink counter synchronisation info" present and the response to which was not submitted to the lower layers due to the cell re-selection:
 - 2> include the IE "START list" in the response message transmitted according to subclause 8.3.1.7;
 - 2> if the CELL UPDATE CONFIRM/URA UPDATE CONFIRM, the response to which was not delivered to the lower layers, due to the cell re-selection, included the IE "RB with PDCP information list":
 - 3> include the IE "RB with PDCP information list" in the response message transmitted according to subclause 8.3.1.7.
- 1> in case of a cell update procedure:
 - 2> set the IE "RRC transaction identifier" in any response message transmitted below to the value of "RRC transaction identifier" in the entry for the CELL UPDATE CONFIRM message in the table "Accepted transactions" in the variable TRANSACTIONS; and
 - 2> clear that entry.
- 1> in case of a URA update procedure:
 - 2> set the IE "RRC transaction identifier" in any response message transmitted below to the value of "RRC transaction identifier" in the entry for the URA UPDATE CONFIRM message in the table "Accepted transactions" in the variable TRANSACTIONS; and
 - 2> clear that entry;
- 1> if the variable PDCP_SN_INFO is non-empty:
 - 2> include the IE "RB with PDCP information list" in any response message transmitted below and set it to the value of the variable PDCP_SN_INFO.
- 1> if the received CELL UPDATE CONFIRM or URA UPDATE CONFIRM message included the IE "Downlink counter synchronisation info":
 - 2> if the variable PDCP_SN_INFO is empty:
 - 3> configure the corresponding RLC entity for all AM and UM radio bearers and AM and UM signalling radio bearers except RB2 to "stop".
 - 2> else:
 - 3> configure the RLC entity for signalling radio bearers RB1, RB3 and RB4 to "stop";
 - 3> configure the RLC entity for UM and AM radio bearers for which the IE "PDCP SN Info" is not included to "stop".
 - 2> re-establish the RLC entity for RB2;
 - 2> clear all entries in the table "Processed transactions" in the variable TRANSACTIONS;
 - 2> for the downlink and the uplink, apply the ciphering configuration as follows:
 - 3> if the received re-configuration message included the IE "Ciphering Mode Info":
 - 4> use the ciphering configuration in the received message when transmitting the response message.
 - 3> if the ciphering configuration for RB2 from a previously received SECURITY MODE COMMAND has not yet been applied because the activation times not having been reached:
 - 4> if the previous SECURITY MODE COMMAND was received due to new keys being received:
 - 5> consider the new ciphering configuration to include the received new keys;
 - 5> initialise the HFN component of the uplink COUNT-C and downlink COUNT-C of SRB2 as indicated in subclause 8.1.12.3.1.

- 4> else if the ciphering configuration for RB2 from a previously received SECURITY MODE COMMAND has not yet been applied because of the corresponding activation times not having been reached and the previous SECURITY MODE COMMAND caused a change in LATEST_CONFIGURED_CN_DOMAIN:
 - 5> consider the new ciphering configuration to include the keys associated with the LATEST_CONFIGURED_CN_DOMAIN;
 - 5> initialise the HFN component of the uplink COUNT-C and downlink COUNT-C of SRB2 to the most recently transmitted IE "START list" or IE "START" for the LATEST_CONFIGURED_CN_DOMAIN at the reception of the previous SECURITY MODE COMMAND.
- 4> apply the new ciphering configuration immediately following RLC re-establishment.
- 3> else:
 - 4> continue using the current ciphering configuration.
- 2> set the new uplink and downlink HFN component of the COUNT-C of RB2 to MAX(uplink HFN component of the COUNT-C of RB2, downlink HFN component of the COUNT-C of RB2);
- 2> increment by one the downlink and uplink values of the HFN component of the COUNT-C for RB2;
- 2> calculate the START value according to subclause 8.5.9;
- 2> include the calculated START values for each CN domain in the IE "START list" in the IE "Uplink counter synchronisation info" in any response message transmitted below;
- 2> if timer T323 value is stored in the IE "UE Timers and constants in connected mode" in the variable TIMERS_AND_CONSTANTS:
 - 3> stop and reset timer T323;
 - 3> clear any value of the timer T323 stored in the IE "UE Timers and constants in connected mode" in the variable TIMERS_AND_CONSTANTS.
- 1> else if the radio bearer is connected to a CS domain radio access bearer and the radio bearer uses UM RLC:
 - 2> re-establish the UM RLC entity;
 - 2> if the value of the IE "Status" in the variable CIPHERING_STATUS of the CN domain as indicated in the IE "CN domain identity" in the IE "RAB info" in the variable ESTABLISHED_RABS is set to "Started":
 - 3> set the HFN component of the respective COUNT-C values for the UM RLC entity equal to the START value included in this CELL UPDATE message for the CN domain as indicated in the IE "CN domain identity" in the IE "RAB info" in the variable ESTABLISHED_RABS;
 - 3> set the remaining bits of the HFN component of the COUNT-C values of the UM RLC entity to zero.
- 1> if the received CELL UPDATE CONFIRM or URA UPDATE CONFIRM message did not include the IE "Downlink counter synchronisation info":
 - 2> if the variable START_VALUE_TO_TRANSMIT is set:
 - 3> include the value of the variable START_VALUE_TO_TRANSMIT in the IE "START" in the response message transmitted below.
- 1> if System Information Block type 11 is scheduled on the BCCH and the UE has not read nor stored the IEs present in this System Information Block; or
- 1> if System Information Block type 11bis is scheduled on the BCCH and the UE has not read nor stored the IEs present in this System Information Block; or
- 1> if System Information Block type 12 is scheduled on the BCCH and the UE has not read nor stored the IEs present in this System Information Block:

- 2> include the IE "Deferred measurement control reading" in any response message transmitted.
- 1> transmit a response message as specified in subclause 8.3.1.7;
- 1> if the IE "Integrity protection mode info" was present in the CELL UPDATE CONFIRM or URA UPDATE CONFIRM message:
 - 2> start applying the new integrity protection configuration in the uplink for signalling radio bearer RB2 from and including the transmitted response message.
- 1> if the variable ORDERED_RECONFIGURATION is set to TRUE caused by the received CELL UPDATE CONFIRM message in case of a cell update procedure:
 - 2> set the variable ORDERED_RECONFIGURATION to FALSE.
- 1> clear the variable PDCP_SN_INFO;
- 1> when the response message transmitted per subclause 8.3.1.7 to the UTRAN has been confirmed by RLC:
 - 2> if the CELL UPDATE CONFIRM / URA UPDATE CONFIRM message contained the IE "Ciphering mode info":
 - 3> resume data transmission on any suspended radio bearer and signalling radio bearer mapped on RLC-AM or RLC-UM;
 - 3> set the IE "Reconfiguration" in the variable CIPHERING_STATUS to FALSE; and
 - 3> clear the variable RB_UPLINK_CIPHERING_ACTIVATION_TIME_INFO.
 - 2> if the CELL UPDATE CONFIRM / URA UPDATE CONFIRM message contained the IE "Integrity protection mode info":
 - 3> set "Uplink RRC Message sequence number" for signalling radio bearer RB0 in the variable INTEGRITY_PROTECTION_INFO to a value such that next RRC message to be sent on uplink RB0 will use the new integrity protection configuration;
 - 3> allow the transmission of RRC messages on all signalling radio bearers with any RRC SN;
 - 3> set the IE "Reconfiguration" in the variable INTEGRITY_PROTECTION_INFO to FALSE.
 - 2> clear the variable INTEGRITY_PROTECTION_ACTIVATION_INFO.
- 1> in case of a cell update procedure:
 - 2> clear the entry for the CELL UPDATE CONFIRM message in the table "Rejected transactions" in the variable TRANSACTIONS.
- 1> in case of a URA update procedure:
 - 2> clear the entry for the URA UPDATE CONFIRM message in the table "Rejected transactions" in the variable TRANSACTIONS.
- 1> set the variable CELL_UPDATE_STARTED to FALSE;
- 1> if the variable AM_RLC_ERROR_PENDING_RB234 is set to TRUE:
 - 2> set the variable AM_RLC_ERROR_PENDING_RB234 to FALSE.
- 1> if the variable AM_RLC_ERROR_PENDING_RB5_AND_UP is set to TRUE:
 - 2> set the variable AM_RLC_ERROR_PENDING_RB5_AND_UP to FALSE.
- 1> clear the variable SECURITY_MODIFICATION.
- 1> stop timers T314 and/or T315 if they are running.

The procedure ends.

8.3.1.7 Transmission of a response message to UTRAN

If CELL UPDATE CONFIRM message:

- includes the IE "RAB information to setup":

the UE shall:

- 1> transmit a RADIO BEARER SETUP COMPLETE as response message using AM RLC.

If the CELL UPDATE CONFIRM message:

- does not include the IE "RAB information for setup"; and
- includes the IE "RB information to release list":

the UE shall:

- 1> transmit a RADIO BEARER RELEASE COMPLETE as response message using AM RLC.

If the CELL UPDATE CONFIRM message:

- does not include the IE "RAB information for setup", nor the IE "RB information to release list"; and
- includes the IE "RB information to reconfigure list"; or
- includes the IE "RB information to be affected list":

the UE shall:

- 1> transmit a RADIO BEARER RECONFIGURATION COMPLETE as response message using AM RLC.

If the CELL UPDATE CONFIRM message:

- does not include the IE "RAB information for setup", the IE "RB information to release list", the IE "RB information to reconfigure list", nor the IE "RB information to be affected list"; and
- includes "Transport channel information elements":

the UE shall:

- 1> transmit a TRANSPORT CHANNEL RECONFIGURATION COMPLETE as response message using AM RLC.

If the CELL UPDATE CONFIRM message:

- does not include the IE "RAB information for setup", the IE "RB information to release list", the IE "RB information to reconfigure list", nor the IE "RB information to be affected list"; and
- does not include "Transport channel information elements"; and
- includes "Physical channel information elements":

the UE shall:

- 1> transmit a PHYSICAL CHANNEL RECONFIGURATION COMPLETE as response message using AM RLC.

If the CELL UPDATE CONFIRM message:

- does not include the IE "RAB information for setup", the IE "RB information to release list", the IE "RB information to reconfigure list", nor the IE "RB information to be affected list"; and
- does not include "Transport channel information elements"; and
- does not include "Physical channel information elements"; and
- includes "CN information elements"; or
- includes the IE "Ciphering mode info"; or
- includes the IE "Integrity protection mode info"; or
- includes the IE "New C-RNTI"; or
- includes the IE "New U-RNTI"; or
- includes the IE "Downlink counter synchronisation info" and the IE "New U-RNTI":

NOTE: In the case of a cell update procedure during an ongoing reconfiguration procedure moving the UE into CELL_PCH/URA_PCH the CELL UPDATE CONFIRM message should include the IE "New C-RNTI".

the UE shall:

- 1> transmit a UTRAN MOBILITY INFORMATION CONFIRM as response message using AM RLC.

If the CELL UPDATE CONFIRM message:

- does not include "RAB information to setup": and
- does not include "RB information elements"; and
- does not include "Transport channel information elements"; and
- does not include "Physical channel information elements"; and
- does not include "CN information elements"; and
- does not include the IE "Ciphering mode info"; and
- does not include the IE "Integrity protection mode info"; and
- does not include the IE "New C-RNTI"; and
- does not include the IE "New U-RNTI":

the UE shall:

- 1> transmit no response message.

If the URA UPDATE CONFIRM message:

- includes "CN information elements"; or
- includes the IE "Ciphering mode info"; or
- includes the IE "Integrity protection mode info"; or
- includes any one or both of the IEs "New C-RNTI" and "New U-RNTI"; or
- includes the IE "Downlink counter synchronisation info" and the IE "New U-RNTI":

the UE shall:

- 1> transmit a UTRAN MOBILITY INFORMATION CONFIRM as response message using AM RLC.

If the URA UPDATE CONFIRM message:

- does not include "CN information elements"; and
- does not include the IE "Ciphering mode info"; and
- does not include the IE "Integrity protection mode info"; and
- does not include the IE "New U-RNTI"; and
- does not include the IE "New C-RNTI":

the UE shall:

- 1> transmit no response message.

If the new state is CELL_DCH state, the UE shall, after the state transition:

- 1> if the IE "Deferred measurement control reading" was included in the response message:
 - 2> clear the variable CELL_INFO_LIST.

If the new state is CELL_DCH or CELL_FACH, the response message shall be transmitted using the new configuration after the state transition., and the UE shall:

- 1> if the IE "Downlink counter synchronisation info" was included in the received CELL UPDATE CONFIRM or URA UPDATE CONFIRM message:
 - 2> when RLC has confirmed the successful transmission of the response message:
 - 3> if the variable PDCP_SN_INFO is empty:
 - 4> configure the RLC entity for all AM and UM radio bearers and AM and UM signalling radio bearers except RB2 to "continue".
 - 3> else:
 - 4> configure the RLC entity for signalling radio bearers RB1, RB3 and RB4 to "continue";
 - 4> configure the RLC entity for UM and AM radio bearers for which the IE " PDCP SN Info" is not included to "continue".
 - 3> re-establish all AM and UM RLC entities with RB identities larger than 4 and set the first 20 bits of all the HFN component of the respective COUNT-C values to the START value included in the response message for the corresponding CN domain;
 - 3> re-establish the RLC entities with RB identities 1, 3 and 4 and set the first 20 bits of all the HFN component of the respective COUNT-C values to the START value included in the response message for the CN domain stored in the variable LATEST_CONFIGURED_CN_DOMAIN;
 - 3> set the remaining bits of the HFN component of the COUNT-C values of all UM RLC entities to zero;
 - 3> if the IE "PDCP context relocation info" is not present:
 - > re-initialise the PDCP header compression entities of each radio bearer in the variable ESTABLISHED_RABS as specified in [36].
 - 3> if the IE "PDCP context relocation info" is present:
 - 4> perform the actions as specified in subclause 8.6.4.13.

- 1> if the variable PDCP_SN_INFO is empty:

- 2> if the CELL UPDATE CONFIRM or URA UPDATE CONFIRM message contained the IE "Ciphering mode info":
 - 3> when RLC has confirmed the successful transmission of the response message:
 - 4> continue with the remainder of the procedure.
- 2> if the CELL UPDATE CONFIRM or URA UPDATE CONFIRM message did not contain the IE "Ciphering mode info":
 - 3> when RLC has been requested to transmit the response message,
 - 4> continue with the remainder of the procedure.
- 1> if the variable PDCP_SN_INFO is non-empty:
 - 2> when RLC has confirmed the successful transmission of the response message:
 - 3> for each radio bearer in the variable PDCP_SN_INFO:
 - 4> if the IE "RB started" in the variable ESTABLISHED_RABS is set to "started":
 - 5> configure the RLC entity for that radio bearer to "continue".
 - 3> continue with the remainder of the procedure.

If the new state is CELL_PCH or URA_PCH, the response message shall be transmitted in CELL_FACH state, and the UE shall:

- 1> when RLC has confirmed the successful transmission of the response message:
 - 2> if the IE "Downlink counter synchronisation info" was included in the received CELL UPDATE CONFIRM or URA UPDATE CONFIRM message:
 - 3> re-establish all AM and UM RLC entities with RB identities larger than 4 and set the first 20 bits of all the HFN component of the respective COUNT-C values to the START value included in the response message for the corresponding CN domain;
 - 3> re-establish the RLC entities with RB identities 1, 3 and 4 and set the first 20 bits of all the HFN component of the respective COUNT-C values to the START value included in the response message for the CN domain stored in the variable LATEST_CONFIGURED_CN_DOMAIN;
 - 3> set the remaining bits of the HFN component of the COUNT-C values of all UM RLC entities to zero;
 - 3> re-initialise the PDCP header compression entities of each radio bearer in the variable ESTABLISHED_RABS as specified in [36].
 - 2> for each radio bearer in the variable PDCP_SN_INFO:
 - 3> if the IE "RB started" in the variable ESTABLISHED_RABS is set to "started":
 - 4> configure the RLC entity for that radio bearer to "continue".
 - 2> enter the new state (CELL_PCH or URA_PCH, respectively).
- 1> continue with the remainder of the procedure.

8.3.1.7a Physical channel failure

If the received CELL UPDATE CONFIRM message would cause the UE to transit to CELL_DCH state:

- 1> if the UE failed to establish the physical channel(s) indicated in the received CELL UPDATE CONFIRM message according to the criteria defined in subclause 8.5.4 are not fulfilled;

- 1> for FDD and 3.84/7.68 Mcps TDD, if the received CELL UPDATE CONFIRM message does not contain dedicated physical channels; or
- 1> for 1.28 Mcps TDD, if the received CELL UPDATE CONFIRM message does not contain dedicated physical channels nor physical shared channels as defined in clause 8.5.4; or
- 1> for 3.84 Mcps TDD or 7.68 Mcps TDD, if the received CELL UPDATE CONFIRM does not contain physical channels to which DCCH(s) are mapped:

the UE shall:

- 1> if, caused by the received CELL UPDATE CONFIRM message
 - 2> the IE "Reconfiguration" in the variable CIPHERING_STATUS is set to TRUE; and/or
 - 2> the IE "Reconfiguration" in the variable INTEGRITY_PROTECTION_INFO is set to TRUE:
 - 3> abort the ongoing integrity and/or ciphering reconfiguration;
 - 3> if the received CELL UPDATE CONFIRM message contained the IE "Ciphering mode info":
 - 4> set the IE "Reconfiguration" in the variable CIPHERING_STATUS to FALSE; and
 - 4> clear the variable RB_UPLINK_CIPHERING_ACTIVATION_TIME_INFO.
 - 3> if the received CELL UPDATE CONFIRM message contained the IE "Integrity protection mode info":
 - 4> set the IE "Reconfiguration" in the variable INTEGRITY_PROTECTION_INFO to FALSE; and
 - 4> clear the variable INTEGRITY_PROTECTION_ACTIVATION_INFO.
- 1> if the variable ORDERED_RECONFIGURATION is set to TRUE caused by the received CELL UPDATE CONFIRM message:
 - 2> set the IE "failure cause" to "physical channel failure";
 - 2> set the variable ORDERED_RECONFIGURATION to FALSE.
- 1> if V302 is equal to or smaller than N302:
 - 2> select a suitable UTRA cell according to [4];
 - 2> set the contents of the CELL UPDATE message according to subclause 8.3.1.3, except for the IE "Cell update cause" which shall be set to "Radio link failure";
 - 2> submit the CELL UPDATE message for transmission on the uplink CCCH;
 - 2> increment counter V302;
 - 2> restart timer T302 when the MAC layer indicates success or failure to transmit the message.
- 1> if V302 is greater than N302:
 - 2> clear the variable RB_UPLINK_CIPHERING_ACTIVATION_TIME_INFO;
 - 2> clear the variable INTEGRITY_PROTECTION_ACTIVATION_INFO;
 - 2> in case of a cell update procedure:
 - 3> clear the entry for the CELL UPDATE CONFIRM message in the table "Rejected transactions" in the variable TRANSACTIONS.
 - 2> release all its radio resources;
 - 2> indicate release (abort) of the established signalling connections (as stored in the variable ESTABLISHED_SIGNALLING_CONNECTIONS) and established radio access bearers (as stored in the variable ESTABLISHED_RABS) to upper layers;

- 2> clear the variable ESTABLISHED_SIGNALLING_CONNECTIONS;
- 2> clear the variable ESTABLISHED_RABS;
- 2> set the variable CELL_UPDATE_STARTED to FALSE;
- 2> enter idle mode.

8.3.1.8 Unsupported configuration by the UE

If the UE does not support the configuration in the CELL UPDATE CONFIRM message and/or the variable UNSUPPORTED_CONFIGURATION is set to TRUE, the UE shall:

- 1> if V302 is equal to or smaller than N302, the UE shall:
 - 2> if, caused by the received CELL UPDATE CONFIRM message
 - 3> the IE "Reconfiguration" in the variable CIPHERING_STATUS is set to TRUE; and/or
 - 3> the IE "Reconfiguration" in the variable INTEGRITY_PROTECTION_INFO is set to TRUE:
 - 4> abort the ongoing integrity and/or ciphering reconfiguration;
 - 4> if the received CELL UPDATE CONFIRM message contained the IE "Ciphering mode info":
 - 5> set the IE "Reconfiguration" in the variable CIPHERING_STATUS to FALSE; and
 - 5> clear the variable RB_UPLINK_CIPHERING_ACTIVATION_TIME_INFO.
 - 4> if the received CELL UPDATE CONFIRM message contained the IE "Integrity protection mode info":
 - 5> set the IE "Reconfiguration" in the variable INTEGRITY_PROTECTION_INFO to FALSE; and
 - 5> clear the variable INTEGRITY_PROTECTION_ACTIVATION_INFO.
 - 2> if the variable ORDERED_RECONFIGURATION is set to TRUE due to the received CELL UPDATE CONFIRM message in case of a cell update procedure:
 - 3> set the variable ORDERED_RECONFIGURATION to FALSE.
 - 2> set the variable FAILURE_INDICATOR to TRUE;
 - 2> set the variable FAILURE_CAUSE to "Unsupported configuration";
 - 2> set the content of the CELL UPDATE message according to subclause 8.3.1.3;
 - 2> submit the CELL UPDATE message for transmission on the uplink CCCH;
 - 2> increment counter V302;
 - 2> restart timer T302 when the MAC layer indicates success or failure to transmit the message.
- 1> if V302 is greater than N302, the UE shall:
 - 2> clear the variable RB_UPLINK_CIPHERING_ACTIVATION_TIME_INFO;
 - 2> clear the variable INTEGRITY_PROTECTION_ACTIVATION_INFO;
 - 2> clear the variable PDCP_SN_INFO;
 - 2> clear the entry for the CELL UPDATE CONFIRM message in the table "Rejected transactions" in the variable TRANSACTIONS;
 - 2> release all its radio resources;

- 2> indicate release (abort) of the established signalling connections (as stored in the variable ESTABLISHED_SIGNALLING_CONNECTIONS) and established radio access bearers (as stored in the variable ESTABLISHED_RABS) to upper layers;
- 2> clear the variable ESTABLISHED_SIGNALLING_CONNECTIONS;
- 2> clear the variable ESTABLISHED_RABS;
- 2> set the variable CELL_UPDATE_STARTED to FALSE;
- 2> enter idle mode;
- 2> Other actions the UE shall perform when entering idle mode from connected mode are specified in subclause 8.5.2;
- 2> and the procedure ends.

8.3.1.9 Invalid configuration

If the variable INVALID_CONFIGURATION is set to TRUE, the UE shall:

- 1> if V302 is equal to or smaller than N302:
 - 2> if, caused by the received CELL UPDATE CONFIRM or URA UPDATE CONFIRM message
 - 3> the IE "Reconfiguration" in the variable CIPHERING_STATUS is set to TRUE; and/or
 - 3> the IE "Reconfiguration" in the variable INTEGRITY_PROTECTION_INFO is set to TRUE:
 - 4> abort the ongoing integrity and/or ciphering reconfiguration;
 - 4> if the received CELL UPDATE CONFIRM or URA UPDATE CONFIRM message contained the IE "Ciphering mode info":
 - 5> set the IE "Reconfiguration" in the variable CIPHERING_STATUS to FALSE; and
 - 5> clear the variable RB_UPLINK_CIPHERING_ACTIVATION_TIME_INFO.
 - 4> if the received CELL UPDATE CONFIRM or URA UPDATE CONFIRM message contained the IE "Integrity protection mode info";
 - 5> set the IE "Reconfiguration" in the variable INTEGRITY_PROTECTION_INFO to FALSE; and
 - 5> clear the variable INTEGRITY_PROTECTION_ACTIVATION_INFO.
 - 2> if the variable ORDERED_RECONFIGURATION is set to TRUE caused by the received CELL UPDATE CONFIRM message in case of a cell update procedure:
 - 3> set the variable ORDERED_RECONFIGURATION to FALSE.
 - 2> in case of a cell update procedure:
 - 3> set the variable FAILURE_INDICATOR to TRUE;
 - 3> set the variable FAILURE_CAUSE to "Invalid configuration";
 - 3> set the contents of the CELL UPDATE message according to subclause 8.3.1.3;
 - 3> submit the CELL UPDATE message for transmission on the uplink CCCH.
 - 2> in case of a URA update procedure:
 - 3> set the contents of the URA UPDATE message according to subclause 8.3.1.3;
 - 3> submit the URA UPDATE message for transmission on the uplink CCCH.
 - 2> increment counter V302;

- 2> restart timer T302 when the MAC layer indicates success or failure to transmit the message.
- 1> if V302 is greater than N302:
 - 2> clear the variable RB_UPLINK_CIPHERING_ACTIVATION_TIME_INFO;
 - 2> clear the variable INTEGRITY_PROTECTION_ACTIVATION_INFO;
 - 2> clear the variable PDCP_SN_INFO;
 - 2> clear the entry for the CELL UPDATE CONFIRM message in the table "Rejected transactions" in the variable TRANSACTIONS;
 - 2> release all its radio resources;
 - 2> indicate release (abort) of the established signalling connections (as stored in the variable ESTABLISHED_SIGNALLING_CONNECTIONS) and established radio access bearers (as stored in the variable ESTABLISHED_RABS) to upper layers;
 - 2> clear the variable ESTABLISHED_SIGNALLING_CONNECTIONS;
 - 2> clear the variable ESTABLISHED_RABS;
 - 2> set the variable CELL_UPDATE_STARTED to FALSE;
 - 2> enter idle mode;
 - 2> Other actions the UE shall perform when entering idle mode from connected mode are specified in subclause 8.5.2;
 - 2> the procedure ends.

8.3.1.9a Incompatible simultaneous reconfiguration

In case of a cell update procedure and if the received CELL UPDATE CONFIRM message

- includes the IE "RB information to release list", and/or the IE "RB information to reconfigure list", and/or the IE "RB information to be affected list", and/or
- includes "Transport channel information elements"; and/or
- includes "Physical channel information elements"; and
- the variable ORDERED_RECONFIGURATION is set to TRUE because of an ongoing Reconfiguration procedure;

or

If the variable INCOMPATIBLE_SECURITY_RECONFIGURATION is set to TRUE due to the received CELL UPDATE CONFIRM or URA UPDATE CONFIRM message:

the UE shall:

- 1> if V302 is equal to or smaller than N302:
 - 2> if, caused by the received CELL UPDATE CONFIRM or URA UPDATE CONFIRM message
 - 3> the IE "Reconfiguration" in the variable CIPHERING_STATUS is set to TRUE; and/or
 - 3> the IE "Reconfiguration" in the variable INTEGRITY_PROTECTION_INFO is set to TRUE:
 - 4> abort the ongoing integrity and/or ciphering reconfiguration;
 - 4> if the received CELL UPDATE CONFIRM or URA UPDATE CONFIRM message contained the IE "Ciphering mode info":
 - 5> set the IE "Reconfiguration" in the variable CIPHERING_STATUS to FALSE; and

- 5> clear the variable RB_UPLINK_CIPHERING_ACTIVATION_TIME_INFO.
- 4> if the received CELL UPDATE CONFIRM or URA UPDATE CONFIRM message contained the IE "Integrity protection mode info":
 - 5> set the IE "Reconfiguration" in the variable INTEGRITY_PROTECTION_INFO to FALSE; and
 - 5> clear the variable INTEGRITY_PROTECTION_ACTIVATION_INFO.
- 2> if the variable ORDERED_RECONFIGURATION is set to TRUE due to the received CELL UPDATE CONFIRM message in case of a cell update procedure:
 - 3> set the variable ORDERED_RECONFIGURATION to FALSE.
 - 2> set the variable FAILURE_INDICATOR to TRUE;
 - 2> set the variable FAILURE_CAUSE to "Incompatible simultaneous reconfiguration";
 - 2> set the content of the CELL UPDATE message according to subclause 8.3.1.3;
 - 2> submit the CELL UPDATE message for transmission on the uplink CCCH;
 - 2> increment counter V302;
 - 2> restart timer T302 when the MAC layer indicates success or failure to transmit the message.
- 1> if V302 is greater than N302:
 - 2> clear the variable RB_UPLINK_CIPHERING_ACTIVATION_TIME_INFO;
 - 2> clear the variable INTEGRITY_PROTECTION_ACTIVATION_INFO;
 - 2> clear the variable PDCP_SN_INFO;
 - 2> set the variable INCOMPATIBLE_SECURITY_RECONFIGURATION to FALSE;
 - 2> clear the entry for the CELL UPDATE CONFIRM message in the table "Rejected transactions" in the variable TRANSACTIONS;
 - 2> release all its radio resources;
 - 2> indicate release (abort) of the established signalling connections (as stored in the variable ESTABLISHED_SIGNALLING_CONNECTIONS) and established radio access bearers (as stored in the variable ESTABLISHED_RABS) to upper layers;
 - 2> clear the variable ESTABLISHED_SIGNALLING_CONNECTIONS;
 - 2> clear the variable ESTABLISHED_RABS;
 - 2> set the variable CELL_UPDATE_STARTED to FALSE;
 - 2> enter idle mode;
 - 2> Other actions the UE shall perform when entering idle mode from connected mode are specified in subclause 8.5.2;
 - 2> the procedure ends.

8.3.1.9b Security reconfiguration during Cell update procedure

If:

- the variable CELL_UPDATE_STARTED is set to TRUE; and
- the UE receives a SECURITY MODE COMMAND message:

the UE shall

- 1> ignore the received SECURITY MODE COMMAND and continue with any ongoing processes and procedures as if the SECURITY MODE COMMAND message has not been received.

8.3.1.10 Confirmation error of URA ID list

If the URA UPDATE CONFIRM message causes a confirmation error of URA identity list as specified in subclause 8.6.2.1 the UE shall:

- 1> check the value of V302; and
- 1> if V302 is smaller or equal than N302:
 - 2> if, caused by the received URA UPDATE CONFIRM message
 - 3> the IE "Reconfiguration" in the variable CIPHERING_STATUS is set to TRUE; and/or
 - 3> the IE "Reconfiguration" in the variable INTEGRITY_PROTECTION_INFO is set to TRUE:
 - 4> abort the ongoing integrity and/or ciphering reconfiguration;
 - 4> if the received URA UPDATE CONFIRM message contained the IE "Ciphering mode info":
 - 5> set the IE "Reconfiguration" in the variable CIPHERING_STATUS to FALSE; and
 - 5> clear the variable RB_UPLINK_CIPHERING_ACTIVATION_TIME_INFO.
 - 4> if the received URA UPDATE CONFIRM message contained the IE "Integrity protection mode info"
 - 5> set the IE "Reconfiguration" in the variable INTEGRITY_PROTECTION_INFO to FALSE; and
 - 5> clear the variable INTEGRITY_PROTECTION_ACTIVATION_INFO.
 - 2> set the IEs in the URA UPDATE message according to subclause 8.3.1.3;
 - 2> submit the URA UPDATE message for transmission on the uplink CCCH;
 - 2> increment counter V302;
 - 2> restart timer T302 when the MAC layer indicates success or failure to transmit the message.
 - 1> if V302 is greater than N302:
 - 2> release all its radio resources;
 - 2> clear the variable RB_UPLINK_CIPHERING_ACTIVATION_TIME_INFO;
 - 2> clear the variable INTEGRITY_PROTECTION_ACTIVATION_INFO;
 - 2> clear the variable PDCP_SN_INFO;
 - 2> indicate release (abort) of the established signalling connections (as stored in the variable ESTABLISHED_SIGNALLING_CONNECTIONS) and established radio access bearers (as stored in the variable ESTABLISHED_RABS) to upper layers;
 - 2> clear the variable ESTABLISHED_SIGNALLING_CONNECTIONS;
 - 2> clear the variable ESTABLISHED_RABS;
 - 2> set the variable CELL_UPDATE_STARTED to FALSE;
 - 2> enter idle mode;
 - 2> perform the actions specified in subclause 8.5.2 when entering idle mode from connected mode;
 - 2> the procedure ends.

8.3.1.11 Invalid CELL UPDATE CONFIRM/URA UPDATE CONFIRM message

If the UE receives an CELL UPDATE CONFIRM/URA UPDATE CONFIRM message, which contains a protocol error causing the variable `PROTOCOL_ERROR_REJECT` to be set to `TRUE` according to clause 9, the UE shall perform procedure specific error handling as follows:

- 1> If `V302` is equal to or smaller than `N302`, the UE shall:
 - 2> set the variable `PROTOCOL_ERROR_INDICATOR` to `TRUE`;
 - 2> in case of a cell update procedure:
 - 3> set the contents of the CELL UPDATE message according to subclause 8.3.1.3;
 - 3> submit the CELL UPDATE message for transmission on the uplink CCCH.
 - 2> in case of a URA update procedure:
 - 3> set the contents of the URA UPDATE message according to subclause 8.3.1.3;
 - 3> submit the URA UPDATE message for transmission on the uplink CCCH.
 - 2> increment counter `V302`;
 - 2> restart timer `T302` when the MAC layer indicates success or failure to transmit the message.
- 1> if `V302` is greater than `N302`, the UE shall:
 - 2> clear the variable `RB_UPLINK_CIPHERING_ACTIVATION_TIME_INFO`;
 - 2> in case of a cell update procedure:
 - 3> clear the entry for the CELL UPDATE CONFIRM message in the table "Rejected transactions" in the variable `TRANSACTIONS`.
 - 2> in case of a URA update procedure:
 - 3> clear the entry for the URA UPDATE CONFIRM message in the table "Rejected transactions" in the variable `TRANSACTIONS`.
 - 2> indicate release (abort) of the established signalling connections (as stored in the variable `ESTABLISHED_SIGNALLING_CONNECTIONS`) and established radio access bearers (as stored in the variable `ESTABLISHED_RABS`) to upper layers;
 - 2> clear the variable `ESTABLISHED_SIGNALLING_CONNECTIONS`;
 - 2> clear the variable `ESTABLISHED_RABS`;
 - 2> set the variable `CELL_UPDATE_STARTED` to `FALSE`;
 - 2> release all its radio resources;
 - 2> enter idle mode;
 - 2> Other actions the UE shall perform when entering idle mode from connected mode are specified in subclause 8.5.2;
 - 2> the procedure ends.

8.3.1.12 T302 expiry or cell reselection

If any or several of the following conditions are true:

- expiry of timer `T302`;
- reselection to another UTRA cell (including the previously serving cell) before completion of the cell update or URA update procedure;

the UE shall:

- 1> stop T302 if it is running;
- 1> if the UE was in CELL_DCH state prior to the initiation of the procedure; and
 - 2> if timers T314 and T315 have elapsed while T302 was running:
 - 3> enter idle mode.
 - 3> indicate release (abort) of the established signalling connections (as stored in the variable ESTABLISHED_SIGNALLING_CONNECTIONS) and established radio access bearers (as stored in the variable ESTABLISHED_RABS) to upper layers. Other actions the UE shall perform when entering idle mode from connected mode are specified in subclause 8.5.2.
 - 3> and the procedure ends.
 - 2> if timer T314 has elapsed while T302 was running and,
 - 3> if "T314 expired" in the variable RB_TIMER_INDICATOR is set to FALSE and
 - 3> if T315 is still running:
 - 4> release locally all radio bearers which are associated with any radio access bearers for which in the variable ESTABLISHED_RABS the value of the IE "Re-establishment timer" is set to "useT314";
 - 4> indicate release of those radio access bearers to upper layers;
 - 4> delete all information about those radio access bearers from the variable ESTABLISHED_RABS;
 - 4> set "T314 expired" in the variable RB_TIMER_INDICATOR to TRUE;
 - 4> if all radio access bearers associated with a CN domain are released:
 - 5> release the signalling connection for that CN domain;
 - 5> remove the signalling connection for that CN domain from the variable ESTABLISHED_SIGNALLING_CONNECTIONS;
 - 5> indicate release (abort) of the signalling connection to upper layers.
 - 2> if timer T315 has elapsed while T302 was running and,
 - 3> if "T315 expired" in the variable RB_TIMER_INDICATOR is set to FALSE and,
 - 3> if T314 is still running:
 - 4> release locally all radio bearers which are associated with any radio access bearers for which in the variable ESTABLISHED_RABS the value of the IE "Re-establishment timer" is set to "useT315";
 - 4> indicate release of those radio access bearers to upper layers;
 - 4> delete all information about those radio access bearers from the variable ESTABLISHED_RABS;
 - 4> set "T315 expired" in the variable RB_TIMER_INDICATOR to TRUE;
 - 4> if all radio access bearers associated with a CN domain are released:
 - 5> release the signalling connection for that CN domain;
 - 5> remove the signalling connection for that CN domain from the variable ESTABLISHED_SIGNALLING_CONNECTIONS;
 - 5> indicate release (abort) of the signalling connection to upper layers.
 - 2> if timers T314 and T315 are not running:
 - 3> enter idle mode;

3> indicate release (abort) of the established signalling connections (as stored in the variable ESTABLISHED_SIGNALLING_CONNECTIONS) and established radio access bearers (as stored in the variable ESTABLISHED_RABS) to upper layers. Other actions the UE shall perform when entering idle mode from connected mode are specified in subclause 8.5.2;

3> and the procedure ends.

1> check whether it is still in "in service area" (see subclause 8.5.5.2);

1> if the variable ORDERED_RECONFIGURATION is set to TRUE caused by the received CELL UPDATE CONFIRM message in case of a cell update procedure:

2> set the variable ORDERED_RECONFIGURATION to FALSE.

1> in case of a cell update procedure:

2> clear any entry for the CELL UPDATE CONFIRM message in the table "Accepted transactions" in the variable TRANSACTIONS.

1> in case of a URA update procedure:

2> clear any entry for the URA UPDATE CONFIRM message in the table "Accepted transactions" in the variable TRANSACTIONS.

If the UE detects "in service area" if it has not entered idle mode, and:

1> if V302 is equal to or smaller than N302, the UE shall:

2> if the UE performed cell re-selection:

3> delete its C-RNTI;

3> for FDD and 1.28 Mcps TDD, if the variable H-RNTI is set:

4> clear the variable H_RNTI;

4> stop using that H_RNTI just cleared from the variable H_RNTI in MAC;

4> clear any stored IEs "HARQ info".

3> for FDD and 1.28 Mcps TDD, if the variable E-RNTI is set:

4> clear the variable E_RNTI.

3> for FDD and 1.28 Mcps TDD, if the UE does support HS-DSCH reception in CELL_FACH state and the IE "HS-DSCH common system information" is included in System Information Block type 5 or System Information Block type 5bis:

4> reset the MAC-ehs entity [15];

4> set variable HS_DSCH_RECEPTION_OF_CCCH_ENABLED to TRUE;

4> and start receiving the HS-DSCH according to the procedure in subclause 8.5.37.

3> else:

4> take the actions related to the HS_DSCH_RECEPTION_GENERAL variable as described in subclause 8.5.37a.

3> determine the value for the READY_FOR_COMMON_EDCH variable and take the corresponding actions as described in subclause 8.5.47;

3> determine the value for the COMMON_E_DCH_TRANSMISSION variable and take the corresponding actions as described in subclause 8.5.46.

2> in case of a cell update procedure:

3> set the contents of the CELL UPDATE message according to subclauses 8.3.1.3 and 8.5.10;

- 3> if a CELL UPDATE CONFIRM message was received and caused the IE "Reconfiguration" in the variable CIPHERING_STATUS to be set to TRUE and/or the IE "Reconfiguration" in the variable INTEGRITY_PROTECTION_INFO to be set to TRUE:
 - 4> if the IE "Downlink counter synchronisation info" was included in the received CELL UPDATE CONFIRM message:
 - 5> apply the new security (integrity protection) configuration received in the CELL UPDATE CONFIRM on the CELL UPDATE message.
- 3> submit the CELL UPDATE message for transmission on the uplink CCCH.
- 2> in case of a URA update procedure:
 - 3> set the contents of the URA UPDATE message according to subclauses 8.3.1.3 and 8.5.10;
 - 3> if a URA UPDATE CONFIRM message was received and caused the IE "Reconfiguration" in the variable CIPHERING_STATUS to be set to TRUE and/or the IE "Reconfiguration" in the variable INTEGRITY_PROTECTION_INFO is set to TRUE:
 - 4> if the IE "Downlink counter synchronisation info" was included in the received URA UPDATE CONFIRM message:
 - 5> apply the new security (integrity protection) configuration received in the URA UPDATE CONFIRM on the URA UPDATE message.
 - 3> submit the URA UPDATE message for transmission on the uplink CCCH.
- 2> increment counter V302;
- 2> restart timer T302 when the MAC layer indicates success or failure to transmit the message.
- 1> if V302 is greater than N302, the UE shall:
 - 2> clear the variable RB_UPLINK_CIPHERING_ACTIVATION_TIME_INFO;
 - 2> clear the variable INTEGRITY_PROTECTION_ACTIVATION_INFO;
 - 2> clear the variable PDCP_SN_INFO;
 - 2> in case of a cell update procedure:
 - 3> clear the entry for the CELL UPDATE CONFIRM message in the table "Rejected transactions" in the variable TRANSACTIONS.
 - 2> in case of a URA update procedure:
 - 3> clear the entry for the URA UPDATE CONFIRM message in the table "Rejected transactions" in the variable TRANSACTIONS.
 - 2> release all its radio resources;
 - 2> indicate release (abort) of the established signalling connections (as stored in the variable ESTABLISHED_SIGNALLING_CONNECTIONS) and established radio access bearers (as stored in the variable ESTABLISHED_RABS) to upper layers;
 - 2> clear the variable ESTABLISHED_SIGNALLING_CONNECTIONS;
 - 2> clear the variable ESTABLISHED_RABS;
 - 2> set the variable CELL_UPDATE_STARTED to FALSE;
 - 2> enter idle mode;
 - 2> other actions the UE shall perform when entering idle mode from connected mode are specified in subclause 8.5.2;

2> and the procedure ends.

If the UE detects "out of service area", it shall:

1> act according to subclause 7.2.2.

8.3.1.13 T314 expiry

Upon expiry of timer T314 the UE shall:

1> if timer T302 is running:

2> continue awaiting response message from UTRAN.

1> if timer T302 is not running and timer T315 is running:

2> set IE "T314 expired" in variable RB_TIMER_INDICATOR to TRUE;

2> release locally all radio bearers which are associated with any radio access bearers for which in the variable ESTABLISHED_RABS the value of the IE "Re-establishment timer" is set to "useT314";

2> indicate release of those radio access bearers to upper layers;

2> delete all information about those radio access bearers from the variable ESTABLISHED_RABS;

2> if all radio access bearers associated with a CN domain are released:

3> release the signalling connection for that CN domain;

3> remove the signalling connection for that CN domain from the variable ESTABLISHED_SIGNALLING_CONNECTIONS;

3> indicate release (abort) of the signalling connection to upper layers.

1> if timers T302 and T315 are not running:

2> clear the variable RB_UPLINK_CIPHERING_ACTIVATION_TIME_INFO;

2> clear the variable INTEGRITY_PROTECTION_ACTIVATION_INFO;

2> clear the variable PDCP_SN_INFO;

2> clear the entry for the CELL_UPDATE_CONFIRM message in the table "Rejected transactions" in the variable TRANSACTIONS;

2> release all its radio resources;

2> indicate release (abort) of the established signalling connections (as stored in the variable ESTABLISHED_SIGNALLING_CONNECTIONS) and established radio access bearers (as stored in the variable ESTABLISHED_RABS) to upper layers;

2> clear the variable ESTABLISHED_SIGNALLING_CONNECTIONS;

2> clear the variable ESTABLISHED_RABS;

2> set the variable CELL_UPDATE_STARTED to FALSE;

2> enter idle mode;

2> other actions the UE shall perform when entering idle mode from connected mode are specified in subclause 8.5.2;

2> and the procedure ends.

8.3.1.14 T315 expiry

Upon expiry of timer T315 the UE shall:

- 1> if timer T302 is running:
 - 2> continue awaiting response message from UTRAN.
- 1> if timer T302 is not running and timer T314 is running:
 - 2> set IE "T315 expired" in variable RB_TIMER_INDICATOR to TRUE;
 - 2> release locally all radio bearers which are associated with any radio access bearers for which in the variable ESTABLISHED_RABS the value of the IE "Re-establishment timer" is set to "use T315";
 - 2> indicate release of those radio access bearers to upper layers;
 - 2> delete all information about those radio access bearers from the variable ESTABLISHED_RABS;
 - 2> if all radio access bearers associated with a CN domain are released:
 - 3> release the signalling connection for that CN domain;
 - 3> remove the signalling connection for that CN domain from the variable ESTABLISHED_SIGNALLING_CONNECTIONS;
 - 3> indicate release (abort) of the signalling connection to upper layers.
- 1> if timers T302 and T314 are not running:
 - 2> clear the variable RB_UPLINK_CIPHERING_ACTIVATION_TIME_INFO;
 - 2> clear the variable INTEGRITY_PROTECTION_ACTIVATION_INFO;
 - 2> clear the variable PDCP_SN_INFO;
 - 2> clear the entry for the CELL UPDATE CONFIRM message in the table "Rejected transactions" in the variable TRANSACTIONS;
 - 2> release all its radio resources;
 - 2> indicate release (abort) of the established signalling connections (as stored in the variable ESTABLISHED_SIGNALLING_CONNECTIONS) and established radio access bearers (as stored in the variable ESTABLISHED_RABS) to upper layers;
 - 2> clear the variable ESTABLISHED_SIGNALLING_CONNECTIONS;
 - 2> clear the variable ESTABLISHED_RABS;
 - 2> set the variable CELL_UPDATE_STARTED to FALSE;
 - 2> enter idle mode;
 - 2> other actions the UE shall perform when entering idle mode from connected mode are specified in subclause 8.5.2;
 - 2> and the procedure ends.

8.3.1.15 Reception of the UTRAN MOBILITY INFORMATION CONFIRM message by the UTRAN

See subclause 8.3.3.4.

8.3.1.16 T320 Expiry

Upon expiry of timer T320, the UE shall:

- 1> if the UE has uplink RLC data PDU or uplink RLC control PDU on RB1 or upwards to transmit:

2> perform a cell update procedure according to subclause 8.3.1 using the cause corresponding to "uplink data transmission".

1> else:

2> if the UE should perform cell update for MBMS ptp radio bearer request as specified in subclause 8.6.9.6:

3> perform a cell update procedure according to subclause 8.3.1 using the cause corresponding to "MBMS ptp RB request".

8.3.2 URA update

See subclause 8.3.1.

8.3.3 UTRAN mobility information

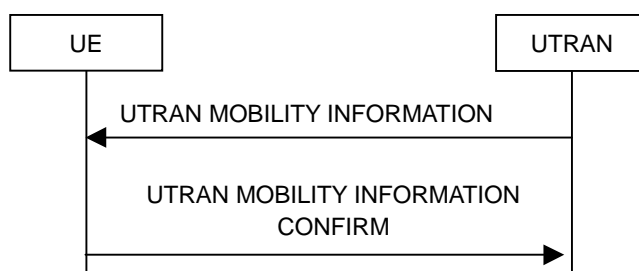

Figure 8.3.3-1: UTRAN mobility information procedure, normal flow

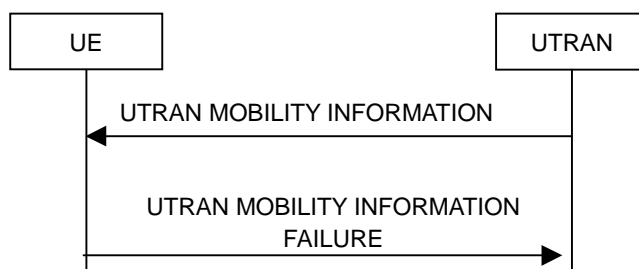

Figure 8.3.3-2: UTRAN mobility information procedure, failure case

8.3.3.1 General

The purpose of this procedure is to allocate any one or a combination of the following to a UE in connected mode:

- a new C-RNTI;
- a new U-RNTI;
- a new H-RNTI (FDD, CELL_FACH state and 1.28 Mcps TDD only);
- a new E-RNTI (FDD, CELL_FACH state and 1.28 Mcps TDD only);
- other mobility related information.

8.3.3.2 Initiation

To initiate the procedure UTRAN transmits a UTRAN MOBILITY INFORMATION message to the UE on the downlink DCCH using AM or UM RLC. In case of SRNS relocation, the message is sent using UM RLC only.

8.3.3.3 Reception of UTRAN MOBILITY INFORMATION message by the UE

When the UE receives a UTRAN MOBILITY INFORMATION message, it shall:

1> act on received information elements as specified in subclause 8.6;

1> if the IE "Dedicated Priority Information" is present:

2> act upon the received IE as described in subclause 8.6.7.23.

1> if the IE "UE Timers and constants in connected mode" is present:

2> store the values of the IE "UE Timers and constants in connected mode" in the variable TIMERS_AND_CONSTANTS, replacing any previously stored value for each timer and constant; and

2> if the IE "T323" is not present:

3> clear any value of the timer T323 stored in the IE "UE Timers and constants in connected mode" in the variable TIMERS_AND_CONSTANTS; and

2> for each updated timer value:

3> start using the new value next time the timer is started;

NOTE: If a new value of timer T305 is included in the IE "UE Timers and constants in connected mode", and the old value of timer T305 is "infinity", the new value may not be used immediately.

2> for each updated constant value:

3> start using the new value directly;

1> if the IE "CN domain specific DRX cycle length coefficient" is present:

2> store the value of the IE "CN domain specific DRX cycle length coefficient" for that CN domain, replacing any previously stored value; and

2> use the value to determine the connected mode paging occasions according to [4].

1> set the IE "RRC transaction identifier" in the UTRAN MOBILITY INFORMATION CONFIRM message to the value of "RRC transaction identifier" in the entry for the UTRAN MOBILITY INFORMATION message in the table "Accepted transactions" in the variable TRANSACTIONS; and

1> clear that entry;

1> if the UTRAN MOBILITY INFORMATION message contained the IE "Ciphering mode info" or contained the IE "Integrity protection mode info":

2> set the IE "Status" in the variable SECURITY_MODIFICATION for all the CN domains in the variable SECURITY_MODIFICATION to "Affected".

1> if the variable PDCP_SN_INFO is non-empty:

2> include the IE "RB with PDCP information list" in the UTRAN MOBILITY INFORMATION CONFIRM message and set it to the value of the variable PDCP_SN_INFO.

1> if the received UTRAN MOBILITY INFORMATION message included the IE "Downlink counter synchronisation info":

2> if the variable PDCP_SN_INFO is empty:

3> configure the corresponding RLC entity for all AM and UM radio bearers and AM and UM signalling radio bearers except RB2 to "stop".

2> else:

3> configure the RLC entity for signalling radio bearers RB1, RB3 and RB4 to "stop";

3> configure the RLC entity for UM and AM radio bearers for which the IE "PDCP SN Info" is not included to "stop".

2> re-establish the RLC entity for RB2;

- 2> clear all entries in the table "Processed transactions" in the variable TRANSACTIONS;
- 2> for the downlink and the uplink, apply the ciphering configuration as follows:
 - 3> if the received re-configuration message included the IE "Ciphering Mode Info":
 - 4> use the ciphering configuration in the received message when transmitting the response message.
 - 3> if the ciphering configuration for RB2 from a previously received SECURITY MODE COMMAND has not yet been applied because the activation times not having been reached:
 - 4> if the previous SECURITY MODE COMMAND was received due to new keys being received:
 - 5> consider the new ciphering configuration to include the received new keys;
 - 5> initialise the HFN component of the uplink COUNT-C and downlink COUNT-C of SRB2 as indicated in subclause 8.1.12.3.1.
 - 4> else if the ciphering configuration for RB2 from a previously received SECURITY MODE COMMAND has not yet been applied because of the corresponding activation times not having been reached and the previous SECURITY MODE COMMAND caused a change in LATEST_CONFIGURED_CN_DOMAIN:
 - 5> consider the new ciphering configuration to include the keys associated with the LATEST_CONFIGURED_CN_DOMAIN;
 - 5> initialise the HFN component of the uplink COUNT-C and downlink COUNT-C of SRB2 to the most recently transmitted IE "START list" or IE "START" for the LATEST_CONFIGURED_CN_DOMAIN at the reception of the previous SECURITY MODE COMMAND.
 - 4> apply the new ciphering configuration immediately following RLC re-establishment.
 - 3> else:
 - 4> continue using the current ciphering configuration.
- 2> set the new uplink and downlink HFN component of COUNT-C of RB2 to MAX(uplink HFN component of COUNT-C of RB2, downlink HFN component of COUNT-C of RB2);
- 2> increment by one the downlink and uplink values of the HFN component of COUNT-C for RB2;
- 2> calculate the START value according to subclause 8.5.9;
- 2> include the calculated START values for each CN domain in the IE "START list" in the IE "Uplink counter synchronisation info" in the UTRAN MOBILITY INFORMATION CONFIRM message.
- 1> transmit a UTRAN MOBILITY INFORMATION CONFIRM message on the uplink DCCH using AM RLC;
- 1> if the IE "Integrity protection mode info" was present in the UTRAN MOBILITY INFORMATION message:
 - 2> start applying the new integrity protection configuration in the uplink for signalling radio bearer RB2 from and including the transmitted UTRAN MOBILITY INFORMATION CONFIRM message.
- 1> if the IE "Downlink counter synchronisation info" was included in the received UTRAN MOBILITY INFORMATION message:
 - 2> when RLC has confirmed the successful transmission of the response message:
 - 3> if the variable PDCP_SN_INFO is empty:
 - 4> configure the RLC entity for all AM and UM radio bearers and AM and UM signalling radio bearers except RB2 to "continue".
 - 3> else:
 - 4> configure the RLC entity for signalling radio bearers RB1, RB3 and RB4 to "continue";

- 4> configure the RLC entity for UM and AM radio bearers for which the IE "PDCP SN Info" is not included to "continue".
- 3> re-establish all AM and UM RLC entities with RB identities larger than 4 and set the first 20 bits of all the HFN component of the respective COUNT-C values to the START value included in the response message for the corresponding CN domain;
- 3> re-establish the RLC entities with RB identities 1, 3 and 4 and set the first 20 bits of all the HFN component of the respective COUNT-C values to the START value included in the response message for the CN domain stored in the variable LATEST_CONFIGURED_CN_DOMAIN;
- 3> set the remaining bits of the HFN component of the COUNT-C values of all UM RLC entities to zero;
- 3> if the IE "PDCP context relocation info" is not present:
 - 4> re-initialise the PDCP header compression entities of each radio bearer in the variable ESTABLISHED_RABS as specified in [36].
- 3> if the IE "PDCP context relocation info" is present:
 - 4> perform the actions as specified in subclause 8.6.4.13.
- 1> if the variable PDCP_SN_INFO is empty; and
 - 2> if the UTRAN MOBILITY INFORMATION message contained the IE "Ciphering mode info":
 - 3> when RLC has confirmed the successful transmission of the UTRAN MOBILITY INFORMATION CONFIRM message:
 - 4> perform the actions below:
 - 2> if the UTRAN MOBILITY INFORMATION message did not contain the IE "Ciphering mode info":
 - 3> when RLC has been requested to transmit the UTRAN MOBILITY INFORMATION CONFIRM message:
 - 4> perform the actions below.
 - 1> if the variable PDCP_SN_INFO is non-empty:
 - 2> when RLC has confirmed the successful transmission of the UTRAN MOBILITY INFORMATION CONFIRM message:
 - 3> for each radio bearer in the variable PDCP_SN_INFO:
 - 4> if the IE "RB started" in the variable ESTABLISHED_RABS is set to "started":
 - 5> configure the RLC entity for that radio bearer to "continue".
 - 3> clear the variable PDCP_SN_INFO; and
 - 3> perform the actions below.

The UE shall:

- 1> if the UTRAN MOBILITY INFORMATION message contained the IE "Ciphering mode info":
 - 2> resume data transmission on any suspended radio bearer and signalling radio bearer mapped on RLC-AM or RLC-UM;
 - 2> set the IE "Reconfiguration" in the variable CIPHERING_STATUS to FALSE; and
 - 2> clear the variable RB_UPLINK_CIPHERING_ACTIVATION_TIME_INFO.
- 1> if the UTRAN MOBILITY INFORMATION message contained the IE "Integrity protection mode info":
 - 2> allow the transmission of RRC messages on all signalling radio bearers with any RRC SN;

- 2> set the IE "Reconfiguration" in the variable INTEGRITY_PROTECTION_INFO to FALSE; and
- 2> clear the variable INTEGRITY_PROTECTION_ACTIVATION_INFO.
- 1> clear the variable SECURITY_MODIFICATION.

The procedure ends.

8.3.3.4 Reception of an UTRAN MOBILITY INFORMATION CONFIRM message by the UTRAN

When the network receives UTRAN MOBILITY INFORMATION CONFIRM message, UTRAN may delete any old U-RNTI. The procedure ends.

8.3.3.5 Cell re-selection

If the UE performs cell re-selection, the UE shall:

- 1> initiate a cell update procedure according to subclause 8.3.1;
- 1> if the UTRAN MOBILITY INFORMATION message contains the IE "New C-RNTI"; and
- 1> if the UE has not yet submitted the UTRAN MOBILITY INFORMATION CONFIRM message to lower layers for transmission; and
- 1> if the IE "Downlink counter synchronisation info" was not included in the received UTRAN MOBILITY INFORMATION message:
 - 2> transmit a UTRAN MOBILITY INFORMATION FAILURE message on the uplink DCCH using AM RLC;
 - 2> set the IE "RRC transaction identifier" in the UTRAN MOBILITY INFORMATION FAILURE message to the value of "RRC transaction identifier" in the entry for the UTRAN MOBILITY INFORMATION message in the table "Accepted transactions" in the variable TRANSACTIONS; and
 - 2> clear that entry.
 - 2> set the IE "failure cause" to the cause value "cell update occurred";
 - 2> when the UTRAN MOBILITY INFORMATION FAILURE message has been submitted to lower layers for transmission:
 - 3> continue with any ongoing processes and procedures as if the invalid UTRAN MOBILITY INFORMATION message has not been received and the procedure ends.
- 1> otherwise:
 - 2> if a UTRAN MOBILITY INFORMATION message was received and caused the IE "Reconfiguration" in the variable CIPHERING_STATUS to be set to TRUE and/or the IE "Reconfiguration" in the variable INTEGRITY_PROTECTION_INFO to be set to TRUE; and
 - 2> if the IE "Downlink counter synchronisation info" was included in the received UTRAN MOBILITY INFORMATION message:
 - 3> apply the new security (integrity protection) configuration received in the UTRAN MOBILITY INFORMATION message on the CELL UPDATE message to be transmitted.
 - 2> continue the procedure normally.

8.3.3.5a Incompatible simultaneous security reconfiguration

If the variable INCOMPATIBLE_SECURITY_RECONFIGURATION becomes set to TRUE of the received UTRAN MOBILITY INFORMATION message, the UE shall:

- 1> transmit a UTRAN MOBILITY INFORMATION FAILURE message on the uplink DCCH using AM RLC;

- 1> set the IE "RRC transaction identifier" in the UTRAN MOBILITY INFORMATION FAILURE message to the value of "RRC transaction identifier" in the entry for the UTRAN MOBILITY INFORMATION message in the table "Accepted transactions" in the variable TRANSACTIONS; and
- 1> clear that entry;
- 1> set the IE "failure cause" to the cause value "incompatible simultaneous reconfiguration";
- 1> when the UTRAN MOBILITY INFORMATION FAILURE message has been delivered to lower layers for transmission:
 - 2> set the variable INCOMPATIBLE_SECURITY_RECONFIGURATION to FALSE;
 - 2> continue with any ongoing processes and procedures as if the UTRAN MOBILITY INFORMATION message has not been received;
 - 2> and the procedure ends.

8.3.3.6 Invalid UTRAN MOBILITY INFORMATION message

If the UTRAN MOBILITY INFORMATION message contains a protocol error causing the variable PROTOCOL_ERROR_REJECT to be set to TRUE according to clause 9, the UE shall perform procedure specific error handling as follows. The UE shall:

- 1> transmit a UTRAN MOBILITY INFORMATION FAILURE message on the uplink DCCH using AM RLC;
- 1> set the IE "RRC transaction identifier" in the UTRAN MOBILITY INFORMATION FAILURE message to the value of "RRC transaction identifier" in the entry for the UTRAN MOBILITY INFORMATION message in the table "Rejected transactions" in the variable TRANSACTIONS, and;
- 1> clear that entry.
- 1> set the IE "failure cause" to the cause value "protocol error";
- 1> include the IE "Protocol error information" with contents set to the value of the variable PROTOCOL_ERROR_INFORMATION;
- 1> when the UTRAN MOBILITY INFORMATION FAILURE message has been submitted to lower layers for transmission:
 - 2> continue with any ongoing processes and procedures as if the invalid UTRAN MOBILITY INFORMATION message has not been received;
 - 2> and the procedure ends.

8.3.3.7 T322 expiry

Upon expiry of timer T322 the UE shall:

- 1> clear the stored IE "Dedicated Priority Information";
- 1> clear the variable PRIORITY_INFO_LIST;
- 1> set the value of IE "Priority status" in the variable PRIORITY_INFO_LIST to "sys_info_priority";
- 1> if the UE is not in CELL_DCH state:
 - 2> take the actions as described in subclause 8.1.1.6.19 using stored System information Block type 19.

8.3.4 Active set update

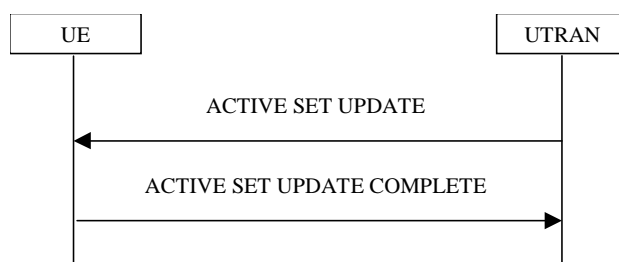

Figure 8.3.4-1: Active Set Update procedure, successful case

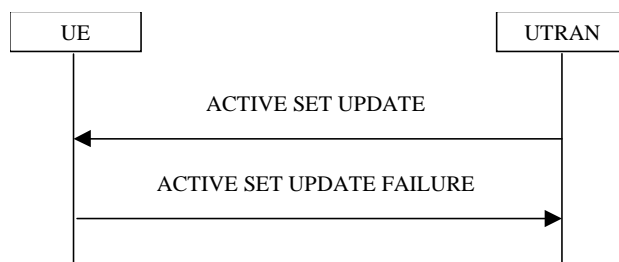

Figure 8.3.4-2: Active Set Update procedure, failure case

8.3.4.1 General

The purpose of the active set update procedure is to update the active set of the connection between the UE and UTRAN. This procedure shall be used in CELL_DCH state. The UE should keep on using the old RLs while configuring the new RLs. Also the UE should keep the transmitter turned on during the procedure. This procedure is only used in FDD mode.

8.3.4.2 Initiation

The procedure is initiated when UTRAN orders a UE in CELL_DCH state, to make the following modifications of the active set of the connection:

- a) Radio link addition;
- b) Radio link removal;
- c) Combined radio link addition and removal;
- d) Addition of a radio link to the E-DCH active set;
- e) Removal of a radio link from the E-DCH active set.

The procedure also allows the addition or removal of a radio link on the downlink frequency associated with the secondary serving HS-DSCH cell. Radio links on the downlink frequency associated with the secondary serving HS-DSCH cell are not part of the active set.

Additionally, the procedure also allows the update of Target cell preconfiguration information for existing radio link(s).

In case a) and c), UTRAN should:

- 1> prepare new additional radio link(s) in the UTRAN prior to the command to the UE.

In all cases, UTRAN should:

- 1> send an ACTIVE SET UPDATE message on downlink DCCH using AM or UM RLC;
- 1> create active sets that contain at least one common radio link across a DPCH or F-DPCH frame boundary as the result of one or multiple (parallel) active set update procedures.

UTRAN should include the following information:

- 1> IE "Radio Link Addition Information": Downlink DPCH information and other optional parameters relevant for the radio links to be added along with the IE "Primary CPICH info" used for the reference ID to indicate which radio link to add. This IE is needed in cases a) and c) listed above;
- 1> IE "Downlink Secondary Cell Info FDD": Downlink optional parameters relevant to reception of secondary serving HS-DSCH cell;
- 1> IE "Radio Link Removal Information": IE "Primary CPICH info" used for the reference ID to indicate which radio link to remove. This IE is needed in cases b) and c) listed above;
- 1> IE "E-DCH reconfiguration information": IE "Primary CPICH info" used for the reference ID along with the IE "E-HICH information" to indicate which radio link to add to the E-DCH active set. This IE is needed in case d) above, when the RL added to the E-DCH active set is already in the DCH active set;
- 1> IE "E-DCH reconfiguration information": IE "Primary CPICH info" used for the reference ID along with the IE "E-HICH release indicator" to indicate which radio link to remove from the E-DCH active set. This IE is needed in case e) above, when the RL removed from the E-DCH active set remains in the DCH active set.

NOTE: The UE behaviour is unspecified if SRBs are mapped on E-DCH and the value for the E_DCH_TRANSMISSION variable is changed to FALSE via the Active Set Update procedure; or if SRBs are mapped on HS-DSCH and the value for the HS_DSCH_RECEPTION variable is changed to FALSE via the Active Set Update procedure.

8.3.4.3 Reception of an ACTIVE SET UPDATE message by the UE

Upon reception of an ACTIVE SET UPDATE message the UE shall act upon all received information elements as specified in 8.6, unless specified otherwise in the following.

The UE may:

- 1> maintain a list of the set of cells to which the UE has Radio Links if the IE "Cell ID" is present.

The UE shall:

- 1> first add the RLs indicated in the IE "Radio Link Addition Information" which are not yet contained in the UEs active set;
- 1> remove the RLs indicated in the IE "Radio Link Removal Information". If the UE active set is full or becomes full, an RL, which is included in the IE "Radio Link Removal Information" for removal, shall be removed before adding RL, which is included in the IE "Radio Link Addition Information" for addition;
- 1> perform the physical layer synchronisation procedure B as specified in [29] for the radio links which are not yet contained in the UEs active set;
- 1> if the IE "E-HICH information" is included:
 - 2> store this E-HICH configuration for the concerning radio link.
- 1> if the IE "E-HICH information" is included:
 - 2> store this E-RGCH configuration for the concerning radio link, if included.
- 1> determine the value for the E_DCH_TRANSMISSION variable and take the corresponding actions as described in subclause 8.5.28;
- 1> if the IE "MAC-es/e reset indicator" is included in the IE "UL 16QAM configuration":
 - 2> reset the MAC-es/e / MAC-is/i entity [15].

NOTE 1: If the IE "MAC-es/e reset indicator" is not included in the IE "UL 16QAM configuration" and 16QAM operations starts or stops, the UE behaviour is unspecified.

- 1> if the IE "UL 16QAM settings" is not included in the IE "16QAM configuration":

2> indicate to lower layers to stop any operation in 16QAM mode.

NOTE 2: If the IE "UL 16QAM configuration" is not included and 16QAM mode operation is currently ongoing, the UE behaviour is unspecified.

1> if the IEs "E-TFCI Boost Info" and/or "E-DPDCH power interpolation" are present, act on the received information elements;

1> if the IEs "E-DPCCH/DPCCH power offset" and/or "Reference E-TFCI PO" are included in the IE "E-DCH reconfiguration information same serving cell", act on the received information elements;

NOTE 3: If E-TFCI boost is signalled to the UE and a reference E-TFCI \leq E-TFCI Boost is signalled to the UE with a Reference E-TFCI PO of value 30 or 31, the UE behaviour is unspecified.

1> if the radio link currently considered to be the serving HS-DSCH radio link is indicated in the IE "Radio Link Removal Information":

2> no longer consider any radio link as the serving HS-DSCH radio link;

2> determine the value for the HS_DSCH_RECEPTION variable and take the corresponding actions as described in subclause 8.5.25.

1> for the radio link in the IE "Radio Link Addition Information":

2> take the actions related to TARGET_CELL_PRECONFIGURATION variable as described in subclause 8.5.52.

1> if the radio link in the IE "Radio Link Addition Information" is already contained in the UE active set and the IE "Radio Link Addition Information" attempts to reconfigure parameters other than "Target cell preconfiguration information" IE for the radio link:

2> the UE behaviour is unspecified.

NOTE: To configure or reconfigure the "Target cell preconfiguration information" IE for the radio link already contained in the UE active set, UTRAN should provide the same value of the mandatory IEs in the IE "Radio Link Addition Information" as the one previously configured. Otherwise the UE behaviour is unspecified.

1> if the table "Target cell preconfigurations" in the variable TARGET_CELL_PRECONFIGURATION included the RL indicated in IE "Radio Link Removal Information":

2> clear the entry from the variable TARGET_CELL_PRECONFIGURATION.

1> if the "E-DCH RL Info other cells" in the table "Target cell preconfiguration information" in the variable TARGET_CELL_PRECONFIGURATION included the RL indicated in the IE "Radio Link Removal Information":

2> clear all "E-DCH RL Info other cells" entries in the variable TARGET_CELL_PRECONFIGURATION for the removed RL(s).

1> if "Serving HS-DSCH cell information" IE is present, act on received information elements as specified in subclause 8.6:

2> if the IEs " Δ_{ACK} ", " Δ_{NACK} ", and "HARQ_preamble_mode" are present, act on the received information elements;

2> if the new H-RNTI and "Primary CPICH info" are included:

3> consider the cell indicated in Primary CPICH as serving HS-DSCH cell and no longer consider any other radio link as serving HS-DSCH cell. If the IE "Downlink Secondary Cell Info FDD" is included for a cell associated with the serving HS-DSCH cell, consider that cell a secondary serving HS-DSCH cell.

2> if the IE "MAC-hs reset indicator" is included:

3> reset the MAC-hs/ehs entity [15].

- 2> determine the value for the HS_DSCH_RECEPTION variable and take the corresponding actions as described in subclause 8.5.25.
- 1> if the IE "E-DCH reconfiguration information" is included:
 - 2> if the IE "E-DCH RL Info other cells" is present:
 - 3> if the IE "E-HICH Information" is present:
 - 4> store the E-HICH and E-RGCH information (if present), contained therein, for the indicated radio link.
 - 3> if the IE "E-HICH release indicator" is present:
 - 4> delete the stored E-HICH, E-AGCH and E-RGCH (if any) configurations.
 - 3> if the IE "E-RGCH release indicator" is set present:
 - 4> delete the stored E-RGCH configuration for this RL.
 - 2> if the IE "E-DCH RL Info new serving cell" is present:
 - 3> consider the cell indicated in "Primary CPICH info" as serving E-DCH radio link and no longer consider any other radio link as serving E-DCH radio link;
 - 3> store the E-HICH and E-RGCH information (if present), contained therein, for the new serving E-DCH radio link;
 - 3> if the IE "E-RGCH release indicator" is present:
 - 4> delete the stored E-RGCH configuration for this RL.
 - 3> store the newly received E-AGCH configuration;
 - 3> if the IE "Serving Grant" is included, and if the IE "Serving Grant Value" is not included:
 - 4> the UE behaviour is not specified.
 - 2> if the IEs "E-DPCCH/DPCCH power offset" and/or "Reference E-TFCI PO" and/or "Power offset for scheduling info" are present, act on the received information elements.
 - 2> if the serving E-DCH radio link was another radio link than this radio link prior to reception of the message:
 - 3> if the IE "New Primary E-RNTI" is not included:
 - 4> clear the Primary E-RNTI stored in the variable E_RNTI.
 - 3> if the IE "New Secondary E-RNTI" is not included:
 - 4> clear the Secondary E-RNTI stored in the variable E_RNTI.
 - 1> if the radio link currently considered to be the serving E-DCH radio link is indicated in the IE "Radio Link Removal Information":
 - 2> no longer consider any radio link as the serving E-DCH radio link.
 - 1> determine the value for the E_DCH_TRANSMISSION variable and take the corresponding actions as described in subclause 8.5.28.
 - 1> stop and reset timer T324 if running;
 - 1> stop monitoring target cell HS-SCCH;
 - 1> set the IE "RRC transaction identifier" in the ACTIVE SET UPDATE COMPLETE message to the value of "RRC transaction identifier" in the entry for the ACTIVE SET UPDATE message in the table "Accepted transactions" in the variable TRANSACTIONS; and
 - 1> clear that entry;

- 1> transmit an ACTIVE SET UPDATE COMPLETE message on the uplink DCCH using AM RLC without waiting for the completion of the Physical Layer synchronisation B, as specified in [29];
- 1> the procedure ends on the UE side.

8.3.4.4 Unsupported configuration in the UE

If UTRAN instructs the UE to use a configuration that it does not support, the UE shall:

- 1> keep the active set as it was before the ACTIVE SET UPDATE message was received;
- 1> transmit an ACTIVE SET UPDATE FAILURE message on the DCCH using AM RLC;
- 1> set the IE "RRC transaction identifier" in the ACTIVE SET UPDATE FAILURE message to the value of "RRC transaction identifier" in the entry for the ACTIVE SET UPDATE message in the table "Accepted transactions" in the variable TRANSACTIONS; and
- 1> clear that entry;
- 1> set the IE "failure cause" to "configuration unsupported";
- 1> when the ACTIVE SET UPDATE FAILURE message has been submitted to lower layers for transmission:
 - 2> the procedure ends on the UE side.

8.3.4.5 Invalid configuration

If any of the following conditions are valid:

- a radio link indicated by the IE "Downlink DPCH info for each RL" in the IE "Radio link addition information" has a different spreading factor than the spreading factor for the radio links in the active set that will be established at the time indicated by the IE "Activation time"; and/or
- a radio link in the IE "Radio link addition information" is also present in the IE "Radio Link Removal Information"; and/or
- the IE "Radio Link Removal Information" contains all the radio links which are part of or will be part of the active set at the time indicated by the IE "Activation time"; and/or
- the IE "TX Diversity Mode" is not set to "none" and it indicates a diversity mode that is different from the one currently used (<STTD> or <closed loop mode1>) in all or part of the active set; and/or
- a radio link indicated by the IE "Radio Link Removal Information" does not exist in the active set; and/or
- after the removal of all radio links indicated by the IE "Radio Link Removal Information" and the addition of all radio links indicated by the IE "Radio Link Addition Information" the active set would contain more than the maximum allowed number of radio links; and/or
- after the addition of all radio links indicated by the IE "Radio Link Addition Information" the active set would contain radio links indicated by the IE "Downlink DPCH info for each RL" and radio links indicated by the IE "Downlink F-DPCH info for each RL"; and/or
- after the addition of all radio links, the active set would contain a radio link configured with the IE "Downlink DPCH info for each RL" and the RL would be included in the table "Target cell preconfigurations" in the variable TARGET_CELL_PRECONFIGURATION; and/or
- the variable INVALID_CONFIGURATION is set to TRUE:

the UE shall:

- 1> keep the active set as it was before the ACTIVE SET UPDATE message was received;
- 1> transmit an ACTIVE SET UPDATE FAILURE message on the DCCH using AM RLC;

- 1> set the IE "RRC transaction identifier" in the ACTIVE SET UPDATE FAILURE message to the value of "RRC transaction identifier" in the entry for the ACTIVE SET UPDATE message in the table "Accepted transactions" in the variable TRANSACTIONS; and
- 1> clear that entry;
- 1> set the IE "failure cause" to "Invalid configuration";
- 1> When the ACTIVE SET UPDATE FAILURE message has been submitted to lower layers for transmission:
 - 2> the procedure ends on the UE side.

If the following condition is valid:

- the active set update procedure results in active sets that do not contain at least one common radio link before and after a DPCH or F-DPCH frame boundary:

the UE behaviour is not specified.

8.3.4.5a Void

8.3.4.5b Incompatible simultaneous reconfiguration

If the variable ORDERED_RECONFIGURATION is set to TRUE, the UE may:

- 1> if the activation time for the procedure that has set variable ORDERED_RECONFIGURATION and the activation time for the Active Set Update procedure are within a time window of 5 frames:
 - 2> transmit an ACTIVE SET UPDATE FAILURE message on the uplink DCCH using AM RLC;
 - 2> set the IE "RRC transaction identifier" in the ACTIVE SET UPDATE FAILURE message to the value of "RRC transaction identifier" in the entry for the ACTIVE SET UPDATE message in the table "Accepted transactions" in the variable TRANSACTIONS; and
 - 2> clear that entry;
 - 2> set the IE "failure cause" to the cause value "incompatible simultaneous reconfiguration";
 - 2> when the ACTIVE SET UPDATE FAILURE message has been delivered to lower layers for transmission:
 - 3> continue with any ongoing processes and procedures as if the ACTIVE SET UPDATE message has not been received.
 - 3> and the procedure ends.

8.3.4.6 Reception of the ACTIVE SET UPDATE COMPLETE message by the UTRAN

When the UTRAN has received the ACTIVE SET UPDATE COMPLETE message,

- 1> the UTRAN may remove radio link(s) that are indicated to remove to the UE in case b) and c); and
- 1> the procedure ends on the UTRAN side.

8.3.4.7 Reception of the ACTIVE SET UPDATE FAILURE message by the UTRAN

When the UTRAN has received the ACTIVE SET UPDATE FAILURE message, the UTRAN may delete radio links that were included in the IE "Radio Link Addition Information" for addition. The procedure ends on the UTRAN side.

8.3.4.8 Invalid ACTIVE SET UPDATE message

If the ACTIVE SET UPDATE message contains a protocol error causing the variable `PROTOCOL_ERROR_REJECT` to be set to `TRUE` according to clause 9, the UE shall perform procedure specific error handling as follows. The UE shall:

- 1> transmit a ACTIVE SET UPDATE FAILURE message on the uplink DCCH using AM RLC;
- 1> set the IE "RRC transaction identifier" in the ACTIVE SET UPDATE FAILURE message to the value of "RRC transaction identifier" in the entry for the ACTIVE SET UPDATE message in the table "Rejected transactions" in the variable `TRANSACTIONS`; and
- 1> clear that entry;
- 1> set the IE "failure cause" to the cause value "protocol error";
- 1> include the IE "Protocol error information" with contents set to the value of the variable `PROTOCOL_ERROR_INFORMATION`;
- 1> when the ACTIVE SET UPDATE FAILURE message has been delivered to lower layers for transmission:
 - 2> continue with any ongoing processes and procedures as if the invalid ACTIVE SET UPDATE message has not been received;
 - 2> and the procedure ends.

8.3.4.9 Reception of an ACTIVE SET UPDATE message in wrong state

If the UE is in another state than `CELL_DCH` state upon reception of the ACTIVE SET UPDATE message, the UE shall perform procedure specific error handling as follows. The UE shall:

- 1> transmit a ACTIVE SET UPDATE FAILURE message on the uplink DCCH using AM RLC;
- 1> set the IE "RRC transaction identifier" in the ACTIVE SET UPDATE FAILURE message to the value of "RRC transaction identifier" in the entry for the ACTIVE SET UPDATE message in the table "Accepted transactions" in the variable `TRANSACTIONS`; and
- 1> clear that entry;
- 1> set the IE "failure cause" to the cause value "protocol error";
- 1> include the IE "Protocol error information" with the IE "Protocol error cause" set to "Message not compatible with receiver state";
- 1> when the ACTIVE SET UPDATE FAILURE message has been delivered to lower layers for transmission:
 - 2> continue with any ongoing processes and procedures as if the ACTIVE SET UPDATE message has not been received;
 - 2> and the procedure ends.

8.3.5 Hard handover

When performing hard handover with change of frequency, the UE shall:

- 1> clear the variable "Adjacent frequency info" if stored in `CELL_INFO_LIST`;
- 1> stop all intra-frequency and inter-frequency measurement reporting on the cells listed in the variable `CELL_INFO_LIST`. Each stopped measurement is restarted when a MEASUREMENT CONTROL message is received with the corresponding measurement identity.

8.3.5.1 Timing re-initialised hard handover

8.3.5.1.1 General

The purpose of the timing re-initialised hard handover procedure is to remove all the RL(s) in the active set and establish new RL(s) along with a change in the CFN in the UE according to the SFN of the target cell.(see subclause 8.5.15).

For TDD timing re-initialised hard handover is realised via CFN calculation (see subclause 8.5.15.2).

NOTE: For FDD, during the hard-handover procedure, the UE will align the timing of the uplink transmission as specified in [26].

This procedure is initiated when UTRAN does not know the target SFN timing before hard handover.

8.3.5.1.2 Initiation (FDD only)

Timing re-initialised hard handover initiated by the UTRAN is normally performed by using the procedure "Physical channel reconfiguration" (subclause 8.2.6), but may also be performed by using either one of the following procedures:

- "radio bearer establishment" (subclause 8.2.1);
- "Radio bearer reconfiguration" (subclause 8.2.2);
- "Radio bearer release" (subclause 8.2.3); or
- "Transport channel reconfiguration" (subclause 8.2.4).

In this case of a timing re-initialised hard handover, UTRAN should include the IE "Default DPCH Offset Value" and:

1> in FDD mode:

2> if the UE is configured for DPCH:

3> set "Default DPCH Offset Value" and "DPCH frame offset" respecting the following relation

$$(\text{Default DPCH Offset Value}) \bmod 38400 = \text{DPCH frame offset}_j$$

- where j indicates the first radio link listed in the message and the IE values used are the Actual Values of the IEs as defined in clause 11.

2> if the UE is configured for F-DPCH:

3> set "Default DPCH Offset Value" and "DPCH frame offset_j" respecting one of the following relations:

4> $(\text{Default DPCH Offset Value}) \bmod 38400 = \text{DPCH frame offset}_j$; or

4> $(\text{Default DPCH Offset Value} + 256) \bmod 38400 = \text{DPCH frame offset}_j$,

- where j indicates the first radio link listed in the message and the IE values used are the Actual Values of the IEs as defined in clause 11.

If the IE "Default DPCH Offset Value" is included, the UE shall:

1> in FDD mode:

2> if the UE is configured for DPCH:

3> if $(\text{Default DPCH Offset Value}) \bmod 38400 = \text{DPCH frame offset}_j$,

- where j indicates the first radio link listed in the message:

4> set DOFF (see subclause 8.5.15.1) to Default DPCH Offset Value.

3> else:

4> set the variable INVALID_CONFIGURATION to TRUE.

2> if the UE is configured for F-DPCH:

3> if $(\text{Default DPCH Offset Value}) \bmod 38400 = \text{DPCH frame offset}_j$,

- where j indicates the first radio link listed in the message:

4> set DOFF (see subclause 8.5.15.1) to Default DPCH Offset Value.

3> else if $(\text{Default DPCH Offset Value}+256) \bmod 38400 = \text{DPCH frame offset}_j$,

- where j indicates the first radio link listed in the message:

4> set DOFF (see subclause 8.5.15.1) to Default DPCH Offset Value + 256.

3> else:

4> set the variable INVALID_CONFIGURATION to TRUE.

If the IE "Default DPCH Offset Value" is not included, the UE shall:

1> set the variable INVALID_CONFIGURATION to TRUE.

8.3.5.2 Timing-maintained hard handover

8.3.5.2.1 General

The purpose of the Timing-maintained hard handover procedure is to remove all the RL(s) in the active set and establish new RL(s) while maintaining the CFN in the UE.

For TDD timing re-initialised hard handover is realised via CFN calculation (see subclause 8.5.15.2).

NOTE: For FDD, during the hard-handover procedure, the UE will align the timing of the uplink transmission as specified in [26].

This procedure can be initiated only if UTRAN knows the target SFN timing before hard handover. The target SFN timing can be known by UTRAN in the following 2 cases:

- UE reads SFN when measuring "Cell synchronisation information" and sends it to the UTRAN in MEASUREMENT REPORT message.
- UTRAN internally knows the time difference between the cells.

8.3.5.2.2 Initiation (FDD only)

Timing-maintained hard handover initiated by the network is normally performed by using the procedure "Physical channel reconfiguration" (subclause 8.2.6), but may also be performed by using either one of the following procedures:

- "radio bearer establishment" (subclause 8.2.1);
- "Radio bearer reconfiguration" (subclause 8.2.2);
- "Radio bearer release" (subclause 8.2.3); or
- "Transport channel reconfiguration" (subclause 8.2.4).

In this case of a timing maintained hard handover procedure the UTRAN should not include the IE "Default DPCH Offset Value".

If the IE "Default DPCH Offset Value" is included, the UE shall:

1> ignore the IE "Default DPCH Offset Value".

8.3.6 Inter-RAT handover to UTRAN

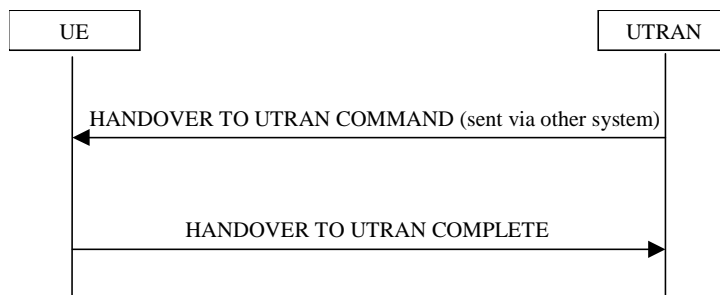

Figure 8.3.6-1: Inter-RAT handover to UTRAN, successful case

8.3.6.1 General

The purpose of the inter-RAT handover procedure is to, under the control of the network, transfer a connection between the UE and another radio access technology (e.g. GSM or E-UTRA) to UTRAN.

This procedure may be used to perform CS handover which applies when there is a signalling connection to the CS domain.

When the UE supports Inter-RAT PS handover, this procedure may be used to perform PS handover which applies when there is only a signalling connection to the PS domain.

This procedure may be used to perform simultaneous CS and PS handover (i.e. DTM Handover) which applies when there are signalling connections to both CS and PS domains.

This procedure may be used to perform PS to CS handover (i.e. SR-VCC Handover) which applies when there is a signalling connection in E-UTRA PS domain to be transferred to UTRA CS domain. SR-VCC handover may be performed with a simultaneous PS handover.

8.3.6.2 Initiation

The procedure is initiated when a radio access technology other than UTRAN, e.g. GSM or E-UTRA, using radio access technology-specific procedures, orders the UE to make a handover to UTRAN.

A HANDOVER TO UTRAN COMMAND message is sent to the UE via the radio access technology from which inter-RAT handover is performed.

In case UTRAN decides to use a predefined or default radio configuration that is stored in the UE, it should include the following information in the HANDOVER TO UTRAN COMMAND message.

- the IE "New U-RNTI" to be assigned;
- the IE "Predefined configuration identity", to indicate which pre-defined configuration of RB, transport channel and physical channel parameters shall be used; or
- the IE "Default configuration mode" and IE "Default configuration identity", to indicate which default configuration of RB, transport channel and physical channel parameters shall be used;
- PhyCH information elements.

NOTE 1: When using a predefined or default configuration during handover to UTRAN, UTRAN can only assign values of IEs "New U-RNTI" and "scrambling code" that are within the special subranges defined exclusively for this procedure. UTRAN may re-assign other values after completion of the handover procedure.

NOTE 2: When using a predefined or default configuration during handover to UTRAN, fewer IEs are signalled; when using this signalling option some parameters e.g. concerning compressed mode, DSCH can not be configured. In this case, the corresponding functionality can not be activated immediately.

NOTE 3: When using a predefined or default configuration, the HANOVER TO UTRAN COMMAND should not include more than one radio link. If UTRAN includes more than one radio link in the HANOVER TO UTRAN COMMAND using a predefined or default configuration, the UE behaviour is unspecified.

In case UTRAN does not use a predefined radio configuration that is stored in the UE, it should include the following information in the HANOVER TO UTRAN COMMAND message.

- the IE "New U-RNTI" to be assigned;
- the complete set of RB, TrCH and PhyCH information elements to be used.

8.3.6.3 Reception of HANOVER TO UTRAN COMMAND message by the UE

The UE shall be able to receive a HANOVER TO UTRAN COMMAND message and perform an inter-RAT handover, even if no prior UE measurements have been performed on the target UTRAN cell and/or frequency.

The UE shall act upon all received information elements as specified in subclause 8.6, unless specified otherwise in the following.

The UE may:

- 1> maintain a list of the set of cells to which the UE has Radio Links if the IE "Cell ID" is present.

The UE shall:

- 1> store a U-RNTI value (32 bits), which is derived by the IEs "SRNC identity" and "S-RNTI 2" included in IE "U-RNTI-short". In order to produce a full size U-RNTI value, a full size "S-RNTI" (20 bits) shall be derived by padding the IE "S-RNTI 2" with 10 zero bits in the most significant positions; and
- 1> if the HANOVER TO UTRAN COMMAND message is used to perform anything other than CS handover from GERAN and the message does not contain at least one instance of the IE "RAB Info";
 - 2> the UE behaviour is unspecified.

- 1> initialise the variable ESTABLISHED_SIGNALLING_CONNECTIONS with the signalling connections that remains after the handover according to the specifications of the source RAT;

NOTE 0: The IE "CN domain identity" in IE "RAB Info" in the HANOVER TO UTRAN COMMAND message determines towards which CN domain signalling connections are established. The HANOVER TO UTRAN COMMAND message contains at least one IE "RAB Info" except in the CS domain handover from GERAN case where it may not be present, in which case the UE behaviour is the same as if "CN domain identity" had been received and set to "CS Domain".

- 1> initialise the variable UE_CAPABILITIES_TRANSFERRED with the UE capabilities that have been transferred to the network up to the point prior to the handover, if any;
- 1> initialise the variable TIMERS_AND_CONSTANTS to the default values and start to use those timer and constants values;
- 1> if IE "Specification mode" is set to "Preconfiguration" and IE "Preconfiguration mode" is set to "Predefined configuration":
 - 2> initiate the radio bearer and transport channel configuration in accordance with the predefined parameters identified by the IE "Predefined configuration identity";
 - 2> initiate the physical channels in accordance with the predefined parameters identified by the IE "Predefined radio configuration identity" and the received physical channel information elements;
 - 2> store information about the established radio access bearers and radio bearers according to the IE "Predefined configuration identity"; and
 - 2> set the IE "RAB Info Post" in the variable ESTABLISHED_RABS and the IE "Re-establishment timer" in the IE "RAB Info" in the variable ESTABLISHED_RABS to "useT314".
- 1> if IE "Specification mode" is set to "Preconfiguration" and IE "Preconfiguration mode" is set to "Default configuration":

- 2> initiate the radio bearer and transport channel configuration in accordance with the default parameters identified by the IE "Default configuration mode" and IE "Default configuration identity";
- 2> initiate the physical channels in accordance with the default parameters identified by the IE "Default configuration mode" and IE "Default configuration identity" and the received physical channel information elements;

NOTE 1: IE "Default configuration mode" specifies whether the FDD or TDD version of the default configuration shall be used.

- 2> set the IE "RAB Info Post" in the variable ESTABLISHED_RABS and the IE "Re-establishment timer" in the IE "RAB Info" in the variable ESTABLISHED_RABS to "useT314".
- 1> if IE "Specification mode" is set to "Preconfiguration":
 - 2> use the following values for parameters that are neither signalled within the HANDOVER TO UTRAN COMMAND message nor included within pre-defined or default configuration:
 - 3> 0 dB for the power offset $P_{\text{Pilot-DPDCH}}$ bearer in FDD;
 - 3> calculate the Default DPCH Offset Value using the following formula:
 - 3> in FDD:
$$\text{Default DPCH Offset Value} = (\text{SRNTI} \bmod 600) * 512$$
 - 3> in TDD:
$$\text{Default DPCH Offset Value} = (\text{SRNTI} \bmod 7)$$
 - 3> handle the above Default DPCH Offset Value as if an IE with that value was included in the message, as specified in subclause 8.6.6.21.
 - 1> if IE "Specification mode" is set to "Complete specification":
 - 2> initiate the radio bearer, transport channel and physical channel configuration in accordance with the received radio bearer, transport channel and physical channel information elements.
 - 1> perform an open loop estimation to determine the UL transmission power according to subclause 8.5.3;
 - 1> set the IE "START" for each CN domain, in the IE "START list" in the HANDOVER TO UTRAN COMPLETE message equal to the START value for each CN domain stored in the USIM if the USIM is present, or as stored in the UE for each CN domain if the SIM is present;

NOTE 2: Keys received while in another RAT (GERAN) or generated when coming from another RAT (EUTRAN) are not regarded as "new" (i.e. do not trigger the actions in subclause 8.1.12.3.1) in a subsequent security mode control procedure in UTRAN, irrespective of whether the keys are already being used in the other RAT or not. If the UE has received new keys in the other RAT before handover, then the START values in the USIM (sent in the HANDOVER TO UTRAN COMPLETE message and in the INTER_RAT_HANDOVER_INFO sent while in the other RAT) will not reflect the receipt of these new keys

If the source RAT is not E-UTRAN: If ciphering has been active for the CS domain in the source RAT, then during the first security mode control procedure following the Inter-RAT handover to UTRAN procedure, UE activates integrity protection using the integrity key of the key set used. The term "key set used" denotes the key set that was used in the last successfully completed RRC Security Mode Control (UTRAN), RR Cipher Mode Control procedure or GMM Authentication and Ciphering procedure (GERAN) after entering connected mode in UTRAN or GERAN. The term "if ciphering has been active for the CS domain" is defined by a successfully completed RRC Security Mode Control procedure with "Ciphering Mode Info" (UTRAN) or RR Cipher Mode Control procedure (GERAN) for the CS domain. More specifically the state of ciphering refers to the establishment of a security context where the key is loaded from the (U)SIM to the ME even if the security command indicates NULL ciphering ("no ciphering" in GERAN or UEA0 in UTRAN).

If the source RAT is E-UTRAN: Upon performing SR-VCC (PS to CS) or PS handover, then during the first security mode control procedure following the Inter-RAT handover to UTRAN procedure, UE activates integrity protection using the integrity key of the key set used (see 8.1.12.2.2.). The term "key set used" denotes the CS (SR-VCC) or PS (PS handover) key set (KSI, CK, IK) which was mapped using the current SECURITY CONTEXT in EUTRAN as defined in [78] and [79].

- 1> set the value of "THRESHOLD" in the variable "START_THRESHOLD" to the 20 MSBs of the value stored in the USIM [50] for the maximum value of START for each CN Domain, or to the default value in [40] if the SIM is present;
- 1> if ciphering is indicated in the HANDOVER TO UTRAN COMMAND by the presence of the IE "Ciphering Algorithm":
 - 2> for the handover of CS domain, indicated by the IE "CN domain identity" of the IE "RAB info" of the IE "RAB information to setup" set to "CS domain" or absence of this IE, if ciphering was not active in the radio access technology from which inter-RAT handover is performed:
 - 3> the UE behaviour is unspecified.

NOTE 2a: The handover of the CS domain from GERAN to UTRAN is particular because CS ciphering must be maintained across the inter-RAT handover procedure. For other inter-RAT handover procedure (SR-VCC and PS handover), ciphering in UTRAN is not dependent on previous ciphering status in the source radio access technology.

- 2> if the handover is from EUTRAN and there is no current SECURITY CONTEXT in EUTRAN:
 - 3> the UE behaviour is unspecified.

NOTE 2b: The current EUTRAN security context is defined in [78] and [79]. For EUTRA to UTRA key mapping, this context consists of a minimum of the current K_{ASME} , the associated key set identifier (KSI) and the associated downlink NAS COUNT values.

- 2> set the variable LATEST_CONFIGURED_CN_DOMAIN to the value indicated in the IE "CN domain identity" of the IE "RAB info" of the IE "RAB information to setup" if all instances of the IE indicate the same CN domain, or to the CS domain when this IE is either not present or different instances indicate different CN domains;
- 2> for the CN domain in variable LATEST_CONFIGURED_CN_DOMAIN set the IE "Status" in the variable CIPHERING_STATUS to "Started";
- 2> if the variable LATEST_CONFIGURED_CN_DOMAIN is set to "CS domain":
 - 3> set the 20 MSB of the HFN component of the COUNT-C variable for all signalling radio bearers to the "START" value from the IE "UE security information" in the variable INTER_RAT_HANDOVER_INFO_TRANSFERRED.

- 2> else if the variable LATEST_CONFIGURED_CN_DOMAIN is set to "PS domain":
 - 3> set the 20 MSB of the HFN component of the COUNT-C variable for all signalling radio bearers to the "START" value from the IE "UE security information2" in the variable INTER_RAT_HANDBOVER_INFO_TRANSFERRED.
 - 2> if the CN domain indicated in the IE "CN domain identity" of any instance of the IE "RAB info" in the IE "RAB information to setup" is "CS domain":
 - 3> set the 20 MSB of the HFN component of the COUNT-C variable for all CS domain radio bearers to the "START" value included in the IE "UE security information" in the variable INTER_RAT_HANDBOVER_INFO_TRANSFERRED;
 - 3> set the IE "Status" in the variable CIPHERING_STATUS to "Started".
 - 2> if the CN domain indicated in the IE "CN domain identity" of any instance of the IE "RAB info" in the IE "RAB information to setup" is "PS domain":
 - 3> set the 20 MSB of the HFN component of the COUNT-C variable for all PS domain radio bearers to the "START" value included in the IE "UE security information2" in the variable INTER_RAT_HANDBOVER_INFO_TRANSFERRED;
 - 3> set the IE "Status" in the variable CIPHERING_STATUS to "Started".
 - 2> set the remaining LSBs of the HFN component of COUNT-C for all radio bearers to zero;
 - 2> not increment the HFN component of COUNT-C for radio bearers using RLC-TM, i.e. keep the HFN value fixed without incrementing every CFN cycle;
 - 2> set the CFN component of the COUNT-C variable for radio bearers using RLC-TM to the value of the CFN as calculated in subclause 8.5.15;
 - 2> for all user radio bearers belonging to the "CS domain" and for signalling radio bearers when the variable LATEST_CONFIGURED_CN_DOMAIN is set to "CS domain":
 - 3> apply the algorithm according to IE "Ciphering Algorithm" with the ciphering key of the key set used and apply ciphering immediately upon reception of the HANDBOVER TO UTRAN COMMAND.
 - 2> for all user radio bearers belonging to the "PS domain" and for signalling radio bearers when the variable LATEST_CONFIGURED_CN_DOMAIN is set to "PS domain":
 - 3> If the source RAT is E-UTRA:
 - 4> apply the algorithm according to IE "Ciphering Algorithm" with the ciphering key of the PS key set used and apply ciphering immediately upon reception of the HANDBOVER TO UTRAN COMMAND.
 - 3> Otherwise:
 - 4> apply the algorithm according to IE "Ciphering Algorithm" with the ciphering key stored in the USIM/SIM and apply ciphering immediately upon reception of the HANDBOVER TO UTRAN COMMAND.
- NOTE 3: If ciphering is indicated in the HANDBOVER TO UTRAN COMMAND, UTRAN should not include the IE "Ciphering mode info" in the SECURITY MODE COMMAND message that starts Integrity protection.
- NOTE 4: DTM Handover is not possible if the IE "specification mode" is set to "Preconfiguration" due to the existence of a single IE "RAB Info".
- 1> if ciphering is not indicated in the HANDBOVER TO UTRAN COMMAND:
 - 2> for the CN domain(s) included in the IE "CN domain identity" which is included in the IE "RAB info" of the IE "RAB information to setup", or the CS domain when these IEs are not present:
 - 3> set the IE "Status" in the variable CIPHERING_STATUS to "Not Started".

If the UE succeeds in establishing the connection to UTRAN, it shall:

- 1> if "RAB Info" list contained only one CN domain identity in IE "CN domain identity":
 - 2> if CN domain is set to CS domain only indicate to upper layers that no CN system information is available for any domain other than the CS domain (see NOTE 5);
 - 2> if CN domain is set to PS domain only indicate to upper layers that no CN system information is available for any domain other than the PS domain (see NOTE 6).

- 1> if "RAB Info" list contained RABs for the PS and CS domain:

- 2> indicate to upper layers that CN system information is available for the PS and CS domain (see NOTE 7).

NOTE 5: After CS handover has been completed, the UTRAN should provide the UE with the CN system information of the PS domain as soon as possible, in order not to delay access to the PS domain.

NOTE 6: After PS handover has been completed, the UTRAN should provide the UE with the CN system information of the CS and PS domain as soon as possible in order not to delay access to the CS domain and trigger a NAS procedure for the PS domain.

NOTE 7: After DTM handover has been completed, the UTRAN should provide the UE with the CN system information of the PS domain as soon as possible in order to trigger a NAS procedure for the PS domain.

- 1> if the USIM or SIM is present:

- 2> set the START value stored in the USIM [50] if present, and as stored in the UE if the SIM is present for any CN domain to the value "THRESHOLD" of the variable START_THRESHOLD.

- 1> if the IE "Status" in the variable CIPHERING_STATUS of a CN domain is set to "Started" and transparent mode radio bearers have been established by this procedure for that CN domain:

- 2> include the IE "COUNT-C activation time" in the response message and specify a CFN value for this IE other than the default, "Now", that is a multiple of 8 frames ($CFN \bmod 8 = 0$) and lies at least 200 frames ahead of the CFN in which the response message is first transmitted;
 - 2> at the CFN value as indicated in the response message in the IE "COUNT-C activation time" for radio bearers using RLC-TM:
 - 3> set the 20 MSB of the HFN component of the COUNT-C variable common for all transparent mode radio bearers of this CN domain to the START value as indicated in the IE "START list" of the response message for the relevant CN domain; and
 - 3> set the remaining LSBs of the HFN component of COUNT-C to zero;
 - 3> increment the HFN component of the COUNT-C variable by one even if the "COUNT-C activation time" is equal to zero;
 - 3> set the CFN component of the COUNT-C to the value of the IE "COUNT-C activation time" of the response message. The HFN component and the CFN component completely initialise the COUNT-C variable;
 - 3> step the COUNT-C variable, as normal, at each CFN value. The HFN component is no longer fixed in value but incremented at each CFN cycle.

- 1> if the IE "Status" in the variable CIPHERING_STATUS of a CN domain is set to "Not Started" and transparent mode radio bearers have been established by this procedure for that CN domain:

- 2> initialise the 20 MSB of the HFN component of COUNT-C common for all transparent mode radio bearers of this CN domain with the START value as indicated in the IE "START list" of the response message for the relevant CN domain;
 - 2> set the remaining LSBs of the HFN component of COUNT-C to zero;
 - 2> do not increment the COUNT-C value common for all transparent mode radio bearers for this CN domain.

- 1> for 3.84/7.68 Mcps TDD, if the HANDOVER TO UTRAN COMMAND provides for E-DCH/HS-DSCH operation without an uplink DPCH:

- 2> the UE shall obtain timing advance for the 3.84/7.68 Mcps TDD cell according to [15] before transmitting on the uplink DCCH.
- 1> transmit a HANDOVER TO UTRAN COMPLETE message on the uplink DCCH, using, if ciphering has been started, the new ciphering configuration;
- 1> when the HANDOVER TO UTRAN COMPLETE message has been submitted to lower layers for transmission:
 - 2> if the source RAT was E-UTRA:
 - 3> store the CS "key set used" including the mapped KSI to the USIM CS security key if SR-VCC was performed;
 - 3> store the PS "key set used" including the mapped KSI to the USIM PS security key if PS handover was performed;
 - 2> enter UTRA RRC connected mode in state CELL_DCH;
 - 2> initialise variables upon entering UTRA RRC connected mode as specified in subclause 13.4;
 - 2> update the variable UE_CAPABILITY_TRANSFERRED with the UE capabilities stored in the variable INTER_RAT_HANDOVER_INFO_TRANSFERRED.
- 1> and the procedure ends.

8.3.6.4 Invalid Handover to UTRAN command message

If the UE receives a HANDOVER TO UTRAN COMMAND message, which contains a protocol error causing the variable `PROTOCOL_ERROR_REJECT` to be set to `TRUE` according to clause 9, the UE shall perform procedure specific error handling according to the source radio access technology. The UE shall:

- 1> if allowed by the source RAT:
 - 2> transmit an RRC FAILURE INFO message to the source radio access technology; and
 - 2> include the IE "Protocol error information" with contents set to the value of the variable `PROTOCOL_ERROR_INFORMATION`;
- 1> Other details may be provided in the specifications related to the source radio access technology.

NOTE: The other RAT may include the above diagnostics information in a subsequent handover request towards the same RNC.

8.3.6.4a Unsupported configuration in HANDOVER TO UTRAN COMMAND message

If the UE does not support the configuration included in the HANDOVER TO UTRAN COMMAND message, e.g., the message includes a pre-defined configuration that the UE has not stored, the UE shall:

- 1> continue the connection using the other radio access technology; and
- 1> indicate the failure to the other radio access technology.

8.3.6.5 UE fails to perform handover

If the UE does not succeed in establishing the connection to UTRAN, it shall:

- 1> terminate the procedure including release of the associated resources;
- 1> resume the connection used before the handover; and
- 1> indicate the failure to the other radio access technology.

Upon receiving an indication about the failure from the other radio access technology, UTRAN should release the associated resources and the context information concerning this UE.

8.3.6.6 Reception of message HANDOVER TO UTRAN COMPLETE by the UTRAN

Upon receiving a HANDOVER TO UTRAN COMPLETE message, UTRAN should consider the inter-RAT handover procedure as having been completed successfully and indicate this to the Core Network.

8.3.7 Inter-RAT handover from UTRAN

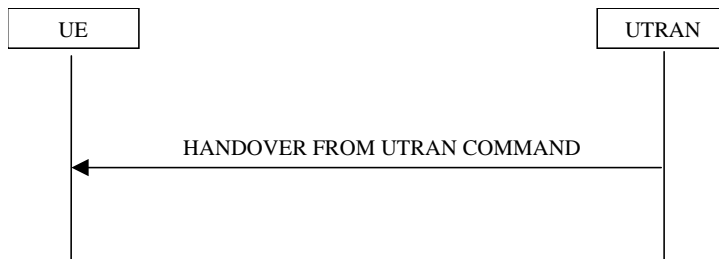

Figure 8.3.7-1: Inter-RAT handover from UTRAN, successful case

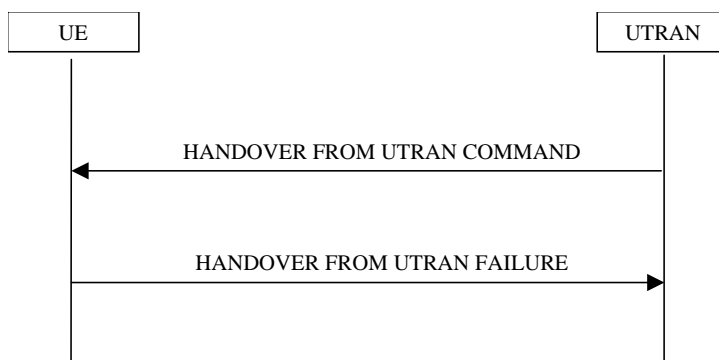

Figure 8.3.7-2: Inter-RAT handover from UTRAN, failure case

8.3.7.1 General

The purpose of the inter-RAT handover procedure is to, under the control of the network, transfer a connection between the UE and UTRAN to another radio access technology (e.g. GSM or E-UTRA). This procedure may be used in CELL_DCH state.

This procedure may be used to perform CS handover which applies when the variable ESTABLISHED_SIGNALLING_CONNECTIONS includes at least the CN domain identity "CS Domain".

When the UE supports Inter-RAT PS handover, this procedure may be used to perform PS handover which applies when the variable ESTABLISHED_SIGNALLING_CONNECTIONS includes at least the CN domain identity "PS Domain".

This procedure may be used to perform simultaneous CS and PS handover which applies when the variable ESTABLISHED_SIGNALLING_CONNECTIONS includes CN domain identities for both "CS Domain" and "PS Domain".

8.3.7.2 Initiation

The procedure is initiated when UTRAN orders a UE in CELL_DCH state, to make a handover to a radio access technology other than UTRAN, e.g. GSM or E-UTRA.

To initiate the procedure, UTRAN sends a HANDOVER FROM UTRAN COMMAND message.

8.3.7.3 Reception of a HANDOVER FROM UTRAN COMMAND message by the UE

The UE shall be able to receive a HANDOVER FROM UTRAN COMMAND message and perform an inter-RAT handover, even if no prior UE measurements have been performed on the target cell.

The UE shall:

1> For FDD:

2> if the UE has a pending "TGPS reconfiguration CFN" at the activation time received in the HANDOVER FROM UTRAN COMMAND the UE may:

3> abort the pending CM activation;

3> set the CM_PATTERN_ACTIVATION_ABORTED to TRUE.

2> otherwise:

3> set the CM_PATTERN_ACTIVATION_ABORTED to FALSE.

1> if the IE "NONCE" in IE "SR-VCC Info" is present:

2> perform security configurations according to subclause 8.6.3.15.

1> establish the connection to the target radio access technology, by using the contents of the IE "Inter-RAT message". This IE contains a message specified in another standard, as indicated by the IE "System type", and carries information about the candidate/ target cell identifier(s) and radio parameters relevant for the target radio access technology. The correspondence between the value of the IE "System type", the standard to apply and the message contained within IE "Inter RAT message" is shown in the following:

| Value of the IE "System type" | Standard to apply | Inter-RAT Message |
|-------------------------------|--|--|
| GSM | GSM TS 04.18, version 8.5.0 or later, or 3GPP TS 44.018 | HANDOVER COMMAND |
| | 3GPP TS 44.060, version 6.13.0 or later | PS HANDOVER COMMAND |
| | 3GPP TS 44.060, version 7.6.0 or later | DTM HANDOVER COMMAND |
| GERAN Iu | 3GPP TS 44.118 | RADIO BEARER RECONFIGURATION |
| cdma2000 | TIA/EIA/IS-2000 or later, TIA/EIA/IS-833 or later, TIA/EIQ/IS-834 or later | |
| E-UTRA | 3GPP TS 36.331 | <i>DL-DCCH-Message containing RRCConnectionReconfiguration</i> |

1> if the IE "RAB info to replace" is present:

2> indicate to the upper layers that the radio access bearer identified by the IE "RAB info to replace" is released as part of a SR-VCC procedure.

1> if the IE "System type" has the value "GSM" or "GERAN Iu":

2> if the IE "Frequency band" has the value "GSM /DCS 1800 band used":

3> set the BAND_INDICATOR [45] to "ARFCN indicates 1800 band".

2> if the IE "Frequency band" has the value " GSM /PCS 1900 band used":

3> set the BAND_INDICATOR [45] to "ARFCN indicates 1900 band".

1> apply the "Inter RAT Message" according to the "standard to apply" in the table above.

1> if the IE "RAB information List" is included in the HANDOVER FROM UTRAN COMMAND message:

2> if the IE "RAB information List" includes one IE "RAB Info" with the IE "CN domain Identity" set to "CS domain":

3> connect upper layer entities corresponding to the indicated CS domain RAB to the radio resources indicated in the inter-RAT message.

2> if the IE "RAB information List" includes one IE "RAB Info" with the IE "CN domain Identity" set to "PS domain":

- 3> connect upper layer entities corresponding to the indicated PS domain RAB to the radio resources indicated in the inter-RAT message.
- 3> if the "System type" is "GSM":
 - 4> use the contents of the IE "GERAN system information" as the system information to begin access on the target GERAN cell.

- NOTE1: In this version of the specification the maximum number of CS domain RABs which may be included in the IE "RAB information List" is limited to 1.
- NOTE2: In handover to GERAN *Iu mode*, the RAB information is included in the RADIO BEARER RECONFIGURATION message specified in [53].
- NOTE3: Requirements concerning the establishment of the radio connection towards the other radio access technology and the signalling procedure are outside the scope of this specification.
- NOTE4: The UE may ignore the IE "NAS synchronisation indicator" if included in the HANDOVER FROM UTRAN COMMAND message;
- NOTE5: The UE behaviour is undefined if the IE "Re-establishment timer" in the IE "RAB info" indicates a timer different from the timer currently configured for this RAB.
- NOTE6: The IE "GERAN System Information" is constructed in the same way as in 2G to 2G PS Handover in [44].

8.3.7.4 Successful completion of the inter-RAT handover

Upon successfully completing the handover, UTRAN should:

- 1> release the radio connection; and
- 1> remove all context information for the concerned UE.

Upon successfully completing the handover, the UE shall:

- 1> if inter-RAT handover to GERAN *Iu mode* is performed:
 - 2> perform the actions on reception of the RADIO BEARER RECONFIGURATION message as specified in [53].
- 1> if inter-RAT handover to GERAN *Iu mode* is performed and if there are any NAS messages for which the successful delivery of the INITIAL DIRECT TRANSFER message or UPLINK DIRECT TRANSFER message on signalling radio bearer RB3 or signalling radio bearer RB4 has not yet been confirmed by RLC; or
- 1> if inter-RAT handover to other RAT than GERAN *Iu mode* and E-UTRAN is performed and if there are any NAS messages with the IE "CN domain identity" set to "CS domain" for which the successful delivery of the INITIAL DIRECT TRANSFER message or UPLINK DIRECT TRANSFER message on signalling radio bearer RB3 or signalling radio bearer RB4 that have not yet been confirmed by RLC:
 - 2> retransmit those NAS messages to the network on the newly established radio connection to the target radio access technology.
- 1> if inter-RAT handover to E-UTRAN is performed and if there are any NAS messages for which the successful delivery of the INITIAL DIRECT TRANSFER message or UPLINK DIRECT TRANSFER message on signalling radio bearer RB3 or signalling radio bearer RB4 has not yet been confirmed by RLC:
 - 2> discard those NAS messages.
- 1> clear or set variables upon leaving UTRA RRC connected mode as specified in subclause 13.4;

NOTE: The release of the UMTS radio resources is initiated from the target RAT.

8.3.7.5 UE fails to complete requested handover

If the UE does not succeed in establishing the connection to the target radio access technology, it shall:

- 1> revert back to the UTRA configuration;
- 1> For FDD:
 - 2> if the CM_PATTERN_ACTIVATION_ABORTED flag is not set to TRUE:
 - 3> establish the UTRA physical channel(s) (including HS-DSCH and E-DCH related channels. If there exists any DTX or DRX configuration, the UE shall instruct the physical layer to consider only the HS-SCCH orders which were acknowledged prior to the activation time of the received message) used at the time for reception of HANDOVER FROM UTRAN COMMAND;
 - 3> if the variable DTX_DRX_STATUS is set to TRUE, re-configure the physical layer to perform discontinuous uplink DPCCCH transmission and enable or disable discontinuous downlink reception operations according to the variable DTX_DRX_PARAMS at the CFN corresponding to the frame boundary that is offset by the stored value of the IE "Enabling Delay" from the frame boundary where uplink transmission resumes with the old configuration;
 - 3> perform the physical layer synchronisation procedure A as specified in [29] (FDD only);
 - 3> apply power control preamble according to [26] during the number of frames indicated in the IE "PC preamble" in the variable LATEST_CONFIGURED_SRB_DELAY_AND_PC_PREAMBLE; and
 - 3> then not send any data on signalling radio bearers RB0 to RB4 during the number of frames indicated in the IE "SRB delay" in the variable LATEST_CONFIGURED_SRB_DELAY_AND_PC_PREAMBLE or while the physical channel is not considered established.
- 1> if the UE does not succeed to establish the UTRA physical channel(s) or for FDD if the CM_PATTERN_ACTIVATION_ABORTED flag is set to TRUE:
 - 2> perform a cell update procedure according to subclause 8.3.1 with cause "Radio link failure";
 - 2> when the cell update procedure has completed successfully:
 - 3> proceed as below.
- 1> transmit the HANDOVER FROM UTRAN FAILURE message setting the information elements as specified below:
 - 2> include the IE "RRC transaction identifier"; and
 - 2> set it to the value of "RRC transaction identifier" in the entry for the HANDOVER FROM UTRAN COMMAND message in the table "Accepted transactions" in the variable TRANSACTIONS; and
 - 2> clear that entry;
 - 2> set the IE "Inter-RAT handover failure" to "physical channel failure".
- 1> When the HANDOVER FROM UTRAN FAILURE message has been submitted to lower layer for transmission:
 - 2> the procedure ends.

8.3.7.6 Invalid HANDOVER FROM UTRAN COMMAND message

If the IE "Inter-RAT message" received within the HANDOVER FROM UTRAN COMMAND message does not include a valid inter RAT handover message in accordance with the protocol specifications for the target RAT, the UE shall perform procedure specific error handling as follows. The UE shall:

- 1> set the IE "failure cause" to the cause value "Inter-RAT protocol error";
- 1> include the IE "Inter-RAT message" in accordance with the specifications applicable to the other RAT;
- 1> transmit a HANDOVER FROM UTRAN FAILURE message on the uplink DCCH using AM RLC;

- 1> when the transmission of the HANDOVER FROM UTRAN FAILURE message has been confirmed by RLC:
 - 2> continue with any ongoing processes and procedures as if the invalid HANDOVER FROM UTRAN COMMAND message has not been received;
 - 2> and the procedure ends.

If the HANDOVER FROM UTRAN COMMAND message contains a protocol error causing the variable `PROTOCOL_ERROR_REJECT` to be set to `TRUE` according to clause 9, the UE shall perform procedure specific error handling as follows. The UE shall:

- 1> set the IE "RRC transaction identifier" in the HANDOVER FROM UTRAN FAILURE message to the value of "RRC transaction identifier" in the entry for the HANDOVER FROM UTRAN COMMAND message in the table "Rejected transactions" in the variable `TRANSACTIONS`; and
- 1> clear that entry;
- 1> set the IE "failure cause" to the cause value "protocol error";
- 1> include the IE "Protocol error information" with contents set to the value of the variable `PROTOCOL_ERROR_INFORMATION`;
- 1> transmit a HANDOVER FROM UTRAN FAILURE message on the uplink DCCH using AM RLC;
- 1> when the HANDOVER FROM UTRAN FAILURE message has been submitted to lower layers for transmission:
 - 2> continue with any ongoing processes and procedures as if the invalid HANDOVER FROM UTRAN COMMAND message has not been received;
 - 2> and the procedure ends.

8.3.7.7 Reception of an HANDOVER FROM UTRAN FAILURE message by UTRAN

Upon receiving an HANDOVER FROM UTRAN FAILURE message, UTRAN may initiate the release the resources in the target radio access technology.

8.3.7.8 Unsupported configuration in HANDOVER FROM UTRAN COMMAND message

If:

- the UTRAN instructs the UE to perform a non-supported handover scenario; or
- the UTRAN instructs the UE to use a non-supported configuration; or
- the UE does not support PS Handover to GERAN, and the inter-RAT handover to GERAN *A/Gb mode* is performed and the IE "RAB information List" is included in the HANDOVER FROM UTRAN COMMAND message and this IE does not include any IE "RAB Info" with the IE "CN domain Identity" set to "CS domain"; or
- the inter-RAT PS handover to GERAN is performed and the HANDOVER FROM UTRAN COMMAND message includes the IE "RAB information List" and includes at least one IE "RAB Info" with the IE "CN domain Identity" set to "PS domain", and the IE "GERAN System Information" is not present; or
- the inter-RAT handover to E-UTRAN is performed and the HANDOVER FROM UTRAN COMMAND message includes the IE "RAB information List" and includes at least one IE "RAB Info" with the IE "CN domain Identity" set to "CS domain";

the UE shall:

- 1> transmit a HANDOVER FROM UTRAN FAILURE message, setting the information elements as specified below;
- 2> include the IE "RRC transaction identifier"; and

- 2> set it to the value of "RRC transaction identifier" in the entry for the HANDOVER FROM UTRAN COMMAND message in the table "Accepted transactions" in the variable TRANSACTIONS; and
- 2> clear that entry;
- 2> set the IE "Inter-RAT handover failure" to "configuration unacceptable";
- 2> when the HANDOVER FROM UTRAN FAILURE message has been submitted to lower layers for transmission:
 - 3> resume normal operation as if the invalid HANDOVER FROM UTRAN COMMAND message has not been received;
 - 3> and the procedure ends.

8.3.7.8a Reception of HANDOVER FROM UTRAN COMMAND message by UE in CELL_FACH

If the UE receives HANDOVER FROM UTRAN COMMAND while in CELL_FACH, the UE shall:

- 1> transmit a HANDOVER FROM UTRAN FAILURE message, setting the information elements as specified below:
 - 2> include the IE "RRC transaction identifier"; and
 - 2> set it to the value of "RRC transaction identifier" in the entry for the HANDOVER FROM UTRAN COMMAND message in the table "Accepted transactions" in the variable TRANSACTIONS; and
 - 2> clear that entry;
 - 2> set the IE "Inter-RAT handover failure" to "protocol error", include IE "Protocol error information"; and
 - 2> set the value of IE "Protocol error cause" to "Message not compatible with receiver state";
 - 2> when the HANDOVER FROM UTRAN FAILURE message has been submitted to lower layers for transmission:
 - 3> resume normal operation as if the invalid HANDOVER FROM UTRAN COMMAND message has not been received;
 - 3> and the procedure ends.

8.3.8 Inter-RAT cell reselection to UTRAN

8.3.8.1 General

The purpose of the inter-RAT cell reselection procedure to UTRAN is to transfer, under the control of the UE and to some extent the source radio access technology, a connection between the UE and another radio access technology (e.g. GSM/GPRS, but not UTRAN) to UTRAN.

8.3.8.2 Initiation

When the UE makes an inter-RAT cell reselection to UTRAN according to the criteria specified in [4], it shall initiate this procedure. The inter-RAT cell reselection made by the UE may use system information broadcast from the source radio access technology or UE dedicated information.

If the NAS procedures associated with inter-system change specified in [5] require the establishment of an RRC connection, the UE shall:

- 1> set the variable ESTABLISHMENT_CAUSE to "Inter-RAT cell reselection";

NOTE: This value of ESTABLISHMENT_CAUSE has priority over the cause requested by upper layers.

- 1> initiate an RRC connection establishment procedure as specified in subclause 8.1.3;

- 1> after initiating an RRC connection establishment:
- 2> release all resources specific to the other radio access technology.

If the NAS procedures associated with inter-system change specified in [5] do not require the establishment of an RRC connection, the UE shall:

- 1> enter idle mode in the target cell without accessing the cell; and
- 1> release all resources specific to the other radio access technology.

8.3.8.2a Initiation of inter-RAT cell reselection from GERAN *Iu mode*

When the UE performs an inter-RAT cell reselection from GERAN *Iu mode* Cell_Shared state, the UE shall:

- 1> initiate the cell update procedure as specified for the cell reselection case in CELL_FACH and CELL_PCH states, using the cause "cell reselection" and setting the G-RNTI in the IE "U-RNTI".

When the UE performs an inter-RAT cell reselection from GERAN *Iu mode* GRA_PCH state, the UE shall:

- 1> compare the GRA identity which the MS had been assigned to in GERAN against the URA identities which are broadcast in the UTRAN cell.
- 1> If the assigned GRA identity is not present in the list of URA identities that are broadcast in the UTRAN cell:
 - 2> initiate the URA update procedure as specified for the URA reselection case in URA_PCH state, using the cause "change of URA" and setting the G-RNTI in the IE "U-RNTI".

The UE shall:

- 1> set the following variables equal to the corresponding variables in GERAN *Iu mode*:

CIPHERING_STATUS
 ESTABLISHED_RABS
 ESTABLISHED_SIGNALLING_CONNECTIONS
 INTEGRITY_PROTECTION_INFO
 INTER_RAT_HANDBOVER_INFO_TRANSFERRED
 LATEST_CONFIGURED_CN_DOMAIN
 START_THRESHOLD
 UE_CAPABILITY_TRANSFERRED.

- 1> set the new uplink and downlink HFN of RB2 to $MSB_{20}(\text{MAX}(\text{uplink HFN of RB2, downlink HFN of RB2}))$.

NOTE: $MSB_{20}()$ operation provides the HFN mapping from GERAN *Iu mode* to UTRAN. In GERAN *Iu mode* the length of HFN component of the COUNT-C of RB2 is longer than 20 bits.

- 1> initialise the variable TIMERS_AND_CONSTANTS to the default values and start to use those timer and constants values.

8.3.8.3 UE fails to complete an inter-RAT cell reselection

If the inter-RAT cell reselection fails before the UE has initiated the RRC connection establishment the UE may return back to the other radio access technology.

If the RRC connection establishment fails, the UE shall enter idle mode.

8.3.8.3a UE fails to complete an inter-RAT cell reselection from GERAN *Iu mode*

When the UE performs an inter-RAT cell reselection from GERAN *Iu mode* to UTRAN, and the cell reselection fails:

1> the UE may return back to the GERAN *Iu mode* state from which it initiated the inter-RAT cell reselection.

8.3.9 Inter-RAT cell reselection from UTRAN

8.3.9.1 General

The purpose of the inter-RAT cell reselection procedure from UTRAN is to transfer, under the control of the UE and to some extent the UTRAN, a connection between the UE and UTRAN to another radio access technology (e.g. GSM/GPRS or E-UTRA).

8.3.9.2 Initiation

This procedure is applicable in states CELL_FACH, CELL_PCH or URA_PCH. Inter-RAT cell reselection to E-UTRAN in CELL_FACH state is not supported in this version of the specification.

When the UE based on received system information makes a cell reselection to a radio access technology other than UTRAN, e.g. GSM/GPRS or E-UTRA, according to the criteria specified in [4], the UE shall:

- 1> If the NAS procedures associated with inter-system change specified in [5] require the establishment of a connection:
- 2> initiate the establishment of a connection to the target radio access technology according to its specifications.

8.3.9.2a Initiation of inter-RAT cell reselection to GERAN *Iu mode*

When the UE in CELL_PCH or CELL_FACH state performs an inter-RAT cell reselection to GERAN *Iu mode*, according to the criteria specified in [4], the UE shall:

- 1> initiate the cell update procedure according to 3GPP TS 44.118 [53], setting the U-RNTI in the IE "G-RNTI".

When the UE in URA_PCH state performs an inter-RAT cell reselection to GERAN *Iu mode*, according to the criteria specified in [4], the UE shall:

- 1> compare the URA identity which the UE had been assigned to in UTRAN against the GRA identities which are broadcast in the GERAN cell;
- 1> If the assigned URA identity is not present in the list of GRA identities that are broadcast in the GERAN cell:
 - 2> initiate the GRA update procedure as specified in 3GPP TS 44.118 [53], setting the U-RNTI in the IE "G-RNTI".

8.3.9.3 Successful cell reselection

When the UE has succeeded in reselecting a cell in the target radio access technology, the UE shall:

- 1> release all UTRAN specific resources.

UTRAN should:

- 1> release all UE dedicated resources upon indication that the UE has completed a connection establishment to the other radio access technology.

8.3.9.4 UE fails to complete an inter-RAT cell reselection

If the inter-RAT cell reselection fails, the UE shall:

- 1> resume the connection to UTRAN using the resources used before initiating the inter-RAT cell reselection procedure.

8.3.10 Inter-RAT cell change order to UTRAN

8.3.10.1 General

The purpose of the inter-RAT cell change order to UTRAN procedure is to transfer, under the control of the source radio access technology, a connection between the UE and another radio access technology (e.g. GSM/GPRS) to UTRAN.

8.3.10.2 Initiation

The procedure is initiated when a radio access technology other than UTRAN, e.g. GSM/GPRS, using procedures specific for that RAT, orders the UE to change to a UTRAN cell.

NOTE: Within the message used to order the UE to change to a UTRAN cell, the source RAT should specify the identity of the target UTRAN cell as specified in the specifications for that RAT.

The UE shall:

1> set the variable ESTABLISHMENT_CAUSE to "Inter-RAT cell change order";

NOTE: This value of ESTABLISHMENT_CAUSE has priority over the cause requested by upper layers.

1> initiate an RRC connection establishment procedure as specified in subclause 8.1.3.

8.3.10.3 UE fails to complete an inter-RAT cell change order

If the inter-RAT cell reselection fails the UE shall return to the other radio access technology and proceed as specified in the appropriate specifications for that RAT.

NOTE 3: The cell change was network ordered. Therefore, failure to change to the target cell should not cause the UE to move to UE- controlled cell selection.

8.3.11 Inter-RAT cell change order from UTRAN

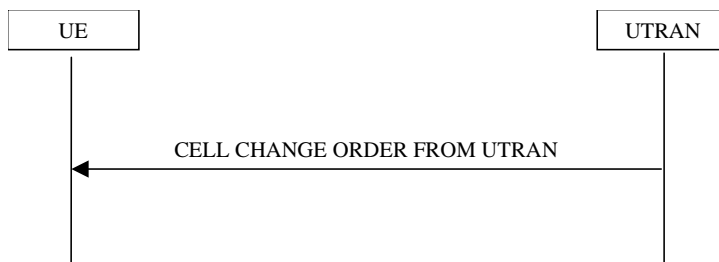

Figure 8.3.11-1: Inter-RAT cell change order from UTRAN

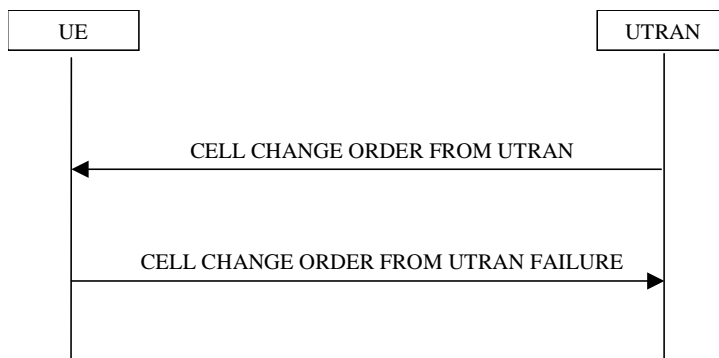

Figure 8.3.11-2: Inter-RAT cell change order from UTRAN, failure case

8.3.11.1 General

The purpose of the inter-RAT cell change order procedure is to transfer, under the control of the network, a connection between the UE and UTRAN to another radio access technology (e.g. GSM). This procedure may be used in CELL_DCH and CELL_FACH state. This procedure may be used when no RABs are established or when the established RABs are only from PS domain. This procedure may not be used when there is no PS signalling connection.

8.3.11.2 Initiation

The procedure is initiated when UTRAN orders a UE in CELL_DCH or CELL_FACH state, to make a cell change to a radio access technology other than UTRAN, e.g. GSM.

To initiate the procedure, UTRAN sends a CELL CHANGE ORDER FROM UTRAN message.

8.3.11.3 Reception of an CELL CHANGE ORDER FROM UTRAN message by the UE

The UE shall be able to receive a CELL CHANGE ORDER FROM UTRAN message and perform a cell change order to another RAT, even if no prior UE measurements have been performed on the target cell.

If the variable ESTABLISHED_SIGNALLING_CONNECTIONS does not include the CN domain identity "PS domain", or if the variable ESTABLISHED_SIGNALLING_CONNECTIONS includes the CN domain identity "CS domain":

- 1> the UE shall act as if the message was never received.

The UE shall:

- 1> For FDD:

- 2> if the UE has a pending "TGPS reconfiguration CFN" at the activation time received in the CELL CHANGE ORDER FROM UTRAN message the UE may:
 - 3> abort the pending CM activation;
 - 3> set the CM_PATTERN_ACTIVATION_ABORTED to TRUE.

- 2> otherwise:

- 3> set the CM_PATTERN_ACTIVATION_ABORTED to FALSE.

- 1> start timer T309; and

- 1> establish the connection to the other radio access technology, as specified within IE "Target cell description". This IE specifies the target cell identity, in accordance with the specifications for that other RAT. In case the target cell is a GSM/ GPRS cell, IE "Target cell description" may also include IE "NC mode", which specifies the cell selection mode to be applied in the target cell; and

- 1> if IE "NC mode" is not included in the CELL CHANGE ORDER FROM UTRAN:

- 2> retrieve it from the target cell as specified in [43];
- 2> act upon IE "NC mode" as specified in [43].

- 1> if the IE "RAB Information List" is included in the CELL CHANGE ORDER FROM UTRAN message:

- 2> ignore the contents of the IE "RAB Information List".

NOTE: Requirements concerning the establishment of the radio connection towards the other radio access technology and the signalling procedure are outside the scope of this specification. In case of GSM/GPRS proceed according to the procedure Network control cell reselection procedure as specified in [44].

- 1> if the UE supports UTRAN to GERAN Network Assisted Cell Change, the IE "Geran System Information" is present and the UE is in CELL_DCH state:

- 2> if according to [44] the IE "GERAN System Information" includes a correct and consistent set of SI or PSI messages:
 - 3> use this information as the system information to begin access on the target GERAN cell.
- 2> otherwise:
 - 3> ignore the IE "GERAN System Information" and continue the Cell Change Order procedure.

NOTE: The IE "GERAN System Information" is constructed in the same way as in 2G to 2G NACC, i.e. the PSI messages are encoded as such, whereas the SI messages exclude 2 octets of headers, see [44].

8.3.11.4 Successful completion of the cell change order

The UE regards the procedure as completed when it has received a successful response from the target RAT, e.g. in case of GSM when it received the response to a (PACKET) CHANNEL REQUEST in the new cell.

Upon successful completion of the cell change order, the UE shall:

- 1> stop timer T309;
- 1> clear or set variables upon leaving UTRA RRC connected mode as specified in subclause 13.4.

Upon indication of the UE having successfully completed the cell change order, UTRAN should:

- 1> release the radio connection; and
- 1> remove all context information for the concerned UE.

NOTE: The release of the UMTS radio resources is initiated from another RAT.

8.3.11.5 Expiry of timer T309 or UE fails to complete requested cell change order

If:

- timer T309 expires prior to the successful establishment of a connection to the target RAT; or
- if the establishment of the connection to the other RAT failed due to other reasons e.g. (random) access failure, rejection due to lack of resources:

the UE shall:

- 1> if it received the CELL CHANGE ORDER FROM UTRAN message in state CELL_DCH:
 - 2> For TDD or for FDD if the CM_PATTERN_ACTIVATION_ABORTED flag is not set to TRUE:
 - 3> revert back to the UTRA configuration;
 - 3> establish the UTRA physical channel(s) (including HS-DSCH and E-DCH related channels) used at the time for reception of CELL CHANGE ORDER FROM UTRAN.
 - 2> For FDD:
 - 3> perform the physical layer synchronisation procedure A as specified in [29];
 - 3> if there exists any DTX or DRX configuration prior to the reception of the CELL CHANGE ORDER FROM UTRAN COMMAND, instruct the physical layer to consider only the HS-SCCH orders which were acknowledged prior to the activation time of the received message;
 - 3> if the variable DTX_DRX_STATUS is set to TRUE, re-configure the physical layer to perform discontinuous uplink DPCCCH transmission and enable or disable discontinuous downlink reception operations according to the variable DTX_DRX_PARAMS at the CFN corresponding to the frame boundary that is offset by the stored value of the IE "Enabling Delay" from the frame boundary where uplink transmission resumes with the old configuration;

- 3> apply power control preamble according to [26] during the number of frames indicated in the IE "PC preamble" in the variable LATEST_CONFIGURED_SRB_DELAY_AND_PC_PREAMBLE; and
 - 3> then not send any data on signalling radio bearers RB0 to RB4 during the number of frames indicated in the IE "SRB delay" in the variable LATEST_CONFIGURED_SRB_DELAY_AND_PC_PREAMBLE or while the physical channel is not considered established;
 - 3> if the CM_PATTERN_ACTIVATION_ABORTED flag is set to TRUE or if the UE does not succeed in establishing the UTRA physical channel(s):
 - 4> perform a cell update procedure according to subclause 8.3.1 with cause "Radio link failure";
 - 4> when the cell update procedure has completed successfully:
 - 5> proceed as below.
 - 3> transmit the CELL CHANGE ORDER FROM UTRAN FAILURE message setting the information elements as specified below:
 - 4> include the IE "RRC transaction identifier"; and
 - 4> set it to the value of "RRC transaction identifier" in the entry for the received message in the table "Accepted transactions" in the variable TRANSACTIONS; and
 - 4> clear that entry;
 - 4> set the IE "Inter-RAT change failure" to "physical channel failure".
 - 3> When the CELL CHANGE ORDER FROM UTRAN FAILURE message has been submitted to lower layer for transmission, the procedure ends.
- 1> if the UE receives the CELL CHANGE ORDER FROM UTRAN message in CELL_FACH state:
 - 2> revert to the cell it was camped on at the reception of the CELL CHANGE ORDER FROM UTRAN message;
 - 2> if the UE is unable to return to this cell:
 - 3> select a suitable UTRA cell according to [4];
 - 3> initiate the cell update procedure according to subclause 8.3.1 using the cause "cell re-selection";
 - 3> when the cell update procedure completed successfully:
 - 4> proceed as below.
 - 2> transmit the CELL CHANGE ORDER FROM UTRAN FAILURE message setting the information elements as specified below:
 - 3> include the IE "RRC transaction identifier"; and
 - 3> set it to the value of "RRC transaction identifier" in the entry for the CELL CHANGE ORDER FROM UTRAN message in the table "Accepted transactions" in the variable TRANSACTIONS; and
 - 3> clear that entry;
 - 3> set the IE "Inter-RAT change failure" to "physical channel failure".
 - 2> When the CELL CHANGE ORDER FROM UTRAN FAILURE message has been submitted to lower layer for transmission:
 - 3> the procedure ends.

8.3.11.6 Unsupported configuration in CELL CHANGE ORDER FROM UTRAN message

If the UTRAN instructs the UE to perform a non-supported cell change order scenario or to use a non-supported configuration, the UE shall:

- 1> transmit a CELL CHANGE ORDER FROM UTRAN FAILURE message, setting the information elements as specified below:
 - 2> include the IE "RRC transaction identifier"; and
 - 2> set it to the value of "RRC transaction identifier" in the entry for the received message in the table "Accepted transactions" in the variable TRANSACTIONS; and
 - 2> clear that entry;
 - 2> set the IE "Inter-RAT change failure" to "configuration unacceptable";
 - 2> when the CELL CHANGE ORDER FROM UTRAN FAILURE message has been submitted to lower layers for transmission:
 - 3> resume normal operation as if the CELL CHANGE ORDER FROM UTRAN message has not been received;
 - 3> and the procedure ends.

8.3.11.7 Invalid CELL CHANGE ORDER FROM UTRAN message

If the CELL CHANGE ORDER FROM UTRAN message contains a protocol error causing the variable PROTOCOL_ERROR_REJECT to be set to TRUE according to clause 9, the UE shall perform procedure specific error handling as follows. The UE shall:

- 1> set the IE "RRC transaction identifier" in the CELL CHANGE ORDER FROM UTRAN FAILURE message to the value of "RRC transaction identifier" in the entry for the CELL CHANGE ORDER FROM UTRAN message in the table "Rejected transactions" in the variable TRANSACTIONS; and
- 1> clear that entry;
- 1> set the IE "Inter-RAT change failure" to the cause value "protocol error";
- 1> include the IE "Protocol error information" with contents set to the value of the variable PROTOCOL_ERROR_INFORMATION;
- 1> transmit a CELL CHANGE ORDER FROM UTRAN FAILURE message on the uplink DCCH using AM RLC;
- 1> when the CELL CHANGE ORDER FROM UTRAN FAILURE message has been submitted to lower layers for transmission:
 - 2> resume normal operation as if the invalid CELL CHANGE ORDER FROM UTRAN message has not been received;
 - 2> and the procedure ends.

8.4 Measurement procedures

8.4.0 Measurement related definitions

UTRAN may control a measurement in the UE either by broadcast of SYSTEM INFORMATION and/or by transmitting a MEASUREMENT CONTROL message.

The following information is used to control the UE measurements and the measurement results reporting:

1. **Measurement identity:** A reference number that should be used by the UTRAN when setting up, modifying or releasing the measurement and by the UE in the measurement report.
2. **Measurement command:** One out of three different measurement commands.
 - Setup: Setup a new measurement.
 - Modify: Modify a previously defined measurement, e.g. to change the reporting criteria.
 - Release: Stop a measurement and clear all information in the UE that are related to that measurement.
3. **Measurement type:** One of the types listed below describing what the UE shall measure.

Presence or absence of the following control information depends on the measurement type

4. **Measurement objects:** The objects on which the UE shall measure measurement quantities, and corresponding object information.
5. **Measurement quantity:** The quantity the UE shall measure on the measurement object. This also includes the filtering of the measurements.
6. **Reporting quantities:** The quantities the UE shall include in the report in addition to the quantities that are mandatory to report for the specific event.
7. **Measurement reporting criteria:** The triggering of the measurement report, e.g. periodical or event-triggered reporting.
8. **Measurement Validity:** Defines in which UE states the measurement is valid.
9. **Measurement reporting mode:** This specifies whether the UE shall transmit the measurement report using AM or UM RLC.
10. **Additional measurement identities:** A list of references to other measurements. When this measurement triggers a measurement report, the UE shall also include the reporting quantities for the measurements referenced by the additional measurement identities.

All these measurement parameters depend on the measurement type and are described in more detail in clause 14.

The different types of measurements are:

- **Intra-frequency measurements:** measurements on downlink physical channels at the same frequency as the active set. A measurement object corresponds to one cell. Detailed description is found in subclause 14.1.
- **Inter-frequency measurements:** measurements on downlink physical channels at frequencies that differ from the frequency of the active set and on downlink physical channels in the active set. A measurement object corresponds to one cell. Detailed description is found in subclause 14.2.
- **Inter-RAT measurements:** measurements on downlink physical channels belonging to another radio access technology than UTRAN, e.g. GSM or E-UTRA. A measurement object corresponds to one cell (e.g. GSM) or one frequency (e.g. E-UTRA). Detailed description is found in subclause 14.3.
- **Traffic volume measurements:** measurements on uplink traffic volume. A measurement object corresponds to one cell. Detailed description is found in subclause 14.4.
- **Quality measurements:** Measurements of downlink quality parameters, e.g. downlink transport block error rate. A measurement object corresponds to one transport channel in case of BLER. A measurement object corresponds to one timeslot in case of SIR (TDD only). Detailed description is found in subclause 14.5.
- **UE-internal measurements:** Measurements of UE transmission power and UE received signal level. Detailed description is found in subclause 14.6.
- **UE positioning measurements:** Measurements of UE position. Detailed description is found in subclause 14.7.

The UE shall support a number of measurements running in parallel as specified in [19] and [20]. The UE shall also support that each measurement is controlled and reported independently of every other measurement.

Cells that the UE is monitoring are grouped in the UE into three mutually exclusive categories:

1. Cells, which belong to the **active set**. User information is sent from all these cells. In FDD, the cells in the active set are involved in soft handover. In TDD the active set always comprises one cell only. The UE shall only consider active set cells included in the variable CELL_INFO_LIST for measurement; i.e. active set cells not included in the CELL_INFO_LIST shall not be considered in any event evaluation and measurement reporting.
2. Cells, which are not included in the active set, but are included in the CELL_INFO_LIST belong to the **monitored set**.
3. Cells detected by the UE, which are neither in the CELL_INFO_LIST nor in the active set belong to the **detected set**. Reporting of measurements of the detected set is only applicable to intra-frequency measurements made by UEs in CELL_DCH state.

If the IE "Cells for measurement" has been included in a MEASUREMENT CONTROL message, only monitored set cells explicitly indicated for a given intra-frequency (resp. inter-frequency, interRAT) measurement by the IE "Cells for measurement" shall be considered for measurement. If the IE "Cells for measurement" has not been included in a MEASUREMENT CONTROL message, all of the intra-frequency (resp. inter-frequency, inter RAT) cells stored in the variable CELL_INFO_LIST shall be considered for measurement. The IE "Cells for measurement" is not applicable to active set cells e.g. when the triggering condition refers to active set cells, the UE shall consider all active set cells in the CELL_INFO_LIST for measurement irrespective if these cells are explicitly indicated by the IE "Cells for measurement".

8.4.1 Measurement control



Figure 8.4.1-1: Measurement Control, normal case

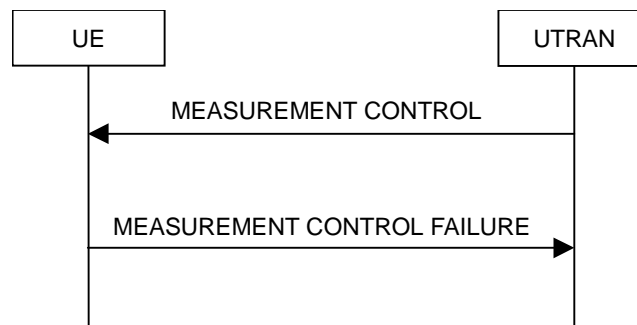

Figure 8.4.1-2: Measurement Control, failure case

8.4.1.1 General

The purpose of the measurement control procedure is to setup, modify or release a measurement in the UE.

In subclause 8.4.1 and its subclauses references to System Information Block type 11 mean the merge of System Information Block Type 11 and System Information Block type 11bis, if scheduled on BCH.

8.4.1.2 Initiation

The UTRAN may request a measurement by the UE to be setup, modified or released with a MEASUREMENT CONTROL message, which is transmitted on the downlink DCCH using AM RLC.

The UTRAN should take the UE capabilities into account when a measurement is requested from the UE.

When a new measurement is created, UTRAN should set the IE "Measurement identity" to a value, which is not used for other measurements. UTRAN may use several "Measurement identity" for the same "Measurement type". In case of setting several "Measurement identity" within a same "Measurement type", the measurement object or the list of measurement objects can be set differently for each measurement with different "Measurement identity".

When a current measurement is modified or released, UTRAN should set the IE "Measurement identity" to the value, which is used for the measurement being modified or released. In case of modifying IEs within a "Measurement identity", it is not needed for UTRAN to indicate the IEs other than modified IEs, and the UE continues to use the current values of the IEs that are not modified. UTRAN should not use "modify" to change the type of measurement stored in the variable MEASUREMENT_IDENTITY for a given measurement identity.

8.4.1.3 Reception of MEASUREMENT CONTROL by the UE

Upon reception of a MEASUREMENT CONTROL message the UE shall perform actions specified in subclause 8.6 unless otherwise specified below.

The UE shall:

- 1> read the IE "Measurement command";
- 1> if the IE "Measurement command" has the value "setup":
 - 2> store this measurement in the variable MEASUREMENT_IDENTITY according to the IE "measurement identity", first releasing any previously stored measurement with that identity if that exists;
 - 2> for FDD or 3.84/7.68 Mcps TDD, if the measurement type is quality, UE internal, intra-frequency, inter-frequency or inter-RAT:
 - 3> if the UE is in CELL_FACH state:
 - 4> the UE behaviour is not specified.
 - 2> for 1.28 Mcps TDD, if the measurement type is quality, UE internal, or inter-RAT:
 - 3> if the UE is in CELL_FACH state:
 - 4> the UE behaviour is not specified.
 - 2> for 1.28 Mcps TDD, if the measurement type is intra-frequency or inter-frequency:
 - 3> if the UE is in CELL_FACH state:
 - 4> if the UE is working on the secondary frequency:
 - 5> begin measurements according to the stored control information for this measurement identity.
 - 4> else:
 - 5> may begin measurements according to the stored control information for this measurement identity.
 - 2> for measurement types "inter-RAT measurement" or "inter-frequency measurement" that require measurements on a frequency other than the actually used frequency:
 - 3> if, according to its measurement capabilities, the UE requires compressed mode to perform that measurement type and after reception of this message a compressed mode pattern sequence with an appropriate measurement purpose is active according to the IE "Current TGPS Status Flag" in UE variable TGPS_IDENTITY; or
 - 3> if, according to its measurement capabilities, the UE does not require compressed mode to perform the measurements on at least one supported band of that measurement type:
 - 4> if the measurement is valid in the current RRC state of the UE:
 - 5> begin measurements according to the stored control information for this measurement identity.

- 3> if according to its measurement capabilities, the UE does not require compressed mode to perform measurement on adjacent frequency and the frequency derived from "Adjacent frequency info" included in the variable CELL_INFO_LIST is an adjacent frequency:
 - 4> if SECONDARY_CELL_HS_DSCH_RECEPTION is set to FALSE; or
 - 4> if SECONDARY_CELL_HS_DSCH_RECEPTION is set to TRUE and the frequency derived from "Adjacent frequency info" included in the variable CELL_INFO_LIST is same as the frequency of the secondary serving HS-DSCH cell:
 - 5> if the measurement is valid in the current RRC state of the UE:
 - 6> begin measurements according to the stored control information for this measurement identity.

NOTE: The UE is not required to perform measurements on cells for which it needs compressed mode but a suitable compressed mode pattern is not activated.

- 2> for measurement type "inter-frequency measurement" that requires measurements only on the same frequency as the actually used frequency:
 - 3> if the measurement is valid in the current RRC state of the UE:
 - 4> begin measurements according to the stored control information for this measurement identity.
- 2> for measurement type "UE positioning measurement":
 - 3> if the UE is in CELL_FACH state:
 - 4> if IE "Positioning Method" is set to "OTDOA":
 - 5> if IE "Method Type" is set to "UE assisted":
 - 6> if IE "UE positioning OTDOA assistance data for UE assisted" is not included:
 - 7> if System Information Block type 15.4 is broadcast:
 - 8> read System Information Block type 15.4.
 - 7> act as specified in subclause 8.6.7.19.2.
 - 5> if IE "Method Type" is set to "UE based":
 - 6> if IE "UE positioning OTDOA assistance data for UE based" is not included:
 - 7> if System Information Block type 15.5 is broadcast:
 - 8> read System Information Block type 15.5.
 - 7> act as specified in subclause 8.6.7.19.2a.
- 2> for any other measurement type:
 - 3> if the measurement is valid in the current RRC state of the UE:
 - 4> begin measurements according to the stored control information for this measurement identity.
- 1> if the IE "Measurement command" has the value "modify":
 - 2> for all IEs present in the MEASUREMENT CONTROL message:
 - 3> if a measurement was stored in the variable MEASUREMENT_IDENTITY associated to the identity by the IE "measurement identity":
 - 4> for FDD or 3.84/7.68 Mcps TDD, if the measurement type is quality, UE internal, intra-frequency, inter-frequency or inter-RAT:
 - 5> if the UE is in CELL_FACH state:

- 6> the UE behaviour is not specified.
- 4> for 1.28 Mcps TDD, if the measurement type is quality, UE internal, or inter-RAT:
 - 5> if the UE is in CELL_FACH state:
 - 6> the UE behaviour is not specified.
 - 4> for 1.28 Mcps TDD, if the measurement type is intra-frequency or inter-frequency:
 - 5> if the UE is in CELL_FACH state:
 - 6> perform the actions as specified below.
 - 4> if measurement type is set to "intra-frequency measurement", for any of the optional IEs "Intra-frequency measurement objects list", "Intra-frequency measurement quantity", "Intra-frequency reporting quantity", "Measurement Validity", "report criteria" and "parameters required for each event" (given "report criteria" is set to "intra-frequency measurement reporting criteria") that are present in the MEASUREMENT CONTROL message:
 - 4> if measurement type is set to "inter-frequency measurement", for any of the optional IEs "Inter-frequency measurement quantity", "Inter-frequency reporting quantity", "Measurement Validity", "Inter-frequency set update" and "parameters required for each event" (given "report criteria" is set to either "inter-frequency measurement reporting criteria" or "intra-frequency measurement reporting criteria") that are present in the MEASUREMENT CONTROL message:
 - 4> if measurement type is set to "inter-RAT measurement", for any of the optional IEs "Inter-RAT measurement objects list", "E-UTRA frequency list", "Inter-RAT measurement quantity", and "Inter-RAT reporting quantity" that are present in the MEASUREMENT CONTROL message:
 - 4> if measurement type is set to "UE positioning measurement" and the IE "UE positioning OTDOA assistance data" is present, for any of the optional IEs "UE positioning OTDOA neighbour cell info for UE-assisted", "UE positioning OTDOA reference cell info for UE-assisted", "UE positioning OTDOA reference cell info for UE-based", "UE positioning OTDOA neighbour cell info for UE-based" and "UE positioning" that are present in the MEASUREMENT CONTROL message:
 - 4> if measurement type is set to "UE positioning measurement" and the IE "UE positioning GPS assistance data" is present, for any of the optional IEs "UE positioning GPS reference time", "UE positioning GPS reference UE position", "UE positioning GPS DGPS corrections", "UE positioning GPS ionospheric model", "UE positioning GPS UTC model", "UE positioning GPS acquisition assistance", "UE positioning GPS real-time integrity" that are present in the MEASUREMENT CONTROL message:
 - 4> if measurement type is set to "UE positioning measurement" and the IE "UE positioning GANSS assistance data" is present, for any of the optional IEs "UE positioning GANSS reference time", "UE positioning GANSS reference UE position", "UE positioning DGANSS corrections", "UE positioning GANSS ionospheric model", "UE positioning GANSS additional ionospheric model", "UE positioning GANSS UTC model", "UE positioning GANSS additional UTC models", "UE positioning GANSS reference measurement information", "UE positioning GANSS data bit assistance", "UE positioning GANSS Time model", "UE positioning GANSS real-time integrity", "UE positioning GANSS Earth orientation parameters", "UE positioning GANSS auxiliary information" that are present in the MEASUREMENT CONTROL message:
 - 4> if measurement type is set to "traffic volume measurement", for any of the optional IEs "Traffic volume measurement Object", "Traffic volume measurement quantity", "Traffic volume reporting quantity", and "Measurement Validity" that are present in the MEASUREMENT CONTROL message:
 - 4> if measurement type is set to "quality measurement", for the optional IE "Quality reporting quantity" if it is present in the MEASUREMENT CONTROL message:
 - 4> if measurement type is set to "UE internal measurement", for any of the optional IEs "UE internal measurement quantity", and "UE internal reporting quantity" that are present in the MEASUREMENT CONTROL message:

- 5> replace all instances of the IEs listed above (and all their children) stored in variable MEASUREMENT_IDENTITY associated to the identity indicated by the IE "measurement identity" with the IEs received in the MEASUREMENT CONTROL message;
 - 5> leave all other stored information elements unchanged in the variable MEASUREMENT_IDENTITY.
- 3> otherwise:
- 4> set the variable CONFIGURATION_INCOMPLETE to TRUE.
- 2> if measurement type is set to "inter-frequency measurement":
- 3> if "report criteria" is set to "intra-frequency measurement reporting criteria" and "reporting criteria" in "inter-frequency measurement quantity" is set to "intra-frequency reporting criteria":
 - 4> for FDD, 3.84 Mcps TDD and 7.68 Mcps TDD; or
 - 4> for 1.28 Mcps TDD, if the UE only uses one frequency:
 - 5> leave the currently stored "inter-frequency measurement reporting criteria" within "report criteria" and "inter-frequency reporting criteria" within "inter-frequency measurement quantity" unchanged, and continue to act on the information stored in these variables.
- NOTE: If the UTRAN wants to modify the inter-frequency cell info list for an inter-frequency measurement configured with event based reporting without repeating any IEs related to the configured events, one possibility is to set the IE "report criteria" to "intra-frequency measurement reporting criteria", not include the IE "parameters required for each event", and set the IE "reporting criteria" in the IE "inter-frequency measurement quantity" to "intra-frequency reporting criteria".
- 4> for 1.28 Mcps TDD, if the UE uses multiple frequencies:
 - 5> use the content of MEASUREMENT CONTROL to replace the IEs related to MEASUREMENT_IDENTITY which have stored;
 - 5> not delete the unchanged values.
- 2> for measurement types "inter-frequency measurement" that require measurements on a frequency other than the actually used frequency, or that require measurements on another RAT:
- 3> if, according to its measurement capabilities, the UE requires compressed mode to perform that measurement type and after reception of this message a compressed mode pattern sequence with an appropriate measurement purpose is active according to the IE "Current TGPS Status Flag" in UE variable TGPS_IDENTITY; or
 - 3> if, according to its measurement capabilities, the UE does not require compressed mode, on at least one supported band of that measurement type, to perform the measurements:
 - 4> resume the measurements according to the new stored measurement control information.
 - 3> if according to its measurement capabilities, the UE does not require compressed mode to perform measurement on adjacent frequency and the frequency derived from "Adjacent frequency info" included in the variable CELL_INFO_LIST is an adjacent frequency:
 - 4> if SECONDARY_CELL_HS_DSCH_RECEPTION is set to FALSE; or
 - 4> if SECONDARY_CELL_HS_DSCH_RECEPTION is set to TRUE and the frequency derived from "Adjacent frequency info" included in the variable CELL_INFO_LIST is same as the frequency of the secondary serving HS-DSCH cell:
 - 5> resume the measurements according to the new stored measurement control information.
- 2> for measurement type "inter-frequency measurement" that requires measurements only on the same frequency as the actually used frequency:
- 3> if the measurement is valid in the current RRC state of the UE:

- 4> resume measurements according to the new stored control information for this measurement identity.
- 2> for any other measurement type:
 - 3> resume the measurements according to the new stored measurement control information.
- 2> for measurement type "inter-RAT measurement":
 - 3> if "report criteria" is set to "inter-RAT measurement reporting criteria":
 - 4> if the value of "report criteria" stored in the variable MEASUREMENT_IDENTITY associated to the identity indicated by the IE "measurement identity" is not "inter-RAT measurement reporting criteria"; or
 - 4> if the value of "report criteria" stored in the variable MEASUREMENT_IDENTITY associated to the identity indicated by the IE "measurement identity" is "inter-RAT measurement reporting criteria" and if the IE "Parameters required for each event" is present:
 - 5> replace the IE "report criteria" (and all its children) stored in variable MEASUREMENT_IDENTITY associated to the identity indicated by the IE "measurement identity" with the IE "reporting criteria" received in the MEASUREMENT CONTROL message.
 - 3> if "report criteria" is not set to "inter-RAT measurement reporting criteria":
 - 4> replace the IE "reporting criteria" (and all its children) stored in variable MEASUREMENT_IDENTITY associated to the identity indicated by the IE "measurement identity" with the IE "reporting criteria" received in the MEASUREMENT CONTROL message.
- 2> for measurement type "UE positioning measurement":
 - 3> if "reporting criteria" is set to "UE positioning reporting criteria":
 - 4> if the value of "reporting criteria" stored in the variable MEASUREMENT_IDENTITY associated to the identity indicated by the IE "measurement identity" is not "UE positioning reporting criteria", or;
 - 4> if the value of "reporting criteria" stored in the variable MEASUREMENT_IDENTITY associated to the identity indicated by the IE "measurement identity" is "UE positioning reporting criteria" and if the IE "Parameters required for each event" is present:
 - 5> replace the IE "reporting criteria" (and all its children) stored in variable MEASUREMENT_IDENTITY associated to the identity indicated by the IE "measurement identity" with the IE "report criteria" received in the MEASUREMENT CONTROL message.
 - 3> if "reporting criteria" is not set to "UE positioning reporting criteria":
 - 4> replace the IE "report criteria" (and all its children) stored in variable MEASUREMENT_IDENTITY associated to the identity indicated by the IE "measurement identity" with the IE "report criteria" received in the MEASUREMENT CONTROL message.
- 2> for measurement type "traffic volume measurement":
 - 3> replace the IE "report criteria" (and all its children) stored in variable MEASUREMENT_IDENTITY associated to the identity indicated by the IE "measurement identity" with the IE "report criteria" received in the MEASUREMENT CONTROL message.
- 2> for measurement type "quality measurement":
 - 3> replace the IE "report criteria" (and all its children) stored in variable MEASUREMENT_IDENTITY associated to the identity indicated by the IE "measurement identity" with the IE "report criteria" received in the MEASUREMENT CONTROL message;
 - 3> if "report criteria" is set to "quality measurement reporting criteria":
 - 4> if the value of "BLER reporting" in any instance of the IE "Quality reporting quantity" stored in the variable MEASUREMENT_IDENTITY associated to the identity indicated by the IE "measurement

identity" with the IE "report criteria" received in the MEASUREMENT CONTROL message is set to TRUE:

5> the UE behaviour is unspecified.

2> for measurement type "UE internal measurement":

3> if "report criteria" is set to "UE internal measurement reporting criteria":

4> if the value of "report criteria" stored in the variable MEASUREMENT_IDENTITY associated to the identity indicated by the IE "measurement identity" is not "UE internal measurement reporting criteria"; or

4> if the value of "report criteria" stored in the variable MEASUREMENT_IDENTITY associated to the identity indicated by the IE "measurement identity" is "UE internal measurement reporting criteria" and if the IE "Parameters sent for each UE internal measurement event" is present:

5> replace the IE "report criteria" (and all its children) stored in variable MEASUREMENT_IDENTITY associated to the identity indicated by the IE "measurement identity" with the IE "report criteria" received in the MEASUREMENT CONTROL message.

3> if "report criteria" is not set to "UE internal measurement reporting criteria":

4> replace the IE "report criteria" (and all its children) stored in variable MEASUREMENT_IDENTITY associated to the identity indicated by the IE "measurement identity" with the IE "report criteria" received in the MEASUREMENT CONTROL message.

1> if the IE "measurement command" has the value "release":

2> terminate the measurement associated with the identity given in the IE "measurement identity";

2> clear all stored measurement control information related associated to this measurement identity in variable MEASUREMENT_IDENTITY.

1> if the IE "DPCH Compressed Mode Status Info" is present:

2> if, as the result of this message, UE will have more than one transmission gap pattern sequence with the same measurement purpose active (according to IEs "TGMP" and "Current TGPS Status Flag" in variable TGPS_IDENTITY):

3> set the variable CONFIGURATION_INCOMPLETE to TRUE.

2> if there is any pending "TGPS reconfiguration CFN" or any pending "TGCFN":

3> the UE behaviour is unspecified.

2> if there is a pending "activation time" for a reconfiguration procedure that included the IE "DPCH Compressed mode info":

3> the UE behaviour is unspecified.

2> if pattern sequence corresponding to IE "TGPSI" is already active (according to "Current TGPS Status Flag" in the variable TGPS_IDENTITY):

3> if the "TGPS Status Flag" in this message is set to "deactivate" for the corresponding pattern sequence:

4> deactivate this pattern sequence at the beginning of the frame indicated by IE "TGPS reconfiguration CFN" received in the message;

4> set the "Current TGPS Status Flag" for this pattern sequence in the variable TGPS_IDENTITY to "inactive" at the frame indicated by IE "TGPS reconfiguration CFN" received in the message.

3> if the "TGPS Status Flag" in this message is set to "activate" for the corresponding pattern sequence:

4> deactivate this pattern sequence at the beginning of the frame indicated by IE "TGPS reconfiguration CFN" received in the message.

- NOTE1: The temporary deactivation of pattern sequences for which the status flag is set to "activate" can be used by the network to align the timing of already active patterns with newly activated patterns.
- NOTE2: The deactivation of pattern sequences only occurs as a result of RRC messages received by the UE, i.e. the UE does not set the "Current TGPS Status Flag" to "inactive" after the final gap of a finite length pattern sequence.
- 2> after the time indicated by IE "TGPS reconfiguration CFN" has elapsed:
 - 3> activate the pattern sequence corresponding to each IE "TGPSI" for which the "TGPS status flag" in this message is set to "activate" at the time indicated by IE "TGCFN"; and
 - 3> set the corresponding "Current TGPS status flag" for this pattern sequence in the variable TGPS_IDENTITY to "active"; and
 - 3> begin the inter-frequency and/or inter-RAT measurements corresponding to the pattern sequence measurement purpose of each activated pattern sequence;
 - 3> if the values of IE "TGPS reconfiguration CFN" and IE "TGCFN" are equal:
 - 4> start the concerned pattern sequence immediately at that CFN.
 - 2> not alter pattern sequences stored in variable TGPS_IDENTITY, if the pattern sequence is not identified in IE "TGPSI" in the received message.
 - 1> if the UE in CELL_FACH state receives a MEASUREMENT CONTROL message, which indicates the same measurement identity as that stored in the variable MEASUREMENT_IDENTITY:
 - 2> update the stored information with the traffic volume measurement control information in variable MEASUREMENT_IDENTITY; and
 - 2> refrain from updating the traffic volume measurement control information associated with this measurement identity in the variable MEASUREMENT_IDENTITY with the information received in System Information Block type 12 (or System Information Block type 11, according to subclause 8.1.1.6.11) until this measurement is explicitly released with another MEASUREMENT CONTROL message.
 - 1> for FDD, if the IE "Read SFN indicator" included in the IE "Cell info" of an inter-frequency cell is set to TRUE and according to the UE's measurement capabilities, the UE requires DL compressed mode in order to perform measurements on the frequency for which the SFN is to be read:
 - 2> set the variable CONFIGURATION_INCOMPLETE to TRUE.
 - 1> clear the entry for the MEASUREMENT CONTROL message in the table "Accepted transactions" in the variable TRANSACTIONS.

The UE may:

- 1> if the IE "Measurement command" has the value "setup":
 - 2> for measurement type "UE positioning measurement":
 - 3> if the UE is CELL_FACH state:
 - 4> if IE "Positioning Method" is set to "GPS":
 - 5> if IE "UE positioning GPS assistance data" is not included and variable UE_POSITIONING_GPS_DATA is empty:
 - 6> if System Information Block types 15, 15.1, 15.2 and 15.3 are broadcast:
 - 7> read System Information Block types 15, 15.1, 15.2 and 15.3.
 - 6> act as specified in subclause 8.6.7.19.3.
 - 5> if IE "GANSS Positioning Methods" is present:
 - 6> for each GNSS indicated in IE "GANSS Positioning Methods" and supported by UE:

- 7> if IE "UE positioning GANSS assistance data" is not included and variable UE_POSITIONING_GANSS_DATA does not contain data for that GNSS:
 - 8> if System Information Block types 15bis, 15.1bis, 15.2bis, 15.2ter, 15.3bis, 15.6, 15.7 and 15.8 are broadcast:
 - 9> read System Information Block types 15bis, 15.1bis, 15.2bis, 15.2ter, 15.3bis, 15.6, 15.7 and 15.8.
 - 8> act as specified in subclause 8.6.7.19.7.

1> and the procedure ends.

8.4.1.4 Unsupported measurement in the UE

If UTRAN instructs the UE to perform a measurement that is not supported by the UE, or would cause the maximum number of reporting criteria supported by the UE [19] to be exceeded, the UE shall:

- 1> retain the measurement configuration that was valid before the MEASUREMENT CONTROL message was received;
- 1> set the IE "RRC transaction identifier" in the MEASUREMENT CONTROL FAILURE message to the value of "RRC transaction identifier" in the entry for the MEASUREMENT CONTROL message in the table "Accepted transactions" in the variable TRANSACTIONS; and
- 1> clear that entry.
- 1> set the cause value in IE "failure cause" to "unsupported measurement";
- 1> submit the MEASUREMENT CONTROL FAILURE message to lower layers for transmission on the DCCH using AM RLC;
- 1> continue with any ongoing processes and procedures as if the invalid MEASUREMENT CONTROL message has not been received;
- 1> and the procedure ends.

8.4.1.4a Configuration Incomplete

If the variable CONFIGURATION_INCOMPLETE is set to TRUE, the UE shall:

- 1> retain the measurement configuration that was valid before the MEASUREMENT CONTROL message was received;
- 1> set the IE "RRC transaction identifier" in the MEASUREMENT CONTROL FAILURE message to the value of "RRC transaction identifier" in the entry for the MEASUREMENT CONTROL message in the table "Accepted transactions" in the variable TRANSACTIONS and clear that entry;
- 1> clear the variable CONFIGURATION_INCOMPLETE;
- 1> set the cause value in IE "failure cause" to "Configuration incomplete";
- 1> submit the MEASUREMENT CONTROL FAILURE message to lower layers for transmission on the DCCH using AM RLC;
- 1> continue with any ongoing processes and procedures as if the invalid MEASUREMENT CONTROL message has not been received;
- 1> and the procedure ends.

8.4.1.5 Invalid MEASUREMENT CONTROL message

If the MEASUREMENT CONTROL message contains a protocol error causing the variable PROTOCOL_ERROR_REJECT to be set to TRUE according to clause 9, the UE shall perform procedure specific error handling as follows. The UE shall:

- 1> set the IE "RRC transaction identifier" in the MEASUREMENT CONTROL FAILURE message to the value of "RRC transaction identifier" in the entry for the MEASUREMENT CONTROL message in the table "Rejected transactions" in the variable TRANSACTIONS; and
- 1> clear that entry.
- 1> set the IE "failure cause" to the cause value "protocol error";
- 1> include the IE "Protocol error information" with contents set to the value of the variable PROTOCOL_ERROR_INFORMATION;
- 1> submit the MEASUREMENT CONTROL FAILURE message to lower layers for transmission on the DCCH using AM RLC;
- 1> continue with any ongoing processes and procedures as if the invalid MEASUREMENT CONTROL message has not been received;
- 1> and the procedure ends.

8.4.1.6 Measurements after transition from CELL_DCH to CELL_FACH/CELL_PCH/URA_PCH state

The UE shall apply the following rules for different measurement types after transiting from CELL_DCH to CELL_FACH/CELL_PCH/URA_PCH state:

8.4.1.6.1 Intra-frequency measurement

Upon transition from CELL_DCH to CELL_FACH/CELL_PCH/URA_PCH state, the UE shall:

- 1> stop intra-frequency type measurement reporting;
- 1> if the transition is due to a reconfiguration message which included the IE "Primary CPICH info" (for FDD) or "Primary CCPCH info" (for TDD), and the UE selects a cell other than that indicated by this IE on the current frequency (in case the IE "Frequency info" is not received) or other than that indicated by this IE on the frequency indicated by the IE "Frequency info" (when the IE "Frequency info" is included); or
- 1> if the transition is due to a reconfiguration message which does not include the IE "Primary CPICH info" (for FDD) or "Primary CCPCH info" (for TDD); or
- 1> if the transition is not due to a reconfiguration message:
 - 2> delete the measurements of type intra-frequency associated with the variable MEASUREMENT_IDENTITY.
- 1> for FDD and 3.84/7.68 Mcps TDD:
 - 2> begin monitoring cells listed in the IE "intra-frequency cell info list" received in System Information Block type 12 (or System Information Block type 11, according to subclause 8.1.1.6.11).
- 1> for 1.28 Mcps TDD:
 - 2> if after state transition the UE enters CELL_FACH state and is working on the primary frequency:
 - 3> begin monitoring cells listed in the IE "intra-frequency cell info list" received in System Information Block type 12 (or System Information Block type 11, according to subclause 8.1.1.6.11).
 - 2> else if after state transition the UE enters CELL_FACH state and is working on the secondary frequency:
 - 3> if the cell in which the UE transited from CELL_DCH state is not included in the active set for the CELL_FACH state; or
 - 3> if the working frequency changes after the state transition:
 - 4> the measurement shall be started when a MEASUREMENT CONTROL message is received with the measurements of type intra-frequency.

8.4.1.6.2 Inter-frequency measurement

Upon transition from CELL_DCH to CELL_FACH/ CELL_PCH/URA_PCH state, the UE shall:

- 1> stop the inter-frequency type measurement reporting assigned in a MEASUREMENT CONTROL message;
- 1> if the transition is due to a reconfiguration message which included the IE "Primary CPICH info" (for FDD) or "Primary CCPCH info" (for TDD), and the UE selects a cell other than that indicated by this IE on the current frequency (in case the IE "Frequency info" is not received) or other than that indicated by this IE on the frequency indicated by the IE "Frequency info" (when the IE "Frequency info" is included); or
- 1> if the transition is due to a reconfiguration message which does not include the IE "Primary CPICH info" (for FDD) or "Primary CCPCH info" (for TDD); or
- 1> if the transition is not due to a reconfiguration message:
 - 2> delete the measurements of type inter-frequency associated with the variable MEASUREMENT_IDENTITY and delete the corresponding compressed mode pattern stored in the variable TGPS_IDENTITY.
- 1> for remaining compressed mode patterns, set the IE "TGPS Status Flag" to "deactivate" and the IE "Current TGPS Status Flag" to "inactive" in the variable TGPS_IDENTITY.
- 1> for FDD and 3.84/7.68 Mcps TDD:
 - 2> begin monitoring cells listed in the IE "inter-frequency cell info list" received in System Information Block type 12 (or System Information Block type 11, according to subclause 8.1.1.6.11);
- 1> in CELL_FACH state:
 - 2> for FDD if variable HS_DSCH_RECEPTION_CELL_FACH_STATE is set to TRUE and the variable HS_DSCH_DRX_CELL_FACH_STATUS is set to TRUE:
 - 3> perform measurements on other frequencies according to the requirements in [19], during the frame(s) with the SFN value not fulfilling the inequality specified in subclause 8.5.49.
 - 2> otherwise:
 - 3> perform measurements on other frequencies, according to the IE "FACH measurement occasion info", as specified in subclause 8.5.11.
 - 2> for TDD:
 - 3> perform measurements on other frequencies according to the IE "FACH measurement occasion info".
- 1> for 1.28 Mcps TDD:
 - 2> if after state transition the UE enters CELL_FACH state and is working on the primary frequency:
 - 3> begin monitoring cells listed in the IE "inter-frequency cell info list" received in System Information Block type 12 (or System Information Block type 11, according to subclause 8.1.1.6.11).
 - 2> else if after state transition the UE enters CELL_FACH state and is working on the secondary frequency:
 - 3> if the cell in which the UE transitioned from CELL_DCH state is not included in the active set for the CELL_FACH state; or
 - 3> if the working frequency changes after the state transition:
 - 4> the measurement shall be started when a MEASUREMENT CONTROL message is received with the measurements of type inter-frequency.

8.4.1.6.3 Inter-RAT measurement

Upon transition from CELL_DCH to CELL_FACH/CELL_PCH/URA_PCH state, the UE shall:

- 1> stop the inter-RAT type measurement reporting assigned in a MEASUREMENT CONTROL message;

- 1> delete the measurements of type inter-RAT associated with the variable MEASUREMENT_IDENTITY and delete the corresponding compressed mode pattern stored in the variable TGPS_IDENTITY;
- 1> begin monitoring cells listed in the IE "inter-RAT cell info list" received in System Information Block type 12 (or System Information Block type 11, according to subclause 8.1.1.6.11);
- 1> in CELL_PCH or URA_PCH state:
 - 2> begin monitoring E-UTRA frequencies listed in the IE "E-UTRA frequency and priority info list" received in System Information Block type 19.
- 1> in CELL_FACH state:
 - 2> for FDD if variable HS_DSCH_RECEPTION_CELL_FACH_STATE is set to TRUE and the variable HS_DSCH_DRX_CELL_FACH_STATUS is set to TRUE:
 - 3> perform measurements on other systems according to the requirements in [19], during the frame(s) with the SFN value not fulfilling the inequality specified in subclause 8.5.49.
 - 2> otherwise:
 - 3> perform measurements on other frequencies according to the IE "FACH measurement occasion info";
 - 3> perform measurements on other systems, according to the IE "FACH measurement occasion info", as specified in subclause 8.5.11.

8.4.1.6.4 Quality measurement

Upon transition from CELL_DCH to CELL_FACH/CELL_PCH/URA_PCH state, the UE shall:

- 1> stop quality type measurement reporting;
- 1> delete all measurement control information of measurement type "quality" stored in the variable MEASUREMENT_IDENTITY.

8.4.1.6.5 UE internal measurement

Upon transition from CELL_DCH to CELL_FACH/CELL_PCH/URA_PCH state, the UE shall:

- 1> stop UE internal measurement type measurement reporting;
- 1> delete all measurement control information of measurement type "UE internal" stored in the variable MEASUREMENT_IDENTITY.

8.4.1.6.6 Traffic volume measurement

Upon transition from CELL_DCH to CELL_FACH or CELL_PCH or URA_PCH state, the UE shall:

- 1> retrieve each set of measurement control information of measurement type "traffic volume" stored in the variable MEASUREMENT_IDENTITY; and
- 2> if the optional IE "measurement validity" for this measurement has not been included:
 - 3> delete the measurement associated with the variable MEASUREMENT_IDENTITY.
- 2> if the IE "measurement validity" for the measurement has been included, and the IE "UE state" has been assigned to value "CELL_DCH":
 - 3> stop measurement reporting;
 - 3> store the measurement associated with the variable MEASUREMENT_IDENTITY to be used after the next transition to CELL_DCH state.

- 2> if the IE "measurement validity" for the measurement has been included, and the IE "UE state" has been assigned to value "all states" or "all states except CELL_DCH", and if the state transition is from CELL_DCH to CELL_PCH or URA_PCH state:
 - 3> stop measurement reporting;
 - 3> store the measurement associated with the variable MEASUREMENT_IDENTITY to be used after the next transition to CELL_FACH state.
- 2> if the IE "measurement validity" for the measurement has been included, and the IE "UE state" has been assigned to value "all states", and if the state transition is from CELL_DCH to CELL_FACH state:
 - 3> if variable READY_FOR_COMMON_EDCH is set to FALSE after state transition:
 - 4> continue measurement reporting.
 - 3> else:
 - 4> for FDD:
 - 5> stop measurement reporting;
 - 5> store the measurement associated with the variable MEASUREMENT_IDENTITY to be used after the next transition to CELL_DCH state, or after cell reselection.
 - 4> for 1.28 Mcps TDD:
 - 5> continue measurement reporting.
- 2> if the IE "measurement validity" has been included and the IE "UE state" has been assigned to value "all states except CELL_DCH", and if the state transition is from CELL_DCH to CELL_FACH state:
 - 3> resume this measurement and associated reporting.
- 1> if no traffic volume type measurement has been assigned to the UE with a MEASUREMENT CONTROL message that is valid in CELL_FACH or CELL_PCH or URA_PCH states (stored in the variable MEASUREMENT_IDENTITY), which has the same identity as the one indicated in the IE "Traffic volume measurement system information":
 - 2> store the measurement control information from the IE "Traffic volume measurement system information" received in System Information Block type 12 (or System Information Block type 11, according to subclause 8.1.1.6.11) in the variable MEASUREMENT_IDENTITY;
 - 2> perform traffic volume measurement reporting according to the assigned information, when in CELL_FACH state.

8.4.1.6.7 UE positioning measurement

Upon transition from CELL_DCH to CELL_FACH and upon transition from CELL_DCH to CELL_PCH or URA_PCH for UE assisted GPS or GANSS measurements, the UE shall:

- 1> retrieve each set of measurement control information of measurement type "UE positioning" stored in the variable MEASUREMENT_IDENTITY; and
 - 2> if the optional IE "measurement validity" for this measurement has not been included:
 - 3> delete the measurement associated with the variable MEASUREMENT_IDENTITY.
 - 2> if the IE "measurement validity" for the measurement has been included, and the IE "UE state" has been assigned to value "CELL_DCH":
 - 3> stop measurement reporting;
 - 3> store the measurement associated with the variable MEASUREMENT_IDENTITY to be used after the next transition to CELL_DCH state.

- 2> if the IE "measurement validity" for the measurement has been included, and the IE "UE state" has been assigned to value "all states":
 - 3> upon transition from CELL_DCH to CELL_PCH or URA_PCH:
 - 4> if the choice in the IE "Reporting Criteria" included the IE "UE Positioning measurement" stored in the variable MEASUREMENT_IDENTITY is set to "UE positioning reporting criteria" and the value of the IE "Measurement interval" included in this IE is less than 64 seconds:
 - 5> use a value of 64 seconds for the measurement interval associated with this measurement while the UE remains in CELL_PCH/URA_PCH.
 - 4> if the choice in the IE "Reporting Criteria" included the IE "UE Positioning measurement" stored in the variable MEASUREMENT_IDENTITY is set to "Periodical Reporting Criteria" and the value of the IE "Reporting interval" included in this IE is less than 64 seconds:
 - 5> use a value of 64 seconds for the reporting interval associated with this measurement while the UE remains in CELL_PCH/URA_PCH.
 - 3> continue measurement reporting according to its UE positioning measurement reporting capability.
- 2> if the IE "measurement validity" has been included and the IE "UE state" has been assigned to value "all states except CELL_DCH":
 - 3> upon transition from CELL_DCH to CELL_PCH or URA_PCH:
 - 4> if the choice in the IE "Reporting Criteria" included the IE "UE Positioning measurement" stored in the variable MEASUREMENT_IDENTITY is set to "UE positioning reporting criteria" and the value of the IE "Measurement interval" included in this IE is less than 64 seconds:
 - 5> use a value of 64 seconds for the measurement interval associated with this measurement while the UE remains in CELL_PCH/URA_PCH.
 - 4> if the choice in the IE "Reporting Criteria" included the IE "UE Positioning measurement" stored in the variable MEASUREMENT_IDENTITY is set to "Periodical Reporting Criteria" and the value of the IE "Reporting interval" included in this IE is less than 64 seconds:
 - 5> use a value of 64 seconds for the reporting interval associated with this measurement while the UE remains in CELL_PCH/URA_PCH.
 - 3> resume this measurement and associated reporting according to its UE Positioning measurement reporting capability.
- 1> if the transition is due to a reconfiguration message which included the IE "Primary CPICH info" (for FDD) or "Primary CCPCH info" (for TDD), and the UE selects a cell other than that indicated by this IE; or
- 1> if the transition is due to a reconfiguration message which does not include the IE "Primary CPICH info" (for FDD) or "Primary CCPCH info" (for TDD); or
- 1> if the transition is due to a reconfiguration message which included the IE "Frequency info", and the UE selects a cell on another frequency than that indicated by this IE; or
- 1> if the transition is due to a reconfiguration message which does not include the IE "Frequency info", and the UE can not find a cell on the current frequency, but it selects a cell on another frequency; or
- 1> if the transition is not due to a reconfiguration message:
 - 2> delete the assistance data included in the variable UE_POSITIONING_OTDOA_DATA_UE_BASED and UE_POSITIONING_OTDOA_DATA_UE_ASSISTED.
- 1> if the IE "Positioning Methods" stored in the variable MEASUREMENT_IDENTITY is set to "OTDOA" or "OTDOA or GPS":
 - 2> if the IE "Method type" stored in the variable MEASUREMENT_IDENTITY is set to "UE-based" or "UE assisted preferred but UE-based allowed" or "UE-based preferred but UE-assisted allowed":

- 3> begin monitoring assistance data received in System Information Block type 15.4 and System Information Block type 15.5 according to subclause 8.1.1.6.15.
- 2> if the IE "Method type" stored in the variable MEASUREMENT_IDENTITY is set to "UE-assisted":
 - 3> begin monitoring assistance data received in System Information Block type 15.4 according to subclause 8.1.1.6.15.
- 1> if the UE is in CELL_FACH state:
 - 2> if the IE "UE positioning OTDOA neighbour cell list for UE assisted" stored in the variable UE_POSITIONING_OTDOA_DATA_UE_ASSISTED or UE_POSITIONING_OTDOA_DATA_UE_BASED contains neighbour cells on other frequencies than the current frequency:
 - 3> perform measurements on other frequencies according to the IE "FACH measurement occasion info".

The UE may:

- 1> if the IE "Positioning Methods" stored in the variable MEASUREMENT_IDENTITY is set to "GPS" or "OTDOA or GPS":
 - 2> begin monitoring assistance data received in System Information Block type 15 and/or System Information Block type 15.1 and/or System Information Block type 15.2 and/or System Information Block type 15.3 according to subclause 8.1.1.6.15.
- 2> if the IE "GANSS Positioning Methods" is present:
 - 3> begin monitoring assistance data received in System Information Block type 15bis and/or System Information Block type 15.1bis and/or System Information Block type 15.2bis and/or System Information Block type 15.2ter and/or System Information Block type 15.3bis and/or System Information Block type 15.6 and/or System Information Block type 15.7 and/or System Information Block type 15.8 according to subclause 8.1.1.6.15.

NOTE: In the case that the measurement or reporting intervals are modified to 64 seconds during a transition to CELL_PCH/URA_PCH as described above, the UE retains the previously used values of "Measurement interval" and "Reporting interval" for use after transition out of CELL_PCH/URA_PCH.

8.4.1.6a Actions in CELL_FACH/CELL_PCH/URA/PCH state upon cell re-selection

Upon cell reselection while in CELL_FACH/CELL_PCH/URA/PCH state and the cell reselection has occurred after the measurement control information was stored, the UE shall:

- 1> delete all measurements of type intra-frequency, inter-frequency, and inter-RAT associated with the variable MEASUREMENT_IDENTITY;
- 1> delete all compressed mode patterns associated with inter-frequency and inter-RAT measurements stored in the variable TGPS_IDENTITY;
- 1> delete the traffic volume measurements that have not been set up or modified through a MEASUREMENT CONTROL message.

8.4.1.7 Measurements after transition from CELL_FACH to CELL_DCH state

The UE shall apply the following rules for different measurement types after transiting from CELL_FACH to CELL_DCH state:

8.4.1.7.1 Intra-frequency measurement

Upon transition from CELL_FACH to CELL_DCH state:

- 1> for FDD or 3.84/7.68 Mcps TDD; or
- 1> for 1.28 Mcps TDD, if the UE is working on the same frequency after the state transition:

- 2> if intra-frequency measurements applicable to CELL_DCH state are stored in the variable MEASUREMENT_IDENTITY:
 - 3> if the cell in which the UE transited from CELL_FACH state is included in the active set for the CELL_DCH state, the UE shall:
 - 4> resume the measurement reporting.
 - 3> otherwise, the UE shall:
 - 4> not resume the measurement reporting. The measurement shall be restarted when a MEASUREMENT CONTROL message is received with the corresponding measurement identity.
- 1> for 1.28 Mcps TDD, if the UE is working on the different frequency after the state transition:
 - 2> not resume the measurement reporting.
 - 2> delete the measurements of type intra-frequency associated with the variable MEASUREMENT_IDENTITY.

8.4.1.7.2 Inter-frequency measurement

Upon transition from CELL_FACH to CELL_DCH state:

- 1> for FDD or 3.84/7.68 Mcps TDD; or
- 1> for 1.28 Mcps TDD, if the UE is working on the same frequency after the state transition:
 - 2> if inter-frequency measurements applicable to CELL_DCH state are stored in the variable MEASUREMENT_IDENTITY:
 - 3> if the cell in which the UE transited from CELL_FACH state is included in the active set for the CELL_DCH state, the UE shall:
 - 4> resume the measurement reporting.
 - 3> otherwise, the UE shall:
 - 4> not resume the measurement reporting. The measurement shall be restarted when a MEASUREMENT CONTROL message is received with the corresponding measurement identity.
 - 1> for 1.28 Mcps TDD, if the UE is working on the different frequency after the state transition:
 - 2> not resume the measurement reporting.
 - 2> delete the measurements of type inter-frequency associated with the variable MEASUREMENT_IDENTITY.

8.4.1.7.3 Inter-RAT measurement

Upon transition from CELL_FACH to CELL_DCH state, the UE shall:

- 1> stop monitoring the list of cells assigned in the IE "inter-RAT cell info list" in System Information Block type 12 (or System Information Block type 11, according to subclause 8.1.1.6.11).

8.4.1.7.4 Traffic volume measurement

Upon transition from CELL_FACH to CELL_DCH state, the UE shall:

- 1> retrieve each set of measurement control information of measurement type "traffic volume" stored in the variable MEASUREMENT_IDENTITY;
- 2> if the optional IE "measurement validity" for this measurement has not been included:
 - 3> delete the measurement associated with the variable MEASUREMENT_IDENTITY.
- 2> if the IE "measurement validity" for the measurement has been included, and the IE "UE state" has been assigned to value "all states except CELL_DCH":

- 3> stop measurement reporting; and
- 3> save the measurement associated with the variable MEASUREMENT_IDENTITY to be used after the next transition to CELL_FACH/CELL_PCH/URA_PCH state.
- 2> if the IE "measurement validity" for the measurement has been included, and the IE "UE state" has been assigned to value "all states":
 - 3> if variable READY_FOR_COMMON_EDCH is set to FALSE before state transition:
 - 4> continue measurement reporting.
 - 3> else:
 - 4> for FDD:
 - 5> resume this measurement and associated reporting.
 - 4> for 1.28 Mcps TDD:
 - 5> continue measurement reporting.
- 2> if the IE "measurement validity" has been included and the IE "UE state" has been assigned to value "CELL_DCH":
 - 3> resume this measurement and associated reporting.
- 1> if no traffic volume type measurement has been assigned to the UE with a MEASUREMENT CONTROL message that is valid in CELL_DCH and has the same identity as the one indicated in the IE "Traffic volume measurement system information":
 - 2> store the measurement control information from the IE "Traffic volume measurement system information" received in System Information Block type 12 (or System Information Block type 11, according to subclause 8.1.1.6.11) in the variable MEASUREMENT_IDENTITY;
 - 2> begin traffic volume measurement reporting according to the assigned information.

8.4.1.7.5 UE positioning measurement

Upon transition from CELL_FACH to CELL_DCH state, the UE shall:

- 1> retrieve each set of measurement control information of measurement type "UE positioning" stored in the variable MEASUREMENT_IDENTITY; and
- 2> if the optional IE "Measurement validity" for this measurement has not been included:
 - 3> delete the measurement associated with the variable MEASUREMENT_IDENTITY.
- 2> if the IE "measurement validity" for the measurement has been included, and the IE "UE state" has been assigned to value "all states except CELL_DCH":
 - 3> stop measurement reporting; and
 - 3> save the measurement associated with the variable MEASUREMENT_IDENTITY to be used after the next transition to CELL_FACH/CELL_PCH/URA_PCH state.
- 2> if the IE "measurement validity" for the measurement has been included, and the IE "UE state" has been assigned to value "all states":
 - 3> continue measurement reporting.
- 2> if the IE "measurement validity" has been included and the IE "UE state" has been assigned to value "CELL_DCH":
 - 3> resume this measurement and associated reporting.

- 1> stop monitoring assistance data received in System Information Block type 15 or System Information Block type 15.1 or System Information Block type 15.2 or System Information Block type 15.3 or System Information Block type 15.4 or System Information Block type 15.5 or System Information Block type 15bis or System Information Block type 15.1bis or System Information Block type 15.2bis or System Information Block type 15.2ter or System Information Block type 15.3bis or System Information Block type 15.6 or System Information Block type 15.7 or System Information Block type 15.8.

8.4.1.8 Measurements after transition from idle mode to CELL_DCH state

The UE shall obey the following rules for different measurement types after transiting from idle mode to CELL_DCH state:

8.4.1.8.1 Intra-frequency measurement

Upon transition from idle mode to CELL_DCH state:

- 1> if intra-frequency measurements applicable to CELL_DCH state are stored in the variable MEASUREMENT_IDENTITY:
 - 2> if the cell in which the UE transited from idle mode is included in the active set for the CELL_DCH state, the UE shall:
 - 3> begin measurement reporting.
 - 2> otherwise, the UE shall:
 - 3> not begin the measurement reporting. The measurement shall be restarted when a MEASUREMENT CONTROL message is received with the corresponding measurement identity.

8.4.1.8.2 Inter-frequency measurement

Upon transition from idle mode to CELL_DCH state, the UE shall:

- 1> stop monitoring the list of cells assigned in the IE "inter-frequency cell info list" in System Information Block type 12 (or System Information Block type 11, according to subclause 8.1.1.6.11).

8.4.1.8.3 Inter-RAT measurement

Upon transition from idle mode to CELL_DCH state, the UE shall:

- 1> stop monitoring the list of cells assigned in the IE "inter-RAT cell info list" in System Information Block type 12 (or System Information Block type 11, according to subclause 8.1.1.6.11);
- 1> stop monitoring the list of E-UTRA frequencies assigned in the IE "E-UTRA frequency and priority info list" in System Information Block type 19.

8.4.1.8.4 Traffic volume measurement

Upon transition from idle mode to CELL_DCH state, the UE shall:

- 1> begin a traffic volume type measurement, assigned in System Information Block type 11 (or System Information Block type 12, according to subclause 8.1.1.6.11).

8.4.1.8.5 UE positioning measurement

Upon transition from idle mode to CELL_DCH state, the UE shall:

- 1> stop monitoring assistance data received in System Information Block type 15 or System Information Block type 15.1 or System Information Block type 15.2 or System Information Block type 15.3 or System Information Block type 15.4 or System Information Block type 15.5 or System Information Block type 15bis or System Information Block type 15.1bis or System Information Block type 15.2bis or System Information Block type 15.2ter or System Information Block type 15.3bis or System Information Block type 15.6 or System Information Block type 15.7 or System Information Block type 15.8.

8.4.1.9 Measurements after transition from idle mode to CELL_FACH state

The UE shall obey the follow rules for different measurement types after transiting from idle mode to CELL_FACH state:

8.4.1.9.1 Intra-frequency measurement

Upon transition from idle mode to CELL_FACH state, the UE shall:

- 1> begin or continue monitoring cells listed in the IE "intra-frequency cell info list" received in System Information Block type 12 (or System Information Block type 11, according to subclause 8.1.1.6.11).

8.4.1.9.2 Inter-frequency measurement

Upon transition from idle mode to CELL_FACH state, the UE shall:

- 1> begin or continue monitoring cells listed in the IE "inter-frequency cell info list" received in System Information Block type 12 (or System Information Block type 11, according to subclause 8.1.1.6.11);

- 1> for FDD, if variable HS_DSCH_RECEPTION_CELL_FACH_STATE is set to TRUE and the variable HS_DSCH_DRX_CELL_FACH_STATUS is set to TRUE:

- 2> perform measurements on other frequencies according to the requirements in [19], during the frame(s) with the SFN value not fulfilling the inequality specified in subclause 8.5.49.

- 1> otherwise:

- 2> perform measurements on other frequencies, according to the IE "FACH measurement occasion info", as specified in subclause 8.5.11.

- 1> for TDD:

- 2> perform measurements on other frequencies according to the IE "FACH measurement occasion info".

8.4.1.9.3 Inter-RAT measurement

Upon transition from idle mode to CELL_FACH state, the UE shall:

- 1> begin or continue monitoring cells listed in the IE "inter-RAT cell info list" received in System Information Block type 12 (or System Information Block type 11, according to subclause 8.1.1.6.11);

- 1> stop monitoring the list of E-UTRA frequencies assigned in the IE "E-UTRA frequency and priority info list" in System Information Block type 19;

- 1> for FDD, if variable HS_DSCH_RECEPTION_CELL_FACH_STATE is set to TRUE and the variable HS_DSCH_DRX_CELL_FACH_STATUS is set to TRUE:

- 2> perform measurements on other systems according to the requirements in [19], during the frame(s) with the SFN value not fulfilling the inequality specified in subclause 8.5.49.

- 1> otherwise:

- 2> perform measurements on other systems, according to the IE "FACH measurement occasion info", as specified in subclause 8.5.11.

- 1> for TDD:

- 2> perform measurements on other frequencies according to the IE "FACH measurement occasion info".

8.4.1.9.4 Traffic volume measurement

Upon transition from idle mode to CELL_FACH state, the UE shall:

1> store the measurement control information from the IE "Traffic volume measurement system information" received in System Information Block type 12 (or System Information Block type 11, according to subclause 8.1.1.6.11) in the variable MEASUREMENT_IDENTITY;

1> begin traffic volume measurement reporting according to the assigned information.

8.4.1.9.5 UE positioning measurement

Upon transition from idle mode to CELL_FACH state, the UE may:

1> begin or continue monitoring assistance data received in System Information Block type 15 or System Information Block type 15.1 or System Information Block type 15.2 or System Information Block type 15.3 or System Information Block type 15.4 or System Information Block type 15.5 or System Information Block type 15bis or System Information Block type 15.1bis or System Information Block type 15.2bis or System Information Block type 15.2ter or System Information Block type 15.3bis or System Information Block type 15.6 or System Information Block type 15.7 or System Information Block type 15.8 according to subclause 8.1.1.6.15;

1> if the IE "UE positioning OTDOA neighbour cell list for UE assisted" stored in the variable UE_POSITIONING_OTDOA_DATA_UE_ASSISTED; or

1> if the IE "UE positioning OTDOA neighbour cell list for UE based" stored in the variable UE_POSITIONING_OTDOA_DATA_UE_BASED contains neighbour cells on other frequencies than the current frequency:

2> perform measurements on other frequencies according to the IE "FACH measurement occasion info".

8.4.1.9a Measurements after transition from connected mode to idle mode

Upon transition from connected mode to idle mode the UE shall:

1> stop measurement reporting for all measurements stored in the variable MEASUREMENT_IDENTITY;

1> clear the variable MEASUREMENT_IDENTITY;

1> apply the following rules for different measurement types.

8.4.1.9a.1 Intra-frequency measurement

Upon transition from connected mode to idle mode, the UE shall:

1> stop monitoring intra-frequency cells listed in the IE "intra-frequency cell info list" received in System Information Block type 12 (if System Information Block type 12 is transmitted in the cell, according to subclause 8.1.1.6.11);

1> begin monitoring intra-frequency cells listed in the IE "intra-frequency cell info list" received in System Information Block type 11.

8.4.1.9a.2 Inter-frequency measurement

Upon transition from connected mode to idle mode, the UE shall:

1> stop monitoring inter-frequency cells listed in the IE "inter-frequency cell info list" received in System Information Block type 12 (if System Information Block type 12 is transmitted in the cell, according to subclause 8.1.1.6.11);

1> begin monitoring inter-frequency cells listed in the IE "inter-frequency cell info list" received in System Information Block type 11.

8.4.1.9a.3 Inter-RAT measurement

Upon transition from connected mode to idle mode, the UE shall:

- 1> stop monitoring inter-RAT cells listed in the IE "inter-RAT cell info list" received in System Information Block type 12 (if System Information Block type 12 is transmitted in the cell, according to 8.1.1.6.11);
- 1> begin monitoring inter-RAT cells listed in the IE "inter-RAT cell info list" received in System Information Block type 11;
- 1> begin monitoring E-UTRA frequencies listed in the IE "E-UTRA frequency and priority info list" received in System Information Block type 19.

8.4.1.9a.4 UE positioning measurement

Upon transition from connected mode to idle mode, the UE may:

- 1> begin or continue monitoring assistance data received in System Information Block type 15 or System Information Block type 15.1 or System Information Block type 15.2 or System Information Block type 15.3 or System Information Block type 15.4 or System Information Block type 15.5 or System Information Block type 15bis or System Information Block type 15.1bis or System Information Block type 15.2bis or System Information Block type 15.2ter or System Information Block type 15.3bis or System Information Block type 15.6 or System Information Block type 15.7 or System Information Block type 15.8.

8.4.1.9b Measurements after transition from CELL_FACH to CELL_PCH/URA_PCH

8.4.1.9b.1 Traffic volume measurement

Upon transition from CELL_FACH to CELL_PCH or URA_PCH, the UE shall:

- 1> stop any ongoing traffic volume measurement, and associated traffic volume measurement reporting.
- 1> store the measurement associated with the variable MEASUREMENT_IDENTITY to be used after the next transition to CELL_FACH state;
- 1> if no traffic volume type measurement has been assigned to the UE with a MEASUREMENT CONTROL message that is valid in CELL_FACH or CELL_PCH or URA_PCH states (stored in the variable MEASUREMENT_IDENTITY), which has the same identity as the one indicated in the IE "Traffic volume measurement system information":
 - 2> store the measurement control information from the IE "Traffic volume measurement system information" received in System Information Block type 12 (or System Information Block type 11, according to subclause 8.1.1.6.11) in the variable MEASUREMENT_IDENTITY.

8.4.1.9b.2 UE positioning measurement

Upon transition from CELL_FACH to CELL_PCH or URA_PCH, the UE shall:

- 1> retrieve each set of measurement control information of measurement type "UE positioning" stored in the variable MEASUREMENT_IDENTITY; and
 - 2> if the optional IE "measurement validity" for this measurement has not been included:
 - 3> delete the measurement associated with the variable MEASUREMENT_IDENTITY.
 - 2> if the IE "measurement validity" for the measurement has been included, and the IE "UE state" has been assigned to value "all states" or "all states except CELL_DCH":
 - 3> if the choice in the IE "Reporting Criteria" included in the IE "UE Positioning measurement" stored in the variable MEASUREMENT_IDENTITY is set to "UE positioning reporting criteria" and the value of the IE "Measurement interval" included in this IE is less than 64 seconds:
 - 4> use a value of 64 seconds for the measurement interval associated with this measurement while the UE remains in CELL_PCH/URA_PCH.
 - 3> if the choice in the IE "Reporting Criteria" included in the IE "UE Positioning measurement" stored in the variable MEASUREMENT_IDENTITY is set to "Periodical Reporting Criteria" and the value of the IE "Reporting interval" included in this IE is less than 64 seconds:

- 4> use a value of 64 seconds for the reporting interval associated with this measurement while the UE remains in CELL_PCH/URA_PCH.

NOTE: In the case that the measurement or reporting intervals are modified to 64 seconds as described above, the UE retains the previously used values of "Measurement interval" and "Reporting interval" for use after transition out of CELL_PCH/URA_PCH.

8.4.1.9b.3 Inter-RAT measurement

Upon transition from CELL_FACH to CELL_PCH or URA_PCH, the UE shall:

- 1> begin monitoring E-UTRA frequencies listed in the IE "E-UTRA frequency and priority info list" in System Information Block type 19.

8.4.1.9b.4 Intra-frequency measurement

Upon transition from CELL_FACH to CELL_PCH or URA_PCH, the UE shall:

- 1> for 1.28 Mcps TDD, if the UE is working on the secondary frequency before state transition:
 - 2> delete the measurements of type intra-frequency associated with the variable MEASUREMENT_IDENTITY.
 - 2> the measurement shall be started when the IE "intra-frequency cell info list" is received in System Information Block type 12 (or System Information Block type 11, according to subclause 8.1.1.6.11).

8.4.1.9b.5 Inter-frequency measurement

Upon transition from CELL_FACH to CELL_PCH or URA_PCH, the UE shall:

- 1> for 1.28 Mcps TDD, if the UE is working on the secondary frequency before state transition:
 - 2> delete the measurements of type inter-frequency associated with the variable MEASUREMENT_IDENTITY.
 - 2> the measurement shall be started when the IE "inter-frequency cell info list" is received in System Information Block type 12 (or System Information Block type 11, according to subclause 8.1.1.6.11).

8.4.1.9c Measurements after transition from CELL_PCH/URA_PCH to CELL_FACH

8.4.1.9c.1 Traffic volume measurement

Upon transition from CELL_PCH or URA_PCH to CELL_FACH and if variable READY_FOR_COMMON_EDCH is set to FALSE after state transition, the UE shall resume any traffic volume measurement stored in the variable MEASUREMENT_IDENTITY with measurement validity "all states" or "all states except CELL_DCH", and start the associated traffic volume measurement reporting.

For FDD, upon transition from CELL_PCH or URA_PCH to CELL_FACH and if variable READY_FOR_COMMON_EDCH is set to TRUE after state transition, the UE shall resume any traffic volume measurement stored in the variable MEASUREMENT_IDENTITY with measurement validity "all states except CELL_DCH" and Uplink transport channel type set to "DCH", and start the associated traffic volume measurement reporting.

NOTE: In FDD, if IE "measurement validity" is set to "all states except CELL_DCH" and IE "Uplink transport channel type" to "DCH", DCH refers as a matter of fact to E-DCH.

For 1.28 Mcps TDD, upon transition from CELL_PCH or URA_PCH to CELL_FACH and if variable READY_FOR_COMMON_EDCH is set to TRUE after state transition, the UE shall resume any traffic volume measurement stored in the variable MEASUREMENT_IDENTITY with measurement validity "all states" or "all states except CELL_DCH" and Uplink transport channel type set to "USCH" and the UL transport channel id is set to 32, and start the associated traffic volume measurement reporting.

NOTE: In 1.28Mcps TDD, if IE "measurement validity" is set to "all states" or "all states except CELL_DCH" and IE "Uplink transport channel type" to "USCH" and the IE "UL Target Transport Channel ID" to 32, it refers as a matter of fact to E-DCH.

8.4.1.9c.2 UE positioning measurement

Upon transition from CELL_PCH or URA_PCH to CELL_FACH, the UE shall continue any UE positioning measurement stored in the variable MEASUREMENT_IDENTITY with measurement validity "all states" or "all states except CELL_DCH", and continue the associated UE positioning measurement reporting.

NOTE: The UE's values of "Measurement interval" in the IE "UE positioning reporting criteria" and "Reporting interval" in the IE "Periodical Reporting Criteria" after this state transition revert to the values stored during the transition to CELL_PCH/URA_PCH (i.e., the 64-second interval specified in subclause 8.4.1.9b.2 is not retained).

8.4.1.9c.3 Inter-RAT measurement

Upon transition from CELL_PCH or URA_PCH to CELL_FACH, the UE shall:

- 1> stop monitoring E-UTRA frequencies listed in the IE "E-UTRA frequency and priority info list" in System Information Block type 19.

8.4.1.10 Changes in measurement objects

8.4.1.10.1 Traffic volume measurement

When performing traffic volume event evaluation or reporting related to a certain transport channel, the UE shall consider all RBs which are mapped to the concerning transport channel e.g. if an additional RB is established on a transport channel used for event triggering or reporting, the new RB shall be taken into account.

NOTE: In this subclause, an "existing" uplink transport channel refers to a configured uplink transport channel applicable in the current RRC state.

The UE shall:

- 1> if variable READY_FOR_COMMON_EDCH is set to FALSE:
 - 2> if the IE "Traffic volume measurement object" is included for this measurement:
 - 3> while a transport channel that is referenced in the IE "Traffic volume measurement object" does not exist:
 - 4> not perform any reporting related to this transport channel.
 - 2> else:
 - 3> report on all existing uplink transport channels; e.g. if an additional transport channel is established while the measurement is ongoing, this new transport channel shall be taken into account in the traffic volume measurement reporting.
 - 1> else:
 - 2> if the UE is in CELL_FACH state:
 - 3> for FDD, if one transport channel that is referenced in the IE "Traffic volume measurement object" as "DCH" and IE "measurement validity" is set to "all states except CELL_DCH":
 - 4> report on the existing transport channel E-DCH.
 - 3> for 1.28 Mcps TDD, if one transport channel that is referenced in the IE "Uplink transport channel type" as "USCH" and the related IE "UL Target Transport Channel ID" is set to 32 and the IE "measurement validity" is set to "all states" or "all states except CELL_DCH":
 - 4> report on the existing transport channel E-DCH.

For every traffic volume event, the UE shall:

- 1> if variable READY_FOR_COMMON_EDCH is set to FALSE:

- 2> if the IE "Uplink transport channel type" is not included in the IE "Traffic volume measurement reporting criteria", or the "Uplink transport channel type" has the value "DCH" or "USCH" and the IE "UL transport channel id" is not included in the IE "Traffic volume measurement reporting criteria":
 - 3> if the IE "Traffic volume measurement object" is not included:
 - 4> take all existing UL transport channels into account for event triggering; e.g. if an additional transport channel is established while the measurement is ongoing, this new transport channel shall be taken into account in the traffic volume event triggering.
 - 3> else:
 - 4> while a transport channel that is referenced in the IE "Traffic Volume Measurement object" does not exist:
 - 5> not take this transport channel identity into account in the traffic volume measurement triggering.
- 2> else:
 - 3> while a transport channel that is referenced in the IE "Traffic Volume Measurement Reporting Criteria" does not exist:
 - 4> not take this transport channel identity into account in the traffic volume event triggering.

8.4.1.10.2 Quality measurement

While a transport channel that is explicitly referenced with a transport channel identity in the IE "Quality Reporting Quantity" does not exist, the UE shall:

- 1> not perform any reporting related to this transport channel identity.

If the IE "Quality Reporting Quantity" does not contain any explicit transport channel identities, the UE shall:

- 1> report the quality of all existing downlink dedicated transport channels;
- 1> if an additional transport channel is established while the measurement is ongoing:
 - 2> take into account this new transport channel in the quality measurement reporting.

While a transport channel that is explicitly referenced with a transport channel id in the IE "Quality Measurement Reporting Criteria" does not exist, the UE shall:

- 1> not take this transport channel identity into account in the quality measurement event triggering.

8.4.1.10.3 Intra-frequency, Inter-frequency and Inter-RAT measurements

For measurements which include the IE "Cells for measurement" the UE shall:

- 1> while an IE "Intra-frequency cell id" or IE "Inter-frequency cell id" or IE "Inter-RAT cell id" in the IE "Cells for measurement" points to a position in the variable CELL_INFO_LIST which is marked as "vacant":
 - 2> not take this position into account for event triggering and reporting.

8.4.1.11 Cell Reselection (FDD only and 1.28 Mcps TDD only)

8.4.1.11.1 Traffic volume measurement

When performing cell reselection in CELL_FACH state, the UE shall:

- 1> retrieve each set of measurement control information of measurement type "traffic volume" stored in the variable MEASUREMENT_IDENTITY:
 - 2> if the IE "measurement validity" for the measurement has been included, and the IE "UE state" has been assigned to value "all states":

- 3> if variable `READY_FOR_COMMON_EDCH` is set to `FALSE` before state transition and set to `TRUE` after cell reselection:

 - 4> stop measurement reporting;
 - 4> store the measurement associated with the variable `MEASUREMENT_IDENTITY` to be used after the next transition to `CELL_DCH` state, or after cell reselection.

- 2> if variable `READY_FbOR_COMMON_EDCH` is set to `TRUE` before state transition and set to `FALSE` after cell reselection:

 - 3> resume measurement reporting.

8.4.2 Measurement report



Figure 8.4.2-1: Measurement report, normal case

8.4.2.1 General

The purpose of the measurement reporting procedure is to transfer measurement results from the UE to UTRAN.

8.4.2.2 Initiation

In `CELL_DCH` state, the UE shall:

- 1> transmit a `MEASUREMENT REPORT` message on the uplink DCCH when the reporting criteria stored in variable `MEASUREMENT_IDENTITY` are met for any ongoing measurements that are being performed in the UE.

In `CELL_FACH` state, the UE shall:

- 1> transmit a `MEASUREMENT REPORT` message on the uplink DCCH when the reporting criteria stored in variable `MEASUREMENT_IDENTITY` are met for any ongoing traffic volume measurement or UE positioning measurement that is being performed in the UE.

In TDD, if the Radio Bearer associated with the `MEASUREMENT_IDENTITY` fulfilling the reporting criteria for an ongoing traffic volume measurement is mapped on transport channel of type USCH, the UE shall:

- 1> initiate the "PUSCH CAPACITY REQUEST" procedure instead of transmitting a `MEASUREMENT REPORT` (TDD Only).

In `CELL_PCH` or `URA_PCH` state, the UE shall:

- 1> if the measurement reporting is not initiated according to subclause 8.5.40, subclass 8.5.47 or subclause 8.5.56:

 - 2> if variable `READY_FOR_COMMON_EDCH` or `HSPA_RNTI_STORED_CELL_PCH` is set to `TRUE`:

 - 3> move to `CELL_FACH`;
 - 3> transmit a `MEASUREMENT REPORT` message on the uplink DCCH when the reporting criteria stored in variable `MEASUREMENT_IDENTITY` are fulfilled for any ongoing UE positioning measurement which is being performed in the UE.

 - 2> else:

- 3> first perform the cell update procedure according to subclause 8.3.1, using the cause "uplink data transmission", in order to transit to CELL_FACH state; and then
- 3> transmit a MEASUREMENT REPORT message on the uplink DCCH when the reporting criteria stored in variable MEASUREMENT_IDENTITY are fulfilled for any ongoing UE positioning measurement which is being performed in the UE.

For FDD and 1.28 Mcps TDD, the UE in CELL_PCH state shall:

- 1> if variable H_RNTI is set:
 - 2> if the measurement reporting is initiated according to subclause 8.5.40, subclause 8.5.47 or subclause 8.5.56:
 - 3> set the IE "measurement identity" to "16";
 - 3> not set the IE "measured results" or "E-UTRA measured results";
 - 3> include the IE "measured results on RACH";
 - 3> if an event triggered traffic volume measurement has been configured:
 - 4> if the TCTV is larger than the threshold in the IE "Reporting threshold" for a traffic volume measurement stored in the MEASUREMENT_IDENTITY variable and that traffic volume measurement has "measurement identity" equal to 4, "Traffic volume event identity" equal to "4a", "Measurement validity" equal to "all states" or "all states except CELL_DCH":
 - 5> set the IE "Traffic volume event identity" to "4a".
 - 3> and then transmit the MEASUREMENT REPORT message on the uplink DCCH using AM RLC; when the MEASUREMENT REPORT message has been submitted to lower layers for transmission the procedure ends.

The reporting criteria are fulfilled if either:

- a periodic MEASUREMENT REPORT message shall be sent according to the IE "Periodical Reporting Criteria"; or
- an event in stored IE "Measurement reporting criteria" was triggered. Events and triggering of reports for different measurement types are described in detail in clause 14.

For the measurement, which triggered the MEASUREMENT REPORT message, the UE shall:

- 1> set the IE "measurement identity" to the measurement identity, which is associated with that measurement in variable MEASUREMENT_IDENTITY;
- 1> set the IE "measured results" or "E-UTRA measured results" to include measurements according to the IE "reporting quantity" of that measurement stored in variable MEASUREMENT_IDENTITY; and
 - 2> if all the reporting quantities are set to FALSE:
 - 3> not set the IE "measured results".
- 1> set the IE "Measured results" in the IE "Additional measured results" according to the IE "reporting quantity" for all measurements associated with the measurement identities included in the "Additional measurements list" stored in variable MEASUREMENT_IDENTITY of the measurement that triggered the measurement report; and
 - 2> if one or more additional measured results are to be included:
 - 3> include only the available additional measured results, and sort them in ascending order according to their IE "measurement identity" in the MEASUREMENT REPORT message.
- 1> if the MEASUREMENT REPORT message was triggered by an event (i.e. not a periodical report):
 - 2> set the IE "Event results" or "E-UTRA event results" according to the event that triggered the report.

- 1> if the IE Inter-RAT measured results list or the IE Inter-RAT measurement event results is included in the measurement report:
 - 2> if the indication status of the IE "Inter-RAT cell info indication" in the variable CELL_INFO_LIST is marked "present" , include the stored value of the IE "Inter-RAT cell info indication" in the MEASUREMENT REPORT message.
- 1> if the measurement report is triggered by intra frequency event 1d and the table "Target cell preconfigurations" in the variable TARGET_CELL_PRECONFIGURATION includes the Radio link that triggered the event:
 - 2> if an "Activation time offset" different from 0 is configured for the target cell, include the IE "Activation time" in MEASUREMENT REPORT message. The Activation time shall be calculated by adding the Activation time offset to the current CFN:
 - 3> start continuous monitoring of target cell HS-SCCH indexed as number 1 in IE "Serving HS-DSCH cell information" in the stored configuration;
 - 3> stop monitoring target cell HS-SCCH at Activation time.
 - 2> else:
 - 3> start if not running, or restart if running, timer T324;
 - 3> start continuous monitoring of target cell HS-SCCH indexed as number 1 in IE "Serving HS-DSCH cell information" in the stored configuration until the expiry of timer T324.

The UE shall:

- 1> transmit the MEASUREMENT REPORT message on the uplink DCCH using either AM or UM RLC according to the stored IE "measurement reporting mode" associated with the measurement identity that triggered the report.

When the MEASUREMENT REPORT message has been submitted to lower layers for transmission:

- 1> the procedure ends.

8.4.3 Assistance Data Delivery



Figure 8.4.3-1 Assistance Data Delivery

8.4.3.1 General

The purpose of the assistance data delivery procedure is to transfer UE positioning related assistance data from the UTRAN to the UE.

8.4.3.2 Initiation

When requested by the Core Network, the UTRAN may deliver UE positioning related assistance data with a ASSISTANCE DATA DELIVERY message, which is transmitted on the downlink DCCH using AM RLC

8.4.3.3 Reception of ASSISTANCE DATA DELIVERY message by the UE

Upon reception of a ASSISTANCE DATA DELIVERY message the UE shall:

- 1> if IE "UE positioning OTDOA assistance data for UE-based" is included:
 - 2> act as specified in subclause 8.6.7.19.2a.
- 1> if IE "UE positioning GPS assistance data" is included:
 - 2> act as specified in subclause 8.6.7.19.3.
- 1> if IE "UE positioning GANSS assistance data" is included:
 - 2> act as specified in subclause 8.6.7.19.7.

8.4.3.4 Invalid ASSISTANCE DATA DELIVERY message

If the UE receives a ASSISTANCE DATA DELIVERY message, which contains a protocol error causing the variable `PROTOCOL_ERROR_REJECT` to be set to `TRUE` according to clause 9, the UE shall perform procedure specific error handling as follows. The UE shall:

- 1> transmit an RRC STATUS message on the uplink DCCH using AM RLC;
- 1> include the IE "Identification of received message"; and
- 1> set the IE "Received message type" to ASSISTANCE DATA DELIVERY; and
- 1> set the IE "RRC transaction identifier" to the value of "RRC transaction identifier" in the entry for the ASSISTANCE DATA DELIVERY message in the table "Rejected transactions" in the variable `TRANSACTIONS`; and
- 1> clear that entry;
- 1> include the IE "Protocol error information" with contents set to the value of the variable `PROTOCOL_ERROR_INFORMATION`.
- 1> when the RRC STATUS message has been submitted to lower layers for transmission:
 - 2> continue with any ongoing processes and procedures as if the invalid ASSISTANCE DATA DELIVERY message has not been received.

8.5 General procedures

8.5.1 Selection of initial UE identity

The purpose of the IE "Initial UE identity" is to provide a unique UE identification at the establishment of an RRC connection. The type of identity shall be selected by the UE according to the following.

If the UE is operating in "GSM-MAP mode", the UE shall choose "UE id type" in the IE "Initial UE identity" with the following priority:

1. TMSI (GSM-MAP): The TMSI (GSM-MAP) shall be chosen if provided by upper layers. The IE "LAI" in the IE "Initial UE identity" shall also be present when TMSI (GSM-MAP) is used, for making it unique.
2. P-TMSI (GSM-MAP): The P-TMSI (GSM-MAP) shall be chosen if provided by upper layers and no TMSI (GSM-MAP) is available. The IE "RAI" in the IE "Initial UE identity" shall in this case also be present when P-TMSI (GSM-MAP) is used, for making it unique.
3. IMSI (GSM-MAP): The IMSI (GSM-MAP) shall be chosen if provided by upper layers and no TMSI (GSM-MAP) or P-TMSI is available.
4. IMEI: The IMEI shall be chosen when none of the above three conditions are fulfilled.

When being used, the IEs "TMSI (GSM-MAP)", "P-TMSI (GSM-MAP)", "IMSI (GSM-MAP)", "LAI" and "RAI" shall be set equal to the values provided by upper layers. The "P-TMSI (GSM-MAP)" and "RAI" may be mapped from a valid GUTI.

If the UE is operating in "ANSI-41 mode", the UE shall choose "UE id type" in the IE "Initial UE identity" according to the procedure specified in the 3GPP2 document "3GPP2 C.P0004-A".

8.5.2 Actions when entering idle mode from connected mode

When entering idle mode from connected mode, the UE shall:

- 1> clear or set variables upon leaving UTRA RRC connected mode as specified in subclause 13.4;
- 1> if the RRC CONNECTION RELEASE message was received and the IE "Redirection info" was present therein:
 - 2> if the IE "Frequency info" is present, attempt to camp on a suitable cell on the indicated UTRA carrier included in the RRC CONNECTION RELEASE message;
 - 2> if the IE "GSM target cell info" is present, attempt to camp on a suitable cell of the list of cells for the indicated RAT included in the RRC CONNECTION RELEASE message. If no cells were indicated for that RAT or no suitable cell of the indicated cells for that RAT is found within 10s, attempt to camp on any suitable cell of that RAT; or
 - 2> if the IE "E-UTRA target info" is present, attempt to camp on any of the frequencies for the indicated RAT included in the RRC CONNECTION RELEASE message, excluding any cell indicated in the list of not allowed cells for that RAT (i.e. the "blacklisted cells per freq list" for E-UTRA), if present. If no suitable cell on the indicated frequencies for that RAT is found within 10s, attempt to camp on any suitable cell of that RAT of that RAT; or
 - 2> if no suitable cell is found on the indicated UTRA carrier or RAT camp on any suitable cell.
- 1> attempt to select a suitable cell to camp on.

When leaving connected mode according to [4], the UE shall:

- 1> perform cell selection.

While camping on a cell, the UE shall:

- 1> acquire system information according to the system information procedure in subclause 8.1;
- 1> perform measurements according to the measurement control procedure specified in subclause 8.4; and
- 1> if the UE is registered:
 - 2> be prepared to receive paging messages according to the paging procedure in subclause 8.2.

If the UE is operating in "GSM-MAP mode", the UE shall:

- 1> delete any NAS system information received in connected mode;
- 1> acquire the NAS system information in system information block type 1; and
- 1> proceed according to subclause 8.6.1.2.

When entering idle mode, the UE shall:

- 1> if the USIM is present, for each CN domain:
 - 2> if a new security key set was received for this CN domain but was not used either for integrity protection or ciphering during this RRC connection:
 - 3> set the START value for this domain to zero; and
 - 3> store this START value for this domain in the USIM.
 - 2> else:

3> if the current "START" value, according to subclause 8.5.9 for a CN domain, is greater than or equal to the value "THRESHOLD" of the variable START_THRESHOLD:

4> delete the ciphering and integrity keys that are stored in the USIM for that CN domain;

4> inform the deletion of these keys to upper layers.

3> else:

4> store the current "START" value for this CN domain on the USIM.

NOTE: Prior to storing the "START" value, the UE should calculate this "START" value according to subclause 8.5.9.

1> else:

2> if the SIM is present, for each CN domain:

3> if a new security key set was received for this CN domain but was not used either for integrity protection or ciphering during this RRC connection:

4> set the START value for this domain to zero; and

4> store this START value for this domain in the UE

3> else:

4> if the current "START" value, according to subclause 8.5.9 for this CN domain, is greater than or equal to the value "THRESHOLD" of the variable START_THRESHOLD:

5> delete the Kc key for this CN domain;

5> delete the ciphering and integrity keys that are stored in the UE for that CN domain;

5> set the "START" values for this CN domain to zero and store it the UE;

5> inform the deletion of the key to upper layers.

4> else:

5> store the current "START" value for this CN domain in the UE.

NOTE: Prior to storing the "START" value, the UE should calculate this "START" value according to subclause 8.5.9.

8.5.3 Open loop power control upon establishment of DPCCH

This procedure is used in FDD mode only.

When establishing the first DPCCH in CELL_DCH the UE shall start the UL inner loop power control at a power level according to:

$$1> \text{DPCCH_Initial_power} = \text{DPCCH_Power_offset} - \text{CPICH_RSCP}$$

Where

DPCCH_Power_offset shall have the value of IE "DPCCH Power offset" in IE "Uplink DPCH power control info"

The value for the CPICH_RSCP shall be measured by the UE.

When establishing the DPCCH in CELL_FACH state or Idle mode the UE shall start the UL inner loop power control at a power level according to:

$$1> \text{DPCCH_Initial_power} = P_{\text{preamble}} + \text{"Power offset Pp-e"}$$

Where

- P_{preamble} is the power of the last transmitted preamble and "Power offset P_{p-e} " power offset between the last transmitted preamble and the initial power of the DPCCCH transmission in the Enhanced Uplink in CELL_FACH state and Idle mode.

8.5.4 Physical channel establishment criteria in CELL_DCH state

When a physical dedicated channel establishment is initiated by the UE, the UE shall start a timer T312 and wait for layer 1 to indicate N312 "in sync" indications. On receiving N312 "in sync" indications, the physical channel is considered established and the timer T312 is stopped and reset.

For 1.28Mcps TDD, when physical dedicated channel(s) are not configured, if a physical shared channel establishment is initiated by the UE, the UE shall start a timer T312 and wait for layer 1 to indicate N312 "in sync" indications. On receiving N312 "in sync" indications, the physical channel is considered established and the timer T312 is stopped and reset.

If the timer T312 expires before the physical channel is established, the UE shall consider this as a "physical channel failure".

NOTE: The criteria defined in this subclause only apply in case the UE performs synchronisation procedure A (FDD only).

NOTE: The physical shared channel defined in this subclause are HS-PDSCH, HS-SCCH or E-AGCH. (1.28 Mcps TDD only).

8.5.4A Physical channel establishment criteria for Enhanced Uplink in CELL_FACH state and Idle mode

When the physical channel establishment for Enhanced Uplink in CELL_FACH state and Idle mode is initiated by the UE, the UE shall considered the physical channel being immediately established.

If the physical layer considers the post-verification of procedure AA failed [29, section 4.3.2.3A], the UE shall consider this as a "physical channel failure".

NOTE: The criteria defined in this subclause only apply in case the UE performs synchronisation procedure AA (FDD only).

8.5.5 Actions in "out of service area" and "in service area"

This subclause specifies the general actions the UE shall perform when it detects "out of service" or "in service" area. The specific UE behaviour when it detects "out of service" or "in service area" and periodical update has been configured by T305 in the IE "UE Timers and constants in connected mode" set to any other value than "infinity" is specified in subclause 8.3.1.

8.5.5.1 Detection of "out of service" area

The UE shall detect "out of service" area as defined in [19].

8.5.5.1.1 Actions following detection of "out of service" area in URA_PCH or CELL_PCH state

If the UE detects the "out of service area" and the UE is in URA_PCH or CELL_PCH state it shall perform the following actions:

- 1> start timer T316;
- 1> perform processes described in subclause 7.2.2.

8.5.5.1.2 Actions following detection of "out of service" area in CELL_FACH state

If the UE detects the "out of service area" and the UE is in CELL_FACH state it shall perform the following actions. The UE shall:

- 1> start timer T317 if not already running;
- 1> perform processes described in subclause 7.2.2.

8.5.5.1.3 Actions following detection of "out of service" area on transition from CELL_DCH to URA_PCH or CELL_PCH

If the UE detects the "out of service area" on transition from CELL_DCH to URA_PCH or CELL_PCH, it shall perform the following actions:

- 1> start timer T316;
- 1> start the timer T305 using its initial value if timer T305 is not running and periodical cell update has been configured by T305 in the IE "UE Timers and constants in connected mode" set to any other value than "infinity";
- 1> perform processes described in subclause 7.2.2.

8.5.5.1.4 Actions following detection of "out of service" area on transition from CELL_DCH to CELL_FACH

If the UE detects the "out of service area" on transition from CELL_DCH to CELL_FACH, it shall perform the following actions:

- 1> if the transition is triggered by a reconfiguration procedure:
 - 2> start timer T317;
 - 2> start the timer T305 using its initial value if timer T305 is not running and periodical cell update has been configured by T305 in the IE "UE Timers and constants in connected mode" set to any other value than "infinity";
 - 2> perform processes described in subclause 7.2.2.
- 1> otherwise:
 - 2> perform processes described in subclause 7.2.2.

8.5.5.2 Detection of "in service" area

When a suitable cell is found based on the description in [4], the UE considers it as having detected "in service area".

8.5.5.2.1 Actions following Re-entry into "in service area" in URA_PCH or CELL_PCH state

If the UE re-enters "in service area" before T316 expiry the UE shall perform the following actions. The UE shall:

- 1> stop T316;
- 1> if T307 is active:
 - 2> stop T307.
- 1> if the UE is in CELL_PCH state and the UE is camped on a cell different from the one where service was lost:
 - 2> for FDD and 1.28 Mcps TDD:
 - 3> clear the variables C_RNTI, H_RNTI and E_RNTI;

3> stop using that C-RNTI, H-RNTI and E-RNTI just cleared from variables C_RNTI, H_RNTI and E_RNTI in MAC.

2> initiate the cell update procedure using the cause "cell-reselection" as specified in subclause 8.3.1.

1> perform processes described in subclause 7.2.2.

8.5.5.2.2 Actions following re-entry into "in service area" in CELL_FACH state

If the UE detects "in service area" before T317 expiry the UE shall perform the following actions. If no cell update procedure or URA update procedure is ongoing, the UE shall:

1> stop T317;

1> if T307 is active:

2> stop T307.

1> initiate the cell update procedure using as cause "Re-entering service area" as specified in subclause 8.3.1;

1> perform processes described in subclause 7.2.2.

If a cell update procedure or URA update procedure is ongoing, the UE shall:

1> stop T317;

1> perform the actions as specified in 8.3.1.

8.5.5.3 T316 expiry

On T316 expiry the UE shall perform the following actions. The UE shall:

1> if "out of service area" is detected:

2> start timer T317;

2> move to CELL_FACH state;

2> perform processes described in subclause 7.2.2.

1> if "in service area" is detected:

2> initiate the cell update procedure using as cause "Re-entering service area" as specified in subclause 8.3.1;

2> perform processes described in subclause 7.2.2.

8.5.5.4 T317 expiry

T317 shall never expire, i.e. all its values shall be assumed to be "infinity".

If T317 is running:

1> the UE behaviour shall be as specified in subclause 7.2.2.2.

8.5.6 Radio link failure criteria and actions upon radio link failure

In CELL_DCH state, after receiving N313 consecutive "out of sync" indications from layer 1 for the established DPCCCH or F-DPCCCH physical channel in FDD, and the physical channels associated with mapped DCCHs in TDD, the UE shall:

1> start timer T313;

1> upon receiving N315 successive "in sync" indications from layer 1 and upon change of UE state:

2> stop and reset timer T313.

1> if T313 expires:

2> consider it as a "Radio link failure".

Periods in time where neither "in sync" nor "out of sync" is reported by layer 1 do not affect the evaluation of the number of consecutive (resp. successive) "in sync" or "out of sync" indications.

For 1.28 Mcps TDD, when the variable E_DCH_TRANSMISSION is set to TRUE (see subclause 8.5.28) and the UE has stored the IE "E-RUCCH info", a "Radio link failure" shall be triggered as below:

1> if the E-RUCCH transmission counter is added greater than N_RUCCH, another hysteresis Timer with the value of N-RUCCH times of T-RUCCH period shall be started:

2> upon the hysteresis Timer expires and still no Grant has been received for the whole time duration since the last E-RUCCH transmission:

3> consider it as a "Radio link failure", refer to [59].

For FDD in CELL_DCH state and in TDD when a radio link failure occurs, the UE shall:

1> clear the dedicated physical channel configuration;

1> perform actions as specified for the ongoing procedure;

1> if no procedure is ongoing or no actions are specified for the ongoing procedure:

2> perform a cell update procedure according to subclause 8.3.1 using the cause "radio link failure".

For FDD, in CELL_FACH state and Idle mode, in conjunction with the Enhanced Uplink in CELL_FACH state, after receiving an indication from layer 1 that physical layer transmission stopped caused by an DL out-of-synchronisation, the UE shall:

1> consider it as a "Radio link failure".

8.5.7 Open loop power control

For FDD, and prior to PRACH transmission or prior to a transmission in Enhanced Uplink in CELL_FACH state and Idle mode, the UE shall:

1> acquire valid versions of the necessary System Information IEs as follows:

2> if the UE has stored valid versions of the IEs "Primary CPICH Tx power" and "Constant value":

3> use the stored content of the IEs.

2> otherwise:

3> read and store the IE "Primary CPICH Tx power" and "Constant value" in System Information Block type 6 (or System Information Block type 5 or System Information Block type 5bis, if System Information Block type 6 is not being broadcast).

2> if variable READY_FOR_COMMON_EDCH is set to TRUE; and

2> if IE "UL interference for common E-DCH" is included in system information block type 5 or 5bis:

3> use the stored value of IE "UL interference for common E-DCH".

2> otherwise:

3> if the UE has a valid version of the IE "UL interference" stored:

4> use the stored content of the IE "UL interference".

3> otherwise:

4> read and store the IE "UL interference" in System Information Block type 7;

4> if the UE fails to read the IE "UL interference" in System Information Block type 7 due to bad radio conditions, the UE shall use the last stored IE "UL interference".

1> measure the value for the CPICH_RSCP;

1> calculate the power for the first preamble as:

$$\text{Preamble_Initial_Power} = \text{Primary CPICH TX power} - \text{CPICH_RSCP} + \text{UL interference} + \text{Constant Value}$$

Where,

Primary CPICH TX power shall have the value of IE "Primary CPICH Tx power",

UL interference shall have the value of IE "UL interference for common E-DCH" if variable READY_FOR_COMMON_EDCH is set to TRUE and IE "UL interference for common E-DCH" is included in SIB 5/5bis; otherwise UL interference shall have the value of IE "UL interference"; and

Constant Value shall have the value of IE "Constant value".

1> as long as the physical layer is configured for PRACH transmission or the PRACH preamble part (as part of the Enhanced Uplink in CELL_FACH state and Idle mode):

2> continuously recalculate the Preamble_Initial_Power when any of the broadcast parameters used in the above formula changes; and

2> resubmit to the physical layer the new calculated Preamble_Initial_Power.

For 3.84 Mcps TDD or 7.68 Mcps TDD the UE shall:

1> if in the IE "Uplink DPCH Power Control info" the "CHOICE UL OL PC info" has the value "Broadcast UL OL PC info":

2> prior to DPCH transmission the UE shall:

3> acquire valid versions of the necessary System Information IEs as follows:

4> if the UE has stored valid versions of the IEs "Primary CCPCH Tx power" and "DPCH Constant value":

5> use the stored content of the IEs.

4> otherwise:

5> read and store the IE "Primary CCPCH Tx power" and "DPCH Constant value" in System Information Block type 6 (or System Information Block type 5, if System Information Block type 6 is not being broadcast).

3> if the UE has a valid version of the IE "UL interference" for each active UL timeslot stored:

4> use the stored content of the IE "UL interference" for each active UL timeslot.

3> otherwise:

4> read and store the IE "UL Timeslot Interference" for each active UL timeslot in System Information Block type 14;

4> if the UE fails to read the IE "UL Timeslot Interference" for each active UL time slot in System Information Block type 14 due to bad radio conditions, the UE shall use the last stored IE "UL Timeslot interference" for each active UL timeslot.

1> otherwise:

2> acquire Reference Power, Constant Values and I_{BTS} for all active UL timeslots from the IE "Uplink DPCH Power Control info".

1> for PUSCH, PRACH and HS-SICH power control:

2> prior to PUSCH or PRACH transmission the UE shall:

3> acquire valid versions of the necessary System Information IEs as follows:

4> if the UE has stored valid versions of the IEs "Primary CCPCH Tx power" and "PUSCH Constant value" for PUSCH transmissions or "PRACH Constant value" for PRACH transmissions:

5> use the stored content of the IEs.

4> otherwise:

5> read and store the IE "Primary CCPCH Tx power" and "PUSCH Constant value" for PUSCH transmissions or "PRACH Constant value" for PRACH transmissions in System Information Block type 6 (or System Information Block type 5, if System Information Block type 6 is not being broadcast).

3> if the UE has a valid version of the IE "UL interference" for each active UL timeslot stored:

4> use the stored content of the IE "UL interference" for each active UL timeslot.

3> otherwise:

4> read and store the IE "UL Timeslot Interference" for each active UL timeslot in System Information Block type 14;

4> if the UE fails to read the IE "UL Timeslot Interference" for each active UL time slot in System Information Block type 14 due to bad radio conditions, the UE shall use the last stored IE "UL Timeslot interference" for each active UL timeslot.

calculate the UL transmit power according to the following formula for the PRACH continuously while the physical channel is active:

$$P_{\text{PRACH}} = L_{\text{PCCPCH}} + I_{\text{BTS}} + \text{PRACH Constant value},$$

2> 3dB shall be added to RACH Constant Value in the above equation for the case where RACH Spreading Factor = 8;

2> for 7.68 Mcps TDD, 3dB shall be added to RACH Constant Value in the above equation for the case where RACH Spreading Factor = 16.

1> calculate the UL transmit power according to the following formula for the DPCH continuously while the physical channel is active:

$$P_{\text{DPCH}} = \alpha L_{\text{PCCPCH}} + (1-\alpha)L_0 + I_{\text{BTS}} + \text{SIR}_{\text{TARGET}} + \text{DPCH Constant value}$$

1> calculate the UL transmit power according to the following formula for the PUSCH continuously while the physical channel is active:

$$P_{\text{PUSCH}} = \alpha L_{\text{PCCPCH}} + (1-\alpha)L_0 + I_{\text{BTS}} + \text{SIR}_{\text{TARGET}} + \text{PUSCH Constant value}$$

1> calculate the initial UL transmit power for HS-SICH according to the following formula:

$$P_{\text{HS-SICH}} = \alpha L_{\text{PCCPCH}} + (1-\alpha)L_0 + I_{\text{BTS}} + \text{SIR}_{\text{TARGET}} + \text{HS-SICH Constant value}$$

Where, for all the above equations for 3.84 Mcps TDD or 7.68 Mcps TDD the following apply:

- $P_{\text{PRACH}}, P_{\text{DPCH}}, P_{\text{PUSCH}}$ and $P_{\text{HS-SICH}}$: Transmitter power level in dBm;
- Pathloss values:
 - L_{PCCPCH} : Measurement representing path loss in dB based on beacon channels (the reference transmit power is signalled as the value of the IE "Primary CCPCH Tx Power" on BCH in System Information Block type 6 (or System Information Block type 5, according to subclause 8.1.1.6.5), or individually signalled in the IE "Uplink DPCH Power Control info").
 - L_0 : Long term average of path loss in dB;

- If the midamble is used in the evaluation of L_{PCCPCH} and L_0 , and the Tx diversity scheme used for the P-CCPCH involves the transmission of different midambles from the diversity antennas, the received power of the different midambles from the different antennas shall be combined prior to evaluation of the variables.
- I_{BTS} : Interference signal power level at cell's receiver in dBm. I_{BTS} shall have the value of the IE "UL Timeslot Interference" (IE "UL Timeslot Interference" is broadcast on BCH in System Information Block type 14 or individually signalled to each UE in the IE "Uplink DPCH Power Control info" for each active uplink timeslot).
- α : α is a weighting parameter, which represents the quality of path loss measurements. α may be a function of the time delay between the uplink time slot and the most recent down link PCCPCH time slot. α is calculated at the UE. α shall be smaller or equal to the value of the IE "Alpha". If the IE "Alpha" is not explicitly signalled to the UE α shall be set to 1. If UE is capable of estimating its position by using the OTDOA IPDL method, the UE shall use the IPDL- α parameter.
- SIR_{TARGET} : Target SNR in dB. This value is individually signalled to UEs in IE "UL target SIR" in IE "Uplink DPCH Power Control Info" or in IE "PUSCH Power Control Info" or in IE "HS-SICH Power Control Info".
- PRACH Constant value: PRACH Constant value shall have the value of the IE "PRACH Constant value".
- DPCH Constant value: DPCH Constant value shall have the value of the IE "DPCH Constant value".
- PUSCH Constant value: PUSCH Constant value shall have the value of the IE "PUSCH Constant value".
- HS-SICH Constant value: HS-SICH Constant value shall have the value of the IE "HS-SICH Constant value".
- Values received by dedicated signalling shall take precedence over broadcast values.
- If IPDLs are applied, the UE may increase UL Tx power by the value given in the IE "Max power increase". This power increase is only allowed in the slots between an idle slot and the next beacon slot.

For 1.28 Mcps TDD the UE shall:

- 1> acquire valid versions of the necessary System Information IEs as follows:
 - 2> if the UE has stored a valid version of the IE "Primary CCPCH Tx Power":
 - 3> use the stored content of the IE.
 - 2> otherwise:
 - 3> read and store the IE "Primary CCPCH Tx Power" from System Information Block type 6 (or System Information Block type 5, if System Information Block type 6 is not being broadcast).

- 1> calculate the UL transmit power according to the following formula for each UpPCH code transmission:

$$P_{UpPCH} = L_{PCCPCH} + PRX_{UpPCHdes} + (i-1) * Pwr_{ramp}$$

NOTE: When i equals 1, the initial signature power "Signature_Initial_Power" defined in [33] corresponds to P_{UpPCH} with i set to 1.

- 1> calculate the UL transmit power according to the following formula for each PRACH transmission:

$$P_{PRACH} = L_{PCCPCH} + PRX_{PRACHdes} + (i_{UpPCH}-1) * Pwr_{ramp}$$

- 1> calculate the initial UL transmit power according to the following formula for the PUSCH. Once the UE receives TPC bits relating to the PUSCH then it transitions to closed loop power control. If successive PUSCH resource allocations are contiguous then no return is made to open loop power control at the beginning of the succeeding resource allocation.

$$P_{USCH} = PRX_{PUSCHdes} + L_{PCCPCH}$$

1> calculate the initial UL transmit power for HS-SICH according to the following formula:

$$P_{\text{HS-SICH}} = \text{PRX}_{\text{HS-SICH}} + L_{\text{PCCPCH}}$$

1> calculate the initial UL transmit power according to the following formula for the DPCH. Once the UE receives TPC bits relating to the uplink DPCH then it transitions to closed loop power control.

$$P_{\text{DPCH}} = \text{PRX}_{\text{DPCHdes}} + L_{\text{PCCPCH}}$$

1> calculate the initial UL transmit power for E-PUCH according to the following formula:

$$P_{\text{E-PUCH}} = \text{PRX}_{\text{des_base}} + L_{\text{PCCPCH}} + \beta_e$$

Where:

- P_{UpPCH} , P_{PRACH} , P_{DPCH} , $P_{\text{HS-SICH}}$, P_{USCH} , & $P_{\text{E-PUCH}}$: Transmitter power level in dBm.
- L_{PCCPCH} : Measurement representing path loss in dB (reference transmit power "Primary CCPCH Tx Power" is broadcast on BCH in System Information Block type 5 and System Information Block type 6, or individually signalled to each UE in the IE "Uplink DPCH Power Control info").
- i is the number of transmission attempts on UpPCH, $i=1 \dots \text{Max SYNC_UL Transmissions}$.
- i_{UpPCH} is the final value of i .
- $\text{PRX}_{\text{PRACHdes}}$: Desired PRACH RX power at the cell's receiver in dBm signalled to the UE by the network in the FPACH response to the UE's successful SYNC_UL transmission.
- $\text{PRX}_{\text{UpPCHdes}}$: Desired UpPCH RX power at the cell's receiver in dBm. The value is broadcast in "PRX_{UpPCHdes}" in IE "SYNC_UL info" on BCH and shall be read on System Information Block type 5 and System Information Block type 6. It can also be signalled directly to the UE in IE "Uplink Timing Advance Control" contained in a protocol message triggering a hard handover or a transition from cell FACH to cell DCH state.
- $\text{PRX}_{\text{PUSCHdes}}$: Desired PUSCH RX power at the cell's receiver in dBm signalled to the UE in IE "PUSCH Power Control Info".
- $\text{PRX}_{\text{DPCHdes}}$: Desired DPCH RX power at the cell's receiver in dBm signalled to the UE in IE "Uplink DPCH Info" and IE "Uplink DPCH Power Control Info".
- P_{wramp} : The UE shall increase its transmission power by the value of the IE "Power Ramp step" by every UpPCH transmission. Its value is signalled in the IE "SYNC_UL info" in System Information Block type 5 and System Information Block type 6 or is signalled to the UE in the IE "Uplink Timing Advance Control" contained in a protocol message triggering a hard handover or a transition from cell FACH state to cell DCH state.
- $\text{PRX}_{\text{HS-SICH}}$: Desired HS-SICH RX power at the cell's receiver in dBm signalled to the UE in IE "Downlink HS-PDSCH Information".
- Ack-Nack Power Offset: Difference in the desired RX power between HS-SICH transmissions conveying an acknowledgement and transmissions conveying a negative acknowledgement signalled to the UE in IE "HS-SCCH Info".
- $\text{PRX}_{\text{des_base}}$: Reference Desired E-PUCH RX power at the cell's receiver in dBm signalled to the UE in CELL_DCH in IE "E-PUCH Info" via dedicated signalling; or via System Information Block 5 for UE in enhanced CELL_FACH and Idle mode.
- β_e : Gain factor for the selected E-TFC transport block size, the allocated E-PUCH physical resources, and the Modulation type and the HARQ power offset (see [33]).

8.5.8 Maintenance of Hyper Frame Numbers

The MSBs of both the ciphering sequence numbers (COUNT-C) and integrity sequence numbers (COUNT-I), for the ciphering and integrity protection algorithms, respectively [40], are called the Hyper Frame Numbers (HFN).

For integrity protection, the UE shall:

- 1> maintain COUNT-I as specified in subclause 8.5.10.

The following hyper frame numbers types are defined:

MAC-d HFN:

24 MSB of COUNT-C for data sent over RLC TM

RLC UM HFN:

25 MSB of COUNT-C for data sent over RLC UM

RLC AM HFN:

20 MSB of COUNT-C for data sent over RLC AM

RRC HFN:

28 MSB of COUNT-I

For non-transparent mode RLC signalling radio bearers and radio bearers, the UE shall:

- 1> maintain one uplink and one downlink COUNT-C per signalling radio bearer and per radio bearer and one uplink and one downlink COUNT-I per signalling radio bearer;
- 1> increment the RLC UM HFN and RLC AM HFN in uplink and downlink by one each time the RLC sequence number wraps around in uplink and downlink respectively;
- 1> if the activation time for a new ciphering configuration set by an RRC procedure is equal to zero:
 - 2> apply the configured RLC UM HFN or RLC AM HFN at this activation time, i.e. the configured HFN is not incremented.

NOTE: On the receiver side it may happen that the RLC PDU with sequence number equal to the activation time is lost and the first received PDU after the activation time implies a wrap around of the sequence number compared to the activation time. In this case the configured HFN is incremented by one. This action is taken only when the activation time is set to a RLC PDU sequence number value other than zero.

For all transparent mode RLC signalling radio bearers and radio bearers of each CN domain, the UE shall:

- 1> maintain one COUNT-C, common for all radio bearers in uplink and downlink;
- 1> increment the MAC-d HFN by one each time the CFN wraps around;
- 1> if the activation time for a new ciphering configuration set by an RRC procedure is equal to zero:
 - 2> apply the configured MAC-d HFN at this activation time, i.e. the configured HFN is not incremented.
- 1> maintain one uplink and one downlink COUNT-I per signalling radio bearer.

NOTE: In this release of the specification there is only an uplink transparent mode COUNT-I, which is used for signalling radio bearer RB0.

COUNT-C and COUNT-I are defined in [40], with the following supplement for COUNT-C: for transparent mode RLC radio bearers with a transmission time interval of x radio frames ($x = 2, 4, 8$), the MAC PDU is carried by L1 in x consecutive radio frames due to radio frame segmentation. In this case, the CFN of the first radio frame in the TTI shall be used as the CFN component of COUNT-C for ciphering of all data in the TTI [15].

8.5.9 START value calculation

In connected mode, if a security mode command procedure has been successfully completed for a CN domain during the current RRC connection, the START value for that CN domain is calculated as:

Let $START_X$ = the $START$ value for CN domain 'X' prior to the calculation below:

$START_X' = MSB_{20} (\text{MAX} \{ \text{COUNT-C}, \text{COUNT-I} \mid \text{radio bearers and signalling radio bearers using the most recently configured } CK_X \text{ and } IK_X \}) + 2.$

- if $START_X' =$ the maximum value = 1048575 then $START_X = START_X'$;
- if the current $START_X < START_X'$ then $START_X = START_X'$, otherwise $START_X$ is unchanged.

NOTE: Here, "most recently configured" means that if there is more than one key in use for a CN domain, due to non-expiry of the ciphering and/or integrity protection activation time for any signalling radio bearers and/or radio bearers, do not include the COUNT-I/COUNT-C for these signalling radio bearers and/or radio bearers in the calculation of the $START_X'$.

COUNT-C corresponding to non-ciphered radio bearers (i.e. RBs with ciphering status set to "not started") shall not be included in the calculation of the $START_X'$. If a radio bearer is released and the radio bearer was ciphered, the values of the COUNT-C at the time the radio bearer is released shall be taken into account in the calculation of the $START_X'$.

If a security mode command procedure has not been successfully completed for a CN domain during the current RRC connection, the UE shall use the latest transmitted $START$ value for this CN domain.

8.5.10 Integrity protection

If the "Status" in the variable INTEGRITY_PROTECTION_INFO has the value "Started" then the UE shall:

- 1> perform integrity protection (and integrity checking) on all RRC messages, with the following exceptions:

ETWS PRIMARY NOTIFICATION WITH SECURITY
 HANDOVER TO UTRAN COMPLETE
 MBMS ACCESS INFORMATION
 MBMS COMMON P-T-M RB INFORMATION
 MBMS CURRENT CELL P-T-M RB INFORMATION
 MBMS GENERAL INFORMATION
 MBMS MODIFIED SERVICES INFORMATION (MCCH only)
 MBMS NEIGHBOURING CELL P-T-M RB INFORMATION
 MBMS SCHEDULING INFORMATION
 MBMS UNMODIFIED SERVICES INFORMATION
 PAGING TYPE 1
 PUSCH CAPACITY REQUEST
 PHYSICAL SHARED CHANNEL ALLOCATION
 RRC CONNECTION REQUEST
 RRC CONNECTION SETUP
 RRC CONNECTION SETUP COMPLETE
 RRC CONNECTION REJECT
 RRC CONNECTION RELEASE (CCCH only)
 SYSTEM INFORMATION
 SYSTEM INFORMATION CHANGE INDICATION

TRANSPORT FORMAT COMBINATION CONTROL (TM DCCH only)

If the "Status" in the variable INTEGRITY_PROTECTION_INFO has the value "Not started" then integrity protection (and integrity checking) shall not be performed on any RRC message.

For each signalling radio bearer, the UE shall use two RRC hyper frame numbers:

- "Uplink RRC HFN";
- "Downlink RRC HFN".

and two message sequence numbers:

- "Uplink RRC Message sequence number";
- "Downlink RRC Message sequence number".

The above information is stored in the variable INTEGRITY_PROTECTION_INFO per signalling radio bearer (RB0-RB4).

Upon the first activation of integrity protection for an RRC connection, UE and UTRAN initialise the "Uplink RRC Message sequence number" and "Downlink RRC Message sequence number" for all signalling radio bearers as specified in subclauses 8.6.3.5 and 8.5.10.1.

The RRC message sequence number (RRC SN) is incremented for every integrity protected RRC message.

If the IE "Integrity Protection Mode Info" is present in a received message, the UE shall:

- 1> perform the actions in subclause 8.6.3.5 before proceeding with the integrity check of the received message.

8.5.10.1 Integrity protection in downlink

If the UE receives an RRC message on signalling radio bearer with RB identity n, the "Status" in the variable INTEGRITY_PROTECTION_INFO has the value "Started" and the IE 'Integrity check info' is present the UE shall:

- 1> check the value of the IE "RRC message sequence number" included in the IE "Integrity check info";
- 2> if the "Downlink RRC Message sequence number" is not present in the variable INTEGRITY_PROTECTION_INFO:
 - 3> initialise the "Downlink RRC Message sequence number" for signalling radio bearer RBn in the variable INTEGRITY_PROTECTION_INFO with the value of the IE "RRC message sequence number" included in the IE "Integrity check info" of the received message.
- 2> if the "Downlink RRC Message sequence number" is present in the variable INTEGRITY_PROTECTION_INFO:
 - 3> if the RRC message sequence number is lower than the "Downlink RRC Message sequence number" for signalling radio bearer RBn in the variable INTEGRITY_PROTECTION_INFO:
 - 4> increment "Downlink RRC HFN" for signalling radio bearer RBn in the variable INTEGRITY_PROTECTION_INFO with one.

NOTE: The actions above imply that also for the case the "Downlink RRC HFN" is re-initialised by a security mode control procedure, this "Downlink RRC HFN" value is incremented by one before it is applied for the integrity protection of any received message if the conditions above are fulfilled.

- 3> if the RRC message sequence number is equal to the "Downlink RRC Message sequence number" for signalling radio bearer RBn in the variable INTEGRITY_PROTECTION_INFO:
 - 4> discard the message.
- 1> calculate an expected message authentication code in accordance with subclause 8.5.10.3;
- 1> compare the expected message authentication code with the value of the received IE "message authentication code" contained in the IE "Integrity check info";

- 2> if the expected message authentication code and the received message authentication code are the same, the integrity check is successful:
 - 3> update the "Downlink RRC Message sequence number" for signalling radio bearer RBn in the variable INTEGRITY_PROTECTION_INFO with the value of the IE "RRC message sequence number" included in the IE "Integrity check info" of the received RRC message.
- 2> if the calculated expected message authentication code and the received message authentication code differ:
 - 3> act as if the message was not received.

If the UE receives an RRC message on signalling radio bearer with identity 0, 1, or 2, the "Status" in the variable INTEGRITY_PROTECTION_INFO has the value "Started" and the IE 'Integrity check info' is not present the UE shall:

- 1> discard the message.

If the UE receives an RRC message on signalling radio bearer with identity 3 or 4, the "Status" in the variable INTEGRITY_PROTECTION_INFO has the value "Started" and the IE 'Integrity check info' is not present:

- 1> if a security mode command procedure has not been successfully completed during the current RRC connection for the CN domain indicated by IE "CN Domain Identity" in the received message:
 - 2> the UE shall forward the message to upper layer.
- 1> else:
 - 2> the UE shall discard the message.

UTRAN may transmit several copies of the same message in the downlink to increase the probability of proper reception of the message by the UE. In such a case, the RRC SN for these repeated messages should be the same.

8.5.10.2 Integrity protection in uplink

Prior to sending an RRC message using the signalling radio bearer with radio bearer identity n, and the "Status" in the variable INTEGRITY_PROTECTION_INFO has the value "Started" the UE shall:

- 1> increment "Uplink RRC Message sequence number" for signalling radio bearer RBn in the variable INTEGRITY_PROTECTION_INFO with 1, even if the message is a retransmission of a previously transmitted message.
- 1> if the "Uplink RRC Message sequence number" for signalling radio bearer RBn in the variable INTEGRITY_PROTECTION_INFO equals zero:
 - 2> increment "Uplink RRC HFN" for signalling radio bearer RBn in the variable INTEGRITY_PROTECTION_INFO by one.

NOTE 1: The actions above imply that also for the case the "Uplink RRC HFN" is re-initialised by a security mode control procedure, this "Uplink RRC HFN" is incremented before it is applied in the integrity protection of any transmitted message if the conditions above are fulfilled.

NOTE 2: For SRB0, this is also valid in case the Message Sequence Number has been increased by N302 +2 resulting in an MSN which equals 0 (i.e.: SRB0 UL activation time equals 0). Then the uplink RRC HFN is incremented by 1 after it is re-initialized and before it is applied in the integrity protection of any transmitted message.

- 1> calculate the message authentication code in accordance with subclause 8.5.10.3;
- 1> replace the "Message authentication code" in the IE "Integrity check info" in the message with the calculated message authentication code;
- 1> replace the "RRC Message sequence number" in the IE "Integrity check info" in the message with contents set to the new value of the "Uplink RRC Message sequence number" for signalling radio bearer RBn in the variable INTEGRITY_PROTECTION_INFO.

In the response message for the procedure ordering the security reconfiguration, the UE indicates the activation time, for each signalling radio bearer. When the new integrity configuration is to be applied in uplink, UTRAN should start to apply the new integrity protection configuration according to the activation time for each signalling radio bearer (except for the signalling radio bearer which is used to send the message that is reconfiguring the security configuration where the new configuration is to be applied starting from and including reception of the response message).

8.5.10.3 Calculation of message authentication code

The UE shall calculate the message authentication code in accordance with [40]. The input parameter MESSAGE [40] for the integrity algorithm shall be constructed by:

- 1> setting the "Message authentication code" in the IE "Integrity check info" in the message to the value of the IE "RB identity" for the signalling radio bearer;
- 1> setting the "RRC Message sequence number" in the IE "Integrity check info" in the message to zero;
- 1> encoding the message;
- 1> appending RRC padding (if any) as a bit string to the encoded bit string as the least significant bits.

For usage on an RRC message transmitted or received on the radio bearer with identity n, the UE shall:

- 1> construct the input parameter COUNT-I [40] by appending the following IEs from the IE "Signalling radio bearer specific integrity protection information" for radio bearer n in the variable INTEGRITY_PROTECTION_INFO:
 - 2> for uplink:
 - 3> "Uplink RRC HFN", as the MSB, and "Uplink RRC Message sequence number", as LSB.
 - 2> for downlink:
 - 3> "Downlink RRC HFN", as the MSB, and the IE "RRC message sequence number" included in the IE "Integrity check info", as LSB.

8.5.11 FACH measurement occasion calculation

For 3.84 Mcps TDD and 7.68 Mcps TDD, when in CELL_FACH state and when the variable C_RNTI is non-empty, or for FDD and 1.28 Mcps TDD, when in CELL_FACH state, when the variable C_RNTI is non-empty and when variable HS_DSCH_RECEPTION_CELL_FACH_STATE is set to FALSE, then the UE shall perform measurements as specified in subclauses 8.4.1.6 and 8.4.1.9 during the frame(s) with the SFN value fulfilling the following equation:

$$\text{SFN div } N = \text{C_RNTI mod } M_REP + n * M_REP$$

where

- N is the TTI (in number of 10ms frames) of the FACH having the largest TTI on the SCCPCH selected by the UE according to the procedure in subclause 8.5.19. FACHs that only carry MBMS logical channels (MTCH, MSCH, or MCCH) are excluded from measurement occasion calculations.
- C_RNTI is the C-RNTI value of the UE stored in the variable C_RNTI
- M_REP is the Measurement Occasion cycle length. According to the equation above, a FACH Measurement Occasion of N frames will be repeated every $N * M_REP$ frame, and $M_REP = 2^k$.

where,

- k is the FACH Measurement occasion cycle length coefficient.
The value of the FACH Measurement occasion cycle length coefficient is read in system information in "System Information Block type 11" or "System Information Block type 12" in the IE "FACH measurement occasion info".
- n = 0,1,2... as long as SFN is below its maximum value

The UE is allowed to measure on other occasions in case the UE moves "out of service" area or in case it can simultaneously perform the ordered measurements.

A UE in TDD mode shall use the frame(s) with the SFN value fulfilling the above equation for neighbour cells measurements.

For FDD when in CELL_FACH state, when the variable C_RNTI is non-empty, when variable HS_DSCH_RECEPTION_CELL_FACH_STATE is set to TRUE, when variable COMMON_E_DCH_TRANSMISSION is set to FALSE and when the variable HS_DSCH_DRX_CELL_FACH_STATUS is set to FALSE, then the UE in FDD mode shall perform measurements as specified in subclauses 8.4.1.6 and 8.4.1.9 during the frame(s) with the SFN value fulfilling the following equation:

$$\text{SFN} = \text{H-RNTI} \bmod \text{M_REP} + n * \text{M_REP}$$

where

- H-RNTI is the value stored in the variable H_RNTI.
- M_REP is the Measurement Occasion cycle length. According to the equation above, a FACH Measurement Occasion of 10ms-frame will be repeated every M_REP frame, and $\text{M_REP} = 2^k$.

where,

- k is the FACH Measurement occasion cycle length coefficient.
The value of the FACH Measurement occasion cycle length coefficient is read in system information in "System Information Block type 11" or "System Information Block type 12" in the IE "FACH measurement occasion info".
- n = 0,1,2... as long as SFN is below its maximum value.

The UE is allowed to measure on other occasions in case the UE moves "out of service" area or in case it can simultaneously perform the ordered measurements.

NOTE: For FDD, in order to meet the MBMS demodulation performance requirements [21], a UE receiving MBMS PTM may not be able use the entire measurement occasion.

For 1.28 Mcps TDD when in CELL_FACH state, when the variable C_RNTI is non-empty, when variable HS_DSCH_RECEPTION_CELL_FACH_STATE is set to TRUE, and when the HS-SCCH(s) and E-AGCH(s) are not configured in TS0, then UE can perform the ordered measurements on any occasions.

For 1.28 Mcps TDD when in CELL_FACH state, when the variable C_RNTI is non-empty, when variable HS_DSCH_RECEPTION_CELL_FACH_STATE is set to TRUE, and when the HS-SCCH(s) or E-AGCH(s) are configured in TS0, then the UE shall perform measurements as specified in subclauses 8.4.1.6 and 8.4.1.9 during the frame(s) with the SFN value fulfilling the following equation:

$$\text{SFN} = \text{H-RNTI} \bmod \text{M_REP} + n * \text{M_REP}$$

where

- H-RNTI is the value stored in the variable H_RNTI.
- M_REP is the Measurement Occasion cycle length. According to the equation above, a FACH Measurement Occasion of 10ms-frame will be repeated every M_REP frame, and $\text{M_REP} = 2^k$.

where,

- k is the FACH Measurement occasion cycle length coefficient.
The value of the FACH Measurement occasion cycle length coefficient is read in system information in "System Information Block type 11" or "System Information Block type 12" in the IE "FACH measurement occasion info".
- n = 0,1,2... as long as SFN is below its maximum value.

The UE is allowed to measure on other occasions in case the UE moves "out of service" area or in case it can simultaneously perform the ordered measurements.

8.5.12 Establishment of Access Service Classes

The PRACH resources (i.e. access slots and preamble signatures for FDD), timeslot (with specific frame allocation and channelisation code for 3.84 Mcps TDD and 7.68 Mcps TDD, and SYNC_UL codes (with specific frame allocation) for 1.28 Mcps TDD) may be divided between different Access Service Classes in order to provide different priorities of RACH usage. It is possible for more than one ASC or for all ASCs to be assigned to the same access slot/signature space in FDD or frame allocation/channelisation codes in 3.84 Mcps TDD or 7.68 Mcps TDD, or frame allocation/SYNC_UL codes in 1.28 Mcps TDD.

Access Service Classes shall be numbered in the range $0 \leq i \leq \text{NumASC} \leq 7$ (i.e. the maximum number of ASCs is 8). An ASC is defined by an identifier, i , that defines a certain partition of the PRACH resources (SYNC_UL resources in 1.28 Mcps TDD) and an associated persistence value P_i . A set of ASC parameters consists of "NumASC+1" such parameters (i, P_i), $i = 0, \dots, \text{NumASC}$.

PRACH partitions shall be established using the information element "PRACH partitioning". The persistence values P_i to be associated with each ASC shall be derived from the dynamic persistence level $N = 1, \dots, 8$ which is broadcast in System Information Block 7, and the persistence scaling factors s_i , broadcast in System Information Block Type 5 or System Information Block type 5bis and possibly also in System Information Block Type 6, as follows:

$$P(N) = 2^{-(N-1)}$$

| ASC # i | 0 | 1 | 2 | 3 | 4 | 5 | 6 | 7 |
|-----------|---|--------|------------|------------|------------|------------|------------|------------|
| P_i | 1 | $P(N)$ | $s_2 P(N)$ | $s_3 P(N)$ | $s_4 P(N)$ | $s_5 P(N)$ | $s_6 P(N)$ | $s_7 P(N)$ |

In addition, MBMS specific persistence values may be provided within the MBMS MODIFIED SERVICES INFORMATION message. The UE behaviour upon receiving upon receiving an MBMS dynamic persistence value is specified in subclause 8.6.9.1a.

Scaling factors s_i are provided optionally for $i = 2, \dots, \text{NumASC}$, where NumASC+1 is the number of ASCs as defined by PRACH partitioning. If no scaling factors are broadcast, default value 1 shall be used if NumASC ≥ 2 .

If $k \geq 1$ scaling factors are broadcast and NumASC $\geq k+2$ then the last scaling factor s_{k+1} shall be used as default for the ASCs where $i > k+1$.

In the case of E-RUCCH operation (3.84/7.68 Mcps TDD only) a separate set of persistence values will be used. For E-RUCCH a single scaling factor S_r is signalled. If the E-RUCCH shares resource with a PRACH then dynamic persistence levels of the PRACH are used and persistence values are determined using the table below:

| ASC # i | 0 | 1 | 2 – 7 |
|-----------------|---|--------|------------|
| P_i (E-RUCCH) | 1 | $P(N)$ | $S_r P(N)$ |

Else if the E-RUCCH does not share resource with a PRACH then persistence values are determined using the table below:

| ASC # i | 0 | 1 | 2--7 |
|-----------------|---|---|-------|
| P_i (E-RUCCH) | 1 | 1 | S_r |

The establishment of Access Service Classes for E-RUCCH (1.28 Mcps TDD only) is similar as PRACH, differently Access Service Classes parameters and persistence scaling factors of E-RUCCH may be acquired from the information element "E-RUCCH info", e.g. in the case of E-DCH serving cell change. Only in the case that the UEs with E-DCH and E-RUCCH configured on the Primary Frequency of the multi-frequency cell, the E-DCH serving cell unchanged and the UEs can obtain the dynamic persistence level N from SIB7 according to the configuration of information element 'E-RUCCH info', the dynamic persistence value N shall be used. Otherwise, dynamic persistence level $N=1$ shall always be used. The persistence values are determined using the table below:

| ASC # i | 0 | 1 | 2 | 3 | 4 | 5 | 6 | 7 |
|-----------------|---|--------|------------|------------|------------|------------|------------|------------|
| P_i (E-RUCCH) | 1 | $P(N)$ | $s_2 P(N)$ | $s_3 P(N)$ | $s_4 P(N)$ | $s_5 P(N)$ | $s_6 P(N)$ | $s_7 P(N)$ |

The set of ASC parameters is provided to MAC with the CMAC-Config-REQ primitive (see [15]), the PRACH partitioning is provided to PHY using the CPHY-RL-Setup-REQ primitive (see [34]). For 3.84/7.68 Mcps TDD E-DCH operation the E-RUCCH persistence values will also be provided to MAC with the CMAC-Config-REQ primitive.

The ASC enumeration shall be such that it corresponds to the order of priority (ASC 0 = highest priority, ASC 7 = lowest priority). ASC 0 shall be used in case of Emergency Call or for reasons with equivalent priority.

ASCs are numbered according to the order in which the IEs "ASC Setting" appear in the IE "PRACH partitioning", where the first IE "ASC Setting" describes ASC 0, the second IE "ASC Setting" describes ASC 1, etc.

At radio bearer setup/reconfiguration each involved logical channel is assigned a MAC Logical channel Priority (MLP) in the range 1,...,8. When the MAC sublayer is configured for RACH transmission in the UE, these MLP levels shall be employed for ASC selection on MAC.

8.5.13 Mapping of Access Classes to Access Service Classes

Access Classes shall only be applied at initial access, i.e. when sending an RRC CONNECTION REQUEST message. A mapping between Access Class (AC) and Access Service Class (ASC) shall be indicated by the information element "AC-to-ASC mapping" in System Information Block type 5 or System Information Block type 5bis. The correspondence between AC and ASC shall be indicated as follows.

| AC | 0 - 9 | 10 | 11 | 12 | 13 | 14 | 15 |
|-----|--------------------|--------------------|--------------------|--------------------|--------------------|--------------------|--------------------|
| ASC | 1 st IE | 2 nd IE | 3 rd IE | 4 th IE | 5 th IE | 6 th IE | 7 th IE |

In the table, "nth IE" designates an ASC number *i* in the range 0 - 7 to AC. If the ASC indicated by the "nth IE" is undefined, the UE behaviour is unspecified.

For the random access and the Enhanced Uplink in CELL_FACH state and Idle mode, the parameters implied by the respective ASC shall be employed. In case the UE is member of several ACs it shall select the ASC for the highest AC number. In connected mode, AC shall not be applied.

8.5.14 PLMN Type Selection

Depending on UE configuration, the UE is operating in "ANSI-41 mode" or "GSM-MAP mode".

8.5.14a Neighbour cells list narrowing for cell reselection

While a UE is camping on a suitable cell, a UE having performed the PLMN identification of the neighbour cells as specified in subclause 8.1.1.6.18 shall narrow the cell list to be used for cell reselection ([4]) to those neighbour cells for which:

The PLMN identity is part of the PLMNs that can make a cell suitable as defined in [4].

8.5.15 CFN calculation

The DOFF used in the formulas in this clause concerns the value of IE "Default DPCH Offset Value" received in the message that instructs the UE to enter CELL_DCH state or to perform timing re-initialised hard handover.

Subclause 8.5.15.5 is used in FDD to initialise the CFN for MTCH and/or MSCH if the IE "MBMS Soft Combining Timing Offset" is included for an S-CCPCH in MBMS CURRENT CELL P-T-M RB INFORMATION or MBMS NEIGHBOURING CELL P-T-M RB INFORMATION, and if only MTCH and/or MSCH are on the S-CCPCH. Otherwise, subclauses 8.5.15.1 through 8.5.15.4 are used to initialise the CFN.

8.5.15.1 Initialisation for CELL_DCH state after state transition

When the UE receives any of the messages causing the UE to perform a state transition to CELL_DCH, the UE shall set the CFN in relation to the SFN of the first radio link listed in the IE "Downlink information per radio link list" included in that message according to the following formula:

- for FDD:

$$\text{CFN} = (\text{SFN} - (\text{DOFF} \text{ div } 38400)) \text{ mod } 256$$

where the formula gives the CFN of the downlink DPCH or F-DPCH frame which starts at the same time as or which starts during the PCCPCH frame with the given SFN. DOFF is determined according to subclause 8.6.6.14.

- for TDD:

$$\text{CFN} = (\text{SFN} - \text{DOFF}) \bmod 256.$$

8.5.15.2 Initialisation in CELL_DCH state at hard handover

When the UE is in CELL_DCH state and receives any of the messages causing the UE to perform a hard handover, the UE shall check the IE "Timing indication" in that message and:

- 1> if IE "Timing indication" has the value "initialise" (i.e. timing re-initialised hard handover):
 - 2> read SFN on target cell identified by the first radio link listed in the IE "Downlink information per radio link list" included in that message;
 - 2> set the CFN according to the following formula:

- 3> for FDD:

$$\text{CFN} = (\text{SFN} - (\text{DOFF} \text{ div } 38400)) \bmod 256$$

where the formula gives the CFN of the downlink DPCH or F-DPCH frame which starts at the same time as or which starts during the PCCPCH frame with the given SFN.

- 3> for TDD:

$$\text{CFN} = (\text{SFN} - \text{DOFF}) \bmod 256.$$

- 1> if IE "Timing indication" has the value "maintain" (i.e. timing-maintained hard handover), the UE shall keep CFN with no change due to the hard handover, and only increase CFN (mod 256) by 1 every frame.

8.5.15.3 Initialisation for CELL_FACH

Unless the conditions of subclause 8.5.15.5 are met, when the UE performs cell selection, re-selection or changes to CELL_FACH state the UE shall set CFN for all common or shared channels according to:

$$\text{CFN} = \text{SFN} \bmod 256$$

where the formula gives the CFN of the downlink common or shared channel frame which starts at the same time as or which starts during the PCCPCH frame with the given SFN.

After the initialisation, the CFN in the UE is increased (mod 256) by 1 every frame.

8.5.15.4 Initialisation after intersystem handover to UTRAN

Upon inter RAT handover to UTRAN the UE shall, regardless of the value received within IE "Timing indication" (if received):

- 1> read SFN on target cell and set the CFN according to the following formula:

- 2> for FDD:

$$\text{CFN} = (\text{SFN} - (\text{DOFF} \text{ div } 38400)) \bmod 256$$

where the formula gives the CFN of the downlink DPCH frame which starts at the same time as or which starts during the PCCPCH frame with the given SFN.

- 2> for TDD:

$$\text{CFN} = (\text{SFN} - \text{DOFF}) \bmod 256.$$

8.5.15.5 Initialisation for MTCH and/or MSCH carried on S-CCPCH that may be soft combined

For FDD, if the IE "MBMS Soft Combining Timing Offset" is included for an S-CCPCH in MBMS CURRENT CELL P-T-M RB INFORMATION or MBMS NEIGHBOURING CELL P-T-M RB INFORMATION, and if only MTCH and/or MSCH are on the S-CCPCH, the UE shall set CFN for the S-CCPCH according to:

$$\text{CFN} = (\text{SFN} - (\text{SCTO} \text{ div } 10\text{ms})) \text{ mod } 256$$

where the formula gives the CFN of the downlink S-CCPCH frame which starts at the same time as or which starts during the PCCPCH frame with the given SFN.

the SCTO used in the formula is the IE "MBMS Soft Combining Timing Offset".

After the initialisation, the CFN in the UE is increased (mod 256) by 1 every frame.

8.5.16 Configuration of CTCH occasions

The CTCH, carrying CBS data is mapped onto only one S-CCPCH. If more than one CTCH is defined, the first CTCH that is configured in the list of S-CCPCHs is the one that is used for CBS data. If the UE is in connected mode it shall ignore any CTCH configuration contained in System Information Block type 6 and use the CTCH configuration contained in System Information Block 5.

The CTCH occasions are identified by the first radio frame of the TTI that can contain CTCH data. The CTCH occasions are fixed on the system frame number cycle 0 .. 4095 (i.e. no modulo calculation) and thus repeated cyclically.

The CTCH occasions are determined by a set of parameters.

M_{TTI} : number of radio frames within the TTI of the FACH used for CTCH

N: period of CTCH allocation on S-CCPCH, integer number of radio frames,
 $M_{\text{TTI}} \leq N \leq 256$, where N is a multiple of M_{TTI} (see [27] and [31]).

MaxSFN: maximum system frame number = 4095 (see [10]).

K: CBS frame offset, integer number of radio frames $0 \leq K \leq N-1$ where K is a multiple of M_{TTI} .

The CTCH occasions are calculated as follows:

$$\text{SFN} = (K + m N), m = 0, 1, \dots, M, \text{ with } M \text{ chosen that } K + MN \leq \text{MaxSFN}.$$

The parameters N and K are broadcast as system information.

If the IE "Period of BMC scheduling messages (P)" is included in System Information Block type 5 or System Information Block type 5bis then BMC Schedule Messages are transmitted periodically every P CTCH occasions. One BMC Schedule Message may be segmented across more than one CTCH occasion. The CTCH occasions that contain the start of the BMC Schedule Messages are calculated as follows:

$$\text{SFN} = (K + m P N), \text{ where } m \text{ is an integer and } 0 \leq \text{SFN} \leq \text{MaxSFN}$$

If the IE "Period of BMC scheduling messages (P)" is not included in system information block type 5 then BMC Schedule Messages could be transmitted in any CTCH occasion.

8.5.17 PRACH selection

For this version of the specification, when a UE selects a cell, the uplink frequency to be used for the initial PRACH transmission shall have a default duplex frequency spacing offset from the downlink frequency that the cell was selected on. The default duplex frequency separation to be used by the UE is specified in [21] for each frequency band (for FDD only).

NOTE: The PRACH selection scheme assumes that all PRACHs configured in System Information Block type 5, System Information Block type 5bis and System Information Block type 6 support all (implicitly or explicitly) configurable RLC sizes of the cell, i.e. at least the transport formats corresponding to a single transport block of each applicable RLC size of the cell must be defined for each PRACH.

The UE shall select a "PRACH system information" according to the following rule. The UE shall:

- 1> select a "PRACH system information" from the ones indicated in the IE "PRACH system information list" in System Information Block type 5 or in System Information Block type 5bis (applicable in Idle Mode and Connected Mode) or System Information Block type 6 (applicable in Connected Mode only), as follows:
 - 2> if in connected mode and System Information Block type 6 is defined and includes PRACH info:
 - 3> compile a list of candidate PRACHs that consists of the PRACH system information listed in System Information Block 6, in the order of appearance as in System Information Block 6.
 - 2> otherwise:
 - 3> compile a list of candidate PRACHs that consists of the PRACH system information listed in System Information Block 5 or in System Information Block 5bis, in the order of appearance as in System Information Block 5 or in System Information Block 5bis, respectively.
 - 2> in FDD:
 - 3> perform RACH TTI selection as specified in subclause 8.5.18.1.
 - 2> in 1.28 Mcps TDD:
 - 3> perform RACH TTI selection according to subclause 8.5.18.2.
 - 2> remove from the list of candidate PRACHs those PRACHs that have a TTI length different from the selected value;
 - 2> select a PRACH randomly from the list of candidate PRACHs as follows:

$$\text{"Index of selected PRACH"} = \text{floor}(\text{rand} * K)$$

where K is equal to the number of candidate PRACH system informations, "rand" is a random number uniformly distributed in the range $0 \leq \text{rand} < 1$ and "floor" refers to rounding down to nearest integer. The candidate PRACH system informations shall be indexed from 0 to K-1. The random number generator is left to implementation. The scheme shall be implemented such that one of the available PRACH system informations is randomly selected with uniform probability. At start-up of the random number generator in the UE the seed shall be dependent on the IMSI of the UE or time, thereby avoiding that all UEs select the same RACH;
 - 2> use the TFCS of the selected PRACH when performing TFC selection (see [15]);
 - 2> reselect the PRACH system information when a new cell is selected. RACH reselection may also be performed after each transmission of a Transport Block Set on RACH.
- 1> for emergency call, the UE is allowed to select any of the available PRACH system informations.

After selecting a PRACH system information, the RRC in the UE shall configure the MAC and the physical layer for the RACH access according to the parameters included in the selected "PRACH system information" IE.

8.5.18 Selection of RACH TTI

8.5.18.1 FDD

In FDD mode, a RACH may employ either 10 or 20 ms TTI. The supported TTI is indicated as a semi-static parameter of the RACH Transport Format in system information. The UE shall select an appropriate TTI length from the RACHs included in the list of candidate PRACH(s) according to the following rule.

The UE shall:

- 1> if only RACHs with one particular TTI length are included in the list of candidate PRACH(s):
 - 2> select this TTI length and proceed as specified in subclause 8.5.17.
- 1> if both PRACHs with 10ms and 20ms TTI lengths are included in the list of candidate PRACH(s):
 - 2> perform TTI selection as follows:
 - 3> when the UE calculates the initial preamble transmit power ("Preamble_Initial_Power") as specified in subclause 8.5.7:
 - 4> select a TF to be employed for calculation of a transmit power margin as follows:
 - 5> from the TFs supported by all candidate PRACHs keep those which correspond to a single transport block of all configured RLC sizes (i.e., in idle mode, the RLC size applicable for RB0, in connected mode, the RLC sizes configured with explicit "RB mapping info"). If more than a single TF remain applicable, the UE may select any of these. Preferably the UE should select the TF which is intended to be used at the next transmission or, if such information is not available, the TF corresponding to the largest configured RLC size.

- 4> calculate a transmit power margin,

$$\text{Margin} = \{ \min(\text{Maximum allowed UL tx power, P_MAX}) - \max(\text{Preamble_Initial_Power, Preamble_Initial_Power} + \Delta P_{p-m} + 10 \cdot \log_{10}(1 + (\beta_d / \beta_c)^2)) \}$$

where "Maximum allowed UL tx power" is the maximum allowed uplink transmit power indicated in system information (in dBm), and P_MAX is the maximum RF output power of the UE (dBm). The margin shall be calculated for the gain factors β_d and β_c of the TF selected in the step above, using 10ms TTI length.

NOTE 1: the expression $\text{Preamble_Initial_Power} + \Delta P_{p-m} + 10 \cdot \log_{10}(1 + (\beta_d / \beta_c)^2)$ represents the total RACH message power if the message would be sent after the initial preamble.

NOTE 2: For all PRACHs with the same TTI the UTRAN should set each of the IEs "Primary CPICH TX power", "Constant value" to the same value, and within these PRACH configurations, the UTRAN should, for all TFs including a single TB, set each of the IEs "Gain Factor β_c ", "Gain Factor β_d " and "Power offset P_p-m" to the same value. If these guidelines are not followed, the UE behaviour is unspecified.

- 3> if the resulting "Margin" value is less than 6 dB:
 - 4> select RACH with 20 ms TTI, and proceed as specified in subclause 8.5.17.
 - 3> otherwise, if the last L1 message transmission on PRACH failed (see [15]):
 - 4> the UE may select RACH with 20ms TTI length and proceed as specified in subclause 8.5.17.
 - 3> otherwise:
 - 4> select RACH with 10ms TTI length and proceed as specified in subclause 8.5.17.

8.5.18.2 1.28 Mcps TDD

In 1.28 Mcps TDD, a RACH may be assigned a 5, 10 or 20 ms TTI. If, in one cell, more than one RACH is defined a UE shall select the RACH that is to be used for each transmission according to the following rule:

- 1> if only RACHs with one particular TTI length are assigned a transport format that is suitable for the transmission of the transport block set:
 - 2> select this RACH's TTI length.
- 1> if more than one RACHs are assigned a transport format that is suitable for the transmission of the transport block set:
 - 2> select the longest of the TTI lengths of these RACHs.

8.5.19 Secondary CCPCH selection

In UTRAN Connected mode, the UE shall select the Secondary CCPCH according to the following rules:

1> in Cell_DCH state:

2> select Secondary CCPCH according to subclause 8.6.6.4.

1> in Cell_FACH state:

2> if System Information Block type 6 is defined and includes one or more SCCPCH that carry a FACH, compile a list of candidate SCCPCH that consists of these SCCPCH, in the order of appearance in System Information Block type 6.

NOTE 1: An SCCPCH carries a FACH if the size of the "FACH/PCH information" list within the IE "Secondary CCPCH system information" exceeds 1 or if the size of this list equals 1 while IE "Secondary CCPCH system information" does not contain an IE "PICH info".

2> otherwise:

3> compile a list of candidate SCCPCH that consists of the SCCPCH(s) included in System Information Block type 5 or System Information Block type 5bis that carry a FACH, in the order of appearance in System Information Block type 5 or System Information Block type 5bis.

2> select an SCCPCH from the list of candidate SCCPCHs based on U-RNTI as follows:

$$\text{"Index of selected SCCPCH"} = \text{U-RNTI mod K},$$

where K is equal to the number of candidate SCCPCHs.

1> in Cell_PCH and URA_PCH states:

2> if System Information Block type 6 is defined and includes one or more SCCPCH that carry a PCH, compile a list of candidate SCCPCH that consists of these SCCPCH, in the order of appearance in System Information Block type 6

NOTE 2: An SCCPCH carries a PCH if the IE "Secondary CCPCH system information" contains IE "PICH info"

2> otherwise compile a list of candidate SCCPCH that consists of the SCCPCH(s) included in System Information Block type 5 or System Information Block type 5bis that that carry a PCH, in the order of appearance in System Information Block type 5 or System Information Block type 5bis;

2> select an SCCPCH from the list of candidate SCCPCHs based on U-RNTI as follows:

$$\text{"Index of selected SCCPCH"} = \text{U-RNTI mod K},$$

where K is equal to the number of candidate SCCPCHs.

The UE shall set the CFN in relation to the SFN of the current cell according to subclause 8.5.15.

The UE shall decode all transport formats on all FACHs multiplexed on the selected S-CCPCH according to its UE capability, as defined in subclauses 8.1.1.6.5 and 8.1.1.6.6, to find blocks addressed to the UE.

8.5.19a Secondary CCPCH and FACH selection for MCCH reception

The UE shall select the Secondary CCPCH for acquiring MCCH information according to the following rules:

1> if System Information Block type 5 or System Information Block type 5bis is defined and includes an S-CCPCH within the IE "Secondary CCPCH system information" including a FACH for which the IE "MCCH configuration information" is included:

2> select that S-CCPCH and FACH for receiving MCCH.

1> otherwise if System Information Block type 5 or System Information Block type 5bis is defined and includes an SCCPCH within the IE "Secondary CCPCH system information MBMS" for which the IE "FACH carrying MCCH" is included:

- 2> select that S-CCPCH and FACH for receiving MCCH.

8.5.20 Unsupported configuration

The UE should set the variable UNSUPPORTED_CONFIGURATION to TRUE if the received message is not according to the UE capabilities.

8.5.21 Actions related to Radio Bearer mapping

When the UE receives the IE "RB mapping info", "CCCH mapping info", "SRB1 mapping info" and/or the IE "Transport format set", when transport channels, MAC-d flows, MAC-ehs reordering queues or E-DCH MAC-d flows are added or deleted, when the UE performs a cell reselection or a state transition, or when the UE releases a RB, the UE shall for each of the configured Radio Bearers:

- 1> upon moving to CELL_FACH state from CELL_DCH state to initiate a cell update procedure and upon subsequent cell reselections until the first successfully completed cell update procedure, only perform the actions defined in the remainder of this subclause after reception of the CELL UPDATE CONFIRM message;
- 1> for FDD, select the multiplexing option according to the following:
 - 2> if the UE is in CELL_PCH state:
 - 3> for FDD, if the UE does support HS-DSCH reception in CELL_PCH and URA_PCH state and IE "HS-DSCH paging system information" is included in System Information Block type 5 or System Information Block type 5bis; or
 - 3> for FDD, if the variable HSPA_RNTI_STORED_CELL_PCH is set to TRUE:
 - 4> if the UE does support Enhanced Uplink in CELL_FACH state and Idle mode and the IE "Common E-DCH system info" is included in System Information Block type 5 or System Information Block type 5bis and if C-RNTI, H-RNTI and primary E-RNTI are provided to the UE:
 - 5> if the RB has a multiplexing option with transport channel type "HS-DSCH" for the DL, and the corresponding MAC-ehs reordering queue is configured, and transport channel type "E-DCH" for the UL and the corresponding common E-DCH MAC-d flow is configured:
 - 6> select this multiplexing option;
 - 4> else:
 - 5> if the RB has a multiplexing option with transport channel type "HS-DSCH" for the DL, and the corresponding MAC-ehs reordering queue is configured, and transport channel type "RACH" for the UL:
 - 6> select this multiplexing option.
 - 2> if the UE is in CELL_FACH state:
 - 3> for FDD, if the UE does not support HS-DSCH reception in CELL_FACH state; or
 - 3> if the IE "HS-DSCH common system information" is not included in System Information Block type 5 or System Information Block type 5bis:
 - 4> if the RB has a multiplexing option with transport channel type "FACH" for the DL, and transport channel type "RACH" for the UL:
 - 5> select this multiplexing option.
 - 3> else:
 - 4> if the UE does not support Enhanced Uplink in CELL_FACH state and Idle mode; or
 - 4> if the IE "Common E-DCH system info" is not included in System Information Block type 5 or System Information Block type 5bis:

- 5> if the RB has a multiplexing option with transport channel type "HS-DSCH" for the DL, and the corresponding MAC-ehs reordering queue is configured, and transport channel type "RACH" for the UL:
 - 6> select this multiplexing option.
- 4> else:
 - 5> if the RB has a multiplexing option with transport channel type "HS-DSCH" for the DL, and the corresponding MAC-ehs reordering queue is configured, and transport channel type "E-DCH" for the UL and the corresponding common E-DCH MAC-d flow is configured:
 - 6> select this multiplexing option.
- 2> if the UE is in CELL_DCH state:
 - 3> if the RB has a multiplexing option with transport channel type "DCH + HS-DSCH" for the DL, and both the corresponding DCH transport channel and the corresponding MAC-d flow or MAC-ehs reordering queue are configured, and with transport channel type "E-DCH" for the UL, and the corresponding E-DCH MAC-d flow is configured:
 - 4> select this multiplexing option; else
 - 3> if the RB has a multiplexing option with transport channel type "DCH + HS-DSCH" for the DL, and both the corresponding DCH transport channel and the corresponding MAC-d flow or MAC-ehs reordering queue are configured, and with transport channel type "DCH" for the UL, and the corresponding DCH transport channel is configured:
 - 4> select this multiplexing option; else
 - 3> if the RB has a multiplexing option with transport channel type "DCH + DSCH" for the DL:
 - 4> the UE behaviour is unspecified; else
 - 3> if the RB has a multiplexing option with transport channel type "HS-DSCH" for the DL, and the corresponding MAC-d flow or MAC-ehs reordering queue is configured, and with transport channel type "E-DCH" for the UL, and the corresponding E-DCH MAC-d flow is configured:
 - 4> select this multiplexing option; else
 - 3> if the RB has a multiplexing option with transport channel type "HS-DSCH" for the DL, and the corresponding MAC-d flow or MAC-ehs reordering queue is configured, and with transport channel type "DCH" for the UL, and the corresponding DCH transport channel is configured:
 - 4> select this multiplexing option; else
 - 3> if the RB has a multiplexing option with transport channel type "DSCH" for the DL:
 - 4> the UE behaviour is unspecified; else
 - 3> if the RB has a multiplexing option with transport channel type "DCH" for the DL, and the corresponding DCH transport channel is configured, and with transport channel type "E-DCH" for the UL, and the corresponding E-DCH MAC-d flow is configured:
 - 4> select this multiplexing option; else
 - 3> if the RB has a multiplexing option with transport channel type "DCH" for the DL, and the corresponding DCH transport channel is configured, and with transport channel type "DCH" for the UL, and the corresponding DCH transport channel is configured:
 - 4> select this multiplexing option.
- 1> for 3.84 Mcps TDD and 7.68 Mcps TDD, select the multiplexing option according to the following:
 - 2> if the UE is in CELL_FACH state:

- 3> if the RB has the multiplexing options with the transport channel types "FACH" and "DSCH" for the DL, and the corresponding FACH and DSCH transport channels are configured, and with the transport channel types "RACH" and "USCH" for the UL, and the corresponding RACH and USCH transport channels are configured:
 - 4> if both PUSCH and PDSCH are allocated:
 - 5> select the multiplexing option "DSCH" for DL and "USCH" for UL; else
 - 4> if only PUSCH is allocated:
 - 5> select the multiplexing option "FACH" for DL and "USCH" for UL; else
 - 4> if only PDSCH is allocated:
 - 5> select the multiplexing option "DSCH" for DL and "RACH" for UL; else
 - 4> if neither PUSCH nor PDSCH is allocated:
 - 5> select the multiplexing option "FACH" for DL and "RACH" for UL.
- 3> if the RB has a single multiplexing option with the transport channel type "FACH" for the DL and the transport channel type "RACH" for the UL:
 - 4> select this multiplexing option; else
- 3> if the RB has a single multiplexing option with the transport channel type "DSCH" for the DL, and the corresponding DSCH transport channel is configured, and with the transport channel type "USCH" for the UL, and the corresponding USCH transport channel is configured:
 - 4> select this multiplexing option; else
- 2> if the UE is in CELL_DCH state:
 - 3> if the RB has a multiplexing option with transport channel type "DCH + HS-DSCH" for the DL, and both the corresponding DCH transport channel and MAC-d flow are configured, and with transport channel type "E-DCH" for the UL, and the corresponding E-DCH MAC-d flow is configured:
 - 4> select this multiplexing option; else
 - 3> if the RB has a multiplexing option with transport channel type "DCH + HS-DSCH" for the DL, and both the corresponding DCH transport channel and MAC-d flow are configured, and with transport channel type "DCH" for the UL, and the corresponding DCH transport channel is configured:
 - 4> select this multiplexing option; else
 - 3> if the RB has a multiplexing option with transport channel type "DCH + DSCH" for the DL, and both the corresponding DCH and DSCH transport channels are configured, and with transport channel type "DCH" for the UL, and the corresponding DCH transport channel is configured:
 - 4> select this multiplexing option; else
 - 3> if the RB has a multiplexing option with transport channel type "HS-DSCH" for the DL, and the corresponding MAC-d flow is configured, and with transport channel type "E-DCH" for the UL, and the corresponding E-DCH MAC-d flow is configured:
 - 4> select this multiplexing option; else
 - 3> if the RB has a multiplexing option with transport channel type "HS-DSCH" for the DL, and the corresponding MAC-d flow is configured, and with transport channel type "DCH" for the UL, and the corresponding DCH transport channel is configured:
 - 4> select this multiplexing option; else
 - 3> if the RB has a multiplexing option with transport channel type "DCH" for the DL, and the corresponding DCH transport channel is configured, and with transport channel type "E-DCH" for the UL, and the corresponding E-DCH MAC-d flow is configured:

- 4> select this multiplexing option; else
- 3> if the RB has a multiplexing option with transport channel type "DCH" for the DL, and the corresponding DCH transport channel is configured, and with transport channel type "DCH" for the UL, and the corresponding DCH transport channel is configured:
 - 4> select this multiplexing option; else
- 3> if the RB has a multiplexing option with transport channel type "DSCH" for the DL, and the corresponding DSCH transport channel is configured, and with transport channel "USCH" for the UL, and the corresponding USCH transport channel is configured:
 - 4> select this multiplexing option.
- 1> for 1.28 Mcps TDD, select the multiplexing option according to the following:
 - 2> if the UE is in CELL_PCH state:
 - 3> if the UE does support HS-DSCH reception in CELL_PCH and URA_PCH state and IE "HS-DSCH paging system information" is included in System Information Block type 5 and the IE "Common E-DCH system info" is included in System Information Block type 5 and if C-RNTI, H-RNTI and primary E-RNTI are provided to the UE:
 - 4> if the RB has a multiplexing option with transport channel type "HS-DSCH" for the DL and transport channel type "E-DCH" for the UL:
 - 5> select this multiplexing option.
 - 2> if the UE is in CELL_FACH state:
 - 3> if the UE does not support HS-DSCH reception in CELL_FACH state and Enhanced Uplink in CELL_FACH state and Idle mode; or
 - 3> if the IE "HS-DSCH common system information" is not included in System Information Block type 5; or
 - 3> if the IE "Common E-DCH system info" is not included in System Information Block type 5:
 - 4> if the RB has a multiplexing option with transport channel type "FACH" for the DL and transport channel type "RACH" for the UL:
 - 5> select this multiplexing option; else
 - 4> if the RB has the multiplexing options with the transport channel types "FACH" and "DSCH" for the DL, and the corresponding FACH and DSCH transport channels are configured, and with the transport channel types "RACH" and "USCH" for the UL, and the corresponding RACH and USCH transport channels are configured:
 - 5> if both PUSCH and PDSCH are allocated:
 - 6> select the multiplexing option "DSCH" for DL and "USCH" for UL; else
 - 5> if only PUSCH is allocated:
 - 6> select the multiplexing option "FACH" for DL and "USCH" for UL; else
 - 5> if only PDSCH is allocated:
 - 6> select the multiplexing option "DSCH" for DL and "RACH" for UL; else
 - 5> if neither PUSCH nor PDSCH is allocated:
 - 6> select the multiplexing option "FACH" for DL and "RACH" for UL.
 - 4> if the RB has a single multiplexing option with the transport channel type "DSCH" for the DL, and the corresponding DSCH transport channel is configured, and with the transport channel type "USCH" for the UL, and the corresponding USCH transport channel is configured:

- 5> select this multiplexing option; else
- 3> else:
 - 4> if the RB has a multiplexing option with transport channel type "HS-DSCH" for the DL and transport channel type "E-DCH" for the UL:
 - 5> select this multiplexing option.
- 2> if the UE is in CELL_DCH state:
 - 3> if the RB has a multiplexing option with transport channel type "DCH + HS-DSCH" for the DL, and both the corresponding DCH transport channel and the corresponding MAC-d flow or MAC-ehs reordering queue are configured, and with transport channel type "E-DCH" for the UL, and the corresponding E-DCH MAC-d flow is configured:
 - 4> select this multiplexing option; else
 - 3> if the RB has a multiplexing option with transport channel type "DCH + HS-DSCH" for the DL, and both the corresponding DCH transport channel and the corresponding MAC-d flow or MAC-ehs reordering queue are configured, and with transport channel type "DCH" for the UL, and the corresponding DCH transport channel is configured:
 - 4> select this multiplexing option; else
 - 3> if the RB has a multiplexing option with transport channel type "DCH + DSCH" for the DL, and both the corresponding DCH and DSCH transport channels are configured, and with transport channel type "DCH" for the UL, and the corresponding DCH transport channel is configured:
 - 4> select this multiplexing option; else
 - 3> if the RB has a multiplexing option with transport channel type "HS-DSCH" for the DL, and the corresponding MAC-d flow or MAC-ehs reordering queue is configured, and with transport channel type "E-DCH" for the UL, and the corresponding E-DCH MAC-d flow is configured:
 - 4> select this multiplexing option; else
 - 3> if the RB has a multiplexing option with transport channel type "HS-DSCH" for the DL, and the corresponding MAC-d flow or MAC-ehs reordering queue is configured, and with transport channel type "DCH" for the UL, and the corresponding DCH transport channel is configured:
 - 4> select this multiplexing option; else
 - 3> if the RB has a multiplexing option with transport channel type "DCH" for the DL, and the corresponding DCH transport channel is configured, and with transport channel type "E-DCH" for the UL, and the corresponding E-DCH MAC-d flow is configured:
 - 4> select this multiplexing option; else
 - 3> if the RB has a multiplexing option with transport channel type "DCH" for the DL, and the corresponding DCH transport channel is configured, and with transport channel type "DCH" for the UL, and the corresponding DCH transport channel is configured:
 - 4> select this multiplexing option; else
 - 3> if the RB has a multiplexing option with transport channel type "DSCH" for the DL, and the corresponding DSCH transport channel is configured, and with transport channel "USCH" for the UL, and the corresponding USCH transport channel is configured:
 - 4> select this multiplexing option.
- 1> configure the MAC with the appropriate transport format set (with computed transport block sizes) for the transport channel used by that RB; or
- 1> configure the MAC with the appropriate MAC-d flow or MAC-ehs reordering queue used by that RB;
- 1> in case the selected multiplexing option is a multiplexing option on E-DCH:

2> if the RLC PDU size is set to "fixed size", the set of RLC sizes that apply to the logical channel used by that RB consists of all RLC PDU sizes listed in the IE "RLC PDU size list" in the RB mapping info for E-DCH.

1> else:

2> determine the sets of RLC sizes that apply to the logical channels used by that RB, based on the IEs "RLC size list" and/or the IEs "Logical Channel List" included in the applicable "Transport format set" (either the ones received in the same message or the ones stored if none were received);

1> in case the selected multiplexing option is a multiplexing option on RACH:

2> ignore the RLC size indexes that do not correspond to any RLC size within the Transport Format Set stored for RACH.

2> if there is no remaining RLC size index corresponding to an RLC size within the Transport Format Set stored for RACH:

3> set the variable INVALID_CONFIGURATION to TRUE.

1> if RACH is the transport channel to be used on the uplink, if that RB has a multiplexing option on RACH and if it is using AM:

2> apply the largest size amongst the ones derived according to the previous bullet for the RLC size (or RLC sizes in case the RB is realised using two logical channels) for the corresponding RLC entity.

NOTE: The IE "RB mapping info" is only included in the IE "Predefined RB configurations" in system information when used for Inter-RAT handover to UTRAN and there is no AM RLC size change involved in this case.

1> if the uplink RLC PDU size is set to "flexible size" and no uplink RLC PDU size is currently set in the RLC entity:

2> if this radio bearer is a signalling radio bearer:

3> the UE behaviour is unspecified.

2> else, configure the corresponding RLC entity with the RLC length indicator size indicated in the IE "Length indicator size".

NOTE1: In uplink, if the UTRAN has configured "Flexible size" RLC PDUs and 7-bit "Length indicator size" field and "Largest UL RLC PDU size" > 126 octets, but the UTRAN has not configured "Use special value of HE field", then the UE behaviour is unspecified.

NOTE2: In uplink, if the UTRAN has configured "Flexible size" RLC PDUs and 7-bit "Length indicator size" field, but the UTRAN has also configured "Minimum UL RLC PDU" > 126 octets, then the UE behaviour is unspecified.

1> if the uplink RLC PDU size is changed from "fixed" to "flexible size" and the RLC length indicator size is 7 bits:

2> if this radio bearer is a signalling radio bearer:

3> the UE behaviour is unspecified.

2> else, configure the corresponding RLC entity with flexible RLC PDU size and the RLC length indicator size indicated in the IE "Length indicator size".

1> if that RB is using AM and the RLC size applicable to the uplink logical channel transporting data PDUs is different from the one derived from the previously stored configuration; or

1> if that RB is using AM and the RLC size applicable to the uplink logical channel transporting data PDUs changed from "flexible size" to "fixed size"; or

1> if that RB is using AM and "flexible size" RLC PDUs and the Length Indicator size applicable to the uplink logical channel transporting data PDUs is different from the one derived from the previously stored configuration; or

- 1> if that RB is using AM and the RLC PDU size applicable to the uplink logical channel transporting data PDUs changed from "fixed size" to "flexible size" and the indicated RLC length indicator size is 15 bits; and
- 1> none of the following conditions is met:
- the RLC size change is caused by a CELL UPDATE CONFIRM and the CELL UPDATE CONFIRM message includes the IE "Downlink counter synchronisation info".
 - the RLC size change is caused by a reconfiguration message, and a cell update procedure occurs during the reconfiguration procedure and the CELL UPDATE CONFIRM message includes the IE "Downlink counter synchronisation info".
 - the RLC size change is caused by a reconfiguration message, and a cell update procedure occurs during this reconfiguration procedure and the CELL UPDATE CONFIRM message includes the IE "RLC re-establish indicator" being set to TRUE for the corresponding radio bearer.
- 2> if the RLC PDU size is set to "flexible size":
- 3> if this radio bearer is a signalling radio bearer:
- 4> the UE behaviour is unspecified.
- 2> if the RLC size change is caused by a reconfiguration message or a CELL UPDATE CONFIRM and the IE "one sided RLC re-establishment" is included in that message and is set to TRUE; or
- 2> the uplink RLC size change is caused by changing the multiplexing option with transport channel type "E-DCH" to transport channel type "RACH" during cell reselection, and the UE enters or remains in CELL_FACH state, or the UE enters CELL_PCH state and the H-RNTI is stored after the state transition into CELL_PCH state, the UE shall after receiving the CELL UPDATE CONFIRM:
- 3> re-establish the transmitting side of the corresponding RLC entity.
- 2> else:
- 3> re-establish the corresponding RLC entity;
- 3> if the RLC entity for SRB2 is re-established:
- 4> clear all entries in the table "Processed transactions" in the variable TRANSACTIONS.
- 2> if the RLC PDU size is set to "fixed size":
- 3> configure the corresponding RLC entity with the new uplink RLC size.
- 2> if the RLC PDU size is set to "flexible size":
- 3> configure the corresponding RLC entity with the RLC length indicator size indicated in the IE "Length indicator size".
- 2> for each AM RLC radio bearer in the CN domain as indicated in the IE "CN domain identity" in the IE "RAB info" in the variable ESTABLISHED_RABS whose RLC size is changed; and
- 2> for each AM RLC signalling radio bearer in the CN domain as indicated in the IE "CN domain identity" in the variable LATEST_CONFIGURED_CN_DOMAIN whose RLC size is changed:
- 3> if the IE "Status" in the variable CIPHERING_STATUS of this CN domain is set to "Started":
- 4> if the information causing the RLC re-establishment was included in system information:
- 5> set the HFN values for the corresponding RLC entity equal to the value of the IE "START" for this CN domain that will be included in the CELL UPDATE message following cell reselection.

NOTE: Since the UE cannot predict the START value at the time of the next CELL UPDATE transmission in the future, UTRAN should desist from changing the RLC size for a signalling radio bearer within a cell. Other than this case the change in RLC size for a signalling radio bearer is known to the UE when reading system information following cell reselection.

- 4> if the RLC re-establishment is caused by a CELL UPDATE CONFIRM:
 - 5> if the whole RLC entity was re-established:
 - 6> set the HFN values for the corresponding RLC entity in uplink and downlink equal to the value of the IE "START" included in the latest transmitted CELL UPDATE message for this CN domain.
 - 5> if only the transmitting side of the RLC entity was re-established:
 - 6> set the HFN value for the corresponding RLC entity in the uplink equal to the value of the IE "START" included in the latest transmitted CELL UPDATE message for this CN domain.
- 4> if the RLC re-establishment is caused by a reconfiguration message:
 - 5> if the whole RLC entity was re-established:
 - 6> set the HFN values for the corresponding RLC entity in uplink and downlink equal to the value of the IE "START" that will be included in the reconfiguration complete message for this CN domain.
 - 5> if only the transmitting side of the RLC entity was re-established:
 - 6> set the HFN value for the corresponding RLC entity in the direction uplink equal to the value of the IE "START" that will be included in the reconfiguration complete message for this CN domain.

NOTE1: If the UTRAN modifies the RLC size for RB2 on any reconfiguration message or Cell Update Confirm message, the UE behaviour is unspecified in this version of the specification.

NOTE2: The UE cannot rely on the configured Transport Formats to determine the RLC sizes to be used in downlink for a particular logical channel. This size can be signalled explicitly in the RLC Info IE.

1> if that RB is using AM or UM; and

1> MAC-i/is is configured and the RLC PDU size is set to "flexible size":

2> indicate the largest RLC size applicable for uplink to the corresponding RLC entity;

2> indicate the minimum RLC size applicable for the uplink to the corresponding RLC entity.

1> MAC-e/es is configured and the RLC PDU size is set to "flexible size":

2> set the variable INVALID_CONFIGURATION to TRUE.

1> if that RB is using UM and MAC-i/is is not configured:

2> indicate the largest RLC size applicable for uplink to the corresponding RLC entity.

1> configure MAC multiplexing according to the selected multiplexing option (MAC multiplexing shall only be configured for a logical channel if the transport channel it is mapped on according to the selected multiplexing option is the same as the transport channel another logical channel is mapped on according to the multiplexing option selected for it);

1> configure the MAC with the logical channel priorities according to selected multiplexing option;

1> configure the MAC with the set of applicable RLC Sizes for each of the logical channels used for that RB;

1> if there is no multiplexing option applicable for the transport channels, MAC-d flows and MAC-ehs reordering queues to be used:

2> set the variable INVALID_CONFIGURATION to TRUE.

1> if there is more than one multiplexing option applicable for the transport channels, MAC-d flows or MAC-ehs reordering queues to be used:

2> set the variable INVALID_CONFIGURATION to TRUE.

If upon cell re-selection or upon moving to CELL_FACH state from CELL_DCH state to initiate cell update procedure the UE sets variable INVALID_CONFIGURATION to TRUE as a result of the actions defined in this subclause, the UE should:

- 1> move to idle mode;
- 1> release (locally) the established signalling connections (as stored in the variable ESTABLISHED_SIGNALLING_CONNECTIONS) and the established radio access bearers (as stored in the variable ESTABLISHED_RABS) and indicate this to upper layers;
- 1> perform other actions when entering idle mode from connected mode as specified in subclause 8.5.2.

8.5.22 Actions when entering another RAT from connected mode

NOTE: This section does not apply when entering GERAN Iu mode from UTRAN connected mode.

When entering another RAT from connected mode (due to Inter-RAT handover from UTRAN, Inter-RAT cell change order from UTRAN or Inter-RAT cell reselection from UTRAN), after successful completion of the procedure causing the transition to the other RAT, the UE shall:

- 1> if the USIM is present, for each CN domain:
 - 2> if a new security key set was received for this CN domain but was not used either for integrity protection or ciphering during this RRC connection:
 - 3> set the START value for this domain to zero and;
 - 3> store this START value for this domain in the USIM;
 - 2> else:
 - 3> store the current START value for every CN domain in the USIM [50].

NOTE: Prior to storing the START value, the UE should calculate this START value according to subclause 8.5.9.

- 1> if the SIM is present, for each CN domain:
 - 2> if a new security key was received for this CN domain but was not used either for integrity protection or ciphering during this RRC connection:
 - 3> set the START value for this domain to zero and;
 - 3> store this START value for this domain in the UE.
 - 2> else:
 - 3> store the current START value for this CN domain in the UE.

NOTE: Prior to storing the START value, the UE should calculate this START value according to subclause 8.5.9.

8.5.23 Measured results on RACH

When transmitting an uplink RRC message and System Information Block type 11, System Information Block type 11bis and System Information Block type 12, if transmitted, have been received, the UE shall:

- 1> if the uplink RRC message is an RRC CONNECTION REQUEST message:
 - 2> if the IE "Intra-frequency reporting quantity for RACH reporting" and the IE "Maximum number of reported cells on RACH" are included in System Information Block type 11:
 - 3> include a measurement report in the IE "Measured results on RACH", as specified in the IE "Intra-frequency reporting quantity for RACH reporting" and the IE "Maximum number of reported cells on RACH" in System Information Block type 11.

- 2> if the IE "Inter-frequency RACH reporting information" is included in System Information Block type 11:
 - 3> if, at the time the message is to be sent, valid measurements are available; and
 - 3> there is one or more cells for which the quantity, indicated by the IE "Reporting quantity" in the IE "Inter-frequency RACH reporting information", exceeds the threshold specified by the IE "Inter-frequency RACH reporting threshold":
 - 4> include a measurement report in the IE "Measured results on RACH";
 - 4> include the cells for which the quantity, indicated by the IE "Reporting quantity" in the IE "Inter-frequency RACH reporting information", exceeds the threshold specified by the IE "Inter-frequency RACH reporting threshold";
 - 4> set the IE "Inter-frequency cell indication- SIB11" to the following value: Value_Tag MOD 2, with Value_Tag corresponding to the value tag of System Information Block Type 11;
 - 4> set the IE "Inter-frequency cell indication- SIB12" to any value.
- 1> for any other uplink RRC message which optionally includes the IE "Measured results on RACH":
 - 2> if the IE "Intra-frequency reporting quantity for RACH reporting" and the IE "Maximum number of reported cells on RACH" are included in System Information Block type 12 (or "System Information Block Type 11", if these IEs are not included in the broadcast "System Information Block Type 12" or "System Information Block Type 12" is not being broadcast).
 - 3> include a measurement report in the IE "Measured results on RACH", as specified in the IE "Intra-frequency reporting quantity for RACH reporting" and the IE "Maximum number of reported cells on RACH" in System Information Block type 12 (or "System Information Block Type 11" if these IEs are not included in the broadcast "System Information Block Type 12" or "System Information Block Type 12" is not being broadcast).
 - 2> if the IE "Inter-frequency RACH reporting information" is included in "System Information Block type 12" (or "System Information Block Type 11" if this IE is not included in the "System Information Block Type 12" or if "System Information Block Type 12" is not being broadcast):
 - 3> if, at the time the message is to be sent, valid measurements are available; and
 - 3> there is one or more cells for which the quantity, indicated by the IE "Reporting quantity" in the IE "Inter-frequency RACH reporting information", exceeds the threshold specified by the IE "Inter-frequency RACH reporting threshold":
 - 4> include a measurement report in the IE "Measured results on RACH";
 - 4> include the cells for which the quantity, indicated by the IE "Reporting quantity" in the IE "Inter-frequency RACH reporting information", exceeds the threshold specified by the IE "Inter-frequency RACH reporting threshold";
 - 4> set the IE "Inter-frequency cell indication- SIB11" to the following value: Value_Tag MOD 2, with Value_Tag corresponding to the value tag of System Information Block Type 11;
 - 4> if "System Information Block Type 12" is being broadcast:
 - 5> set the IE "Inter-frequency cell indication- SIB12" to the following value: Value_Tag MOD 2, with Value_Tag corresponding to the value tag of System Information Block Type 12.
 - 4> else:
 - 5> set the IE "Inter-frequency cell indication- SIB12" to any value.
 - 1> include in the IE "Measured results on RACH" all requested reporting quantities for cells for which measurements are reported.

NOTE: The UE only includes measurement results for neighbour cells for which valid measurements are available at the time the message is sent. At cell access following selection or reselection to a cell, the UE may not have had sufficient time to obtain valid measurement results for neighbour cells.

- 1> for messages transmitted on CCCH, take care that the maximum allowed message size is not exceeded when forming the IE "Measured results on RACH", i.e. limit the number of included neighbour cells or if required omit the IE "Measured results on RACH" altogether. When limiting the number of included neighbouring cells, the number of inter-frequency cells should be limited first i.e. inter-frequency cells should be omitted before limiting the number of intra- frequency cells.

When transmitting an uplink RRC message and the System Information Block type 11, System Information Block type 11bis and System Information Block type 12, if transmitted, have not been received, the UE shall:

- 1> for any uplink RRC message which optionally includes the IE "Measured results on RACH", include a measurement report in the IE "Measured results on RACH" according to the following rules:
 - 2> if the IE "Intra-frequency reporting quantity SIB3" was not present in System Information Block type 3:
 - 3> include a measurement report for the serving cell using CPICH RSCP as a measurement quantity;
 - 3> include measurement reports for cells on the used frequency for which measured results are available, using CPICH RSCP as measurement quantity for each cell;
 - 3> omit the IE "Measurement results for monitored cells on non-used frequencies".
 - 2> if the IE "Intra-frequency reporting quantity SIB3" was present in System Information Block type 3:
 - 3> include a measurement report for the serving cell using as a measurement quantity given in IE "Intra-frequency reporting quantity SIB3";
 - 3> include measurement reports for cells on the used frequency for which measured results are available, using as a measurement quantity given in IE "Intra-frequency reporting quantity SIB3" for each cell;
 - 3> omit the IE "Measurement results for monitored cells on non-used frequencies".
- 2> for TDD, include measurement reports using the measurement quantities specified in the IE "Reporting quantity list".

If the IE "Measured results on RACH" is present in the message, the UTRAN should extract the contents to be used for radio resource control.

8.5.24 Change of PLMN while in RRC connected mode

If the UE camps on an acceptable cell to obtain limited service while in RRC connected mode the UE shall:

- 1> keep the RRC connection and its behaviour, while camping on an acceptable cell as if in Idle mode in that PLMN;
- 1> if the UE re-enters "in service area" in a suitable cell, or cannot maintain limited service (i.e. cannot find any acceptable cell of any PLMN), the UE shall resume its RRC Connected mode behaviour as if it had not camped on any cell whilst being in "out of service area".

The UE shall:

- 1> if the NAS indicates the selection of a new PLMN resulting from manual- or automatic mode PLMN selection [25] while the UE is in RRC connected mode; or
- 1> if the UE attempts transmission on an acceptable cell while the UE is in RRC connected mode (i.e. to initiate emergency call), the UE shall:
 - 2> move to idle mode;
 - 2> release all dedicated resources;
 - 2> indicate release (abort) of the established signalling connections (as stored in the variable ESTABLISHED_SIGNALLING_CONNECTIONS) and established radio access bearers (as stored in the variable ESTABLISHED_RABS) to upper layers;
 - 2> clear the variable ESTABLISHED_SIGNALLING_CONNECTIONS;

- 2> clear the variable ESTABLISHED_RABS; and
- 2> perform actions specified in subclause 8.5.2 when entering idle mode from connected mode.

NOTE: NAS can inform AS about a new selected PLMN as a result of a PLMN selection (manual- or automatic mode PLMN selection (see [25])), or as a result of network signalling (after inter-RAT handover or inter-PLMN SRNS relocation). Only in the first case (manual- or automatic mode PLMN selection), this will result in an immediate RRC connection release.

8.5.25 Actions related to HS_DSCH_RECEPTION variable

The variable HS_DSCH_RECEPTION shall be set to TRUE only when all the following conditions are met:

- 1> for FDD and 1.28 Mcps TDD:
 - 2> the UE is in CELL_DCH state.
- 1> for 3.84 Mcps TDD or 7.68 Mcps TDD:
 - 2> a dedicated physical channel is allocated to the UE in the uplink.
- 1> the variable H_RNTI is set;
- 1> the UE has a stored IE "HS-SCCH info";
- 1> the UE has a stored IE "HARQ info";
- 1> for FDD:
 - 2> one of the radio links in the active set is configured as the serving HS-DSCH radio link;
 - 2> the UE has stored the following IEs:
 - IE "Measurement Feedback Info";
 - IE "Uplink DPCH Power Control Info" including stored Δ_{ACK} , Δ_{NACK} and Ack-NACK Repetition factor.
- 1> for 3.84 Mcps TDD or 7.68 Mcps TDD, the UE has stored the IE "HS-PDSCH Timeslot Configuration" and either of the following conditions are met:
 - 2> a dedicated physical channel is allocated to the UE in the downlink;
 - 2> the UE has stored $D_{hs-sync}$.
- 1> for 1.28 Mcps TDD, the UE has stored the IE "HS-PDSCH Midamble Configuration":
- 1> there is at least one RB mapped to HS-DSCH;
- 1> at least for one of the RBs mapped to HS-DSCH, there is either:
 - 2> at least one MAC-hs queue (including the IE "MAC-d PDU size Info") configured for the concerning MAC-d flow; or
 - 2> at least one MAC-ehs reordering queue configured for the associated logical channel.

NOTE 1: In CELL_DCH, to enable or disable HS-DSCH reception, the UTRAN has the possibility to add/remove the concerning HS-DSCH related RB mapping options, add/remove the concerning MAC-d flows or, for FDD, add/remove the concerning MAC-ehs reordering queue, add/remove the serving HS-DSCH radio link or, for TDD add/remove H-RNTI upon hard handover.

NOTE 2: In CELL_DCH, if HS_DSCH_RECEPTION is set to TRUE and a reconfiguration, an inter-RAT handover from UTRAN, or a cell change order procedure is initiated, the UE checks the conditions only when the reconfiguration, inter-RAT handover from UTRAN, or cell change order procedure is successfully completed. Doing so ensures that, in case of failure in the reconfiguration, inter-RAT handover from UTRAN, or cell change order procedure, the UE can return to the old configuration as if the message was not received, e.g. without performing a MAC-HS reset.

If any of the above conditions is not met and the variable HS_DSCH_RECEPTION is set to TRUE, the UE shall:

- 1> set the variable HS_DSCH_RECEPTION to FALSE;
- 1> for UE in CELL_DCH:
 - 2> set the variable HS_DSCH_RECEPTION_GENERAL to FALSE;
 - 2> stop any HS-SCCH reception procedures;
 - 2> stop any HS-DSCH reception procedures;
 - 2> clear the variable H_RNTI and remove any stored H-RNTI;
 - 2> reset the MAC-hs/ehs entity [15];
 - 2> release all HARQ resources;
 - 2> no long consider any radio link to be the HS-DSCH serving radio link.
- 1> for 3.84 Mcps TDD or 7.68 Mcps TDD, if no downlink DPCH is assigned the UE shall clear the uplink DPCH configuration and initiate the Cell Update procedure according to subclause 8.3.1, cause "radio link failure".

NOTE 3: If configured for HS-DSCH and not explicitly indicated as being cleared, the UE will have still stored the IEs "HARQ info", "Added or Reconfigured MAC-d flow", "Added or Reconfigured MAC-ehs reordering queue", "RB mapping Info", "Downlink HS-PDSCH information" and "Downlink secondary cell info FDD".

Whenever the variable HS_DSCH_RECEPTION is set to TRUE, the UE shall:

- 1> set the variable HS_DSCH_RECEPTION_GENERAL to TRUE;
- 1> perform HS-SCCH reception procedures according to the stored HS-SCCH configuration as stated in:
 - 2> subclause 8.6.6.33 for the IE "HS-SCCH Info".
 - 2> for 1.28 Mcps TDD, when performing reception on signalling radio bearer before RAB has been established,
 - 3> if MAC-ehs is not configured,
 - 4> use the table of transport block size for the HS-DSCH physical layer category 1 as specified in [15], and consider the UE capability "Total number of soft channel bits in HS-DSCH" equal to that of the HS-DSCH physical layer category 1 as specified in [35].
 - 3> else,
 - 4> use the table of transport block size for the HS-DSCH physical layer category 9 as specified in [15], and consider the UE capability "Total number of soft channel bits in HS-DSCH" equal to that of the HS-DSCH physical layer category 9 as specified in [35].

NOTE 4: For 1.28 Mcps TDD, when performing transmission on signalling radio bearer before RAB has been established, UTRAN should use the same rules with the UE as described above, when performing scheduling and signalling the control information on HS-SCCH, as it is not possible for Node B to be aware of the UE's HSDPA capability category during this period.

- 1> perform HS-DSCH reception procedures according to the stored HS-PDSCH configuration as stated in:
 - 2> subclause 8.6.3.1b for the IE "H-RNTI";
 - 2> subclause 8.6.5.6b for the IE "HARQ info";
 - 2> subclause 8.6.6.34 for the IE "Measurement Feedback Info".
- 1> use the relevant CQI reporting table as stated in subclause 8.5.44.

In CELL_DCH, whenever the variable HS_DSCH_RECEPTION is set to FALSE, the UE shall:

- 1> not perform HS-SCCH reception procedures;

- 1> not perform HS-DSCH reception procedures.

For FDD and CELL_DCH state, determine the value for the SECONDARY_CELL_HS_DSCH_RECEPTION variable and take the corresponding actions as described in subclause 8.5.51.

8.5.26 Service prioritisation

If the UE detects an MBMS service reception inability as specified in subclause 8.5.30, the UE may:

- 1> request upper layers to prioritise the services and to initiate release of non- prioritised services that may cause interruption in the reception of the prioritised services;
- 1> if reception of the prioritised MBMS service is inhibited by one or more MBMS service(s) provided via a p-t-p radio bearer:
 - 2> request UTRAN to terminate these MBMS service(s) using the MBMS MODIFICATION REQUEST message as specified in subclause 8.7.6.

NOTE: The termination of MBMS services is performed by RRC procedures, while clearing of non- MBMS services is performed by upper layers.

8.5.27 MBMS frequency selection

The UE shall perform the MBMS frequency layer selection procedure upon receiving the IE "MBMS Preferred frequency information", when specified explicitly e.g. as in subclause 8.6.9.2, or when the priority for an MBMS service as indicated by upper layers changes.

The UE shall:

- 1> if there exist two or more preferred frequencies for services included in variable MBMS_ACTIVATED_SERVICES:
 - 2> request from upper layers the priorities of the different MBMS services included in variable MBMS_ACTIVATED_SERVICES for which a preferred frequency has been received.
- 1> if the UE is in idle mode:
 - 2> if a preferred frequency layer applies for a service included in variable MBMS_ACTIVATED_SERVICES:
 - 3> select the preferred frequency indicated for the MBMS service(s) prioritised most by upper layers for which a preferred frequency exists as the preferred frequency.
- 1> if the UE is in CELL_FACH, CELL_PCH or URA_PCH state; and
- 1> if there exists one or more preferred frequencies for services included in variable MBMS_ACTIVATED_SERVICES and the variable MBMS_PL_SERVICE_RESTRICTION_INFO_DEDICATED is set to FALSE:
 - 2> if the IE "RAB information" in the variable ESTABLISHED_RABS is not empty:
 - 3> if the current frequency is the frequency corresponding with the preferred frequency indicated for the MBMS service(s) prioritised most by upper layers for which a preferred frequency exists:
 - 4> select the current frequency as the preferred frequency.
 - 3> else:
 - 4> if there exists one or more preferred frequencies for services included in variable MBMS_ACTIVATED_SERVICES for which the IE "MBMS PL Service Restriction Information" has not been received in the MBMS GENERAL INFORMATION message:
 - 5> select the preferred frequency indicated for the MBMS service(s) prioritised most by upper layers for which a preferred frequency exists for which the IE "MBMS PL Service Restriction Information" has not been received in the MBMS GENERAL INFORMATION message as the preferred frequency.

- 2> else:
 - 3> select the preferred frequency indicated for the MBMS service(s) prioritised most by upper layers for which a preferred frequency exists as the preferred frequency.
- 1> if the UE is in CELL_DCH:
 - 2> if there exists one or more preferred frequencies for services included in variable MBMS_ACTIVATED_SERVICES and the variable MBMS_PL_SERVICE_RESTRICTION_INFO_DEDICATED is set to FALSE:
 - 3> if the current frequency does not correspond to the preferred frequency indicated for the MBMS service(s) prioritised most by upper layers for which a preferred frequency exists:
 - 4> select as preferred frequency the preferred frequency indicated for the MBMS service(s) prioritised most by upper layers for which a preferred frequency exists for which the IE "MBMS PL Service Restriction Information" is not included in the MBMS GENERAL INFORMATION message;
 - 4> if a preferred frequency has been selected and the current frequency is different from the selected frequency:
 - 5> request UTRAN to be moved to the preferred frequency by means of the MBMS MODIFICATION REQUEST message as specified in subclause 8.7.6;
 - 5> if the variable MBMS_PREV_FREQUENCY_INFO is empty:
 - 6> upon receiving a request to move to the requested preferred frequency, store the frequency information of the frequency on which the UE was operating prior to the hard-handover to the preferred frequency in the variable MBMS_PREV_FREQUENCY_INFO.
 - 1> if a preferred frequency has been selected:
 - 2> if the UE is not in CELL_DCH state:
 - 3> apply the cell-reselection procedure as described in [4], using the received "MBMS Preferred frequency information" applicable to the selected frequency;
 - 3> if the UE re-selects to a cell on the indicated preferred frequency:
 - 4> if HCS is not used, and the IE "Qoffmbms" is not present for the MBMS preferred frequency:
 - 5> consider the cells on the MBMS preferred frequency having a Qoffmbms equal to "infinity".
 - 4> if HCS is used, and the IE "HCS_OFFmbms" is not present for the MBMS preferred frequency:
 - 5> consider the cells on the MBMS preferred frequency having the highest HCS priority level.
 - 4> if the UE is in CELL_FACH, CELL_PCH or URA_PCH:
 - 5> act according to subclause 8.3.1.2.
 - 4> if the selected frequency is different to the frequency on which the UE was previously operating; and
 - 4> if the variable MBMS_PREV_FREQUENCY_INFO is empty:
 - 5> store the frequency information of the frequency on which the UE was operating prior to cell-reselection to the preferred frequency in the variable MBMS_PREV_FREQUENCY_INFO.
 - 4> apply the MCCH acquisition procedure, as specified in subclause 8.7.2.
 - 1> else:
 - 2> if the UE is not in CELL_DCH state:
 - 3> stop applying any "MBMS Preferred frequency information".
 - 3> if the UE is not redirected to another frequency; and

- 3> if the UE does not decide to receive an MBMS service; and
- 3> if the variable MBMS_PREV_FREQUENCY_INFO is not empty:
 - 4> if any frequency in SIB11 or SIB12 has the same frequency stored in the variable MBMS_PREV_FREQUENCY_INFO:
 - 5> select a suitable UTRA cell in that frequency;
 - 5> if no suitable UTRA cell in that frequency is found:
 - 6> select a suitable UTRA cell in another frequency.
 - 4> if no frequency in SIB11 or SIB12 has the same frequency stored in the variable MBMS_PREV_FREQUENCY_INFO:
 - 5> select a frequency randomly among the inter-frequencies indicated in SIB11 or SIB12:
 - 6> select a suitable UTRA cell in the selected frequency;
 - 6> if no suitable UTRA cell in the selected frequency is found:
 - 7> select a suitable UTRA cell in another frequency.
 - 4> clear the variable MBMS_PREV_FREQUENCY_INFO.

NOTE: The UE is only required to acquire the relevant SIB11 or SIB12, according to what is specified in subclauses 8.1.1.6.11 and 8.1.1.6.12.

8.5.28 Actions related to E_DCH_TRANSMISSION variable

The variable E_DCH_TRANSMISSION shall be set to TRUE only when all the following conditions are met:

- 1> the UE is in CELL_DCH state;
- 1> the variable E_RNTI includes either the Primary E-RNTI or the Secondary E-RNTI or both the Primary and the Secondary E-RNTI;
- 1> For FDD:
 - 2> the UE has stored the following IEs:
 - IE "E-DCH Transmission Time Interval";
 - IE "HARQ info for E-DCH";
 - IE "E-DCH info", including the IE "E-DPCCH info" and the IE "E-DPDCH info";
 - one of the radio links in the active set is configured as the serving E-DCH radio link, and for this radio link the UTRAN has configured the IE "E-HICH configuration" and the IE "E-AGCH info".
- 1> For TDD:
 - 2> for non-scheduled transmission, the UE has stored the following IEs:
 - IE "HARQ info for E-DCH";
 - IE "E-DCH information", including the IE "E-PUCH info";
 - IE "Non-scheduled transmission grant info".
 - 2> for scheduled transmission, the UE has stored the following IEs:
 - IE "HARQ info for E-DCH";
 - IE "E-DCH information", including the IE "E-RUCCH info" and the IE "E-PUCH info";

- IE "E-HICH info";
- IE "E-AGCH info".

1> there is at least one logical channel mapped to E-DCH for which:

- 2> the corresponding E-DCH MAC-d flow is configured, i.e. the IEs "E-DCH MAC-d flow power offset" and "E-DCH MAC-d flow maximum number of retransmissions", and the transmission grant type are configured.

If any of the above conditions is not met and the variable E_DCH_TRANSMISSION is set to TRUE, the UE in CELL_DCH state shall:

1> set the variable E_DCH_TRANSMISSION to FALSE;

1> stop any E-AGCH and E-HICH reception procedures;

1> For FDD:

- 2> stop any E-RGCH reception procedures.

1> For FDD:

- 2> stop any E-DPCCH and E-DPDCH transmission procedures.

1> For TDD:

- 2> stop any E-RUCCH and E-PUCH transmission procedures.

1> clear the variable E_RNTI;

1> act as if the IE "MAC-es/e reset indicator" was received and set to TRUE;

1> release all E-DCH HARQ resources;

1> no longer consider any radio link to be the serving E-DCH radio link.

Whenever the variable E_DCH_TRANSMISSION is set to TRUE, the UE shall:

1> if MAC-i/is is configured:

- 2> if MAC-ehs is not configured:

- 3> the UE behaviour is not specified.

1>For FDD:

- 2> perform E-AGCH reception procedures according to the stored E-AGCH configuration as stated in:

- 3> subclause 8.6.3.14 for the IE "New Primary E-RNTI" and the IE "New Secondary E-RNTI".

- 2> perform E-HICH reception procedures for all radio links in the E-DCH active set;

- 2> perform E-RGCH reception procedures for all radio links in the active set for which an E-RGCH configuration has been provided;

- 2> perform E-DPCCH transmission procedures according to the stored E-DPCCH configuration as stated in:

- 3> subclause 8.6.6.37 for the IE "E-DPCCH Info".

- 2> perform E-DPDCH transmission procedures according to the stored E-DPDCH configuration as stated in:

- 3> subclause 8.6.5.16 for the IE "E-DCH Transmission Time Interval";

- 3> subclause 8.6.5.17 for the IE "HARQ info for E-DCH";

- 3> subclause 8.6.6.37 for the IE "E-DPDCH Info".

- 2> inclusion of MAC-d PDU's in a MAC-e or MAC-i PDU for logical channels belonging to a MAC-d flow for which the IE "Non-scheduled transmission grant info" is configured shall:

- 3> obey the scheduling and size restrictions as specified for that MAC-d flow (see subclause 8.6.5.18).
- 2> inclusion of MAC-d PDU's in a MAC-e or MAC-i PDU for logical channels belonging to a MAC-d flow for which the IE "Scheduled transmission grant info" is configured shall:
 - 3> be performed in accordance with the received scheduling grant on E-AGCH/E-RGCH (see [15]); and
 - 3> obey the scheduling restrictions as specified for scheduled transmissions (see subclause 8.6.6.37).

1>For TDD:

- 2> if scheduled transmission is configured, perform E-AGCH reception procedures according to the stored E-AGCH configuration as stated in:
 - 3> subclause 8.6.3.14 for the IE "New Primary E-RNTI".
- 2> Perform E-HICH reception;
- 2> for 3.84/7.68 Mcps TDD, perform E-RUCCH transmission procedures according to the stored E-RUCCH configuration as stated in:
 - 3> subclause 8.6.6.37 for the IE "E-RUCCH Info".
- 2> for 1.28 Mcps TDD, if scheduled transmission is configured, perform E-RUCCH transmission procedure according to the stored PRACH configuration (see [60]) and the stored E-RUCCH configuration as stated in:
 - 3> subclause 8.6.6.37 for the IE "E-RUCCH Info".

NOTE 1: The PRACH configuration is signalled directly to the UE in "E-RUCCH Info" IE in case of E-DCH serving cell change.

- 2> Perform E-PUCH transmission procedures according to the stored E-PUCH configuration as stated in:
 - 3> subclause 8.6.6.37 for the IE "E-PUCH Info".
- 2> inclusion of MAC-d PDU's in a MAC-e or MAC-i PDU for logical channels belonging to a MAC-d flow for which the IE "Non-scheduled transmission grant info" is configured shall:
 - 3> obey the scheduling and size restrictions as specified for that MAC-d flow (see subclause 8.6.5.18).
- 2> inclusion of MAC-d PDU's in a MAC-e or MAC-i PDU for logical channels belonging to a MAC-d flow for which the IE "Scheduled transmission grant info" is configured shall:
 - 3> be performed in accordance with the received scheduling grant on E-AGCH (see [15]); and
 - 3> obey the scheduling restrictions as specified for scheduled transmissions (see subclause 8.6.6.37).
- 2> obtain and format the appropriate information on E-UCCH (see [15]).
- 2> for 1.28 Mcps TDD, when performing transmission on signalling radio bearer before RAB has been established,
 - 3> if MAC-i/is is not configured,
 - 4> use the tables of transport block size for the E-DCH physical layer category 1 as specified in [15].
 - 3> else,
 - 4> use the tables of transport block size for the E-DCH physical layer category 3 as specified in [15].

NOTE 2: For 1.28 Mcps TDD, when performing transmission on signalling radio bearer before RAB has been established, UTRAN should use the same rules with the UE as described above, when performing configuration, scheduling and reading the control information on E-UCCH, as it is not possible for Node B to be aware of the UE's E-DCH capability category during this period.

Whenever the variable E_DCH_TRANSMISSION is set to FALSE, the UE in CELL_DCH state shall:

- 1> not perform E-AGCH, E-HICH and/or E-RGCH reception procedures;

1> not perform E-DPCCH, E-DPDCH, E-RUCCH and/or E-PUCH transmission procedures.

8.5.29 MBMS modification period identity calculation

The UE shall calculate the identity of a Modification period as follows:

$$MP\ identity = (SFNMP \div MP_{len}) \bmod 2$$

With SFN_{MP} being the SFN corresponding with the frame in which the concerned Modification Period starts

MP_{len} being the length of the Modification Period, that is indicated by the IE 'Modification period coefficient' that is included in System Information Block type 5 and 5bis.

8.5.30 Detecting MBMS service reception inability

The UE may detect that it becomes incapable of receiving all services it is interested in at any time due to implementation specific constraints as well as upon state transitions, service / session start, service / session stop, service reconfiguration e.g. transfer mode change and preferred frequency layer changes or whenever there are changes concerning the subset of services that it has selected to receive.

When evaluating its MBMS service reception abilities, the UE shall:

- 1> consider that MBMS services, for which a preferred frequency layer is specified, are available only on the concerned frequency;
- 1> consider that MBMS services, for which no preferred frequency layer is specified are available on all frequencies;
- 1> consider non- MBMS services to be available on all frequencies unless specified otherwise in the following:
 - 1> if the variable MBMS_PL_SERVICE_RESTRICTION_INFO_DEDICATED is set to TRUE:
 - 2> consider the established non-MBMS services not to be available on any MBMS preferred frequency.
 - 1> if the IE "MBMS PL Service Restriction Information" is included in the MBMS GENERAL INFORMATION message for the MBMS preferred frequency the UE is considering to select to:
 - 2> consider non-MBMS services not to be available on the concerned MBMS preferred frequency.

If the UE is unable to receive the MBMS and the non-MBMS services it is interested in, the UE shall:

- 1> detect an MBMS service reception inability.

8.5.31 Actions related to DEFERRED_MEASUREMENT_STATUS variable

If after state transition the UE remains in a state other than CELL_DCH state, the UE shall:

- 1> if variable DEFERRED_MEASUREMENT_STATUS is set to TRUE:
 - 2> if System Information Block type 11 is referenced in the master information block or in the scheduling blocks:
 - 3> if the UE has not read and stored System Information Block type 11:
 - 4> read and store System Information Block type 11.
 - 3> if System Information Block type 11bis is referenced in the master information block or in the scheduling blocks:
 - 4> if the UE has not read and stored System Information Block type 11bis:
 - 5> read and store System Information Block type 11bis.
 - 2> if System Information Block type 12 is referenced in the master information block or in the scheduling blocks, or broadcast of System Information Block type 12 is indicated in System Information Block type 11:

- 3> if the UE has not read and stored System Information Block type 12:
 - 4> read and store System Information Block type 12.

8.5.32 Actions related to MIMO_PARAMS variable

If the UE receives an ACTIVE SET UPDATE, CELL UPDATE CONFIRM, or any reconfiguration message:

- 1> if the IE "MIMO parameters" is not included:
 - 2> clear the MIMO_PARAMS variable;
 - 2> trigger lower layers to stop operation in MIMO mode.
- 1> otherwise:
 - 2> for FDD, if the IE "MIMO N_cqi_typeA/M_cqi ratio" is included:
 - 3> store the value of the IE "MIMO N_cqi_typeA/M_cqi ratio" in the MIMO_PARAMS variable.
 - 2> for FDD, if the IE "MIMO pilot configuration" is included:
 - 3> store the value of the IE "MIMO pilot configuration" in the MIMO_PARAMS variable.
 - 2> for 1.28 Mcps TDD, if the IE "MIMO SF Mode for HS-PDSCH dual stream" is included:
 - 3> store the value of the IE "MIMO SF Mode for HS-PDSCH dual stream" in the MIMO_PARAMS variable.
 - 2> if the IE "MIMO operation" is set to "start":
 - 3> for FDD, if the IE "Precoding weight set restriction" is included:
 - 4> store the value of the IE "Precoding weight set restriction" in the MIMO_PARAMS variable. In addition, it shall be indicated to lower layers that precoding weight set restriction is configured.
 - 3> else:
 - 4> clear the value of the IE "Precoding weight set restriction" in the MIMO_PARAMS variable. In addition, it shall be indicated to lower layers that precoding weight set restriction is not configured.
 - 2> else if the IE "MIMO operation" is set to "continue":
 - 3> if the IE "Precoding weight set restriction" is included:
 - 4> if the IE "Precoding weight set restriction" is already stored in the variable MIMO_PARAMS before receiving this message:
 - 5> continue using "Precoding weight set restriction" for MIMO operation.
 - 4> else:
 - 5> UE behaviour is undefined.
 - 3> else:
 - 4> if the IE "Precoding weight set restriction" is already stored in the variable MIMO_PARAMS before receiving this message:
 - 5> continue using "Precoding weight set restriction" for MIMO operation.
 - 4> else:
 - 5> continue MIMO operation without using "Precoding weight set restriction".

NOTE: This subclause applies to FDD and 1.28 Mcps TDD only.

8.5.33 Actions related to MIMO_STATUS variable

If the UE receives an ACTIVE SET UPDATE, CELL UPDATE CONFIRM, or any reconfiguration message, the UE shall:

- 1> take actions related to the MIMO_PARAMS variable as specified in subclause 8.5.32;
- 1> determine the value of the MIMO_STATUS variable.

The MIMO_STATUS variable shall be set to TRUE only when all the following conditions are met:

- 1> The UE is in CELL_DCH state;
- 1> the variable HS_DSCH_RECEPTION is set to TRUE;
- 1> for FDD, the variable MIMO_PARAMS contains a value for the IE "MIMO N_cqi_typeA/M_cqi ratio"; and
- 1> for FDD, the variable MIMO_PARAMS contains a value for the IE "MIMO pilot configuration".
- 1> for 1.28 Mcps TDD, the variable MIMO_PARAMS contains a value for the IE "MIMO SF Mode for HS-PDSCH dual stream".

If any of the above conditions is not met and the MIMO_STATUS variable is set to TRUE, the UE shall:

- 1> set the MIMO_STATUS variable to FALSE;
- 1> clear the MIMO_PARAMS variable;
- 1> trigger lower layers to stop operation in MIMO mode.

If the MIMO_STATUS variable is set to FALSE:

- 1> if prior to receiving an ACTIVE SET UPDATE, CELL UPDATE CONFIRM, or any reconfiguration message, the MIMO_STATUS variable was set to TRUE:
 - 2> if the IE "HARQ info" is not included in the received message:
 - 3> the UE behaviour is unspecified.

If the MIMO_STATUS variable is set to TRUE:

- 1> if prior to receiving an ACTIVE SET UPDATE, CELL UPDATE CONFIRM, or any reconfiguration message, the MIMO_STATUS variable was set to FALSE:
 - 2> if the IE "HARQ info" is not included in the received message:
 - 3> the UE behaviour is unspecified.

NOTE: This subclause applies to FDD and 1.28 Mcps TDD only.

8.5.34 Actions related to DTX_DRX_STATUS variable (FDD only)

If the UE receives RRC CONNECTION SETUP, ACTIVE SET UPDATE, CELL UPDATE CONFIRM, any reconfiguration message, or target cell HS-SCCH order:

- 1> the UE shall determine the value for the DTX_DRX_STATUS variable.

The variable DTX_DRX_STATUS shall be set to TRUE only when all the following conditions are met:

- 1> the UE is in CELL_DCH state;
- 1> both variables HS_DSCH RECEPTION and E_DCH_TRANSMISSION are set to TRUE;
- 1> no DPDCH is present in uplink and F-DPCH is configured in downlink;
- 1> the variable DTX_DRX_PARAMS is set;

- 1> the IE "DTX-DRX timing information" is included in the received message or in the IE "Target cell preconfiguration information" stored in the variable TARGET_CELL_PRECONFIGURATION associated with the cell from which target cell HS-SCCH order is received.

If any of the above conditions is not met and the variable DTX_DRX_STATUS is set to TRUE, the UE shall:

- 1> set the variable DTX_DRX_STATUS to FALSE;
- 1> clear the variable DTX_DRX_PARAMS;
- 1> stop DTX-DRX mode related activities.

NOTE: If the uplink slot format is not changed by the received RRC message, the UE keeps using the same uplink slot format currently configured.

If the variable DTX_DRX_STATUS is set to TRUE and the serving HS-DSCH cell was changed as a result of the received message or HS-SCCH order from the target cell, the UE shall instruct the physical layer to consider that the HS-SCCH orders from the serving cell were never received.

If the variable DTX_DRX_STATUS is set to TRUE, the value of IE "DTX-DRX timing information" included in the message is "Continue" and the serving HS-DSCH cell was not changed as a result of the received message, the UE shall instruct the physical layer to consider that the DTX, DRX related HS-SCCH orders were received.

Whenever the variable DTX_DRX_STATUS is set to TRUE after receiving this message and the value of IE "DTX-DRX timing information" included in this message is not "Continue", the UE shall:

- 1> if the variable DTX_DRX_STATUS was set to TRUE before receiving this message:
 - 2> re-configure the physical layer to perform discontinuous uplink DPCH transmission and enable or disable discontinuous downlink reception operations according to the variable DTX_DRX_PARAMS at the CFN corresponding to the frame boundary that is offset by the value of the IE "Enabling Delay" from the frame boundary where uplink transmission starts with the new configuration;
 - 2> let the MAC layer continue any current restriction on E-DCH transmission and monitoring of absolute and relative grant channels from the frame boundary where the uplink transmission starts with the new configuration and for the duration of the IE "Enabling Delay".

NOTE: Whenever the variable DTX_DRX_STATUS is set to TRUE before and after receiving the message, the value of IE "DTX-DRX timing information" included in the message is not "Continue" and the serving HS-DSCH cell was not changed as a result of this message, the UE may or may not instruct the physical layer to consider that the DTX, DRX related HS-SCCH orders were never received.

1> else:

- 2> perform discontinuous uplink DPCH transmission and enable discontinuous downlink reception operations by configuring the physical layer according to the variable DTX_DRX_PARAMS at the CFN corresponding to the frame boundary that is offset by the value of the IE "Enabling Delay" from the frame boundary where the uplink transmission starts with the new configuration.
- 1> configure the MAC layer to start restricting E-DCH transmissions and monitor absolute and relative grant channels at the CFN corresponding to the frame boundary that is offset by the value of IE "Enabling Delay" from the frame boundary where the uplink transmission starts with the new configuration taking into account the IEs "UE DTX DRX Offset", "MAC DTX Cycle", "MAC Inactivity Threshold" and "Inactivity Threshold for UE Grant Monitoring".

NOTE: If a post-verification period is configured [29], then the uplink transmission starts when the physical channel establishment is initiated by the UE. If a post-verification period is configured and the post-verification procedure fails then uplink transmission (re)starts when the downlink physical channel is established and the enabling delay timer is (re)started. If a post-verification period is not configured, the uplink transmission starts when the downlink physical channel is established.

8.5.35 Actions related to HS_SCCH_LESS_STATUS variable (FDD only)

If the UE receives RRC CONNECTION SETUP, ACTIVE SET UPDATE, CELL UPDATE CONFIRM, or any reconfiguration message;

1> the UE shall determine the value for the HS_SCCH_LESS_STATUS variable.

The variable HS_SCCH_LESS_STATUS shall be set to TRUE only when all the following conditions are met:

- 1> the UE is in CELL_DCH state;
- 1> the variable HS_DSCH_RECEPTION is set to TRUE;
- 1> no DPDCH is present in uplink and F-DPCH is configured in downlink;
- 1> the UE is not configured in MIMO mode;
- 1> the variable HS_SCCH_LESS_PARAMS is set;
- 1> the IE "HS-SCCH less information" is included in the received message.

If any of the above conditions is not met and the variable HS_SCCH_LESS_STATUS is set to TRUE the UE shall:

- 1> set the variable HS_SCCH_LESS_STATUS to FALSE;
- 1> clear the variable HS_SCCH_LESS_PARAMS;
- 1> stop all HS-SCCH less related activities.

If variable HS_SCCH_LESS_STATUS is set to TRUE and the serving HS-DSCH cell was changed as a result of the received message or HS-SCCH order from the target cell, the UE shall instruct the physical layer to consider that the HS-SCCH orders from the serving cell were never received.

If the variable HS_SCCH_LESS_STATUS is set to TRUE, the value of IE "HS-SCCH less information" included in the message is not "Continue HS-SCCH less operation" and the serving HS-DSCH cell was not changed as a result of the received message, the UE shall instruct the physical layer to consider that the HS-SCCH less related HS-SCCH orders were never received.

If the variable HS_SCCH_LESS_STATUS is set to TRUE, the value of IE "HS-SCCH less information" included in the message is "Continue HS-SCCH less operation" and the serving HS-DSCH cell was not changed as a result of the received message, the UE shall instruct the physical layer to consider that the HS-SCCH less related HS-SCCH orders were received.

Whenever the variable HS_SCCH_LESS_STATUS is set to TRUE, the UE shall:

- 1> configure the physical and MAC layers to operate according to the HS_SCCH_LESS_PARAMS;
- 1> configure the physical layer to use a virtual IR buffer size of at least 4536 bits for HS-SCCH less HS-DSCH transmissions.

8.5.36 Actions related to HS_DSCH_RECEPTION_CELL_FACH_STATE variable (FDD and 1.28 Mcps TDD only)

The variable HS_DSCH_RECEPTION_CELL_FACH_STATE shall be set to TRUE only when all the following conditions are met:

- 1> the UE is in CELL_FACH;
- 1> the variable H_RNTI is set;
- 1> the variable C_RNTI is set;
- 1> the UE has stored the IE "Added or reconfigured MAC-ehs reordering queue";
- 1> System Information Block type 5 or System Information Block type 5bis includes IE "HS-DSCH common system information";
- 1> for 1.28 Mcps TDD, System Information Block type 5 includes IE "Common E-DCH system info".

If any of the above conditions is not met and the variable HS_DSCH_RECEPTION_CELL_FACH_STATE is set to TRUE, the UE shall:

- 1> set the variable HS_DSCH_RECEPTION_CELL_FACH_STATE to FALSE;
- 1> if the UE is in CELL_FACH and variable HS_DSCH_RECEPTION_OF_CCCH_ENABLED is set to FALSE:
 - 2> set the variable HS_DSCH_RECEPTION_GENERAL to FALSE;
 - 2> stop any HS-SCCH reception procedures;
 - 2> stop any HS-DSCH reception procedures;
 - 2> clear the variable H_RNTI and remove any stored H-RNTI;
 - 2> reset the MAC-ehs entity [15];
 - 2> release all HARQ resources;
 - 2> clear any stored IEs "HARQ info";

Whenever the variable HS_DSCH_RECEPTION_CELL_FACH_STATE is set to TRUE, the UE shall:

- 1> set the variable HS_DSCH_RECEPTION_GENERAL to TRUE;
- 1> use the IE "HS-DSCH common system information" in System Information Block type 5 or System Information Block type 5bis;
- 1> for FDD, receive the HS-SCCH(s) according to the IE "HS-SCCH channelisation code" on the serving cell applying the scrambling code as received in the IE "DL Scrambling code" as received in IE "HS-DSCH common system information";
- 1> for 1.28 Mcps TDD, receive the HS-SCCH(s) according to the stored HS-SCCH configuration, applying the HS-PDSCH midamble code according to the stored HS-PDSCH midamble configuration;
- 1> for FDD:
 - 2> determine the "Total number of soft channel bits" (defined in Table 5.1a of [35]) according to subclause 8.1.6.2 and use it in the physical layer;
 - 2> use the octet aligned HS-DSCH transport block table [15] in the MAC-ehs entity.
- 1> perform HS-DSCH reception procedures for DCCH or DTCH:
 - 2> if the UE has a stored IE "HARQ info":
 - 3> act on subclause 8.6.5.6b for the stored IE "HARQ info".
 - 2> else:
 - 3> act on subclause 8.6.5.20 for the IE "HARQ System info" as received in IE "HS-DSCH common system information".
 - 2> and use the value of the variable H_RNTI as UE identity in the HS-SCCH reception procedure in the physical layer.
 - 2> configure the MAC-ehs reordering queues according to IE "Added or reconfigured MAC-ehs reordering queue" as defined in subclauses 8.6.5.23.
- 1> and for FDD, for BCCH reception perform HS-DSCH reception procedures by listening to the first indexed HS-SCCH code listed in the IE "HS-SCCH channelisation code" with "BCCH specific H-RNTI" as received in IE "HS-DSCH common system information".
- 1> and for 1.28 Mcps TDD, for BCCH reception perform HS-DSCH reception procedures by listening to the first indexed HS-SCCH according to the stored HS-SCCH configuration with "BCCH specific H-RNTI" as received in IE "HS-DSCH common system information".

NOTE : For 1.28 Mcps TDD, when performing HS-DSCH reception in CELL_FACH state, the UE shall use the table of transport block size for the HS-DSCH physical layer category 9 as specified in [15].

Whenever the variable HS_DSCH_RECEPTION_CELL_FACH_STATE is set to FALSE, the UE shall:

- 1> if the UE is in CELL_FACH and variable HS_DSCH_RECEPTION_OF_CCCH_ENABLED is set to FALSE:
 - 2> not perform HS-SCCH reception procedures;
 - 2> not perform HS-DSCH reception procedures.

8.5.37 Actions related to HS_DSCH_RECEPTION_OF_CCCH_ENABLED variable (FDD and 1.28 Mcps TDD only)

When UE does not support HS-DSCH reception in CELL_FACH state or when the IE "HS-DSCH common system information" is not included in System Information Block type 5 or System Information Block type 5bis, the UE shall:

- 1> set the variable HS_DSCH_RECEPTION_OF_CCCH_ENABLED to FALSE;
- 1> set the variable HS_DSCH_RECEPTION_GENERAL to FALSE.

When the variable HS_DSCH_RECEPTION_OF_CCCH_ENABLED is set to TRUE, the UE shall:

- 1> set the variable HS_DSCH_RECEPTION_GENERAL to TRUE;
- 1> use the IE "HS-DSCH common system information" in System Information Block type 5 or System Information Block type 5bis;
- 1> for FDD:
 - 2> configure the physical layer to use the "Total number of soft channel bits" (defined in Table 5.1a of [35]) for category 12 for HS-DSCH reception;
 - 2> use the octet aligned HS-DSCH transport block table [15] in the MAC-ehs entity;
- 1> configure the HARQ according to IE "HARQ System info" as defined in subclause 8.6.5.20;
- 1> configure the common MAC-ehs reordering queues according to IE "Common MAC-ehs reordering queues" as defined in subclauses 8.6.5.22; and then
- 1> receive the CCCH according to IE "CCCH mapping info" as defined in subclause 8.6.5.21;
- 1> if the UE is RRC Connected mode:
 - 2> select a common H-RNTI as specified in 8.5.38;
 - 2> if the variable HS_DSCH_RECEPTION_OF_CCCH_ENABLED is set to TRUE:
 - 3> receive the SRB1 according to IE "SRB1 mapping info" as defined in subclause 8.6.5.19.
- 1> else:
 - 2> select a common H-RNTI as specified in [4].
- 1> and for FDD, start to receive the HS-SCCH(s) with selected H-RNTI according to the IE "HS-SCCH channelisation code" on the selected cell applying the scrambling code as received in the IE "DL Scrambling code";
- 1> and for 1.28 Mcps TDD, start to receive the HS-SCCH(s) with selected H-RNTI according to the IE "HS-SCCH system info" on primary frequency in the selected cell applying the midamble code as received in the IE "HS-PDSCH Midamble Configuration";
- 1> configure the MAC flow for BCCH reception as specified in [15];
- 1> and for FDD, start to receive the first indexed HS-SCCH code listed in the IE "HS-SCCH channelisation code" with "BCCH specific H-RNTI" as received in IE "HS-DSCH common system information".

- 1> and for 1.28 Mcps TDD, for BCCH reception perform HS-DSCH reception procedures by listening to the first indexed HS-SCCH according to the IE "HS-SCCH system info" with "BCCH specific H-RNTI" as received in IE "HS-DSCH common system information".

NOTE : For 1.28 Mcps TDD, when performing HS-DSCH reception in CELL_FACH state, the UE shall use the table of transport block size for the HS-DSCH physical layer category 9 as specified in [15].

8.5.37a Actions related to HS_DSCH_RECEPTION_GENERAL

The UE shall:

- 1> For CELL_FACH state, if the UE supports HS-DSCH reception in CELL_FACH state and the IE "HS-DSCH common system information" is not included in the System Information Block Type 5/5bis; or,
- 1> For CELL_PCH and URA_PCH state, if the UE supports HS-DSCH reception in CELL_PCH and URA_PCH state and the IE "HS-DSCH paging system information" is not included in System Information Block type 5 or System Information Block type 5bis:
 - 2> if the variable HS_DSCH_RECEPTION_GENERAL is set to TRUE:
 - 3> set the variable HS_DSCH_RECEPTION_GENERAL to FALSE;
 - 3> stop any HS-SCCH reception procedures;
 - 3> stop any HS-DSCH reception procedures;
 - 3> if the variable HSPA_RNTI_STORED_CELL_PCH is set to FALSE:
 - 4> clear the variable H_RNTI and remove any stored H-RNTI.
 - 3> reset the MAC-ehs entity [15];
 - 3> release all HARQ resources.

8.5.38 Common H-RNTI selection (FDD and 1.28 Mcps TDD only)

When the IE "Common H-RNTI Information" is included in System Information Block type 5 or System Information Block type 5bis, the UE shall select the Common H-RNTI according to the following rules:

- 1> compile a list of candidate Common H-RNTI IE(s) "Common H-RNTI" in the order of appearance in System Information Block type 5 or System Information Block type 5bis;
- 1> select a Common H-RNTI from the list of candidate Common H-RNTIs based on U-RNTI as follows:

$$\text{"Index of selected Common H-RNTI"} = \text{U-RNTI mod K},$$

where K is equal to the number of candidate Common H-RNTIs.

The UE shall set the CFN in relation to the SFN of the current cell according to subclause 8.5.15.

8.5.39 PICH selection for HSDPA based paging (FDD and 1.28 Mcps TDD only)

For FDD, when the IE "HS-DSCH paging system information" is included in System Information Block type 5 or System Information Block type 5bis and the UE is in UTRAN in CELL_PCH or URA_PCH state, the UE shall select the PICH according to the following rules:

- 1> compile a list of candidate PICH for HSDPA from IE(s) "HSDPA associated PICH info" in the order of appearance in System Information Block type 5 or System Information Block type 5bis;
- 1> select a PICH from the list of candidate PICHs based on U-RNTI as follows:

$$\text{"Index of selected HSDPA associated PICH"} = \text{U_RNTI value mod K},$$

where K is equal to the number of candidate PICHs for HSDPA.

For 1.28 Mcps TDD, when the IE "PICH for HS-DSCH list" is included in the IE "HS-DSCH paging system information" in System Information Block type 5 and the UE is in CELL_PCH or URA_PCH state, and the variable HS_DSCH_RECEPTION_GENERAL is set to TRUE, the UE shall select the PICH according to the following rules:

1> compile a list of candidate PICH for HSDPA from IE(s) "HSDPA associated PICH info" in the order of appearance in System Information Block type 5;

1> select a PICH from the list of candidate PICHs based on U-RNTI as follows:

$$\text{"Index of selected HSDPA associated PICH"} = U_RNTI \text{ value mod } K,$$

where K is equal to the number of candidate PICHs for HSDPA.

8.5.40 HS_DSCH Reception in CELL_PCH and URA_PCH (FDD only)

When the IE "HS-DSCH paging system information" is included in System Information Block type 5 or System Information Block type 5bis and the UE supports HS-DSCH reception in CELL_PCH and URA_PCH state and the UE is in CELL_PCH or URA_PCH state, the UE shall:

1> set the variable HS_DSCH_RECEPTION_GENERAL to TRUE;

1> use the octet aligned HS-DSCH transport block table [15] in the MAC-ehs entity;

1> if variable H_RNTI and variable C_RNTI are set and the UE is in CELL_PCH state:

2> determine the "Total number of soft channel bits" (defined in Table 5.1a of [35]) according to subclause 8.1.6.2 and use it in the physical layer;

2> for DCCH or DTCH reception:

3> use the value of the variable H_RNTI as UE identity in the HS-SCCH reception procedure in the physical layer

2> for BCCH reception:

3> perform HS-DSCH reception procedures by listening to the first indexed HS-SCCH code listed in the IE "HS-SCCH channelisation code" with "BCCH specific H-RNTI" as received in IE "HS-DSCH common system information" from System Information Block type 5 or System Information Block type 5bis.

2> if the UE detects the value of the variable H_RNTI in the HS-SCCH reception procedure:

3> initiate the measurement report procedure as specified in subclause 8.4.2;

3> move to CELL_FACH;

3> start to receive HS-DSCH according to the procedure in subclause 8.5.36;

3> stop timer T319 if it is running;

3> restart the timer T305 if it is set to any value other than "infinity".

2> if the UE has uplink RLC data PDU or uplink RLC control PDU on RB1 or upwards to transmit:

3> initiate the measurement report procedure as specified in subclause 8.4.2;

3> move to CELL_FACH state;

3> start to receive HS-DSCH according to the procedure in subclause 8.5.36;

3> stop timer T319 if it is running;

3> restart the timer T305 if it is set to any value other than "infinity".

1> else:

- 2> if variable H_RNTI or variable C_RNTI are set, or if the UE is in URA_PCH state:
 - 3> clear the variable H_RNTI;
 - 3> clear the variable C_RNTI;
 - 3> clear any stored IE "HARQ Info";
 - 3> reset the MAC-ehs entity [15].
- 2> perform the HS-DSCH reception procedure according to IE "HS-DSCH paging system information" as received in System Information Block type 5 or System Information Block type 5bis, receive the HS-PDSCH applying:
 - 3> a scrambling code as received in the IE "DL Scrambling code";
 - 3> a channelisation code selected according to 8.5.41 in "Number of PCCH transmissions" consecutive TTIs;
 - 3> the Transport block sizes indexed in the IE "Transport Block Size List" for demultiplexing of upper layer PDUs from transport blocks delivered from the physical layer on HS-DSCH, as described in [29]; and
 - 3> configure the physical layer to use the "Total number of soft channel bits" (defined in Table 5.1a of [35]) for category 12 for HS-DSCH reception.

8.5.40a HS_DSCH Reception in CELL_PCH and URA_PCH (1.28 Mcps TDD only)

When the IE "HS-DSCH paging system information" is included in System Information Block type 5 and the UE is in CELL_PCH or URA_PCH state, the UE shall:

- 1> if variable H_RNTI and variable C_RNTI are set:
 - 2> if the UE is in CELL_PCH state:
 - 3> set the variable HS_DSCH_RECEPTION_GENERAL to TRUE;
 - 3> use the value of the variable H_RNTI as UE identity in the HS-SCCH reception procedure in the physical layer for DCCH or DTCH reception; and
 - 3> for BCCH reception perform HS-DSCH reception procedures by listening to the first indexed HS-SCCH code listed in the IE "HS-SCCH channelisation code" for FDD or first instance in the IE "HS-SCCH Set Configuration" for 1.28 Mcps TDD with "BCCH specific H-RNTI" as received in IE "HS-DSCH common system information" from System Information Block type 5 or System Information Block type 5bis;
 - 3> if the UE detects the value of the variable H_RNTI in the HS-SCCH reception procedure:
 - 4> initiate the enhanced uplink synchronization procedure;
 - 4> move to CELL_FACH;
 - 4> stop timer T319 if it is running.
 - 3> if the UE has uplink RLC data PDU or uplink RLC control PDU on RB1 or upwards to transmit:
 - 4> move to CELL_FACH state;
 - 4> stop timer T319 if it is running.
 - 2> if the UE is in URA_PCH state:
 - 3> clear the variable H_RNTI;
 - 3> clear the variable C_RNTI;
 - 3> clear any stored IE "HARQ Info";

- 3> reset the MAC-ehs entity [15];
- 3> if the IE "PICH info" isn't included in IE "Secondary CCPCH system information" in System Information Block type 5 or System Information Block type 6:
 - 4> set the variable HS_DSCH_RECEPTION_GENERAL to TRUE;
 - 4> perform the HS-DSCH reception procedure according to IE "HS-DSCH paging system information" as received in System Information Block type 5:
 - 5> receive the HS-PDSCH applying the configuration according to 8.5.41 in "Paging Sub-Channel Size" * 2 consecutive TTIs and use the Transport block sizes indexed in the IE "Transport Block Size List" for demultiplexing of upper layer PDUs from transport blocks delivered from the physical layer on HS-DSCH, as described in [33].
- 1> else:
 - 2> if variable H_RNTI or variable C_RNTI are set:
 - 3> clear the variable H_RNTI;
 - 3> clear the variable C_RNTI;
 - 3> clear any stored IE "HARQ Info";
 - 3> reset the MAC-ehs entity [15].
 - 2> if the IE "PICH info" isn't included in IE "Secondary CCPCH system information" in System Information Block type 5 or System Information Block type 6:
 - 3> set the variable HS_DSCH_RECEPTION_GENERAL to TRUE;
 - 3> perform the HS-DSCH reception procedure according to IE "HS-DSCH paging system information" as received in System Information Block type 5, receive the HS-PDSCH applying:
 - 4> HS-PDSCH configuration selected according to 8.5.41 in "Paging Sub-Channel Size" * 2 consecutive TTIs;
 - 4> the Transport block sizes indexed in the IE "Transport Block Size List" for demultiplexing of upper layer PDUs from transport blocks delivered from the physical layer on HS-DSCH, as described in [33].

NOTE : When performing HS-DSCH reception in CELL_PCH and URA_PCH state, the UE shall use the table of transport block size for the HS-DSCH physical layer category 9 as specified in [15].

8.5.41 HS-PDSCH channelisation codes selection for paging reception (FDD and 1.28 Mcps TDD only)

For FDD, when the IE "HS-DSCH paging system information" is included in System Information Block type 5 or System Information Block type 5bis and the UE is in UTRAN in CELL_PCH or URA_PCH state with variable H_RNTI not set, the UE shall select the channelisation code for HS-PDSCH reception according to the following rules:

- 1> compile a list of candidate HS-PDSCH channelisation codes from the IE(s) "HS-PDSCH Channelisation Code" in the order of appearance in System Information Block type 5 or System Information Block type 5bis;
- 1> select a HS-PDSCH channelisation codes from the list of candidate HS-PDSCH channelisation codes based on U-RNTI as follows:

"Index of selected HS-PDSCH channelisation codes" = U_RNTI value mod K,

where K is equal to the number of candidate HS-PDSCH channelisation codes.

For 1.28 Mcps TDD, when the IE "Paging associated HS-PDSCH info" is included in the IE "HS-DSCH paging system information" in System Information Block type 5 and the UE is in CELL_PCH or URA_PCH state, and the variable

HS_DSCH_RECEPTION_GENERAL is set to TRUE, the UE shall select the HS-PDSCH according to the following rules:

1> compile a list of candidate HS-PDSCH configuration from IE(s) "Paging associated HS-PDSCH info" in the order of appearance in System Information Block type 5;

1> select an HS-PDSCH configuration from the list of candidate HS-PDSCHs based on U-RNTI as follows:

$$\text{"Index of selected HS-PDSCH"} = U_RNTI \text{ value mod } K,$$

where K is equal to the number of candidate HS-PDSCH configuration.

8.5.42 Autonomous UTRAN DRX Cycle length coefficient change

If timer T319 expires:

1> set k to the value of the stored IE "DRX cycle length coefficient";

1> store the result of $\text{MAX}(2^k, \text{PBP})$, where PBP is the Paging Block Periodicity, as the DRX cycle length; and

1> determine its connected mode paging occasions and PICH monitoring occasions in the same way as for idle mode, according to [4].

NOTE: The DRX cycle length to use in connected mode is defined in [4].

8.5.43 Reception of MBMS from a cell operating in MBSFN mode

A cell provides MBMS service in MBSFN mode if it is indicated so in system information, see subclause 8.1.1.6.3. A UE that supports MBSFN operation may receive MBMS services via a cell operating in MBSFN mode. For FDD, 3.84 Mcps TDD IMB and 3.84/7.68 Mcps TDD in order to receive an MBMS service via a MBSFN cluster the UE shall select the MBSFN cluster as specified in [4] in addition to selecting a cell for normal camping as specified in [4]. For 1.28 Mcps TDD in order to receive an MBMS service via an MBSFN cluster the UE shall at the first step camp on a unicast cell and get the frequency and "cell parameter ID" from the system information, and then get synchronized to the MBSFN cluster operating with that frequency and "cell parameter ID". For 3.84/7.68 Mcps TDD a cell shall be considered to be operating in MBSFN mode when individual scrambling codes are assigned to all timeslots (via the IE "TDD MBSFN Information").

For 3.84 Mcps TDD IMB, MBMS reception is provided on a 3.84 Mcps TDD frequency [22]. The S-CCPCH frame type 2 format shall be used for the S-CCPCHs carrying MTCH. Unless specified otherwise, the RRC protocol is operated according to the FDD requirements applicable for MBSFN.

8.5.44 HS-DSCH CQI reporting tables

If the variable HS_DSCH_RECEPTION is set to "TRUE", the UE shall:

1> if the UE has been configured with at least one MAC-ehs reordering queue:

2> use the relevant CQI tables, as defined in [29], for the HS-DSCH category indicated by the IE "HS-DSCH physical layer category extension" or "HS-DSCH physical layer category extension2" stored in the variable UE_CAPABILITY_TRANSFERRED. For 1.28 Mcps TDD, use the table of transport block size, as defined in [15], for the HS-DSCH category indicated by the IE "HS-DSCH physical layer category extension" stored in the variable UE_CAPABILITY_TRANSFERRED.

1> otherwise:

2> use the relevant CQI tables, as defined in [29], for the HS-DSCH category indicated by the IE "HS-DSCH physical layer category" stored in the variable UE_CAPABILITY_TRANSFERRED. For 1.28 Mcps TDD, use the table of transport block size, as defined in [15], for the HS-DSCH category indicated by the IE "HS-DSCH physical layer category" stored in the variable UE_CAPABILITY_TRANSFERRED.

8.5.45 Enhanced Uplink in CELL_FACH state and Idle mode (FDD only)

For this version of the specification, when a UE selects a cell, the uplink frequency to be used for the PRACH preamble (physical signal) and DPCCH/E-DPCCH/E-DPDCH transmission shall have a default duplex frequency spacing offset from the downlink frequency that the cell was selected on. The default duplex frequency separation to be used by the UE is specified in [21] for each frequency band.

If variable `READY_FOR_COMMON_EDCH` is set to `TRUE` the UE shall:

- 1> configure and use the MAC and the physical layer for the PRACH preamble transmission according to the parameters included in the selected "PRACH preamble control parameters (for Enhanced Uplink)" IE according [15];
- 1> compile a list of candidate common E-DCH resource configuration in the order of appearance as contained in IE "Common E-DCH Resource Configuration information list".

If variable `READY_FOR_COMMON_EDCH` is set to `TRUE`, then after receiving the "E-DCH resource index" by MAC with the `CMAC-STATUS` primitive, the UE selects the Common E-DCH Resource Configuration from the list of candidate common E-DCH resource configuration as follows:

"Index of the selected Common E-DCH resource configuration" = "E-DCH resource index".

After selection of a common E-DCH resource configuration, the UE shall configure MAC and the physical layer for E-DCH and HSDPA transmission according to the following:

- 1> configure Uplink DPCH in accordance with the uplink DPCCH slot format 1 [26], the IE "Uplink DPCH code info" and IE "Uplink DPCH power control info";
- 1> if IE "ACK/NACK support on HS-DPCCH" is set to `TRUE`:
 - 2> if any of the IE "ACK", "NACK" or "Ack-Nack repetition factor" is not included in the IE "Uplink DPCH power control info":
 - 3> the UE behaviour is not specified.
 - 2> else:
 - 3> configure the HS-DPCCH in accordance with HS-DPCCH slot format [26], the HS-DPCCH code [28] and IE "Uplink DPCH power control info".
- 1> configure the common E-DCH MAC-d flows as described in subclause 8.6.5.24;
- 1> configure the UL E-DPCCH in accordance with the IE "E-DPCCH info" configuration;
- 1> apply the TTI as signalled in the IE "E-DCH Transmission Time Interval" on the E-DPDCH;
- 1> use a redundancy version for each HARQ transmission as configured by the IE "HARQ RV Configuration";
- 1> use the same scrambling code for F-DPCH, E-RGCH, E-HICH and E-AGCH reception as configured for the Primary CPICH;
- 1> use a channelization code for F-DPCH reception as configured by IE "F-DPCH Code number";
- 1> configure F-DPCH in accordance with the F-DPCH slot format #0 [26];
- 1> apply the `DPC_Mode=0` for F-DPCH according to [29];
- 1> configure the MAC with the stored IE "E-DPDCH info" configuration and/or the information contained in IE "Scheduled Transmission configuration";
- 1> configure the E-HICH in accordance with the IE "E-HICH info" configuration;
- 1> configure the E-AGCH in accordance with the IE "E-AGCH info" configuration;
- 1> configure the E-RGCH in accordance with the IE "E-RGCH info" configuration if an E-RGCH configuration has been provided with the system information;

- 1> configure the radio link as the serving E-DCH radio link;
- 1> determine the value for the COMMON_E_DCH_TRANSMISSION variable and take the corresponding actions as described in subclause 8.5.46.

8.5.45a Enhanced Uplink in CELL_FACH state and Idle mode (1.28 Mcps TDD only)

If variable READY_FOR_COMMON_EDCH is set to TRUE, the RRC in the UE shall configure MAC and the physical layer for E-DCH and HS-DSCH transmission, and the UE shall:

- 1> configure the common E-DCH MAC-d flows as described in subclause 8.6.5.24;
- 1> use a redundancy version for each HARQ transmission as configured by the IE "HARQ info for E-DCH";
- 1> configure the PHY with the stored IE "E-PUCH info" configuration and the information contained in IE "E-RUCCH info";
- 1> configure the E-HICH in accordance with the stored IE "E-HICH info" configuration;
- 1> configure the E-AGCH in accordance with the stored IE "E-AGCH info" configuration;
- 1> configure the radio link as the serving E-DCH radio link;
- 1> determine the value for the COMMON_E_DCH_TRANSMISSION variable and take the corresponding actions as described in subclause 8.5.46.

NOTE: For 1.28 Mcps TDD, when performing E-DCH transmission in CELL_FACH state and Idle mode, the UE shall use the tables of transport block size for the E-DCH physical layer category 3 as specified in [15].

8.5.46 Actions related to COMMON_E_DCH_TRANSMISSION variable (FDD and 1.28 Mcps TDD only)

The variable COMMON_E_DCH_TRANSMISSION shall be set to TRUE only when all the following conditions are met:

- 1> the UE is in CELL_FACH state or Idle mode;
- 1> one radio link is configured as the serving E-DCH radio link, and for this radio link the UTRAN has configured the IE "E-HICH info" and the IE "E-AGCH info", and for 1.28Mcps TDD the IE "E-RUCCH Info" and "E-PUCH Info";
- 1> all logical channels are mapped to E-DCH, and for each of which there is:
 - 2> one E-DCH MAC-d flow is configured, i.e. the IEs "E-DCH MAC-d flow power offset", "E-DCH MAC-d flow maximum number of retransmissions", and for 1.28 Mcps TDD, the IEs "E-DCH MAC-d flow retransmission timer".

If any of the above conditions is not met and the variable COMMON_E_DCH_TRANSMISSION is set to TRUE, the UE shall:

- 1> set the variable COMMON_E_DCH_TRANSMISSION to FALSE;
- 1> if not in CELL_DCH state:
 - 2> stop any E-AGCH, E-RGCH (FDD only) and E-HICH reception procedures;
 - 2> for FDD, stop any E-DPCCH and E-DPDCH transmission procedures;
 - 2> for 1.28 Mcps TDD, stop any E-RUCCH and E-PUCH transmission procedure;
 - 2> act as if the IE "MAC-es/e reset indicator" was received and set to TRUE;
 - 2> release all E-DCH HARQ resources;

2> no longer consider any radio link to be the serving E-DCH radio link.

For FDD, whenever the variable COMMON_E_DCH_TRANSMISSION is set to TRUE, the UE shall:

- 1> perform uplink DPCCCH transmission;
- 1> if a CCCH message is submitted for transmission on the uplink:
 - 2> no E-AGCH and E-RGCH reception procedure is performed in the physical layer.
- 1> if a DCCH and/or DTCH message is submitted for transmission on the uplink:
 - 2> use the value stored in the variable E_RNTI as UE identity in the E-AGCH reception procedure in the physical layer;
 - 2> perform E-RGCH reception procedure for the serving radio link if an E-RGCH configuration has been provided with the common E-DCH resource.
- 1> perform E-HICH reception procedures for the serving E-DCH radio link;
- 1> perform E-DPCCH transmission procedures for the serving E-DCH radio link;
- 1> perform E-DPDCH transmission procedures for the serving E-DCH radio link;
- 1> perform the inclusion of MAC-d PDUs or MAC-c PDUs in a MAC-i PDU for logical channels belonging to the MAC-d or MAC-c flows in accordance with the serving grant (see [15]);
- 1> if transmitting DCCH or DTCH data:
 - 2> if IE "ACK/NACK support on HS-DPCCH" is set to TRUE:
 - 3> after collision resolution provide ACK/NACK feedback in accordance with [29] in the physical layer on the serving HS-DSCH radio link, using the information in the IE "Uplink DPCH power control info";
 - 3> after collision resolution use the information for the channel quality indication (CQI) procedure in the physical layer on the serving HS-DSCH radio link if the IE "Measurement Feedback Info" has been provided with the common E-DCH resource.
- 1> if the UE received the "Enhanced Uplink in CELL_FACH and Idle mode process termination" by MAC with the CMAC-STATUS primitive; or
- 1> if the UE according to subclause 8.5.4A failed to establish the physical channels; or
- 1> if the criteria for radio link failure are met as specified in subclause 8.5.6:
 - 2> set the variable COMMON_E_DCH_TRANSMISSION to FALSE;
 - 2> stop any E-AGCH, E-RGCH and E-HICH reception procedures;
 - 2> stop any E-DPCCH and E-DPDCH transmission procedures;
 - 2> act as if the IE "MAC-es/e reset indicator" was received and set to TRUE;
 - 2> release all E-DCH HARQ resources;
 - 2> no longer consider any radio link to be the serving E-DCH radio link.

For 1.28 Mcps TDD, whenever the variable COMMON_E_DCH_TRANSMISSION is set to TRUE, the UE shall:

- 1> if CCCH message is submitted for transmission on the uplink and if the variable E_RNTI is not set:
 - 2> select a common E-RNTI according to subclause 8.5.50;
 - 2> perform E-RUCCH transmission procedure, using the selected common E-RNTI as UE identity;
 - 2> use the selected common E-RNTI as UE identity in the E-AGCH reception procedure in the physical layer in the common E-RNTI scheduling window according to subclause 8.5.50.

1> else:

- 2> perform E-RUCCH transmission procedure according to the stored PRACH configuration (see [60]), using the value stored in the variable E_RNTI as UE identity;
- 2> use the value stored in the variable E_RNTI as UE identity in the E-AGCH reception procedure in the physical layer.

1> perform E-HICH reception procedures for the serving E-DCH radio link;

1> perform E-PUCH transmission procedures according to the stored E-PUCH configuration;

1> perform the inclusion of MAC-d PDUs and MAC-c PDUs in a MAC-i PDU for logical channels belonging to the MAC-d flows in accordance with the received scheduling grant on E-AGCH (see [15]).

NOTE: For 1.28 Mcps TDD, when performing E-DCH transmission in CELL_FACH state and Idle mode, the UE shall use the tables of transport block size for the E-DCH physical layer category 3 as specified in [15].

Whenever the variable COMMON_E_DCH_TRANSMISSION is set to FALSE, the UE shall:

1> if not in CELL_DCH state:

- 2> for FDD, not perform uplink DPCCH transmission;
- 2> not perform E-AGCH, E-RGCH (FDD only) and E-HICH reception procedures;
- 2> for FDD, not perform E-DPCCH and/or E-DPDCH transmission procedures;
- 2> for 1.28 Mcps TDD, not perform E-RUCCH and E-PUCH transmission procedures.

8.5.47 Actions related to READY_FOR_COMMON_EDCH variable (FDD and 1.28 Mcps TDD only)

The variable READY_FOR_COMMON_EDCH shall be set to TRUE only when all the following conditions are met:

1> if the UE is in CELL_FACH state or in Idle mode:

- 2> the UE supports E-DCH transmission in CELL_FACH state and Idle mode;
- 2> the IE "HS-DSCH common system information" is included in system information block type 5 or 5bis;
- 2> the IE "Common E-DCH system info" is included system information block type 5 or 5bis.

1> if the UE is in CELL_PCH state:

- 2> the UE supports E-DCH transmission in CELL_FACH state and Idle mode;
- 2> the UE supports HS-DSCH reception in CELL_PCH and URA_PCH state;
- 2> the IE "HS-DSCH paging system information" is included in system information block type 5 or 5bis;
- 2> the IE "Common E-DCH system info" is included system information block type 5 or 5bis;
- 2> variable H-RNTI is set;
- 2> variable E_RNTI is set;
- 2> variable C_RNTI is set.

If any of the above conditions is not met and the variable READY_FOR_COMMON_EDCH is set to TRUE, the UE shall:

1> set the variable READY_FOR_COMMON_EDCH to FALSE;

1> if in CELL_FACH, CELL_PCH, URA_PCH state or in Idle mode:

- 2> if the variable HSPA_RNTI_STORED_CELL_PCH is set to FALSE:

- 3> clear variable E-RNTI.
- 2> reset the MAC-is/i entity [15];
- 2> if in connected mode and System Information Block type 6 is indicated in System Information Block type 5 or 5bis as used in the cell:
 - 3> replace the TFS of the RACH with the one stored in the UE if any;
 - 3> let the physical channel(s) of type PRACH given by the IE(s) "PRACH info" be the default in uplink if UE is in CELL_FACH state. If the IE "PRACH info" is not included in System Information Block type 6, the UE shall read the corresponding IE(s) in System Information Block type 5 or System Information Block type 5bis and use that information to configure the PRACH;
 - 3> start to receive the physical channel of type AICH using the parameters given by the IE "AICH info" when associated PRACH is used. If the IE "AICH info" is not included in System Information Block type 6, the UE shall read the corresponding IE in System Information Block type 5 or System Information Block type 5bis and use that information (FDD only);
 - 3> if the IE "Additional Dynamic Transport Format Information for CCCH" is included for the selected RACH:
 - 4> use this transport format for transmission of the CCCH (FDD only).
 - 3> else:
 - 4> use the first instance of the list of transport formats as in the IE "RACH TFS" for the used RACH received in the IE "PRACH system information list" when using the CCCH (FDD only).
- 2> else:
 - 3> replace the TFS of the RACH with the one stored in the UE if any;
 - 3> let the physical channel(s) of type PRACH given by the IE(s) "PRACH info" in System Information Block type 5 or 5bis be the default in uplink for the PRACH if UE is in CELL_FACH state;
 - 3> start to receive the physical channel of type AICH using the parameters given by the IE "AICH info" in System Information Block type 5 or 5bis when given allocated PRACH is used;
 - 3> if the IE "Additional Dynamic Transport Format Information for CCCH" is included in System Information Block type 5 or 5bis for the selected PRACH:
 - 4> use this transport format for transmission of the CCCH.
 - 3> else:
 - 4> use the first instance of the list of transport formats as in the IE "RACH TFS" in System Information Block type 5 or 5bis for the used RACH received in the IE "PRACH system information list" in System Information Block type 5 or 5bis when using the CCCH.

If variable READY_FOR_COMMON_EDCH is set to TRUE:

- 1> if the UE is in CELL_PCH state; and
- 1> if the UE has uplink RLC data PDU or uplink RLC control PDU on RB1 or upwards to transmit:
 - 2> initiate the measurement report procedure as specified in subclause 8.4.2;
 - 2> move the UE to CELL_FACH state;
 - 2> restart the timer T305 using its initial value if periodical cell update has been configured by T305 in the IE "UE Timers and constants in connected mode" set to any other value than "infinity".
- 1> for 1.28 Mcps TDD, if the UE is in CELL_PCH state and if the UE initiates uplink synchronization:
 - 2> move the UE to CELL_FACH state.

8.5.48 Actions related to HS_DSCH_DRX_CELL_FACH_STATUS variable (FDD and 1.28 Mcps TDD only)

The HS_DSCH_DRX_CELL_FACH_STATUS variable shall be set to TRUE only when the following conditions are met:

- 1> the UE supports HS-DSCH DRX operation in CELL_FACH state;
- 1> the UE is in CELL_FACH state;
- 1> the UE has a dedicated H-RNTI configured;
- 1> the IE "HS-DSCH DRX in CELL_FACH Information" for FDD or IE "HS-DSCH DRX in CELL_FACH Information 1.28 Mcps TDD" for 1.28 Mcps TDD has been received from System Information Block Type 5 or System Information Block Type 5bis;
- 1> for 1.28 Mcps TDD, UE with dedicated H-RNTI configured, after transitting from CELL_PCH to CELL_FACH state, has detected its dedicated H-RNTI on HS-SCCH indicating HS-DSCH reception;
- 1> for FDD, either of the following conditions is met:
 - 2> the value of the IE "DRX Interruption by HS-DSCH data" received from System Information Block Type 5 or System Information Block Type 5bis has been set to TRUE; or
 - 2> the UE supports common E-DCH transmission and the IE "Common E-DCH system info" is included in System Information Block type 5 or System Information Block Type 5bis.

If any of the above conditions is not met and the HS_DSCH_DRX_CELL_FACH_STATUS variable is set to TRUE, the UE shall:

- 1> stop any ongoing CELL_FACH HS-DSCH DRX operation;
- 1> set the HS_DSCH_DRX_CELL_FACH_STATUS to FALSE;
- 1> stop the timer T321, if it is ongoing.

8.5.49 CELL_FACH HS-DSCH DRX operation (FDD only)

The CELL_FACH HS-DSCH DRX operation determines the occasions in which the UE is allowed to discontinuously receive HS-DSCH in CELL_FACH state.

If the variable HS_DSCH_DRX_CELL_FACH_STATUS is set to TRUE, the UE shall:

- 1> if E-DCH resource index information is received from lower layers:
 - 2> stop the timer T321, if it is ongoing;
 - 2> continuously receive HS-DSCH.
- 1> if E-DCH enhanced random access process termination information is received from lower layers:
 - 2> start the timer T321.
- 1> if the value of the IE "DRX Interruption by HS-DSCH data" received from System Information Block Type 5 or System Information Block Type 5bis is TRUE:
 - 2> if the UE does not have an E-DCH resource assigned and data is received on HS-DSCH:
 - 3> start or, if the timer is running, restart the timer T321 at the end of the HS-SCCH subframe addressed to this UE.
 - 3> continuously receive HS-DSCH.

Upon timer T321 expiry:

- 1> the UE shall receive HS-DSCH during the frame(s) with the SFN value fulfilling the following inequality:

$$(\text{SFN} - \text{H-RNTI} + 65536) \bmod \text{DRX_cycle} < \text{Rx_burst}$$

where:

- H-RNTI is the value stored in the variable H_RNTI;
- DRX_cycle is the length of the DRX cycle in radio frames, signalled by the IE "HS-DSCH DRX cycle_{FACH}";
- Rx burst is the period in frames within the DRX cycle, in which the UE receives HS-DSCH, signalled by the IE "HS-DSCH Rx burst_{FACH}".

For FDD when in CELL_FACH state, when the variable HS_DSCH_RECEPTION_CELL_FACH_STATE is set to TRUE and the variable HS_DSCH_DRX_CELL_FACH_STATUS is set to TRUE, then the UE in FDD mode shall perform measurements as specified in subclauses 8.4.1.6 and 8.4.1.9, according to the requirements in [19].

8.5.49a CELL_FACH HS-DSCH DRX operation (1.28Mcps TDD only)

The CELL_FACH HS-DSCH DRX operation determines the occasions in which the UE is allowed to discontinuously receive HS-DSCH in CELL_FACH state.

The HS-DSCH DRX pattern is the set of frames in which the UE shall receive on downlink during the frame(s) with the SFN value fulfilling the following inequality:

$$(\text{SFN} - \text{H-RNTI} + 65536) \bmod \text{DRX_cycle} < \text{Rx_burst}$$

where:

- H-RNTI is the value stored in the variable H_RNTI;
- DRX_cycle is the length of the DRX cycle in radio frames, signalled by the IE "DRX cycle_{FACH}";
- Rx burst is the period in frames within the DRX cycle, in which the UE receives on downlink, signalled by the IE "Rx burst_{FACH}".

8.5.50 Common E-RNTI selection (1.28 Mcps TDD only)

When the IE "Common E-RNTI Information" is included in System Information Block type 5, and if the UE is in CELL_FACH state or Idle mode, and if the variable E_RNTI is not set, UE shall use a common E-RNTI for CCCH transmission (i.e. the common E-RNTI identifies the initial access, including RRC connection request and cell update after cell re-selection):

1> configure the MAC layer with the information in the IE(s) "Common E-RNTI information";

1> when a CCCH message is to be sent, and if the variable E_RNTI is not set, the MAC layer operates as follows:

2> select an E-RUCCH;

2> select the instance of the IE(s) "Common E-RNTI information" which is related to the selected E-RUCCH;

2> select a common E-RNTI which is related to the selected E-RUCCH according to the following procedure:

3> compile a list of candidate common E-RNTI group from the selected instance of the IE(s) "Common E-RNTI information" in the order of appearance in System Information Block type 5, and select a common E-RNTI group from the list of candidate Common E-RNTI groups based on the E-RUCCH transmission occasion:

"Index of selected Common E-RNTI group" = $\text{SFN}_{\text{E-RUCCH}} \bmod K$, for TTI of E-RUCCH = 10ms;

or "Index of selected Common E-RNTI group" = $\text{SFN} \cdot \text{E-RUCCH} \bmod K$, for TTI of E-RUCCH = 5ms;

Where K is the number of E-RNTI groups related to the E-RUCCH; $\text{SFN}_{\text{E-RUCCH}}$ or $\text{SFN}_{\text{E-RUCCH}}$ is the frame or sub-frame on which the E-RUCCH shall be sent [33].

3> select a common E-RNTI randomly amongst the candidate the candidate E-RNTIs in the selected group.

- 2> use the value of the selected common E-RNTI as UE identity in current E-RUCCH transmission, and in the E-AGCH reception within the common E-RNTI scheduling window which is of K frames or K sub-frames length.

8.5.51 Actions related to SECONDARY_CELL_HS_DSCH_RECEPTION variable (FDD only)

The variable SECONDARY_CELL_HS_DSCH_RECEPTION shall be set to TRUE only when all the following conditions are met:

- 1> the UE is in CELL_DCH state;
- 1> the IE "Downlink Secondary Cell Info FDD" is not empty;
- 1> the variable HS_DSCH_RECEPTION is set to TRUE

If any of the above conditions is not met and the variable SECONDARY_CELL_HS_DSCH_RECEPTION is set to TRUE, the UE shall:

- 1> set the variable SECONDARY_CELL_HS_DSCH_RECEPTION to FALSE;
- 1> clear the IE "Downlink Secondary Cell Info FDD";
- 1> flush the HARQ buffers of the HARQ entity associated to the secondary serving HS-DSCH cell;
- 1> release HARQ resources associated to the secondary serving HS-DSCH cell.

Whenever the variable SECONDARY_CELL_HS_DSCH_RECEPTION is set to TRUE, the UE shall:

- 1> receive the HS-SCCH(s) according to the IE "Downlink Secondary Cell Info FDD" on the serving HS-DSCH radio link applying the scrambling code as received in the IE "DL Scrambling code";
- 1> partition the soft memory buffer in the MAC-e-hs, used for the secondary serving HS-DSCH cell reception, using the information in the IE "HARQ Info" of the serving HS-DSCH cell and performing the procedure described in subclause 8.6.5.6b;
- 1> perform HS-DSCH reception procedures for the secondary serving HS-DSCH cell according to the stored HS-PDSCH configuration as stated in:
 - 2> subclause 8.6.3.1b for the IE "H-RNTI";
 - 2> subclause 8.6.5.6b for the IE "HARQ info";
 - 2> subclause 8.6.6.34 for the IE "Measurement Feedback Info";
 - 2> subclause 8.6.6.45 for the IE "Downlink Secondary Cell Info FDD".
- 1> use the relevant CQI reporting table as stated in subclause 8.5.44.

Whenever the variable SECONDARY_CELL_HS_DSCH_RECEPTION is set to FALSE, the UE shall:

- 1> not perform HS-SCCH reception procedures on the secondary serving HS-DSCH cell;
- 1> not perform HS-DSCH reception procedures on the secondary serving HS-DSCH cell.

If the variable SECONDARY_CELL_HS_DSCH_RECEPTION is set to TRUE and the serving HS-DSCH cell was changed as a result of the received message or HS-SCCH order from the target cell, the UE shall instruct the physical layer to consider that the HS-SCCH orders from the serving cell were never received.

NOTE 1: Whenever the variable SECONDARY_CELL_HS_DSCH_RECEPTION is set to TRUE before and after receiving the message, and the value of IE "Configuration info" contained in the IE "Downlink Secondary Cell Info FDD" is set to either "Continue" or "New configuration", and the serving HS-DSCH cell was not changed as a result of this message, the UE may or may not instruct the physical layer to consider that the secondary serving HS-DSCH cell activation/deactivation HS-SCCH orders were never received.

NOTE 2: If the variable SECONDARY_CELL_HS_DSCH_RECEPTION is set to TRUE and the IE "Tx Diversity Mode" is set to "closed loop mode1", the UE behaviour is unspecified.

8.5.52 Actions related to TARGET_CELL_PRECONFIGURATION variable (FDD only)

When all the following conditions are met:

- 1> the UE is in CELL_DCH state;
- 1> the UE has indicated support of Target Cell Pre-Configuration;
- 1> the IE "Target cell preconfiguration information" is included in the Radio link addition information in the Active Set Update message;

the UE shall:

- 1> if the variable TARGET_CELL_PRECONFIGURATION already contains the information for this radio link:
 - 2> clear the old entry from the variable TARGET_CELL_PRECONFIGURATION.
- 1> store the "Target cell preconfiguration information" in the variable TARGET_CELL_PRECONFIGURATION so that the configurations are to be applied later once the Target cell HS-SCCH order has been read from the target cell;
- 1> store the configuration given in the IEs "Serving Cell Change MAC reset", "Serving Cell Change Message Type" and "Serving Cell Change Transaction Id" in the variable TARGET_CELL_PRECONFIGURATION to be applied later once the Target cell HS-SCCH order has been read from the target cell.

NOTE: If the IE "Primary CPICH info" is received in IE "Serving HS-DSCH cell information" as part of the IE "Target cell preconfiguration information" and is not the same value as the IE "Primary CPICH info" of the corresponding IE "Radio Link Addition Information" then the UE behaviour is unspecified.

If any of the above conditions is not met and the Radio Link is included in the table "Target cell preconfigurations" in the variable TARGET_CELL_PRECONFIGURATION, the UE shall:

- 1> clear the entry from the variable TARGET_CELL_PRECONFIGURATION.

8.5.53 Actions related to CONTROL_CHANNEL_DRX_STATUS variable (1.28 Mcps TDD only)

If the UE receives RRC CONNECTION SETUP, CELL UPDATE CONFIRM, or any reconfiguration message:

- 1> the UE shall determine the value for the CONTROL_CHANNEL_DRX_STATUS variable.

The variable CONTROL_CHANNEL_DRX_STATUS shall be set to TRUE only when all the following conditions are met:

- 1> the UE is in CELL_DCH state;
- 1> the variable HS_DSCH RECEPTION is set to TRUE;
- 1> the IE "Control Channel DRX information" is included in the received message.

If any of the above conditions is not met and the variable CONTROL_CHANNEL_DRX_STATUS is set to TRUE, the UE shall:

- 1> set the variable CONTROL_CHANNEL_DRX_STATUS to FALSE;
- 1> clear the variable CONTROL_CHANNEL_DRX_PARAMS;
- 1> disable the Control Channel DRX related activities.

If variable CONTROL_CHANNEL_DRX_STATUS is set to TRUE and the serving HS-DSCH cell was changed as a result of the received message, the UE shall instruct the physical layer to consider HS-SCCH orders were never received.

Whenever the variable CONTROL_CHANNEL_DRX_STATUS is set to TRUE after receiving this message and the value of IE "Control Channel DRX information" included in this message is "Continue Control Channel DRX operation", the UE shall:

- 1> continue the Control Channel DRX related activities with the IE in the variable CONTROL_CHANNEL_DRX_PARAMS.

8.5.54 Actions related to E_DCH_SPS_STATUS variable (1.28 Mcps TDD only)

If the UE receives RRC CONNECTION SETUP, CELL UPDATE CONFIRM, or any reconfiguration message:

- 1> the UE shall determine the value for the E_DCH_SPS_STATUS variable.

The variable E_DCH_SPS_STATUS shall be set to TRUE only when all the following conditions are met:

- 1> the UE is in CELL_DCH state;
- 1> the variable E_DCH_TRANSMISSION is set to TRUE;
- 1> the IE "E-DCH SPS information" is included in the received message and the UE has stored the following IEs in variable E_DCH_SPS_PARAMS:
 - 2> IE "Transmission Pattern List".

If any of the above conditions is not met and the variable E_DCH_SPS_STATUS is set to TRUE, the UE shall:

- 1> set the variable E_DCH_SPS_STATUS to FALSE;
- 1> clear the variable E_DCH_SPS_PARAMS;
- 1> stop all E-DCH SPS related activities.

Whenever the variable E_DCH_SPS_STATUS is set to TRUE, the UE shall:

- 1> configure the physical and MAC layers to operate according to the E_DCH_SPS_PARAMS.

If variable E_DCH_SPS_STATUS is set to TRUE and the serving E-DCH cell was changed as a result of the received message and the value of IE "E-DCH SPS Information" included in this message is "Continue E-DCH SPS operation", then UE behaviour is unspecified.

8.5.55 Actions related to HS_DSCH_SPS_STATUS variable (1.28 Mcps TDD only)

If the UE receives RRC CONNECTION SETUP, CELL UPDATE CONFIRM, or any reconfiguration message:

- 1> the UE shall determine the value for the HS_DSCH_SPS_STATUS variable.

The variable HS_DSCH_SPS_STATUS shall be set to TRUE only when all the following conditions are met:

- 1> the UE is in CELL_DCH state;
- 1> the variable HS_DSCH_RECEPTION is set to TRUE;
- 1> the IE "HS-DSCH SPS information" is included in the received message and the UE has stored the following IEs in variable HS_DSCH_SPS_PARAMS:
 - 2> IE "Transmission Pattern List";
 - 2> IE "Reception Pattern List";

2> IE "HARQ Info for Semi-Persistent Scheduling".

If any of the above conditions is not met and the variable HS_DSCH_SPS_STATUS is set to TRUE, the UE shall:

- 1> set the variable HS_DSCH_SPS_STATUS to FALSE;
- 1> clear the variable HS_DSCH_SPS_PARAMS;
- 1> stop all HS-DSCH SPS related activities.

Whenever the variable HS_DSCH_SPS_STATUS is set to TRUE, the UE shall:

- 1> configure the physical and MAC layers to operate according to the HS_DSCH_SPS_PARAMS.

If variable HS_DSCH_SPS_STATUS is set to TRUE and the serving HS-DSCH cell was changed as a result of the received message and the value of IE "HS-DSCH SPS information" included in this message is "Continue HS-DSCH SPS operation", then UE behaviour is unspecified.

8.5.56 Actions related to HSPA_RNTI_STORED_CELL_PCH variable (FDD and 1.28 Mcps TDD only)

The variable HSPA_RNTI_STORED_CELL_PCH shall be set to TRUE only when all the following conditions are met:

- 1> the UE is in CELL_PCH state or the UE after state transition enters CELL_PCH state if the variable HSPA_RNTI_STORED_CELL_PCH is determined according to subclause 8.2.2.3 or 8.3.1.6; and
- 1> the UE supports E-DCH transmission in CELL_FACH state and Idle mode; and
- 1> the UE supports HS-DSCH reception in CELL_FACH state; and
- 1> the IE "HS-DSCH common system information" is included in system information block type 5 or 5bis; and
- 1> the IE "Common E-DCH system info" is included in system information block type 5 or 5bis; and
- 1> the IE "HS-DSCH paging system information" is not included in system information block type 5 or 5bis or the UE does not support HS-DSCH reception in CELL_PCH and URA_PCH state; and
- 1> the RBs have the multiplexing option with transport channel type "HS-DSCH" for the DL and transport channel type "E-DCH" in the UL; and
- 1> variable H-RNTI is set; and
- 1> variable E-RNTI is set; and
- 1> IE "New C-RNTI" is included in the received message if the variable HSPA_RNTI_STORED_CELL_PCH is determined according to subclause 8.2.2.3 or 8.3.1.6, or variable C-RNTI is set if the variable HSPA_RNTI_STORED_CELL_PCH is determined according to subclause 8.1.1.6.5.

If any of the above conditions is not met and the variable HSPA_RNTI_STORED_CELL_PCH is set to TRUE, the UE shall:

- 1> set the variable HSPA_RNTI_STORED_CELL_PCH to FALSE.

If the variable HSPA_RNTI_STORED_CELL_PCH is set to TRUE:

- 1> if the UE has uplink RLC data PDU or uplink RLC control PDU on RB1 or upwards to transmit: or
- 1> if the UE is requested to move into CELL_FACH state by paging type 1 as described in subclause 8.1.2.3, UE shall:
 - 2> move the UE to CELL_FACH state;
 - 2> set the variable HSPA_RNTI_STORED_CELL_PCH to FALSE;
 - 2> stop timer T319 if it is running;

- 2> restart the timer T305 if it is set to any value other than "infinity";
- 2> determine the value for the READY_FOR_COMMON_EDCH variable and take the corresponding actions as described in subclause 8.5.47;
- 2> determine the value for the COMMON_E_DCH_TRANSMISSION variable and take the corresponding actions as described in subclause 8.5.46;
- 2> for FDD and 1.28 Mcps TDD:
 - 3> initiate the measurement report procedure as specified in subclause 8.4.2;
 - 3> not prohibit periodical status transmission in RLC;
 - 3> configure the Enhanced Uplink in CELL_FACH state and Idle mode as specified in subclause 8.5.45 for FDD and 8.5.45a for 1.28 Mcps TDD;
 - 3> start to receive HS-DSCH according to the procedure in subclause 8.5.36.

8.6 Generic actions on receipt and absence of an information element

8.6.1 CN information elements

8.6.1.1 Void

8.6.1.2 CN information info

If the IE "CN information info" is present in a message, the UE shall:

- 1> if the IE "Primary PLMN Identity" is present:
 - 2> forward the content of the IE "Primary PLMN identity" to upper layers.
- 1> else:
 - 2> if the IE "PLMN Identity" is present:
 - 3> forward the content of the IE "PLMN identity" to upper layers.
- 1> if present, forward the content of the IE "CN common GSM-MAP NAS system information" to upper layers;
- 1> if the IE "CN domain related information" is present:
 - 2> forward each occurrence of the IE "CN domain specific GSM-MAP NAS system info" together with the IE "CN domain identity" to upper layers.
 - 2> if an IE "CN domain specific GSM-MAP NAS system info" is not present for a particular CN domain:
 - 3> indicate to upper layers that no CN system information is available for that CN domain.

NOTE: If UTRAN at SRNS relocation includes and sets the IE "Primary PLMN identity" to the PLMN identity signalled in RANAP RELOCATION REQUEST [57], the UTRAN should also set the IE "PLMN identity" to the PLMN identity in the IE "PLMN Identity" of the Master Information Block transmitted in the cell(s) used by the UE after completed SRNS relocation.

8.6.1.3 Signalling connection release indication

If the IE "Signalling Connection release indication" is present in a message, the UE shall:

- 1> if all radio access bearers for the CN domain identified with the value of the IE "Signalling Connection release indication" would have been released in the variable ESTABLISHED_RABS after processing of the received message:
 - 2> indicate release of the signalling connection identified with the value of the IE "Signalling Connection release indication" to the upper layers;
 - 2> remove the signalling connection identified with the value of the IE "Signalling Connection release indication" from the variable ESTABLISHED_SIGNALLING_CONNECTIONS.
- 1> if radio access bearers for the CN domain identified with the value of the IE "Signalling Connection release indication" would remain in the variable ESTABLISHED_RABS after processing of the received message:
 - 2> set the variable INVALID_CONFIGURATION to TRUE.

8.6.2 UTRAN mobility information elements

8.6.2.1 URA identity

The UE shall:

- 1> if the IE "URA identity" is included in a received message:
 - 2> if the IE "RRC State Indicator" is included and set to "URA_PCH":
 - 3> store this URA identity in the variable URA_IDENTITY;
 - 3> after sending a possible message to UTRAN and entering URA_PCH state as specified elsewhere, read system information block type 2 in the selected cell;
 - 3> if the stored URA identity in the variable URA_IDENTITY is not included in the list of URA identities in System Information Block type 2 in the selected cell, the list of URA identities in system information block type 2 is empty or if the system information block type 2 can not be found, a confirmation error of URA identity list has occurred:
 - 4> if no URA update procedure is ongoing:
 - 5> initiate a URA update procedure after entering URA_PCH state; see subclause 8.3.1.2.
 - 4> if a URA update procedure is ongoing:
 - 5> take actions as specified in subclause 8.3.1.10.
 - 1> if the IE "URA identity" is not included in a received message:
 - 2> if the IE "RRC State Indicator" is included and set to "URA_PCH":
 - 3> after sending a possible message to UTRAN and entering URA_PCH state as specified elsewhere, read System Information Block type 2 in the selected cell;
 - 3> if System Information Block type 2 in the selected cell contains a single URA identity:
 - 4> store this URA identity in the variable URA_IDENTITY.
 - 3> if System Information Block type 2 of the selected cell contains more than one URA identity, the list of URA identities in system information block type 2 is empty or if the system information block type 2 can not be found, a confirmation error of URA identity list has occurred:
 - 4> if no URA update procedure is ongoing:
 - 5> initiate a URA update procedure after entering URA_PCH state, see subclause 8.3.1.2.
 - 4> if a URA update procedure is ongoing:
 - 5> take actions as specified in subclause 8.3.1.10.

8.6.2.2 Mapping info

For FDD, 3.84 Mcps TDD and 7.68 Mcps TDD, if the IE "Mapping info" is received, the UE shall in this version of the specification:

1> ignore the contents of this IE.

For 1.28 Mcps TDD, if the IE "Mapping info" is received, the UE shall:

1> if the IE "Map parameter 1" is included, interpret the IE "Map parameter 1" as IE "UpPCH Position Info":

2> store and use the UpPCH position indicated by the IE "UpPCH Position Info". The calculation of the uplink access position is described in [33].

1> if the IE "Map parameter 1" is not included:

2> use the UpPTS as the default UpPCH position.

1> ignore other contents of the IE "Mapping info".

8.6.2.3 RNC support for change of UE capability

The UE shall:

1> if the IE "RNC support for change of UE capability" is included in a received message:

2> set the variable RNC_CAPABILITY_CHANGE_SUPPORT to the value of the IE "RNC support for change of UE capability".

8.6.2.4 CSG PSC Split Information

The UE shall:

1> if the IE "CSG PSC Split Information" is included in a received message:

2> consider the CSG PSC split information received on this cell to be valid for:

3> the UARFCN of the carrier on which it was received;

3> the PLMN as indicated by IE "PLMN Identity" broadcasted in the MIB of the cell;

3> 24 hours from the time it was received.

NOTE: If the IE "CSG PSC Split Information" is received in both SIB3 and SIB11bis in the same cell then UE behaviour is unspecified.

8.6.2.5 E-UTRA detection

If the IE "E-UTRA detection" is included in a received message and set to TRUE and the UE is in CELL_PCH, URA_PCH state or idle mode, the UE may detect the presence of a E-UTRA cell on a frequency with a priority lower than the current UTRA cell and report the information to the NAS.

8.6.3 UE information elements

8.6.3.1 Activation time

If the UE receives a message in which presence is needed for the IE "Activation time", and the value is other than the default value "Now", the UE shall:

1> let the "reference CCTrCH" be defined as the CCTrCh that includes any transport channel or is associated with any physical channel which is being added, re-configured or removed, or, in the case of HS-DSCH, the CCTrCh including the associated DCH;

1> if the frame boundary immediately before the frame with the CFN (Connection Frame Number) value indicated by the IE "Activation Time" is at the TTI boundary common to all the transport channels that are multiplexed onto the reference CCTrCh:

2> select that frame boundary as the activation time T.

1> else:

2> select the next TTI boundary, which is common to all the transport channels that are multiplexed onto the reference CCTrCh, after the frame with the CFN (Connection Frame Number) value indicated by the IE "Activation Time", as the activation time T.

1> if the IE "Delay restriction flag" is received and activation time T is more than 128 frames from the CFN at which the message was received:

2> choose an activation time T as soon as possible after reception of the message, respecting the performance requirements in subclause 13.5, which is common to all the transport channels that are multiplexed onto the reference CCTrCh.

NOTE: If the UE receives a message containing the IE "Delay restriction flag" and that message causes a transport channel or physical channel reconfiguration of the reference CCTrCH then the UE behaviour is not specified.

1> at the activation time T:

2> for a physical channel reconfiguration other than an HS-DSCH related reconfiguration, caused by the received message:

3> release the physical channel configuration, which was present before T;

3> initiate the establishment of the physical channel configuration as specified for the physical channel information elements in the received message as specified elsewhere.

2> for an HS-DSCH related reconfiguration in FDD or 1.28 Mcps TDD caused by the received message:

3> select the HS-SCCH subframe boundary immediately before the first HS-SCCH subframe, which entirely falls within the 10 ms frame following T;

3> start using, at that HS-SCCH subframe boundary, the new HS-DSCH configuration in the received message, replacing any old HS-DSCH configuration.

2> for an HS-DSCH related reconfiguration in 3.84 Mcps TDD or 7.68 Mcps TDD caused by the received message:

3> start using, at activation time T, the new HS-DSCH configuration in the received message, replacing any old HS-DSCH configuration.

2> for actions, other than a physical channel reconfiguration, caused by the received message:

3> perform the actions for the information elements in the received message as specified elsewhere.

NOTE: In FDD an "HS-DSCH related reconfiguration" includes, in particular, reconfigurations that need to be time-aligned with the 2ms subframe of the HS-SCCH, HS-PDSCH and/or HS-DPCCH. For example, start and stop of HS-SCCH reception and serving HS-DSCH cell change.

If the UE receives a message in which presence is needed for the IE "Activation time", and the value is the default value "Now", the UE shall:

1> choose an activation time T as soon as possible after the reception of the message, respecting the performance requirements in subclause 13.5;

1> at the activation time T:

2> perform the actions for the information elements in the received message as specified elsewhere.

NOTE: In FDD, if the UE was in idle mode or CELL_FACH or CELL_PCH state upon reception of the message, regardless of the state the UE enters after reception of the message, and the value of the IE "Activation time" in the received message is different from "Now", the UE behaviour is unspecified. In TDD, if the UE was in idle mode or CELL_FACH state upon reception of the message, the value of the IE "Activation time" in the received message is relative to the CFN associated with the cell from which the message was received.

8.6.3.1a CN domain specific DRX cycle length coefficient

The UE updates CN domain specific DRX cycle length coefficient as specified in [4]. The UE shall use it to calculate the CN domain specific DRX cycle length, according to the following:

- 1> set k to the value of the IE "CN domain specific DRX cycle length coefficient".
- 1> store the result of $\text{MAX}(2^k, \text{PBP})$, where PBP is the Paging Block Periodicity, as the CN domain specific DRX cycle length for the CN domain indicated by the IE "CN domain identity". For FDD PBP=1.

The UE shall determine its idle mode paging occasions and PICH monitoring occasions for that CN domain, according to [4], based on the stored CN domain specific DRX cycle length, when using DRX in idle mode.

8.6.3.1b H-RNTI

If an IE "New H-RNTI" is included and the UE will be in CELL_DCH state after completion of this procedure, the UE shall:

- 1> if the IE "New H-RNTI" is received in a UTRAN MOBILITY INFORMATION message
 - 2> the UE behaviour is unspecified.
- 1> store the value in the variable H_RNTI;
- 1> determine the value for the HS_DSCH_RECEPTION variable and take the corresponding actions as described in subclause 8.5.25;
- 1> determine the value for the SECONDARY_CELL_HS_DSCH_RECEPTION variable and take the corresponding actions as described in subclause 8.5.51.

If the message that triggers the HS_DSCH_RECEPTION variable to change value from FALSE to TRUE does not contain the IE "New H-RNTI"; and

if, before receiving that message, the UE is not in CELL_FACH or CELL_PCH state or the variable H_RNTI is not set:

- 1> the UE behaviour is not defined.

When the variable HS_DSCH_RECEPTION is set to TRUE the UE shall:

- 1> use the value of the variable H_RNTI as UE identity in the HS-SCCH reception procedure in the physical layer.

In FDD and 1.28 Mcps TDD, if the IE "New H-RNTI" is included and the UE will be in CELL_FACH state after completion of this procedure, the UE shall:

- 1> store the value in the variable H_RNTI;
- 1> determine the value for the HS_DSCH_RECEPTION_CELL_FACH_STATE variable and take the corresponding actions as described in subclause 8.5.36.
- 1> for 1.28 Mcps TDD, If the IE "Treset Usage Indicator" has been stored:
 - 2> stop using all configured Treset timer [15].

When the variable HS_DSCH_RECEPTION_CELL_FACH_STATE is set to TRUE the UE shall:

- 1> use the value of the variable H_RNTI as UE identity in the HS-SCCH reception procedure in the physical layer.

When the variable SECONDARY_CELL_HS_DSCH_RECEPTION is set to TRUE the UE shall:

- 1> use the value of the variable H_RNTI associated with the secondary serving HS-DSCH cell as UE identity in the HS-SCCH reception procedure in the physical layer on that cell.

In FDD and 1.28 Mcps TDD, if the IE "New H-RNTI" is included and the UE will be in CELL_PCH state after completion of this procedure, the UE shall:

- 1> store the value in the variable H_RNTI.
- 1> for 1.28 Mcps TDD, If the IE "Treset Usage Indicator" has been stored:
 - 2> stop using all configured Treset timer [15].

8.6.3.2 UTRAN DRX Cycle length coefficient

If the IE "UTRAN DRX cycle length coefficient" is present, the UE shall use it to calculate the UTRAN DRX cycle length, according to the following:

- 1> start timer T319 using the IE "Time for DRX cycle 2" value;
- 1> store IE "DRX cycle length coefficient";
- 1> set k to the value of the IE "DRX cycle length coefficient 2";
- 1> store the result of $\text{MAX}(2^k \cdot \text{PBP})$, where PBP is the Paging Block Periodicity, as the DRX cycle length.

The UE shall determine its connected mode paging occasions and PICH monitoring occasions in the same way as for idle mode, according to [4].

The DRX cycle length to use in connected mode is defined in [4].

8.6.3.3 Generic state transition rules depending on received information elements

The IE "RRC State Indicator" indicates the state the UE shall enter. The UE shall enter the state indicated by the IE "RRC State Indicator" even if the received message includes other IEs relevant only for states other than indicated by the IE "RRC State Indicator". E.g. if the RRC state indicator is set to CELL_FACH while other IEs provide information about a configuration including dedicated channels, the UE shall enter CELL_FACH state. If however the UE has no information about the configuration corresponding to the state indicated by the IE "RRC State Indicator", it shall consider the requested configuration as invalid.

The UE shall, if the IE "RRC State Indicator" in the received message has the value:

- 1> "CELL_FACH":
 - 2> enter CELL_FACH state as dictated by the procedure governing the message received.
- 1> "CELL_DCH":
 - 2> if neither DPCH is assigned in the message nor is the UE in CELL_DCH:
 - 3> set the variable INVALID_CONFIGURATION to TRUE.
 - 2> else:
 - 3> enter CELL_DCH state as dictated by the procedure governing the message received.
- 1> "CELL_PCH":
 - 2> if the received message is RRC CONNECTION SETUP and IE "RRC State Indicator" is set to CELL_PCH:
 - 3> set the variable INVALID_CONFIGURATION to TRUE.
 - 2> else:
 - 3> enter CELL_PCH state as dictated by the procedure governing the message received.
- 1> "URA_PCH":

- 2> if the received message is RRC CONNECTION SETUP and IE "RRC State Indicator" is set to URA_PCH:
 - 3> set the variable INVALID_CONFIGURATION to TRUE.
- 2> else:
 - 3> enter URA_PCH state as dictated by the procedure governing the message received.

8.6.3.4 Ciphering mode info

The IE "Ciphering mode info" defines the new ciphering configuration. At any given time, the UE needs to store at most two different ciphering configurations (keyset and algorithm) per CN domain at any given time in total for all radio bearers and three configurations in total for all signalling radio bearers.

If the IE "Ciphering mode info" is present and if the IE "Reconfiguration" in the variable CIPHERING_STATUS is set to TRUE, the UE shall:

- 1> ignore this second attempt to change the ciphering configuration; and
- 1> set the variable INCOMPATIBLE_SECURITY_RECONFIGURATION to TRUE.

If the IE "Ciphering mode info" is present and if the IE "Reconfiguration" in the variable CIPHERING_STATUS is set to FALSE, the UE shall:

- 1> if none of the IE "Status" in the variable CIPHERING STATUS has the value "Started", and this IE "Ciphering mode info" was included in a message that is not the message SECURITY MODE COMMAND or this IE "Ciphering mode info" was included in a message that doesn't include the IE "SR-VCC Info"; or
- 1> if the IE "Ciphering Mode Info" was received in the message SECURITY MODE COMMAND and there does not exist exactly one ciphering activation time in the IE "Radio bearer downlink ciphering activation time info" for each established RLC-AM and RLC-UM radio bearers included in the IE "RB information" in the IE "ESTABLISHED_RABS" for the CN domain as indicated in the variable LATEST_CONFIGURED_CN_DOMAIN; or
- 1> if the IE "Ciphering Mode Info" was received in the message SECURITY MODE COMMAND and the IE "Ciphering activation time for DPCH" is not included in the message, and there exist radio bearers using RLC-TM according to the IE "RB information" in the IE "ESTABLISHED_RABS" for the CN domain as indicated in the variable LATEST_CONFIGURED_CN_DOMAIN; or
- 1> if the IE "Ciphering Mode Info" was received in the message SECURITY MODE COMMAND and there does not exist exactly one ciphering activation time in the IE "Radio bearer downlink ciphering activation time info" for each established signalling radio bearer included in the IE "Signalling radio bearer information" in the IE "ESTABLISHED_RABS":
 - 2> ignore this attempt to change the ciphering configuration;
 - 2> set the variable INVALID_CONFIGURATION to TRUE;
 - 2> perform the actions as specified in subclause 8.1.12.4c.
- 1> set the IE "Reconfiguration" in the variable CIPHERING_STATUS to TRUE;
- 1> set the IE "Status" in the variable CIPHERING_STATUS of the CN domains for which the IE "Status" of the variable SECURITY_MODIFICATION is set to "Affected" to "Started";
- 1> apply the new ciphering configuration in the lower layers for all RBs that belong to a CN domain for which the IE "Status" of the variable SECURITY_MODIFICATION is set to "Affected" and all signalling radio bearers:
 - 2> using the ciphering algorithm (UEA [40]) indicated by the IE "Ciphering algorithm" as part of the new ciphering configuration;
 - 2> for each radio bearer that belongs to a CN domain for which the IE "Status" of the variable SECURITY_MODIFICATION is set to "Affected" and all signalling radio bearers:
 - 3> using the value of the IE "RB identity" in the variable ESTABLISHED_RABS minus one as the value of BEARER [40] in the ciphering algorithm.

- 1> for the downlink and the uplink, apply the new ciphering configuration as follows:
 - 2> if the ciphering configuration for a AM or UM radio bearer or signalling radio bearer from a previously received SECURITY MODE COMMAND has not yet been applied because of the corresponding activation times not having been reached and the current received message includes the IE "DL Counter Synch Info" or the current received message is a RADIO BEARER RECONFIGURATION message and includes the IE "New U-RNTI":
 - 3> if the previous SECURITY MODE COMMAND was received due to new keys being received:
 - 4> consider the new ciphering configuration to include the received new keys.
 - 3> else if the previous SECURITY MODE COMMAND caused a change in LATEST_CONFIGURED_CN_DOMAIN:
 - 4> consider the new ciphering configuration to include the keys associated with the LATEST_CONFIGURED_CN_DOMAIN.
 - 3> apply the new ciphering configuration in uplink and downlink immediately following RLC re-establishment.
 - 2> if the IE "Ciphering activation time for DPCH" is present in the IE "Ciphering mode info" and the UE was in CELL_DCH state prior to this procedure:
 - 3> for radio bearers using RLC-TM:
 - 4> apply the old ciphering configuration for CFN less than the number indicated in the IE "Ciphering activation time for DPCH";
 - 4> apply the new ciphering configuration for CFN greater than or equal to the number indicated in IE "Ciphering activation time for DPCH".
 - 2> if the IE "Radio bearer downlink ciphering activation time info" is present:
 - 3> apply the following procedure for each radio bearer and signalling radio bearers using RLC-AM or RLC-UM indicated by the IE "RB identity":
 - 4> suspend uplink transmission on the radio bearer or the signalling radio bearer (except for the SRB where the response message is transmitted) according to the following:
 - 5> do not transmit RLC PDUs with sequence number greater than or equal to the uplink activation time, where the uplink activation time is selected according to the rules below.
 - 4> select an "RLC sequence number" at which (activation) time the new ciphering configuration shall be applied in uplink for that radio bearer according to the following:
 - 5> consider a ciphering activation time in uplink to be pending until the RLC sequence number of the next RLC PDU to be transmitted for the first time is equal to or larger than the selected activation time;
 - 5> for each radio bearer and signalling radio bearer that has no pending ciphering activation time in uplink as set by a previous procedure changing the security configuration:
 - 6> set a suitable value that would ensure a minimised delay in the change to the latest ciphering configuration.
 - 5> for each radio bearer and signalling radio bearer that has a pending ciphering activation time in uplink as set by a previous procedure changing the security configuration:
 - 6> for radio bearers and signalling radio bearers except SRB2:
 - 7> set the same value as the pending ciphering activation time.
 - 6> for signalling radio bearer SRB2:
 - 7> set a suitable value that would ensure a minimised delay in the change to the latest ciphering configuration.

- 4> store the selected "RLC sequence number" for that radio bearer in the entry for the radio bearer in the variable RB_UPLINK_CIPHERING_ACTIVATION_TIME_INFO;
- 4> switch to the new ciphering configuration according to the following:
 - 5> use the old ciphering configuration for the transmitted and received RLC PDUs with RLC sequence numbers smaller than the corresponding RLC sequence numbers indicated in the IE "Radio bearer uplink ciphering activation time info" sent to UTRAN and in the received IE "Radio bearer downlink ciphering activation time info" received from UTRAN, respectively;
 - 5> use the new ciphering configuration for the transmitted and received RLC PDUs with RLC sequence numbers greater than or equal to the corresponding RLC sequence numbers indicated in the IE "Radio bearer uplink ciphering activation time info" sent to UTRAN and in the received IE "Radio bearer downlink ciphering activation time info" received from UTRAN, respectively;
 - 5> for a radio bearer using RLC-AM, when the RLC sequence number indicated in the IE "Radio bearer downlink ciphering activation time info" falls below the RLC receiving window and the RLC sequence number indicated in the IE "Radio bearer uplink ciphering activation time info" falls below the RLC transmission window, the UE may release the old ciphering configuration for that radio bearer;
 - 5> if an RLC reset or re-establishment of the transmitting side of an RLC entity occurs before the activation time for the new ciphering configuration has been reached in uplink, ignore the activation time and apply the new ciphering configuration in uplink immediately after the RLC reset or RLC re-establishment;
 - 5> if an RLC reset or re-establishment of the receiving side of an RLC entity occurs before the activation time for the new ciphering configuration has been reached in downlink, ignore the activation time and apply the new ciphering configuration in downlink immediately after the RLC reset or RLC re-establishment.
- 2> if the current received message includes the IE "Downlink counter synchronisation info" or the current received message is a RADIO BEARER RECONFIGURATION message and includes the IE "New U-RNTI"; or
- 2> if the current received message includes the IE "SR-VCC Info":
 - 3> apply the new ciphering configuration in uplink and downlink immediately following RLC re-establishment.

If the IE "Radio bearer downlink ciphering activation time info" was received in another message than SECURITY MODE COMMAND:

- 1> the UE behaviour is unspecified.

If the IE "Ciphering mode info" is not present, the UE shall:

- 1> for the downlink and the uplink, apply the ciphering configuration as follows:
 - 2> if the ciphering configuration for a AM or UM radio bearer or signalling radio bearer from a previously received SECURITY MODE COMMAND has not yet been applied because of the corresponding activation times not having been reached and the current received message includes the IE "Downlink counter synchronisation info" or the current received message is a RADIO BEARER RECONFIGURATION message and includes the IE "New U-RNTI" or the current received message triggering SR-VCC:
 - 3> if the previous SECURITY MODE COMMAND was received due to new keys being received:
 - 4> consider the ciphering configuration to include the received new keys.
 - 3> else if the previous SECURITY MODE COMMAND caused a change in LATEST_CONFIGURED_CN_DOMAIN:
 - 4> consider the ciphering configuration to include the keys associated with the LATEST_CONFIGURED_CN_DOMAIN.
 - 3> apply the ciphering configuration in uplink and downlink immediately following RLC re-establishment.

2> else:

3> not change the ciphering configuration.

8.6.3.5 Integrity protection mode info

The IE "Integrity protection mode info" defines the new integrity protection configuration. At any given time, the UE needs to store at most three different integrity protection configurations (keysets) in total for all signalling radio bearers for all CN domains.

If the IE "Integrity protection mode info" is present and if the IE "Reconfiguration" in the variable INTEGRITY_PROTECTION_INFO is set to TRUE, the UE shall:

1> ignore this second attempt to change the integrity protection configuration; and

1> set the variable INCOMPATIBLE_SECURITY_RECONFIGURATION to TRUE.

If the IE "Integrity protection mode command" has the value "Start", the IE "Status" in the variable INTEGRITY_PROTECTION_INFO has the value "Not started" and the IE "Integrity protection mode info" was not included in the message SECURITY MODE COMMAND and the IE "Integrity protection mode info" was not included in the message triggering SR-VCC and including the IE "NONCE"; or

If the IE "Integrity protection mode command" has the value "Start", the IE "Status" in the variable INTEGRITY_PROTECTION_INFO has the value "Not started", the IE "Integrity protection mode info" was included in the message SECURITY MODE COMMAND or the IE "Integrity protection mode info" was included in the message triggering SR-VCC and the IE "Integrity protection algorithm" is not included; or

If the IE "Integrity protection mode command" has the value "Modify" and the IE "Status" in the variable INTEGRITY_PROTECTION_INFO has the value "Not Started"; or

If the IE "Integrity protection mode command" has the value "Start", the IE "Status" in the variable INTEGRITY_PROTECTION_INFO has the value "Started" and the IE "Integrity protection mode command info" was included in the message SECURITY MODE COMMAND; or

If the IE "Integrity protection mode command" has the value "Modify" and there does not exist exactly one integrity protection activation time in the IE "Downlink integrity protection activation info" for each established signalling radio bearer included in the IE "Signalling radio bearer information" in the IE "ESTABLISHED_RABS"; or

If the IE "Integrity protection mode command" has the value "Modify", the IE "Status" in the variable INTEGRITY_PROTECTION_INFO has the value "Started" and the IE "Integrity protection mode info" was not included in the message SECURITY MODE COMMAND and the IE "Integrity protection mode info" was not included in the message triggering SR-VCC:

the UE shall:

1> ignore this attempt to change the integrity protection configuration; and

1> set the variable INVALID_CONFIGURATION to TRUE.

If the IE "Integrity protection mode info" is not present, the UE shall:

1> not change the integrity protection configuration.

If the IE "Integrity protection mode info" is present and if the IE "Reconfiguration" in the variable INTEGRITY_PROTECTION_INFO is set to FALSE, the UE shall:

1> set the IE "Reconfiguration" in the variable INTEGRITY_PROTECTION_INFO to TRUE;

1> perform the actions in accordance with subclauses 8.6.3.5.1, 8.6.3.5.2 and 8.6.3.5.3.

8.6.3.5.1 Initialisation of Integrity Protection

The UE shall:

- 1> if the IE "Integrity protection mode command" has the value "start" and the IE "Status" in the variable INTEGRITY_PROTECTION_INFO has the value "Not started", and this IE was included in the message SECURITY MODE COMMAND or this IE was included in the message triggering SR-VCC and including the IE "NONCE":
 - 2> initialise the information for all signalling radio bearers in the variable INTEGRITY_PROTECTION_INFO according to the following:
 - 3> set the IE "Uplink RRC Message sequence number" in the variable INTEGRITY_PROTECTION_INFO to zero;
 - 3> do not set the IE "Downlink RRC Message sequence number" in the variable INTEGRITY_PROTECTION_INFO;
 - 3> set the variable INTEGRITY_PROTECTION_ACTIVATION_INFO to zero for each signalling radio bearer in the IE "ESTABLISHED_RABS".

NOTE: The IEs "Integrity protection activation info" and "RRC Message sequence number" included in the IE "Integrity Check Info" in the transmitted message do not have identical values, but integrity protection is applied from the first transmitted message.

- 2> set the IE "Status" in the variable INTEGRITY_PROTECTION_INFO to the value "Started";
- 2> perform integrity protection on the received message, applying the new integrity protection configuration, as described in subclause 8.5.10.1 by:
 - 3> using the algorithm (UIA [40]) indicated by the IE "Integrity protection algorithm" contained in the IE "Integrity protection mode info";
 - 3> using the IE "Integrity protection initialisation number", contained in the IE "Integrity protection mode info" as the value of FRESH [40].
- 2> start applying the new integrity protection configuration in the downlink for each signalling radio bearer in the IE "ESTABLISHED_RABS" except RB2 at the next received RRC message;
- 2> start applying the new integrity protection configuration in the downlink for signalling radio bearer RB2 from and including the received SECURITY MODE COMMAND message or the message triggering SR-VCC;
- 2> start applying the new integrity protection configuration in the uplink for signalling radio bearer RB2 from and including the transmitted SECURITY MODE COMPLETE message or the transmitted response message for the message triggering SR-VCC;
- 2> start applying the new integrity protection configuration in the uplink for signalling radio bearers other than RB2 at the uplink activation time included in the IE "Uplink integrity protection activation info".

NOTE: After Inter-RAT handover to UTRAN, and ciphering was activated in the other RAT, then during the first security mode control procedure following the handover, UE activates integrity protection using the integrity key of the same key set as used in the other RAT (see subclause 8.3.6.3).

8.6.3.5.2 Integrity Protection Re-configuration for SRNS Relocation, intra-RAT SR-VCC and handover from GERAN Iu mode

The UE shall:

- 1> if IE "Integrity protection mode command" has the value "start" and the IE "Status" in the variable INTEGRITY_PROTECTION_INFO has the value "Started" and this IE was not included SECURITY MODE COMMAND:

NOTE: This case is used in SRNS relocation, in SR-VCC and in handover from GERAN *Iu mode*.

- 2> perform integrity protection on the received message, applying the new integrity protection configuration, as described in subclause 8.5.10.1 by:
 - 3> using the algorithm (UIA [40]) indicated by the IE "Integrity protection algorithm" contained in the IE "Integrity protection mode info";

NOTE: If the algorithm indicated by the IE "Integrity protection algorithm" is different from the one currently used by the UE, then this leads to a change of the integrity protection algorithm.

- 3> using the IE "Integrity protection initialisation number", contained in the IE "Integrity protection mode info" as the value of FRESH [40].
- 2> let RB_m be the signalling radio bearer where the reconfiguration message was received and let RB_n be the signalling radio bearer where the response message is transmitted;
- 2> prohibit transmission of RRC messages on all signalling radio bearers in the IE "ESTABLISHED_RABS" except on RB₀ and the radio bearer where the response message is transmitted;
- 2> for the downlink, for each signalling radio bearer, if for the signalling radio bearer, a security configuration triggered by a previous SECURITY MODE COMMAND or a previous message triggering SR-VCC has not yet been applied, due to the activation time for the signalling radio bearer not having been reached:
 - 3> set "Down link RRC Message sequence number" for this signalling radio bearer in the variable INTEGRITY_PROTECTION_INFO to (activation time -1), where the activation time is the corresponding activation time for this signalling radio bearer;
 - 3> if the previous SECURITY MODE COMMAND was received due to new keys being received:
 - 4> consider the new integrity protection configuration to include the received new keys.
 - 3> else if the previous SECURITY MODE COMMAND or the previous message triggering SR-VCC caused a change in LATEST_CONFIGURED_CN_DOMAIN:
 - 4> consider the new Integrity Protection configuration to include the keys associated with the LATEST_CONFIGURED_CN_DOMAIN associated with the previously received SECURITY MODE COMMAND.
- 2> start applying the new integrity protection configuration in the downlink for each signalling radio bearer in the IE "ESTABLISHED_RABS" except RB_m at the next received RRC message for the corresponding signalling radio bearer;
- 2> start applying the new integrity protection configuration in the downlink for signalling radio bearer RB_m from and including the received configuration message;
- 2> start applying the new integrity protection configuration in the uplink for signalling radio bearer RB_n from and including the transmitted response message;
- 2> start applying the new integrity protection configuration in the uplink for signalling radio bearers other than RB_n from the first message onwards.

8.6.3.5.3 Integrity Protection modification in case of new keys or initialisation of signalling connection

The UE shall:

- 1> if the IE "Integrity protection mode command" has the value "modify" and the IE "Status" in the variable INTEGRITY_PROTECTION_INFO has the value "Started" and this IE was included in SECURITY MODE COMMAND or this IE was included in a message triggering SR-VCC:
 - 2> store the (oldest currently used) integrity protection configuration until activation times have elapsed for the new integrity protection configuration to be applied on all signalling radio bearers;
 - 2> start applying the new integrity protection configuration in the downlink for each signalling radio bearer n, at the first received message with RRC Sequence number greater than or equal to the RRC sequence number indicated by the entry for signalling radio bearer n in the "RRC message sequence list" in the IE "Downlink integrity protection activation info", included in the IE "Integrity protection mode info";
 - 2> perform integrity protection on the received message, applying the new integrity protection configuration, as described in subclause 8.5.10.1;
 - 3> if present, use the algorithm indicated by the IE "Integrity protection algorithm" (UIA [40]);

- 2> set the content of the variable INTEGRITY_PROTECTION_ACTIVATION_INFO according to the following:
 - 3> for each established signalling radio bearer, stored in the variable ESTABLISHED_RABS:
 - 4> select a value of the RRC sequence number at which (activation) time the new integrity protection configuration shall be applied in uplink for that signalling radio bearer according to the following:
 - 5> for each signalling radio bearer except RB0:
 - 6> set the activation time for the new integrity protection configuration to the next RRC SN.
 - 4> for signalling radio bearer RB0:
 - 5> set the value of the included RRC sequence number to greater than or equal to the current value of the RRC sequence number for signalling radio bearer RB0 in the variable INTEGRITY_PROTECTION_INFO, plus the value of the constant N302 plus two.
 - 4> prohibit the transmission of RRC messages on all signalling radio bearers, except for RB2, with RRC SN greater than or equal to the value in the "RRC message sequence number list" for the signalling radio bearer in the IE "Uplink integrity protection activation info" of the variable INTEGRITY_PROTECTION_ACTIVATION_INFO.
 - 2> start applying the new integrity protection configuration in the uplink at the RRC sequence number, for each RBn, except for signalling radio bearer RB2, indicated by the entry for signalling radio bearer n in the "RRC message sequence number list" in the IE "Uplink integrity protection activation info", included in the variable INTEGRITY_PROTECTION_ACTIVATION_INFO;
 - 2> start applying the new integrity protection configuration in the uplink at the RRC sequence number for signalling radio bearer RB2, as specified for the procedure initiating the integrity protection reconfiguration;
 - 2> start applying the new integrity protection configuration in the downlink at the RRC sequence number, for each RBn, except for signalling radio bearer RB2, indicated by the entry for signalling radio bearer n in the "RRC message sequence number list" in the IE "Downlink integrity protection activation info";
- NOTE: For signalling radio bearers that have a pending activation time as set for integrity protection by a previous procedure changing the integrity protection configuration, UTRAN should set this value in IE "Downlink integrity protection activation info".
- 2> start applying the new integrity protection configuration in the downlink at the RRC sequence number for signalling radio bearer RB2, as specified for the procedure initiating the integrity protection reconfiguration.

8.6.3.6 Void

8.6.3.7 Void

8.6.3.8 Integrity check info

If the IE "Integrity check info" is present the UE shall:

- 1> act as described in subclause 8.5.10.1.

8.6.3.9 New C-RNTI

If the IE "New C-RNTI" is included, the UE shall:

- 1> store the value in the variable C_RNTI, replacing any old stored value;
- 1> use that C-RNTI when using common transport channels of type RACH and FACH in the current cell;

1> for FDD and 1.28 Mcps TDD:

2> if the UE is in CELL_FACH and CELL_PCH:

3> use that C-RNTI when using the transport channel of type HS-DSCH.

8.6.3.9a New DSCH-RNTI

In TDD if the IE "New DSCH-RNTI" is included, the UE shall:

1> if the UE will be in CELL_DCH or CELL_FACH at the end of the procedure where the received message included this IE:

2> if the UE supports DSCH or USCH as indicated in the IE "Physical Channel Capability" included in the IE "UE Radio Access Capability":

3> store the value in the variable DSCH_RNTI, replacing any old stored value;

3> use that DSCH-RNTI when using SHCCH signalling in the current cell.

8.6.3.10 New U-RNTI

If the IE "New U-RNTI" is included in a received message, the UE shall:

1> store the value in the variable U_RNTI, replacing any old stored value.

8.6.3.11 RRC transaction identifier

The IE "RRC transaction identifier" may be used, together with the message type, for identification of an invocation of a downlink procedure (transaction). The UE behaviour for accepting or rejecting transactions based on the message type and the IE "RRC transaction identifier" is specified below.

If the IE "RRC transaction identifier" is included in a received message or if a Target cell HS-SCCH order is received, the UE shall perform the actions below. When a Target cell HS-SCCH order is received, the UE shall consider this as a received message with IE "RRC transaction identifier" and "Message Type" equivalent to the fields "Serving Cell Change Transaction Id" and "Serving Cell Change Message Type" stored in the variable TARGET_CELL_PRECONFIGURATION. The UE shall:

If the received message is any of the messages:

- RADIO BEARER SETUP; or
- RADIO BEARER RECONFIGURATION; or
- RADIO BEARER RELEASE; or
- TRANSPORT CHANNEL RECONFIGURATION; or
- PHYSICAL CHANNEL RECONFIGURATION; or
- a Target cell HS-SCCH order:

the UE shall:

1> if the variable ORDERED_RECONFIGURATION is set to FALSE; and

1> if the variable CELL_UPDATE_STARTED is set to FALSE; and

1> if the received message does not contain a protocol error according to clause 9 and the variable PROTOCOL_ERROR_REJECT is set to FALSE; and

1> if the table "Accepted transactions" in the variable TRANSACTIONS does not contain an entry with an IE "Message Type" set to ACTIVE SET UPDATE; and

1> if the UE has received:

- 2> a Target cell HS-SCCH order; or
- 2> an RRC message and the table "Processed transactions" in the variable TRANSACTIONS does not contain an entry with the same "Message Type" and "Transaction identifier" as the received message, the UE shall:
 - 3> accept the transaction; and
 - 3> store the IE "Message type" and the IE "RRC transaction identifier" of the received message in the table "Accepted transactions" in the variable TRANSACTIONS. In case of the reception of a Target cell HS-SCCH order, the UE shall use the values received in the IEs "Serving Cell Change Message Type" and "Serving Cell Change Transaction Id" which were received in the Active Set Update; and
 - 3> if the received message is not a Target cell HS-SCCH order:
 - 4> clear all entries in the table "Processed transactions" in the variable TRANSACTIONS.

1> else:

- 2> if the variable ORDERED_RECONFIGURATION is set to TRUE; or
- 2> if the variable CELL_UPDATE_STARTED is set to TRUE; or
- 2> if the table "Accepted transactions" in the variable TRANSACTIONS contains an entry with an IE "Message Type" set to ACTIVE SET UPDATE; or
- 2> if the received message contains a protocol error according to clause 9 causing the variable PROTOCOL_ERROR_REJECT to be set to TRUE; or
- 2> if the UE received an RRC message and the table "Processed transactions" in the variable TRANSACTIONS contains an entry with the same "Message Type" and "Transaction identifier" as the received message:
 - 3> if the UE received an RRC message and the table "Processed transactions" in the variable TRANSACTIONS contains an entry with the same "Message Type" and "Transaction identifier" as the received message:
 - 4> ignore the transaction; and
 - 4> continue with any ongoing processes and procedures as if the message was not received; and
 - 4> clear one entry which is identified by IE "Message Type" and "RRC transaction identifier" of the received message in "Processed transactions" in the variable TRANSACTIONS; and
 - 4> end the procedure.
 - 3> else if the IE "RRC transaction identifier" of the received message is identical to the "RRC transaction identifier" stored for the same "Message Type" as the received message in the table "Accepted transactions" in the variable TRANSACTIONS:
 - 4> ignore the transaction; and
 - 4> continue with any ongoing processes and procedures as if the message was not received; and
 - 4> end the procedure.
- 3> else:
 - 4> reject the transaction; and
 - 4> if the IE "Message Type" of the received message is not present in the table "Rejected transactions" in the variable TRANSACTIONS:
 - 5> store the IE "Message type" and the IE "RRC transaction identifier" of the received message in the table "Rejected transactions" in the variable TRANSACTIONS.

Else:

If the received message is any of the messages:

- RRC CONNECTION SETUP; or
- CELL UPDATE CONFIRM; or
- URA UPDATE CONFIRM; or
- UE CAPABILITY ENQUIRY;

the UE shall:

- 1> if the IE "Message Type" of the received message is not present in the table "Accepted transactions" in the variable TRANSACTIONS:
 - 2> if the received message does not contain a protocol error according to clause 9 and the variable PROTOCOL_ERROR_REJECT is set to FALSE:
 - 3> accept the transaction; and
 - 3> store the IE "Message type" and the IE "RRC transaction identifier" of the received message in the table "Accepted transactions" in the variable TRANSACTIONS.
 - 2> else:
 - 2> if the received message contains a protocol error according to clause 9 causing the variable PROTOCOL_ERROR_REJECT to be set to TRUE:
 - 3> reject the transaction; and
 - 3> if the IE "Message Type" of the received message is not present in the table "Rejected transactions" in the variable TRANSACTIONS:
 - 4> store the IE "Message type" and the IE "RRC transaction identifier" of the received message in the table "Rejected transactions" in the variable TRANSACTIONS.
 - 1> else:
 - 1> if the IE "Message Type" of the received message is present in the table "Accepted transactions" in the variable TRANSACTIONS:
 - 2> if the IE "RRC transaction identifier" of the received message is identical to the "RRC transaction identifier" stored for the "Message Type" in the table "Accepted transactions" in the variable TRANSACTIONS:
 - 3> ignore the transaction; and
 - 3> continue with any ongoing processes and procedures as the message was not received; and
 - 3> end the procedure.
 - 2> else:
 - 2> if the IE "RRC transaction identifier" of the received message is different from the "RRC transaction identifier" stored for the "Message Type" in the table "Accepted transactions" in the variable TRANSACTIONS:
 - 3> if the received message does not contain a protocol error according to clause 9 and the variable PROTOCOL_ERROR_REJECT is set to FALSE:
 - 4> ignore the once accepted transaction and instead accept the new transaction; and
 - 4> store the IE "Message type" and the IE "RRC transaction identifier" of the received message in the table "Accepted transactions" in the variable TRANSACTIONS, replacing the previous entry.

NOTE 1: The UE is expected to process the first RRC CONNECTION SETUP/CELL UPDATE CONFIRM/URA UPDATE COMFIRM message that it receives after transmitting an RRC CONNECTION REQUEST/CELL_UPDATE/URA_UPDATE message. If the UE receives further RRC CONNECTION SETUP/CELL UPDATE CONFIRM/URA UPDATE COMFIRM messages without having transmitted another RRC CONNECTION REQUEST/CELL_UPDATE/URA_UPDATE message, the UE is not required to process these messages.

NOTE 2: If the previously accepted transaction was a CELL UPDATE CONFIRM/URA UPDATE CONFIRM that included the IE "Dowlink counter synchronisation info", rather than ignore the first accepted transaction the UE may continue with the first transaction in the case where a cell re-selection interrupted the on-going procedure causing a cell update procedure to be triggered. In this case the response message acts as an explicit acknowledgement of both the CELL UPDATE CONFIRM/URA UPDATE CONFIRM message signalling an SRNS relocation and the subsequent CELL UPDATE CONFIRM/URA UPDATE CONFIRM.

3> else:

3> if the received message contains a protocol error according to clause 9 causing the variable `PROTOCOL_ERROR_REJECT` to be set to TRUE:

4> reject the transaction; and

4> if the IE "Message Type" of the received message is not present in the table "Rejected transactions" in the variable `TRANSACTIONS`:

5> store the IE "Message type" and the IE "RRC transaction identifier" of the received message in the table "Rejected transactions" in the variable `TRANSACTIONS`.

Else:

If the received message is any of the messages:

- HANDOVER FROM UTRAN COMMAND; or
- CELL CHANGE ORDER FROM UTRAN:

the UE shall:

1> if the variable `ORDERED_RECONFIGURATION` is set to TRUE;

2> reject the transaction; and

2> if the IE "Message Type" of the received message is not present in the table "Rejected transactions" in the variable `TRANSACTIONS`:

3> store the IE "Message type" and the IE "RRC transaction identifier" of the received message in the table "Rejected transactions" in the variable `TRANSACTIONS`.

Else:

If the received message is any other message, the UE shall:

1> if the IE "Message Type" of the received message is not present in the table "Accepted transactions" in the variable `TRANSACTIONS`:

2> if the received message does not contain a protocol error according to clause 9 and the variable `PROTOCOL_ERROR_REJECT` is set to FALSE:

3> accept the transaction; and

3> store the IE "Message type" and the IE "RRC transaction identifier" of the received message in the table "Accepted transactions" in the variable `TRANSACTIONS`.

2> else:

2> if the received message contains a protocol error according to clause 9 causing the variable `PROTOCOL_ERROR_REJECT` to be set to TRUE:

- 3> reject the transaction; and
 - 3> store the IE "Message type" and the IE "RRC transaction identifier" of the received message in the table "Rejected transactions" in the variable TRANSACTIONS.
- 1> else:
- 1> if the IE "Message Type" of the received message is present in the table "Accepted transactions" in the variable TRANSACTIONS:
 - 2> if the IE "RRC transaction identifier" of the received message is identical to the "RRC transaction identifier" stored in any entry for the "Message Type" in the table "Accepted transactions" in the variable TRANSACTIONS:
 - 3> ignore the transaction; and
 - 3> continue with any ongoing processes and procedures as the message was not received; and
 - 3> end the procedure.
 - 2> else:
 - 2> if the IE "RRC transaction identifier" of the received message is different from the "RRC transaction identifier" stored in all entries for the "Message Type" in the table "Accepted transactions" in the variable TRANSACTIONS:
 - 3> if the received message does not contain a protocol error according to clause 9 and the variable PROTOCOL_ERROR_REJECT is set to FALSE:
 - 4> accept the additional transaction; and
 - 4> store the IE "Message type" and the IE "RRC transaction identifier" of the received message in the table "Accepted transactions" in the variable TRANSACTIONS, in addition to the already existing entries.
 - 3> else:
 - 3> if the received message contains a protocol error according to clause 9 causing the variable PROTOCOL_ERROR_REJECT to be set to TRUE:
 - 4> reject the transaction; and
 - 4> store the IE "Message type" and the IE "RRC transaction identifier" of the received message in the table "Rejected transactions" in the variable TRANSACTIONS.

8.6.3.12 Capability Update Requirement

If the IE "Capability Update Requirement" is included the UE shall:

- 1> if the IE "UE radio access FDD capability update requirement" has the value TRUE:
 - 2> if the UE supports FDD mode:
 - 3> store its UTRA FDD capabilities and its UTRA capabilities common to FDD and TDD in the IE "UE radio access capability" and the IE "UE radio access capability extension" in variable UE_CAPABILITY_REQUESTED as specified below:
 - 4> if the UE supports any radio access capability included in IE "UE radio access capability extension" that is not included in IE "UE radio access capability":

NOTE: This is valid e.g. for UE that supports multiple UTRA FDD Bands, UE that supports a single UTRA FDD Band different from Band I [21] or UE that supports E-UTRA.

- 5> store the IE "UE radio access capability", excluding IEs "RF capability FDD" and "Measurement capability";

5> store the IE "UE radio access capability extension", including the IEs "RF capability FDD extension" and the "Measurement capability extension" associated with each supported UTRA FDD frequency band indicated in the IE "Frequency band".

4> else:

5> store the IE "UE radio access capability", including the IEs "RF capability FDD" and "Measurement capability" associated with the Band I [21].

1> if the IE "UE radio access 3.84 Mcps TDD capability update requirement" has the value TRUE:

2> if the UE supports 3.84 Mcps TDD mode:

3> store its UTRAN-specific 3.84 Mcps TDD capabilities and its UTRAN-specific capabilities common to FDD and TDD in the variable UE_CAPABILITY_REQUESTED.

1> if the IE "UE radio access 7.68 Mcps TDD capability update requirement" has the value TRUE:

2> if the UE supports 7.68 Mcps TDD mode:

3> store its UTRAN-specific 7.68 Mcps TDD capabilities and its UTRAN-specific capabilities common to FDD and TDD in the variable UE_CAPABILITY_REQUESTED.

1> if the IE "UE radio access 1.28 Mcps TDD capability update requirement" has the value TRUE:

2> if the UE supports 1.28 Mcps TDD mode:

3> store its UTRAN-specific 1.28 Mcps TDD capabilities and its UTRAN-specific capabilities common to FDD and TDD in the variable UE_CAPABILITY_REQUESTED;

3> if the UE supports E-UTRA:

4> store the IE "UE radio access capability", including "Measurement capability TDD" associated with each supported E-UTRA band.

1> if the IE "System specific capability update requirement list" is present:

2> for each of the RAT requested in the IE "UE system specific capability"

3> if the UE supports the listed RAT:

4> include its inter-RAT radio access capabilities for the listed RAT in the IE "UE system specific capability" from the variable UE_CAPABILITY_REQUESTED.

4> if the listed RAT is GSM and PS Handover to GPRS is supported:

5> include the IE "MS Radio Access Capability" in the variable UE_CAPABILITY_REQUESTED;

If the IE " Capability update requirement " is not present, the UE shall:

1> assume the default values as specified in subclause 10.3.3.2 and act in accordance with the above.

8.6.3.13 Group release information

The UE shall apply the following procedure to compare the IE "U-RNTI group" with the U-RNTI allocated to the UE stored in the variable U_RNTI.

If the IE "group discriminator" is equal to "All":

1> consider this as a group identity match.

If the IE "group discriminator" is equal to "U-RNTI mask":

1> let N be the value of the IE "U-RNTI bit mask index";

1> if N is equal to b20, b21, ... or b31:

- 2> compare pairs of bits, starting from bit b31 downto, and including, bit N of the "SRNC identity" of the IE "U-RNTI" with the corresponding bits stored in the variable U_RNTI;
- 2> if all pairs of bits are equal:
 - 3> consider this as a group identity match.
- 1> if N is equal to b1, b2, ... or b19:
 - 2> compare pairs of bits, starting from bit b31 downto, and including, bit b20 of the "SRNC identity" in the IE "U-RNTI" with the corresponding bits of the "SRNC identity" stored in the variable U_RNTI;
 - 2> if all pairs of bits are equal:
 - 3> then compare pairs of bits, starting from bit b19 downto, and including, bit N of the "S-RNTI" in the IE "U-RNTI" with the corresponding bits of the "S-RNTI" stored in the variable U_RNTI;
 - 3> if all pairs of bits are equal:
 - 4> consider this as a group identity match.

NOTE 1: The most significant bits of the U-RNTI, which indicate the "SRNC identity" must be unique among all RNC's, which support all the UEs in the group to be released, in order to obtain correct behaviour of group release.

8.6.3.14 New E-RNTI

If the IE "New Primary E-RNTI" and/or the IE "New Secondary E-RNTI" (FDD only) are/is included and the UE will be in CELL_DCH state after completion of this procedure, the UE shall:

- 1> if the IE "New Primary E-RNTI" is received in a UTRAN MOBILITY INFORMATION message:
 - 2> the UE behaviour is unspecified;
- 1> store the new value(s) in the variable E_RNTI;
- 1> determine the value for the E_DCH_TRANSMISSION variable and take the corresponding actions as described in subclause 8.5.28.

If, after state transition the UE enters CELL_PCH or URA_PCH state and the UE was in CELL_DCH state upon reception of the reconfiguration message the UE shall:

- 1> if the UE supports E-DCH transmission in CELL_FACH state and Idle mode and the IE "Common E-DCH system info" is included in system information block type 5 or 5bis:
 - 2> clear the variable E_RNTI.

For FDD and 1.28 Mcps TDD, if the IE "New Primary E-RNTI" is included and the UE will be in CELL_FACH or CELL_PCH state after completion of this procedure, the UE shall:

- 1> store the new value in the variable E_RNTI;
- 1> determine the value for the READY_FOR_COMMON_EDCH variable and perform the corresponding actions as described in subclause 8.5.47.

If, after the completion of this procedure, the variable E_DCH_TRANSMISSION is set to FALSE, the UE in CELL_DCH state shall:

- 1> clear the variable E_RNTI.

If, after the completion of this procedure, the variable READY_FOR_COMMON_EDCH is set to FALSE and the variable HSPA_RNTI_STORED_CELL_PCH is also set to FALSE, the UE shall:

- 1> if not in CELL_DCH state:
 - 2> clear the variable E_RNTI.

When the variable E_DCH_TRANSMISSION is set to TRUE the UE shall:

1> for FDD:

2> use the value of the Primary E-RNTI and/or Secondary E-RNTI stored in the variable E_RNTI as UE identities in the E-AGCH reception procedure in the physical layer.

1> for TDD:

2> use the value of New Primary E-RNTI stored in the variable E_RNTI as the UE identity in the E-AGCH reception procedure and the E-RUCCH transmission procedure in the physical layer.

8.6.3.15 SR-VCC Info

The presence of the IE "NONCE" in the IE "SR-VCC Info" triggers the relevant actions for mapping keys from the PS domain to the CS domain. The IE "NONCE" is not included if ciphering is not active for PS domain prior to the reception of the the IE "SR-VCC Info".

If the IE "SR-VCC Info" is included and the IE "NONCE" is present in the IE "SR-VCC Info", the UE shall:

1> set the "Status" in the variable CIPHERING_STATUS of the CS domain to "Started";

1> calculate the CK and IK for the CS domain as specified in [40];

1> if the IE "SR-VCC Info" is included in a message other than HANDOVER FROM UTRAN COMMAND:

2> set the variable LATEST_CONFIGURED_CN_DOMAIN to "CS domain";

2> use the ciphering algorithm in use for the PS domain as part of the new ciphering configuration for the CS domain unless otherwise specified by the message triggering SR-VCC.

If the IE "SR-VCC Info" is included, the UE shall:

1> add the signalling connection with the identity "CS domain" in the variable ESTABLISHED_SIGNALLING_CONNECTIONS.

8.6.4 Radio bearer information elements

8.6.4.1 Signalling RB information to setup list

If the IE "Signalling RB information to setup list" is included the UE shall:

1> use the same START value to initialise the COUNT-C and COUNT-I variables for all the signalling radio bearers in the list;

1> if the IE "Signalling RB information to setup list" was included in the RADIO BEARER SETUP message:

2> if the variable LATEST_CONFIGURED_CN_DOMAIN has been initialised:

3> calculate the START value only once during this procedure according to subclause 8.5.9 for the CN domain indicated in the variable LATEST_CONFIGURED_CN_DOMAIN;

3> store the calculated START value in the variable START_VALUE_TO_TRANSMIT.

1> for each occurrence of the IE "Signalling RB information to setup":

2> use the value of the IE "RB identity" as the identity of the signalling radio bearer to setup;

2> if the signalling radio bearer identified with the IE "RB identity" does not exist in the variable ESTABLISHED_RABS:

3> create a new entry for the signalling radio bearer in the variable ESTABLISHED_RABS.

2> if the IE "Signalling RB information to setup list" was received in a message other than HANDOVER TO UTRAN COMMAND; and

- 2> if the variable LATEST_CONFIGURED_CN_DOMAIN has been initialised and the value "STATUS" of the variable CIPHERING_STATUS of the CN domain stored in this variable is "Started":
 - 3> if the IE "Uplink RLC mode" or the IE "Downlink RLC mode" either in the IE "RLC info" or referenced by the RB identity in the IE "Same as RB" is set to "AM RLC" or "UM RLC":
 - 4> initialise the 20 MSB of the hyper frame number component of COUNT-C for this signalling radio bearer with the START value in the variable START_VALUE_TO_TRANSMIT;
 - 4> set the remaining LSB of the hyper frame number component of COUNT-C for this signalling radio bearer to zero;
 - 4> start to perform ciphering on this signalling radio bearer, using the value of the IE "RB identity" minus one as the value of BEARER in the ciphering algorithm.
- 2> if the IE "Signalling RB information to setup list" was received in a message other than HANDOVER TO UTRAN COMMAND; and
- 2> if the variable LATEST_CONFIGURED_CN_DOMAIN has been initialised and the value "Status" of the variable "INTEGRITY_PROTECTION_INFO" of the CN domain stored in this variable is "Started":
 - 3> initialise the 20 MSB of the hyper frame number component of COUNT-I for this signalling radio bearer with the START value in the variable START_VALUE_TO_TRANSMIT;
 - 3> set the remaining LSB of the hyper frame number component of COUNT-I for this signalling radio bearer to zero;
 - 3> for this signalling radio bearer, set the IE "Uplink RRC Message sequence number" in the variable INTEGRITY_PROTECTION_INFO to zero;
 - 3> start performing integrity protection according to subclauses 8.5.10.1 and 8.5.10.2.
- 2> perform the actions for the IE "RLC info" as specified in subclause 8.6.4.9, applied for that signalling radio bearer;
- 2> perform the actions for the IE "RB mapping info" as specified in subclause 8.6.4.8, applied for that signalling radio bearer.
- 1> apply a default value of the IE "RB identity" equal to 1 for the first IE "Signalling RB information to setup"; and
- 1> increase the default value by 1 for each occurrence.

NOTE: The UTRAN should only use the default value of the IE "RB identity" within the RRC Connection Setup and Handover to UTRAN Command messages. If the default value of the IE "RB identity" is used in any other message then the UE behaviour is not specified.

8.6.4.2 RAB information for setup

If the IE "RAB information for setup" is included, the procedure is used to establish or establish/release (only if CS domain RAB mapping is reconfigured between DCH and EDCH/HSPA or IE "RAB info to replace" exists) radio bearers belonging to a radio access bearer, and the UE shall:

- 1> if several IEs "RAB information for setup" are included in a message other than HANDOVER TO UTRAN COMMAND and the included IEs "CN domain identity" in the IE "RAB info" does not all have the same value:
 - 2> set the variable INVALID_CONFIGURATION to TRUE.
- 1> if the radio access bearer identified with the IE "RAB info" does not exist in the variable ESTABLISHED_RABS:
 - 2> create a new entry for the radio access bearer in the variable ESTABLISHED_RABS;
 - 2> store the content of the IE "RAB info" in the entry for the radio access bearer in the variable ESTABLISHED_RABS;

- 2> indicate the establishment of each radio access bearer to the upper layer entity using the IE "CN domain identity", forwarding the content of the IE "RAB identity" and the IEs NAS Synchronization Indicator as well as the following IEs if included in the IE "RAB info": "MBMS Session identity" and/ or "MBMS Service Identity";
- 2> if prior to this procedure there exists no transparent mode radio bearer for the CN domain included in the IE "CN domain identity" and at least one transparent mode radio bearer is included in the IE "RB information to setup"; or
- 2> if at least one RLC-AM or RLC-UM radio bearer is included in the IE "RB information to setup":
 - 3> calculate the START value only once during this procedure (the same START value shall be used on all new radio bearers created for this radio access bearer) according to subclause 8.5.9 for the CN domain as indicated in the IE "CN domain identity" in the IE "RAB info" part of the IE "RB information to setup";

NOTE: For the case of SR-VCC the START value from the mapped CS key will be incremented and compared with the START value read from the (U)SIM at connection setup. The largest value will be used for the new CS START value. This operation is provided with the existing procedure in subclause 8.5.9.

- 3> store the calculated START value in the variable START_VALUE_TO_TRANSMIT.
- 1> if the radio access bearer identified with the IE "RAB identity" in the IE "RAB info" already exists in the variable ESTABLISHED_RABS:
 - 2> if prior to this procedure there exists no transparent mode radio bearer for the CN domain included in the IE "CN domain identity" and at least one transparent mode radio bearer is included in the IE "RB information to setup"; or
 - 2> if at least one RLC-AM or RLC-UM radio bearer is included in the IE "RB information to setup":
 - 3> calculate the START value only once during this procedure (the same START value shall be used on all new radio bearers created for this radio access bearer) according to subclause 8.5.9 for the CN domain as indicated in the IE "CN domain identity" in the IE "RAB info" part of the IE "RB information to setup";
 - 3> store the calculated START value in the variable START_VALUE_TO_TRANSMIT.
 - 2> for each radio bearer in the variable ESTABLISHED_RABS for that radio access bearer:
 - 3> release the PDCP and RLC entities for that radio bearer;
 - 3> release the RAB subflow associated with the radio bearer;
 - 3> delete the information about the radio bearer from the variable ESTABLISHED_RABS.

NOTE: When CS domain RAB mapping is reconfigured between DCH and E-DCH/HS-DSCH, UTRAN should change the radio bearer identity.

- 1> if the radio access bearer identified with the "IE RAB info to replace" already exists in the variable ESTABLISHED_RABS:
 - 2> for each radio bearer in the variable ESTABLISHED_RABS for that radio access bearer:
 - 3> release the PDCP and RLC entities for that radio bearer;
 - 3> release the RAB subflow associated with the radio bearer;
 - 3> delete the information about the radio bearer from the variable ESTABLISHED_RABS.

NOTE: When an SR-VCC procedure is initiated, if the received reconfiguration message attempts to configure RBs with the same RB Identity as an existing or about to be released radio bearer identity, the UE behaviour is not specified.

- 2> indicate to the upper layers that the radio access bearer identified by the IE "RAB info to replace" is released as part of a SR-VCC procedure.
- 1> for each radio bearer in the IE "RB information to setup":

- 2> if the radio bearer identified with the IE "RB identity" does not exist in the variable ESTABLISHED_RABS:
 - 3> perform the actions specified in subclause 8.6.4.3;
 - 3> store information about the new radio bearer in the entry for the radio access bearer identified by "RAB info" in the variable ESTABLISHED_RABS;
 - 3> create a new RAB subflow for the radio access bearer;
 - 3> number the RAB subflow in ascending order, assigning the smallest number to the RAB subflow corresponding to the first radio bearer in the list;
 - 3> if the IE "CN domain identity" in the IE "RAB info" is set to "PS domain" and the number of RAB subflows for the radio access bearer is greater than 1:
 - 4> set the variable INVALID_CONFIGURATION to TRUE.
- 2> if the radio bearer identified with the IE "RB identity" already exists in the variable ESTABLISHED_RABS:
 - 3> set the variable INVALID_CONFIGURATION to TRUE.
- 1> if the IE "CS-HSPA information" is included:
 - 2> forward the content of the IE "UL AMR rate" to upper layers;
 - 2> use the information in the IE "Max CS delay" to determine the maximum buffering of the voice frames (see [36]).

8.6.4.2a RAB information to reconfigure

If the IE "RAB information to reconfigure" is included then the UE shall:

- 1> if the entry for the radio access bearer identified by the IE "CN domain identity" together with the IE "RAB Identity" in the variable ESTABLISHED_RABS already exists:
 - 2> perform the action for the IE "NAS Synchronization Indicator", according to subclause 8.6.4.12.
- 1> else:
 - 2> set the variable INVALID_CONFIGURATION to TRUE.
- 1> if the IE "CS-HSPA information" is included:
 - 2> forward the content of the IE "UL AMR rate" to upper layers;
 - 2> use the information in the IE "Max CS delay" to determine the maximum buffering of the voice frames (see [36]).

8.6.4.3 RB information to setup

If the IE "RB information to setup" is included, the UE shall apply the following actions on the radio bearer identified with the value of the IE "RB identity". The UE shall:

- 1> use the same START value to initialise the hyper frame number components of COUNT-C variables for all the new radio bearers to setup;
- 1> perform the actions for the IE "PDCP info", if present, according to subclause 8.6.4.10, applied for the radio bearer;
- 1> perform the actions for the IE "RLC info", according to subclause 8.6.4.9, applied for the radio bearer;
- 1> perform the actions for the IE "RB mapping info", according to subclause 8.6.4.8, applied for the radio bearer;
- 1> if the IE "Downlink RLC mode" either in the IE "RLC info" or referenced by the RB identity in the IE "Same as RB" is set to "TM RLC":

- 2> configure delivery of erroneous SDUs in lower layers according to indication from upper layer [5].
- 1> if the IE "Downlink RLC mode" either in the IE "RLC info" or referenced by the RB identity in the IE "Same as RB" is set to "UM RLC" and if the radio bearer is connected to a CS domain radio access bearer:
 - 2> configure delivery of RLC sequence number in lower layers;
 - 2> if the IE "RB information to setup" was received in a message other than HANDOVER TO UTRAN COMMAND:
 - 3> if the IE "SR-VCC Info" is present and contains the IE "NONCE":
 - 4> initialise the 20 MSB of the hyper frame number component of COUNT-C for this radio bearer (including uplink and downlink) with zero for CS domain;
 - 3> else:
 - 4> initialise the 20 MSB of the hyper frame number component of COUNT-C for this radio bearer (including uplink and downlink) with the latest transmitted START for CS domain;
 - 3> set the remaining LSB of the hyper frame number component of COUNT-C for this radio bearer (including uplink and downlink) to zero;
 - 3> start incrementing the COUNT-C values.
 - 1> else if the IE "RB information to setup" was received in a message other than HANDOVER TO UTRAN COMMAND; and
 - 1> if the IE "Uplink RLC mode" or the IE "Downlink RLC mode" either in the IE "RLC info" or referenced by the RB identity in the IE "Same as RB" is set to "AM RLC" or "UM RLC":
 - 2> initialise the 20 MSB of the hyper frame number component of COUNT-C for this radio bearer with the START value in the variable START_VALUE_TO_TRANSMIT;
 - 2> set the remaining LSB of the hyper frame number component of COUNT-C for this radio bearer to zero;
 - 2> start incrementing the COUNT-C values.
 - 1> if the IE "RB information to setup" was received in a message other than HANDOVER TO UTRAN COMMAND; and
 - 1> if the IE "Uplink RLC mode" and the IE "Downlink RLC mode" either in the IE "RLC info" or referenced by the RB identity in the IE "Same as RB" is set to "TM RLC":
 - 2> if prior to this procedure there exists no transparent mode radio bearer for the CN domain included in the IE "CN domain identity" in the IE "RAB info" in the variable ESTABLISHED_RABS and at least one transparent mode radio bearer is included in the IE "RB information to setup":
 - 3> if the IE "Status" in the variable CIPHERING_STATUS of the CN domain as indicated in the IE "CN domain identity" in the IE "RAB info" in the variable ESTABLISHED_RABS is set to "Not Started":
 - 4> at the activation time as specified in the IE "Ciphering activation time for DPCH" if included in the IE "Ciphering mode info" in the command message or, if this IE is not included, as specified in the IE "COUNT-C activation time" included in the response message:
 - 5> initialise the 20 most significant bits of the hyper frame number component of COUNT-C common for all transparent mode radio bearers of this CN domain with the START value in the variable START_VALUE_TO_TRANSMIT;
 - 5> set the remaining LSB of the hyper frame number component of COUNT-C to zero;
 - 5> do not increment the COUNT-C value common for all transparent mode radio bearers for this CN domain.
 - 3> if the IE "Status" in the variable CIPHERING_STATUS of the CN domain as indicated in the IE "CN domain identity" in the IE "RAB info" in the variable ESTABLISHED_RABS is set to "Started":

- 4> at the activation time as specified in the IE "Activation Time" in the RADIO BEARER SETUP message:
 - 5> if the IE "CN domain identity" in the "IE RAB info" is set to CS; and
 - 5> if the IE "SR-VCC Info" is present and contains the IE "NONCE":
 - 6> initialise the 20 most significant bits of the HFN component of COUNT-C common for all transparent mode RLC radio bearers to zero.
 - 5> otherwise:
 - 6> initialise the 20 most significant bits of the HFN component of COUNT-C common for all transparent mode RLC radio bearer to the value of the latest transmitted START for this CN domain.
 - 5> while not incrementing the value of the HFN component of COUNT-C at each CFN cycle; and
 - 5> set the remaining LSB of the HFN component of COUNT-C to zero;
 - 5> start to perform cipherring on the radio bearer in lower layers while not incrementing the HFN.
- 4> at the activation time as specified in the IE "Cipherring activation time for DPCH" if included in the IE "Cipherring mode info" in the command message or, if this IE is not included, as specified in the IE "COUNT-C activation time" included in the response message:
 - 5> initialise the 20 most significant bits of the HFN component of COUNT-C common for all transparent mode radio bearers of this CN domain with the START value in the variable START_VALUE_TO_TRANSMIT;
 - 5> set the remaining LSB of the HFN component of COUNT-C to zero;
 - 5> if the received message is used to perform a Timing re-initialised hard handover:
 - 6> increment the HFN component of the COUNT-C variable by one even if the "COUNT-C activation time" is set to zero.
 - 5> start incrementing the COUNT-C value common for all transparent mode radio bearers of this CN domain as normal, at each CFN value, i.e. the HFN component is no longer fixed in value but incremented at each CFN cycle.
- 2> if prior to this procedure there exists at least one transparent mode radio bearer for the CN domain included in the IE "CN domain identity" in the IE "RAB info" in the variable ESTABLISHED_RABS:
 - 3> if the IE "Status" in the variable CIPHERING_STATUS of the CN domain as indicated in the IE "CN domain identity" in the IE "RAB info" in the variable ESTABLISHED_RABS is set to "Not Started":
 - 4> do not increment the COUNT-C value common for all transparent mode radio bearers for this CN domain.
 - 3> if the IE "Status" in the variable CIPHERING_STATUS of the CN domain as indicated in the IE "CN domain identity" in the IE "RAB info" in the variable ESTABLISHED_RABS is set to "Started":
 - 4> use the COUNT-C value common for all transparent mode radio bearers of this CN domain.
- 1> if the IE "Status" in the variable CIPHERING_STATUS of the CN domain as indicated in the IE "CN domain identity" in the IE "RAB info" in the variable ESTABLISHED_RABS is set to "Started":
 - 2> start to perform cipherring on the radio bearer in lower layers, using the value of the IE "RB identity" minus one as the value of BEARER in the cipherring algorithm.

NOTE: UTRAN should not use the IE "RB information to setup" to setup radio bearers with RB identity in the range 1-4.

8.6.4.4 RB information to be affected

If the IE "RB information to be affected" is included, the UE shall apply the following actions on the radio bearer identified with the value of the IE "RB identity". The UE shall:

- 1> perform the actions for the IE "RB mapping info", according to subclause 8.6.4.8, applied for the radio bearer.

8.6.4.4a Void

8.6.4.5 RB information to reconfigure

If the IE "RB information to reconfigure" is included, the UE shall apply the following actions on the radio bearer identified with the value of the IE "RB identity". The UE shall:

- 1> perform the actions for the IE "PDCP info", if present, according to subclause 8.6.4.10, applied for the radio bearer;

- 1> if the IE "RLC info" is present:

- 2> perform the actions for the IE "RLC info", according to subclause 8.6.4.9, applied for the radio bearer.

- 1> else:

- 2> continue using the current RLC configuration for the radio bearer.

- 1> perform the actions for the IE "RB mapping info", according to subclause 8.6.4.8, applied for the radio bearer;

- 1> if the IE "Downlink RLC mode" in the IE "RLC info" is set to "TM RLC":

- 2> configure delivery of erroneous SDUs in lower layers according to indication from upper layer [5].

- 1> if the IE "PDCP SN info" is included:

- 2> perform the actions as specified in subclause 8.6.4.11 applied for the radio bearer.

- 1> if the IE "RB stop/continue" is included; and

- 2> if the "RB identity" has a value greater than 2; and

- 3> if the value of the IE "RB stop/continue" is "stop":

- 4> configure the RLC entity for the radio bearer to stop;

- 4> set the IE "RB started" in the variable ESTABLISHED_RABS to "stopped" for that radio bearer.

- 3> if the value of the IE "RB stop/continue" is "continue":

- 4> configure the RLC entity for the radio bearer to continue;

- 4> set the IE "RB started" in the variable ESTABLISHED_RABS to "started" for that radio bearer.

- 2> if the IE "RB identity" is set to a value less than or equal to 2:

- 3> set the variable INVALID_CONFIGURATION to TRUE.

8.6.4.6 RB information to release

If the IE "RB information to release" is included, the UE shall apply the following actions on the radio bearer identified with the value of the IE "RB identity". The UE shall:

- 1> if the IE "RB identity" is set to a value less than 4:

- 2> set the variable INVALID_CONFIGURATION to TRUE.

- 1> if the IE "RB identity" refers to a signalling radio bearer:
 - 2> release the RLC entity for the signalling radio bearer;
 - 2> delete the information about the signalling radio bearer from the variable ESTABLISHED_RABS.
- 1> if the IE "RB identity" refers to a radio bearer:
 - 2> release the PDCP and RLC entities for that radio bearer;
 - 2> indicate release of the RAB subflow associated with the radio bearer to upper layers;
 - 2> delete the information about the radio bearer from the variable ESTABLISHED_RABS;
 - 2> when all radio bearers belonging to the same radio access bearer have been released:
 - 3> indicate release of the radio access bearer to upper layers providing the "CN domain identity" together with the "RAB identity" and the "MBMS Service Identity" if stored in the variable ESTABLISHED_RABS;
 - 3> delete all information about the radio access bearer from the variable ESTABLISHED_RABS.

The UE shall:

- 1> determine the value for the HS_DSCH_RECEPTION variable and take the corresponding actions as described in subclause 8.5.25;
- 1> determine the value for the E_DCH_TRANSMISSION variable and take the corresponding actions as described in subclause 8.5.28.

8.6.4.7 RB with PDCP information

If the IE "RB with PDCP information" is included, the UE shall apply the following actions on the radio bearer identified with the value of the IE "RB identity". The UE shall:

- 1> for the IE "PDCP SN info":
 - 2> perform the actions as specified in subclause 8.6.4.11.

8.6.4.8 RB mapping info

If the IE "RB mapping info" is included, the UE shall:

- 1> for each multiplexing option of the RB:
 - 2> if a multiplexing option that maps a logical channel corresponding to a TM-RLC entity onto RACH, FACH, USCH, DSCH (only for TDD), HS-DSCH or E-DCH is included:
 - 3> set the variable INVALID_CONFIGURATION to TRUE.
 - 2> if the multiplexing option realises the radio bearer on the uplink (resp. on the downlink) using two logical channels with different values of the IE "Uplink transport channel type" (resp. of the IE "Downlink transport channel type"):
 - 3> set the variable INVALID_CONFIGURATION to TRUE.
 - 2> if that RB is using TM and the IE "Segmentation indication" is set to TRUE and, based on the multiplexing configuration resulting from this message, the logical channel corresponding to it is mapped onto the same transport channel as another logical channel:
 - 3> set the variable INVALID_CONFIGURATION to TRUE.
 - 2> if the transport channel considered in that multiplexing option is different from RACH and if that RB is using AM and the set of RLC sizes applicable to the uplink logical channel transferring data PDUs has more than one element not equal to zero:

- 3> set the variable INVALID_CONFIGURATION to TRUE.
- 2> if that RB is using UM or TM and the multiplexing option realises it using two logical channels:
 - 3> set the variable INVALID_CONFIGURATION to TRUE.
 - 2> for each logical channel in that multiplexing option:
 - 3> if the value of the IE "RLC size list" is set to "Explicit list":
 - 4> if a "Transport format set" for the transport channel this logical channel is mapped on in this multiplexing option is included in the same message, and the value (index) of any IE "RLC size index" in the IE "Explicit list" does not correspond to an "RLC size" in the IE transport format set of that transport channel given in the message; or
 - 4> if the transport channel this logical channel is mapped on in this multiplexing option is different from RACH, and if a "Transport format set" for that transport channel is not included in the same message, and the value (index) of any IE "RLC size index" in the IE "Explicit list" does not correspond to an "RLC size" in the stored transport format set of that transport channel; or
 - 4> if a "Transport format set" for the transport channel this logical channel is mapped on in this multiplexing option is included in the same message, and the value of any IE "Logical channel list" in the transport format set is not set to "Configured"; or
 - 4> if a "Transport format set" for the transport channel this logical channel is mapped on in this multiplexing option is not included in the same message, and the value of any IE "Logical channel list" in the stored transport format set of that transport channel is not set to "Configured":
 - 5> set the variable INVALID_CONFIGURATION to TRUE.
 - 3> if the value of the IE "RLC size list" is set to "All":
 - 4> if the transport channel this logical channel is mapped on is RACH; or
 - 4> if a "Transport format set" for the transport channel this logical channel is mapped on in this multiplexing option is included in the same message, and the value of any IE "Logical channel list" in the transport format set is not set to "Configured"; or
 - 4> if a "Transport format set" for the transport channel this logical channel is mapped on in this multiplexing option is not included in the same message, and the value of any IE "Logical channel list" in the stored transport format set of that transport channel is not set to "Configured":
 - 5> set the variable INVALID_CONFIGURATION to TRUE.
 - 3> if the value of the IE "RLC size list" is set to "Configured":
 - 4> if the transport channel this logical channel is mapped on is RACH; or
 - 4> if a "Transport format set" for the transport channel this logical channel is mapped on in this multiplexing option is included in the same message, and for none of the RLC sizes defined for that transport channel in the "Transport format set", the "Logical Channel List" is set to "All" or given as an "Explicit List" which contains this logical channel; or
 - 4> if a "Transport format set" for the transport channel this logical channel is mapped on in this multiplexing option is not included in the same message, and for none of the RLC sizes defined in the transport format set stored for that transport channel, the "Logical Channel List" is set to "All" or given as an "Explicit List" which contains this logical channel:
 - 5> set the variable INVALID_CONFIGURATION to TRUE.
 - 1> if, for the HS-DSCH transport channel, when MAC-hs is configured and as a result of the message this IE is included in, several radio bearers can be mapped onto the same MAC-d flow, and the IE "Logical Channel Identity" was not included in the RB mapping info of any of those radio bearers for a multiplexing option on that MAC-d flow or the same "Logical Channel Identity" was used more than once in the RB mapping info of those radio bearers for the multiplexing options on that MAC-d flow:

- 2> the UE behaviour is not specified.
- 1> if, for the HS-DSCH transport channel, when MAC-ehs is configured and as a result of the message this IE is included in, several radio bearers can be mapped onto the reordering queue(s), and the IE "Logical Channel Identity" was not included in the RB mapping info of any of those radio bearers for a multiplexing option on at least one reordering queue or the same "Logical Channel Identity" was used more than once in the RB mapping info of those radio bearers for the multiplexing options on any reordering queue:
 - 2> the UE behaviour is not specified.
- 1> if, as a result of the message this IE is included in, several radio bearers can be mapped onto the E-DCH MAC-d flows(s), and the IE "Logical Channel Identity" was not included in the RB mapping info of any of those radio bearers for a multiplexing option on at least one E-DCH MAC-d flow or the same "Logical Channel Identity" was used more than once in the RB mapping info of those radio bearers for the multiplexing options on any MAC-d flow:
 - 2> the UE behaviour is not specified.
- 1> if, for transport channels other than HS-DSCH and E-DCH, as a result of the message this IE is included in, several radio bearers can be mapped onto the same transport channel, and the IE "Logical Channel Identity" was not included in the RB mapping info of any of those radio bearers for a multiplexing option on that transport channel or the same "Logical Channel Identity" was used more than once in the RB mapping info of those radio bearers for the multiplexing options on that transport channel:
 - 2> set the variable INVALID_CONFIGURATION to TRUE.
- 1> if, as a result of the message this IE is included in, there are several radio bearers configured with a multiplexing option mapped on "HS-DSCH", i.e., a downlink transport channel of type "HS-DSCH" or "DCH + HS-DSCH", and there is at least one radio bearer with a multiplexing option configured with the DL MAC header type set to "MAC-hs" and at least one radio bearer with a multiplexing option configured with the DL MAC header type set to "MAC-ehs":
 - 2> set the variable INVALID_CONFIGURATION to TRUE.
- 1> if the "RB mapping info" is considered as valid according to the rules above:
 - 2> delete all previously stored multiplexing options for that radio bearer;
 - 2> store each new multiplexing option for that radio bearer;
 - 2> perform the actions as specified in subclause 8.5.21;
 - 2> determine the value for the HS_DSCH_RECEPTION variable and take the corresponding actions as described in subclause 8.5.25;
 - 2> determine the value for the E_DCH_TRANSMISSION variable and take the corresponding actions as described in subclause 8.5.28.
- 1> if the IE "Uplink transport channel type" is set to the value "RACH":
 - 2> in FDD:
 - 3> refer the IE "RLC size index" to the RACH Transport Format Set of the first PRACH received in the IE "PRACH system information list" received in System Information Block 5, System Information Block 5bis or System Information Block 6.
 - 2> in TDD:
 - 3> use the first Transport Format of the PRACH of the IE "PRACH system information list" at the position equal to the value in the IE "RLC size index".
- 1> if the IE "Downlink transport channel type" is set to the value "HS-DSCH" and the DL MAC header type is set to "MAC-ehs":
 - 2> if the IE "Logical channel identity" is present:

- 3> configure the receiving MAC-ehs entity with the value of the IE "Logical channel identity" to be used in the "LCH-ID" field of the MAC-ehs header [15] associated with the MAC-ehs reordering queue identified by the value of the IE "DL HS-DSCH MAC-ehs Queue Id".

2> else:

- 3> set the variable INVALID_CONFIGURATION to TRUE.

In case IE "RLC info" includes IE "Downlink RLC mode" ("DL RLC logical channel info" is mandatory present) but IE "Number of downlink RLC logical channels" is absent in the corresponding IE "RB mapping info", the parameter values are exactly the same as for the corresponding UL logical channels. In case two multiplexing options are specified for the UL, the first options shall be used as default for the DL. As regards the IE "Channel type", the following rule should be applied to derive the DL channel type from the UL channel included in the IE:

| Channel used in UL | DL channel type implied by "same as" |
|--------------------|--------------------------------------|
| DCH | DCH |
| RACH | FACH |
| USCH | DSCH |

If ciphering is applied, UTRAN should not map Transparent Mode RBs of different CN domains on the same transport channel and it should not map transparent mode SRBs and RBs onto the same transport channel. In such cases the UE behaviour is not specified.

For FDD the list of multiplexing options configured in the UE for each RB and SRB should comply with the following rules otherwise the UE behaviour is not specified:

- at most one multiplexing option can contain the combination "FACH" for the DL and "RACH" for the UL;
- for FDD, at most one multiplexing option can contain the combination "HS-DSCH" mapped on MAC-ehs for the DL and "RACH" for the UL;
- at most one multiplexing option can contain the combination "DCH" or "DCH + HS-DSCH" for the DL together with "DCH" for the UL;
- at most one multiplexing option can contain the combination "HS-DSCH" or "DCH + HS-DSCH" for the DL together with "DCH" for the UL;
- at most one multiplexing option can contain the combination "DCH" or "DCH + HS-DSCH" for the DL together with "E-DCH" for the UL; and
- at most one multiplexing option can contain the combination "HS-DSCH" or "DCH + HS-DSCH" for the DL together with "E-DCH" for the UL.

8.6.4.9 RLC Info

Upon reception of the IE "RLC Info", the UE shall:

- 1> if both the IE "Uplink RLC mode" and the IE "Downlink RLC mode" are present in the IE "RLC info":
 - 2> configure the transmitting and receiving RLC entities in the UE for that radio bearer accordingly.
- 1> else, if the IE "Uplink RLC mode" is present and the IE "Downlink RLC mode" is not present in the IE "RLC info":
 - 2> configure the transmitting RLC entity in the UE for that radio bearer accordingly and keep the configuration existing before the reception of the message for the receiving RLC entity.
- 1> else, if the IE "Uplink RLC mode" is not present and the IE "Downlink RLC mode" is present in the IE "RLC info":
 - 2> configure the receiving RLC entity in the UE for that radio bearer accordingly and keep the configuration existing before the reception of the message for the transmitting RLC entity.
- 1> if the IE "Polling info" is present in the IE "RLC info":

- 2> for each present IE in the IE "Polling info":
 - 3> configure RLC to use the corresponding function according to the value of the IE.
 - 2> for each absent IE in the IE "Polling info":
 - 3> configure RLC to not use the corresponding function.
 - 1> if the IE "Polling info" is absent:
 - 2> configure RLC to not use the polling functionality.
 - 1> if the IE "Downlink RLC STATUS info" is present in the IE "RLC info" (this IE is present for AM RLC):
 - 2> for each present IE in the IE "Downlink RLC STATUS info":
 - 3> configure RLC to use the corresponding function according to value of the IE.
 - 2> for each absent IE in the IE "Downlink RLC STATUS info":
 - 3> configure RLC to not use the corresponding function.
 - 1> if the IE "Transmission RLC discard" is present:
 - 2> configure the discard procedure in RLC according to the IE "Transmission RLC discard"
 - 1> if the IE "Transmission RLC discard" is absent (only possible for TM RLC and UM RLC):
 - 2> do not configure SDU discard in RLC.
 - 1> if the IE "Uplink RLC mode" is present and is set to "AM RLC":
 - 2> if the IE "Use special value of HE field" is present:
 - 3> configure the uplink RLC entity to use the special value of the HE field to indicate the end of an SDU.
 - 2> if the IE "Use special value of HE field" is not present:
 - 3> configure the uplink RLC entity to not use the special value of the HE field to indicate the end of an SDU.
 - 1> if the IE "Uplink RLC mode" is present and is set to "UM RLC":
 - 2> if the IE "Alternative E-bit interpretation" is present:
 - 3> configure the uplink RLC entity to use the alternative E-bit interpretation and corresponding LI's.
 - 2> if the IE "Alternative E-bit interpretation" is not present:
 - 3> configure the uplink RLC entity to use the normal E-bit interpretation and corresponding LI's.
 - 1> if the IE "Downlink RLC mode" is present and is set to "AM RLC":
 - 2> if IE "DL RLC PDU size" is not present:
 - 3> determining the downlink RLC PDU size will be handled at RLC level as described in [16], without any configuration from RRC.
- NOTE: The case where this mandatory IE is not present is meant to handle the interaction with a network using an earlier release of the specification.
- 2> else, if the IE "DL RLC PDU size" is present, the DL RLC PDU size is set to "fixed size" and no downlink RLC PDU size is currently set in the RLC entity:
 - 3> configure the corresponding RLC entity with the downlink RLC PDU size.
 - 2> else, if the DL RLC PDU size is set to "flexible size" and no downlink RLC PDU size is currently set in the RLC entity:
 - 3> if this radio bearer is a signalling radio bearer:

- 4> the UE behaviour is unspecified.
- 3> else, configure the corresponding RLC entity with the RLC length indicator size indicated in the IE "Length indicator size".
- 2> else, if the DL RLC PDU size is changed to "flexible size" from "fixed size" and the the indicated RLC length indicator size is 7 bits:
 - 3> if this radio bearer is a signalling radio bearer:
 - 4> the UE behaviour is unspecified.
 - 3> else, configure the corresponding RLC entity with flexible RLC PDU size and the RLC length indicator size indicated in the IE "Length indicator size".
 - 2> else, if the IE "DL RLC PDU size" is present, the DL RLC PDU size is set to "fixed size" and DL RLC PDU size value is different from the one currently set in the RLC entity; or
 - 2> the DL RLC PDU size is set to "flexible size" and the indicated RLC length indicator size is different from the one currently set in the RLC entity; or
 - 2> the DL RLC PDU size is changed to "fixed size" from "flexible size"; or
 - 2> the DL RLC PDU size is changed to "flexible size" from "fixed size" and the indicated RLC length indicator size is 15 bits:

NOTE: The downlink RLC PDU size set in the RLC entity should be explicitly configured in this release of the specification.

- 3> if the DL RLC PDU size is set to "flexible size":
 - 4> if this radio bearer is a signalling radio bearer:
 - 5> the UE behaviour is unspecified.
 - 3> if the IE "one sided RLC re-establishment" is set to TRUE:
 - 4> re-establish the receiving side of the corresponding RLC entity.
 - 3> else:
 - 4> re-establish the corresponding RLC entity.
 - 3> if the RLC entity for SRB2 is re-established:
 - 4> clear all entries in the table "Processed transactions" in the variable TRANSACTIONS.
 - 3> if the DL RLC PDU size is set to "fixed size":
 - 4> configure the corresponding RLC entity with the new downlink RLC PDU size.
 - 3> if the DL RLC PDU size is set to "flexible size":
 - 4> configure the corresponding RLC entity with the RLC length indicator size indicated in the IE "Length indicator size".
 - 3> if the UE supports the lossless DL RLC PDU size change and PDCP was configured for that radio bearer with the IE "Support for lossless SRNS relocation or for lossless DL RLC PDU size change" set to TRUE:
 - 4> include the current DL PDCP receive sequence number and the radio bearer identity for that radio bearer in the variable PDCP_SN_INFO.
 - 3> if the IE "Status" in the variable CIPHERING_STATUS of the CN domain as indicated in the IE "CN domain identity" in the IE "RAB info" for this radio bearer is set to "Started":
 - 4> if the RLC re-establishment is caused by a CELL UPDATE CONFIRM:

- 5> if only the receiving side of the RLC entity was re-established:
 - 6> set the HFN values for the corresponding RLC entity in downlink equal to the value of the IE "START" included in the latest transmitted CELL UPDATE message for this CN domain.
 - 5> if the whole RLC entity was re-established:
 - 6> set the HFN values for the corresponding RLC entity in uplink and downlink equal to the value of the IE "START" included in the latest transmitted CELL UPDATE message for this CN domain.
 - 4> if the RLC re-establishment is caused by a reconfiguration message:
 - 5> if only the receiving side of the RLC entity was re-established:
 - 6> set the HFN values for the corresponding RLC entity in downlink equal to the value of the IE "START" that will be included in the reconfiguration complete message for this CN domain.
 - 5> if the whole RLC entity was re-established:
 - 6> set the HFN values for the corresponding RLC entity in uplink and downlink equal to the value of the IE "START" that will be included in the reconfiguration complete message for this CN domain.
 - 2> if the IE "Use special value of HE field" is present:
 - 3> configure the downlink RLC entity to use the special value of the HE field to indicate the end of an SDU.
 - 2> if the IE "Use special value of HE field" is not present:
 - 3> configure the downlink RLC entity to not use the special value of the HE field to indicate the end of an SDU.
 - 1> if the IE "Downlink RLC mode" is present and is set to "UM RLC":
 - 2> if the IE "DL UM RLC LI size" is not present:
 - 3> configure the corresponding RLC entity with an LI size of 7 bits;
- NOTE: The case where this mandatory IE is not present is meant to handle the interaction with a network using an earlier release of the specification.
- 2> else:
 - 3> configure the corresponding RLC entity with the LI size indicated in the IE "DL UM RLC LI size".
 - 2> if the IE "DL Reception Window Size" is present:
 - 3> if the variable UE_CAPABILITY_TRANSFERRED indicates "Support of HS-PDSCH" as "Supported":
 - 4> configure the corresponding RLC entity to support out-of-sequence reception with the receive window size indicated in the IE.
 - 3> if the variable UE_CAPABILITY_TRANSFERRED indicates "Support of HS-PDSCH" as "Unsupported":
 - 4> the UE behaviour is not specified.
 - 2> else:
 - 3> configure the corresponding RLC entity without out-of-sequence reception.
- NOTE: If the "Uplink RLC mode" or the "Downlink RLC mode" of an existing radio bearer is modified by a reconfiguration message, the UE behaviour is unspecified.
- 2> if the IE "Alternative E-bit interpretation" is present:
 - 3> configure the downlink RLC entity to use the alternative E-bit interpretation and corresponding LI's.

- 2> if the IE "Alternative E-bit interpretation" is not present:
 - 3> configure the downlink RLC entity to use the normal E-bit interpretation and corresponding LI's.

8.6.4.10 PDCP Info

For RFC 3095:

- 1> the chosen MAX_CID shall be less than the value "Maximum number of ROHC context sessions" as indicated in the IE "PDCP Capability".

If IE "PDCP info" is included, the UE shall:

- 1> if the radio bearer is connected to a CS domain radio access bearer:
 - 2> if the IE "PDCP info" is included in any other message than the RADIO BEARER SETUP, CELL UPDATE CONFIRM or the HANDOVER TO UTRAN COMMAND message; or
 - 2> if the IE "PDCP PDU header" is set to the value "absent"; or
 - 2> if the IE "Support for lossless SRNS relocation or for lossless DL RLC PDU size change" is set to TRUE; or
 - 2> if the IE "Header compression information" is present; or
 - 2> if the UE does not support CS voice service over HSDPA and EDCH:
 - 3> set the variable INVALID_CONFIGURATION to TRUE.
 - 2> else
 - 3> include PDCP headers in both uplink and downlink PDCP PDUs.
 - 3> configure "PDCP Unrecoverable Error Detection" in lower layer.
- 1> else if the radio bearer is connected to a PS domain radio access bearer:
 - 2> if the IE "PDCP PDU header" is set to the value "absent":
 - 3> if the IE "Support for lossless SRNS relocation or for lossless DL RLC PDU size change" is TRUE:
 - 4> set the variable INVALID_CONFIGURATION to TRUE.
 - 2> if the IE "PDCP PDU header" is set to the value "present":
 - 3> include PDCP headers in both uplink and downlink PDCP PDUs;
 - 3> if the IE "Support for lossless SRNS relocation or for lossless DL RLC PDU size change" is FALSE:
 - 4> if the IE "Header compression information" is absent:
 - 5> set the variable INVALID_CONFIGURATION to TRUE.
 - 2> if the IE "Header compression information" is absent:
 - 3> not use Header compression after the successful completion of this procedure;
 - 3> remove any stored configuration for the IE "Header compression information".
 - 2> if the IE "Header compression information" is present:
 - 3> if the IE "Algorithm Type" is set to "RFC 2507":
 - 4> if the UE capability "Maximum header compression context space", as specified in [35], is exceeded with this configuration:
 - 5> set the variable INVALID_CONFIGURATION to TRUE.
 - 4> if the IE "PDCP PDU header" is set to the value "absent":

- 5> the behaviour of the UE is unspecified.
- 3> if the IE "Algorithm Type" is set to "RFC 3095":
 - 4> if the uplink RLC mode for this radio bearer is RLC-TM:
 - 5> the behaviour of the UE is unspecified.
- 1> configure the PDCP entity for that radio bearer accordingly;
- 1> configure the RLC entity for that radio bearer according to the value of the IE "Support for lossless SRNS relocation or for lossless DL RLC PDU size change";
- 1> set the PROFILES parameter, used by inband ROHC profile negotiation, for this PDCP entity for both UL and DL equal to the list of ROHC profiles received in the IE "PDCP info". A UE complying to this version of the protocol shall support ROHC profiles 0x0000 (ROHC uncompressed), 0x0001 (ROHC RTP), 0x0002 (ROHC UDP) and 0x0003 (ROHC ESP) (see [52]).
- 1> if the IE "PDCP ROHC target mode" is received:
 - 2> set the variable " PDCP_ROHC_TARGET_MODE " to the received value.
- 1> if the IE "PDCP ROHC target mode" is not received in either of the CELL UPDATE CONFIRM, the RADIO BEARER RECONFIGURATION or the RADIO BEARER SETUP message:
 - 2> delete the variable "PDCD_ROHC_TARGET_MODE" and act according to actions specified in [36].

8.6.4.11 PDCP SN Info

If the IE "PDCP SN Info" is included, the UE shall:

- 1> transfer the sequence number to the PDCP entity for the radio bearer;
- 1> configure the RLC entity for the radio bearer to stop;
- 1> include the current PDCP receive sequence number and the radio bearer identity for the radio bearer in the variable PDCP_SN_INFO.

8.6.4.12 NAS Synchronisation Indicator

If the IE "NAS Synchronisation Indicator" is present in a message, the UE shall:

- 1> forward the content to upper layers along with the IE "CN domain identity" of the associated RAB stored in the variable ESTABLISHED_RABS at the CFN indicated in the IE "Activation time" in order to synchronise actions in NAS and AS.

8.6.4.13 PDCP context relocation info

If the IE "PDCP context relocation info" is included, the UE shall, for each radio bearer included in this IE:

- 1> If the IE "Downlink RFC 3095 context relocation indication" is set to TRUE:
 - 2> perform the actions as specified in [36] for all RFC 3095 contexts associated with that radio bearer in the downlink.
- 1> If the IE "Uplink RFC 3095 context relocation indication" is set to TRUE:
 - 2> perform the actions as specified in [36] for all RFC 3095 contexts associated with that radio bearer in the uplink.

8.6.4.14 RLC Info MBMS

Upon reception of the IE "RLC Info MBMS", the UE shall:

- 1> configure the receiving RLC entity in the UE for that radio bearer accordingly;

- 1> configure the corresponding RLC entity with the LI size indicated in the IE "DL UM RLC LI size".
- 1> if the IE "DL Duplication Avoidance and Reordering info" is present:
 - 2> configure the corresponding RLC entity to use the UM duplication avoidance and reordering functionality.
- 1> if the IE "DL Out of sequence delivery info" is present:
 - 2> configure the corresponding RLC entity to use the UM out of sequence delivery functionality.

8.6.4.15 RAB information for MBMS ptp bearer

If the IE "RAB information for MBMS ptp bearer" is included then the UE shall:

- 1> if an entry for the radio access bearer identified by the IE "RB Identity" already exists in the variable ESTABLISHED_RABS and a value of the IE "MBMS Service Identity" is stored in this entry of the variable ESTABLISHED_RABS:
 - 2> notify upper layers that the radio access bearer characterised by the parameters currently stored in this entry of the variable ESTABLISHED_RABS is released;
 - 2> reuse this entry of the variable ESTABLISHED_RABS and update it with the received value of IE "MBMS Service Identity" and, if included, with the received value of IE "MBMS Session Identity";
 - 2> notify upper layers that the radio access bearer characterised by the updated parameters in this entry is established.
- 1> else:
 - 2> set the variable INVALID_CONFIGURATION to TRUE.

8.6.5 Transport channel information elements

8.6.5.1 Transport Format Set

If the IE "Transport format set" is included, the UE shall:

- 1> if the transport format set is a RACH TFS received in System Information Block type 5 or System Information Block type 5bis or System Information Block type 6, and CHOICE "Logical Channel List" has a value different from "Configured":
 - 2> ignore that System Information Block.

NOTE: The TFS added by the IE "Additional Dynamic Transport Format Information for CCCH" has no CHOICE "Logical Channel List" and can thus never be considered as different from "Configured".

- 1> if the transport format set for a downlink transport channel is received in a System Information Block, and CHOICE "Logical Channel List" has a value different from 'ALL':
 - 2> ignore that System Information Block.
- 1> if the transport format set for a downlink transport channel is received in a message on a DCCH, and CHOICE "Logical Channel List" has a value different from 'ALL':
 - 2> keep the transport format set if this exists for that transport channel;
 - 2> set the variable INVALID_CONFIGURATION to TRUE.
- 1> if the value of any IE "RB identity" (and "Logical Channel" for RBs using two UL logical channels) in the IE "Logical channel list" does not correspond to a logical channel indicated to be mapped onto this transport channel in any RB multiplexing option (either included in the same message or previously stored and not changed by this message); or
- 1> if the "Logical Channel List" for any of the RLC sizes defined for that transport channel is set to "Configured" while it is set to "All" or given as an "Explicit List" for any other RLC size; or

- 1> if the "Logical Channel List" for any of the RLC sizes defined for that transport channel is set to "All" and for any logical channel mapped to this transport channel, the value of the "RLC size list" (either provided in the IE "RB mapping info" if included in the same message, or stored) is not set to "Configured"; or
- 1> if the "Logical Channel List" for any of the RLC sizes defined for that transport channel is given as an "Explicit List" that contains a logical channel for which the value of the "RLC size list" (either provided in the IE "RB mapping info" if included in the same message, or stored) is not set to "Configured"; or
- 1> if the "Logical Channel List" for all the RLC sizes defined for that transport channel are given as "Explicit List" and if one of the logical channels mapped onto this transport channel is not included in any of those lists; or
- 1> if the "Logical Channel List" for the RLC sizes defined for that transport channel is set to "Configured" and for any logical channel mapped onto that transport channel, the value of the "RLC size list" (either provided in the IE "RB mapping info" if included in the same message, or stored) is also set to "Configured"; or
- 1> if the IE "Transport Format Set" was not received within the IE "PRACH system information list" and if the "Logical Channel List" for the RLC sizes defined for that transport channel is set to "Configured" and for any logical channel mapped onto that transport channel, the "RLC size list" (either provided in the IE "RB mapping info" if included in the same message, or stored) is given as an "Explicit List" that includes an "RLC size index" that does not correspond to any RLC size in this "Transport Format Set"; or
- 1> if the IE "Transport Format Set" was not received within the IE "PRACH system information list", and if that RB is using AM and the set of RLC sizes applicable to the logical channel transferring data PDUs has more than one element not equal to zero:
 - 2> keep the transport format set if this exists for that transport channel;
 - 2> set the variable INVALID_CONFIGURATION to TRUE.
- 1> if the total number of configured transport formats for the transport channel exceeds maxTF:
 - 2> keep the transport format set if this exists for that transport channel;
 - 2> set the variable INVALID_CONFIGURATION to TRUE.
- 1> if the IE "Transport format set" is considered as valid according to the rules above:
 - 2> remove a previously stored transport format set if this exists for that transport channel;
 - 2> store the transport format set for that transport channel;
 - 2> consider the first instance of the parameter *Number of TBs and TTI List* within the *Dynamic transport format information* to correspond to transport format 0 for this transport channel, the second to transport format 1 and so on;
 - 2> if the IE "Transport format Set" has the choice "Transport channel type" set to "Dedicated transport channel":
 - 3> calculate the transport block size for all transport formats in the TFS using the following

| | |
|--------------------------------------|---------------------|
| TB size = RLC size + MAC header size | if "RLC size" <> 0, |
| TB size = 0 | if "RLC size" = 0, |
 - where:
 - MAC header size is calculated according to [15] if MAC multiplexing is used. Otherwise it is 0 bits;
 - 'RLC size' reflects the RLC PDU size.
- 2> if the IE "Transport format Set" has the choice "Transport channel type" set to "Common transport channel":
 - 3> calculate the transport block size for all transport formats in the TFS using the following:

$$\text{TB size} = \text{RLC size.}$$
- 2> if the IE "Number of Transport blocks" <> 0 and IE "RLC size" = 0, no RLC PDU data exists but only parity bits exist for that transport format;

- 2> if the IE "Number of Transport blocks" = 0, neither RLC PDU neither data nor parity bits exist for that transport format;
- 2> perform the actions as specified in subclause 8.5.21.

For configuration restrictions on Blind Transport Format Detection, see [27].

8.6.5.2 Transport format combination set

If the IE "Transport format combination set" is included for the uplink, the UE shall for that direction:

- 1> store the new transport format combination set, or (if this exists) modify a previously stored transport format combination set according to IEs included in IE "Transport format combination set";
- 1> start to respect those transport format combinations;
- 1> if IE "Transport format combination subset" is received in this message:
 - 2> perform the actions as specified in subclause 8.6.5.3.
- 1> if IE "Transport format combination subset" is not received in this message:
 - 2> clear the IE "Duration" in the variable TFC_SUBSET;
 - 2> set both the IE "Current TFC subset" and the IE "Default TFC subset" in the variable TFC_SUBSET to the value indicating "full transport format combination set".

If the IE "Transport format combination set" is included for the downlink, the UE shall for that direction:

- 1> store the new transport format combination set, or (if this exists) modify a previously stored transport format combination set according to IEs included in IE "Transport format combination set";
- 1> start to respect those transport format combinations.

If the IE "Transport format combination set" is not included for the uplink and if there is no addition, removal or reconfiguration of transport channels, the UE shall for that direction:

- 1> use a previously stored transport format combination set if this exists.

If the IE "Transport format combination set" is not included for the downlink and if there is no addition, removal or reconfiguration of transport channels, the UE shall for that direction:

- 1> use a previously stored transport format combination set if this exists.

If the IE "Transport format combination set" is not included for either the uplink or the downlink and for that direction after the reconfiguration there is one or more stored DCH configuration; and

- 1> if no transport format combination set is stored in the UE; or
- 1> if transport channels are added or removed in the message; or
- 1> if any transport channel is reconfigured in the message such that the size of the transport format set is changed:

the UE shall:

- 1> set the variable INVALID_CONFIGURATION to TRUE.

If the IE "Transport format combination set" is not included for either the uplink or the downlink and for that direction after the reconfiguration there is no stored DCH configuration, the UE shall:

- 1> remove any stored transport format combination set for dedicated channels for that direction.

In the uplink TFCS the minimum set of TFCs is the set of TFCs that is needed for the TFC selection algorithm defined in [15] to give a predictable result. Any configured TFCS or TFC subset shall satisfy the requirements as specified by the minimum set. In the definition of the minimum set of TFCs below, only logical channels for which the TFCS or the TFC subset include at least one TFC with non-empty TF for the corresponding transport channel should be considered.

The minimum set of TFCs consists of the following:

1> for each UM logical channel:

2> a TFC with one transport block for this transport channel and empty TFs (see [34]) for all the others. If more than one TFC fulfils these criteria, only the TFC with the lowest number of bits should be included in the minimum set of TFCs.

1> for each AM logical channel:

2> a TFC with a non-empty TF for the corresponding transport channel and empty TFs for all other transport channels, where the non-empty TF includes one transport block with "Configured RLC Size" equal to the RLC PDU size.

1> for each set of "synchronous" TM logical channels (see the definition below) and for each set of SDU sizes associated with it:

2> a TFC with TFs corresponding to any combination of SDU sizes that can be received in a TTI from higher layers on the corresponding transport channels and empty TFs for all other transport channels.

NOTE: In case an adaptive rate codec is used and the TFCS has been restricted by the IE "TFC subset", the minimum set consists of the set of TFCs with TFs corresponding to any combination of SDU sizes that can be received in a TTI respecting the restricted TFCS.

1> for each TM logical channel that is not part of a set of "synchronous" TM logical channels (see the definition below):

2> a TFC with non-empty TFs for the corresponding transport channel, and empty TFs for all other transport channels, where

3> for non-segmented mode TM-RLC logical channels the non-empty TFs include, for the smallest SDU size that can be received in a single TTI from higher layer:

4> a TF with non-zero number of transport blocks with "Configured RLC Size" equal to the corresponding SDU size. If more than one TFC fulfils these criteria, only the TFC with the lowest number of bits in the TFC is included in the minimum set of TFCs.

3> for segmented mode TM-RLC, the non-empty TFs include any TF such that the number of transport blocks multiplied by the "Configured RLC Size" is equal to the smallest SDU size that can be received in a single TTI from higher layer.

1> an "empty" TFC (see [34]).

Furthermore, the UTRAN should ensure that the uplink TFCS and any configured TFC Subset satisfies the following rules:

1> for each TTI length with which at least one transport channel is configured:

2> for each combination of TFs for the transport channels configured with this TTI length included in the TFCS:

3> a TFC with these TFs for the transport channels configured with this TTI length and empty TFs on all transport channels configured with shorter TTI lengths is also included in the TFCS.

For TDD, the TFCS of a CCTrCH should include those of the above combinations, which include a TF with one transport block for a transport channel used in that CCTrCH, and the "empty" TFC should be included in the TFCS of every CCTrCH.

Synchronous TM logical channels are logical channels on which higher layer traffic is generated in a perfectly correlated fashion (e.g. AMR RAB).

NOTE: The "Configured RLC Size" is defined as the transport block size minus the MAC header size.

8.6.5.3 Transport format combination subset

When configuring a TFC Subset, the UTRAN should follow the guidelines defined in subclause 8.6.5.2.

If a DCH is configured on the uplink and the IE "Transport format combination subset" ("TFC subset") is included, the UE shall:

- 1> if the IE "Minimum allowed Transport format combination index" is included; and
 - 2> if the value of the IE "Minimum allowed Transport format combination index" is greater than the highest TFCI value in the current transport format combination set:
 - 3> consider the TFC subset to be incompatible with the current transport format combination set.
- 1> if the IE "Allowed transport format combination list" is included; and
 - 2> if the value of any of the IEs "Allowed transport format combination" included in the IE "Allowed transport format combination list" does not match a TFCI value in the current transport format combination set:
 - 3> consider the TFC subset to be incompatible with the current transport format combination set.
- 1> if the IE "Non-allowed transport format combination list" is included; and
 - 2> if the value of any of the IEs "Non-allowed transport format combination" included in the IE "Non-allowed transport format combination list" does not match a TFCI value in the current transport format combination set:
 - 3> consider the TFC subset to be incompatible with the current transport format combination set.
- 1> if the IE "Restricted TrCH information" is included:
 - 2> if the value of any of the IEs "Uplink transport channel type" and "Restricted UL TrCH identity" included in the IE "Restricted TrCH information" do not correspond to any of the transport channels for which the current transport format combination set is valid:
 - 3> consider the TFC subset to be incompatible with the current transport format combination set.
 - 2> if the IE "Allowed TFIs" is included; and
 - 3> if the value of each of the IEs "Allowed TFI" included in the IE "Allowed TFIs" corresponds to a transport format for that transport channel within the current transport format combination set:
 - 4> allow all transport format combinations that include these transport formats for the transport channel;
 - 4> restrict all other transport format combinations.
 - 3> else:
 - 4> consider the TFC subset to be incompatible with the current transport format combination set.
 - 2> if the IE "Allowed TFIs" is not included:
 - 3> restrict all transport format combinations where the transport channel has a transport format of non-zero rate.
- 1> if the UE considers the TFC subset to be incompatible with the current Transport format combination set according to the above:
 - 2> keep any previous restriction of the transport format combination set;
 - 2> set the variable INVALID_CONFIGURATION to TRUE.
- 1> if the UE does not consider the TFC subset to be incompatible with the current Transport format combination set according to the above:
 - 2> if the IE "Transport format combination subset" is received in a message other than a TRANSPORT FORMAT COMBINATION CONTROL message:
 - 3> set both the IE "Current TFC subset" and the IE "Default TFC subset" in the variable TFC_SUBSET to the IE "Transport format combination subset" (in case of TDD for the uplink CCTrCH specified by the IE "TFCS Id");

- 3> clear the IE "Duration" in the variable TFC_SUBSET;
 - 3> apply the transport format combination subset in the IE "Current TFC subset" stored in the variable TFC_SUBSET.
- 1> if the IE "transport format combination subset" indicates the "full transport format combination set":
- 2> set both the IE "Current TFC subset" and the IE "Default TFC subset" in the variable TFC_SUBSET to the value indicating "full transport format combination set";
 - 2> clear the IE "Duration" in the variable TFC_SUBSET;
 - 2> if the IE "Transport format combination subset" is received in a TRANSPORT FORMAT COMBINATION CONTROL message, then at the CFN indicated by the IE "Activation time for TFC subset" any restriction on transport format combination set is released and the UE may use the full transport format combination set;
 - 2> else:
 - 3> any restriction on transport format combination set is released and the UE may use the full transport format combination set.

8.6.5.4 DCH quality target

If the IE "DCH quality target" is included, the UE shall:

- 1> set, at physical channel establishment, the initial downlink target SIR value based on the received IE "DCH quality target" for the transport channel with respect to all transport formats;
- 1> adjust the target SIR for the downlink power control to meet the quality target received in the IE "DCH quality target" for the transport channel. The UE shall not compensate for the fact that the required SIR to achieve a target BLER for a particular transport format may be different from the required SIR to achieve the target BLER for another transport format..

NOTE 1: Adjusting the target SIR is possible to do continuously by the UE if a CRC exists in all transport formats in the downlink TFS for a DCH. If a CRC does not exist in all transport formats, the UE can only adjust the target SIR when receiving transport formats containing a CRC and the UE has knowledge about the transport format according to [27].

NOTE 2: If the UTRAN configures a UE to use blind transport format detection and configures a transport channel such that single transport format detection [27] must be used to detect the TF, then it is not possible for the UE to maintain a quality target for that transport channel.

8.6.5.5 Added or Reconfigured UL TrCH information

If the IE "Added or Reconfigured UL TrCH information" is included then the UE shall:

- 1> for the transport channel identified by the IE "UL Transport Channel Identity" and IE "Uplink transport channel type":
 - 2> perform the actions for the IE "Transport Format Set" as specified in subclause 8.6.5.1.

NOTE: The UE stores the UL transport channel configuration until it is explicitly deleted by a message containing the IE "Deleted UL TrCH information" or the UE leaves RRC Connected mode.

- 1> if the choice "UL parameters" is set to 'E-DCH':
 - 2> for FDD:
 - 3> apply the values of the IE "E-DCH Transmission Time Interval" and the IE "HARQ info for E-DCH" to all E-DCH MAC-d flows.
 - 2> for TDD:
 - 3> apply the value of the IE "HARQ info for E-DCH" to all E-DCH MAC-d flows.

- 2> for the IE "HARQ Info for E-DCH":
 - 3> perform the actions specified in subclause 8.6.5.17.
- 2> if the IE "Added or Reconfigured E-DCH MAC-d Flow list " is included:
 - 3> for each MAC-d flow identified by the IE "Mac-d flow identity":
 - 4> perform the actions as specified in subclause 8.6.5.18.
- 2> determine the value for the E_DCH_TRANSMISSION variable and take the corresponding actions as described in subclause 8.5.28.

NOTE: In case of multiple E-DCH MAC-d flows, IE "Added or Reconfigured UL TrCH information" is only included once. If the IE "Added or Reconfigured UL TrCH information" is included more than once with the IE "Uplink transport channel type" set to 'E-DCH', the UE behaviour is unspecified.

NOTE: In case the IE "Added or Reconfigured UL TrCH information" is included in a message that contains the IE "Deleted UL TrCH information" with a transport channel with the same identity as indicated by IE "UL Transport Channel Identity" and same type as indicated in the IE "Uplink transport channel type" then the UE behaviour is unspecified.

8.6.5.5a Added or reconfigured MAC-d flow

If the IE "Added or reconfigured MAC-d flow" is included, the UE shall:

- 1> if a MAC-hs queue (identified by the IE "MAC-hs queue Id") is included in both the IE "MAC-hs queue to add or reconfigure list" and the IE "MAC-hs queue to delete list":
 - 2> set the variable INVALID_CONFIGURATION to TRUE.
- 1> for each MAC-hs queue included in the IE "MAC-hs queue to add or reconfigure" list:
 - 2> if the UE has previously stored a mapping between this MAC-hs queue and a MAC-d flow:
 - 3> delete the old mapping.
 - 2> map the MAC-d flow indicated in the current message to this MAC-hs queue;
 - 2> set the release timer for each of the MAC-hs queues in the MAC-hs entity to the value in the corresponding IE "T1";
 - 2> set the MAC-hs receiver window size for each of the MAC-hs queues in the MAC-hs entity to the value in the corresponding IE "MAC-hs window size"; and
 - 2> configure MAC-hs with the mapping between MAC-d PDU sizes index and allowed MAC-d PDU sizes as follows:
 - 3> if a MAC-d PDU size has been stored for a MAC-d PDU size index for the corresponding MAC-hs queue and no mapping is provided in the current message for this MAC-d PDU index:
 - 4> continue to use this mapping.
 - 3> if a MAC-d PDU size has been stored for a MAC-d PDU size index for the corresponding MAC-hs queue and a mapping is provided in the current message for this MAC-d PDU index:
 - 4> configure the MAC-hs entity with the mapping indicated in the current message.
- 1> for each MAC-hs queue included in the IE "MAC-hs queue to delete" list:
 - 2> delete any information about the MAC-hs queue identified by the IE "MAC-hs queue Id".
- 1> if the IE "Added or reconfigured MAC-d flow" is considered valid according to the rules above:
 - 2> perform the actions as specified in subclause 8.5.21.

8.6.5.6 Added or Reconfigured DL TrCH information

If the IE "Added or Reconfigured DL TrCH information" is included the UE shall:

- 1> for the transport channel identified by the IE "DL Transport Channel Identity":
 - 2> if the choice "DL parameters" is set to 'explicit':
 - 3> perform the actions for the IE "Transport Format Set" as specified in subclause 8.6.5.1.
 - 2> if the choice "DL parameters" is set to 'same as uplink':
 - 3> if the IE "UL Transport Channel Identity" indicates an existing or a new UL Transport Channel:
 - 4> store as transport format for this transport channel the transport format associated with the transport channel identified by the IE "UL Transport Channel Identity".
 - 3> else:
 - 4> set the variable INVALID_CONFIGURATION to TRUE.
 - 2> if the IE "DCH quality target" is included:
 - 3> perform the actions specified in subclause 8.6.5.4.
- 1> if the choice "DL parameters" is set to "HSDSCH":
- 2> if the IE "HARQ Info" is included:
 - 3> perform the actions specified in subclause 8.6.5.6b.
 - 2> if the IE "Added or Reconfigured MAC-d Flow" is included:
 - 3> perform the actions as specified in subclause 8.6.5.5a.
 - 2> if the IE "Added or Reconfigured MAC-ehs reordering queue" is included:
 - 3> perform the actions as specified in subclause 8.6.5.23.
- 2> determine the value for the HS_DSCH_RECEPTION variable and take the corresponding actions as described in subclause 8.5.25.

NOTE: The UE stores the DL transport channel configuration until it is explicitly deleted by a message containing the IE "Deleted DL TrCH information" or the UE leaves RRC connected mode.

NOTE: In case the IE "Added or Reconfigured DL TrCH information" is included in a message that contains the IE "Deleted DL TrCH information" with a transport channel with the same identity as indicated by IE "DL Transport Channel Identity" and same type as indicated in the IE "Downlink transport channel type" then the UE behaviour is unspecified.

8.6.5.6a Void

8.6.5.6b HARQ Info

If the IE "HARQ Info" is included, the UE shall:

- 1> store the received configuration;
- 1> determine the value for the HS_DSCH_RECEPTION variable and take the corresponding actions as described in subclause 8.5.25;
- 1> determine the value for the HS_DSCH_RECEPTION_CELL_FACH_STATE variable and take the corresponding actions as described in subclause 8.5.36.

When the variable HS_DSCH_RECEPTION or variable HS_DSCH_RECEPTION_CELL_FACH_STATE is set to TRUE the UE shall:

- 1> for 1.28 Mcps TDD, when variable HS_DSCH_RECEPTION_CELL_FACH_STATE is TRUE,
 - 2> consider the UE capability "Total number of soft channel bits in HS-DSCH" equal to that of the HS-DSCH physical layer category 9 as specified in [35];
- 1> configure the MAC-hs/ehs entity with the number of HARQ processes indicated in IE "Number of Processes";
- 1> assign to each of these HARQ processes IDs going from 0 to "Number of Processes" – 1;
- 1> if the IE "Memory Partitioning" is set to 'Implicit':
 - 2> partition the soft memory buffer in the MAC-hs/ehs entity equally among the HS-DSCH transport channels. In the event that the division of the soft memory buffer results in a non-Integer value the partition memory size is rounded down to the nearest Integer value.
 - 2> partition the soft memory buffer per HS-DSCH transport channel in the MAC-hs/ehs entity equally among the processes configured above. In the event that the division of the soft memory buffer results in a non-Integer value the partition memory size is rounded down to the nearest Integer value.
- 1> if the IE "Memory Partitioning" is set to 'Explicit':
 - 2> if the UE capability "Total number of soft channel bits in HS-DSCH", as specified in [35], is exceeded with this configuration; or
 - 2> if the IE "Process Memory size" is set to a value greater than the number of soft channel bits for an implicit memory partitioning with 6 processes per HS-DSCH channel, and the IE "Downlink secondary cell info FDD" (10.3.6.31a) is included:
 - 3> set the variable INVALID_CONFIGURATION to TRUE.
 - 2> else:
 - 3> partition the soft memory buffer in the MAC-hs/ehs entity equally among the HS-DSCH transport channels. In the event that the division of the soft memory buffer results in a non-Integer value the partition memory size is rounded down to the nearest Integer value.
 - 3> partition the soft memory buffer per HS-DSCH transport channel in the MAC-hs/ehs entity according to the IE "Process memory size" assuming that the order in the list follows the order in the HARQ process IDs.

8.6.5.7 Deleted UL TrCH information

If the IE "Deleted UL TrCH information" is included the UE shall:

- 1> if an Uplink transport channel is requested to be deleted:
 - 2> delete any information about the transport channel identified by the IE "UL TrCH identity" and the IE "Uplink transport channel type".
- 1> if an E-DCH MAC-d flow is requested to be deleted:
 - 2> delete any information about the E-DCH MAC-d flow identified by the IE "E-DCH MAC-d flow identity";
 - 2> determine the value for the E_DCH_TRANSMISSION variable and take the corresponding actions as described in subclause 8.5.28.

8.6.5.8 Deleted DL TrCH information

If the IE "Deleted DL TrCH information" is included the UE shall:

- 1> if a Downlink transport channel is requested to be deleted:
 - 2> delete any information about the transport channel identified by the IE "DL TrCH identity".
- 1> if a DL MAC-d flow is requested to be deleted:

- 2> delete any information about the DL HS-DSCH MAC-d flow identified by the IE "MAC-d Flow Identity", i.e. delete any information about MAC-hs queue(s) mapped onto this MAC-d flow.
- 2> determine the value for the HS_DSCH_RECEPTION variable and take the corresponding actions as described in subclause 8.5.25.
- 1> if a DL MAC-ehs reordering queue is requested to be deleted:
 - 2> delete any information about the DL HS-DSCH DL MAC-ehs reordering queue identified by the IE "DL HS-DSCH MAC-ehs queue Id";
 - 2> determine the value for the HS_DSCH_RECEPTION variable and take the corresponding actions as described in subclause 8.5.25.

8.6.5.9 UL Transport channel information common for all transport channels

If the IE "UL Transport channel information common for all transport channels" is included the UE shall:

- 1> perform actions for the IE "TFC subset" as specified in subclause 8.6.5.3;
- 1> if the IE "PRACH TFCS" is included:
 - 2> set the variable INVALID_CONFIGURATION to TRUE.
- 1> if the IE has the choice "mode" set to FDD:
 - 2> perform actions for the IE "UL DCH TFCS" as specified in subclause 8.6.5.2.
- 1> if the IE has the choice "mode" set to TDD:
 - 2> if the IE "Individual UL CCTrCH information" is included:
 - 3> for each TFCS identified by IE "UL TFCS id":
 - 4> perform actions for the IE "UL TFCS" as specified in subclause 8.6.5.2.
- 1> if the IE "TFC subset list" is included:
 - 2> remove a previously stored TFC subset list if this exists in the IE "TFC subset list" in the variable TFC_SUBSET;
 - 2> store the IE "TFC subset list" in the IE "TFC subset list" in the variable TFC_SUBSET;
 - 2> consider the first instance of the IE "TFC subset" in the IE "TFC subset list" as Transport Format Combination Subset 0 (TFC subset identity = 0), the second instance as Transport Format Combination Subset 1 (TFC subset identity = 1) and so on;
 - 2> if the IE "TFC subset list" contains greater than 8 elements then the UE behaviour is not specified.

NOTE: The UTRAN should not modify the TFC subset list when a temporary restriction of the TFC set is being applied, due to the reception of the IE "TFC Control Duration" in a TRANSPORT FORMAT COMBINATION CONTROL message is still being applied.

8.6.5.10 DL Transport channel information common for all transport channels

If the IE "DL Transport channel information common for all transport channels" is included the UE shall:

- 1> if the IE "SCCPCH TFCS" is included:
 - 2> set the variable INVALID_CONFIGURATION to TRUE.
- 1> if the IE choice "mode" is set to FDD:
 - 2> if the choice "DL parameters" is set to 'explicit':
 - 3> if the IE "DL DCH TFCS" is included:

4> if the IE "SCCPCH TFCS" is included and the state the UE enters after handling the received information is other than CELL_DCH:

5> ignore the received IE "DL DCH TFCS".

NOTE: the IE "DL Transport channel information common for all transport channels" always includes a DL DCH TFCS configuration, either by including the IE "DL DCH TFCS " or by specifying that the TFCS is the same as in UL. If UTRAN does not require the reconfiguration of the concerned parameters, UTRAN may replace one TFC with the value that is already assigned for this IE.

4> else:

5> perform actions as specified in subclause 8.6.5.2.

1> if the IE choice "mode" is set to TDD:

2> if the IE "Individual DL CCTRCH information" is included:

3> for each DL TFCS identified by the IE "DL TFCS identity":

4> if the IE choice "DL parameters" is set to 'independent':

5> perform actions for the IE "DL TFCS" as specified in subclause 8.6.5.2.

4> if the IE choice "DL parameters" is set to 'same as UL':

5> if the IE "UL DCH TFCS identity" indicates an existing or a new UL TFCS:

6> store for that DL TFCS the TFCS identified by the IE "UL DCH TFCS identity".

5> else:

6> set the variable INVALID_CONFIGURATION to TRUE.

8.6.5.11 Void

8.6.5.12 TFCS Reconfiguration/Addition Information

If the IE "TFCS Reconfiguration/Addition Information" is included the UE shall:

1> store the TFCs to be reconfigured/added indicated in the IE "CTFC information" as specified below;

1> if the IE "Power offset information" is included:

2> perform actions as specified in [29].

In order to identify the TFCs included in this IE the UE shall calculate the CTFC as specified in subclause 14.10.

1> if the IE "Additional Dynamic Transport Format Information for CCCH" was included in the IE "RACH TFS":

2> ignore for the CTFC calculation any TF added by the IE "Additional Dynamic Transport Format Information for CCCH".

If the IE "TFCS Reconfiguration/Addition Information" is used in case of TFCS "Complete reconfiguration" the UE shall:

1> remove a previously stored transport format combination set if this exists;

1> consider the first instance of the IE "CTFC information" as Transport Format Combination 0 in FDD (TFCI=0) and 1 in TDD (TFCI=1), the second instance as Transport Format Combination 1 in FDD (TFCI=1) and 2 in TDD (TFCI=2) and so on. In TDD the TFCI value = 0 is reserved for physical layer use.

If the IE "TFCS Reconfiguration/Addition Information" is used in case of TFCS "Addition" the UE shall insert the new additional(s) TFC into the first available position(s) in ascending TFCI order in the TFCS.

8.6.5.12a Additional RACH TFCS for CCCH

If the IE "Additional RACH TFCS for CCCH" is included the UE shall:

1> if the IE "Power offset information" is included:

2> perform actions as specified in [29].

1> add to the TFCS as calculated in 8.6.5.12 for the corresponding PRACH the TFC which consists of the TF added by the IE "Additional Dynamic Transport Format Information for CCCH" into the next position in ascending order after the highest TFCI value already used.

NOTE: On PRACH only one transport channel can be multiplexed.

8.6.5.13 TFCS Removal Information

If the IE "TFCS Removal Information" is included the UE shall:

1> remove the TFC indicated by the IE "TFCI" from the current TFCS, and regard this position (TFCI) in the TFCS as vacant.

8.6.5.14 Void

8.6.5.15 TFCS Explicit Configuration

If the IE "TFCS Explicit Configuration" is included the UE shall:

1> if the IE choice "TFCS representation" is set to 'complete reconfiguration':

2> perform the actions for the IE "TFCS Reconfiguration/Addition Information" as specified in subclause 8.6.5.12.

1> if the IE choice "TFCS representation" is set to 'addition':

2> perform the actions for the IE "TFCS Reconfiguration/Addition Information" as specified in subclause 8.6.5.12.

1> if the IE choice "TFCS representation" is set to 'removal':

2> perform the actions for the IE "TFCS Removal Information" as specified in subclause 8.6.5.13.

1> if the IE choice "TFCS representation" is set to 'replace':

2> perform first the actions for the IE "TFCS Removal Information" as specified in subclause 8.6.5.13; and then

2> perform the actions for the IE "TFCS Reconfiguration/Addition Information" as specified in subclause 8.6.5.12.

8.6.5.16 E-DCH Transmission Time Interval (FDD only)

If the IE "E-DCH Transmission Time Interval" is included, the UE shall:

1> store the received TTI;

1> determine the value for the E_DCH_TRANSMISSION variable and take the corresponding actions as described in subclause 8.5.28.

When the variable E_DCH_TRANSMISSION is set to TRUE the UE shall:

1> apply the TTI as signalled in the IE "E-DCH Transmission Time Interval" on the E-DPDCH.

If the received "E-DCH Transmission Time Interval" is 2 ms and the previously stored TTI was 10 ms:

1> not send any data on E-DPDCH in first 8 TTIs after activation time of new TTI.

8.6.5.17 HARQ Info for E-DCH

If the IE "HARQ Info for E-DCH" is included, the UE shall:

1> store the received configuration;

1> determine the value for the E_DCH_TRANSMISSION variable and take the corresponding actions as described in subclause 8.5.28.

When the variable E_DCH_TRANSMISSION is set to TRUE the UE shall:

1> use a redundancy version for each HARQ transmission as configured by the IE "HARQ RV Configuration".

8.6.5.18 Added or reconfigured E-DCH MAC-d flow

If the IE "Added or reconfigured E-DCH MAC-d flow" is included, the UE shall:

1> if the IE "E-DCH MAC-d flow power offset" is included:

2> configure the power offset indicated in the IE "E-DCH MAC-d flow power offset" for the E-DCH MAC-d flow identified by the IE "E-DCH MAC-d flow identity".

1> if the IE "E-DCH MAC-d flow maximum number of retransmissions" is included:

2> configure the maximum number of retransmissions indicated in the IE "E-DCH MAC-d flow maximum number of retransmissions" for the E-DCH MAC-d flow identified by the IE "E-DCH MAC-d flow identity".

1> for 1.28 Mcps TDD, if the IE "E-DCH MAC-d flow retransmission timer" is included:

2> configure the retransmission timer for the E-DCH MAC-d flow identified by the IE "E-DCH MAC-d flow identity".

1> if the IE "E-DCH MAC-d flow multiplexing list" is included:

2> only multiplex MAC-d PDU's from the E-DCH MAC-d flow indicated in the IE "E-DCH MAC-d flow identity" with MAC-d PDU's from E-DCH MAC-d flows with which multiplexing in the same MAC-e or MAC-i PDU is allowed in accordance to the IE "E-DCH MAC-d flow multiplexing list".

1> else:

2> if previously the IE "E-DCH MAC-d flow multiplexing list" was already received for this E-DCH MAC-d flow:

3> continue to only multiplex E-DCH PDU's from the E-DCH MAC-d flow indicated in the IE "E-DCH MAC-d flow identity" with MAC-d PDU's from E-DCH MAC-d flows with which multiplexing in the same MAC-e or MAC-i PDU is allowed according to the previously received IE "E-DCH MAC-d flow multiplexing list".

2> else (never received the IE "E-DCH MAC-d flow multiplexing list" for this E-DCH MAC-d flow):

3> allow multiplexing of MAC-d PDU's from the E-DCH MAC-d flow indicated in the IE "E-DCH MAC-d flow identity" with MAC-d PDU's from any other E-DCH MAC-d flow in the same MAC-e or MAC-i PDU.

1> for FDD:

2> if the IE "Non-scheduled transmission grant info" is included:

3> if the TTI configured on the E-DCH equals 2ms, and the IE "2ms non-scheduled transmission grant HARQ process allocation" is configured for this MAC-d flow:

4> MAC-d PDU's for logical channels belonging to this MAC-d flow shall only be included in a MAC-e or MAC-i PDU transmitted by HARQ processes allowed by the IE "2ms non-scheduled transmission grant HARQ process allocation", with a total contribution from this MAC-d flow (i.e. including

MAC-e/es or MAC-i/is headers) not exceeding the size as signalled by the IE "Max MAC-e PDU contents size".

3> else:

4> MAC-d PDU's for logical channels belonging to this MAC-d flow shall be included in a MAC-e or MAC-i PDU transmitted by any HARQ process, with a total contribution from this MAC-d flow (i.e. including MAC-e/es or MAC-i/is headers) not exceeding the size as signalled by the IE "Max MAC-e PDU contents size".

2> if the IE "Scheduled transmission grant info" is included:

3> transmission of MAC-d PDU's for logical channels belonging to this MAC-d flow shall be in accordance with the received scheduled grant on E-AGCH/E-RGCH (see [15]).

1> for TDD:

2> if the IE "Non-scheduled transmission grant info" is included:

3> MAC-d PDU's for logical channels belonging to this MAC-d flow shall only be included in a MAC-e or MAC-i PDU transmitted by HARQ processes designated as non scheduled (Ids 4 – 7) in the TTIs indicated (for 3.84 Mcps TDD and 7.68 Mcps TDD, as determined from the IEs "Activation Time", "Resource Duration" and "Resource Periodicity"; for 1.28 Mcps TDD, as determined from the IEs "Activation Time", "Subframe number", "Resource Duration" and "Resource Periodicity", and the calculation of assigned Non-scheduled transmission grant is specified in subclause 8.6.6.16a).

2> if the IE "Scheduled transmission grant info" is included:

3> transmission of MAC-d PDUs for logical channels belonging to this MAC-d flow shall be in accordance with the received scheduled grant on E-AGCH (see [15]).

1> perform the actions as specified in subclause 8.5.21;

1> determine the value for the E_DCH_TRANSMISSION variable and take the corresponding actions as described in subclause 8.5.28.

8.6.5.19 SRB1 mapping info (FDD and 1.28 Mcps TDD only)

When variable HS_DSCH_RECEPTION_CELL_FACH_STATE or variable HS_DSCH_RECEPTION_OF_CCCH_ENABLED are set to TRUE and the UE is in CELL_FACH state, the UE shall:

1> if no MAC-ehs queue with identified by the "MAC-ehs queue identity" value as received in IE "SRB1 mapping info" of System Information Block type 5 or System Information Block type 5bis is configured:

2> the UE behaviour is unspecified.

1> else:

2> map the logical channel identified by the IE "Logical channel identity" to the MAC-ehs queue identified by the IE "MAC-ehs queue identity" as received in IE "SRB1 mapping info" of System Information Block type 5 or System Information Block type 5bis.

1> if there is more than one multiplexing option applicable for logical channels to be used:

2> the UE behaviour is unspecified.

8.6.5.20 HARQ System Info (FDD and 1.28 Mcps TDD only)

When the UE is not in RRC Connected state and the variable HS_DSCH_RECEPTION_OF_CCCH_ENABLED is set to TRUE, or when the UE is in CELL_FACH state or will be in CELL_FACH state at the completion of this procedure, the UE shall:

1> if IE "HS-DSCH common system information" is included in System Information Block type 5 or System Information Block type 5bis:

- 2> for 1.28 Mcps TDD, consider the UE capability "Total number of soft channel bits in HS-DSCH" equal to that of the HS-DSCH physical layer category 9 as specified in [35];
- 2> configure the MAC-ehs entity with the number of HARQ processes indicated in IE "Number of Processes";
- 2> assign to each of these HARQ processes IDs going from 0 to "Number of Processes" – 1;
- 2> if the IE "Memory Partitioning" is set to 'Implicit':
 - 3> partition the soft memory buffer in the MAC-ehs entity equally among the processes configured above. In the event that the division of the soft memory buffer results in a non-Integer value the partition memory size is rounded down to the nearest Integer value.
- 2> if the IE "Memory Partitioning" is set to 'Explicit':
 - 3> if the UE capability "Total number of soft channel bits in HS-DSCH", as specified in [35], is exceeded with this configuration:
 - 4> the UE behaviour is unspecified.
 - 3> else:
 - 4> partition the soft memory buffer in the MAC-ehs entity according to the IE "Process memory size" assuming that the order in the list follows the order in the HARQ process IDs.

8.6.5.21 CCCH mapping info (FDD and 1.28 Mcps TDD only)

When the variable HS_DSCH_RECEPTION_OF_CCCH_ENABLED is set to TRUE, the UE shall:

- 1> if no MAC-ehs queue with identified by the "MAC-ehs queue identity" value as received in IE "CCCH mapping info" of System Information Block type 5 or System Information Block type 5bis is configured:
 - 2> set the variable INVALID_CONFIGURATION to TRUE.
- 1> else:
 - 2> map the logical channel identified by the IE "Logical channel identity" to the MAC-ehs queue identified by the IE "MAC-ehs queue identity" as received in IE "CCCH mapping info" of System Information Block type 5 or System Information Block type 5bis.
- 1> if there is more than one multiplexing option applicable for logical channels to be used:
 - 2> the UE behaviour is not specified.

8.6.5.22 Common MAC-ehs reordering queue (FDD and 1.28 Mcps TDD only)

When the variable HS_DSCH_RECEPTION_OF_CCCH_ENABLED is set to TRUE, the UE shall:

- 1> set the release timer for the MAC-ehs queue in the MAC-ehs entity to the value in the corresponding IE "T1";
- 1> set the reset timer for the MAC-ehs queue in the MAC-ehs entity to the value in te corresponding IE "Treset";
- 1> set the MAC-ehs receiver window size for the MAC-ehs queues in the MAC-ehs entity to the value in the corresponding IE "MAC-ehs window size".

8.6.5.23 Added or reconfigured MAC-ehs reordering queue

If the IE "Added or reconfigured MAC-ehs reordering queue" is included, the UE shall:

- 1> if the IE "Deleted DL TrCH information" is included in the received message; and
 - 1> if a MAC-ehs queue (identified by the IE "MAC-ehs queue Id") is included in both the IE "MAC-ehs queue to add or reconfigure list" and the IE "DL HS-DSCH MAC-ehs reordering queue" within the IE "Deleted DL TrCH information":

2> the UE behaviour is unspecified.

1> for each MAC-ehs queue included in the IE "MAC-ehs queue to add or reconfigure" list:

2> set the release timer for each of the MAC-ehs queues in the MAC-ehs entity to the value in the corresponding IE "T1";

2> set the reset timer for the MAC-ehs queue in the MAC-ehs entity to the value in the corresponding IE "Treset";

NOTE: A UE that does not support reception of HS-DSCH in CELL_FACH state may ignore the IE "Treset".

2> set the MAC-ehs receiver window size for each of the MAC-ehs queues in the MAC-ehs entity to the value in the corresponding IE "MAC-ehs window size".

1> if the IE "Added or reconfigured MAC-ehs reordering queue" is considered valid according to the rules above:

2> perform the actions as specified in subclause 8.5.21.

8.6.5.24 Common E-DCH MAC-d flows (FDD and 1.28 Mcps TDD only)

The UE shall:

1> configure the power offset indicated in the IE "E-DCH MAC-d flow power offset" for the E-DCH MAC-d or MAC-c (for FDD) flow identified by the IE "E-DCH MAC-d flow identity";

1> configure the maximum number of retransmissions indicated in the IE "E-DCH MAC-d flow maximum number of retransmissions" for the E-DCH MAC-d or MAC-c (for FDD) flow identified by the IE "E-DCH MAC-d flow identity";

1> for 1.28 Mcps TDD, configure the maximum retransmission timer indicated in the IE "E-DCH MAC-d flow retransmission timer" for the E-DCH MAC-d flow identified by the IE "E-DCH MAC-d flow identity";

1> if the IE "E-DCH MAC-d flow multiplexing list" is included:

2> only multiplex MAC-d PDUs from the E-DCH MAC-d flow indicated in the IE "E-DCH MAC-d flow identity" with MAC-d PDUs from E-DCH MAC-d flows with which multiplexing in the same MAC-i PDU is allowed in accordance to the IE "E-DCH MAC-d flow multiplexing list".

1> else (IE "E-DCH MAC-d flow multiplexing list" not included in the system information):

2> allow multiplexing of MAC-d PDUs from the E-DCH MAC-d flow indicated in the IE "E-DCH MAC-d flow identity" with MAC-d PDUs from any other E-DCH MAC-d flow in the same MAC-i PDU.

2> for FDD, prohibit multiplexing of MAC-c PDUs from the E-DCH MAC-c flow indicated in the IE "E-DCH MAC-d flow identity" with MAC-d PDUs from any other E-DCH MAC-d flow in the same MAC-i PDU.

1> transmission of MAC-d PDUs or MAC-c PDUs for logical channels belonging to this MAC-d or MAC-c flow shall be in accordance with the serving grant (FDD only) (see [15]);

1> perform the actions as specified in subclause 8.5.21.

8.6.6 Physical channel information elements

This subclause specifies the actions upon reception and/or non-reception of the physical channel information elements. The combination of the values of those information elements included in a given message shall follow the compatibility rules that are specified in the physical layer specifications. In case those rules are not followed, the UE shall set the variable INVALID_CONFIGURATION to TRUE.

8.6.6.1 Frequency info

If, after completion of the procedure, the UE will be in CELL_DCH state, the UE shall:

1> for FDD, 3.84 Mcps TDD and 7.68 Mcps TDD, if the IE "Frequency info" is included; or

- 1> for 1.28 Mcps TDD, if the IE "Frequency info" is included and the "Second Frequency info" is not included:
 - 2> if the frequency is different from the currently used frequency:
 - 3> store and use the frequency indicated by the IE "Frequency Info";
 - 3> if the received message is used to perform a Timing-maintained hard handover (see subclause 8.3.5.2), and IE "Timing maintained Synchronization indicator" is included:
 - 4> not perform any physical layer synchronisation procedure (FDD only);
 - 3> else:
 - 4> perform the physical layer synchronisation procedure A as specified in [29] (FDD only).
 - 2> if the frequency is the same as the currently used frequency:
 - 3> continue to use the currently used frequency;
 - 3> perform the physical layer synchronisation procedure A as specified in [29] (FDD only).
- 1> for 1.28 Mcps TDD, if both the IE "Frequency info" and the IE "Second Frequency info" are included:
 - 2> the frequency in IE "Frequency info" is used as the primary frequency, and the frequency in IE "Second Frequency info" is used as the secondary frequency;
 - 2> store the primary frequency;
 - 2> if the secondary frequency is different with the currently used frequency:
 - 3> store and use the secondary frequency.
 - 2> if the secondary frequency is the same as the currently used frequency:
 - 3> continue to use the currently used frequency.
- 1> if the IE "Frequency info" is not included and the UE has a currently used frequency:
 - 2> continue to use the currently used frequency;

NOTE If the received message is used to perform a Timing-reinitialised hard handover, and the IE "Frequency Info" is not included, the UE may perform the physical layer synchronisation procedure A as specified in [29] (FDD only).

For 1.28 Mcps TDD, if, after completion of the procedure, the UE will be in CELL_FACH state, the UE shall:

- 1> if the IE "Frequency info" is included and the "Second Frequency info" is not included:
 - 2> store and use the frequency indicated by the IE "Frequency Info" as working frequency.
- 1> if both the IE "Frequency info" and the IE "Second Frequency info" are included:
 - 2> the frequency in IE "Frequency info" is used as the primary frequency, and the frequency in IE "Second Frequency info" is used as the secondary frequency;
 - 2> store the primary frequency;
 - 2> if the secondary frequency is different with the currently used frequency:
 - 3> store and use the secondary frequency as working frequency.
 - 2> if the secondary frequency is the same as the currently used frequency:
 - 3> continue to use the currently used frequency as working frequency.

8.6.6.2 Void

8.6.6.2a PNBSCH allocation

The UE shall consider the frame numbers fulfilling the following equation as "PRACH blocked frames" as specified in [33].

$$SFN = \lfloor k * \text{Repetition period} \rfloor$$

for an integer k with k ∈ {0, 1, 2, 3, 4, ... , value of IE "Number of repetitions per SFN period" - 1}, where:

Repetition period is: 4096 / value of IE "Number of repetitions per SFN period".

The UE shall configure the physical layer for the physical random access procedure accordingly.

8.6.6.3 Void

8.6.6.3a Downlink information per radio link list

If the IE "Downlink information per radio link list" is included in a received message, the UE shall:

- 1> if the active set resulting after the reception of the IE "Downlink information per radio link list" would contain radio links indicated by the IE "Downlink DPCH info for each RL" and radio links indicated by the IE "Downlink F-DPCH info for each RL":
 - 2> set the variable INVALID_CONFIGURATION to TRUE.
- 1> if the active set resulting after the reception of the IE "Downlink information per radio link list" would contain radio links indicated by the IE "Downlink DPCH info for each RL" and the radio link is included in the table "Target cell preconfigurations" in the variable TARGET_CELL_PRECONFIGURATION:
 - 2> clear all the entries from the variable TARGET_CELL_PRECONFIGURATION.
- 1> if the message was received in CELL_DCH state and the UE remains in CELL_DCH state according to subclause 8.6.3.3 applied on the received message:
 - 2> for FDD, check whether the radio links included in the IE "Downlink information per radio link list" are part of the current active set considering that a radio link is uniquely identified by the downlink UARFCN and the primary scrambling code;
 - 2> for TDD, check whether the radio links included in the IE "Downlink information per radio link list" are part of the current active set considering that a radio link is uniquely identified by the UARFCN and the primary CCPCH;
 - 2> if all radio links included in the IE "Downlink information per radio link list" are part of the current active set:
 - 3> for radio links part of the current active set, and present in the IE "Downlink information per radio link list":
 - 4> update the downlink physical channel configuration according to the IE "Downlink information for each radio link" as specified in subclause 8.6.6.4.
 - 3> for radio links part of the current active set, and absent in the IE "Downlink information per radio link list":
 - 4> not change its current downlink physical channel configuration;
 - 4> For FDD, in case the IE "Serving HS-DSCH radio link indicator" is set to 'TRUE' for another radio link, no longer consider any of these absent radio links as serving HS-DSCH radio link;
 - 4> For FDD, in case the IE "Serving E-DCH radio link indicator" is set to 'TRUE' for another radio link, no longer consider any of these absent radio links as serving E-DCH radio link.

- 2> if all radio links included in the IE "Downlink information per radio link list" are not part of the current active set:
 - 3> perform a hard handover by replacing all the radio links in the current active set with the radio links in the IE "Downlink information per radio link list", each with a downlink physical channel configuration according to the IE "Downlink information for each radio link" as specified in subclause 8.6.6.4;
 - 3> perform the checks on the value of the IE "Default DPCH Offset Value" as specified in subclause 8.3.5.1.2 or 8.3.5.2.2;
 - 3> act on the IE "Timing indication" and the IE "Default DPCH Offset Value", if included, as specified in subclause 8.5.15.2;

NOTE: UTRAN should not mix radio links which are part of the current active set and radio links which are not part of the current active set in the same IE "Downlink information per radio link list". In such cases the UE behaviour is unspecified.

1> otherwise:

- 2> if the message was received in CELL_FACH state and the UE would transit to CELL_DCH state according to subclause 8.6.3.3 applied on the received message:
 - 3> establish a downlink physical channel configuration for each of the included radio links according to the IE "Downlink information for each radio link" as specified in subclause 8.6.6.4.

8.6.6.4 Downlink information for each radio link

If the IE "Downlink information for each radio link" is included in a received message, the UE shall:

- 1> if the UE would enter CELL_DCH state according to subclause 8.6.3.3 applied on the received message:
 - 2> if the UE is in TDD mode and shared transport channels are assigned to the UE:
 - 3> start to receive the indicated Secondary CCPCH.
 - 2> if the UE is in TDD mode and no shared transport channels are assigned to the UE:
 - 3> set the variable UNSUPPORTED_CONFIGURATION to TRUE.
 - 2> For FDD:
 - 3> if the IE "Serving HS-DSCH radio link indicator" is set to 'TRUE':
 - 4> consider this radio link as the serving HS-DSCH radio link and no longer consider any other radio link as serving HS-DSCH radio link.
 - 2> For FDD:
 - 3> if the IE "Serving E-DCH radio link indicator" is set to 'TRUE':
 - 4> consider this radio link as the serving E-DCH radio link and no longer consider any other radio link as serving E-DCH radio link.
 - 3> if the IE "E-AGCH Info" is included for the serving E-DCH radio link:
 - 4> store the newly received E-AGCH configuration.
- NOTE: The UTRAN should always include the IE "E-AGCH info" if the serving E-DCH radio link indicated in the message is another radio link than the serving E-DCH radio link prior to the procedure.
- 3> if the IE "E-HICH information" is included:
 - 4> store this E-HICH configuration for the concerning radio link.
 - 3> if the IE "E-HICH information" is included or previously stored:

- 4> store this E-RGCH configuration for the concerning radio link, if included.
- 3> determine the value for the E_DCH_TRANSMISSION variable and take the corresponding actions as described in subclause 8.5.28.
- 2> for TDD:
 - 3> if the IE "E-AGCH Info" is included:
 - 4> store the newly received E-AGCH configuration.
 - 3> if the IE "E-HICH information" is included:
 - 4> store the E-HICH configuration.
 - 3> determine the value for the E_DCH_TRANSMISSION variable and take the corresponding actions as described in subclause 8.5.28.
- 2> act on the other IEs contained in the IE "Downlink information for each radio link" as specified in subclause 8.6 applied on this radio link.
- 1> in addition, if the message was received in CELL_DCH state and the UE remains in CELL_DCH state according to subclause 8.6.3.3 applied on the received message:
 - 2> For FDD:
 - 3> if the IE "Serving HS-DSCH radio link indicator" is set to "TRUE":
 - 4> consider this radio link as the serving HS-DSCH radio link;
 - 4> if the serving HS-DSCH radio link was another radio link than this radio link prior to reception of the message and the IE "H-RNTI" is not included:
 - 5> clear the variable H_RNTI.
 - 3> if the IE "Serving HS-DSCH radio link indicator" is set to "FALSE" and this radio link was considered the serving HS-DSCH radio link prior to reception of this message:
 - 4> no longer consider this radio link as the serving HS-DSCH radio link.
 - 3> determine the value for the HS_DSCH_RECEPTION variable and take the corresponding actions as described in subclause 8.5.25;
 - 3> if the IE "Serving E-DCH radio link indicator" is set to "TRUE":
 - 4> consider this radio link as the serving E-DCH radio link;
 - 4> if the serving E-DCH radio link was another radio link than this radio link prior to reception of the message:
 - 5> if the IE "New Primary E-RNTI" is not included:
 - 6> clear the Primary E-RNTI stored in the variable E_RNTI.
 - 5> if the IE "New Secondary E-RNTI" is not included:
 - 6> clear the Secondary E-RNTI stored in the variable E_RNTI.
 - 3> if the IE "Serving E-DCH radio link indicator" is set to "FALSE" and this radio link was considered the serving E-DCH radio link prior to reception of this message:
 - 4> no longer consider this radio link as the serving E-DCH radio link.
 - 3> if the IE "E-HICH release indicator" is present:
 - 4> delete the stored E-HICH, E-AGCH and E-RGCH (if any) configurations.
 - 3> if the IE "E-RGCH release indicator" is present:

- 4> delete the stored E-RGCH configuration for this RL.
 - 3> determine the value for the E_DCH_TRANSMISSION variable and take the corresponding actions as described in subclause 8.5.28.
 - 2> For TDD:
 - 3> if the IE "H-RNTI" is not included and the primary CCPCH has changed:
 - 4> clear the variable H_RNTI.
 - 3> determine the value for the HS-DSCH_RECEPTION variable and take the corresponding actions as described in subclause 8.5.25.
 - 2> for TDD:
 - 3> if the IE "New Primary E-RNTI" is not included:
 - 4> clear the variable E_RNTI.
 - 3> determine the value for the E_DCH_TRANSMISSION variable and take the corresponding actions as described in subclause 8.5.28.
 - 2> for each optional IE part of the IE "Downlink information for each radio link" that is not present:
 - 3> do not change its current downlink physical channel configuration corresponding to the IE, which is absent, if not stated otherwise elsewhere.
- NOTE: The Release '99 RADIO BEARER RECONFIGURATION message always includes at least one IE "Downlink information for each radio link" containing the mandatory IEs, even if UTRAN does not require the reconfiguration of any radio link.
- 1> if the UE would enter either the CELL_FACH, CELL_PCH or URA_PCH state according to subclause 8.6.3.3 applied on the received message:
 - 2> if IEs other than the IE "Primary CPICH info" (for FDD) or the IE "Primary CCPCH info" (for TDD) are included in the IE "Downlink information for each radio link":
 - 3> ignore these IEs.
 - 2> act on the other IEs contained in the IE "Downlink information for each radio link" as specified in subclause 8.6 applied on this radio link.
 - 2> for 1.28Mcps TDD:
 - 3> if the IE "E-AGCH Info" is included:
 - 4> store the newly received E-AGCH configuration.
 - 3> if the IE "E-HICH information" is included:
 - 4> store the E-HICH configuration.
 - 3> determine the value for the COMMON_E_DCH_TRANSMISSION variable and take the corresponding actions as described in subclause 8.5.46.

8.6.6.5 Void

8.6.6.6 Uplink DPCH info

If the IE "Uplink DPCH info" is included, the UE shall:

For FDD:

1> release any active uplink physical channels and activate the given physical channels;

1> if the IE "Number of FBI bits" is not included:

2> use 0 FBI bits in the Uplink DPCH.

1> if the IE "Number of TPC bits" is not included:

2> use 2 TPC bits in the Uplink DPCH.

1> else:

2> if F-DPCH is not configured then the UE behaviour is unspecified.

1> use an SF equal to or greater than the minimum SF indicated in the IE "Spreading Factor" during uncompressed frames or compressed frames by HL scheduling;

1> use an SF equal to or greater than the minimum SF divided by 2 during compressed frames by SF reduction.

For TDD:

1> release the uplink physical channels associated with any CCTrCH that is removed or reconfigured and activate the physical channels assigned to any CCTrCH that is added or reconfigured;

1> for 3.84 Mcps TDD or 7.68 Mcps TDD use the IE "UL target SIR" specified for each added or reconfigured CCTrCH as described in subclause 8.5.7. For 1.28 Mcps TDD use the value of IE 'UL target SIR' specified for each added or reconfigured CCTrCH for parameter $PRX_{DPCHdes}$ as described in subclause 8.5.7;

1> for 1.28 Mcps TDD:

2> if "PLCCH Info" is included then store PLCCH Info parameters with respect to this uplink DPCH (overwriting parameter values previously stored);

2> if "PLCCH Info" is not included then delete the PLCCH Info stored with respect to this uplink DPCH.

1> use the parameters of the IE "Time info" for each added or reconfigured CCTrCH;

1> if present, use the IE "Uplink Timing Advance Control" as specified in subclause 8.6.6.26.

8.6.6.7 Void

8.6.6.8 Maximum allowed UL TX power

If the IE "Maximum allowed UL TX power" is included in the Handover to UTRAN Command, in any other dedicated message or in System Information Block type 3 or in System Information Block 4, the UE shall:

1> store and use the value until it is updated.

If the IE "Maximum allowed UL TX power" was not included in any dedicated message, the UE shall:

1> use the value previously stored, when received in an earlier dedicated message, Handover to UTRAN Command message or received in System Information Block type 3 or in System Information Block 4.

For all cases, the UE shall:

1> keep the UE uplink transmit power at or below the indicated power value;

1> if the current UE uplink transmit power is above the indicated power value:

2> decrease the power to a level at or below the power value.

The maximum UE TX power is defined as the lower of the maximum output power of the UE power class and the maximum allowed UL TX power indicated in this IE. The maximum UE TX power shall not be exceeded.

8.6.6.9 Void

8.6.6.10 Void

8.6.6.11 Uplink DPCH power control info

The UE shall:

1> in FDD:

2> if the IE "Uplink DPCH power control info" is included:

3> if a synchronisation procedure A in CELL_DCH is performed according to [29]; or

3> if a synchronisation procedure AA for Enhanced Uplink in CELL_FACH state or Idle mode is performed according to [29]:

4> calculate and set an initial uplink transmission power;

4> start inner loop power control as specified in subclause 8.5.3;

4> for the UL inner loop power control:

5> use the parameters specified in the IE.

3> else:

4> ignore the IEs "DPCCH Power offset", "PC Preamble" and "SRB delay";

4> act on the IE "Power control algorithm" and the IE "TPC step size", if included.

3> act on the IEs " Δ_{ACK} ", " Δ_{NACK} " and "Ack-Nack repetition factor", if included;

3> use the procedure for transmitting HS-DPCCH preamble and postamble according to [29], if the IE "HARQ_preamble_mode" is set to 1.

1> in 3.84 Mcps TDD or 7.68 Mcps TDD:

2> if the IE "Uplink DPCH power control info" is included:

3> use the parameters specified in the IE for open loop power control as defined in subclause 8.5.7.

2> else:

3> use the current uplink transmission power.

1> in 1.28 Mcps TDD:

2> if the CHOICE UL OL PC info is set to 'Broadcast UL OL PC info':

3> set the variable INVALID_CONFIGURATION to TRUE.

2> if the IE "Uplink DPCH power control info" is included in the UPLINK PHYSICAL CHANNEL CONTROL message:

3> use "Beacon PL Est. " and the TPC step size for the closed loop power control of the CCTrCH identified in the message, replacing the existing value used for the CCTrCH.

3> if the IE " UL target SIR " is included:

4> use this value for parameter $PRX_{DPCHdes}$ for open loop power control of the CCTrCH identified in the message in the case of a transition from closed loop to open loop power control as specified in [33].

- 2> if the IE "Uplink DPCH power control info" is included in the IE "Uplink DPCH info":
 - 3> use the "Beacon PL Est. " and TPC step size for the closed loop power control of all CCTrCH added or reconfigured by the IE replacing any existing values used for the CCTrCHs;
 - 3> if the IE " UL target SIR " is included ignore the parameter.
- 1> both in FDD and TDD;
 - 2> if the IE "Uplink DPCH power control info" is not included in a message used to enter CELL_DCH:
 - 3> set the variable INVALID_CONFIGURATION to TRUE.
- 1> determine the value for the HS_DSCH_RECEPTION variable and take the corresponding actions as described in subclause 8.5.25.

8.6.6.12 Secondary CPICH info

If the IE Secondary CPICH info is included, the UE may:

- 1> use the channelisation code according to IE "channelisation code", with scrambling code according to IE "DL scrambling code" in the IE "Secondary CPICH info", for channel estimation of that radio link;
- 1> use the pilot bits on DPCCH for channel estimation.

If the IE Secondary CPICH info is not included, the UE shall:

- 1> not use any previously stored configuration corresponding to the usage of the Secondary CPICH info.

8.6.6.13 Primary CPICH usage for channel estimation

If the IE "Primary CPICH usage for channel estimation" is included and has the value "Primary CPICH may be used" the UE:

- 1> may use the Primary CPICH for channel estimation;
- 1> may use the pilot bits on DPCCH for channel estimation.

NOTE: If the IE "Primary CPICH usage for channel estimation" has the value "Primary CPICH shall not be used" and the IE "Secondary CPICH info" is not included for that radio link then the UE behaviour is not specified.

If the IE "Primary CPICH usage for channel estimation" is included and has the value "Primary CPICH shall not be used" the UE:

- 1> shall not use the Primary CPICH for channel estimation;
- 1> may use the Secondary CPICH for channel estimation;
- 1> may use the pilot bits on DPCCH for channel estimation.

8.6.6.14 DPCH frame offset (FDD Only)

If "DPCH frame offset" is included in a message that instructs the UE to enter CELL_DCH state:

- 1> UTRAN should:
 - 2> if only one Radio Link is included in the message:
 - 3> if the UE is configured for DPCH:
 - 4> set "Default DPCH Offset Value" and "DPCH frame offset" respecting the following relation:

$$(\text{Default DPCH Offset Value}) \bmod 38400 = \text{DPCH frame offset}$$

- where the IE values used are the Actual Values of the IEs as defined in clause 11.

- 3> if the UE is configured for F-DPCH:
 - 4> set "Default DPCH Offset Value" and "DPCH frame offset" respecting one of the following relations:
 - 5> (Default DPCH Offset Value) mod 38400 = DPCH frame offset; or
 - 5> (Default DPCH Offset Value+256) mod 38400 = DPCH frame offset,
 - where the IE values used are the Actual Values of the IEs as defined in clause 11.
- 2> if more than one Radio Link are included in the message:
 - 3> if the UE is configured for DPCH:
 - 4> set "Default DPCH Offset Value" and "DPCH frame offset" respecting the following relation:
$$(\text{Default DPCH Offset Value}) \bmod 38400 = \text{DPCH frame offset}_j$$
 - where j indicates the first radio link listed in the message and the IE values used are the Actual Values of the IEs as defined in clause 11.
 - 3> if the UE is configured for F-DPCH:
 - 4> set "Default DPCH Offset Value" and "DPCH frame offset $_j$ " respecting one of the following relations:
 - 5> (Default DPCH Offset Value) mod 38400 = DPCH frame offset $_j$; or
 - 5> (Default DPCH Offset Value+256) mod 38400 = DPCH frame offset $_j$,
 - where j indicates the first radio link listed in the message and the IE values used are the Actual Values of the IEs as defined in clause 11.
- 1> The UE shall:
 - 2> if only one Radio Link is included in the message:
 - 3> if the UE is configured for DPCH:
 - 4> if (Default DPCH Offset Value) mod 38400 = DPCH frame offset:
 - 5> set DOFF (see subclause 8.5.15.1) to Default DPCH Offset Value.
 - 4> else:
 - 5> set the variable INVALID_CONFIGURATION to TRUE.
 - 3> if the UE is configured for F-DPCH:
 - 4> if (Default DPCH Offset Value) mod 38400 = DPCH frame offset:
 - 5> set DOFF (see subclause 8.5.15.1) to Default DPCH Offset Value.
 - 4> else if (Default DPCH Offset Value+256) mod 38400 = DPCH frame offset:
 - 5> set DOFF (see subclause 8.5.15.1) to Default DPCH Offset Value + 256.
 - 4> else:
 - 5> set the variable INVALID_CONFIGURATION to TRUE.
 - 2> if more than one Radio Links are included in the message:
 - 3> if the UE is configured for DPCH:
 - 4> if (Default DPCH Offset Value) mod 38400 = DPCH frame offset $_j$,
 - where j indicates the first radio link listed in the message:
 - 5> set DOFF (see subclause 8.5.15.1) to Default DPCH Offset Value.

- 4> else:
 - 5> set the variable INVALID_CONFIGURATION to TRUE.
- 3> if the UE is configured for F-DPCH:
 - 4> if (Default DPCH Offset Value) mod 38400 = DPCH frame offset_j,
 - where *j* indicates the first radio link listed in the message:
 - 5> set DOFF (see subclause 8.5.15.1) to Default DPCH Offset Value.
 - 4> else if (Default DPCH Offset Value+256) mod 38400 = DPCH frame offset_j,
 - where *j* indicates the first radio link listed in the message:
 - 5> set DOFF (see subclause 8.5.15.1) to Default DPCH Offset Value + 256.
 - 4> else:
 - 5> set the variable INVALID_CONFIGURATION to TRUE.

If the IE "DPCH frame offset" is included the UE shall:

- 1> use its value to determine the beginning of the DPCH or F-DPCH frame.

8.6.6.15 DPCH Compressed mode info

If the IE "DPCH compressed mode info" is included, and if the IE group "transmission gap pattern sequence configuration parameters" is included, the UE shall for each transmission gap pattern sequence perform the following consistency checks:

- 1> if the UE, according to its measurement capabilities, and for all supported bands of the UTRA mode or RAT associated with the measurement purpose indicated by IE "TGMP", requires UL compressed mode, and CHOICE 'UL/DL mode' indicates 'DL only':
 - 2> set the variable INVALID_CONFIGURATION to TRUE.
- 1> if the UE, according to its measurement capabilities, and for all supported bands of the UTRA mode or RAT associated with the measurement purpose indicated by IE "TGMP", requires DL compressed mode, and CHOICE 'UL/DL mode' indicates 'UL only':
 - 2> set the variable INVALID_CONFIGURATION to TRUE.
- 1> if the UE, according to its measurement capabilities, does not require UL compressed mode for any of supported band of the UTRA mode or RAT associated with the measurement purpose indicated by the IE "TGMP", and CHOICE 'UL/DL mode' indicates 'UL only' or 'UL and DL':
 - 2> set the variable INVALID_CONFIGURATION to TRUE.
- 1> if the UE, according to its measurement capabilities, does not require DL compressed mode for any supported band of the UTRA mode or RAT associated with the measurement purpose indicated by the IE "TGMP", and CHOICE 'UL/DL mode' indicates 'DL only' or 'UL and DL':
 - 2> set the variable INVALID_CONFIGURATION to TRUE.
- 1> if UE already has an active transmission gap pattern sequence that, according to IE "TGMP", has the same measurement purpose, and both patterns will be active (according to the IE "Current TGPS Status Flag" in variable TGPS_IDENTITY) after the new configuration has been taken into use:
 - 2> set the variable INVALID_CONFIGURATION to TRUE.
- 1> if there is any pending "TGPS reconfiguration CFN" or any pending "TGCFN":
 - 2> the UE behaviour is unspecified.

If variable INVALID_CONFIGURATION has value FALSE after UE has performed the checks above, the UE shall:

- 1> if pattern sequence corresponding to IE "TGPSI" is already active (according to "Current TGPS Status Flag") in the variable TGPS_IDENTITY):
 - 2> if the "TGPS Status Flag" in this message is set to "deactivate" for the corresponding pattern sequence:
 - 3> deactivate this pattern sequence at the beginning of the frame, indicated by IE "Activation time" (see subclause 8.6.3.1) received in this message, when the new configuration received in this message is taken into use.
 - 3> set the "Current TGPS Status Flag" for this pattern sequence in the variable TGPS_IDENTITY to "inactive" at the frame, indicated by IE "Activation time" (see subclause 8.6.3.1) received in this message, when the new configuration received in this message is taken into use.

- 2> if the "TGPS Status Flag" in this message is set to "activate" for the corresponding pattern sequence:

- 3> deactivate this pattern sequence at the beginning of the frame, indicated by IE "Activation time" (see subclause 8.6.3.1) received in this message, when the new configuration received in this message is taken into use.

NOTE1: The temporary deactivation of pattern sequences for which the status flag is set to "activate" can be used by the network to align the timing of already active patterns with newly activated patterns.

NOTE2: The deactivation of pattern sequences only occurs as a result of RRC messages received by the UE, i.e. the UE does not set the "Current TGPS Status Flag" to "inactive" after the final gap of a finite length pattern sequence.

- 1> update each pattern sequence to the variable TGPS_IDENTITY according to the IE "TGPSI";

- 1> update into the variable TGPS_IDENTITY the configuration information defined by IE group "transmission gap pattern sequence configuration parameters";

- 1> if an F-DPCH is configured:

- 2> not use the IEs "Downlink compressed mode method", "Downlink frame type", "DeltaSIR1", "DeltaSIRafter1", and if included, the IEs "DeltaSIR2", "DeltaSIRafter2".

- 1> after the instant in which the message is to be executed, as specified in subclause 8.6.3.1:

- 2> activate the stored pattern sequence corresponding to each IE "TGPSI" for which the "TGPS status flag" in the variable TGPS_IDENTITY is set to "activate" at the time indicated by IE "TGCFN"; and
 - 2> set the "Current TGPS Status Flag" for this pattern sequence in the variable TGPS_IDENTITY to "active".

NOTE1: If the pattern is activated with a message that includes the IE "Activation time", and if the CFN value indicated by the IE "Activation Time" and the CFN value indicated by the TGCFN are included in the same TTI (but not at the TTI boundary) common to all the transport channels that are multiplexed onto the reference CCTrCh (as defined in subclause 8.6.3.1), and if the CFN value indicated by the TGCFN is equal or higher than the CFN value indicated by the IE "Activation Time" (as defined in subclause 8.6.3.1) value, the UE behaviour is not specified.

NOTE2: If the pattern is activated with a message used to perform timing re-initialised hard handover, the UE can start evaluating the activation of the pattern (i.e. compare the value of the CFN in the new configuration with the value of the TGCFN) at any time between the message activation time and the completion of the synchronisation procedure A.

- 2> if the IE "DPCH compressed mode info" is included in a message used to perform a Hard Handover with change of frequency (see subclause 8.3.5); or
- 2> if the IE "DPCH compressed mode info" is included in a message used to transfer the UE from Cell_FACH to Cell_DCH, and the cell in which the UE transited from CELL_FACH state is not included in the active set for the CELL_DCH state (see subclause 8.4.1.7.2):
 - 3> not begin the inter-frequency measurement reporting corresponding to the pattern sequence measurement purpose of each activated pattern sequence.

- 2> else:

- 3> begin the inter-frequency measurement reporting corresponding to the pattern sequence measurement purpose of each activated pattern sequence.
- 2> begin the inter-RAT measurement reporting corresponding to the pattern sequence measurement purpose of each activated pattern sequence;
- 2> if the new configuration is taken into use at the same CFN as indicated by IE "TGCFN":
 - 3> start the concerned pattern sequence immediately at that CFN.
- 1> monitor if the parallel transmission gap pattern sequences create an illegal overlap, and in case of overlap, take actions as specified in subclause 8.2.11.2.

If the IE "DPCH compressed mode info" is included, and if the IE group "transmission gap pattern sequence configuration parameters" is not included, the UE shall:

- 1> if, as the result of this message, UE will have more than one transmission gap pattern sequence with the same measurement purpose active (according to IEs "TGMP" and "Current TGPS Status Flag" in variable TGPS_IDENTITY):
 - 2> set the variable CONFIGURATION_INCOMPLETE to TRUE.
- 1> if there is any pending "TGPS reconfiguration CFN" or any pending "TGCFN":
 - 2> the UE behaviour is unspecified.
- 1> if pattern sequence corresponding to IE "TGPSI" is already active (according to "Current TGPS Status Flag" in the variable TGPS_IDENTITY):
 - 2> if the "TGPS Status Flag" in this message is set to "deactivate" for the corresponding pattern sequence:
 - 3> deactivate this pattern sequence at the beginning of the frame, indicated by IE "Activation time"(see subclause 8.6.3.1) received in this message, when the new configuration received in this message is taken into use;
 - 3> set the "Current TGPS Status Flag" for this pattern sequence in the variable TGPS_IDENTITY to "inactive" at the frame, indicated by IE "Activation time"(see subclause 8.6.3.1) received in this message, when the new configuration received in this message is taken into use.
 - 2> if the "TGPS Status Flag" in this message is set to "activate" for the corresponding pattern sequence:
 - 3> deactivate this pattern sequence at the beginning of the frame, indicated by IE "Activation time"(see subclause 8.6.3.1) received in this message, when the new configuration received in this message is taken into use.

NOTE1: The temporary deactivation of pattern sequences for which the status flag is set to "activate" can be used by the network to align the timing of already active patterns with newly activated patterns.

NOTE2: The deactivation of pattern sequences only occurs as a result of RRC messages received by the UE, i.e. the UE does not set the "Current TGPS Status Flag" to "inactive" after the final gap of a finite length pattern sequence.

- 1> after the instant in which the message is to be executed, as specified in subclause 8.6.3.1:
 - 2> activate the stored pattern sequence corresponding to each IE "TGPSI" for which the "TGPS status flag" is set to "activate" at the time indicated by IE "TGCFN"; and

NOTE1: If the pattern is activated with a message that includes the IE "Activation time", and if the CFN value indicated by the IE "Activation Time" and the CFN value indicated by the TGCFN are included in the same TTI (but not at the TTI boundary) common to all the transport channels that are multiplexed onto the reference CCTrCh (as defined in subclause 8.6.3.1), and if the CFN value indicated by the TGCFN is equal or higher than the CFN value indicated by the IE "Activation Time" (as defined in subclause 8.6.3.1) value, the UE behaviour is not specified.

NOTE2: If the pattern is activated with a message used to perform timing re-initialised hard handover, the UE can start evaluating the activation of the pattern (i.e. compare the value of the CFN in the new configuration with the value of the TGCFN) at any time between the message activation time and the completion of the synchronisation procedure A.

- 2> set the "Current TGPS Status Flag" for this pattern sequence in the variable TGPS_IDENTITY to "active";
- 2> if the IE "DPCH compressed mode info" is included in a message used to perform a Hard Handover with change of frequency (see subclause 8.3.5); or
- 2> if the IE "DPCH compressed mode info" is included in a message used to transfer the UE from Cell_FACH to Cell_DCH, and the cell in which the UE transited from CELL_FACH state is not included in the active set for the CELL_DCH state (see subclause 8.4.1.7.2):
 - 3> not begin the inter-frequency measurement reporting corresponding to the pattern sequence measurement purpose of each activated pattern sequence.
- 2> else:
 - 3> begin the inter-frequency measurement reporting corresponding to the pattern sequence measurement purpose of each activated pattern sequence.
- 2> begin the inter-RAT measurement reporting corresponding to the pattern sequence measurement purpose of each activated pattern sequence;
- 2> if the new configuration is taken into use at the same CFN as indicated by IE "TGCFN":
 - 3> start the concerned pattern sequence immediately at that CFN.

For transmission gap pattern sequences stored in variable TGPS_IDENTITY, but not identified in IE "TGPSI" (either due to the absence of the IE "DPCH compressed mode info" in the received message or due to not receiving the corresponding TGPSI value in the IE "DPCH compressed mode info"), the UE shall:

- 1> if the received message implies a timing re-initialised hard handover (see subclause 8.3.5.1):
 - 2> deactivate such transmission gap pattern sequences at the beginning of the frame, indicated by IE "Activation time" (see subclause 8.6.3.1) received in this message; and
 - 2> set IE "Current TGPS Status Flag" in corresponding UE variable TGPS_IDENTITY to 'inactive'.
- 1> if the received message not implies a timing re-initialised hard handover (see subclause 8.3.5.1):
 - 2> continue such transmission gap pattern sequence according to IE "Current TGPS Status Flag" in the corresponding UE variable TGPS_IDENTITY.

Uplink and downlink compressed mode methods are described in [27]. For UL "higher layer scheduling" compressed mode method and transport format combination selection, see [15].

8.6.6.16 Repetition period, Repetition length, Offset (TDD only)

In case the physical allocations of different channels overlap the following priority rules shall apply for common channels and shall be taken into account by the UE:

- 1> PICH takes precedence over Primary CCPCH;
- 1> PICH takes precedence over Secondary CCPCH;
- 1> MICH takes precedence over Primary CCPCH;
- 1> MICH takes precedence over Secondary CCPCH;
- 1> Secondary CCPCH takes precedence over Primary CCPCH.

The frame allocation can be derived by following rules:

If no IE "Offset" is explicitly given, the parameter "Offset" to be used is calculated by the following equation:

Activation time mod Repetition period = Offset.

Frames from CFN CFN_{off} to $CFN_{off} + \text{Repetition length} - 1$ belong to the allocation with CFN_{off} fulfilling the following equation:

$$CFN_{off} \text{ mod Repetition period} = \text{Offset.}$$

Repetition length is always a multiple of the largest TTI within the CCTrCH fulfilling the following equation:

$$(\text{largest TTI within CCTrCH}) * X = \text{Repetition Length}$$

Example of usage:

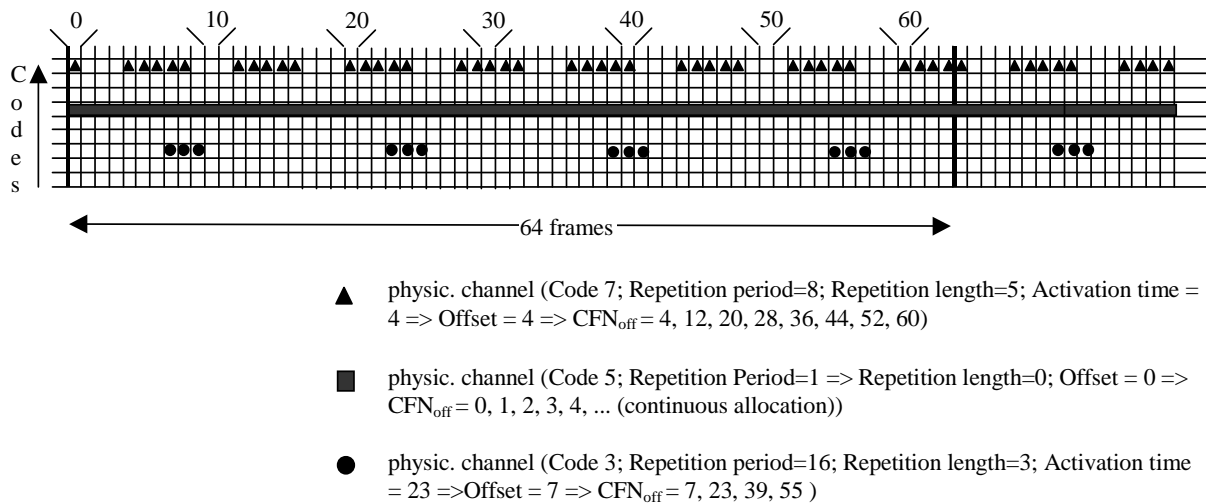

Figure 8.6.6.16-1: Examples for frame allocations in TDD

8.6.6.16a Repetition period, Repetition length, $Offset_{sub}$ (1.28 Mcps TDD non-scheduled transmission only)

The subframes, i.e. TTI in 5ms, of non-scheduled E-PUCH allocated can be determined from "Activation Time", "Subframe number", "Resource Duration" and "Resource Periodicity", or of initial SPS E-PUCH and HS-PDSCH allocated can be determined from "Activation time", "Subframe number", "Repetition period" and "Repetition length" as below:

The parameter " $Offset_{sub}$ " is defined to denote the offset of assigned E-PUCH or HS-PDSCH physical resource within each Repetition period and numerated in subframe number.

" $Offset_{sub}$ " to be used is calculated by the following equation:

$$(\text{Activation time} * 2 + \text{Subframe number}) \text{ mod Repetition period} = \text{Offset}_{sub}$$

Here, a new term subCFN is defined to represent the Subframe within a specified CFN, and subCFN within a specified CFN is counted as below:

$$CFN * 2 + \text{Subframe number} = \text{subCFN.}$$

SubFrames from $subCFN_{off}$ to $subCFN_{off} + \text{Repetition length} - 1$ belong to the allocation with $subCFN_{off}$ fulfilling the following equation:

$$subCFN_{off} \text{ mod Repetition period} = \text{Offset}_{sub}$$

Example of usage:

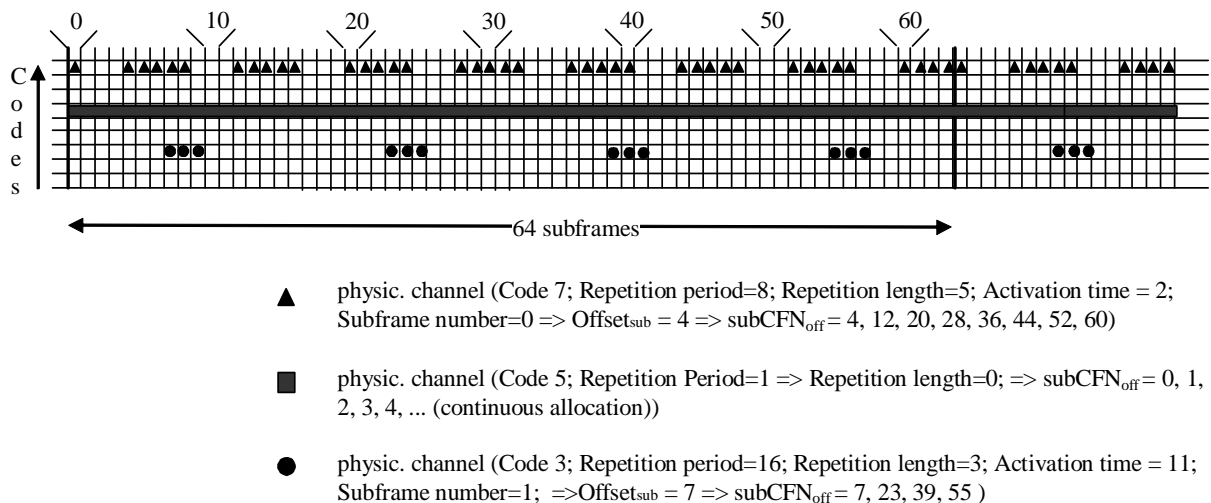

Figure 8.6.6.16a-1: Examples for subframe allocations in TDD

8.6.6.17 Primary CCPCH info

If the IE "Primary CCPCH info" is included, the UE shall:

- 1> use the information elements in this IE.

8.6.6.18 Primary CPICH info

If the IE "Primary CPICH info" in FDD is included, the UE shall:

- 1> use the value of this IE as the primary scrambling code for the downlink radio link.

8.6.6.19 Void

8.6.6.20 Void

8.6.6.21 Void

8.6.6.22 Secondary Scrambling Code, Code Number

The following description applies to FDD.

Code Number can be assigned by following rules:

- 1> When more than one DL DPDCH is assigned per RL, the segmented physical channel shall be mapped on to DL DPDCHs according to [27]. When p number of DL DPDCHs are assigned to each RL, the first pair of Secondary Scrambling Code and Code Number corresponds to "PhCH number 1", the second to "PhCH number 2", and so on until the p th to "PhCH number p ".

8.6.6.23 PDSCH Power Control info

The UE shall:

- 1> if the IE "PDSCH Power Control info" is included:

- 2> configure PDSCH power control with the received values.
- 1> if the IE "PDSCH Power Control info" is not included:
 - 2> continue to use the stored values.

8.6.6.24 Tx Diversity Mode

If the IE "Tx Diversity Mode" is included the UE shall:

- 1> if the value of the IE "Tx Diversity Mode" is STTD:
 - 2> configure the Layer 1 to use the Tx diversity mode indicated in the IE "Tx Diversity Mode" for the radio links for which the IE "Closed loop timing adjustment mode" is included, ignoring the actual value of IE "Closed loop timing adjustment mode".
- 1> if the value of the IE "Tx Diversity Mode" is closed loop mode 1:
 - 2> configure the Layer 1 to use the Tx diversity mode indicated in the IE "Tx Diversity Mode" for the radio links for which the IE "Closed loop timing adjustment mode" is included, using the actual value of the IE "Closed loop timing adjustment mode".
- 1> if the value of the IE "Tx Diversity Mode" is "none":
 - 2> configure the Layer 1 not to use Tx diversity for all radio links in the active set.

If the IE "Tx Diversity Mode" is not included, the UE shall:

- 1> continue to use the already configured Tx diversity mode;
- 1> in case no Tx diversity mode has been configured:
 - 2> do not apply Tx diversity.

For F-DPCH the UE shall:

- 1> if the IE "STTD indication" is included in the IE "Downlink F-DPCH info for each RL":
 - 2> use STTD for F-DPCH on the radio links for which the IE "STTD indication" is set to TRUE.

For HS-SCCH, the UE shall:

- 1> if the DPCH associated with a HS-SCCH is using either open or closed loop transmit diversity on the radio link transmitted from the HS-DSCH serving cell:
 - 2> use STTD for this HS-SCCH;
- 1> if the F-DPCH associated with an HS-SCCH is using open loop transmit diversity on the radio link transmitted from the HS-DSCH serving cell:
 - 2> use STTD for this HS-SCCH.
- 1> otherwise:
 - 2> not use Tx diversity for this HS-SCCH.

For E-AGCH, E-RGCH, and E-HICH from the same cell, the UE shall:

- 1> for each radio link:
 - 2> if the DPCH associated with E-AGCH, E-RGCH, and E-HICH from the same cell is using either open or closed loop transmit diversity:
 - 3> use STTD for these E-AGCH, E-RGCH, and E-HICH.
 - 2> if the F-DPCH associated with E-AGCH, E-RGCH, and E-HICH from the same cell is using open loop transmit diversity:

- 3> use STTD for these E-AGCH, E-RGCH, and E-HICH.
- 2> otherwise:
 - 3> not use Tx diversity for these E-AGCH, E-RGCH, and E-HICH.

8.6.6.25 Void

8.6.6.26 UL Timing Advance Control (TDD only)

If the IE "UL Timing Advance Control" is present, the UE shall:

- 1> if the IE "Uplink Timing Advance Control" has the value "disabled":
 - 2> reset timing advance to 0;
 - 2> disable calculated timing advance following handover;
 - 2> in case of handover:
 - 3> start uplink transmissions in the target cell without applying timing advance.
- 1> if the IE "Uplink Timing Advance Control" has the value "enabled":
 - 2> in 3.84 Mcps TDD or 7.68 Mcps TDD:
 - 3> in case of no cell change:
 - 4> evaluate and apply the timing advance value for uplink transmission as indicated in the IE "Uplink Timing Advance" or the IE "Extended Uplink Timing Advance" at the CFN indicated in the IE "Activation Time".
 - 3> in case of cell change:
 - 4> use the IE "Uplink Timing Advance" or the IE "Extended UL Timing Advance" as TA_{old} and apply TA_{new} for uplink transmission in the target cell at the CFN indicated in the IE "Activation Time" as specified in [33];
 - 4> include the value of the applied timing advance in the IE "Timing Advance" or the IE "Extended UL Timing Advance" in the COMPLETE message.
 - 2> in 1.28 Mcps TDD:
 - 3> if the IE "Synchronisation parameters" is included:
 - 4> initiate a sequence of UpPCH SYNC_UL code transmissions using a code selected from the set specified and continue until a timing correction is received in the specified FPACH (received for WT sub-frames following the sub-frame in which the transmission was made) or until Max SYNC_UL transmissions have been completed. The power used for each SYNC_UL transmission is as specified in subclause 8.5.7. Each transmission is made in the first sub-frame possible following the end of each FPACH reception interval using the timing specified in [33]. A new code is selected for each transmission. The detection that the FPACH relates to the transmitted SYNC_UL code is described in [33];
 - 4> if a timing correction is received within Max SYNC_UL transmissions the procedure is completed. The assigned uplink resources may then be used, commencing at the first possible TTI boundary or the SFN in which the assignment commences, whichever is the later. The timing of the uplink transmission is described in [33];
 - 4> if no timing correction has been received within Max SYNC_UL transmissions, the synchronisation procedure has failed. If the assigned resources are DCH, the UE should not transmit using these resources and should respond as if a physical channel failure has occurred as specified in subclauses

8.1.3.7 or 8.2.2.7 or 8.3.1.7, or 8.3.6.5. If the assigned resources are USCH then the UE should ignore the USCH allocation.

3> if the IE "Synchronisation parameters" is not included:

4> in case of no cell change:

5> continue to use the current uplink timing.

4> in case of cell change:

5> evaluate and apply the timing correction TA_{new} for uplink transmissions using the procedure as specified in [33].

8.6.6.26a Uplink synchronisation parameters (TDD only)

The UE shall apply uplink synchronisation using the values of the IEs "Uplink synchronisation step size" and "Uplink synchronisation frequency" as specified in [33].

8.6.6.27 Downlink information common for all radio links

If the IE "Downlink information common for all radio links" is included the UE shall:

1> if the IE "Downlink DPCH info common for all RL" is included:

2> perform actions as specified in subclause 8.6.6.28.

1> if the IE "Downlink F-DPCH info common for all RL" is included:

2> perform actions as specified in subclause 8.6.6.28a.

1> if the IE choice "mode" is set to 'FDD':

2> perform actions for the IE "DPCH compressed mode info" as specified in subclause 8.6.6.15;

2> perform actions for the IE "Tx Diversity mode" as specified in subclause 8.6.6.24.

1> if the IE "MAC-hs reset indicator" is included:

2> if the serving HS-DSCH radio link is the same radio link as prior to the reception of the message; and

2> if, as a result of the reconfiguration message where this IE is received, the MAC header type (i.e., either MAC-hs or MAC-ehs) is unchanged:

3> the UE behaviour is unspecified.

2> reset the MAC-hs/ehs entity [15].

NOTE: If the MAC header type is changed, either from MAC-hs to MAC-ehs or from MAC-ehs to MAC-hs, UTRAN should include the IE "MAC-hs reset indicator" in order to ensure a reset of the MAC-hs/ehs entity in the UE prior to MAC-hs/ehs reconfiguration, otherwise the UE behaviour is unspecified.

8.6.6.28 Downlink DPCH info common for all radio links

If the IE "Downlink DPCH info common for all RL" is included the UE shall:

1> if:

2> the IE "Downlink DPCH info common for all RL" is included in a reconfiguration message; and

2> the UE was in CELL_DCH state upon reception of the message and remains in CELL_DCH state; and

2> the message is not used to perform a hard handover (as specified in subclause 8.6.6.3a) and the IE "Timing indication" is set to "initialise":

3> the UE behaviour is not specified.

- 1> if the IE "Downlink DPCH power control information" is included:
 - 2> in the case of FDD:
 - 3> perform actions for the IE "DPC Mode" according to [29].
 - 2> in the case of TDD:
 - 3> perform actions for the IE "TPC Step Size" according to [33].
- 1> if the IE choice "mode" is set to 'FDD':
 - 2> if the IE "Downlink rate matching restriction information" is included:
 - 3> set the variable INVALID_CONFIGURATION to TRUE.
 - 2> perform actions for the IE "spreading factor";
 - 2> perform actions for the IE "Fixed or Flexible position";
 - 2> perform actions for the IE "TFCI existence";
 - 2> if the IE choice "SF" is set to 256:
 - 3> store the value of the IE "Number of bits for pilot bits".
 - 2> if the IE choice "SF" is set to 128:
 - 3> store the value of the IE "Number of bits for pilot bits".

If the IE "Downlink DPCH info common for all RL" is included in a message used to perform a Timing re-initialised hard handover or the IE "Downlink DPCH info common for all RL" is included in a message other than RB SETUP used to transfer the UE from a state different from Cell_DCH to Cell_DCH, and ciphering is active for any radio bearer using RLC-TM, the UE shall, after having activated the dedicated physical channels indicated by that IE:

- 1> if any ciphering configuration for a radio bearer using RLC-TM has not been applied, due to that the activation time from a previous procedure has not elapsed:
 - 2> apply the ciphering configuration immediately and consider the activation time from the previous procedure to be elapsed.
- 1> if the IE "MAC-d HFN initial value" is included in the IE "Downlink DPCH info common for all RL":
 - 2> set the HFN component of COUNT-C for TM-RLC to the value of the IE "MAC-d HFN initial value", while not incrementing the value of the HFN component of COUNT-C at each CFN cycle.

NOTE: The UTRAN should choose a value for the IE "MAC-d HFN initial value" using the COUNT-C value of the RBs using RLC-TM indicated by the Source RNC to the Target RNC in the IE "SRNS Relocation Info" and include some margin in such a way that no values of COUNT-C are repeated after the handover.

- 1> else:
 - 2> set the 20 MSB of the HFN component of COUNT-C for TM-RLC to the value of the latest transmitted IE "START" or "START List" for this CN domain, while not incrementing the value of the HFN component of COUNT-C at each CFN cycle; and
 - 2> set the remaining LSBs of the HFN component of COUNT-C to zero.
- 1> start to perform ciphering on the radio bearer in lower layers while not incrementing the HFN;
- 1> include the IE "COUNT-C activation time" in the response message and specify a CFN value for this IE other than the default, "Now", that is a multiple of 8 frames ($CFN \bmod 8 = 0$) and lies at least 200 frames ahead of the CFN in which the response message is first transmitted;
- 1> calculate the START value according to subclause 8.5.9;

- 1> include the calculated START values for each CN domain in the IE "START list" in the IE "Uplink counter synchronisation info" in the response message;
- 1> at the CFN value as indicated in the response message in the IE "COUNT-C activation time":
 - 2> set the 20 MSB of the HFN component of the COUNT-C variable common for all transparent mode radio bearers of this CN domain to the START value as indicated in the IE "START list" of the response message for the relevant CN domain; and
 - 2> set the remaining LSBs of the HFN component of COUNT-C to zero;
 - 2> increment the HFN component of the COUNT-C variable by one even if the "COUNT-C activation time" is equal to zero;
 - 2> set the CFN component of the COUNT-C to the value of the IE "COUNT-C activation time" of the response message. The HFN component and the CFN component completely initialise the COUNT-C variable;
 - 2> step the COUNT-C variable, as normal, at each CFN value, i.e. the HFN component is no longer fixed in value but incremented at each CFN cycle.

8.6.6.28a Downlink F-DPCH info common for all radio links

If the IE "Downlink F-DPCH info common for all RL" is included the UE shall:

- 1> if the IE "Downlink F-DPCH info common for all RL" is included in a message used to perform a hard handover:
 - 2> perform actions for the IE "Timing indication" as specified in subclause 8.5.15.2, and subclause 8.3.5.1 or 8.3.5.2.
- 1> if the IE "Downlink DPCH power control information" is included:
 - 2> perform actions for the IE "DPC Mode" according to [29].

8.6.6.29 ASC setting

If the IE "ASC setting" is included, the UE shall:

- 1> establish the available signatures for this ASC as specified in the following:
 - 2> separately renumber the list of available signatures specified in the IE "Available signature" included in the IE "PRACH info" and the IE "PRACH preamble control parameters (for Enhanced Uplink)" from signature index 0 to signature index N-1, where N is the number of available signatures, starting with the lowest available signature number and continuing in sequence, in the order of increasing signature numbers;
 - 2> consider as available signatures for this ASC the signatures included in this renumbered list from the index specified by the IE "Available signature Start Index" to the index specified by the IE "Available signature End Index".
- 1> establish the available access slot sub-channels for this ASC as specified in the following:
 - 2> if the IE "AICH transmission timing" included in the IE "AICH Info" is set to '0':
 - 3> ignore the leftmost (most significant) bit (bit b3) of the bit string specified by the IE "Assigned Sub-Channel Number";
 - 3> repeat 4 times the 3 rightmost (least significant) bits (bits b2-b0) of the bit string specified by the IE "Assigned Sub-Channel Number" to form a resulting bit string 'b2 b1 b0 b2 b1 b0 b2 b1 b0 b2 b1 b0' of length 12 bits, where the leftmost bit is the most significant.
 - 2> if the IE "AICH transmission timing" included in the IE "AICH Info" is set to '1':
 - 3> repeat 3 times the bit string (bits b3-b0) specified by the IE "Assigned Sub-Channel Number" to form a bit string 'b3 b2 b1 b0 b3 b2 b1 b0 b3 b2 b1 b0' of length 12 bits, where the leftmost bit is the most significant.

- 2> perform in both cases, for the resulting bit string (that includes the repetitions) bit-wise logical AND operation separately with the IE "Available Sub Channel number" included in IE "PRACH info (for RACH)" and "PRACH preamble control parameters (for Enhanced Uplink)";
- 2> consider as available sub-channels for this ASC the available sub-channels indicated in the resulting bit string, after logical AND operation i.e. each bit set to 1 or 0 indicates availability or non-availability, respectively, of sub-channel number x , with x from 0 to 11, for the respective ASC.

NOTE 1: In FDD, the list of available signatures is renumbered from signature index 0 to signature index $N-1$, where N is the number of available signatures, starting with the lowest available signature number and continuing in sequence, in the order of increasing signature numbers.

- List of available signatures: 16 or fewer signatures are available.
- Example: only signatures 0, 5, 10 and 15 are available, then :
 - Signature 0 is: available signature index 0
 - Signature 5 is: available signature index 1
 - Signature 10 is: available signature index 2
 - Signature 15 is: available signature index 3

NOTE 2: In 3.84 Mcps TDD, the list of available channelisation codes (defined in PRACH info) is renumbered from channelisation code index 0 to channelisation code index $N-1$, where N is the number of available channelisation codes, starting with the lowest available channelisation code number and continuing in sequence, in the order of increasing channelisation code numbers

List of available channelisation codes : 8 or less channelisation codes are available.

The i -th bit of the bitmap defined in the IE "Available Channelisation Code indices" defines whether the channelisation code with the available channelisation code index i is to be used for this ASC (bit set means used, bit unset means not used). Only the low N bits shall be used in the bitmap, where N is the number of available channelisation codes defined in PRACH info.

Ex : spreading factor 16, channelisation codes 16/1, 16/2, 16/5, 16/8 are available :

- Channelisation code 16/1 is: available channelisation code index 0
- Channelisation code 16/2 is: available channelisation code index 1
- Channelisation code 16/5 is: available channelisation code index 2
- Channelisation code 16/8 is: available channelisation code index 3

Available Channelisation Code indices has the value '00001100' means: Channelisation Codes 16/5 and 16/8 are available for this ASC.

NOTE 2a: In 7.68 Mcps TDD, the list of available channelisation codes (defined in PRACH info) is renumbered from channelisation code index 0 to channelisation code index $N-1$, where N is the number of available channelisation codes, starting with the lowest available channelisation code number and continuing in sequence, in the order of increasing channelisation code numbers

List of available channelisation codes : 16 or less channelisation codes are available.

The i -th bit of the bitmap defined in the IE "Available Channelisation Code indices" defines whether the channelisation code with the available channelisation code index i is to be used for this ASC (bit set means used, bit unset means not used). Only the low N bits shall be used in the bitmap, where N is the number of available channelisation codes defined in PRACH info.

Ex : spreading factor 32, channelisation codes 32/1, 32/2, 32/5, 32/8 are available :

- Channelisation code 32/1 is: available channelisation code index 0
- Channelisation code 32/2 is: available channelisation code index 1
- Channelisation code 32/5 is: available channelisation code index 2
- Channelisation code 32/8 is: available channelisation code index 3

Available Channelisation Code indices has the value '000000000001100' means: Channelisation Codes 32/5 and 32/8 are available for this ASC.

NOTE 3: In TDD, the subchannel description is found in [33].

NOTE 4: In 1.28 Mcps TDD, the list of available SYNC_UL codes (defined in PRACH info) is numbered from SYNC_UL code index 0 to SYNC_UL code index N-1, where N is the number of available SYNC_UL codes, starting with the lowest available SYNC_UL code number and continuing in sequence, in the order of increasing SYNC_UL code numbers

The i-th bit of the bitmap defined in the IE "Available SYNC_UL codes indices" defines whether the SYNC_UL code with the available SYNC_UL code index i is to be used for this ASC (bit set means used, bit unset means not used). Only the low N bits shall be used in the bitmap, where N is the number of available SYNC_UL codes defined in PRACH info.

- List of available SYNC_UL codes: 8 or fewer SYNC_UL codes are available.

Example: only signatures 0, 5, 6 and 7 are available, then:

- SYNC_UL codes 0 is: available SYNC_UL codes index 0
- SYNC_UL codes 5 is: available SYNC_UL codes index 1
- SYNC_UL codes 6 is: available SYNC_UL codes index 2
- SYNC_UL codes 7 is: available SYNC_UL codes index 3

Available SYNC_UL codes indices has the value '00001100' means: SYNC_UL codes 6 and 7 are available for this ASC.

8.6.6.30 SRB delay, PC preamble (FDD only)

When the IE "SRB delay" and IE "PC preamble" is received in a message that results in a configuration of uplink DPCH or E-DPCH, and synchronisation procedure A is being used as specified in [29], the UE shall:

- 1> store the received IE "SRB delay" and IE "PC preamble" in the variable LATEST_CONFIGURED_SRB_DELAY_AND_PC_PREAMBLE;
- 1> apply power control preamble according to [26] during the number of frames indicated in the IE "PC preamble"; and
- 1> then not send any data on signalling radio bearers RB0 to RB4 during the number of frames indicated in the IE "SRB delay" or while the physical channel is not considered established.

8.6.6.31 Void

8.6.6.32 Void

8.6.6.33 HS-SCCH Info

If the IE "HS-SCCH Info" is included and the UE will be in CELL_DCH state after completion of this procedure, the UE shall:

- 1> store the received configuration.
- 1> determine the value for the HS_DSCH_RECEPTION variable and take the corresponding actions as described in subclause 8.5.25.

When the variable HS_DSCH_RECEPTION is set to TRUE the UE shall:

- 1> in the case of FDD:
 - 2> receive the HS-SCCH(s) according to the IE "HS-SCCH channelisation code" on the serving HS-DSCH radio link applying the scrambling code as received in the IE "DL Scrambling code".

- 1> in the case of TDD:
 - 2> receive the HS-SCCH(s) according to the IEs "Timeslot Number", "Channelisation Code" and Midamble configuration IEs.
 - 2> transmit the HS-SICH according to the IEs "Timeslot Number", "Channelisation Code" and Midamble configuration IEs.
 - 2> for HS-SCCH power control the UE shall use the "BLER target" signalled in the first occurrence of the "HS-SCCH Set Configuration", and the UE shall also use the IE "Power Control GAP" for 1.28 Mcps TDD.
 - 2> in 3.84 Mcps TDD and 7.68 Mcps TDD:
 - 3> use the parameters specified in the IE "HS-SICH power control info" for open loop power control as defined in subclause 8.5.7.
 - 2> in 1.28 Mcps TDD:
 - 3> use the IE "PRX_{HS-SICH}" to calculate and set an initial uplink transmission power;
 - 3> use the IE "TPC step size" upon reception of TPC commands for closed loop power control;
 - 3> perform closed loop power control on HS-SICH within the interval indicated in the IE "Power Control GAP";
 - 3> use the IE "Pathloss compensation switch" to determine if the pathloss compensation from the beacon channel estimation should be taken into account for closed loop power control on HS-SICH;
 - 3> use default value of "Uplink synchronisation frequency" and same value of "Uplink synchronisation step size" in "Uplink DPCH info" for HS-SICH upon reception of SS commands for closed loop uplink synchronisation on HS-SICH.

For 1.28 Mcps TDD, if the IE "HS-SCCH Info" is included and the UE will be in CELL_FACH state after completion of this procedure, the UE shall:

- 1> store the received configuration;
- 1> determine the value for the HS_DSCH_RECEPTION_CELL_FACH_STATE variable and take the corresponding actions as described in subclause 8.5.36.

For 1.28 Mcps TDD, when the variable HS_DSCH_RECEPTION_CELL_FACH_STATE is set to TRUE the UE shall:

- 1> receive the HS-SCCH(s) according to the IEs "Timeslot Number", "Channelisation Code" and Midamble configuration IEs;
- 1> transmit the HS-SICH according to the IEs "Timeslot Number", "Channelisation Code" and Midamble configuration IEs;
- 1> for HS-SCCH power control the UE shall use the "BLER target" signalled in the first occurrence of the "HS-SCCH Set Configuration", and the UE shall also use the IE "Power Control GAP" for 1.28 Mcps TDD;
- 1> use the value of "TPC step size" in the IE "E-AGCH info" for HS-SCCH closed loop power control;
- 1> use the IE "PRX_{HS-SICH}" to calculate and set an initial uplink transmission power;
- 1> use the IE "TPC step size" upon reception of TPC commands for closed loop power control;
- 1> perform closed loop power control on HS-SICH within the interval indicated in the IE "Power Control GAP";
- 1> use the IE "Pathloss compensation switch" to determine if the pathloss compensation from the beacon channel estimation should be taken into account for closed loop power control on HS-SICH;
- 1> use default value of "Uplink synchronisation frequency" and same value of "Uplink synchronisation step size" in "Uplink DPCH info" for HS-SICH upon reception of SS commands for closed loop uplink synchronisation on HS-SICH.

8.6.6.34 Measurement Feedback Info

If the IE "Measurement Feedback Info" is included and the UE will be in CELL_DCH state after completion of this procedure, the UE shall:

- 1> store the received configuration;
- 1> determine the value for the HS_DSCH_RECEPTION variable and take the corresponding actions as described in subclause 8.5.25.

When the variable HS_DSCH_RECEPTION is set to TRUE the UE shall:

- 1> use the information for the channel quality indication (CQI) procedure in the physical layer on the serving HS-DSCH radio link.

8.6.6.35 DPC Mode

If the IE "DPC Mode" is included, the UE shall:

- 1> apply the indicated DPC mode according to [29].

If the IE "DPC Mode" is not included, the UE shall:

- 1> continue with the currently used DPC mode.

8.6.6.36 Downlink HS-PDSCH Information

If the IE "Downlink HS-PDSCH Information" is included and the UE would be in CELL_DCH state after completion of this procedure, the UE shall:

- 1> for 1.28 Mcps TDD, if the HS-PDSCH has been configured by the IE "DL Multi-carrier information":
 - 2> clear other stored carriers configuration in the IE "DL Multi-carrier information".
- 1> if the IE "HS-SCCH Info" is included:
 - 2> act as specified in subclause 8.6.6.33.
- 1> if the IE "Measurement Feedback Info" is included:
 - 2> act as specified in subclause 8.6.6.34.
- 1> if the IE "HS-DSCH Timeslot Configuration" or "HS-PDSCH Midamble Configuration" is included:
 - 2> store the received configuration;
 - 2> determine the value for the HS_DSCH_RECEPTION variable and take actions as described in subclause 8.5.25.

For 1.28 Mcps TDD, if the IE "Downlink HS-PDSCH Information" is included and the UE would be in CELL_FACH state after completion of this procedure, the UE shall:

- 1> if the IE "HS-SCCH Info" is included:
 - 2> act as specified in subclause 8.6.6.33.
- 1> if the IE "HS-PDSCH Midamble Configuration" is included:
 - 2> store the received configuration.
- 1> determine the value for the HS_DSCH_RECEPTION_CELL_FACH_STATE variable and take the corresponding actions as described in subclause 8.5.36.

8.6.6.36a DL Multi-carrier information (1.28 Mcps TDD only)

The IE "DL Multi-carrier information" is used in multiple carriers system.

NOTE: When only one frequency is configured to the UE, either the IE "DL Multi-carrier information" or the IE "Downlink HS-PDSCH Information" may be used but should use only one of them and the DPCCH frequency shall be aligned with the IE "DL Multi-carrier information".

If the IE "DL Multi-carrier information" is included, the UE shall:

- 1> if the IE "TSN-Length" is included:
 - 2> store the new TSN length indicated by the IE "TSN-Length".
- 1> if the IE "TSN-Length" is not included:
 - 2> if the UE has stored TSN length:
 - 3> use the stored content of the IE.
 - 2> else:
 - 3> set the TSN length to 6bits.
- 1> if the IE "Multi-Carrier number" is included:
 - 2> store the new multiple carriers number indicated by the IE "Multi-Carrier number";
 - 2> start reception procedure on the HS-SCCHs (refer to [33]).
- 1> if the IE "DL-HSPDSCH-MultiCarrier-Information" is included:
 - 2> if the IE "HS-SCCH Set Configuration" is included:
 - 3> perform processes described in subclause 8.6.6.33.
 - 2> if the IE "HARQ-Info" is included:
 - 3> perform processes described in subclause 8.6.5.6b.
 - 2> if the IE "HS-PDSCH Midamble Configuration" is included:
 - 3> store the HS-PDSCH midamble configuration indicated by the IE "HS-PDSCH Midamble Configuration";
 - 3> perform processes described in subclause 8.5.25.
- 1> if the carrier which has been stored by the UE is not included in the the IE "DL-HSPDSCH-MultiCarrier-Information", the UE should delete all the configurations related to this carrier.

8.6.6.37 E-DCH Info

If the IE "E-DCH Info" is included and the UE will be in CELL_DCH state after completion of this procedure, the UE shall:

- 1> for FDD:
 - 2> if the IE "E-DPCCH Info" is included:
 - 3> store the newly received E-DPCCH configuration.
 - 2> if the IE "E-DPDCH Info" is included:
 - 3> store the newly received E-DPDCH configuration.
 - 2> if the IE "UL 16QAM settings" is not included:
 - 3> indicate to lower layers to stop any operation in 16QAM mode.
- 1> for TDD:
 - 2> if the IE "E-RUCCH Info" is included:

3> store the newly received E-RUCCH configuration.

2> if the IE "E-PUCH Info" is included:

3> store the newly received E-PUCH configuration.

NOTE 1: The UTRAN should ensure the ordering of the E-TFCI table in strictly increasing order of transmission power prior to quantization, by correct setting of the reference E-TFCI power offsets otherwise the UE behaviour is unspecified.

NOTE 2: If a reference E-TFCI signalled to the UE is outside the UE physical channel capability, the UE behaviour is unspecified.

NOTE 2a: If E-TFCI boost is signalled to the UE and a reference E-TFCI \leq E-TFCI Boost is signalled to the UE with a Reference E-TFCI PO of value 30 or 31, the UE behaviour is unspecified.

NOTE 2b: If the UE is configured with E-TFCI table 0 and 2ms TTI, and a reference E-TFCI =120 has been configured, the UE behavior is unspecified.

NOTE 2c: If the UE is configured with E-TFCI table 1 and 2ms TTI, and a reference E-TFCI =115 has been configured, the UE behavior is unspecified.

NOTE 2d: If the UE is configured with E-TFCI table 2 and 2ms TTI, and a reference E-TFCI =121 has been configured, the UE behavior is unspecified.

NOTE 2e: If the UE is configured with E-TFCI table 3 and 2ms TTI, and a reference E-TFCI =101 or a reference E-TFCI = 102 has been configured, the UE behavior is unspecified.

1> if the IE "MAC-es/e reset indicator" is included:

2> reset the MAC-es/e or MAC-i/is entity [15].

NOTE 3: If the IE "MAC-es/e reset indicator" is not set to TRUE in case the IE "E-DCH Transmission Time Interval" is reconfigured, the UE behaviour is unspecified.

NOTE 4: If the IE "MAC-es/e reset indicator" is not set to TRUE in case the UL MAC header type is reconfigured from MAC-es/e to MAC-is/i or from MAC-is/i to MAC-e/es, the UE behaviour is unspecified.

NOTE 5: If the IE "MAC-es/e reset indicator" is not included in the IE "E-DCH Info" and 16QAM operation starts or stops, the UE behaviour is unspecified.

1> determine the value for the E_DCH_TRANSMISSION variable and take the corresponding actions as described in subclause 8.5.28.

When the variable E_DCH_TRANSMISSION is set to TRUE the UE shall:

1> for FDD:

2> configure the UL E-DPCCH in accordance with the stored IE "E-DPCCH" configuration;

2> configure the MAC with the stored IE "E-DPDCH" configuration and/or the information contained in IE "Scheduled Transmission configuration".

1> for TDD:

2> configure the E-RUCCH with the stored E-RUCCH configuration;

2> configure the MAC with the stored E-PUCH configuration.

For 1.28 Mcps TDD, If the IE "E-DCH Info" is included and the UE will be in CELL_FACH state after completion of this procedure, the UE shall:

1> if the IE "E-RUCCH Info" is included:

2> store the newly received E-RUCCH configuration.

1> if the IE "E-PUCH Info" is included:

- 2> store the newly received E-PUCH configuration.
- 1> if the IE "MAC-es/e reset indicator" is included:
 - 2> reset the MAC-es/e or MAC-i/is entity [15].
- 1> determine the value for the COMMON_E_DCH_TRANSMISSION variable and take the corresponding actions as described in subclause 8.5.46.

For 1.28 Mcps TDD, when the variable COMMON_E_DCH_TRANSMISSION is set to TRUE the UE shall:

- 1> configure the E-RUCCH with the stored E-RUCCH configuration;
- 1> configure the MAC with the stored E-PUCH configuration.

8.6.6.38 DTX-DRX timing information (FDD only)

If the IE "DTX-DRX timing information" is included and the UE will be in CELL_DCH state after completion of this procedure, the UE shall:

- 1> if the CHOICE "timing" is set to "New timing":
 - 2> use the newly received DTX-DRX timing configuration.
- 1> if the CHOICE "timing" is set to "Continue", and the message is used to perform a hard handover (as specified in subclause 8.6.6.3a); or
- 1> if the received message does not include the IE "DTX-DRX information" and this message will perform E-DCH TTI reconfiguration:
 - 2> the UE behaviour is unspecified.
- 1> determine the value for the DTX_DRX_STATUS variable and take the corresponding actions as described in subclause 8.5.34.

8.6.6.39 DTX-DRX information (FDD only)

If the IE "DTX-DRX information" is included and the UE will be in CELL_DCH state after completion of this procedure, the UE shall:

- 1> store the contents of the IE in the variable DTX_DRX_PARAMS, replacing or clearing any previously stored "DTX Information" or "DRX Information";
- 1> determine the value for the DTX_DRX_STATUS variable and take the corresponding actions as described in subclause 8.5.34;
- 1> if the value of the IE "UE DTX cycle 2" is not an integer multiple of the value of the IE "UE DTX cycle 1"; or
- 1> if the value of the IE "UE DTX cycle 2" is not an integer multiple or a divisor of the value of the IE "CQI Feedback cycle, k" divided by 2; or
- 1> if the value of the IE "UE DPCCH burst 1" is greater than the value of the IE "UE DTX cycle 1"; or
- 1> if the value of the IE "UE DPCCH burst 2" is greater than the value of the IE "UE DTX cycle 2"; or
- 1> if the IE "UE DTX long preamble length" is set to 4 or 15 slots and the value of the IE "Inactivity Threshold for UE DTX cycle 2" is less than 4 TTIs (for 10ms E-DCH TTI) or 8 TTIs (for 2ms E-DCH TTI); or
- 1> if the IE "UE DRX cycle" is not an integer multiple or a divisor of the value of the IE "UE DTX cycle 1"; or
- 1> if the value of the IE "UE DTX cycle 1" is not an integer multiple or a divisor of the value of the IE "MAC DTX cycle"; or
- 1> if the IE "DTX-DRX timing information" is included in this message and if the CHOICE "timing" is set to "continue"; or

1> if the IE "Uplink DPCCH slot format information" is received in an ACTIVE SET UPDATE message and indicates different uplink DPCCH slot format from the one currently configured, and neither the indicated uplink DPCCH slot format nor the currently configured uplink DPCCH slot format are uplink DPCCH slot format 4; or

1> if the IE "DTX Information" is not included in this message:

2> the UE behaviour is unspecified.

NOTE: If the IE "Uplink DPCH info" is included in this message, the UTRAN should ensure that the configuration of the uplink DPCH does not contradict the uplink DPCH configuration indicated in the IE "Uplink DPCCH slot format information".

8.6.6.40 HS-SCCH less information (FDD only)

If the IE "HS-SCCH less information" is included and the UE will be in CELL_DCH state after completion of this procedure, the UE shall:

1> if the CHOICE "HS-SCCH less operation" is set to "New HS-SCCH less operation":

2> store the contents of the IE in the variable HS_SCCH_LESS_PARAMS.

1> determine the value for the HS_SCCH_LESS_STATUS variable and take the corresponding actions as described in subclause 8.5.35.

8.6.6.41 MIMO parameters

If the IE "MIMO parameters" is included, the UE shall:

1> act as specified in clauses 8.5.32 and 8.5.33;

1> If the IE "MIMO operation" is set to "start":

2> If the MIMO_STATUS variable is set to FALSE:

3> the UE behaviour is undefined.

2> otherwise:

3> indicate to lower layers to start operation in MIMO mode, using the parameter values stored in the variable MIMO_PARAMS.

1> If the IE "MIMO operation" is set to "continue":

2> If the MIMO_STATUS variable is set to FALSE:

3> the UE behaviour is undefined.

1> for FDD, if the IE "Primary CPICH usage for Channel Estimation" is set to "Primary CPICH shall not be used":

2> the UE behavior is undefined.

1> for FDD, if the IE "Secondary CPICH Info" is included and if the IE "Channelisation code" in MIMO pilot configuration is different from the IE "Channelisation Code" in Secondary CPICH info:

2> the UE behavior is undefined.

1> for FDD, if the IE "Secondary CPICH Info" is included and if the IE "Power Offset For S-CPICH for MIMO" is provided, then pass the offset value received in the IE "Power Offset For S-CPICH for MIMO" to the lower layers.

NOTE: This subclause applies to FDD and 1.28 Mcps TDD only.

8.6.6.42 UL 16QAM settings

If the IE "UL 16QAM settings" is included, the UE shall:

1> indicate to lower layers to operate in 16QAM mode, using the parameters contained in the IE.

8.6.6.43 Multi-frequency Info (1.28 Mcps TDD only)

Upon reception of the IE "Multi-frequency info", the UE shall:

1> If the IE "Second Frequency info" is included:

2> act as specified in section 8.6.6.1.

1> If the IE "FPACH Frequency info" is included:

2> store the FPACH frequency indicated in the IE "FPACH Frequency info".

1> else:

2> use the primary frequency as FPACH frequency.

1> If the IE "UpPCH Position Info" is included:

2> store and use the UpPCH position indicated by the IE "UpPCH Positon Info ". The calculation of the uplink access position is described in [33].

1> else:

2> use the UpPTS as the default UpPCH position.

8.6.6.44 Void

8.6.6.45 Downlink Secondary Cell Info FDD

If the IE "Downlink Secondary Cell Info FDD" is not included and the UE has any stored IE "Downlink Secondary Cell Info FDD", the UE shall:

1> clear the stored IE "Downlink Secondary Cell Info FDD";

1> determine the value for the SECONDARY_CELL_HS_DSCH_RECEPTION variable and take the corresponding actions as described in subclause 8.5.51.

If the IE "Downlink Secondary Cell Info FDD" is included and the UE will be in CELL_DCH state after completion of this procedure, the UE shall:

1> if the CHOICE "Configuration info" is set to "New configuration":

2> store the IE "Downlink Secondary Cell Info FDD", replacing any stored IE "Downlink Secondary Cell Info FDD".

1> if the CHOICE "Configuration info" is set to "Continue" and the UE has any stored IE "Downlink Secondary Cell Info FDD":

2> keep the stored IE "Downlink Secondary Cell Info FDD".

1> determine the value for the SECONDARY_CELL_HS_DSCH_RECEPTION variable and take the corresponding actions as described in subclause 8.5.51.

1> if the IE "Different Tx diversity mode configuration from serving HS-DSCH cell" is present and Tx diversity is configured in the serving HS-DSCH cell,

2> not configure Tx diversity for the secondary serving HS-DSCH cell.

1> if the IE "Different Tx diversity mode configuration from serving HS-DSCH cell" is present and Tx diversity is not configured in the serving HS-DSCH cell,

2> configure Tx diversity in the secondary serving HS-DSCH cell.

- 1> if the IE "Different Tx diversity mode configuration from serving HS-DSCH cell" is not present,
- 2> the Tx diversity mode configured in the secondary serving HS-DSCH cell shall be the same as the Tx diversity mode configured in the serving HS-DSCH cell.

If the variable "Adjacent frequency info" is stored in CELL_INFO_LIST, and its "UARFCN downlink (Nd)" is different from the "UARFCN downlink (Nd)" of the stored IE "Downlink Secondary Cell Info FDD":

- 1> stop all inter-frequency measurement reporting on the cells that belong to the frequency derived from the variable "Adjacent frequency info". Each stopped measurement is restarted when a MEASUREMENT CONTROL message is received with the corresponding measurement identity.
- 1> clear the variable "Adjacent frequency info".

8.6.6.46 Control Channel DRX information (1.28 Mcps TDD only)

If the IE "Control Channel DRX information" is included and the UE will be in CELL_DCH state after completion of this procedure, the UE shall:

- 1> if the CHOICE "*Control Channel DRX operation*" is set to "New Control Channel DRX operation":
 - 2> store the contents of the IE in the variable CONTROL_CHANNEL_DRX_PARAMS, replacing or clearing any previously stored "Control Channel DRX operation";
 - 2> use the newly received Control Channel DRX configuration.
 - 2> if the IE "E-AGCH DRX Information" is not included:
 - 3> not perform E-AGCH discontinuous reception.
- 1> if the CHOICE "*Control Channel DRX operation*" is set to "Continue", and the message is used to perform a hard handover (as specified in subclause 8.6.6.3a):
 - 2> the UE behaviour is unspecified.
- 1> determine the value for the CONTROL_CHANNEL_DRX_STATUS variable and take the corresponding actions as described in subclause 8.5.53.
- 1> if the IE "E-AGCH DRX Information" is included, and the variable E_DCH_TRANSMISSION is set to FALSE:
 - 2> the UE behaviour is unspecified.

8.6.6.47 SPS information (1.28 Mcps TDD only)

If the IE "SPS information" is included and the UE will be in CELL_DCH state after completion of this procedure, the UE shall:

- 1> if the IE "E-DCH SPS Information" is included and the UE will be in CELL_DCH state after completion of this procedure, the UE shall:
 - 2> if the CHOICE "E-DCH SPS operation" is set to "New E-DCH SPS operation":
 - 3> after the UE has received IE "E-HICH Information":
 - 4> if the CHOICE "Configuration Mode" is set to "Implicit":
 - 5> if the IE "EI" is included:
 - 6> consider the E-HICH has the same configuration as that in the IE "E-HICH Info" for 1.28Mcps TDD which has the same value of EI indicated by the IE "EI" in this message.
 - 5> else:
 - 6> use the same configuration as the E-HICH for non-schedule transmission.
 - 4> else:

- 5> store the E-HICH configuration according to the IEs "Timeslot Number", "Channelisation Code" and midamble configuration IEs.
- 4> store and use the Signature Sequence indicated by the IE "Signature Sequence Group Index".
- 3> if the IE "Transmission Pattern List" is included:
 - 4> store the contents of the IE in the variable E_DCH_SPS_PARAMS.
- 3> if the IE "Initial SPS info for E-DCH" is included:
 - 4> perform E-DCH SPS operation on the semi-persistent E-PUCH resource configured by the IE at the CFN determined by the IE "Activation Time" and the IE "Subframe number".
- 2> determine the value for the E_DCH_SPS_STATUS variable and take the corresponding actions as described in subclause 8.5.54.
- 2> if the IE "Initial SPS info for E-DCH" is included, the calculation of assigned initial E-DCH SPS transmission grant is specified in subclause 8.6.6.16a
- 1> else if the IE "E-DCH SPS Information" is not included, the UE shall:
 - 2> set the variable E_DCH_SPS_STATUS to FALSE;
 - 2> clear the variable E_DCH_SPS_PARAMS;
 - 2> stop all E-DCH SPS related activities.
- 1> if the IE "HS-DSCH SPS Information" is included and the UE will be in CELL_DCH state after completion of this procedure, the UE shall:
 - 2> if the CHOICE "HS-DSCH SPS operation" is set to "New HS-DSCH SPS operation":
 - 3> if the IE "Transport Block Size List" or the IE "Reception Pattern List" is included:
 - 4> store the contents of the IE in the variable HS_DSCH_SPS_PARAMS.
 - 3> if the IE "HARQ Info for Semi-Persistent Scheduling" is included:
 - 4> calculate the size of each virtual IR buffer according to following equation:
 Size of virtual IR soft buffer = Total buffer for HS-SCCH SPS operation / N_{IR}
 where
 - Total buffer for HS-SCCH SPS operation is signalled in the IE "Process Memory size", and the IE is the total size of the virtual IR buffers which could be used in HS-SCCH SPS operation;
 - N_{IR} is the value of the IE "Number of Processes", and the IE is the number of HARQ processes which could be used in HS-SCCH SPS operation.
 - 3> after the UE has received IE "HS-SICH List":
 - 4> if the CHOICE "Configuration Mode" is set to "Implicit":
 - 5> transmit the HS-SICH according to the configuration in the IE "HS-SCCH Configuration" for 1.28Mcps TDD, of which the position listed in the IE "HS-SCCH Set Configuration" in ascending order is indicated by the IE "HS-SCCH Index" in this message.
 - 4> else:
 - 5> transmit the HS-SICH according to the IEs "Timeslot Number", "Channelisation Code" and Midamble configuration IEs.
 - 3> if the IE "Initial SPS info for HS-DSCH" is included:
 - 4> perform HS-SCCH SPS operation on the semi-persistent HS-PDSCH resource configured by the IE at the CFN determined by the IE "Activation Time" and the IE "Subframe number".

- 2> determine the value for the HS_DSCH_SPS_STATUS variable and take the corresponding actions as described in subclause 8.5.55.
 - 2> if the IE "Initial SPS info for HS-DSCH" is included, the calculation of assigned initial HS-DSCH SPS transmission grant is specified in subclause 8.6.6.16a
- 1> else if the IE "HS-DSCH SPS Information" is not included, the UE shall:
- 2> set the variable HS_DSCH_SPS_STATUS to FALSE;
 - 2> clear the variable HS_DSCH_SPS_PARAMS;
 - 2> stop all HS-DSCH SPS related activities.

8.6.7 Measurement information elements

On reception of measurement information elements the UE shall:

- 1> store the received information in the variable MEASUREMENT_IDENTITY and CELL_INFO_LIST as specified;
- 1> perform further actions as specified in subclause 8.6.7 and subclause 8.4, based on the content of the variable MEASUREMENT_IDENTITY.

If a configuration is considered to be invalid the UE may:

- 1> set the variable CONFIGURATION_INCOMPLETE to TRUE.

8.6.7.1 Measurement validity

If the IE "measurement validity" for a given measurement has not been included in measurement control information, the UE shall delete the measurement associated with the variable MEASUREMENT_IDENTITY after the UE makes a transition to a new state.

If the IE "measurement validity" for this measurement has been included in measurement control information, the UE shall save the measurement associated with the variable MEASUREMENT_IDENTITY. The IE "UE state" defines the scope of resuming the measurement.

If the "UE state" is defined as "all states", the UE shall continue the measurement after making a transition to a new state. This scope is assigned for traffic volume measurement type and UE positioning measurement type. For traffic volume measurement type this scope can only be applied by the UE if the IE "traffic volume measurement object" has been included in measurement control information. If the IE "traffic volume measurement object" has not been included in measurement control information, the UE shall not save the measurement control information in variable MEASUREMENT_IDENTITY, but shall send a MEASUREMENT CONTROL FAILURE message to the UTRAN with failure cause "Configuration incomplete". For 1.28 Mcps TDD, this scope is also assigned for intra-frequency measurement type and inter-frequency measurement type.

If the "UE state" is defined as "all states except CELL_DCH", the UE shall store the measurement to be resumed after a subsequent transition from CELL_DCH state to any of the other states in connected mode. This scope is assigned for traffic volume measurement type or UE positioning measurement type. For 1.28 Mcps TDD, this scope is also assigned for intra-frequency measurement type and inter-frequency measurement type.

If the "UE state" is defined as "CELL_DCH", the UE shall store the measurement to be resumed after a subsequent transition to CELL_DCH state.

For FDD, 3.84/7.68 Mcps TDD, if the IE "measurement type" received in a MEASUREMENT CONTROL message is set to "inter-frequency measurement" or "intra-frequency measurement" and the IE "measurement validity" is present and is set to a value other than "CELL_DCH", the UE behaviour is unspecified.

8.6.7.2 Filter coefficient

If the IE "Filter coefficient" is received the UE shall, depending on the measurement quantity (see Table 8.6.7.2), apply filtering of the measurements for that measurement quantity according to the formula below. This filtering shall be performed by the UE before UE event evaluation. The UE shall depending on the reporting quantity (see Table 8.6.7.2),

also filter the measurements reported in the IE "Measured results" or "E-UTRA measured results". The filtering shall not be performed for the measurements reported in the IE "Measured results on RACH" and for cell-reselection in connected or idle mode.

The filtering shall be performed according to the following formula.

$$F_n = (1 - a) \cdot F_{n-1} + a \cdot M_n$$

The variables in the formula are defined as follows:

F_n is the updated filtered measurement result

F_{n-1} is the old filtered measurement result

M_n is the latest received measurement result from physical layer measurements, the unit used for M_n is the same unit as the reported unit in the MEASUREMENT REPORT message or the unit used in the event evaluation.

$a = 1/2^{(k/2)}$, where k is the parameter received in the IE "Filter coefficient".

NOTE: if k is set to 0 that will mean no layer 3 filtering.

In order to initialise the averaging filter, F_0 is set to M_1 when the first measurement result from the physical layer measurement is received.

The physical layer measurement results are sampled once every measurement period. The measurement period and the accuracy for a certain measurement is defined in [19] and [20].

Table 8.6.7.2 lists for all measurement quantities and reporting quantities if L3-filtering is applicable or not and used L3-filtering type for each measurement quantity.

Table 8.6.7.2: L3 filtering applicable for each measurement quantity and reporting quantity

| Measurement- / Reporting quantity | L3-filtering applicable | Linear or logarithmic filtering | Comment |
|-----------------------------------|-------------------------|---------------------------------|---|
| Pathloss | Yes | Log | |
| Cell synchronisation information | No | - | |
| Cell Identity | No | - | |
| Frequency quality estimate | No | - | Although the frequency quality estimate itself is not filtered, the inputs to the frequency quality estimate calculation (CPICH Ec/N0 or CPICH RSCP or P-CCPCH RSCP) are filtered |
| UTRA carrier RSSI | Yes | Log | |
| GSM carrier RSSI | Yes | Log | |
| UE transmitted power | Yes | Log | |
| FDD | | | |
| > UE Rx-Tx time difference | No | - | |
| > CPICH Ec/N0 | Yes | Log | |
| > CPICH RSCP | Yes | Log | |
| TDD | | | |

| | | | |
|------------------------------|-----|-----|--|
| > Primary CCPCH RSCP | Yes | Log | |
| > Proposed TGSN | No | - | |
| > Timeslot ISCP | Yes | Log | |
| > TADV (1.28 Mcps TDD) | No | - | |
| > Applied TA (3.84 Mcps TDD) | No | - | |
| > Applied TA (7.68 Mcps TDD) | No | - | |
| E-UTRA RSRP | Yes | Log | |
| E-UTRA RSRQ | Yes | Log | |

The UE shall support 2 different layer 3 filters per measurement type defined in subclause 8.4.0 (i.e. the UE shall be capable to apply at least 2 different L3 filters to intra-frequency measurement results – see NOTE, at least 2 different L3 filters to inter-frequency measurement results, etc.). If a MEASUREMENT CONTROL message is received that would require the UE to configure more than 2 different layer 3 filters, the UE may:

- 1> set the variable CONFIGURATION_INCOMPLETE to TRUE.

NOTE: Any L3 filter applied to a measurement configured with measurement quantity and/or reporting quantity that evaluates or reports measurement results for the current used frequency, is counted as one intra-frequency L3 filter, and is therefore included in the count of used intra-frequency filters.

8.6.7.3 Intra-frequency/Inter-frequency/Inter-RAT cell info list

If the IE "Intra-frequency cell info list" is received in System Information Block Type 11, the UE shall update the variable CELL_INFO_LIST accordingly and in the following order. The UE shall:

- 1> if the IE "Intra-frequency cell removal" is received:
 - 2> ignore the IE.
- 1> if the IE "New Intra-frequency cells" is received, for each cell, and in the same order as the cells appear in the IE:
 - 2> update the variable CELL_INFO_LIST as follows:
 - 3> if the IE "Intra-frequency cell id" is received:
 - 4> store received cell information at this position in the Intra-frequency cell info list in the variable CELL_INFO_LIST, possibly overwriting any existing information in this position; and
 - 4> mark the position "occupied".
 - 3> if the IE "Intra-frequency cell id" is not received:
 - 4> store the received cell information at the first vacant position in ascending order in the Intra-frequency cell info list in the variable CELL_INFO_LIST; and
 - 4> mark the position as "occupied".

If the IE "Intra-frequency cell info list" is received in System Information Block Type 11bis, the UE shall update the variable CELL_INFO_LIST accordingly and in the following order. The UE shall:

- 1> for each cell, and in the same order as the cells appear in the IE:
 - 2> update the variable CELL_INFO_LIST as follows:
 - 3> if the IE "Intra-frequency cell id" is received:

- 4> store received cell information at this position in the Intra-frequency cell info list in the variable CELL_INFO_LIST, possibly overwriting any existing information in this position; and
 - 4> mark the position "occupied".
- 3> if the IE "Intra-frequency cell id" is not received:
- 4> store the received cell information at the first vacant position in ascending order in the Intra-frequency cell info list in the variable CELL_INFO_LIST; and
 - 4> mark the position as "occupied".

If the IE "Intra-frequency cell info list" is received in System Information Block Type 12, the UE shall update the variable CELL_INFO_LIST accordingly and in the following order. The UE shall:

- 1> if the IE "Intra-frequency cell removal" is received:
 - 2> if it has the value "Remove some intra-frequency cells", at the position indicated by the IE "Intra-frequency cell id":
 - 3> clear the cell information stored in the variable CELL_INFO_LIST; and
 - 3> mark the position "vacant".
 - 2> if it has the value "Remove all intra-frequency cells":
 - 3> for each position referring to an intra-frequency cell in the variable CELL_INFO_LIST:
 - 4> clear the cell information stored in the variable CELL_INFO_LIST; and
 - 4> mark the position "vacant".
 - 2> if it has the value "Remove no intra-frequency cells":
 - 3> leave the variable CELL_INFO_LIST unchanged.
- 1> if the IE "New Intra-frequency cells" is received, for each cell, and in the same order as the cells appear in the IE:
 - 2> update the variable CELL_INFO_LIST as follows:
 - 3> if the IE "Intra-frequency cell id" is received:
 - 4> store received cell information at this position in the Intra-frequency cell info list in the variable CELL_INFO_LIST, possibly overwriting any existing information in this position; and
 - 4> mark the position "occupied".
 - 3> if the IE "Intra-frequency cell id" is not received:
 - 4> store the received cell information at the first vacant position in ascending order in the Intra-frequency cell info list in the variable CELL_INFO_LIST; and
 - 4> mark the position as "occupied".

If the IE "Intra-frequency cell info list" is received in a MEASUREMENT CONTROL message, the UE shall update the variable CELL_INFO_LIST accordingly and in the following order. The UE shall:

- 1> if the CHOICE "Intra-frequency cell removal" is received:
 - 2> if it has the value "Remove some intra-frequency cells", at the position indicated by the IE "Intra-frequency cell id":
 - 3> clear the cell information stored in the variable CELL_INFO_LIST; and
 - 3> mark the position "vacant".
 - 2> if it has the value "Remove all intra-frequency cells":

- 3> for each position referring to an intra-frequency cell in the variable CELL_INFO_LIST:
 - 4> clear the cell information stored in the variable CELL_INFO_LIST; and
 - 4> mark the position "vacant".
- 2> if it has the value "Remove no intra-frequency cells":
 - 3> leave the variable CELL_INFO_LIST unchanged.
- 1> if the IE "New Intra-frequency cells" is received, for each cell, and in the same order as the cells appear in the IE:
 - 2> update the variable CELL_INFO_LIST as follows:
 - 3> if the IE "Intra-frequency cell id" is received:
 - 4> store received cell information at this position in the Intra-frequency cell info list in the variable CELL_INFO_LIST, possibly overwriting any existing information in this position; and
 - 4> mark the position "occupied".
 - 3> if the IE "Intra-frequency cell id" is not received:
 - 4> store the received cell information at the first vacant position in ascending order in the Intra-frequency cell info list in the variable CELL_INFO_LIST; and
 - 4> mark the position as "occupied".
- 1> if the IE "Cells for measurement" is received, in the measurement configured by this message only:
 - 2> consider Intra-frequency cells whose cell information is stored at the position indicated by the IE "Intra-frequency cell id" in the variable CELL_INFO_LIST.
- 1> if the IE "Cells for measurement" is not received, in the measurement configured by this message:
 - 2> consider all Intra-frequency cells whose cell information is stored in CELL_INFO_LIST.

If the IE "Inter-frequency cell info list" is received in System Information Block Type 11 update the variable CELL_INFO_LIST accordingly and in the following order. The UE shall:

- 1> if the IE "Inter-frequency cell removal" is received:
 - 2> ignore the IE.
- 1> if the IE "New Inter-frequency cells" is received, for each cell, and in the same order as the cells appear in the IE:
 - 2> update the variable CELL_INFO_LIST as follows:
 - 3> if the IE "Inter-frequency cell id" is received:
 - 4> store received cell information at this position in the Inter-frequency cell info list in the variable CELL_INFO_LIST, possibly overwriting any existing information in this position; and
 - 4> mark the position "occupied".
 - 3> if the IE "Inter-frequency cell id" is not received:
 - 4> store the received cell information at the first vacant position in ascending order in the Inter-frequency cell info list in the variable CELL_INFO_LIST; and
 - 4> mark the position as "occupied".

If the IE "Inter-frequency cell info list" is received in System Information Block Type 11bis, the UE shall update the variable CELL_INFO_LIST accordingly and in the following order. The UE shall:

- 1> for each cell, and in the same order as the cells appear in the IE:

- 2> update the variable CELL_INFO_LIST as follows:
 - 3> if the IE "Inter-frequency cell id" is received:
 - 4> store received cell information at this position in the Inter-frequency cell info list in the variable CELL_INFO_LIST, possibly overwriting any existing information in this position; and
 - 4> mark the position "occupied".
 - 3> if the IE "Inter-frequency cell id" is not received:
 - 4> store the received cell information at the first vacant position in ascending order in the Inter-frequency cell info list in the variable CELL_INFO_LIST; and
 - 4> mark the position as "occupied".

If the IE "Inter-frequency cell info list" is received in System Information Block Type 12, the UE shall update the variable CELL_INFO_LIST accordingly and in the following order. The UE shall:

- 1> if the CHOICE "Inter-frequency cell removal" is received:
 - 2> if it has the value "Remove some inter-frequency cells", at the position indicated by the IE "Inter-frequency cell id":
 - 3> clear the cell information stored in the variable CELL_INFO_LIST; and
 - 3> mark the position "vacant".
 - 2> if it has the value "Remove all inter-frequency cells":
 - 3> for each position referring to an inter-frequency cell in the variable CELL_INFO_LIST:
 - 4> clear the cell information stored in the variable CELL_INFO_LIST; and
 - 4> mark the position "vacant".
 - 2> if it has the value "Remove no inter-frequency cells":
 - 3> leave the variable CELL_INFO_LIST unchanged.
- 1> if the IE "New Inter-frequency cells" is received, for each cell, and in the same order as the cells appear in the IE:
 - 2> update the variable CELL_INFO_LIST as follows:
 - 3> if the IE "Inter-frequency cell id" is received:
 - 4> store received cell information at this position in the Inter-frequency cell info list in the variable CELL_INFO_LIST, possibly overwriting any existing information in this position; and
 - 4> mark the position "occupied".
 - 3> if the IE "Inter-frequency cell id" is not received:
 - 4> store the received cell information at the first vacant position in ascending order in the Inter-frequency cell info list in the variable CELL_INFO_LIST; and
 - 4> mark the position as "occupied".

If the IE "Inter-frequency cell info list" is received in a MEASUREMENT CONTROL message, the UE shall update the variable CELL_INFO_LIST accordingly and in the following order:

- 1> if the CHOICE "Inter-frequency cell removal" is received:
 - 2> if it has the value "Remove some inter-frequency cells", at the position indicated by the IE "Inter-frequency cell id":
 - 3> clear the cell information stored in the variable CELL_INFO_LIST; and

- 3> mark the position "vacant".
- 2> if it has the value "Remove all inter-frequency cells":
 - 3> for each position referring to an inter-frequency cell in the variable CELL_INFO_LIST:
 - 4> clear the cell information stored in the variable CELL_INFO_LIST; and
 - 4> mark the position "vacant".
 - 2> if it has the value "Remove no inter-frequency cells":
 - 3> leave the variable CELL_INFO_LIST unchanged.
- 1> if the IE "New Inter-frequency cells" is received, for each cell, and in the same order as the cells appear in the IE:
 - 2> update the variable CELL_INFO_LIST as follows:
 - 3> if the IE "Inter-frequency cell id" is received:
 - 4> store received cell information at this position in the Inter-frequency cell info list in the variable CELL_INFO_LIST, possibly overwriting any existing information in this position; and
 - 4> mark the position "occupied".
 - 3> if the IE "Inter-frequency cell id" is not received:
 - 4> store the received cell information at the first vacant position in ascending order in the Inter-frequency cell info list in the variable CELL_INFO_LIST; and
 - 4> mark the position as "occupied".
- 1> if the IE "Cells for measurement" is received, in the measurement configured by this message only:
 - 2> consider Inter-frequency cells whose cell information is stored at the position indicated by the IE "Inter-frequency cell id" in the variable CELL_INFO_LIST.
- 1> if the IE "Cells for measurement" is not received, in the measurement configured by this message:
 - 2> consider all Inter-frequency cells whose cell information is stored in CELL_INFO_LIST.

If the IE "Inter-RAT cell info list" is received in System Information Block Type 11, the UE shall update the variable CELL_INFO_LIST accordingly and in the following order. The UE shall:

- 1> ignore the IE "Inter-RAT cell removal".
- 1> if the IE "New Inter-RAT cells" is received, for each cell, and in the same order as the cells appear in the IE:
 - 2> if the IE "Radio Access Technology" is set to "None":
 - 3> ignore the cell.
 - 2> otherwise:
 - 3> update the variable CELL_INFO_LIST as follows:
 - 4> if the IE "Inter-RAT cell id" is received:
 - 5> store received cell information at this position in the Inter-RAT cell info list in the variable CELL_INFO_LIST, possibly overwriting any existing information in this position; and
 - 5> mark the position "occupied".
 - 4> if the IE "Inter-RAT cell id" is not received:
 - 5> store the received cell information at the first vacant position in ascending order in the Inter-RAT cell info list in the variable CELL_INFO_LIST; and

5> mark the position as "occupied".

1> if the IE "Cells for measurement" is received:

2> ignore the IE.

1> set the "Inter-RAT cell info indication" to the value "0" and mark the indication status "present" in the variable CELL_INFO_LIST.

If the IE "Inter-RAT cell info list" is received in System Information Block Type 11bis, the UE shall update the variable CELL_INFO_LIST accordingly and in the following order. The UE shall:

1> for each cell, and in the same order as the cells appear in the IE:

2> update the variable CELL_INFO_LIST as follows:

3> if the IE "Inter-RAT cell id" is received:

4> store received cell information at this position in the Inter-RAT cell info list in the variable CELL_INFO_LIST, possibly overwriting any existing information in this position; and

4> mark the position "occupied".

3> if the IE "Inter-RAT cell id" is not received:

4> store the received cell information at the first vacant position in ascending order in the Inter-RAT cell info list in the variable CELL_INFO_LIST; and

4> mark the position as "occupied".

If the IE "Inter-RAT cell info list" is received in System Information Block Type 12, the UE shall update the variable CELL_INFO_LIST accordingly and in the following order. The UE shall:

1> if the IE "Inter-RAT cell removal" is received:

2> if it has the value "Remove some inter-RAT cells", at the position indicated by the IE "Inter-RAT cell id":

3> clear the cell information stored in the variable CELL_INFO_LIST; and

3> mark the position "vacant".

2> if it has the value "Remove all inter-RAT cells":

3> for each position referring to an inter-RAT cell in the variable CELL_INFO_LIST:

4> clear the cell information stored in the variable CELL_INFO_LIST; and

4> mark the position "vacant".

2> if it has the value "Remove no inter-RAT cells":

3> leave the variable CELL_INFO_LIST unchanged.

1> if the IE "New Inter-RAT cells" is received, for each cell, and in the same order as the cells appear in the IE:

2> if the IE "Radio Access Technology" is set to "None":

3> ignore the cell.

2> otherwise:

3> update the variable CELL_INFO_LIST as follows:

4> if the IE "Inter-RAT cell id" is received:

5> store received cell information at this position in the Inter-RAT cell info list in the variable CELL_INFO_LIST, possibly overwriting any existing information in this position; and

- 5> mark the position "occupied".
- 4> if the IE "Inter-RAT cell id" is not received:
 - 5> store the received cell information at the first vacant position in ascending order in the Inter-RAT cell info list in the variable CELL_INFO_LIST; and
 - 5> mark the position as "occupied".
- 1> if the IE "Cells for measurement" is received:
 - 2> ignore the IE;
 - 1> set the "Inter-RAT cell info indication" to the value "0" and mark the indication status "present" in the variable CELL_INFO_LIST.

If the IE "Inter-RAT cell info list" is received in a MEASUREMENT CONTROL message, the UE shall update the variable CELL_INFO_LIST accordingly and in the following order. The UE shall:

- 1> if the IE "Inter-RAT cell removal" is received:
 - 2> if it has the value "Remove some inter-RAT cells", at the position indicated by the IE "Inter-RAT cell id":
 - 3> clear the cell information stored in the variable CELL_INFO_LIST; and
 - 3> mark the position "vacant".
 - 2> if it has the value "Remove all inter-RAT cells":
 - 3> for each position referring to an inter RAT cell in the variable CELL_INFO_LIST:
 - 4> clear the cell information stored in the variable CELL_INFO_LIST; and
 - 4> mark the position "vacant".
 - 2> if it has the value "Remove no inter-RAT cells":
 - 3> leave the variable CELL_INFO_LIST unchanged.
- 1> if the IE "New Inter-RAT cells" is received, for each cell, and in the same order as the cells appear in the IE:
 - 2> if the IE "Radio Access Technology" is set to "None":
 - 3> ignore the cell.
 - 2> otherwise:
 - 3> update the variable CELL_INFO_LIST as follows:
 - 4> if the IE "Inter-RAT cell id" is received:
 - 5> store received cell information at this position in the Inter-RAT cell info list in the variable CELL_INFO_LIST, possibly overwriting any existing information in this position; and
 - 5> mark the position "occupied".
 - 4> if the IE "Inter-RAT cell id" is not received:
 - 5> store the received cell information at the first vacant position in ascending order in the Inter-RAT cell info list in the variable CELL_INFO_LIST; and
 - 5> mark the position as "occupied".
- 1> if the IE "Cells for measurement" is received, in the measurement configured by this message only:
 - 2> consider Inter-RAT cells whose cell information is stored at the position indicated by the IE "Inter-RAT cell id" in the variable CELL_INFO_LIST.

- 1> if the IE "Cells for measurement" is not received, in the measurement configured by this message:
 - 2> consider all Inter-RAT cells whose cell information is stored in CELL_INFO_LIST.
 - 1> if the IE "Cell selection and re-selection info for SIB11/12" is present:
 - 2> ignore the IE.
 - 1> if the IE "Inter-RAT cell info indication" is present:
 - 2> store the received value of the IE "Inter-RAT cell info indication" and mark the indication status "present" in the variable CELL_INFO_LIST.
 - 1> if the IE "Inter-RAT cell info indication" is not present:
 - 2> clear the "Inter-RAT cell info indication" and mark the indication status "not present" in the variable CELL_INFO_LIST.
- NOTE: If UTRAN signalling would result in more than "maxCellMeas" cells for the Intra-frequency, Inter-frequency or Inter-RAT cell information list the UE behaviour is unspecified.

8.6.7.3a UTRA priority info list

If the IE "UTRA priority info list" is received in System Information Block Type 19, the UE shall:

- 1> if the value of the IE "Priority status" in the variable PRIORITY_INFO_LIST equals "dedicated_priority":
 - 2> store the value of the IEs " $S_{\text{prioritysearch1}}$ ", " $S_{\text{prioritysearch2}}$ " and " $\text{Thresh}_{\text{servng,low}}$ " in the IE "UTRA Serving Cell" in the variable PRIORITY_INFO_LIST;
 - 2> if any of the values in any of the occurrences of the IE "Frequency List" in any occurrence of the IE "Priority Info List" within the variable PRIORITY_INFO_LIST is the frequency of the serving cell:
 - 3> store the value of the IE "priority" in the IE "UTRA Serving Cell" in the variable PRIORITY_INFO_LIST.
 - 2> otherwise:
 - 3> clear the value of the IE "priority" in the IE "UTRA Serving Cell" in the variable PRIORITY_INFO_LIST.
 - 2> for each occurrence of the IE "UTRAN FDD Frequencies":
 - 3> if the value of the IE "UARFCN" exists in the list of UTRA FDD priorities in the PRIORITY_INFO_LIST then, in the occurrence of IE "Frequency List" within the variable PRIORITY_INFO_LIST with that value of the IE "UARFCN":
 - 4> store the value of the IEs " $\text{Thresh}_{x,\text{high}}$ ", " $\text{Thresh}_{x,\text{low}}$ ", " QqualminFDD " and " QrxlevminFDD ".
 - 2> for each occurrence of the IE "UTRAN TDD Frequencies":
 - 3> if the value of the IE "UARFCN" exists in the list of UTRA TDD priorities in the PRIORITY_INFO_LIST then, in the occurrence of IE "Frequency List" within the variable PRIORITY_INFO_LIST with that value of the IE "UARFCN":
 - 4> store the value of the IEs " $\text{Thresh}_{x,\text{high}}$ ", " $\text{Thresh}_{x,\text{low}}$ " and " QrxlevminTDD ".
- 1> otherwise:
 - 2> update the PRIORITY_INFO_LIST IE "Priority status" to cause "sys_info_priority".
 - 2> store information in the IE "UTRA Serving Cell" in the IE "UTRA Serving Cell" within the variable PRIORITY_INFO_LIST;
 - 2> for each occurrence of the IE "UTRAN FDD Frequencies":

- 3> if an entry already exists in the IE "Priority Info List" in the variable PRIORITY_INFO_LIST with the same priority value as indicated in the IE "priority" and has the CHOICE "Radio Access Technology" set to "UTRA FDD":
 - 4> create a new entry in the IE "Frequency List" in that occurrence of IE "Priority Info List", and store the value of "UARFCN" in the IE "UARFCN" in this occurrence of the IE "Frequency List" within the variable PRIORITY_INFO_LIST, and in that new entry:
 - 5> store the IEs "Thresh_{x,high}", "Thresh_{x,low}", "QqualminFDD" and "QrxlevminFDD".
- 3> otherwise:
 - 4> create a new entry in the IE "Priority Info List" and store the value of "priority" in the IE "priority" in this occurrence of the IE "Priority Info List" within the variable PRIORITY_INFO_LIST, and in that new entry:
 - 5> set the CHOICE "Radio Access Technology" to "UTRA FDD" and store the value of "UARFCN" in the IE "UARFCN" in the first occurrence of the IE "Frequency List";
 - 5> store the IEs "Thresh_{x,high}", "Thresh_{x,low}", "QqualminFDD" and "QrxlevminFDD" in that occurrence of the IE "Frequency List".
- 2> for each occurrence of the IE "UTRAN TDD Frequencies":
 - 3> if an entry already exists in the IE "Priority Info List" in the variable PRIORITY_INFO_LIST with the same priority value as indicated in the IE "priority" and has the CHOICE "Radio Access Technology" set to "UTRA TDD":
 - 4> create a new entry in the IE "Frequency List" in that occurrence of IE "Priority Info List", and store the value of "UARFCN" in the IE "UARFCN" in this occurrence of the IE "Frequency List" within the variable PRIORITY_INFO_LIST, and in that new entry:
 - 5> store the IEs "Thresh_{x,high}", "Thresh_{x,low}" and "QrxlevminTDD".
 - 3> otherwise:
 - 4> create a new entry in the IE "Priority Info List" and store the value of "priority" in the IE "priority" in this occurrence of the IE "Priority Info List" within the variable PRIORITY_INFO_LIST, and in that new entry:
 - 5> set the CHOICE "Radio Access Technology" to "UTRA TDD" and store the value of "UARFCN" in the IE "UARFCN" in the first occurrence of the IE "Frequency List";
 - 5> store the IEs "Thresh_{x,high}", "Thresh_{x,low}" and "QrxlevminTDD" in that occurrence of the IE "Frequency List".

8.6.7.3b GSM priority info list

If the IE "GSM priority info list" is received in System Information Block Type 19, the UE shall:

- 1> if the value of the IE "Priority status" in the variable PRIORITY_INFO_LIST equals "dedicated_priority":
 - 2> for each occurrence of the IE "GSM Priority Info":
 - 3> store the IEs "QrxlevminGSM", "Thresh_{x,high}" and "Thresh_{x,low}" in every entry of PRIORITY_INFO_LIST with CHOICE "Radio Access Technology" set to "GSM", which contains an IE "BCCH ARFCN" matching a BCCH ARFCN indicated in the IE "GSM cell group".
- 1> otherwise:
 - 2> for each occurrence of the IE "GSM Priority Info":
 - 3> create a new entry in the IE "Priority Info List" in the variable PRIORITY_INFO_LIST, and in this new entry:

- 4> store the value of IE "priority" from the IE "GSM Priority Info", and set the CHOICE "Radio Access Technology" to "GSM";
- 4> for each of the BCCH ARFCNs indicated by the IE "GSM cell group":
 - 5> create a new entry in the IE "Frequency List" and store the IEs "Band Indicator", "QrxlevminGSM", "Thresh_{x,high}" and "Thresh_{x,low}" and store the indicated BCCH ARFCN in the IE "BCCH ARFCN".

8.6.7.3c E-UTRA frequency and priority info list

If the IE "E-UTRA frequency and priority info list" is received in System Information Block Type 19, the UE shall:

- 1> for each occurrence of the IE "E-UTRA frequency and priority":
 - 2> create a new entry in the IE "Frequency Info List" in the variable EUTRA_FREQUENCY_INFO_LIST, and in that new entry:
 - 3> store the IEs "EARFCN" and "Measurement bandwidth";
 - 3> if the IE "Blacklisted cells per freq list" is present in the IE "E-UTRA frequency and priority":
 - 4> store the blacklisted cells information.
 - 1> if the value of the IE "Priority status" in the variable PRIORITY_INFO_LIST equals "dedicated_priority":
 - 2> for each occurrence of the IE "E-UTRA frequency and priority":
 - 3> if the value of IE "EARFCN" exists in the list of E-UTRA priorities in the variable PRIORITY_INFO_LIST, then in that occurrence of the IE "Priority Info List":
 - 4> store the IEs "Thresh_{x,high}", "Thresh_{x,low}" and "QrxlevminEUTRA" from the IE "E-UTRA frequency and priority" occurrence.
 - 1> otherwise:
 - 2> for each occurrence of the IE "E-UTRA frequency and priority":
 - 3> if an entry already exists in the IE "Priority Info List" in the variable PRIORITY_INFO_LIST with the same priority value as indicated in the IE "priority" and has the CHOICE "Radio Access Technology" set to "E-UTRA":
 - 4> create a new entry in the IE "Frequency List" in that occurrence of IE "Priority Info List", and store the value of "EARFCN" in the IE "EARFCN" in this occurrence of the IE "Frequency List" within the variable PRIORITY_INFO_LIST, and:
 - 5> store the IEs "Thresh_{x,high}", "Thresh_{x,low}" and "QrxlevminEUTRA" in that occurrence of the IE "Frequency List".
 - 3> otherwise:
 - 4> create a new entry in the IE "Priority Info List" and store the value of "priority" in the IE "priority" in this occurrence of the IE "Priority Info List" within the variable PRIORITY_INFO_LIST, and in that new entry:
 - 5> set the CHOICE "Radio Access Technology" to "E-UTRA" and store the value of "EARFCN" in the IE "EARFCN" in the first occurrence of the IE "Frequency List";
 - 5> store the IEs "Thresh_{x,high}", "Thresh_{x,low}" and "QrxlevminEUTRA" in that occurrence of the IE "Frequency List".
 - 2> store the IE "E-UTRA detection".

8.6.7.3d E-UTRA frequency list

If the "E-UTRA frequency list" IE is received in a MEASUREMENT CONTROL message, the UE shall update the variable EUTRA_FREQUENCY_INFO_LIST accordingly and in the following order. The UE shall:

- 1> if the IE "E-UTRA frequency removal" is received:
 - 2> if it has the value "Remove some frequencies", for all the frequencies indicated by the IE "Removed frequencies":
 - 3> clear the information stored in the variable EUTRA_FREQUENCY_INFO_LIST for the indicated frequencies.
 - 2> if it has the value "Remove all frequencies":
 - 3> clear the information stored in the variable EUTRA_FREQUENCY_INFO_LIST for all frequencies.
 - 2> if it has the value "Remove no frequencies":
 - 3> leave the variable EUTRA_FREQUENCY_INFO_LIST unchanged.
- 1> if the IE "New frequencies" is received, for each frequency:
 - 2> update the variable EUTRA_FREQUENCY_INFO_LIST as follows:
 - 3> if the frequency is not present in the variable EUTRA_FREQUENCY_INFO_LIST:
 - 4> store the information for the received frequency, including measurement bandwidth and blacklist, in the variable EUTRA_FREQUENCY_INFO_LIST.
 - 3> otherwise, if the frequency is already included in the variable EUTRA_FREQUENCY_INFO_LIST:
 - 4> store the information for the received frequency, including measurement bandwidth and blacklist, in the variable EUTRA_FREQUENCY_INFO_LIST, overwriting the existing information for the frequency.

8.6.7.4 Intra-frequency measurement quantity

If the IE "Intra-frequency measurement quantity" is received in a MEASUREMENT CONTROL message, the UE shall:

- 1> if the IE "Measurement quantity" is set to "pathloss"; and
 - 1> for any intra-frequency cell indicated by the IE "Cells for measurement", the IE "Primary CPICH Tx power" in FDD or the IE "Primary CCPCH TX Power" in TDD in the intra frequency cell info list in the variable CELL_INFO_LIST is not present:
 - 2> set the variable CONFIGURATION_INCOMPLETE to TRUE.
- 1> else:
 - 2> configure the measurement quantity accordingly.

8.6.7.5 Inter-RAT measurement quantity

If the IE "Inter-RAT measurement quantity" is received in a MEASUREMENT CONTROL message and CHOICE system is GSM, the UE shall:

- 1> if IE "BSIC verification required" is set to "required", for cells that match any of the BCCH ARFCN and BSIC combinations in the list of inter-RAT cells that the UE has received in IE "Inter-RAT cell info list", and that has a "verified" BSIC:
 - 2> report measurement quantities according to IE "inter-RAT reporting quantity" taking into account the restrictions defined in subclause 8.6.7.6;
 - 2> trigger inter-RAT events according to IE "inter-RAT measurement reporting criteria"; and

- 2> perform event evaluation for event-triggered reporting after BSIC has been verified for a GSM cell as defined in [19]; and
- 2> trigger periodical reports according to the given "Reporting interval"; and
- 2> when a periodical measurement report is triggered, include only BSIC verified GSM cells in the IE "Inter-RAT measured results list"; and
 - 3> indicate verified BSIC for a GSM cell in the IE "Inter-RAT measured results list" as defined in subclause 8.6.7.6.
- 2> when an event triggered measurement report is triggered, include only BSIC verified GSM cells in the IE "Inter-RAT measured results list"; and
 - 3> indicate verified BSIC for a GSM cell in the IE "Inter-RAT measured results list" as defined in subclause 8.6.7.6.
- 1> if IE "BSIC verification required" is set to "not required", for cells that match any of the BCCH ARFCN in the list of inter-RAT cells that the UE has received in IE "Inter-RAT cell info list", regardless if the BSIC is "verified" or "non-verified":
 - 2> report measurement quantities according to IE "inter-RAT reporting quantity";
 - 2> trigger inter-RAT events according to IE "inter-RAT measurement reporting criteria";
 - 2> when an event triggered or periodical measurement report is triggered, include GSM cells in the IE "Inter-RAT measured results list" regardless of whether the BSIC of the GSM cell has been verified or not; and
 - 3> for any GSM cell that has not been verified, indicate non-verified BSIC for a GSM cell in the "Inter-RAT measured results list" IE as defined in subclause 8.6.7.6.
 - 3> for any GSM cell that has been verified, indicate verified BSIC for a GSM cell in the "Inter-RAT measured results list" IE as defined in subclause 8.6.7.6.
- 1> if the IE "Measurement quantity" is set to "pathloss":
 - 2> set the variable CONFIGURATION_INCOMPLETE to TRUE.

NOTE: The requirements for a cell to be considered "verified" or "non-verified" can be found in [19].

If the IE "Inter-RAT measurement quantity" is received in a MEASUREMENT CONTROL message and CHOICE system is E-UTRA, the UE shall:

- 1> for cells whose carrier frequency matches any of the EARFCNs in the list of E-UTRA frequencies that the UE has stored in the variable "EUTRA_FREQUENCY_INFO_LIST", and for which the Physical Cell Identity is not included in the blacklist for that frequency:
 - 2> report measurement quantities according to IE "inter-RAT reporting quantity" taking into account the restrictions defined in subclause 8.6.7.6;
 - 2> trigger inter-RAT events according to IE "inter-RAT measurement reporting criteria"; and
 - 2> perform event evaluation for event-triggered reporting; and
 - 2> trigger periodical reports according to the given "Reporting interval"; and
 - 2> when a periodical measurement report is triggered, for each frequency include in the IE "E-UTRA measured results list" only E-UTRA cells for which the Physical layer Cell Identity has been identified and is not included in the blacklist for that frequency; and
 - 3> include the Physical layer Cell Identity for a E-UTRA cell in the IE "E-UTRA measured results list" as defined in subclause 8.6.7.6.
 - 2> when an event triggered measurement report is triggered, include in the IE "E-UTRA measured results list" only E-UTRA cells for which the Physical layer Cell Identity has been identified and is not included in the blacklist for that frequency; and

- 3> include the Physical layer Cell Identity for a E-UTRA cell in the IE "E-UTRA measured results list" as defined in subclause 8.6.7.6.

8.6.7.6 Inter-RAT reporting quantity

If the IE "Inter-RAT reporting quantity" is received by the UE, the UE shall:

- 1> store the content of the IE to the variable MEASUREMENT_IDENTITY.

If the IE "Inter-RAT measurement quantity" is received and CHOICE system is GSM, the UE shall check each quantity in the GSM choice. The UE shall include measured results in MEASUREMENT REPORT as specified in the IE "Inter-RAT reporting quantity" with the following restrictions:

- 1> if the UE has not confirmed the BSIC of the measured cell:
 - 2> if no compressed mode pattern sequence specified with measurement purpose "Initial BSIC identification" is active and according to its capabilities the UE requires compressed mode to measure this, the UE is not required to include the "inter-RAT cell id" in the IE "Inter-RAT measured results list", when a MEASUREMENT REPORT is triggered.
- 1> if the UE has confirmed the BSIC of the measured cell, then:
 - 2> if no compressed mode pattern sequence specified with measurement purpose "Initial BSIC identification" nor "BSIC re-confirmation" is active and according to its capabilities the UE requires compressed mode to measure this, the UE is not required to include the "inter-RAT cell id" in the IE "Inter-RAT measured results", when a MEASUREMENT REPORT is triggered. If no compressed mode pattern sequence with measurement purpose "GSM carrier RSSI measurements" is active and according to its capabilities the UE requires compressed mode to measure this, the UE may include "inter-RAT cell id" in MEASUREMENT REPORT without "GSM carrier RSSI" even if it is defined in the IE "Inter-RAT reporting quantity".
- 1> if the IE "UTRAN estimated quality" is set to TRUE:
 - 2> ignore that IE.
- 1> if IE "GSM Carrier RSSI" is set to TRUE:
 - 2> include optional IE "GSM Carrier RSSI" with a value set to the measured RXLEV to that GSM cell in IE "Inter-RAT measured results list". If no compressed mode pattern sequence specified with measurement purpose "GSM carrier RSSI measurements" is active and according to its capabilities the UE requires compressed mode to measure this, the UE is not required to include the "GSM carrier RSSI" in the IE "Inter-RAT measured results list", when a MEASUREMENT REPORT is triggered.
- 1> if the BSIC of reported GSM cell is "verified":
 - 2> set the CHOICE BSIC to "Verified BSIC" and IE "inter-RAT cell id" to the value that GSM cell had in the IE "Inter-RAT cell info list".
- 1> if the BSIC of reported GSM cell is "non-verified":
 - 2> set the CHOICE BSIC to "Non verified BSIC" and the IE "BCCH ARFCN" to the value of that GSM cells ARFCN.

The requirements for a cell to be considered "verified" or "non-verified" can be found in [19].

If the IE "Inter-RAT reporting quantity" is received and CHOICE system is E-UTRA, the UE shall check each quantity in the E-UTRA choice. The UE shall include measured results in MEASUREMENT REPORT as specified in the IE "Inter-RAT reporting quantity".

8.6.7.7 Cell Reporting Quantities

If the IE "Cell Reporting Quantities" is received by the UE, the UE shall store the content of the IE "Cell Reporting Quantities" to the variable MEASUREMENT_IDENTITY.

The UE shall include measured results in MEASUREMENT REPORT as specified in the IE "Cell Reporting Quantities", except for the following cases:

If the IE "Cell Identity" is set to TRUE, the UE shall in this version of the specification:

- 1> treat the IE as if the IE "Cell Identity" is set to FALSE.

If the IE "Cell synchronisation information reporting indicator" is set to TRUE, the UE shall:

- 1> include the IE "Cell synchronisation information" in MEASUREMENT REPORT as specified in the IE "Cell Reporting Quantities":
 - 2> if the measurement is performed on another frequency; or
 - 2> if the IE "Read SFN indicator" included in the IE "Cell info" of the measured cell is set to FALSE:
 - 3> the UE may omit the information group "COUNT-C-SFN frame difference" in the IE "Cell synchronisation information".
 - 2> if the measurement is performed on the same frequency and no RLC Transparent Mode COUNT-C exists in the UE:
 - 3> set the IE "COUNT-C-SFN high" to 0.
 - 2> otherwise:
 - 3> include the information group "COUNT-C-SFN frame difference" with IE "COUNT-C-SFN high" set to:
$$\text{COUNT-C-SFN high} = (((\text{SFN} - (\text{COUNT-C} \bmod 4096)) \bmod 4096) \text{ div } 256) * 256;$$
 - 3> if RLC Transparent Mode COUNT-Cs exist in both CN domains:
 - 4> use the COUNT-C of CS domain in this measurement.

If the IE "Proposed TGSN Reporting required" is set to TRUE, the UE shall:

- 1> if compressed mode was used to monitor a TDD cell and the variable TGSN_REPORTED is set to FALSE:
 - 2> report the IE "Proposed TGSN" indicating the TGSN that suits best to the measured cell;
 - 2> set the variable TGSN_REPORTED to TRUE.
- 1> otherwise
 - 2> omit the IE "Proposed TGSN".

8.6.7.8 Periodical Reporting Criteria

If the IE "Periodical Reporting Criteria" is received by the UE, the UE shall:

- 1> store the contents of the IE "Amount of Reporting" and IE "Reporting interval" in the variable MEASUREMENT_IDENTITY.

For the first MEASUREMENT REPORT message, the UE shall:

- 1> send the MEASUREMENT REPORT as soon as all requested reporting quantities are available according to the requirements and the measurement capabilities set in [19] and [20] for at least one measurement object stored in the variable MEASUREMENT_IDENTITY, but never later than one reporting interval after measurement initiation.

Following the first MEASUREMENT REPORT message, the UE shall:

- 1> send a MEASUREMENT REPORT message one reporting interval after the previous MEASUREMENT REPORT message;

The first and subsequent periodic MEASUREMENT REPORT messages shall only include measured results for reporting quantities that are available according to the requirements and the measurement capabilities set in [19] and [20] i.e. if no measured results are available and the measurement type is not UE positioning, the IE "Measured Results" shall not be included in the MEASUREMENT REPORT message. If no measured results are available and the

measurement type is UE positioning, the UE shall include the IE "Measured Results" in the MEASUREMENT REPORT message in order to include the IE "UE positioning error" as specified in 8.6.7.19a and 8.6.7.19b.

After the UE has sent a total number of MEASUREMENT REPORT messages, which equal the value indicated in the IE "Amount of reporting", the UE shall:

- 1> terminate measurement reporting; and
- 1> delete all measurement information linked with the "Measurement identity" of the ongoing measurement from the variable MEASUREMENT_IDENTITY.

If according to subclause 8.6.7.19.1a or 8.6.7.19.1b, a UE configured with a UE positioning measurement is unable to report the requested measurement results due to missing GPS or GANSS assistance data and sends a MEASUREMENT REPORT containing the IE "UE positioning error" and the IE "Error reason" is set to "Assistance Data Missing", then this is not counted in the total number of MEASUREMENT REPORT messages sent.

8.6.7.9 Reporting Cell Status

If the IE "Reporting Cell Status" is received, the UE shall set the IE "Measured Results" in MEASUREMENT REPORT as follows. The UE shall:

- 1> for intra-frequency measurement and inter-frequency measurement:
 - 2> include the IE "Cell Measured Results" for cells (excluding cells of another RAT) that satisfy the condition (such as "Report cells within active set") specified in the IE "Reporting Cell Status", in descending order by the measurement quantity.
 - 2> the maximum number of the IE "Cell Measured Results" to be included in the IE "Measured Results" per reported frequency is the number specified in the IE "Reporting Cell Status".
- 1> for periodic inter-frequency measurement:
 - 2> include in the IE "Inter-frequency measured results list" the measured results for all non-used frequencies.
- 1> for inter-RAT measurement:
 - 2> include the measurement results for cells of other RAT (e.g., GSM or E-UTRA) that satisfy the condition specified in the IE "Reporting Cell Status", in descending order by the measurement quantity.
 - 2> the maximum number of the IE "Measured GSM Cells" to be included in the IE "Measured Results" is the number specified in the IE "Reporting Cell Status"; or:
 - 2> the maximum number of the IE "Measured E-UTRA Cells" to be included in the IE "E-UTRA measured results" is the number specified in the IE "Reporting Cell Status".

If the IE "Reporting Cell Status" is not received for intra-frequency, inter-frequency measurement, or inter-RAT measurement, the UE shall:

- 1> for intra-frequency measurement, inter-frequency measurement and inter-RAT measurement:
 - 2> exclude the IE "Measured Results" in MEASUREMENT REPORT.

NOTE: The IE "Reporting Cell Status" within "Event Criteria List" defines whether "Cell Measured Results" is present for event-based reporting.

The IE "Reporting Cell Status" is not included in System Information Block 11/12 for periodic intra-frequency measurements. In this case the UE shall assume the default values "Report cells within active set and/or monitored set on used frequency" and "6".

8.6.7.10 Traffic Volume Measurement

If the IE "Traffic Volume Measurement" is received by the UE, the UE shall:

- 1> store the content of the IE to the variable MEASUREMENT_IDENTITY.

If IE "Traffic volume measurement" is received by the UE in a MEASUREMENT CONTROL message, where IE "measurement command" has the value "setup", and if the IE "traffic volume reporting quantity" is included, the UE shall:

- 1> if the parameter "Average of RLC Buffer Payload for each RB" or the parameter "Variance of RLC Buffer payload for each RB" is set to TRUE:
 - 2> if the IE "Traffic volume measurement quantity" is not included:
 - 3> set the variable CONFIGURATION_INCOMPLETE to TRUE.
 - 2> if the IE "Traffic volume measurement quantity" is included:
 - 3> if the parameter "time interval to take an average or a variance" is not included:
 - 4> set the variable CONFIGURATION_INCOMPLETE to TRUE.

If IE "Traffic volume measurement" is received by the UE in a MEASUREMENT CONTROL message, where IE "measurement command" has the value "setup", but IE "Traffic volume reporting quantity" or is not received, the UE shall:

- 1> set the variable CONFIGURATION_INCOMPLETE to TRUE.

8.6.7.11 Traffic Volume Measurement Reporting Criteria

If the IE "Traffic Volume Measurement Reporting Criteria" is received by the UE, the UE shall:

- 1> if the IE "Parameters sent for each transport channel" is absent:
 - 2> set the variable PROTOCOL_ERROR_REJECT to TRUE;
 - 2> set the IE "Protocol error cause" in the variable PROTOCOL_ERROR_INFORMATION to "Information element missing".
- 1> for each IE "Parameters sent for each transport channel":
 - 2> if the IE "Parameters required for each Event" is absent:
 - 3> set the variable CONFIGURATION_INCOMPLETE to TRUE.

8.6.7.12 FACH measurement occasion info

IE "FACH measurement occasion info" is used to control UE measurement activities in inter-frequency and inter-RAT cells in CELL_FACH state.

For FDD and 1.28 Mcps TDD when variable HS_DSCH_RECEPTION_CELL_FACH_STATE is set to FALSE, or for 3.84Mcps TDD and 7.68Mcps TDD: if IE "FACH measurement occasion info" is received, UE shall, when in CELL_FACH state:

- 1> if IE "FACH Measurement occasion cycle length coefficient" is included:
 - 2> if, according to its measurement capabilities, UE is not able to perform some of the indicated measurements in this IE simultaneously as receiving the SCCPCH of serving cell:
 - 3> perform those measurements during FACH measurement occasions, see subclause 8.5.11.
 - 2> if, according to its measurement capabilities, UE is able to perform some of the indicated measurements in this IE simultaneously as receiving the SCCPCH of serving cell:
 - 3> UE may perform measurements also on other occasions.
 - 2> if, according to its measurement capabilities, UE is able to perform the measurements and indicated in this IE simultaneously as receiving the SCCPCH of serving cell:
 - 3> perform the measurements simultaneously as receiving the SCCPCH of serving cell.

- 1> if IE "FACH Measurement occasion cycle length coefficient" is not included:
 - 2> perform those indicated measurements indicated in this IE that UE, according to its measurement capabilities, is able to perform simultaneously as receiving the SCCPCH of serving cell.
- 1> if IE "Inter-frequency FDD measurement indicator" is set to TRUE:
 - 2> perform measurements and evaluate cell re-selection criteria according to [4] on inter-frequency FDD cells listed in "System Information Block type 11", "System Information Block type 11bis", if scheduled on BCH, and "System Information Block type 12", if scheduled on BCH.
- 1> if IE "Inter-frequency FDD measurement indicator" is set to FALSE:
 - 2> neither perform measurements nor evaluate cell re-selection criteria on inter-frequency FDD cells.
- 1> if IE "Inter-frequency TDD measurement indicator" is set to TRUE:
 - 2> perform measurements and evaluate cell re-selection criteria according to [4] on inter-frequency TDD cells listed in "System Information Block type 11", "System Information Block type 11bis", if scheduled on BCH, and "System Information Block type 12", if scheduled on BCH.
- 1> if IE "Inter-frequency TDD measurement indicator" is set to FALSE:
 - 2> neither perform measurements nor evaluate cell re-selection criteria on inter-frequency TDD cells.
- 1> if IE "Inter-RAT measurement indicators" is included:
 - 2> perform measurements and evaluate cell re-selection criteria according to [4] on those cells of listed Inter-RAT types that are present in "System Information Block type 11", "System Information Block type 11bis", if scheduled on BCH, and "System Information Block type 12", if scheduled on BCH.

For FDD and 1.28 Mcps TDD when variable HS_DSCH_RECEPTION_CELL_FACH_STATE is set to TRUE: if IE "FACH measurement occasion info" is received, UE shall:

- 1> if IE "FACH Measurement occasion cycle length coefficient" is included:
 - 2> if, according to its measurement capabilities, the UE is not able to perform some of the indicated measurements in this IE simultaneously as receiving the HS-DSCH and its associated physical channels of serving cell:
 - 3> perform those measurements during FACH measurement occasions, see subclause 8.5.11.
 - 2> if, according to its measurement capabilities, the UE is able to perform some of the indicated measurements in this IE simultaneously as receiving the HS-DSCH and its associated physical channels of serving cell:
 - 3> the UE may perform measurements also on other occasions.
 - 2> if, according to its measurement capabilities, the UE is able to perform the measurements and indicated in this IE simultaneously as receiving the HS-DSCH and its associated physical channels of serving cell:
 - 3> perform the measurements simultaneously as receiving the HS-DSCH and its associated physical channels of serving cell.
- 1> if IE "FACH Measurement occasion cycle length coefficient" is not included:
 - 2> perform those indicated measurements indicated in this IE that UE, according to its measurement capabilities, is able to perform simultaneously as receiving the HS-DSCH and its associated physical channels of serving cell.
- 1> if IE "Inter-frequency FDD measurement indicator" is set to TRUE:
 - 2> perform measurements and evaluate cell re-selection criteria according to [4] on inter-frequency FDD cells listed in "System Information Block type 11", "System Information Block type 11bis", if scheduled on BCH, and "System Information Block type 12", if scheduled on BCH.
- 1> if IE "Inter-frequency FDD measurement indicator" is set to FALSE:

- 2> neither perform measurements nor evaluate cell re-selection criteria on inter-frequency FDD cells.
- 1> if IE "Inter-RAT measurement indicators" is included:
 - 2> perform measurements and evaluate cell re-selection criteria according to [4] on those cells of listed Inter-RAT types that are present in "System Information Block type 11", "System Information Block type 11bis", if scheduled on BCH, and "System Information Block type 12", if scheduled on BCH.

8.6.7.13 Measurement Reporting Mode

If IE "Measurement Reporting Mode" is received by the UE, the UE shall:

- 1> store the contents of the IE "Measurement Report Transfer Mode" in the variable MEASUREMENT_IDENTITY;
- 1> use the indicated RLC mode when sending MEASUREMENT REPORT message(s) related to this measurement;
- 1> ignore IE "Periodical Reporting / Event Trigger Reporting Mode".

If IE "Measurement Reporting Mode" is not received by the UE in MEASUREMENT CONTROL message, where IE "measurement command" has the value "setup", the UE shall:

- 1> clear all stored measurement control information related associated to this measurement identity in variable MEASUREMENT_IDENTITY;
- 1> set the variable CONFIGURATION_INCOMPLETE to TRUE.

8.6.7.14 Inter-frequency measurement

If the Inter-frequency cell info list, included in the variable CELL_INFO_LIST, includes a number (M) of frequencies that is larger than the number (N) considered in a UE performance requirement defined in [19] and [20]:

- 1> the UE shall:
 - 2> meet this performance requirement on the first relevant (N) frequencies, according to the order defined by the position of the frequencies in the Inter-frequency cell info list, included in the variable CELL_INFO_LIST.
- 1> the UE may:
 - 2> ignore the remaining (M-N) frequencies.

If IE "Inter-frequency measurement" is received by the UE in a MEASUREMENT CONTROL message, where IE "measurement command" has the value "setup", but IE "Inter-frequency measurement quantity", IE "Inter-frequency reporting quantity" or IE "parameters required for each event" (given "CHOICE Report criteria" is set to "inter-frequency measurement reporting criteria") is not received, the UE shall:

- 1> clear all stored measurement control information related associated to this measurement identity in variable MEASUREMENT_IDENTITY;
- 1> set the variable CONFIGURATION_INCOMPLETE to TRUE.

If IE "Inter-frequency measurement" is received by the UE in a MEASUREMENT CONTROL message, where IE "measurement command" has the value "modify":

- 1> if CHOICE "Report criteria" in IE "Inter-frequency measurement" is set to "intra-frequency measurement reporting criteria" and IE "parameters required for each event" is present:
 - 2> for FDD, 3.84 Mcps TDD and 7.68 Mcps TDD; or
 - 2> for 1.28 Mcps TDD, if the UE uses only one frequency:
 - 3> the UE behaviour is unspecified.

If IE "Inter-frequency measurement" is received by the UE in a MEASUREMENT CONTROL message, where IE "measurement command" has the value "setup" and CHOICE "Report criteria" in IE "Inter-frequency measurement" is set to "intra-frequency measurement reporting criteria":

- 1> for FDD, 3.84 Mcps TDD and 7.68 Mcps TDD; or
- 1> for 1.28 Mcps TDD, if the UE uses only one frequency:
 - 2> the UE behaviour is unspecified.

In the case of an inter-frequency measurement for FDD, the UE shall:

- 1> if IE "Inter-frequency measurement" is received by the UE in a MEASUREMENT CONTROL message, where IE "measurement command" has the value "setup", if an inter-frequency event is configured that is different from event 2d or 2f, and if the IE "Inter-frequency SET UPDATE" is not received in that same message:
 - 2> set the variable CONFIGURATION_INCOMPLETE to TRUE.

NOTE: The UTRAN should include the IE "Inter-frequency SET UPDATE" in the MEASUREMENT CONTROL message with the IE "measurement command" set to "modify" when event 2a, 2b, 2c or 2e is first configured, and when the UE is requested to measure a frequency that has not been previously measured. Otherwise the UE behaviour is unspecified.

If IE "Inter-frequency measurement" is received by the UE in a MEASUREMENT CONTROL message:

- 1> if CHOICE "Report criteria" is set to "inter-frequency measurement reporting criteria" and CHOICE "reporting criteria" in "inter-frequency measurement quantity" is not set to "inter-frequency reporting criteria"; or
- 1> if CHOICE "Report criteria" is set to "intra-frequency measurement reporting criteria" and CHOICE "reporting criteria" in "inter-frequency measurement quantity" is not set to "intra-frequency reporting criteria":
 - 2> for FDD, 3.84 Mcps TDD and 7.68 Mcps TDD; or
 - 2> for 1.28 Mcps TDD, if the UE uses only one frequency:
 - 3> the UE behaviour is not specified.

If the variable CONFIGURATION_INCOMPLETE is set to TRUE, the UE shall:

- 1> act as described in subclause 8.4.1.4a.

8.6.7.15 Inter-RAT measurement

If the Inter-RAT cell info list, included in the variable CELL_INFO_LIST, includes a number (M) of frequencies that is larger than the number (N) considered in a UE performance requirement defined in [19] and [20]:

- 1> the UE shall:
 - 2> meet this performance requirement on the first relevant (N) frequencies, according to the order defined by the position of the frequencies in the Inter-RAT cell info list, included in the variable CELL_INFO_LIST.
- 1> the UE may:
 - 2> ignore the remaining (M-N) frequencies.

If IE "Inter-RAT measurement" is received by the UE in a MEASUREMENT CONTROL message, where IE "measurement command" has the value "setup", but IE "Inter-RAT measurement quantity", IE "Inter-RAT reporting quantity" or "parameters required for each event" (given "CHOICE Report criteria" is set to "inter-RAT measurement reporting criteria") is not received, the UE shall:

- 1> clear all stored measurement control information related associated to this measurement identity in variable MEASUREMENT_IDENTITY;
- 1> set the variable CONFIGURATION_INCOMPLETE to TRUE.

8.6.7.16 Intra-frequency measurement

If IE "Intra-frequency measurement" is received by the UE in a MEASUREMENT CONTROL message, where IE "measurement command" has the value "setup", but IE "Intra-frequency measurement quantity", IE "Intra-frequency

reporting quantity", "CHOICE Report criteria" or "parameters required for each event" (given "CHOICE report criteria" is set to "intra-frequency measurement reporting criteria") is not received, the UE shall:

- 1> clear all stored measurement control information related associated to this measurement identity in variable MEASUREMENT_IDENTITY;
- 1> set the variable CONFIGURATION_INCOMPLETE to TRUE.

In case of 1a or 1e event-triggered reporting:

- 1> if the IE "Intra-frequency measurement quantity" is set to "pathloss", the UE shall:
 - 2> if detected set cells are indicated as possibly triggering the event within the IEs "Triggering condition 2" :
 - 3> set the variable CONFIGURATION_INCOMPLETE to TRUE.

8.6.7.17 Quality measurement

If IE "Quality measurement" is received by the UE in a MEASUREMENT CONTROL message, where IE "measurement command" has the value "setup", but IE "Quality reporting quantity" is not received, the UE shall:

- 1> clear all stored measurement control information related associated to this measurement identity in variable MEASUREMENT_IDENTITY;
- 1> set the variable CONFIGURATION_INCOMPLETE to TRUE.

If Transport Channel BLER reporting is requested in IE "Quality Reporting Quantity", but no transport channels are explicitly referenced with transport channel identities, the UE shall

- 1> report BLER for all downlink transport channels, for which Transport Channel BLER is defined and can be requested [7, 8].

If a transport channel, for which Transport Channel BLER is not defined and can not be requested [7, 8], is referenced with a transport channel identity in IE "Quality Reporting Quantity" and/or IE "Quality Measurement Reporting Criteria":

- 1> the UE behaviour is not specified.

8.6.7.18 UE internal measurement

If IE "UE internal measurement" is received by the UE in a MEASUREMENT CONTROL message, where IE "measurement command" has the value "setup", but IE "UE internal measurement quantity", IE "UE internal reporting quantity" or "parameters sent for each UE internal measurement event" (given "CHOICE report criteria" is set to "UE internal measurement reporting criteria") is not received, the UE shall:

- 1> clear all stored measurement control information related associated to this measurement identity in variable MEASUREMENT_IDENTITY;
- 1> set the variable CONFIGURATION_INCOMPLETE to TRUE.

8.6.7.18a Void

8.6.7.19 UE positioning

8.6.7.19.0 UE positioning reporting criteria

If IE "UE positioning reporting criteria" is included, the UE shall:

- 1> perform the necessary measurements and evaluate the event in the interval indicated in IE "Measurement Interval";
- 1> if IE "Event ID" is set to "7a" and if IE "Report first fix" is set to TRUE:

- 2> if the IE "Method Type" included in the variable MEASUREMENT_IDENTITY is set to "UE based":
 - 3> act as specified in subclause 8.6.7.19.1b.

8.6.7.19.1 UE positioning reporting quantity

The UE shall:

- 1> ignore IE "Multiple Sets";
- 1> ignore IE "Response Time";
- 1> if IE "Horizontal Accuracy" and/or IE "Vertical Accuracy" is included:
 - 2> should try to achieve the requested level(s) of positioning accuracy with 67% confidence.
- 1> if IE "Positioning Methods" is set to "Cell ID":
 - 2> act as specified in subclause 8.6.7.19.1a.
- 1> if the IE "Method Type" is set to "UE based":
 - 2> if the IE "Positioning Methods" is set to "GPS"; and
 - 2> if the IE "Additional Assistance Data Request" is set to FALSE; and
 - 2> if the IE "UE positioning GPS assistance data" is not received in the MEASUREMENT CONTROL message; and
 - 2> if, according to its UE positioning capabilities, the UE supports a standalone positioning method:
 - 3> use the standalone positioning method.
 - 2> act as specified in subclause 8.6.7.19.1b.
- 1> if the IE "Method Type" is set to "UE assisted":
 - 2> act as specified in subclause 8.6.7.19.1a.
- 1> if the IE "Method Type" is set to "UE-assisted preferred but UE-based allowed" or "UE-based preferred but UE-assisted allowed":
 - 2> act either according to subclause 8.6.7.19.1a or 8.6.7.19.1b depending on the method type chosen by the UE.

If UE according to its capabilities supports Rx-Tx time difference type 2 measurement and if IE "Positioning Methods" is set to "Cell ID" and the IE "Method Type" is set to "UE-based", the UE shall:

- 1> set the variable CONFIGURATION_INCOMPLETE to TRUE.

If UE according to its capabilities supports Rx-Tx time difference type 2 measurement and if IE "Positioning Methods" is set to "Cell ID" and the IE "Measurement validity" stored in the variable MEASUREMENT_IDENTITY is other than "CELL_DCH", the UE shall:

- 1> set the variable CONFIGURATION_INCOMPLETE to TRUE.

The UE shall perform the following consistency check:

- 1> if UE, according to its capabilities, does not support UE-based OTDOA and if IE "Positioning Methods" is set to "OTDOA" and if IE "Method Type" is set to "UE-based":
 - 2> set the variable CONFIGURATION_INCOMPLETE to TRUE.
- 1> if UE, according to its capabilities, does not support UE-assisted OTDOA and if IE "Positioning Methods" is set to "OTDOA" and if IE "Method Type" is set to "UE-assisted":
 - 2> set the variable CONFIGURATION_INCOMPLETE to TRUE.

- 1> if UE, according to its capabilities, does not support UE-based GPS and does not support a standalone positioning method and if IE "Positioning Methods" is set to "GPS" and if the IE "GANSS Positioning Methods" is not present and if IE "Method Type" is set to "UE-based":
 - 2> set the variable CONFIGURATION_INCOMPLETE to TRUE.
- 1> if UE, according to its capabilities, does not support UE-assisted GPS and if the IE "GANSS Positioning Methods" is not present and if IE "Positioning Methods" is set to "GPS" and if IE "Method Type" is set to "UE-assisted":
 - 2> set the variable CONFIGURATION_INCOMPLETE to TRUE.
- 1> if UE, according to its capabilities, does not support UE-based positioning and if IE "Positioning Methods" is set to "OTDOAorGPS" and if IE "Method Type" is set to "UE-based":
 - 2> set the variable CONFIGURATION_INCOMPLETE to TRUE.
- 1> if UE, according to its capabilities, does not support UE-based GANSS and if IE "Positioning Methods" is set to "GPS" and if IE "GANSS Positioning Methods" is present and if IE "Method Type" is set to "UE-based":
 - 2> set the variable CONFIGURATION_INCOMPLETE to TRUE.
- 1> if UE, according to its capabilities, does not support UE-assisted GANSS and if IE "Positioning Methods" is set to "GPS" and if IE "GANSS Positioning Methods" is present and if IE "Method Type" is set to "UE-assisted":
 - 2> set the variable CONFIGURATION_INCOMPLETE to TRUE.
- 1> if IE "Positioning Methods" is set to "GPS" and if IE "GANSS Positioning Methods" is present and if UE, according to its capabilities, does not support any GNSS indicated in IE "GANSS Positioning Methods":
 - 2> set the variable CONFIGURATION_INCOMPLETE to TRUE.
- 1> if UE, according to its capabilities, does not support Rx-Tx time difference type 2 measurement and if IE "Positioning Methods" is set to "Cell ID":
 - 2> set the variable CONFIGURATION_INCOMPLETE to TRUE.
- 1> if UE, according to its capabilities, does not support UE GPS timing of cell frames measurement and if IE "GPS timing of Cell wanted" is set to TRUE:
 - 2> set the variable CONFIGURATION_INCOMPLETE to TRUE.

8.6.7.19.1a UE positioning reporting for UE assisted methods

The UE shall:

- 1> when a measurement report is triggered:
 - 2> if the UE was able to perform measurements on at least one neighbour cell included in the variable UE_POSITIONING_OTDOA_DATA_UE_ASSISTED in case of OTDOA or one satellite included in the variable UE_POSITIONING_GPS_DATA in case of GPS positioning or one satellite included in the variable UE_POSITIONING_GANSS_DATA in case of GANSS positioning or one cell from the active set in case of CELL ID:
 - 3> if the IE "Vertical Accuracy" is included:
 - 4> interpret the presence of this IE to indicate that the UTRAN desires to compute a 3-dimensional position estimate.
 - 3> if the IE "Positioning Methods" is set to "GPS" and if the IE "GANSS Positioning Methods" is not present or if the IE "GANSS Positioning Methods" is present indicating GPS allowed:
 - 4> include the IE "UE positioning GPS measured results" in the measurement report and set the contents of the IE as follows:
 - 5> if the UE supports the capability to provide the GPS timing of the cell frames measurement:

- 6> if the IE "GPS timing of Cell wanted" is set to TRUE:
 - 7> perform the UE GPS timing of cell frames measurement on the serving cell or on one cell of the active set.
 - 7> include the IE "Primary CPICH Info" for FDD or the IE "cell parameters id" for TDD; and
 - 7> include the IE "Reference SFN", the IE "UE GPS timing of cell frames" and the IE "UE Positioning GPS Reference Time Uncertainty".
- 6> if the IE "GPS timing of Cell wanted" is set to FALSE:
 - 7> include the IE "GPS TOW msec" and set it to the GPS TOW when the measurements included in the MEASUREMENT REPORT were valid;
 - 7> include the IE "UE Positioning GPS Reference Time Uncertainty" and set it to the uncertainty of the GPS TOW when the measurements included in the MEASUREMENT REPORT were valid.
- 5> if the UE does not support the capability to provide the GPS timing of the cell:
 - 6> include the IE "GPS TOW msec" and set it to the GPS TOW when the measurements included in the MEASUREMENT REPORT were valid;
 - 6> include the IE "UE Positioning GPS Reference Time Uncertainty" and set it to the uncertainty of the GPS TOW when the measurements included in the MEASUREMENT REPORT were valid.
- 3> if the IE "Positioning Methods" is set to "GPS" and the IE "GANSS Positioning Methods" is present indicating other GNSS than GPS allowed and if any of these other GNSSs is measured:
- 4> include the IE "UE positioning GANSS measured results" in the measurement report and set the contents of the IE as follows:
 - 5> if the UE supports the capability to provide the GANSS timing of the cell frames measurement:
 - 6> if the IE "GANSS timing of Cell wanted" is included with one bit set to value one for a supported GANSS and if IE "UE GPS timing of cell frames" is not present:
 - 7> perform the UE GANSS timing of cell frames measurement on the serving cell or on one cell of the active set;
 - 7> include the IE "Primary CPICH Info" for FDD or the IE "cell parameters id" for TDD; and
 - 7> include the IE "Reference SFN" and the IE "UE GANSS timing of cell frames".
 - 6> if the IE "GANSS timing of Cell wanted" is not included, or included with each bit set to value zero and if IE 'UE positioning GPS measured results' is not present:
 - 7> include the IE "GANSS TOD msec" and set it to the GANSS TOD when the measurements included in the MEASUREMENT REPORT were valid.
 - 5> if the UE does not support the capability to provide the GANSS timing of the cell and if IE "UE positioning GPS measured results" is not present:
 - 6> include the IE "GANSS TOD msec" and set it to the GANSS TOD when the measurements included in the MEASUREMENT REPORT were valid.
 - 5> if the UE supports the capability to provide the GANSS carrier-phase measurements:
 - 6> if the IE "GANSS Carrier-Phase Measurement Requested" is included with one bit set to value one for a supported GANSS:
 - 7> include the IE "Carrier Quality Indication" and include the IE "ADR".
 - 5> if the UE supports the capability to perform GANSS measurements on multiple GANSS frequencies:

- 6> if the IE "GANSS Multi-frequency Measurement Requested" is included with one bit set to value one for a supported GANSS, and if any of these GANSS signals are measured:
 - 7> include the IE "GANSS Signal Measurement Information" for each measured GANSS signal.
- 3> if the IE "Positioning Methods" is set to "OTDOA":
 - 4> include the IE "UE positioning OTDOA measured results" in the measurement report and set the contents of the IE as follows:
 - 5> set IE "SFN" to the SFN when the last measurement was performed;
 - 5> if the UE supports the capability to perform the Rx-Tx time difference type 2 measurement:
 - 6> if the UE is in CELL_DCH state:
 - 7> if the measured value is equal to "1279.9375":
 - 8> set the IE "Rx-Tx time difference type 2" in IE "UE positioning OTDOA measured results" for the reference cell to "1279.8750".
 - 7> otherwise:
 - 8> set the IE "Rx-Tx time difference type 2" in IE "UE positioning OTDOA measured results" for the reference cell to the measured value.
 - 7> include the IE group "Rx-Tx time difference type 2 info" for the reference cell and for each neighbour cell listed in variable UE_POSITIONING_OTDOA_DATA_UE_ASSISTED that belongs to the active set.
 - 5> if the UE does not support the capability to perform the Rx-Tx time difference type 2 measurement:
 - 6> set the IE "Rx-Tx time difference type 2" in IE "UE positioning OTDOA measured results" for the reference cell to value "1279.9375" to indicate that the measurement is not supported.
 - 4> include IE group "Neighbour" for all neighbour cells listed in variable UE_POSITIONING_OTDOA_DATA_UE_ASSISTED on which the SFN-SFN observed time difference type 2 measurement could be performed.
- 3> if IE "Positioning Methods" in the MEASUREMENT CONTROL message has been assigned to value "OTDOA or GPS":
 - 4> the UE may choose to either act as if IE "Positioning Methods" is set to "GPS" or "OTDOA" depending on the method chosen by the UE.
- 3> if the IE "Positioning Methods" is set to "CELL ID":
 - 4> if the UE supports the capability to perform the Rx-Tx time difference type 2 measurement; and
 - 4> if the UE is in CELL_DCH state:
 - 5> perform the Rx-Tx time difference type 2 measurement on the cells in the active set; and
 - 5> report the measurement results back to the network in the MEASUREMENT REPORT by using IE "UE positioning OTDOA measured results" including measurements on the cells in the active set; and
 - 5> report Rx-Tx time difference type 2 measurement of the reference cell (as designated by the UE); and
 - 5> for all reported neighbour cells:
 - 6> report Rx-Tx time difference type 2 measurement; and

- 6> set the IE "SFN-SFN observed time difference type 2" and all IEs within the corresponding IE "UE positioning OTDOA quality" in IE "UE positioning OTDOA measured results" to value "0".
- 2> if the UE is not able to report the requested measurement results:
 - 3> include IE "UE positioning error" in the MEASUREMENT REPORT and set the contents of this IE as specified in subclause 8.6.7.19.5.
- 1> if the UE is unable to report the requested measurement results due to missing GPS assistance data:
 - 2> the UE may at anytime send a measurement report containing the IE "UE positioning error" and set the contents of this IE as specified in subclause 8.6.7.19.5.
 - 2> after sending the measurement report, the UE shall not send another measurement report to request the same GPS assistance data for at least 20s. This requirement does not apply after release of the current RRC connection.
- 1> if the UE is unable to report the requested measurement results due to missing GANSS assistance data:
 - 2> the UE may at anytime send a measurement report containing the IE "UE positioning error" and set the contents of this IE as specified in subclause 8.6.7.19.5;
 - 2> after sending the measurement report, the UE shall not send another measurement report to request the same GANSS assistance data for at least 20s. This requirement does not apply after release of the current RRC connection.

8.6.7.19.1b UE positioning reporting for UE based methods

The UE shall:

- 1> when a measurement report is triggered:
 - 2> if the UE has been able to calculate a position after performing measurements on the cells included in the variable UE_POSITIONING_OTDOA_DATA_UE_BASED in case of OTDOA or the UE has been able to calculate a position in case of GPS or GANSS positioning or the UE has been able to calculate a position using a standalone positioning method:
 - 3> include IE "UE positioning Position Estimate Info" in the MEASUREMENT REPORT and set the contents of the IE as follows:
 - 4> if the UE supports the capability to perform the UE GPS timing of cell frames measurement:
 - 5> if the IE "GPS timing of Cell wanted" is set to TRUE:
 - 6> perform the UE GPS timing of cell frames measurement on the serving cell or on one cell of the active set.
 - 6> include the IE "Primary CPICH Info" for FDD or the IE "cell parameters id" for TDD;
 - 6> include the SFN when the position was determined;
 - 6> include the IE "UE GPS timing of cell frames";
 - 6> include the IE "UE Positioning GPS Reference Time Uncertainty".
 - 5> if the IE "GPS timing of Cell wanted" is set to FALSE:
 - 6> include the IE "GPS TOW msec" and set it to the GPS TOW when the position estimate was valid.
 - 4> if the position was calculated with GPS; and
 - 4> the UE does not support the capability to provide the GPS timing of the cell:
 - 5> include the IE "GPS TOW msec" and set it to the GPS TOW when the position estimate was valid.

- 4> if the UE supports the capability to provide the GANSS timing of the cell frames measurement:
 - 5> if the IE "GANSS timing of Cell wanted" is included with one bit set to value one for a supported GANSS:
 - 6> perform the UE GANSS timing of cell frames measurement on the serving cell or on one cell of the active set;
 - 6> include the IE "GANSS Time ID" to identify the GNSS system time;
 - 6> include the IE "Primary CPICH Info" for FDD or the IE "cell parameters id" for TDD; and
 - 6> include the IE "Reference SFN" and the IE "UE GANSS timing of cell frames".
 - 5> if the IE "GANSS timing of Cell wanted" is not included, or included with each bit set to value zero:
 - 6> include the IE "GANSS TOD msec" and set it to the GANSS TOD when the position estimate was valid.
- 4> if the UE does not support the capability to provide the GANSS timing of the cell:
 - 5> include the IE "GANSS TOD msec" and set it to the GANSS TOD when the position estimate was valid;
 - 5> include the IE "GANSS Time ID" to identify the GNSS system time.
- 4> if IE "Vertical Accuracy" has been included in IE "UE positioning reporting quantity":
 - 5> if the IE "Vertical Accuracy" has been assigned to value "0":
 - 6> if the IE "Horizontal Accuracy" has been assigned a value "0":
 - 7> may include IE "Ellipsoid point with altitude".
 - 6> if the IE "Horizontal Accuracy" has been assigned a value unequal to "0"; and
 - 6> if the UE has been able to calculate a 3-dimensional position
 - 7> include IE "Ellipsoid point with altitude" or IE "Ellipsoid point with altitude and uncertainty ellipsoid" as the position estimate.
 - 6> if the UE has not been able to calculate a 3-dimensional position:
 - 7> may act as if IE "Vertical Accuracy" was not included in IE "UE positioning reporting quantity".
 - 5> if the IE "Vertical Accuracy" has been assigned to a value unequal to "0":
 - 6> if the UE has been able to calculate a 3-dimensional position:
 - 7> include IE "Ellipsoid point with altitude and uncertainty ellipsoid" as the position estimate.
 - 6> if the UE has not been able to calculate a 3-dimensional position:
 - 7> act as if IE "Vertical Accuracy" has not been included in IE "UE positioning reporting quantity".
- 4> if IE "Vertical Accuracy" has not been included in IE "UE positioning reporting quantity":
 - 5> if IE "Horizontal Accuracy" in IE "UE positioning reporting quantity" has been assigned to value "0":
 - 6> may include IE "Ellipsoid point".
 - 5> if IE "Horizontal Accuracy" in IE "UE positioning reporting quantity" has been assigned to a value unequal to 0:

- 6> include either IE "Ellipsoid point with uncertainty circle" or IE "Ellipsoid point with uncertainty ellipse" or IE "Ellipsoid point with altitude and uncertainty ellipsoid" as the position estimate.
- 4> if any of the IEs "Ellipsoid point with uncertainty ellipse" or "Ellipsoid point with altitude and uncertainty ellipsoid" is reported:
 - 5> should calculate a value of the IE "Confidence", different from "0", as the probability that the UE is located within the uncertainty region of the one of the IEs "Ellipsoid point with uncertainty ellipse" or "Ellipsoid point with altitude and uncertainty ellipsoid" that is reported.
- NOTE: The value "0" of the IE "Confidence" is interpreted as "no information" by the UTRAN [57].
- 4> if IE "Velocity Requested" has been included in IE "UE positioning reporting quantity":
 - 5> include IE "Velocity estimate" if supported and available.
- 2> if the UE was not able to calculate a position:
 - 3> include IE "UE positioning error" in the MEASUREMENT REPORT and set the contents of this IE as specified in subclause 8.6.7.19.5.
- 1> if the UE is unable to calculate a position due to missing GPS assistance data:
 - 2> the UE may at any time send a measurement report containing the IE "UE positioning error" and set the contents of this IE as specified in subclause 8.6.7.19.5;
 - 2> after sending the measurement report, the UE shall not send another measurement report to request the same GPS assistance data for at least 20s. This requirement does not apply after release of the current RRC connection.
- 1> if the UE is unable to report the requested measurement results due to missing GANSS assistance data:
 - 2> the UE may at anytime send a measurement report containing the IE "UE positioning error" and set the contents of this IE as specified in subclause 8.6.7.19.5;
 - 2> after sending the measurement report, the UE shall not send another measurement report to request the same GANSS assistance data for at least 20s. This requirement does not apply after release of the current RRC connection.

8.6.7.19.2 UE positioning OTDOA assistance data for UE-assisted

If IE "UE positioning OTDOA reference cell info for UE-assisted" is received in System Information Block type 15.4 or in the MEASUREMENT CONTROL message, the UE shall update the variable UE_POSITIONING_OTDOA_DATA_UE_ASSISTED accordingly. The UE shall:

- 1> store received cell information in the UE positioning reference cell info in the variable UE_POSITIONING_OTDOA_DATA_UE_ASSISTED, overwriting any existing information.

If IE "UE positioning OTDOA neighbour cell list for UE-assisted" is received in System Information Block type 15.4 or in the MEASUREMENT CONTROL message, the UE shall update the variable UE_POSITIONING_OTDOA_DATA_UE_ASSISTED accordingly. The UE shall:

- 1> store received cell information in the neighbour cell info list in the variable UE_POSITIONING_OTDOA_DATA_UE_ASSISTED, overwriting any existing information.

If, according to its capabilities, UE does not support IPDLs and if IE "IPDL parameters" is received for the reference or any of the neighbour cells, the UE shall:

- 1> ignore this IE.

In 1.28 Mcps TDD, if the IE "IPDL parameters" is received and the UE supports IPDLs, the UE shall:

- 1> ignore the IE IP_Slot;
- 1> if the IE "IP_PCCPCH" is set to FALSE:

2> configure the physical layer with IP_Sub to be first subframe according to [33].

1> if the IE "IP_PCCPCH" is set to TRUE:

2> configure the physical layer with IP_Sub to be second subframe according to [33].

1> if the IE "IP_PCCPCH" is absent:

2> configure the physical layer with IP_Sub to use both subframes according to [33].

If IE "SFN offset validity" is set to FALSE, the UE shall:

1> ignore the IE "SFN offset".

If IE "UE positioning measurement" is received in the MEASUREMENT CONTROL message, the UE shall also perform the following consistency checks:

1> if IE "Positioning Methods" is set to "OTDOA":

2> if IE "UE positioning OTDOA reference cell info for UE-assisted" is not included and if UE positioning OTDOA reference cell info for UE-assisted in variable UE_POSITIONING_OTDOA_DATA_UE_ASSISTED is empty:

3> set the variable CONFIGURATION_INCOMPLETE to TRUE.

1> if IE "Positioning Methods" is set to "OTDOA":

2> if IE "UE positioning OTDOA neighbour cell list for UE-assisted" is not included and if less than two neighbour cells are stored in UE positioning OTDOA neighbour cell info list for UE-assisted in variable UE_POSITIONING_OTDOA_DATA_UE_ASSISTED:

3> set the variable CONFIGURATION_INCOMPLETE to TRUE.

8.6.7.19.2a UE positioning OTDOA assistance data for UE-based

The UE shall:

1> if IE "UE positioning OTDOA reference cell info for UE-based" is received in System Information Block type 15.5 or in the MEASUREMENT CONTROL message or in the ASSISTANCE DATA DELIVERY:

2> update the variable UE_POSITIONING_OTDOA_DATA_UE_BASED accordingly;

2> store received cell information in the UE positioning reference cell info for UE-based in the variable UE_POSITIONING_OTDOA_DATA_UE_BASED, overwriting any existing information.

1> if IE "UE positioning OTDOA neighbour cell list for UE-based" is received in System Information Block type 15.5 or in the MEASUREMENT CONTROL message or in the ASSISTANCE DATA DELIVERY:

2> update the variable UE_POSITIONING_OTDOA_DATA_UE_BASED accordingly;

2> store received cell information in the neighbour cell info list for UE-based in the variable UE_POSITIONING_OTDOA_DATA_UE_BASED, overwriting any existing information.

1> if, according to its capabilities, UE does not support IPDLs and if IE "IPDL parameters" is received for the reference or any of the neighbour cells:

2> ignore this IE.

1> in 1.28 Mcps TDD:

2> if the IE "IPDL parameters" is received and the UE supports IPDLs:

3> ignore the IE IP_Slot;

3> if the IE "IP_PCCPCH" is set to FALSE:

4> configure the physical layer with IP_Sub to be first subframe according to [33].

- 3> if the IE "IP_PCCPCH" is set to TRUE:
 - 4> configure the physical layer with IP_Sub to be second subframe according to [33].
- 3> if the IE "IP_PCCPCH" is absent:
 - 4> configure the physical layer with IP_Sub to use both subframes according to [33].
- 1> if IE "SFN offset validity" is set to FALSE:
 - 2> ignore the IE "SFN offset".
- 1> if IE "UE positioning measurement" is received in the MEASUREMENT CONTROL message:
 - 2> also perform the following consistency checks:
 - 3> if IE "Positioning Methods" is set to "OTDOA":
 - 4> if IE "UE positioning OTDOA reference cell info for UE-based" is not included and if UE positioning OTDOA reference cell info for UE-based in variable UE_POSITIONING_OTDOA_DATA_UE_BASED is empty:
 - 5> set the variable CONFIGURATION_INCOMPLETE to TRUE.
 - 3> if IE "Positioning Methods" is set to "OTDOA":
 - 4> if IE "UE positioning OTDOA neighbour cell list for UE-based" is not included and if less than two neighbour cells are stored in UE positioning OTDOA neighbour cell info list for UE-based in variable UE_POSITIONING_OTDOA_DATA_UE_BASED:
 - 5> set the variable CONFIGURATION_INCOMPLETE to TRUE.
 - 4> if IE "Method Type" is set to "UE based":
 - 5> if IE "UE positioning OTDOA reference cell info for UE-based" is included and if IE "Cell Position" for the reference cell is not included:
 - 6> set the variable CONFIGURATION_INCOMPLETE to TRUE.
 - 5> if the IE "UE positioning OTDOA neighbour cell list for UE-based" is included and if cell position of less than two neighbour cells of the cells included in this IE and stored in variable UE_POSITIONING_OTDOA_DATA_UE_BASED are different; or
 - 5> if the IE "UE positioning OTDOA neighbour cell list for UE-based" is included and if cell position of only two neighbour cells of the cells included in this IE and stored in variable UE_POSITIONING_OTDOA_DATA_UE_BASED are different and if those cell positions are not different to the one of the reference cell stored in variable UE_POSITIONING_OTDOA_DATA_UE_BASED:
 - 6> set the variable CONFIGURATION_INCOMPLETE to TRUE.
 - 5> if the IE "Round Trip Time" is neither included for the neighbour cells nor for the reference cell info; and
 - 6> if the IE "UE positioning OTDOA neighbour cell list for UE-based" is included and if cell position of only two neighbour cells of the cells included in this IE and stored in variable UE_POSITIONING_OTDOA_DATA_UE_BASED are different; or
 - 6> if the IE "UE positioning OTDOA neighbour cell list for UE-based" is included and if cell position of only three neighbour cells of the cells included in this IE and stored in variable UE_POSITIONING_OTDOA_DATA_UE_BASED are different and if those cell positions are not different to the one of the reference cell stored in variable UE_POSITIONING_OTDOA_DATA_UE_BASED:
 - 7> set the variable CONFIGURATION_INCOMPLETE to TRUE.

8.6.7.19.3 UE positioning GPS assistance data

The UE may receive GPS assistance data in System Information Block types 15, 15.1, 15.2, or 15.3, or in the ASSISTANCE DATA DELIVERY message, or in the MEASUREMENT CONTROL message.

8.6.7.19.3.1 UE positioning GPS acquisition assistance

If the IE "UE positioning GPS acquisition assistance" is included, the UE shall:

- 1> update the variable UE_POSITIONING_GPS_DATA as follows:
 - 2> delete all information currently stored in the IE "UE positioning GPS acquisition assistance" in the variable UE_POSITIONING_GPS_DATA;
 - 2> store the received acquisition assistance information in the IE "UE positioning GPS acquisition assistance" in the variable UE_POSITIONING_GPS_DATA;
 - 2> store the IE "GPS TOW msec" in the IE "UE positioning GPS acquisition assistance" in variable UE_POSITIONING_GPS_DATA and use it as an estimate of the GPS Time-of-Week at the time of reception of the complete message containing the IE "GPS TOW msec";

NOTE: The UE does not need to apply any compensation on the GPS Time-of-Week.

- 1> if the IEs "SFN" and "UTRAN GPS timing of cell frames" are included:
 - 2> if the UE is able to utilise these IEs:
 - 3> store these IEs in the IE "UE positioning GPS acquisition assistance" in variable UE_POSITIONING_GPS_DATA;
 - 3> if the IE "Primary CPICH Info" for FDD or IE "cell parameters id" for TDD is not included:
 - 4> if the UE is not in CELL_DCH state:
 - 5> use IEs "SFN" and "UTRAN GPS timing of cell frames" to estimate the relationship between GPS time and radio interface timing of the NODE B transmission in the serving cell.
 - 5> if the IE "UE Positioning GPS ReferenceTime Uncertainty" is included:
 - 6> store this IE in the IE "UE Positioning GPS acquisition assistance" in variable UE_POSITIONING_GPS_DATA and use it to determine the relationship between GPS time and air-interface timing of the NODE B transmission.
 - 4> if the UE is in CELL_DCH state:
 - 5> ignore IEs "SFN" and "UTRAN GPS timing of cell frames".
 - 3> if the IE "Primary CPICH Info" for FDD or IE "cell parameters id" for TDD is also included:
 - 4> store this IE in the IE "UE positioning acquisition assistance" in variable UE_POSITIONING_GPS_DATA;
 - 4> use IEs "SFN" and "UTRAN GPS timing of cell frames" to estimate the relationship between GPS time and air-interface timing of the NODE B transmission in the cell indicated by "Primary CPICH info" or "cell parameters id".
 - 4> if the IE "UE Positioning GPS ReferenceTime Uncertainty" is included:
 - 5> store this IE in the IE "UE Positioning GPS acquisition assistance" in variable UE_POSITIONING_GPS_DATA and use it to determine the relationship between GPS time and air-interface timing of the NODE B transmission.

8.6.7.19.3.2 UE positioning GPS Almanac

If the IE "UE positioning GPS Almanac" is included, the UE shall:

1> if the IE "SV Global Health" is included:

1> store this IE in the IE in the IE "SV Global Health" in the IE "UE positioning GPS Almanac" in variable UE_POSITIONING_GPS_DATA.

1> for each satellite:

2> store received GPS almanac information at the position indicated by the IE "Sat ID" in the IE "UE positioning GPS Almanac" in the variable UE_POSITIONING_GPS_DATA, possibly overwriting any existing information in this position.

2> interpret IE "Data ID" as the Data ID field contained in the indicated subframe, word 3, most significant 2 bits, as defined by [12];

2> act on the rest of the IEs in a similar manner as specified in [12].

8.6.7.19.3.3 UE positioning D-GPS Corrections

If the IE "UE positioning GPS DGPS corrections" is included, the UE shall:

1> update the variable UE_POSITIONING_GPS_DATA as follows:

2> delete all information currently stored in the IE "UE positioning GPS DGPS corrections" in the variable UE_POSITIONING_GPS_DATA;

2> store the received DGPS corrections in the IE "UE positioning GPS DGPS corrections" in the variable UE_POSITIONING_GPS_DATA.

1> use IE "GPS TOW sec" to determine when the differential corrections were calculated;

1> use IE "Status/Health" to determine the status of the differential corrections.

8.6.7.19.3.3a UE positioning GPS Navigation Model

If the IE "UE positioning GPS Navigation Model" is included, for each satellite, the UE shall:

1> use IE "Satellite Status" to determine if an update of IE "UE positioning GPS Ephemeris and Clock Correction parameters" has been provided for the satellite indicated by the IE "SatID";

1> if an update has been provided for this satellite:

2> act as specified in subclause 8.6.7.19.3.4.

8.6.7.19.3.4 UE positioning GPS Ephemeris and Clock Correction Parameters

If the IE "UE positioning GPS Ephemeris and Clock Correction parameters" is included, for each satellite, the UE shall:

1> update the variable UE_POSITIONING_GPS_DATA as follows:

2> store this IE at the position indicated by the IE "Sat ID" in the IE "UE positioning GPS Navigation Model" in the variable UE_POSITIONING_GPS_DATA, possibly overwriting any existing information in this position.

1> act on these GPS ephemeris and clock correction parameters in a manner similar to that specified in [12].

8.6.7.19.3.5 UE positioning GPS ionospheric model

If IE "UE positioning GPS ionospheric model" is included, the UE shall:

1> store this IE in the IE "UE positioning GPS ionospheric model" in variable UE_POSITIONING_GPS_DATA;

1> act on these GPS ionospheric model parameters in a manner similar to that specified in [12].

8.6.7.19.3.6 UE positioning GPS real-time integrity

If this list of bad satellites is included, the UE shall:

- 1> update the variable UE_POSITIONING_GPS_DATA as follows:
 - 2> add the Sat IDs that are not yet included in the list of satellites in the IE "UE positioning GPS real time integrity" in the variable UE_POSITIONING_GPS_DATA;
 - 2> remove all Sat IDs in the list of satellites in the IE "UE positioning GPS real time integrity" in the variable UE_POSITIONING_GPS_DATA that are not included in IE UE positioning GPS real time integrity.
- 1> consider the data associated with the satellites identified in the variable UE_POSITIONING_GPS_DATA as invalid.

8.6.7.19.3.7 UE positioning GPS reference time

If the IE "UE positioning GPS reference time" is included, the UE shall:

- 1> store the IE "GPS Week" in "UE positioning GPS reference time" in variable UE_POSITIONING_GPS_DATA and use it as the current GPS week;
- 1> store the IE "GPS TOW msec" in the IE "UE positioning GPS reference time" in variable UE_POSITIONING_GPS_DATA and use it as an estimate of the GPS Time-of-Week at the time of reception of the complete message containing the IE "GPS TOW msec";

NOTE: The UE does not need to apply any compensation on the GPS Time-of-Week.

- 1> if the IE "SFN" and IE "UTRAN GPS timing of cell frames" are included:
 - 2> if the UE is able to utilise the IEs:
 - 3> store these IEs in the IE "UE positioning GPS reference time" in variable UE_POSITIONING_GPS_DATA;
 - 3> if the IE "Primary CPICH Info" for FDD or IE "cell parameters id" for TDD is not included:
 - 4> if the UE is not in CELL_DCH state:
 - 5> use IEs "SFN" and "UTRAN GPS timing of cell frames" to estimate the relationship between GPS time and air-interface timing of the NODE B transmission in the serving cell.
 - 5> if the IE "UE Positioning GPS ReferenceTime Uncertainty" is included:
 - 6> store this IE in the IE "UE positioning GPS reference time" in variable UE_POSITIONING_GPS_DATA and use it to determine the relationship between GPS time and air-interface timing of the NODE B transmission.
 - 4> if the UE is in CELL_DCH state:
 - 5> ignore IEs "SFN" and "UTRAN GPS timing of cell frames".
 - 3> if the IE "Primary CPICH Info" for FDD or IE "cell parameters id" for TDD is also included:
 - 4> store this IE in the IE "UE positioning GPS reference time" in variable UE_POSITIONING_GPS_DATA;
 - 4> use IEs "SFN" and "UTRAN GPS timing of cell frames" to estimate the relationship between GPS time and air-interface timing of the NODE B transmission in the cell indicated by "Primary CPICH info" or "cell parameters id".
 - 4> if the IE "UE Positioning GPS ReferenceTime Uncertainty" is included:
 - 5> store this IE in the IE "UE positioning GPS reference time" in variable UE_POSITIONING_GPS_DATA and use it to determine the relationship between GPS time and air-interface timing of the NODE B transmission.

- 1> if the IE "UE Positioning GPS ReferenceTime Uncertainty" is not included; and
- 1> if the IE "SFN-TOW Uncertainty" is included:
 - 2> store this IE in the IE "UE positioning GPS reference time" in variable UE_POSITIONING_GPS_DATA and use it to determine if the relationship between GPS time and air-interface timing of the NODE B transmission is known to within at least 10ms.
- 1> if the IE "T_{UTRAN-GPS} drift rate" is included:
 - 2> store this IE in the IE "UE positioning GPS reference time" in variable UE_POSITIONING_GPS_DATA; and
 - 2> may use it as an estimate of the drift rate of the NODE B clock relative to GPS time.
- 1> if the IE "GPS TOW Assist" is included:
 - 2> for each satellite:
 - 3> delete all information currently stored in the IE "GPS TOW Assist" in the IE "UE positioning GPS reference time" in the variable UE_POSITIONING_GPS_DATA;
 - 3> store the received GPS TOW Assist information in the IE "UE positioning GPS reference time" in the variable UE_POSITIONING_GPS_DATA.

8.6.7.19.3.8 UE positioning GPS reference UE position

If the IE "UE positioning GPS reference UE position" is included, the UE shall:

- 1> store this IE in the IE "UE positioning GPS reference UE position" in variable UE_POSITIONING_GPS_DATA; and
- 1> use it as a priori knowledge of the approximate location of the UE.

8.6.7.19.3.9 UE positioning UTC model

If the IE "UE positioning GPS UTC model" is included, the UE shall:

- 1> store this IE in the IE "UE positioning GPS UTC model" in variable UE_POSITIONING_GPS_DATA.

8.6.7.19.4 UE positioning Ciphering info

The UE shall:

- 1> if deciphering information is received from higher layers for deciphering of GPS assistance data broadcast on system information:
 - 2> store the current key in IE "Current deciphering key" in variable UE_POSITIONING_GPS_DATA;
 - 2> store the next key in IE "Next deciphering key" in variable UE_POSITIONING_GPS_DATA;
 - 2> store the ciphering key flag in UE_POSITIONING_GPS_DATA.
- 1> if deciphering information is received from higher layers for deciphering of GANSS assistance data broadcast on system information:
 - 2> store the current key in IE "Current deciphering key" in variable UE_POSITIONING_GANSS_DATA;
 - 2> store the next key in IE "Next deciphering key" in variable UE_POSITIONING_GANSS_DATA;
 - 2> store the ciphering key flag in UE_POSITIONING_GANSS_DATA.
- 1> if deciphering information is received from higher layers for deciphering of OTDOA assistance data broadcast on system information:

- 2> store the current key in IE "Current deciphering key" in variable UE_POSITIONING_OTDOA_DATA_UE_BASED;
 - 2> store the next key in IE "Next deciphering key" in variable UE_POSITIONING_OTDOA_DATA_UE_BASED;
 - 2> store the ciphering key flag in UE_POSITIONING_OTDOA_DATA_UE_BASED.
- 1> if the IE "GPS Data ciphering info" is included in System Information Block type 15:
- 2> select one of the two deciphering keys received and stored it in UE_POSITIONING_GPS_DATA according to the following:
 - 3> if the value of the received IE "Ciphering Key Flag" is the same as the value of the IE "Ciphering Key Flag" stored in the variable UE_POSITIONING_GPS_DATA:
 - 4> select the current deciphering key.
 - 3> if the value of the received IE "Ciphering Key Flag" is different from the value of the IE "Ciphering Key Flag" stored in the variable UE_POSITIONING_GPS_DATA:
 - 4> select the next deciphering key.
 - 2> store the received IE in the variable UE_POSITIONING_GPS_DATA;
 - 2> use the selected deciphering key to decipher the broadcast UE positioning GPS information contained within the System Information Block types 15.1, 15.2 and 15.3.
- 1> if the IE "GANSS Data ciphering info" is included in System Information Block type 15.8:
- 2> select one of the two deciphering keys received and stored it in UE_POSITIONING_GANSS_DATA according to the following:
 - 3> if the value of the received IE "Ciphering Key Flag" is the same as the value of the IE "Ciphering Key Flag" stored in the variable UE_POSITIONING_GANSS_DATA:
 - 4> select the current deciphering key.
 - 3> if the value of the received IE "Ciphering Key Flag" is different from the value of the IE "Ciphering Key Flag" stored in the variable UE_POSITIONING_GANSS_DATA:
 - 4> select the next deciphering key.
 - 2> store the received IE in the variable UE_POSITIONING_GANSS_DATA;
 - 2> use the selected deciphering key to decipher the broadcast UE positioning GANSS information contained within the System Information Block types 15.1bis, 15.2bis, 15.2ter, 15.3bis, 15.6 and 15.7.
- 1> if the IE "OTDOA positioning ciphering info" is included in System Information Block type 15.4:
- 2> select one of the two deciphering keys and stored it in UE_POSITIONING_OTDOA_DATA_UE_BASED according to the following:
 - 3> if the value of the received IE "Ciphering Key Flag" is the same as the value of the IE "Ciphering Key Flag" stored in the variable UE_POSITIONING_OTDOA_DATA_UE_BASED:
 - 4> select the current deciphering key.
 - 3> if the value of the received IE "Ciphering Key Flag" is different from the value of the IE "Ciphering Key Flag" stored in the variable UE_POSITIONING_OTDOA_DATA_UE_BASED:
 - 4> select the next deciphering key.
 - 2> store the received IE in the variable UE_POSITIONING_OTDOA_DATA_UE_BASED;
 - 2> use the selected deciphering key to decipher the IE "OTDOA assistance data" included in the System Information Block types 15.4.

8.6.7.19.5 UE positioning Error

The UE shall set the contents of the IE "UE positioning Error" as follows:

- 1> if the IE "Positioning Methods" in IE "UE positioning reporting quantity" has been assigned to value "OTDOA" and no neighbour cells could be received,
 - 2> set IE "Error reason" to "Not Enough OTDOA Cells";
- 1> if the IE "Positioning Methods" in IE "UE positioning reporting quantity" has been assigned to value "GPS":
 - 2> if there were not enough GPS satellites to be received:
 - 3> set IE "Error reason" to "Not Enough GPS Satellites".
 - 2> if some GPS assistance data was missing:
 - 3> set IE "Error reason" to "Assistance Data Missing"; and
 - 3> if the IE "Additional Assistance Data Request" included in the IE "UE positioning reporting quantity" stored in the variable MEASUREMENT_IDENTITY is set to TRUE:
 - 4> include the IE "GPS Additional Assistance Data Request".
 - 3> if the IE "Additional Assistance Data Request" included in the IE "UE positioning reporting quantity" stored in the variable MEASUREMENT_IDENTITY is set to FALSE:
 - 4> not include the IE "GPS Additional Assistance Data Request", and use the assistance data available for doing a positioning estimate.
 - 2> if the UE was not able to read the SFN of the reference cell included in the IE "UE positioning GPS reference time" or in the IE "UE positioning acquisition assistance":
 - 3> set IE "Error reason" to "Reference Cell Not Serving Cell".
 - 2> if the UE was not able to measure the requested GPS timing of cell frames measurement:
 - 3> set IE "Error reason" to "Not Accomplished GPS Timing Of Cell Frames".
 - 1> if the IE "Positioning Methods" in IE "UE positioning reporting quantity" has been assigned to value "GPS" and the IE "GANSS Positioning Methods" is present:
 - 2> if there were not enough GANSS satellites to be received:
 - 3> set IE "Error reason" to "Not Enough GANSS Satellites".
 - 2> if some GANSS assistance data was missing:
 - 3> set IE "Error reason" to "Assistance Data Missing"; and
 - 3> if the IE "Additional Assistance Data Request" included in the IE "UE positioning reporting quantity" stored in the variable MEASUREMENT_IDENTITY is set to TRUE:
 - 4> include the IE "GANSS Additional Assistance Data Request".
 - 3> if the IE "Additional Assistance Data Request" included in the IE "UE positioning reporting quantity" stored in the variable MEASUREMENT_IDENTITY is set to FALSE:
 - 4> not include the IE "GANSS Additional Assistance Data Request", and use the assistance data available for doing a positioning estimate.
 - 2> if the UE was not able to read the SFN of the reference cell included in the IE "UE positioning GANSS reference time":
 - 3> set IE "Error reason" to "Reference Cell Not Serving Cell".
 - 2> if the UE was not able to measure the requested GANSS timing of cell frames measurement:

3> set IE "Error reason" to "Not Accomplished GANSS Timing Of Cell Frames".

1> if none of the conditions above are fulfilled:

2> set IE "Error reason" to "Undefined Error".

The UE shall not set the IE "Error reason" to "Request Denied By User" or "Not Processed and Timeout".

8.6.7.19.6 Void

8.6.7.19.7 UE positioning GANSS assistance data

The UE may receive GANSS assistance data in System Information Block types 15bis, 15.1bis, 15.2bis, 15.2ter, 15.3bis, 15.6, 15.7 or 15.8 or in the ASSISTANCE DATA DELIVERY message, or in the MEASUREMENT CONTROL message. IE "UE positioning GANSS assistance data" is divided into a common part which is applicable to any GNSS and a generic part which contains assistance data separately for each supported GNSS.

8.6.7.19.7.1 UE positioning GANSS reference measurement information

If the IE "UE positioning GANSS reference measurement information" is included, the UE shall:

1> update the variable UE_POSITIONING_GANSS_DATA as follows:

2> for each GANSS the IE "UE positioning GANSS reference measurement information" is included:

3> delete all information currently stored in the IE "UE positioning GANSS reference measurement information" in the variable UE_POSITIONING_GANSS_DATA;

3> store the received information in the IE "UE positioning GANSS reference measurement information" in the variable UE_POSITIONING_GANSS_DATA.

1> perform the following consistency check:

2> if the IE "UE positioning GANSS reference time" is included and the IE "UE positioning GPS acquisition assistance" is not included, the UE shall interpret the IE "Satellite information" to be valid at the time provided in IE "UE positioning GANSS reference time";

2> if the IE "UE positioning GPS acquisition assistance" is included, the UE shall interpret the IE "Satellite information" to be valid at the time provided in the IE "UE positioning GPS acquisition assistance";

2> if neither the IE "UE positioning GANSS reference time" nor the IE "UE positioning GPS acquisition assistance" is included:

3> set the variable CONFIGURATION_INCOMPLETE to TRUE.

8.6.7.19.7.2 UE positioning GANSS Almanac

If the IE "UE positioning GANSS Almanac" is included, the UE shall:

1> for each GANSS:

2> for each satellite:

3> store received GANSS almanac information at the position indicated by the IE "SV ID" in the IE "UE positioning GANSS Almanac" in the variable UE_POSITIONING_GANSS_DATA, possibly overwriting any existing information in this position;

3> act on the information in a similar manner as specified in [61], [68], [69], [70], [71], [72], [73] for a particular GANSS.

8.6.7.19.7.3 UE positioning D-GANSS Corrections

If the IE "UE positioning DGANSS corrections" is included, the UE shall:

1> for each GANSS:

2> update the variable UE_POSITIONING_GANSS_DATA as follows:

3> delete all information currently stored in the IE "UE positioning DGANSS corrections" in the variable UE_POSITIONING_GANSS_DATA;

3> store the received DGANSS corrections in the IE "UE positioning DGANSS corrections" in the variable UE_POSITIONING_GANSS_DATA.

2> use IE "DGANSS Reference Time" to determine when the differential corrections were calculated;

2> use IE "Status/Health" to determine the status of the differential corrections.

8.6.7.19.7.4 UE positioning GANSS Navigation Model

If the IE "UE positioning GANSS Navigation Model" is included, the UE shall:

1> for each GANSS:

2> for each satellite, the UE shall:

3> for IE "UE positioning GANSS clock model":

4> act as specified in subclause 8.6.7.19.7.4a.

3> for IE "UE positioning GANSS orbit model":

4> act as specified in subclause 8.6.7.19.7.4b.

8.6.7.19.7.4a UE positioning GANSS Clock Model

If the IE "UE positioning GANSS clock model" is included, the UE shall:

1> for each GANSS:

2> update the variable UE_POSITIONING_GANSS_DATA as follows:

3> store this IE at the position indicated by the IE "Sat ID" in the IE "UE positioning GANSS Navigation Model" in the variable UE_POSITIONING_GANSS_DATA, possibly overwriting any existing information in this position.

2> act on these GANSS clock models in a manner similar to that specified in a relevant ICD.

8.6.7.19.7.4b UE positioning GANSS Orbit Model

If the IE "UE positioning GANSS orbit model" is included, for each satellite of each supported GNSS, the UE shall:

1> update the variable UE_POSITIONING_GANSS_DATA as follows:

2> store this IE at the position indicated by the IE "Sat ID" in the IE "UE positioning GANSS Navigation Model" in the variable UE_POSITIONING_GANSS_DATA, possibly overwriting any existing information in this position..

1> act on these GANSS orbit models in a manner similar to that specified in a relevant ICD.

8.6.7.19.7.5 UE positioning GANSS ionospheric model

If the IE "UE positioning GANSS ionospheric model" is included, the UE shall:

1> store this IE in the IE "UE positioning GANSS ionospheric model" in variable UE_POSITIONING_GANSS_DATA;

1> act on these GANSS ionospheric model parameters in a manner similar to that specified in [61].

8.6.7.19.7.6 UE positioning GANSS real-time integrity

If this list of bad satellites is included, the UE shall for each GANSS:

- 1> update the variable UE_POSITIONING_GANSS_DATA as follows:
 - 2> for each satellite included in the list:
 - 3> add the Sat IDs that are not yet included in the list of satellites in the IE "UE positioning GANSS real time integrity" in the variable UE_POSITIONING_GANSS_DATA;
 - 3> if the IE "Bad GNSS Signal ID" is included in the satellite information:
 - 4> store this IE at the position indicated by the IE "Bad GNSS SatID" in the variable UE_POSITIONING_GANSS_DATA, possibly overwriting any existing information in this position.
 - 3> remove all Sat IDs in the list of satellites in the IE "UE positioning GANSS real time integrity" in the variable UE_POSITIONING_GANSS_DATA that are not included in IE "UE positioning GANSS real time integrity".
 - 1> consider the data associated with the satellites or signals identified in the variable UE_POSITIONING_GANSS_DATA as invalid.

8.6.7.19.7.7 UE positioning GANSS reference time

If the IE "UE positioning GANSS reference time" is included, the UE shall:

- 1> if the IE "GANSS Day" is included:
 - 2> store this IE in "UE positioning GANSS reference time" in variable UE_POSITIONING_GANSS_DATA and use it as the current GANSS day.
- 1> store the IE "GANSS TOD" in the IE "UE positioning GANSS reference time" in variable UE_POSITIONING_GANSS_DATA and use it as an estimate of the GANSS Time-of-Day at the time of reception of the complete message containing the IE "GANSS TOD";

NOTE: The UE does not need to apply any compensation on the GANSS Time-of-Day.

- 1> if the IE "GANSS TOD Uncertainty" is included:
 - 2> store this IE in the IE "UE positioning GANSS reference time" in variable UE_POSITIONING_GANSS_DATA and use it to determine the uncertainty of the relationship between GANSS time and air-interface timing of the NODE B transmission.
- 1> if the IE "GANSS Time ID" is not included:
 - 2> use Galileo system time as a reference for GANSS-Time-of-Day.
- 1> if the IE "GANSS Time ID" is included:
 - 2> use the system time indicated by this IE as a reference for GANSS-Time-of-Day.
- 1> if the IE "SFN" and IE "UTRAN GANSS timing of cell frames" are included:
 - 2> if the UE is able to utilise the IEs:
 - 3> store these IEs in the IE "UE positioning GANSS reference time" in variable UE_POSITIONING_GANSS_DATA;
 - 3> if the IE "Primary CPICH Info" for FDD or IE "cell parameters id" for TDD is not included:
 - 4> if the UE is not in CELL_DCH state:
 - 5> use IEs "SFN" and "UTRAN GANSS timing of cell frames" to estimate the relationship between GANSS time and air-interface timing of the NODE B transmission in the serving cell.
 - 4> if the UE is in CELL_DCH state:

5> ignore IEs "SFN" and "UTRAN GANSS timing of cell frames".

3> if the IE "Primary CPICH Info" for FDD or IE "cell parameters id" for TDD is also included:

4> store this IE in the IE "UE positioning GANSS reference time" in variable UE_POSITIONING_GANSS_DATA;

4> use IEs "SFN" and "UTRAN GANSS timing of cell frames" to estimate the relationship between GANSS time and air-interface timing of the NODE B transmission in the cell indicated by "Primary CPICH info" or "cell parameters id".

1> if the IE "T_{UTRAN-GANSS} drift rate" is included:

2> store this IE in the IE "UE positioning GANSS reference time" in variable UE_POSITIONING_GANSS_DATA; and

2> may use it as an estimate of the drift rate of the NODE B clock relative to GANSS time.

8.6.7.19.7.8 UE positioning GANSS reference UE position

If the IE "UE positioning GANSS reference UE position" is included, the UE shall:

1> store this IE in the IE "UE positioning GANSS reference UE position" in variable UE_POSITIONING_GANSS_DATA; and

1> use it as a priori knowledge of the approximate location of the UE.

8.6.7.19.7.9 UE positioning GANSS time model

If the IE "UE positioning GANSS time model" is included, the UE shall for each GANSS:

1> store the information in "UE positioning GANSS time model" in variable UE_POSITIONING_GANSS_DATA;

1> use the stored parameters to relate GANSS time for the GANSS indicated by "GANSS ID" to time reference indicated by IE "GNSS_TO_ID".

8.6.7.19.7.10 UE positioning GANSS UTC model

If the IE "UE positioning GANSS UTC model" is included, the UE shall for each GANSS:

1> store this IE in the IE "UE positioning GANSS UTC model" in variable UE_POSITIONING_GANSS_DATA.

8.6.7.19.7.11 UE positioning GANSS data bit assistance

If the IE "UE positioning GANSS data bit assistance" is included, the UE shall for each GANSS:

1> store this IE in the IE "UE positioning GANSS data bit assistance" in variable UE_POSITIONING_GANSS_DATA;

1> use the data in IE "Data Bits" for data wipe-off of satellite signal indicated by IEs "Satellite ID" and "GANSS Signal ID".

8.6.7.19.7.12 UE positioning GANSS additional ionospheric model

If the IE "UE positioning GANSS additional ionospheric model" is included, the UE shall:

1> store this IE in the IE "UE positioning GANSS additional ionospheric model" in variable UE_POSITIONING_GANSS_DATA;

1> act on these GANSS additional ionospheric model parameters in a manner similar to that specified in [72].

8.6.7.19.7.13 UE positioning GANSS Earth orientation parameters

If the IE "UE positioning GANSS Earth orientation parameters" is included, the UE shall:

1> store this IE in the IE "UE positioning GANSS Earth orientation parameters" in variable UE_POSITIONING_GANSS_DATA;

1> act on these GANSS Earth orientation parameters in a manner similar to that specified in [68].

8.6.7.19.7.14 UE positioning GANSS additional navigation models

If the IE "UE positioning GANSS additional navigation models" is included, the UE shall:

1> for each GANSS:

2> for each satellite, the UE shall:

3> for IE "UE positioning GANSS additional clock models":

4> act as specified in subclause 8.6.7.19.7.14a.

3> for IE "UE positioning GANSS additional orbit models":

4> act as specified in subclause 8.6.7.19.7.14b.

8.6.7.19.7.14a UE positioning GANSS additional clock models

If the IE "UE positioning GANSS additional clock models" is included, the UE shall:

1> for each GANSS:

2> update the variable UE_POSITIONING_GANSS_DATA as follows:

3> store this IE at the position indicated by the IE "Sat ID" in the IE "UE positioning GANSS additional navigation models" in the variable UE_POSITIONING_GANSS_DATA, possibly overwriting any existing information in this position.

2> act on these GANSS additional clock models in a manner similar to that specified in the ICD for the particular model.

8.6.7.19.7.14b UE positioning GANSS additional orbit models

If the IE "UE positioning GANSS additional orbit models" is included, for each satellite of each supported GANSS, the UE shall:

1> update the variable UE_POSITIONING_GANSS_DATA as follows:

2> store this IE at the position indicated by the IE "Sat ID" in the IE "UE positioning GANSS additional navigation models" in the variable UE_POSITIONING_GANSS_DATA, possibly overwriting any existing information in this position.

1> act on these GANSS additional orbit models in a manner similar to that specified in the ICD for the particular model.

8.6.7.19.7.15 UE positioning GANSS additional UTC models

If the IE "UE positioning GANSS additional UTC models" is included, the UE shall for each GANSS:

1> store this IE in the IE "UE positioning GANSS additional UTC models" in variable UE_POSITIONING_GANSS_DATA;

1> act on these GANSS additional UTC models in a manner similar to that specified in the ICD for the particular model.

8.6.7.19.7.16 UE positioning GANSS auxiliary information

If the IE "UE positioning GANSS auxiliary information" is included, the UE shall for each GANSS:

- 1> store this IE in the IE "UE positioning GANSS auxiliary information" in variable UE_POSITIONING_GANSS_DATA;
- 1> if the IE "GANSS-ID-1" is included:
 - 2> use the IE "Signals Available" as an indication of ranging signals supported on the satellite identified by the IE "Sat ID" for the GANSS "Modernized GPS".
- 1> if the IE "GANSS-ID-3" is included:
 - 2> use the IE "Signals Available" as an indication of ranging signals supported on the satellite identified by the IE "Sat ID" for the GANSS "GLONASS";
 - 2> use the IE "Channel Number" as an indication of the carrier frequency number of the satellite identified by the IE "Sat ID" for the GANSS "GLONASS".

8.6.7.20 Void

8.6.7.21 Intra-frequency reporting quantity for RACH reporting

If the IE "Intra-frequency reporting quantity for RACH reporting" is included, the UE shall:

- 1> if the IE "SFN-SFN observed time difference reporting indicator" has the value "type 2":
 - 2> act as if the value of the IE "SFN-SFN observed time difference reporting indicator" is "no reporting".
- 1> if the IE "Reporting quantity" (FDD) or all IEs "Reporting quantity" (TDD) have the value "no report":
 - 2> the UE behaviour is unspecified.

8.6.7.22 Additional Measurement List

If the IE "Additional Measurement List" is received in a MEASUREMENT CONTROL message, the UE shall:

- 1> if the received measurement configuration in this MEASUREMENT CONTROL message, or any measurement referenced in the "Additional Measurement List" do not all have the same validity (for this consistency check the UE shall assume "CELL_DCH" as the measurement validity for measurements of type "inter-RAT", "UE internal", and "quality"):
 - 2> set the variable CONFIGURATION_INCOMPLETE to TRUE.
- 1> if any of the measurements referenced in the "Additional Measurement List" is an intra-frequency, inter-frequency or inter-RAT measurement, and this measurement is configured with event based reporting:
 - 2> the UE behaviour is not specified.
- 1> if any of the "intra-frequency", "inter-frequency", "traffic volume" or "UE positioning" measurements referenced in the "Additional Measurement List" has been setup without including the IE "measurement validity":
 - 2> the UE behaviour is not specified.
- 1> if the result of this MEASUREMENT CONTROL message is such that more than one additional measurement of the same type will be referenced in the IE "Additional Measurement List" in the MEASUREMENT_IDENTITY variable:
 - 2> the UE behaviour is not specified.
- 1> if the UE has no IE "Additional Measurement List" stored in the variable MEASUREMENT_IDENTITY associated with the identity indicated by the IE "measurement identity":
 - 2> store the received IE "Additional Measurement List" in the variable MEASUREMENT_IDENTITY.

If the IE "Additional Measurement List" is received in a MEASUREMENT CONTROL message with the IE "Measurement command" value set to "modify", and the UE has an IE "Additional Measurement List" stored in the variable MEASUREMENT_IDENTITY associated with the identity indicated by the IE "measurement identity", the UE shall:

- 1> replace the information stored in "Additional Measurement List" in variable MEASUREMENT_IDENTITY associated to the identity indicated by the IE "measurement identity" with the one received in the MEASUREMENT CONTROL message.

If the IE "Additional Measurement List" is not received in a MEASUREMENT CONTROL message and the IE "Measurement command" has the value "modify" and the UE has an IE "Additional Measurement List" stored in the variable MEASUREMENT_IDENTITY associated with the identity indicated by the IE "measurement identity", the UE shall:

- 1> leave the IE "Additional Measurement List" stored in the variable MEASUREMENT_IDENTITY associated with the identity indicated by the IE "measurement identity" unchanged.

If, at any time during the life-time of a measurement, any measurement referenced in the Additional Measurement List does not exist, the UE shall:

- 1> remove this measurement identity from the Additional Measurement List.

NOTE: A measurement referenced in the Additional Measurement List which is updated with a measurement command set to "modify", or replaced with a measurement command set to "setup", continues to exist.

If the measurement configured with the MEASUREMENT CONTROL message triggers a measurement report, the UE shall:

- 1> also include the reporting quantities for the measurements referenced by the additional measurement identities. The contents of the IE "Additional Measured results" are completely determined by the measurement configuration of the referenced additional measurement.

8.6.7.23 Dedicated Priority Information

The UE shall:

- 1> store IE "Dedicated Priority Information";

If the CHOICE "Action" has the value "Clear dedicated priorities", the UE shall:

- 1> clear the variable PRIORITY_INFO_LIST;
- 1> stop timer T322, if it is running;
- 1> set the value of IE "Priority status" in the variable PRIORITY_INFO_LIST to "sys_info_priority".
- 1> if the UE is not in CELL_DCH state:
 - 2> take the actions as described in subclause 8.1.1.6.19 using stored System information Block type 19.

If the CHOICE "Action" has the value "Configure dedicated priorities", the UE shall:

- 1> clear the variable PRIORITY_INFO_LIST;
- 1> stop timer T322, if it is running;
- 1> set the value of IE "Priority status" in the variable PRIORITY_INFO_LIST to "dedicated_priority";
- 1> for each occurrence of the IE "Priority Level List":
 - 2> create a new entry in the IE "Priority Info List" in the variable PRIORITY_INFO_LIST, and in that new entry:
 - 3> set the CHOICE "Radio Access Technology" to the value received in the IE "Priority Level List";
 - 3> set the IE "priority" to the value received in the IE "Priority Level List";

3> set the values in IE "Frequency List" or "BCCH ARFCN" to the values received in the IE "Priority Level List".

1> set the IE "E-UTRA detection" to the value received in the IE "Priority Level List".

1> if the IE "T322" is present:

2> start timer T322 using the value signalled in this IE.

1> if the UE is not in CELL_DCH state:

2> take the actions as described in subclause 8.1.1.6.19 using stored System information Block type 19.

8.6.7.24 Adjacent frequency index

If the IE "Adjacent frequency index" is received by the UE, the UE shall:

1> if prior to the reception of the message, the variable "Adjacent frequency info" is stored in CELL_INFO_LIST:

2> stop all inter-frequency measurement reporting on the cells that belong to the frequency derived from the variable "Adjacent frequency info". Each stopped measurement is restarted when a MEASUREMENT CONTROL message is received with the corresponding measurement identity.

2> clear the variable "Adjacent frequency info".

1> Extract the frequency information of the element contained in the IE 'New inter-frequency cells' that is indexed by the IE "Adjacent frequency index".

1> Store this frequency information in the variable "Adjacent frequency info" in CELL_INFO_LIST.

If the IE "Adjacent frequency index" is received by the UE and the UE does not support adjacent frequency measurements without compressed mode:

1> The UE behaviour is unspecified.

8.6.7.25 Idle Interval Information (TDD only)

If the IE "Idle Interval Information" is received by the UE, the UE shall:

1> store this information and execute the inter-RAT measurement during the idle interval, if needed;

1> the SFN that the idle interval exists should fulfil the following equation:

$$\text{Offset} = \text{SFN} \bmod (2^k)$$

Where:

- k is the coefficient parameter to calculate the idle interval period;
- Offset is the idle interval position in a period.

8.6.8 Void

8.6.8a Other Information elements

8.6.8a.1 ETWS information

If RRC is configured from upper layers to receive primary notification for ETWS, and if the IE "ETWS information" is received in a PAGING TYPE 1 or a SYSTEM INFORMATION CHANGE INDICATION message, an ETWS capable UE shall:

1> if the variable ETWS_DUPLICATE_DETECT_PARAM is set:

- 2> if the IE "Message Identifier" and the IE "Serial Number" included in the IE "ETWS information" have the same values as the corresponding IEs in an entry of the variable ETWS_DUPLICATE_DETECT_PARAM:
 - 3> discard the IE "ETWS information".

1> otherwise;

- 2> set the IE "Message Identifier" and IE "Serial Number" in an entry of the variable ETWS_DUPLICATE_DETECT_PARAM;
- 2> forward the IE "ETWS information" to upper layers.

NOTE: The UE may receive the IE "ETWS information" also in an ETWS PRIMARY NOTIFICATION WITH SECURITY message. The UE behaviour is specified in subclause 8.1.17.4.

8.6.9 MBMS specific information elements

The UE shall perform the generic actions defined in this subclause only for the information elements corresponding with services that are included in variable MBMS_ACTIVATED_SERVICES.

8.6.9.1 Continue MCCH Reading

If the "Continue MCCH Reading " is included the UE shall:

- 1> if the IE "Continue MCCH reading " is set to 'TRUE':
 - 2> continue receiving the MBMS MODIFIED SERVICES INFORMATION from MCCH in the next modification period and act upon it as specified in subclause 8.7.3.4.

8.6.9.1a MBMS dynamic persistence level

If the IE "MBMS dynamic persistence level" is included the UE shall:

- 1> Apply the dynamic persistence level in place of that broadcast in SIB 7 for MBMS related PRACH transmissions that are made within the modification period in which this IE was received.

8.6.9.2 MBMS PL Service Restriction Information

The UE shall:

- 1> if the UE receives a Radio Bearer Control message or a CELL UPDATE CONFIRM message:
 - 2> if the IE "MBMS PL Service Restriction Information" is included:
 - 3> set the variable MBMS_PL_SERVICE_RESTRICTION_INFO_DEDICATED to TRUE.
 - 2> else:
 - 3> set the variable MBMS_PL_SERVICE_RESTRICTION_INFO_DEDICATED to FALSE.
- 1> if the UE receives a Radio Bearer Control message or a CELL UPDATE CONFIRM message or an MBMS GENERAL INFORMATION message:
 - 2> perform the MBMS frequency selection procedure as specified in subclause 8.5.27.

8.6.9.3 MBMS L1 combining schedule

If the IE "MBMS L1 combining schedule" is included the UE may:

- 1> apply L1 combining between the concerned neighbouring cell' S-CCPCH and the corresponding current cell's S-CCPCH for the periods indicated by this IE.

8.6.9.3a MBMS Number of neighbour cells

The UE may:

- 1> apply the number of neighbour cells to identify if all MBMS NEIGHBOURING CELL P-T-M RB INFORMATION messages have been received from MCCH.

8.6.9.4 MBMS Preferred frequency information

If the IE "MBMS Preferred frequency information" is included the UE shall:

- 1> if HCS is not used, and the IE "Qoffmbms" is not present for the MBMS preferred frequency:
 - 2> consider the cells on the MBMS preferred frequency having a Qoffmbms equal to "infinity".
- 1> if HCS is used, and the IE "HCS_OFFmbms" is not present for the MBMS preferred frequency:
 - 2> consider the cells on the MBMS preferred frequency having the highest HCS priority level.
- 1> perform the MBMS frequency selection procedure as specified in subclause 8.5.27.

8.6.9.4a Void

8.6.9.4b MBMS p-t-m activation time

Upon reception of the IE "MBMS p-t-m activation time", for the services included in the IE "Modified service list" in the MBMS MODIFIED SERVICES INFORMATION message, and, if the IE "MBMS all unmodified p-t-m services" is included in the MBMS MODIFIED SERVICES INFORMATION message, for the services included in the IE "Unmodified services list" included in the MBMS UNMODIFIED SERVICES INFORMATION message, the UE shall:

- 1> if the IE "MBMS required UE action" for this service is set to "Acquire PTM RB info":
 - 2> for the current cell:
 - 3> stop using any old configuration on TTIs that are after or contain the time instant as indicated by the IE "MBMS p-t-m activation time";
 - 3> start using the configuration for the S-CCPCH received for that p-t-m bearer in the same modification period as the IE "MBMS p-t-m activation time" on TTIs that are after or that contain the time instant as indicated by the IE "MBMS p-t-m activation time".
 - 2> for neighbouring cells:
 - 3> for the neighbouring cells for which the IE "MBMS transmission time difference" is included:
 - 4> stop using any old configuration on TTIs corresponding to the TTIs of the cell wherein the UE is reading the MCCH from and where the new p-t-m radio bearer information is valid according to the above;
 - 4>> start using the configuration for the S-CCPCH received for that p-t-m bearer in the same modification period as the IE "MBMS p-t-m activation time" on TTIs corresponding to the TTIs of the cell wherein the UE is reading the MCCH from and where the new p-t-m radio bearer information is valid according to the above.
 - 3> for the neighbouring cells for which the IE "MBMS transmission time difference" is not included:
 - 4> stop using any old configuration on TTIs that are after or contain the time instant as indicated by the IE "MBMS p-t-m activation time".

- 4> start using the configuration for the S-CCPCH received for that p-t-m bearer in the same modification period as the IE "MBMS p-t-m activation time" on TTIs that are after the time instant as indicated by the IE "MBMS p-t-m activation time".

8.6.9.5 MBMS RB list released to change transfer mode

If the IE "MBMS RB list released to change transfer mode" is included the UE shall:

- 1> perform the service prioritisation procedure as specified in subclause 8.5.26, taking into account that the MBMS service(s) for which the radio bearers are released will be provided via p-t-m radio bearer(s).

8.6.9.6 MBMS Required UE action

If the IE "MBMS required UE action" is included and concerns an MBMS activated service the UE shall:

- 1> if the "MBMS required UE action" is set to 'None':
 - 2> take no action with respect to this IE.
- 1> if the IE "MBMS required UE action" is set to 'Acquire counting info' or set to 'Acquire counting info– PTM RBs unmodified':
 - 2> perform the MBMS counting procedure as specified in subclause 8.7.4;

NOTE: If upper layers indicate that an MBMS transmission has already been received correctly, the UE will continue as if the information about the concerned MBMS transmission was not included in the message. This implies that the UE does not respond to counting for a transmission already received correctly.

- 1> if the IE "MBMS required UE action" is set to 'Acquire PTM RB info'; or
- 1> if the IE "MBMS required UE action" is set to 'Acquire counting info– PTM RBs unmodified' and the UE is not receiving a p-t-m RB for the concerned service:
 - 2> continue acquiring the MBMS COMMON P-T-M RB INFORMATION, MBMS CURRENT CELL P-T-M RB INFORMATION and the MBMS NEIGHBOURING CELL P-T-M RB INFORMATION messages without delaying reading of MCCCH until the next modification period and without stopping at the end of the modification period, in accordance with subclause 8.7.1.3
 - 2> act upon the MBMS COMMON P-T-M RB INFORMATION, MBMS CURRENT CELL P-T-M RB INFORMATION and the MBMS NEIGHBOURING CELL P-T-M RB INFORMATION message, if received, in accordance with subclause 8.7.5;
- 1> if the IE "MBMS required UE action" is set to 'Request PTP RB':
 - 2> if the UE is in idle mode:
 - 3> indicate to upper layers that establishment of a PS signalling connection is required to receive the concerned MBMS [5], unless the UE has already requested p-t-p RB establishment in the current modification period, and use the establishment cause set to 'MBMS ptp RB request' in the RRC connection establishment procedure.
 - 2> if the UE is in URA_PCH, Cell_PCH or CELL_FACH states:
 - 3> indicate to upper layers to initiate a service request procedure [5] to receive the concerned MBMS service;
 - 3> perform the cell update procedure with cause "MBMS ptp RB request", as specified in subclause 8.3.1.2, unless the UE has already requested p-t-p RB establishment in the current modification period.
 - 2> if the UE is in CELL_DCH:
 - 3> indicate to upper layers to initiate a service request procedure [5] to receive the concerned MBMS service.
- 1> if the IE "MBMS required UE action" is set to 'Release PTM RB':

- 2> stop receiving the concerned MBMS service;
- 2> for 1.28 Mcps TDD, if the IE "MBMS PTM RB Release Cause" is present to indicate the actual MBMS PTM RB release cause to UE:
 - 3> pass the value of the IE "MBMS PTM RB Release Cause" to upper layers.
- 2> if the UE is in a state other than CELL_DCH (for FDD) or if the UE is in Idle mode, URA_PCH or CELL_PCH state (for TDD); and
- 2> if the UE decides not to receive an MBMS service indicated on the MCCH; and
- 2> if the variable MBMS_PREV_FREQUENCY_INFO is not empty:
 - 3> if any frequency in SIB11 or SIB12 has the same frequency stored in the variable MBMS_PREV_FREQUENCY_INFO:
 - 4> select a suitable UTRA cell in that frequency.
 - 4> if no suitable UTRA cell in that frequency is found:
 - 5> select a suitable UTRA cell in another frequency.
 - 3> if no frequency in SIB11 or SIB12 has the same frequency stored in the variable MBMS_PREV_FREQUENCY_INFO.
 - 4> select a frequency randomly among the inter-frequencies indicated in SIB11 or SIB12.
 - 5> select a suitable UTRA cell in the selected frequency
 - 5> if no suitable UTRA cell in the selected frequency is found:
 - 6> select a suitable UTRA cell in another frequency.
 - 3> clear the variable MBMS_PREV_FREQUENCY_INFO.
 - 2> clear all service specific information applicable for the concerned service.

NOTE: The UE is only required to acquire the relevant SIB11 or SIB12, according to what is specified in subclauses 8.1.1.6.11 and 8.1.1.6.12.

8.6.9.6a MBMS re- acquire MCCH

If the UE receives the IE " MBMS re- acquire MCCH", the UE shall:

- 1> perform the MCCH acquisition procedure as specified in subclause 8.7.2.

8.6.9.7 MBMS Service transmissions info list

If the UE receives the IE "MBMS Service transmissions info list", the UE may:

- 1> discontinue reception of the S-CCPCH on which the IE was received, except for the service transmissions indicated by this IE for the concerned scheduling period.

8.6.9.8 MBMS Short transmission ID

If the IE "MBMS short transmission ID" is included the UE shall:

- 1> if the value of the "MBMS short transmission ID" is less than or equal to the number of services identified by the IE "Modified services list" included in the MBMS MODIFIED SERVICES INFORMATION message acquired in the same modification period as the one in which the "MBMS short transmission ID" is received:
- 2> consider the "MBMS short transmission ID" to be an index to the list of services contained in the IE "Modified services list" and apply the MBMS transmission identity specified for this entry.

- 1> otherwise:

- 2> compile a list of available MBMS services, as included in the MBMS MODIFIED SERVICES INFORMATION and the MBMS UNMODIFIED SERVICES INFORMATION messages acquired in the same modification period as the one in which the "MBMS short transmission ID" is received:
- 3> concatenate the services contained in IE "Modified services list" included in the MBMS MODIFIED SERVICES INFORMATION and the services contained in IE "Unmodified services list" included in the MBMS UNMODIFIED SERVICES INFORMATION.
- 2> consider the 'MBMS short transmission ID' to be the index of the entry in the list of available services and apply the MBMS transmission identity specified for this entry.

8.6.9.9 MBMS Transmission identity

If the IE "MBMS transmission identity" is included the UE shall:

- 1> if upper layers indicate that the MBMS transmission has already been received correctly:
 - 2> ignore the information about this MBMS transmission i.e. continue as if the information about the concerned MBMS transmission was not included in the message.
- 1> otherwise:
 - 2> act upon the information about the concerned MBMS transmission as specified elsewhere.

The UE behaviour is unspecified if an MBMS transmission identity appears more than once in the combined list of transmissions i.e. the IE is included more than once in the MBMS MODIFIED SERVICES INFORMATION or in the MBMS UNMODIFIED SERVICES INFORMATION, or once in both message.

8.6.9.9a MBMS transmission time difference

The IE "MBMS transmission time difference" indicates the time difference between the transmissions on the current and the neighbour cell i.e. indicating the TTIs that can be L1- combined. The UE shall:

- 1> derive the parameter Neighbor_Start from the IE MBMS transmission time difference as follows:

$$\text{MBMS transmission time difference} = (\text{Neighbor_Start} / \text{Max_TTI_Size}) \bmod 4$$

where Neighbor_Start is the CFN of the first radio frame in a TTI on the neighbour cell that may be combined with the TTI on the current cell of which the CFN of the first radio frame equals 0 while Max_TTI_Size is the largest TTI size on the S-CCPCHs to be soft combined;

- 1> in case of partial soft combining, derive the CFN of the first radio frame in a TTI on the neighbour cell that may be combined assuming the same time difference applies.

The maximum delay between S-CCPCH clusters that the UE may combine is set by UE performance requirements.

NOTE: The MBMS transmission time difference is semi-static; it does not vary within or between L1 combining periods nor when full combining is used.

8.6.9.9ab MBSFN cluster frequency

If the cell is operating in MBSFN mode according to subclause 8.1.1.6.3 the UE shall:

- 1> if for two or more services included in variable MBMS_ACTIVATED_SERVICES the IE "MBSFN cluster frequency" is available:
 - 2> request from upper layers the priorities of the different MBMS services included in variable MBMS_ACTIVATED_SERVICES for which the IE "MBSFN cluster frequency" is available;
 - 2> if the IE "MBSFN cluster frequency" is available for the service with the highest priority included in variable MBMS_ACTIVATED_SERVICES:
 - 3> tune to the frequency indicated in the IE "MBSFN cluster frequency" of that service.

8.6.9.9ac MBSFN frequency list

For FDD and 3.84/7.68 Mcps TDD this IE may be included in system information block 11 in a cell which is not providing MBMS service in MBSFN mode in order to provide information about frequencies providing MBMS service in MBSFN mode. For 1.28 Mcps TDD this IE shall be included in system information block 11 in a cell which is not providing MBMS service in MBSFN only mode but is associated with one or more cells in MBSFN only mode, in order to provide information about frequencies providing MBMS service in MBSFN only mode, and this IE also provides information about the secondary frequencies providing MBMS service in non-MBSFN only mode of current multi-frequency cell.

If the IE "MBSFN frequency list" is included in system information block 11, a UE may consider that all frequencies on which FDD or 3.84/7.68 Mcps TDD cells providing MBMS service in MBSFN mode are listed in the IE "MBSFN frequency list". If the IE "IMB indication" is included in the IE "MBSFN frequency list", the UE shall consider that the cells on the corresponding frequencies are 3.84 Mcps TDD IMB cells providing MBMS service in MBSFN mode.

If the IE "MBSFN frequency list" is included in system information block 11 and no frequency is included in the IE "MBSFN frequency list" a UE may consider that no cell operating in MBSFN mode is available.

For FDD and 3.84/7.68 Mcps TDD if the IE "MBSFN frequency list" is not included in system information block 11 and if services are listed in the variable MBMS_ACTIVATED_SERVICES a UE supporting reception of MBMS service in MBSFN mode shall search for cells providing MBMS service in MBSFN mode.

For 1.28 Mcps TDD the IE "Cell parameter ID" in the IE "MBSFN frequency list" included in system information block 11 indicates the cell which is providing MBMS service in MBSFN only mode on the corresponding frequency; if the IE "Cell parameter ID" is not included in the IE "MBSFN frequency list", a UE may consider that the corresponding frequency is the secondary frequency providing MBMS service in non-MBSFN only mode of current multi-frequency cell.

8.6.9.9ad MBSFN inter frequency neighbour list

For FDD, 3.84 Mcps TDD IMB and 3.84/7.68 Mcps TDD, this IE may be signalled in the "MBMS GENERAL INFORMATION" message received in the cells providing MBMS service in MBSFN mode. If the IE "MBSFN inter frequency neighbour list" is included and the UE does not receive a service from this MBSFN cluster, the UE shall:

- 1> consider that MBMS services transmitted in MBSFN mode are available on these frequencies;
- 1> if IE "IMB indication" is included:
 - 2> consider that the cells on the corresponding frequencies are 3.84 Mcps TDD IMB cells providing MBMS service in MBSFN mode.
- 1> if "MBSFN services notified" is indicated for a frequency listed in the IE "MBSFN inter frequency neighbour list":
 - 2> consider that available services provided on this frequency are notified on the current frequency.
- 1> if at least one frequency is listed for which "MBSFN services not notified" is indicated in the IE "MBSFN inter frequency neighbour list":
 - 2> if the IE "All MBSFN services notified" is included for one frequency, as defined in [21] for FDD and [22] for TDD, on which the UE supports reception in MBSFN mode:
 - 3> attempt to receive notifications on one of the frequencies for which the IE "All MBSFN services notified" is included according to subclause 8.7.3.
 - 2> else:
 - 3> attempt to receive notifications on all frequencies for which the IE 'MBSFN services not notified' is indicated as specified in subclause 8.7.3 on that band.

NOTE 1: The UE may not be able to receive frequencies listed in the IE "MBSFN inter frequency neighbour list" on a different band compared to the band on which the information is sent (this depends on UE capabilities).

NOTE 2: The indications for different frequencies (i.e. "MBSFN services notified", "MBSFN services not notified", "All MBSFN services notified") in the MBMS GENERAL INFORMATION message can be different depending on the frequency in which the MBMS GENERAL INFORMATION message has been received.

8.6.9.9ae MBSFN TDM Information

If the IE "MBSFN TDM Information List" is included, the UE shall:

- 1> assume that the MBMS service identified in IE "MBMS short transmission ID" can be received only in frame(s) with the CFN fulfilling the following equation:

$$(CFN \text{ div } N) \bmod \text{TDM_Rep} = \text{TDM_Offset} + i, i = 0 \text{ to } \text{TDM_Length} - 1$$

where

- N is the TTI (in number of 10ms frames) of the FACH
- TDM_Rep is the repetition period
- TDM_Offset is the offset
- TDM_Length is the number of TTIs the MBMS Service is transmitted, starting from TDM_Offset
- CFN is set according to subclause 8.5.15.3 (Initialisation for Cell_FACH).

8.6.9.9b MCCH configuration information

If the IE "MCCH configuration information" is included the UE shall:

- 1> Consider an access information period to start from the frame with the SFN value fulfilling the following equation (where m is the modification period coefficient and a is the access info period coefficient):

$$\text{SFN} \bmod 2^{(m-a)} = 0$$

- 1> Consider a repetition period to start from the frame with the SFN value fulfilling the following equation (where m is the modification period coefficient and r is the repetition period coefficient):

$$\text{SFN} \bmod 2^{(m-r)} = 0$$

- 1> Consider a modification period to start from the frame with the SFN value fulfilling the following equation (where m is the modification period coefficient):

$$\text{SFN} \bmod 2^m = 0$$

- 1> configure the RLC entity in the UE used for receiving MCCH in accordance with 8.6.4.9;

- 1> configure the MAC entity in the UE, used for receiving MCCH, for receiving TCTF field unless the IE 'TCTF presence' is received;

8.6.9.10 Next scheduling period

If the IE "Next scheduling period" is included for an MBMS service the UE may:

- 1> discontinue reception of the given MBMS service for the number of scheduling periods indicated by this IE.

8.6.9.11 TDD MBSFN Information

For TDD if the UE receives "TDD MBSFN Information" (via System Information Block type 5) then the UE shall assume that any CCTrCH configured to use the timeslots indicated by this IE shall use MBSFN Burst Type.

8.6.9.12 Network Standard Time Information

For 1.28Mcps TDD, when UE receives 'Network Standard Time Information' via MBMS general information, the UE can adjust its local time settings according to the values in 'Network Standard Time Information'. The adjustment process is as following:

- 1) Compare currently SFN and 'Correlative SFN', get a difference;
- 2) Add this difference to 'Network Standard Time'

The result is the precise standard time in currently SFN, and then UE can maintain this standard time. How often does UE do this adjustment is a UE implementation.

8.7 MBMS specific procedures

8.7.1 Reception of MBMS control information

8.7.1.1 General

The procedure for receiving MBMS control information is used by a UE to receive information from UTRAN concerning the way it provides MBMS services the UE has activated. The procedure applies to all UEs supporting MBMS, irrespective of its state (idle, URA_PCH, CELL_PCH, CELL_FACH and CELL_DCH).

Most MBMS control information is provided on the MCCH. The information on MCCH is transmitted using a fixed schedule, which is common for all services. MCCH information other than MBMS ACCESS INFORMATION message is transmitted periodically based on a repetition period. This MCCH information is repeated a configurable number of times with exactly the same content; the period in which the content of MCCH information other than MBMS ACCESS INFORMATION message remains unchanged is called the modification period. MBMS ACCESS INFORMATION message may be transmitted more frequently, based on the Access Info period. The transmissions of MBMS ACCESS INFORMATION message within a modification period need not have exactly the same content (the value of some parameters eg. IE 'Access probability factor – Idle' may change). Nevertheless, the transmissions of MBMS ACCESS INFORMATION message within a modification period should concern the same MBMS service(s), although information for a service may be removed eg. upon completion of the counting for that service.

The general principles are illustrated in figure 8.7.1-1, in which different colours indicate potentially different content of the MCCH information.

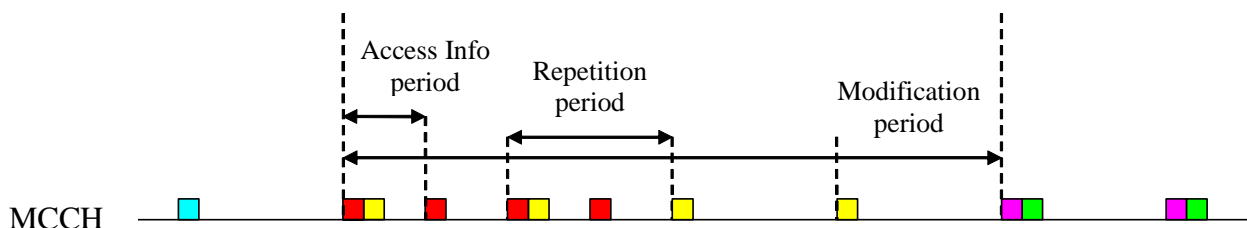

Figure 8.7.1-1: Scheduling of MCCH Information

For services provided via a p-t-m radio bearer scheduling information may be provided on an MSCH mapped on the same S-CCPCH as the p-t-m radio bearer(s). For some of the services provided p-t-m this scheduling information may be provided by signalling an MBMS SCHEDULING INFORMATION message at every scheduling period, while for others the MBMS SCHEDULING INFORMATION message may be signalled less frequently i.e. after a multiple of the scheduling period. In general, the UE is neither required to acquire MSCH information nor to act on it.

In case the UE shall acquire MCCH information that is scheduled at the same time as MSCH information, the reception of the MCCH information shall take precedence.

In order to minimise the time the UE needs to read MCCH upon notification as specified in 8.7.3 to acquire the required information, UTRAN should schedule the MCCH messages in a specific order ie. any message that needs to be read by any UE due to the reception of the MBMS MODIFIED SERVICES INFORMATION message should be scheduled prior to the remaining messages. More specifically, the UE may assume that UTRAN schedules the MCCH messages in the following order:

MBMS MODIFIED SERVICES INFORMATION,

followed by messages that needs to be read by any UE due to the content of the MBMS MODIFIED SERVICES INFORMATION message in the following order: MBMS GENERAL INFORMATION, MBMS COMMON P-T-M RB INFORMATION, MBMS CURRENT CELL P-T-M RB INFORMATION, one or more MBMS NEIGHBOURING CELL P-T-M RB INFORMATION,

MBMS UNMODIFIED SERVICES INFORMATION,

followed by messages that do not need to be read by any UE due to the content of the MBMS MODIFIED SERVICES INFORMATION message in the following order: MBMS GENERAL INFORMATION, MBMS COMMON P-T-M RB INFORMATION, MBMS CURRENT CELL P-T-M RB INFORMATION, one or more MBMS NEIGHBOURING CELL P-T-M RB INFORMATION

8.7.1.2 Initiation

The requirements concerning which MBMS control information the UE shall acquire in the different cases is specified in other subclauses. This section specifies common requirements concerning the reception of MCCH information and MSCH information.

8.7.1.3 UE requirements on reading of MCCH information

When requested to acquire MBMS control information other than the MBMS ACCESS INFORMATION message , the UE shall:

- 1> if requested to start reading MCCH at the next modification period:
 - 2> start reading MCCH at the beginning of the next modification period.
- 1> otherwise
 - 2> start reading MCCH at the beginning of the next repetition period.
- 1> if requested to stop reading MCCH at the end of the modification period:
 - 2> continue reading MCCH until the required MBMS control information is received or until the UE detects a TTI in which no MCCH information is transmitted, whichever is first;
 - 2> continue reading MCCH in this manner at every subsequent repetition period, until the information is received correctly or until the end of the modification period.
- 1> otherwise:
 - 2> continue reading MCCH until the required MBMS control information is received or until the UE detects a TTI in which no MCCH information is transmitted, whichever is first;
 - 2> continue reading MCCH in this manner at every subsequent repetition period, until the information is received correctly.

NOTE 1: The UE may combine information received at different repetition periods within a modification period.

When requested to acquire the MBMS ACCESS INFORMATION message, the UE shall:

- 1> if requested to start reading MCCH at the next modification period:
 - 2> start reading MCCH at the beginning of the next modification period.
- 1> otherwise:
 - 2> start reading MCCH at the beginning of the next access info period.
- 1> continue reading MCCH in this manner at every subsequent access info period, until the message is received correctly or until the end of the modification period.

If the UE is CELL_DCH and has a compressed mode pattern that overlaps with the period in which it needs to read MCCH, the UE may temporarily refrain from receiving MCCH unless it is capable of simultaneous operation. If the UE

is CELL_FACH and has a measurement occasion that overlaps with the period in which it needs to read MCCH, the UE may temporarily refrain from receiving MCCH unless it is capable of simultaneous operation. A UE in CELL_FACH may omit performing measurements during a measurement occasion in order to receive MCCH provided that this does not prevent it from fulfilling the measurement performance requirements as specified in [19]. In Idle mode as well as in CELL_PCH and URA_PCH states the UE may temporarily refrain from receiving MCCH if needed to fulfil the measurements performance requirements as specified in [19].

NOTE 2: The UTRAN should endeavour to ensure that for each UE in CELL_FACH the assigned measurement occasions do not overlap constantly with the periodic MCCH transmissions.

If the UE selects to another cell, the UE shall re-establish the RLC entity used for MCCH reception.

8.7.1.4 UE requirements on reading of MSCH information

If the UE supports reception of MSCH, UE shall:

- 1> if the UE needs to acquire MCCH information that is transmitted at the same time as the MSCH information and the UE does not support simultaneous reception:
 - 2> refrain from reading MSCH.

If the UE supports reception of MSCH, UE should:

- 1> start reading MSCH at the beginning of the next scheduling period;
- 1> continue reading MSCH until the required MBMS control information is received or until the UE detects a TTI in which no MSCH information is transmitted, whichever is first.

8.7.2 MCCH acquisition

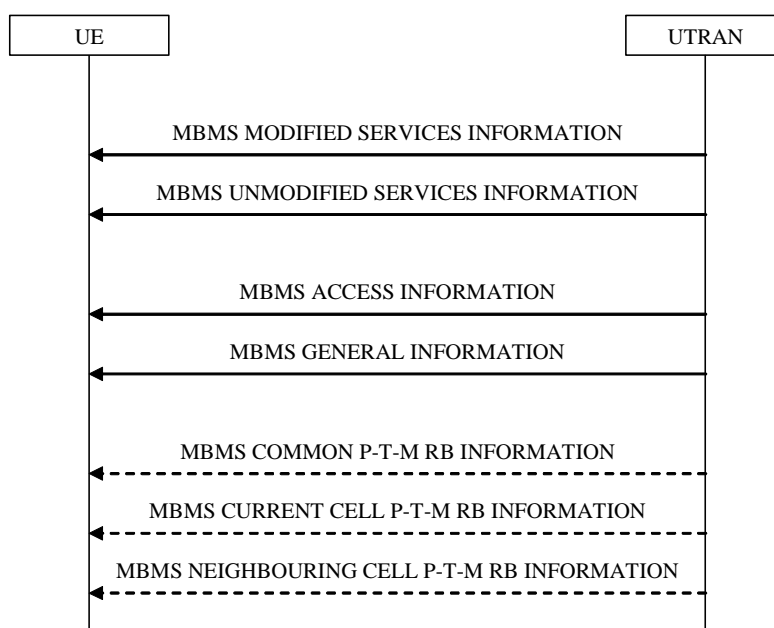

Figure 8.7.2-1: MCCH acquisition, normal

8.7.2.1 General

The UE applies the MCCH acquisition procedure to determine the MBMS services available in the cell and to initiate reception of the services that the UE has activated. The procedure applies to all UEs supporting MBMS, irrespective of their state (idle, URA_PCH, CELL_PCH, CELL_FACH and CELL_DCH). The UE may also apply the MCCH acquisition procedure to inform NAS of other available services that are not activated.

For 1.28 Mcps TDD, if the cell is operating in MBSFN mode, the MCCH will be deployed on the MBSFN Special Timeslot [30].

8.7.2.2 Initiation

If the variable MBMS_ACTIVATED_SERVICES is not empty, the UE shall apply the MCCH acquisition procedure upon selecting (eg. upon power on) or re-selecting a cell supporting MBMS or an MBSFN cluster, upon change of MBMS controlling cell (eg. due to an active set update or hard handover), upon entering UTRA from another RAT, upon release of a MBMS PTP RB for the purpose of changing transfer mode, upon return from loss of coverage and upon receiving an indication from upper layers that the set of activated services has changed.

8.7.2.3 MCCH information to be acquired by the UE

The UE shall detect the available MBMS services by acquiring the MBMS MODIFIED SERVICES INFORMATION and the MBMS UNMODIFIED SERVICES INFORMATION messages without delaying reading of MCCH until the next modification period and without stopping at the end of the modification period, in accordance with subclause 8.7.1.3.

For cells not operating in MBSFN mode as indicated in subclause 8.1.1.6.3 the UE shall immediately acquire the MBMS ACCESS INFORMATION and the MBMS GENERAL INFORMATION messages ie. it shall not delay reception of these messages until it has completed the acquisition of the MBMS MODIFIED SERVICES INFORMATION and the MBMS UNMODIFIED SERVICES INFORMATION messages. Likewise for cells not operating in MBSFN mode as indicated in subclause 8.1.1.6.3, the UE should immediately acquire the MBMS CURRENT CELL P-T-M RB INFORMATION and MBMS NEIGHBOURING CELL P-T-M RB INFORMATION messages.

For cells operating in MBSFN mode as indicated in subclause 8.1.1.6.3 the UE shall immediately acquire the MBMS GENERAL INFORMATION messages ie. it shall not delay reception of these messages until it has completed the acquisition of the MBMS MODIFIED SERVICES INFORMATION and the MBMS UNMODIFIED SERVICES INFORMATION messages. Likewise for cells operating in MBSFN mode as indicated in subclause 8.1.1.6.3, the UE should immediately acquire the MBMS CURRENT CELL P-T-M RB INFORMATION.

The UE shall continue acquiring the above messages until it has received a consistent set of MCCH information eg. both the MBMS MODIFIED SERVICES INFORMATION and the MBMS UNMODIFIED SERVICES INFORMATION message should be acquired in the same modification period.

8.7.2.4 Reception of the MBMS MODIFIED SERVICES INFORMATION and the MBMS UNMODIFIED SERVICES INFORMATION by the UE

If the UE is receiving an MBMS service that is not included in variable MBMS_ACTIVATED_SERVICES and that is using a p-t-m radio bearer, the UE shall:

- 1> stop receiving the concerned MBMS service and clear all service specific information applicable for the concerned service.
- 1> if the UE is in a state other than CELL_DCH (for FDD) or if the UE is in Idle mode, URA_PCH or CELL_PCH state (for TDD); and
- 1> if the UE does not decide to receive an MBMS service; and
- 1> if the variable MBMS_PREV_FREQUENCY_INFO is not empty:
 - 2> if any frequency in SIB11 or SIB12 has the same frequency stored in the variable MBMS_PREV_FREQUENCY_INFO:
 - 3> select a suitable UTRA cell in that frequency;
 - 3> if no suitable UTRA cell in that frequency is found:
 - 4> select a suitable UTRA cell in another frequency.
 - 2> if no frequency in SIB11 or SIB12 has the same frequency stored in the variable MBMS_PREV_FREQUENCY_INFO:
 - 3> select a frequency randomly among the inter-frequencies indicated in SIB11 or SIB12:
 - 4> select a suitable UTRA cell in the selected frequency;

4> if no suitable UTRA cell in the selected frequency is found:

5> select a suitable UTRA cell in another frequency.

2> clear the variable MBMS_PREV_FREQUENCY_INFO.

NOTE: The UE is only required to acquire the relevant SIB11 or SIB12, according to what is specified in subclauses 8.1.1.6.11 and 8.1.1.6.12.

Upon completing the reception of the MBMS MODIFIED SERVICES INFORMATION and the MBMS UNMODIFIED SERVICES INFORMATION messages, the UE shall

- 1> act as follows for each of the services included in these messages provided that the service is included in variable MBMS_ACTIVATED_SERVICES and upper layers indicate that the session has not yet been received correctly (referred to as 'applicable services');
- 1> act upon all received information elements as specified in subclause 8.6, unless specified otherwise in the following;
 - 1> if one or more preferred frequency applies for the applicable services:
 - 2> delay acting upon the "MBMS Preferred frequency information" until receiving the relevant MCCH information i.e. the MBMS GENERAL INFORMATION message;
 - 2> act upon the "MBMS Preferred frequency information" as specified in subclause 8.6.9.4 for the service(s) that upper layers indicate to have highest priority.
- 1> perform the MBMS frequency selection procedure as specified in subclause 8.5.27;
- 1> if the UE receives an MBMS service using a p-t-m radio bearer and the received messages do not contain an IE "MBMS required UE action" set to "Acquire PTM RB info" or set to "Acquire counting info- PTM RBs unmodified" for that service then the UE shall:
 - 2> stop receiving the concerned MBMS service and clear all service specific information applicable for the concerned service.

8.7.2.5 Reception of the other MBMS messages by the UE

For cells not operating in MBSFN mode as indicated in subclause 8.1.1.6.3, upon receiving the MBMS ACCESS INFORMATION message, the UE shall act as specified in subclause 8.7.4.3.

Upon receiving the MBMS GENERAL INFORMATION message, the UE should store all relevant IEs included in this message. The UE shall also:

- 1> act upon all received information elements as specified in subclause 8.6, unless specified otherwise in the following.

For cells not operating in MBSFN mode as indicated in subclause 8.1.1.6.3, upon receiving the MBMS CURRENT CELL P-T-M RB INFORMATION and MBMS NEIGHBOURING CELL P-T-M RB INFORMATION messages, the UE shall act as specified in subclauses 8.7.5.3 and subclause 8.7.5.4 respectively.

For cells operating in MBSFN mode as indicated in subclause 8.1.1.6.3 upon receiving the MBMS CURRENT CELL P-T-M RB INFORMATION message, the UE shall act as specified in subclauses 8.7.5.3.

The procedure ends.

8.7.3 MBMS Notification

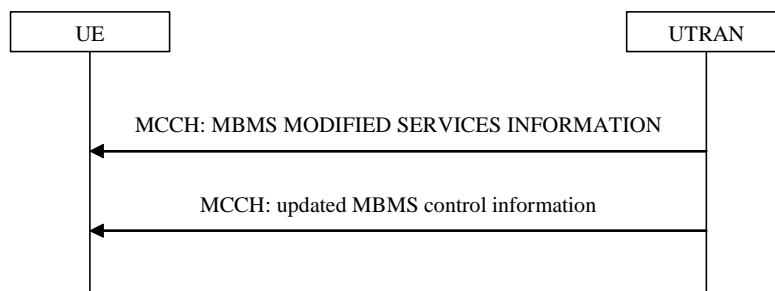

Figure 8.7.3-1: MBMS notification on MCCH

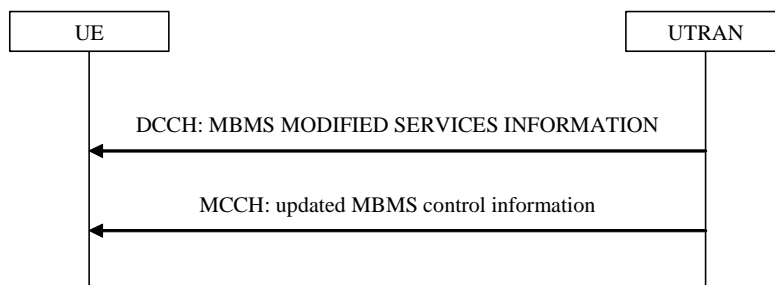

Figure 8.7.3-2: MBMS notification on DCCH

8.7.3.1 General

The MBMS notification procedure is used by the UE to respond to a notification provided by UTRAN, indicating a change applicable for one or more MBMS services the UE has activated. The procedure applies to all UEs supporting MBMS, irrespective of their state (idle and connected mode: URA_PCH, CELL_PCH, CELL_FACH and CELL_DCH). The actual notification mechanism to be used depends on the UE state.

Reception of the MBMS MODIFIED SERVICES INFORMATION message on DCCH is optional for a UE capable of reading MCCH in CELL_DCH.

8.7.3.2 Initiation

UTRAN initiates the notification procedure to inform UEs about a change applicable for one or more MBMS services available in a cell. Some types of MBMS service changes e.g. the establishment of a p-t-m radio bearer, involve a modification of MCCH messages other than the MBMS MODIFIED SERVICES INFORMATION message.

NOTE 1: On MCCH, the MBMS MODIFIED SERVICES INFORMATION as well as the MBMS UNMODIFIED SERVICES INFORMATION messages are signalled even if no services are contained in the message.

NOTE 2: A service remains in the MBMS MODIFIED SERVICES INFORMATION message until it enters a 'steady state', upon which it moves to the MBMS UNMODIFIED SERVICES INFORMATION message. In case counting is used, the service remains in the MBMS MODIFIED SERVICES INFORMATION message through the moment UTRAN has decided the transfer mode.

8.7.3.3 Receiving the MBMS Notification information

8.7.3.3.1 Reception via MCCH

The UE may:

- 1> monitor the MBMS notification Indicator Channel (MICH);
- 1> if a notification on the MICH for one or more of the MBMS services included in the variable MBMS_ACTIVATED_SERVICES is detected:

2> acquire the MBMS MODIFIED SERVICES INFORMATION message with delaying the reading of MCCH until the next modification period and with stopping at the end of the modification period, in accordance with subclause 8.7.1.3;

2> handle the MBMS MODIFIED SERVICES INFORMATION message as specified in subclause 8.7.3.4.

The UE shall:

1> if in idle mode, URA_PCH, CELL_PCH or CELL_FACH state:

2> if not monitoring MICH during the current or the previous modification period:

3> acquire the MBMS MODIFIED SERVICES INFORMATION message from MCCH at the start of every modification period, in accordance with subclause 8.7.1.3;

3> handle the MBMS MODIFIED SERVICES INFORMATION message as specified in subclause 8.7.3.4.

1> if in CELL_DCH state:

2> if receiving an MBMS service that is provided via a p-t-m radio bearer and not monitoring MICH:

3> acquire the MBMS MODIFIED SERVICES INFORMATION message from MCCH at the start of every modification period, in accordance with subclause 8.7.1.3;

3> handle the MBMS MODIFIED SERVICES INFORMATION message as specified in subclause 8.7.3.4.

8.7.3.3.2 Void

8.7.3.3.3 Reception via DCCH

Notification via DCCH is used to notify the UE about the start of a session for which a PL applies, to notify the UE about the establishment of a p-t-m radio bearer and to request a UE in PMM_idle state to establish a PMM connection to enable reception of a service provided via a p-t-p radio bearer.

Upon receiving the MBMS MODIFIED SERVICES INFORMATION message via DCCH, a UE in CELL_DCH shall:

1> handle the MBMS MODIFIED SERVICES INFORMATION message as specified in subclause 8.7.3.4.

8.7.3.4 UE action upon receiving MBMS MODIFIED SERVICES INFORMATION message

Upon receiving the MBMS MODIFIED SERVICES INFORMATION message, if the IE "MIB Value tag" is present, the UE should check it to ensure that the stored system information blocks are up to date. If the received IE "MIB Value tag" does not match the value tag stored in the variable VALUE_TAG for the master information block the UE should not consider any MBMS configuration stored or received to be valid, until the stored system information blocks are up to date.

Upon receiving the MBMS MODIFIED SERVICES INFORMATION message, the UE shall act as follows for each of the services included in this messages provided that the service is included in variable MBMS_ACTIVATED_SERVICES and upper layers indicate that the session has not yet been received correctly (referred to as 'applicable services'):

1> if the IE "MBMS all unmodified p-t-m services" is included in the MBMS MODIFIED SERVICES INFORMATION messages:

2> for all services listed in the message UNMODIFIED SERVICES INFORMATION, provided that the service is included in variable MBMS_ACTIVATED_SERVICES, upper layers indicate that the session has not yet been received correctly (referred to as 'applicable services') and the IE "MBMS required UE action" in the message MBMS UNMODIFIED SERVICES INFORMATION is set to "Acquire PTM RB info":

3> continue acquiring the MBMS UNMODIFIED SERVICES INFORMATION, MBMS COMMON P-T-M RB INFORMATION, MBMS CURRENT CELL P-T-M RB INFORMATION, and for FDD and

3.84/7.68 Mcps TDD cells not operating in MBSFN mode as indicated in subclause 8.1.1.6.3 the MBMS NEIGHBOURING CELL P-T-M RB INFORMATION messages without delaying reading of MCCH until the next modification period and without stopping at the end of the modification period, in accordance with subclause 8.7.1.3;

- 3> act upon the MBMS UNMODIFIED SERVICES INFORMATION MBMS COMMON P-T-M RB INFORMATION, MBMS CURRENT CELL P-T-M RB INFORMATION and for FDD and 3.84/7.68 Mcps TDD cells not operating in MBSFN mode as indicated in subclause 8.1.1.6.3 the MBMS NEIGHBOURING CELL P-T-M RB INFORMATION message, if received, in accordance with subclause 8.7.5, and assuming the p-t-m configuration indicated in these messages is valid immediately, unless the IE "MBMS p-t-m activation time" is included in the MBMS MODIFIED SERVICES INFORMATION message.
- 2> if the UE receives an MBMS service using a p-t-m radio bearer and the messages MBMS UNMODIFIED SERVICES INFORMATION and MBMS MODIFIED SERVICES INFORMATION do not contain an IE "MBMS required action" set to "Acquire PTM RB info" or set to "Acquire counting info – PTM RBs unmodified" for that service then the UE shall:
 - 3> stop receiving the concerned MBMS service and clear all service specific information applicable for the concerned service.
 - 3> if the UE is in a state other than CELL_DCH (for FDD) or if the UE is in Idle mode, URA_PCH or CELL_PCH state (for TDD); and
 - 3> if the UE does not decide to receive an MBMS service; and
 - 3> if the variable MBMS_PREV_FREQUENCY_INFO is not empty:
 - 4> if any frequency in SIB11 or SIB12 has the same frequency stored in the variable MBMS_PREV_FREQUENCY_INFO:
 - 5> select a suitable UTRA cell in that frequency;
 - 5> if no suitable UTRA cell in that frequency is found:
 - 6> select a suitable UTRA cell in another frequency.
 - 4> if no frequency in SIB11 or SIB12 has the same frequency stored in the variable MBMS_PREV_FREQUENCY_INFO:
 - 5> select a frequency randomly among the inter-frequencies indicated in SIB11 or SIB12:
 - 6> select a suitable UTRA cell in the selected frequency;
 - 6> if no suitable UTRA cell in the selected frequency is found:
 - 7> select a suitable UTRA cell in another frequency.
 - 4> clear the variable MBMS_PREV_FREQUENCY_INFO.

NOTE: The UE is only required to acquire the relevant SIB11 or SIB12, according to what is specified in subclauses 8.1.1.6.11 and 8.1.1.6.12.

- 1> act upon all received information elements as specified in subclause 8.6, unless specified otherwise in the following
 - 1> if one or more preferred frequency applies for the applicable services:
 - 2> acquire the MBMS GENERAL INFORMATION message.
 - 1> perform the MBMS frequency selection procedure as specified in subclause 8.5.27;
 - 1> the procedure ends.

8.7.3.5 UE fails to receive MBMS Notification information

If the UE fails to receive the MBMS MODIFIED SERVICES INFORMATION message within the current modification period, the UE shall:

- 1> Acquire the MBMS MODIFIED SERVICES INFORMATION and the MBMS UNMODIFIED SERVICES INFORMATION messages without delaying reading of MCCH until the next modification period and with stopping at the end of that modification period, in accordance with subclause 8.7.1.3;
- 1> act upon the received MBMS MODIFIED SERVICES INFORMATION and the MBMS UNMODIFIED SERVICES INFORMATION messages as specified in subclause 8.7.2.4.

8.7.4 MBMS counting

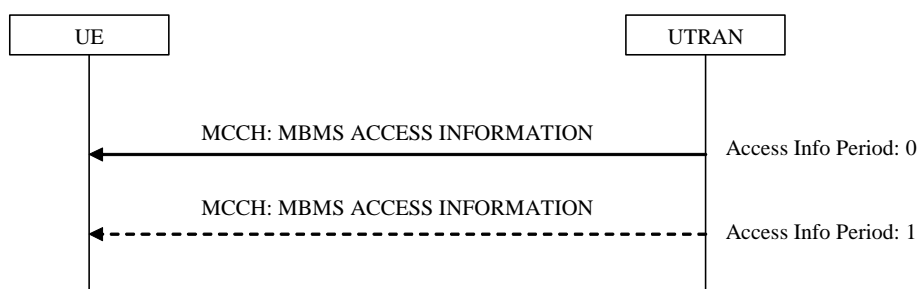

Figure 8.7.4-1: MBMS counting, normal

8.7.4.1 General

The MBMS counting procedure is used by the UE to inform UTRAN about its interest to receive an MBMS transmission. The procedure applies to UEs supporting MBMS that are in idle mode or in connected mode for cells not operating in MBSFN mode as indicated in subclause 8.1.1.6.3. In connected mode the procedure applies to the URA_PCH, Cell_PCH and/ or Cell_FACH states dependent upon the value of the IE "Connected mode counting scope".

8.7.4.2 Initiation

The UE initiates the MBMS counting procedure for an MBMS transmission upon receiving an MBMS MODIFIED SERVICES message including IE "MBMS required UE action" with the value set to 'Acquire counting info' or set to 'Acquire counting info- PTM RBs unmodified'.

8.7.4.3 Reception of the MBMS ACCESS INFORMATION

For cells not operating in MBSFN mode as indicated in subclause 8.1.1.6.3 the UE shall acquire the MBMS ACCESS INFORMATION message without delaying reading of MCCH until the next modification period in accordance with subclause 8.7.1.3. If the procedure the UE would apply to respond to counting (Idle mode: RRC connection establishment, connected mode: Cell update) is ongoing, the UE may defer acquiring the MBMS ACCESS INFORMATION message until this procedure has completed.

The UE behaviour upon receiving an MBMS ACCESS INFORMATION message that is contained in more than one TTI is not specified.

Upon receiving the MBMS ACCESS INFORMATION message for cells not operating in MBSFN mode as indicated in subclause 8.1.1.6.3 including one or more MBMS service(s) it has joined and/or including one or more MBMS Selected Services, the UE shall for each joined and/or selected service:

- 1> if the UE is in idle mode:
 - 2> draw a random number, "rand", uniformly distributed in the range: $0 \leq \text{rand} < 1$
 - 2> if 'rand' is lower than the value indicated by the IE 'Access probability factor-Idle' for the concerned service:

- 3> indicate to upper layers that establishment of an RRC connection is required to receive the concerned MBMS service, with the establishment cause set to 'MBMS reception';
 - 3> if the above condition applies for more than one service, initiate a single indication to upper layers;
 - 3> if the RRC connection establishment succeeds, the procedure ends.
- 2> otherwise:
 - 3> if the message triggering the MBMS counting procedure included the IE "Continue MCCH reading" with a value set to TRUE:
 - 4> continue acquiring further MBMS ACCESS INFORMATION messages without delaying reading of MCCH until the next modification period and without stopping at the end of the modification period, in accordance with subclause 8.7.1.3.
 - 3> otherwise:
 - 4> continue acquiring further MBMS ACCESS INFORMATION messages without delaying reading of MCCH until the next modification period and with stopping at the end of the modification period, in accordance with subclause 8.7.1.3.
 - 1> if the UE is in URA_PCH state, Cell_PCH or Cell_FACH state and the IE "Connected mode counting scope" indicates that counting is applicable for this UE state:
 - 2> draw a random number, "rand", uniformly distributed in the range: $0 \leq \text{rand} < 1$.
 - 2> if 'rand' is lower than the value indicated by the IE 'Access probability factor-connected' for the concerned service:
 - 3> if a cell update has not been successfully transmitted for this service in the current modification period:
 - 4> initiate the cell update procedure with 'Cell update cause' set to "MBMS reception", in accordance with subclause 8.3.1;
 - 4> if the above condition applies for more than one service, initiate a single cell update;
 - 4> if the cell update procedure succeeds,
 - 5> the procedure ends.
 - 2> otherwise:
 - 3> if the message triggering the MBMS counting procedure included the IE "Continue MCCH reading" with a value set to TRUE:
 - 4> continue acquiring further MBMS ACCESS INFORMATION messages without delaying reading of MCCH until the next modification period and without stopping at the end of the modification period, in accordance with subclause 8.7.1.3.
 - 3> otherwise:
 - 4> continue acquiring further MBMS ACCESS INFORMATION messages without delaying reading of MCCH until the next modification period and with stopping at the end of the modification period, in accordance with subclause 8.7.1.3.
 - 1> otherwise:
 - 2> the procedure ends;

Upon receiving the MBMS ACCESS INFORMATION message not including an MBMS service(s) the UE has joined or selected:

 - 1> the procedure ends;

8.7.4.4 Termination of the MBMS counting procedure

If the UE detects that the MBMS ACCESS INFORMATION message is not provided at an access info period; OR

If the UE receives an MBMS ACCESS INFORMATION message not including an MBMS service the UE has joined or selected, the UE shall:

- 1> terminate the MBMS counting procedure.

If the UE receives an RRC CONNECTION REJECT message with Rejection Cause 'unspecified' and including the MBMS "Counting completion" IE, the UE shall:

- 1> consider the MBMS counting procedure ended for the MBMS service(s) for which the UE has initiated the MBMS counting response;
- 1> indicate to upper layers that the establishment of an RRC connection with the establishment cause set to 'MBMS reception' shall be aborted.

8.7.4.5 Failure of the counting response procedure

If the counting response procedure (RRC connection establishment or Cell update) fails, the UE shall:

- 1> if the failure occurs in the same modification period as the one in which the UE initiated the counting response procedure; or
- 1> if the message triggering the MBMS counting procedure included the IE "Continue MCCH reading" with a value set to TRUE that is applicable in the modification period in which the UE detects the failure:
 - 2> continue acquiring further MBMS ACCESS INFORMATION messages without delaying reading of MCCH until the next modification period and without stopping at the end of the modification period, in accordance with subclause 8.7.1.3.
- 1> otherwise:
 - 2> the procedure ends.

8.7.5 MBMS p-t-m radio bearer configuration

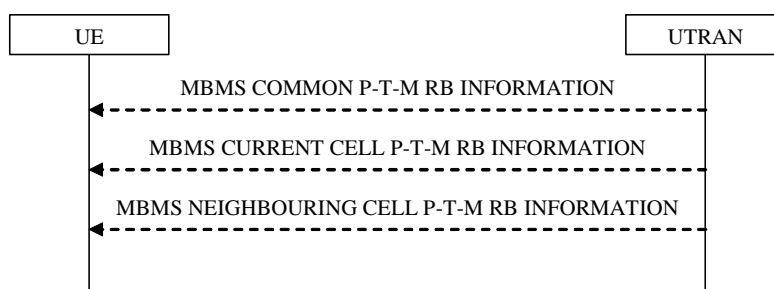

Figure 8.7.5-1: MBMS p-t-m radio bearer modification, normal

8.7.5.1 General

The MBMS p-t-m radio bearer configuration procedure is used by the UE to acquire the (modified) radio bearer configuration for one or more activated MBMS services. The procedure applies to all UEs supporting MBMS, irrespective of their state (idle and connected mode: URA_PCH, CELL_PCH, CELL_FACH and CELL_DCH).

8.7.5.2 Initiation

The UE applies the MBMS p-t-m radio bearer configuration procedure whenever it detects that one of the activated services is provided by means of a p-t-m radio bearer. This may occur as part of the MCCH acquisition or the MBMS Notification procedure.

8.7.5.3 Reception of the MBMS Current Cell PTM RB information

Upon completing the reception of the MBMS COMMON P-T-M RB INFORMATION and the MBMS CURRENT CELL P-T-M RB INFORMATION messages for an activated MBMS service, the UE shall:

- 1> if the UE is already receiving an MTCH and does not have the capability to receive the new service in addition:
 - 2> the UE behaviour is undefined.

NOTE: In this case, the UE may request upper layers to prioritise the services and only receive the service(s) prioritised by upper layers.

- 1> act upon all received information elements as specified in subclause 8.6, unless specified otherwise in the following;
 - 1> if the UE previously received the service by means of a p-t-m radio bearer from a cell belonging to another MBMS cell group:
 - 2> re-establish RLC;
 - 2> re-initialise PDCP.
- 1> start immediately to use the indicated configuration unless specified otherwise;
- 1> start or continue receiving the indicated p-t-m radio bearers depending on its UE capabilities.

The UE shall continue acquiring the above messages until it has received a consistent set of MCCH information i.e. the MBMS MODIFIED SERVICES INFORMATION message, MBMS UNMODIFIED SERVICES INFORMATION message, MBMS COMMON P-T-M RB INFORMATION and the MBMS CURRENT CELL P-T-M RB INFORMATION message should be acquired in the same modification period.

8.7.5.4 Reception of the MBMS Neighbouring Cell PTM RB information

Upon receiving the MBMS NEIGHBOURING CELL P-T-M RB INFORMATION message for an activated MBMS service for a cell not operating in MBSFN mode as indicated in subclause 8.1.1.6.3, the UE shall:

- 1> start immediately to use the indicated neighbouring cells and configuration, or a subset of them, for L1- or L2 combining or Chip combining (1.28Mcps TDD only) unless specified otherwise;
- 1> start or continue receiving the indicated p-t-m radio bearers from the selected neighbouring cells depending on its UE capabilities.

The UE shall apply MBMS NEIGHBOURING CELL P-T-M RB INFORMATION only in combination with an MBMS MODIFIED SERVICES INFORMATION message, MBMS UNMODIFIED SERVICES INFORMATION message, MBMS COMMON P-T-M RB INFORMATION and MBMS CURRENT CELL P-T-M RB INFORMATION message acquired in the same modification period.

8.7.6 MBMS modification request



Figure 8.7.6-1: MBMS modification request, normal

8.7.6.1 General

The MBMS modification request procedure is used by the UE to request UTRAN to release the p-t-p radio bearers of one or more MBMS services the UE is receiving. The procedure is also used to request to be moved to a preferred frequency applicable for one or more (prioritised) activated MBMS services the UE, and to indicate the UE MBMS

Selected Services. The procedure applies to all UEs supporting MBMS, that are in CELL_DCH, CELL_PCH, URA_PCH or CELL_FACH state.

8.7.6.2 Initiation

A UE entering CELL_DCH shall initiate the MBMS modification request procedure in the following cases:

- 1> if the UE has any MBMS Selected Service; and
- 1> if the IE "MCCH configuration information" was received in System Information Block Type 5 or System Information Block Type 5bis prior to entering CELL_DCH.

A UE completing an RRC Connection Setup procedure shall initiate the MBMS modification request procedure in the following cases:

- 1> if the UE has any MBMS Selected Service; and
- 1> if the IE "MCCH configuration information" was received in System Information Block Type 5 or System Information Block Type 5bis prior to completing the RRC Connection Setup procedure.

A UE in CELL_DCH shall initiate the MBMS modification request procedure in the following cases:

- 1> the preferred frequency applicable for the MBMS service prioritised by upper layers is different from the currently used frequency;
- 1> upper layers request to discontinue reception of an MBMS service provided via a p-t-p radio bearer e.g. because this inhibits reception of a higher priority service;
- 1> upon a change in selection of the MBMS Selected Services.

NOTE: The above case may occur upon receiving a dedicated notification or in other cases eg. a change of transfer mode from p-t-p to p-t-m for the UE's highest priority MBMS service.

A UE in CELL_FACH, CELL_PCH or URA_PCH state shall initiate the MBMS modification request procedure in the following cases:

- 1> upon a change in selection of the MBMS Selected Services that are indicated on MCCH; and
- 1> if the IE "Indicate changes in MBMS Selected Services" that is included in the MBMS GENERAL INFORMATION message is set to TRUE.

If the UE is required to initiate the MBMS modification request procedure as specified in the conditions above, the UE shall:

- 1> transmit an MBMS MODIFICATION REQUEST message with the contents as specified in subclause 8.7.6.2a.

If applicable, the UE shall use a single MBMS MODIFICATION REQUEST message to request a move to the preferred frequency and/or to request release of radio bearers corresponding with lower priority MBMS services provided p-t-p and/or to report the MBMS Selected Services.

8.7.6.2a MBMS MODIFICATION REQUEST message contents to set

The UE shall set the contents of the MBMS MODIFICATION REQUEST message as follows:

- 1> if the preferred frequency applicable for the MBMS service prioritised by upper layers is different from the currently used frequency:
 - 2> include the IE "MBMS preferred frequency request" and set it to the prioritised MBMS service identity;
- 1> if upper layers request to discontinue reception of an MBMS service provided via a p-t-p radio bearer:
 - 2> include the p-t-p radio bearers used for the corresponding MBMS services within the IE "MBMS RB list requested to be released".
- 1> if the UE enters CELL_DCH; or

- 1> if the UE completes the RRC connection establishment procedure; or
- 1> if there is a change in selection of one or more of the MBMS Selected Services:
 - 2> if the UE has not selected any MBMS Selected Service:
 - 3> include the IE "MBMS Selected Service Info" and set the Status to 'None'.
 - 2> otherwise:
 - 3> include the IE "MBMS Selected Service Info" and set the Status to 'Some';
 - 3> include the IE "Support of MBMS service change for a ptp RB";
 - 3> for each MBMS Selected Service:
 - 4> order the MBMS Selected Services such that those selected with a higher priority are listed in the IE "MBMS Selected Services Full" before those selected with a lower priority;
 - 4> include the IE "MBMS Selected Service ID" within the IE "MBMS Selected Services Full".

8.7.6.3 Reception of a MBMS MODIFICATION REQUEST message by the UTRAN

Upon reception of a MBMS MODIFICATION REQUEST message, the UTRAN may take further action depending on the contents of the received message.

The procedure ends.

8.7.7 MBMS service scheduling

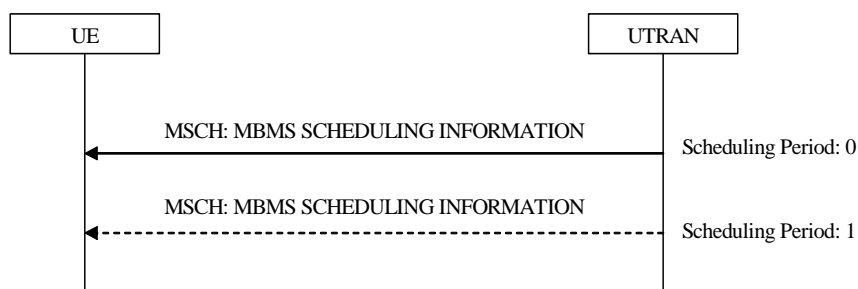

Figure 8.7.7-1: MBMS service scheduling, normal

8.7.7.1 General

The MBMS service scheduling procedure is used by the UE that is receiving one or more activated MBMS services to acquire the MBMS scheduling information for the MBMS services. The procedure applies to all UEs that are receiving an MBMS service provided via a p-t-m radio bearer, irrespective of their state (idle and connected mode: URA_PCH, CELL_PCH, CELL_FACH and CELL_DCH).

8.7.7.2 Initiation

The UE may initiate the MBMS service scheduling procedure for any scheduling period of the concerned MBMS service while receiving an SCCPCH carrying an MBMS service.

8.7.7.3 Reception of the MBMS scheduling information

Upon receiving the MBMS SCHEDULING INFORMATION message, the UE should:

- 1> act as follows for each of the services included in these messages provided that the service is included in variable MBMS_ACTIVATED_SERVICES;

- 1> act upon all received information elements as specified in subclause 8.6, unless specified otherwise in the following.

The procedure ends.

9 Handling of unknown, unforeseen and erroneous protocol data

9.1 General

This subclause specifies procedures for the handling of unknown, unforeseen, and erroneous protocol data by the receiving entity. These procedures are called "error handling procedures", but in addition to provide recovery mechanisms for error situations they define a compatibility mechanism for future extensions of the protocol.

The error handling procedures specified in this subclause shall apply to all RRC messages. When there is a specific handling for messages received on different logical channels this is specified.

For system information received on the BCCH, the error handling procedures are applied on the BCCH message SYSTEM INFORMATION, the re-assembled system information segments as well as the system information blocks (including the master information block and the scheduling blocks), with specific error handling as specified below.

When the UE receives an RRC message, it shall set the variable `PROTOCOL_ERROR_REJECT` to FALSE and then perform the checks in the order as defined below.

The error cases specified in the following include the handling upon reception of spare values. This behaviour also applies in case the actual value of the IE results from mapping the originally sent IE value. Moreover, in certain error cases, as specified in the following, default values apply. In this case, the default values specified within the ASN.1, the tabular and the procedure specifications apply.

9.2 ASN.1 violation or encoding error

If the UE receives an RRC message on the DCCH for which the encoded message does not result in any valid abstract syntax value [49] (or "encoding error"), it shall perform the following. The UE shall:

- 1> set the variable `PROTOCOL_ERROR_REJECT` to TRUE;
- 1> transmit an RRC STATUS message on the uplink DCCH. The IE "Protocol error information" shall contain an IE "Protocol error cause" set to "ASN.1 violation or encoding error";
- 1> when RRC STATUS message has been submitted to lower layers for transmission:
 - 2> continue with any ongoing processes and procedures as if the invalid message had not been received.

NOTE In this case, the UE does not perform procedure specific error handling according to clause 8.

If the UE receives an RRC message sent via a radio access technology other than UTRAN, for which the encoded message does not result in any valid abstract syntax, the UE shall:

- 1> set the variable `PROTOCOL_ERROR_REJECT` to TRUE;
- 1> set the IE "Protocol error cause" in the variable `PROTOCOL_ERROR_INFORMATION` to "ASN.1 violation or encoding error";
- 1> perform procedure specific error handling according to clause 8.

If a reassembled set of system information segments received in messages on the BCCH does not result in any valid abstract syntax value, the UE shall:

- 1> ignore the reassembled set of system information segments;

- 1> treat the rest of each message containing the ignored system information segments as if those segments were not present.

If the UE receives an RRC message on the BCCH, PCCH, CCCH, MCCH, MSCH or SHCCH for which the encoded message does not result in any valid abstract syntax value, it shall ignore the message.

9.3 Unknown or unforeseen message type

If a UE receives an RRC message on the DCCH with a message type not defined for the DCCH it shall:

- 1> set the variable `PROTOCOL_ERROR_REJECT` to `TRUE`;
- 1> transmit an RRC `STATUS` message on the uplink DCCH. The IE "Protocol error information" shall contain an IE "Protocol error cause" set to "Message type non-existent or not implemented";
- 1> when the RRC `STATUS` message has been submitted to lower layers for transmission:
 - 2> continue with any ongoing processes and procedures as if the invalid message had not been received.

If the UE receives an RRC message on the BCCH, PCCH, CCCH, MCCH, MSCH or SHCCH with a message type not defined for the logical channel type the message was received on, it shall ignore the message.

9.3a Unsolicited received message

If the UE receives any of the following messages:

- an RRC `CONNECTION SETUP` message addressed to the UE on the CCCH; or
- an RRC `CONNECTION REJECT` message addressed to the UE on the CCCH; or
- a UE `CAPABILITY INFORMATION CONFIRM` message on the DCCH; or
- a `CELL UPDATE CONFIRM` message addressed to the UE on the CCCH or on the DCCH; or
- a `URA UPDATE CONFIRM` message addressed to the UE on the CCCH or on the DCCH

and no procedure is ongoing according to clause 8 which expects the message to be received:

the UE shall:

- 1> ignore the received message.

9.3b Unexpected critical message extension

If the UE receives an RRC message on the DCCH, or addressed to the UE on the CCCH or on the SHCCH, or sent via a radio access technology other than UTRAN, containing an undefined critical message extension, the UE shall:

- 1> set the variable `PROTOCOL_ERROR_REJECT` to `TRUE`;
- 1> set the IE "Protocol error cause" in the variable `PROTOCOL_ERROR_INFORMATION` to "Message extension not comprehended";
- 1> if the IE "Message Type" of the received message is not present in the table "Rejected transactions" in the variable `TRANSACTIONS`:
 - 2> store the IE "Message type" of the received message in the table "Rejected transactions" in the variable `TRANSACTIONS`; and
 - 2> set the IE "RRC transaction identifier" to zero in that table entry.
- 1> perform procedure specific error handling according to clause 8.

If the UE receives an RRC message on the BCCH, MCCH, MSCH or PCCH, containing an undefined critical message extension, the UE shall:

- 1> ignore the message.

9.4 Unknown or unforeseen information element value, mandatory information element

If the UE receives an RRC message on the DCCH, or addressed to the UE on the CCCH or on the SHCCH, or sent via a radio access technology other than UTRAN, with a mandatory IE having a value, including choice, reserved for future extension (spare) or a value not used in this version of the specification (e.g. a dummy value), the UE shall:

- 1> if a default value of the IE is defined:
 - 2> treat the rest of the message using the default value of the IE.
- 1> if no default value of the IE is defined:
 - 2> set the variable `PROTOCOL_ERROR_REJECT` to `TRUE`;
 - 2> set the IE "Protocol error cause" in the variable `PROTOCOL_ERROR_INFORMATION` to "Information element value not comprehended";
 - 2> perform procedure specific error handling according to clause 8.

If the UE receives a system information block on the BCCH with a mandatory IE having a value reserved for future extension (spare) or a value not used in this version of the specification (e.g. a dummy value), the UE shall:

- 1> if a default value of the IE is defined:
 - 2> treat the rest of the system information block using the default value of the IE.
- 1> if no default value of the IE is defined:
 - 2> ignore the system information block.

If the UE receives an RRC message on the BCCH, MCCH, MSCH or PCCH with a mandatory IE having a value reserved for future extension (spare) or a value not used in this version of the specification (e.g. a dummy value), the UE shall:

- 1> if a default value of the IE is defined:
 - 2> treat the rest of the message using the default value of the IE.
- 1> if no default value of the IE is defined:
 - 2> ignore the message.

9.5 Conditional information element error

If the UE receives an RRC message on the DCCH, BCCH, PCCH, MCCH, MSCH or addressed to the UE on the CCCH or on the SHCCH, or sent via a radio access technology other than UTRAN, for which the specified conditions for absence of a conditional IE are met and that IE is present, the UE shall:

- 1> ignore the IE;
- 1> treat the rest of the message as if the IE was not present.

If the UE receives an RRC message on the DCCH, or addressed to the UE on the CCCH or on the SHCCH, or sent via a radio access technology other than UTRAN, for which the specified conditions for presence of a conditional IE are met and that IE is absent, the UE shall:

- 1> set the variable `PROTOCOL_ERROR_REJECT` to `TRUE`;

- 1> set the IE "Protocol error cause" in the variable `PROTOCOL_ERROR_INFORMATION` to "Information element missing";
- 1> perform procedure specific error handling according to clause 8.

If the UE receives a system information block on the BCCH for which the specified conditions for presence of a conditional IE are met and that IE is absent, the UE shall:

- 1> ignore the system information block.

If the UE receives an RRC message on the BCCH, MCCH, MSCH or PCCH for which the specified conditions for presence of a conditional IE are met and that IE is absent, the UE shall:

- 1> ignore the message.

9.6 Unknown or unforeseen information element value, conditional information element

If the UE receives an RRC message on the DCCH, or addressed to the UE on the CCCH or on the SHCCH, or sent via a radio access technology other than UTRAN, for which the specified conditions for presence of a conditional IE are met, that IE is present, and that IE has a value, including choice, reserved for future extension (spare) or a value not used in this version of the specification (e.g. a dummy value), the UE shall:

- 1> if a default value of the IE is defined:
 - 2> treat the rest of the message using the default value of the IE.
- 1> if no default value of the IE is defined:
 - 2> set the variable `PROTOCOL_ERROR_REJECT` to `TRUE`;
 - 2> set the IE "Protocol error cause" in the variable `PROTOCOL_ERROR_INFORMATION` to "Information element value not comprehended";
 - 2> perform procedure specific error handling according to clause 8.

If the UE receives a system information block on the BCCH for which the specified conditions for presence of a conditional IE are met, that IE is present, and that IE has a value, including choice, reserved for future extension (spare) or a value not used in this version of the specification (e.g. a dummy value), the UE shall:

- 1> if a default value of the IE is defined:
 - 2> treat the rest of the system information block using the default value of the IE.
- 1> if no default value of the IE is defined:
 - 2> ignore the system information block.

If the UE receives an RRC message on the BCCH, MCCH, MSCH or PCCH for which the specified conditions for presence of a conditional IE are met, that IE is present, and that IE has a value, including choice, reserved for future extension (spare) or a value not used in this version of the specification (e.g. a dummy value), the UE shall:

- 1> if a default value of the IE is defined:
 - 2> treat the rest of the message using the default value of the IE.
- 1> if no default value of the IE is defined:
 - 2> ignore the message.

9.7 Unknown or unforeseen information element value, optional information element

If the UE receives an RRC message on the DCCH, or addressed to the UE on the CCCH or on the SHCCH, or sent via a radio access technology other than UTRAN, with an optional IE having a value, including choice, reserved for future extension (spare) or a value not used in this version of the specification (e.g. a dummy value), it shall:

- 1> ignore the value of the IE;
- 1> treat the rest of the message as if the IE was not present.

If the UE receives a system information block on the BCCH with an optional IE having a value, including choice, reserved for future extension (spare) or a value not used in this version of the specification (e.g. a dummy value), it shall:

- 1> ignore the value of the IE;
- 1> treat the rest of the system information block as if the IE was not present.

If the UE receives an RRC message on the BCCH, MCCH or MSCH or PCCH with an optional IE having a value, including choice, reserved for future extension (spare) or a value not used in this version of the specification (e.g. a dummy value), it shall:

- 1> ignore the value of the IE;
- 1> treat the rest of the message as if the IE was not present.

9.8 Unexpected non-critical message extension

If the UE receives an RRC message on the DCCH, or addressed to the UE on the CCCH or on the SHCCH, or sent via a radio access technology other than UTRAN, containing an undefined non-critical message extension, the UE shall:

- 1> if the non critical extension is included in the "Variable Length Extension Container":
 - 2> ignore the content of the extension and the contents of this container after the not comprehended extension, and continue decoding the rest of the message.
- 1> otherwise:
 - 2> ignore the content of the extension and the message contents after the extension, but treat the parts of the message up to the extension normally.

If the UE receives a system information block on the BCCH containing an undefined non-critical message extension, the UE shall:

- 1> ignore the content of the extension and the system information block contents after the extension, but treat the parts of the system information block up to the extension normally.

If the UE receives an RRC message on the BCCH, MCCH or MSCH or PCCH, containing an undefined non-critical message extension, the UE shall:

- 1> ignore the content of the extension and the message contents after the extension, but treat the parts of the message up to the extension normally.

9.9 Handling of errors in nested information elements

An erroneous IE may be included in another IE, which may be included in another IE and so on. This subclause specifies the handling of errors in mandatory IEs as well as for conditional IEs for which the specified conditions for presence are met, that are nested in another IE.

In case the UE receives an IE (IE1) that includes a mandatory IE (IE1-1) having a value, including choice, reserved for future extension (spare) or a value not used in this version of the specification (e.g. a dummy value), the UE shall:

1> consider IE1 to have an undefined value; and

1> apply the corresponding generic error handling to IE1.

In case there are many IE nesting levels, in all of which the IE is mandatory while no default value is defined, this treatment may need to be repeated several times. The following example illustrates the general principle.

| | | |
|---|------------------|-----------|
| ExampleMessage ::= | SEQUENCE { | |
| ie1 | IE1 | OPTIONAL, |
| ie2 | IE2 | |
| } | | |
| IE1 ::= | SEQUENCE { | |
| ie1-1 | INTEGER (1..16), | |
| -- ie1-1 values 13..16 are spare and should not be used in this version of the protocol | | |
| ie1-2 | IE1-2 | OPTIONAL, |
| ie1-3 | IE1-3 | |
| } | | |

If in the above example, UTRAN would include ie1 and set ie1-1 to value 13, the UE experiences an error in a mandatory IE. The guideline outlined in the previous then means that the UE shall not discard the entire message but instead consider "ie1" to have an unknown value. Since IE1 is optional, the generic error handling would be to ignore "ie1".

In case the UE receives an IE (IE1) that includes a list of another IE (IE1-1) for which one or more entries in the list have a value, including choice, reserved for future extension (spare) or a value not used in this version of the specification (e.g. a dummy value), the UE shall:

1> consider the list as if these entries were not included.

NOTE: In case the above generic error handling procedures do not result in the desired behaviour, the introduction of spares may need to be reconsidered.

10 Message and information element functional definition and content

10.1 General

The function of each Radio Resource Control message together with message contents in the form of a list of information elements is defined in subclause 10.2.

Functional definitions of the information elements are then described in subclause 10.3.

Information elements are marked as either MP - Mandatory present, MD - Mandatory with default value, OP - Optional, CV - Conditional on value or CH - Conditional on history (see Table 10.1 with information extracted from [14]).

Table 10.1: Meaning of abbreviations used in RRC messages and information elements

| Abbreviation | Meaning |
|--------------|--|
| MP | Mandatory present
A value for that information is always needed, and no information is provided about a particular default value. If ever the transfer syntax allows absence (e.g., due to extension), then absence leads to an error diagnosis. |
| MD | Mandatory with default value
A value for that information is always needed, and a particular default value is mentioned (in the 'Semantical information' column). This opens the possibility for the transfer syntax to use absence or a special pattern to encode the default value. |

| Abbreviation | Meaning |
|--------------|--|
| CV | <p>Conditional on value</p> <p>The need for a value for that information depends on the value of some other IE or IEs, and/or on the message flow (e.g., channel, SAP). The need is specified by means of a condition, the result of which may be that the information is mandatory present, mandatory with default value, not needed or optional.</p> <p>If one of the results of the condition is that the information is mandatory present, the transfer syntax must allow for the presence of the information. If in this case the information is absent an error is diagnosed.</p> <p>If one of the results of the condition is that the information is mandatory with default value, and a particular default value is mentioned (in the 'Semantical information' column), the transfer syntax may use absence or a special pattern to encode the default value.</p> <p>If one of the results of the condition is that the information is not needed, the transfer syntax must allow encoding the absence. If in this case the information is present, it will be ignored. In specific cases however, an error may be diagnosed instead.</p> <p>If one of the results of the condition is that the information is optional, the transfer syntax must allow for the presence of the information. In this case, neither absence nor presence of the information leads to an error diagnosis.</p> |
| CH | <p>Conditional on history</p> <p>The need for a value for that information depends on information obtained in the past (e.g., from messages received in the past from the peer). The need is specified by means of a condition, the result of which may be that the information is mandatory present, mandatory with default value, not needed or optional.</p> <p>The handling of the conditions is the same as described for CV.</p> |
| OP | <p>Optional</p> <p>The presence or absence is significant and modifies the behaviour of the receiver. However whether the information is present or not does not lead to an error diagnosis.</p> |

10.1.1 Protocol extensions

RRC messages may be extended in future versions of this protocol, either by adding values for choices, enumerated and size constrained types or by adding information elements. An important aspect concerns the behaviour of a UE, conforming to this revision of the standard, upon receiving a not comprehended future extension. The details of this error handling behaviour are provided in clause 9.

NOTE 1: By avoiding the need for partial decoding (skipping uncomprehended IEs to continue decoding the remainder of the message), the RRC protocol extension mechanism also avoids the overhead of length determinants for extensions. "Variable length extension containers" (i.e. non critical extension containers that have their abstract syntax defined using the ASN.1 type "BIT STRING") have been defined to support the introduction of extensions to a release after the subsequent release is frozen (and UEs based on that subsequent release may appear). For this container a length determinant is used, which facilitates partial decoding of the container as well as the decoding of the extensions included after the container.

Two kinds of protocol extensions are distinguished: non-critical and critical extensions. In general, a receiver shall process a message including not comprehended non-critical extensions as if the extensions were absent. However, a receiver shall entirely reject a message including not comprehended critical extensions (there is no partial rejection) and notify the sender, as specified in clause 9.

The general mechanism for adding critical extensions is by defining a new version of the message, which is indicated at the beginning of the message.

The UE shall always comprehend the complete transfer syntax specified for the protocol version it supports; if the UE comprehends the transfer syntax defined within protocol version A for message 1, it shall also comprehend the transfer syntax defined within protocol version A for message 2.

The following table shows for which messages only non-critical extensions may be added while for others both critical and non-critical extensions may be added.

NOTE 2: Critical extensions can only be added to certain downlink messages.

| Extensions | Message |
|--------------------------------------|---|
| Critical and non-critical extensions | ACTIVE SET UPDATE 10.2.1
ASSISTANCE DATA DELIVERY 10.2.4
CELL CHANGE ORDER FROM UTRAN 10.2.5
CELL UPDATE CONFIRM 10.2.8
COUNTER CHECK 10.2.9
DOWNLINK DIRECT TRANSFER 10.2.11
HANDOVER TO UTRAN COMMAND 10.2.16a
HANDOVER FROM UTRAN COMMAND 10.2.15
MEASUREMENT CONTROL 10.2.17
PHYSICAL CHANNEL RECONFIGURATION 10.2.22
PHYSICAL SHARED CHANNEL ALLOCATION 10.2.25
RADIO BEARER RECONFIGURATION 10.2.27
RADIO BEARER RELEASE 10.2.30
RADIO BEARER SETUP 10.2.33
RRC CONNECTION REJECT 10.2.36
RRC CONNECTION RELEASE 10.2.37
RRC CONNECTION SETUP 10.2.40
SECURITY MODE COMMAND 10.2.43
SIGNALLING CONNECTION RELEASE 10.2.46
TRANSPORT CHANNEL RECONFIGURATION 10.2.50
UE CAPABILITY ENQUIRY 10.2.55
UE CAPABILITY INFORMATION CONFIRM 10.2.57
UPLINK PHYSICAL CHANNEL CONTROL 10.2.59
URA UPDATE CONFIRM 10.2.61
UTRAN MOBILITY INFORMATION 10.2.62 |
| Non-critical extensions only | ACTIVE SET UPDATE COMPLETE 10.2.2
ACTIVE SET UPDATE FAILURE 10.2.3
CELL CHANGE ORDER FROM UTRAN FAILURE 10.2.6
CELL UPDATE 10.2.7
COUNTER CHECK RESPONSE 10.2.10
ETWS PRIMARY NOTIFICATION WITH SECURITY 10.2.12a
HANDOVER TO UTRAN COMPLETE 10.2.16b
INITIAL DIRECT TRANSFER 10.2.16c
HANDOVER FROM UTRAN FAILURE 10.2.16
MBMS ACCESS INFORMATION 10.2.16e
MBMS COMMON P-T-M RB INFORMATION 10.2.16f
MBMS CURRENT CELL P-T-M RB INFORMATION 10.2.16g
MBMS GENERAL INFORMATION 10.2.16h
MBMS MODIFICATION REQUEST 10.2.16i
MBMS MODIFIED SERVICES INFORMATION 10.2.16j
MBMS NEIGHBOURING CELL P-T-M RB INFORMATION 10.2.16k
MBMS SCHEDULING INFORMATION 10.2.16L
MBMS UNMODIFIED SERVICES INFORMATION 10.2.16m
MEASUREMENT CONTROL FAILURE 10.2.18
MEASUREMENT REPORT 10.2.19
PAGING TYPE 1 10.2.20
PAGING TYPE 2 10.2.21
PHYSICAL CHANNEL RECONFIGURATION COMPLETE 10.2.23
PHYSICAL CHANNEL RECONFIGURATION FAILURE 10.2.24
PUSCH CAPACITY REQUEST 10.2.26
RADIO BEARER RECONFIGURATION COMPLETE 10.2.28
RADIO BEARER RECONFIGURATION FAILURE 10.2.29
RADIO BEARER RELEASE COMPLETE 10.2.31
RADIO BEARER RELEASE FAILURE 10.2.32
RADIO BEARER SETUP COMPLETE 10.2.34
RADIO BEARER SETUP FAILURE 10.2.35
RRC CONNECTION RELEASE COMPLETE 10.2.38 |

| Extensions | Message |
|---------------|--|
| | RRC CONNECTION REQUEST 10.2.39
RRC CONNECTION SETUP COMPLETE 10.2.41
RRC STATUS 10.2.42
SECURITY MODE COMPLETE 10.2.44
SECURITY MODE FAILURE 10.2.45
SIGNALLING CONNECTION RELEASE INDICATION 10.2.47
Master Information Block 10.2.48.8.1
System Information Block type 1 to
System Information Block type 20 10.2.48.8.4 to 10.2.48.8.23
SYSTEM INFORMATION CHANGE INDICATION 10.2.49
TRANSPORT CHANNEL RECONFIGURATION COMPLETE 10.2.51
TRANSPORT CHANNEL RECONFIGURATION FAILURE 10.2.52
TRANSPORT FORMAT COMBINATION CONTROL 10.2.53
TRANSPORT FORMAT COMBINATION CONTROL FAILURE 10.2.54
UE CAPABILITY INFORMATION 10.2.56
UPLINK DIRECT TRANSFER 10.2.58
URA UPDATE 10.2.60
UTRAN MOBILITY INFORMATION CONFIRM 10.2.63
UTRAN MOBILITY INFORMATION FAILURE 10.2.64 |
| No extensions | SYSTEM INFORMATION 10.2.48
First Segment 10.2.48.1
Subsequent or last Segment 10.2.48.3
Complete SIB 10.2.48.5
SIB content 10.2.48.8.1 |

NOTE 3: For the SYSTEM INFORMATION message protocol extensions are only possible at the level of system information blocks.

10.1.1.1 Non-critical extensions

10.1.1.1.1 Extension of an information element with additional values or choices

In future versions of this protocol, non-critical values may be added to choices, enumerated and size constrained types.

For choices, enumerated and size constrained types it is possible to indicate how many non-critical spare values need to be reserved for future extension. In this case, the tabular format should indicate the number of spare values that are needed. The value range defined in ASN.1 for the extensible IE should include the number of spares that are needed, since a value outside the range defined for this IE will result in a general ASN.1 violation error.

For downlink messages, spare values may be defined for non-critical information elements for which the need is specified to be MD or OP (or CV case leading to MD or OP). In this case, a receiver not comprehending the received spare value shall consider the information element to have the default value or consider it to be absent respectively.

For uplink messages spare values may be defined for all information elements, including those for which the need is specified to be MP (or CV case leading to MP).

In all cases at most one spare should be defined for choices. In this case, information elements applicable to the spare choices shall be added to the end of the message.

10.1.1.1.2 Extension of a message with additional information elements

In future versions of this protocol, non-critical information elements may be added to RRC messages. These additional information elements shall be normally appended at the end of the message; the transfer syntax specified in this revision of the standard facilitates this. A receiver conformant to this revision of the standard shall accept such extension, and proceed as if it was not included.

A transmitter conformant to this version of the standard shall not include an extension reserved for introducing non critical extensions in later versions of the standard; i.e. the corresponding parameter defined in the ASN.1 shall be absent.

NOTE: If an extension, reserved for future non-critical extensions, is included (even if it is empty), this may result in transfer syntax errors when received by an implementation conforming to a later version of the standard.

Extensions to a release that are introduced after the subsequent release is frozen may however be inserted prior to the end of the message. To facilitate this, "variable length extension containers" have been introduced in most messages.

10.1.1.2 Critical extensions

10.1.1.2.1 Extension of an information element with additional values or choices

In versions of this protocol, choices, enumerated and size constrained types may be extended with critical values. For extension with critical values the general critical extension mechanism is used, i.e. for this no spare values are reserved since backward compatibility is not required.

10.1.1.2.2 Extension of a message with additional information elements

In future versions of this protocol, RRC messages may be extended with new information elements. Since messages including critical extensions are rejected by receivers not comprehending them, these messages may be modified completely, e.g. IEs may be inserted at any place and IEs may be removed or redefined.

10.2 Radio Resource Control messages

10.2.1 ACTIVE SET UPDATE

NOTE: Only for FDD.

This message is used by UTRAN to add, replace or delete radio links in the active set of the UE.

RLC-SAP: AM or UM

Logical channel: DCCH

Direction: UTRAN → UE

| Information Element/Group name | Need | Multi | Type and reference | Semantics description | Version |
|------------------------------------|------|-------|---|-------------------------|---------|
| Message Type | MP | | Message Type | | |
| UE information elements | | | | | |
| RRC transaction identifier | MP | | RRC transaction identifier
10.3.3.36 | | |
| Integrity check info | CH | | Integrity check info
10.3.3.16 | | |
| Activation time | MD | | Activation time
10.3.3.1 | Default value is "now". | |
| New U-RNTI | OP | | U-RNTI
10.3.3.47 | | |
| New H-RNTI | OP | | H-RNTI
10.3.3.14a | | REL-6 |
| New Primary E-RNTI | OP | | E-RNTI
10.3.3.10a | | REL-6 |
| New Secondary E-RNTI | OP | | E-RNTI
10.3.3.10a | | REL-6 |
| CN information elements | | | | | |
| CN Information info | OP | | CN Information info
10.3.1.3 | | |
| Phy CH information elements | | | | | |

| Information Element/Group name | Need | Multi | Type and reference | Semantics description | Version |
|----------------------------------|----------------------|----------------|--|---|---------|
| DTX-DRX timing information | OP | | DTX-DRX timing information
10.3.6.34b | | REL-7 |
| DTX-DRX Information | OP | | DTX-DRX Information
10.3.6.34a | | REL-7 |
| HS-SCCH less Information | OP | | HS-SCCH less Information
10.3.6.36a
b | | REL-7 |
| MIMO parameters | OP | | MIMO parameters
10.3.6.41a | | REL-7 |
| Uplink radio resources | | | | | |
| Maximum allowed UL TX power | MD | | Maximum allowed UL TX power
10.3.6.39 | Default value is the existing "maximum UL TX power. | |
| Downlink radio resources | | | | | |
| Radio link addition information | OP | 1 to <maxRL-1> | | Radio link addition information required for each RL to add | |
| >Radio link addition information | MP | | Radio link addition information
10.3.6.68 | | |
| Serving Cell Change Parameters | CV-TargetCellPreconf | | Serving Cell Change Parameters
10.3.6.74b | | REL-8 |
| Radio link removal information | OP | 1 to <maxRL> | | Radio link removal information required for each RL to remove | |
| >Radio link removal information | MP | | Radio link removal information
10.3.6.69 | | |
| TX Diversity Mode | MD | | TX Diversity Mode
10.3.6.86 | Default value is the TX diversity mode currently used in all or part of the active set. | |

| Information Element/Group name | Need | Multi | Type and reference | Semantics description | Version |
|---|------|-------|--|---|---------|
| DPC Mode | OP | | Enumerated (Single TPC, TPC triplet in soft) | "Single TPC" is DPC_Mode=0 and "TPC triplet in soft" is DPC_mode=1 in [29]. | REL-5 |
| Serving HS-DSCH cell information | OP | | Serving HS-DSCH cell information 10.3.6.74a | | REL-6 |
| E-DCH reconfiguration information | OP | | E-DCH reconfiguration information 10.3.6.69a | | REL-6 |
| UL 16QAM configuration | OP | | UL 16QAM configuration 10.3.6.86o | | REL-7 |
| E-DCH reconfiguration information same serving cell | OP | | E-DCH reconfiguration information same serving cell 10.3.6.69b | This IE is not present if the serving E-DCH cell is changed with this message. | REL-7 |
| E-TFC Boost Info | OP | | E-TFC Boost Info 10.3.6.106 | Absence of this IE means that boosting of E-DPCCH is disabled | REL-7 |
| E-DPDCH power interpolation | OP | | Boolean | TRUE means E-DPDCH power interpolation formula is used, FALSE means E-DPDCH power extrapolation formula is used for the computation of the gain factor β_{ed} according to [29] | REL-7 |
| Downlink secondary cell info FDD | OP | | Downlink secondary cell info FDD 10.3.6.31a | FDD only | REL-8 |

| Condition | Explanation |
|--------------------------|---|
| <i>TargetCellPreconf</i> | This IE is mandatory present if Radio Links are added and at least one added Radio Link contains the IE Target cell preconfiguration. |

10.2.2 ACTIVE SET UPDATE COMPLETE

NOTE: For FDD only.

This message is sent by UE when active set update has been completed.

RLC-SAP: AM

Logical channel: DCCH

Direction: UE→UTRAN

| Information Element/Group name | Need | Multi | Type and reference | Semantics description |
|--------------------------------|------|-------|---|-----------------------|
| Message Type | MP | | Message Type | |
| UE information elements | | | | |
| RRC transaction identifier | MP | | RRC transaction identifier
10.3.3.36 | |
| Integrity check info | CH | | Integrity check info
10.3.3.16 | |

10.2.3 ACTIVE SET UPDATE FAILURE

NOTE: Only for FDD.

This message is sent by UE if the update of the active set has failed, e.g. because the radio link is not a part of the active set.

RLC-SAP: AM

Logical channel: DCCH

Direction: UE→UTRAN

| Information Element/Group name | Need | Multi | Type and reference | Semantics description |
|--------------------------------|------|-------|--|-----------------------|
| Message Type | MP | | Message Type | |
| UE information elements | | | | |
| RRC transaction identifier | MP | | RRC transaction identifier
10.3.3.36 | |
| Integrity check info | CH | | Integrity check info
10.3.3.16 | |
| Failure cause | MP | | Failure cause and error information
10.3.3.14 | |

10.2.4 ASSISTANCE DATA DELIVERY

This message is sent by UTRAN to convey UE positioning assistance data to the UE.

RLC-SAP: AM

Logical channel: DCCH

Direction: UTRAN→UE

| Information Element/Group name | Need | Multi | Type and reference | Semantics description | Version |
|--------------------------------|-----------|-------|---|-----------------------|---------|
| Message Type | MP | | Message Type | | |
| UE information elements | | | | | |
| RRC transaction identifier | MP | | RRC transaction identifier
10.3.3.36 | | |

| Information Element/Group name | Need | Multi | Type and reference | Semantics description | Version |
|---|------|-------|--|-----------------------|---------|
| Integrity check info | CH | | Integrity check info
10.3.3.16 | | |
| Measurement Information elements | | | | | |
| UE positioning OTDOA assistance data for UE-based | OP | | UE positioning OTDOA assistance data for UE-based
10.3.7.103a | | |
| UE positioning GPS assistance data | OP | | UE positioning GPS assistance data
10.3.7.90 | | |
| UE positioning GANSS assistance data | OP | | UE positioning GANSS assistance data
10.3.7.90b | | REL-7 |

10.2.5 CELL CHANGE ORDER FROM UTRAN

This message is used to order a cell change from UTRA to another radio access technology, e.g., GSM.

RLC-SAP: AM

Logical channel: DCCH

Direction: UTRAN→UE

| Information Element/Group name | Need | Multi | Type and reference | Semantics description | Version |
|--|------|---------------------------|---|---|---------|
| Message Type | MP | | Message Type | | |
| UE information elements | | | | | |
| RRC transaction identifier | MP | | RRC transaction identifier
10.3.3.36 | | |
| Integrity check info | CH | | Integrity check info
10.3.3.16 | | |
| Activation time | MD | | Activation time
10.3.3.1 | Default value is "now" | |
| RB Information elements | | | | | |
| RAB information list | OP | 1 to
<maxRA
Bsetup> | | This IE should not be included in this version of the protocol. | |
| >RAB info | MP | | RAB info
10.3.4.8 | | |
| Other information elements | | | | | |
| Target cell description | MP | | | | |
| >CHOICE <i>Radio Access Technology</i> | MP | | | Two spare values are needed. | |
| >>GSM | | | | | |
| >>>BSIC | MP | | BSIC 10.3.8.2 | | |
| >>>Band Indicator | MP | | Enumerated | Indicates how to | |

| Information Element/Group name | Need | Multi | Type and reference | Semantics description | Version |
|----------------------------------|------|-------|--|---|---------|
| | | | (DCS 1800 band used, PCS 1900 band used) | interpret the BCCH ARFCN | |
| >>>BCCH ARFCN | MP | | Integer (0..1023) | [45] | |
| >>>NC mode | OP | | Bit string(3) | Includes bits b1-b3 of the NC mode IE specified in [43]. b1 is the least significant bit.
NOTE: The Bit string should be extended to 4 bits in a later version of the message. | |
| >>>CHOICE GERAN System Info type | OP | | | | REL-5 |
| >>>>SI | | | GERAN system information 10.3.8.4f | See [44] | REL-5 |
| >>>>PSI | | | GERAN system information 10.3.8.4f | See [44] | REL-5 |
| >>IS-2000 | | | | | |

10.2.6 CELL CHANGE ORDER FROM UTRAN FAILURE

This message is sent on the RRC connection used before the Cell change order from UTRAN was executed. The message indicates that the UE has failed to seize the new channel in the other radio access technology.

RLC-SAP: AM

Logical channel: DCCH

Direction: UE→UTRAN

| Information Element/Group name | Need | Multi | Type and reference | Semantics description |
|-----------------------------------|------|-------|--------------------------------------|-----------------------|
| Message Type | MP | | Message Type | |
| UE information elements | | | | |
| RRC transaction identifier | MP | | RRC transaction identifier 10.3.3.36 | |
| Integrity check info | CH | | Integrity check info 10.3.3.16 | |
| Other information elements | | | | |
| Inter-RAT change failure | MP | | Inter-RAT change failure 10.3.8.5 | |

10.2.7 CELL UPDATE

This message is used by the UE to initiate a cell update procedure.

RLC-SAP: TM

Logical channel: CCCH

Direction: UE→UTRAN

| Information Element/Group name | Need | Multi | Type and reference | Semantics description | Version |
|--|-----------------------|-----------------------|--|--|---------|
| Message Type | MP | | Message Type | | |
| UE information elements | | | | | |
| U-RNTI | MP | | U-RNTI
10.3.3.47 | | |
| RRC transaction identifier | CV-
<i>Failure</i> | | RRC transaction identifier
10.3.3.36 | | |
| Integrity check info | CH | | Integrity check info
10.3.3.16 | | |
| START list | MP | 1 to <maxCN domains > | | START [40] values for all CN domains. | |
| >CN domain identity | MP | | CN domain identity
10.3.1.1 | | |
| >START | MP | | START
10.3.3.38 | START value to be used in this CN domain. | |
| AM_RLC error indication(RB2, RB3 or RB4) | MP | | Boolean | TRUE indicates AM_RLC unrecoverable error [16] occurred on RB2, RB3 or RB4 in the UE | |
| AM_RLC error indication(RB>4) | MP | | Boolean | TRUE indicates AM_RLC unrecoverable error [16] occurred on RB>4 in the UE | |
| Cell update cause | MP | | Cell update cause
10.3.3.3 | | |
| Traffic volume indicator | OP | | Enumerated (TRUE) | This IE shall be set to TRUE when the criteria for event based traffic volume measurement reporting is fulfilled. Absence of this element means not fulfilled. | REL-6 |
| Failure cause | OP | | Failure cause and error information
10.3.3.14 | | |
| RB timer indicator | MP | | RB timer indicator
10.3.3.28 | | |

| Information Element/Group name | Need | Multi | Type and reference | Semantics description | Version |
|--|-------------------------|-------|------------------------------------|--|---------|
| Establishment cause | OP | | Establishment cause 10.3.3.11 | | REL-5 |
| CS Call Type | CV-
ConversationalCS | | Enumerated (speech, video, other) | One spare value is needed | REL-7 |
| HS-PDSCH in CELL_FACH | OP | | Enumerated (TRUE) | The absence of this IE indicates that the UE does not support HS-PDSCH reception in CELL_FACH state. Note 1. | REL-7 |
| Support of common E-DCH | OP | | Enumerated (TRUE) | The absence of this IE indicates that the UE does not support E-DCH enhanced random access in CELL_FACH state and Idle mode. Note 1. | REL-8 |
| Support of HS-DSCH DRX operation | OP | | Enumerated (TRUE) | The absence of this IE indicates that the UE does not support HS-DSCH DRX operation in CELL_FACH state. | REL-8 |
| Support of MAC-i/is | OP | | Enumerated (TRUE) | The absence of this IE indicates that the UE does not support MAC-i/is operation. | REL-8 |
| Support of SPS operation | OP | | Enumerated (TRUE) | The absence of this IE indicates that the UE does not support SPS operation. | REL-8 |
| Support of control channel DRX operation | OP | | Enumerated (TRUE) | The absence of this IE indicates that the UE does not support control channel DRX operation. | REL-8 |
| UE Mobility State Indicator | MD | | Enumerated (High-mobilityDetected) | Absence of this IE implies that, according to [4] either the High mobility state is not applicable or it has not been detected by the UE. | REL-7 |
| Capability change indicator | OP | | Enumerated (TRUE) | TRUE indicates that the UE capability has changed compared to the value stored in the variable UE_CAPABILITY_TRANSFERRED. | REL-7 |
| Reconfiguration Status Indicator | OP | | Enumerated (TRUE) | TRUE indicates a reconfiguration procedure is ongoing within the UE or a response message has been submitted to RLC and the UE is waiting for the layer 2 ACK. | REL-6 |
| MBMS Selected Services | OP | | MBMS Selected Services Short | | REL-6 |

| Information Element/Group name | Need | Multi | Type and reference | Semantics description | Version |
|---|------|-------|------------------------------------|---|---------|
| | | | 10.3.9a.7d | | |
| Support for Two DRX schemes in URA_PCH and CELL_PCH | OP | | Enumerated (TRUE) | The absence of this IE indicates that the UE does not support Two DRX schemes in URA_PCH and CELL_PCH | REL-7 |
| Measurement information elements | | | | | |
| Measured results on RACH | OP | | Measured results on RACH 10.3.7.45 | | |

NOTE 1: For 1.28 Mcps TDD, UE supporting HS-PDSCH in CELL_FACH always supports E-DCH enhanced random access in CELL_FACH state and Idle mode, and vice versa. And UE supporting HS-PDSCH reception in CELL_FACH state always supports HS-DSCH reception in CELL_PCH and URA_PCH state and CELL_FACH HS-DSCH DRX operation.

| Condition | Explanation |
|-------------------------|---|
| <i>Failure</i> | This IE is mandatory present if the IE "Failure cause" is present and not needed otherwise. |
| <i>ConversationalCS</i> | This IE is mandatory present if the IE 'Establishment cause' has the value 'Originating Conversational Call' or 'EmergencyCall' and a CS call is being initiated. Otherwise it is not needed. |

10.2.8 CELL UPDATE CONFIRM

This message confirms the cell update procedure and can be used to reallocate new RNTI information for the UE valid in the new cell.

RLC-SAP: UM

Logical channel: CCCH or DCCH

Direction: UTRAN→UE

| Information Element/Group name | Need | Multi | Type and reference | Semantics description | Version |
|--------------------------------|----------------|-------|--|--|---------|
| Message Type | MP | | Message Type | | |
| UE Information Elements | | | | | |
| U-RNTI | <i>CV-CCCH</i> | | U-RNTI 10.3.3.47 | | |
| RRC transaction identifier | MP | | RRC transaction identifier 10.3.3.36 | | |
| Integrity check info | CH | | Integrity check info 10.3.3.16 | | |
| Integrity protection mode info | OP | | Integrity protection mode info 10.3.3.19 | The UTRAN should not include this IE unless it is performing an SRNS relocation or a cell reselection from | |

| Information Element/Group name | Need | Multi | Type and reference | Semantics description | Version |
|---|-------|-------|--|---|---------|
| | | | | GERAN <i>lu mode</i> | |
| Ciphering mode info | OP | | Ciphering mode info 10.3.3.5 | The UTRAN should not include this IE unless it is performing either an SRNS relocation or a cell reselection from GERAN <i>lu mode</i> , and a change in ciphering algorithm. | |
| Activation time | MD | | Activation time 10.3.3.1 | Default value is "now" | |
| New U-RNTI | OP | | U-RNTI 10.3.3.47 | | |
| New C-RNTI | OP | | C-RNTI 10.3.3.8 | | |
| New DSCH-RNTI | OP | | DSCH-RNTI 10.3.3.9a | Should not be set in FDD. If received, the UE should ignore it | |
| New H-RNTI | OP | | H-RNTI 10.3.3.14a | | REL-5 |
| New Primary E-RNTI | OP | | E-RNTI 10.3.3.10a | | REL-6 |
| New Secondary E-RNTI | OP | | E-RNTI 10.3.3.10a | FDD only | REL-6 |
| RRC State Indicator | MP | | RRC State Indicator 10.3.3.35a | | |
| UTRAN DRX cycle length coefficient | OP | | UTRAN DRX cycle length coefficient 10.3.3.49 | | |
| Wait time | OP | | Wait time 10.3.3.50 | | |
| RLC re-establish indicator (RB2, RB3 and RB4) | MP | | RLC re-establish indicator 10.3.3.35 | Should not be set to TRUE if IE "Downlink counter synchronisation info" is included in message. | |
| RLC re-establish indicator (RB5 and upwards) | MP | | RLC re-establish indicator 10.3.3.35 | Should not be set to TRUE if IE "Downlink counter synchronisation info" is included in message. | |
| CN Information Elements | | | | | |
| CN Information info | OP | | CN Information info 10.3.1.3 | | |
| UTRAN Information Elements | | | | | |
| URA identity | OP | | URA identity 10.3.2.6 | | |
| RNC support for change of UE capability | OP | | Boolean | Should be included if the message is used to perform an SRNS relocation | REL-7 |
| RB information elements | | | | | |
| RAB information for setup | CV-CS | | RAB information for setup | RAB identity shall be identical to the one currently | |

| Information Element/Group name | Need | Multi | Type and reference | Semantics description | Version |
|--|------|----------------------|--|---|---------|
| | | | 10.3.4.10 | configured and UE behaviour is unspecified otherwise. | |
| RB information to release list | OP | 1 to <maxRB> | | | |
| >RB information to release | MP | | RB information to release 10.3.4.19 | | |
| RB information to reconfigure list | OP | 1 to <maxRB> | | | |
| >RB information to reconfigure | MP | | RB information to reconfigure 10.3.4.18 | | |
| RB information to be affected list | OP | 1 to <maxRB> | | | |
| >RB information to be affected | MP | | RB information to be affected 10.3.4.17 | | |
| Downlink counter synchronisation info | OP | | | | |
| >RB with PDCP information list | OP | 1 to <maxRBall RABs> | | | |
| >>RB with PDCP information | MP | | RB with PDCP information 10.3.4.22 | This IE is needed for each RB having PDCP in the case of lossless SRNS relocation | |
| | OP | | | | REL-5 |
| >>>PDCP context relocation info | OP | | PDCP context relocation info 10.3.4.1a | This IE is needed for each RB having PDCP and performing PDCP context relocation | REL-5 |
| PDCP ROHC target mode | OP | | PDCP ROHC target mode 10.3.4.2a | | REL-5 |
| TrCH Information Elements | | | | | |
| Uplink transport channels | | | | | |
| UL Transport channel information common for all transport channels | OP | | UL Transport channel information common for all transport channels 10.3.5.24 | | |
| Deleted TrCH information list | OP | 1 to <maxTrCH > | | | |
| >Deleted UL TrCH information | MP | | Deleted UL TrCH information 10.3.5.5 | | |
| Added or Reconfigured TrCH information list | OP | 1 to <maxTrCH > | | | |
| >Added or Reconfigured UL | MP | | Added or | | |

| Information Element/Group name | Need | Multi | Type and reference | Semantics description | Version |
|--|------|-----------------|--|---|---------|
| TrCH information | | | Reconfigured UL TrCH information
10.3.5.2 | | |
| Downlink transport channels | | | | | |
| DL Transport channel information common for all transport channels | OP | | DL Transport channel information common for all transport channels
10.3.5.6 | | |
| Deleted TrCH information list | OP | 1 to <maxTrCH > | | | |
| >Deleted DL TrCH information | MP | | Deleted DL TrCH information
10.3.5.4 | | |
| Added or Reconfigured TrCH information list | OP | 1 to <maxTrCH > | | | |
| >Added or Reconfigured DL TrCH information | MP | | Added or Reconfigured DL TrCH information
10.3.5.1 | | |
| PhyCH information elements | | | | | |
| Frequency info | OP | | Frequency info
10.3.6.36 | | |
| Multi-frequency Info | OP | | Multi-frequency Info
10.3.6.39a | This IE is used for 1.28 Mcps TDD only | REL-7 |
| DTX-DRX timing information | OP | | DTX-DRX timing information
10.3.6.34b | | REL-7 |
| DTX-DRX Information | OP | | DTX-DRX Information
10.3.6.34a | | REL-7 |
| HS-SCCH less Information | OP | | HS-SCCH less Information
10.3.6.36ab | | REL-7 |
| MIMO parameters | OP | | MIMO parameters
10.3.6.41a | | REL-7 |
| Control Channel DRX information | OP | | Control Channel DRX information
1.28 Mcps TDD
10.3.6.107 | This IE is used for 1.28 Mcps TDD only | REL-8 |
| SPS Information | OP | | SPS information
1.28 Mcps TDD
10.3.6.110 | This IE is used for 1.28 Mcps TDD only | REL-8 |
| Uplink radio resources | | | | | |
| Maximum allowed UL TX power | MD | | Maximum allowed UL TX power
10.3.6.39 | Default value is the existing maximum UL TX power | |

| Information Element/Group name | Need | Multi | Type and reference | Semantics description | Version |
|---|------|--------------|--|--|---------|
| Uplink DPCH info | OP | | Uplink DPCH info
10.3.6.88 | | |
| E-DCH Info | OP | | E-DCH Info
10.3.6.97 | | REL-6 |
| Downlink radio resources | | | | | |
| Downlink HS-PDSCH Information | OP | | Downlink HS_PDSCH Information
10.3.6.23a | | REL-5 |
| Downlink information common for all radio links | OP | | Downlink information common for all radio links
10.3.6.24 | | |
| Downlink information per radio link list | OP | 1 to <maxRL> | | Send downlink information for each radio link to be set-up | |
| >Downlink information for each radio link | MP | | Downlink information for each radio link
10.3.6.27 | | |
| Downlink secondary cell info FDD | OP | | Downlink secondary cell info FDD
10.3.6.31a | FDD only | REL-8 |
| MBMS PL Service Restriction Information | OP | | Enumerated (TRUE) | | REL-6 |

| Condition | Explanation |
|-----------|---|
| CCCH | This IE is mandatory present when CCCH is used and ciphering is not required and not needed otherwise. |
| CS | This IE is optionally present only if CS domain RAB mapping is reconfigured between DCH and E-DCH/HS-DSCH and shall not be present otherwise. |

10.2.9 COUNTER CHECK

This message is used by the UTRAN to indicate the current COUNT-C MSB values associated to each radio bearer utilising UM or AM RLC mode and to request the UE to compare these to its COUNT-C MSB values and to report the comparison results to UTRAN.

RLC-SAP: AM

Logical channel: DCCH

Direction: UTRAN→UE

| Information Element/Group name | Presence | Multi | IE type and reference | Semantics description |
|--------------------------------|----------|-------|---|-----------------------|
| Message Type | MP | | | |
| UE information elements | | | | |
| RRC transaction identifier | MP | | RRC transaction identifier
10.3.3.36 | |
| Integrity check info | CH | | Integrity check info
10.3.3.16 | |
| RB information elements | | | | |

| Information Element/Group name | Presence | Multi | IE type and reference | Semantics description |
|--------------------------------|----------|------------------------|--------------------------------------|--|
| RB COUNT-C MSB information | MP | 1 to < maxRBallR ABs > | | For each RB (excluding signalling radio bearers) using UM or AM RLC. |
| >RB COUNT-C MSB information | MP | | RB COUNT-C MSB information 10.3.4.14 | |

10.2.10 COUNTER CHECK RESPONSE

This message is used by the UE to respond to a COUNTER CHECK message.

RLC-SAP: AM

Logical channel: DCCH

Direction: UE→UTRAN

| Information Element/Group name | Presence | Multi | IE type and reference | Semantics description |
|--------------------------------|----------|------------------------|--------------------------------------|-----------------------|
| Message Type | MP | | | |
| UE information elements | | | | |
| RRC transaction identifier | MP | | RRC transaction identifier 10.3.3.36 | |
| Integrity check info | CH | | Integrity check info 10.3.3.16 | |
| RB information elements | | | | |
| RB COUNT-C information | OP | 1 to < maxRBallR ABs > | | |
| >RB COUNT-C information | MP | | RB COUNT-C information 10.3.4.15 | |

10.2.11 DOWNLINK DIRECT TRANSFER

This message is sent by UTRAN to transfer higher layer messages.

RLC-SAP: AM

Logical channel: DCCH

Direction: UTRAN -> UE

| Information Element/Group name | Need | Multi | Type and reference | Semantics description |
|--------------------------------|------|-------|--------------------------------------|-----------------------|
| Message Type | MP | | Message Type | |
| UE information elements | | | | |
| RRC transaction identifier | MP | | RRC transaction identifier 10.3.3.36 | |
| Integrity check info | CH | | Integrity check info 10.3.3.16 | |
| CN information elements | | | | |
| CN Domain Identity | MP | | Core | |

| Information Element/Group name | Need | Multi | Type and reference | Semantics description |
|--------------------------------|------|-------|----------------------------------|-----------------------|
| | | | Network Domain Identity 10.3.1.1 | |
| NAS message | MP | | NAS message 10.3.1.8 | |

10.2.12 Void

10.2.12a ETWS PRIMARY NOTIFICATION WITH SECURITY

This message is used by UTRAN to send ETWS information to the UE.

RLC-SAP: AM or UM

Logical channel: DCCH

Direction: UTRAN → UE

| Information Element/Group name | Need | Multi | Type and reference | Semantics description | Version |
|-----------------------------------|------|-------|-----------------------------|-----------------------|---------|
| Message Type | MP | | Message Type | | REL-8 |
| Other Information elements | | | | | REL-8 |
| ETWS information | MP | | ETWS information 10.3.8.4ea | | REL-8 |

10.2.13 Void

10.2.14 Void

10.2.15 HANDOVER FROM UTRAN COMMAND

This message is used for handover from UMTS to another system e.g. GSM. One or several messages from the other system can be included in the Inter-RAT message information element in this message. These messages are structured and coded according to that systems specification.

RLC-SAP: AM

Logical channel: DCCH

Direction: UTRAN→UE

| Information Element/Group name | Need | Multi | Type and reference | Semantics description | Version |
|--------------------------------|------|-------|--------------------|-----------------------|---------|
| Message Type | MP | | Message Type | | |
| UE information elements | | | | | |
| RRC transaction identifier | MP | | RRC transaction | | |

| Information Element/Group name | Need | Multi | Type and reference | Semantics description | Version |
|---|--------------|--|--|---|---------|
| | | | identifier
10.3.3.36 | | |
| Integrity check info | CH | | Integrity
check info
10.3.3.16 | | |
| SR-VCC Info | CV-
SRVCC | | SR-VCC
info
10.3.4.24
a | | REL-8 |
| Activation time | MD | | Activation
time
10.3.3.1 | Default value is "now" | |
| RB information elements | | | | | |
| RAB information list | OP | 1 to
<maxRA
Bsetup> | | For each RAB to be
handed over. In
handover to GERAN <i>lu</i>
<i>mode</i> the RAB
information is included
in the GERAN <i>lu</i>
message below. | |
| >RAB info | MP | | RAB info
10.3.4.8 | | |
| RAB info to replace | CV-
SRVCC | | RAB info
to replace
10.3.4.11
a | | REL-8 |
| Other information elements | | | | | |
| CHOICE <i>System type</i> | MP | | | This IE indicates which
specification to apply, to
decode the transported
messages | |
| >GSM | | | | | |
| >>Frequency band | MP | | Enumerat
ed
(GSM/DC
S 1800
band
used),
GSM/PC
S 1900
band
used) | | |
| >>>CHOICE <i>GSM message</i> | | | | | |
| >>>Single GSM message | MP | | Bit string
(no
explicit
size
constraint
) | Formatted and coded
according to GSM
specifications The
first/leftmost/most
significant bit of the bit
string contains bit 8 of
the first octet of the
GSM message. | |
| >>>GSM message List | MP | 1.to.<ma
xInterSy
sMessa
ges> | Bit string
(1..512) | Formatted and coded
according to GSM
specifications. The
first/leftmost/most
significant bit of the bit
string contains bit 8 of
the first octet of the
GSM message. | |
| >>>CHOICE <i>GERAN System Info type</i> | OP | | | | REL-6 |
| >>>SI | MP | | GERAN
system | See [44] | REL-6 |

| Information Element/Group name | Need | Multi | Type and reference | Semantics description | Version |
|--------------------------------|------|----------------------------|---|--|---------|
| | | | information
10.3.8.4f | | |
| >>>PSI | MP | | GERAN system information
10.3.8.4f | See [44] | REL-6 |
| >GERAN lu | | | | | REL-5 |
| >>Frequency band | MP | | Enumerated (GSM/DCS 1800 band used), GSM/PCSS 1900 band used) | | REL-5 |
| >>CHOICE GERAN lu message | | | | | REL-5 |
| >>>Single GERAN lu message | MP | | Bit string (no explicit size constraint) | Formatted and coded according to [53]. The first/leftmost/most significant bit of the bit string contains bit 8 of the first octet of the message. | REL-5 |
| >>>GERAN lu message List | MP | 1 to <maxInterSysMessages> | Bit string (1..32768) | Formatted and coded according to [53]. The first/leftmost/most significant bit of the bit string contains bit 8 of the first octet of the message. | REL-5 |
| >cdma2000 | | | | | |
| >>cdma2000MessageList | MP | 1.to.<maxInterSysMessages> | | | |
| >>>MSG_TYPE(s) | MP | | Bit string (8) | Formatted and coded according to cdma2000 specifications. The MSG_TYPE bits are numbered b0 to b7. The first/leftmost/most significant bit of the bit string contains bit 7 of the MSG_TYPE. | |
| >>>cdma2000Messagepayload(s) | MP | | Bit string (1..512) | Formatted and coded according to cdma2000 specifications. The first/leftmost/most significant bit of the bit string contains the bit 7 of the first octet of the cdma2000 message. | |
| >E-UTRA | | | | | REL-8 |
| >>E-UTRA message | MP | | Octet string | Formatted and coded according to E-UTRA specifications The first/leftmost/most significant bit of the octet string contains bit 8 of the first octet of the E-UTRA message. | REL-8 |

| Condition | Explanation |
|-----------|--|
| SRVCC | This IE is mandatory present when an SR-VCC procedure is initiated and not needed otherwise. |

10.2.16 HANDOVER FROM UTRAN FAILURE

This message is sent on the RRC connection used before the Inter-RAT Handover was executed. The message indicates that the UE has failed to seize the new channel in the other system.

RLC-SAP: AM

Logical channel: DCCH

Direction: UE→UTRAN

| Information Element/Group name | Need | Multi | Type and reference | Semantics description | Version |
|-----------------------------------|------|-------------------------------|---|--|---------|
| Message Type | MP | | Message Type | | |
| UE information elements | | | | | |
| RRC transaction identifier | MP | | RRC transaction identifier
10.3.3.36 | | |
| Integrity check info | CH | | Integrity check info
10.3.3.16 | | |
| Other information elements | | | | | |
| Inter-RAT handover failure | OP | | Inter-RAT handover failure
10.3.8.6 | | |
| CHOICE <i>System type</i> | OP | | | This IE indicates which specification to apply to decode the transported messages | |
| >GSM | | | | | |
| >>GSM message List | MP | 1.to.<maxInterSystemMessages> | Bit string (1..512) | Formatted and coded according to GSM specifications. The first/leftmost/most significant bit of the bit string contains bit 8 of the first octet of the GSM message. | |
| >GERAN Iu | | | | | REL-5 |
| >>GERAN Iu message List | MP | 1 to <maxInterSystemMessages> | Bit string (1..32768) | Formatted and coded according to [53]. The first/leftmost/most significant bit of the bit string contains bit 8 of the first octet of the message. | REL-5 |
| >cdma2000 | | | | | |
| >>cdma2000MessageList | MP | 1.to.<maxInterSystemMessages> | | | |
| >>>MSG_TYPE(s) | MP | | Bit string (8) | Formatted and coded according to cdma2000 specifications. The | |

| Information Element/Group name | Need | Multi | Type and reference | Semantics description | Version |
|--------------------------------|------|-------|---------------------|--|---------|
| | | | | MSG_TYPE bits are numbered b0 to b7. The first/leftmost/most significant bit of the bit string contains bit 7 of the MSG_TYPE. | |
| >>>cdma2000MessagePayload(s) | MP | | Bit string (1..512) | Formatted and coded according to cdma2000 specifications. The first/leftmost/most significant bit of the bit string contains bit 7 of the first octet of the cdma2000 message. | |
| >E-UTRA | | | | | REL-8 |
| >>>E-UTRA message | OP | | Octet string | Formatted and coded according to E-UTRA specifications. The first/leftmost/most significant bit of the octet string contains bit 8 of the first octet of the E-UTRA message. | REL-8 |

10.2.16a HANDOVER TO UTRAN COMMAND

This message is sent to the UE via other system to make a handover to UTRAN.

RLC-SAP: N/A (Sent through a different RAT)

Logical channel: N/A (Sent through a different RAT)

Direction: UTRAN → UE

| Information Element/Group name | Need | Multi | Type and reference | Semantics description | Version |
|--|------|--------------------|---------------------------------|--|---------|
| New U-RNTI | MP | | U-RNTI Short
10.3.3.48 | | |
| Ciphering algorithm | OP | | Ciphering algorithm
10.3.3.4 | | |
| RNC support for change of UE capability | MP | | Boolean | | REL-7 |
| New H-RNTI | OP | | H-RNTI
10.3.3.14a | | REL-6 |
| New Primary E-RNTI | OP | | E-RNTI
10.3.3.10a | | REL-6 |
| New Secondary E-RNTI | OP | | E-RNTI
10.3.3.10a | FDD only | REL-6 |
| Specification mode information elements | | | | | REL-8 |
| CHOICE <i>specification mode</i> | MP | | | | |
| >Complete specification | | | | | |
| RB information elements | | | | | |
| >>>Signalling RB information to setup list | MP | 1 to <maxSRBsetup> | | For each signalling radio bearer established | |

| Information Element/Group name | Need | Multi | Type and reference | Semantics description | Version |
|--|------|--------------------|--|--------------------------|---------|
| >>>Signalling RB information to setup | MP | | Signalling RB information to setup 10.3.4.24 | | |
| >>RAB information to setup list | OP | 1 to <maxRABsetup> | | For each RAB established | |
| >>>RAB information for setup | MP | | RAB information for setup 10.3.4.10 | | |
| Uplink transport channels | | | | | |
| >>UL Transport channel information common for all transport channels | MP | | UL Transport channel information common for all transport channels 10.3.5.24 | | |
| >>Added or Reconfigured TrCH information | MP | 1 to <maxTrCH> | | | |
| >>>Added or Reconfigured UL TrCH information | MP | | Added or Reconfigured UL TrCH information 10.3.5.2 | | |
| Downlink transport channels | | | | | |
| >>DL Transport channel information common for all transport channels | MP | | DL Transport channel information common for all transport channels 10.3.5.6 | | |
| >>Added or Reconfigured TrCH information | MP | 1 to <maxTrCH> | | | |
| >>>Added or Reconfigured DL TrCH information | MP | | Added or Reconfigured DL TrCH information 10.3.5.1 | | |
| Uplink radio resources | | | | | |
| >>Uplink DPCH info | MP | | Uplink DPCH info 10.3.6.88 | | |
| >>E-DCH Info | OP | | E-DCH Info 10.3.6.97 | | REL-6 |
| Downlink radio resources | | | | | |
| >>Downlink HS-PDSCH Information | OP | | Downlink HS-PDSCH Information 10.3.6.23a | | REL-6 |
| >>Downlink information common for all radio links | MP | | Downlink information common for all radio links 10.3.6.24 | | |
| >>Downlink information per radio link | MP | 1 to <maxRL> | | | |
| >>>Downlink information for each radio link | MP | | Downlink information | | |

| Information Element/Group name | Need | Multi | Type and reference | Semantics description | Version |
|---|------|--------------|--|---|---------|
| | | | for each radio link
10.3.6.27 | | |
| >Preconfiguration | | | | | |
| >>CHOICE
<i>Preconfiguration mode</i> | MP | | | | |
| >>>Predefined configuration | MP | | Predefined configuration identity
10.3.4.5 | NOTE 1 | |
| >>>Default configuration | | | | | |
| >>>>Default configuration mode | MP | | Enumerated (FDD, TDD) | Indicates whether the FDD or TDD version of the default configuration shall be used | |
| >>>>Default configuration identity | MP | | Default configuration identity
10.3.4.0 | | |
| >>RAB info | OP | | RAB info
Post
10.3.4.9 | One RAB is established | |
| >>Uplink DPCH info | MP | | Uplink DPCH info
Post
10.3.6.89 | | |
| Downlink radio resources | | | | | |
| >>Downlink information common for all radio links | MP | | Downlink information common for all radio links
Post
10.3.6.25 | | |
| >>Downlink information per radio link | MP | 1 to <maxRL> | | Send downlink information for each radio link to be set-up.
In TDD MaxRL is 1. | |
| >>>Downlink information for each radio link | MP | | Downlink information for each radio link
Post
10.3.6.28 | | |
| >>CHOICE <i>mode</i> | MP | | | | |
| >>>FDD | | | | (no data) | |
| >>>TDD | | | | | |
| >>>>Primary CCPCH Tx Power | MP | | Primary CCPCH Tx Power
10.3.6.59 | | |
| Frequency info | MP | | Frequency info
10.3.6.36 | | |
| Multi-frequency Info | OP | | Multi-frequency Info
10.3.6.39a | This IE is used for 1.28 Mcps TDD only | REL-7 |
| Maximum allowed UL TX | MP | | Maximum | | |

| Information Element/Group name | Need | Multi | Type and reference | Semantics description | Version |
|--------------------------------|------|-------|----------------------------------|-----------------------|---------|
| power | | | allowed UL TX power
10.3.6.39 | | |

NOTE 1: Predefined configurations are not used in case of handover from E-UTRAN.

10.2.16b HANDOVER TO UTRAN COMPLETE

This message is sent by the UE when a handover to UTRAN has been completed.

RLC-SAP: AM

Logical channel: DCCH

Direction: UE → UTRAN

| Information Element/Group name | Need | Multi | Type and reference | Semantics description |
|--------------------------------|------|----------------------|--------------------------------|--|
| Message Type | MP | | Message Type | |
| UE Information elements | | | | |
| START list | CH | 1 to <maxCNdo mains> | | START [40] values for all CN domains. |
| >CN domain identity | MP | | CN domain identity
10.3.1.1 | |
| >START | MP | | START
10.3.3.38 | |
| RB Information elements | | | | |
| COUNT-C activation time | OP | | Activation time
10.3.3.1 | Used for radio bearers mapped on RLC-TM. |

10.2.16c INITIAL DIRECT TRANSFER

This message is used to initiate a signalling connection based on indication from the upper layers, and to transfer a NAS message.

RLC-SAP: AM

Logical channel: DCCH

Direction: UE -> UTRAN

| Information Element/Group name | Need | Multi | Type and reference | Semantics description | Version |
|---|-------------------------|-------|--|---|---------|
| Message Type | MP | | Message Type | | |
| UE information elements | | | | | |
| Integrity check info | CH | | Integrity check info
10.3.3.16 | | |
| PLMN identity | OP | | PLMN identity
10.3.1.11 | This IE indicates the PLMN to which the UE requests the signalling connection to be established. | REL-6 |
| Support of CSG | OP | | Enumerated
(TRUE) | The absence of this IE indicates that the UE does not support access control based on CSG | REL-8 |
| CN information elements | | | | | |
| CN domain identity | MP | | CN domain identity
10.3.1.1 | | |
| Intra Domain NAS Node Selector | MP | | Intra Domain NAS Node Selector
10.3.1.6 | | |
| NAS message | MP | | NAS message
10.3.1.8 | | |
| START | OP | | START
10.3.3.38 | START value to be used in the CN domain as indicated in the IE "CN domain identity". This IE shall always be present in this version of the protocol. | |
| Establishment cause | OP | | Establishment cause
10.3.3.11 | | Rel-5 |
| CS Call Type | CV-
ConversationalCS | | Enumerated
(speech, video, other) | One spare value is needed | REL-7 |
| Measurement information elements | | | | | |
| Measured results on RACH | OP | | Measured results on RACH
10.3.7.45 | | |
| MBMS joined information | OP | | | | REL-6 |
| >P-TMSI | OP | | P-TMSI
(GSM-MAP)
10.3.1.13 | | REL-6 |

| Condition | Explanation |
|-------------------------|--|
| <i>ConversationalCS</i> | This IE is mandatory present if the IE 'Establishment cause' has the value 'Originating Conversational Call' or 'EmergencyCall' and the IE 'CN domain identity' has the value "CS domain". Otherwise it is not needed. |

10.2.16d INTER RAT HANDOVER INFO

This message is sent by the UE via another radio access technology to provide information to the target RNC when preparing for a handover to UTRAN.

RLC-SAP: N/A (Sent through a different RAT)

Logical channel: N/A (Sent through a different RAT)

Direction: UE → UTRAN

| Information Element/Group Name | Need | Multi | Type and reference | Semantics description | Version |
|--|------|-------|--|--|---------|
| Radio Bearer IEs | | | | | |
| Predefined configuration status information | OP | | Predefined configuration status information 10.3.4.5a | | |
| Predefined configuration status information compressed | OP | | Predefined configuration status information compressed 10.3.4.5b | | REL-5 |
| UE Information elements | | | | | |
| UE security information | OP | | UE security information 10.3.3.42b | | |
| UE security information2 | OP | | UE security information2 10.3.3.42c | | REL-6 |
| UE Specific Behaviour Information 1 interRAT | OP | | UE Specific Behaviour Information 1 interRAT 10.3.3.52 | This IE shall not be included in this version of the protocol | |
| UE capability container | OP | | | | |
| >UE radio access capability | MP | | UE radio access capability 10.3.3.42 | | |
| >UE radio access capability extension | MP | | UE radio access capability extension 10.3.3.42a | Although this IE is not always required, the need has been set to MP to align with the ASN.1 | |

| Information Element/Group Name | Need | Multi | Type and reference | Semantics description | Version |
|---|------------------|-------|--|-----------------------|---------|
| UE radio access capability compressed | OP | | UE radio access capability compressed
10.3.3.42o | | REL-5 |
| UE radio access capability comp 2 | <i>CV-Fdd</i> | | UE radio access capability comp 2
10.3.3.42oa | | REL-6 |
| UE radio access capability comp for 1.28 Mcps | <i>CV-128Tdd</i> | | UE radio access capability comp for 1.28 Mcps TDD
10.3.3.42ob | | REL-8 |

| Condition | Explanation |
|---------------|---|
| <i>Fdd</i> | This IE is mandatory present for FDD, otherwise it is not needed. |
| <i>128Tdd</i> | This IE is mandatory present for 1.28 Mcps TDD, otherwise it is not needed. |

10.2.16e MBMS Access Information

This message is transmitted periodically by UTRAN to inform UEs that have joined or selected a particular MBMS service about the need to establish an RRC connection or to perform a cell update. While the message contents may change within a modification period, all occurrences of the information within a modification period concern the same MBMS service(s). If the cell on which this message is sent is operating in MBSFN mode as indicated in subclause 8.1.1.6.3 the UE behaves as if this message would not have been received.

RLC-SAP: UM

Logical channel: MCCH

Direction: UTRAN → UE

| Information Element/Group name | Need | Multi | Type and reference | Semantics description | Version |
|--|------|--------------------------|---|--|---------|
| Message type | MP | | Message Type | | REL-6 |
| Service list | MP | 1 to <maxMBMSserv Count> | | | REL-6 |
| >MBMS short transmission ID | MP | | MBMS Short transmission identity 10.3.9a.10 | Reference/ index to a transmission listed in the MBMS MODIFIED SERVICES INFORMATION or MBMS UNMODIFIED SERVICES INFORMATION | REL-6 |
| >Access probability factor - Idle | MP | | Integer (0 to 960 by step of 32, 1000) | Access probability factor for UEs in idle mode. The actual Access Probability (AP) is a function of the Access Probability Factor (APF):
$AP (APF) = 2^{-(APF/100)}$ | REL-6 |
| >Access probability factor – connected | MD | | Integer (0 to 960 by step of 32, 1000) | Access probability factor for UEs in connected mode. The actual Access Probability (AP) is a function of the Access Probability Factor (APF):
$AP (APF) = 2^{-(APF/100)}$

Default value is the value included in IE "Access probability factor - Idle" | REL-6 |
| >Connected mode counting scope | MP | | | | REL-6 |
| >>URA_PCH | MP | | BOOLEAN | TRUE means that UEs in URA_PCH state shall participate in counting | REL-6 |
| >>CELL_PCH | MP | | BOOLEAN | TRUE means that UEs in CELL_PCH state shall participate in counting | REL-6 |
| >> CELL_FACH | MP | | BOOLEAN | TRUE means that UEs in CELL_FACH state shall participate in counting | REL-6 |

10.2.16f MBMS Common p-t-m rb Information

This message is transmitted periodically by UTRAN to inform UEs about the p-t-m RB configuration information that may be common between different services, applicable in the current and/ or in neighbouring cells. The message contents does not change within a modification period.

RLC-SAP: UM

Logical channel: MCCH

Direction: UTRAN → UE

| Information Element/Group name | Need | Multi | Type and reference | Semantics description | Version |
|----------------------------------|------|------------------------------|--|---|---------|
| Message type | MP | | Message Type | | REL-6 |
| RB information list | MP | 1 to <maxMB MS-CommonRB> | | | REL-6 |
| >RB identity | MP | | MBMS Common RB identity 10.3.9a.3 | | REL-6 |
| >PDCP info | MP | | PDCP info 10.3.4.2 | | REL-6 |
| >RLC info | MP | | RLC info MBMS 10.3.4.23a | | REL-6 |
| TrCh information for each TrCh | MP | 1 to <maxMB MS-CommonTrCh> | | | REL-6 |
| >Transport channel identity | MP | | MBMS Common TrCh identity 10.3.9a.4 | | REL-6 |
| >TFS | MP | | Transport format set 10.3.5.23 | | REL-6 |
| TrCh information for each CCTrCh | OP | 1 to <maxMB MS-CommonCCTrCh> | | The list needs not include the CCTrCh for which the default TFCS for MBMS applies, as specified in subclause 14.10.1. | REL-6 |
| >CCTrCH identity | MP | | MBMS Common CCTrCh identity 10.3.9a.1 | | REL-6 |
| >TFCS | MP | | Transport format combination set 10.3.5.20 | | REL-6 |
| PhyCh information | MP | 1 to <maxMB MS-CommonPhyCh> | | | REL-6 |
| >PhyCh identity | MP | | MBMS Common PhyCh identity 10.3.9a.2 | | REL-6 |
| >CHOICE mode | MP | | | | REL-8 |
| >>FDD or TDD | | | | | REL-8 |
| >>>Secondary CCPCH info MBMS | MP | | Secondary CCPCH info MBMS 10.3.6.71 | | REL-6 |

| Information Element/Group name | Need | Multi | Type and reference | Semantics description | Version |
|--------------------------------------|------|-------|---|---|---------|
| | | | a | | |
| >>3.84 Mcps TDD IMB | | | | 3.84 Mcps TDD IMB is a subset of 3.84 Mcps TDD. | REL-8 |
| >>>Secondary CCPCH frame type 2 info | MP | | Secondary CCPCH frame type 2 info
10.3.6.114 | | REL-8 |
| LCR TDD MBSFN information | OP | | LCR TDD MBSFN Information
10.3.6.78c | 1.28 Mcps TDD only: included only if some timeslots of the secondary frequency of a multi-frequency cell are designated to MBSFN. | REL-7 |

10.2.16g MBMS Current Cell p-t-m rb Information

This message is transmitted periodically by UTRAN to inform UEs about the PTM RB configuration used to in a cell, in case one or more MBMS service is provided using p-t-m radio bearers. The message contents does not change within a modification period.

RLC-SAP: UM

Logical channel: MCCH

Direction: UTRAN → UE

| Information Element/Group name | Need | Multi | Type and reference | Semantics description | Version |
|---------------------------------------|-------------|-----------------------|--|---|---------|
| Message type | MP | | Message Type | Current cell PTM RB info | REL-6 |
| S-CCPCH list | OP | 1 to <maxSC CPCH> | | Absent in case MTCH are only mapped to the S-CCPCH(s) included in SIB type 5 or 5bis | REL-6 |
| >S-CCPCH identity | OP | | MBMS Current cell S-CCPCH identity 10.3.9a.5 | When L1- or L2 combining applies, this identity is used to refer to this S-CCPCH within the NEIGHBOURING CELL P-T-M RB INFORMATION message
If the cell is operating in MBSFN mode as indicated in subclause 8.1.1.6.3 the UE behaviour upon reception of this IE is unspecified.
When Chip combining (1.28Mcps TDD only) applies, this identity is used to refer to the S-CCPCH within the NEIGHBOURING CELL P-T-M RB INFORMATION message | REL-6 |
| >Secondary CCPCH info | MP | | MBMS Common PhyCh identity 10.3.9a.2 | Refers to a configuration in the common RB info | REL-6 |
| >MBMS Soft Combining Timing Offset | CV-Soft-FDD | | MBMS Soft Combining Timing Offset 10.3.9a.1 0a | Timing offset applied in the CFN calculation in sub-clause 8.5.15.5. The default value is 0 ms.
If the cell is operating in MBSFN mode as indicated in subclause 8.1.1.6.3 the UE behaviour upon reception of this IE is unspecified. | REL-6 |
| >TrCh information common for all TrCh | MD | | MBMS Common CCTrCh identity 10.3.9a.1 | Refers to a (TFCS) configuration in the common RB info
The default value of the TFCS is specified in subclause 14.10.1 | REL-6 |
| >TrCH information list | MP | 1 to <maxFA CHPCH > | | List of FACH transport channels carrying one or more MTCH and optionally one MSCH | REL-6 |
| >>TrCh information | MP | | MBMS Common TrCh identity 10.3.9a.4 | Refers to a (TFS) configuration in the common RB info | REL-6 |
| >>>RB information list | OP | 1 to <maxRB perTrCh > | | The IE is absent if temporarily no RBs are mapped to this TrCh or if the TrCH only carries MSCH | REL-6 |
| >>>>RB information | MP | | MBMS p-t-m RB information 10.3.9a.7 a | | REL-6 |
| >>>>MSCH configuration information | OP | | MSCH configuration information 10.3.9a.1 6 | | REL-6 |
| S-CCPCH in SIB type 5 | OP | 1 to <maxSC | | Every S-CCPCH"s included in SIB type 5 or 5bis may carry | REL-6 |

| Information Element/Group name | Need | Multi | Type and reference | Semantics description | Version |
|------------------------------------|----------|-----------------------|--|---|---------|
| | | CPCH> | | MTCH
If the cell is operating in MBSFN mode as indicated in subclause 8.1.1.6.3 the UE behaviour upon reception of this IE is unspecified. | |
| >S-CCPCH identity | | | Integer (1..maxS CCPCH) | Index of the S-CCPCH within the list included in SIB type 5 or 5bis | REL-6 |
| >TrCH information list | MP | 1 to <maxFA CHPCH > | | List of FACH transport channels carrying one or more MTCH and optionally one MSCH | REL-6 |
| >>TrCh identity | MP | | Integer (1..maxF ACHPCH) | Index of the FACH within the list of TrChs defined for that S-CCPCH as included in SIB type 5 or 5bis | REL-6 |
| >>>RB information list | OP | 1 to <maxRB perTrCh > | | The IE is absent if this TrCh only carries MSCH | REL-6 |
| >>>>RB information | MP | | MBMS p-t-m RB information
10.3.9a.7a | | REL-6 |
| >>>>MSCH configuration information | OP | | MSCH configuration information
10.3.9a.16 | Included if the TrCH carries MSCH | REL-6 |
| MBSFN TDM Info List | CV-Mbsfn | | MBSFN TDM Information List
10.3.9a.12b | | REL-7 |

| Condition | Explanation |
|-----------------|--|
| <i>Soft-FDD</i> | This IE is used only for FDD. It is mandatory default for FDD if the IE "L1 combining" is included in MBMS NEIGHBOURING CELL P-T-M RB INFORMATION. Otherwise it is not needed. |
| <i>Mbsfn</i> | The IE is optionally present if the cell supports MBSFN, and not needed otherwise. |

10.2.16h MBMS General Information

This message is transmitted periodically by UTRAN to inform UEs about the general MBMS (configuration) information. The message contents does not change within a modification period.

RLC-SAP: UM

Logical channel: MCCH

Direction: UTRAN → UE

| Information Element/Group name | Need | Multi | Type and reference | Semantics description | Version |
|--|------|-------|---|--|---------|
| Message type | MP | | Message Type | | REL-6 |
| MBMS preferred frequency information | OP | | MBMS preferred frequency information
10.3.7.43 a | If the cell is operating in MBSFN mode as indicated in subclause 8.1.1.6.3 the UE behaviour upon reception of this IE is unspecified. | REL-6 |
| MBMS timers and counters | MP | | MBMS specific timers and counters
10.3.9a.1 1 | | REL-6 |
| MICH configuration information | MP | | MICH configuration information
10.3.9a.1 4 | | REL-6 |
| Cell group identity | MP | | Bit string (12) | Identifies the group of cells for which the same common RLC and PDCP entity is used as the current cell | REL-6 |
| Default MSCH configuration information | OP | | MSCH configuration information
10.3.9a.1 6 | The default MSCH configuration | REL-6 |
| Indicate changes in MBMS Selected Services | MD | | Boolean | TRUE means the UE indicates changes in MBMS Selected Services while in URA_PCH, CELL_PCH or in CELL_FACH
Default value is FALSE
If the cell is operating in MBSFN mode as indicated in subclause 8.1.1.6.3 the UE behaves as if this IE has the value FALSE. | REL-6 |
| MBSFN inter frequency neighbour list | OP | | MBSFN inter frequency neighbour list
10.3.7.43 b | May be included for FDD and 3.84/7.68 Mcps TDD if the cell is operating in MBSFN mode | Rel-7 |
| Network Standard Time Information | OP | | Network standard time information
10.3.9a.1 7 | Only for 1.28 Mcps TDD | Rel-8 |

10.2.16i MBMS Modification request

The UE transmits this message to request UTRAN to take certain actions to improve the UE's ability to receive its (prioritised) activated MBMS services and/ or sessions.

RLC-SAP: AM

Logical channel: DCCH

Direction: UE → UTRAN

| Information Element/Group name | Need | Multi | Type and reference | Semantics description | Version |
|---|------|---------------|--|---|---------|
| Message type | MP | | Message Type | | REL-6 |
| UE information elements | | | | | REL-6 |
| Integrity check info | CH | | Integrity check info
10.3.3.16 | | REL-6 |
| MBMS information elements | | | | | REL-6 |
| MBMS preferred frequency request | OP | | MBMS service identity
10.3.9a.8 | The MBMS preferred frequency the UE would like to be moved to. The MBMS preferred frequency is identified by the identity of the MBMS service the UE would like to receive. | REL-6 |
| MBMS RB list requested to be released | OP | 1 to <maxRB > | | RBs of lower priority MBMS services inhibiting reception of a higher priority service | REL-6 |
| >RB information to release | MP | | RB information to release
10.3.4.19 | | REL-6 |
| MBMS Selected Service Info | OP | | MBMS Selected Service Info
10.3.9a.7b | | REL-6 |
| Support of MBMS service change for a ptp RB | OP | | Enumerated (TRUE) | In this version of the specification, this IE has no meaning but it shall be included upon the conditions specified in subclause 8.7.6.2a. | REL-6 |

10.2.16j MBMS Modified services Information

This information is transmitted periodically by UTRAN to inform UEs about a change applicable for one or more MBMS services available in the current cell and possibly in neighbouring cells.

RLC-SAP: AM (DCCH only) or UM

Logical channel: MCCH, DCCH

Direction: UTRAN → UE

| Information Element/Group name | Need | Multi | Type and reference | Semantics description | Version |
|----------------------------------|---|-----------------------------------|--|--|---------|
| Message type | MP | | Message Type | | REL-6 |
| UE information elements | | | | | REL-6 |
| Integrity check info | CV-DCCH
H | | Integrity check info
10.3.3.16 | Integrity check info is included if integrity protection is applied | REL-6 |
| MBMS information elements | | | | | REL-6 |
| Modified service list | OP | 1..
<maxMB
MSserv
Modif> | | | REL-6 |
| >MBMS Transmission identity | MP | | MBMS Transmission identity
10.3.9a.1
2 | | REL-6 |
| >MBMS required UE action | MP | | Enumerated (None, Acquire counting info, Acquire counting info – PTM RBs unmodified, Acquire PTM RB info, RequestPTP RB, Release PTM RB) | Indicates required UE action upon receiving the message. When sent on the DCCH, only the following values apply: None, Acquire PTM RB info, request PTP RB).
If the cell is operating in MBSFN mode as indicated in subclause 8.1.1.6.3 all values except 'Acquire PTM RB info' and "Release PTM RB" are handled as if 'None' was received. | REL-6 |
| >MBMS PTM RB Release Cause | CV-
<i>PTM_RB_RELEASE_CAUSE_LR_TDD</i> | | Enumerated (NormalRelease, Out of MBMS Service Coverage in RAN, Network Abnormal Release) | Indicates the PTM RB Release cause. For 1.28 Mcps TDD only. | REL-7 |
| >MBMS preferred frequency | OP | | | Indicates the frequency that UEs shall consider as the preferred frequency.
If the cell is operating in MBSFN mode as indicated in subclause 8.1.1.6.3 the UE behaviour upon reception of this IE is unspecified. | REL-6 |
| >>PFL index | CV-
<i>MCCH</i> | | Integer (1..
<maxMB
MS-Freq>) | Index pointing to an entry in the list included in MBMS GENERAL INFORMATION.
If the cell is operating in MBSFN mode as indicated in subclause 8.1.1.6.3 the UE behaviour upon reception of this IE is unspecified. | REL-6 |
| >>PFL info | CV-
<i>DCCH</i> | | Frequency info
10.3.6.36 | | REL-6 |
| >Continue MCCH | MP | | BOOLEA | MCCH in- band notification. | REL-6 |

| Information Element/Group name | Need | Multi | Type and reference | Semantics description | Version |
|------------------------------------|-----------|-------|---------------------------------------|---|---------|
| reading | | | N | Indicates whether or not the UE should continue reading MCCH in the next modification period. Not applicable when sent on the DCCH | |
| >MBSFN cluster frequency | CV-MBSFN | | Integer (1..<max MBSFNclusters>) | For FDD and 3.84/7.68 Mcps TDD index pointing to a frequency indicated in the IE "MBSFN inter frequency neighbour list " in MBMS General Information. Default: the current MBSFN cluster.
For 1.28 Mcps TDD index pointing to a frequency indicated in the SIB 11. Default: the current MBSFN cluster. | REL-7 |
| MBMS re- acquire MCCH | CV-MCCHOP | | Enumerated (TRUE) | | REL-6 |
| MBMS dynamic persistence level | CV-MCCHOP | | Dynamic persistence level 10.3.6.35 | If the cell is operating in MBSFN mode as indicated in subclause 8.1.1.6.3 the UE behaviour upon reception of this IE is unspecified | REL-6 |
| End of modified MCCH information | CV-MCCHOP | | Integer (1..16) | If present: the UE may assume that, in each repetition period, all the MCCH information preceding the MBMS UNMODIFIED SERVICES INFORMATION message is transmitted within the indicated number of TTIs. | REL-6 |
| MBMS number of neighbour cells | MP | | Integer (0..32) | Indicates the number of MBMS NEIGHBOURING CELL P-T-M RB INFORMATION messages that are contained within the MCCH transmission. Not applicable when sent on the DCCH.
If the cell is operating in MBSFN mode as indicated in subclause 8.1.1.6.3 the UE behaves as if the value 0 was received. | REL-6 |
| MBMS all unmodified p-t-m services | CV-MCCHOP | | Enumerated (TRUE) | TRUE means that the UE should re-acquire the PtM information for all services listed in the message MBMS UNMODIFIED SERVICES INFORMATION with the IE 'MBMS required UE action' set to 'Acquire PTM RB info' | REL-6 |
| MBMS p-t-m activation time | CV-MCCHOP | | MBMS p-t-m activation time 10.3.9a.7o | | REL-6 |
| MIB Value tag | OP | | MIB Value tag 10.3.8.9 | Indicates the matching System Information. | REL-7 |

| Condition | Explanation |
|-------------------------------|--|
| <i>MCCH</i> | This IE is mandatory present if the message is sent via MCCH and not needed otherwise. |
| <i>DCCH</i> | This IE is mandatory present if the message is sent via DCCH and not needed otherwise. |
| <i>MCCHOP</i> | This IE is optionally present if the message is sent via MCCH and not needed otherwise. |
| <i>DCCHCH</i> | This IE is present conditionnaly on history if the message is sent via DCCH and not present otherwise. |
| <i>MBSFN</i> | This IE is mandatory default when the cell on which this IE is sent is operating in MBSFN mode according to subclause 8.1.1.6.3. Otherwise the IE is not needed. |
| <i>PTM_RB_RELEASE_LCR_TDD</i> | This IE is optionally present if the IE 'MBMS required UE action' has the value 'Release PTM RB'. Otherwise it is not needed. For 1.28 Mcps TDD only. |

10.2.16k MBMS Neighbouring Cell p-t-m rb Information

This message is transmitted periodically by UTRAN to inform UEs about the p-t-m RB configuration used to in neighbouring cells, indicating the UE may perform selection and/ or soft combining. The message content does not change within a modification period. If the cell is operating in MBSFN mode as indicated in subclause 8.1.1.6.3 the UE behaviour upon reception of this message is unspecified.

RLC-SAP: UM

Logical channel: MCCH

Direction: UTRAN → UE

| Information Element/Group name | Need | Multi | Type and reference | Semantics description | Version |
|--|------|-------------------|--|--|---------|
| Message type | MP | | Message Type | | REL-6 |
| Neighbouring cell identity | MP | | Integer (0..<max CellMeas -1>) | The intra-frequency cell id of the cell obtained from the IE 'Intra-frequency Cell Info list' in SIB 11/SIB 11bis. In case the intra-frequency cell id is omitted in the IE "Intra-frequency Cell Info list" in SIB 11/SIB11bis, it refers to the index (starting at zero) in the CELL_INFO_LIST as if the CELL_INFO_LIST was constructed from SIB11/SIB11bis only, see 8.6.7.3. | REL-6 |
| Neighbouring cell"s S-CCPCH list | MP | 1 to <maxSC CPCH> | | | REL-6 |
| >CHOICE <i>PhyCh</i> | MP | | | | REL-7 |
| >>By reference | | | | | REL-7 |
| >>>Secondary CCPCH info | MP | | MBMS Common PhyCh identity 10.3.9a.2 | S-CCPCH configuration used in neighbouring cell. Refers to a configuration in the common RB info of the current cell | REL-6 |
| >>Extended | | | | FDD only | REL-7 |
| >>>Secondary CCPCH info | OP | | MBMS Common PhyCh identity 10.3.9a.2 | Referenced S-CCPCH configuration used in neighbouring cell. Refers to a configuration in the common RB info of the current cell | REL-7 |
| >>>Secondary CCPCH info MBMS Diff | MP | | Secondary CCPCH info MBMS Diff 10.3.6.71 b | Differential S-CCPCH configuration. Physical configuration parameters in this IE replace the corresponding parameters in the referenced S-CCPCH configuration. If the referenced S-CCPCH configuration is absent, the full set of parameters is needed. | REL-7 |
| >Secondary CCPCH Power Offset Difference | MD | | Integer (-6, -3, 3, 6) | Difference ($P_n - O_f$) between the S-CCPCH power offset (P_n) of the neighboring cell S-CCPCH and the S-CCPCH power offset (O_f) of the serving cell that is going to be combined to this neighbour cell S-CCPCH, in dB. Default value is 0. Note 3 and 4. | REL-6 |
| >L1 combining | OP | | | L2- combining applies if the IE is absent | REL-6 |
| >>CHOICE <i>mode</i> | MP | | | | REL-6 |
| >>>FDD | | | | | REL-6 |
| >>>>MBMS Soft Combining Timing Offset | MP | | MBMS Soft Combining Timing Offset 10.3.9a.1 0a | Timing offset applied in the CFN calculation in subclause 8.5.15.5 | REL-6 |
| >>>>MBMS transmission time difference | MP | | Integer (0..3) | Indicates the time difference between the TTIs on the current and the neighbouring cell"s SCCPCH that can be L1-combined | REL-6 |
| >>>>MBMS L1 combining schedule | OP | | MBMS L1 combining | If included partial layer 1 combining applies, in which case | REL-6 |

| Information Element/Group name | Need | Multi | Type and reference | Semantics description | Version |
|---|------|----------------------|---|--|---------|
| | | | schedule
10.3.9a.7 | this IE indicates when L1-combining applies. If the IE is absent, L1 combining applies continuously | |
| >>>TDD | | | | (no data) | REL-6 |
| | | | | If L1 combining is configured, for 1.28Mcps TDD UE, MBMS data reception shall be implemented by means of chip combine receiver [55]. | REL-7 |
| >CHOICE L23 configuration | MP | | | | REL-6 |
| >>SameAs Current cell | | | | Apart from the physical channel configuration and the MSCH configuration information, the same configuration as for the indicated S-CCPCH used in the current cell applies. The MSCH is mapped on the same transport channel as in the current cell. | REL-6 |
| >>>Current cell's S-CCPCH | MP | | MBMS Current cell S-CCPCH identity
10.3.9a.5 | Reference to the S-CCPCH in the current cell which uses exactly the same configuration (excluding MSCH configuration). | REL-6 |
| >>>MSCH configuration information | OP | | MSCH configuration information
10.3.9a.16 | | REL-6 |
| >>Different | | | | | REL-6 |
| >>>TrCh information for common for all TrCh | MD | | MBMS Common CTrCh identity
10.3.9a.1 | Refers to a (TFCS) configuration in the common RB info
The default value of the TFCS is specified in subclause 14.10.1 | REL-6 |
| >>>TrCH information list | MP | 1 to <maxFACHPCH> | | List of FACH transport channels carrying one or more MTCH and optionally one MSCH | REL-6 |
| >>>>TrCh information | MP | | MBMS Common TrCh identity
10.3.9a.4 | Refers to a (TFS) configuration in the common RB info | REL-6 |
| >>>>TrCh combining status | MP | | BOOLEAN | Value TRUE means that TrCh combining is used for this transport channel (TDD only).
Note 2.
The IE shall be ignored in FDD mode. | REL-6 |
| >>>>RB information list | OP | 1 to <maxRB perTrCh> | | The IE is only present for the radio bearers for which selection (FDD) or transport channel (TDD) combining applies. | REL-6 |
| >>>>>RB information | MP | | MBMS p-t-m RB information
10.3.9a.7a | | REL-6 |
| >>>>MSCH configuration information | OP | | MSCH configuration | Included if the TrCH carries MSCH | REL-6 |

| Information Element/Group name | Need | Multi | Type and reference | Semantics description | Version |
|--------------------------------|------|-------|--|-----------------------|---------|
| | | | ion
informatio
n
10.3.9a.1
6 | | |

NOTE 1: The signalling supports the option that UTRAN maps one service to L1 combining slots for some neighbours and to the L2 combining slots for other neighbours ie. the use of different combining schemes for different neighbours

NOTE 2: Transport combining can only be indicated when the complete L2 configuration is provided for the neighbouring cell (i.e. using L2 configuration choice 'different'). Fortunately, a scenario in which the neighbouring cell configuration is different from the current cell is regarded as the typical scenario for using transport combining.

NOTE 3: For FDD, an S-CCPCH power offset is defined as the offset between the transmitted power of the data part of one S-CCPCH and the transmitted power of the P-CPICH of a given cell ($P_{s\text{-ccpch}} - P_{p\text{-cpich}}$). For TDD, an S-CCPCH power offset is defined as the offset between one S-CCPCH and the P-CCPCH of a given cell ($P_{s\text{-ccpch}} - P_{p\text{-ccpch}}$).

NOTE 4: The Secondary CCPCH Power Offset Difference IE gives the UE an indication of the S-CCPCH power on the neighbouring cells that may be used to complete the neighbouring cell ranking based on P-CPICH power for FDD or P-CCPCH for TDD.

10.2.16L MBMS Scheduling Information

This message is transmitted periodically by UTRAN to inform UEs when the MBMS services, provided on the same S-CCPCH as the message is sent, are scheduled to be transmitted. The UE may use the scheduling information to discontinue receiving the concerned S-CCPCH. The message is transmitted in accordance with the MSCH configuration applicable for the corresponding S-CCPCH.

RLC-SAP: UM

Logical channel: MSCH

Direction: UTRAN → UE

| Information Element/Group name | Need | Multi | Type and reference | Semantics description | Version |
|---------------------------------------|------|-------------------------|--|---|---------|
| Message type | MP | | Message Type | | REL-6 |
| Service scheduling info list | MP | 1 to <maxMBMSservSched> | | | REL-6 |
| >MBMS Transmission identity | MP | | MBMS Transmission identity 10.3.9a.1 2 | | REL-6 |
| >MBMS Service transmissions info list | OP | 1 to <maxMBMSTransmis> | | One or more sets of scheduling information comprising of the beginning and duration of an MBMS service transmission for one scheduling period | REL-6 |
| >>Start | MP | | Integer (0..1020) by step of 4 | Indicates the start of the transmission relative to the start of the TTI in which the MBMS SCHEDULING INFORMATION message was received. In number of radio frames (i.e. the value 0 would correspond to the start of the MBMS transmission being in the same TTI as the MBMS Scheduling Information message.) See note 1. | REL-6 |
| >>Duration | MP | | Integer (4..1024) by step of 4 | In number of radio frames | REL-6 |
| >Next scheduling period | MP | | Integer (0..31) | Number of scheduling periods (see 10.3.9a.16), after the current scheduling period, in which no data will be transmitted for the concerned service. If the Next scheduling period is set to 0, data may be transmitted for the concerned service in the scheduling period immediately following the current scheduling period | REL-6 |

NOTE: If UTRAN sets the value of the IE "Start" to a value less than or equal to 16 then the UE may not successfully receive the start of the MTCH transmission.

10.2.16m MBMS Unmodified services Information

This message is transmitted periodically by UTRAN to inform UEs about the MBMS services, available in the current cell and possibly in neighbouring cells, that have not changed if the IE "MBMS all unmodified p-t-m services" is not included in the MBMS MODIFIED SERVICES INFORMATION message in this modification period. The message is repeated every repetition period while its contents does not change within a modification period.

RLC-SAP: UM

Logical channel: MCCH

Direction: UTRAN → UE

| Information Element/Group name | Need | Multi | Type and reference | Semantics description | Version |
|--------------------------------|--------------|-----------------------------|---|---|---------|
| Message type | MP | | Message Type | | REL-6 |
| Unmodified services list | OP | 1 to <maxMBMSserv Unmodif > | | If the IE 'MBMS all unmodified p-t-m services' is included in the MBMS MODIFIED SERVICES INFORMATION message in this modification period, the services with the IE 'MBMS required UE action' set to 'Acquire PTM RB info' in the message MBMS UNMODIFIED SERVICES INFORMATION should be considered as modified. | REL-6 |
| >MBMS Transmission identity | MP | | MBMS Transmission identity 10.3.9a.1 2 | | REL-6 |
| >MBMS required UE action | MP | | Enumerated (None, Acquire PTM RB info, Request PTP RB) | Indication of the UE action required to receive the service.
If the cell is operating in MBSFN mode as indicated in subclause 8.1.1.6.3 all values except 'Acquire PTM RB info' are handled as if 'None' was received. | REL-6 |
| >MBMS preferred frequency | OP | | Integer (1.. <maxMBMS-Freq>) | Information about the frequency that UEs shall consider as the preferred frequency layer for cell re-selection during a session for an activated MBMS service, as specified in [25.304].
Index pointing to an entry in the list included in MBMS GENERAL INFORMATION.
If the cell is operating in MBSFN mode as indicated in subclause 8.1.1.6.3 the UE behaviour upon reception of this IE is unspecified. | REL-6 |
| >MBSFN cluster frequency | CV-
MBSFN | | Integer (1..<max MBSFNclusters>) | For FDD and 3.84/7.68 Mcps TDD index pointing to a frequency indicated in the IE "MBSFN inter frequency neighbour list " in MBSFN General Information. Default: the current MBSFN cluster.
For 1.28 Mcps TDD index pointing to a frequency indicated in the SIB 11. Default: the current MBSFN cluster. | REL-7 |

| Condition | Explanation |
|--------------|--|
| <i>MBSFN</i> | This IE is mandatory present when the cell on which this IE is sent is operating in MBSFN mode according to subclause 8.1.1.6.3. Otherwise the IE is not needed. |

10.2.17 MEASUREMENT CONTROL

This message is sent by UTRAN to setup, modify or release a measurement in the UE.

RLC-SAP: AM

Logical channel: DCCH

Direction: UTRAN→UE

| Information Element/Group name | Need | Multi | Type and reference | Semantics description | Version |
|---|-------------------|-------|--|-----------------------|---------|
| Message Type | MP | | Message Type | | |
| UE information elements | | | | | |
| RRC transaction identifier | MP | | RRC transaction identifier
10.3.3.36 | | |
| Integrity check info | CH | | Integrity check info
10.3.3.16 | | |
| Measurement Information elements | | | | | |
| Measurement Identity | MP | | Measurement Identity
10.3.7.48 | | |
| Measurement Command | MP | | Measurement Command
10.3.7.46 | | |
| Measurement Reporting Mode | OP | | Measurement Reporting Mode
10.3.7.49 | | |
| Additional measurements list | OP | | Additional measurements list
10.3.7.1 | | |
| <i>CHOICE Measurement type</i> | <i>CV-command</i> | | | | |
| >Intra-frequency measurement | | | Intra-frequency measurement
10.3.7.36 | | |
| >Inter-frequency measurement | | | Inter-frequency measurement
10.3.7.16 | | |
| >Inter-RAT measurement | | | Inter-RAT measurement
10.3.7.27 | | |
| >UE positioning measurement | | | UE positioning measurement
10.3.7.100 | | |
| >Traffic Volume measurement | | | Traffic Volume measurement
10.3.7.68 | | |
| >Quality measurement | | | Quality measurement
10.3.7.56 | | |
| >UE internal | | | UE | | |

| Information Element/Group name | Need | Multi | Type and reference | Semantics description | Version |
|--|------|-------|---|-----------------------|---------|
| measurement | | | internal measurement
10.3.7.77 | | |
| Physical channel information elements | | | | | |
| DPCH compressed mode status info | OP | | DPCH compressed mode status info
10.3.6.34 | | |

| Condition | Explanation |
|----------------|---|
| <i>Command</i> | The IE is mandatory present if the IE "Measurement command" is set to "Setup", optional if the IE "Measurement command" is set to "modify", otherwise the IE is not needed. |

10.2.18 MEASUREMENT CONTROL FAILURE

This message is sent by UE, if it cannot initiate a measurement as instructed by UTRAN.

RLC-SAP: AM

Logical channel: DCCH

Direction: UE→UTRAN

| Information Element/Group name | Need | Multi | Type and reference | Semantics description |
|--------------------------------|------|-------|--|-----------------------|
| Message Type | MP | | Message Type | |
| UE information elements | | | | |
| RRC transaction identifier | MP | | RRC transaction identifier
10.3.3.36 | |
| Integrity check info | CH | | Integrity check info
10.3.3.16 | |
| Failure cause | MP | | Failure cause and error information
10.3.3.14 | |

10.2.19 MEASUREMENT REPORT

This message is used by UE to transfer measurement results to the UTRAN.

RLC-SAP: AM or UM

Logical channel: DCCH

Direction: UE→UTRAN

| Information Element/Group name | Need | Multi | Type and reference | Semantics description | Version |
|---|-----------------------|------------------------------|---------------------------------------|-----------------------|---------|
| Message Type | MP | | Message Type | | |
| UE information elements | | | | | |
| Integrity check info | CH | | Integrity check info
10.3.3.16 | | |
| Activation time | CV-
<i>PreConf</i> | | Activation time
10.3.3.1 | | REL-8 |
| Measurement Information Elements | | | | | |
| Measurement identity | MP | | Measurement identity
10.3.7.48 | | |
| Measured Results | OP | | Measured Results
10.3.7.44 | | |
| Measured Results on RACH | OP | | Measured Results on RACH
10.3.7.45 | | |
| Additional Measured results | OP | 1 to
<maxAdditional Meas> | | | |
| >Measured Results | MP | | Measured Results
10.3.7.44 | | |
| Event results | OP | | Event results
10.3.7.7 | | |
| Inter-RAT cell info indication | CV-
<i>IRAT</i> | | Integer
(0..3) | | REL-5 |
| E-UTRA Measured Results | OP | | E-UTRA Measured Results
10.3.7.6c | | REL-8 |
| E-UTRA Event Results | OP | | E-UTRA Event Results
10.3.7.6a | | REL-8 |

| Condition | Explanation |
|----------------|---|
| <i>IRAT</i> | The IE is optionally present if at least one of the IE "Inter-RAT measured results list" and the IE "Inter-RAT measurement event results" is included in the message. Otherwise, the IE is not needed. |
| <i>PreConf</i> | The IE is mandatory if the table 'Target cell preconfigurations' in the variable includes the cell that triggered the event and the IE 'Activation time offset' is different from 0. Otherwise, the IE is not needed. |

10.2.20 PAGING TYPE 1

This message is used to send information on the paging channel. One or several UEs, in idle or connected mode, can be paged in one message, which also can contain other information.

RLC-SAP: TM

Logical channel: PCCH

Direction: UTRAN → UE

| Information Element/Group name | Need | Multi | Type and reference | Semantics description | Version |
|-----------------------------------|------|-----------------|---------------------------------|-----------------------|---------|
| Message Type | MP | | Message Type | | |
| UE Information elements | | | | | |
| Paging record list | OP | 1 to <maxPage1> | | | |
| >Paging record | MP | | Paging record 10.3.3.23 | | |
| Other information elements | | | | | |
| BCCH modification info | OP | | BCCH modification info 10.3.8.1 | | |
| ETWS information | OP | | ETWS information 10.3.8.4e | | REL-8 |

If the encoded message does not fill a transport block, the RRC layer shall add padding according to subclause 12.1.

10.2.21 PAGING TYPE 2

This message is used to page a UE in connected mode, when using the DCCH for CN originated paging.

RLC-SAP: AM

Logical channel: DCCH

Direction: UTRAN → UE

| Information Element/Group name | Need | Multi | Type and reference | Semantics description |
|--------------------------------|------|-------|--|-----------------------|
| Message Type | MP | | Message Type | |
| UE information elements | | | | |
| RRC transaction identifier | MP | | RRC transaction identifier
10.3.3.36 | |
| Integrity check info | CH | | Integrity check info
10.3.3.16 | |
| Paging cause | MP | | Paging cause
10.3.3.22 | |
| CN Information elements | | | | |
| CN domain identity | MP | | CN domain identity
10.3.1.1 | |
| Paging Record Type Identifier | MP | | Paging Record Type Identifier
10.3.1.10 | |

10.2.22 PHYSICAL CHANNEL RECONFIGURATION

This message is used by UTRAN to assign, replace or release a set of physical channels used by a UE.

RLC-SAP: AM or UM

Logical channel: DCCCH

Direction: UTRAN → UE

| Information Element/Group name | Need | Multi | Type and reference | Semantics description | Version |
|--------------------------------|------|-------|---|---|---------|
| Message Type | MP | | Message Type | | |
| UE Information Elements | | | | | |
| RRC transaction identifier | MP | | RRC transaction identifier
10.3.3.36 | | |
| Integrity check info | CH | | Integrity check info
10.3.3.16 | | |
| Integrity protection mode info | OP | | Integrity protection mode info
10.3.3.19 | The UTRAN should not include this IE unless it is performing an SRNS relocation | |
| Ciphering mode info | OP | | Ciphering mode info
10.3.3.5 | The UTRAN should not include this IE unless it is performing an SRNS relocation and a change in ciphering algorithm | |
| Activation time | MD | | Activation time
10.3.3.1 | Default value is "now" | |
| Delay restriction flag | OP | | Enumerated (TRUE) | This IE is always set to TRUE and included if the activation time is restricted | REL-6 |

| Information Element/Group name | Need | Multi | Type and reference | Semantics description | Version |
|--|---------------------|----------------------|---|--|---------|
| | | | | according to subclause 8.6.3.1 | |
| New U-RNTI | OP | | U-RNTI
10.3.3.47 | | |
| New C-RNTI | OP | | C-RNTI
10.3.3.8 | | |
| New DSCH-RNTI | OP | | DSCH-RNTI
10.3.3.9a | Should not be set in FDD. If received the UE should ignore it | |
| New H-RNTI | OP | | H-RNTI
10.3.3.14a | | REL-5 |
| New Primary E-RNTI | OP | | E-RNTI
10.3.3.10a | | REL-6 |
| New Secondary E-RNTI | OP | | E-RNTI
10.3.3.10a | FDD only | REL-6 |
| RRC State Indicator | MP | | RRC State Indicator
10.3.3.35a | | |
| UE Mobility State Indicator | CV-
FACH_PC
H | | Enumerated (High-mobility Detected) | Absence of this IE implies that, according to [4], the UE shall consider itself being in the mobility state the UE has maintained in CELL_DCH state or being not in high mobility state after the state transition, if applicable. | REL-7 |
| UTRAN DRX cycle length coefficient | OP | | UTRAN DRX cycle length coefficient
10.3.3.49 | | |
| CN Information Elements | | | | | |
| CN Information info | OP | | CN Information info
10.3.1.3 | | |
| UTRAN mobility information elements | | | | | |
| URA identity | OP | | URA identity
10.3.2.6 | | |
| RNC support for change of UE capability | OP | | Boolean | Should be included if the message is used to perform an SRNS relocation | REL-7 |
| Reconfiguration in response to requested change of UE capability | OP | | Enumerated (TRUE) | | REL-7 |
| RB information elements | | | | | |
| Downlink counter synchronisation info | OP | | | | |
| >RB with PDCP information list | OP | 1 to <maxRBall RABs> | | | |

| Information Element/Group name | Need | Multi | Type and reference | Semantics description | Version |
|------------------------------------|------|-------|--|---|---------|
| >>RB with PDCP information | MP | | RB with PDCP information 10.3.4.22 | This IE is needed for each RB having PDCP in the case of lossless SRNS relocation | |
| | OP | | | | REL-5 |
| >>PDCP context relocation info | OP | | PDCP context relocation info 10.3.4.1a | This IE is needed for each RB having PDCP and performing PDCP context relocation | REL-5 |
| Downlink transport channels | | | | | |
| HARQ Info | OP | | HARQ info 10.3.5.7a | | REL-7 |
| PhyCH information elements | | | | | |
| Frequency info | OP | | Frequency info 10.3.6.36 | | |
| Multi-frequency Info | OP | | Multi-frequency Info 10.3.6.39a | This IE is used for 1.28 Mcps TDD only | REL-7 |
| DTX-DRX timing information | OP | | DTX-DRX timing information 10.3.6.34b | | REL-7 |
| DTX-DRX Information | OP | | DTX-DRX Information 10.3.6.34a | | REL-7 |
| HS-SCCH less Information | OP | | HS-SCCH less Information 10.3.6.36ab | | REL-7 |
| MIMO parameters | OP | | MIMO parameters 10.3.6.41a | | REL-7 |
| Control Channel DRX information | OP | | Control Channel DRX information 1.28 Mcps TDD 10.3.6.107 | This IE is used for 1.28 Mcps TDD only | REL-8 |
| SPS Information | OP | | SPS information 1.28 Mcps TDD 10.3.6.110 | This IE is used for 1.28 Mcps TDD only | REL-8 |
| Uplink radio resources | | | | | |
| Maximum allowed UL TX power | MD | | Maximum allowed UL TX power 10.3.6.39 | Default value is the existing value of the maximum allowed UL TX power | |
| Uplink DPCH info | OP | | Uplink DPCH info 10.3.6.88 | | |
| E-DCH Info | OP | | E-DCH Info 10.3.6.97 | | REL-6 |
| Downlink radio resources | | | | | |
| Downlink HS-PDSCH Information | OP | | Downlink HS_PDSCH Information 10.3.6.23a | | REL-5 |

| Information Element/Group name | Need | Multi | Type and reference | Semantics description | Version |
|---|------|--------------|---|---|---------|
| Downlink information common for all radio links | OP | | Downlink information common for all radio links 10.3.6.24 | | |
| Downlink information per radio link list | OP | 1 to <maxRL> | | Send downlink information for each radio link | |
| >Downlink information for each radio link | MP | | Downlink information for each radio link 10.3.6.27 | | |
| Downlink secondary cell info FDD | OP | | Downlink secondary cell info FDD 10.3.6.31a | FDD only | REL-8 |
| MBMS PL Service Restriction Information | OP | | Enumerated (TRUE) | | REL-6 |

| Condition | Explanation |
|-----------------|---|
| <i>FACH_PCH</i> | This IE is mandatory default when a transition from CELL_DCH to CELL_FACH, URA_PCH or CELL_PCH is requested by the message and is not needed otherwise. |

10.2.23 PHYSICAL CHANNEL RECONFIGURATION COMPLETE

This message is sent from the UE when a physical channel reconfiguration has been done.

RLC-SAP: AM

Logical channel: DCCH

Direction: UE → UTRAN

| Information Element/Group name | Need | Multi | Type and reference | Semantics description | Version |
|---|------|-------|--|-----------------------|---------|
| Message Type | MP | | Message Type | | |
| UE information elements | | | | | |
| RRC transaction identifier | MP | | RRC transaction identifier 10.3.3.36 | | |
| Integrity check info | CH | | Integrity check info 10.3.3.16 | | |
| Uplink integrity protection activation info | OP | | Integrity protection activation info 10.3.3.17 | | |
| CHOICE <i>mode</i> | MP | | | | |
| >FDD | | | | (no data) | |
| >TDD | | | | | |
| >>CHOICE <i>TDD option</i> | MP | | | | REL-4 |
| >>>3.84 Mcps TDD | | | | | REL-4 |
| >>>>Uplink Timing Advance | OP | | Uplink Timing Advance 10.3.6.95 | | |

| Information Element/Group name | Need | Multi | Type and reference | Semantics description | Version |
|--------------------------------------|------|----------------------|--|---|---------|
| >>>>Extended Uplink Timing Advance | OP | | Extended Uplink Timing Advance
10.3.6.95a | | REL-7 |
| >>>7.68 Mcps TDD | | | | | REL-7 |
| >>>>Extended Uplink Timing Advance | OP | | Extended Uplink Timing Advance
10.3.6.95a | | REL-7 |
| >>>1.28 Mcps TDD | | | | (no data) | REL-4 |
| Other Information elements | | | | | REL-7 |
| Deferred measurement control reading | MD | | Enumerated (TRUE) | Indicates the UE has not read SIB11, SIB11bis and SIB12, if available. Default value is FALSE | REL-7 |
| RB Information elements | | | | | |
| COUNT-C activation time | OP | | Activation time
10.3.3.1 | Used for radio bearers mapped on RLC-TM. | |
| Uplink counter synchronisation info | OP | | | | |
| >RB with PDCP information list | OP | 1 to <maxRBall RABs> | | | |
| >>RB with PDCP information | MP | | RB with PDCP information
10.3.4.22 | | |
| >START list | MP | 1 to <maxCNdo mains> | | START [40] values for all CN domains. | |
| >>CN domain identity | MP | | CN domain identity
10.3.1.1 | | |
| >>START | MP | | START
10.3.3.38 | START value to be used in this CN domain. | |

10.2.24 PHYSICAL CHANNEL RECONFIGURATION FAILURE

This message is sent by UE if the configuration given by UTRAN is unacceptable or if the UE failed to assign, replace or release a set of physical channel(s).

RLC-SAP: AM

Logical channel: DCCH

Direction: UE→UTRAN

| Information Element/Group name | Need | Multi | Type and reference | Semantics description |
|--------------------------------|------|-------|--|-----------------------|
| Message type | MP | | Message type | |
| UE information elements | | | | |
| RRC transaction identifier | OP | | RRC transaction identifier
10.3.3.36 | |
| Integrity check info | CH | | Integrity check info
10.3.3.16 | |
| Failure cause | MP | | Failure cause and error information
10.3.3.14 | |

10.2.25 PHYSICAL SHARED CHANNEL ALLOCATION

NOTE: Only for TDD.

This message is used by UTRAN to assign physical resources to USCH/DSCH transport channels in TDD, for temporary usage by the UE.

RLC-SAP: UM on SHCCH, UM on DCCH

Logical channel: SHCCH or DCCH

Direction: UTRAN → UE

| Information Element/Group name | Need | Multi | Type and reference | Semantics description |
|--------------------------------|------|-------|---|---|
| Message Type | MP | | Message type | |
| DSCH-RNTI | OP | | DSCH-RNTI
10.3.3.9a | |
| RRC transaction identifier | MP | | RRC transaction identifier
10.3.3.36 | |
| Uplink timing advance Control | MD | | Uplink Timing Advance Control
10.3.6.96 | Default value is the existing value for uplink timing advance |
| PUSCH capacity allocation info | OP | | PUSCH Capacity Allocation info
10.3.6.64 | |
| PDSCH capacity allocation info | OP | | PDSCH Capacity Allocation info
10.3.6.42 | |
| Confirm request | MD | | Enumerated(No Confirm, Confirm PDSCH, Confirm PUSCH) | Default value is No Confirm |
| Traffic volume report request | OP | | Integer (0 .. 255) | Indicates the number of frames between start of the allocation period and sending measurement report. The |

| Information Element/Group name | Need | Multi | Type and reference | Semantics description |
|--------------------------------|------|------------|------------------------------|---|
| | | | | value should be less than the value for Allocation Duration. |
| ISCP Timeslot list | OP | 1 to maxTS | | |
| >Timeslot number | MP | | Timeslot number
10.3.6.84 | Timeslot numbers, for which the UE shall report the timeslot ISCP in PUSCH CAPACITY REQUEST message. |
| Request P-CCPCH RSCP | MP | | Boolean | TRUE indicates that a Primary CCPCH RSCP measurement shall be reported by the UE in PUSCH CAPACITY REQUEST message. |

10.2.26 PUSCH CAPACITY REQUEST

NOTE: Only for TDD.

This message is used by the UE for request of PUSCH resources to the UTRAN.

RLC-SAP: TM

Logical channel: SHCCH

Direction: UE → UTRAN

| Information Element/Group name | Need | Multi | Type and reference | Semantics description |
|---------------------------------------|------------|------------|--|------------------------|
| Message Type | MP | | Message Type | |
| DSCH-RNTI | OP | | DSCH-RNTI
10.3.3.9a | |
| RRC transaction identifier | CV-ProtErr | | RRC transaction identifier
10.3.3.36 | |
| Traffic Volume | OP | | Traffic Volume, measured results list
10.3.7.67 | |
| Timeslot list | OP | 1 to maxTS | | |
| >Timeslot number | MP | | Timeslot number
10.3.6.84 | |
| >Timeslot ISCP | MP | | Timeslot ISCP info
10.3.7.65 | |
| Primary CCPCH RSCP | OP | | Primary CCPCH RSCP info
10.3.7.54 | |
| <i>CHOICE Allocation confirmation</i> | OP | | | |
| >PDSCH Confirmation | | | Integer(1..hi PDSCHidentities) | |
| >PUSCH Confirmation | | | Integer(1..hi PUSCHidentities) | |
| Protocol error indicator | MD | | Protocol error indicator
10.3.3.27 | Default value is FALSE |

| Information Element/Group name | Need | Multi | Type and reference | Semantics description |
|--------------------------------|------------|-------|--------------------------------------|-----------------------|
| Protocol error information | CV-ProtErr | | Protocol error information 10.3.8.12 | |

| Condition | Explanation |
|----------------|---|
| <i>ProtErr</i> | This IE is mandatory present if the IE "Protocol error indicator" has the value TRUE. Otherwise it is not needed. |

10.2.27 RADIO BEARER RECONFIGURATION

This message is sent from UTRAN to reconfigure parameters related to a change of QoS or to release and setup a radio bearer used for ptp transmission of MBMS services of the broadcast type. This procedure can also change the multiplexing of MAC, reconfigure transport channels and physical channels. This message is also used to perform a handover from GERAN *Iu mode* to UTRAN.

RLC-SAP: AM or UM or sent through GERAN *Iu mode*

Logical channel: DCCH or sent through GERAN *Iu mode*

Direction: UTRAN → UE

| Information Element/Group name | Need | Multi | Type and reference | Semantics description | Version |
|--------------------------------|------|-------|--|--|---------|
| Message Type | MP | | Message Type | | |
| UE Information elements | | | | | |
| RRC transaction identifier | MP | | RRC transaction identifier 10.3.3.36 | | |
| Integrity check info | CH | | Integrity check info 10.3.3.16 | | |
| Integrity protection mode info | OP | | Integrity protection mode info 10.3.3.19 | The UTRAN should not include this IE unless it is performing an SRNS relocation or a handover from GERAN <i>Iu mode</i> | |
| Ciphering mode info | OP | | Ciphering mode info 10.3.3.5 | The UTRAN should not include this IE unless it is performing either an SRNS relocation or a handover from GERAN <i>Iu mode</i> and a change in ciphering algorithm | |
| Activation time | MD | | Activation time 10.3.3.1 | Default value is "now" | |
| Delay restriction flag | OP | | Enumerated (TRUE) | This IE is always set to TRUE and included if the activation time is restricted according to | REL-6 |

| Information Element/Group name | Need | Multi | Type and reference | Semantics description | Version |
|--|---------------------|---------------------|---|--|---------|
| | | | | subclause 8.6.3.1 | |
| New U-RNTI | OP | | U-RNTI
10.3.3.47 | | |
| New C-RNTI | OP | | C-RNTI
10.3.3.8 | | |
| New DSCH-RNTI | OP | | DSCH-RNTI
10.3.3.9a | Should not be set in FDD. If received The UE should ignore it | |
| New H-RNTI | OP | | H-RNTI
10.3.3.14a | | REL-5 |
| New Primary E-RNTI | OP | | E-RNTI
10.3.3.10a | | REL-6 |
| New Secondary E-RNTI | OP | | E-RNTI
10.3.3.10a | FDD only | REL-6 |
| RRC State Indicator | MP | | RRC State Indicator
10.3.3.35a | | |
| UE Mobility State Indicator | CV-
FACH_PC
H | | Enumerated (High-mobilityDetected) | Absence of this IE implies that, according to [4], the UE shall consider itself being in the mobility state the UE has maintained in CELL_DCH state or being not in high mobility state after the state transition, if applicable. | REL-7 |
| UTRAN DRX cycle length coefficient | OP | | UTRAN DRX cycle length coefficient
10.3.3.49 | | |
| CN information elements | | | | | |
| CN Information info | OP | | CN Information info
10.3.1.3 | | |
| UTRAN mobility information elements | | | | | |
| RNC support for change of UE capability | OP | | Boolean | Should be included if the message is used to perform an SRNS relocation | REL-7 |
| Reconfiguration in response to requested change of UE capability | OP | | Enumerated (TRUE) | | REL-7 |
| URA identity | OP | | URA identity
10.3.2.6 | | |
| Specification mode information elements | | | | | |
| CHOICE specification mode | MP | | | | REL-5 |
| >Complete specification | | | | | |
| RB information elements | | | | | |
| >>RAB information to reconfigure list | OP | 1 to <maxRABsetup > | | | |
| >>>RAB information to reconfigure | MP | | RAB information to reconfigure | | |

| Information Element/Group name | Need | Multi | Type and reference | Semantics description | Version |
|--|------|----------------------------|--|--|---------|
| | | | 10.3.4.11 | | |
| >>RAB information for MBMS ptp bearer list | OP | 1 to <maxMBMS servSelect > | | | REL-6 |
| >>>RAB information for MBMS ptp bearer | MP | | RAB information for MBMS ptp bearer 10.3.4.9a | | REL-6 |
| >>RB information to reconfigure list | MP | 1to <maxRB> | | Although this IE is not always required, need is MP to align with ASN.1 | |
| | OP | | | | REL-4 |
| >>>RB information to reconfigure | MP | | RB information to reconfigure 10.3.4.18 | | |
| >>RB information to be affected list | OP | 1 to <maxRB> | | | |
| >>>RB information to be affected | MP | | RB information to be affected 10.3.4.17 | | |
| >>RB with PDCP context relocation info list | OP | 1 to <maxRBall RABs> | | This IE is needed for each RB having PDCP and performing PDCP context relocation | REL-5 |
| >>>PDCP context relocation info | MP | | PDCP context relocation info 10.3.4.1a | | REL-5 |
| >>PDCP ROHC target mode | OP | | PDCP ROHC target mode 10.3.4.2a | | REL-5 |
| TrCH Information Elements | | | | | |
| Uplink transport channels | | | | | |
| >>UL Transport channel information common for all transport channels | OP | | UL Transport channel information common for all transport channels 10.3.5.24 | | |
| >>Deleted TrCH information list | OP | 1 to <maxTrCH > | | | |
| >>>Deleted UL TrCH information | MP | | Deleted UL TrCH information 10.3.5.5 | | |
| >>Added or Reconfigured TrCH information list | OP | 1 to <maxTrCH > | | | |
| >>>Added or Reconfigured UL TrCH information | MP | | Added or Reconfigured UL TrCH information 10.3.5.2 | | |

| Information Element/Group name | Need | Multi | Type and reference | Semantics description | Version |
|--|------|-----------------|---|---|---------|
| Downlink transport channels | | | | | |
| >>DL Transport channel information common for all transport channels | OP | | DL Transport channel information common for all transport channels 10.3.5.6 | | |
| >>>Deleted TrCH information list | OP | 1 to <maxTrCH > | | | |
| >>>>Deleted DL TrCH information | MP | | Deleted DL TrCH information 10.3.5.4 | | |
| >>Added or Reconfigured TrCH information list | OP | 1 to <maxTrCH > | | | |
| >>>Added or Reconfigured DL TrCH information | MP | | Added or Reconfigured DL TrCH information 10.3.5.1 | | |
| >Preconfiguration | | | | | REL-5 |
| >>CHOICE <i>Preconfiguration mode</i> | MP | | | This value only applies in case the message is sent through GERAN <i>lu mode</i> | |
| >>>Predefined configuration identity | MP | | Predefined configuration identity 10.3.4.5 | | |
| >>>>Default configuration | | | | | |
| >>>>>Default configuration mode | MP | | Enumerated (FDD, TDD) | Indicates whether the FDD or TDD version of the default configuration shall be used | |
| >>>>>Default configuration identity | MP | | Default configuration identity 10.3.4.0 | | |
| PhyCH information elements | | | | | |
| Frequency info | OP | | Frequency info 10.3.6.36 | | |
| Multi-frequency Info | OP | | Multi-frequency Info 10.3.6.39a | This IE is used for 1.28 Mcps TDD only | REL-7 |
| DTX-DRX timing information | OP | | DTX-DRX timing information 10.3.6.34b | | REL-7 |
| DTX-DRX Information | OP | | DTX-DRX Information 10.3.6.34a | | REL-7 |
| HS-SCCH less Information | OP | | HS-SCCH less Information 10.3.6.36ab | | REL-7 |
| MIMO parameters | OP | | MIMO parameters 10.3.6.41a | | REL-7 |

| Information Element/Group name | Need | Multi | Type and reference | Semantics description | Version |
|---|------|--------------|---|---|---------|
| Control Channel DRX information | OP | | Control Channel DRX information 1.28 Mcps TDD 10.3.6.107 | This IE is used for 1.28 Mcps TDD only | REL-8 |
| SPS Information | OP | | SPS information 1.28 Mcps TDD 10.3.6.110 | This IE is used for 1.28 Mcps TDD only | REL-8 |
| Uplink radio resources | | | | | |
| Maximum allowed UL TX power | MD | | Maximum allowed UL TX power 10.3.6.39 | Default value is the existing maximum UL TX power | |
| Uplink DPCH info | OP | | Uplink DPCH info 10.3.6.88 | | |
| E-DCH Info | OP | | E-DCH Info 10.3.6.97 | | REL-6 |
| Downlink radio resources | | | | | |
| Downlink HS-PDSCH Information | OP | | Downlink HS-PDSCH Information 10.3.6.23a | | REL-5 |
| Downlink information common for all radio links | OP | | Downlink information common for all radio links 10.3.6.24 | | |
| Downlink information per radio link list | MP | 1 to <maxRL> | | Although this IE is not always required, need is MP to align with ASN.1 | |
| | OP | | | | REL-4 |
| >Downlink information for each radio link | MP | | Downlink information for each radio link 10.3.6.27 | | |
| Downlink secondary cell info FDD | OP | | Downlink secondary cell info FDD 10.3.6.31a | FDD only | REL-8 |
| MBMS PL Service Restriction Information | OP | | Enumerated (TRUE) | | REL-6 |

| Condition | Explanation |
|-----------------|---|
| <i>FACH_PCH</i> | This IE is mandatory default when a transition from CELL_DCH to CELL_FACH, URA_PCH or CELL_PCH is requested by the message and is not needed otherwise. |

10.2.28 RADIO BEARER RECONFIGURATION COMPLETE

This message is sent from the UE when a RB and signalling link reconfiguration has been done.

RLC-SAP: AM

Logical channel: DCCH

Direction: UE → UTRAN

| Information Element/Group name | Need | Multi | Type and reference | Semantics description | Version |
|---|------|----------------------|---|---|---------|
| Message Type | MP | | Message Type | | |
| UE information elements | | | | | |
| RRC transaction identifier | MP | | RRC transaction identifier
10.3.3.36 | | |
| Integrity check info | CH | | Integrity check info
10.3.3.16 | | |
| Uplink integrity protection activation info | OP | | Integrity protection activation info
10.3.3.17 | | |
| <i>CHOICE mode</i> | MP | | | (no data) | |
| >FDD | | | | | |
| >TDD | | | | | |
| >>CHOICE <i>TDD option</i> | MP | | | | REL-4 |
| >>>3.84 Mcps TDD | | | | | REL-4 |
| >>>>Uplink Timing Advance | OP | | Uplink Timing Advance
10.3.6.95 | | |
| >>>>Extended Uplink Timing Advance | OP | | Extended Uplink Timing Advance
10.3.6.95a | | REL-7 |
| >>>7.68 Mcps TDD | | | | | REL-7 |
| >>>>Extended Uplink Timing Advance | OP | | Extended Uplink Timing Advance
10.3.6.95a | | REL-7 |
| >>>1.28 Mcps TDD | | | | (no data) | REL-4 |
| Other Information elements | | | | | |
| Deferred measurement control reading | MD | | Enumerated (TRUE) | Indicates the UE has not read SIB11, SIB11bis and SIB12, if available. Default value is FALSE | REL-7 |
| RB Information elements | | | | | |
| COUNT-C activation time | OP | | Activation time
10.3.3.1 | Used for radio bearers mapped on RLC-TM. | |
| Uplink counter synchronisation info | OP | | | | |
| >RB with PDCP information list | OP | 1 to <maxRBall RABs> | | | |
| >>RB with PDCP information | MP | | RB with PDCP information
10.3.4.22 | | |
| >START list | MP | 1 to <maxCNdo mains> | | START [40] values for all CN domains. | |
| >>CN domain identity | MP | | CN domain identity
10.3.1.1 | | |

| Information Element/Group name | Need | Multi | Type and reference | Semantics description | Version |
|--------------------------------|------|-------|--------------------|---|---------|
| >>START | MP | | START
10.3.3.38 | START value to be used in this CN domain. | |

10.2.29 RADIO BEARER RECONFIGURATION FAILURE

This message is sent by UE if the configuration given by UTRAN is unacceptable or if the UE failed to establish the physical channel(s).

RLC-SAP: AM

Logical channel: DCCH

Direction: UE→UTRAN

| Information Element/Group name | Need | Multi | Type and reference | Semantics description |
|---|------|--------------|--|-----------------------|
| Message Type | MP | | Message Type | |
| UE information elements | | | | |
| RRC transaction identifier | MP | | RRC transaction identifier
10.3.3.36 | |
| Integrity check info | CH | | Integrity check info
10.3.3.16 | |
| Failure cause | MP | | Failure cause and error information
10.3.3.14 | |
| RB information elements | | | | |
| Radio bearers for which reconfiguration would have succeeded List | OP | 1 to <maxRB> | | |
| >Radio bearer for which reconfiguration would have succeeded | MP | | RB identity,
10.3.4.16 | |

10.2.30 RADIO BEARER RELEASE

This message is used by UTRAN to release a radio bearer. It can also include modifications to the configurations of transport channels and/or physical channels. It can simultaneously indicate release of a signalling connection when UE is connected to more than one CN domain.

RLC-SAP: AM or UM

Logical channel: DCCH

Direction: UTRAN → UE

| Information Element/Group name | Need | Multi | Type and reference | Semantics description | Version |
|--------------------------------|------|-------|---|-----------------------|---------|
| Message Type | MP | | Message Type | | |
| UE Information Elements | | | | | |
| RRC transaction identifier | MP | | RRC transaction identifier
10.3.3.36 | | |

| Information Element/Group name | Need | Multi | Type and reference | Semantics description | Version |
|--|-----------------|---------------------|--|--|---------|
| Integrity check info | CH | | Integrity check info 10.3.3.16 | | |
| Integrity protection mode info | OP | | Integrity protection mode info 10.3.3.19 | The UTRAN should not include this IE unless it is performing an SRNS relocation. | |
| Ciphering mode info | OP | | Ciphering mode info 10.3.3.5 | The UTRAN should not include this IE unless it is performing an SRNS relocation and a change in ciphering algorithm. | |
| Activation time | MD | | Activation time 10.3.3.1 | Default value is "now" | |
| New U-RNTI | OP | | U-RNTI 10.3.3.47 | | |
| New C-RNTI | OP | | C-RNTI 10.3.3.8 | | |
| New DSCH-RNTI | OP | | DSCH-RNTI 10.3.3.9a | Should not be set in FDD. If received the UE should ignore it | |
| New H-RNTI | OP | | H-RNTI 10.3.3.14a | | REL-5 |
| New Primary E-RNTI | OP | | E-RNTI 10.3.3.10a | | REL-6 |
| New Secondary E-RNTI | OP | | E-RNTI 10.3.3.10a | FDD only | REL-6 |
| RRC State Indicator | MP | | RRC State Indicator 10.3.3.35a | | |
| UE Mobility State Indicator | CV-FACH_PC
H | | Enumerated (High-mobilityDetected) | Absence of this IE implies that, according to [4], the UE shall consider itself being in the mobility state the UE has maintained in CELL_DCH state or being not in high mobility state after the state transition, if applicable. | REL-7 |
| UTRAN DRX cycle length coefficient | OP | | UTRAN DRX cycle length coefficient 10.3.3.49 | | |
| CN Information Elements | | | | | |
| CN Information info | OP | | CN Information info 10.3.1.3 | | |
| Signalling Connection release indication | OP | | CN domain identity 10.3.1.1 | | |
| UTRAN mobility information elements | | | | | |
| URA identity | OP | | URA identity 10.3.2.6 | | |
| RNC support for change of UE capability | OP | | Boolean | Should be included if the message is used to perform an SRNS relocation | REL-7 |
| RB Information Elements | | | | | |
| RAB information to reconfigure list | OP | 1 to <maxRABsetup > | | | |
| >RAB information to reconfigure | MP | | RAB information to reconfigure 10.3.4.11 | | |

| Information Element/Group name | Need | Multi | Type and reference | Semantics description | Version |
|--|------|----------------------|--|---|---------|
| RB information to release list | MP | 1 to <maxRB> | | | |
| >RB information to release | MP | | RB information to release 10.3.4.19 | | |
| RB information to reconfigure list | OP | 1to <maxRB> | | | REL-6 |
| >RB information to reconfigure | MP | | RB information to reconfigure 10.3.4.18 | | REL-6 |
| RB information to be affected list | OP | 1 to <maxRB> | | | |
| >RB information to be affected | MP | | RB information to be affected 10.3.4.17 | | |
| Downlink counter synchronisation info | OP | | | | |
| >RB with PDCP information list | OP | 1 to <maxRBall RABs> | | | |
| >>RB with PDCP information | MP | | RB with PDCP information 10.3.4.22 | This IE is needed for each RB having PDCP in the case of lossless SRNS relocation | |
| | OP | | | | REL-5 |
| >RB with PDCP context relocation info list | OP | 1 to <maxRBall RABs> | | | REL-5 |
| >>PDCP context relocation info | MP | | PDCP context relocation info 10.3.4.1a | This IE is needed for each RB having PDCP and performing PDCP context relocation | REL-5 |
| TrCH Information Elements | | | | | |
| Uplink transport channels | | | | | |
| UL Transport channel information common for all transport channels | OP | | UL Transport channel information common for all transport channels 10.3.5.24 | | |
| Deleted TrCH information list | OP | 1 to <maxTrCH > | | | |
| >Deleted UL TrCH information | MP | | Deleted UL TrCH information 10.3.5.5 | | |
| Added or Reconfigured TrCH information list | OP | 1 to <maxTrCH > | | | |
| >Added or Reconfigured UL TrCH information | MP | | Added or Reconfigured UL TrCH information 10.3.5.2 | | |
| Downlink transport channels | | | | | |
| DL Transport channel information common for all | OP | | DL Transport channel | | |

| Information Element/Group name | Need | Multi | Type and reference | Semantics description | Version |
|---|------|-----------------|--|---|---------|
| transport channels | | | information common for all transport channels
10.3.5.6 | | |
| Deleted TrCH information list | OP | 1 to <maxTrCH > | | | |
| >Deleted DL TrCH information | MP | | Deleted DL TrCH information
10.3.5.4 | | |
| Added or Reconfigured TrCH information list | OP | 1 to <maxTrCH > | | | |
| >Added or Reconfigured DL TrCH information | MP | | Added or Reconfigured DL TrCH information
10.3.5.1 | | |
| PhyCH information elements | | | | | |
| Frequency info | OP | | Frequency info
10.3.6.36 | | |
| Multi-frequency Info | OP | | Multi-frequency Info
10.3.6.39a | This IE is used for 1.28 Mcps TDD only | REL-7 |
| DTX-DRX timing information | OP | | DTX-DRX timing information
10.3.6.34b | | REL-7 |
| DTX-DRX Information | OP | | DTX-DRX Information
10.3.6.34a | | REL-7 |
| HS-SCCH less Information | OP | | HS-SCCH less Information
10.3.6.36ab | | REL-7 |
| MIMO parameters | OP | | MIMO parameters
10.3.6.41a | | REL-7 |
| Control Channel DRX information | OP | | Control Channel DRX information
1.28 Mcps TDD
10.3.6.107 | This IE is used for 1.28 Mcps TDD only | REL-8 |
| SPS Information | OP | | SPS information
1.28 Mcps TDD
10.3.6.110 | This IE is used for 1.28 Mcps TDD only | REL-8 |
| Uplink radio resources | | | | | |
| Maximum allowed UL TX power | MD | | Maximum allowed UL TX power
10.3.6.39 | Default value is the existing maximum UL TX power | |
| Uplink DPCH info | OP | | Uplink DPCH info
10.3.6.88 | | |
| E-DCH Info | OP | | E-DCH Info
10.3.6.97 | | REL-6 |
| Downlink radio resources | | | | | |

| Information Element/Group name | Need | Multi | Type and reference | Semantics description | Version |
|---|------|--------------|---|--|---------|
| Downlink HS-PDSCH Information | OP | | Downlink HS-PDSCH Information 10.3.6.23a | | REL-5 |
| Downlink information common for all radio links | OP | | Downlink information common for all radio links 10.3.6.24 | | |
| Downlink information per radio link list | OP | 1 to <maxRL> | | Send downlink information for each radio link to be set-up | |
| >Downlink information for each radio link | MP | | Downlink information for each radio link 10.3.6.27 | | |
| Downlink secondary cell info FDD | OP | | Downlink secondary cell info FDD 10.3.6.31a | FDD only | REL-8 |
| MBMS PL Service Restriction Information | OP | | Enumerated (TRUE) | | REL-6 |
| MBMS RB list released to change transfer mode | OP | 1 to <maxRB> | | | REL-6 |
| >RB information to release | MP | | RB information to release 10.3.4.19 | | REL-6 |

| Condition | Explanation |
|-----------|---|
| FACH_PCH | This IE is mandatory default when a transition from CELL_DCH to CELL_FACH, URA_PCH or CELL_PCH is requested by the message and is not needed otherwise. |

10.2.31 RADIO BEARER RELEASE COMPLETE

This message is sent from the UE when radio bearer release has been completed.

RLC-SAP: AM

Logical channel: DCCH

Direction: UE → UTRAN

| Information Element/Group name | Need | Multi | Type and reference | Semantics description | Version |
|---|------|-------|--|---|---------|
| Message Type | MP | | Message Type | | |
| UE information elements | | | | | |
| RRC transaction identifier | MP | | RRC transaction identifier 10.3.3.36 | | |
| Integrity check info | CH | | Integrity check info 10.3.3.16 | Integrity check info is included if integrity protection is applied | |
| Uplink integrity protection activation info | OP | | Integrity protection activation info 10.3.3.17 | | |

| Information Element/Group name | Need | Multi | Type and reference | Semantics description | Version |
|--------------------------------------|------|----------------------|--|--|---------|
| CHOICE <i>mode</i> | MP | | | | |
| >FDD | | | | (no data) | |
| >TDD | | | | | |
| >>CHOICE <i>TDD option</i> | MP | | | | REL-4 |
| >>>3.84 Mcps TDD | | | | | REL-4 |
| >>>>Uplink Timing Advance | OP | | Uplink Timing Advance
10.3.6.95 | This information element shall be present in case of handover procedure if timing advance is enabled. Calculated timing advance value for the new cell after handover in a synchronous TDD network | |
| >>>>Extended Uplink Timing Advance | OP | | Extended Uplink Timing Advance
10.3.6.95a | | REL-7 |
| >>>7.68 Mcps TDD | | | | | REL-7 |
| >>>>Extended Uplink Timing Advance | OP | | Extended Uplink Timing Advance
10.3.6.95a | This information element shall be present in case of handover procedure if timing advance is enabled. Calculated timing advance value for the new cell after handover in a synchronous TDD network | REL-7 |
| >>>1.28 Mcps TDD | | | | (no data) | REL-4 |
| Other Information elements | | | | | REL-7 |
| Deferred measurement control reading | MD | | Enumerated (TRUE) | Indicates the UE has not read SIB11, SIB11bis and SIB12, if available. Default value is FALSE | REL-7 |
| RB Information elements | | | | | |
| COUNT-C activation time | OP | | Activation time
10.3.3.1 | Used for radio bearers mapped on RLC-TM. | |
| Uplink counter synchronisation info | OP | | | | |
| >RB with PDCP information list | OP | 1 to <maxRBall RABs> | | This IE is needed for each RB having PDCP in the case of lossless SRNS relocation | |
| >>RB with PDCP information | MP | | RB with PDCP information
10.3.4.22 | | |
| >START list | MP | 1 to <maxCNdo mains> | | START [40] values for all CN domains. | |
| >>CN domain identity | MP | | CN domain | | |

| Information Element/Group name | Need | Multi | Type and reference | Semantics description | Version |
|--------------------------------|------|-------|----------------------|---|---------|
| | | | identity
10.3.1.1 | | |
| >>START | MP | | START
10.3.3.38 | START value to be used in this CN domain. | |

10.2.32 RADIO BEARER RELEASE FAILURE

This message is sent by UE if the configuration given by UTRAN is unacceptable or if radio bearer cannot be released.

RLC-SAP: AM

Logical channel: DCCH

Direction: UE→UTRAN

| Information Element/Group name | Need | Multi | Type and reference | Semantics description |
|---|------|--------------|--|-----------------------|
| Message Type | MP | | Message Type | |
| UE information elements | | | | |
| RRC transaction identifier | MP | | RRC transaction identifier
10.3.3.36 | |
| Integrity check info | CH | | Integrity check info
10.3.3.16 | |
| Failure cause | MP | | Failure cause and error information
10.3.3.14 | |
| RB information elements | | | | |
| Radio bearers for which reconfiguration would have succeeded | OP | 1 to <maxRB> | | |
| >Radio bearer for which reconfiguration would have been succeeded | MP | | RB identity,
10.3.4.16 | |

10.2.33 RADIO BEARER SETUP

This message is sent by UTRAN to the UE to establish new radio bearer(s). It can also include modifications to the configurations of transport channels and/or physical channels.

RLC-SAP: AM or UM

Logical channel: DCCH

Direction: UTRAN → UE

| Information Element/Group name | Need | Multi | Type and reference | Semantics description | Version |
|--------------------------------|------|-------|---|-----------------------|---------|
| Message Type | MP | | Message Type | | |
| UE Information Elements | | | | | |
| RRC transaction identifier | MP | | RRC transaction identifier
10.3.3.36 | | |

| Information Element/Group name | Need | Multi | Type and reference | Semantics description | Version |
|--|----------|---------------|--|---|---------|
| Integrity check info | CH | | Integrity check info 10.3.3.16 | | |
| Integrity protection mode info | OP | | Integrity protection mode info 10.3.3.19 | The UTRAN should not include this IE unless it is performing an SRNS relocation or an SR-VCC | |
| Ciphering mode info | OP | | Ciphering mode info 10.3.3.5 | The UTRAN should not include this IE unless it is performing an SRNS relocation and a change in ciphering algorithm or it is performing an SR-VCC | |
| SR-VCC info | CV-SRVCC | | SR-VCC info 10.3.4.24a | | REL-8 |
| Activation time | MD | | Activation time 10.3.3.1 | Default value is "now" | |
| New U-RNTI | OP | | U-RNTI 10.3.3.47 | | |
| New C-RNTI | OP | | C-RNTI 10.3.3.8 | | |
| New DSCH-RNTI | OP | | DSCH-RNTI 10.3.3.9a | Should not be set in FDD. If received the UE should ignore it | |
| New H-RNTI | OP | | H-RNTI 10.3.3.14a | | REL-5 |
| New Primary E-RNTI | OP | | E-RNTI 10.3.3.10a | | REL-6 |
| New Secondary E-RNTI | OP | | E-RNTI 10.3.3.10a | FDD only | REL-6 |
| RRC State Indicator | MP | | RRC State Indicator 10.3.3.35a | | |
| UTRAN DRX cycle length coefficient | OP | | UTRAN DRX cycle length coefficient 10.3.3.49 | | |
| CN Information Elements | | | | | |
| CN Information info | OP | | CN Information info 10.3.1.3 | | |
| UTRAN mobility information elements | | | | | |
| URA identity | OP | | URA identity 10.3.2.6 | | |
| RNC support for change of UE capability | OP | | Boolean | Should be included if the message is used to perform an SRNS relocation | REL-7 |
| RB Information Elements | | | | | |
| CHOICE specification mode | MP | | | | REL-6 |
| >Complete specification | | | | In this version of the specification, only this value is specified | REL-6 |
| >>Signalling RB information to setup list | OP | 1 to <maxSRBs | | For each signalling radio | |

| Information Element/Group name | Need | Multi | Type and reference | Semantics description | Version |
|--|------|----------------------|--|---|---------|
| | | etup> | | bearer established | |
| >>>Signalling RB information to setup | MP | | Signalling RB information to setup 10.3.4.24 | | |
| >>RAB information to setup list | OP | 1 to <maxRABs etup> | | For each RAB established | |
| >>>RAB information for setup | MP | | RAB information for setup 10.3.4.10 | | |
| >>RAB information to reconfigure list | OP | 1 to <maxRABse tup > | | | REL-6 |
| >>>RAB information to reconfigure | MP | | RAB information to reconfigure 10.3.4.11 | | REL-6 |
| >>RB information to reconfigure list | OP | 1to <maxRB> | | | REL-6 |
| >>>RB information to reconfigure | MP | | RB information to reconfigure 10.3.4.18 | | REL-6 |
| >>RB information to be affected list | OP | 1 to <maxRB> | | | |
| >>>RB information to be affected | MP | | RB information to be affected 10.3.4.17 | | |
| >>Downlink counter synchronisation info | OP | | | | |
| >>>RB with PDCP information list | OP | 1 to <maxRBall RABs> | | | |
| >>>>RB with PDCP information | MP | | RB with PDCP information 10.3.4.22 | This IE is needed for each RB having PDCP in the case of lossless SRNS relocation | |
| | OP | | | | REL-5 |
| >>>>PDCP context relocation info | OP | | PDCP context relocation info 10.3.4.1a | This IE is needed for each RB having PDCP and performing PDCP context relocation | REL-5 |
| >>PDCP ROHC target mode | OP | | PDCP ROHC target mode 10.3.4.2a | | REL-5 |
| TrCH Information Elements | | | | | |
| Uplink transport channels | | | | | |
| >>UL Transport channel information common for all transport channels | OP | | UL Transport channel information common for all transport channels 10.3.5.24 | | |

| Information Element/Group name | Need | Multi | Type and reference | Semantics description | Version |
|--|------|-----------------|---|--|---------|
| >>Deleted TrCH information list | OP | 1 to <maxTrCH > | | | |
| >>>Deleted UL TrCH information | MP | | Deleted UL TrCH information 10.3.5.5 | | |
| >>Added or Reconfigured TrCH information list | OP | 1 to <maxTrCH > | | | |
| >>>Added or Reconfigured UL TrCH information | MP | | Added or Reconfigured UL TrCH information 10.3.5.2 | | |
| Downlink transport channels | | | | | |
| >>DL Transport channel information common for all transport channels | OP | | DL Transport channel information common for all transport channels 10.3.5.6 | | |
| >>Deleted TrCH information list | OP | 1 to <maxTrCH > | | | |
| >>>Deleted DL TrCH information | MP | | Deleted DL TrCH information 10.3.5.4 | | |
| >>Added or Reconfigured TrCH information list | OP | 1 to <maxTrCH > | | | |
| >>>Added or Reconfigured DL TrCH information | MP | | Added or Reconfigured DL TrCH information 10.3.5.1 | | |
| PhyCH information elements | | | | | |
| Frequency info | OP | | Frequency info 10.3.6.36 | | |
| Multi-frequency Info | OP | | Multi-frequency Info 10.3.6.39a | This IE is used for 1.28 Mcps TDD only | REL-7 |
| DTX-DRX timing information | OP | | DTX-DRX timing information 10.3.6.34b | | REL-7 |
| DTX-DRX Information | OP | | DTX-DRX Information 10.3.6.34a | | REL-7 |
| HS-SCCH less Information | OP | | HS-SCCH less Information 10.3.6.36ab | | REL-7 |
| MIMO parameters | OP | | MIMO parameters 10.3.6.41a | | REL-7 |

| Information Element/Group name | Need | Multi | Type and reference | Semantics description | Version |
|---|------|--------------|---|---|---------|
| Control Channel DRX information | OP | | Control Channel DRX information 1.28 Mcps TDD 10.3.6.107 | This IE is used for 1.28 Mcps TDD only | REL-8 |
| SPS Information | OP | | SPS information 1.28 Mcps TDD 10.3.6.110 | This IE is used for 1.28 Mcps TDD only | REL-8 |
| Uplink radio resources | | | | | |
| Maximum allowed UL TX power | MD | | Maximum allowed UL TX power 10.3.6.39 | Default value is the existing maximum UL TX power | |
| Uplink DPCH info | OP | | Uplink DPCH info 10.3.6.88 | | |
| E-DCH Info | OP | | E-DCH Info 10.3.6.97 | | REL-6 |
| Downlink radio resources | | | | | |
| Downlink HS-PDSCH Information | OP | | Downlink HS-PDSCH Information 10.3.6.23a | | REL-5 |
| Downlink information common for all radio links | OP | | Downlink information common for all radio links 10.3.6.24 | | |
| Downlink information per radio link list | OP | 1 to <maxRL> | | Send downlink information for each radio link | |
| >Downlink information for each radio link | MP | | Downlink information for each radio link 10.3.6.27 | | |
| Downlink secondary cell info FDD | OP | | Downlink secondary cell info FDD 10.3.6.31a | FDD only | REL-8 |
| MBMS PL Service Restriction Information | OP | | Enumerated (TRUE) | | REL-6 |

| Condition | Explanation |
|-----------|--|
| SRVCC | This IE is mandatory if an SR-VCC procedure is initiated and not needed otherwise. |

10.2.34 RADIO BEARER SETUP COMPLETE

This message is sent by the UE to confirm the establishment of the radio bearer.

RLC-SAP: AM

Logical channel: DCCH

Direction: UE → UTRAN

| Information Element/Group name | Need | Multi | Type and reference | Semantics description | Version |
|--------------------------------|------|-------|--------------------|-----------------------|---------|
|--------------------------------|------|-------|--------------------|-----------------------|---------|

| Information Element/Group name | Need | Multi | Type and reference | Semantics description | Version |
|---|------|-------|---|--|---------|
| Message Type | MP | | Message Type | | |
| UE information elements | | | | | |
| RRC transaction identifier | MP | | RRC transaction identifier
10.3.3.36 | | |
| Integrity check info | CH | | Integrity check info
10.3.3.16 | | |
| Uplink integrity protection activation info | OP | | Integrity protection activation info
10.3.3.17 | | |
| CHOICE <i>mode</i> | OP | | | | |
| >FDD | | | | (no data) | |
| >TDD | | | | | |
| >>CHOICE <i>TDD option</i> | MP | | | | REL-4 |
| >>>3.84 Mcps TDD | | | | | REL-4 |
| >>>>Uplink Timing Advance | OP | | Uplink Timing Advance
10.3.6.95 | This information element shall be present in case of handover procedure if timing advance is enabled. Calculated timing advance value for the new cell after handover in a synchronous TDD network | |
| >>>>Extended Uplink Timing Advance | OP | | Extended Uplink Timing Advance
10.3.6.95a | | REL-7 |
| >>>7.68 Mcps TDD | | | | | REL-7 |
| >>>>Extended Uplink Timing Advance | OP | | Extended Uplink Timing Advance
10.3.6.95a | This information element shall be present in case of handover procedure if timing advance is enabled. Calculated timing advance value for the new cell after handover in a synchronous TDD network | REL-7 |
| >>>1.28 Mcps TDD | | | | (No data) | REL-4 |
| START | OP | | START
10.3.3.38 | This information element is not needed for transparent mode RBs if prior to this procedure there exists one RB using RLC-TM. | |

| Information Element/Group name | Need | Multi | Type and reference | Semantics description | Version |
|--------------------------------------|------|----------------------|---------------------------------------|---|----------------|
| Other information elements | | | | | |
| Deferred measurement control reading | MD | | Enumerated (TRUE) | Indicates the UE has not read SIB11, SIB11bis and SIB12, if available. Default value is FALSE | REL-7
REL-7 |
| RB Information elements | | | | | |
| COUNT-C activation time | OP | | Activation time
10.3.3.1 | Used for radio bearers mapped on RLC-TM. | |
| Uplink counter synchronisation info | OP | | | | |
| >RB with PDCP information list | OP | 1 to <maxRBall RABs> | | This IE is needed for each RB having PDCP in the case of lossless SRNS relocation | |
| >>RB with PDCP information | MP | | RB with PDCP information
10.3.4.22 | | |
| >START list | MP | 1 to <maxCNdo mains> | | START [40] values for all CN domains. | |
| >>CN domain identity | MP | | CN domain identity
10.3.1.1 | | |
| >>START | MP | | START
10.3.3.38 | START value to be used in this CN domain. | |

10.2.35 RADIO BEARER SETUP FAILURE

This message is sent by UE, if it does not support the configuration given by UTRAN.

RLC-SAP: AM

Logical channel: DCCH

Direction: UE→UTRAN

| Information Element/Group name | Need | Multi | Type and reference | Semantics description |
|--|------|--------------|--|-----------------------|
| Message Type | MP | | Message Type | |
| UE information elements | | | | |
| RRC transaction identifier | MP | | RRC transaction identifier
10.3.3.36 | |
| Integrity check info | CH | | Integrity check info
10.3.3.16 | |
| Failure cause | MP | | Failure cause and error information
10.3.3.14 | |
| RB information elements | | | | |
| Radio bearers for which reconfiguration would have succeeded | OP | 1 to <maxRB> | | |
| >Radio bearer for which reconfiguration would have succeeded | MP | | RB identity,
10.3.4.16 | |

10.2.36 RRC CONNECTION REJECT

The network transmits this message when the requested RRC connection cannot be accepted.

RLC-SAP: UM

Logical channel: CCCH

Direction: UTRAN → UE

| Information Element/Group name | Need | Multi | Type and reference | Semantics description | Version |
|--------------------------------|------|-------|---|---|---------|
| Message Type | MP | | Message Type | | |
| UE information elements | | | | | |
| RRC transaction identifier | MP | | RRC transaction identifier
10.3.3.36 | | |
| Initial UE identity | MP | | Initial UE identity
10.3.3.15 | | |
| Rejection cause | MP | | Rejection cause
10.3.3.31 | | |
| Wait time | MP | | Wait time
10.3.3.50 | | |
| Redirection info | OP | | Redirection info
10.3.3.29 | | |
| Counting completion | OP | | Enumerated (TRUE) | This field may be present if the Rejection Cause is set to 'unspecified' otherwise it shall be ignored. | REL-6 |

10.2.37 RRC CONNECTION RELEASE

This message is sent by UTRAN to release the RRC connection. The message also releases the signalling connection and all radio bearers between the UE and UTRAN.

RLC-SAP: UM

Logical channel: CCCH or DCCH

Direction: UTRAN→UE

| Information Element/Group name | Need | Multi | Type and reference | Semantics description | Version |
|-----------------------------------|--------------------|-----------------------------|---|---|---------|
| Message Type | MP | | Message Type | | |
| UE information elements | | | | | |
| CHOICE identity type | CV-
CCCH | | | | REL-5 |
| >U-RNTI | | | U-RNTI
10.3.3.47 | | |
| > Group identity | | 1 to
<maxUR
NTIgroup> | | | REL-5 |
| >>Group release information | MP | | Group release information
10.3.3.140 | | REL-5 |
| RRC transaction identifier | MP | | RRC transaction identifier
10.3.3.36 | | |
| Integrity check info | CV-
DCCH | | Integrity check info
10.3.3.16 | Integrity check info is included if integrity protection is applied | |
| N308 | CH-
Cell_DCH | | Integer(1..8) | | |
| Release cause | MP | | Release cause
10.3.3.32 | | |
| UE Mobility State Indicator | CV-
DCCH_
MD | | Enumerated (High-mobilityDetected) | Absence of this IE implies that, according to [4] the UE shall consider itself being in the mobility state the UE has maintained in CELL_DCH state or being not in high-mobility state when entering in Idle Mode, if applicable. | REL-7 |
| Other information elements | | | | | |
| Rplmn information | OP | | Rplmn information
10.3.8.15 | | |
| Redirection info | OP | | Redirection info
10.3.3.29 | | REL-6 |

| Condition | Explanation |
|-----------------|---|
| <i>CCCH</i> | This IE is mandatory present when CCCH is used and not needed otherwise. |
| <i>DCCH</i> | This IE is mandatory present when DCCH is used and not needed otherwise. |
| <i>DCCH_MD</i> | This IE is mandatory default when DCCH is used and not needed otherwise. |
| <i>Cell_DCH</i> | This IE is mandatory present when UE is in CELL_DCH state and not needed otherwise. |

10.2.38 RRC CONNECTION RELEASE COMPLETE

This message is sent by UE to confirm that the RRC connection has been released.

RLC-SAP: AM or UM

Logical channel: DCCH

Direction: UE → UTRAN

| Information Element/Group name | Need | Multi | Type and reference | Semantics description |
|--------------------------------|------|-------|--|-----------------------|
| Message Type | MP | | Message Type | |
| UE information elements | | | | |
| RRC transaction identifier | MP | | RRC transaction identifier
10.3.3.36 | |
| Integrity check info | CH | | Integrity check info
10.3.3.16 | |
| Error indication | OP | | Failure cause and error information
10.3.3.14 | |

10.2.39 RRC CONNECTION REQUEST

RRC Connection Request is the first message transmitted by the UE when setting up an RRC Connection to the network.

RLC-SAP: TM

Logical channel: CCCH

Direction: UE → UTRAN

| Information Element/Group name | Need | Multi | Type and reference | Semantics description | Version |
|---|-------------------------|-------|---|---|---------|
| Message Type | MP | | Message Type | | |
| Radio Bearer IEs | | | | | |
| Predefined configuration status information | MP | | Boolean | TRUE indicates the UE has all pre-configurations stored with the same value tag as broadcast in the cell in which the RRC connection establishment is initiated | REL-5 |
| UE information elements | | | | | |
| Initial UE identity | MP | | Initial UE identity
10.3.3.15 | | |
| Establishment cause | MP | | Establishment cause
10.3.3.11 | | |
| Protocol error indicator | MD | | Protocol error indicator
10.3.3.27 | Default value is FALSE | |
| >UE Specific Behaviour Information 1 idle | OP | | UE Specific Behaviour Information 1 idle
10.3.3.51 | This IE shall not be included in this version of the protocol | |
| Domain indicator | MP | | CN domain identity
10.3.1.1 | | REL-6 |
| Call type | CV-CS-
<i>Domain</i> | | Enumerated (speech, video, other) | One spare value is needed | REL-6 |
| UE capability indication | OP | | Enumerated (HS-DSCH, HS-DSCH+E-DCH) | Absence of this IE implies that neither HS-DSCH nor E-DCH are supported by the UE | REL-6 |
| MBMS Selected Services | OP | | MBMS Selected Services Short
10.3.9a.7d | | REL-6 |
| UE Mobility State Indicator | MD | | Enumerated (High-mobilityDetected) | Absence of this IE implies that, according to [4] either the High mobility state is not applicable or it has not been detected by the UE. | REL-7 |
| Support for F-DPCH | OP | | Enumerated (TRUE) | The IE shall be set to TRUE when F-DPCH is fully supported by the UE.
Absence of this information element indicates that F-DPCH is not fully supported | REL-6 |

| | | | | | |
|--|----|--|------------------------------------|--|-------|
| Support for Enhanced F-DPCH | OP | | Enumerated (TRUE) | The absence of this IE indicates that the UE does not support enhanced F-DPCH | REL-7 |
| HS-PDSCH in CELL_FACH | OP | | Enumerated (TRUE) | The absence of this IE indicates that the UE does not support HS-PDSCH reception in CELL_FACH state.
Note 1 | REL-7 |
| MAC-ehs support | OP | | Enumerated (TRUE) | The presence of this IE indicates that UE supports MAC-ehs, octet aligned transport block table, the use of special value of HE field to indicate end of an SDU for RLC AM and different HS-SCCHs in contiguous TTIs. The absence of this IE indicates that the UE does not support either MAC-ehs, octet aligned transport block table or the use of special value of HE field to indicate end of an SDU for RLC AM or different HS-SCCHs in contiguous TTIs. | REL-7 |
| DPCCH Discontinuous Transmission support | OP | | Enumerated (TRUE) | The absence of this IE indicates that the UE does not support DPCCH Discontinuous Transmission | REL-7 |
| Support of common E-DCH | OP | | Enumerated (TRUE) | The absence of this IE indicates that the UE does not support E-DCH enhanced random access in CELL_FACH state and Idle mode.
Note 1 | REL-8 |
| Multi cell support | OP | | Enumerated (TRUE) | The absence of this IE indicates that the UE does not support dual cell operations on adjacent frequencies. | REL-8 |
| Pre-redirection info | OP | | Pre-redirection info
10.3.3.25a | The presence of this IE indicates the UE support of radio access | REL-8 |

| | | | | | |
|---|----|-------|------------------------------------|--|-------|
| | | | | technologies that the UE could be directed to | |
| Support of MAC-i/is | OP | | Enumerated (TRUE) | The absence of this IE indicates that the UE does not support MAC-i/is operation. | REL-8 |
| Support of SPS operation | OP | | Enumerated (TRUE) | For 1.28 Mcps TDD only. The absence of this IE indicates that the UE does not support SPS operation. | REL-8 |
| Support for CS Voice over HSPA | OP | | Enumerated (TRUE) | The IE indicates the UE's support for CS Voice over HSPA, if set. | REL-8 |
| Measurement information elements | | | | | |
| Measured results on RACH | OP | | Measured results on RACH 10.3.7.45 | | |
| Access stratum release indicator | MP | | Enumerated(REL-4, | Absence of the IE implies R99. The IE also indicates the release of the RRC transfer syntax supported by the UE. 11 spare values are needed. | REL-4 |
| | | | REL-5, | | REL-5 |
| | | | REL-6, | | REL-6 |
| | | | REL-7, | | REL-7 |
| REL-8) | | REL-8 | | | |

NOTE 1: For 1.28 Mcps TDD, UE supporting HS-PDSCH in CELL_FACH always supports E-DCH enhanced random access in CELL_FACH state and Idle mode, and vice versa. And UE supporting HS-PDSCH reception in CELL_FACH state always supports HS-DSCH reception in CELL_PCH and URA_PCH state and CELL_FACH HS-DSCH DRX operation.

| Condition | Explanation |
|-----------|--|
| CS-Domain | This IE is mandatory present if the IE "Domain indicator" has the value "CS domain". Otherwise it is not needed. |

If the encoded message does not fill a transport block, the RRC layer shall insert padding according to subclause 12.1.

10.2.40 RRC CONNECTION SETUP

This message is used by the network to accept the establishment of an RRC connection for a UE, including assignment of signalling link information, transport channel information and optionally physical channel information.

RLC-SAP: UM

Logical channel: CCCH

Direction: UTRAN → UE

| Information Element/Group name | Need | Multi | Type and reference | Semantics description | Version |
|--------------------------------|------|-------|--------------------|-----------------------|---------|
|--------------------------------|------|-------|--------------------|-----------------------|---------|

| Information Element/Group name | Need | Multi | Type and reference | Semantics description | Version |
|--|------|-----------------|---|--|---------|
| Message Type | MP | | Message Type | | |
| UE Information Elements | | | | | |
| Initial UE identity | MP | | Initial UE identity
10.3.3.15 | | |
| RRC transaction identifier | MP | | RRC transaction identifier
10.3.3.36 | | |
| Activation time | MD | | Activation time 10.3.3.1 | Default value is "now" | |
| New U-RNTI | MP | | U-RNTI
10.3.3.47 | | |
| New C-RNTI | OP | | C-RNTI
10.3.3.8 | | |
| New H-RNTI | OP | | H-RNTI
10.3.3.14a | | REL-6 |
| New Primary E-RNTI | OP | | E-RNTI
10.3.3.10a | | REL-6 |
| New Secondary E-RNTI | OP | | E-RNTI
10.3.3.10a | FDD only | REL-6 |
| RRC State Indicator | MP | | RRC State Indicator
10.3.3.35a | | |
| UTRAN DRX cycle length coefficient | MP | | UTRAN DRX cycle length coefficient
10.3.3.49 | | |
| Capability update requirement | MD | | Capability update requirement
10.3.3.2 | Default value is defined in subclause 10.3.3.2 | |
| RNC support for change of UE capability | MP | | Boolean | | REL-7 |
| Specification mode information elements | | | | | |
| CHOICE <i>specification mode</i> | MP | | | | REL-5 |
| >Complete specification | | | | | |
| RB Information Elements | | | | | |
| >>Signalling RB information to setup list | MP | 3 to 4 | | | |
| >>>Signalling RB information to setup | MP | | Signalling RB information to setup
10.3.4.24 | | |
| TrCH Information Elements | | | | | |
| Uplink transport channels | | | | | |
| >>UL Transport channel information common for all transport channels | OP | | UL Transport channel information common for all transport channels
10.3.5.24 | | |
| >>Added or Reconfigured TrCH information list | MP | 1 to <maxTrCH > | | Although this IE is not required when the IE "RRC state indicator" is set to "CELL_FACH", need is MP to align with ASN.1 | |
| | OP | | | | REL-4 |
| >>>Added or Reconfigured UL | MP | | Added or | | |

| Information Element/Group name | Need | Multi | Type and reference | Semantics description | Version |
|--|------|-----------------|---|--|---------|
| TrCH information | | | Reconfigured UL TrCH information 10.3.5.2 | | |
| Downlink transport channels | | | | | |
| >>DL Transport channel information common for all transport channels | OP | | DL Transport channel information common for all transport channels 10.3.5.6 | | |
| >>>Added or Reconfigured TrCH information list | MP | 1 to <maxTrCH > | | Although this IE is not required when the IE "RRC state indicator" is set to "CELL_FACH", need is MP to align with ASN.1 | |
| | OP | | | | REL-4 |
| >>>>Added or Reconfigured DL TrCH information | MP | | Added or Reconfigured DL TrCH information 10.3.5.1 | | |
| >Preconfiguration | | | | | REL-5 |
| >>CHOICE <i>Preconfiguration mode</i> | MP | | | | REL-5 |
| >>>Predefined configuration identity | MP | | Predefined configuration identity 10.3.4.5 | | REL-5 |
| >>>Default configuration | | | | | REL-5 |
| >>>>Default configuration mode | MP | | Enumerated (FDD, TDD) | Indicates whether the FDD or TDD version of the default configuration shall be used | REL-5 |
| >>>>Default configuration identity | MP | | Default configuration identity 10.3.4.0 | | REL-5 |
| PhyCH information elements | | | | | |
| Frequency info | OP | | Frequency info 10.3.6.36 | | |
| Multi-frequency Info | OP | | Multi-frequency Info 10.3.6.39a | This IE is used for 1.28 Mcps TDD only | REL-7 |

| Information Element/Group name | Need | Multi | Type and reference | Semantics description | Version |
|---|------|--------------|---|--|---------|
| DTX-DRX timing information | OP | | DTX-DRX timing information 10.3.6.34b | | REL-7 |
| DTX-DRX Information | OP | | DTX-DRX Information 10.3.6.34a | | REL-7 |
| HS-SCCH less Information | OP | | HS-SCCH less Information 10.3.6.36ab | | REL-7 |
| SPS Information | OP | | SPS information 1.28 Mcps TDD 10.3.6.110 | This IE is used for 1.28 Mcps TDD only | REL-8 |
| Uplink radio resources | | | | | |
| Maximum allowed UL TX power | MD | | Maximum allowed UL TX power 10.3.6.39 | Default value is the existing maximum UL TX power | |
| Uplink DPCH info | OP | | Uplink DPCH info 10.3.6.88 | | |
| E-DCH Info | OP | | E-DCH Info 10.3.6.97 | | REL-6 |
| Downlink radio resources | | | | | |
| Downlink HS-PDSCH Information | OP | | Downlink HS-PDSCH information 10.3.6.23a | | REL-6 |
| Downlink information common for all radio links | OP | | Downlink information common for all radio links 10.3.6.24 | | |
| Downlink information per radio link list | OP | 1 to <maxRL> | | Send downlink information for each radio link to be set-up | |
| >Downlink information for each radio link | MP | | Downlink information for each radio link 10.3.6.27 | | |
| Downlink secondary cell info FDD | OP | | Downlink secondary cell info FDD 10.3.6.31a | FDD only | REL-8 |

10.2.41 RRC CONNECTION SETUP COMPLETE

This message confirms the establishment of the RRC Connection by the UE.

RLC-SAP: AM

Logical channel: DCCH

Direction: UE → UTRAN

| Information Element/Group name | Need | Multi | Type and reference | Semantics description | Version |
|--------------------------------|------|-------|--------------------|-----------------------|---------|
| Message Type | MP | | Message Type | | |

| Information Element/Group name | Need | Multi | Type and reference | Semantics description | Version |
|---------------------------------------|------|-------------------------------|--|---|---------|
| UE Information Elements | | | | | |
| RRC transaction identifier | MP | | RRC transaction identifier
10.3.3.36 | | |
| START list | MP | 1 to <maxCNdomains> | | START [40] values for all CN domains. | |
| >CN domain identity | MP | | CN domain identity
10.3.1.1 | | |
| >START | MP | | START
10.3.3.38 | START value to be used in this CN domain. | |
| UE radio access capability | OP | | UE radio access capability
10.3.3.42 | | |
| UE radio access capability extension | OP | | UE radio access capability extension
10.3.3.42a | | |
| Other information elements | | | | | |
| UE system specific capability | OP | 1 to <maxInterSystemMessages> | | | |
| >Inter-RAT UE radio access capability | MP | | Inter-RAT UE radio access capability
10.3.8.7 | | |
| Deferred measurement control reading | MD | | Enumerated (TRUE) | Indicates the UE has not read SIB11, SIB11bis and SIB12, if available. Default value is FALSE | REL-7 |

10.2.41a RRC FAILURE INFO

This message is sent by the UE via another radio access technology to provide information about the cause for failure to perform the requested operation.

RLC-SAP: N/A (Sent through a different RAT)

Logical channel: N/A (Sent through a different RAT)

Direction: UE → UTRAN

| Information Element/Group Name | Need | Multi | Type and reference | Semantics description |
|-----------------------------------|------------|-------|---|-----------------------|
| Other Information elements | | | | |
| Failure cause | MP | | Failure cause
10.3.3.13 | |
| Protocol error information | CV-ProtErr | | Protocol error information
10.3.8.12 | |

| Condition | Explanation |
|----------------|---|
| <i>ProtErr</i> | Presence is mandatory if the IE "Failure cause" has the value "Protocol error"; otherwise the element is not needed in the message. |

10.2.42 RRC STATUS

This message is sent to indicate a protocol error.

RLC-SAP: AM

Logical channel: DCCH

Direction: UE→UTRAN

| Information Element/Group name | Need | Multi | Type and reference | Semantics description |
|------------------------------------|----------------------------------|-------|---|---|
| Message Type | MP | | Message Type | |
| UE information elements | | | | |
| Integrity check info | CH | | Integrity check info
10.3.3.16 | Integrity check info is included if integrity protection is applied |
| Identification of received message | CV-
<i>Message identified</i> | | | |
| >Received message type | MP | | Message Type | |
| >RRC transaction identifier | MP | | RRC transaction identifier
10.3.3.36 | |
| Other information elements | | | | |
| Protocol error information | MP | | Protocol error information
10.3.8.12 | |

| Condition | Explanation |
|---------------------------|---|
| <i>Message identified</i> | This IE is mandatory present if the IE "Protocol error cause" in the IE "Protocol error information" has any other value than "ASN.1 violation or encoding error" or "Message type non-existent or not implemented" and not needed otherwise. |

10.2.43 SECURITY MODE COMMAND

This message is sent by UTRAN to start or reconfigure ciphering and/or integrity protection parameters.

RLC-SAP: AM

Logical channel: DCCH

Direction: UTRAN to UE

| Information Element/Group name | Need | Multi | Type and reference | Semantics description |
|--------------------------------|------|-------|---|-----------------------|
| Message Type | MP | | Message Type | |
| UE information elements | | | | |
| RRC transaction identifier | MP | | RRC transaction identifier
10.3.3.36 | |

| Information Element/Group name | Need | Multi | Type and reference | Semantics description |
|--|------|-----------------------------|---|--|
| Integrity check info | MP | | Integrity check info
10.3.3.16 | |
| Security capability | MP | | Security capability
10.3.3.37 | |
| Ciphering mode info | OP | | Ciphering mode info
10.3.3.5 | Only present if ciphering shall be controlled |
| Integrity protection mode info | OP | | Integrity protection mode info
10.3.3.19 | Only present if integrity protection shall be controlled |
| CN Information elements | | | | |
| CN domain identity | MP | | CN domain identity
10.3.1.1 | Indicates which ciphering and integrity protection keys are applicable |
| Other information elements | | | | |
| UE system specific security capability | CH | 1 to <maxInter SysMessages> | | This IE is included if the IE "Inter-RAT UE radio access capability" was included in RRC CONNECTION SETUP COMPLETE message |
| >Inter-RAT UE security capability | MP | | Inter-RAT UE security capability
10.3.8.8a | |

10.2.44 SECURITY MODE COMPLETE

This message is sent by UE to confirm the reconfiguration of ciphering and/or integrity protection.

RLC-SAP: AM

Logical channel: DCCH

Direction: UE to UTRAN

| Information Element/Group name | Need | Multi | Type and reference | Semantics description |
|--|------|-------|---|-----------------------|
| Message Type | MP | | Message Type | |
| UE information elements | | | | |
| RRC transaction identifier | MP | | RRC transaction identifier
10.3.3.36 | |
| Integrity check info | MP | | Integrity check info
10.3.3.16 | |
| Uplink integrity protection activation info | OP | | Integrity protection activation info
10.3.3.17 | |
| RB Information elements | | | | |
| Radio bearer uplink ciphering activation time info | OP | | RB activation time info
10.3.4.13 | |

10.2.45 SECURITY MODE FAILURE

This message is sent to indicate a failure to act on a received SECURITY MODE COMMAND message.

RLC-SAP: AM

Logical channel: DCCH

Direction: UE→UTRAN

| Information Element/Group name | Need | Multi | Type and reference | Semantics description |
|--------------------------------|------|-------|--|-----------------------|
| Message Type | MP | | Message Type | |
| UE information elements | | | | |
| RRC transaction identifier | MP | | RRC transaction identifier
10.3.3.36 | |
| Integrity check info | CH | | Integrity check info
10.3.3.16 | |
| Failure cause | MP | | Failure cause and error information
10.3.3.14 | |

10.2.46 SIGNALLING CONNECTION RELEASE

This message is used to notify the UE that its ongoing signalling connection to a CN domain has been released.

RLC-SAP: AM

Logical channel: DCCH

Direction: UTRAN→UE

| Information Element/Group name | Need | Multi | Type and reference | Semantics description |
|--------------------------------|------|-------|---|---|
| Message Type | MP | | Message Type | |
| UE information elements | | | | |
| RRC transaction identifier | MP | | RRC transaction identifier
10.3.3.36 | |
| Integrity check info | CH | | Integrity check info
10.3.3.16 | Integrity check info is included if integrity protection is applied |
| CN information elements | | | | |
| CN domain identity | MP | | CN domain identity
10.3.1.1 | |

10.2.47 SIGNALLING CONNECTION RELEASE INDICATION

This message is used by the UE to indicate to UTRAN the release of an existing signalling connection.

RLC-SAP: AM

Logical channel: DCCH

Direction: UE→UTRAN

| Information Element/Group name | Need | Multi | Type and reference | Semantics description | Version |
|--|------|-------|--|-----------------------|---------|
| Message Type | MP | | Message type | | |
| UE Information Elements | | | | | |
| Integrity check info | CH | | Integrity check info
10.3.3.1
6 | | |
| CN information elements | | | | | |
| CN domain identity | MP | | CN domain identity
10.3.1.1 | | |
| Signalling Connection Release Indication Cause | MP | | Signalling Connection Release Indication Cause
10.3.3.3
7a | NOTE1 | REL-8 |

NOTE1: For the sake of backward compatibility, when the cause value is set to a value other than "UE Requested PS Data session end" according to 8.1.14.2: in this release of the specification, the UE may exclude this IE by not including the ASN.1 non-critical extension where it is referenced, alternatively, if the UE includes this IE it shall set it to "any Other Cause".

10.2.48 SYSTEM INFORMATION

This message is used by the UTRAN to convey system information blocks to the UE.

RLC-SAP: TM

Logical channel: BCCH

Direction: UTRAN→UE

| Information Element/Group name | Need | Multi | Type and reference | Semantics description |
|-----------------------------------|------------------------|-------|--------------------------------------|--|
| Message type | CV-
<i>channel1</i> | | Message type | |
| SFNprime | CV-
<i>channel2</i> | | Integer(0..40
94 by step of
2) | SFN=SFNprime (for first 10ms
frame of 20ms TTI),
SFN=SFNprime+1 (for last
10ms frame of 20ms TTI) |
| <i>CHOICE Segment combination</i> | MP | | | Five spares are needed |
| >Combination 1 | | | | (no data) |
| >Combination 2 | | | | |
| >>First Segment | MP | | First
Segment,
10.2.48.1 | |
| >Combination 3 | | | | |
| >>Subsequent Segment | MP | | Subsequent
Segment,
10.2.48.3 | |
| >Combination 4 | | | | |

| Information Element/Group name | Need | Multi | Type and reference | Semantics description |
|---|------|---------------------|----------------------------------|-----------------------|
| >>Last segment | MP | | Last segment (short), 10.2.48.5 | |
| >Combination 5 | | | | NOTE 2 |
| >>Last segment | MP | | Last Segment (short) 10.2.48.5 | |
| >>>First Segment | MP | | First Segment (short), 10.2.48.2 | |
| >Combination 6 | | | | NOTE 2 |
| >>Last Segment | MP | | Last Segment (short), 10.2.48.5 | |
| >>>Complete list | MP | 1 to maxSIBper Msg | | NOTE 1 |
| >>>>Complete | MP | | Complete SIB (short), 10.2.48.7 | |
| >Combination 7 | | | | NOTE 2 |
| >>Last Segment | MP | | Last Segment (short), 10.2.48.5 | |
| >>>Complete list | MP | 1..< maxSIBper Msg> | | NOTE 1 |
| >>>>Complete | MP | | Complete SIB (short), 10.2.48.7 | |
| >>>>First Segment | MP | | First Segment (short), 10.2.48.2 | |
| >Combination 8 | | | | NOTE 2 |
| >>>>Complete list | MP | 1 to maxSIBper Msg | | NOTE 1 |
| >>>>>Complete | MP | | Complete SIB (short), 10.2.48.7 | |
| >Combination 9 | | | | NOTE 2 |
| >>>>>Complete list | MP | 1..MaxSIB perMsg | | NOTE 1 |
| >>>>>>Complete | MP | | Complete SIB (short), 10.2.48.7 | |
| >>>>>>>First Segment | MP | | First Segment (short), 10.2.48.2 | |
| >Combination 10 | | | | |
| >>>>>>>>Complete SIB of size 215 to 226 | MP | | Complete SIB, 10.2.48.6 | |
| >Combination 11 | | | | |

| Information Element/Group name | Need | Multi | Type and reference | Semantics description |
|---|------|-------|-------------------------|-----------------------|
| >>Last segment of size 215 to 222 | MP | | Last segment, 10.2.48.4 | |
| NOTE 1: If Combination 6 - 9 contains a Master information block, the Master information block shall be located as the first IE in the list. | | | | |
| NOTE 2: If one of the combinations 5 to 9 is used, the IE "SIB type" = "Extension Type" should not occur more than once in that message, otherwise the UE behaviour is unspecified. | | | | |

| Condition | Explanation |
|-----------------|--|
| <i>channel1</i> | The IE is mandatory present if the message is sent on the FACH and not needed otherwise. |
| <i>channel2</i> | This IE is mandatory present if the channel is BCH, otherwise it is not needed. |

If the encoded message does not fill a transport block, the RRC layer shall insert padding according to subclause 12.1. Padding is needed e.g. if the remaining space is insufficient to start a new First Segment (which requires several bits for SIB type, SEG_COUNT and SIB data).

10.2.48.1 First Segment

This segment type is used to transfer the first segment of a segmented system information block. The IE is used when the first segment fills the entire transport block (Combination 2).

| Information Element/Group name | Need | Multi | Type and reference | Semantics description |
|-----------------------------------|------|-------|---------------------------|-----------------------|
| Other information elements | | | | |
| SIB type | MP | | SIB Type, 10.3.8.21 | |
| SEG_COUNT | MP | | SEG COUNT, 10.3.8.17 | |
| SIB data fixed | MP | | SIB data fixed, 10.3.8.19 | |

10.2.48.2 First Segment (short)

This segment type is used to transfer the first segment of a segmented system information block. The IE is used when the first segment is concatenated after other segments in a transport block (Combination 5, 7 and 9).

| Information Element/Group name | Need | Multi | Type and reference | Semantics description |
|-----------------------------------|------|-------|------------------------------|-----------------------|
| Other information elements | | | | |
| SIB type | MP | | SIB Type, 10.3.8.21 | |
| SEG_COUNT | MP | | SEG COUNT, 10.3.8.17 | |
| SIB data variable | MP | | SIB data variable, 10.3.8.20 | |

10.2.48.3 Subsequent Segment

This segment type is used to transfer a subsequent segment of a segmented system information block.

| Information Element/Group name | Need | Multi | Type and reference | Semantics description |
|-----------------------------------|------|-------|---------------------------|-----------------------|
| Other information elements | | | | |
| SIB type | MP | | SIB Type, 10.3.8.21 | |
| Segment index | MP | | Segment Index, 10.3.8.18 | |
| SIB data fixed | MP | | SIB data fixed, 10.3.8.19 | |

10.2.48.4 Last Segment

This segment type is used to transfer the last segment of a segmented system information block. The IE is used when the last segment has a length, excluding length denominator, from 215 through 222 (Combination 11).

| Information Element/Group name | Need | Multi | Type and reference | Semantics description |
|-----------------------------------|------|-------|---------------------------|--|
| Other information elements | | | | |
| SIB type | MP | | SIB Type, 10.3.8.21 | |
| Segment index | MP | | Segment Index, 10.3.8.18 | |
| SIB data fixed | MP | | SIB data fixed, 10.3.8.19 | In case the SIB data is less than 222 bits, padding shall be used. The same padding bits shall be used as defined in clause 12.1 |

10.2.48.5 Last Segment (short)

This segment type is used to transfer the last segment of a segmented system information block. The IE is used when the last segment has a length, excluding length denominator, of upto 214 bits (Combination 4, 5, 6 and 7).

| Information Element/Group name | Need | Multi | Type and reference | Semantics description |
|-----------------------------------|------|-------|------------------------------|-----------------------|
| Other information elements | | | | |
| SIB type | MP | | SIB Type, 10.3.8.21 | |
| Segment index | MP | | Segment Index, 10.3.8.18 | |
| SIB data variable | MP | | SIB data variable, 10.3.8.20 | |

10.2.48.6 Complete SIB

This segment type is used to transfer a non-segmented system information block. The IE is used when the complete SIB has a length, excluding length denominator, from 215 through 226 (Combination 10).

| Information Element/Group name | Need | Multi | Type and reference | Semantics description |
|-----------------------------------|------|-------|---------------------|---|
| Other information elements | | | | |
| SIB type | MP | | SIB Type, 10.3.8.21 | |
| SIB data fixed | MP | | Bit string (226) | The first/leftmost/most significant bit of the bit string contains the first bit of the segment. In case the SIB data is less than 226 bits, padding shall be used. The same padding bits shall be used as defined in clause 12.1 |

10.2.48.7 Complete SIB (short)

This segment type is used to transfer a non-segmented system information block. The IE is used when the complete SIB has a length, excluding length denominator, of upto 214 bits (Combination 6, 7, 8 and 9).

| Information Element/Group name | Need | Multi | Type and reference | Semantics description |
|-----------------------------------|------|-------|------------------------------|-----------------------|
| Other information elements | | | | |
| SIB type | MP | | SIB Type, 10.3.8.21 | |
| SIB data variable | MP | | SIB data variable, 10.3.8.20 | |

10.2.48.8 System Information Blocks

The IE "SIB data" within the IEs, "First Segment", "Subsequent or last Segment" and "Complete SIB" contains either complete system information block or a segment of a system information block. The actual system information blocks are defined in the following clauses.

10.2.48.8.1 Master Information Block

| Information Element/Group name | Need | Multi | Type and reference | Semantics description | Version |
|---|------------|-------|---|--|---------|
| Other information elements | | | | | |
| MIB Value tag | MP | | MIB Value tag 10.3.8.9 | | |
| CN information elements | | | | | |
| Supported PLMN types | MP | | PLMN Type 10.3.1.12 | | |
| PLMN Identity | CV-GSM | | PLMN Identity 10.3.1.11 | | |
| Multiple PLMN List | OP | | Multiple PLMN List 10.3.1.7a | If present, this IE specifies the PLMNs of the cell. If absent, the IE 'PLMN Identity' specifies the PLMN of the cell. | REL-6 |
| ANSI-41 information elements | | | | | |
| ANSI-41 Core Network Information | CV-ANSI-41 | | ANSI-41 Core Network Information 10.3.9.1 | | |
| References to other system information blocks and scheduling blocks | MP | | References to other system information blocks and scheduling blocks 10.3.8.14 | | |
| CSG Indicator | OP | | Enumerated (TRUE) | If present, the cell is a CSG cell (see [4]). If absent, the cell is not a CSG cell. | REL-8 |

| Condition | Explanation |
|----------------|---|
| <i>GSM</i> | The IE is mandatory present if the IE "Supported PLMN Types" is set to 'GSM-MAP' or 'GSM-MAP AND ANSI-41', and not needed otherwise |
| <i>ANSI-41</i> | The IE is mandatory present if the IE "Supported PLMN Types" is set to 'ANSI-41' or 'GSM-MAP AND ANSI-41', and not needed otherwise |

10.2.48.8.2 Scheduling Block 1

| Information Element/Group name | Need | Multi | Type and reference | Semantics description |
|---|------|-------|---|-----------------------|
| References to other system information blocks | MP | | References to other system information blocks 10.3.8.13 | |

10.2.48.8.3 Scheduling Block 2

| Information Element/Group name | Need | Multi | Type and reference | Semantics description |
|---|------|-------|--|-----------------------|
| References to other system information blocks | MP | | References to other system information blocks
10.3.8.13 | |

10.2.48.8.4 System Information Block type 1

The system information block type 1 contains NAS system information as well as UE timers and counters to be used in idle mode and in connected mode.

| Information Element/Group name | Need | Multi | Type and reference | Semantics description |
|---|------|----------------------|--|---|
| CN information elements | | | | |
| CN common GSM-MAP NAS system information | MP | | NAS system information (GSM-MAP)
10.3.1.9 | |
| CN domain system information list | MP | 1 to <maxCNdo mains> | | Send CN information for each CN domain. |
| >CN domain system information | MP | | CN domain system information
10.3.1.2 | |
| UE information | | | | |
| UE Timers and constants in idle mode | MD | | UE Timers and constants in idle mode
10.3.3.44 | The UE behaviour is unspecified if this IE is absent. |
| UE Timers and constants in connected mode | MD | | UE Timers and constants in connected mode
10.3.3.43 | Default value means that for all timers and constants
- For parameters with need MD, the defaults specified in 10.3.3.43 apply and
- For parameters with need OP, the parameters are absent |

10.2.48.8.5 System Information Block type 2

The system information block type 2 contains the URA identity.

| Information Element/Group name | Need | Multi | Type and reference | Semantics description |
|--|------|--------------|--------------------------|-----------------------|
| UTRAN mobility information elements | | | | |
| URA identity list | MP | 1 ..<maxURA> | | |
| >URA identity | MP | | URA identity
10.3.2.6 | |

10.2.48.8.6 System Information Block type 3

The system information block type 3 contains parameters for cell selection and re-selection.

| Information Element/Group name | Need | Multi | Type and reference | Semantics description | Version |
|--|------|-------|--|---|---------|
| SIB4 Indicator | MP | | Boolean | TRUE indicates that SIB4 is broadcast in the cell. | |
| UTRAN mobility information elements | | | | | |
| Cell identity | MP | | Cell identity 10.3.2.2 | | |
| Cell selection and re-selection info | MP | | Cell selection and re-selection info for SIB3/4 10.3.2.3 | | |
| Cell Access Restriction | MP | | Cell Access Restriction 10.3.2.1 | | |
| Domain Specific Access Restriction Parameters For PLMN Of MIB | OP | | Domain Specific Access Restriction Parameters 10.3.1.3c | This IE specifies the Domain Specific Access Restriction Parameters for UEs which has chosen the PLMN in the IE 'PLMN identity' of the Master Information Block.
If the cell is operating in MBSFN mode as indicated in subclause 8.1.1.6.3 the UE behaviour upon reception of this IE is unspecified. | REL-6 |
| Domain Specific Access Restriction For Shared Network | OP | | | If the cell is operating in MBSFN mode as indicated in subclause 8.1.1.6.3 the UE behaviour upon reception of this IE is unspecified. | REL-6 |
| >CHOICE <i>barring representation</i> | MP | | | | REL-6 |
| >>Domain Specific Access Restriction List | | | | | REL-6 |
| >>>Domain Specific Access Restriction Parameters For Operator1 | OP | | Domain Specific Access Restriction Parameters 10.3.1.3c | This IE specifies the Domain Specific Access Restriction Parameters for UEs which has chosen the first PLMN in the IE 'multiplePLMNs' in the IE 'Multiple PLMN List' of the Master Information Block. | REL-6 |
| >>>Domain Specific Access Restriction Parameters For Operator2 | OP | | Domain Specific Access Restriction Parameters 10.3.1.3c | This IE specifies the Domain Specific Access Restriction Parameters for UEs which has chosen the second PLMN in the IE 'multiplePLMNs' in the IE 'Multiple PLMN List' of the Master Information Block. | REL-6 |
| >>>Domain Specific Access Restriction Parameters For Operator3 | OP | | Domain Specific Access Restriction Parameters 10.3.1.3c | This IE specifies the Domain Specific Access Restriction Parameters for UEs which has chosen the third PLMN in the IE 'multiplePLMNs' in the IE 'Multiple PLMN List' of the Master Information Block. | REL-6 |
| >>>Domain Specific Access Restriction Parameters For Operator4 | OP | | Domain Specific Access Restriction Parameters 10.3.1.3c | This IE specifies the Domain Specific Access Restriction Parameters for UEs which has chosen the fourth PLMN in the IE 'multiplePLMNs' in the IE 'Multiple PLMN List' of the Master Information Block. | REL-6 |
| >>>Domain Specific Access Restriction Parameters For Operator5 | OP | | Domain Specific Access Restriction | This IE specifies the Domain Specific Access Restriction Parameters for UEs which has chosen the fifth PLMN in the | REL-6 |

| | | | | | |
|--|----|--------|---|---|-------|
| | | | Parameters 10.3.1.3c | IE 'multiplePLMNs' in the IE 'Multiple PLMN List' of the Master Information Block. | |
| >>Domain Specific Access Restriction Parameters For All | | | | | REL-6 |
| >>>Domain Specific Access Restriction Parameters | | | Domain Specific Access Restriction Parameters 10.3.1.3c | This IE specifies the common Domain Specific Access Restriction Parameters applied to all PLMNs in the IE 'multiplePLMNs' in the IE 'Multiple PLMN List' of the Master Information Block. | REL-6 |
| Deferred measurement control reading support | OP | | | If present, the UE may apply deferred reading of SIB11, SIB11bis and SIB12. If not present, deferred reading may not be applied. | REL-7 |
| >CHOICE <i>mode</i> | OP | | | If absent, the default reporting quantities are: "CPICH RSCP" (FDD) and "Primary CCPCH RSCP" (TDD). | REL-7 |
| >>FDD | | | | | REL-7 |
| >>>Intra-frequency reporting quantity SIB3 | MP | | Enumerated(CPICH Ec/N0, CPICH RSCP) | | REL-7 |
| >>TDD | | | | | REL-7 |
| >>>Reporting quantity list | MP | 1 to 2 | | | REL-7 |
| >>>>Intra-frequency reporting quantity SIB3 | MP | | Enumerated (Primary CCPCH RSCP, Timeslot ISCP) | | REL-7 |
| MBSFN only service | OP | | Enumerated (TRUE) | Indicates if the cell provides only MBMS services in MBSFN mode | REL-7 |
| Paging Permission with Access Control Parameters For PLMN Of MIB | OP | | Paging Permission with Access Control Parameters 10.3.1.10a | This IE specifies the Paging Permission With Access Control Parameters for UEs which has chosen the PLMN in the IE 'PLMN identity' of the Master Information Block. If the cell is operating in MBSFN mode as indicated in subclause 8.1.1.6.3 the UE behaviour upon reception of this IE is unspecified. | REL-8 |
| Paging Permission with Access Control For Shared Network | OP | | | If the cell is operating in MBSFN mode as indicated in subclause 8.1.1.6.3 the UE behaviour upon reception of this IE is unspecified. | REL-8 |
| >CHOICE <i>barring representation</i> | MP | | | | REL-8 |
| >>Paging Permission with Access Control List | | | | | REL-8 |
| >>>Paging Permission with Access Control Parameters For Operator1 | OP | | Paging Permission with Access Control Parameters 10.3.1.10a | This IE specifies the Paging Permission with Access Control Parameters for UEs which has chosen the first PLMN in the IE 'multiplePLMNs' in the IE 'Multiple PLMN List' of the Master Information Block. | REL-8 |
| >>>>Paging Permission with Access Control Parameters For Operator2 | OP | | Paging Permission with Access | This IE specifies the Paging Permission with Access Control Parameters for UEs | REL-8 |

| | | | | | |
|---|----|--|---|---|-------|
| | | | Control Parameters 10.3.1.10a | which has chosen the second PLMN in the IE 'multiplePLMNs' in the IE 'Multiple PLMN List' of the Master Information Block. | |
| >>>Paging Permission with Access Control Parameters For Operator3 | OP | | Paging Permission with Access Control Parameters 10.3.1.10a | This IE specifies the Paging Permission with Access Control Parameters for UEs which has chosen the third PLMN in the IE 'multiplePLMNs' in the IE 'Multiple PLMN List' of the Master Information Block. | REL-8 |
| >>>Paging Permission with Access Control Parameters For Operator4 | OP | | Paging Permission with Access Control Parameters 10.3.1.10a | This IE specifies the Paging Permission with Access Control Parameters for UEs which has chosen the fourth PLMN in the IE 'multiplePLMNs' in the IE 'Multiple PLMN List' of the Master Information Block. | REL-8 |
| >>>Paging Permission with Access Control Parameters For Operator5 | OP | | Paging Permission with Access Control Parameters 10.3.1.10a | This IE specifies the Paging Permission with Access Control Parameters for UEs which has chosen the fifth PLMN in the IE 'multiplePLMNs' in the IE 'Multiple PLMN List' of the Master Information Block. | REL-8 |
| >>Paging Permission with Access Control Parameters For All | | | | | REL-8 |
| >>>Paging Permission with Access Control Parameters | MP | | Paging Permission with Access Control Parameters 10.3.1.10a | This IE specifies the common Paging Permission with Access Control Parameters applied to all PLMNs in the IE 'multiplePLMNs' in the IE 'Multiple PLMN List' of the Master Information Block. | REL-8 |
| CSG Identity | OP | | CSG Identity 10.3.2.8 | | REL-8 |
| CSG PSC Split Information | OP | | CSG PSC Split Information 10.3.2.9 | This IE specifies the Primary Scrambling Code reservation information for CSG Cells. | REL-8 |

10.2.48.8.7 System Information Block type 4

The system information block type 4 contains parameters for cell selection and re-selection to be used in connected mode.

| Information Element/Group name | Need | Multi | Type and reference | Semantics description |
|--|------|-------|---|-----------------------|
| UTRAN mobility information elements | | | | |
| Cell identity | MP | | Cell identity
10.3.2.2 | |
| Cell selection and re-selection info | MP | | Cell selection and re-selection info for SIB3/4
10.3.2.3 | |
| Cell Access Restriction | MP | | Cell Access Restriction
10.3.2.1 | |

10.2.48.8.8 System Information Block type 5 and 5bis

The system information block type 5 contains parameters for the configuration of the common physical channels in the cell. System information block type 5bis uses the same structure as System information block type 5. System information block type 5bis is sent instead of system information block type 5 in cells that use Band IV or Band IX or Band X.

| Information Element/Group name | Need | Multi | Type and reference | Semantics description | Version |
|-----------------------------------|------|-------|---|---|---------|
| SIB6 Indicator | MP | | Boolean | TRUE indicates that SIB6 is broadcast in the cell. | |
| PhyCH information elements | | | | | |
| PICH Power offset | MP | | PICH Power offset
10.3.6.50 | If the cell is operating in MBSFN mode as indicated in subclause 8.1.1.6.3 the UE behaves as if this IE would not have been received. | |
| CHOICE <i>mode</i> | MP | | | | |
| >FDD | | | | | |
| >>AICH Power offset | MP | | AICH Power offset
10.3.6.3 | If the cell is operating in MBSFN mode as indicated in subclause 8.1.1.6.3 the UE behaves as if this IE would not have been received. | |
| >TDD | | | | | |
| >>PUSCH system information | OP | | PUSCH system information
10.3.6.66 | If the cell is operating in MBSFN mode as indicated in subclause 8.1.1.6.3 the UE behaviour upon reception of this IE is unspecified. | |
| >>PUSCH system information VHCR | OP | | PUSCH system information VHCR
10.3.6.66a | Only for 7.68 Mcps TDD
If the cell is operating in MBSFN mode as indicated in subclause 8.1.1.6.3 the UE behaviour upon reception of this IE is unspecified. | REL-7 |
| >>PDSCH system information | OP | | PDSCH system information | If the cell is operating in MBSFN mode as indicated in subclause 8.1.1.6.3 the UE | |

| Information Element/Group name | Need | Multi | Type and reference | Semantics description | Version |
|------------------------------------|--------------------|-------|--|---|---------|
| | | | 10.3.6.46 | behaviour upon reception of this IE is unspecified. | |
| >>TDD open loop power control | MP | | TDD open loop power control 10.3.6.79 | If the cell is operating in MBSFN mode as indicated in subclause 8.1.1.6.3 the UE behaves as if this IE would not have been received. | |
| Primary CCPCH info | OP | | Primary CCPCH info 10.3.6.57 | Note 1 | |
| PRACH system information list | MP | | PRACH system information list 10.3.6.55 | If the cell is operating in MBSFN mode as indicated in subclause 8.1.1.6.3 the UE behaves as if this IE would not have been received. | |
| Common E-DCH system info | OP | | Common E-DCH system info 10.3.6.9a | | REL-8 |
| Secondary CCPCH system information | MP | | Secondary CCPCH system information 10.3.6.72 | Note 2
If the cell is operating in MBSFN mode as indicated in subclause 8.1.1.6.3 the UE behaves as if this IE would not have been received. | |
| CBS DRX Level 1 information | CV-
<i>CTCH</i> | | CBS DRX Level 1 information 10.3.8.3 | | |

| Information Element/Group name | Need | Multi | Type and reference | Semantics description | Version |
|---|------|-------|---|--|---------|
| Frequency band indicator | OP | | Frequency band indicator 10.3.6.35 b | | REL-6 |
| Frequency band indicator 2 | OP | | Frequency band indicator 2 10.3.6.35 c | | REL-6 |
| HSDPA cell Indicator | MD | | Enumerated (HSDPA Capable Cell) | Default is "HSDPA capability not indicated".

"HSDPA Capable Cell" means that the UE may consider this cell as part of the HSDPA coverage area for display indication only. This indication shall not be used for any other purpose. If the cell is operating in MBSFN mode as indicated in subclause 8.1.1.6.3 the UE behaves as if this IE would not have been received. | REL-6 |
| E-DCH cell Indicator | MD | | Enumerated (E-DCH Capable Cell) | Default is "E-DCH capability not indicated".

"E-DCH Capable Cell" means that the UE may consider this cell as part of the E-DCH coverage area for display indication only. This indication shall not be used for any other purpose. If the cell is operating in MBSFN mode as indicated in subclause 8.1.1.6.3 the UE behaves as if this IE would not have been received. | REL-6 |
| Secondary CCPCH system information MBMS | OP | | Secondary CCPCH system information MBMS 10.3.6.72 a | Included if MCCH is on an S-CCPCH used only for MBMS. Note 2 | REL-6 |
| CHOICE <i>mode</i> | OP | | | | REL-7 |
| >FDD | | | | | REL-7 |
| >>HS-DSCH common system information | MP | | HS-DSCH common system information 10.3.6.36 | Included if cell supports HS-DSCH reception in CELL_FACH and during IDLE to RRC Connection state transition. | REL-7 |

| Information Element/Group name | Need | Multi | Type and reference | Semantics description | Version |
|--|--------------|-------|--|--|----------------|
| >>HS-DSCH paging system information | OP | | c
HS-DSCH paging system information
10.3.6.36d | Included if cell supports for UEs in RRC Connected state paging message reception on HS-DSCH. | REL-7 |
| >TDD
>>HS-DSCH common system information | MP | | HS-DSCH common system information
1.28Mcps TDD
10.3.6.36ca | Included if cell supports HS-DSCH reception in CELL_FACH and during IDLE to RRC Connection state transition. | REL-7
REL-8 |
| >>HS-DSCH paging system information | OP | | HS-DSCH paging system information
1.28Mcps TDD
10.3.6.36da | Included if cell supports for UEs in RRC Connected state paging message reception on HS-DSCH. | REL-8 |
| TDD MBSFN information | OP | | TDD MBSFN Information
10.3.6.78b | TDD only: included only if some timeslots are designated to MBSFN. | REL-7 |
| HS-DSCH DRX in CELL_FACH Information | OP | | HS-DSCH DRX in CELL_FACH Information
10.3.6.36g | | REL-8 |
| HS-DSCH DRX in CELL_FACH Information 1.28 Mcps TDD | OP | | HS-DSCH DRX in CELL_FACH Information 1.28 Mcps TDD
10.3.6.36h | | REL-8 |
| Frequency info | OP | | Integer (0 .. 16383) | Note 3 | REL-8 |
| Treset Usage Indicator | OP | | Enumerated (TRUE) | Only for 1.28 Mcps TDD. The presence of this IE means the timer Treset is not valid when the dedicated H-RNTI is configured in CELL_FACH and CELL_PCH. | REL-8 |
| UpPCH Position Info | CV-Frequency | | Integer (0 .. 127) | Only for 1.28 Mcps TDD. | REL-8 |
| | | | | | |

NOTE 1: DL scrambling code of the Primary CCPCH is the same as the one for Primary CPICH (FDD only).

NOTE 2: There is only one MCCH in a cell, which may either be mapped on to an S-CCPCH also used for non-MBMS purposes or to an S-CCPCH dedicated to MBMS. In the first case the MCCH configuration is specified within the IE "Secondary CCPCH system information", in the latter case the MCCH configuration is provided within the IE "Secondary CCPCH system information MBMS".

NOTE 3: This IE is used in 1.28 Mcps TDD multi-frequency cell to indicate the secondary frequency at which enhanced E-DCH transmission and HS-PDSCH reception for 1.28 Mcps TDD is supported and to indicate that corresponding IEs: "Common E-DCH system info", "HS-DSCH common system information" (TDD) and "HS-DSCH DRX in CELL_FACH Information 1.28 Mcps TDD" can apply for this frequency. The absence of "Frequency info" means that enhanced E-DCH transmission and HS-PDSCH reception and above IEs apply for primary frequency. For 1.28 Mcps TDD only.

| Condition | Explanation |
|------------------|--|
| <i>CTCH</i> | The IE is mandatory present if the IE "CTCH indicator" is equal to TRUE for at least one FACH, otherwise the IE is not needed in the message |
| <i>Frequency</i> | The IE is optional if the IE "Frequency info" is present, otherwise the IE is not needed. |

10.2.48.8.9 System Information Block type 6

The system information block type 6 contains parameters for the configuration of the common and shared physical channels to be used in connected mode.

| Information Element/Group name | Need | Multi | Type and reference | Semantics description | Version |
|-----------------------------------|------|-------|---|------------------------|---------|
| PhyCH information elements | | | | | |
| PICH Power offset | MP | | PICH Power offset
10.3.6.50 | | |
| CHOICE <i>mode</i> | MP | | | | |
| >FDD | | | | | |
| >>AICH Power offset | MP | | AICH Power offset
10.3.6.3 | | |
| >TDD | | | | | |
| >>PUSCH system information | OP | | PUSCH system information
10.3.6.66 | | |
| >>PUSCH system information VHCR | OP | | PUSCH system information VHCR
10.3.6.66a | Only for 7.68 Mcps TDD | REL-7 |
| >>PDSCH system information | OP | | PDSCH system information
10.3.6.46 | | |
| >>TDD open loop power control | MP | | TDD open loop power control
10.3.6.79 | | |
| Primary CCPCH info | OP | | Primary CCPCH info | Note 1 | |

| Information Element/Group name | Need | Multi | Type and reference | Semantics description | Version |
|------------------------------------|--------------------|-------|---|-----------------------|---------|
| | | | 10.3.6.57 | | |
| PRACH system information list | OP | | PRACH system information list
10.3.6.55 | | |
| Secondary CCPCH system information | OP | | Secondary CCPCH system information
10.3.6.72 | | |
| CBS DRX Level 1 information | CV-
<i>CTCH</i> | | CBS DRX Level 1 information
10.3.8.3 | | |
| Frequency band indicator | OP | | Frequency band indicator
10.3.6.35 b | | REL-6 |
| Frequency band indicator 2 | OP | | Frequency band indicator
2
10.3.6.35 c | | REL-6 |

NOTE 1: DL scrambling code of the Primary CCPCH is the same as the one for Primary CPICH (FDD only).

| Condition | Explanation |
|-------------|---|
| <i>CTCH</i> | The IE is mandatory present if the IE "CTCH indicator" is equal to TRUE for at least one FACH, otherwise the IE is not needed |

10.2.48.8.10 System Information Block type 7

The system information block type 7 contains the fast changing parameters UL interference and Dynamic persistence level.

| Information Element/Group name | Need | Multi | Type and reference | Semantics description |
|--|------|-----------------|--|--|
| CHOICE <i>mode</i> | MP | | | |
| >FDD | | | | |
| >>UL interference | MP | | UL interference
10.3.6.87 | |
| >TDD | | | | (no data) |
| PhyCH information elements | | | | |
| PRACHs listed in system information block type 5 | MP | 1 to <maxPRACH> | | The order of the PRACHs is the same as in system information block type 5 or 5bis. |
| >Dynamic persistence level | MP | | Dynamic persistence level
10.3.6.35 | |
| PRACHs listed in system information block type 6 | OP | 1 to <maxPRACH> | | The order of the PRACHs is the same as in system information block type 6. |
| >Dynamic persistence level | MP | | Dynamic persistence level
10.3.6.35 | |
| Expiration Time Factor | MD | | Expiration Time Factor
10.3.3.12 | Default is 1. |

10.2.48.8.11 Void

10.2.48.8.12 Void

10.2.48.8.13 Void

10.2.48.8.14 System Information Block type 11

The system information block type 11 contains measurement control information to be used in the cell.

| Information Element/Group name | Need | Multi | Type and reference | Semantics description |
|---|------|-------|--|---|
| SIB12 Indicator | MP | | Boolean | TRUE indicates that SIB12 is broadcast in the cell. |
| Measurement information elements | | | | |
| FACH measurement occasion info | OP | | FACH measurement occasion info
10.3.7.8 | If the cell is operating in MBSFN mode as indicated in subclause 8.1.1.6.3 the UE behaviour upon reception of this IE is unspecified. |
| Measurement control system information | MP | | Measurement control system information | For 1.28 Mcps TDD if the cell is operating in MBSFN only mode the UE behaviour upon reception of this IE is |

| Information Element/Group name | Need | Multi | Type and reference | Semantics description |
|--------------------------------|------|-------|-------------------------------------|--|
| | | | 10.3.7.47 | unspecified. |
| MBSFN frequency list | OP | | MBSFN frequency list
10.3.9a.12a | If present contains all neighbouring frequencies of MBSFN clusters operating in MBSFN mode as indicated in subclause 8.1.1.6.3.
If the cell is operating in MBSFN mode as indicated in subclause 8.1.1.6.3 the UE behaviour upon reception of this IE is unspecified. |

10.2.48.8.14a System Information Block type 11bis

The system information block type 11bis contains measurement control information to be used in the cell in addition to System Information Block type 11 and optionally UTRAN mobility information for CSG cells.

| Information Element/Group name | Need | Multi | Type and reference | Semantics description | Version |
|--|------|----------------------------|--|--|---------|
| Measurement information elements | | | | | REL-6 |
| Measurement control system information extension | MP | | Measurement control system information extension
10.3.7.47a | | REL-6 |
| UTRAN mobility information elements | | | | | REL-8 |
| CSG PSC Split Information | OP | | CSG PSC Split Information
10.3.2.9 | This IE specifies the Primary Scrambling Code reservation information for CSG Cells. | REL-8 |
| Dedicated CSG frequency list | OP | 1 to <maxDedicatedCSGFreq> | | This IE specifies the frequencies dedicated for CSG cells only. | REL-8 |
| >Dedicated CSG frequency | MP | | Frequency Info
10.3.6.36 | | REL-8 |

10.2.48.8.15 System Information Block type 12

The system information block type 12 contains measurement control information to be used in connected mode.

| Information Element/Group name | Need | Multi | Type and reference | Semantics description |
|---|------|-------|---|-----------------------|
| Measurement information elements | | | | |
| FACH measurement occasion info | OP | | FACH measurement occasion info
10.3.7.8 | |
| Measurement control system information | MP | | Measurement control system information
10.3.7.47 | |

10.2.48.8.16 System Information Block type 13

The system information block type 13 contains ANSI-41 system information.

| Information Element/Group name | Need | Multi | Type and reference | Semantics description |
|--------------------------------------|------|----------------------|--|---|
| Other information elements | | | | |
| CN Information Elements | | | | |
| CN Domain system information list | MP | 1 to <maxCNdo mains> | | Send CN information for each CN domain. |
| >CN Domain system information | MP | | CN Domain system information 10.3.1.2 | |
| UE Information | | | | |
| UE timers and constants in idle mode | MD | | UE timers and constants in idle mode 10.3.3.44 | The UE behaviour is unspecified if this IE is absent. |
| Capability update requirement | MD | | Capability update requirement 10.3.3.2 | Default value is defined in subclause 10.3.3.2 |

10.2.48.8.16.1 System Information Block type 13.1

The system information block type 13.1 contains the ANSI-41 RAND information.

| Information Element/Group name | Need | Multi | Type and reference | Semantics description |
|-------------------------------------|------|-------|-----------------------------------|-----------------------|
| ANSI-41 information elements | | | | |
| ANSI-41 RAND information | MP | | ANSI-41 RAND information 10.3.9.6 | |

10.2.48.8.16.2 System Information Block type 13.2

The system information block type 13.2 contains the ANSI-41 User Zone Identification information.

| Information Element/Group name | Need | Multi | Type and reference | Semantics description |
|--|------|-------|---|-----------------------|
| ANSI-41 information elements | | | | |
| ANSI-41 User Zone Identification information | MP | | ANSI-41 User Zone Identification information 10.3.9.7 | |

10.2.48.8.16.3 System Information Block type 13.3

The system information block type 13.3 contains the ANSI-41 Private Neighbour List information.

| Information Element/Group name | Need | Multi | Type and reference | Semantics description |
|--|------|-------|---|-----------------------|
| ANSI-41 information elements | | | | |
| ANSI-41 Private Neighbour List information | MP | | ANSI-41 Private Neighbour List information 10.3.9.5 | |

10.2.48.8.16.4 System Information Block type 13.4

The system information block type 13.4 contains the ANSI-41 Global Service Redirection information.

| Information Element/Group name | Need | Multi | Type and reference | Semantics description |
|--|------|-------|---|-----------------------|
| ANSI-41 information elements | | | | |
| ANSI-41 Global Service Redirection information | MP | | ANSI-41 Global Service Redirection information 10.3.9.2 | |

10.2.48.8.17 System Information Block type 14

NOTE: Only for 3.84 Mcps TDD and 7.68 Mcps TDD.

The system information block type 14 contains parameters for common and dedicated physical channel uplink outer loop power control information to be used in both idle and connected mode.

| Information Element/Group name | Need | Multi | Type and reference | Semantics description |
|---------------------------------------|------|--------------|--|-----------------------|
| PhyCH information elements | | | | |
| Individual Timeslot interference list | MP | 1 to <maxTS> | | |
| >Individual Timeslot interference | MP | | Individual Timeslot interference 10.3.6.38 | |
| Expiration Time Factor | MD | | Expiration Time Factor 10.3.3.12 | Default is 1. |

10.2.48.8.18 System Information Block type 15

The system information block type 15 contains information useful for UE-based or UE-assisted positioning methods.

| Information Element/Group name | Need | Multi | Type and Reference | Semantics description |
|--------------------------------|------|---------------|--|--|
| GPS Data ciphering info | OP | | UE positioning Ciphering info
10.3.7.86 | If this IE is present then the SIB types 15.1, 15.2 & 15.3 are ciphered in accordance with the Data Assistance Ciphering Algorithm specified in [18] |
| Reference position | MP | | Ellipsoid point with altitude and uncertainty ellipsoid
10.3.8.4c | approximate position where the UE is located |
| GPS reference time | MP | | UE positioning GPS reference time
10.3.7.96 | |
| Satellite information | OP | 1 to <maxSat> | | This IE is present whenever bad (failed/failing) satellites are detected by UTRAN [18]. |
| >BadSatID | MP | | Enumerated(0..63) | |

10.2.48.8.18.0 System Information Block type 15bis

The system information block type 15bis contains information useful for UE-based or UE-assisted positioning methods. The content of this SIB is common to all GANSS.

| Information Element/Group name | Need | Type and Reference | Semantics description | Version |
|------------------------------------|------|--|--|---------|
| Reference position | MP | Ellipsoid point with altitude and uncertainty ellipsoid
10.3.8.4c | approximate position where the UE is located | REL-7 |
| GANSS reference time | MP | UE positioning GANSS reference time
10.3.7.96o | | REL-7 |
| GANSS ionospheric model | OP | UE positioning GANSS ionospheric model
10.3.7.92a | | REL-7 |
| GANSS additional ionospheric model | OP | UE positioning GANSS additional ionospheric model
10.3.7.92b | | REL-8 |
| GANSS Earth orientation parameters | OP | UE positioning GANSS Earth orientation parameters
10.3.7.92c | | REL-8 |

10.2.48.8.18.1 System Information Block type 15.1

The system information block type 15.1 contains information useful for UE positioning DGPS Corrections. The DGPS Corrections message contents are based on a Type-1 message of DGPS specified in [13].

| Information Element/Group name | Need | Multi | Type and Reference | Semantics description |
|--------------------------------|------|-------|---|-----------------------|
| DGPS corrections | MP | | UE positioning GPS DGPS corrections 10.3.7.91 | |

10.2.48.8.18.1a System Information Block type 15.1bis

The system information block type 15.1bis contains information useful for UE positioning DGNSS Corrections. The DGNSS Corrections message contents are based on a Type-1 message of DGNSS specified in [13]. The content of this SIB is GNSS specific.

| Information Element/Group name | Need | Type and Reference | Semantics description | Version |
|--------------------------------|------|---|-----------------------|---------|
| DGNSS corrections | MP | UE positioning DGNSS corrections 10.3.7.91b | | REL-7 |

10.2.48.8.18.2 System Information Block type 15.2

The system information block type 15.2 contains information useful for GPS Navigation Model. These IE fields are based on information extracted from the subframes 1 to 3 of the GPS navigation message [12].

| Information Element/Group name | Need | Multi | Type and Reference | Semantics description |
|---|------|-------|---|--|
| Transmission TOW | MP | | Integer (0..604799) | The approximate GPS time-of-week when the message is broadcast. in seconds |
| SatID | MP | | Integer (0..63) | Satellite ID |
| GPS Ephemeris and Clock Correction Parameters | MP | | UE positioning GPS Ephemeris and Clock Correction parameters 10.3.7.91a | |

10.2.48.8.18.2a System Information Block type 15.2bis

The system information block type 15.2bis contains information useful for GANSS Navigation Model. The content of this SIB is GNSS specific.

| Information Element/Group name | Need | Type and Reference | Semantics description | Version |
|--------------------------------|------|--|-----------------------|---------|
| GANSS Navigation Model | MP | UE positioning GANSS navigation model 10.3.7.94a | | REL-7 |

10.2.48.8.18.2b System Information Block type 15.2ter

The system information block type 15.2ter contains information useful for GANSS Navigation Model. The content of this SIB is GNSS specific.

| Information Element/Group name | Need | Type and Reference | Semantics description | Version |
|------------------------------------|------|--|-----------------------|---------|
| GANSS additional navigation models | MP | UE positioning GANSS additional navigation models 10.3.7.94b | | REL-8 |

10.2.48.8.18.3 System Information Block type 15.3

The system information block type 15.3 contains information useful for ionospheric delay, UTC offset, and Almanac. These IEs contain information extracted from the subframes 4 and 5 of the GPS navigation message, [12].

| Information Element/Group name | Need | Multi | Type and Reference | Semantics description |
|----------------------------------|--------------------|-------|--|--|
| Transmission TOW | MP | | Integer (0..604799) | The approximate GPS time-of-week when the message is broadcast. in seconds |
| GPS Almanac and Satellite Health | OP | | UE positioning GPS almanac 10.3.7.89 | |
| GPS ionospheric model | OP | | UE positioning GPS ionospheric model 10.3.7.92 | |
| GPS UTC model | OP | | UE positioning GPS UTC model 10.3.7.97 | |
| SatMask | CV- <i>Almanac</i> | | Bit string(1..32) | indicates the satellites that contain the pages being broadcast in this data set |
| LSB TOW | CV- <i>Almanac</i> | | Bit string(8) | |

| Condition | Explanation |
|----------------|--|
| <i>Almanac</i> | This IE is mandatory present if the IE "GPS Almanac and Satellite Health" is present |

10.2.48.8.18.3a System Information Block type 15.3bis

The system information block type 15.3bis contains information useful for GANSS time model, UTC offset and Almanac, as well as auxiliary information. The content of this SIB is GNSS specific.

| Information Element/Group name | Need | Multi | Type and Reference | Semantics description | Version |
|--------------------------------|------|-------------------|---|-----------------------|---------|
| GANSS Almanac | OP | | UE positioning GANSS almanac 10.3.7.89a | | REL-7 |
| GANSS time models | OP | 1 to <maxGANSS-1> | | | REL-7 |
| >GANSS time model | OP | | UE positioning GANSS time model 10.3.7.97a | | REL-7 |
| GANSS UTC model | OP | | UE positioning GANSS UTC model 10.3.7.97c | | REL-7 |
| GANSS additional UTC models | OP | | UE positioning GANSS additional UTC models 10.3.7.97d | | REL-8 |
| GANSS auxiliary information | OP | | UE positioning GANSS auxiliary information 10.3.7.97f | | REL-8 |

10.2.48.8.18.4 System Information Block type 15.4

The system information block type 15.4 contains ciphering information for System Information Block type 15.5 and information useful for OTDOA UE-assisted Positioning method.

| Information Element/Group name | Need | Multi | Type and Reference | Semantics description |
|---------------------------------------|------|-------|---|---|
| OTDOA Data ciphering info | OP | | UE positioning Ciphering info 10.3.7.86 | If this IE is present then the for UE-based the System Information Block type 15.5 is ciphered in accordance with the Data Assistance Ciphering Algorithm specified in [18] |
| OTDOA assistance data for UE-assisted | MP | | UE positioning OTDOA assistance data for UE-assisted 10.3.7.103 | |

10.2.48.8.18.4a System Information Block type 15.5

The system information block type 15.5 contains information useful for OTDOA UE-based Positioning method.

| Information Element/Group name | Need | Multi | Type and Reference | Semantics description |
|------------------------------------|------|-------|--|-----------------------|
| OTDOA assistance data for UE-based | MP | | UE positioning OTDOA assistance data for UE-based
10.3.7.103a | |

10.2.48.8.18.5 System Information Block type 15.6

The system information block type 15.6 contains information useful for acquisition of GANSS signals. The content of this SIB is GNSS specific.

| Information Element/Group name | Need | Multi | Type and Reference | Semantics description | Version |
|---|------|-------|--|--|---------|
| GANSS TOD | MP | | Integer (0..86399) | GANSS Time of Day in seconds where GANSS reference measurement information is valid. | REL-7 |
| GANSS reference measurement information | MP | | UE positioning GANSS reference measurement information
10.3.7.88b | | REL-7 |

10.2.48.8.18.6 System Information Block type 15.7

The system information block type 15.7 contains data bits which can be used for data wipe-off. The content of this SIB is GNSS specific.

| Information Element/Group name | Need | Multi | Type and Reference | Semantics description | Version |
|--------------------------------|------|-------|--|-----------------------|---------|
| GANSS data bit assistance | MP | | UE positioning GANSS data bit assistance
10.3.7.97b | | REL-7 |

10.2.48.8.18.7 System Information Block type 15.8

The system information block type 15.8 contains ciphering information and real-time integrity information. The content of this SIB is GNSS specific.

| Information Element/Group name | Need | Multi | Type and Reference | Semantics description | Version |
|--------------------------------|------|-------|--|--|---------|
| GANSS Data ciphering info | OP | | UE positioning Ciphering info
10.3.7.86 | If this IE is present then the SIB types 15.1bis, 15.2bis, 15.2ter, 15.3bis, 15.6 and 15.7 are ciphered in accordance with the Data Assistance Ciphering Algorithm specified in [18] | REL-7 |
| GANSS real-time integrity | OP | | UE positioning GANSS real-time integrity
10.3.7.95b | | REL-7 |

10.2.48.8.19 System Information Block type 16

The system information block type 16 contains radio bearer, transport channel and physical channel parameters to be stored by UE in idle and connected mode for use during handover to UTRAN.

| Information Element/Group name | Need | Multi | Type and Reference | Semantics description |
|-----------------------------------|------|-------|--|-----------------------|
| RB information elements | | | | |
| Predefined RB configuration | MP | | Predefined RB configuration 10.3.4.7 | |
| TrCH Information Elements | | | | |
| Predefined TrCH configuration | MP | | Predefined TrCH configuration 10.3.5.9 | |
| PhyCH Information Elements | | | | |
| Predefined PhyCH configuration | MP | | Predefined PhyCH configuration 10.3.6.56 | |

10.2.48.8.20 System Information Block type 17

NOTE: Only for TDD.

The system information block type 17 contains fast changing parameters for the configuration of the shared physical channels to be used in connected mode.

| Information Element/Group name | Need | Multi | Type and reference | Semantics description | Version |
|-----------------------------------|------|-------|--|------------------------|---------|
| PhyCH information elements | | | | | |
| PUSCH system information | OP | | PUSCH system information 10.3.6.66 | | |
| PUSCH system information VHCR | OP | | PUSCH system information VHCR 10.3.6.66a | Only for 7.68 Mcps TDD | REL-7 |
| PDSCH system information | OP | | PDSCH system information 10.3.6.46 | | |

10.2.48.8.21 System Information Block type 18

The System Information Block type 18 contains PLMN identities of neighbouring cells to be considered in idle mode as well as in connected mode.

| Information Element/Group name | Need | Multi | Type and reference | Semantics description | Version |
|--|------|-------|--|-----------------------|---------|
| Idle mode PLMN identities | OP | | PLMN identities of neighbour cells
10.3.7.53a | | |
| Connected mode PLMN identities | OP | | PLMN identities of neighbour cells
10.3.7.53a | | |
| Idle mode PLMN identities for SIB 11bis | OP | | PLMN identities of neighbour cells
10.3.7.53a | | REL-6 |
| Connected mode PLMN identities for SIB 11bis | OP | | PLMN identities of neighbour cells
10.3.7.53a | | REL-6 |

10.2.48.8.22 System Information Block type 19

The system information block type 19 contains Inter-RAT frequency and priority information to be used in the cell.

| Information Element/Group name | Need | Multi | Type and reference | Semantics description | Version |
|---|------|-------|---|-----------------------|---------|
| UTRA priority info list | MP | | UTRA priority info list
10.3.7.113 | | REL-8 |
| GSM priority info list | OP | | GSM priority info list
10.3.7.114 | | REL-8 |
| E-UTRA frequency and priority info list | OP | | E-UTRA frequency and priority info list
10.3.7.115 | | REL-8 |

10.2.48.8.23 System Information Block type 20

The system information block type 20 contains HNBNName.

| Information Element/Group name | Need | Multi | Type and reference | Semantics description | Version |
|--------------------------------|------|-------|-----------------------|-----------------------|---------|
| HNB Name | OP | | HNB Name
10.3.8.4m | | REL-8 |

10.2.49 SYSTEM INFORMATION CHANGE INDICATION

This message is used to send information on FACH or HS-DSCH (FDD and 1.28 Mcps TDD only) to the UEs in state CELL_FACH, CELL_PCH (FDD and 1.28 Mcps TDD only), or CELL_DCH(TDD only) about coming modification of the system information.

RLC-SAP: TM

Logical channel: BCCH

Direction: UTRAN → UE

| Information Element/Group name | Need | Multi | Type and reference | Semantics description | Version |
|-----------------------------------|------|-------|------------------------------------|-----------------------|---------|
| Message Type | MP | | Message Type | | |
| Other information elements | | | | | |
| BCCH modification info | MP | | BCCH modification info
10.3.8.1 | | |
| ETWS information | OP | | ETWS information
10.3.8.4e
a | | REL-8 |

If the encoded message does not fill a transport block, the RRC layer shall insert padding according to subclause 12.1.

10.2.50 TRANSPORT CHANNEL RECONFIGURATION

This message is used by UTRAN to configure the transport channel of a UE. This also includes a possible reconfiguration of physical channels. The message can also be used to assign a TFC subset and reconfigure physical channel.

RLC-SAP: AM or UM

Logical channel: DCCH

Direction: UTRAN → UE

| Information Element/Group name | Need | Multi | Type and reference | Semantics description | Version |
|--------------------------------|------|-------|---|---|---------|
| Message Type | MP | | Message Type | | |
| UE Information Elements | | | | | |
| RRC transaction identifier | MP | | RRC transaction identifier
10.3.3.36 | | |
| Integrity check info | CH | | Integrity check info
10.3.3.16 | | |
| Integrity protection mode info | OP | | Integrity protection mode info
10.3.3.19 | The UTRAN should not include this IE unless it is performing an SRNS relocation | |
| Ciphering mode info | OP | | Ciphering mode info
10.3.3.5 | The UTRAN should not include this IE unless it is performing an SRNS relocation and a change in ciphering algorithm | |
| Activation time | MD | | Activation time
10.3.3.1 | Default value is "now" | |
| Delay restriction flag | OP | | Enumerated (TRUE) | This IE is always set to TRUE and included if the | REL-6 |

| Information Element/Group name | Need | Multi | Type and reference | Semantics description | Version |
|--|---------------------|----------------------|---|--|---------|
| | | | | activation time is restricted according to subclause 8.6.3.1 | |
| New U-RNTI | OP | | U-RNTI
10.3.3.47 | | |
| New C-RNTI | OP | | C-RNTI
10.3.3.8 | | |
| New DSCH-RNTI | OP | | DSCH-RNTI
10.3.3.9a | Should not be set in FDD. If received the UE should ignore it | |
| New H-RNTI | OP | | H-RNTI
10.3.3.14a | | REL-5 |
| New Primary E-RNTI | OP | | E-RNTI
10.3.3.10a | | REL-6 |
| New Secondary E-RNTI | OP | | E-RNTI
10.3.3.10a | FDD only | REL-6 |
| RRC State Indicator | MP | | RRC State Indicator
10.3.3.35a | | |
| UE Mobility State Indicator | CV-
FACH_PC
H | | Enumerated (High-mobilityDetected) | Absence of this IE implies that, according to [4], the UE shall consider itself being in the mobility state the UE has maintained in CELL_DCH state or being not in high mobility state after the state transition, if applicable. | REL-7 |
| UTRAN DRX cycle length coefficient | OP | | UTRAN DRX cycle length coefficient
10.3.3.49 | | |
| CN Information Elements | | | | | |
| CN Information info | OP | | CN Information info
10.3.1.3 | | |
| UTRAN mobility information elements | | | | | |
| URA identity | OP | | URA identity
10.3.2.6 | | |
| RNC support for change of UE capability | OP | | Boolean | Should be included if the message is used to perform an SRNS relocation | REL-7 |
| Reconfiguration in response to requested change of UE capability | OP | | Enumerated (TRUE) | | REL-7 |
| RB information elements | | | | | |
| Downlink counter synchronisation info | OP | | | | |
| >RB with PDCP information list | OP | 1 to <maxRBall RABs> | | | |

| Information Element/Group name | Need | Multi | Type and reference | Semantics description | Version |
|--|------|-----------------|--|---|---------|
| >>RB with PDCP information | MP | | RB with PDCP information 10.3.4.22 | This IE is needed for each RB having PDCP in the case of lossless SRNS relocation | |
| | OP | | | | REL-5 |
| >>PDCP context relocation info | OP | | PDCP context relocation info 10.3.4.1a | This IE is needed for each RB having PDCP and performing PDCP context relocation | REL-5 |
| TrCH Information Elements | | | | | |
| Uplink transport channels | | | | | |
| UL Transport channel information common for all transport channels | OP | | UL Transport channel information common for all transport channels 10.3.5.24 | | |
| Added or Reconfigured TrCH information list | OP | 1 to <maxTrCH > | | | |
| >Added or Reconfigured UL TrCH information | MP | | Added or Reconfigured UL TrCH information 10.3.5.2 | | |
| Downlink transport channels | | | | | |
| DL Transport channel information common for all transport channels | OP | | DL Transport channel information common for all transport channels 10.3.5.6 | | |
| Added or Reconfigured TrCH information list | OP | 1 to <maxTrCH > | | | |
| >Added or Reconfigured DL TrCH information | MP | | Added or Reconfigured DL TrCH information 10.3.5.1 | | |
| PhyCH information elements | | | | | |
| Frequency info | OP | | Frequency info 10.3.6.36 | | |
| Multi-frequency Info | OP | | Multi-frequency Info 10.3.6.39a | This IE is used for 1.28 Mcps TDD only | REL-7 |
| DTX-DRX timing information | OP | | DTX-DRX timing information 10.3.6.34b | | REL-7 |
| DTX-DRX Information | OP | | DTX-DRX Information 10.3.6.34a | | REL-7 |
| HS-SCCH less Information | OP | | HS-SCCH less Information 10.3.6.36ab | | REL-7 |
| MIMO parameters | OP | | MIMO parameters | | REL-7 |

| Information Element/Group name | Need | Multi | Type and reference | Semantics description | Version |
|---|------|--------------|--|---|---------|
| | | | 10.3.6.41a | | |
| Control Channel DRX information | OP | | Control Channel DRX information
1.28 Mcps TDD
10.3.6.107 | This IE is used for 1.28 Mcps TDD only | REL-8 |
| SPS Information | OP | | SPS information
1.28 Mcps TDD
10.3.6.110 | This IE is used for 1.28 Mcps TDD only | REL-8 |
| Uplink radio resources | | | | | |
| Maximum allowed UL TX power | MD | | Maximum allowed UL TX power
10.3.6.39 | Default value is the existing maximum UL TX power | |
| Uplink DPCH info | OP | | Uplink DPCH info
10.3.6.88 | | |
| E-DCH Info | OP | | E-DCH Info
10.3.6.97 | | REL-6 |
| Downlink radio resources | | | | | |
| Downlink HS-PDSCH Information | OP | | Downlink HS-PDSCH Information
10.3.6.23a | | REL-5 |
| Downlink information common for all radio links | OP | | Downlink information common for all radio links
10.3.6.24 | | |
| Downlink information per radio link list | OP | 1 to <maxRL> | | Send downlink information for each radio link | |
| >Downlink information for each radio link | MP | | Downlink information for each radio link
10.3.6.27 | | |
| Downlink secondary cell info FDD | OP | | Downlink secondary cell info FDD
10.3.6.31a | FDD only | REL-8 |
| MBMS PL Service Restriction Information | OP | | Enumerated (TRUE) | | REL-6 |

| Condition | Explanation |
|-----------|---|
| FACH_PCH | This IE is mandatory default when a transition from CELL_DCH to CELL_FACH, URA_PCH or CELL_PCH is requested by the message and is not needed otherwise. |

10.2.51 TRANSPORT CHANNEL RECONFIGURATION COMPLETE

This message is sent from the UE when a transport channel reconfiguration has been done.

RLC-SAP: AM

Logical channel: DCCH

Direction: UE → UTRAN

| Information Element/Group name | Need | Multi | Type and reference | Semantics description | Version |
|---|------|----------------------|---|--|---------|
| Message Type | MP | | Message Type | | |
| UE information elements | | | | | |
| RRC transaction identifier | MP | | RRC transaction identifier
10.3.3.36 | | |
| Integrity check info | CH | | Integrity check info
10.3.3.16 | | |
| Uplink integrity protection activation info | OP | | Integrity protection activation info
10.3.3.17 | | |
| CHOICE <i>mode</i> | OP | | | | |
| >FDD | | | | (no data) | |
| >TDD | | | | | |
| >>CHOICE <i>TDD option</i> | MP | | | | REL-4 |
| >>>3.84 Mcps TDD | | | | | REL-4 |
| >>>>Uplink Timing Advance | OP | | Uplink Timing Advance
10.3.6.95 | | |
| >>>>Extended Uplink Timing Advance | OP | | Extended Uplink Timing Advance
10.3.6.95a | | REL-7 |
| >>>7.68 Mcps TDD | | | | | REL-7 |
| >>>>Extended Uplink Timing Advance | OP | | Extended Uplink Timing Advance
10.3.6.95a | | REL-7 |
| >>>1.28 Mcps TDD | | | | (no data) | REL-4 |
| Other information elements | | | | | |
| Deferred measurement control reading | MD | | Enumerated (TRUE) | Indicates the UE has not read SIB11, SIB11bis and SIB12, if available. Default value is FALSE | REL-7 |
| RB Information elements | | | | | |
| COUNT-C activation time | OP | | Activation time
10.3.3.1 | Used for radio bearers mapped on RLC-TM. Only applicable if the UE is moving to CELL_DCH state due to this procedure | |
| Uplink counter synchronisation info | OP | | | | |
| >RB with PDCP information list | OP | 1 to <maxRBall RABs> | | | |
| >>RB with PDCP information | MP | | RB with PDCP information
10.3.4.22 | | |
| >START list | MP | 1 to <maxCNdo mains> | | START [40] values for all CN domains. | |

| Information Element/Group name | Need | Multi | Type and reference | Semantics description | Version |
|--------------------------------|------|-------|--------------------------------|---|---------|
| >>CN domain identity | MP | | CN domain identity
10.3.1.1 | | |
| >>START | MP | | START
10.3.3.38 | START value to be used in this CN domain. | |

10.2.52 TRANSPORT CHANNEL RECONFIGURATION FAILURE

This message is sent by UE if the configuration given by UTRAN is unacceptable or if the UE failed to establish the physical channel(s).

RLC-SAP: AM

Logical channel: DCCH

Direction: UE→UTRAN

| Information Element/Group name | Need | Multi | Type and reference | Semantics description |
|--------------------------------|------|-------|--|-----------------------|
| Message Type | MP | | Message Type | |
| UE information elements | | | | |
| RRC transaction identifier | MP | | RRC transaction identifier
10.3.3.36 | |
| Integrity check info | CH | | Integrity check info
10.3.3.16 | |
| Failure cause | MP | | Failure cause and error information
10.3.3.14 | |

10.2.53 TRANSPORT FORMAT COMBINATION CONTROL

This message is sent by UTRAN to control the uplink transport format combination within the allowed transport format combination set. This message has different structures depending if the message is sent on transparent (TM) or non-transparent mode (AM or UM).

RLC-SAP: AM or UM

Logical channel: DCCH

Direction: UTRAN→UE

| Information Element/Group name | Need | Multi | Type and reference | Semantics description | Version |
|----------------------------------|------|-------|---|-----------------------|---------|
| Message Type | MP | | Message Type | | |
| UE information elements | | | | | |
| RRC transaction identifier | MP | | RRC transaction identifier
10.3.3.36 | | |
| Integrity check info | CH | | Integrity check info
10.3.3.16 | | |
| TrCH information elements | | | | | |

| Information Element/Group name | Need | Multi | Type and reference | Semantics description | Version |
|---|------|-------|---|---|---------|
| CHOICE <i>mode</i> | MP | | | | |
| >FDD | | | | (no data) | |
| >TDD | | | | | |
| >>TFCS Id | OP | | Transport Format Combination Set Identity 10.3.5.21 | | |
| DPCH/PUSCH TFCS in uplink | MP | | Transport Format Combination subset 10.3.5.22 | NOTE 1 | |
| Activation time for TFC subset | MD | | Activation time 10.3.3.1 | Default value is "now" | |
| TFC Control duration | OP | | TFC Control duration 10.3.6.80 | | |
| UL AMR rate | OP | | Enumerated(t0, t1, t2, t3, t4, t5, t6, t7, t8) | Indicates the bit rate as defined in [62] and [63]. | REL-8 |
| NOTE 1: If the IE 'UL AMR rate' is included, no DCH is configured on the uplink and the IE 'DPCH/PUSCH TFCS in uplink' is not set to 'Full transport format combination set' the UE behaviour is unspecified. | | | | | |

In case of transparent mode signalling the following message structure shall be used:

RLC-SAP: TM

Logical channel: DCCH

Direction: UTRAN→UE

| Information Element/Group name | Need | Multi | Type and reference | Semantics description |
|--------------------------------|------|-------|--------------------|-----------------------|
| TFC subset identity | MP | | INTEGER (0..7) | |

The encoding of this message is specified in subclause 12.4.1.1.

10.2.54 TRANSPORT FORMAT COMBINATION CONTROL FAILURE

This message is sent to indicate that a received TRANSPORT FORMAT COMBINATION CONTROL message could not be handled by the UE.

RLC-SAP: AM

Logical channel: DCCH

Direction: UE→UTRAN

| Information Element/Group name | Need | Multi | Type and reference | Semantics description |
|--------------------------------|------|-------|--|-----------------------|
| Message Type | MP | | Message Type | |
| UE information elements | | | | |
| RRC transaction identifier | MP | | RRC transaction identifier
10.3.3.36 | |
| Integrity check info | CH | | Integrity check info
10.3.3.16 | |
| Failure cause | MP | | Failure cause and error information
10.3.3.14 | |

10.2.55 UE CAPABILITY ENQUIRY

The UE CAPABILITY ENQUIRY is used by the UTRAN to enquire inter-RAT classmarks from the UE.

RLC-SAP: AM or UM

Logical channel: DCCH

Direction: UTRAN → UE

| Information Element/Group name | Need | Multi | Type and reference | Semantics description |
|--------------------------------|------|-------|---|---|
| Message Type | MP | | Message Type | |
| UE information elements | | | | |
| RRC transaction identifier | MP | | RRC transaction identifier
10.3.3.36 | |
| Integrity check info | CH | | Integrity check info
10.3.3.16 | Integrity check info is included if integrity protection is applied |
| Capability update requirement | MP | | Capability update requirement
10.3.3.2 | |

10.2.56 UE CAPABILITY INFORMATION

This message is sent by UE to convey UE specific capability information to the UTRAN.

RLC-SAP: AM

Logical channel: DCCH

Direction: UE → UTRAN

| Information Element/Group name | Need | Multi | Type and reference | Semantics description |
|---------------------------------------|------|-----------------------------|--|---|
| Message Type | MP | | Message Type | |
| UE information elements | | | | |
| RRC transaction identifier | OP | | RRC transaction identifier
10.3.3.36 | |
| Integrity check info | CH | | Integrity check info
10.3.3.16 | Integrity check info is included if integrity protection is applied |
| UE radio access capability | OP | | UE radio access capability
10.3.3.42 | |
| UE radio access capability extension | OP | | UE radio access capability extension
10.3.3.42a | |
| Other information elements | | | | |
| UE system specific capability | OP | 1 to <maxInter SysMessages> | | |
| >Inter-RAT UE radio access capability | MP | | Inter-RAT UE radio access capability
10.3.8.7 | |

10.2.57 UE CAPABILITY INFORMATION CONFIRM

This message is sent by UTRAN to confirm that UE capability information has been received.

RLC-SAP: AM or UM

Logical channel: DCCH

Direction: UTRAN → UE

| Information Element/Group name | Need | Multi | Type and reference | Semantics description |
|--|------|-------|---|--|
| Message Type | MP | | Message Type | |
| UE information elements | | | | |
| RRC transaction identifier | MP | | RRC transaction identifier
10.3.3.36 | |
| Integrity check info | CH | | Integrity check info
10.3.3.16 | Integrity check info is included if integrity protection is applied |
| Acceptance of requested change of capability | OP | | Enumerated (Refused, Accepted, Accepted with reconfiguration to follow) | Included if the message was sent in response to a UE request for a capability change in connected mode |

10.2.58 UPLINK DIRECT TRANSFER

This message is used to transfer NAS messages for an existing signalling connection.

RLC-SAP: AM

Logical channel: DCCH

Direction: UE ->UTRAN

| Information Element/Group name | Need | Multi | Type and reference | Semantics description |
|---|------|-------|---------------------------------------|---|
| Message Type | MP | | Message Type | |
| UE information elements | | | | |
| Integrity check info | CH | | Integrity check info
10.3.3.16 | Integrity check info is included if integrity protection is applied |
| CN information elements | | | | |
| CN domain identity | MP | | CN domain identity
10.3.1.1 | |
| NAS message | MP | | NAS message
10.3.1.8 | |
| Measurement information elements | | | | |
| Measured results on RACH | OP | | Measured results on RACH
10.3.7.45 | |

10.2.59 UPLINK PHYSICAL CHANNEL CONTROL

NOTE: Only for TDD.

This message is used to transfer uplink physical channel parameters to the UE.

RLC-SAP: AM or UM

Logical channel: DCCH

Direction: UTRAN→UE

| Information Element/Group name | Need | Multi | Type and Reference | Semantics description | Version |
|-----------------------------------|------|-------|---|--|---------|
| Message Type | MP | | Message Type | | |
| UE information elements | | | | | |
| RRC transaction identifier | MP | | RRC transaction identifier
10.3.3.36 | | |
| Integrity check info | OP | | Integrity check info
10.3.3.16 | | |
| PhyCH information elements | | | | | |
| CCTrCH power control info | OP | | CCTrCH power control info
10.3.6.8 | Power control information for one CCTrCH | |

| Information Element/Group name | Need | Multi | Type and Reference | Semantics description | Version |
|-------------------------------------|----------|-------|--|--|---------|
| Special Burst Scheduling | OP | | Special Burst Scheduling
10.3.6.75a | UL Special Burst generation period in radio frames | |
| CHOICE <i>TDD option</i> | MP | | | | REL-4 |
| >3.84 Mcps TDD | | | | | REL-4 |
| >>Alpha | OP | | Alpha
10.3.6.5 | | |
| >>Timing Advance Control | OP | | UL Timing Advance Control
10.3.6.96 | | |
| >>PRACH Constant Value | OP | | Constant value TDD
10.3.6.11a | Operator controlled PRACH Margin | |
| >>PUSCH Constant Value | OP | | Constant value TDD
10.3.6.11a | Operator controlled PUSCH Margin | |
| >>UE positioning related parameters | CV-IPDLs | | | | REL-4 |
| >>>IPDL-Alpha | MP | | Alpha
10.3.6.5 | | REL-4 |
| >>>Max power increase | MP | | Integer (0..3) | In dB | REL-4 |
| >> HS-SICH power control info | OP | | HS-SICH Power Control Info
10.3.6.36b | Only applies to TDD 3.84 Mcps | REL-5 |
| >7.68 Mcps TDD | | | | | REL-7 |
| >>Alpha | OP | | Alpha
10.3.6.5 | | REL-7 |
| >>Timing Advance Control | OP | | UL Timing Advance Control
10.3.6.96 | | REL-7 |
| >>PRACH Constant Value | OP | | Constant value TDD
10.3.6.11a | Operator controlled PRACH Margin | REL-7 |
| >>PUSCH Constant Value | OP | | Constant value TDD
10.3.6.11a | Operator controlled PUSCH Margin | REL-7 |
| >>UE positioning related parameters | CV-IPDLs | | | | REL-4 |
| >>>IPDL-Alpha | MP | | Alpha
10.3.6.5 | | REL-4 |
| >>>Max power increase | MP | | Integer (0..3) | In dB | REL-4 |
| >> HS-SICH power control info | OP | | HS-SICH Power Control Info
10.3.6.36b | Only applies to TDD 7.68 Mcps | REL-5 |
| >1.28 Mcps TDD | | | | | REL-4 |
| >>Uplink synchronisation parameters | MD | | | Default: Uplink synchronisation step size 1. Uplink synchronisation frequency 1. | REL-4 |
| >>>Uplink synchronisation step size | MP | | Integer(1..8) | This parameter specifies the step size to be used for the adjustment of the uplink transmission timing | REL-4 |
| >>>Uplink synchronisation frequency | MP | | Integer(1..8) | This parameter specifies the | REL-4 |

| Information Element/Group name | Need | Multi | Type and Reference | Semantics description | Version |
|--------------------------------|------|-------|----------------------------------|---|---------|
| | | | | frequency of the adjustment of the uplink transmission timing | |
| >>PRX _{HS-SICH} | OP | | Integer (-120..-58 by step of 1) | In dBm. Desired power level for HS-SICH. | REL-6 |
| >>TPC step size | OP | | Integer (1, 2, 3) | In dB. For HS-SICH | REL-6 |

| Condition | Explanation |
|--------------|---|
| <i>IPDLs</i> | This IE is present only if idle periods are applied |

10.2.60 URA UPDATE

This message is used by the UE to initiate a URA update procedure.

RLC-SAP: TM

Logical channel: CCCH

Direction: UE→UTRAN

| Information Element/Group name | Need | Multi | Type and reference | Semantics description | Version |
|--------------------------------|-----------------------|-------|---|------------------------|---------|
| Message Type | MP | | Message Type | | |
| UE information elements | | | | | |
| U-RNTI | MP | | U-RNTI
10.3.3.47 | | |
| RRC transaction identifier | CV-
<i>ProtErr</i> | | RRC transaction identifier
10.3.3.36 | | |
| Integrity check info | CH | | Integrity check info
10.3.3.16 | | |
| URA update cause | MP | | URA update cause
10.3.3.46 | | |
| Protocol error indicator | MD | | Protocol error indicator
10.3.3.27 | Default value is FALSE | |

| Information Element/Group name | Need | Multi | Type and reference | Semantics description | Version |
|---|------------|-------|--------------------------------------|--|---------|
| HS-PDSCH in CELL_PCH and URA_PCH | OP | | Enumerated (TRUE) | This IE indicates whether the UE supports HS-PDSCH reception in CELL_PCH and URA_PCH states. The absence of this IE indicates that the UE does not support HS-PDSCH reception in CELL_PCH or URA_PCH states. | REL-7 |
| HS-PDSCH in CELL_FACH | OP | | Enumerated (TRUE) | This IE indicates whether the UE supports HS-PDSCH reception in CELL_FACH state. The absence of this IE indicates that the UE does not support HS-PDSCH reception in CELL_FACH state. | REL-7 |
| Support of HS-DSCH DRX operation | OP | | Enumerated (TRUE) | The absence of this IE indicates that the UE does not support HS-DSCH DRX operation in CELL_FACH state. | REL-8 |
| Support of common E-DCH | OP | | Enumerated (TRUE) | The absence of this IE indicates that the UE does not support E-DCH enhanced random access in CELL_FACH state and Idle mode. | REL-8 |
| Support of MAC-i/is | OP | | Enumerated (TRUE) | This IE indicates whether the UE supports MAC-i/is operation. | REL-8 |
| Support for Two DRX schemes in URA_PCH and CELL_PCH | OP | | Enumerated (TRUE) | The absence of this IE indicates that the UE does not support Two DRX schemes in URA_PCH and CELL_PCH | REL-7 |
| Other information elements | | | | | |
| Protocol error information | CV-ProtErr | | Protocol error information 10.3.8.12 | | |

| Condition | Explanation |
|----------------|---|
| <i>ProtErr</i> | The IE is mandatory present if the IE "Protocol error indicator" has the value TRUE and not needed otherwise. |

10.2.61 URA UPDATE CONFIRM

This message confirms the URA update procedure and can be used to reallocate new RNTI information for the UE valid after the URA update.

RLC-SAP: UM

Logical channel: CCCH or DCCH

Direction: UTRAN→UE

| Information Element/Group name | Need | Multi | Type and reference | Semantics description | Version |
|--------------------------------|------|-------|--------------------|-----------------------|---------|
| Message Type | MP | | Message Type | | |
| UE information elements | | | | | |

| Information Element/Group name | Need | Multi | Type and reference | Semantics description | Version |
|--|-----------------|----------------------------|---|--|---------|
| U-RNTI | CV- <i>CCCH</i> | | U-RNTI
10.3.3.47 | | |
| RRC transaction identifier | MP | | RRC
transaction
identifier
10.3.3.36 | | |
| Integrity check info | CH | | Integrity
check info
10.3.3.16 | Integrity check
info is included if
integrity protection
is applied | |
| Integrity protection mode info | OP | | Integrity
protection
mode info
10.3.3.19 | The UTRAN
should not include
this IE unless it is
performing an
SRNS relocation | |
| Ciphering mode info | OP | | Ciphering
mode info
10.3.3.5 | The UTRAN
should not include
this IE unless it is
performing an
SRNS relocation
and a change in
ciphering
algorithm | |
| New U-RNTI | OP | | U-RNTI
10.3.3.47 | | |
| New C-RNTI | OP | | C-RNTI
10.3.3.8 | | |
| New H-RNTI | OP | | H-RNTI
10.3.3.14a | | REL-8 |
| New Primary E-RNTI | OP | | E-RNTI
10.3.3.10a | | REL-8 |
| RRC State Indicator | MP | | RRC State
Indicator
10.3.3.35a | | |
| UTRAN DRX cycle length
coefficient | OP | | UTRAN DRX
cycle length
coefficient
10.3.3.49 | | |
| CN Information Elements | | | | | |
| CN Information info | OP | | CN
Information
info 10.3.1.3 | | |
| UTRAN mobility information
elements | | | | | |
| URA identity | OP | | URA identity
10.3.2.6 | | |
| RNC support for change of UE
capability | OP | | Boolean | Should be
included if the
message is used
to perform an
SRNS relocation | REL-7 |
| RB information elements | | | | | |
| Downlink counter
synchronisation info | OP | | | | |
| >RB with PDCP information list | OP | 1 to
<maxRBall
RABs> | | | |
| >>RB with PDCP information | MP | | RB with
PDCP
information
10.3.4.22 | This IE is needed
for each RB
having PDCP in
the case of
lossless SRNS
relocation | |
| | OP | | | | REL-5 |
| >>PDCP context relocation info | OP | | PDCP | This IE is needed | REL-5 |

| Information Element/Group name | Need | Multi | Type and reference | Semantics description | Version |
|--------------------------------|------|-------|--------------------------------------|--|---------|
| | | | context relocation info
10.3.4.1a | for each RB having PDCP and performing PDCP context relocation | |

| Condition | Explanation |
|-----------|--|
| CCCH | This IE is mandatory present when CCCH is used and not needed otherwise. |

10.2.62 UTRAN MOBILITY INFORMATION

This message is used by UTRAN to allocate a new RNTI and to convey other UTRAN mobility related information to a UE.

RLC-SAP: AM or UM

Logical channel: DCCH

Direction: UTRAN→UE

| Information Element/Group name | Need | Multi | Type and reference | Semantics description | Version |
|---|------|-------|--|---|---------|
| Message Type | MP | | Message Type | | |
| UE Information Elements | | | | | |
| Integrity check info | CH | | Integrity check info
10.3.3.16 | | |
| RRC transaction identifier | MP | | RRC transaction identifier
10.3.3.36 | | |
| Integrity protection mode info | OP | | Integrity protection mode info
10.3.3.19 | The UTRAN should not include this IE unless it is performing an SRNS relocation | |
| Ciphering mode info | OP | | Ciphering mode info
10.3.3.5 | The UTRAN should not include this IE unless it is performing an SRNS relocation and a change in ciphering algorithm | |
| New U-RNTI | OP | | U-RNTI
10.3.3.47 | | |
| New C-RNTI | OP | | C-RNTI
10.3.3.8 | | |
| New H-RNTI | OP | | H-RNTI
10.3.3.14a | | REL-7 |
| New Primary E-RNTI | OP | | E-RNTI
10.3.3.10a | | REL-8 |
| UE Timers and constants in connected mode | OP | | UE Timers and constants in connected mode
10.3.3.43 | | |
| Dedicated priority information | OP | | Dedicated priority information | | REL-8 |

| Information Element/Group name | Need | Multi | Type and reference | Semantics description | Version |
|---|------|----------------------|--|---|---------|
| | | | 10.3.2.7 | | |
| CN Information Elements | | | | | |
| CN Information info | OP | | CN Information info full 10.3.1.3a | | |
| UTRAN Information Elements | | | | | |
| URA identity | OP | | URA identity 10.3.2.6 | | |
| RNC support for change of UE capability | OP | | Boolean | Should be included if the message is used to perform an SRNS relocation | REL-7 |
| RB Information elements | | | | | |
| Downlink counter synchronisation info | OP | | | | |
| >RB with PDCP information list | OP | 1 to <maxRBall RABs> | | | |
| >>RB with PDCP information | MP | | RB with PDCP information 10.3.4.22 | This IE is needed for each RB having PDCP in the case of lossless SRNS relocation | |
| | OP | | | | REL-5 |
| >>PDCP context relocation info | OP | | PDCP context relocation info 10.3.4.1a | This IE is needed for each RB having PDCP and performing PDCP context relocation | REL-5 |

10.2.63 UTRAN MOBILITY INFORMATION CONFIRM

This message is used to confirm the new UTRAN mobility information for the UE.

RLC-SAP: AM

Logical channel: DCCH

Direction: UE→UTRAN

| Information Element/Group name | Need | Multi | Type and reference | Semantics description | Version |
|---|------|-------|--|-----------------------|---------|
| Message Type | MP | | Message Type | | |
| UE information elements | | | | | |
| RRC transaction identifier | MP | | RRC transaction identifier 10.3.3.36 | | |
| Integrity check info | CH | | Integrity check info 10.3.3.16 | | |
| Uplink integrity protection activation info | OP | | Integrity protection activation info 10.3.3.17 | | |

| Information Element/Group name | Need | Multi | Type and reference | Semantics description | Version |
|--------------------------------------|------|-----------------------|------------------------------------|--|---------|
| Other Information Elements | | | | | REL-7 |
| Deferred measurement control reading | MD | | Enumerated (TRUE) | Indicates the UE has not read SIB11 and SIB12. Default value is FALSE | REL-7 |
| RB Information elements | | | | | |
| COUNT-C activation time | OP | | Activation time 10.3.3.1 | Used for radio bearers mapped on RLC-TM. Only applicable if the UE is moving to CELL_DCH state due to this procedure | |
| Uplink counter synchronisation info | OP | | | | |
| >RB with PDCP information list | OP | 1 to <maxRB allRBs> | | This IE is needed for each RB having PDCP in the case of lossless SRNS relocation | |
| >>RB with PDCP information | MP | | RB with PDCP information 10.3.4.22 | | |
| >START list | MP | 1 to <maxCN domains > | | START [40] values for all CN domains. | |
| >>CN domain identity | MP | | CN domain identity 10.3.1.1 | | |
| >>START | MP | | START 10.3.3.38 | START value to be used in this CN domain. | |

10.2.64 UTRAN MOBILITY INFORMATION FAILURE

This message is sent to indicate a failure to act on a received UTRAN MOBILITY INFORMATION message.

RLC-SAP: AM

Logical channel: DCCH

Direction: UE→UTRAN

| Information Element/Group name | Need | Multi | Type and reference | Semantics description |
|--------------------------------|------|-------|---|-----------------------|
| Message Type | MP | | Message Type | |
| UE information elements | | | | |
| RRC transaction identifier | MP | | RRC transaction identifier 10.3.3.36 | |
| Integrity check info | CH | | Integrity check info 10.3.3.16 | |
| Failure cause | MP | | Failure cause and error information 10.3.3.14 | |

10.3 Information element functional definitions

10.3.1 CN Information elements

10.3.1.1 CN domain identity

Identifies the type of core network domain.

| Information Element/Group name | Need | Multi | Type and reference | Semantics description |
|--------------------------------|------|-------|-----------------------------------|-----------------------|
| CN domain identity | MP | | Enumerated (CS domain, PS domain) | |

10.3.1.2 CN Domain System Information

| Information Element/Group name | Need | Multi | Type and reference | Semantics description |
|---|------|-------|---|-----------------------|
| CN domain identity | MP | | CN domain identity 10.3.1.1 | |
| CHOICE <i>CN Type</i> | MP | | | |
| >GSM-MAP | | | | |
| >>CN domain specific NAS system information | MP | | NAS system information (GSM-MAP) 10.3.1.9 | |
| >ANSI-41 | | | | |
| >>CN domain specific NAS system information | MP | | ANSI-41 NAS system information, 10.3.9.4 | |
| CN domain specific DRX cycle length coefficient | MP | | CN domain specific DRX cycle length coefficient, 10.3.3.6 | |

10.3.1.3 CN Information info

| Information Element/Group name | Need | Multi | Type and reference | Semantics description | Version |
|---|------|----------------------|--|-----------------------|---------|
| PLMN identity | OP | | PLMN identity
10.3.1.11 | | |
| CN common GSM-MAP NAS system information | OP | | NAS system information (GSM-MAP)
10.3.1.9 | | |
| CN domain related information | OP | 1 to <maxCNdo mains> | | | |
| >CN domain identity | MP | | CN domain identity
10.3.1.1 | | |
| >CN domain specific GSM-MAP NAS system info | MP | | NAS system information (GSM-MAP)
10.3.1.9 | | |
| Primary PLMN identity | OP | | PLMN identity
10.3.1.11 | | REL-6 |

10.3.1.3a CN Information info full

| Information Element/Group name | Need | Multi | Type and reference | Semantics description | Version |
|--|------|----------------------|--|-----------------------|---------|
| PLMN identity | OP | | PLMN identity
10.3.1.11 | | |
| CN common GSM-MAP NAS system information | OP | | NAS system information (GSM-MAP)
10.3.1.9 | | |
| CN domain related information | OP | 1 to <maxCNdo mains> | | | |
| >CN domain identity | MP | | CN domain identity
10.3.1.1 | | |
| >CN domain specific GSM-MAP NAS system info | MP | | NAS system information (GSM-MAP)
10.3.1.9 | | |
| >CN domain specific DRX cycle length coefficient | MP | | CN domain specific DRX cycle length coefficient,
10.3.3.6 | | |
| Primary PLMN identity | OP | | PLMN identity
10.3.1.11 | | REL-6 |

10.3.1.3b Domain Specific Access Restriction

| Information Element/Group name | Need | Multi | Type and reference | Semantics description | Version |
|--|------|---------|---------------------------------|--|---------|
| CHOICE <i>restriction status</i> | MP | | | | REL-6 |
| >no restriction | | | | (no data)
This means "no Access Class is barred" | REL-6 |
| >restriction | | | | | REL-6 |
| >>Domain Specific Access Class Barred List | MD | <MaxAC> | | The first instance of the parameter corresponds to Access Class 0, the second to Access Class 1 and so on up to Access Class 15. UE reads this IE of its access class stored in SIM.
The default value is the IE "Access Class Barred list" contained in the IE "Cell Access Restriction" of the System Information Block Type 3. | REL-6 |
| >>>Access Class Barred | MP | | Enumerated(barred, not barred) | | REL-6 |

10.3.1.3c Domain Specific Access Restriction Parameters

This IE specifies domain specific access class restriction parameters for CS and PS domain.

| Information Element/Group name | Need | Multi | Type and reference | Semantics description | Version |
|---------------------------------------|------|-------|--|---|---------|
| CS Domain Specific Access Restriction | MP | | Domain Specific Access Restriction 10.3.1.3b | This IE contains Domain Specific Access Restriction Parameters for CS domain. | REL-6 |
| PS Domain Specific Access Restriction | MP | | Domain Specific Access Restriction 10.3.1.3b | This IE contains Domain Specific Access Restriction Parameters for PS domain. | REL-6 |

10.3.1.4 IMEI

This IE contains an International Mobile Equipment Identity. Setting specified in [11].

| Information Element/Group name | Need | Multi | Type and reference | Semantics description |
|--------------------------------|------|-------|--------------------|--|
| IMEI | MP | 15 | | The first element contains the first IMEI digit, the second element the second IMEI digit and so on. |
| >IMEI digit | MP | | INTEGER(0..15) | |

10.3.1.5 IMSI (GSM-MAP)

This IE contains an International Mobile Subscriber Identity, used towards a GSM-MAP type of PLMN. Setting specified in [11].

| Information Element/Group name | Need | Multi | Type and reference | Semantics description |
|--------------------------------|------|---------|--------------------|---|
| IMSI | MP | 6 to 21 | | The first element contains the first IMSI digit, the second element the second IMSI digit and so on.
Although normally upto 15 digits are used for this IE, a bigger length is used to support future extension. |
| >IMSI digit | MP | | INTEGER(0..9) | |

10.3.1.6 Intra Domain NAS Node Selector

This IE carries information to be used to route the establishment of a signalling connection to a CN node within a CN domain.

| Information Element/Group name | Need | Multi | Type and reference | Semantics description |
|---|------|-------|--------------------|---|
| CHOICE <i>version</i> | MP | | | |
| >R99 | | | | This choice shall also be used by mobiles that are compliant to this version of the protocol |
| >>CHOICE <i>CN type</i> | MP | | | |
| >>>GSM-MAP | | | | |
| >>>>CHOICE <i>Routing basis</i> | MP | | | |
| >>>>>local (P)TMSI | | | | TMSI allocated in the current LA or PTMSI allocated in the current RA |
| >>>>>>Routing parameter | MP | | Bit string (10) | The TMSI/ PTMSI consists of 4 octets (32bits). This can be represented by a string of bits numbered from b0 to b31, with bit b0 being the least significant
The "Routing parameter" bit string consists of bits b14 through b23 of the TMSI/ PTMSI. The first/leftmost/most significant bit of the bit string contains bit b23 of the TMSI/PTMSI. |
| >>>>>>(P)TMSI of same PLMN, different (RA)LA; or, PTMSI mapped from a valid GUTI allocated by same PLMN | | | | TMSI allocated in another LA of this PLMN or PTMSI allocated in another RA this PLMN; or, PTMSI mapped from a valid GUTI [11] (GUTI allocated in same PLMN) |
| >>>>>>>Routing parameter | MP | | Bit string (10) | The TMSI/ PTMSI consists of 4 octets (32bits). This can be represented by a string of bits numbered from b0 to b31, with bit b0 being the least significant
The "Routing parameter" bit string consists of bits b14 through b23 of the TMSI/ PTMSI. The first/leftmost/most significant bit of the bit string contains bit b23 of the TMSI/ PTMSI. |

| Information Element/Group name | Need | Multi | Type and reference | Semantics description |
|--|------|-------|--------------------|--|
| >>>>>(P)TMSI of different PLMN; or, PTMSI mapped from a valid GUTI allocated by a different PLMN | | | | TMSI or a PTMSI allocated in another PLMN; or, PTMSI mapped from a valid GUTI [11] (GUTI allocated in another PLMN) |
| >>>>>Routing parameter | MP | | Bit string (10) | The TMSI/ PTMSI consists of 4 octets (32bits). This can be represented by a string of bits numbered from b0 to b31, with bit b0 being the least significant.
The "Routing parameter" bit string consists of bits b14 through b23 of the TMSI/ PTMSI. The first/leftmost/most significant bit of the bit string contains bit b23 of the TMSI/ PTMSI. |
| >>>>>IMSI(response to IMSI paging) | | | | NAS identity is IMSI |
| >>>>>Routing parameter | MP | | Bit string (10) | The "Routing parameter" bit string consists of DecimalToBinary [(IMSI div 10) mod 1000]. The first/leftmost bit of the bit string contains the most significant bit of the result. |
| >>>>>IMSI(cause UE initiated event) | | | | NAS identity is IMSI |
| >>>>>Routing parameter | MP | | Bit string (10) | The "Routing parameter" bit string consists of DecimalToBinary [(IMSI div 10) mod 1000]. The first/leftmost bit of the bit string contains the most significant bit of the result. |
| >>>>>IMEI | | | | NAS parameter is IMEI |
| >>>>>Routing parameter | MP | | Bit string (10) | The "Routing parameter" bit string consists of DecimalToBinary [(IMEI div 10) mod 1000]. The first/leftmost bit of the bit string contains the most significant bit of the result. |
| >>>>>Spare 1 | | | Bit string (10) | This choice shall not be used in this version |
| >>>>>Spare 2 | | | Bit string (10) | This choice shall not be used in this version |
| >>>ANSI-41 | | | Bit string (14) | All bits shall be set to 0 |
| >Later | | | Bit string(15) | This bit string shall not be sent by mobiles that are compliant to this version of the protocol. |

10.3.1.7 Location Area Identification

Identifies uniquely a location area for a GSM-MAP type of PLMN. Setting specified in [5].

| Information Element/Group name | Need | Multi | Type and reference | Semantics description |
|--------------------------------|------|-------|-------------------------|-----------------------------------|
| PLMN identity | MP | | PLMN identity 10.3.1.11 | |
| LAC | MP | | Bit string(16) | The first/leftmost bit of the bit |

| Information Element/Group name | Need | Multi | Type and reference | Semantics description |
|--------------------------------|------|-------|--------------------|---|
| | | | | string contains the most significant bit of the LAC.. |

10.3.1.7oa Location/Registration Parameters

| Information Element/Group name | Need | Multi | Type and reference | Semantics description | Version |
|--|------|-------|---------------------------------|--|---------|
| CHOICE <i>restriction status</i> | MP | | | | REL-8 |
| >no restriction | | | | (no data)
This means "no Access Class is barred" | REL-8 |
| >restriction | | | | | REL-8 |
| >>Location/Registration Access Class Barred List | MP | 15 | | The first ten instance of the parameter corresponds to Access Class 0 to 9, and eleventh to fifteenth instance of the parameter corresponds to Access Class 11 to 15, respectively. UE reads this IE of its access class stored in SIM (except for Access Class 10). | REL-8 |
| >>>Access Class Barred | MP | | Enumerated(barred, not barred) | | REL-8 |

10.3.1.7a Multiple PLMN List

This information element identifies the multiple Public Land Mobile Networks (for a GSM-MAP type of PLMN) of a cell in a shared network.

| Information Element/Group name | Need | Multi | Type and reference | Semantics description | Version |
|----------------------------------|------|--------|---|---|---------|
| MIB PLMN Identity | MP | | Boolean | The PLMN identity IE 10.3.1.11, broadcasted in the MIB, shall be included in the multiple PLMN list if and only if this IE is TRUE. | REL-6 |
| Multiple PLMNs | MP | 1 to 5 | | | REL-6 |
| >PLMN identity with Optional MCC | | | PLMN identity with Optional MCC
10.3.1.11a | | REL-6 |

10.3.1.8 NAS message

A non-access stratum message to be transferred transparently through UTRAN.

| Information Element/Group name | Need | Multi | Type and reference | Semantics description |
|--------------------------------|------|-------|--------------------|-----------------------|
| | | | | |

| | | | | |
|-------------|----|--|------------------------|---|
| NAS message | MP | | Octet string (1..4095) | The first octet contains octet 1 [17] of the NAS message, the second octet contains octet 2 of the NAS message and so on. |
|-------------|----|--|------------------------|---|

10.3.1.9 NAS system information (GSM-MAP)

This information element contains system information that belongs to the non-access stratum for a GSM-MAP type of PLMN. This information is transparent to RRC. It may contain either information specific to one CN domain (CS or PS) or information common for both CN domains.

| Information Element/Group name | Need | Multi | Type and reference | Semantics description |
|--------------------------------|------|-------|---------------------|--|
| GSM-MAP NAS system information | MP | | Octet string(1..8) | The first octet contains octet 1 [5] of the NAS system information element, the second octet contains octet 2 of the NAS system information element and so on. |

10.3.1.10 Paging record type identifier

| Information Element/Group name | Need | Multi | Type and reference | Semantics description |
|--------------------------------|------|-------|---|-----------------------|
| Paging record type identifier | MP | | Enumerated (IMSI (GSM-MAP), TMSI (GSM-MAP)/ P-TMSI, IMSI (DS-41), TMSI (DS-41)) | |

10.3.1.10a Paging Permission with Access Control Parameters

| Information Element/Group name | Need | Multi | Type and reference | Semantics description | Version |
|---|------|-------|--|-----------------------|---------|
| Paging Response Restriction Indication | MP | | Enumerated (All, CS, PS, None) | | REL-8 |
| Location/Registration Restriction Indicator | MP | | Enumerated (All, CS, PS) | | REL-8 |
| Location/Registration | MP | | Location /Registration Parameters 10.3.1.7oa | | REL-8 |

10.3.1.11 PLMN identity

This information element identifies a Public Land Mobile Network for a GSM-MAP type of PLMN. Setting of digits is defined in [11].

| Information Element/Group name | Need | Multi | Type and reference | Semantics description |
|--------------------------------|------|-------|--------------------|--|
| MCC | MP | 3 | | The first element contains the first MCC digit, the second element the second MCC digit and so on. |
| >MCC digit | MP | | INTEGER(0. | |

| Information Element/Group name | Need | Multi | Type and reference | Semantics description |
|--------------------------------|------|--------|--------------------|--|
| MNC | MP | 2 to 3 | | The first element contains the first MNC digit, the second element the second MNC digit and so on. |
| >MNC digit | MP | | INTEGER(0..9) | |

10.3.1.11a PLMN identity with Optional MCC

This information element is a PLMN identity in subclause 10.3.1.11 where MCC is optional. It is used in a shared network and inserted in the Multiple PLMN List in subclause 10.3.1.7a.

| Information Element/Group name | Need | Multi | Type and reference | Semantics description | Version |
|--------------------------------|------|--------|--------------------|--|---------|
| MCC | MD | 3 | | The first element contains the first MCC digit, the second element the second MCC digit and so on. | REL-6 |
| >MCC digit | MP | | Integer (0..9) | | REL-6 |
| MNC | MP | 2 to 3 | | The first element contains the first MNC digit, the second element the second MNC digit and so on. | REL-6 |
| >MNC digit | MP | | Integer (0..9) | | REL-6 |

10.3.1.12 PLMN Type

Identifies the type of Public Land Mobile Network (PLMN). This IE shall be used to control the interpretation of network dependent messages and information elements in the RRC protocol.

| Information Element/Group name | Need | Multi | Type and reference | Semantics description |
|--------------------------------|------|-------|--|----------------------------|
| PLMN Type | MP | | Enumerated (GSM-MAP, ANSI-41, GSM-MAP and ANSI-41) | One spare value is needed. |

10.3.1.13 P-TMSI (GSM-MAP)

This IE contains a Packet Temporary Mobile Subscriber Identity, used towards a GSM-MAP type of PLMN.

| Information Element/Group name | Need | Multi | Type and reference | Semantics description |
|--------------------------------|------|-------|--------------------|--|
| P-TMSI | MP | | Bit string (32) | Setting specified in [11]. The first/leftmost bit of the bit string contains the most significant bit of the P-TMSI. |

10.3.1.14 RAB identity

This information element uniquely identifies a radio access bearer within a CN domain.

| Information Element/Group name | Need | Multi | Type and reference | Semantics description |
|--|------|-------|--------------------|---|
| CHOICE <i>RAB identity type</i>
>RAB identity (GSM-MAP) | MP | | Bit string (8) | Formatted according to [5].
The first/leftmost bit of the bit string contains the most significant bit of the RAB identity.
In case of a radio bearer setup for an MBMS selected service, the RAB identity is set to the value reserved for "MBMS Broadcast mode", see [5]. |
| >RAB identity (ANSI-41) | | | Bit string (8) | The first/leftmost bit of the bit string contains the most significant bit of the RAB identity. |

| CHOICE <i>NAS binding info type</i> | Condition under which the given <i>RAB identity type</i> is chosen |
|-------------------------------------|--|
| RAB identity (GSM-MAP) | PLMN is of type GSM-MAP |
| RAB identity (ANSI-41) | PLMN is of type ANSI-41 |

10.3.1.15 Routing Area Code

Identifies a routing area within a location area for a GSM-MAP type of PLMN.

| Information Element/Group name | Need | Multi | Type and reference | Semantics description |
|--------------------------------|------|-------|--------------------|---|
| Routing Area Code | MP | | Bit string(8) | Setting specified in [11]. The first/leftmost bit of the bit string contains the most significant bit of the Routing Area Code. |

10.3.1.16 Routing Area Identification

Identifies uniquely a routing area for a GSM-MAP type of PLMN. Setting specified in [11].

| Information Element/Group name | Need | Multi | Type and reference | Semantics description |
|--------------------------------|------|-------|--|-----------------------|
| LAI | MP | | Location area identification
10.3.1.7 | |
| RAC | MP | | Routing area code
10.3.1.15 | |

10.3.1.17 TMSI (GSM-MAP)

This IE contains a Temporary Mobile Subscriber Identity, used towards a GSM-MAP type of PLMN.

| Information Element/Group name | Need | Multi | Type and reference | Semantics description |
|--------------------------------|------|-------|--------------------|--|
| TMSI (GSM-MAP) | MP | | Bit string (32) | Setting specified in [11]. The first/leftmost bit of the bit string contains the most significant bit of the TMSI. |

10.3.2 UTRAN mobility Information elements

10.3.2.1 Cell Access Restriction

Indicates the restrictions to cell access.

| Information Element/Group name | Need | Multi | Type and reference | Semantics description | Version |
|---|--------------------|-------|--|--|---------|
| Cell Barred | MP | | Enumerated(not barred, barred) | If the cell is operating in MBSFN mode as indicated in subclause 8.1.1.6.3 and the value in this IE is different from 'barred' the UE behaviour is unspecified. | |
| Intra-frequency cell re-selection indicator | CV- <i>Barred</i> | | Enumerated(not allowed, allowed) | | |
| T_{barred} | CV- <i>Barred</i> | | Integer (10,20,40,80,160,320,640,1280) | [4]
[s] | |
| Cell Reserved for operator use | MP | | Enumerated(reserved, not reserved) | | |
| Cell Reservation Extension | MP | | Enumerated(reserved, not reserved) | | |
| Cell Reserved for CSG | CV-CSG | | Enumerated(TR UE) | | REL-8 |
| Access Class Barred list | CV- <i>SIB3-MD</i> | maxAC | | Default is no access class barred is applied. The first instance of the parameter corresponds to Access Class 0, the second to Access Class 1 and so on up to Access Class 15. UE reads this IE of its access class stored in SIM. | |
| >Access Class Barred | MP | | Enumerated (barred, not barred) | | |

| Condition | Explanation |
|----------------|--|
| <i>Barred</i> | The IE is mandatory present if the IE "Cell Barred" has the value "Barred"; otherwise the element is not needed in the message. |
| <i>SIB3-MD</i> | The IE is mandatory and has a default value if the IE "Cell Access Restriction" is included in SIB 3. Otherwise the IE is not needed. |
| <i>CSG</i> | The IE is optional present if the cell is a CSG cell and the IE 'Cell Reservation Extension' has the value "reserved". Otherwise the IE is not needed. |

10.3.2.2 Cell identity

This information element identifies a cell unambiguously within a PLMN.

NOTE: This information element may carry any implementation dependent identity that unambiguously identifies a cell within a PLMN. For GAN to UTRAN HO the Cell id is encoded as required in [9].

| Information Element/Group name | Need | Multi | Type and reference | Semantics description |
|--------------------------------|------|-------|--------------------|-----------------------|
| Cell identity | MP | | bit string(28) | |

10.3.2.3 Cell selection and re-selection info for SIB3/4

| Information Element/Group name | Need | Multi | Type and reference | Semantics description | Version |
|--|------|--------------------|--------------------------------------|--|---------|
| Mapping Info | OP | | Mapping info
10.3.2.5 | This IE should not be sent. | |
| Cell selection and reselection quality measure | MP | | Enumerated (CPICH Ec/N0, CPICH RSCP) | Choice of measurement (CPICH Ec/N0 or CPICH RSCP) to use as quality measure Q for FDD cells.
This IE is also sent to the UE in SIB11/12.
Both occurrences of the IE should be set to the same value. | |
| CHOICE <i>mode</i> | MP | | | | |
| >FDD | | | | | |
| >>S _{intrasearch} | OP | | Integer (-32..20 by step of 2) | If a negative value is received the UE shall consider the value to be 0.
[4]
[dB] | |
| >>S _{intersearch} | OP | | Integer (-32..20 by step of 2) | If a negative value is received the UE shall consider the value to be 0.
[4]
[dB] | |
| >>S _{searchHCS} | OP | | Integer (-105..91 by step of 2) | If a negative value is received the UE shall consider the value to be 0.
[4]
[dB] | |
| >>>RAT List | OP | 1 to <maxOtherRAT> | | | |
| >>>RAT identifier | MP | | Enumerated (GSM, cdma2000) | | |
| >>>S _{search,RAT} | MP | | Integer (-32..20 by step of 2) | In case the value 20 is received the UE shall consider this IE as if it was absent according to [4]
If a negative value is received the UE shall consider the value to be 0.
[dB] | |
| >>>S _{HCS,RAT} | OP | | Integer (-105..91 by step of 2) | If a negative value is received the UE shall consider the value to be 0.
[4]
[dB] | |
| >>>S _{limit,SearchRAT} | MP | | Integer (- | If a negative value is | |

| Information Element/Group name | Need | Multi | Type and reference | Semantics description | Version |
|---------------------------------|------------------|---------------------|----------------------------------|---|---------|
| | | | 32..20 by step of 2) | received the UE shall consider the value to be 0.
[4]
[dB] | |
| >>Qqualmin | MP | | Integer (-24..0) | Ec/N0, [dB] | |
| >>Qrxlevmin | MP | | Integer (-115..-25 by step of 2) | RSCP, [dBm] | |
| >> Delta _{Qrxlevmin} | CV- <i>Delta</i> | | Integer(-4..-2 by step of 2) | If present, the actual value of Qrxlevmin = Qrxlevmin + Delta _{Qrxlevmin} | REL-5 |
| >>Qqualmin-offset | CV- <i>SIB3</i> | | Integer (1..16) | Ec/N0, [dB]
The default value is 0 | REL-7 |
| >>Qrxlevmin-offset | CV- <i>SIB3</i> | | Integer (2..16 by step of 2) | RSCP, [dB]
The default value is 0 | REL-7 |
| >TDD | | | | | |
| >>S _{intrasearch} | OP | | Integer (-105..91 by step of 2) | If a negative value is received the UE shall consider the value to be 0.
[4]
[dB] | |
| >>S _{intersearch} | OP | | Integer (-105..91 by step of 2) | If a negative value is received the UE shall consider the value to be 0.
[4]
[dB] | |
| >>S _{searchHCS} | OP | | Integer (-105..91 by step of 2) | If a negative value is received the UE shall consider the value to be 0.
[4]
[dB] | |
| >>RAT List | OP | 1 to <maxOtherRAT > | | | |
| >>>RAT identifier | MP | | Enumerated (GSM, cdma2000) | | |
| >>>S _{search,RAT} | MP | | Integer (-105..91 by step of 2) | In case the value 91 is received the UE shall consider this IE as if it was absent according to [4]
If a negative value is received the UE shall consider the value to be 0.
[dB] | |
| >>>S _{HCS,RAT} | OP | | Integer (-105..91 by step of 2) | If a negative value is received the UE shall consider the value to be 0.
[4]
[dB] | |
| >>>S _{limit,SearchRAT} | MP | | Integer (-105..91 by step of | If a negative value is received the UE shall consider the value to be | |

| Information Element/Group name | Need | Multi | Type and reference | Semantics description | Version |
|--------------------------------|--|-------|----------------------------------|---|---------|
| | | | 2) | 0.
[4]
[dB] | |
| >>Qrxlevmin | MP | | Integer (-115..-25 by step of 2) | RSCP, [dBm] | |
| >>Delta _{Qrxlevmin} | CV-
<i>Delta</i> | | Integer(-4..-2 by step of 2) | If present, the actual value of Qrxlevmin = Qrxlevmin + Delta _{Qrxlevmin} | REL-5 |
| >>Qrxlevmin-offset | CV-SIB3 | | Integer (2..16 by step of 2) | RSCP, [dB]
The default value is 0 | REL-7 |
| Qhyst1 _s | MP | | Integer (0..40 by step of 2) | [4]
[dB] | |
| Qhyst1 _{s,PCH} | CV-SIB4 | | Integer (0..40) | If present, it is used as Qhyst1 _s for UE in CELL_PCH or URA_PCH state [4]
[dB] | REL-5 |
| Qhyst1 _{s,FACH} | CV-SIB4 | | Integer (0..40) | If present, it is used as Qhyst1 _s for UE in CELL_FACH state [4]
[dB] | REL-5 |
| Qhyst2 _s | CV-
<i>FDD-
Quality-
Measure</i> | | Integer (0..40 by step of 2) | Default value is Qhyst1 _s [4]
[dB] | |
| Qhyst2 _{s,PCH} | CV-
SIB4-
<i>FDD-
Quality-
Measure</i> | | Integer (0..40) | If present, it is used as Qhyst2 _s for UE using CPICH Ec/No quality measure in CELL_PCH or URA_PCH state. Default value is Qhyst1 _{s,PCH} [4]
[dB] | REL-5 |
| Qhyst2 _{s,FACH} | CV-
SIB4-
<i>FDD-
Quality-
Measure</i> | | Integer (0..40) | If present, it is used as Qhyst2 _s for UE using CPICH Ec/No quality measure in CELL_FACH state. Default value is Qhyst1 _{s,FACH} [4]
[dB] | REL-5 |
| Treselection _s | MP | | Integer (0..31) | [s] | |
| Treselection _{s,PCH} | CV-SIB4 | | Integer (0..31) | If present, it is used as Treselection _s for UE in CELL_PCH or URA_PCH state [4]
[s] | REL-5 |
| Treselection _{s,FACH} | CV-SIB4 | | Real (0..6.2 by step of 0.2) | If present, it is used as Treselection _s for UE in CELL_FACH state [4]
[s] | REL-5 |

| Information Element/Group name | Need | Multi | Type and reference | Semantics description | Version |
|--|--------------------------|-------|---|--|---------|
| Speed dependent ScalingFactor for Treselection | OP | | Real (0..1 by step of 0.1) | This IE is used by the UE in high mobility state as scaling factor for Treselection _s or Treselection _{s,PCH} or Treselection _{s,FACH} [4]. | REL-5 |
| Inter-frequency ScalingFactor for Treselection | OP | | Real (1..4.75 by step of 0.25) | If present, it is used by the UE as scaling factor for Treselection _s or Treselection _{s,PCH} or Treselection _{s,FACH} for inter-frequency cell reselection evaluation [4]. | REL-5 |
| Inter-RAT ScalingFactor for Treselection | OP | | Real (1..4.75 by step of 0.25) | If present, it is used by the UE as scaling factor for Treselection _s or Treselection _{s,PCH} or Treselection _{s,FACH} for inter-RAT cell reselection evaluation [4]. | REL-5 |
| Non-HCS_T _{CRmax} | MD | | Enumerated (not used, 30, 60, 120, 180, 240) | [s]
Default value is "not used". | REL-5 |
| Non-HCS_N _{CR} | CV-UE speed detector _MD | | Integer (1..16) | Default value = 8 | REL-5 |
| Non-HCS_T _{CRmaxHyst} | CV-UE speed detector _MP | | Enumerated (not used, 10, 20, 30, 40, 50, 60, 70) | [s] | REL-5 |
| HCS Serving cell Information | OP | | HCS Serving cell information
10.3.7.12 | | |
| Maximum allowed UL TX power | MP | | Maximum allowed UL TX power
10.3.6.39 | [dBm]
UE_TXPWR_MAX_RACH in [4]. | |

| Condition | Explanation |
|---------------------------------------|---|
| <i>FDD-Quality-Measure</i> | The IE is not needed if the IE "Cell selection and reselection quality measure" has the value CPICH RSCP, otherwise the IE is mandatory and has a default value. |
| <i>Delta</i> | This IE is optional if the value of Qrxlevmin is below – 115dBm. It is not needed otherwise. |
| <i>SIB3</i> | This IE is mandatory default if the IE 'Cell selection and re-selection info for SIB3/4' is included in SIB type 3. It is not needed otherwise. |
| <i>SIB4</i> | This IE is optional if the IE 'Cell selection and re-selection info for SIB3/4' is included in SIB type 4. It is not needed otherwise. |
| <i>SIB4-FDD-Quality-Measure</i> | This IE is optional if the IE 'Cell selection and re-selection info for SIB3/4' is included in SIB type 4, and the IE "Cell selection and reselection quality measure" has the value CPICH Ec/N0. It is not needed otherwise. |
| <i>UE Speed detector_MD (non-HCS)</i> | This IE is not needed if non-HCS_TCRmax equals 'not used', else it is mandatory default. |
| <i>UE Speed detector_MP (non-HCS)</i> | This IE is not needed if non-HCS_TCRmax equals 'not used', else it is mandatory present. |

10.3.2.4 Cell selection and re-selection info for SIB11/12

| Information Element/Group name | Need | Multi | Type and reference | Semantics description | Version |
|-----------------------------------|------------------------|-------|---|--|---------|
| Qoffset1 _{s,n} | MD | | Integer(-50..50) | Default value is 0. [dB] | |
| Qoffset2 _{s,n} | CV-FDD-Quality-Measure | | Integer(-50..50) | Default value is 0. [dB] | |
| Maximum allowed UL TX power | MD | | Maximum allowed UL TX power 10.3.6.39 | According to UE_TXPWR_MAX_RACH in [4], [dBm]. If applied to FDD or TDD cells, the default is the Maximum allowed UL TX power for the serving cell. If applied to a GSM cell, the default is the UE maximum output power applicable for this GSM cell, according to the UE's radio access capability. | |
| HCS neighbouring cell information | OP | | HCS Neighbouring cell information 10.3.7.11 | | |
| CHOICE mode | MP | | | | |
| >FDD | | | | | |
| >>Qqualmin | CV-FDD-Serving-Cell | | Integer (-24..0) | Ec/N0, [dB]
Default value is Qqualmin for the serving cell | |
| >>Qrxlevmin | MD | | Integer (- | RSCP, [dBm] | |

| Information Element/Group name | Need | Multi | Type and reference | Semantics description | Version |
|--------------------------------|----------|-------|----------------------------------|--|---------|
| | | | 115..-25 by step of 2) | Default value is Qrxlevmin for the serving cell | |
| >>Delta _{Qrxlevmin} | CV-Delta | | Integer(-4..-2 by step of 2) | If present, the actual value of Qrxlevmin = Qrxlevmin + Delta _{Qrxlevmin} | REL-5 |
| >TDD | | | | | |
| >>Qrxlevmin | MD | | Integer (-115..-25 by step of 2) | RSCP, [dBm]
Default value is Qrxlevmin for the serving cell | |
| >> Delta _{Qrxlevmin} | CV-Delta | | Integer(-4..-2 by step of 2) | If present, the actual value of Qrxlevmin = Qrxlevmin + Delta _{Qrxlevmin} | REL-5 |
| >GSM | | | | | |
| >>Qrxlevmin | MD | | Integer (-115..-25 by step of 2) | GSM RSSI, [dBm]
Default value is Qrxlevmin for the serving cell | |

| Condition | Explanation |
|----------------------------|--|
| <i>FDD-Quality-Measure</i> | This IE is mandatory and has a default value for Intra/Inter Frequency Cells if the IE "Cell selection and reselection quality measure" has the value CPICH Ec/No. Otherwise the IE is absent. |
| <i>FDD-Serving-Cell</i> | This IE is mandatory and has a default value if the serving cell is an FDD cell. Otherwise the IE is mandatory present. |
| <i>Delta</i> | This IE is optional if Qrxlevmin is present and the value of Qrxlevmin is below -115dBm. It is not needed otherwise. |

10.3.2.5 Mapping Info

| Information Element/Group name | Need | Multi | Type and Reference | Semantics description | Version |
|----------------------------------|------|--------------------------|--|---|---|
| Mapping List | MP | 1 to <MaxRAT> | | | |
| >RAT | MP | | Enumerated (UTRA FDD, UTRA TDD 3.84 Mcps, UTRA TDD 1.28 Mcps, GSM, cdma2000) | | UTRA TDD 1.28 Mcps is included for REL-4. |
| >Mapping Function Parameter List | MP | 1 to <maxMeas Intervals> | | | |
| >>Function type | MP | | Enumerated (linear, function type 2, function type 3, function type 4) | Type of the function within the interval. | |
| >>Map_parameter_1 | MD | | Integer (0..99) | Parameter describing the mapping function between the quality | |

| Information Element/Group name | Need | Multi | Type and Reference | Semantics description | Version |
|--------------------------------|-------------------|-------|-----------------------|--|---|
| | | | | measurement and the representing quality value, see [4].
Default value is zero for the first interval or otherwise the value of Map_parameter_2 of the interval before. | |
| | | | Integer (0..127) | For 1.28 Mcps TDD, the parameter is used to indicate the uplink access location of the serving cell. | REL-7 |
| >>Map_parameter_2 | MP | | Integer (0..99) | Parameter describing the mapping function between the quality measurement and the representing quality value, see [4]. | |
| >>Upper_limit | CV- <i>MaxInt</i> | | Integer (1..MaxMeas) | Upper limit of interval for which the Map_parameter_1 and Map_parameter_2 are valid.
MaxMeas = 25 if RAT = UTRA FDD / CPICH Ec/N0,
MaxMeas = 91 if RAT = UTRA TDD 3.84 Mcps or if RAT = UTRA TDD 1.28 Mcps or if RAT = UTRA FDD/ CPICH RSCP,
MaxMeas = 63 if RAT = GSM. | UTRA TDD 1.28 Mcps is included for REL-4. |

| Condition | Explanation |
|---------------|---|
| <i>MaxInt</i> | This IE is mandatory present if Mapping Function Parameter List has not reached maxMeasIntervals and is not needed otherwise. |

10.3.2.6 URA identity

Gives the identity of the UTRAN Registration Area. It can be used to indicate to the UE which URA it shall use in case of overlapping URAs.

| Information Element/Group name | Need | Multi | Type and reference | Semantics description |
|--------------------------------|------|-------|--------------------|-----------------------|
| URA identity | MP | | bit string(16) | |

10.3.2.7 Dedicated priority Information

This IE indicates priority information for GERAN, UTRAN and E-UTRAN for reselections.

| Information Element/Group name | Need | Multi | Type and Reference | Semantics description | Version |
|------------------------------------|------|-------------------------|---------------------------------------|--|---------|
| CHOICE <i>Action</i> | MP | | | | REL-8 |
| >Clear dedicated priorities | | | NULL | | REL-8 |
| >Configure dedicated priorities | | | | | REL-8 |
| >>T322 | OP | | Integer (5, 10, 20, 30, 60, 120, 180) | Time in minutes for which the configured dedicated priorities are valid. When the timer expires the UE should revert to using the priorities signalled in system information. Absence of this IE means that the configured dedicated priorities are valid until the next update. One spare value needed. | REL-8 |
| >>Priority Level List | OP | 1 to <maxPrio> | | | REL-8 |
| >>>priority | OP | | Integer (0.. <maxPrio-1>) | Absence of this IE indicates that no priority is assigned to the indicated frequencies. 0 is the lowest priority and maxPrio-1 is the highest | REL-8 |
| >>>>CHOICE Radio Access Technology | MP | | | | REL-8 |
| >>>>>UTRA FDD | | | | | REL-8 |
| >>>>>Frequency List | MP | 1 to <maxNumFDDFreqs> | | | REL-8 |
| >>>>>>UARFCN | MP | | Integer(0 .. 16383) | UARFCN of the downlink carrier frequency [25.101] | REL-8 |
| >>>>>UTRA TDD | | | | | REL-8 |
| >>>>>Frequency List | MP | 1 to <maxNumTDDFreqs> | | | REL-8 |
| >>>>>>UARFCN | MP | | Integer(0 .. 16383) | UARFCN of the downlink carrier frequency [25.101] | REL-8 |
| >>>>>E-UTRA | | | | | REL-8 |
| >>>>>Frequency List | | 1 to <maxNumEUTRAFreqs> | | | REL-8 |
| >>>>>>EARFCN | MP | | Integer(0 .. 65535) | EARFCN of the downlink carrier frequency [36.101] | REL-8 |
| >>>>>GSM | | | | | REL-8 |
| >>>>>GSM cell group | MP | | GSM cell group 10.3.7.9a | | REL-8 |

| Information Element/Group name | Need | Multi | Type and Reference | Semantics description | Version |
|--------------------------------|------|-------|--------------------|---|---------|
| >>E-UTRA detection | MP | | Boolean | "TRUE" means that the UE may detect the presence of a E-UTRA cell and report to NAS | REL-8 |

NOTE: It is always ensured by the UTRAN that priorities for different Radio Access Technologies are always different (e.g. a GERAN group of cells cannot have the same priority as a UTRA or E-UTRA frequency).

10.3.2.8 CSG Identity

| Information Element/Group name | Need | Multi | Type and reference | Semantics description | Version |
|--------------------------------|------|-------|--------------------|-----------------------|---------|
| CSG Identity | MP | | Bit string(27) | As defined in [76] | REL-8 |

10.3.2.9 CSG PSC Split Information

| Information Element/Group name | Need | Multi | Type and reference | Semantics description | Version |
|--|--------------------------|-------|---|--|---------|
| Start PSC | MP | | Integer (0..504 by step of 8) | The value of this IE specifies the start PSC of the first PSC range (NOTE 1). | REL-8 |
| Number of PSCs | MP | | Enumerated (5, 10, 15, 20, 30, 40, 50, 64, 80, 120, 160, 256, alltheRest) | This IE specifies the number of PSCs reserved for CSG cells in each PSC range. 'alltheRest' indicates all values from Start PSC to 511. Three spare values are needed. | REL-8 |
| PSC Range 2 Offset | CV-
<i>alltheRest</i> | | Integer (8..504 by step of 8) | If this IE is included, the UE shall calculate the second PSC range (NOTE 2).
If this IE is not included, the UE shall consider the second PSC range to be not present. | REL-8 |
| NOTE 1: Let the IE "Start PSC" = s. and "Number of PSCs" = n. The complete set of (n) PSC values in range 1 is defined as: {s, ((s + 1) mod 512), ((s + 2) mod 512) ... ((s + n-1) mod 512)}. | | | | | |
| NOTE 2: Let the IEs "Start PSC" + "Number of PSCs" - 1 + "PSC Range 2 Offset" = s. and "Number of PSCs" = n. The complete set of (n) PSC values in range 2 is defined as: {(s mod 512), ((s + 1) mod 512), ((s + 2) mod 512) ... ((s + n-1) mod 512)}. | | | | | |

| Condition | Explanation |
|-------------------|--|
| <i>alltheRest</i> | This IE is optionally present if the value of IE 'Number of PSCs' is not set to 'alltheRest'. Otherwise, it is not needed. |

10.3.3 UE Information elements

10.3.3.1 Activation time

Activation Time defines the frame number/time at which the operation/changes caused by the related message shall take effect. Values between 0 and 255 indicate the absolute value of CFN (Connection Frame Number) of that frame number/time.

| Information Element/Group name | Need | Multi | Type and reference | Semantics description |
|--------------------------------|------|-------|--------------------|-----------------------|
| Activation time | MP | | Integer(0..255) | CFN [10] |

10.3.3.2 Capability Update Requirement

This IE indicates to the UE which specific capabilities to transfer to the network.

| Information Element/Group name | Need | Multi | Type and reference | Semantics description | Version |
|---|------|----------------------------|------------------------------------|--|-----------------------|
| UE radio access FDD capability update requirement | MP | | Boolean | TRUE indicates update required | |
| UE radio access 3.84 Mcps TDD capability update requirement | MP | | Boolean | TRUE indicates update required | Name changed in REL-4 |
| UE radio access 7.68 Mcps TDD capability update requirement | MP | | Boolean | TRUE indicates update required | REL-7 |
| UE radio access 1.28 Mcps TDD capability update requirement | MP | | Boolean | TRUE indicates update required | REL-4 |
| System specific capability update requirement list | OP | 1 to <maxSystemCapability> | | In this version, a maximum size of 4 of the list shall be applied and any items after the 4 th item in the list shall be ignored. | |
| >System specific capability update requirement | MP | | Enumerated (GSM, GERAN Iu, E-UTRA) | Five spare values needed. | REL-5
REL-8 |

Default value is:

"UE radio capability FDD update requirement" = FALSE

"UE radio capability 3.84 Mcps TDD update requirement" = FALSE

"UE radio capability 7.68 Mcps TDD update requirement" = FALSE

"UE radio capability 1.28 Mcps TDD update requirement" = FALSE

"System specific capability update requirement" not present.

10.3.3.3 Cell update cause

Indicates the cause for cell update.

| Information Element/Group name | Need | Multi | Type and reference | Semantics description | Version |
|--------------------------------|------|-------|--|----------------------------|---------|
| Cell update cause | MP | | Enumerated (cell reselection, periodical cell update, uplink data transmission, paging response, re-entered service area, radio link failure, RLC unrecoverable error, | One spare value is needed. | REL-6 |
| | | | MBMS reception, MBMS ptp RB request) | | |

10.3.3.4 Ciphering Algorithm

| Information Element/Group name | Need | Multi | Type and reference | Semantics description | Version |
|--------------------------------|------|-------|------------------------|-----------------------|---------|
| Ciphering algorithm | MP | | Enumerated (UEA0, UEA1 | | REL-7 |
| | | | , UEA2) | | |

10.3.3.5 Ciphering mode info

This information element contains the ciphering specific security mode control information.

| Information Element/Group name | Need | Multi | Type and reference | Semantics description |
|--|------|-------|------------------------------------|---|
| Ciphering mode command | MP | | Enumerated (start/restart) | |
| Ciphering algorithm | MP | | Ciphering algorithm 10.3.3.4 | |
| Ciphering activation time for DPCH | OP | | Activation time 10.3.3.1 | Used for radio bearers mapped on RLC-TM. Only applicable if the UE is already in CELL_DCH state |
| Radio bearer downlink ciphering activation time info | OP | | RB activation time info, 10.3.4.13 | Used for radio bearers mapped on RLC-AM or RLC-UM
The UTRAN should not include this IE in a message other than a SECURITY MODE COMMAND |

10.3.3.6 CN domain specific DRX cycle length coefficient

A coefficient in the formula to count the paging occasions to be used by a specific UE (specified in [4]).

| Information Element/Group name | Need | Multi | Type and reference | Semantics description |
|---|------|-------|--------------------|---|
| CN domain specific DRX cycle length coefficient | MP | | Integer(6...9) | Refers to 'k' in the formula as specified in [4], Discontinuous reception |

10.3.3.7 Void

10.3.3.7a Common E-RNTI info

NOTE: For 1.28 Mcps TDD only.

This IE defines the common E-RNTI used in enhanced CELL_FACH and Idle mode. Each instance in the IE "Common E-RNTI information" is related to an E-RUCCH which is defined in the PRACH system information in System Information Block 5. The first instance in IE "Common E-RNTI information" is related to the first instance of E-RUCCH in the PRACH system information in System Information Block 5 in the order of their appearances, the second instance in IE "Common E-RNTI information" is related to the second instance of E-RUCCH in the PRACH system information in System Information Block 5 and so on.

From each instance in the IE "Common E-RNTI information", we can compile a common E-RNTI list which is related to a certain E-RUCCH. For each E-RUCCH, there are a number of common E-RNTI groups related to it; up to 2 common E-RNTIs allocated in each group. The common E-RNTI list related to a certain E-RUCCH is derived in incremental manner with start code indicated by IE "Starting E-RNTI". The "Starting E-RNTI" corresponds to the first E-RNTI in the first group; if the "Number of E-RNTI per group" is bigger than one, then the second E-RNTI in the first group is derived by the first E-RNTI plus 1; the first E-RNTI in the second group is derived by the last of E-RNTI of the first group plus 1... the whole common E-RNTI list related to the E-RUCCH is compiled in this manner.

| Information Element/Group name | Need | Multi | Type and reference | Semantics description | Version |
|--------------------------------|------|------------------|------------------------------|--|---------|
| Common E-RNTI information | MP | 1 to <maxERUCCH> | | | REL-8 |
| >Starting E-RNTI | MP | | E-RNTI 10.3.3.10a | Indicates the starting code of E-RNTI related to a certain E-RUCCH. | REL-8 |
| >Number of group | MP | | Integer(1..maxERNTIgroup) | Indicates the number of common E-RNTI groups related to the E-RUCCH. | REL-8 |
| >Number of E-RNTI per group | MP | | Integer(1..maxERNTIperGroup) | Indicates the number of common E-RNTIs in the group. | REL-8 |

10.3.3.8 C-RNTI

The cell RNTI (C-RNTI) identifies a UE having a RRC connection within a cell.

| Information Element/Group name | Need | Multi | Type and reference | Semantics description |
|--------------------------------|------|-------|--------------------|-----------------------|
| C-RNTI | MP | | bit string(16) | |

10.3.3.9 Void

10.3.3.9a DSCH-RNTI

In TDD, the DSCH-RNTI identifies a UE in CELL_DCH or CELL_FACH using a DSCH or USCH within the cell.

| Information Element/Group name | Need | Multi | Type and reference | Semantics description |
|--------------------------------|------|-------|--------------------|-----------------------|
| DSCH-RNTI | MP | | bit string(16) | |

10.3.3.10 Void

10.3.3.10a E-RNTI

| Information Element/Group name | Need | Multi | Type and reference | Semantics description | Version |
|---------------------------------------|-------------|--------------|---------------------------|------------------------------|----------------|
| E-RNTI | MP | | bit string(16) | | REL-6 |

10.3.3.11 Establishment cause

Cause for an RRC connection establishment request.

| Information Element/Group name | Need | Multi | Type and reference | Semantics description |
|--------------------------------|------|-------|---|---------------------------------|
| Establishment cause | MP | | Enumerated(Originating Conversational Call, Originating Streaming Call, Originating Interactive Call, Originating Background Call, Originating Subscribed traffic Call, Terminating Conversational Call, Terminating Streaming Call, Terminating Interactive Call, Terminating Background Call, Emergency Call, Inter-RAT cell re-selection, Inter-RAT cell change order, Registration, Detach, Originating High Priority Signalling, Originating Low Priority Signalling, Call re-establishment, Terminating High Priority Signalling, Terminating Low Priority Signalling, Terminating – cause unknown, MBMS reception, MBMS ptp RB request) | Eleven spare values are needed. |

10.3.3.12 Expiration Time Factor

| Information Element/Group name | Need | Multi | Type and reference | Semantics description |
|--------------------------------|------|-------|---|-----------------------|
| Expiration Time Factor | MP | | Enumerated(2times, 4times, 8times, 16times, 32times, 64times, 128times, 256times) | |

10.3.3.13 Failure cause

Cause for failure to perform the requested procedure.

| Information Element/Group name | Need | Multi | Type and reference | Semantics description |
|--------------------------------|------|-------|--|-------------------------------|
| Failure cause | MP | | Enumerated (configuration unsupported, physical channel failure, incompatible simultaneous reconfiguration, protocol error, compressed mode runtime error, cell update occurred, invalid configuration, configuration incomplete, unsupported measurement, MBMS session already received correctly, lower priority MBMS service) | Five spare values are needed. |

10.3.3.14 Failure cause and error information

Cause for failure to perform the requested procedure.

| Information Element/Group name | Need | Multi | Type and reference | Semantics description |
|--------------------------------|------|-------|-------------------------|-----------------------|
| Failure cause | MP | | Failure cause 10.3.3.13 | |

| | | | | |
|----------------------------|-----------------------|--|---|--|
| Protocol error information | <i>CV-ProtErr</i> | | Protocol error information
10.3.8.12 | |
| Deleted TGPSI | <i>CV-CompModeErr</i> | | TGPSI
10.3.6.82 | |

| Condition | Explanation |
|--------------------|---|
| <i>ProtErr</i> | The IE is mandatory present if the IE "Failure cause" has the value "Protocol error"; otherwise it is not needed in the message. |
| <i>CompModeErr</i> | The IE is mandatory present if the IE "Failure cause" has the value "Compressed mode runtime error"; otherwise it is not needed in the message. |

10.3.3.14o Group release information

Contains addressing information to perform a release of a group of RRC connections.

| Information Element/Group name | Need | Multi | Type and reference | Semantics description | Version |
|--------------------------------|------|-------|----------------------------|-----------------------|---------|
| U-RNTI group | MP | | U-RNTI group
10.3.3.47a | | REL-5 |

10.3.3.14a H-RNTI

The H-RNTI identifies an UE having a HS-PDSCH assignment within a cell.

| Information Element/Group name | Need | Multi | Type and reference | Semantics description | Version |
|--------------------------------|------|-------|--------------------|-----------------------|---------|
| H-RNTI | MP | | bit string(16) | | REL-5 |

10.3.3.15 Initial UE identity

This information element identifies the UE at a request of an RRC connection.

| Information Element/Group name | Need | Multi | Type and reference | Semantics description |
|--------------------------------|------|-------|--|-----------------------|
| CHOICE <i>UE id type</i> | MP | | | |
| >IMSI (GSM-MAP) | | | IMSI (GSM-MAP)
10.3.1.5 | |
| >TMSI and LAI (GSM-MAP) | | | | |
| >>TMSI (GSM-MAP) | MP | | TMSI (GSM-MAP)
10.3.1.17 | |
| >>LAI (GSM-MAP) | MP | | Location Area Identification
10.3.1.7 | |
| >P-TMSI and RAI (GSM-MAP) | | | | |
| >>P-TMSI (GSM-MAP) | MP | | P-TMSI (GSM-MAP)
10.3.1.13 | |
| >>RAI (GSM-MAP) | MP | | Routing Area Identification
10.3.1.16 | |
| >IMEI | | | IMEI
10.3.1.4 | |

| | | | | |
|-----------------------|----|--|-----------------------------------|---|
| >ESN (DS-41) | | | Bit string
(SIZE (32)) | TIA/EIA/IS-2000-4 |
| >IMSI (DS-41) | | | Octet string
(SIZE (5..7)) | TIA/EIA/IS-2000-4 |
| >IMSI and ESN (DS-41) | | | | TIA/EIA/IS-2000-4 |
| >>IMSI (DS-41) | MP | | Octet string
(SIZE (5..7)) | TIA/EIA/IS-2000-4 |
| >>ESN (DS-41) | MP | | Bit string
(SIZE (32)) | TIA/EIA/IS-2000-4 |
| >TMSI (DS-41) | | | Octet string
(SIZE
(2..17)) | TIA/EIA/IS-2000-4
Although normally upto 12
digits are used for this IE, a
bigger length is used to
support future extension. |

10.3.3.16 Integrity check info

The Integrity check info contains the RRC message sequence number needed in the calculation of XMAC-I [40] and the calculated MAC-I.

| Information Element/Group name | Need | Multi | Type and reference | Semantics description |
|--------------------------------|------|-------|--------------------|--|
| Message authentication code | MP | | bit string(32) | MAC-I [40]. The first/leftmost bit of the bit string contains the most significant bit of the MAC-I. The 27 MSB of the IE shall be set to zero and the 5 LSB of the IE shall be set to the value of the IE "RB identity" for the used signalling radio bearer when the encoded RRC message is used as the MESSAGE parameter in the integrity protection algorithm. |
| RRC Message sequence number | MP | | Integer
(0..15) | The local RRC hyper frame number (RRC HFN) is concatenated with the RRC message sequence number to form the input parameter COUNT-I for the integrity protection algorithm. The IE value shall be set to zero when the encoded RRC message is used as the MESSAGE parameter in the integrity protection algorithm. |

10.3.3.17 Integrity protection activation info

This IE contains the time, in terms of RRC sequence numbers, when a new integrity protection configuration shall be activated for the signalling radio bearers.

| Information Element/Group name | Need | Multi | Type and reference | Semantics description |
|----------------------------------|------|--------|--------------------|--|
| RRC message sequence number list | MP | 4 to 5 | | The RRC sequence number when a new integrity protection configuration shall be applied, for signalling radio bearers in the order RB0, RB1, RB2, RB3, RB4.

The value for RB1 shall be ignored if this IE was included in a RRC message sent on RB1.

The value for RB2 shall be ignored if this IE was included in a RRC message sent on RB2. |
| >RRC message sequence number | MP | | Integer (0..15) | |

10.3.3.18 Integrity protection Algorithm

| Information Element/Group name | Need | Multi | Type and reference | Semantics description | Version |
|--------------------------------|------|-------|-------------------------|-----------------------|---------|
| Integrity protection algorithm | MP | | Enumerated (UIA1, UIA2) | | REL-7 |

10.3.3.19 Integrity protection mode info

| Information Element/Group name | Need | Multi | Type and reference | Semantics description |
|---|------------------|-------|---|--|
| Integrity protection mode command | MP | | Enumerated (start, modify) | |
| Downlink integrity protection activation info | <i>CV-modify</i> | | Integrity protection activation info
10.3.3.17 | |
| Integrity protection algorithm | OP | | Integrity protection algorithm
10.3.3.18 | |
| Integrity protection initialisation number | <i>CV-start</i> | | Bit string(32) | FRESH [40]. The first/leftmost bit of the bit string contains the most significant bit of the FRESH. |

| Condition | Explanation |
|---------------|--|
| <i>Start</i> | The IE is mandatory present if the IE "Integrity protection mode command" has the value "start ", otherwise it is not needed in the message. |
| <i>Modify</i> | The IE is mandatory present if the IE "Integrity protection mode command" has the value "modify" and not needed otherwise. |

10.3.3.19a Void

10.3.3.20 Void

10.3.3.21 Measurement capability

| Information Element/Group name | Need | Multi | Type and reference | Semantics description | Version |
|--|------------------------------|-------|--------------------|--|-----------------------|
| Need for downlink compressed mode | | | | | |
| FDD measurements | MP | | Boolean | TRUE means that the UE requires DL compressed mode in order to perform measurements on FDD | |
| 3.84 Mcps TDD measurements | CV-
3.84_Mcps
_tdd_sup | | Boolean | TRUE means that the UE requires DL compressed mode in order to perform measurements on 3.84 Mcps TDD | Name changed in REL-4 |
| 7.68 Mcps TDD measurements | CV-
7.68_Mcps
_tdd_sup | | Boolean | TRUE means that the UE requires DL compressed mode in order to perform measurements on 7.68 Mcps TDD | REL-7 |
| 1.28 Mcps TDD measurements | CV-
1.28_Mcps
_tdd_sup | | Boolean | TRUE means that the UE requires DL compressed mode in order to perform measurements on 1.28 Mcps TDD | REL-4 |
| GSM measurements | CV-
gsm_sup | | | | |
| >GSM 900 | MP | | Boolean | TRUE means that the UE requires DL compressed mode in order to perform measurements on GSM 900 | |
| >DCS 1800 | MP | | Boolean | TRUE means that the UE requires DL compressed mode in order to perform measurements on DCS 1800 | |
| >GSM 1900 | MP | | Boolean | TRUE means that the UE requires DL compressed mode in order to perform measurements on GSM 1900 | |
| Multi-carrier measurement | CV-
mc_sup | | Boolean | TRUE means that the UE requires DL compressed mode in order to perform measurements on | |

| Information Element/Group name | Need | Multi | Type and reference | Semantics description | Version |
|---|---------------------------------|-------|--------------------|--|-----------------------|
| | | | | multi-carrier | |
| Adjacent Frequency measurements without compressed mode | CV-
<i>not_iRAT_HoInfo</i> | | Enumerated (TRUE) | TRUE means that the UE does not require compressed mode for adjacent frequency measurements. | REL-8 |
| Need for uplink compressed mode | | | | | |
| FDD measurements | MP | | Boolean | TRUE means that the UE requires UL compressed mode in order to perform measurements on FDD | |
| 3.84 Mcps TDD measurements | CV-
<i>3.84_Mcps_tdd_sup</i> | | Boolean | TRUE means that the UE requires UL compressed mode in order to perform measurements on 3.84 Mcps TDD | Name changed in REL-4 |
| 7.68 Mcps TDD measurements | CV-
<i>7.68_Mcps_tdd_sup</i> | | Boolean | TRUE means that the UE requires UL compressed mode in order to perform measurements on 7.68 Mcps TDD | REL-7 |
| 1.28 Mcps TDD measurements | CV-
<i>1.28_Mcps_tdd_sup</i> | | Boolean | TRUE means that the UE requires DL compressed mode in order to perform measurements on 1.28 Mcps TDD | REL-4 |
| GSM measurements | CV-
<i>gsm_sup</i> | | | | |
| >GSM 900 | MP | | Boolean | TRUE means that the UE requires UL compressed mode in order to perform measurements on GSM 900 | |
| >DCS 1800 | MP | | Boolean | TRUE means that the UE requires UL compressed mode in order to perform measurements on DCS 1800 | |
| >GSM 1900 | MP | | Boolean | TRUE means that the UE requires UL compressed mode in order to perform measurements on GSM 1900 | |
| Multi-carrier measurement | CV-
<i>mc_sup</i> | | Boolean | TRUE means that the UE requires UL compressed mode in order to perform | |

| Information Element/Group name | Need | Multi | Type and reference | Semantics description | Version |
|--------------------------------|------|-------|--------------------|-------------------------------|---------|
| | | | | measurements on multi-carrier | |

| Condition | Explanation |
|--------------------------|---|
| <i>3.84_Mcps_tdd_sup</i> | The IE is mandatory present if an IE "TDD RF capability" is present with the IE "Chip rate capability" set to "3.84 Mcps". Otherwise this field is not needed in the message. |
| <i>7.68_Mcps_tdd_sup</i> | The IE is mandatory present if an IE 'TDD RF capability' is present with the IE 'Chip rate capability' set to '7.68 Mcps'. Otherwise this field is not needed in the message. |
| <i>1.28_Mcps_tdd_sup</i> | The IE is mandatory present if an IE "TDD RF capability" is present with the IE "Chip rate capability" set to "1.28 Mcps". Otherwise this field is not needed in the message. |
| <i>gsm_sup</i> | The IE is mandatory present if the IE "Inter-RAT UE radio access capability" indicates support for GSM900, GSM1800 and/or GSM1900. Otherwise this field is not needed in the message. |
| <i>mc_sup</i> | The IE is mandatory present if the IE "Support of multi-carrier" has the value TRUE. Otherwise this field is not needed in the message. |
| <i>not_iRAT_HoInfo</i> | The IE is not needed in the INTER RAT HANDOVER INFO message. Otherwise, it is optionally present. |

10.3.3.21a Measurement capability extension

This IE may be used to replace the measurement capability information provided within IE "Measurement capability".

| Information Element/Group name | Need | Multi | Type and reference | Semantics description | Version |
|--------------------------------|------|-------------------------|--|---|---------|
| FDD measurements | MP | 1 to <maxFreqBands FDD> | | The network should ignore the entry that includes the "extension indicator". | |
| >FDD Frequency band | MD | | Enumerated(Band I, Band II, | The default value is the same as indicated in the IE "Frequency band" included in the IE " UE radio access capability extension". Band numbering is defined in [21]. | |
| | | | Band III, | | REL-5 |
| | | | Band VI, Band IV, Band V, Band VII, extension indicator) | The default value is the same as R99, if the IE 'FDD Frequency band 2' below is not included. The default value is the same as the IE 'FDD Frequency band 2', if the IE 'FDD Frequency band 2' is included. The setting of the value "extension indicator" by the UE is not specified in the specification. | REL-6 |

| Information Element/Group name | Need | Multi | Type and reference | Semantics description | Version |
|--------------------------------|--------------------|-------------------------|---|---|---------|
| >FDD Frequency band 2 | MD | | Enumerated(Band VIII, Band IX, Band X, Band XI, Band XII, Band XIII, Band XIV, extension Indicator) | The default value is the same as indicated in the IE "Frequency band 2" included in the IE "UE radio access capability extension"., if the IE 'FDD Frequency band' above is not included. The default value is the same as the IE 'FDD Frequency band', if the IE 'FDD Frequency band' is included.
The setting of the value "extension indicator" by the UE is not specified in the specification.
Eight spare values are needed | REL-6 |
| >Need for DL compressed mode | MP | | Boolean | TRUE means that the UE requires DL compressed mode in order to perform measurements on the FDD frequency band indicated by the IE "FDD Frequency band" | |
| >Need for UL compressed mode | MP | | Boolean | TRUE means that the UE requires UL compressed mode in order to perform measurements on the FDD frequency band indicated by the IE "FDD Frequency band" | |
| TDD measurements | CV- <i>tdd_sup</i> | 1 to <maxFreqBands TDD> | | | |
| >TDD Frequency band | MP | | Enumerated(a, b, c) | | REL-7 |
| | | | Enumerated(a, b, c, d) | | |
| >Need for DL compressed mode | MP | | Boolean | TRUE means that the UE requires DL compressed mode in order to perform measurements on TDD frequency band indicated by the IE "TDD Frequency band" | |
| >Need for UL compressed mode | MP | | Boolean | TRUE means that the UE requires UL compressed mode in order to perform measurements on TDD frequency band indicated by the IE "TDD Frequency band" | |
| GSM measurements | CV- <i>gsm_sup</i> | 1 to <maxFreqBands GSM> | | | |

| Information Element/Group name | Need | Multi | Type and reference | Semantics description | Version |
|---|-----------------------|---------------------------|--|---|---------|
| >GSM Frequency band | MP | | Enumerated(GSM450, GSM480, GSM850, GSM900P, GSM900E, GSM1800, GSM1900) | as defined in [45]. Nine spare values are needed. | |
| >Need for DL compressed mode | MP | | Boolean | TRUE means that the UE requires DL compressed mode in order to perform measurements on GSM frequency band indicated by the IE "GSM Frequency band" | |
| >Need for UL compressed mode | MP | | Boolean | TRUE means that the UE requires UL compressed mode in order to perform measurements on GSM frequency band indicated by the IE "GSM Frequency band" | |
| Multi-carrier measurement | CV- <i>mc_sup</i> | | | | |
| >Need for DL compressed mode | MP | | Boolean | TRUE means that the UE requires DL compressed mode in order to perform measurements on multi-carrier | |
| >Need for UL compressed mode | MP | | Boolean | TRUE means that the UE requires UL compressed mode in order to perform measurements on multi-carrier | |
| E-UTRA measurements | CV- <i>eutra_susp</i> | 1 to <maxFreqBands EUTRA> | | Note 1 | REL-8 |
| >E-UTRA Frequency band | MP | | Integer (1..64) | as defined in [36.101]. | REL-8 |
| >Need for compressed mode | MP | | Boolean | TRUE means that the UE requires DL and UL compressed mode in order to perform measurements on E-UTRA frequency band indicated by the IE "E-UTRA Frequency band" | REL-8 |
| Note 1: Indicates E-UTRA bands supported and the need for compressed mode, E-UTRAN measurement support may be separately indicated as specified in Annex E. | | | | | |

| Condition | Explanation |
|------------------|--|
| <i>tdd_sup</i> | The IE is mandatory present if the IE "Multi-mode capability" has the value "TDD" or "FDD/TDD". Otherwise this field is not needed in the message. |
| <i>gsm_sup</i> | The IE is mandatory present if the IE "Support of GSM" has the value TRUE. Otherwise this field is not needed in the message. |
| <i>mc_sup</i> | The IE is mandatory present if the IE "Support of multi-carrier" has the value TRUE. Otherwise this field is not needed in the message. |
| <i>eutra_sup</i> | At least one of these IEs is mandatory present if the IE "Support of E-UTRA" has the value TRUE. Otherwise these fields are not needed in the message. |

10.3.3.21b Measurement capability TDD

This IE is only used for TDD if the UE is a multi-RAT capable which also supports E-UTRA.

| Information Element/Group name | Need | Multi | Type and reference | Semantics description | Version |
|--------------------------------|-------------------------|---------------------------------|--------------------|---|---------|
| E-UTRA measurements | CV-
<i>eutra_sup</i> | 1 to
<maxFreqBands
EUTRA> | | | REL-8 |
| >E-UTRA Frequency band | MP | | Integer
(1..64) | as defined in [36.101]. | REL-8 |
| >Need for Idle Interval | MP | | Boolean | TRUE means that the UE requires idle interval in order to perform measurements on E-UTRA frequency band indicated by the IE "E-UTRA Frequency band" | REL-8 |

| Condition | Explanation |
|------------------|--|
| <i>eutra_sup</i> | At least one of these IEs is mandatory present if the IE "Support of E-UTRA" has the value TRUE. Otherwise these fields are not needed in the message. |

10.3.3.22 Paging cause

Cause for a CN originated page.

| Information Element/Group name | Need | Multi | Type and reference | Semantics description |
|--------------------------------|------|-------|--|----------------------------|
| Paging cause | MP | | Enumerated(Terminating Conversational Call, Terminating Streaming Call, Terminating Interactive Call, Terminating Background Call, Terminating High Priority Signalling, Terminating Low Priority Signalling, Terminating – cause unknown) | One spare value is needed. |

10.3.3.23 Paging record

| Information Element/Group name | Need | Multi | Type and reference | Semantics description | Version |
|--|------|-------|-----------------------------|--------------------------------|---------|
| CHOICE <i>Used paging identity</i> | MP | | | | |
| >CN identity | | | | | |
| >>Paging cause | MP | | Paging cause 10.3.3.22 | | |
| >>>CN domain identity | MP | | CN domain identity 10.3.1.1 | | |
| >>>CHOICE <i>UE Identity</i> | MP | | | Three spare values are needed. | |
| >>>>IMSI (GSM-MAP) | | | IMSI (GSM-MAP) 10.3.1.5 | | |
| >>>>TMSI (GSM-MAP) | | | TMSI (GSM-MAP) 10.3.1.17 | | |
| >>>>P-TMSI (GSM-MAP) | | | P-TMSI (GSM-MAP) 10.3.1.13 | | |
| >>>>IMSI (DS-41) | | | Octet string (SIZE (5..7)) | TIA/EIA/IS-2000-4 | |
| >>>>TMSI (DS-41) | | | Octet string (SIZE (2..17)) | TIA/EIA/IS-2000-4 | |
| >UTRAN single UE identity | | | | | |
| >>U-RNTI | MP | | U-RNTI 10.3.3.47 | | |
| >>>CN originated page to connected mode UE | OP | | | | |
| >>>>Paging cause | MP | | Paging cause 10.3.3.22 | | |

| Information Element/Group name | Need | Multi | Type and reference | Semantics description | Version |
|--------------------------------------|------|----------------------|--|-----------------------|---------|
| >>>CN domain identity | MP | | CN domain identity
10.3.1.1 | | |
| >>>Paging record type identifier | MP | | Paging record type identifier
10.3.1.10 | | |
| >>RRC connection release information | MP | | RRC connection release information
10.3.3.35o | | REL-5 |
| >UTRAN group identity | | 1 to <maxURNTIgroup> | | | REL-5 |
| >>RRC connection release information | MP | | RRC connection release information
10.3.3.35o | | REL-5 |
| >>Group release information | MP | | Group release information
10.3.3.14o | | REL-5 |

| Condition | Explanation |
|------------------------------------|---|
| CHOICE Used paging identity | Condition under which the given used paging identity is chosen |
| CN identity | For CN originating pages (for idle mode UEs) |
| UTRAN single UE identity | For UTRAN originating pages (for connected mode UEs), addressing a single UE |
| UTRAN group identity | For UTRAN originating pages (for connected mode UEs), addressing a group of UEs |

10.3.3.24 PDCP capability

Indicates which algorithms and which value range of their parameters are supported by the UE.

| Information Element/Group name | Need | Multi | Type and reference | Semantics description | Version |
|---|---------------------|-------|---|---|---------|
| Support for lossless SRNS relocation | MP | | Boolean | TRUE means supported | |
| Support for lossless DL RLC PDU size change | CV-not_iRAT_HoInfo2 | | Boolean | TRUE means supported Default value is FALSE | REL-5 |
| Support for RFC2507 | MP | | Boolean | TRUE means supported | |
| >Max HC context space | MP | | Integer(1024, 2048, 4096, 8192, 16384, 32768, 65536, 131072) | Note 1 | REL-5 |
| Support for RFC 3095 | CV-not_iRAT_HoInfo | | Boolean | TRUE means supported | REL-4 |
| >Maximum number of ROHC context sessions | MD | | Integer(2, 4, 8, 12, 16, 24, 32, 48, 64, 128, 256, 512, 1024, 16384) | Default value is 16. | REL-4 |
| >Reverse decompression depth | MD | | Integer | Default value is 0 | REL-4 |

| Information Element/Group name | Need | Multi | Type and reference | Semantics description | Version |
|--|--------------------------------|-------|--------------------|---|---------|
| | | | (0..65535) | (reverse decompression is not supported). | |
| >Support for RFC 3095 context relocation | MP | | Boolean | TRUE means supported | REL-5 |
| Support for CS Voice over HSPA | CV-
<i>not_iRAT_HoInfo3</i> | | Enumerated (TRUE) | The IE indicates the UE's support for CS Voice over HSPA, if set. | REL-8 |
| Note 1: The IE "Max HC context space" values 16384, 32768, 65536 and 131072 are not used in the INTER RAT HANDOVER INFO message. | | | | | |

| Condition | Explanation |
|-------------------------|---|
| <i>not_iRAT_HoInfo</i> | The IE is not needed in the INTER RAT HANDOVER INFO message. Otherwise, it is mandatory present. |
| <i>not_iRAT_HoInfo2</i> | The IE is not needed in the INTER RAT HANDOVER INFO message. Otherwise, it is mandatory default. |
| <i>not_iRAT_HoInfo3</i> | The IE is not needed in the INTER RAT HANDOVER INFO message. Otherwise, it is optionally present. |

10.3.3.25 Physical channel capability

| Information Element/Group name | Need | Multi | Type and Reference | Semantics description | Version |
|--------------------------------|------|-------|--------------------|-----------------------|---------|
|--------------------------------|------|-------|--------------------|-----------------------|---------|

| Information Element/Group name | Need | Multi | Type and Reference | Semantics description | Version |
|--|--|-------|---|--|---------|
| Downlink physical channel capability information elements | | | | | |
| FDD downlink physical channel capability | CH-
<i>fdd_req_su</i>
<i>p</i> | | | | |
| >Max no DPCH codes | MP | | Integer
(1..8) | Maximum number of DPCH codes to be simultaneously received | |
| >Max no physical channel bits received | MP | | Integer
(1200, 2400, 3600, 4800, 7200, 9600, 14400, 19200, 28800, 38400, 48000, 57600, 67200, 76800) | Maximum number of physical channel bits received in any 10 ms interval (DPCH, S-CCPCH) | |
| >Support for SF 512 and 80 ms TTI for DPCH | MP | | Boolean | TRUE means supported | |
| >CHOICE <i>Support of HS-PDSCH</i> | CV-
<i>not_iRAT_</i>
<i>HoInfo</i> | | | | REL-5 |
| >>Supported | | | | | REL-5 |
| >>>HS-DSCH physical layer category | MP | | Integer
(1..64) | As defined in [35]. Values 13..64 are spares. See Note 5. | REL-5 |
| >>>HS-DSCH physical layer category extension | OP | | Integer
(1..20) | As defined in [35]. See Note 6. | REL-7 |
| >>>HS-DSCH physical layer category extension 2 | OP | | Integer
(21..24) | As defined in [35]. See Note 12. Absence of this IE means that dual cell operation is not supported. | REL-8 |
| >>>HS-SCCHless HS-DSCH operation support | OP | | Enumerated
(TRUE) | The absence of this IE indicates that the UE does not support HS-SCCHless HS-DSCH operation. | REL-7 |
| >>>Enhanced F-DPCH support | OP | | Enumerated
(TRUE) | The absence of this IE indicates that the UE does not support enhanced F-DPCH | REL-7 |
| >>>HS-PDSCH in CELL_FACH | OP | | Enumerated
(TRUE) | The absence of this IE indicates that the UE does not support HS-PDSCH reception in CELL_FACH | REL-7 |
| >>>HS-PDSCH in CELL_PCH and URA_PCH | OP | | Enumerated
(TRUE) | The absence of this IE indicates that the UE does not support HS-PDSCH in neither CELL_PCH nor URA_PCH states. | REL-7 |
| >>>Target Cell Pre- | OP | | Enumerated | The absence of | REL-8 |

| Information Element/Group name | Need | Multi | Type and Reference | Semantics description | Version |
|--|---------------------------|-------|--------------------|---|-----------------------|
| Configuration | | | (TRUE) | this IE indicates that the UE does not support HS-SCCH reception in target cell | |
| >>>Support of HS-DSCH DRX operation | OP | | Enumerated (TRUE) | The absence of this IE indicates that the UE does not support HS-DSCH DRX operation | REL-8 |
| >>Unsupported | | | | (no data) | REL-5 |
| 3.84 Mcps TDD downlink physical channel capability | CH-3.84_Mcps_tdd_req_s_up | | | | Name changed in REL-4 |
| >Maximum number of timeslots per frame | MP | | Integer (1..14) | | |
| >Maximum number of physical channels per frame | MP | | Integer (1..224) | | |
| >Minimum SF | MP | | Integer (1, 16) | | |
| >Support of PDSCH | MP | | Boolean | TRUE means supported | |
| >CHOICE <i>Support of HS-PDSCH</i> | CV-not_iRAT_HoInfo | | | | REL-5 |
| >>Supported | | | | | REL-5 |
| >>>HS-DSCH physical layer category | MP | | Integer (1..64) | As defined in [35] | REL-5 |
| >>Unsupported | | | | (no data) | REL-5 |
| >Maximum number of physical channels per timeslot | MP | | Integer (5..16) | | |
| 7.68 Mcps TDD downlink physical channel capability | CH-7.68_Mcps_tdd_req_s_up | | | | REL-7 |
| >Maximum number of timeslots per frame | MP | | Integer (1..14) | | REL-7 |
| >Maximum number of physical channels per frame | MP | | Integer (1..448) | | REL-7 |
| >Minimum SF | MP | | Integer (1, 32) | | REL-7 |
| >Support of PDSCH | MP | | Boolean | TRUE means supported | REL-7 |
| >CHOICE <i>Support of HS-PDSCH</i> | CV-not_iRAT_HoInfo | | | | REL-7 |
| >>Supported | | | | | REL-7 |
| >>>HS-DSCH physical layer category | MP | | Integer (1..64) | As defined in [35] | REL-7 |
| >>Unsupported | | | | (no data) | REL-7 |
| >Maximum number of physical channels per timeslot | MP | | Integer (1..32) | | REL-7 |
| 1.28 Mcps TDD downlink physical channel capability | CH-1.28_Mcps_tdd_req_s_up | | | | REL-4 |
| >Maximum number of timeslots per subframe | MP | | Integer (1..6) | | REL-4 |
| >Maximum number of physical channels per subframe | MP | | Integer (1..96) | | REL-4 |
| >Minimum SF | MP | | Integer (1, 16) | | REL-4 |
| >Support of PDSCH | MP | | Boolean | TRUE means | REL-4 |

| Information Element/Group name | Need | Multi | Type and Reference | Semantics description | Version |
|--|--------------------|-------|--|--|---------|
| | | | | supported | |
| >CHOICE <i>Support of HS-PDSCH</i> | CV-not_iRAT_HoInfo | | | | REL-5 |
| >>Supported | | | | | REL-5 |
| >>>HS-DSCH physical layer category | MP | | Integer (1..64) | As defined in [35]. Values 16..64 are spares. See Note 8. | REL-5 |
| >>>HS-DSCH physical layer category extension | OP | | Integer (1..64) | As defined in [35]. See Note 6. | REL-8 |
| >>>Multi-carrier HS-DSCH physical layer category | OP | | Integer (1..64) | As defined in [35]. Absent if downlink multiple carrier is not supported. Values 19..64 are spares. See Note 10. | REL-7 |
| >>>Multi-carrier HS-DSCH physical layer category extension | OP | | Integer (1..36) | As defined in [35]. Absent if downlink multiple carrier is not supported. See Note 11. | REL-8 |
| >>>Support of SF Mode For HS-PDSCH dual stream | OP | | Enumerated (SF1, SF1/SF16) | For, 1.28 Mcps TDD only
The absence of this IE indicates that the UE does not support MIMO. | REL-8 |
| >>Unsupported | | | | (no data) | REL-5 |
| >Maximum number of physical channels per timeslot | MP | | Integer (1..16) | | REL-4 |
| >Support of 8PSK | MP | | Boolean | TRUE means supported | REL-4 |
| Uplink physical channel capability information elements | | | | | |
| FDD uplink physical channel capability | CH-fdd_req_supp | | | | |
| >Maximum number of DPDCH bits transmitted per 10 ms | MP | | Integer (600, 1200, 2400, 4800, 9600, 19200, 28800, 38400, 48000, 57600) | | |
| >CHOICE <i>Support of E-DCH</i> | CV-not_iRAT_HoInfo | | | | REL-6 |
| >>Supported | | | | | REL-6 |
| >>>E-DCH physical layer category | MP | | Integer (1..16) | As defined in [35] in Rel-6
Values 7 to 16 are spares. See Note 4. | REL-6 |
| >>>E-DCH physical layer category extension | OP | | Integer (7) | As defined in [35]. | REL-7 |
| >>>DPCCH Discontinuous Transmission support | OP | | Enumerated (TRUE) | The absence of this IE indicates that the UE does not support DPCCH Discontinuous | REL-7 |

| Information Element/Group name | Need | Multi | Type and Reference | Semantics description | Version |
|---|---------------------------|-------|--------------------------|--|-----------------------|
| | | | | Transmission | |
| >>>Slot Format #4 support | OP | | Enumerated (TRUE) | The absence of this IE indicates that the UE does not support Slot Format #4 | REL-7 |
| >>Unsupported | | | | (no data) | REL-6 |
| 3.84 Mcps TDD uplink physical channel capability | CH-3.84_Mcps_tdd_req_s up | | | | Name changed in REL-4 |
| >Maximum Number of timeslots per frame | MP | | Integer (1..14) | | |
| >Maximum number of physical channels per timeslot | MP | | Integer (1, 2) | | |
| >Minimum SF | MP | | Integer (1, 2, 4, 8) | | |
| >Support of PUSCH | MP | | Boolean | TRUE means supported | |
| >CHOICE Support of E-DCH | CV-not_iRAT_HoInfo | | | | REL-7 |
| >>Supported | | | | | REL-7 |
| >>>E-DCH physical layer category | MP | | Integer (1..16) | As defined in [35] | REL-7 |
| >>Unsupported | | | | (no data) | REL-7 |
| 7.68 Mcps TDD uplink physical channel capability | CH-7.68_Mcps_tdd_req_s up | | | | REL-7 |
| >Maximum Number of timeslots per frame | MP | | Integer (1..14) | | REL-7 |
| >Maximum number of physical channels per timeslot | MP | | Integer (1, 2) | | REL-7 |
| >Minimum SF | MP | | Integer (1, 2, 4, 8) | | REL-7 |
| >Support of PUSCH | MP | | Boolean | TRUE means supported | REL-7 |
| >CHOICE Support of E-DCH | CV-not_iRAT_HoInfo | | | | REL-7 |
| >>Supported | | | | | REL-7 |
| >>>E-DCH physical layer category | MP | | Integer (1..16) | As defined in [35] | REL-7 |
| >>Unsupported | | | | (no data) | REL-7 |
| 1.28 Mcps TDD uplink physical channel capability | CH-1.28_Mcps_tdd_req_s up | | | | REL-4 |
| >Maximum Number of timeslots per subframe | MP | | Integer (1..6) | | REL-4 |
| >Maximum number of physical channels per timeslot | MP | | Integer (1, 2, 3, 4) | | REL-4
REL-7 |
| >Minimum SF | MP | | Integer (1, 2, 4, 8, 16) | | REL-4 |
| >Support of PUSCH | MP | | Boolean | TRUE means supported | REL-4 |
| >Support of 8PSK | MP | | Boolean | TRUE means supported | REL-4 |
| >CHOICE Support of E-DCH | CV-not_iRAT_HoInfo | | | | REL-7 |
| >>Supported | | | | | REL-7 |

| Information Element/Group name | Need | Multi | Type and Reference | Semantics description | Version |
|--|------|-------|--------------------|-----------------------|---------|
| >>>E-DCH physical layer category | MP | | Integer (1..6) | As defined in [35] | REL-7 |
| >>Unsupported | | | | (no data) | REL-7 |
| NOTE 1: Void. | | | | | |
| NOTE 2: Void. | | | | | |
| NOTE 3: Void. | | | | | |
| NOTE 4: All UEs supporting E-DCH should signal a category between 1 and 6 for this IE even if the UE physical capability category is above 6. | | | | | |
| NOTE 5: All UEs supporting HS-DSCH should signal a category between 1 and 12 for this IE even if the UE physical capability category is above 12. This IE corresponds to the HS-DSCH category supported by the UE when MAC-ehs is not configured. | | | | | |
| NOTE 6: This IE corresponds to the HS-DSCH category supported by the UE when MAC-ehs is configured. | | | | | |
| NOTE 7: Void | | | | | |
| NOTE 8: All UEs supporting HS-DSCH should signal a category between 1 and 15 for this IE even if the UE physical capability category is above 15. This IE corresponds to the HS-DSCH category supported by the UE when MAC-ehs is not configured. | | | | | |
| NOTE 9: Void. | | | | | |
| NOTE 10: All UEs supporting multi-carrier HS-DSCH should signal a category between 1 and 18 for this IE even if the UE physical capability category is above 18. This IE corresponds to the multi-carrier HS-DSCH category supported by the UE when MAC-ehs is not configured. | | | | | |
| NOTE 11: This IE corresponds to the multi-carrier HS-DSCH category supported by the UE when MAC-ehs is configured. | | | | | |
| NOTE 12: This IE corresponds to the HS-DSCH category supported by the UE when dual cell operation is configured. | | | | | |

| Condition | Explanation |
|------------------------------|---|
| <i>3.84_Mcps_tdd_req_sup</i> | The IE is mandatory present if the IE "TDD RF capability" is present with the IE "Chip rate capability" set to "3.84 Mcps" and a 3.84 Mcps TDD capability update has been requested in a previous message. Otherwise this field is not needed in the message. |
| <i>7.68_Mcps_tdd_req_sup</i> | The IE is mandatory present if the IE "TDD RF capability" is present with the IE "Chip rate capability" set to "7.68 Mcps" and a 7.68 Mcps TDD capability update has been requested in a previous message. Otherwise this field is not needed in the message. |
| <i>1.28_Mcps_tdd_req_sup</i> | The IE is mandatory present if the IE "TDD RF capability" is present with the IE "Chip rate capability" set to "1.28 Mcps" and a 1.28 Mcps TDD capability update has been requested in a previous message. Otherwise this field is not needed in the message. |
| <i>fdd_req_sup</i> | The IE is mandatory present if the IE "Multi-mode capability" has the value "FDD" or "FDD/TDD" and a FDD capability update has been requested in a previous message. Otherwise this field is not needed in the message. |
| <i>not_iRAT_HoInfo</i> | The CHOICE <i>Support of HS-PDSCH</i> is not needed in the INTER RAT HANDOVER INFO message. Otherwise, it is mandatory present. |
| <i>not_iRAT_HoInfo</i> | The CHOICE <i>Support of E-DCH</i> is not needed in the INTER RAT HANDOVER INFO message. Otherwise, it is mandatory present. |

10.3.3.25a Pre-redirection info

| Information Element/Group name | Need | Multi | Type and Reference | Semantics description | Version |
|--------------------------------|------|-------|--------------------|-----------------------|---------|
| Support of E-UTRA FDD | MP | | Boolean | | REL-8 |
| Support of E-UTRA TDD | MP | | Boolean | | REL-8 |

10.3.3.26 Protocol error cause

This IE indicates the cause for a message or information that was not comprehended.

| Information Element/Group name | Need | Multi | Type and reference | Semantics description |
|--------------------------------|------|-------|---|------------------------------|
| Protocol error cause | MP | | Enumerated (ASN.1 violation or encoding error, Message type non-existent or not implemented, Message not compatible with receiver state, Information element value not comprehended, Information element missing, Message extension not comprehended) | Two spare values are needed. |

10.3.3.27 Protocol error indicator

This IE indicates whether a message was transmitted due to a protocol error or not.

| Information Element/Group name | Need | Multi | Type and Reference | Semantics description |
|--------------------------------|------|-------|--------------------|---|
| Protocol error indicator | MP | | Boolean | TRUE means a protocol error occurred. FALSE means a protocol error did not occur. |

10.3.3.28 RB timer indicator

This IE is used to indicate to UTRAN if the timers T314 or T315 has expired in the UE.

| Information Element/Group name | Need | Multi | Type and reference | Semantics description |
|--------------------------------|------|-------|--------------------|---|
| T314 expired | MP | | Boolean | TRUE means that the timer has expired or the stored value is zero.
FALSE means that the timer has not expired. |
| T315 expired | MP | | Boolean | TRUE means that the timer has expired or the stored value is zero.
FALSE means that the timer has not expired. |

10.3.3.29 Redirection info

This IE is used to redirect the UE to another frequency or other system. With the Release 6 version a list of cells may be provided to the UE, where cell selection shall be started.

| Information Element/Group name | Need | Multi | Type and reference | Semantics description | Version |
|---------------------------------------|------|-------|-----------------------------|-----------------------|---------|
| CHOICE <i>Redirection Information</i> | MP | | | | |
| >Frequency info | | | Frequency info
10.3.6.36 | | |
| >Inter-RAT info | | | Inter-RAT info
10.3.7.25 | | |

10.3.3.30 Re-establishment timer

This information element indicates which timer to associate with RAB.

| Information Element/Group name | Need | Multi | Type and reference | Semantics description |
|--------------------------------|------|-------|-------------------------------------|-----------------------|
| Re-establishment timer | MP | | Enumerated(
useT314,
useT315) | |

10.3.3.31 Rejection cause

Cause for rejection of RRC connection establishment request.

| Information Element/Group name | Need | Multi | Type and reference | Semantics description |
|--------------------------------|------|-------|--|-----------------------|
| Rejection cause | MP | | Enumerated(
congestion,
unspecified) | |

10.3.3.32 Release cause

Cause for release of RRC connection.

| Information Element/Group name | Need | Multi | Type and reference | Semantics description |
|--------------------------------|------|-------|--|----------------------------|
| Release cause | MP | | Enumerated
(normal event,
unspecified,
pre-emptive release,
congestion,
re-establishment reject,
directed signalling connection re-establishment, user inactivity) | One spare value is needed. |

10.3.3.32a RF Capability Compressed

| Information Element/Group name | Need | Multi | Type and reference | Semantics description | Version |
|--|------|----------------------------|--|--|---------|
| CHOICE <i>FDD</i> | MP | | | | REL-5 |
| >Supported | | | | | REL-5 |
| >>RF capability band FDD list Compressed | MP | 1..<maxf reqband sFDD> | | | REL-5 |
| | | 1..<maxf reqband sFDD-ext> | | | REL-6 |
| >>>RF Capability Band FDD Compressed | MP | | Enumerated (not supported, default TxRx separation) | TX/RX frequency separation capability for the supported frequency band(s). Default is the TX/RX frequency separation defined in [21] for each frequency band. Two spare values are needed. | REL-5 |
| >Not supported | | | NULL | | REL-5 |
| CHOICE <i>TDD-3.84Mcps</i> | MP | | | | REL-5 |
| >Supported | | | | | REL-5 |
| >>Radio Frequency Band TDD List | MP | | Enumerated (a, b, c, a+b, a+c, b+c, a+b+c) | As defined in [22]. One spare value needed | REL-5 |
| | | | Enumerated (a, b, c, d, a+b, a+c, a+d, b+c, b+d, c+d, a+b+c, a+b+d, a+c+d, b+c+d, a+b+c+d) | | REL-7 |
| >Not supported | | | NULL | | REL-5 |
| CHOICE <i>TDD-7.68Mcps</i> | MP | | | | REL-7 |
| >Supported | | | | | REL-7 |
| >>Radio Frequency Band TDD List | MP | | Enumerated (a, b, c, d, a+b, a+c, a+d, b+c, a+b+c, a+b+d, a+c+d, b+c+d, a+b+c+d) | As defined in [22]. One spare value needed | REL-7 |
| | | | Enumerated (a, b, c, d, a+b, a+c, a+d, b+c, b+d, c+d, a+b+c, a+b+d, a+c+d, b+c+d, a+b+c+d) | | REL-7 |
| >Not supported | | | NULL | | REL-7 |
| CHOICE <i>TDD-1.28Mcps</i> | MP | | | | REL-5 |
| >Supported | | | | | REL-5 |
| >>Radio Frequency Band TDD List | MP | | Enumerated (a, b, c, a+b, a+c, b+c, a+b+c) | As defined in [22]. One spare value needed | REL-5 |
| | | | Enumerated (a, b, c, d, a+b, a+c, a+d, b+c, b+d, c+d, a+b+c, a+b+d, a+c+d, b+c+d, a+b+c+d) | | REL-7 |
| >Not supported | | | NULL | | REL-5 |

10.3.3.33 RF capability FDD

| Information Element/Group name | Need | Multi | Type and Reference | Semantics description | Version |
|--------------------------------|------|-------|-------------------------------------|--|---------|
| UE power class | MP | | Enumerated(1..4) | As defined in [21] | |
| Tx/Rx frequency separation | MP | | Enumerated(default TxRx separation) | Default is the TX/RX frequency separation defined in [21] for each | |

| Information Element/Group name | Need | Multi | Type and Reference | Semantics description | Version |
|--------------------------------|------|-------|--------------------|---|---------|
| | | | | frequency band.
Two spare values are needed. | |

10.3.3.33a RF capability FDD extension

| Information Element/Group name | Need | Multi | Type and Reference | Semantics description |
|--------------------------------|------|-------|-------------------------------------|--|
| UE power class extension | MP | | Enumerated(1..4) | As defined in [21]. A UE with UE power class 3bis signals the value 3. Four spare values are needed |
| Tx/Rx frequency separation | MP | | Enumerated(default TxRx separation) | Default is the TX/RX frequency separation defined in [21] for each frequency band.
Two spare values are needed. |

10.3.3.33b RF capability TDD

| Information Element/Group name | Need | Multi | Type and Reference | Semantics description | Version |
|--------------------------------------|------|----------------------------|--|--|---------|
| UE power class | MP | | Enumerated (1..4) | as defined in [22] | |
| Radio frequency bands | MP | | Enumerated(a, b, c, a+b, a+c, b+c, a+b+c) | as defined in [22].
One spare value needed. | REL-7 |
| | | | Enumerated (a, b, c, d, a+b, a+c, a+d, b+c, b+d, c+d, a+b+c, a+b+d, a+c+d, b+c+d, a+b+c+d, | | |
| | | | Notabcd) | as defined in [22].
The value 'Notabcd' indicate that the UE does not support neither one of the bands a, b, c nor d. | REL-8 |
| Radio frequency bands extension list | OP | 1 to <maxFreqBandSTDD-ext> | | as defined in [22]. | REL-8 |
| >Radio frequency bands ext | MP | | Enumerated (e, f, g, h, i, j, k, l, m, n, o, p) | as defined in [22].
Band g to band p are reserved for future use. | REL-8 |
| Chip rate capability | MP | | Enumerated (3.84Mcps, 1.28Mcps, | as defined in [22] | |
| | | | 7.68 Mcps) | | |

10.3.3.33c RF capability TDD 1.28 Mcps

| Information Element/Group name | Need | Multi | Type and Reference | Semantics description | Version |
|--------------------------------|------|-------|--|--|---------|
| Radio frequency bands | MP | | Enumerated(a, b, c, a+b, a+c, b+c, a+b+c) | as defined in [22].
One spare value needed. | |
| | | | Enumerated (a, b, c, d, a+b, a+c, a+d, b+c, b+d, c+d, a+b+c, a+b+d, a+c+d, b+c+d, a+b+c+d) | | REL-7 |

10.3.3.34 RLC capability

| Information Element/Group name | Need | Multi | Type and Reference | Semantics description | Version |
|---|-------------------------------|-------|---|---|---------|
| Total RLC AM buffer size | MP | | Integer (10, 50, 100, 150, 500, 1000, 200, 300, 400, 750) | Total receiving and transmitting RLC AM buffer and MAC-hs reordering buffer capability in kBytes. Note 1. | REL-5 |
| | | | | | |
| Maximum RLC AM Window Size | MP | | Integer(20 47,4095) | Maximum supported RLC TX and RX window in UE | |
| Maximum number of AM entities | MP | | Integer (4,5,6,8,16,30) | | |
| Support for Two logical channel Configuration | CV-
<i>not_iRAT_HoInfo</i> | | Boolean | TRUE means supported | REL-7 |
| Note 1: The IE "Total RLC AM buffer size" values 200, 300, 400 and 750 are not used in the INTER RAT HANDOVER INFO message. | | | | | |

| Condition | Explanation |
|------------------------|--|
| <i>not_iRAT_HoInfo</i> | The IE is not needed in the INTER RAT HANDOVER INFO message. Otherwise, it is mandatory present. |

10.3.3.35 RLC re-establish indicator

This IE is used to re-configure AM RLC on c-plane and u-plane.

| Information Element/Group name | Need | Multi | Type and reference | Semantics description |
|--------------------------------|------|-------|--------------------|---|
| RLC re-establish indicator | MP | | Boolean | TRUE means re-establish required
FALSE means re-establish not required |

10.3.3.35o RRC connection release information

Indicates whether the UE shall perform a release of the RRC connection.

| Information Element/Group name | Need | Multi | Type and reference | Semantics description | Version |
|---------------------------------|------|-------|----------------------------|-------------------------------|---------|
| CHOICE <i>Release indicator</i> | MD | | | Default value is 'No release' | REL-5 |
| >No release | | | | | REL-5 |
| >Release | | | | | REL-5 |
| >>Release cause | MP | | Release cause
10.3.3.32 | | REL-5 |

10.3.3.35a RRC State Indicator

Indicates to a UE the RRC state to be entered.

| Information Element/Group name | Need | Multi | Type and reference | Semantics description |
|--------------------------------|------|-------|---|-----------------------|
| RRC State indicator | MP | | Enumerated(
CELL_DCH,
CELL_FACH
,
CELL_PCH,
URA_PCH) | |

10.3.3.36 RRC transaction identifier

This IE contains an identification of the RRC procedure transaction local for the type of the message this IE was included within.

| Information Element/Group name | Need | Multi | Type and reference | Semantics description | Version |
|--------------------------------|------|-------|--------------------|-----------------------|---------|
| CHOICE <i>RRC Tr Id type</i> | MP | | | | REL-5 |
| > <i>Normal</i> | | | | | |
| >>RRC transaction identifier | MP | | Integer
(0..3) | | |
| > <i>Extended</i> | | | | | REL-5 |
| >>RRC transaction identifier | MP | | Integer
(0..15) | | REL-5 |

| CHOICE <i>RRC Tr Id type</i> | Condition under which the given <i>RRC Tr Id type</i> is chosen |
|------------------------------|--|
| <i>Normal</i> | All cases where the <i>RRC Tr Id type: Extended</i> is not chosen. |
| <i>Extended</i> | Optional in the MEASUREMENT CONTROL message. Mandatory in the MEASUREMENT CONTROL FAILURE message. |

10.3.3.37 Security capability

| Information Element/Group name | Need | Multi | Type and reference | Semantics description | Version |
|---|------|-------|--------------------|--|---------|
| Ciphering algorithm capability | MP | | | | |
| >UEA0 | MP | | Boolean | | |
| >UEA1 | MP | | Boolean | | |
| >UEA2 | MP | | Boolean | The value TRUE means that UEA2 is fully interoperability tested.
If fully interoperability tested, also "Security capability indication" of "UE radio access capability compressed" shall be set to TRUE. | REL-7 |
| >Spare | MP | 13 | Boolean | Shall be set to FALSE by UEs complying with this version of the protocol. | |
| Integrity protection algorithm capability | MP | | | | |
| >UIA1 | MP | | Boolean | The value TRUE means that UIA1, Kasumi, is supported | |
| >UIA2 | MP | | Boolean | The value TRUE means that UIA2 is fully interoperability tested.
If fully interoperability tested, also "Security capability indication" of "UE radio access capability compressed" shall be set to TRUE. | REL-7 |
| >Spare | MP | 14 | Boolean | Shall be set to FALSE by UEs complying with this version of the protocol. | |

10.3.3.37a Signalling Connection Release Indication Cause

This IE is used to indicate to the UTRAN that there is no more PS data for a prolonged period.

| Information Element/Group name | Need | Multi | Type and Reference | Semantics description | Version |
|--|------|-------|--|-----------------------|---------|
| Signalling Connection Release Indication Cause | MP | | Enumerated (UE Requested PS Data session end, any other cause) | | REL-8 |

10.3.3.38 START

There is a START value per CN domain. The START is used to initialise the 20 MSBs of all hyper frame numbers (MAC-d HFN, RLC UM HFN, RLC AM HFN, RRC HFN) for a CN domain.

| Information Element/Group name | Need | Multi | Type and Reference | Semantics description |
|--------------------------------|------|-------|--------------------|--|
| START | MP | | Bit string (20) | START [40]. The first/leftmost bit of the bit string contains the most significant bit of the START. |

10.3.3.39 Void

10.3.3.40 Transport channel capability

| Information Element/Group name | Need | Multi | Type and Reference | Semantics description |
|---|-----------------------------|-------|--|---|
| Downlink transport channel capability information elements | | | | |
| Max no of bits received | MP | | Integer(640, 1280, 2560, 3840, 5120, 6400, 7680, 8960, 10240, 20480, 40960, 81920, 163840) | Maximum sum of number of bits of all transport blocks received at an arbitrary time instant |
| Max convolutionally coded bits received | MP | | Integer(640, 1280, 2560, 3840, 5120, 6400, 7680, 8960, 10240, 20480, 40960, 81920, 163840) | Maximum sum of number of bits of all convolutionally coded transport blocks received at an arbitrary time instant |
| Max turbo coded bits received | CV-
<i>turbo_dec_sup</i> | | Integer(640, 1280, 2560, 3840, 5120, 6400, 7680, 8960, 10240, 20480, 40960, 81920, 163840) | Maximum sum of number of bits of all turbo coded transport blocks received at an arbitrary time instant |
| Maximum number of simultaneous transport channels | MP | | Integer(4, 8, 16, 32) | |
| Maximum number of simultaneous CCTrCH | MP | | Integer (1..8) | |
| Max no of received transport blocks | MP | | Integer(4, 8, 16, 32, 48, 64, 96, 128, 256, 512) | Maximum total number of transport blocks received within TTIs that end at within the same 10ms interval |
| Maximum number of TFC | MP | | Integer(16, 32, 48, 64, 96, 128, 256, 512, 1024) | |
| Maximum number of TF | MP | | Integer(32, 64, 128, 256, 512, 1024) | |
| Support for turbo decoding | MP | | Boolean | TRUE means supported |
| Uplink transport channel capability information elements | | | | |
| Max no of bits transmitted | MP | | Integer(640, 1280, 2560, 3840, 5120, 6400, 7680, 8960, 10240, 20480, 40960, 81920, 163840) | Maximum sum of number of bits of all transport blocks transmitted at an arbitrary time instant |

| Information Element/Group name | Need | Multi | Type and Reference | Semantics description |
|---|-----------------------------|-------|--|--|
| Max convolutionally coded bits transmitted | MP | | Integer(640, 1280, 2560, 3840, 5120, 6400, 7680, 8960, 10240, 20480, 40960, 81920, 163840) | Maximum sum of number of bits of all convolutionally coded transport blocks transmitted at an arbitrary time instant |
| Max turbo coded bits transmitted | CV-
<i>turbo_enc_sup</i> | | Integer(640, 1280, 2560, 3840, 5120, 6400, 7680, 8960, 10240, 20480, 40960, 81920, 163840) | Maximum sum of number of bits of all turbo coded transport blocks transmitted at an arbitrary time instant |
| Maximum number of simultaneous transport channels | MP | | Integer(4, 8, 16, 32) | |
| Maximum number of simultaneous CCTrCH of DCH type | CH-
<i>tdd_req_sup</i> | | Integer (1..8) | |
| Max no of transmitted transport blocks | MP | | Integer(4, 8, 16, 32, 48, 64, 96, 128, 256, 512) | Maximum total number of transport blocks transmitted within TTIs that start at the same time |
| Maximum number of TFC | MP | | Integer(16, 32, 48, 64, 96, 128, 256, 512, 1024) | |
| Maximum number of TF | MP | | Integer(32, 64, 128, 256, 512, 1024) | |
| Support for turbo encoding | MP | | Boolean | TRUE means supported |

| Condition | Explanation |
|----------------------|---|
| <i>turbo_dec_sup</i> | The IE is mandatory present if the IE "Support of turbo decoding" = TRUE. Otherwise this field is not needed in the message. |
| <i>turbo_enc_sup</i> | The IE is mandatory present if the IE "Support of turbo encoding" = TRUE. Otherwise this field is not needed in the message. |
| <i>tdd_req_sup</i> | The IE is mandatory present if the IE "Multi-mode capability" has the value "TDD" or "FDD/TDD" and a TDD capability update has been requested in a previous message. Otherwise this field is not needed in the message. |

10.3.3.41 UE multi-mode/multi-RAT capability

| Information Element/Group name | Need | Multi | Type and Reference | Semantics description | Version |
|--|---------------------|-------|---|---|---------|
| Multi-RAT capability | | | | | |
| Support of GSM | MP | | Boolean | | |
| Support of multi-carrier | MP | | Boolean | | |
| Multi-mode capability | MP | | Enumerated (TDD, FDD, FDD/TDD) | | |
| Support of UTRAN to GERAN NACC | CV-not_iRAT_HoInFo | | Boolean | | REL-5 |
| Support of Handover to GAN | CV-not_iRAT_HoInFo2 | | Enumerated (DoesSupportHandoverToGAN) | Absence of this IE means that the UE does not support Handover to GAN. | REL-6 |
| Support of Inter-RAT PS handover | CV-not_iRAT_HoInFo2 | | Enumerated (DoesSupportInter-RAT-PS-Handover) | Absence of this IE means that the UE does not support Inter-RAT PS Handover to GERAN | REL-6 |
| Support of PS Handover to GAN | CV-not_iRAT_HoInFo2 | | Enumerated (DoesSupportPSHandoverToGAN) | Absence of this IE means that the UE does not support PS Handover to GAN. | REL-7 |
| Support of E-UTRA FDD | CV-not_iRAT_HoInFo2 | | Enumerated (DoesSupportEUTRAFDD) | Absence of this IE means that the UE does not support E-UTRA FDD | REL-8 |
| Support of Inter-RAT PS Handover to E-UTRA FDD | CV-not_iRAT_HoInFo2 | | Enumerated (DoesSupportInter-RAT-PS-HandoverToEUTRAFDD) | Absence of this IE means that the UE does not support Inter-RAT PS Handover to E-UTRA FDD | REL-8 |
| Support of E-UTRA TDD | CV-not_iRAT_HoInFo2 | | Enumerated (DoesSupportEUTRATDD) | Absence of this IE means that the UE does not support E-UTRA TDD | REL-8 |
| Support of Inter-RAT PS Handover to E-UTRA TDD | CV-not_iRAT_HoInFo2 | | Enumerated (DoesSupportInter-RAT-PS-HandoverToEUTRATDD) | Absence of this IE means that the UE does not support Inter-RAT PS Handover to E-UTRA TDD | REL-8 |
| EUTRA Feature Group Indicators | CV-not_iRAT_HoInFo2 | | Bit string (4) | The definitions of the bits are described in Annex E | REL-8 |

| Condition | Explanation |
|-------------------------|--|
| <i>not_iRAT_HoInfo</i> | The IE is not needed in the INTER RAT HANDOVER INFO message. Otherwise, it is mandatory present. |
| <i>not_iRAT_HoInfo2</i> | The IE is not needed in the INTER RAT HANDOVER INFO message. Otherwise, it is optional. |

NOTE: The UE sets the capability of Inter-RAT PS Handover (by means of the IE "Support of Inter-RAT PS handover") to the same value as the corresponding GERAN capability in [5].

10.3.3.42 UE radio access capability

| Information Element/Group name | Need | Multi | Type and reference | Semantics description | Version |
|---|---|--------|--|---|---------|
| Access stratum release indicator | MP | | Enumerated(R99) | Indicates the release of the UE according to [35]. The IE also indicates the release of the RRC transfer syntax supported by the UE.. | |
| | CV-
<i>not_rrc_connectionSetupComplete</i> | | Enumerated(REL-4, | 11 spare values are needed. | REL-4 |
| | | | REL-5, | | REL-5 |
| | | | REL-6, | | REL-6 |
| | | | REL-7, | | REL-7 |
| REL-8) | REL-8 | | | | |
| DL capability with simultaneous HS-DSCH configuration | CV-
<i>not_iRAT_HoInfo</i> | | Enumerated(32kbps, 64kbps, 128kbps, 384kbps) | | REL-5 |
| PDCP capability | MP | | PDCP capability 10.3.3.24 | | |
| RLC capability | MP | | RLC capability 10.3.3.34 | | |
| Transport channel capability | MP | | Transport channel capability 10.3.3.40 | | |
| RF capability FDD | OP | | RF capability FDD 10.3.3.33 | | |
| RF capability TDD | OP | | RF capability TDD 10.3.3.33b | One "TDD RF capability" entity shall be included for every Chip rate capability supported. | |
| | | 1 to 2 | | Note 1 | REL-4 |
| RF capability TDD 1.28 Mcps | CV-
<i>iRAT_HoInfo</i> | | RF capability TDD 1.28 Mcps 10.3.3.33c | Note 1 | REL-4 |
| Physical channel capability | MP | | Physical channel capability 10.3.3.25 | | |
| UE multi-mode/multi-RAT capability | MP | | UE multi-mode/multi-RAT | | |

| Information Element/Group name | Need | Multi | Type and reference | Semantics description | Version |
|---|------|-------|---|--|---------|
| | | | capability 10.3.3.41 | | |
| Security capability | MP | | Security capability 10.3.3.37 | | |
| UE positioning capability | MP | | UE positioning capability 10.3.3.45 | | |
| Measurement capability | OP | | Measurement capability 10.3.3.21 | | |
| Measurement capability TDD | OP | | Measurement capability TDD 10.3.3.21b | | REL-8 |
| Device type | MD | | Enumerated (DoesNotBenefitFromBatteryConsumptionOptimisation) | <p>Absence of this value means that the device does benefit from NW-based battery consumption optimisation.</p> <p>UE may set the value to DoesNotBenefitFromBatteryConsumptionOptimisation when it does not foresee to particularly benefit from NW-based</p> | REL-6 |
| Support for System Information Block type 11bis | OP | | Enumerated (TRUE) | | REL-6 |
| | | | | The IE shall be present and set to TRUE | REL-7 |

| Information Element/Group name | Need | Multi | Type and reference | Semantics description | Version |
|--|--------------------|-------|---|---|---------|
| Support for F-DPCH | OP | | Enumerated (TRUE) | The IE shall be set to TRUE when F-DPCH is fully supported by the UE.
Absence of this information element indicates that F-DPCH is not fully supported | REL-6 |
| MAC-ehs support | OP | | Enumerated (TRUE) | The presence of this IE indicates that UE supports MAC-ehs, the use of special value of HE field to indicate end of an SDU for RLC AM, octet aligned transport block table and different HS-SCCHs in contiguous TTIs.
The absence of this IE indicates that the UE does not support either MAC-ehs, octet aligned transport block table or the use of special value of HE field to indicate end of an SDU for RLC AM or different HS-SCCHs in contiguous TTIs. | REL-7 |
| UE specific capability Information LCR TDD | OP | | Enumerated (NF, TriRxUniTx, TriRxTriTx, HexRxUniTx, HexRxTriTx, HexRxHexTx) | For 1.28 Mcps TDD only
10 spare values needed. | REL-7 |
| Support for E-DPCCH Power Boosting | OP | | Enumerated (TRUE) | The absence of this IE indicates that the E-DPCCH Power Boosting is not supported. The presence of this IE indicates that the E-DPCCH Power Boosting is supported by the UE. | REL-7 |
| Support of common E-DCH | CV-not_iRAT_HoInfo | | Enumerated (TRUE) | The absence of this IE indicates that the UE does not support E-DCH enhanced random access in CELL_FACH state and Idle mode. | REL-8 |

| Information Element/Group name | Need | Multi | Type and reference | Semantics description | Version |
|---|-------------------------------------|-------|--------------------|---|---------|
| | | | | Note 2 | |
| Support of MAC-i/is | <i>CV-not_iRAT_HoInfo</i> | | Enumerated (TRUE) | The absence of this IE indicates that the UE does not support MAC-i/is operation. | REL-8 |
| Support of SPS operation | <i>CV-not_iRAT_HoInfo</i> | | Enumerated (TRUE) | For 1.28 Mcps TDD only.
The absence of this IE indicates that the UE does not support SPS operation. | REL-8 |
| Support of Control Channel DRX operation | <i>CV-not_iRAT_HoInfo</i> | | Enumerated (TRUE) | For 1.28 Mcps TDD only.
The absence of this IE indicates that the UE does not support Control Channel DRX operation | REL-8 |
| Support of CSG | <i>CV-not_iRAT_HoInfo</i> | | Enumerated (TRUE) | The absence of this IE indicates that the UE does not support access control based on CSG | REL-8 |
| Support for Two DRX schemes in URA_PCH and CELL_PCH | OP | | Enumerated (TRUE) | The absence of this IE indicates that the UE does not support Two DRX schemes in URA_PCH and CELL_PCH | REL-7 |
| Support for E-DPDCH power interpolation formula | OP | | Enumerated (TRUE) | The absence of this IE indicates that the UE does not support E-DPDCH power interpolation formula when 16QAM is not configured | REL-7 |
| Support for absolute priority based cell re-selection in UTRAN | OP | | Enumerated (TRUE) | The absence of this IE indicates that the UE does not support absolute priority based cell re-selection to UTRA inter-frequency | REL-8 |
| Support for cell-specific Tx diversity configuration for dual-cell operation | <i>CV-Dual_Cell_HSDPA_supported</i> | | Enumerated (TRUE) | The absence of this IE indicates that the UE does not support cell-specific Tx diversity configuration when configured for dual-cell operation. | REL-8 |
| Support of TX Diversity on DL Control Channels by MIMO Capable UE when MIMO operation is active | <i>CV-not_iRAT_HoInfo</i> | | Enumerated (TRUE) | The absence of this IE indicates that the MIMO capable UE does not support TX | REL-7 |

| Information Element/Group name | Need | Multi | Type and reference | Semantics description | Version |
|--------------------------------|--|-------|--------------------|---|---------|
| | | | | diversity on DL Control Channels (HS-SCCH, F-DPCH, E-AGCH, E-HICH, E-RGCH) when MIMO is active, P-CPICH is configured on antenna 1, and S-CPICH on antenna 2. | |
| Note 1: | The second entity of the "RF capability TDD" is not needed in the INTER RAT HANDOVER INFO message: if both TDD 3.84/7.68 Mcps and TDD 1.28 Mcps are supported, the "RF capability TDD 1.28 Mcps" entity shall be used for TDD 1.28 Mcps; the "UE power class" in the "RF capability TDD" entity shall apply for both chip rates. | | | | |
| Note 2: | For 1.28 Mcps TDD, UE supporting E-DCH enhanced random access in CELL_FACH state and Idle mode always supports HS-PDSCH reception in CELL_FACH, CELL_PCH and URA_PCH state and CELL_FACH HS-DSCH DRX operation. | | | | |

| Condition | Explanation |
|--|---|
| <i>not_rrc_connectionSetupComplete</i> | The IE is not needed in the RRC CONNECTION SETUP COMPLETE message. Otherwise the IE is mandatory present. |
| <i>not_iRAT_HoInfo</i> | The IE is not needed in the INTER RAT HANDOVER INFO message. Otherwise, it is optional. |
| <i>iRAT_HoInfo</i> | The IE is optional in the INTER RAT HANDOVER INFO message. Otherwise, the IE is not needed. |
| <i>Dual_Cell_HSDPA_supported</i> | This IE is optionally present if Dual-Cell HSDPA is supported. Otherwise it is not needed. |

10.3.3.42o UE radio access capability compressed

| Information Element/Group name | Need | Multi | Type and reference | Semantics description | Version |
|---|------|-------|-------------------------------------|--|---------|
| Access stratum release indicator | MP | | Enumerated(| 11 spare values are needed | REL-5 |
| | | | REL-4, | | REL-6 |
| | | | REL-5, | | REL-7 |
| | | | REL-6, | | REL-8 |
| Total AM RLC buffer size exceeds 10 kByte | MP | | BOOLEAN | | REL-5 |
| RF capability compressed | MP | | RF capability compressed 10.3.3.32a | | REL-5 |
| Support for System Information Block type 11bis | OP | | Enumerated (TRUE) | | REL-6 |
| | | | | The IE shall be present and set to TRUE | REL-7 |
| MAC-ehs support | OP | | Enumerated (TRUE) | The presence of this IE indicates that UE supports MAC-ehs, the use of special value of HE field to indicate end of an SDU for RLC AM, octet aligned transport block table and different HS-SCCHs in contiguous TTIs. Absent if either | REL-7 |

| Information Element/Group name | Need | Multi | Type and reference | Semantics description | Version |
|--------------------------------|------|-------|--------------------|--|---------|
| | | | | MAC-ehs, octet aligned transport block table or the use of special value of HE field to indicate end of an SDU for RLC AM or different HS-SCCHs in contiguous TTIs are not supported | |
| Security capability indication | OP | | Enumerated (TRUE) | TRUE indicates UE security capabilities beyond R99 requirements, see 10.3.3.37 | REL-7 |
| GANSS support indication | OP | | Enumerated (TRUE) | TRUE indicates that the UE supports GANSS | REL-7 |

10.3.3.42oa UE radio access capability comp 2

| Information Element/Group name | Need | Multi | Type and reference | Semantics description | Version |
|--|------|-------|-------------------------------|---|---------|
| FDD physical channel capability for HS-PDSCH/E-DCH | OP | | | Absent if HS-PDSCH and E-DCH are not supported | REL-6 |
| >DL capability with simultaneous HS-DSCH configuration | OP | | Enumerated (32, 64, 128, 384) | Unit: kbps. This IE is always required, but the need is set to OP to align with ASN.1 | REL-6 |
| >HS-DSCH physical layer category | MP | | Integer (1..64) | As defined in [35] Values 13..64 are spare. | REL-6 |
| >HS-DSCH physical layer category extension | OP | | Integer (1..20) | As defined in [35]. See Note 1. | REL-7 |
| >HS-DSCH physical layer category extension 2 | OP | | Integer (21..24) | As defined in [35]. See Note 2. | REL-8 |
| >CHOICE Support of E-DCH | MP | | | | REL-6 |
| >>Supported | | | | | REL-6 |
| >>>E-DCH physical layer category | MP | | Integer (1..16) | As defined in [35] | REL-6 |
| >>>>E-DCH physical layer category extension | OP | | Integer (7) | As defined in [35]. | REL-7 |
| >>Unsupported | | | | (no data) | REL-6 |

| Information Element/Group name | Need | Multi | Type and reference | Semantics description | Version |
|--|------|-------|--------------------|--|---------|
| Support for F-DPCH | OP | | Enumerated (TRUE) | | REL-6 |
| | | | | The IE shall be set to TRUE when F-DPCH is fully supported by the UE. Absence of this information element indicates that F-DPCH is not fully supported | REL-7 |
| HS-SCCHless HS-DSCH operation support | OP | | Enumerated (TRUE) | The absence of this IE indicates that the UE does not support HS-SCCHless HS-DSCH operation. | REL-7 |
| Enhanced F-DPCH support | OP | | Enumerated (TRUE) | The absence of this IE indicates that the UE does not support enhanced F-DPCH | REL-7 |
| HS-PDSCH in CELL_FACH | OP | | Enumerated (TRUE) | The absence of this IE indicates that the UE does not support HS-PDSCH reception in CELL_FACH | REL-7 |
| HS-PDSCH in CELL_PCH and URA_PCH | OP | | Enumerated (TRUE) | The absence of this IE indicates that the UE does not support HS-PDSCH in neither CELL_PCH nor URA_PCH states. | REL-7 |
| DPCCH Discontinuous Transmission support | OP | | Enumerated (TRUE) | The absence of this IE indicates that the UE does not support DPCCH Discontinuous Transmission | REL-7 |
| Slot Format #4 support | OP | | Enumerated (TRUE) | The absence of this IE indicates that the UE does not support Slot Format #4 | REL-7 |
| Support for CS Voice over HSPA | OP | | Enumerated (TRUE) | The IE indicates the UE's support for CS Voice over HSPA, if set. | REL-8 |
| Support for E-DPCCH Power Boosting | OP | | Enumerated (TRUE) | The absence of this IE indicates that the E-DPCCH Power Boosting is not supported. The presence of this IE indicates that the E-DPCCH Power Boosting is supported by the UE. | REL-7 |
| Support of MAC-i/is | OP | | Enumerated (TRUE) | The absence of this IE indicates that the UE does | REL-8 |

| Information Element/Group name | Need | Multi | Type and reference | Semantics description | Version |
|---|------|-------|--------------------|---|---------|
| | | | | not support MAC-i/is operation. | |
| Support of TX Diversity on DL Control Channels by MIMO Capable UE when MIMO operation is active | OP | | Enumerated (TRUE) | The absence of this IE indicates that the MIMO capable UE does not support TX diversity on DL Control Channels (HS-SCCH, F-DPCH, E-AGCH, E-HICH, E-RGCH) when MIMO is active, P-CPICH is configured on antenna 1, and S-CPICH on antenna 2. | REL-7 |

NOTE 1: This IE corresponds to the HS-DSCH category supported by the UE when MAC-ehs is configured.

NOTE 2: This IE corresponds to the HS-DSCH category supported by the UE when dual cell operation is configured.

10.3.3.42ob UE radio access capability comp for 1.28 Mcps TDD

| Information Element/Group name | Need | Multi | Type and reference | Semantics description | Version |
|--|------|-------|--------------------|--|---------|
| 1.28 Mcps TDD physical channel capability for HS-PDSCH/E-DCH | OP | | | Absent if HS-PDSCH and E-DCH are not supported | REL-8 |

| Information Element/Group name | Need | Multi | Type and reference | Semantics description | Version |
|---|------|----------------------------|---|--|---------|
| >Support of SF Mode For HS-PDSCH dual stream | OP | | Enumerated (SF1, SF1/SF16) | For 1.28 Mcps TDD only
The absence of this IE indicates that the UE does not support MIMO. | REL-8 |
| Support of common E-DCH | OP | | Enumerated (TRUE) | The absence of this IE indicates that the UE does not support E-DCH enhanced random access in CELL_FACH state and Idle mode. | REL-8 |
| Support of MAC-i/is | OP | | Enumerated (TRUE) | The absence of this IE indicates that the UE does not support MAC-i/is operation. | REL-8 |
| Support of Control Channel DRX operation | OP | | Enumerated (TRUE) | For 1.28 Mcps TDD only.
The absence of this IE indicates that the UE does not support Control Channel DRX operation | REL-8 |
| Support of SPS operation | OP | | Enumerated (TRUE) | For 1.28 Mcps TDD only.
The absence of this IE indicates that the UE does not support SPS operation. | REL-8 |
| Radio frequency bands extension list | OP | 1 to <maxFreqBandsTDD-ext> | | as defined in [22]. | REL-8 |
| >Radio frequency bands ext | MP | | Enumerated (e, f, g, h, i, j, k, l, m, n, o, p) | as defined in [22].
Band g to band p are reserved for future use. | REL-8 |
| NOTE 1: All UEs supporting HS-DSCH should signal a category between 1 and 15 for this IE even if the UE physical capability category is above 15. This IE corresponds to the HS-DSCH category supported by the UE when MAC-ehs is not configured. | | | | | |
| NOTE 2: This IE corresponds to the HS-DSCH category supported by the UE when MAC-ehs is configured. | | | | | |
| NOTE 3: All UEs supporting multi-carrier HS-DSCH should signal a category between 1 and 18 for this IE even if the UE physical capability category is above 18. This IE corresponds to the multi-carrier HS-DSCH category supported by the UE when MAC-ehs is not configured. | | | | | |
| NOTE 4: This IE corresponds to the multi-carrier HS-DSCH category supported by the UE when MAC-ehs is configured. | | | | | |

10.3.3.42a UE radio access capability extension

| Information Element/Group name | Need | Multi | Type and reference | Semantics description | Version |
|---|------|------------------------|--|--|---------|
| Frequency band specific capability list | MP | 1 to <maxFreqbandsFDD> | | The network should ignore the entry that includes the "extension indicator". | |
| >Frequency band | MP | | Enumerated (Band I, Band II, Band III, | | REL-5 |

| Information Element/Group name | Need | Multi | Type and reference | Semantics description | Version |
|-----------------------------------|------|-------|---|---|---------|
| | | | Band VI, Band IV, Band V, Band VII, extension indicator) | The setting of the value "extension indicator" by the UE is not specified in the specification. | REL-6 |
| >Frequency band 2 | OP | | Enumerated(Band VIII, Band IX, Band X, Band XI, Band XII, Band XIII, Band XIV, extension Indicator) | This IE indicates the supported frequency bands Band VIII and beyond. The setting of the value "extension indicator" by the UE is not specified in the specification. Eight spare values are needed | REL-6 |
| >RF capability FDD extension | MD | | RF capability FDD extension 10.3.3.33 a | the default values are the same values as in the immediately preceding IE "RF capability FDD extension"; the first occurrence is MP | |
| >Measurement capability extension | MP | | Measurement capability extension 10.3.3.21 a | | |

10.3.3.42b UE security information

Upon receiving a UE information request from another system, the UE shall indicate the requested security information. The UE security information includes the following RRC information.

| Information Element/Group name | Need | Multi | Type and reference | Semantics description |
|--------------------------------|------|-------|--------------------|--|
| UE information elements | | | | |
| START-CS | MP | | START 10.3.3.38 | START values to be used in this CN domain. |

10.3.3.42c UE security information2

Upon receiving a UE information request from another system, the UE shall indicate the requested security information. The UE security information includes the following RRC information.

| Information Element/Group name | Need | Multi | Type and reference | Semantics description | Version |
|--------------------------------|------|-------|--------------------|--|---------|
| START-PS | MP | | START 10.3.3.38 | START values to be used in this CN domain. | Rel-6 |

10.3.3.43 UE Timers and Constants in connected mode

This information element specifies timer- and constants values used by the UE in connected mode.

| Information Element/Group name | Need | Multi | Type and reference | Semantics description | Version |
|--------------------------------|------|-------|----------------------|---|---------|
| T301 | MD | | Integer(10 0, 200 .. | Value in milliseconds. Default value is 2000. | |

| Information Element/Group name | Need | Multi | Type and reference | Semantics description | Version |
|--------------------------------|------|-------|--|---|---------|
| | | | 2000 by step of 200, 3000, 4000, 6000, 8000) | This IE should not be used by the UE in this release of the protocol. One spare value is needed. | |
| N301 | MD | | Integer(0..7) | Default value is 2. This IE should not be used by the UE in this release of the protocol. | |
| T302 | MD | | Integer(100, 200... 2000 by step of 200, 3000, 4000, 6000, 8000) | Value in milliseconds. Default value is 4000. One spare value is needed. | |
| N302 | MD | | Integer(0..7) | Default value is 3. | |
| T304 | MD | | Integer(100, 200, 400, 1000, 2000) | Value in milliseconds. Default value is 2000. Three spare values are needed. | |
| N304 | MD | | Integer(0..7) | Default value is 2.. | |
| T305 | MD | | Integer(5, 10, 30, 60, 120, 360, 720, infinity) | Value in minutes. Default value is 30. Infinity means no update | |
| T307 | MD | | Integer(5, 10, 15, 20, 30, 40, 50) | Value in seconds. Default value is 30. One spare value is needed. | |
| T308 | MD | | Integer(40, 80, 160, 320) | Value in milliseconds. Default value is 160. | |
| T309 | MD | | Integer(1...8) | Value in seconds. Default value is 5. | |
| T310 | MD | | Integer(40.. 320 by step of 40) | Value in milliseconds. Default value is 160. | |
| N310 | MD | | Integer(0.. 7) | Default value is 4. | |
| T311 | MD | | Integer(250 .. 2000 by step of 250) | Value in milliseconds. Default value is 2000. | |
| T312 | MD | | Integer (0..15) | Value in seconds. Default value is 1. The value 0 is not used in this version of the specification. | |
| N312 | MD | | Integer (1, 2, 4, 10, 20, 50, 100, 200, 400, 600, 800, 1000) | Default value is 1. | |
| T313 | MD | | Integer | Value in seconds. | |

| Information Element/Group name | Need | Multi | Type and reference | Semantics description | Version |
|--------------------------------|------|-------|---|---|---------|
| | | | (0..15) | Default value is 3. | |
| N313 | MD | | Integer (1, 2, 4, 10, 20, 50, 100, 200) | Default value is 20. | |
| T314 | MD | | Integer(0, 2, 4, 6, 8, 12, 16, 20) | Value in seconds.
Default value is 12. | |
| T315 | MD | | Integer (0,10, 30, 60, 180, 600, 1200, 1800) | Value in seconds.
Default value is 180. | |
| N315 | MD | | Integer (1, 2, 4, 10, 20, 50, 100, 200, 400, 600, 800, 1000) | Default value is 1. | |
| T316 | MD | | Integer(0, 10, 20, 30, 40, 50, infinity) | Value in seconds.
Default value is 30.
One spare value is needed. | |
| T317 | MD | | | Default value is infinity. | |
| | | | Enumerated (infinity, infinity, infinity, infinity, infinity, infinity, infinity) | All the values are changed to "infinity" in the Rel-5. | REL-5 |
| T323 | OP | | Enumerated (0, 5, 10, 20, 30, 60, 90, 120) | Value in seconds.
The use of 0secs indicates no need to apply the inhibit timer.
See Note 1 | REL-8 |

NOTE 1: If T323 is configured or cleared via non-critical extensions of UTRAN MOBILITY INFORMATION message, UTRAN should explicitly signal the other timers and constants in the same message. Otherwise the T323 configuration change is not applied to UE.

10.3.3.44 UE Timers and Constants in idle mode

This information element specifies timer- and constant values used by the UE in idle mode.

| Information Element/Group name | Need | Multi | Type and reference | Semantics description |
|--------------------------------|------|-------|--|---|
| T300 | MP | | Integer(100, 200... 2000 by step of 200, 3000, 4000, 6000, 8000) | Value in milliseconds. Default value is 1000. Use of Default is described in 10.2.48.8.4 and in 10.2.48.8.16. |
| N300 | MP | | Integer(0..7) | Default value is 3. Use of Default is described in 10.2.48.8.4 and in |

| Information Element/Group name | Need | Multi | Type and reference | Semantics description |
|--------------------------------|------|-------|--|---|
| | | | | 10.2.48.8.16. |
| T312 | MP | | Integer(0 .. 15) | Value in seconds. Default value is 1. Use of Default is described in 10.2.48.8.4 and in 10.2.48.8.16. The value 0 is not used in this version of the specification. |
| N312 | MP | | Integer (1, 2, 4, 10, 20, 50, 100, 200, 400, 600, 800, 1000) | Default value is 1. Use of Default is described in 10.2.48.8.4 and in 10.2.48.8.16. |

10.3.3.45 UE positioning capability

| Information Element/Group name | Need | Multi | Type and reference | Semantics description | Version |
|---|---|--------------------|--|--|---------|
| Standalone location method(s) supported | MP | | Boolean | Defines if a UE can measure its location by some means unrelated to UTRAN
TRUE means supported | |
| UE based OTDOA supported | MP | | Boolean | TRUE means supported | |
| Network Assisted GPS support | MP | | Enumerated ('Network based', 'UE based', 'Both', 'None') | Defines if the UE supports network based or UE based GPS methods. | |
| Network Assisted GANSS support List | CV-
<i>not_iRA</i>
<i>T_Holnf</i>
<i>o</i> | 1 to
<maxGANSS> | | Absent if GANSS is not supported | REL-7 |
| >GANSS ID | OP | | Enumerated(| Absence of this IE means Galileo. Eight spare values needed. | REL-7 |
| | | | SBAS, Modernized_GPS, QZSS, GLONASS) | Absence of this IE means Galileo. Four spare values needed. | REL-8 |
| >SBAS IDs | CV-
GANSS-
ID-SBAS | | Bit String(8) | Defines the specific SBAS(s) supported. This is represented using a bit string with one bit per SBAS as defined in NOTE 1 where a one value indicates support and a zero value no support. | REL-8 |
| >GANSS mode | MP | | Enumerated ('Network based', 'UE based', 'Both', 'None') | Defines if the UE supports network based or UE based GANSS methods | REL-7 |
| >GANSS Signal ID | OP | | 10.3.3.45a | Absence of this field means the default value as defined in 10.3.3.45a for the GANSS identified by GANSS ID. | REL-7 |
| >GANSS Signal IDs | OP | | Bit String(8) | Defines if a UE has the capability to perform measurements on more than one GANSS signal and which signals are supported. This is represented using a bit string with one bit per signal as defined in NOTE 2 where a one value indicates support and a zero value no support. | REL-8 |
| >Support for GANSS | MP | | Boolean | Defines if a UE has the | REL-7 |

| | | | | | |
|---|------------------------|--|-------------------|--|-------|
| timing of cell frames measurement | | | | capability to perform the UE GANSS timing of cell frames measurement.
TRUE means capable | |
| >Support for GANSS Carrier-Phase Measurement | OP | | Boolean | Defines if a UE has the capability to perform the UE GANSS Carrier-Phase Measurement.
TRUE means capable | REL-7 |
| >Support for non-native assistance choices | OP | | Enumerated (TRUE) | Absence of this element means not supported and presence means the UE supports assistance data choices in formats not defined in the ICD of a particular GANSS. Multiple choices exist for assistance data elements defined in 10.3.7.89a, 10.3.7.94a/b, 10.3.7.97d. | REL-8 |
| GANSS support indication | CV- <i>iRAT_HoInfo</i> | | Enumerated (TRUE) | TRUE indicates that the UE supports GANSS | REL-7 |
| Support for GPS timing of cell frames measurement | MP | | Boolean | Defines if a UE has the capability to perform the UE GPS timing of cell frames measurement [7].
TRUE means capable | |
| Support for IPDL | MP | | Boolean | Defines if a UE has the capability to use IPDL to enhance its 'SFN-SFN observed time difference –type 2' measurement.
TRUE means supported | |
| Support for Rx-Tx time difference type2 measurement | MP | | Boolean | TRUE means supported | |
| Support for UP assisted GPS measurement validity in CELL_PCH and URA_PCH states | CV-GPSsupported | | Enumerated (TRUE) | | |
| Support for SFN-SFN observed time difference type 2 measurement | OP | | Enumerated (TRUE) | Absence of this element means not supported and presence means supported. | |

| Condition | Explanation |
|------------------------|---|
| <i>GPSsupported</i> | This IE is mandatory present if the IE 'Network Assisted GPS support' is set to 'Network based', 'UE based' or 'Both'. Otherwise, it is not needed. |
| <i>not_iRAT_HoInfo</i> | These IEs are not needed in the INTER RAT HANDOVER INFO message. Otherwise, they are optionally present. |
| <i>iRAT_HoInfo</i> | This IE is optionally present in the INTER RAT HANDOVER INFO message. Otherwise, the IE is not needed. |
| <i>GANSS-ID-SBAS</i> | This IE is mandatory present if the IE 'GANSS ID' is 'SBAS' and not needed otherwise. |

NOTE 1: Coding of SBAS IDs:

| SBAS IDs Bit String(8) | | | | | | | |
|------------------------|-------|-------|-------|-------|-------|-------|-------------|
| Bit 1 (MSB) | Bit 2 | Bit 3 | Bit 4 | Bit 5 | Bit 6 | Bit 7 | Bit 8 (LSB) |
| WAAS | EGNOS | MSAS | GAGAN | - | - | - | - |

NOTE 2: Coding of GANSS Signal IDs:

| GANSS | GANSS Signal IDs Bit String(8) | | | | | | | |
|----------------|--------------------------------|---------|---------|--------|---------|-------|-------|-------------|
| | Bit 1 (MSB) | Bit 2 | Bit 3 | Bit 4 | Bit 5 | Bit 6 | Bit 7 | Bit 8 (LSB) |
| Galileo | E1 | E5a | E5b | E6 | E5a+E5b | - | - | - |
| Modernized GPS | L1C | L2C | L5 | - | - | - | - | - |
| SBAS | L1 | - | - | - | - | - | - | - |
| QZSS | QZS-L1 | QZS-L1C | QZS-L2C | QZS-L5 | - | - | - | - |
| GLONASS | G1 | G2 | G3 | - | - | - | - | - |

10.3.3.45a GANSS Signal Id

The GANSS Signal ID encodes the identification of the signal for each GANSS. It depends on the GANSS Id.

| Information Element/Group name | Need | Multi | Type and reference | Semantics description | Version |
|-------------------------------------|------|-------|--------------------|-----------------------|---------|
| GANSS Signal Identity per Signal Id | MD | | INTEGER (0..7) | See NOTE 1 | REL-7 |

NOTE 1:

| GANSS Id | Value | Explanation | Version |
|------------------|---------------|-------------------|---------|
| Default: Galileo | Default Value | Galileo E1 | REL-7 |
| | 0 | Galileo E5A | |
| | 1 | Galileo E5B | |
| | 2 | Galileo E6 | |
| | 3 | Galileo E5A + E5B | |
| | 4-7 | Reserved | |
| Modernized GPS | Default Value | GPS L1C | REL-8 |
| | 0 | GPS L2C | |
| | 1 | GPS L5 | |
| | 2-7 | Reserved | |
| SBAS | Default Value | L1 | |
| | 0-7 | Reserved | |
| QZSS | Default Value | QZS-L1 | |
| | 0 | QZS-L1C | |
| | 1 | QZS-L2C | |
| | 2 | QZS-L5 | |
| | 3-7 | Reserved | |
| GLONASS | Default Value | GLONASS G1 | |
| | 0 | GLONASS G2 | |
| | 1 | GLONASS G3 | |
| | 2-7 | Reserved | |

10.3.3.46 URA update cause

Indicates the cause for s URA update.

| Information Element/Group name | Need | Multi | Type and reference | Semantics description |
|--------------------------------|------|-------|---|----------------------------|
| URA update cause | MP | | Enumerated(change of URA, periodic URA update) | One spare value is needed. |

10.3.3.47 U-RNTI

The U-RNTI (UTRAN Radio Network Temporary Identity) is allocated to a UE having a RRC connection and identifies the UE within UTRAN.

| Information Element/Group name | Need | Multi | Type and reference | Semantics description |
|--------------------------------|------|-------|--------------------|---|
| SRNC identity | MP | | bit string(12) | The SRNC ID unique in PLMN is encoded to SRNC identity IE in descending order from b31 . The b31 is the most significant bit. If the SRNC ID is more than 12 bits as defined in [57], the remaining bits are included as most significant bits of S-RNTI IE. |
| S-RNTI | MP | | bit string(20) | The UE ID unique in SRNS is encoded to the S-RNTI IE in descending order. If the SRNC ID is more than 12 bits as defined in [57], S-RNTI include both part of the SRNC ID and the UE-ID. The least significant bits encode the UE-ID to the S-RNTI IE in descending order. The b0 is the least significant bit. |

10.3.3.47a U-RNTI group

The U-RNTI group is used to identify a group of UEs having an RRC connection.

| Information Element/Group name | Need | Multi | Type and reference | Semantics description | Version |
|-----------------------------------|------|-------|---------------------------|---|---------|
| CHOICE <i>group discriminator</i> | MP | | | | REL-5 |
| >All | | | | (no data) | REL-5 |
| >U-RNTI mask | | | | | REL-5 |
| >>U-RNTI | MP | | U-RNTI 10.3.3.47 | The bits that are less significant than the bit position indicated by the U-RNTI bit mask index shall be ignored. | REL-5 |
| >>U-RNTI bit mask index | MP | | Enumerated(b1, b2,..b31) | Values b1 to b31 indicate bit positions in the S-RNTI and in the SRNC identity. | REL-5 |

10.3.3.48 U-RNTI Short

The U-RNTI (UTRAN Radio Network Temporary Identity) is allocated to a UE having a RRC connection and identifies the UE within UTRAN.

| Information Element/Group name | Need | Multi | Type and reference | Semantics description |
|--------------------------------|------|-------|--------------------|---|
| SRNC identity | MP | | bit string(12) | The SRNC identity bits are numbered b20 to b31, where b20 is the least significant bit. If the SRNC ID is more than 12 bits as defined in [57], the remaining bits are included as most significant bits of S-RNTI 2 IE. |
| S-RNTI 2 | MP | | bit string(10) | The UE ID is encoded in S-RNTI 2 in descending order. If the SRNC ID is more than 12 bits as defined in [57], S-RNTI include both part of the SRNC ID and the UE-ID. The least significant bits encode the UE-ID to the S-RNTI IE in descending order. The b0 is the least significant bit. |

10.3.3.49 UTRAN DRX cycle length coefficient

A coefficient in the formula to count the paging occasions to be used by a specific UE (specified in [4]).

| Information Element/Group name | Need | Multi | Type and reference | Semantics description | Version |
|--------------------------------|------|-------|--|---|---------|
| DRX cycle length coefficient | MP | | Integer(3..9) | Refers to 'k' in the formula as specified in [4], Discontinuous reception | |
| DRX cycle length coefficient 2 | MD | | Integer(3..9) | Refers to 'k' in the formula as specified in [4], Discontinuous reception. The default value is 'same as DRX cycle length coefficient'. | REL-7 |
| Time for DRX cycle 2 | MD | | Integer(80, 160, 320, 640, 1280, 2560, 5120) | Values in milliseconds. The default value is 0 ms. | REL-7 |

10.3.3.50 Wait time

Wait time defines the time period the UE has to wait before repeating the rejected procedure.

| Information Element/Group name | Need | Multi | Type and reference | Semantics description |
|--------------------------------|------|-------|--------------------|---|
| Wait time | MP | | Integer(0..15) | Wait time in seconds
The value 0 indicates that repetition is not allowed. |

10.3.3.51 UE Specific Behaviour Information 1 idle

This IE indicates the UE conformance typically for RRC connection establishment from idle mode.

| Information Element/Group name | Need | Multi | Type and Reference | Semantics description |
|--|------|-------|--------------------|-----------------------|
| UE Specific Behaviour Information 1 idle | MP | | bit string(4) | |

10.3.3.52 UE Specific Behaviour Information 1 interRAT

This IE indicates the UE conformance typically for RRC connection establishment from another RAT.

| Information Element/Group name | Need | Multi | Type and Reference | Semantics description |
|--|------|-------|--------------------|-----------------------|
| UE Specific Behaviour Information 1 interRAT | MP | | bit string(8) | |

10.3.4 Radio Bearer Information elements

10.3.4.0a Common RB mapping info

NOTE: For FDD and 1.28 Mcps TDD only.

A multiplexing option between a logical channel and a MAC-ehs queue.

| Information Element/Group name | Need | Multi | Type and reference | Semantics description | Version |
|--------------------------------|------|-------|-------------------------------|-----------------------|---------|
| Logical channel identity | MP | | Integer(1..15) | Note | REL-7 |
| MAC-ehs queue identity | MP | | MAC-ehs Queue Id
10.3.5.7f | | REL-7 |

NOTE: the IE "Logical channel identity" conveys the value to be used in the "LCH-ID" field of the MAC-ehs header [15] associated with the MAC-ehs reordering queue identified by the IE "MAC-ehs queue identity".

10.3.4.0 Default configuration identity

This information element identifies a default radio parameter configuration. The corresponding default configurations are specified in subclause 13.7.

| Information Element/Group name | Need | Multi | Type and reference | Semantics description | Version |
|--------------------------------|------|-------|--------------------|--|---------|
| Default configuration identity | MP | | Integer (0..10, | For TDD, default configurations 0, 1, 5, 6 and 7 are incorrect and they should not be used in this version of the specification. | |
| | | | 11, | | REL-4 |
| | | | 13, | Default configuration ID 2 is not used. | REL-5 |
| | | | 12, 14, 15, 16 | | REL-6 |
| | | | 17, | Used only in RRC Connection Setup message. | REL-6 |
| | | | 18..22, | For TDD, default configuration 22 is incorrect and it should not be used in this version of the specification. | REL-6 |
| | | | 23..31) | Reserved for future extension | REL-8 |

10.3.4.0a Default configuration for CELL_FACH

This section is not used in this version of the specifications.

10.3.4.1 Downlink RLC STATUS info

| Information Element/Group name | Need | Multi | Type and reference | Semantics description |
|--------------------------------|------|-------|--|--|
| Timer_Status_Prohibit | OP | | Integer(10..50 by step of 10, 550..1000 by step of 50) | Minimum time in ms between STATUS reports |
| Missing PDU Indicator | MP | | Boolean | Value TRUE indicates that UE should send a STATUS report for each missing PDU that is detected |
| Timer_STATUS_periodic | OP | | Integer(100, 200, 300, 400, 500, 750, 1000, 2000) | Time in milliseconds |

10.3.4.1a PDCP context relocation info

This information element indicates that the header compression context relocation is to be performed during SRNS relocation for the given radio bearer.

| Information Element/Group name | Need | Multi | Type and reference | Semantics description | Version |
|---|------|-------|-----------------------|---|---------|
| RB identity | MP | | RB identity 10.3.4.16 | | REL-5 |
| Downlink RFC 3095 context relocation indication | MP | | Boolean | TRUE means RFC 3095 context relocation is performed in downlink | REL-5 |
| Uplink RFC 3095 context relocation indication | MP | | Boolean | TRUE means RFC 3095 context relocation is performed in uplink | REL-5 |

10.3.4.2 PDCP info

The purpose of the PDCP info IE is to indicate which algorithms shall be established and to configure the parameters of each of the algorithms.

| Information Element/Group name | Need | Multi | Type and reference | Semantics description | Version |
|---|-----------------------------|------------------------|------------------------------|---|---------|
| Support for lossless SRNS relocation or for lossless DL RLC PDU size change | CV- <i>LosslessCriteria</i> | | Boolean | TRUE means support | |
| Max PDCP SN window size | CV- <i>Lossless</i> | | Enumerated(sn255, sn65535) | Maximum PDCP sequence number window size. The handling of sequence number when the Max PDCP SN window size is 255 is specified in [23]. | |
| PDCP PDU header | MP | | Enumerated (present, absent) | Whether a PDCP PDU header is existent or not. | |
| Header compression information | OP | 1 to <maxPDCPAlgoType> | | | |
| >CHOICE <i>algorithm type</i> | MP | | | Note 1 | |
| >>RFC 2507 | | | | Header compression according to IETF standard RFC 2507 | |
| >>>F_MAX_PERIOD | MD | | Integer (1..65535) | Largest number of compressed non-TCP headers that may be sent without sending a full header. Default value is 256. | |
| >>>F_MAX_TIME | MD | | Integer (1..255) | Compressed headers may not be sent more than F_MAX_TIME seconds after sending last full header. Default value is 5. | |
| >>>MAX_HEADER | MD | | Integer (60..65535) | The largest header size in octets that may be | |

| Information Element/Group name | Need | Multi | Type and reference | Semantics description | Version |
|---------------------------------|------|--------------------------|---|--|---------|
| | | | | compressed.
Default value is 168. | |
| >>>TCP_SPACE | MD | | Integer (3..255) | Maximum CID value for TCP connections.
Default value is 15. | |
| >>>NON_TCP_SPACE | MD | | Integer (3..65535) | Maximum CID value for non-TCP connections.
Default value is 15. | |
| >>>EXPECT_REORDERING | MD | | Enumerated (reordering not expected, reordering expected) | Whether the algorithm shall reorder PDCP SDUs or not.
Default value is "reordering not expected". | |
| >>RFC 3095 | | | | Header compression according to IETF standard RFC 3095 | REL-4 |
| >>>Profiles | MP | 1 to <maxRO HC-Profiles> | | Profiles supported by both compressor and decompressor in both UE and UTRAN. Profile 0 shall always be supported. | REL-4 |
| >>>>Profile instance | MP | | Integer(1.. 3) | 1 = 0x0001, 2 = 0x0002, 3 = 0x0003 (see [52]) | REL-4 |
| >>>Uplink | OP | | | Indicates the necessary information elements for Uplink. | REL-4 |
| >>>>Max_CID | MD | | Integer (1.. 16383) | Highest context ID number to be used by the UE compressor.
Default value is 15. | REL-4 |
| >>>Downlink | OP | | | Indicates the necessary information elements for Downlink. | REL-4 |
| >>>>Max_CID | MD | | Integer (1.. 16383) | Highest context ID number to be used by the UE decompressor.
Default value is 15. | REL-4 |
| >>>>Reverse-Decompression_Depth | MD | | Integer (0..65535) | Determines whether reverse decompression should be used or not and the maximum number of packets that can be reverse | REL-4 |

| Information Element/Group name | Need | Multi | Type and reference | Semantics description | Version |
|--|------|-------|--------------------|--|---------|
| | | | | decompressed by the UE decompressor. Default value is 0 (reverse decompression shall not be used). | |
| Note 1: If several occurrences of the same algorithm type are included in the same IE 'header compression information', the UE behaviour is unspecified. | | | | | |

| Condition | Explanation |
|-------------------------|---|
| <i>LosslessCriteria</i> | This IE is mandatory present if the IE "RLC mode" is "Acknowledged", the IE "In-sequence delivery " is TRUE and the IE "SDU Discard Mode" is "No discard" and not needed otherwise. |
| <i>Lossless</i> | This IE is mandatory present if the IE "Support for lossless SRNS relocation or for lossless RLC PDU size change" Is TRUE, otherwise it is not needed. |

10.3.4.2a PDCP ROHC target mode

| Information Element/Group name | Need | Multi | Type and Reference | Semantics description | Version |
|--------------------------------|------|-------|-----------------------------|---|---------|
| Target Mode | MP | | Enumerated (O-mode, R-mode) | The UE shall only transit to the signalled mode for operation of ROHC as described in [36]. | REL-5 |

10.3.4.3 PDCP SN info

| Information Element/Group name | Need | Multi | Type and Reference | Semantics description |
|--------------------------------|------|-------|--------------------|---|
| Receive PDCP sequence number | MP | | Integer(0..65535) | The PDCP sequence number, which the sender of the message is expecting next to be received. |

10.3.4.4 Polling info

| Information Element/Group name | Need | Multi | Type and reference | Semantics description |
|--------------------------------|------|-------|--|---|
| Timer_poll_prohibit | OP | | Integer(10..50 by step of 10, 600..1000 by step of 50) | Minimum time between polls in ms |
| Timer_poll | OP | | Integer(10..50 by step of 10, 600..1000 by step of 50) | Time in ms. |
| Poll_PDU | OP | | Integer(1,2,4,8,16,32,64,128) | Number of PDUs, interval between pollings |
| Poll_SDU | OP | | Integer(1,4,16,64) | Number of SDUs, interval between pollings |
| Last transmission PDU poll | MP | | Boolean | TRUE indicates that poll is made at last PDU in transmission buffer |
| Last retransmission PDU poll | MP | | Boolean | TRUE indicates that poll is made at last PDU in retransmission buffer |
| Poll_Window | OP | | Integer(50,60,70,80,85,90,95,99) | Percentage of transmission window, threshold for polling |
| Timer_poll_periodic | OP | | Integer(100, 200, 300, 400, 500, 750, 1000, 2000) | Time in milliseconds Timer for periodic polling. |

10.3.4.5 Predefined configuration identity

This information element identifies a pre- defined radio parameter configuration.

| Information Element/Group name | Need | Multi | Type and reference | Semantics description |
|---|------|-------|--------------------|-----------------------|
| Predefined radio configuration identity | MP | | Integer (0..15) | |

10.3.4.5a Predefined configuration status information

Another system may provide the UE with one or more predefined UTRAN configurations, comprising of radio bearer, transport channel and physical channel parameters. If requested, the UE shall indicate the configurations it has stored. The predefined configuration status information should include the following RRC information.

| Information Element/Group name | Need | Multi | Type and reference | Semantics description |
|-------------------------------------|------|-----------------------|---|---|
| RB information elements | | | | |
| Predefined configurations | | maxPredef ConfigCount | | The list is in order of preconfiguration identity |
| >Predefined configuration value tag | OP | | Predefined configuration value tag 10.3.4.6 | The UE shall include the value tag if it has stored the concerned configuration |

| Multi Bound | Explanation |
|----------------------|---|
| MaxPredefConfigCount | Maximum number of predefined configurations |

10.3.4.5b Predefined configuration status information compressed

Another system may provide the UE with one or more predefined UTRAN configurations, comprising of radio bearer, transport channel and physical channel parameters. If requested, the UE shall indicate the configurations it has stored. The compressed predefined configuration status information should include the following RRC information.

| Information Element/Group name | Need | Multi | Type and reference | Semantics description | Version |
|--|------|-----------------------|--|---|---------|
| Sets with different value tags | MP | | | | REL-5 |
| >Pre-defined configuration set with different value tags | MP | 1..2 | | | REL-5 |
| >>Start position | MD | | INTEGER (0..10) | Default value is 0, corresponding with the first pre-defined configuration. The pre-defined configuration where the consecutive sequence of pre-defined configurations begins. | REL-5 |
| >>Pre-defined configuration value tag list | MP | 6..<max PredefConfig> | Pre-defined configuration value tag 10.3.4.6 | Value Tags for each pre-defined configuration starting from the lowest. | REL-5 |
| Other Entries | OP | | | | REL-5 |
| >Pre-defined configuration list with variable size | MP | 1..<max PredefConfig> | | List of other pre-defined configurations not included within the Sets with different value tags, in consecutive order starting with the lowest. If there are stored pre-defined configurations positioned after a pre-defined configuration that is not stored, the UE shall indicate the not-stored pre-defined configuration by explicitly indicating it to be absent. If there are no stored pre-defined configurations positioned after a pre-defined configuration that is not stored, then the UE may totally omit these pre-defined configurations from the IE, i.e. reduce the size of the list to correspond to the last position that contained a stored pre-defined configuration. | REL-5 |
| >>Predefined configuration value tag | OP | | Predefined configuration value tag 10.3.4.6 | The UE shall include the value tag if it has stored the concerned configuration | REL-5 |

10.3.4.6 Predefined configuration value tag

This information element is used to identify different versions of a radio bearer configuration as may be used within one PLMN e.g. to support different UTRAN implementations.

| Information Element/Group name | Need | Multi | Type and Reference | Semantics description |
|------------------------------------|------|-------|--------------------|-----------------------|
| Predefined configuration value tag | MP | | Integer(0..15) | |

10.3.4.7 Predefined RB configuration

This information element concerns a pre- defined configuration of radio bearer parameters

| Information Element/Group name | Need | Multi | Type and Reference | Semantics description |
|--|------|---------------------|---|----------------------------------|
| UE information elements | | | | |
| Re-establishment timer | MP | | Re-establishment timer
10.3.3.30 | Only one RAB supported |
| Signalling radio bearer information | | | | |
| Signalling RB information to setup List | MP | 1 to <maxSRBs etup> | | For each signalling radio bearer |
| >Signalling RB information to setup | MP | | Signalling RB information to setup
10.3.4.24 | |
| RB information | | | | |
| RB information to setup list | MP | 1 to <maxRBperRAB> | | Only one RAB supported |
| >RB information to setup | MP | | RB information to setup
10.3.4.20 | |

10.3.4.8 RAB info

This IE contains information used to uniquely identify a radio access bearer.

| Information Element/Group name | Need | Multi | Type and reference | Semantics description | Version |
|---|----------------|-------|--|--|---------|
| RAB identity | MP | | RAB identity
10.3.1.14 | | |
| MBMS Service Identity | CV-
Message | | MBMS service ID
10.3.9a.8a | Included when establishing a RB for a MBMS service of the broadcast type; NOTE 1 | REL-6 |
| MBMS Session identity | CV-
Message | | MBMS Session identity
10.3.9a.9 | | REL-6 |
| CN domain identity | MP | | CN domain identity
10.3.1.1 | | |
| NAS Synchronization Indicator | OP | | NAS Synchronization indicator
10.3.4.12 | | |
| Re-establishment timer | MP | | Re-establishment timer
10.3.3.30 | | |
| NOTE 1: Only the "MBMS Service ID" part of the MBMS service identity is signalled in this IE. The UE should consider that the "PLMN identity" part of the MBMS service identity equals the PLMN identity of an MBMS service with the same "MBMS Service ID" stored in the variable ACTIVATED_MBMS_SERVICES. If there is no such MBMS service or more than one such MBMS service, the UE behaviour is unspecified. | | | | | |

| Condition | Explanation |
|-----------|---|
| Message | This IE is optionally present in the RADIO BEARER SETUP and the SRNS RELOCATION INFO messages and not needed otherwise. |

10.3.4.9 RAB info Post

This IE contains information used to uniquely identify a radio access bearer.

| Information Element/Group name | Need | Multi | Type and reference | Semantics description |
|--------------------------------|------|-------|--|-----------------------|
| RAB identity | MP | | RAB identity
10.3.1.14 | |
| CN domain identity | MP | | CN domain identity
10.3.1.1 | |
| NAS Synchronization Indicator | OP | | NAS Synchronization indicator
10.3.4.12 | |

10.3.4.9a RAB information for MBMS ptp bearers

| Information Element/Group name | Need | Multi | Type and reference | Semantics description | Version |
|--------------------------------|------|-------|------------------------------------|---|---------|
| RB identity | MP | | RB identity
10.3.4.16 | | REL-7 |
| MBMS Service Identity | MP | | MBMS Service ID
10.3.9a.8a | Indicates that this radio bearer is used for a different MBMS service. | REL-7 |
| MBMS Session Identity | OP | | MBMS Session identity
10.3.9a.9 | Indicates that this radio bearer is used for a different session of the MBMS service. | REL-7 |

10.3.4.10 RAB information for setup

| Information Element/Group name | Need | Multi | Type and reference | Semantics description | Version |
|--------------------------------|----------|---------------------------|--|--|---------|
| RAB info | MP | | RAB info
10.3.4.8 | | |
| CS-HSPA information | CV-CS | | | | REL-8 |
| >UL AMR rate | MD | | Enumerated
(t0, t1, t2, t3,
t4, t5, t6, t7,
t8) | Indicates the bit rate as defined in [62] and [63].
In case NAS Synchronization Indicator indicates AMR, default value is 't7'.
In case NAS Synchronization Indicator indicates AMR-WB, default value is 't8'.
7 spare values are needed. | REL-8 |
| >Max CS delay | MP | | Integer
(20..200 by step of 10) | Indicates the maximum possible delay for CS voice frames
Unit is ms | REL-8 |
| RAB info to replace | CV-SRVCC | | RAB info to replace
10.3.4.11a | | REL-8 |
| RB information to setup list | MP | 1 to
<maxRBpe
rRAB> | | | |
| >RB information to setup | MP | | RB information to setup
10.3.4.20 | | |

| Condition | Explanation |
|-----------|--|
| CS | This IE is mandatory if the IE 'CN domain identity' has the value 'CS domain' and the RAB is mapped on HS-DSCH/E-DCH. It is not needed otherwise. |
| SRVCC | This IE is mandatory if the RAB is established as part of an SR-VCC procedure and the message is not HANDOVER TO UTRAN COMMAND message or CELL UPDATE CONFIRM message, and not needed otherwise. |

10.3.4.11 RAB information to reconfigure

| Information Element/Group name | Need | Multi | Type and reference | Semantics description | Version |
|--------------------------------|-------|-------|--|---|---------|
| RAB identity | MP | | RAB Identity 10.3.1.14 | | |
| CN domain identity | MP | | CN domain identity 10.3.1.1 | | |
| NAS synchronization indicator | MP | | NAS Synchronization info 10.3.4.12 | Note 1 | |
| CS-HSPA information | CV-CS | | | | REL-8 |
| >UL AMR rate | MD | | Enumerated(t0, t1, t2, t3, t4, t5, t6, t7, t8) | Indicates the bit rate as defined in [62] and [63]. In case NAS Synchronization Indicator indicates AMR, default value is 't7'. In case NAS Synchronization Indicator indicates AMR-WB, default value is 't8'. 7 spare values are needed. | REL-8 |
| >Max CS delay | MP | | Integer(20..200 by step of 10) | Indicates the maximum possible delay for CS voice frames Unit is ms | REL-8 |

| Condition | Explanation |
|-----------|---|
| CS | This IE is mandatory if the IE 'CN domain identity' has the value 'CS domain' and the RAB is mapped on HS-DSCH/E-DCH. It is not needed otherwise. |

NOTE 1: This IE is only relevant for the CS domain.

10.3.4.11a RAB info to replace

This IE contains information to identify a radio access bearer to be replaced with a new radio access bearer as part of SR-VCC procedures. This IE is not included in case SR-VCC from LTE to UMTS.

| Information Element/Group name | Need | Multi | Type and reference | Semantics description | Version |
|--------------------------------|------|-------|-----------------------------|-----------------------|---------|
| RAB identity | MP | | RAB identity 10.3.1.14 | | REL-8 |
| CN domain identity | MP | | CN domain identity 10.3.1.1 | | REL-8 |

10.3.4.12 NAS Synchronization indicator

A container for non-access stratum information to be transferred transparently through UTRAN.

| Information Element/Group name | Need | Multi | Type and reference | Semantics description |
|--------------------------------|------|-------|--------------------|--|
| NAS Synchronization indicator | MP | | Bit string(4) | The first/leftmost bit of the bit string contains the most significant bit of the NAS Synchronization indicator. |

10.3.4.13 RB activation time info

This IE contains the time, in terms of RLC sequence numbers, when a certain configuration shall be activated, for a number of radio bearers.

| Information Element/Group name | Need | Multi | Type and reference | Semantics description |
|--------------------------------|------|--------------|-----------------------|---|
| Radio bearer activation time | MP | 1 to <maxRB> | | |
| >RB identity | MP | | RB identity 10.3.4.16 | |
| >RLC sequence number | MP | | Integer (0..4095) | RLC SN [16] .
Used for radio bearers mapped on RLC AM and UM |

10.3.4.14 RB COUNT-C MSB information

The MSB of the COUNT-C values of the radio bearer.

| Information Element/Group name | Needed | Multi | Type and reference | Semantics description |
|--------------------------------|--------|-------|---------------------------|--|
| RB identity | MP | | RB identity 10.3.4.16 | |
| COUNT-C-MSB-uplink | MP | | Integer (0.. $2^{25}-1$) | 25 MSBs from COUNT-C associated to this RB |
| COUNT-C-MSB-downlink | MP | | Integer (0.. $2^{25}-1$) | 25 MSBs from COUNT-C associated to this RB |

10.3.4.15 RB COUNT-C information

The COUNT-C values of the radio bearer.

| Information Element/Group name | Needed | Multi | Type and reference | Semantics description |
|--------------------------------|--------|-------|---------------------------|-----------------------|
| RB identity | MP | | RB identity 10.3.4.16 | |
| COUNT-C-uplink | MP | | Integer (0.. $2^{32}-1$) | |
| COUNT-C-downlink | MP | | Integer (0.. $2^{32}-1$) | |

10.3.4.16 RB identity

An identification number for the radio bearer affected by a certain message.

| Information Element/Group name | Need | Multi | Type and reference | Semantics description |
|--------------------------------|------|-------|--------------------|--|
| RB identity | MP | | Integer(1..32) | Values 1-4 shall only be used for signalling radio bearers. The IE value minus one shall be used as BEARER in the ciphering algorithm. |

10.3.4.17 RB information to be affected

| Information Element/Group name | Need | Multi | Type and reference | Semantics description |
|--------------------------------|------|-------|------------------------------|-----------------------|
| RB identity | MP | | RB identity
10.3.4.16 | |
| RB mapping info | MP | | RB mapping info
10.3.4.21 | |

10.3.4.18 RB information to reconfigure

| Information Element/Group name | Need | Multi | Type and reference | Semantics description |
|--------------------------------|------|-------|-----------------------------------|---|
| RB identity | MP | | RB identity
10.3.4.16 | |
| PDCP info | OP | | PDCP info
10.3.4.2 | |
| PDCP SN info | OP | | PDCP SN info
10.3.4.3 | PDCP sequence number info from the network. Present only in case of lossless SRNS relocation. |
| RLC info | OP | | RLC info
10.3.4.23 | |
| RB mapping info | OP | | RB mapping info
10.3.4.21 | |
| RB stop/continue | OP | | Enumerated(
stop,
continue) | |

10.3.4.19 RB information to release

| Information Element/Group name | Need | Multi | Type and reference | Semantics description |
|--------------------------------|------|-------|--------------------------|-----------------------|
| RB identity | MP | | RB identity
10.3.4.16 | |

10.3.4.20 RB information to setup

| Information Element/Group name | Need | Multi | Type and reference | Semantics description |
|--------------------------------|------|-------|------------------------------|---|
| RB identity | MP | | RB identity
10.3.4.16 | |
| PDCP info | OP | | PDCP info
10.3.4.2 | |
| CHOICE <i>RLC info type</i> | MP | | | |
| >RLC info | | | RLC info
10.3.4.23 | |
| >Same as RB | | | RB identity
10.3.4.16 | Identity of RB with exactly the same RLC info IE values |
| RB mapping info | MP | | RB mapping info
10.3.4.21 | |

NOTE: This information element is included within IE "Predefined RB configuration".

10.3.4.21 RB mapping info

A multiplexing option for each possible transport channel MAC-d flow or E-DCH MAC-d flow this RB can be multiplexed on.

| Information Element/Group name | Need | Multi | Type and reference | Semantics description | Version |
|--|--------------------------|------------------------|--------------------------------------|---|---------|
| Information for each multiplexing option | MP | 1 to <maxRBmuxOptions> | | | |
| >RLC logical channel mapping indicator | CV-UL-RLCLogicalChannels | | Boolean | TRUE indicates that the first logical channel shall be used for data PDUs and the second logical channel shall be used for control PDUs. FALSE indicates that control and data PDUs can be sent on either of the two logical channels. This parameter is not used in this release and shall be set to TRUE. | |
| >Number of uplink RLC logical channels | CV-UL-RLC info | 1 to MaxLoCHperRLC | | 1 or 2 logical channels per RLC entity or radio bearer RLC [16] | |
| >>CHOICE Uplink transport channel type | | | | | REL-6 |
| >>>DCH, RACH, USCH | | | | | REL-6 |
| >>>>Uplink transport channel type | MP | | Enumerated(DCH,RACH,USCH) | USCH is TDD only | |
| >>>>ULTransport channel identity | CV-UL-DCH/USCH | | Transport channel identity 10.3.5.18 | This is the ID of a DCH or USCH (TDD only) that this RB could be mapped onto. | |
| >>>>Logical channel identity | OP | | Integer(1..15) | This parameter is used to distinguish logical channels multiplexed by MAC on a transport channel. | |
| >>>>CHOICE RLC size list | MP | | | The RLC sizes that are allowed for this logical channel. | |
| >>>>>All | | | Null | All RLC sizes listed in the Transport Format Set. 10.3.5.23 | |
| >>>>>Configured | | | Null | The RLC sizes configured for this logical channel in the Transport Format Set. 10.3.5.23 if present in this message or in the | |

| Information Element/Group name | Need | Multi | Type and reference | Semantics description | Version |
|--------------------------------|-------------------|---------------------------------|-------------------------------------|--|---------|
| | | | | previously stored configuration otherwise | |
| >>>>>Explicit List | | 1 to <maxTF> | | Lists the RLC sizes that are valid for the logical channel. | |
| >>>>>RLC size index | MP | | Integer(1..maxTF) | The integer number is a reference to the RLC size which arrived at that position in the Transport Format Set 10.3.5.23 | |
| >>>E-DCH | | | | Note 4 | REL-6 |
| >>>>Logical channel identity | MP | | Integer(1..15) | This parameter is used to distinguish logical channels multiplexed by MAC on a transport channel | REL-6 |
| >>>>E-DCH MAC-d flow identity | MP | | E-DCH MAC-d flow identity 10.3.5.7e | | REL-6 |
| >>>>CHOICE RLC PDU size | MP | | | | REL-8 |
| >>>>>Fixed size | | | | | REL-8 |
| >>>>>>DDI | MP | | Integer (0..62) | If more than 1 UL RLC PDU size is configured for this RB, the different sizes will use subsequent DDI values starting from this DDI value. Value '0x3F' is reserved Note 6 | REL-6 |
| >>>>>>RLC PDU size list | MP | 1 to <maxRLC PDUsizePerLogChan> | | | REL-6 |
| >>>>>>>RLC PDU size | MP | | Integer(16..5000 by step of 8) | Unit is bits | REL-6 |
| >>>>>Flexible size | | | | | REL-8 |
| >>>>>>>Length indicator size | CV-UL-RLC AM mode | | Enumerated (7-bit, 15-bit) | | REL-8 |
| >>>>>>>Minimum UL RLC PDU size | MP | | Integer (16..12040 by step of 8) | Unit is bits | REL-8 |
| >>>>>>>Largest UL RLC PDU size | MP | | Integer (16..12040 by step of 8) | Unit is bits | REL-8 |
| >>>>Include in Scheduling Info | MP | | Boolean | Indicates whether or not this logical channel is to be considered when performing scheduling info reporting, as per | REL-6 |

| Information Element/Group name | Need | Multi | Type and reference | Semantics description | Version |
|---|-----------------------|--------------------|--|--|---------|
| | | | | [15] | |
| >>MAC logical channel priority | MP | | Integer(1..8) | This is priority between a user's different RBs (or logical channels).
[15] | |
| >Downlink RLC logical channel info | <i>CV-DL-RLC info</i> | | | | |
| >>Number of downlink RLC logical channels | <i>MD</i> | 1 to MaxLoCHperRLC | | 1 or 2 logical channels per RLC entity or radio bearer
RLC [16]
Default value is that parameter values for DL are exactly the same as for corresponding UL logical channel. In case two multiplexing options are specified for the UL, the first options shall be used as default for the DL. As regards to the IE "Channel type", rule is specified in 8.6.4.8. | |
| >>>Downlink transport channel type | MP | | Enumerated(DCH,FACH, DSCH,DCH+ DSCH
, HS-DSCH, DCH + HS-DSCH) | Note 3
Note 4 | REL-5 |
| >>>DL DCH Transport channel identity | <i>CV-DL-DCH</i> | | Transport channel identity
10.3.5.18 | | |
| >>>DL DSCH Transport channel identity | <i>CV-DL-DSCH</i> | | Transport channel identity
10.3.5.18 | | |
| >>>CHOICE DL MAC header type | <i>CV-DL-HS-DSCH</i> | | | Depending on the MAC-hs/ehs type of header selected for HS-DSCH | REL-7 |
| >>>>MAC-hs | | | | | REL-7 |
| >>>>>DL HS-DSCH MAC-d flow identity | MP | | MAC-d flow identity
10.3.5.7c | | REL-5 |
| >>>>MAC-ehs | | | | | REL-7 |
| >>>>>DL HS-DSCH MAC-ehs Queue Id | MP | | MAC-ehs Queue Id
10.3.5.7f | Note 5 | REL-7 |
| >>>Logical channel identity | OP | | Integer(1..15) | 16 is reserved
Note 5 | |

| Information Element/Group name | Need | Multi | Type and reference | Semantics description | Version |
|--------------------------------|------|-------|--------------------|---|---------|
| Note 3: | | | | The IE "Downlink transport channel type" values "DSCH" and "DCH+DSCH" should not be used for FDD. If received the UE behaviour is unspecified. | |
| Note 4: | | | | If included in System Information Block Type 16, the values "HS-DSCH" and "DCH + HS-DSCH" do not apply for the IE "Downlink transport channel type". Furthermore, if included in System Information Block Type 16, the value "E-DCH" for the IE "Uplink transport channel type" does not apply. | |
| Note 5: | | | | If the IE "Downlink transport channel type" is "HS-DSCH" or "DCH + HS-DSCH" and the DL MAC header type is "MAC-ehs", the IE "Logical channel identity" conveys the value to be used in the "LCH-ID" field of the MAC-ehs header [15], associating the logical channel with the MAC-ehs reordering queue identified by the IE "DL HS-DSCH MAC-ehs Queue Id". | |
| Note 6: | | | | If the radio bearer has a multiplexing option configured with the UL MAC header type of "MAC-i/is" then this value is ignored. | |

| Condition | Explanation |
|------------------------------|--|
| <i>UL-RLC info</i> | If "CHOICE <i>Uplink RLC mode</i> " in the IE "RLC info" that applies for that RB (i.e. either the one stored or received in the same message for the RB for which the "RB mapping info" was received, or the one stored or received in the same message for the RB pointed at in the IE "Same as RB" in the IE "RB information to setup" stored or received in the same message) is present this IE is mandatory present. Otherwise the IE is not needed. |
| <i>DL-RLC info</i> | If "CHOICE <i>Downlink RLC mode</i> " in the IE "RLC info" that applies for that RB (i.e. either the one stored or received in the same message for the RB for which the "RB mapping info" was received, or the one stored or received in the same message for the RB pointed at in the IE "Same as RB" in the IE "RB information to setup" stored or received in the same message) is present this IE is mandatory present. Otherwise the IE is not needed. |
| <i>UL-RLCLogicalChannels</i> | If "Number of uplink RLC logical channels" in IE "RB mapping info" is 2, then this IE is mandatory present. Otherwise this IE is not needed. |
| <i>UL-DCH/USCH</i> | If IE "Uplink transport channel type" is equal to "DCH" or "USCH" (TDD only) this IE is mandatory present. Otherwise the IE is not needed. |
| <i>DL-DCH</i> | If IE "Downlink transport channel type" is equal to "DCH", "DCH+DSCH" or "DCH + HS-DSCH" this IE is mandatory present. Otherwise the IE is not needed. |
| <i>DL-DSCH</i> | If IE "Downlink transport channel type" is equal to "DSCH" or "DCH+DSCH" this IE is mandatory present. Otherwise the IE is not needed. |
| <i>DL-HS-DSCH</i> | If IE "Downlink transport channel type" is equal to "HS-DSCH" or "DCH + HS-DSCH" this IE is mandatory present. Otherwise the IE is not needed. |
| <i>UL-RLC AM mode</i> | If "CHOICE <i>Uplink RLC mode</i> " in the IE "RLC info" that applies for that RB (i.e. either the one stored or received in the same message for the RB for which the "RB mapping info" was received, or the one stored or received in the same message for the RB pointed at in the IE "Same as RB" in the IE "RB information to setup" stored or received in the same message) is 'AM RLC' this IE is mandatory present. Otherwise the IE is not needed. |

10.3.4.22 RB with PDCP information

| Information Element/Group name | Need | Multi | Type and reference | Semantics description | Version |
|--------------------------------|------|-------|--------------------------|-----------------------|---------|
| RB identity | MP | | RB identity
10.3.4.16 | | |

| | | | | | |
|--------------|----|--|-----------------------|---|-------|
| PDCP SN info | MP | | PDCP SN info 10.3.4.3 | PDCP sequence number info from the sender of the message for lossless SRNS relocation. | REL-5 |
| | | | | PDCP sequence number info from the sender of the message for lossless SRNS relocation or for lossless DL RLC PDU size change. | |

10.3.4.23 RLC info

| Information Element/Group name | Need | Multi | Type and reference | Semantics description | Version |
|---------------------------------|------------|-------|---|--|---------|
| CHOICE <i>Uplink RLC mode</i> | OP | | | Indicates if Acknowledged, Unacknowledged or Transparent mode RLC shall be used. | |
| >AM RLC | | | | | |
| >>Transmission RLC discard | MP | | Transmission RLC discard 10.3.4.25 | | |
| >>Transmission window size | MP | | Integer(1,8,16,32,64,128,256,512,768,1024,1536,2047,2560,3072,3584,4095) | Maximum number of RLC PUs sent without getting them acknowledged. This parameter is needed if acknowledged mode is used. UE shall also assume that the UTRAN receiver window is equal to this value. | |
| >>Timer_RST | MP | | Integer(50, 100, 150, 200, 250, 300, 350, 400, 450, 500, 550, 600, 700, 800, 900, 1000) | Elapsed time in milliseconds. It is used to trigger the retransmission of RESET PDU. | |
| >>Max_RST | MP | | Integer(1, 4, 6, 8, 12, 16, 24, 32) | Defined in [16] | |
| >>Polling info | OP | | Polling info 10.3.4.4 | | |
| >UM RLC | | | | | |
| >>Transmission RLC discard | CV-CS-HSPA | | Transmission RLC discard 10.3.4.25 | NOTE 3 | |
| >TM RLC | | | | | |
| >>Transmission RLC discard | OP | | Transmission RLC discard 10.3.4.25 | | |
| >>Segmentation indication | MP | | Boolean | TRUE indicates that segmentation is performed. | |
| CHOICE <i>Downlink RLC mode</i> | OP | | | Indicates if Acknowledged, Unacknowledged or Transparent mode RLC shall be used | |
| >AM RLC | | | | | |
| >>CHOICE <i>DL RLC PDU size</i> | MP | | | | REL-7 |
| >>>Fixed size | | | | | REL-7 |

| Information Element/Group name | Need | Multi | Type and reference | Semantics description | Version |
|---|---------------|-------|--|---|---------|
| >>>>DL RLC PDU size | MP | | Integer(16..5000 by step of 8) | Unit is bits | REL-5 |
| >>>Flexible size | | | | NOTE 1 | REL-7 |
| >>>>Length indicator size | MP | | Enumerated (7-bit, 15-bit) | | REL-7 |
| >>In-sequence delivery | MP | | Boolean | TRUE indicates that RLC shall preserve the order of higher layer PDUs when these are delivered.
FALSE indicates that receiving RLC entity could allow SDUs to be delivered to the higher layer in different order than submitted to RLC sublayer at the transmitting side. | |
| >>Receiving window size | MP | | Integer(1,8,16,32,64,128,256,512,768,1024,1536,2047,2560,3072,3584,4095) | Maximum number of RLC PUs allowed to be received. This parameter is needed if acknowledged mode is used. UE shall also assume that the UTRAN transmitter window is equal to this value | |
| >>Downlink RLC status Info | MP | | Downlink RLC status info
10.3.4.1 | | |
| >UM RLC | | | | | |
| >>DL UM RLC LI size | MP | | Integer(7, 15) | Size in bits to use for the downlink RLC UM LI. | REL-5 |
| >>DL Reception Window Size | CV-Not-SIB16o | | Integer(32, 48, 64, 80, 96, 112) | | REL-6 |
| >TM RLC | | | | | |
| >>Segmentation indication | MP | | Boolean | TRUE indicates that segmentation is performed. | |
| One sided RLC re-establishment | MP | | Boolean | TRUE indicates that only one side of the AM RLC entity is re-established. | REL-5 |
| Alternative E-bit interpretation | CV-Not-SIB16o | | Enumerated (TRUE) | The absence of this IE implies: "normal E-bit interpretation". | REL-6 |
| Use special value of HE field | CV-Not-SIB16o | | Enumerated (TRUE) | The absence of this IE implies: 'do not use special value of the HE field'
NOTE 2, NOTE 4 | REL-7 |
| NOTE 1: If included in SIB type 16, the "Flexible size" does not apply for downlink RLC PDU size (AM RLC). | | | | | |
| NOTE 2: If the value of the IE "Use special value of HE field" is used in a reconfiguration, and the signalled value differs from the previously configured value, then both of the IEs "Uplink RLC mode" and "Downlink RLC mode" should be included in the message, otherwise the UE behaviour is unspecified. | | | | | |
| NOTE 3: If this IE is absent and the radio bearer is connected to a CS domain radio access bearer, the UE behaviour is unspecified. | | | | | |

NOTE 4: If the IE "Use special value of HE field" is absent in the received message while the previously configured value of IE "Use special value of HE field" is set to true and the received message does not initiate any RLC re-establishment procedure on the corresponding downlink RLC entity, then the UE will drop AM data PDUs with special value of HE and it will lead to either RLC reset procedure or RLC unrecoverable error [16].

| Condition | Explanation |
|------------|---|
| Not-SIB16o | If included in SYSTEM INFORMATION BLOCK TYPE 16, this IE is not needed. Otherwise the IE is optional |
| CS-HSPA | This IE is mandatory present If the radio bearer is connected to a CS domain radio access bearer, Otherwise the IE is optional. |

NOTE: This information element is included within IE "Predefined RB configuration".

10.3.4.23a RLC info MBMS

The IE RLC info MBMS is used for point-to-multipoint radio bearers, featuring only the downlink RLC UMD.

| Information Element/Group name | Need | Multi | Type and reference | Semantics description | Version |
|--|----------------|-------|---|---|---------|
| DL UM RLC LI size | MP | | Integer (7, 15) | Size in bits to use for the downlink RLC UM LI. | REL-6 |
| DL Duplication Avoidance and Reordering info | <i>CV-MTCH</i> | | UM Duplication Avoidance and Reordering info
10.3.4.26 | | REL-6 |
| DL Out of sequence delivery info | <i>CV-MCCH</i> | | UM Out of sequence delivery info
10.3.4.27 | | REL-6 |

| Condition | Explanation |
|-------------|--|
| <i>MTCH</i> | If the IE concerns MTCH (see Note 1), this IE is optional. Otherwise the IE is not needed. |
| <i>MCCH</i> | If the IE concerns MCCH, this IE is optional. Otherwise the IE is not needed. |

NOTE 1: The UE behaviour is unspecified if this IE is received with regard to an MTCH configured for MBSFN operation. A network should not send this IE with regard to an MTCH configured for MBSFN operation.

10.3.4.24 Signalling RB information to setup

| Information Element/Group name | Need | Multi | Type and reference | Semantics description |
|--------------------------------|------|-------|------------------------------|---|
| RB identity | MD | | RB identity
10.3.4.16 | Default value is specified in subclause 8.6.4.1 |
| CHOICE <i>RLC info type</i> | MP | | | |
| >RLC info | | | RLC info
10.3.4.23 | |
| >Same as RB | | | RB identity
10.3.4.16 | Identity of RB with exactly the same RLC info IE values |
| RB mapping info | MP | | RB mapping info
10.3.4.21 | |

NOTE: This information element is included within IE "Predefined RB configuration".

10.3.4.24a SR-VCC Info

This IE contains information that allows the calculation of the CK and IK for the CS domain, due to a SR-VCC procedure.

| Information Element/Group name | Need | Multi | Type and reference | Semantics description | Version |
|--------------------------------|------|-------|---------------------|-----------------------|---------|
| NONCE | OP | | Bit string
(128) | | REL-8 |

10.3.4.25 Transmission RLC Discard

| Information Element/Group name | Need | Multi | Type and reference | Semantics description |
|--------------------------------|------|-------|---|--|
| CHOICE <i>SDU Discard Mode</i> | MP | | | Different modes for discharge the RLC buffer on the transmitter side; "Timer based with explicit signalling", "Timer based without explicit signalling", "Discard after Max_DAT retransmissions" or "No_discard". For unacknowledged mode and transparent mode, only Timer based without explicit signalling is applicable. If "No_discard" is used, reset procedure shall be done after Max_DAT retransmissions |
| >Timer based explicit | | | | |
| >>Timer_MRW | MP | | Integer(50,60, 70, 80, 90, 100, 120, 140, 160, 180, 200, 300, 400, 500, 700, 900) | Elapsed time in milliseconds. It is used to trigger the retransmission of a STATUS PDU containing an MRW SUFI field |
| >>Timer_discard | MP | | Integer(100, 250, 500, 750, 1000, 1250, 1500, 1750, 2000, 2500, 3000, 3500, 4000, 4500, 5000, 7500) | Elapsed time in milliseconds before a SDU is discarded. |
| >>MaxMRW | MP | | Integer(1, 4, 6, 8, 12, 16, 24, 32) | Defined in [16] |
| >Timer based no explicit | | | | |
| >>Timer_discard | MP | | Integer(10,20,30,40,50,60,70,80,90,100) | Elapsed time in milliseconds before a SDU is discarded. |
| >Max DAT retransmissions | | | | |
| >>Max_DAT | MP | | Integer(1, 2, 3, 4, 5, 6, 7, 8, 9, 10, 15, 20, 25, 30, 35, 40) | Defined in [16] |
| >>Timer_MRW | MP | | Integer(50, 60, 70, 80, 90, 100, 120, 140, 160, 180, 200, 300, 400, 500, 700, 900) | Elapsed time in milliseconds. It is used to trigger the retransmission of a STATUS PDU containing an MRW SUFI field |
| >>MaxMRW | MP | | Integer(1, 4, 6, 8, 12, 16, 24, 32) | Defined in [16] |

| Information Element/Group name | Need | Multi | Type and reference | Semantics description |
|--------------------------------|------|-------|--|-----------------------|
| >No discard | | | | |
| >>Max_DAT | MP | | Integer(1, 2, 3, 4, 5, 6, 7, 8, 9, 10, 15, 20, 25, 30, 35, 40) | Defined in [16] |

| CHOICE SDU Discard Mode | Condition under which the given SDU Discard Mode is chosen |
|-------------------------|---|
| Timer based explicit | If the modes for discharge of the RLC buffer on the transmitter side is "Timer based with explicit signalling" |
| Timer based no explicit | If the modes for discharge of the RLC buffer on the transmitter side is "Timer based without explicit signalling"
For unacknowledged mode, only Timer based without explicit signalling is applicable. |
| Max DAT retransmissions | If the modes for discharge of the RLC buffer on the transmitter side is "Discard after Max_DAT retransmissions" |
| No discard | If the modes for discharge the of RLC buffer on the transmitter side is "Reset procedure shall be done after Max_DAT retransmissions" |

10.3.4.26 UM Duplication Avoidance and Reordering info

| Information Element/Group name | Need | Multi | Type and reference | Semantics description | Version |
|--------------------------------|------|-------|--|---|---------|
| Timer_DAR | MP | | Integer(40, 80, 120, 160, 240, 320, 480, 640, 960, 1280, 1920, 2560, 3840, 5120) | Timer (in milliseconds) when PDUs are released to the upper layers even though there are outstanding PDUs with lower RLC SN values. | REL-6 |
| Window size DAR | MP | | Integer(4, 8, 16, 32, 40, 48, 56, 64) | | REL-6 |

10.3.4.27 UM Out of sequence delivery info

| Information Element/Group name | Need | Multi | Type and reference | Semantics description | Version |
|--------------------------------|-----------------------|-------|---|-----------------------|---------|
| Timer_OSD | CV-
<i>notMCCH</i> | | Integer (40, 80, 120, 160, 240, 320, 480, 640, 960, 1280, 1920, 2560, 3840, 5120) | | REL-6 |
| Window size OSD | MP | | Integer(8, 16, 32,40, 48, 56, 64) | | REL-6 |

NOTE: This timer used to flush the buffer is configured at RRC level and indicated via a local primitive.

| Condition | Explanation |
|----------------|---|
| <i>notMCCH</i> | If this concerns a logical channel other than MCCH then this IE is mandatory otherwise it is not needed. In the latter case Timer_OSD takes the value of the IE Modification Period as indicated within the IE MCCH configuration information |

10.3.5 Transport CH Information elements

10.3.5.1 Added or Reconfigured DL TrCH information

| Information Element/Group name | Need | Multi | Type and reference | Semantics description | Version |
|---|-----------------------|-------|--|---|---------|
| Downlink transport channel type | MP | | Enumerated(DCH,DSCH,HS-DSCH) | Note 2 | |
| | | | | Note 3 | REL-5 |
| DL Transport channel identity | MP | | Transport channel identity 10.3.5.18 | | |
| | <i>CV-not HS-DSCH</i> | | | | REL-5 |
| <i>CHOICE DL parameters</i> | | | | | |
| <i>>Explicit</i> | | | | | |
| <i>>>TFS</i> | MP | | Transport Format Set 10.3.5.23 | | |
| <i>>SameAsUL</i> | | | | | |
| <i>>>Uplink transport channel type</i> | MP | | Enumerated(DCH,USCH) | USCH is TDD only | |
| <i>>>UL TrCH identity</i> | MP | | Transport channel identity 10.3.5.18 | Same TFS applies as specified for indicated UL TrCH | |
| <i>>HS-DSCH</i> | | | | | |
| <i>>>HARQ Info</i> | OP | | HARQ info 10.3.5.7a | For 1.28 Mcps TDD, if HARQ Information is included in the IE DL MultiCarrier Information, this IE shall not be present. | REL-5 |
| <i>>>>CHOICE DL MAC header type</i> | OP | | | | REL-7 |
| <i>>>>MAC-hs</i> | | | | | |
| <i>>>>>Added or reconfigured MAC-d flow</i> | MP | | Added or reconfigured MAC-d flow 10.3.5.1a | | REL-5 |
| <i>>>>>MAC-ehs</i> | | | | | |
| <i>>>>>Added or reconfigured MAC-ehs reordering queue</i> | MP | | Added or reconfigured MAC-ehs reordering queue 10.3.5.1c | | REL-7 |
| DCH quality target | OP | | Quality target 10.3.5.10 | | |

| Information Element/Group name | Need | Multi | Type and reference | Semantics description | Version |
|--------------------------------|--|-------|--------------------|-----------------------|---------|
| Note 1: | Void | | | | |
| Note 2: | The IE "Downlink transport channel type" value "DSCH" should not be used for FDD. If received the UE behaviour is unspecified. | | | | |
| Note 3: | If included in SIB type 16, the value "HS-DSCH" does not apply for the IE "Downlink transport channel type". | | | | |

| Condition | Explanation |
|-------------------|---|
| <i>NotHS-DSCH</i> | If the downlink transport channel type is DCH or DSCH then this IE is mandatory otherwise it is not needed. |

10.3.5.1a Added or reconfigured MAC-d flow

This IE is used in relation to the MAC-d flows mapped to the HS-DSCH transport channel.

| Information Element/Group name | Need | Multi | Type and reference | Semantics description | Version |
|---|------|--------------------------|--|--|---------|
| MAC-hs queue to add or reconfigure list | OP | <1 to maxQueue ID> | | | REL-5 |
| >MAC-hs queue Id | MP | | Integer(0..7) | The MAC-hs queue ID is unique across all MAC-d flows. | REL-5 |
| >MAC-d Flow Identity | MP | | MAC-d Flow Identity
10.3.5.7c | | REL-5 |
| >T1 | MP | | Integer(10, 20, 30, 40, 50, 60, 70, 80, 90, 100, 120, 140, 160, 200, 300, 400) | Timer (in milliseconds) when PDUs are released to the upper layers even though there are outstanding PDUs with lower TSN values. | REL-5 |
| >MAC-hs window size | MP | | Integer(4, 6, 8, 12, 16, 24, 32) | The set of values is used for Multi-carrier case in 1.28 Mcps TDD mode for 9bits TSN option. | REL-5 |
| | | | Integer(32, 64, 96, 128, 160, 192, 256) | | REL-7 |
| >MAC-d PDU size Info | OP | <1 to max MACdPDU sizes> | | Mapping of the different MAC-d PDU sizes configured for the HS-DSCH to the MAC-d PDU size index in the MAC-hs header. | REL-5 |
| >>MAC-d PDU size | MP | | Integer (1..5000) | | REL-5 |
| >>MAC-d PDU size index | MP | | Integer(0..7) | | REL-5 |
| MAC-hs queue to delete list | OP | <1 to maxQueue ID> | | | REL-5 |
| >MAC-hs queue Id | MP | | Integer(0..7) | The MAC-hs queue ID is unique across all MAC-d flows. | REL-5 |

10.3.5.1b Added or reconfigured E-DCH MAC-d flow

This IE is used in relation to MAC-d flows mapped to the E-DCH transport channel.

| Information Element/Group name | Need | Multi | Type and reference | Semantics description | Version |
|--|------------------|-------|---|---|---------|
| E-DCH MAC-d flow identity | MP | | E-DCH MAC-d flow identity
10.3.5.7e | | REL-6 |
| E-DCH MAC-d flow power offset | OP | | Integer(0..6) | Only allowed to be absent when already defined for this E-DCH MAC-d flow, unit is dB | REL-6 |
| E-DCH MAC-d flow maximum number of retransmissions | OP | | Integer (0..15) | Only allowed to be absent when already defined for this E-DCH MAC-d flow | REL-6 |
| E-DCH MAC-d flow retransmission timer | <i>CV-Tdd128</i> | | Enumerated (10, 15, 20, 25, 30, 35, 40, 45, 50, 55, 60, 65, 70, 75, 80, 85, 90, 95, 100, 110, 120, 140, 160, 200, 240, 280, 320, 400, 480, 560) | Unit: ms | REL-7 |
| E-DCH MAC-d flow multiplexing list | OP | | Bitstring (maxE-DCHMACdFlow) | Indicates, if this is the first MAC-d flow for which PDUs are placed in the MAC-e or MAC-i PDU, the other MAC-d flows from which MAC-d PDUs are allowed to be included in the same MAC-e or MAC-i PDU.
Bit 0 is for MAC-d flow 0, Bit 1 is for MAC-d flow 1, ...
Value '1' for a bit means multiplexing is allowed. Bit 0 is the first/leftmost bit of the bit string.

NOTE: The bit that corresponds to the MAC-d flow itself is ignored. | REL-6 |
| CHOICE transmission grant type | OP | | | Only allowed to be absent when already defined for this E-DCH MAC-d flow | REL-6 |
| >Non-scheduled transmission grant info | | | | | REL-6 |
| >>CHOICE <i>mode</i> | MP | | | | REL-7 |
| >>>FDD | | | | | REL-7 |
| >>>>Max MAC-e PDU contents size | MP | | Integer (1..19982) | | REL-6 |

| | | | | | |
|--|----|--|---------------|--|-------|
| >>>>2ms non-scheduled transmission grant HARQ process allocation | MD | | Bitstring (8) | MAC-d PDUs for this MAC-d flow are only allowed to be transmitted in those processes for which the bit is set to '1'.
Bit 0 corresponds to HARQ process 0, bit 1 corresponds to HARQ process 1,...
Default value is: transmission in all HARQ processes is allowed. Bit 0 is the first/leftmost bit of the bit string. | REL-6 |
| >>>TDD | | | NULL | No data | REL-7 |
| >Scheduled transmission grant info | | | NULL | | REL-6 |

| Condition | Explanation |
|---------------|--|
| <i>Tdd128</i> | This IE is mandatory present for 1.28Mcps TDD, otherwise it is not needed. |

10.3.5.1c Added or reconfigured MAC-ehs reordering queue

This IE is used in relation to the MAC-ehs reordering queues mapped to the HS-DSCH transport channel.

| Information Element/Group name | Need | Multi | Type and reference | Semantics description | Version |
|--|------|--------------------|---|---|---------|
| MAC-ehs queue to add or reconfigure list | OP | <1 to maxQueue ID> | | | REL-7 |
| >MAC-ehs queue Id | MP | | MAC-ehs Queue Id
10.3.5.7f | | REL-7 |
| >T1 | MP | | Integer (10, 20, 30, 40, 50, 60, 70, 80, 90, 100, 120, 140, 160, 200, 300, 400) | Timer (in milliseconds) when PDUs are released to the upper layers even though there are outstanding PDUs with lower TSN values. | REL-7 |
| >Treset | MD | | Integer (1, 2, 3, 4) | Timer in multiples of T1 values (milliseconds). Used when MAC-ehs reordering queue is reset in CELL_FACH and CELL_PCH (FDD only).
Default value is 2 | REL-7 |
| >MAC-ehs window size | MP | | Integer (4, 6, 8, 12, 16, 24, 32) | One spare value needed. | REL-7 |

10.3.5.2 Added or Reconfigured UL TrCH information

| Information Element/Group name | Need | Multi | Type and reference | Semantics description | Version |
|--|--------------------|--------------------------|--|---|---------|
| Uplink transport channel type | MP | | Enumerated(DCH,USCH | USCH is TDD only | |
| | | | ,E-DCH) | Note 1 | REL-6 |
| UL Transport channel identity | MP | | Transport channel identity 10.3.5.18 | | |
| | <i>CV-NotE-DCH</i> | | | | REL-6 |
| <i>CHOICE UL parameters</i> | | | | | REL-6 |
| >DCH,USCH | | | | | REL-6 |
| >>TFS | MP | | Transport Format Set 10.3.5.23 | | |
| >E-DCH | | | | | REL-6 |
| >>UL MAC header type | OP | | Enumerated (MAC-i/is) | If this IE is present, MAC-i/is header type [15] is used, else MAC-e/es header type [15] is used. | REL-8 |
| >>>CHOICE mode | MP | | | | REL-7 |
| >>>>FDD | | | | | REL-7 |
| >>>>>E-DCH Transmission Time Interval | MP | | Integer(2,10) | Unit is ms. | REL-6 |
| >>>>>TDD | | | | No data | REL-7 |
| >>>HARQ info for E-DCH | MP | | 10.3.5.7d | | REL-6 |
| >>>Added or reconfigured E-DCH MAC-d flow list | OP | <1 to maxE-DCHMACd Flow> | | | REL-6 |
| >>>>Added or reconfigured E-DCH MAC-d flow | MP | | Added or reconfigured E-DCH MAC-d flow 10.3.5.1b | | REL-6 |
| Note 1: If included in System Information Block Type 16, the values "E-DCH" does not apply for the IE "Uplink transport channel type". | | | | | |

| Condition | Explanation |
|-----------------|---|
| <i>NotE-DCH</i> | If the uplink transport channel type is DCH or USCH then this IE is mandatory otherwise it is not needed. |

NOTE: This information element is included within IE "Predefined RB configuration".

10.3.5.2a Additional Dynamic Transport Format Information for CCCH

| Information Element/Group name | Need | Multi | Type and reference | Semantics description | Version |
|--------------------------------|------|-------|--------------------|--|---------|
| RLC Size | MP | | Integer (48..4968) | Unit is bits
For FDD, values are restricted to:
Integer (48..296 by step of 8,
312..1320 by step of 16, 1384..4968 by step of 64) | Rel-6 |
| Number of Transport blocks | MP | | Integer (1) | NOTE 1 | Rel-6 |

NOTE 1: The "Integer (1)" type does not result in bits in the transfer syntax and is not needed in the ASN.1.

10.3.5.2b Additional RACH TFCS for CCCH

| Information Element/Group name | Need | Multi | Type and reference | Semantics description | Version |
|--------------------------------|------|-------|--------------------------------------|---|---------|
| Power offset Information | MP | | Power Offset Information
10.3.5.8 | The actual TFCS is specified in 8.6.5.12a | Rel-6 |

10.3.5.3 Void

10.3.5.3a Common MAC-ehs reordering queue list

NOTE: For FDD and 1.28 Mcps TDD only.

This IE is defines common MAC-ehs priority queue parameters, which can be used for CCCH and SRB1 reception.

| Information Element/Group name | Need | Multi | Type and reference | Semantics description | Version |
|---------------------------------|------|----------------------------|---|--|---------|
| MAC-ehs queue to configure list | MP | <1 to maxComm onQueueel D> | | | REL-7 |
| >MAC-ehs queue Id | MP | | MAC-ehs Queue Id
10.3.5.7f | | REL-7 |
| >T1 | MP | | Integer (10, 20, 30, 40, 50, 60, 70, 80, 90, 100, 120, 140, 160, 200, 300, 400) | Timer (in milliseconds) when PDUs are released to the upper layers even though there are outstanding PDUs with lower TSN values. | REL-7 |
| >Treset | MD | | Integer (1, 2, 3, 4) | Timer in multiples of T1 values (milliseconds). Used when MAC-ehs reordering queue is reset in CELL_FACH and CELL_PCH (FDD and 1.28 Mcps TDD only). Default value is 2 | REL-7 |
| >MAC-ehs window size | MP | | Integer (4, 6, 8, 12, 16, 24, 32) | | REL-7 |

10.3.5.3b Common E-DCH MAC-d flows

This IE is used in relation to MAC-d and MAC-c (for FDD) flows mapped to the E-DCH transport channels.

NOTE: Only for FDD and 1.28 Mcps TDD.

| Information Element/Group name | Need | Multi | Type and reference | Semantics description | Version |
|---|-----------------------|-------------------------|---|---|---------|
| Configured E-DCH MAC-d flow list | MP | 1 to <maxE-DCHMACdFlow> | | | REL-8 |
| >E-DCH MAC-d flow identity | MP | | E-DCH MAC-d Flow Identity 10.3.5.7e | NOTE 1 | REL-8 |
| >E-DCH MAC-d flow power offset | MP | | Integer(0..6) | | REL-8 |
| >E-DCH MAC-d flow maximum number of retransmissions | MP | | Integer (0..15) | | REL-8 |
| >E-DCH MAC-d flow multiplexing list | CV-
NotCCCHF
DD | | Bitstring (maxE-DCHMACdFlow) | Indicates, if this is the first MAC-d flow for which PDUs are placed in the MAC-i PDU, the other MAC-d flows from which MAC-d PDUs are allowed to be included in the same MAC-i PDU.
Bit 0 is for MAC-d flow 0, Bit 1 is for MAC-d flow 1, ...
Value '1' for a bit means multiplexing is allowed. Bit 0 is the first/leftmost bit of the bit string.

NOTE: The bit that corresponds to the MAC-d flow itself is ignored. | REL-8 |
| >E-DCH MAC-d flow retransmission timer | CV- <i>Tdd128</i> | | Enumerated (10, 15, 20, 25, 30, 35, 40, 45, 50, 55, 60, 65, 70, 75, 80, 85, 90, 95, 100, 110, 120, 140, 160, 200, 240, 280, 320, 400, 480, 560) | Unit: ms | REL-8 |

NOTE 1: For FDD, E-DCH MAC-d flow identity 7 is reserved for CCCH transmission.

| Condition | Explanation |
|-------------------|--|
| <i>Tdd128</i> | This IE is mandatory present for 1.28 Mcps TDD, otherwise it is not needed. |
| <i>NotCCCHFDD</i> | This IE is not needed for the E-DCH MAC-d flow reserved for CCCH transmission for FDD, otherwise it is optional. |

10.3.5.4 Deleted DL TrCH information

| Information Element/Group name | Need | Multi | Type and reference | Semantics description | Version |
|--|----------------------|-------|--------------------------------------|-----------------------|---------|
| Downlink transport channel type | MP | | Enumerated (DCH,DSCH , HS-DSCH) | Note 1 | REL-5 |
| DL Transport channel identity | MP | | Transport channel identity 10.3.5.18 | | REL-5 |
| | <i>CV-notHS-DSCH</i> | | | | REL-5 |
| CHOICE DL MAC header type | <i>CV-HS-DSCH</i> | | | | REL-7 |
| >MAC-hs | | | | | REL-7 |
| >>DL HS-DSCH MAC-d flow identity | MP | | MAC-d flow identity 10.3.5.7c | | REL-5 |
| >MAC-ehs | | | | | REL-7 |
| >>DL HS-DSCH MAC-ehs reordering queue | MP | | MAC-ehs Queue Id 10.3.5.7f | | REL-7 |
| Note 1: The IE "Downlink transport channel type" value " DSCH " should not be used for FDD. If received the UE behaviour is unspecified. | | | | | |

| Condition | Explanation |
|-------------------|---|
| <i>NotHS-DSCH</i> | If the downlink transport channel type is DCH or DSCH then this IE is mandatory otherwise it is not needed. |
| <i>HS-DSCH</i> | If the downlink transport channel type is HS-DSCH then this IE is mandatory otherwise it is not needed. |

10.3.5.5 Deleted UL TrCH information

| Information Element/Group name | Need | Multi | Type and reference | Semantics description | Version |
|--------------------------------|--------------------|-------|--------------------------------------|-----------------------|---------|
| Uplink transport channel type | MP | | Enumerated(DCH,USCH ,E-DCH) | USCH is TDD only | REL-6 |
| UL Transport channel identity | MP | | Transport channel identity 10.3.5.18 | | REL-6 |
| | <i>CV-NotE-DCH</i> | | | | REL-6 |
| E-DCH MAC-d flow identity | <i>CV-E-DCH</i> | | E-DCH MAC-d flow identity 10.3.5.7e | | REL-6 |

| Condition | Explanation |
|-----------------|---|
| <i>NotE-DCH</i> | If the uplink transport channel type is DCH or USCH then this IE is mandatory otherwise it is not needed. |
| <i>E-DCH</i> | If the uplink transport channel type is E-DCH then this IE is mandatory otherwise it is not needed. |

10.3.5.6 DL Transport channel information common for all transport channels

| Information Element/Group name | Need | Multi | Type and reference | Semantics description | Version |
|------------------------------------|------|------------------|---|---|---------|
| SCCPCH TFCS | OP | | Transport Format Combination Set 10.3.5.20 | This IE should not be included in this version of the protocol. | |
| CHOICE <i>mode</i> | MP | | | Although this IE is not always required, need is MP to align with ASN.1 | |
| | OP | | | | REL-4 |
| >FDD | | | | | |
| >>CHOICE <i>DL parameters</i> | OP | | | | |
| >>>Explicit | | | | | |
| >>>>DL DCH TFCS | MP | | Transport Format Combination Set 10.3.5.20 | Although this IE is not always required, need is MP to align with ASN.1 | |
| | OP | | | | REL-4 |
| >>>SameAsUL | | | | (no data)
See note 2 | |
| >TDD | | | | | |
| >>Individual DL CCTrCH information | OP | 1 to <maxCCTrCH> | | | |
| >>>DL TFCS Identity | MP | | Transport format combination set identity 10.3.5.21 | Identifies a special CCTrCH for shared or dedicated channels. | |
| >>>CHOICE <i>DL parameters</i> | MP | | | | |
| >>>>Independent | | | | | |
| >>>>>DL TFCS | MP | | Transport format combination set 10.3.5.20 | | |
| >>>>>SameAsUL | | | | See note 2 | |
| >>>>>>UL DCH TFCS Identity | MP | | Transport format combination set identity 10.3.5.21 | Same TFCS applies as specified for the indicated UL DCH TFCS identity except for information applicable for UL only | |

NOTE 1: This information element is included within IE "Predefined TrCh configuration".

NOTE 2: The UTRAN should only use the choice "SameAsUL" if the transport channel numbering, the number of TFs in the TFS of each transport channel, and the TFCS are identical in the uplink and downlink.

10.3.5.7 Void

10.3.5.7a HARQ Info

This IE is used in relation to the HS-DSCH transport channel.

| Information Element/Group name | Need | Multi | Type and reference | Semantics description | Version |
|---|------|----------------------|---|---|---------|
| Number of Processes | MP | | Integer (1..8, | NOTE 3 | REL-5 |
| | | | 12, 14, 16) | NOTE 1, NOTE 2 | REL-7 |
| <i>CHOICE Memory Partitioning</i> | MP | | | | REL-5 |
| >Implicit | | | | UE shall apply memory partitioning of equal size across all HARQ processes | REL-5 |
| >Explicit | | | | | REL-5 |
| >>Memory size | MP | <1 to MaxHProcesses> | | | REL-5 |
| >>>Process Memory size | MP | | Integer(800 .. 16000 by step of 800, 17600 .. 32000 by step of 1600, 36000 .. 80000 by step of 4000, 88000 .. 160000 by step of 8000, 176000 .. 304000 by step of 16000) | Maximum number of soft channel bits available in the virtual IR buffer [27] | REL-5 |
| >>Additional memory sizes for MIMO | OP | <1 to MaxHProcesses> | | NOTE 2 | REL-7 |
| >>>Process Memory size | MP | | Integer (800 .. 16000 by step of 800, 17600 .. 32000 by step of 1600, 36000 .. 80000 by step of 4000, 88000 .. 160000 by step of 8000, 176000 .. 304000 by step of 16000) | Maximum number of soft channel bits available in the virtual IR buffer [27] | REL-7 |
| NOTE 1: If the IE "Number of processes" is not set to one of the values 12, 14 or 16 and the IE "MIMO parameters" (10.3.6.41a) is included and the IE "MIMO operation" is set to either 'start' or 'continue', the UE behaviour is unspecified. If the IE "Number of processes" is set to one of the values 12, 14, or 16 and the IE "MIMO parameters" (10.3.6.41a) is not included, the UE behaviour is unspecified. | | | | | |
| NOTE 2: The values of the IE "Number of processes" greater than 8 and the IE "Additional memory sizes for MIMO" are not needed in SIB type 5 and SIB type 5bis. | | | | | |
| NOTE 3: If the IE "Number of processes" is not set to one of the values 6, 7 or 8, the IE "Memory Partitioning" is set to implicit and the IE "Downlink secondary cell info FDD" (10.3.6.31a) is included, the UE behaviour is unspecified | | | | | |

10.3.5.7b Void

10.3.5.7c MAC-d Flow Identity

| Information Element/Group name | Need | Multi | Type and reference | Semantics description | Version |
|--------------------------------|------|-------|--------------------|-----------------------|---------|
| MAC-d flow identity | MP | | Integer (0..7) | | REL-5 |

10.3.5.7d HARQ Info for E-DCH

This IE is used in relation to the E-DCH transport channel.

| Information Element/Group name | Need | Multi | Type and reference | Semantics description | Version |
|--------------------------------|------|-------|---------------------------|--|---------|
| CHOICE <i>mode</i> | MP | | | | REL-7 |
| >FDD | | | | | REL-7 |
| >>HARQ RV Configuration | MP | | Enumerated (rv0, rvtable) | If 'rv0' is indicated, the UE shall only use E_DCH RV index 0.
If 'rvtable' is indicated, the UE shall use an RSN based RV index as specified in [27] | REL-6 |
| >TDD | | | | | REL-7 |
| >>HARQ RV Configuration | MP | | Enumerated (rv0, rvtable) | If 'rv0' is indicated, the UE shall only use E_DCH RV index 0.
If 'rvtable' is indicated, the UE shall use an RSN based RV index as specified in [31] | REL-7 |

10.3.5.7e E-DCH MAC-d Flow Identity

| Information Element/Group name | Need | Multi | Type and reference | Semantics description | Version |
|--------------------------------|------|-------|---------------------------------|-----------------------|---------|
| E-DCH MAC-d flow identity | MP | | Integer (0..maxE-DCHMACdFlow-1) | | REL-6 |

10.3.5.7f MAC-ehs Queue Id

| Information Element/Group name | Need | Multi | Type and reference | Semantics description | Version |
|--------------------------------|------|-------|--------------------|-----------------------|---------|
| MAC-ehs queue id | MP | | Integer (0..7) | | REL-7 |

10.3.5.8 Power Offset Information

| Information Element/Group name | Need | Multi | Type and reference | Semantics description |
|--------------------------------|------|-------|--------------------|-----------------------|
| CHOICE <i>Gain Factors</i> | MP | | | |

| Information Element/Group name | Need | Multi | Type and reference | Semantics description |
|---------------------------------|------|-------|--------------------|---|
| >Signalled Gain Factors | | | | |
| >>CHOICE mode | | | | |
| >>>FDD | | | | |
| >>>>Gain Factor β_c | MP | | Integer (0.. 15) | For UL DPCCH or control part of PRACH |
| >>>TDD | | | | (no data) |
| >>Gain Factor β_d | MP | | Integer (0..15) | For UL DPDCH or data part of PRACH and all uplink channels in TDD |
| >>Reference TFC ID | OP | | Integer (0..3) | If this TFC is a reference TFC, indicates the reference ID. |
| >Computed Gain Factors | | | | |
| >>Reference TFC ID | MP | | Integer (0.. 3) | Indicates the reference TFC Id of the TFC to be used to calculate the gain factors for this TFC. In case of using computed gain factors, at least one signalled gain factor is necessary for reference. |
| CHOICE mode | MP | | | |
| >FDD | | | | |
| >>Power offset P _{p-m} | OP | | Integer(-5..10) | In dB. Power offset between the last transmitted preamble and the control part of the message (added to the preamble power to receive the power of the message control part)
Needed only for PRACH |
| >TDD | | | | (no data) |

| CHOICE Gain Factors | Condition under which the way to signal the Gain Factors is chosen |
|------------------------|---|
| Signalled Gain Factors | The values for gain factors β_c (only in FDD mode) and β_d are signalled directly for a TFC. |
| Computed Gain Factors | The gain factors β_c (only in FDD mode) and β_d are computed for a TFC, based on the signalled settings for the associated reference TFC. |

10.3.5.9 Predefined TrCH configuration

This information element concerns a pre- defined configuration of transport channel parameters.

| Information Element/Group name | Need | Multi | Type and Reference | Semantics description |
|--|------|------------------------|--|-----------------------|
| UL Transport channel information common for all transport channels | MP | | UL Transport channel information common for all transport channels 10.3.5.24 | |
| Added or Reconfigured TrCH information | | | | |
| Added or Reconfigured UL TrCH information | MP | 1 to <maxTrCH preconf> | | |
| >Added or Reconfigured UL TrCH information | MP | | Added or Reconfigured UL TrCH information 10.3.5.2 | |
| DL Transport channel information common for all transport channels | MP | | DL Transport channel information common for all transport channels 10.3.5.6 | |
| Downlink transport channels | | | | |
| Added or Reconfigured DL TrCH information | MP | 1 to <maxTrCH preconf> | | |
| >Added or Reconfigured DL TrCH information | MP | | Added or Reconfigured DL TrCH information 10.3.5.1 | |

10.3.5.10 Quality Target

| Information Element/Group name | Need | Multi | Type and reference | Semantics description |
|--------------------------------|------|-------|-------------------------------|---|
| BLER Quality value | MP | | Real(-6.3 ..0 by step of 0.1) | Signalled value is Log10(Transport channel BLER quality target) |

10.3.5.11 Semi-static Transport Format Information

| Information Element/Group name | Need | Multi | Type and reference | Semantics description | Version |
|--------------------------------|------|-------|----------------------------------|--|---------|
| Transmission time interval | MP | | Integer(10, 20, 40, 80, dynamic) | In ms. The value dynamic is only used in TDD mode. For FDD DCH, the value '80' is applicable only when SF=512. | |

| Information Element/Group name | Need | Multi | Type and reference | Semantics description | Version |
|--------------------------------|-----------|-------|---|--|---------|
| | | | 5) | 5 is only applicable for the RACH in 1.28 Mcps TDD | REL-4 |
| Type of channel coding | MP | | Enumerated(No coding, Convolutional, Turbo) | The option "No coding" is only valid for TDD. | |
| Coding Rate | CV-Coding | | Enumerated(1/2, 1/3) | | |
| Rate matching attribute | MP | | Integer(1..hi RM) | | |
| CRC size | MP | | Integer(0, 8, 12, 16, 24) | in bits | |

| Condition | Explanation |
|---------------|--|
| <i>Coding</i> | This IE is mandatory present if IE "Type of channel coding" is "Convolutional" and not needed otherwise. |

10.3.5.12 Void

10.3.5.13 TFCS Explicit Configuration

| Information Element/Group name | Need | Multi | IE type and reference | Semantics description |
|---|------|-------|---|-----------------------|
| CHOICE <i>TFCS representation</i> | MP | | | |
| >Complete reconfiguration | | | | |
| >>TFCS complete reconfiguration information | MP | | TFCS Reconfiguration/Addition information 10.3.5.15 | |
| >Addition | | | | |
| >>TFCS addition information | MP | | TFCS Reconfiguration/Addition information 10.3.5.15 | |
| >Removal | | | | |
| >>TFCS removal information | MP | | TFCS Removal Information 10.3.5.16 | |
| >Replace | | | | |
| >>TFCS removal information | MP | | TFCS Removal Information 10.3.5.16 | |
| >>TFCS addition information | MP | | TFCS Reconfiguration/Addition information 10.3.5.15 | |

10.3.5.14 Void

10.3.5.15 TFCS Reconfiguration/Addition Information

| Information Element/Group name | Need | Multi | IE type and reference | Semantics description |
|--------------------------------|------|---------------|-----------------------------------|---|
| CHOICE CTFC Size | MP | | | |
| >2 bit CTFC | | | | |
| >>CTFC information | MP | 1 to <maxTFC> | | |
| >>>2bit CTFC | MP | | Integer(0..3) | |
| >>>Power offset Information | OP | | Power Offset Information 10.3.5.8 | Needed only for uplink physical channels. |
| >4 bit CTFC | | | | |
| >>CTFC information | MP | 1 to <maxTFC> | | |
| >>>4bit CTFC | MP | | Integer(0..15) | |
| >>>Power offset Information | OP | | Power Offset Information 10.3.5.8 | Needed only for uplink physical channels. |
| >6 bit CTFC | | | | |
| >>CTFC information | MP | 1 to <maxTFC> | | |
| >>>6 bit CTFC | MP | | Integer(0..63) | |
| >>>Power offset Information | OP | | Power Offset Information 10.3.5.8 | Needed only for uplink physical channels. |
| >8 bit CTFC | | | | |
| >>CTFC information | MP | 1 to <MaxTFC> | | |
| >>>8 bit CTFC | MP | | Integer(0..255) | |
| >>>Power offset Information | OP | | Power Offset Information 10.3.5.8 | Needed only for uplink physical channels. |
| >12 bit CTFC | | | | |
| >>CTFC information | MP | 1 to <maxTFC> | | |
| >>>12 bit CTFC | MP | | Integer(0..4095) | |
| >>>Power offset Information | OP | | Power Offset Information 10.3.5.8 | Needed only for uplink physical channels. |
| >16 bit CTFC | | | | |
| >>CTFC information | MP | 1 to <maxTFC> | | |
| >>>16 bit CTFC | MP | | Integer(0..65535) | |
| >>>Power offset Information | OP | | Power Offset Information 10.3.5.8 | Needed only for uplink physical channels. |
| >24 bit CTFC | | | | |
| >>CTFC information | MP | 1 to <MaxTFC> | | |
| >>>24 bit CTFC | MP | | Integer(0..16777215) | |
| >>>Power offset Information | OP | | Power Offset Information 10.3.5.8 | Needed only for uplink physical channels. |

10.3.5.16 TFCS Removal Information

| Information Element/Group name | Need | Multi | IE type and reference | Semantics description |
|--------------------------------|------|---------------|--|------------------------------|
| Removal TFCI information | MP | 1 to <maxTFC> | | |
| >TFCI | MP | | Transport Format Combination (TFC) 10.3.5.19 | In TDD 0 is a reserved value |

10.3.5.17 Void

10.3.5.18 Transport channel identity

This information element is used to distinguish transport channels. Transport channels of different type (RACH, USCH, FACH/PCH, DSCH or DCH) have separate series of identities. This also holds for uplink and downlink transport channel identities (i.e. for DCH). Depending on in which context a transport channel identity n that is sent, it will have different meaning

| Information Element/Group name | Need | Multi | Type and reference | Semantics description |
|--------------------------------|------|-------|--------------------|-----------------------|
| Transport channel identity | MP | | Integer(1..32) | |

10.3.5.19 Transport Format Combination (TFC)

| Information Element/Group name | Need | Multi | Type and reference | Semantics description |
|--------------------------------|------|-------|--------------------|-----------------------|
| Transport format combination | MP | | Integer (0..1023) | |

10.3.5.20 Transport Format Combination Set

Indicates the allowed combinations of already defined Transport formats and the mapping between these allowed TFCs and the corresponding TFCI values.

For TDD, different coded composite transport channels have independent transport format combination sets and thus independent TFCI values.

| Information Element/Group name | Need | Multi | IE type and reference | Semantics description |
|--------------------------------|------|-------|---------------------------------------|-----------------------|
| TFCI Field 1 Information | MP | | TFCS explicit Configuration 10.3.5.13 | |

10.3.5.21 Transport Format Combination Set Identity

NOTE: Only for TDD.

| Information Element/Group name | Need | Multi | Type and reference | Semantics description |
|--------------------------------|------|-------|--------------------|---------------------------------|
| TFCS ID | MD | | Integer | Indicates the identity of every |

| | | | | |
|--------------------------|----|--|---------|--|
| | | | (1..8) | TFCS within a UE. Default value is 1. |
| Shared Channel Indicator | MP | | Boolean | TRUE indicates the use of shared channels. Default is FALSE. |

10.3.5.22 Transport Format Combination Subset

Indicates which Transport format combinations in the already defined Transport format combination set are allowed.

| Information Element/Group name | Need | Multi | Type and reference | Semantics description |
|---|------|----------------|--|-----------------------|
| CHOICE <i>Subset representation</i> | MP | | | |
| >Minimum allowed Transport format combination index | | | Transport format combination 10.3.5.19 | |
| >Allowed transport format combination list | | 1 to <maxTFC> | | |
| >>Allowed transport format combination | MP | | Transport format combination 10.3.5.19 | |
| >Non-allowed transport format combination list | | 1 to <maxTFC> | | |
| >>Non-allowed transport format combination | MP | | Transport format combination 10.3.5.19 | |
| >Restricted TrCH information | | 1 to <maxTrCH> | | |
| >>Uplink transport channel type | MP | | Enumerated(DCH, USCH) | USCH is TDD only |
| >>>Restricted UL TrCH identity | MP | | Transport channel identity 10.3.5.18 | |
| >>>Allowed TFIs | OP | 1 to <maxTF> | | |
| >>>>Allowed TFI | MP | | Integer(0..31) | |
| >Full transport format combination set | | | | (No data) |

10.3.5.23 Transport Format Set

| Information Element/Group name | Need | Multi | Type and reference | Semantics description | Version |
|--|--------------|--------------|--------------------------------|---|---------|
| CHOICE <i>Transport channel type</i> | MP | | | | |
| >Dedicated transport channels | | | | The transport channel that is configured with this TFS is of type DCH | |
| >>Dynamic Transport Format Information | MP | 1 to <maxTF> | | | |
| >>>RLC Size | MP | | Integer(16..5000 by step of 8) | Unit is bits | |
| >>>>Number of TBs and TTI List | MP | 1 to <maxTF> | | Present for every valid number of TB's (and TTI) for this RLC Size. | |
| >>>>>Transmission Time Interval | CV-dynamicTT | | Integer(10,20,40,80) | Unit is ms. | |

| Information Element/Group name | Need | Multi | Type and reference | Semantics description | Version |
|--|--------------------------|--------------|--|---|---------|
| | / | | | | |
| >>>>Number of Transport blocks | MP | | Integer(0..512) | | |
| >>>CHOICE <i>Logical Channel List</i> | MP | | | The logical channels that are allowed to use this RLC Size | |
| >>>>ALL | | | Null | All logical channels mapped to this transport channel. | |
| >>>>Configured | | | Null | The logical channels configured to use this RLC size in the <i>RB mapping info</i> . 10.3.4.21 if present in this message or in the previously stored configuration otherwise | |
| >>>>Explicit List | | 1 to 15 | | Lists the logical channels that are allowed to use this RLC size. | |
| >>>>>RB Identity | MP | | RB identity 10.3.4.16 | | |
| >>>>>LogicalChannel | CH-UL-RLCLogicalChannels | | Integer(0..1) | Indicates the relevant UL logical channel for this RB. "0" corresponds to the first, "1" corresponds to the second UL logical channel configured for this RB in the IE "RB mapping info". | |
| >>Semi-static Transport Format Information | MP | | Semi-static Transport Format Information 10.3.5.11 | | |
| >Common transport channels | | | | The transport channel that is configured with this TFS is of a type not equal to DCH | |
| >>Dynamic Transport Format Information | MP | 1 to <maxTF> | | Note | |
| >>>RLC Size | MP | | Integer (48..4968) | Unit is bits. For FDD, values are restricted to: Integer (48..296 by step of 8, 312..1320 by step of 16, 1384..4968 by step of 64). | |
| >>>Number of TBs and TTI List | MP | 1 to <maxTF> | | Present for every valid number of TB's (and TTI) for this RLC Size. | |
| >>>>Number of Transport blocks | MP | | Integer(0..512) | | |
| >>>>CHOICE <i>mode</i> | MP | | | | |
| >>>>>FDD | | | | (no data) | |
| >>>>>TDD | | | | | |
| >>>>>>Transmission Time Interval | CV-dynamicTTI | | Integer(10,20,40,80) | Unit is ms. | |
| >>>CHOICE <i>Logical Channel List</i> | MP | | | The logical channels that are allowed to use this RLC Size. | |
| >>>>ALL | | | Null | All logical channels mapped to this transport channel. | |
| >>>>Configured | | | Null | The logical channels configured to use this RLC size in the <i>RB mapping info</i> . 10.3.4.21 if present in this message or in the previously stored configuration otherwise | |
| >>>>Explicit List | | 1 to 15 | | Lists the logical channels that are allowed to use this RLC size. | |

| Information Element/Group name | Need | Multi | Type and reference | Semantics description | Version |
|--|---------------------------------|-------|---|---|---------|
| >>>>>RB Identity | MP | | RB identity
10.3.4.16 | | |
| >>>>>LogicalChannel | <i>CV-UL-RLCLogicalChannels</i> | | Integer(0..1) | Indicates the relevant UL logical channel for this RB. "0" corresponds to the first, "1" corresponds to the second UL logical channel configured for this RB in the IE "RB mapping info". | |
| >>Semi-static Transport Format Information | MP | | Semi-static Transport Format Information
10.3.5.11 | | |

| Condition | Explanation |
|------------------------------|--|
| <i>dynamicTTI</i> | This IE is mandatory present if dynamic TTI usage is indicated in IE Transmission Time Interval in Semi-static Transport Format Information. Otherwise it is not needed. |
| <i>UL-RLCLogicalChannels</i> | If "Number of uplink RLC logical channels" in IE "RB mapping info" in this message is 2 or the IE "RB mapping info" is not present in this message and 2 UL logical channels are configured for this RB, then this IE is mandatory present. Otherwise this IE is not needed. |

10.3.5.24 UL Transport channel information common for all transport channels

| Information Element/Group name | Need | Multi | Type and reference | Semantics description | Version |
|--------------------------------|------|-------|--|---|---------|
| PRACH TFCS | OP | | Transport format combination set 10.3.5.20 | This IE should not be included in this version of the protocol. | |
| CHOICE <i>mode</i> | OP | | | | |
| >FDD | | | | | |

| | | | | | |
|------------------------------------|----|------------------|---|---|-------|
| >>TFC subset | MD | | Transport Format Combination Subset 10.3.5.22 | Default value is the complete existing set of transport format combinations | |
| >>UL DCH TFCS | MP | | Transport format combination set 10.3.5.20 | | |
| >TDD | | | | | |
| >>Individual UL CCTrCH information | OP | 1 to <maxCCTrCH> | | | |
| >>>UL TFCS Identity | MP | | Transport format combination set identity 10.3.5.21 | Identifies a special CCTrCH for shared or dedicated channels. | |
| >>>UL TFCS | MP | | Transport format combination set 10.3.5.20 | | |
| >>>TFC subset | MD | | Transport Format Combination Subset 10.3.5.22 | Default value is the complete existing set of transport format combinations | |
| TFC subset list | OP | 1 to <maxTFCsub> | | The maximum number of elements in the TFC subset list is 8. | REL-4 |
| >CHOICE mode | MP | | | | REL-4 |
| >>FDD | | | | (no data) | REL-4 |
| >>TDD | | | | | REL-4 |
| >>>TFCS Id | OP | | Transport Format Combination Set Identity 10.3.5.21 | | REL-4 |
| >TFC subset | MD | | Transport Format Combination Subset 10.3.5.22 | | REL-4 |

NOTE: This information element is included within IE "Predefined TrCh configuration".

10.3.6 Physical CH Information elements

10.3.6.1 AC-to-ASC mapping

| Information Element/Group name | Need | Multi | Type and reference | Semantics description |
|--------------------------------|------|-----------|--------------------|---|
| AC-to-ASC mapping table | MP | maxASCmap | | |
| >AC-to-ASC mapping | MP | | Integer(0...7) | Mapping of Access Classes to Access Service Classes (see subclause 8.5.13.) |

10.3.6.2 AICH Info

NOTE: Only for FDD.

| Information Element/Group name | Need | Multi | Type and reference | Semantics description |
|--------------------------------|------|-------|-----------------------------|--|
| Channelisation code | MP | | Integer(0..255) | SF is fixed and equal to 256 |
| STTD indicator | MP | | STTD Indicator
10.3.6.78 | |
| AICH transmission timing | MP | | Enumerated(0, 1) | See parameter AICH_Transmission_Timing in [26] |

10.3.6.3 AICH Power offset

NOTE: Only for FDD.

This parameter is used to indicate the power level of AICH channel. This is the power per transmitted Acquisition Indicator, Extended Acquisition Indicator minus power of the Primary CPICH.

| Information Element/Group name | Need | Multi | Type and reference | Semantics description |
|--------------------------------|------|-------|--------------------|-----------------------|
| AICH Power offset | MP | | Integer(-22..+5) | Offset in dB |

10.3.6.4 Allocation period info

NOTE: Only for TDD.

Parameters used by UE to determine period of shared channel allocation.

| Information Element/Group name | Need | Multi | Type and reference | Semantics description |
|--------------------------------|------|-------|--------------------|---|
| Allocation Activation Time | MP | | Integer(0..255) | Start the allocation period at the given CFN. |
| Allocation Duration | MP | | Integer(1..256) | Total number of frames for the allocation period. |

10.3.6.5 Alpha

| Information Element/Group name | Need | Multi | Type and reference | Semantics description |
|--------------------------------|------|-------|---|-----------------------|
| Alpha Value | MP | | Enumerated(0, 1/8, 2/8, 3/8, 4/8, 5/8, 6/8, 7/8, 1) | |

10.3.6.6 ASC setting

| Information Element/Group name | Need | Multi | Type and reference | Semantics description | Version |
|-----------------------------------|------|-------|--------------------|-----------------------|---------|
| CHOICE <i>mode</i> | MP | | | | |
| >FDD | | | | | |
| >>Available signature Start Index | MP | | Integer(0..15) | | |
| >>Available signature End Index | MP | | Integer(0..15) | | |
| >>Assigned Sub-Channel | MP | | Bit string(4) | This IE defines | |

| Information Element/Group name | Need | Multi | Type and reference | Semantics description | Version |
|---|------|-------|--------------------|--|---------|
| Number | | | | the subchannel assignment as specified in 8.6.6.29.
The first/leftmost bit of the bit string contains the most significant bit of the Assigned Sub-Channel Number.. | |
| >TDD | | | | | |
| >>CHOICE <i>TDD option</i> | MP | | | | REL-4 |
| >>>3.84 Mcps TDD | | | | | REL-4 |
| >>>>Available Channelisation codes indices | MD | | Bit string(8) | Each bit indicates availability of a channelisation code index, where the channelisation code indices are numbered "channelisation code index 0" to "channelisation code index 7".
The value 1 of a bit indicates that the channelisation code index is available for the ASC this IE is associated to. The value 0 of a bit indicates that the channelisation code index is not available for the ASC this IE is associated to.
Default is that all channelisation codes defined in PRACH Info are available. | |
| >>>>7.68 Mcps TDD | | | | | REL-7 |
| >>>>>Available Channelisation codes indices | MD | | Bit string(16) | Each bit indicates availability of a channelisation code index, where the channelisation code indices are numbered "channelisation code index 0" to "channelisation code index 15".
The value 1 of a bit indicates that the channelisation code index is available for the ASC this IE is associated to. The value 0 of a bit indicates that the channelisation code index is not | REL-7 |

| Information Element/Group name | Need | Multi | Type and reference | Semantics description | Version |
|-------------------------------------|------|-------|--------------------|---|---------|
| | | | | available for the ASC this IE is associated to. Default is that all channelisation codes defined in PRACH Info are available. | |
| >>>1.28 Mcps TDD | | | | | REL-4 |
| >>>>Available SYNC_UL codes indices | MD | | Bit string(8) | Each bit indicates availability of a SYNC_UL code index, where the SYNC_UL code indices are numbered "SYNC_UL code index 0" to "SYNC_UL code index 7". The value 1 of a bit indicates that the SYNC_UL code index is available for the ASC this IE is associated to. The value 0 of a bit indicates that the SYNC_UL code index is not available for the ASC this IE is associated to. Default is that all SYNC_UL codes defined in SYNC_UL Info are available. | REL-4 |
| >>CHOICE <i>subchannel size</i> | MP | | | | |
| >>>Size1 | | | | | |
| >>>>Available Subchannels | MP | | null | Indicates that all Subchannels are available | |
| >>>Size2 | | | | | |
| >>>>Available Subchannels | MD | | Bit string (2) | NOTE | |
| >>>Size4 | | | | | |
| >>>>Available Subchannels | MD | | Bit string (4) | NOTE | |
| >>>Size8 | | | | | |
| >>>>Available Subchannels | MD | | Bit string (8) | NOTE | |
| >>>Size16 | | | | | |
| >>>>Available Subchannels | MD | | Bit string (16) | NOTE | |

NOTE: Each bit indicates availability of a subchannel, where the subchannels are numbered subchannel 0, subchannel 1 etc. The value 1 of a bit indicates that the subchannel is available for the ASC this IE is associated with. The value 0 of a bit indicates that the subchannel is not available for the ASC this IE is associated with. Default value of the IE is that all subchannels within the size are available for the ASC this IE is associated with.

10.3.6.7 Void

10.3.6.8 CCTrCH power control info

Parameters used by UE to set the SIR target value for uplink open loop power control in TDD.

| Information Element/Group name | Need | Multi | Type and Reference | Semantics description |
|--------------------------------|------|-------|---|---|
| TFCS Identity | OP | | Transport Format Combination Set Identity 10.3.5.21 | TFCS Identity of this CCTrCH. Default value is 1. |
| Uplink DPCH power control info | MP | | Uplink DPCH power control info 10.3.6.91 | |

10.3.6.8a Cell and Channel Identity info

NOTE: Only for TDD.

| Information Element/Group name | Need | Multi | Type and Reference | Semantics description |
|--------------------------------|------|-------|-----------------------------|---|
| Burst type | MP | | Enumerated (Type1, Type2) | Identifies the channel in combination with the Midamble shift and slot number. It is not used in 1.28 Mcps TDD and may be set to either value. This IE should be ignored by the receiver. |
| Midamble Shift | MP | | Integer (0...15) | |
| Time Slot | MP | | Timeslot number 10.3.6.84 | This IE is present only if no IPDL scheme is configured in the reference cell. Otherwise the slot is defined by the IPDL configuration. |
| Cell parameters ID | MP | | Cell parameters ID 10.3.6.9 | Identifies the cell |

10.3.6.9 Cell parameters Id

| Information Element/Group name | Need | Multi | Type and Reference | Semantics description |
|--------------------------------|------|-------|--------------------|-----------------------|
| Cell parameter Id | MP | | Integer(0..127) | |

10.3.6.9a Common E-DCH system info

NOTE: Only for FDD and 1.28 Mcps TDD.

| Information Element/Group name | Need | Multi | Type and reference | Semantics description | Version |
|--------------------------------|------|-------|--------------------|-----------------------|---------|
|--------------------------------|------|-------|--------------------|-----------------------|---------|

| | | | | | |
|---|----|--|---|--|-------|
| UL interference for common E-DCH | OP | | UL interference
10.3.6.87 | | REL-8 |
| Common E-DCH MAC-d flows | MP | | Common E-DCH MAC-d flows
10.3.5.3b | | REL-8 |
| CHOICE <i>mode</i> | MP | | | | REL-8 |
| >FDD | | | | | REL-8 |
| >>PRACH preamble control parameters (for Enhanced Uplink) | MP | | PRACH preamble control parameters (for Enhanced Uplink)
10.3.6.54a | Control parameters of the physical signal. | REL-8 |
| >>Initial Serving grant value | MP | | Integer (0..37) | (0..37) indicates E-DCH serving grant index as defined in [15]. | REL-8 |
| >>E-DCH Transmission Time Interval | MP | | Integer(2,10) | Unit is ms. | REL-8 |
| >>E-AGCH Info | MP | | E-AGCH Info
10.3.6.100 | | REL-8 |
| >>HARQ info for E-DCH | MP | | HARQ info for E-DCH
10.3.5.7d | | REL-8 |
| >>Uplink DPCH power control info | MP | | Uplink DPCH power control info for Common E-DCH
10.3.6.91a | | REL-8 |
| >>E-DPCCH info | MP | | E-DPCCH Info
10.3.6.98 | | REL-8 |
| >>E-DPDCH info | MP | | E-DPDCH info
10.3.6.99 | | REL-8 |
| >>F-DPCH TPC command error rate target | MP | | Real (0.01..0.1 by step of 0.01). | Downlink F-DPCH information. The actual value of dl-FDPCH-TPCcommandErrorRate = IE value * 0.01 | REL-8 |
| >>Additional E-DCH transmission back off | MP | | Integer (0..15) | In terms of TTIs. | REL-8 |
| >>Maximum E-DCH resource allocation for CCCH | MP | | Enumerated (8, 12, 16, 20, 24, 32, 40, 80) | In terms of TTIs. | REL-8 |
| >>Maximum period for collision resolution phase | MP | | Integer (8..24) | In terms of TTIs. | REL-8 |
| >>E-DCH transmission continuation back off | MP | | Enumerated (0, 4, 8, 16, 24, 40, 80, infinity) | In terms of TTIs. If set to "infinity", implicit common E-DCH resource release is disabled. | REL-8 |
| >>ACK/NACK support on HS-DPCCH | MP | | Boolean | TRUE indicates that HS-DPCCH shall be used when a common E-DCH resource is allocated to the UE for DTCH/DCCH transmission after collision resolution. FALSE indicates that | REL-8 |

| | | | | | |
|---|----------|-----------------|---|--|-------|
| | | | | HS-DPCCH shall not be used | |
| >>Measurement Feedback Info | OP | | Measurement Feedback Info
10.3.6.40a | | REL-8 |
| >>>Common E-DCH Resource Configuration information list | MP | 1 to <maxEDCHs> | | | REL-8 |
| >>>>Soffset | MD | | Integer(0..9) | (0..9) indicates symbol offset as defined in [26]
NOTE3 | REL-8 |
| >>>>F-DPCH Code number | CV-Short | | Integer (0..255) | If this IE is not present, the value is equal to the last occurrence of this IE. | REL-8 |
| >>>>E-RGCH Information | OP | | E-RGCH Info for Common E-DCH
10.3.6.115 | | REL-8 |
| >>>>E-HICH info | MP | | E-HICH info for Common E-DCH
10.3.6.116 | | REL-8 |
| >>>>Uplink DPCH code info | MP | | Uplink DPCH code info for Common E-DCH
10.3.6.87b | | REL-8 |
| >TDD | | | | | REL-8 |
| >>CHOICE <i>TDD option</i> | MP | | | | REL-8 |
| >>>7.68 Mcps TDD | | | NULL | | REL-8 |
| >>>3.84 Mcps TDD | | | NULL | | REL-8 |
| >>>1.28 Mcps TDD | | | | | REL-8 |
| >>>>E-RUCCH Info | MP | | E-RUCCH Info 1.28 Mcps TDD
10.3.6.103a | | REL-8 |
| >>>>E-PUCH info | MP | | E-PUCH Info 1.28 Mcps TDD
10.3.6.104a | Note1 | REL-8 |
| >>>>E-HICH info | MP | | E-HICH info 1.28 Mcps TDD
10.3.6.101a | Note1 | REL-8 |
| >>>>E-AGCH Info | MP | | E-AGCH Info 1.28 Mcps TDD
10.3.6.100a | Note1 | REL-8 |
| >>>>HARQ info for E-DCH | MP | | HARQ info for E-DCH
10.3.5.7d | | REL-8 |
| >>>>CCCH transmission info | MP | | | Note2 | REL-8 |
| >>>>>Common E-RNTI info | MP | | Common E-RNTI info
10.3.3.7a | | REL-8 |
| >>>>>HARQ maximum number of retransmissions | MP | | Integer (0..7) | | REL-8 |
| >>>>>HARQ retransmission timer | MP | | Enumerated (10, 15, 20, 25, 30, 35, 40, 45, 50, 55, 60, 65, 70, 75, 80, | Unit: ms | REL-8 |

| | | | | | |
|---|----|--|---|--|-------|
| | | | 85, 90, 95,
100, 110,
120, 140,
160) | | |
| >>>>HARQ power offset | MP | | Integer(0..6) | | REL-8 |
| <p>NOTE3: The default value is defined by:
 $Soffset = (offset + common\ E\text{-}DCH\ resource\ list\ position) \bmod 10$
 where "offset" is the value of the last instance of the IE "Soffset". If the IE "Soffset" was not present in the first occurrence, "offset" is equal to zero.
 "common E-DCH resource list position" indicates the Common E-DCH resource Configuration Information number by order of appearance. The value of the "common E-DCH resource list position" is zero for the first occurrence.</p> | | | | | |

| Condition | Explanation |
|-----------|--|
| Short | This IE is mandatory present for the first occurrence. Otherwise, this IE is optional. |

NOTE1: These IEs correspond to the HS-DSCH configuration for CELL_FACH, CELL_PCH and URA_PCH state on primary frequency, the configuration on secondary frequency is signalled to UE via dedicated signalling.

NOTE2: These IEs correspond to CCCH transmission configuration for CELL_FACH state on the primary frequency and secondary frequency.

| Condition | Explanation |
|-----------|--|
| Short | This IE is mandatory present for the first occurrence. Otherwise, this IE is optional. |

10.3.6.10 Common timeslot info

| Information Element/Group name | Need | Multi | Type and reference | Semantics description |
|-----------------------------------|------|-------|-----------------------------------|---|
| 2 nd interleaving mode | MD | | Enumerated(Frame, Timeslot) | Frame timeslot related interleaving. Default value is "Frame" |
| TFCI coding | MD | | Integer(4,8,16,32) | Describes the amount of bits for the TFCI bits code word as described in [31]. Defaults is no TFCI bit:
In case of 8 PSK in 1.28Mcps TDD:
4 corresponds to 6 TFCI code word bits.
8 corresponds to 12 TFCI code word bits.
16 corresponds to 24 TFCI code word bits.
32 corresponds to 48 TFCI code word bits. |
| Puncturing limit | MP | | Real(0.40..1.0 by step of 0.04) | |
| Repetition period | MD | | Integer(1, 2,4,8,16,32,64) | Default is continuous allocation. Value 1 indicate continuous |
| Repetition length | MP | | Integer(1..Repetition period - 1) | NOTE: This is empty if repetition period is set to 1. |

10.3.6.10a Common timeslot info MBMS

| Information Element/Group name | Need | Multi | Type and reference | Semantics description |
|-----------------------------------|------|-------|---------------------------------|---|
| 2 nd interleaving mode | MD | | Enumerated(Frame, Timeslot) | Frame timeslot related interleaving. Default value is "Frame" |
| TFCI coding | MD | | Integer(4,8,16,32) | Describes the amount of bits for the TFCI bits code word as described in [31]. Defaults is no TFCI bit:
In case of 8 PSK in 1.28Mcps TDD:
4 corresponds to 6 TFCI code word bits.
8 corresponds to 12 TFCI code word bits.
16 corresponds to 24 TFCI code word bits.
32 corresponds to 48 TFCI code word bits. |
| Puncturing limit | MP | | Real(0.40..1.0 by step of 0.04) | |

10.3.6.11 Constant value

NOTE: Only for FDD.

This constant value is used by the UE to calculate the initial output power on PRACH according to the Open loop power control procedure.

| Information Element/Group name | Need | Multi | Type and reference | Semantics description |
|--------------------------------|------|-------|--------------------|-----------------------|
| Constant value | MP | | Integer (-35..-10) | In dB |

10.3.6.11a Constant value TDD

NOTE: Only for 3.84 Mcps TDD and 7.68 Mcps TDD.

3.84 Mcps TDD and 7.68 Mcps TDD constant values are used for open loop power control of PRACH, USCH, HS-SICH and UL DPCH as defined in subclause 8.5.7.

| Information Element/Group name | Need | Multi | Type and reference | Semantics description |
|--------------------------------|------|-------|--------------------|-----------------------|
| TDD Constant value | MP | | Integer (-35..+10) | In dB |

10.3.6.12 Void

10.3.6.13 Void

10.3.6.14 Void

10.3.6.15 Void

10.3.6.16 Default DPCH Offset Value

Indicates the default offset value within interleaving size at a resolution of 512chip (1/5 slot) in FDD and a resolution of one frame in TDD to offset CFN in the UE. This is used to distribute discontinuous transmission periods in time and also to distribute NodeB-RNC transmission traffics in time. Even though the CFN is offset by DOFF, the start timing of the interleaving will be the timing that "CFN mod (interleaving size)"=0 (e.g. interleaving size: 2,4,8) in both UE and SRNC.

| Information Element/Group name | Need | Multi | Type and reference | Semantics description |
|------------------------------------|------|-------|------------------------------------|--|
| CHOICE <i>mode</i> | | | | |
| >FDD | | | | |
| >>Default DPCH Offset Value (DOFF) | MP | | Integer (0..306688 by step of 512) | Number of chips=. 0 to 599 time 512 chips, see [10]. |
| >TDD | | | | |
| >>Default DPCH Offset Value (DOFF) | MP | | Integer(0..7) | Number of frames; See [10] |

10.3.6.17 Downlink channelisation codes

NOTE: Only for 1.28 Mcps TDD and 3.84 Mcps TDD.

| Information Element/Group name | Need | Multi | Type and reference | Semantics description |
|------------------------------------|------|-------|----------------------------------|--|
| CHOICE <i>codes representation</i> | MP | | | |
| >Consecutive codes | | | | |
| >>First channelisation code | MP | | Enumerated ((16/1)...(16/1 6)) | If a TFCI exists in this timeslot, it is mapped to the channelisation code as defined in [30]. |
| >>>Last channelisation code | MP | | Enumerated ((16/1)...(16/1 6)) | If this is the same as First channelisation code, only one code is used by the physical layer. |
| >Bitmap | | | | |
| >>Channelisation codes bitmap | MP | | Bit string(16) | Each bit indicates the availability of a channelisation code for SF16, where the channelisation codes are numbered as channelisation code 1 (SF16) to channelisation code 16 (SF16). (For SF 16, a 1 in the bitmap means that the corresponding code is used, a 0 means that the corresponding code is not used.)
If all bits are set to zero, SF 1 shall be used.
For dedicated MBSFN frequency timeslot, if the first half in the bit pattern is set to 1010101000000000, the first channelisation code with SF 2 shall be used; if the second half of bit pattern is set to 0000000010101010, the second channelisation code with SF 2 shall be used; if all bits are set to 1010101010101010, both the first and second channelisation codes with SF2 shall be used. |

10.3.6.17a Downlink channelisation codes VHCR

NOTE: Only for 7.68 Mcps TDD VHCR

| Information Element/Group name | Need | Multi | Type and reference | Semantics description | Version |
|------------------------------------|------|-------|---------------------------------|--|---------|
| CHOICE <i>codes representation</i> | MP | | | | REL-7 |
| >Consecutive codes | | | | | REL-7 |
| >>First channelisation code | MP | | Enumerated ((32/1)...(32/3 2)) | If a TFCI exists in this timeslot, it is mapped to the channelisation code as defined in [30]. | REL-7 |
| >>>Last channelisation code | MP | | Enumerated ((32/1)...(32/3 2)) | If this is the same as First channelisation code, only one code is used by the physical layer. | REL-7 |
| >Bitmap | | | | | REL-7 |
| >>Channelisation codes bitmap | MP | | Bit string(32) | Each bit indicates the availability of a channelisation code for SF32, where the channelisation codes are numbered as channelisation code 1 (SF32) to channelisation code 32 (SF32). (For SF 32, a 1 in the bitmap means that the corresponding code is used, a 0 means that the corresponding code is not used.) If all bits are set to zero, SF 1 shall be used. | REL-7 |

10.3.6.18 Downlink DPCH info common for all RL

| Information Element/Group name | Need | Multi | Type and reference | Semantics description | Version |
|---|--------------------|-------|---|--|---------|
| Timing Indication | MP | | Enumerated(Initialise, Maintain) | NOTE | |
| Timing maintained Synchronization indicator | CV- <i>Synch</i> | | Enumerated (FALSE) | FALSE indicates that no synchronisation procedure shall be performed for timing maintained inter-frequency hard handover [29]. Absence of this element means that the synchronization procedure A shall be used. | REL-6 |
| Downlink DPCH power control information | OP | | Downlink DPCH power control information 10.3.6.23 | | |
| MAC-d HFN initial value | CV- <i>Message</i> | | Bit string(24) | | REL-4 |
| CHOICE <i>mode</i> | MP | | | | |
| >FDD | | | | | |
| >>Power offset $P_{\text{Pilot-DPCH}}$ | MP | | Integer(0..24) | Power offset equals $P_{\text{Pilot}} - P_{\text{DPCH}}$, range 0..6 dB, in steps of 0.25 dB | |
| >>>Downlink rate matching restriction information | OP | | Downlink rate matching restriction information | If this IE is set to "absent", no Transport CH is restricted in TFI. | |

| Information Element/Group name | Need | Multi | Type and reference | Semantics description | Version |
|-----------------------------------|------|-------|--|---|---------|
| | | | n
10.3.6.31 | | |
| >>Spreading factor | MP | | Integer(4, 8, 16, 32, 64, 128, 256, 512) | | |
| >>Fixed or Flexible Position | MP | | Enumerated (Fixed, Flexible) | | |
| >>TFCI existence | MP | | Boolean | TRUE indicates that TFCI is used. When spreading factor is less than or equal to 64, FALSE indicates that TFCI is not used and therefore DTX is used in the TFCI field. | |
| >>>CHOICE SF | MP | | | | |
| >>>>SF = 256 | | | | | |
| >>>>Number of bits for Pilot bits | MP | | Integer (2,4,8) | In bits | |
| >>>>SF = 128 | | | | | |
| >>>>Number of bits for Pilot bits | MP | | Integer(4, 8) | In bits | |
| >>>>Otherwise | | | | (no data). In ASN.1 choice "Otherwise" is not explicitly available as all values are available, it is implied by the use of any value other than 128 or 256. | |
| >TDD | | | | (no data) | |

| CHOICE SF | Condition under which the given SF is chosen |
|-----------|--|
| SF=128 | "Spreading factor" is set to 128 |
| SF=256 | "Spreading factor" is set to 256 |
| Otherwise | "Spreading factor" is set to a value distinct from 128 and 256 |

| Condition | Explanation |
|----------------|--|
| <i>Message</i> | This IE is not needed if the IE "Downlink DPCH info common for all RL" is included in RRC CONNECTION SETUP or HANDOVER TO UTRAN COMMAND messages. Otherwise it is optional. |
| <i>Synch</i> | The IE is not needed in the CELL UPDATE CONFIRM, HANDOVER TO UTRAN COMMAND and the RRC CONNECTION SETUP messages or if the IE "Timing Indication" is set to "Initialise" or if the IE 'Frequency Info' is not included. Otherwise, it is optional. |

NOTE: Within the HANDOVER TO UTRAN COMMAND message, only value "initialise" is applicable.

10.3.6.19 Downlink DPCH info common for all RL Post

| Information Element/Group name | Need | Multi | Type and reference | Semantics description |
|---|------|-------|--|-----------------------|
| Downlink DPCH power control information | OP | | Downlink DPCH power control information
10.3.6.23 | |

10.3.6.20 Downlink DPCH info common for all RL Pre

| Information Element/Group name | Need | Multi | Type and reference | Semantics description |
|-----------------------------------|------|-------|--|---|
| CHOICE <i>mode</i> | MP | | | |
| >FDD | | | | |
| >>Spreading factor | MP | | Integer(4, 8, 16, 32, 64, 128, 256, 512) | Defined in CHOICE SF512-Andpilot with "number of its for pilot bits" in ASN.1 |
| >>Fixed or Flexible Position | MP | | Enumerated (Fixed, Flexible) | |
| >>TFCI existence | MP | | Boolean | TRUE indicates that TFCI is used. When spreading factor is less than or equal to 64, FALSE indicates that TFCI is not used and therefore DTX is used in the TFCI field. |
| >>CHOICE <i>SF</i> | MP | | | |
| >>>SF = 256 | | | | |
| >>>>Number of bits for Pilot bits | MP | | Integer (2,4,8) | In bits |
| >>>SF = 128 | | | | |
| >>>>Number of bits for Pilot bits | MP | | Integer(4,8) | In bits |
| >>>Otherwise | | | | (no data) |
| >TDD | | | | |
| >>Common timeslot info | MP | | Common Timeslot Info
10.3.6.10 | |

| CHOICE <i>SF</i> | Condition under which the given <i>SF</i> is chosen |
|------------------|--|
| SF=128 | "Spreading factor" is set to 128 |
| SF=256 | "Spreading factor" is set to 256 |
| Otherwise | "Spreading factor" is set to a value distinct from 128 and 256 |

10.3.6.21 Downlink DPCH info for each RL

| Information Element/Group name | Need | Multi | Type and reference | Semantics description | Version |
|--|------|-------|---|---|---------|
| CHOICE <i>mode</i> | MP | | | | |
| >FDD | | | | | |
| >>Primary CPICH usage for channel estimation | MP | | Primary CPICH usage for channel estimation
10.3.6.62 | | |
| >>DPCH frame offset | MP | | Integer(0..38144 by | Offset (in number of chips) between the | |

| Information Element/Group name | Need | Multi | Type and reference | Semantics description | Version |
|--------------------------------------|---------------------|------------------------|---|--|---------|
| | | | step of 256) | beginning of the P-CCPCH frame and the beginning of the DPCH frame
This is called $\tau_{DPCH,n}$ in [26] | |
| >>Secondary CPICH info | OP | | Secondary CPICH info
10.3.6.73 | | |
| >>DL channelisation code | MP | 1 to <maxDPCH-DLchan > | | For the purpose of physical channel mapping [27] the DPCHs are numbered, starting from DPCH number 1, according to the order that they are contained in this IE. | |
| >>>Secondary scrambling code | MD | | Secondary scrambling code
10.3.6.74 | Default is the same scrambling code as for the Primary CPICH | |
| >>>Spreading factor | MP | | Integer(4, 8, 16, 32, 64, 128, 256, 512) | Defined in CHOICE SF512-AndCodenumbr with "code number" in ASN.1 | |
| >>>Code number | MP | | Integer(0.. Spreading factor - 1) | | |
| >>>Scrambling code change | CH-SF/2 | | Enumerated (code change, no code change) | Indicates whether the alternative scrambling code is used for compressed mode method 'SF/2'. | |
| >>TPC combination index | MP | | TPC combination index
10.3.6.85 | | |
| >>Power offset $P_{TPC-DPDCCH}$ | OP | | Integer (0..24) | Power offset equals $P_{TPC} - P_{DPDCCH}$, range 0..6 dB, in steps of 0.25 dB | REL-5 |
| >>Closed loop timing adjustment mode | CH-TxDiversity Mode | | Integer(1, 2) | It is present if Tx Diversity is used in the radio link. | |
| >1.28 Mcps TDD or 3.84 Mcps TDD | | | | | |
| >>DL CCTrCh List | OP | 1..<max CCTrCH > | | DL physical channels to establish or reconfigure list. | |
| >>>TFCS ID | MD | | Integer(1.. 8) | Identity of this CCTrCh. Default value is 1 | |
| >>>Time info | MP | | Time Info
10.3.6.83 | | |
| >>>Common timeslot info | MD | | Common Timeslot Info
10.3.6.10 | Default is the current Common timeslot info | |
| >>>Downlink DPCH timeslots and codes | MD | | Downlink Timeslots and Codes
10.3.6.32 | Default is to use the old timeslots and codes. | |
| >>>UL CCTrCH TPC List | MD | 0..<max CCTrCH | | UL CCTrCH identities for TPC commands | |

| Information Element/Group name | Need | Multi | Type and reference | Semantics description | Version |
|---|------|------------------|---|---|---------|
| | | > | | associated with this DL CcTrCH. Default is previous list or all defined UL CcTrCHs. This list is not required for 1.28 Mcps TDD and is to be ignored by the UE. | |
| >>>>UL TPC TFCS Identity | MP | | Transport Format Combination Set Identity 10.3.5.21 | | |
| >>DL CcTrCH List to Remove | OP | 1..<max CcTrCH > | | DL physical channels to remove list. | |
| >>>TFCS ID | MP | | Integer(1..8) | | |
| >7.68 Mcps TDD | | | | | REL-7 |
| >>DL CcTrCh List | OP | 1..<max CcTrCH > | | DL physical channels to establish or reconfigure list. | REL-7 |
| >>>TFCS ID | MD | | Integer(1..8) | Identity of this CcTrCh. Default value is 1 | REL-7 |
| >>>Time info | MP | | Time Info 10.3.6.83 | | REL-7 |
| >>>Common timeslot info | MD | | Common Timeslot Info 10.3.6.10 | Default is the current Common timeslot info | REL-7 |
| >>>Downlink DPCH timeslots and codes VHCR | MD | | Downlink Timeslots and Codes VHCR 10.3.6.32 a | Default is to use the old timeslots and codes. | REL-7 |
| >>>>UL CcTrCH TPC List | MD | 0..<max CcTrCH > | | UL CcTrCH identities for TPC commands associated with this DL CcTrCH. Default is previous list or all defined UL CcTrCHs. This list is not required for 1.28 Mcps TDD and is to be ignored by the UE. | REL-7 |
| >>>>UL TPC TFCS Identity | MP | | Transport Format Combination Set Identity 10.3.5.21 | | REL-7 |
| >>DL CcTrCH List to Remove | OP | 1..<max CcTrCH > | | DL physical channels to remove list. | REL-7 |
| >>>TFCS ID | MP | | Integer(1..8) | | REL-7 |

| Condition | Explanation |
|-------------------------|--|
| <i>SF/2</i> | The information element is mandatory present if the UE has a compressed mode pattern sequence configured in variable TGPS_IDENTITY or included in the message including IE "Downlink DPCH info for each RL", which is using compressed mode method "SF/2". Otherwise the IE is not needed. |
| <i>TxDiversity Mode</i> | This IE is mandatory present if any TX Diversity Mode is used on the radio link, i.e. if STTD or "closed loop mode 1" is used on the radio link. Otherwise the IE is not needed. |

10.3.6.22 Downlink DPCH info for each RL Post

| Information Element/Group name | Need | Multi | Type and reference | Semantics description |
|--|---------|-------|---|--|
| CHOICE <i>mode</i> | MP | | | |
| >FDD | | | | |
| >>Primary CPICH usage for channel estimation | MP | | Primary CPICH usage for channel estimation
10.3.6.62 | |
| >>Secondary scrambling code | MD | | Secondary scrambling code
10.3.6.74 | Default is the same scrambling code as for the Primary CPICH |
| >>CHOICE <i>Spreading factor</i> | MP | | Integer(4, 8, 16, 32, 64, 128, 256, 512) | Defined in CHOICE SF512-AndCodenumbr with "code number" in ASN.1 |
| >>Code number | MP | | Integer(0.. Spreading factor - 1) | |
| >>Scrambling code change | CH-SF/2 | | Enumerated (code change, no code change) | Indicates whether the alternative scrambling code is used for compressed mode method 'SF/2'. |
| >>TPC combination index | MP | | TPC combination index
10.3.6.85 | |
| >1.28 Mcps TDD or 3.84 Mcps TDD | | | | |
| >>Downlink DPCH timeslots and codes | MP | | Downlink Timeslots and Codes
10.3.6.32 | |
| >7.68 Mcps TDD | | | | REL-7 |
| >>Downlink DPCH timeslots and codes VHCR | MP | | Downlink Timeslots and Codes VHCR
10.3.6.32a | REL-7 |

| Condition | Explanation |
|-------------|---|
| <i>SF/2</i> | The information element is mandatory present if the UE has a compressed mode pattern sequence configured in variable TGPS_IDENTITY or included in the message including IE "Downlink DPCH info for each RL Post", which is using compressed mode method "SF/2". Otherwise the IE is not needed. |

10.3.6.23 Downlink DPCH power control information

| Information Element/Group name | Need | Multi | Type and reference | Semantics description |
|--------------------------------|------|-------|--|---|
| CHOICE <i>mode</i> | MP | | | |
| >FDD | | | | |
| >>DPC Mode | MP | | Enumerated (Single TPC, TPC triplet in soft) | "Single TPC" is DPC_Mode=0 and "TPC triplet in soft" is DPC_mode=1 in [29]. |
| >TDD | | | | |
| >>TPC Step Size | OP | | Integer (1, 2, 3) | In dB |

10.3.6.23oa Downlink F-DPCH info common for all RL

NOTE: For FDD only.

| Information Element/Group name | Need | Multi | Type and reference | Semantics description | Version |
|---|------------------|-------|---|---|---------|
| Timing Indication | MP | | Enumerated (Initialise, Maintain) | | REL-6 |
| Timing maintained Synchronization indicator | CV- <i>Synch</i> | | Enumerated (FALSE) | FALSE indicates that no synchronisation procedure shall be performed for timing maintained intra- and inter-frequency hard handover [29]. Absence of this element means that the synchronization procedure A shall be used. | REL-6 |
| Downlink F-DPCH power control information | OP | | Downlink DPCH power control information 10.3.6.23 | | REL-6 |
| TPC command error rate target | MP | | Real (0.01..0.1 by step of 0.01) | | REL-6 |

| Condition | Explanation |
|--------------|--|
| <i>Synch</i> | The IE is not needed in the CELL UPDATE CONFIRM, HANDOVER TO UTRAN COMMAND and the RRC CONNECTION SETUP messages or if the IE "Timing Indication" is set to "Initialise". Otherwise, it is optional. |

10.3.6.23ob Downlink F-DPCH info for each RL

NOTE: For FDD only.

| Information Element/Group name | Need | Multi | Type and reference | Semantics description | Version |
|--|------|-------|--|-----------------------|---------|
| Primary CPICH usage for channel estimation | MP | | Primary CPICH usage for channel estimation 10.3.6.62 | | REL-6 |
| F-DPCH frame | MP | | Integer (0..38144 | Offset (in | REL-6 |

| Information Element/Group name | Need | Multi | Type and reference | Semantics description | Version |
|--------------------------------|---------------------------|-------|-------------------------------------|---|---------|
| offset | | | by step of 256) | number of chips) between the beginning of the P-CCPCH frame and the beginning of the F-DPCH frame
This is called $\tau_{F-DPCH,n}$ in [26] | |
| F-DPCH slot format | OP | | Integer (0..9 by steps of 1) | Slot format used by F-DPCH in [26].
Absence of this element means that slot format 0 is applied. | REL-7 |
| Secondary CPICH info | OP | | Secondary CPICH info 10.3.6.73 | | REL-6 |
| Secondary scrambling code | MD | | Secondary scrambling code 10.3.6.74 | Default is the same scrambling code as for the Primary CPICH | REL-6 |
| Code number | MP | | Integer (0..255) | | REL-6 |
| TPC combination index | MP | | TPC combination index 10.3.6.85 | | REL-6 |
| STTD indication | CV-
<i>NoHOtoUTRAN</i> | | Enumerated (TRUE) | This IE shall be set to TRUE when STTD is used. Absence of this element means STTD is not used. | REL-6 |

| Condition | Explanation |
|--------------------|---|
| <i>NoHOtoUTRAN</i> | This IE is not needed in the HANDOVER TO UTRAN COMMAND and it is optional in all the other messages in which the IE "Downlink F-DPCH info for each RL" can be included. |

10.3.6.23a Downlink HS-PDSCH Information

| Information Element/Group name | Need | Multi | Type and reference | Semantics description | Version |
|--|------------------------|-------|---|--|---------|
| HS-SCCH Info | OP | | HS-SCCH Info
10.3.6.36a | For 1.28 Mcps TDD, if IE DL Multi-Carrier Information is present, ignore this IE. | REL-5 |
| Measurement Feedback Info | OP | | Measurement Feedback Info
10.3.6.40a | | REL-5 |
| CHOICE mode | MP | | | | REL-5 |
| >TDD | | | | | |
| >>CHOICE <i>TDD option</i> | MP | | | | REL-5 |
| >>>3.84 Mcps | | | | | |
| >>>>HS-PDSCH Timeslot Configuration | OP | | HS-PDSCH Timeslot Configuration
10.3.6.36o | | REL-5 |
| >>>>7.68 Mcps | | | | | REL-7 |
| >>>>HS-PDSCH Timeslot Configuration VHCR | OP | | HS-PDSCH Timeslot Configuration VHCR
10.3.6.36oa | | REL-7 |
| >>>>1.28 Mcps | | | | | |
| >>>>>HS-PDSCH Midamble Configuration | OP | | HS-PDSCH Midamble Configuration
10.3.6.36oo | For 1.28 Mcps TDD, if IE DL Multi-Carrier Information is present, ignore this IE. | REL-5 |
| >>>>>DL Multi-Carrier Information | OP | | DL Multi-Carrier Information
10.3.6.28a | | REL-7 |
| >>>>>Out of Sync window | MD | | Enumerated (40, 80, 160, 320, 640) | Value in milliseconds. Default value is 160. Three spare values needed. | REL-8 |
| >FDD | | | | | |
| >>Downlink 64QAM configured | OP | | Enumerated (TRUE) | Absence of this IE means that the HS-SCCH does not use the 64QAM format. The presence of this IE means the UE uses the octet aligned table [15]. | REL-7 |
| >>HS-DSCH TB size table | CV-
<i>Not64QAM</i> | | Enumerated (octet aligned) | If this IE is present, octet aligned table [15] is used, else bit aligned table [15] is used. NOTE 1 | REL-7 |
| NOTE 1: UE shall apply this rule only if the IE "Downlink HS-PDSCH information" is present in the received message. UE behaviour is unspecified if the IE "Downlink HS-PDSCH information" is absent when the ASN.1 non-critical extension where the IE "HS-DSCH TB size table" is referenced is present in the received message. | | | | | |

| Condition | Explanation |
|-----------------|--|
| <i>Not64QAM</i> | This IE is optionally present if 64QAM is not configured and MAC-e-hs is configured. Otherwise it is not needed. |

10.3.6.24 Downlink information common for all radio links

| Information Element/Group name | Need | Multi | Type and reference | Semantics description | Version |
|---|---------------------------|-------|---|---|---------|
| CHOICE <i>DPCH info</i> | OP | | | | REL-6 |
| >Downlink DPCH info common for all RL | MP | | Downlink DPCH info common for all RL
10.3.6.18 | | |
| >Downlink F-DPCH info common for all RL | MP | | Downlink F-DPCH info common for all RL
10.3.6.23oa | | REL-6 |
| CHOICE <i>mode</i> | MP | | | | |
| >FDD | | | | | |
| >>DPCH compressed mode info | OP | | DPCH compressed mode info
10.3.6.33 | | |
| >>TX Diversity Mode | MD | | TX Diversity Mode
10.3.6.86 | Default value is the existing value of TX Diversity mode | |
| >TDD | | | | (no data) | |
| >>CHOICE <i>TDD option</i> | MP | | | | REL-4 |
| >>>3.84 Mcps TDD | | | | (no data) | REL-4 |
| >>>7.68 Mcps TDD | | | | (no data) | REL-7 |
| >>>1.28 Mcps TDD | | | | | REL-4 |
| >>>>TSTD indicator | MP | | TSTD indicator
10.3.6.85a | | REL-4 |
| Default DPCH Offset Value | OP | | Default DPCH Offset Value,
10.3.6.16 | | |
| MAC-hs reset indicator | CV-
<i>messageType</i> | | Enumerated (TRUE) | TRUE Indicates the MAC-hs/ehs entity needs to be reset. | REL-5 |
| Post-verification period | OP | | Enumerated (TRUE) | TRUE indicates that a post-verification period shall be used [29]. Absence of this element means that a post-verification period shall not be used. | REL-6 |

| Condition | Explanation |
|--------------------|---|
| <i>MessageType</i> | The IE is not needed in the HANDOVER TO UTRAN COMMAND and the RRC CONNECTION SETUP messages. Otherwise, it is optional. |

10.3.6.25 Downlink information common for all radio links Post

| Information Element/Group name | Need | Multi | Type and reference | Semantics description |
|--------------------------------------|------|-------|---|-----------------------|
| Downlink DPCH info common for all RL | MP | | Downlink DPCH info common for all RL Post 10.3.6.19 | |

10.3.6.26 Downlink information common for all radio links Pre

| Information Element/Group name | Need | Multi | Type and reference | Semantics description |
|--------------------------------------|------|-------|--|-----------------------|
| Downlink DPCH info common for all RL | MP | | Downlink DPCH info common for all RL Pre 10.3.6.20 | |

10.3.6.27 Downlink information for each radio link

| Information Element/Group name | Need | Multi | Type and reference | Semantics description | Version |
|---|------|-------|---|---|---------|
| CHOICE <i>mode</i> | MP | | | | |
| >FDD | | | | | |
| >>Primary CPICH info | MP | | Primary CPICH info
10.3.6.60 | | |
| >>>Cell ID | OP | | Cell ID
10.3.2.2 | | REL-4 |
| >>>Serving HS-DSCH radio link indicator | MP | | Boolean | The value TRUE indicates that this radio link is the serving HS-DSCH radio link | REL-5 |
| >>>Serving E-DCH radio link indicator | MP | | Boolean | The value TRUE indicates that this radio link is the serving E-DCH radio link | REL-6 |
| >TDD | | | | | |
| >>Primary CCPCH info | MP | | Primary CCPCH info
10.3.6.57 | | |
| CHOICE <i>DPCH info</i> | OP | | | | REL-6 |
| >Downlink DPCH info for each RL | MP | | Downlink DPCH info for each RL
10.3.6.21 | | |
| >Downlink F-DPCH info for each RL | MP | | Downlink F-DPCH info for each RL
10.3.6.23ob | | REL-6 |
| E-AGCH Info | OP | | E-AGCH Info
10.3.6.100 | | REL-6 |
| CHOICE <i>mode</i> | | | | | REL-7 |
| >FDD | | | | | REL-7 |
| >>CHOICE <i>E-HICH Information</i> | OP | | | | REL-6 |
| >>>E-HICH Information | MP | | E-HICH Info
10.3.6.101 | | REL-6 |
| >>>E-HICH release indicator | | | | (no data) | REL-6 |
| >>CHOICE <i>E-RGCH Information</i> | OP | | | | REL-6 |
| >>>E-RGCH Information | MP | | E-RGCH Info
10.3.6.102 | | REL-6 |
| >>>E-RGCH release indicator | | | | (no data) | REL-6 |
| >TDD | | | | (no data) | REL-7 |
| >>E-HICH Information | OP | | E-HICH Info
10.3.6.101 | | REL-7 |

10.3.6.28 Downlink information for each radio link Post

| Information Element/Group name | Need | Multi | Type and reference | Semantics description | Version |
|--------------------------------|------|-------|---------------------------------|-----------------------|---------|
| Choice mode | MP | | | | |
| >FDD | | | | | |
| >>Primary CPICH info | MP | | Primary CPICH info
10.3.6.60 | | |
| >TDD | | | | | |
| >>Primary CCPCH info | MP | | Primary CCPCH info
post | | |

| Information Element/Group name | Need | Multi | Type and reference | Semantics description | Version |
|--------------------------------|------|-------|---|-----------------------|---------|
| Downlink DPCH info for each RL | MP | | 10.3.6.58
Downlink DPCH info for each RL Post
10.3.6.22 | | |

10.3.6.28a DL Multi-Carrier Information (1.28 Mcps TDD only)

| Information Element/Group name | Need | Multi | Type and reference | Semantics description | Version |
|-------------------------------------|-------|-------------------------|--|---|---------|
| TSN-Length | OP | | Enumerated (tsn-6bits, tsn-9bits) | | REL-7 |
| Multi-Carrier number | OP | | Integer(1..maxTDD128Carrier) | | REL-7 |
| DI-HSPDSCH-MultiCarrier-Information | OP | 1 to <maxTDD128Carrier> | | The number of HS-SCCH Sets shall not be larger than UE Multi-Carrier capability | REL-7 |
| >Carrier-Uarfcn | MP | | Integer(0..16383) | | REL-7 |
| >HARQ Info | OP | | HARQ info 10.3.5.7a | | REL-7 |
| >HS-PDSCH Midamble Configuration | OP | | HS-PDSCH Midamble Configuration 10.3.6.36oo | | REL-7 |
| >HS-SCCH Set Configuration | OP | 1 to <maxHS-SCCHs> | | | REL-7 |
| >>HS-SCCH-Receive-Uarfcn | MP | | Integer(0..16383) | | REL-7 |
| >>Timeslot number | MP | | Integer (0..6) | | REL-7 |
| >>First Channelisation code | MP | | Enumerated ((16/1)..(16/16)) | | REL-7 |
| >>Second Channelisation code | MP | | Enumerated ((16/1)..(16/16)) | | REL-7 |
| >>Midamble Allocation mode | MP | | Enumerated (Default midamble, Common midamble, UE specific midamble) | | REL-7 |
| >>Midamble Shift | CV-UE | | Integer (0..15) | | REL-7 |
| >>Midamble configuration | MP | | Integer (2, 4, 6, 8, 10, 12, 14, 16) | | REL-7 |
| >>BLER target | MP | | Real (-3.15..0 by step of 0.05) | Signalled value is Log10(HS-SCCH BLER quality target). The UE shall use the BLER target signalled in the first occurrence of the HS-SCCH Set Configuration. | REL-7 |
| >>HS-SICH configuration | | | | | REL-7 |
| >>>Timeslot number | MP | | Integer (0..6) | | REL-7 |
| >>>Channelisation code | MP | | Enumerated ((16/1)..(16/16)) | | REL-7 |
| >>>Midamble Allocation mode | MP | | Enumerated | | REL-7 |

| | | | | | |
|---------------------------|-------|--|--|---------------------------------------|-------|
| | | | (Default midamble, UE specific midamble) | | |
| >>>Midamble configuration | MP | | Integer (2, 4, 6, 8, 10, 12, 14, 16) | | REL-7 |
| >>>Midamble Shift | CV-UE | | Integer (0..15) | | REL-7 |
| >>>Ack-Nack Power Offset | MP | | Integer (-7..8 by step of 1) | dB. | REL-7 |
| >>>PRX _{HS-SICH} | MP | | Integer (-120..-58 by step of 1) | dBm. Desired power level for HS-SICH. | REL-7 |
| >>>TPC step size | MP | | Integer (1, 2, 3) | dB. | REL-7 |

| Condition | Explanation |
|-----------|--|
| UE | This IE is mandatory present when the value of the IE "Midamble Allocation Mode" is "UE specific midamble" and not needed otherwise. |

10.3.6.29 Void

10.3.6.30 Void

10.3.6.31 Downlink rate matching restriction information

This IE indicates which TrCH is restricted in TFI.

| Information Element/Group name | Need | Multi | Type and reference | Semantics description |
|----------------------------------|------|----------------|--------------------------------------|-----------------------|
| Restricted TrCH information | OP | 1 to <maxTrCH> | | |
| >Downlink transport channel type | MP | | Enumerated(DCH) | |
| >Restricted DL TrCH identity | MP | | Transport channel identity 10.3.5.18 | |
| >Allowed TFIs | MP | 1 to <maxTF> | | |
| >>Allowed TFI | MP | | Integer(0..31) | |

10.3.6.31a Downlink secondary cell info FDD

| Information Element/Group name | Need | Multi | Type and reference | Semantics description | Version |
|--------------------------------|------|-------|--------------------|-----------------------|---------|
|--------------------------------|------|-------|--------------------|-----------------------|---------|

| | | | | | |
|--|------------------------|---------------------------|--|--|-------|
| CHOICE Configuration info | MP | | | | REL-8 |
| >Continue | | | | (no data) | REL-8 |
| >New configuration | | | | | REL-8 |
| >>New H-RNTI | MP | | H-RNTI
10.3.3.14a | | REL-8 |
| >>Downlink 64QAM configured | OP | | Enumerated
(TRUE) | Absence of this IE means that the secondary cell HS-SCCH does not use the 64QAM format. The presence of this IE means the UE uses the octet aligned table [15]. | REL-8 |
| >>HS-DSCH TB size table | CV-
<i>Not64QAM</i> | | Enumerated
(octet aligned) | If this IE is present, octet aligned table [15] is used, else bit aligned table [15] is used. | REL-8 |
| >>Primary CPICH info | MP | | Primary
CPICH Info
10.3.6.60 | | REL-8 |
| >>DL Scrambling Code | MD | | Secondary
scrambling
code
10.3.6.74 | DL Scrambling code to be applied for HS-DSCH and HS-SCCH. Default is same scrambling code as for the primary CPICH. | REL-8 |
| >>HS-SCCH Channelisation Code Information | MP | 1 to
<maxHSS
CCHs > | | Note 1 | REL-8 |
| >>>HS-SCCH Channelisation Code | MP | | Integer
(0..127) | | REL-8 |
| >>Measurement Power Offset | MP | | Real (-6 .. 13
by step of
0.5) | The measurement power offset, Γ , in dB, as described in [29]. | REL-8 |
| >>UARFCN downlink (Nd) | MP | | Integer(0 ..
16383) | [21] | REL-8 |
| >>Different Tx diversity mode configuration from serving HS-DSCH cell | OP | | Enumerated
(Different) | The presence of this IE means that the Tx diversity Mode is different to the Diversity Mode indicated in the serving HS-DSCH cell. Absence of this IE means that the same Tx diversity mode is used as that used for the serving HS-DSCH cell.
Note 2 | REL-8 |
| Note 1: The list of HS-SCCH(s) is assumed to be indexed starting from one. | | | | | |
| Note 2: The UE behaviour is unspecified if the IE "Different Tx diversity mode configuration from serving HS-DSCH cell" is present and the IE "CHOICE Configuration info" is not set to "New configuration" in the received message. | | | | | |

| Condition | Explanation |
|-----------------|---|
| <i>Not64QAM</i> | This IE is optionally present if 64QAM is not configured and MAC-ehs is configured. Otherwise it is not needed. |

10.3.6.32 Downlink Timeslots and Codes

NOTE: Only for 1.28 Mcps TDD and 3.84 Mcps TDD.

| Information Element/Group name | Need | Multi | Type and reference | Semantics description |
|-------------------------------------|------|----------------|---|--|
| First Individual timeslot info | MP | | Individual timeslot info 10.3.6.37 | Individual timeslot info for the first timeslot used by the physical layer. |
| First timeslot channelisation codes | MP | | Downlink channelisation codes 10.3.6.17 | These codes shall be used by the physical layer in the timeslot given in First Individual timeslot info. |
| CHOICE <i>more timeslots</i> | MP | | | |
| >No more timeslots | | | | (no data) |
| >Consecutive timeslots | | | | |
| >>Number of additional timeslots | MP | | Integer(1..maxTS-1) | The timeslots used by the physical layer shall be timeslots:
N mod maxTS
(N+1) mod maxTS
...
(N+k) mod maxTS
in that order, where N is the timeslot number in the First individual timeslot info and k the Number of additional timeslots.
The additional timeslots shall use the same parameters (e.g. channelisation codes, midamble shifts etc.) as the first timeslot. |
| >Timeslot list | | | | |
| >>Additional timeslot list | MP | 1 to <maxTS-1> | | The first instance of this parameter corresponds to the timeslot that shall be used second by the physical layer, the second to the timeslot that shall be used third and so on. |
| >>>CHOICE <i>parameters</i> | MP | | | |
| >>>>Same as last | | | | |
| >>>>>Timeslot number | MP | | Timeslot Number 10.3.6.84 | The physical layer shall use the same parameters (e.g. channelisation codes, midamble shifts etc.) for this timeslot as for the last one. |
| >>>>>New parameters | | | | |
| >>>>>Individual timeslot info | MP | | Individual timeslot info 10.3.6.37 | |
| >>>>>Channelisation codes | MP | | Downlink channelisation codes 10.3.6.17 | |

10.3.6.32a Downlink Timeslots and Codes VHCR

NOTE: Only for 7.68 Mcps TDD.

| Information Element/Group name | Need | Multi | Type and reference | Semantics description | Version |
|--|------|----------------|---|--|---------|
| First Individual timeslot info | MP | | Individual timeslot info 10.3.6.37 | Individual timeslot info for the first timeslot used by the physical layer. | REL-7 |
| First timeslot channelisation codes VHCR | MP | | Downlink channelisation codes VHCR 10.3.6.17a | These codes shall be used by the physical layer in the timeslot given in First Individual timeslot info. | REL-7 |
| CHOICE <i>more timeslots</i> | MP | | | | REL-7 |
| >No more timeslots | | | | (no data) | REL-7 |
| >Consecutive timeslots | | | | | REL-7 |
| >>Number of additional timeslots | MP | | Integer(1..maxTS-1) | The timeslots used by the physical layer shall be timeslots: N mod maxTS (N+1) mod maxTS ... (N+k) mod maxTS in that order, where N is the timeslot number in the First individual timeslot info and k the Number of additional timeslots. The additional timeslots shall use the same parameters (e.g. channelisation codes, midamble shifts etc.) as the first timeslot. | REL-7 |
| >Timeslot list | | | | | REL-7 |
| >>Additional timeslot list | MP | 1 to <maxTS-1> | | The first instance of this parameter corresponds to the timeslot that shall be used second by the physical layer, the second to the timeslot that shall be used third and so on. | REL-7 |
| >>>CHOICE <i>parameters</i> | MP | | | | REL-7 |
| >>>>Same as last | | | | | REL-7 |
| >>>>>Timeslot number | MP | | Timeslot Number 10.3.6.84 | The physical layer shall use the same parameters (e.g. channelisation codes, midamble shifts etc.) for this timeslot as for the last one. | REL-7 |
| >>>>>New parameters | | | | | REL-7 |
| >>>>>Individual timeslot info | MP | | Individual timeslot info 10.3.6.37 | | REL-7 |
| >>>>>Channelisation codes VHCR | MP | | Downlink channelisation codes VHCR 10.3.6.17a | | REL-7 |

10.3.6.33 DPCH compressed mode info

NOTE: Only for FDD.

This information element indicates the parameters of the compressed mode to be used by the UE in order to perform inter-frequency and inter-RAT measurements.

| Information Element/Group name | Need | Multi | Type and reference | Semantics description | Version |
|-----------------------------------|------|-----------------|--------------------|-----------------------------|---------|
| Transmission gap pattern sequence | MP | 1 to <maxTGP S> | | | |
| >TGPSI | MP | | TGPSI 10.3.6.82 | | |
| >TGPS Status Flag | MP | | Enumerated(| This flag indicates whether | |

| Information Element/Group name | Need | Multi | Type and reference | Semantics description | Version |
|---|-----------|-------|---|---|---------|
| | | | activate, deactivate) | the Transmission Gap Pattern Sequence shall be activated or deactivated. | |
| >TGCFN | CV-Active | | Integer (0..255) | Connection Frame Number of the first frame of the first pattern within the Transmission Gap Pattern Sequence. | |
| >Transmission gap pattern sequence configuration parameters | OP | | | | |
| >>TGMP | MP | | Enumerated(TDD measurement, FDD measurement, GSM carrier RSSI measurement, GSM Initial BSIC identification, GSM BSIC re-confirmation, Multi-carrier measurement, | Transmission Gap pattern sequence Measurement Purpose. | |
| | | | E-UTRA measurement) | One spare value is needed | REL-8 |
| >>TGPRC | MP | | Integer (1..511, Infinity) | The number of transmission gap patterns within the Transmission Gap Pattern Sequence. | |
| >>TGSN | MP | | Integer (0..14) | Transmission Gap Starting Slot Number
The slot number of the first transmission gap slot within the TGCFN. | |
| >>TGL1 | MP | | Integer(1..14) | The length of the first Transmission Gap within the transmission gap pattern expressed in number of slots | |
| >>TGL2 | MD | | Integer (1..14) | The length of the second Transmission Gap within the transmission gap pattern. If omitted, then TGL2=TGL1. The value of TGL2 shall be ignored if TGD is set to "undefined" | |
| >>TGD | MP | | Integer(15..269, undefined) | Transmission gap distance indicates the number of slots between starting slots of two consecutive transmission gaps within a transmission gap pattern. If there is only one transmission gap in the transmission gap pattern, this parameter shall be set to undefined. | |
| >>TGPL1 | MP | | Integer (1..144) | The duration of transmission gap pattern 1. | |
| >>RPP | MP | | Enumerated (mode 0, | Recovery Period Power control mode during the | |

| Information Element/Group name | Need | Multi | Type and reference | Semantics description | Version |
|-------------------------------------|------|-------|--|--|---------|
| | | | mode 1). | frame after the transmission gap within the compressed frame. Indicates whether normal PC mode or compressed PC mode is applied | |
| >>ITP | MP | | Enumerated (mode 0, mode 1). | Initial Transmit Power is the uplink power control method to be used to compute the initial transmit power after the compressed mode gap. | |
| >>>CHOICE <i>UL/DL mode</i> | MP | | | | |
| >>>>DL only | | | | Compressed mode used in DL only | |
| >>>>Downlink compressed mode method | MP | | Enumerated (SF/2, higher layer scheduling) | Method for generating downlink compressed mode gap.
If F-DPCH is configured this IE shall not be used by the UE | |
| >>>>UL only | | | | Compressed mode used in UL only | |
| >>>>Uplink compressed mode method | MP | | Enumerated (SF/2, higher layer scheduling) | Method for generating uplink compressed mode gap | |
| >>>>UL and DL | | | | Compressed mode used in UL and DL | |
| >>>>Downlink compressed mode method | MP | | Enumerated (SF/2, higher layer scheduling) | Method for generating downlink compressed mode gap.
If F-DPCH is configured this IE shall not be used by the UE | |
| >>>>Uplink compressed mode method | MP | | Enumerated (SF/2, higher layer scheduling) | Method for generating uplink compressed mode gap | |
| >>>Downlink frame type | MP | | Enumerated (A, B) | If F-DPCH is configured this IE shall not be used by the UE | |
| >>>DeltaSIR1 | MP | | Real(0..3 by step of 0.1) | Delta in DL SIR target value to be set in the UE during the frame containing the start of the first transmission gap in the transmission gap pattern (without including the effect of the bit-rate increase).
If F-DPCH is configured this IE shall not be used by the UE | |
| >>>DeltaSIRafter1 | MP | | Real(0..3 by step of 0.1) | Delta in DL SIR target value to be set in the UE one frame after the frame containing the start of the first transmission gap in the transmission gap pattern.
If F-DPCH is configured this IE shall not be used by the UE | |
| >>>DeltaSIR2 | OP | | Real(0..3 by step of 0.1) | Delta in DL SIR target value to be set in the UE during the frame containing the start of the second transmission gap in the transmission gap | |

| Information Element/Group name | Need | Multi | Type and reference | Semantics description | Version |
|--------------------------------|--------------------|-------|--------------------------------|--|---------|
| | | | | pattern (without including the effect of the bit-rate increase)
When omitted, DeltaSIR2 = DeltaSIR1.
If F-DPCH is configured this IE shall not be used by the UE | |
| >>DeltaSIRafter2 | OP | | Real(0..3 by step of 0.1) | Delta in DL SIR target value to be set in the UE one frame after the frame containing the start of the second transmission gap in the transmission gap pattern.
When omitted, DeltaSIRafter2 = DeltaSIRafter1.
If F-DPCH is configured this IE shall not be used by the UE | |
| >>N Identify abort | CV-Initial BSIC | | Integer(1..128) | Indicates the maximum number of repeats of patterns that the UE shall use to attempt to decode the unknown BSIC of the GSM cell in the initial BSIC identification procedure | |
| >>T Reconfirm abort | CV-Re-confirm BSIC | | Real(0.5..10.0 by step of 0.5) | Indicates the maximum time allowed for the re-confirmation of the BSIC of one GSM cell in the BSIC re-confirmation procedure. The time is given in steps of 0.5 seconds. | |

| Condition | Explanation |
|-----------------|--|
| Active | This IE is mandatory present when the value of the IE "TGPS Status Flag" is "Activate" and not needed otherwise. |
| Initial BSIC | This IE is mandatory present when the value of the IE "TGMP" is set to "GSM Initial BSIC identification" and not needed otherwise. |
| Re-confirm BSIC | This IE is mandatory present when the value of the IE "TGMP" is set to "GSM BSIC re-confirmation" and not needed otherwise. |

10.3.6.34 DPCH Compressed Mode Status Info

This information element indicates status information of the compressed mode used by the UE in order to perform inter-frequency and inter-RAT measurements.

| Information Element/Group name | Need | Multi | Type and reference | Semantics description |
|-----------------------------------|------|-----------------|----------------------|--|
| TGPS reconfiguration CFN | MP | | Integer (0..255) | |
| Transmission gap pattern sequence | MP | 1 to <maxTGP S> | | |
| >TGPSI | MP | | TGPSI 10.3.6.82 | Transmission Gap Pattern Sequence Identifier |
| >TGPS Status Flag | MP | | Enumerated(activate, | This flag indicates whether the Transmission Gap Pattern |

| Information Element/Group name | Need | Multi | Type and reference | Semantics description |
|--------------------------------|-----------|-------|--------------------|---|
| | | | deactivate) | Sequence it shall be activated or deactivated. |
| >TGCFN | CV-Active | | Integer (0..255) | Connection Frame Number of the first frame of the first pattern within the Transmission Gap Pattern Sequence. |

| Condition | Explanation |
|-----------|--|
| Active | This IE is mandatory present when the value of the IE "TGPS Status Flag" is "Activate" and not needed otherwise. |

10.3.6.34a DTX-DRX information

NOTE: For FDD only.

| Information Element/Group name | Need | Multi | Type and reference | Semantics description | Version |
|---|------|-------|---|--|---------|
| DTX Information | OP | | | | REL-7 |
| >CHOICE <i>E-DCH TTI length</i> | MP | | | | REL-7 |
| >>10 ms | | | | | REL-7 |
| >>>UE DTX cycle 1 | MP | | Enumerated (1, 5, 10, 20) | Units of subframes. | REL-7 |
| >>>UE DTX cycle 2 | MP | | Enumerated (5, 10, 20, 40, 80, 160) | Units of subframes.
Two spare values are needed. | REL-7 |
| >>>MAC DTX cycle | MP | | Enumerated (5, 10, 20) | Units of subframes.
One spare value is needed. | REL-7 |
| >>2 ms | | | | | REL-7 |
| >>>UE DTX cycle 1 | MP | | Enumerated (1, 4, 5, 8, 10, 16, 20) | Units of subframes.
One spare value is needed. | REL-7 |
| >>>UE DTX cycle 2 | MP | | Enumerated (4, 5, 8, 10, 16, 20, 32, 40, 64, 80, 128, 160) | Units of subframes.
Four spare values are needed. | REL-7 |
| >>>MAC DTX cycle | MP | | Enumerated (1, 4, 5, 8, 10, 16, 20) | Units of subframes.
One spare value is needed. | REL-7 |
| >Inactivity Threshold for UE DTX cycle 2 | MP | | Enumerated (1, 4, 8, 16, 32, 64, 128, 256) | Units of E-DCH TTIs.
Eight spare values are needed. | REL-7 |
| >Default SG in DTX Cycle 2 | OP | | Integer (0..37,38) | Serving Grant value to be used at the transition in DTX-Cycle-2.
(0..37) indicates E-DCH serving grant index as defined in [15]; index 38 means zero grant. | REL-7 |
| >UE DTX long preamble length | MD | | Enumerated (4, 15) | Units of slots
Default value is 2 slots | REL-7 |
| >MAC Inactivity Threshold | MP | | Enumerated (1, 2, 4, 8, 16, 32, 64, 128, 256, 512, Infinity) | Units of E-DCH TTIs.
Five spare values are needed. | REL-7 |
| >CQI DTX Timer | MP | | Enumerated (0, 1, 2, 4, 8, 16, 32, 64, 128, 256, 512, Infinity) | Units of subframes.
Four spare values are needed. | REL-7 |
| >UE DPCCH burst_1 | MP | | Enumerated (1, 2, 5) | Units of sub-frames.
One spare value is needed. | REL-7 |
| >UE DPCCH burst_2 | MP | | Enumerated (1, 2, 5) | Units of sub-frames.
One spare value is needed. | REL-7 |
| DRX Information | OP | | | | REL-7 |
| >UE DRX cycle | MP | | Enumerated (4, 5, 8, 10, 16, 20) | Units of subframes.
Two spare values are needed. | REL-7 |
| >Inactivity Threshold for UE DRX cycle | MP | | Enumerated (0, 1, 2, 4, 8, 16, 32, 64, 128, 256, 512) | Units of subframes.
Five spare values are needed. | REL-7 |
| >Inactivity Threshold for UE Grant Monitoring | MP | | Enumerated (0, 1, 2, 4, 8, 16, 32, 64, 128, 256) | Units of E-DCH TTIs.
Six spare values are needed. | REL-7 |
| >UE DRX Grant Monitoring | MP | | Boolean | | REL-7 |
| Uplink DPCCH slot format information | MP | | Enumerated (1, 4) | Slot format # to be used on UL DPCCH [26].
One spare value is needed. | REL-7 |

10.3.6.34b DTX-DRX timing information

NOTE: For FDD only.

| Information Element/Group name | Need | Multi | Type and reference | Semantics description | Version |
|---|------|-------|---|--|---------|
| CHOICE <i>timing</i> | MP | | | | REL-7 |
| >Continue | | | (no data) | Used in reconfigurations without interruption of DTX-DRX and HS-SCCH less. | REL-7 |
| >New timing | | | | | REL-7 |
| >>Enabling Delay | MP | | Enumerated (0, 1, 2, 4, 8, 16, 32, 64, 128) | In radio frames. Seven spare values are needed. | REL-7 |
| >>>UE DTX DRX Offset | MP | | Integer (0..159) | Units of subframes. Offset of the DTX and DRX cycles at the given TTI. | REL-7 |
| Note: Only the values of the IE 'UE DTX DRX Offset' that fulfill the equation $UE\ DTX\ DRX\ Offset \bmod 5=0$ can be configured with 10ms E-DCH TTI. The UE behaviour is not specified if any other values are used with 10ms TTI. | | | | | |

10.3.6.35 Dynamic persistence level

| Information Element/Group name | Need | Multi | Type and reference | Semantics description |
|--------------------------------|------|-------|--------------------|---|
| Dynamic persistence level | MP | | Integer(1..8) | Level shall be mapped to a dynamic persistence value in the range 0 .. 1. The mapping is described in subclause 8.5.12. |

10.3.6.35a FPACH info

NOTE: Only for 1.28 Mcps TDD.

| Information Element/Group name | Need | Multi | Type and reference | Semantics description | Version |
|--------------------------------|------|-------|---|---|---------|
| Timeslot number | MP | | Integer(0..6) | | REL-4 |
| Channelisation code | MP | | Enumerated((16/1)..(16/16)) | | REL-4 |
| Midamble Shift and burst type | MP | | Midamble shift and burst type 10.3.6.41 | | REL-4 |
| WT | MP | | Integer(1..4) | The number of sub-frames, following the sub-frame in which the SYNC UL is transmitted, in which the FPACH can be transmitted. | REL-4 |

10.3.6.35b Frequency band indicator

| Information Element/Group name | Need | Multi | Type and reference | Semantics description | Version |
|--------------------------------|------|-------|---|-----------------------|---------|
| Frequency band indicator | MP | | Enumerated(Band I, Band II, Band III, Band IV, Band V, Band VI, Band VII, extension indicator) | | REL-6 |

10.3.6.35c Frequency band indicator 2

| Information Element/Group name | Need | Multi | Type and reference | Semantics description | Version |
|--------------------------------|------|-------|--|--|---------|
| Frequency band indicator 2 | MP | | Enumerated(Band VIII, Band IX, Band X, Band XI, Band XII, Band XIII, Band XIV, Band XV, Band XVI, Band XVII, Band XVIII, Band XIX, Band XX, Band XXI, Band XXII, extension indicator) | Band XV – Band XXII are yet to be defined in this version of the specification | REL-6 |

10.3.6.36 Frequency info

| Information Element/Group name | Need | Multi | Type and reference | Semantics description |
|--------------------------------|------|-------|---------------------|--|
| CHOICE <i>mode</i> | MP | | | |
| >FDD | | | | |
| >>UARFCN uplink (Nu) | OP | | Integer(0..16383) | If this IE is not present, the default duplex distance defined for the operating frequency band shall be used [21] |
| >>UARFCN downlink (Nd) | MP | | Integer(0 .. 16383) | [21] |
| >TDD | | | | |
| >>UARFCN (Nt) | MP | | Integer(0 .. 16383) | [22] |

10.3.6.36oo HS-PDSCH Midamble Configuration

NOTE: Only for TDD 1.28 Mcps.

| Information Element/Group name | Need | Multi | Type and reference | Semantics description | Version |
|--------------------------------|-------|-------|--|---|---------|
| Midamble Allocation Mode | MP | | Enumerated(Default midamble, Common midamble, UE specific midamble) | This midamble allocation mode applies to all HS-PDSCH resources assigned to the UE. | REL-5 |
| Midamble Configuration | MP | | Integer(2, 4, 6, 8, 10, 12, 14, 16) | This configuration applies to all HS-PDSCH resources assigned to the UE. | REL-5 |
| Midamble Shift | CV-UE | | Integer(0..15) | This shift, when present, applies to all HS-PDSCH resources assigned to the UE. | REL-5 |

| Condition | Explanation |
|-----------|--|
| UE | This IE is mandatory present when the value of the IE "Midamble Allocation Mode" is "UE specific midamble" and not needed otherwise. |

10.3.6.36o HS-PDSCH Timeslot Configuration

NOTE: Only for TDD 3.84 Mcps.

| Information Element/Group name | Need | Multi | Type and reference | Semantics description | Version |
|--|-------|----------------|--|-----------------------|---------|
| HS-PDSCH Timeslot Configuration List | MP | 1 to <maxTS-1> | | | REL-5 |
| >Timeslot Number | MP | | Integer (0..14) | | REL-5 |
| >CHOICE Burst Type | MP | | | | REL-5 |
| >>Type 1 | | | | | REL-5 |
| >>>Midamble Allocation Mode | MP | | Enumerated (Default midamble, Common midamble, UE specific midamble) | | REL-5 |
| >>>Midamble configuration burst type 1 and 3 | MP | | Integer (4, 8, 16) | As defined in [30] | REL-5 |
| >>>Midamble Shift | CV-UE | | Integer (0..15) | | REL-5 |
| >>Type 2 | | | | | REL-5 |
| >>>Midamble Allocation Mode | MP | | Enumerated (Default midamble, Common midamble, UE specific midamble) | | REL-5 |
| >>>Midamble configuration burst type 2 | MP | | Integer (3, 6) | As defined in [30] | REL-5 |
| >>>Midamble Shift | CV-UE | | Integer (0..5) | | REL-5 |

| Condition | Explanation |
|-----------|--|
| <i>UE</i> | This IE is mandatory present when the value of the IE "Midamble Allocation Mode" is "UE specific midamble" and not needed otherwise. |

10.3.6.36oa HS-PDSCH Timeslot Configuration VHCR

NOTE: Only for TDD 7.68 Mcps.

| Information Element/Group name | Need | Multi | Type and reference | Semantics description | Version |
|--|-------|----------------|--|-----------------------|---------|
| HS-PDSCH Timeslot Configuration List | MP | 1 to <maxTS-1> | | | REL-7 |
| >Timeslot Number | MP | | Integer (0..14) | | REL-7 |
| >CHOICE Burst Type | MP | | | | REL-7 |
| >>Type 1 | | | | | REL-7 |
| >>>Midamble Allocation Mode | MP | | Enumerated (Default midamble, Common midamble, UE specific midamble) | | REL-7 |
| >>>Midamble configuration burst type 1 and 3 | MP | | Integer (4, 8, 16) | As defined in [30] | REL-7 |
| >>>Midamble Shift | CV-UE | | Integer (0..15) | | REL-7 |
| >>Type 2 | | | | | REL-7 |
| >>>Midamble Allocation Mode | MP | | Enumerated (Default midamble, Common midamble, UE specific midamble) | | REL-7 |
| >>>Midamble configuration burst type 2 | MP | | Integer (4, 8) | As defined in [30] | REL-7 |
| >>>Midamble Shift | CV-UE | | Integer (0..7) | | REL-7 |

| Condition | Explanation |
|-----------|--|
| <i>UE</i> | This IE is mandatory present when the value of the IE "Midamble Allocation Mode" is "UE specific midamble" and not needed otherwise. |

10.3.6.36a HS-SCCH Info

| Information Element/Group name | Need | Multi | Type and reference | Semantics description | Version |
|---|------|---------------------|--|---|---------|
| CHOICE mode | MP | | | | REL-5 |
| >FDD | | | | | REL-5 |
| >>DL Scrambling Code | MD | | Secondary scrambling code
10.3.6.74 | DL Scrambling code to be applied for HS-DSCH and HS-SCCH. Default is same scrambling code as for the primary CPICH. | REL-5 |
| >>HS-SCCH Channelisation Code Information | MP | 1 to <maxHSS CCHs > | | Note 2 | REL-5 |
| >>>HS-SCCH Channelisation Code | MP | | Integer (0..127) | | REL-5 |
| >TDD | | | | | REL-5 |
| >>CHOICE <i>TDD option</i> | MP | | | | REL-5 |
| >>>3.84 Mcps | | | | | REL-5 |
| >>>> Ack-Nack Power Offset | MP | | Integer (-7..8 by step of 1) | dB
Note 1 | REL-5 |
| >>>> HS-SICH Power Control Info | MP | | HS-SICH Power Control Info
10.3.6.36b | | REL-5 |
| >>>> BLER target | MP | | Real (-3.15..0 by step of 0.05) | Signalled value is Log10(HS-SCCH BLER quality target). This IE is Not Present in REL-5. | REL-6 |
| >>>> $D_{\text{hs-sync}}$ | OP | | Integer (-20..+10) | Value in dB set to indicate the dB difference between the maximum allowed HS-SCCH physical channel transmit power [33] and the beacon reference power (it is one means of controlling the area of HS-DSCH operation within the cell). | REL-6 |
| >>>>HS-SCCH Set Configuration | MP | 1 to <maxHSS CCHs> | | | REL-5 |
| >>>>>Timeslot number | MP | | Integer (0..14) | | REL-5 |
| >>>>>Channelisation code | MP | | Enumerated ((16/1) ..(16/16)) | | REL-5 |
| >>>>>Midamble Allocation mode | MP | | Enumerated (Default midamble, Common midamble, UE specific midamble) | HS-SCCH always uses burst type 1. | REL-5 |
| >>>>>Midamble configuration | MP | | Integer | | REL-5 |

| | | | | | |
|--------------------------------|-------|--|---|---|-------|
| | | | (4, 8, 16) | | |
| >>>>>Midamble Shift | CV-UE | | Integer(0..15) | | REL-5 |
| >>>>>BLER target | MP | | Real (-3.15..0 by step of 0.05) | Signalled value is Log10(HS-SCCH BLER quality target). This IE is not present in REL-6 and beyond. | REL-5 |
| >>>>>HS-SICH configuration | | | | | REL-5 |
| >>>>>>Timeslot number | MP | | Integer (0..14) | | REL-5 |
| >>>>>>Channelisation code | MP | | Enumerated ((16/1) ..(16/16)) | | REL-5 |
| >>>>>>Midamble Allocation mode | MP | | Enumerated (Default midamble, UE specific midamble) | HS-SICH always uses burst type 1. | REL-5 |
| >>>>>>Midamble configuration | MP | | Integer (4, 8, 16) | | REL-5 |
| >>>>>>Midamble Shift | CV-UE | | Integer (0..15) | | REL-5 |
| >>>7.68 Mcps | | | | | REL-7 |
| >>>>Ack-Nack Power Offset | MP | | Integer (-7..8 by step of 1) | dB | REL-7 |
| >>>>HS-SICH Power Control Info | MP | | HS-SICH Power Control Info 10.3.6.36b | | REL-7 |
| >>>>BLER target | MP | | Real (-3.15..0 by step of 0.05) | Signalled value is Log10(HS-SCCH BLER quality target). | REL-7 |
| >>>>D _{hs-sync} | OP | | Integer (-20..+10) | Value in dB set to indicate the dB difference between the maximum allowed HS-SCCH physical channel transmit power [33] and the beacon reference power (it is one means of controlling the area of HS-DSCH operation within the cell). | REL-7 |
| >>>>D _{hs-sync} | OP | | Integer (-20..+10) | Value in dB set to indicate the dB difference between the maximum allowed HS-SCCH physical channel transmit power [33] and the beacon reference power (it is one means of controlling the area of HS-DSCH operation within the cell). | REL-7 |

| | | | | | |
|----------------------------------|-------------------------|--------------------|--|--|-------|
| >>>>HS-SCCH Set Configuration | MP | 1 to <maxHS-SCCHs> | | | REL-7 |
| >>>>Timeslot number | MP | | Integer (0..14) | | REL-7 |
| >>>>Channelisation code | MP | | Enumerated ((32/1)..(32/32)) | | REL-7 |
| >>>>Midamble Allocation mode | MP | | Enumerated (Default midamble, Common midamble, UE specific midamble) | HS-SCCH always uses burst type 1. | REL-7 |
| >>>>Midamble configuration | MP | | Integer (4, 8, 16) | | REL-7 |
| >>>>Midamble Shift | CV-UE | | Integer(0..15) | | REL-7 |
| >>>>HS-SICH configuration | | | | | REL-5 |
| >>>>>Timeslot number | MP | | Integer (0..14) | | REL-5 |
| >>>>>Channelisation code | MP | | Enumerated ((32/1)..(32/32)) | | REL-5 |
| >>>>>Midamble Allocation mode | MP | | Enumerated (Default midamble, UE specific midamble) | HS-SICH always uses burst type 1. | REL-5 |
| >>>>>Midamble configuration | MP | | Integer (4, 8, 16) | | REL-5 |
| >>>>>Midamble Shift | CV-UE | | Integer (0..15) | | REL-5 |
| >>>1.28 Mcps | | | | | REL-5 |
| >>>>Ack-Nack Power Offset | MP | | Integer (-7..8 by step of 1) | dB.
This IE is Not Present in REL-5.

Note | REL-6 |
| >>>>PRX _{HS-SICH} | MP | | Integer (-120..-58 by step of 1) | dBm. Desired power level for HS-SICH.
This IE is Not Present in REL-5 | REL-6 |
| >>>>TPC step size | MP | | Enumerated (1, 2, 3) | dB. TPC step size for HS-SICH. One spare value.
This IE is Not Present in REL-5. | REL-6 |
| >>>>BLER target | MP | | Real (-3.15..0 by step of 0.05) | Signalled value is Log10(HS-SCCH BLER quality target).
This IE is Not Present in REL-5. | REL-6 |
| >>>>HS-SCCH TPC step size | CV-
NoDPCH_
EAGCH | | Enumerated (1, 2, 3) | dB.
One spare value. | REL-8 |
| >>>>Power Control GAP | MD | | Integer (1..255) | Unit: Number of subframes
Default value is 1. | REL-7 |
| >>>>Pathloss compensation switch | MD | | Boolean | TRUE: UE shall perform the pathloss compensation for HS-SICH power control when HS- | REL-7 |

| | | | | | |
|---------------------------------|-------|--------------------|--|---|-------|
| | | | | SICH transmission gap is less than 'Power Control GAP'.
FALSE: UE shall not consider the pathloss compensation for HS-SICH power control.
Default value is FALSE. | |
| >>>>HS-SCCH Set Configuration | MP | 1 to <maxHSS CCHs> | | | REL-5 |
| >>>>>Timeslot number | MP | | Integer (0..6) | | REL-5 |
| >>>>>First Channelisation code | MP | | Enumerated ((16/1) ..(16/16)) | | REL-5 |
| >>>>>Second Channelisation code | MP | | Enumerated ((16/1) ..(16/16)) | | REL-5 |
| >>>>>Midamble Allocation mode | MP | | Enumerated (Default midamble, Common midamble, UE specific midamble) | | REL-5 |
| >>>>> Midamble Shift | CV-UE | | Integer (0..15) | | REL-5 |
| >>>>>Midamble configuration | MP | | Integer (2, 4, 6, 8, 10, 12, 14, 16) | | REL-5 |
| >>>>>BLER target | MP | | Real (-3.15..0 by step of 0.05) | Signalled value is Log10(HS-SCCH BLER quality target).
This IE is not present in REL-6 and beyond. | REL-5 |
| >>>>>HS-SICH configuration | | | | | REL-5 |
| >>>>>>Timeslot number | MP | | Integer (0..6) | | REL-5 |
| >>>>>>Channelisation code | MP | | Enumerated ((16/1) ..(16/16)) | | REL-5 |
| >>>>>>Midamble Allocation mode | MP | | Enumerated (Default midamble, UE specific midamble) | | REL-5 |
| >>>>>>Midamble configuration | MP | | Integer (2, 4, 6, 8, 10, 12, 14, 16) | | REL-5 |
| >>>>>>Midamble Shift | CV-UE | | Integer (0..15) | | REL-5 |
| >>>>>>Ack-Nack Power Offset | MP | | Integer (-7..8 by step of 1) | dB.
This IE is not present in REL-6 and beyond. | REL-5 |
| >>>>>>PRX _{HS-SICH} | MP | | Integer | Note
dBm. Desired | REL-5 |

| | | | | | |
|--|----|--|--------------------------|--|-------|
| | | | (-120..-58 by step of 1) | power level for HS-SICH. This IE is not present in REL-6 and beyond. | |
| >>>>>TPC step size | MP | | Enumerated (1, 2, 3) | dB. One spare value. This IE is not present in REL-6 and beyond. | REL-5 |
| <p>Note 1: Ack-Nack Power Offset is the difference in the desired RX power between HS-SICH transmissions conveying an acknowledgement and transmissions conveying a negative acknowledgement signalled to the UE in IE "HS-SCCH Info".</p> <p>Note 2: The list of HS-SCCH(s) is assumed to be indexed starting from one.</p> | | | | | |

| Condition | Explanation |
|---------------------|--|
| <i>UE</i> | This IE is mandatory present when the value of the IE "Midamble Allocation Mode" is "UE specific midamble" and not needed otherwise. |
| <i>NoDPCH_EAGCH</i> | This IE is mandatory present when neither DPCH nor E-AGCH is configured and not needed otherwise. |

10.3.6.36ab HS-SCCH less information

NOTE: For FDD only

| Information Element/Group name | Need | Multi | Type and reference | Semantics description | Version |
|--------------------------------------|------|---------------------------|--------------------|---|---------|
| CHOICE <i>HS-SCCH less operation</i> | MP | | | | REL-7 |
| >Continue HS-SCCH less operation | | | (no data) | | REL-7 |
| >New HS-SCCH less operation | | | | | REL-7 |
| >>HS-PDSCH Code Index | MP | | Integer (1..15) | Index of first HS-PDSCH code | REL-7 |
| >>>Transport Block Size List | | 1..<maxHS-SCCHLessTrBlk > | | | REL-7 |
| >>>>Transport Block Size Index | MP | | Integer (1..90) | Index of the MAC-hs or MAC-ehs transport block size as described in appendix A of [15] | REL-7 |
| >>>>HS-PDSCH Second Code Support | MP | | Boolean | Indicates whether the second HS-PDSCH code is used for this TB size. If TRUE, the HS-PDSCH second code index value is the value of IE 'HS-PDSCH Code Index' incremented by 1. | REL-7 |

10.3.6.36b HS-SICH Power Control Info

This IE is used to transfer HS-SICH power control info to the UE and only applies to TDD 3.84 Mcps and 7.68 Mcps.

| Information Element/Group name | Need | Multi | Type and reference | Semantics description | Version |
|--------------------------------|------|-------|-------------------------------|-----------------------|---------|
| UL target SIR | MP | | Real (-11..20 by step of 0.5) | dB | REL-5 |
| HS-SICH Constant value | MP | | Constant value 10.3.6.11 | NOTE 1 | REL-5 |

NOTE 1: Alignment to ASN.1: the IE "Constant value TDD" (10.3.6.11a) should have been used to provide the correct value range. The IE "Constant value" (10.3.6.11) is used to keep compatibility with REL-5.

10.3.6.36c HS-DSCH common system information

NOTE: For FDD only.

| Information Element/Group name | Need | Multi | Type and reference | Semantics description | Version |
|--------------------------------------|------|------------------------|--|-----------------------|---------|
| CCCH mapping info | MP | | Common RB mapping info 10.3.4.0a | | REL-7 |
| SRB1 mapping info | MD | | Common RB mapping info 10.3.4.0a | Note | REL-7 |
| Common MAC-ehs reordering queue list | MP | | Common MAC-ehs reordering queue list 10.3.5.3a | | REL-7 |
| HS-SCCH system info | MP | | HS-SCCH system info 10.3.6.36e | | REL-7 |
| HARQ system Info | MP | | HARQ Info 10.3.5.7a | | REL-7 |
| Common H-RNTI Information | MP | 1 to <maxCommonHRNTI > | | | REL-7 |
| >Common H-RNTI | MP | | H-RNTI 10.3.3.14a | | REL-7 |
| BCCH specific H-RNTI | MP | | H-RNTI 10.3.3.14a | | REL-7 |

NOTE: The default values for the "SRB1 mapping info" are 1 for the Logical channel identity and 0 for the MAC-ehs queue identity.

10.3.6.36ca HS-DSCH common system information 1.28Mcps TDD

NOTE: For 1.28 Mcps TDD only.

| Information Element/Group name | Need | Multi | Type and reference | Semantics description | Version |
|--------------------------------------|------|-----------------------|--|-----------------------|---------|
| CCCH mapping info | MP | | Common RB mapping info 10.3.4.0a | | REL-8 |
| SRB1 mapping info | MD | | Common RB mapping info 10.3.4.0a | Note 1 | REL-8 |
| Common MAC-ehs reordering queue list | MP | | Common MAC-ehs reordering queue list 10.3.5.3a | | REL-8 |
| HS-SCCH system info | MP | | HS-SCCH system info 1.28Mcps TDD 10.3.6.36ea | Note 2 | REL-8 |
| HARQ system Info | MP | | HARQ Info 10.3.5.7a | | REL-8 |
| HS-PDSCH Midamble Configuration | MP | | HS-PDSCH Midamble Configuration 10.3.6.36oo | | REL-8 |
| Common H-RNTI Information | MP | 1 to <maxCommonHRNTI> | | | REL-8 |
| >Common H-RNTI | MP | | H-RNTI 10.3.3.14a | | REL-8 |
| BCCH specific H-RNTI | MP | | H-RNTI 10.3.3.14a | | REL-8 |

NOTE 1: The default values for the "SRB1 mapping info" are 1 for the Logical channel identity and 0 for the MAC-ehs queue identity.

NOTE 2: These IEs correspond to the HS-DSCH configuration for CELL_FACH, CELL_PCH state.

10.3.6.36d HS-DSCH paging system information

These parameters enable the UE in CELL_PCH and URA_PCH to receive transmissions on HSDPA cell resources.

NOTE: Only for FDD.

| Information Element/Group name | Need | Multi | Type and reference | Semantics description | Version |
|--------------------------------------|------|------------------|-------------------------------------|---|---------|
| DL Scrambling Code | MD | | Secondary scrambling code 10.3.6.74 | DL Scrambling code to be applied for HS-DSCH and HS-SCCH. Default is same scrambling code as for the primary CPICH. | REL-7 |
| PICH for HSDPA supported paging list | MP | 1 to <maxSCCPCH> | | | REL-7 |

| | | | | | |
|-------------------------------|----|--------|------------------------|--|-------|
| >HSDPA associated PICH info | MP | | PICH info
10.3.6.49 | | REL-7 |
| >HS-PDSCH Channelisation Code | MP | | Integer
(0..15) | HS-PDSCH channel, associated with the PICH for HS-SCCH less PAGING TYPE 1 message transmission. | REL-7 |
| Number of PCCH transmissions | MP | | Integer (1..5) | number of subframes used to transmit the PAGING TYPE 1. | REL-7 |
| Transport Block Size List | MP | 1 to 2 | | | REL-7 |
| >Transport Block Size Index | MP | | Integer
(1..32) | Index of value range 1 to 32 of the MAC-e-hs transport block size as described in appendix A of [15] | REL-7 |

10.3.6.36da HS-DSCH paging system information 1.28Mcps TDD

These parameters enable the UE in CELL_PCH and URA_PCH to receive PCCH, DCCH/DTCH transmissions on HSDPA cell resources.

NOTE: Only for 1.28 Mcps TDD.

| Information Element/Group name | Need | Multi | Type and reference | Semantics description | Version |
|--|------|------------------|---|--|---------|
| PICH for HS-DSCH list | MP | 1 to <maxSCCPCH> | | | REL-8 |
| >CHOICE Configuration Mode | MP | | | | REL-8 |
| >>Implicit | | | | The choice Indicates the PICH is shared with PCH. | REL-8 |
| >>>Occurrence sequence number in S-CCPCH system Info | MD | | Integer (1..maxSCCPCH) | Indicates the occurrence sequence number of "PICH Info" in Secondary CCPCH System Information. Default value implies the first occurrence or the only occurrence of "PICH Info" in Secondary CCPCH System Information. | REL-8 |
| >>Explicit | | | | | REL-8 |
| >>>HSDPA associated PICH info | MP | | PICH info 10.3.6.49 | | REL-8 |
| DTCH/DCCH Reception window size | MP | | Integer (1..16) | Number of subframe for UE to detect the HS-SCCH | REL-8 |
| PCCH related information | OP | | | See Note 1 | REL-8 |
| >Paging associated HS-PDSCH info | MP | 1 to <maxSCCPCH> | | See Note 3 | REL-8 |
| >>HS-PDSCH Midamble Configuration | MP | | HS-PDSCH Midamble Configuration 10.3.6.36oo | | REL-8 |
| >>Timeslot Resource Related Informationl | MP | | Bit string (6) | Each bit indicates availability of a timeslot, where the bit 0 corresponds to TS0, the bit 1 is TS2, the bit 2 is TS3... bit 6 corresponds to TS6. The value 1 of a bit indicates that the corresponding timeslot is available. Bit 0 is the first/leftmost bit of the bit string. | REL-8 |
| >>>Code Resource Information | MP | | | Note 2 | REL-8 |
| >>>Start code | MP | | Enumerated((16/1)..(16/16)) | | REL-8 |
| >>>Stop code | MP | | Enumerated((16/1)..(16/16)) | | REL-8 |
| >Paging Sub-Channel Size | MP | | Integer (1..3) | number of frames for a Paging sub- | REL-8 |

| | | | | | |
|------------------------------|----|--------|-----------------|---|-------|
| | | | | channel | |
| >Transport Block Size List | MP | 1 to 2 | | | REL-8 |
| >>Transport Block Size Index | MP | | Integer (1..32) | Index of value range 1 to 32 of the MAC-ehs transport block size as described in Table 9.2.3.3.8 [15] | REL-8 |

NOTE 1: The IE is not signalled when the "PICH info" is present in "Secondary CCPCH system information" in SIB5 and SIB6.

NOTE 2: HS-PDSCH channelisation codes are allocated contiguously from a signalled start code to a signalled stop code, and the allocation includes both the start and stop code. If a value of Start code = 16 and Stop code = 1 is signalled, a spreading factor of SF=1 shall be used for the HS-PDSCH resources.

NOTE 3: The timing between PICH and the paging associated HS-PDSCH is specified in [30]. UE should receive the HS-PDSCH based on the timing specification.

10.3.6.36e HS-SCCH system info

These parameters enable the UE to receive transmission on HSDPA cell resources, when the UE is not in CELL_DCH.

NOTE: for FDD only.

| Information Element/Group name | Need | Multi | Type and reference | Semantics description | Version |
|---|------|--------------------|-------------------------------------|---|---------|
| DL Scrambling Code | MD | | Secondary scrambling code 10.3.6.74 | DL Scrambling code to be applied for HS-DSCH and HS-SCCH. Default is same scrambling code as for the primary CPICH. | REL-7 |
| HS-SCCH Channelisation Code Information | MP | 1 to <maxHSS CCHs> | | | REL-7 |
| >HS-SCCH Channelisation Code | MP | | Integer (0..127) (NOTE) | | REL-7 |

NOTE: UTRAN should use the first indexed HS-SCCH Channelisation code for the BCCH specific H-RNTI to indicate system information change information. Otherwise UE behaviour is unspecified.

10.3.6.36ea HS-SCCH system info 1.28Mcps TDD

These parameters enable the UE to receive transmission on HSDPA cell resources on primary frequency or secondary frequency, when the UE is not in CELL_DCH.

NOTE: for 1.28 Mcps TDD only.

| Information Element/Group name | Need | Multi | Type and reference | Semantics description | Version |
|--------------------------------|-------|--------------------|--|---|---------|
| HS-SCCH Set Configuration | MP | 1 to <maxHSS CCHs> | | | REL-8 |
| >Timeslot number | MP | | Integer (0..6) | | REL-8 |
| >First Channelisation code | MP | | Enumerated ((16/1)..(16/16)) | | REL-8 |
| >Second Channelisation code | MP | | Enumerated ((16/1)..(16/16)) | | REL-8 |
| >Midamble Allocation mode | MP | | Enumerated (Default midamble, Common midamble, UE specific midamble) | | REL-8 |
| >Midamble Shift | CV-UE | | Integer (0..15) | | REL-8 |
| >Midamble configuration | MP | | Integer (2, 4, 6, 8, 10, 12, 14, 16) | | REL-8 |
| >HS-SICH configuration | MP | | | | REL-8 |
| >>Timeslot number | MP | | Integer (0..6) | | REL-8 |
| >>Channelisation code | MP | | Enumerated ((16/1)..(16/16)) | | REL-8 |
| >>Midamble Allocation mode | MP | | Enumerated (Default midamble, UE specific midamble) | | REL-8 |
| >>Midamble Shift | CV-UE | | Integer (0..15) | | REL-8 |
| >>Midamble configuration | MP | | Integer (2, 4, 6, 8, 10, 12, 14, 16) | | REL-8 |
| PRX _{HS-SICH} | MP | | Integer (-120..-58 by step of 1) | dBm. Desired power level for HS-SICH. | REL-8 |
| Ack-Nack Power Offset | MP | | Integer (-7..8 by step of 1) | dB. | REL-8 |
| TPC step size | MP | | Enumerated (1, 2, 3) | dB. TPC step size for HS-SICH. One spare value. | REL-8 |
| BLER target | MP | | Real (-3.15..0 by step of 0.05) | Signalled value is Log ₁₀ (HS-SCCH BLER quality target). | REL-8 |
| Power Control GAP | MD | | Integer (1...255) | Unit: Number of subframes
Default value is 1. | REL-8 |
| Pathloss compensation switch | MD | | Boolean | TRUE: UE shall perform the pathloss compensation for HS-SICH power control when HS-SICH | REL-8 |

| | | | | | |
|--|--|--|--|--|--|
| | | | | transmission gap is less than 'Power Control GAP'.
FALSE: UE shall not consider the pathloss compensation for HS-SICH power control.
Default value is FALSE. | |
|--|--|--|--|--|--|

| Condition | Explanation |
|-----------|--|
| UE | This IE is mandatory present when the value of the IE "Midamble Allocation Mode" is "UE specific midamble" and not needed otherwise. |

NOTE: UTRAN should use the first indexed HS-SCCH Channelisation code for the BCCH specific H-RNTI to indicate system information change information on primary frequency or secondary frequency. Otherwise UE behaviour is unspecified.

10.3.6.36f Void

10.3.6.36g HS-DSCH DRX in CELL_FACH information

These parameters configure the UE in CELL_FACH state to discontinuously receive HS-DSCH.

NOTE: Only for FDD.

| Information Element/Group name | Need | Multi | Type and reference | Semantics description | Version |
|-----------------------------------|------|-------|---------------------------------|---|---------|
| T321 | MP | | Enumerated (100, 200, 400, 800) | Determines the time the UE waits until initiating DRX operation, in ms. | REL-8 |
| HS-DSCH DRX cycle _{FACH} | MP | | Enumerated (4, 8, 16, 32) | Determines the length of the DRX Cycle during DRX operation, in frames | REL-8 |
| HS-DSCH Rx burst _{FACH} | MP | | Enumerated (1, 2, 4, 8, 16) | Determines the period within the DRX Cycle that the UE continuously receives HS-DSCH, in frames. Three spare values are needed | REL-8 |
| DRX Interruption by HS-DSCH data | MP | | Boolean | TRUE means that the DRX operation can be interrupted by HS-DSCH data.
FALSE means that the DRX operation cannot be interrupted by HS-DSCH data | REL-8 |

10.3.6.36h HS-DSCH DRX in CELL_FACH information 1.28Mcps TDD

These parameters configure the UE in CELL_FACH state to discontinuously receive HS-DSCH.

NOTE: Only for 1.28 Mcps TDD.

| Information Element/Group name | Need | Multi | Type and reference | Semantics description | Version |
|--------------------------------|------|-------|---------------------------------|--|---------|
| T321 | MP | | Enumerated (100, 200, 400, 800) | Determines the time the UE waits until initiating DRX operation, in ms. | REL-8 |
| DRX cycle _{FACH} | MP | | Enumerated (4, 8, 16, 32) | Determines the length of the DRX Cycle during DRX operation, in frames | REL-8 |
| Rx burst _{FACH} | MP | | Enumerated (1, 2, 4, 8, 16) | Determines the period within the DRX Cycle that the UE continuously receives HS-DSCH, in frames. Three spare values are needed | REL-8 |

10.3.6.37 Individual timeslot info

| Information Element/Group name | Need | Multi | Type and reference | Semantics description | Version |
|--------------------------------|------|-------|---|--|---------|
| Timeslot number | MP | | Timeslot number 10.3.6.84 | Timeslot within a frame | |
| TFCI existence | MP | | Boolean | TRUE indicates that the TFCI exists. It shall be coded in the physical channel defined in [30] of this timeslot. | |
| Midamble Shift and burst type | MP | | Midamble shift and burst type 10.3.6.41 | For 1.28 Mcps TDD, if the cell is operating in MBSFN mode, the UE shall ignore the contents of this IE. | |
| CHOICE <i>TDD option</i> | MP | | | | REL-4 |
| >3.84 Mcps TDD | | | | (no data) | REL-4 |
| >7.68 Mcps TDD | | | | (no data) | REL-7 |
| >1.28 Mcps TDD | | | | | REL-4 |
| >>Modulation | MP | | Enumerated(QPSK, 8PSK) | | REL-4 |
| >>SS-TPC Symbols | MP | | Enumerated(0, 1, 16/SF) | Denotes amount of SS and TPC bits send in this timeslot | REL-4 |

| Information Element/Group name | Need | Multi | Type and reference | Semantics description | Version |
|--------------------------------|------|-------|--------------------|--|---------|
| >>Additional TPC-SS Symbols | OP | | Integer(1..15) | Specifies the number of additional codes in this timeslot that carry TPC and SS symbols as specified in [33] | REL-4 |

10.3.6.38 Individual Timeslot interference

Parameters used by the UE for uplink open loop power control in TDD.

| Information element | Need | Multi | Type and reference | Semantics description |
|--------------------------|------|-------|-----------------------------------|-----------------------|
| Timeslot number | MP | | Timeslot number
10.3.6.84 | |
| UL Timeslot Interference | MP | | UL Interference TDD
10.3.6.87a | |

10.3.6.39 Maximum allowed UL TX power

This information element indicates the maximum allowed uplink transmit power.

| Information Element | Need | Multi | Type and reference | Semantics description |
|-----------------------------|------|-------|--------------------|-----------------------|
| Maximum allowed UL TX power | MP | | Integer(-50..33) | In dBm |

10.3.6.39a Multi-frequency Info (1.28 Mcps TDD only)

| IE/Group Name | Presence | Multi | IE Type and Reference | Semantics Description | Version |
|-----------------------|----------|-------|-----------------------|---|---------|
| Second Frequency Info | OP | | Integer (0 .. 16383) | 1.28 Mcps TDD only | REL-7 |
| FPACH Frequency Info | OP | | Integer (0 .. 16383) | 1.28 Mcps TDD only | REL-7 |
| UpPCH Position Info | OP | | Integer (0 .. 127) | Only for 1.28 Mcps TDD, if UpPCH occupies UpPTS, the parameter is not needed. Or the parameter is calculated for the uplink access position of a cell | REL-7 |

10.3.6.40 Void

10.3.6.40a Measurement Feedback Info

| Information Element/Group name | Need | Multi | Type and reference | Semantics description | Version |
|--------------------------------|------|-------|---|---|---------|
| CHOICE <i>mode</i> | MP | | | | REL-5 |
| >FDD | | | | | REL-5 |
| >>Measurement Power Offset | MP | | Real (-6 .. 13 by step of 0.5) | The measurement power offset, Γ , in dB, as described in [29]. | REL-5 |
| >>>CQI Feedback cycle, k | MP | | Integer (0, 2, 4, 8, 10, 20, 40, 80, 160, 16, 32, 64) | In milliseconds. | REL-5 |
| >>>>CQI repetition factor | MP | | Integer (1..4) | In milliseconds. | REL-7 |
| >>>> Δ_{CQI} | MP | | Integer (0..8) | Refer to quantization of the power offset in [28] | REL-5 |
| >TDD | | | | (no data) | REL-5 |

10.3.6.41 Midamble shift and burst type

NOTE: Only for TDD.

This information element indicates burst type and midamble allocation. Three different midamble allocation schemes exist:

- Default midamble: the midamble shift is selected by layer 1 depending on the associated channelisation code (DL and UL)
- Common midamble: the midamble shift is chosen by layer 1 depending on the number of channelisation codes (possible in DL only)
- UE specific midamble: a UE specific midamble is explicitly assigned (DL and UL).

| Information Element/Group name | Need | Multi | Type and reference | Semantics description | Version |
|---|-------|-------|--|-----------------------|---------|
| CHOICE <i>TDD option</i> | MP | | | | REL-4 |
| >3.84 Mcps TDD | | | | | REL-4 |
| >>CHOICE <i>Burst Type</i> | MP | | | | |
| >>>Type 1 | | | | | |
| >>>>Midamble Allocation Mode | MP | | Enumerated (Default midamble, Common midamble, UE specific midamble) | | |
| >>>>Midamble configuration burst type 1 and 3 | MP | | Integer(4, 8, 16) | As defined in [30] | |
| >>>>Midamble Shift | CV-UE | | Integer(0..15) | | |
| >>>>Type 2 | | | | | |
| >>>>>Midamble Allocation Mode | MP | | Enumerated (Default midamble, Common midamble, UE specific midamble) | | |

| Information Element/Group name | Need | Multi | Type and reference | Semantics description | Version |
|---|-------|-------|--|--|---------|
| >>>>Midamble configuration burst type 2 | MP | | Integer(3, 6) | As defined in [30] | |
| >>>>Midamble Shift | CV-UE | | Integer(0..5) | | |
| >>>>Type 3 | | | | | |
| >>>>Midamble Allocation Mode | MP | | Enumerated (Default midamble, UE specific midamble) | | |
| >>>>Midamble configuration burst type 1 and 3 | MP | | Integer(4, 8, 16) | As defined in [30] | |
| >>>>Midamble Shift | CV-UE | | Integer (0..15) | NOTE: Burst Type 3 is only used in uplink. | |
| >>>>MBSFN Burst Type | | | | (no data) DL only | REL-7 |
| >7.68 Mcps TDD | | | | | REL-7 |
| >>CHOICE <i>Burst Type</i> | MP | | | | REL-7 |
| >>>>Type 1 | | | | | REL-7 |
| >>>>Midamble Allocation Mode | MP | | Enumerated (Default midamble, Common midamble, UE specific midamble) | | REL-7 |
| >>>>Midamble configuration burst type 1 and 3 | MP | | Integer(4, 8, 16) | As defined in [30] | REL-7 |
| >>>>Midamble Shift | CV-UE | | Integer(0..15) | | REL-7 |
| >>>>Type 2 | | | | | REL-7 |
| >>>>Midamble Allocation Mode | MP | | Enumerated (Default midamble, Common midamble, UE specific midamble) | | REL-7 |
| >>>>Midamble configuration burst type 2 | MP | | Integer(4, 8) | As defined in [30] | REL-7 |
| >>>>Midamble Shift | CV-UE | | Integer(0..7) | | REL-7 |
| >>>>Type 3 | | | | | REL-7 |
| >>>>Midamble Allocation Mode | MP | | Enumerated (Default midamble, UE specific midamble) | | REL-7 |
| >>>>Midamble configuration burst type 1 and 3 | MP | | Integer(4, 8, 16) | As defined in [30] | REL-7 |
| >>>>Midamble Shift | CV-UE | | Integer (0..15) | NOTE: Burst Type 3 is only used in uplink. | REL-7 |
| >>>>MBSFN Burst Type | | | | (no data) DL only | REL-7 |
| >1.28 Mcps TDD | | | | | REL-4 |
| >>Midamble Allocation Mode | MP | | Enumerated (Default midamble, Common midamble, UE specific midamble) | | REL-4 |
| >>Midamble configuration | MP | | Integer(2, 4, 6, 8, 10, 12, 14, 16) | As defined in [30] | REL-4 |
| >>Midamble Shift | CV-UE | | Integer (0..15) | | REL-4 |

| Condition | Explanation |
|-----------|--|
| UE | This IE is mandatory present when the value of the IE "Midamble Allocation Mode" is "UE-specific midamble" and not needed otherwise. |

10.3.6.41a MIMO parameters

| Information Element/Group name | Need | Multi | Type and reference | Semantics description | Version |
|---|------|---------------------|---|--|---------|
| MIMO operation | MP | | Enumerated (start, continue) | | REL-7 |
| CHOICE mode | MP | | | | REL-8 |
| >FDD | | | | | REL-8 |
| >>MIMO N_cqi_typeA/M_cqi ratio | OP | | Enumerated(1/2, 2/3, 3/4, 4/5, 5/6, 6/7, 7/8, 8/9, 9/10, 1/1) | | REL-7 |
| >>MIMO pilot configuration | OP | | MIMO pilot configuration 10.3.6.41b | | REL-7 |
| >>Precoding weight set restriction | OP | | Enumerated (TRUE) | If present and MIMO operation is set to start, the UE starts using precoding weight set restriction. | REL-7 |
| >TDD | | | | | REL-8 |
| >>CHOICE <i>TDD option</i> | MP | | | | REL-8 |
| >>>1.28 Mcps TDD | | | | | REL-8 |
| >>>>MIMO SF Mode for HS-PDSCH dual stream | MP | | Enumerated (SF1, SF1/SF16) | | REL-8 |
| >>>>HS-SICH Reference Signal Info | OP | <1 to maxHSSC CHs > | | The order of the list corresponds to the order of HS-SCCHs in HS-SCCH info | REL-8 |
| >>>>> Reference Signal Midamble configuration | MP | | Integer (2, 4, 6, 8, 10, 12, 14, 16) | Midamble Allocation mode is UE specific midamble allocation | REL-8 |
| >>>>>Reference Signal Midamble Shift | MP | | Integer (0..15) | The allocated midamble shift. | REL-8 |
| >>>>>Reference Signal Timeslot number | MP | | Integer (1..5) | | REL-8 |
| >>>3.84 Mcps TDD or 7.68 Mcps TDD | | | | (no data) | REL-8 |

10.3.6.41b MIMO pilot configuration

| Information Element/Group name | Need | Multi | Type and reference | Semantics description | Version |
|-------------------------------------|------|-------|--------------------|---|---------|
| CHOICE <i>Second CPICH pattern</i> | MP | | | | REL-7 |
| >Antenna2 P-CPICH | | | | (no data) | REL-7 |
| >Antenna1 S-CPICH | | | | | REL-7 |
| >>Channelisation code | MP | | Integer (0..255) | | REL-7 |
| >>Power Offset for S-CPICH for MIMO | OP | | Integer(-6 .. 0) | Power offset relative to the P-CPICH Tx power in dB | REL-7 |

10.3.6.41c Non-scheduled transmission grant info (TDD only)

| Information Element/Group name | Need | Multi | Type and reference | Semantics description | Version |
|--|---------------------|-------|--|---|---------|
| CHOICE <i>TDD Option</i> | | | | | REL-7 |
| >3.84/7.68 Mcps TDD | | | | | REL-7 |
| >>Timeslot Resource Related InformationI | MP | | Bit string (13) | Bitmap indicating which of the timeslots configured for E-DCH are allocated for non-scheduled transmissions | REL-7 |
| >>Power Resource Related Information | MP | | Integer (1..32) | Specifies the maximum allowed E-PUCH resource that the UE may use [15]. | REL-7 |
| >>Activation Time | MP | | Activation time 10.3.3.1 | | REL-7 |
| >>Repetition period and length | MD | | | Default is "Repetition period" = 1 (continuous) | REL-7 |
| >>>Repetition period | MP | | Integer (1, 2, 4, 8, 16, 32, 64) | Periodicity in terms of TTIs for which resource is allocated. 1= continuous allocation, 2 indicates every other TTI, 4 = every 4 th , 8 every 8 th etc. | REL-7 |
| >>>Repetition Length | MP | | Integer (1..Repetition period-1) | TTI in which resource is assigned. If Repetition period = 1 then value is ignored | REL-7 |
| >>Code Resource Information | MP | | Enumerated ((1/1),(2/1),(2/2),(4/1)..(4/4),(8/1)..(8/8),(16/1)..(16/16)) | | REL-7 |
| >1.28 Mcps TDD | | | | | REL-7 |
| >>N _{E-UCCH} | MD | | Integer (1..8) | Number of E-UCCH and TPC instances within an E-DCH TTI. Default = 1. | REL-7 |
| >>N _{E-HICH} | CV-Scheduled E-PUCH | | Integer(4..15) | Minimum number of slots between start last active slot of E-DCH TTI and start of ACK/NACK on E-HICH. | REL-7 |
| >>Timeslot Resource Related InformationI | MP | | Bit string (5) | Bitmap indicating which of the timeslots configured for E-DCH are allocated for non-scheduled transmissions | REL-7 |
| >>Power Resource Related Information | MP | | Integer (1..32) | Indicates 0-31 PRRI index | REL-7 |

| | | | | | |
|-----------------------------------|-----------------|--|---|---|-------|
| | | | | defined in [31], which specifies the maximum allowed E-PUCH resource that the UE may use [15]. | |
| >>Activation Time | MP | | Activation time 10.3.3.1 | Specifies the E-PUCH Offset in Radio Frame level. | REL-7 |
| >>Subframe number | MP | | Integer (0..1) | Specifies the E-PUCH Offset in subframe level. | REL-7 |
| >>Repetition period and length | MD | | | Default is "Repetition period" = 1 (continuous) | REL-7 |
| >>>Repetition period | MP | | Integer (1, 2, 4, 8, 16, 32, 64) | Periodicity in terms of TTIs for which resource is allocated. 1= continuous allocation, 2 indicates every other TTI, 4 = every 4 th , 8 every 8 th etc. | REL-7 |
| >>>Repetition Length | MP | | Integer (1..Repetition period-1) | TTI in which resource is assigned. If Repetition period = 1 then value is ignored | REL-7 |
| >>Code Resource Information | MP | | Enumerated ((1/1), (2/1),(2/2),(4/1)..(4/4),(8/1)..(8/8),(16/1)..(16/16)) | | REL-7 |
| >>E-HICH Information | MP | | | | REL-7 |
| >>>Timeslot number | MP | | Integer (0..6) | | REL-7 |
| >>>Channelisation code | MP | | Enumerated ((16/1)..(16/16)) | | REL-7 |
| >>>Midamble Allocation mode | MP | | Enumerated (Default midamble, UE specific midamble) | | REL-7 |
| >>>Midamble configuration | MP | | Integer (2, 4, 6, 8, 10, 12, 14, 16) | | REL-7 |
| >>>Midamble Shift | CV-UE specific | | Integer (0..15) | | REL-7 |
| >>>Signature Sequence Group Index | MP | | Integer (0..19) | | REL-7 |
| >>T-SI-NST | CV-E-RUCCH info | | Enumerated (everyEDCH TTI, 20,40,60,80, 160,200) | Values in ms. If T-SI-NST expires then UE should include scheduling information in the next new non-scheduled MAC-e PDU or MAC-i PDU. | REL-7 |

| Condition | Explanation |
|-------------------------|--|
| <i>Scheduled E-PUCH</i> | If NE-HICH is given in scheduled E-PUCH information, this IE is not needed, otherwise it is mandatory |
| <i>UE specific</i> | If UE specific midamble allocation mode is configured, this IE is mandatory, otherwise it is not needed. |
| <i>E-RUCCH info</i> | This IE is optionally present if the IE "E-RUCCH Info" is not included, otherwise the IE is not needed. |

10.3.6.42 PDSCH Capacity Allocation info

NOTE: Only for TDD.

| Information Element/Group name | Need | Multi | Type and reference | Semantics description |
|--------------------------------|------|-------|------------------------------------|-----------------------|
| PDSCH allocation period info | MP | | Allocation Period Info 10.3.6.4 | |
| <i>CHOICE Configuration</i> | MP | | | |
| >Old configuration | | | | |
| >>TFCS ID | MD | | Integer(1..8) | Default is 1. |
| >>PDSCH Identity | MP | | Integer(1..hi PDSCHidentities) | |
| >New configuration | | | | |
| >>PDSCH Info | MP | | PDSCH Info 10.3.6.44 | |
| >>PDSCH Identity | OP | | Integer(1..hi PDSCHidentities) | |
| >>PDSCH power control info | OP | | PDSCH power control info 10.3.6.45 | |

10.3.6.43 Void

10.3.6.44 PDSCH info

NOTE: Only for TDD.

| Information Element/Group name | Need | Multi | Type and reference | Semantics description | Version |
|--|------|-------|---|--|---------|
| TFCS ID | MD | | Integer(1..8) | TFCS to be used. Default value is 1. | |
| Common timeslot info | OP | | Common timeslot info 10.3.6.10 | | |
| PDSCH timeslots and codes for 1.28 Mcps TDD or 3.84 Mcps TDD | OP | | Downlink Timeslots and Codes 10.3.6.32 | Default is to use the old timeslots and codes. | |
| PDSCH timeslots and codes for 7.68 Mcps TDD | OP | | Downlink Timeslots and Codes VHR 10.3.6.32a | Default is to use the old timeslots and codes. | REL-7 |

10.3.6.45 PDSCH Power Control info

NOTE: Only for TDD.

| Information Element/Group name | Need | Multi | Type and reference | Semantics description |
|--------------------------------|------|-----------------|---|--|
| TPC Step Size | OP | | Integer (1, 2, 3) | In dB |
| UL CCTrCH TPC List | OP | 1..<maxCC TrCH> | | UL CCTrCH identities for TPC commands associated with this DL CCTrCH.

This list is not used in 1.28 Mcps TDD. |
| >UL TPC TFCS Identity | MP | | Transport Format Combination Set Identity 10.3.5.21 | |

10.3.6.46 PDSCH system information

NOTE: Only for TDD.

| Information Element/Group name | Need | Multi | Type and reference | Semantics description | Version |
|------------------------------------|------------|------------------|--|---|---------|
| PDSCH information | MP | 1 to <maxPD SCH> | | | |
| >PDSCH Identity | MP | | Integer(1..hiPDSCH identities) | | |
| >PDSCH info | MP | | PDSCH info 10.3.6.44 | | |
| >SFN Time Info | CH-Block17 | | SFN Time Info 10.3.6.75 | | |
| >DSCH TFS | OP | | Transport format set 10.3.5.23 | | |
| >DSCH Transport Channels | OP | 1 to <maxTr CH> | | If PDSCH is configured for 3.84Mcps TDD in Rel-5 or for 7.68 Mcps in Rel-7 this IE may be included. | REL-5 |
| >> DSCH Transport channel identity | MP | | Transport channel identity 10.3.5.18 | | REL-5 |
| >>>DSCH TFS | MP | | Transport format set 10.3.5.23 | | REL-5 |
| >DSCH TFCS | OP | | Transport Format Combination Set 10.3.5.20 | | |

| Condition | Explanation |
|-----------|---|
| Block17 | This IE is not needed in System Information Block 17. Otherwise it is optional. |

10.3.6.47 Void

10.3.6.48 Persistence scaling factors

This IE defines scaling factors associated with ASC 2 – ASC 7 to be applied to the dynamic persistence value.

| Information Element/Group name | Need | Multi | Type and reference | Semantics description |
|--------------------------------|------|-----------------------|--------------------------------|--|
| Access Service Class | MP | 1 to maxASCpersistent | | multiplicity corresponds to the number of PRACH partitions minus 2 |
| >Persistence scaling factor | MP | | Real(0.9..0.2, by step of 0.1) | Scaling factors in the range 0,...,1 |

10.3.6.49 PICH Info

| Information Element/Group name | Need | Multi | Type and reference | Semantics description | Version |
|---------------------------------|------|-------|---|--|---------|
| CHOICE <i>mode</i> | MP | | | | |
| >FDD | | | | | |
| >>Channelisation code | MP | | Integer(0..255) | SF is fixed and equal to 256 | |
| >>Number of PI per frame | MP | | Integer (18, 36, 72, 144) | | |
| >>STTD indicator | MP | | STTD Indicator 10.3.6.78 | | |
| >TDD | | | | | |
| >>Timeslot number | MD | | Timeslot number 10.3.6.84 | Default value is the timeslot used by the SCCPCH carrying the associated PCH. | |
| >>Midamble shift and burst type | MP | | Midamble shift and burst type 10.3.6.41 | | |
| >>>CHOICE <i>TDD option</i> | MP | | | | REL-4 |
| >>>>3.84 Mcps TDD | | | | | REL-4 |
| >>>>>Channelisation code | MD | | Enumerated ((16/1)...(16/16)) | Default value is the channelisation code used by the SCCPCH carrying the associated PCH. | |
| >>>>>7.68 Mcps TDD | | | | | REL-7 |
| >>>>>>Channelisation code | MD | | Enumerated ((32/1)...(32/32)) | Default value is the channelisation code used by the SCCPCH carrying the associated PCH. | REL-7 |
| >>>>>>>1.28 Mcps TDD | | | | | REL-4 |
| >>>>>>>>Codes list | MP | 1..2 | | | REL-4 |
| >>>>>>>>>Channelisation code | MP | | Enumerated ((16/1)...(16/16)) | | REL-4 |
| >>Repetition period/length | MD | | Enumerated((4/2),(8/2), (8/4),(16/2), (16/4), | Default value is "(64/2)". | |

| | | | | | |
|---------------------------|----|--|--|--|--|
| | | | (32/2),(32/4),
(64/2),(64/4)) | | |
| >>Offset | MP | | Integer
(0...Repetition
period -1) | SFN mod
Repetitionperiod =
Offset. | |
| >>Paging indicator length | MD | | Integer (4, 8,
16) | Indicates the
length of one
paging indicator in
Bits. Default value
is 4. | |
| >>N _{GAP} | MD | | Integer(2, 4,
8) | Number of frames
between the last
frame carrying
PICH for this
Paging Occasion
and the first frame
carrying paging
messages for this
Paging Occasion.
Default value is 4. | |
| >>N _{PCH} | MD | | Integer(1 ..
8) | Number of paging
groups. Default
value is 2. | |

10.3.6.50 PICH Power offset

This is the power transmitted on the PICH minus power of the Primary CPICH in FDD and Primary CCPCH Tx Power in TDD.

| Information Element/Group name | Need | Multi | Type and reference | Semantics description |
|--------------------------------|------|-------|-----------------------|-----------------------|
| PICH Power offset | MP | | Integer(-10 ..
+5) | Offset in dB |

10.3.6.50a PLCCH Info

NOTE: Only for 1.28 Mcps TDD

| Information Element/Group name | Need | Multi | Type and reference | Semantics description |
|--------------------------------|------|-------|--|---|
| PLCCH sequence number | M | | Integer(1..
14) | |
| Timeslot number | M | | Integer(0..
6) | |
| Channelisation Code | M | | Enumerated((16/1)..(1
6/16)) | |
| TPC command target rate | M | | Real(0.01..
0.1 by
steps of
0.01) | Transmit Power Control
command target rate |

10.3.6.51 PRACH Channelisation Code List

NOTE: Only for 3.84 Mcps TDD.

| Information Element/Group name | Need | Multi | Type and reference | Semantics description | Version |
|--------------------------------|------|--------|--------------------|-----------------------|---------|
| CHOICE SF | MP | | | | |
| >SF16 | | | | | |
| >>Channelisation Code List | MP | 1 to 8 | | | |
| >>>Channelisation code | MP | | Enumerated | There is a 1:1 | |

| Information Element/Group name | Need | Multi | Type and reference | Semantics description | Version |
|--------------------------------|------|--------|-------------------------|---|---------|
| | | | ((16/1)...(16/16)) | mapping between spreading code and midamble shift defined in [30] for channelisation codes (16/1) to (16/8).

NOTE:
channelisation codes (16/9) to (16/16) are not to be used. | |
| >SF8 | | | | | |
| >>Channelisation Code List | MP | 1 to 8 | | | |
| >>>Channelisation Code | MP | | Enumerated(8/1)..(8/8)) | | |

10.3.6.51a PRACH Channelisation Code 1.28 Mcps TDD

NOTE: Only for 1.28 Mcps TDD.

| Information Element/Group name | Need | Multi | Type and reference | Semantics description | Version |
|--------------------------------|------|--------|--|-----------------------|---------|
| Channelisation Code List | MP | 1 to 4 | | | REL-4 |
| >Channelisation Code | MP | | Enumerated(4/1)..(4/4),(8/1)..(8/8),(16/1)..(16/16)) | | REL-4 |

10.3.6.51b PRACH Channelisation Code List VHCR

NOTE: Only for 7.68 Mcps TDD.

| Information Element/Group name | Need | Multi | Type and reference | Semantics description | Version |
|--------------------------------|------|---------|------------------------------|--|---------|
| CHOICE SF | MP | | | | REL-7 |
| >SF32 | | | | | REL-7 |
| >>Channelisation Code List | MP | 1 to 16 | | | REL-7 |
| >>>Channelisation code | MP | | Enumerated((32/1)...(32/32)) | There is a 1:1 mapping between spreading code and midamble shift defined in [30] for channelisation codes (32/1) to (32/16).

NOTE:
channelisation codes (32/17) to (32/32) are not to be used. | REL-7 |
| >SF16 | | | | | REL-7 |
| >>Channelisation Code List | MP | 1 to 16 | | | REL-7 |
| >>>Channelisation code | MP | | Enumerated((16/1)...(16/16)) | There is a 1:1 mapping between spreading code and midamble shift defined in | REL-7 |

| Information Element/Group name | Need | Multi | Type and reference | Semantics description | Version |
|--------------------------------|------|-------|--------------------|--|---------|
| | | | | [30] for channelisation codes (16/1) to (16/16). | |

10.3.6.52 PRACH info (for RACH)

| Information Element/Group name | Need | Multi | Type and reference | Semantics description | Version |
|------------------------------------|------|-------|---|---|---------|
| CHOICE <i>mode</i> | MP | | | | |
| >FDD | | | | | |
| >>Available Signature | MP | | Bit string(16) | Each bit indicates availability for a signature, where the signatures are numbered "signature 0" up to "signature 15". The value 1 of a bit indicates that the corresponding signature is available and the value 0 that it is not available. | |
| >>Available SF | MP | | Integer (32,64,128,256) | In chips per symbol
Defines the minimum allowed SF (i.e. the maximum rate) | |
| >>Preamble scrambling code number | MP | | Integer (0 .. 15) | Identification of scrambling code see [28] | |
| >>Puncturing Limit | MP | | Real(0.40..1.00 by step of 0.04) | | |
| >>Available Sub Channel Number | MP | | Bit string(12) | Each bit indicates availability for a subchannel, where the subchannels are numbered "subchannel 0" to "subchannel 11". The value 1 of a bit indicates that the corresponding subchannel is available and the value 0 indicates that it is not available. | |
| >TDD | | | | | |
| >>CHOICE <i>TDD option</i> | MP | | | | REL-4 |
| >>>3.84 Mcps TDD | | | | | REL-4 |
| >>>>Timeslot number | MP | | Timeslot number
10.3.6.84 | | |
| >>>>PRACH Channelisation Code List | MP | | PRACH Channelisation Code List
10.3.6.51 | | |

| | | | | | |
|---|----|----------------------|--|---|-------|
| >>>>PRACH Midamble | MP | | Enumerated (Direct, Direct/Inverted) | Direct or direct and inverted midamble are used for PRACH | |
| >>>>PNBSCH allocation | OP | | PNBSCH allocation 10.3.8.10a | Identifies frames used for cell synchronisation purposes | REL-4 |
| >>>7.68 Mcps TDD | | | | | REL-7 |
| >>>>Timeslot number | MP | | Timeslot number 10.3.6.84 | | REL-7 |
| >>>>PRACH Channelisation Code List VHCR | MP | | PRACH Channelisation Code List VHCR 10.3.6.51b | | REL-7 |
| >>>>PRACH Midamble | MP | | Enumerated (Direct, Direct/Inverted) | Direct or direct and inverted midamble are used for PRACH | REL-7 |
| >>>>PNBSCH allocation | OP | | PNBSCH allocation 10.3.8.10a | Identifies frames used for cell synchronisation purposes | REL-7 |
| >>>1.28 Mcps TDD | | | | | REL-4 |
| >>>>SYNC_UL info | MP | | SYNC_UL info 10.3.6.78a | | REL-4 |
| >>>>PRACH Definition | MP | 1..<maxPRACH_FPA CH> | | | REL-4 |
| >>>>>Timeslot number | MP | | Timeslot number 10.3.6.84 | | REL-4 |
| >>>>>PRACH Channelisation Code | MP | | PRACH Channelisation Code 1.28 Mcps TDD 10.3.6.51a | | REL-4 |
| >>>>>Midamble Shift and burst type | MP | | Midamble shift and burst type 10.3.6.41 | | REL-4 |
| >>>>>FPACH info | MP | | FPACH info 10.3.6.35a | | REL-4 |

10.3.6.53 PRACH partitioning

| Information Element/Group name | Need | Multi | Type and reference | Semantics description |
|--------------------------------|------|-------------|----------------------|--|
| Access Service class | MP | 1 to maxASC | | If only "NumASC+1" (with, NumASC+1 < maxASC) ASCs are listed, the remaining (NumASC+2 through maxASC) ASCs are unspecified. |
| >ASC Setting | MD | | ASC setting 10.3.6.6 | The default values are same as the previous ASC. If the "default" is used for the first ASC, the default values are all available signatures and "all available sub-channels" for FDD and "all available channelisation codes" and "all available subchannels" with "subchannel size=Size 1" in TDD. |

10.3.6.54 PRACH power offset

NOTE: Only for FDD.

| Information Element/Group name | Need | Multi | Type and reference | Semantics description |
|--------------------------------|------|-------|--------------------|--|
| Power Ramp Step | MP | | Integer (1..8) | Power step when no acquisition indicator is received in dB |
| Preamble Retrans Max | MP | | Integer (1..64) | Maximum number of preambles in one preamble ramping cycle |

10.3.6.54a PRACH preamble control parameters (for Enhanced Uplink)

| Information Element/Group name | Need | Multi | Type and reference | Semantics description | Version |
|--------------------------------|------|-------|--------------------|-----------------------|---------|
|--------------------------------|------|-------|--------------------|-----------------------|---------|

| | | | | | |
|---------------------------------|----|--|-------------------|--|-------|
| Available Signature | MD | | Bit string(16) | The default value is the inverse of the bitstring indicated in the IE "Available Signature" in the IE "PRACH Info (for RACH)" in the first occurrence in list "PRACH system information list" in SIB5 or SIB5bis. Each bit indicates availability for a signature. Each available signature on the AICH is associated with one Common E-DCH Resource Configuration in the 'Common E-DCH resource configuration information list'. | REL-8 |
| E-AI Indication | MP | | BOOLEAN | TRUE: E-AIs are in use on the AICH.
FALSE: E-AIs are not in use on the AICH. | REL-8 |
| Preamble scrambling code number | MD | | Integer (0 .. 15) | The default value is the value indicated in the IE "Preamble scrambling code number" in the IE "PRACH Info (for RACH)" in the first occurrence in list "PRACH system information list" in SIB5 or SIB5bis. Identification of scrambling code, see [28] | REL-8 |
| Available Sub Channel Number | MD | | Bit string(12) | The default value is the same value indicated in the IE "Available Sub Channel Number" in the IE "PRACH system information list" in the first occurrence in list "PRACH system information list" in SIB5 or SIB5bis. Each bit indicates availability for a subchannel, where the subchannels are numbered "subchannel 0" to "subchannel 11". The value 1 of a bit indicates that the corresponding subchannel is available and the value 0 indicates that it is not available. | REL-8 |

| | | | | | |
|-------------------------------|----|--|---|---|-------|
| PRACH partitioning | MD | | PRACH partitioning
10.3.6.53 | Default value is the value of "PRACH partitioning" in the first occurrence in list 'PRACH system information list' in SIB5 or SIB5bis. | REL-8 |
| Persistence scaling factors | OP | | Persistence scaling factors
10.3.6.48 | This IE shall not be present if only ASC 0 and ASC 1 are defined. If this IE is absent, default value is the value of "Persistence scaling factors" in the first occurrence in list 'PRACH system information list' in SIB5 or SIB5bis, if value exists | REL-8 |
| AC-to-ASC mapping | MD | | AC-to-ASC mapping
10.3.6.1 | Default value is the value of "AC-to-ASC mapping" in the first occurrence in list 'PRACH system information list' in SIB5 or SIB5bis. | REL-8 |
| Primary CPICH TX power | MD | | Primary CPICH TX power
10.3.6.61 | Default value is the value of "Primary CPICH TX power" in the first occurrence in list 'PRACH system information list' in SIB5 or SIB5bis. | REL-8 |
| Constant value | MD | | Constant value
10.3.6.11 | Default value is the value of "Constant value" in the first occurrence in list 'PRACH system information list' in SIB5 or SIB5bis | REL-8 |
| PRACH power offset | MD | | PRACH power offset
10.3.6.54 | Default value is the value of "PRACH power offset" in the first occurrence in list 'PRACH system information list' in SIB5 or SIB5bis | REL-8 |
| PRACH transmission parameters | MD | | RACH transmission parameters
10.3.6.67 | Default value is the value of "RACH transmission parameters" in the first occurrence in list 'PRACH system information list' in SIB5 or SIB5bis. | REL-8 |
| AICH info | MD | | AICH info
10.3.6.2 | Default value is the value of "AICH info" in the first occurrence in list 'PRACH system information list' in SIB5 or SIB5bis. | REL-8 |
| Power offset P _{p-e} | MP | | Integer(-5..10) | In dB. Power offset between the last transmitted preamble and the initial DPCCH transmission as defined in [26] | REL-8 |

10.3.6.55 PRACH system information list

| Information element | Need | Multi | Type and reference | Semantics description | Version |
|-----------------------------------|---------------------|------------------------|--|---|---------|
| PRACH system information | MP | 1 ..
<maxPRA
CH> | | | |
| >PRACH info | MP | | PRACH info
(for RACH)
10.3.6.52 | | |
| >Transport channel identity | MP | | Transport
channel
identity
10.3.5.18 | | |
| >RACH TFS | MD | | Transport
format set
10.3.5.23 | Default value is the value of
"RACH TFS" for the previous
PRACH in the list
NOTE: The first occurrence is
then MP).
NOTE: For TDD in this release
there is a single TF
within the RACH
TFS. | |
| >Additional RACH TFS for
CCCH | OP | | Additional
Dynamic
Transport
Format
Information
for CCCH
10.3.5.2a | FDD only | REL-6 |
| >RACH TFCS | MD | | Transport
Format
Combination
Set
10.3.5.20 | Default value is the value of
"RACH TFCS" for the previous
PRACH in the list.
NOTE: The first occurrence is
then MP).
NOTE: For TDD in this release
there is no TFCS
required. | |
| >Additional RACH TFCS for
CCCH | CV-Add-
RACH-TFS | | Additional
RACH TFCS
for CCCH
10.3.5.2b | | REL-6 |
| >PRACH partitioning | MD | | PRACH
partitioning
10.3.6.53 | Default value is the value of
"PRACH partitioning" for the
previous PRACH in the list
(note : the first occurrence is
then MP) | |
| >Persistence scaling factors | OP | | Persistence
scaling
factors
10.3.6.48 | This IE shall not be present if
only ASC 0 and ASC 1 are
defined. If this IE is absent,
value is the value of
"Persistence scaling factors"
for the previous PRACH in the
list if value exists | |
| >AC-to-ASC mapping | CV-SIB5-
MD | | AC-to-ASC
mapping
10.3.6.1 | Only present in SIB 5 and in
SIB 5bis.
Default value is the value of
"AC-to-ASC mapping" for the
previous PRACH in the list.
NOTE: The first occurrence is
then MP in SIB5
and in SIB5bis. | |
| >CHOICE mode | MP | | | | |
| >>FDD | | | | | |
| >>>Primary CPICH TX power | MD | | Primary | Default value is the value of | |

| Information element | Need | Multi | Type and reference | Semantics description | Version |
|---------------------------------|------|-------|---|--|---------|
| | | | CPICH TX power
10.3.6.61 | "Primary CPICH TX power" for the previous PRACH in the list.
NOTE: The first occurrence is then MP. | |
| >>>Constant value | MD | | Constant value
10.3.6.11 | Default value is the value of "Constant value" for the previous PRACH in the list.
NOTE: The first occurrence is then MP. | |
| >>>PRACH power offset | MD | | PRACH power offset
10.3.6.54 | Default value is the value of "PRACH power offset" for the previous PRACH in the list.
NOTE: The first occurrence is then MP. | |
| >>>RACH transmission parameters | MD | | RACH transmission parameters
10.3.6.67 | Default value is the value of "RACH transmission parameters" for the previous PRACH in the list.
NOTE: The first occurrence is then MP. | |
| >>>AICH info | MD | | AICH info
10.3.6.2 | Default value is the value of "AICH info" for the previous PRACH in the list.
NOTE: The first occurrence is then MP. | |
| >>TDD | | | | (no data) | |

| Condition | Explanation |
|---------------------|--|
| <i>SIB5-MD</i> | The information element is present only in SIB 5 and in SIB5bis. In SIB 5 and in SIB 5bis it is mandatory with default. |
| <i>Add-RACH-TFS</i> | The information element is MP if the IE "Additional RACH TFS for CCCH" is included. Otherwise the information element is not needed. |

NOTE: If the setting of the PRACH information results in that a combination of a signature, preamble scrambling code and subchannel corresponds to a RACH with different TFS and/or TFCS, then for that combination only the TFS/TFCS of the PRACH listed first is valid, where PRACHs listed in System Information Block type 5 or 5bis shall be counted first.

10.3.6.56 Predefined PhyCH configuration

This information element concerns a pre- defined configuration of physical channel parameters.

| Information Element/Group name | Need | Multi | Type and Reference | Semantics description |
|---|------|-------|---|-----------------------|
| Uplink radio resources | | | | |
| Uplink DPCH info | MP | | Uplink DPCH info
Pre
10.3.6.90 | |
| Downlink radio resources | | | | |
| Downlink information common for all radio links | OP | | Downlink information common for all radio links
Pre
10.3.6.26 | |

10.3.6.57 Primary CCPCH info

| Information Element/Group name | Need | Multi | Type and reference | Semantics description | Version |
|--------------------------------|------|-------|-----------------------------|---|---------|
| CHOICE <i>mode</i> | MP | | | | |
| >FDD | | | | | |
| >>TX Diversity indicator | MP | | Boolean | TRUE indicates that transmit diversity is used. | |
| >TDD | | | | | |
| >>CHOICE <i>TDD option</i> | MP | | | | REL-4 |
| >>>3.84 and 7.68 Mcps TDD | | | | | REL-4 |
| >>>>CHOICE <i>SyncCase</i> | OP | | | | |
| >>>>>Sync Case 1 | | | | | |
| >>>>>>Timeslot | MP | | Integer (0...14) | PCCPCH timeslot | |
| >>>>>>>Sync Case 2 | | | | | |
| >>>>>>>>Timeslot | MP | | Integer(0..6) | | |
| >>>>>>>>1.28 Mcps TDD | | | | | REL-4 |
| >>>>>TSTD indicator | MP | | TSTD indicator 10.3.6.85a | | REL-4 |
| >>>>>>Cell parameters ID | OP | | Cell parameters Id 10.3.6.9 | The Cell parameters ID is described in [32]. | |
| >>>>>>>SCTD indicator | MP | | SCTD indicator 10.3.6.70a | | |

10.3.6.58 Primary CCPCH info post

NOTE: Only for TDD

| Information Element/Group name | Need | Multi | Type and reference | Semantics description | Version |
|--------------------------------|------|-------|-----------------------------|--|---------|
| CHOICE <i>TDD option</i> | MP | | | | REL-4 |
| >3.84 Mcps TDD | | | | | REL-4 |
| >>CHOICE <i>SyncCase</i> | MP | | | | |
| >>>Sync Case 1 | | | | | |
| >>>>Timeslot | MP | | Integer (0...14) | PCCPCH timeslot | |
| >>>>Sync Case 2 | | | | | |
| >>>>>Timeslot | MP | | Integer(0..6) | | |
| >7.68 Mcps TDD | | | | | REL-7 |
| >>CHOICE <i>SyncCase</i> | MP | | | | REL-7 |
| >>>Sync Case 1 | | | | | REL-7 |
| >>>>Timeslot | MP | | Integer (0...14) | PCCPCH timeslot | REL-7 |
| >>>>Sync Case 2 | | | | | REL-7 |
| >>>>>Timeslot | MP | | Integer(0..6) | | REL-7 |
| >1.28 Mcps TDD | | | | | REL-4 |
| >>TSTD indicator | MP | | TSTD indicator 10.3.6.85a | | REL-4 |
| Cell parameters ID | MP | | Cell parameters Id 10.3.6.9 | The Cell parameters ID is described in [32]. | |
| SCTD indicator | MP | | SCTD indicator 10.3.6.70a | | |

10.3.6.59 Primary CCPCH TX Power

NOTE: Only for TDD.

| Information Element/group name | Need | Multi | Type and reference | Semantics description |
|--------------------------------|------|-------|--------------------|-----------------------|
| Primary CCPCH Tx Power | MP | | Integer(6..43) | In dBm |

10.3.6.60 Primary CPICH info

NOTE: Only for FDD.

| Information Element/Group name | Need | Multi | Type and reference | Semantics description |
|--------------------------------|------|-------|--------------------|-----------------------|
| Primary scrambling code | MP | | Integer(0..511) | |

10.3.6.61 Primary CPICH Tx power

NOTE: Only for FDD.

| Information Element/Group name | Need | Multi | Type and reference | Semantics description |
|--------------------------------|------|-------|--------------------|-----------------------|
| Primary CPICH Tx Power | MP | | Integer(-10..50) | Power in dBm. |

10.3.6.62 Primary CPICH usage for channel estimation

NOTE: Only for FDD.

| Information Element/Group name | Need | Multi | Type and Reference | Semantics description |
|--|------|-------|--|-----------------------|
| Primary CPICH usage for channel estimation | MP | | Enumerated(Primary CPICH may be used, Primary CPICH shall not be used) | |

10.3.6.63 PUSCH info

NOTE: Only for 1.28 Mcps and 3.84 Mcps TDD.

| Information Element/Group name | Need | Multi | Type and reference | Semantics description |
|--------------------------------|------|-------|--------------------------------------|-----------------------|
| TFCS ID | MD | | Integer(1..8) | Default value is 1 |
| Common timeslot info | OP | | Common timeslot info 10.3.6.10 | |
| PUSCH timeslots and codes | OP | | Uplink Timeslots and Codes 10.3.6.94 | |

10.3.6.63a PUSCH info VHCR

NOTE: Only 7.68 Mcps TDD (REL-7).

| Information Element/Group name | Need | Multi | Type and reference | Semantics description | Version |
|--------------------------------|------|-------|---|-----------------------|---------|
| TFCS ID | MD | | Integer(1..8) | Default value is 1 | REL-7 |
| Common timeslot info | OP | | Common timeslot info
10.3.6.10 | | REL-7 |
| PUSCH timeslots and codes VHCR | OP | | Uplink Timeslots and Codes VHCR
10.3.6.94b | | REL-7 |

10.3.6.64 PUSCH Capacity Allocation info

NOTE: Only for TDD.

| Information Element/Group name | Need | Multi | Type and reference | Semantics description | Version |
|--|------|-------|---------------------------------------|-----------------------|---------|
| CHOICE <i>PUSCH allocation</i> | MP | | | | |
| >PUSCH allocation pending | | | | (no data) | |
| >PUSCH allocation assignment | | | | | |
| >>PUSCH allocation period info | MP | | Allocation Period Info
10.3.6.4 | | |
| >>>PUSCH power control info | OP | | PUSCH power control info
10.3.6.65 | | |
| >>>CHOICE <i>Configuration</i> | MP | | | | |
| >>>>Old configuration | | | | | |
| >>>>TFCS ID | MD | | Integer(1..8) | Default is 1. | |
| >>>>PUSCH Identity | MP | | Integer(1..hiPUSCHidentities) | | |
| >>>>New 1.28 Mcps TDD or 3.84 Mcps TDD configuration | | | | | |
| >>>>PUSCH info | MP | | PUSCH info
10.3.6.63 | | |
| >>>>PUSCH Identity | OP | | Integer(1..hiPUSCHidentities) | | |
| >>>>New 7.68 Mcps TDD configuration | | | | | REL-7 |
| >>>>PUSCH info VHCR | MP | | PUSCH info VHCR
10.3.6.63a | | REL-7 |
| >>>>PUSCH Identity | OP | | Integer(1..hiPUSCHidentities) | | REL-7 |

10.3.6.65 PUSCH power control info

NOTE: Only for TDD.

Interference level measured for a frequency at the UTRAN access point used by UE to set PUSCH output power.

| Information Element/Group name | Need | Multi | Type and reference | Semantics description | Version |
|--------------------------------|------|-------|--------------------|-----------------------|---------|
|--------------------------------|------|-------|--------------------|-----------------------|---------|

| Information Element/Group name | Need | Multi | Type and reference | Semantics description | Version |
|--------------------------------|------|-------|------------------------------------|--|---------|
| UL target SIR | MP | | Real (-11 .. 20 by step of 0.5 dB) | For 1.28 Mcps TDD this parameter represents PRXPUSCHdes with range Integer(-120...-58 by step of 1) dBm | REL-4 |
| CHOICE TDD option | MP | | | | REL-4 |
| >3.84 Mcps TDD | | | | (no data) | REL-4 |
| >7.68 Mcps TDD | | | | (no data) | REL-7 |
| >1.28 Mcps TDD | | | | | REL-4 |
| >>TPC Step Size | OP | | Integer (1, 2, 3) | In dB | REL-4 |
| >>Beacon PL Est. | OP | | Enumerated (TRUE) | The presence of this IE indicates that the UE may take into account path loss estimated from beacon function physical channels. The absence indicates that UE may not take into account path loss estimated from beacon function physical channels | REL-6 |

10.3.6.66 PUSCH system information

NOTE: Only for 1.28 Mcps or 3.84 Mcps TDD.

| Information Element/Group name | Need | Multi | Type and reference | Semantics description | Version |
|--------------------------------|------------|-----------------|--------------------------------|-----------------------|---------|
| PUSCH information | MP | 1 to <maxPUSCH> | | | |
| >PUSCH Identity | MP | | Integer(1..hiPUSCHidentities) | | |
| >PUSCH info | MP | | PUSCH info 10.3.6.63 | | |
| >SFN Time Info | CH-Block17 | | SFN Time Info 10.3.6.75 | | |
| >USCH TFS | OP | | Transport format set 10.3.5.23 | | |

| Information Element/Group name | Need | Multi | Type and reference | Semantics description | Version |
|------------------------------------|------|----------------|--|--|---------|
| >USCH Transport Channels | OP | 1 to <maxTrCH> | | If PUSCH is configured for 3.84 Mcps TDD in Rel-5 this IE may be included. | REL-5 |
| >> USCH Transport channel identity | MP | | Transport channel identity 10.3.5.18 | | REL-5 |
| >>USCH TFS | MP | | Transport format set 10.3.5.23 | | REL-5 |
| >USCH TFCS | OP | | Transport Format Combination Set 10.3.5.20 | | |

| Condition | Explanation |
|----------------|---|
| <i>Block17</i> | This IE is not needed in System Information Block 17. Otherwise it is optional. |

10.3.6.66a PUSCH system information VHCR

NOTE: Only for 7.68 Mcps TDD (REL-7).

| Information Element/Group name | Need | Multi | Type and reference | Semantics description | Version |
|--------------------------------|-----------------------|-----------------|--------------------------------|-----------------------|---------|
| PUSCH information | MP | 1 to <maxPUSCH> | | | REL-7 |
| >PUSCH Identity | MP | | Integer(1..hiPUSCHidentities) | | REL-7 |
| >PUSCH info VHCR | MP | | PUSCH info VHCR 10.3.6.63a | | REL-7 |
| >SFN Time Info | CH-
<i>Block17</i> | | SFN Time Info 10.3.6.75 | | REL-7 |
| >USCH TFS | OP | | Transport format set 10.3.5.23 | | REL-7 |

| Information Element/Group name | Need | Multi | Type and reference | Semantics description | Version |
|------------------------------------|------|-----------------|--|--|---------|
| >USCH Transport Channels | OP | 1 to <maxTr CH> | | If PUSCH is configured for 7.68 Mcps TDD in Rel-7 this IE may be included. | REL-7 |
| >> USCH Transport channel identity | MP | | Transport channel identity 10.3.5.18 | | REL-7 |
| >>USCH TFS | MP | | Transport format set 10.3.5.23 | | REL-7 |
| >USCH TFCS | OP | | Transport Format Combination Set 10.3.5.20 | | REL-7 |

| Condition | Explanation |
|----------------|---|
| <i>Block17</i> | This IE is not needed in System Information Block 17. Otherwise it is optional. |

10.3.6.67 RACH transmission parameters

NOTE: Only for FDD.

| Information Element/Group name | Need | Multi | Type and reference | Semantics description |
|--------------------------------|------|-------|--------------------|--------------------------------------|
| Mmax | MP | | Integer(1..32) | Maximum number of preamble cycles |
| NB01min | MP | | Integer(0..50) | Sets lower bound for random back-off |
| NB01max | MP | | Integer(0..50) | Sets upper bound for random back-off |

10.3.6.68 Radio link addition information

| Information Element/Group name | Need | Multi | Type and reference | Semantics description | Version |
|--|------|-------|--|-----------------------|---------|
| Primary CPICH info | MP | | Primary CPICH info 10.3.6.60 | | |
| Cell ID | OP | | Cell ID 10.3.2.2 | | REL-4 |
| CHOICE <i>DPCH info</i> | MP | | | | REL-6 |
| >Downlink DPCH info for each RL | MP | | Downlink DPCH info for each RL 10.3.6.21 | | |
| >Downlink F-DPCH info for each RL | MP | | Downlink F-F-DPCH info for each RL 10.3.6.23ob | | REL-6 |
| E-HICH Information | OP | | E-HICH Info 10.3.6.101 | | REL-6 |
| E-RGCH Information | OP | | E-RGCH Info 10.3.6.102 | | REL-6 |
| Target cell preconfiguration information | OP | | Target cell preconfiguration information | | REL-8 |

| Information Element/Group name | Need | Multi | Type and reference | Semantics description | Version |
|--------------------------------|------|-------|--------------------|-----------------------|---------|
| | | | 10.3.6.79a | | |

10.3.6.69 Radio link removal information

| Information Element/Group name | Need | Multi | Type and reference | Semantics description |
|--------------------------------|------|-------|---------------------------------|-----------------------|
| Primary CPICH info | MP | | Primary CPICH info
10.3.6.60 | |

10.3.6.69a E-DCH reconfiguration information

NOTE: Only for FDD.

| Information Element/Group name | Need | Multi | Type and reference | Semantics description | Version |
|--------------------------------|------|-------|---------------------------------|--|---------|
| E-DCH RL Info new serving cell | OP | | | | REL-6 |
| >Primary CPICH info | MP | | Primary CPICH info
10.3.6.60 | Indicates scheduling E-DCH cell from the active set cells. | REL-6 |
| >E-AGCH Info | MP | | E-AGCH Info
10.3.6.100 | | REL-6 |

| Information Element/Group name | Need | Multi | Type and reference | Semantics description | Version |
|------------------------------------|------|-------------------|-------------------------------------|---|----------------|
| >Serving Grant | OP | | | | REL-6 |
| >>Serving Grant value | OP | | Integer (0..37,38) | (0..37) indicates E-DCH serving grant index as defined in [15]; index 38 means zero grant. | REL-6 |
| >>Primary/Secondary Grant Selector | MP | | Enumerated ('primary', 'secondary') | Indicates whether the Serving Grant is received with a Primary E-RNTI or Secondary E-RNTI. | REL-6 |
| >E-DPCCH/DPCCH power offset | OP | | Integer (0..8) | Refer to quantization of the power offset in [28]. | REL-6 |
| >Reference E-TFCIs | OP | 1 to 8 | | See [29]. | REL-6 |
| >>Reference E-TFCI | MP | | Integer (0..127) | | REL-6 |
| >>>Reference E-TFCI PO | MP | | Integer (0..29, 30, 31) | Refer to quantization of the power offset in [28].
Values 30 and 31 are only used for E-TFCI > ETFCI Boost | REL-6
REL-7 |
| >Power Offset for Scheduling Info | OP | | Integer (0..6) | Only used when no MACd PDU's are included in the same MAC-e or MAC-i PDU. Unit is in dB. | REL-6 |
| >3-Index-Step Threshold | OP | | Integer (0..37) | Refers to an index in the 'SG-Table' (see [15]).
NOTE 1 | REL-6 |
| >2-Index-Step Threshold | OP | | Integer (0..37) | Refers to an index in the 'SG-Table' (see [15]).
NOTE 1 | REL-6 |
| >E-HICH Information | OP | | E-HICH Info 10.3.6.101 | This IE is not present if the serving E-DCH cell is added to the active set with this message. | REL-6 |
| >CHOICE E-RGCH Information | OP | | | This IE is not present if the serving E-DCH cell is added to the active set with this message | REL-6 |
| >>E-RGCH Information | MP | | E-RGCH Info 10.3.6.102 | | REL-6 |
| >>>E-RGCH release indicator | | | | (no data) | REL-6 |
| E-DCH RL Info other cells | OP | 1 to <maxEDC HRL> | | This IE is not allowed to include information on a RL added by this message, except in the case of an update to target cell | REL-6 |

| Information Element/Group name | Need | Multi | Type and reference | Semantics description | Version |
|--|------|-------|---------------------------------|-------------------------------|---------|
| | | | | preconfiguration information. | |
| >Primary CPICH info | MP | | Primary CPICH info
10.3.6.60 | | REL-6 |
| >CHOICE E-HICH Information | OP | | | | REL-6 |
| >>E-HICH Information | MP | | E-HICH Info
10.3.6.101 | | REL-6 |
| >>E-HICH release indicator | | | | (no data) | REL-6 |
| >CHOICE E-RGCH Information | OP | | | | REL-6 |
| >>E-RGCH Information | MP | | E-RGCH Info
10.3.6.102 | | REL-6 |
| >>E-RGCH release indicator | | | | (no data) | REL-6 |
| NOTE 1: If the 3-index-Step Threshold value is greater than 2-index-Step Threshold, the UE behaviour is unspecified. | | | | | |

10.3.6.69b E-DCH reconfiguration information same serving cell

NOTE: Only for FDD.

| Information Element/Group name | Need | Multi | Type and reference | Semantics description | Version |
|--------------------------------|------|--------|--------------------|---|---------|
| E-DPCCH/DPCCH power offset | OP | | Integer (0..8) | This IE is not present if the serving E-DCH cell is changed with this message. Refer to quantization of the power offset in [28]. | REL-7 |
| Reference E-TFCIs | OP | 1 to 8 | | This IE is not present if the serving E-DCH cell is changed with this message. See [29]. | REL-7 |
| >Reference E-TFCI | MP | | Integer (0..127) | | REL-7 |
| >Reference E-TFCI PO | MP | | Integer (0..29, | Refer to quantization of the power offset in [28]. | REL-7 |
| | | | 30, 31) | Values 30 and 31 are only used for E-TFCI > ETFCI Boost | REL-7 |

10.3.6.70 Void

10.3.6.70a SCTD indicator

NOTE: Only for TDD

| Information Element/Group name | Need | Multi | Type and reference | Semantics description |
|---------------------------------------|-------------|--------------|---------------------------|----------------------------------|
| SCTD indicator | MP | | Boolean | TRUE indicates that SCTD is used |

10.3.6.71 Secondary CCPCH info

| Information Element/Group name | Need | Multi | Type and reference | Semantics description | Version |
|---------------------------------|------|-------|--|---|---------|
| CHOICE <i>mode</i> | MP | | | | |
| >FDD | | | | | |
| >>Secondary scrambling code | OP | | Secondary scrambling code
10.3.6.74 | May only be sent for SCCPCH channels not carrying the PCH. | |
| >>STTD indicator | MP | | STTD Indicator
10.3.6.78 | | |
| >>Spreading factor | MP | | Integer(4, 8, 16, 32, 64, 128, 256) | | |
| >>Code number | MP | | Integer(0..Spreading factor - 1) | | |
| >>Pilot symbol existence | MP | | Boolean | TRUE means the existence. | |
| >>TFCI existence | MP | | Boolean | TRUE indicates that TFCI is used. When spreading factor is less than or equal to 64, FALSE indicates that TFCI is not used and therefore DTX is used in the TFCI field. | |
| >>Fixed or Flexible Position | MP | | Enumerated (Fixed, Flexible) | | |
| >>Timing Offset | MD | | Integer(0..38144 by step of 256) | Chip Delay of the Secondary CCPCH relative to the Primary CCPCH. Default value is 0. | |
| >1.28 Mcps TDD or 3.84 Mcps TDD | | | | | |
| >>Offset | MP | | Integer (0..Repetition Period - 1) | SFN modulo Repetition period = offset. Repetition period is the one indicated in the accompanying Common timeslot info IE | |
| >>Common timeslot info | MP | | Common | | |

| Information Element/Group name | Need | Multi | Type and reference | Semantics description | Version |
|--------------------------------|------|---------|------------------------------------|---|---------|
| | | | timeslot info 10.3.6.10 | | |
| >>Individual timeslot info | MP | | Individual timeslot info 10.3.6.37 | | |
| >>Code List | MP | 1 to 16 | | | |
| >>>Channelisation Code | MP | | Enumerated((16/1)..(16/16)) | | |
| >7.68 Mcps TDD | | | | | REL-7 |
| >>Offset | MP | | Integer (0...Repetition Period -1) | SFN modulo Repetition period = offset. Repetition period is the one indicated in the accompanying Common timeslot info IE | REL-7 |
| >>Common timeslot info | MP | | Common timeslot info 10.3.6.10 | | REL-7 |
| >>Individual timeslot info | MP | | Individual timeslot info 10.3.6.37 | | REL-7 |
| >>Code List | MP | 1 to 32 | | | REL-7 |
| >>>Channelisation Code | MP | | Enumerated((32/1)..(32/32)) | | REL-7 |

10.3.6.71a Secondary CCPCH info MBMS

| Information Element/Group name | Need | Multi | Type and reference | Semantics description | Version |
|--|----------|-------|---|--|---------|
| CHOICE <i>mode</i> | MP | | | | REL-6 |
| >FDD | | | | | REL-6 |
| >>Secondary scrambling code | OP | | Secondary scrambling code
10.3.6.74 | May only be sent for SCCPCH channels not carrying the PCH. | REL-6 |
| >>STTD indicator | MP | | STTD Indicator
10.3.6.78 | If the cell is operating in MBSFN mode as indicated in subclause 8.1.1.6.3, the UE behaviour upon reception of this IE is unspecified. | REL-6 |
| >>Spreading factor | MP | | Integer(4, 8, 16, 32, 64, 128, 256) | | REL-6 |
| >>Code number | MP | | Integer(0..Spreading factor – 1) | | REL-6 |
| >>Timing Offset | MD | | Integer(0..38144 by step of 256) | Chip Delay of the Secondary CCPCH relative to the Primary CCPCH. Default value is 0. | REL-6 |
| >>CHOICE Modulation | CV-MBSFN | | | | REL-7 |
| >>>QPSK | MP | | | (no data) | REL-7 |
| >>>16QAM | MP | | | | REL-7 |
| >>>>CPICH secondary CCPCH power offset | MP | | Integer(-11..4) | | REL-7 |
| >1.28/3.84 Mcps TDD | | | | | REL-6 |
| >> Common timeslot info MBMS | MP | | Common timeslot info MBMS
10.3.6.10a | Interleaving mode, TFCI coding and puncturing limit for Secondary CCPCH info MBMS | REL-6 |
| >>Downlink Timeslots and Codes | MP | | Downlink timeslots and codes
10.3.6.32 | One or more timeslots and codes for S-CCPCH supporting MBMS MTCH | REL-6 |
| >> MBSFN Special Time Slot | OP | | Time Slot LCR Extension
10.3.6.83a | For 1.28 Mcps TDD MBSFN only mode, this IE indicates the SCCPCH is deployed on the MBSFN Special Time Slot [30]. The IE "Timeslot number" in "Downlink Timeslots and Codes" shall be ignored if this IE appears. | REL-7 |
| >>Modulation | MP | | Enumerated (QPSK, 16QAM) | | REL-7 |
| >7.68 Mcps TDD | | | | | REL-7 |
| >>Common timeslot info MBMS | MP | | Common timeslot info MBMS
10.3.6.10a | Interleaving mode, TFCI coding and puncturing limit for Secondary CCPCH info MBMS | REL-7 |
| >>Downlink Timeslots and | MP | | Downlink | One or more | REL-7 |

| Information Element/Group name | Need | Multi | Type and reference | Semantics description | Version |
|--|----------|-------|--------------------------------------|---|---------|
| Codes VHCR | | | timeslots and codes VHCR 10.3.6.32a | timeslots and codes for S-CCPCH supporting MBMS MTCH | |
| >>Modulation | MP | | Enumerated (QPSK, 16QAM) | | REL-7 |
| >3.84 Mcps TDD MBSFN IMB | | | | | REL-8 |
| >>Secondary scrambling code | OP | | Secondary scrambling code 10.3.6.74 | Not applicable: if present, the UE behaviour is unspecified | REL-8 |
| >>STTD indicator | MP | | STTD Indicator 10.3.6.78 | Not applicable: the UE behaviour is unspecified | REL-8 |
| >>Spreading factor | MP | | Integer (4, 8, 16, 32, 64, 128, 256) | SF = 256; other values not applicable | REL-8 |
| >>Code number | MP | | Integer (0..Spreading factor – 1) | Only code numbers 2 to 15 are applicable | REL-8 |
| >>Timing Offset | MD | | Integer (0..38144 by step of 256) | Not applicable: if present, the UE behaviour is unspecified | REL-8 |
| >>CHOICE Modulation | CV-MBSFN | | | | REL-8 |
| >>>QPSK | MP | | | (no data) | REL-8 |
| >>>16QAM | MP | | | Not applicable: the UE behaviour is unspecified | REL-8 |
| >>>>CPICH secondary CCPCH power offset | MP | | Integer (-11..4) | | REL-8 |

| Condition | Explanation |
|--------------|--|
| <i>MBSFN</i> | This IE is mandatory present when the cell on which this IE is sent is operating in MBSFN mode according to subclause 8.1.1.6.3. Otherwise the IE is not needed. |

NOTE: For FDD, the S-CCPCH signalled in this IE is always configured with flexible position, TFCI is always present and pilot is always absent.

10.3.6.71b Secondary CCPCH info MBMS Diff

| Information Element/Group name | Need | Multi | Type and reference | Semantics description | Version |
|--------------------------------|------|-------|--|--|---------|
| Secondary scrambling code | OP | | Secondary scrambling code
10.3.6.74 | May only be sent for SCCPCH channels not carrying the PCH. | REL-7 |
| STTD indicator | MP | | STTD Indicator
10.3.6.78 | | REL-7 |
| Spreading factor | OP | | Integer(4, 8, 16, 32, 64, 128, 256) | | REL-7 |
| Code number | OP | | Integer(0..Spreading factor – 1) | | REL-7 |
| Timing Offset | OP | | Integer(0..38144 by step of 256) | Chip Delay of the Secondary CCPCH relative to the Primary CCPCH. | REL-7 |

NOTE: For FDD, the S-CCPCH signalled in this IE is always configured with flexible position, TFCI is always present and pilot is always absent.

10.3.6.72 Secondary CCPCH system information

| Information element | Need | Multi | Type and reference | Semantics description | Version |
|---|---------------|--------------------|--|--|---------|
| Secondary CCPCH system information list | MP | 1 to <maxSCC PCH> | | | |
| >Secondary CCPCH info | MP | | Secondary CCPCH info 10.3.6.71 | Note 1 | |
| >TFCS | MD | | Transport format combination set 10.3.5.20 | For FACHs and PCH
Default value is the value of "TFCS" for the previous SCCPCH in the list.
NOTE: The first occurrence is then MP. | |
| >FACH/PCH information list | MD | 1 to <maxFAC HPCH> | | Default value is the value of "FACH/PCH" for the previous SCCPCH in the list.
NOTE: The first occurrence is then MP. | |
| >>TFS | MP | | Transport format set 10.3.5.23 | For each FACH and PCH
Note 2 | |
| >>Transport channel identity | MP | | Transport channel identity 10.3.5.18 | | |
| >>CTCH indicator | MP | | Boolean | The value TRUE indicates that a CTCH is mapped on the FACH, and FALSE that no CTCH is mapped. | |
| >PICH info | OP | | PICH info 10.3.6.49 | PICH info is present only when PCH is multiplexed on Secondary CCPCH | |
| MCCH configuration information | CV-SIB type 5 | | MCCH configuration information 10.3.9a.13 | Included if MCCH is on an S-CCPCH used also for Non-MBMS
Note 3 | REL-6 |

NOTE 1: The secondary CCPCHs carrying a PCH shall be listed first.

NOTE 2: TFS for PCH shall be the first "FACH/PCH information" in the list if a PCH exists for the respective secondary CCPCH.

NOTE 3: If the IE "MCCH configuration information is included", it applies to the last S-CCPCH in the IE "Secondary CCPCH system information list" and to the last FACH included in the IE "FACH/PCH information list".

| Condition | Explanation |
|------------|--|
| SIB type 5 | The IE is optional if the IE "Secondary CCPCH system information" is included in the SIB type 5 or 5bis, otherwise the IE is not needed in the message |

10.3.6.72a Secondary CCPCH system information MBMS

| Information element | Need | Multi | Type and reference | Semantics description | Version |
|------------------------------------|------|--------------------|--|--|---------|
| Secondary CCPCH system information | MP | | | An S-CCPCH carrying MCCH and possibly also MTCH and MSCH | REL-6 |
| >Secondary CCPCH info MBMS | MP | | Secondary CCPCH info MBMS 10.3.6.71a | | REL-6 |
| >TFCS | MP | | Transport format combination set 10.3.5.20 | | REL-6 |
| >FACH carrying MCCH | MP | | | | REL-6 |
| >>TFS | MP | | Transport format set 10.3.5.23 | | REL-6 |
| >>MCCH configuration information | MP | | MCCH configuration information 10.3.9a.13 | | REL-6 |
| >FACH carrying MTCH list | OP | 1 to <maxFAC HPCH> | | | REL-6 |
| >>TFS | MP | | Transport format set 10.3.5.23 | | REL-6 |
| >Scheduling information | OP | | | | REL-6 |
| >>FACH carrying MSCH | MP | | Transport format set 10.3.5.23 | Transport channel carrying MSCH | REL-6 |

10.3.6.73 Secondary CPICH info

NOTE: Only for FDD.

| Information Element/Group name | Need | Multi | Type and reference | Semantics description |
|--------------------------------|------|-------|-------------------------------------|--|
| Secondary scrambling code | MD | | Secondary scrambling code 10.3.6.74 | Default is the same scrambling code as for the Primary CPICH |
| Channelisation code | MP | | Integer(0..255) | SF=256 |

10.3.6.74 Secondary scrambling code

| Information Element/Group name | Need | Multi | Type and reference | Semantics description |
|--------------------------------|------|-------|--------------------|-----------------------|
| Secondary scrambling code | MP | | Integer(1..15) | |

10.3.6.74a Serving HS-DSCH cell information

| Information Element/Group name | Need | Multi | Type and reference | Semantics description | Version |
|--------------------------------|------|-------|--|---|---------|
| Δ_{ACK} | OP | | Integer(0..8) | Refer to quantization of the power offset in [28] | REL-6 |
| Δ_{NACK} | OP | | Integer(0..8) | Refer to quantization of the power offset in [28] | REL-6 |
| HARQ_preamble_mode | MP | | Integer(0, 1) | 1 indicates that preamble and postamble are used on the HS-DPCCH – see [29] | REL-6 |
| Primary CPICH info | OP | | Primary CPICH info 10.3.6.60 | Indicate the new HS-DSCH serving cell | REL-6 |
| Downlink HS-PDSCH Information | OP | | Downlink HS_PDSCH Information 10.3.6.23a | | REL-6 |
| HARQ Info | OP | | HARQ info 10.3.5.7a | | REL-6 |
| MAC-hs reset indicator | OP | | Enumerated (TRUE) | TRUE Indicates the MAC-hs/ehs entity needs to be reset. | REL-6 |

10.3.6.74b Serving Cell Change Parameters

The IE "Serving Cell Change Parameters" is used prepare the UE for enhanced serving cell change.

| Information Element/Group name | Need | Multi | Type and reference | Semantics description | Version |
|------------------------------------|------|-------|--|---|---------|
| Serving Cell Change MAC reset | MP | | Boolean | TRUE means the MAC-hs/ehs entity needs to be reset, FALSE means TPC combination Index is used to determine if MAC-hs/ehs reset is needed, 8.2.2.3 | REL-8 |
| Serving Cell Change Message Type | MP | | Enumerated (RadioBearerSetup, RadioBearerReconfiguration, TransportChannelReconfiguration, PhysicalChannelReconfiguration) | The reconfiguration procedure configuration used for Target cell preconfiguration, 8.2.2.4 | REL-8 |
| Serving Cell Change Transaction Id | MP | | Integer (0..3) | Transaction Id that shall be used as the RRC Transaction Identifier with the corresponding response message configured by the IE 'Serving Cell Change Message Type' | REL-8 |

10.3.6.75 SFN Time info

| Information Element/Group name | Need | Multi | Type and reference | Semantics description |
|--------------------------------|------|-------|--------------------|--|
| Activation time SFN | MP | | Integer (0..4095) | System frame number start of the physical channel existence. |
| Duration | MP | | Integer(1..4096) | Total number of frames the physical channel will exist. |

10.3.6.75a Special Burst Scheduling

NOTE: Only for TDD.

| Information Element/Group name | Need | Multi | Type and reference | Semantics description |
|---------------------------------|------|-------|--------------------|---|
| Special Burst Generation Period | MP | | Integer (0..7) | Value represents number of radio frames
0 = 2 frames, 1 = 4 frames,
2 = 8 frames, 3 = 16 frames,
4 = 32 frames, 5 = 64 frames,
6 = 128 frames, 7 = 256 frames |

10.3.6.76 Void

10.3.6.77 Void

10.3.6.78 STTD indicator

NOTE: Only for FDD

Indicates whether STTD is used or not.

| Information Element/Group name | Need | Multi | Type and reference | Semantics description |
|--------------------------------|------|-------|--------------------|------------------------------|
| STTD Indicator | MP | | Boolean | TRUE means that STTD is used |

10.3.6.78o SYNC_UL codes bitmap

NOTE: Only for 1.28 Mcps TDD.

| Information Element/ Group name | Need | Multi | Type and reference | Semantics description | Version |
|---------------------------------|------|-------|--------------------|-----------------------|---------|
|---------------------------------|------|-------|--------------------|-----------------------|---------|

| | | | | | |
|----------------------|----|--|--------------|---|-------|
| SYNC_UL codes bitmap | MP | | Bitstring(8) | Each bit indicates availability of a SYNC_UL code, where the SYNC_UL codes are numbered "code 0" to "code 7".
The value 1 of a bit indicates that the corresponding SYNC_UL code can be used.
The value 0 of a bit indicates that the corresponding SYNC_UL code can not be used. | REL-7 |
|----------------------|----|--|--------------|---|-------|

10.3.6.78a SYNC_UL info

NOTE: Only for 1.28 Mcps TDD.

| Information Element/ Group name | Need | Multi | Type and reference | Semantics description | Version |
|---------------------------------|------|-------|------------------------------------|---|---------|
| SYNC_UL codes bitmap | MP | | SYNC_UL codes bitmap
10.3.6.78o | | REL-4 |
| PRX _{UpPCHdes} | MP | | Integer(-120...-58 by step of 1) | In dBm | REL-4 |
| Power Ramp Step | MP | | Integer(0,1,2,3) | In dB | REL-4 |
| Max SYNC_UL Transmissions | MP | | Integer(1,2,4,8) | Maximum numbers of SYNC_UL transmissions in a power ramping sequence. | REL-4 |
| Mmax | MP | | Integer(1..32) | Maximum number of synchronisation attempts. | REL-4 |
| E-RUCCH SYNC_UL codes bitmap | MP | | SYNC_UL codes bitmap
10.3.6.78o | | REL-7 |

10.3.6.78b TDD MBSFN Information

NOTE: Only for TDD

This information indicates which timeslots are assigned to TDD MBSFN and the scrambling codes assigned to each timeslot.

| Information Element/Group name | Need | Multi | Type and reference | Semantics description | Version |
|--------------------------------|------|------------|------------------------------|-----------------------|---------|
| Time slot list | MP | 1..<maxTS> | | | REL-7 |
| >Timeslot Number | MP | | Timeslot Number
10.3.6.84 | | REL-7 |
| >Cell parameters ID | MP | | Cell parameters | | REL-7 |

| Information Element/Group name | Need | Multi | Type and reference | Semantics description | Version |
|--------------------------------|------|-------|--------------------|-----------------------|---------|
| | | | Id 10.3.6.9 | | |

10.3.6.78c LCR TDD MBSFN Information

NOTE: Only for 1.28Mcps TDD

This information indicates which timeslots of the secondary frequency of a multi-frequency cell are assigned to 1.28Mcps TDD MBSFN and the scrambling codes related to each timeslot.

| Information Element/Group name | Need | Multi | Type and reference | Semantics description | Version |
|--------------------------------|------|-------------------------|---------------------------------|--|---------|
| Time slot info list | MP | 1 to <maxMBSFNclusters> | | | REL-7 |
| >Frequency index | MP | | Integer (1..<maxMBSFNclusters>) | For 1.28 Mcps TDD index pointing to a frequency indicated in the SIB 11. | REL-7 |
| >Time slot list | MP | 1 to <maxTS> | | | REL-7 |
| >>Timeslot Number | MP | | Timeslot Number 10.3.6.84 | | REL-7 |
| >>Cell parameters ID | MP | | Cell parameters Id 10.3.6.9 | | REL-7 |

10.3.6.78d SYNC_UL info for E-RUCCH

NOTE: Only for 1.28 Mcps TDD.

| Information Element/Group name | Need | Multi | Type and reference | Semantics description | Version |
|--------------------------------|-------------------------------|-------|----------------------------------|---|---------|
| PRXUpPCHdes | CV-Synchronisation parameters | | Integer(-120...-58 by step of 1) | In dBm | REL-7 |
| Power Ramp Step | CV-Synchronisation parameters | | Integer(0,1,2,3) | In dB | REL-7 |
| Max SYNC_UL Transmissions | CV-Synchronisation parameters | | Integer(1,2,4,8) | Maximum numbers of SYNC_UL transmissions in a power ramping sequence. | REL-7 |
| Mmax | MP | | Integer(1..32) | Maximum number of synchronisation attempts. | REL-7 |
| E-RUCCH SYNC_UL codes bitmap | MP | | SYNC_UL codes bitmap 10.3.6.78o | | REL-7 |

| Condition | Explanation |
|-----------------------------------|---|
| <i>Synchronisation parameters</i> | This IE is mandatory present if the IE 'Synchronisation parameters' does not exist, Otherwise it is not needed. |

10.3.6.79 TDD open loop power control

This information element contains parameters for open loop power control setting for TDD.

| Information Element/Group name | Need | Multi | Type and reference | Semantics description | Version |
|-------------------------------------|-----------------|-------|-------------------------------------|------------------------------------|---------|
| Primary CCPCH Tx Power | MP | | Primary CCPCH Tx Power
10.3.6.59 | For path loss calculation | |
| <i>CHOICE TDD option</i> | MP | | | | REL-4 |
| >3.84 Mcps TDD | | | | | REL-4 |
| >>Alpha | OP | | Alpha
10.3.6.5 | | |
| >>PRACH Constant Value | MP | | Constant Value TDD
10.3.6.11a | Operator controlled PRACH Margin | |
| >>DPCH Constant Value | MP | | Constant Value TDD
10.3.6.11a | Operator controlled UL DPCH Margin | |
| >>PUSCH Constant Value | OP | | Constant Value TDD
10.3.6.11a | Operator controlled PUSCH Margin | |
| >>UE positioning related parameters | <i>CV-IPDLs</i> | | | | REL-4 |
| >>>IPDL-Alpha | MP | | Alpha
10.3.6.5 | | REL-4 |
| >>>Max power increase | MP | | Integer (0..3) | In db | REL-4 |
| >7.68 Mcps TDD | | | | | REL-7 |
| >>Alpha | OP | | Alpha
10.3.6.5 | | REL-7 |
| >>PRACH Constant Value | MP | | Constant Value TDD
10.3.6.11a | Operator controlled PRACH Margin | REL-7 |
| >>DPCH Constant Value | MP | | Constant Value TDD
10.3.6.11a | Operator controlled UL DPCH Margin | REL-7 |
| >>PUSCH Constant Value | OP | | Constant Value TDD
10.3.6.11a | Operator controlled PUSCH Margin | REL-7 |
| >>UE positioning related parameters | <i>CV-IPDLs</i> | | | | REL-7 |
| >>>IPDL-Alpha | MP | | Alpha
10.3.6.5 | | |
| >>>Max power increase | MP | | Integer (0..3) | In db | REL-7 |
| >1.28 Mcps TDD | | | | (no data) | REL-4 |

| Condition | Explanation |
|--------------|---|
| <i>IPDLs</i> | This IE is present only if idle periods are applied |

10.3.6.79a Target cell preconfiguration information

| Information Element/Group name | Need | Multi | Type and reference | Semantics description | Version |
|------------------------------------|------|-------|---|--|---------|
| >Activation time offset | OP | | Integer (0..255) | If present, the 'Activation time offset' IE is used by UE to calculate Activation time for inclusion in measurement report for event 1d. | REL-8 |
| >New H-RNTI | MP | | H-RNTI
10.3.3.14a | | REL-8 |
| >New Primary E-RNTI | OP | | E-RNTI
10.3.3.10a | | REL-8 |
| >New Secondary E-RNTI | OP | | E-RNTI
10.3.3.10a | | REL-8 |
| >Serving HS-DSCH cell information | MP | | Serving HS-DSCH cell information
10.3.6.74a | | REL-8 |
| >E-DCH reconfiguration information | MP | | E-DCH reconfiguration information
10.3.6.69a | | REL-8 |
| >DTX-DRX timing information | OP | | DTX-DRX timing information
10.3.6.34b | | REL-8 |
| >DTX-DRX Information | OP | | DTX-DRX Information
10.3.6.34a | | REL-8 |
| >HS-SCCH less Information | OP | | HS-SCCH less Information
10.3.6.36ab | | REL-8 |
| >MIMO parameters | OP | | MIMO parameters
10.3.6.41a | | REL-8 |
| >Downlink secondary cell info FDD | OP | | Downlink secondary cell info FDD
10.3.6.31a | | REL-8 |

10.3.6.80 TFC Control duration

| Information Element/Group name | Need | Multi | Type and reference | Semantics description |
|--------------------------------|------|-------|--|---|
| TFC Control duration | MP | | Integer (1, 2, 4, 8, 16, 24, 32, 48, 64, 128, 192, 256, 512) | Defines the period in multiples of 10 ms frames for which the defined TFC sub-set is to be applied. |

10.3.6.81 Void

10.3.6.82 TGPSI

| Information Element/Group name | Need | Multi | Type and reference | Semantics description |
|--------------------------------|------|-------|---------------------|--|
| TGPSI | MP | | Integer(1..MaxTGPS) | Transmission Gap Pattern Sequence Identifier
Establish a reference to the compressed mode pattern sequence. Up to <MaxTGPS> simultaneous compressed mode pattern sequences can be used. |

10.3.6.83 Time info

| Information Element/Group name | Need | Multi | Type and reference | Semantics description |
|--------------------------------|------|-------|----------------------------|--|
| Activation time | MD | | Activation time 10.3.3.1 | Frame number start of the physical channel existence. Default value is "Now" |
| Duration | MD | | Integer(1..4096, infinite) | Total number of frames the physical channel will exist. Default value is "infinite". |

10.3.6.83a Time Slot LCR Extension

| IE/Group Name | Presence | Range | IE Type and Reference | Semantics Description |
|-------------------------|----------|-------|-----------------------|--|
| Time Slot LCR Extension | | | ENUMERATED (TS7, ...) | TS7 indicates the MBSFN Special Timeslot for 1.28 Mcps TDD MBSFN Dedicated Carrier. Three spare values are reserved. |

10.3.6.84 Timeslot number

| Information Element/Group name | Need | Multi | Type and reference | Semantics description | Version |
|--------------------------------|------|-------|--------------------|----------------------------|---------|
| CHOICE <i>TDD option</i> | MP | | | | REL-4 |
| >3.84 Mcps TDD | | | | | REL-4 |
| >>Timeslot number | MP | | Integer(0..14) | Timeslot within a frame | |
| >7.68 Mcps TDD | | | | | REL-7 |
| >>Timeslot number | MP | | Integer(0..14) | Timeslot within a frame | REL-7 |
| >1.28 Mcps TDD | | | | | REL-4 |
| >>Timeslot number | MP | | Integer(0..6) | Timeslot within a subframe | REL-4 |

10.3.6.85 TPC combination index

NOTE: Only for FDD.

| Information Element/Group name | Need | Multi | Type and reference | Semantics description | Version |
|--------------------------------|------|-------|--------------------|--|---------|
| TPC combination index | MP | | Integer(0..5) | Radio links with the same index have TPC bits, which for the UE are known to be the same. | |
| | | | | Radio links that are part of the E-DCH active set and with the same index have acknowledgement feedback signals on the E-HICH which for the UE are known to be the same. | REL-6 |

10.3.6.85a TSTD indicator

NOTE: Only for 1.28 Mcps TDD.

| Information Element/Group name | Need | Multi | Type and reference | Semantics description | Version |
|--------------------------------|------|-------|--------------------|-----------------------|---------|
| TSTD indicator | MD | | Boolean | Default value is TRUE | REL-4 |

10.3.6.86 TX Diversity Mode

NOTE: Only for FDD.

| Information Element/Group name | Need | Multi | Type and reference | Semantics description |
|--------------------------------|------|-------|--|-----------------------|
| Tx diversity Mode | MP | | Enumerated (none, STTD, closed loop mode1) | |

10.3.6.86o UL 16QAM configuration

NOTE: Only for FDD.

| Information Element/Group name | Need | Multi | Type and reference | Semantics description | Version |
|---|----------------------|-------|---------------------------------|--|---------|
| UL 16QAM settings | CV-
<i>2msTTI</i> | | UL 16QAM settings
10.3.6.86a | Presence of this IE indicates that the UE should operate in 16QAM mode; absence indicates that the UE is not to operate in 16QAM mode. See Note 2. | REL-7 |
| MAC-es/e reset indicator | OP | | Enumerated (TRUE) | TRUE Indicates the MAC-es/e or MAC-i/is entity needs to be reset. | REL-7 |
| E-TFCI table index | OP | | Integer (0..1) | Indicates which standardised E-TFCI TB size table shall be used. See Note 1. | REL-7 |
| NOTE 1: If the UE is operating in 16QAM mode, the value of 'E-TFCI table index' is increased by 2, and indices in the SG-Table refer to Scheduling Grant Table 2 in [15]. | | | | | |
| NOTE 2: If this IE is not present, the indices signaled on the E-AGCH refer to the Mapping of Absolute Grant Value Table 16B in [27]. | | | | | |

| Condition | Explanation |
|---------------|---|
| <i>2msTTI</i> | This IE is present only if 2ms TTI is configured, otherwise it is not needed. |

10.3.6.86a UL 16QAM settings

| Information Element/Group name | Need | Multi | Type and reference | Semantics description | Version |
|------------------------------------|------|-------|--------------------|---|---------|
| BetaEd gain E-AGCH table selection | MP | | Integer (0..1) | The value 0 indicates that the indices signaled on the E-AGCH refer to the Mapping of Absolute Grant Value Table 16B in [27], and the value 1 indicates Mapping using Absolute Grant Value Table 16B.1 in [27]. | REL-7 |

10.3.6.87 UL interference

| Information Element/Group name | Need | Multi | Type and reference | Semantics description |
|--------------------------------|------|-------|---------------------|-----------------------|
| UL interference | MP | | Integer (-110..-70) | In dBm |

NOTE: In TDD, this IE is a timeslot specific value.

10.3.6.87a UL interference TDD

NOTE: Only for TDD.

| Information Element/Group name | Need | Multi | Type and reference | Semantics description |
|--------------------------------|------|-------|---------------------|-----------------------|
| TDD UL interference | MP | | Integer (-110..-52) | In dBm |

NOTE: This IE is a timeslot specific value.

10.3.6.87b Uplink DPCH code info for Common E-DCH

| Information Element/Group name | Need | Multi | Type and reference | Semantics description | Version |
|--|----------|-------|-------------------------|-----------------------|---------|
| Scrambling code type | MP | | Enumerated(short, long) | | REL-8 |
| Scrambling code number | CV-Short | | Integer(0..16777215) | NOTE1 | REL-8 |
| <p>NOTE1: If this IE is not included, the value is given by:
 Scrambling code number = (offset + common E-DCH resource list position) mod 16777216
 where
 "offset" is the value of the last occurrence of the IE "scrambling code number".
 "common E-DCH resource list position" indicates the Common E-DCH resource Configuration Information number by order of appearance. The value of the "common E-DCH resource list position" is zero for the first occurrence.</p> | | | | | |

| Condition | Explanation |
|--------------|--|
| <i>Short</i> | This IE is mandatory present for the first occurrence. Otherwise, this IE is optional. |

10.3.6.88 Uplink DPCH info

| Information Element/Group name | Need | Multi | Type and reference | Semantics description | Version |
|---------------------------------|-------------------------------------|-------------------|---|---|---------|
| Uplink DPCH power control info | OP | | Uplink DPCH power control info
10.3.6.91 | | |
| CHOICE <i>mode</i> | MP | | | | |
| >FDD | | | | | |
| >>Scrambling code type | MP | | Enumerated(short, long) | | |
| >>Scrambling code number | MP | | Integer(0..16777215) | | |
| >>Number of DPDCH | MD | | Integer(1..maxDPDCH-UL,
0) | Default value is 1. Number of DPDCH is 1 in HANDOVER TO UTRAN COMMAND.

Value 0 may only be used if target configuration has no uplink DPDCH. | REL-6 |
| >>Spreading factor | CV-
DPDCH present | | Integer(4, 8, 16, 32, 64, 128, 256) | Minimum allowed SF of the channelisation code for data part | |
| >>TFCI existence | MP | | Boolean | TRUE means existence. | |
| >>Number of FBI bits | OP | | Integer (1, 2) | In bits. | |
| >>Number of TPC bits | CV-
Neither TFCI nor FBI present | | Integer (4) | In bits | REL-7 |
| >>Puncturing Limit | CV-
DPDCH present | | Real(0.40 ..1 by step of 0.04) | | |
| >TDD | | | | | |
| >>Uplink Timing Advance Control | OP | | Uplink Timing Advance Control
10.3.6.96 | | |
| >>UL CCH List | OP | 1 to <maxCC TrCH> | | UL physical channels to establish or reconfigure list. | |
| >>>TFCS ID | MD | | Integer(1..8) | Default value is 1. | |
| >>>UL target SIR | MP | | Real (-11 .. 20 by step of 0.5dB) | In dB

For 1.28 Mcps TDD this parameter represents PRX _{DPCHdes} with range Integer(-120...-58 by step of 1) dBm | REL-4 |
| >>>Time info | MP | | Time info
10.3.6.83 | | |
| >>>Common timeslot info | MD | | Common timeslot info
10.3.6.10 | Default is the current Common timeslot info | |

| Information Element/Group name | Need | Multi | Type and reference | Semantics description | Version |
|---|------|------------------|--|--|---------|
| >>> CHOICE TDD option | | | | | REL-7 |
| >>>> 3.84 Mcps TDD | | | | | REL-7 |
| >>>>>Uplink DPCH timeslots and codes | MD | | Uplink Timeslots and Codes
10.3.6.94 | Default is to use the old timeslots and codes. | |
| >>>>>7.68 Mcps TDD | | | | | REL-7 |
| >>>>>Uplink DPCH timeslots and codes VHCR | MD | | Uplink Timeslots and Codes
VHCR
10.3.6.94
b | Default is to use the old timeslots and codes | REL-7 |
| >>>>> 1.28 Mcps TDD | | | | | REL-7 |
| >>>>>Uplink DPCH timeslots and codes LCR | MD | | Uplink Timeslots and Codes
LCR
10.3.6.94
a | Default is to use the old timeslots and codes. | REL-7 |
| >>UL CCTrCH List to Remove | OP | 1..<max CCTrCH > | | UL physical channels to remove list | |
| >>>TFCS ID | MP | | Integer(1..8) | | |

| Condition | Explanation |
|-------------------------------------|--|
| <i>DPDCHpresent</i> | This IE is mandatory if the target configuration includes a DPDCH, otherwise it is not needed. |
| <i>Neither TFCI nor FBI present</i> | This IE is optional if the IE 'TFCI existence' is set to FALSE and the IE 'Number of FBI bits' is not present, otherwise it is not needed. |

10.3.6.89 Uplink DPCH info Post

| Information Element/Group name | Need | Multi | Type and reference | Semantics description | Version |
|-----------------------------------|------|-------|---|--|---------|
| Uplink DPCH power control info | MP | | Uplink DPCH power control info Post 10.3.6.92 | | |
| CHOICE <i>mode</i> | MP | | | | |
| >FDD | | | | | |
| >>Scrambling code type | MP | | Enumerated(short, long) | | |
| >>>Reduced scrambling code number | MP | | Integer(0..8191) | Sub-range of values for initial use upon handover to UTRAN. | |
| >>>Spreading factor | MP | | Integer(4, 8, 16, 32, 64, 128, 256) | SF of the channelisation code for data part
There is only one DPDCH for this case | |
| >1.28 Mcps TDD and 3.84 Mcps TDD | | | | | |
| >>Uplink Timing Advance Control | OP | | Uplink Timing Advance Control 10.3.6.96 | | |
| >>Uplink DPCH timeslots and codes | MP | | Uplink Timeslots and Codes 10.3.6.94 | | |
| >7.68 Mcps TDD | | | | | REL-7 |
| >>Uplink Timing Advance Control | OP | | Uplink Timing Advance Control 10.3.6.96 | | REL-7 |
| >>Uplink DPCH timeslots and codes | MP | | Uplink Timeslots and Codes VHCR 10.3.6.94b | | REL-7 |

10.3.6.90 Uplink DPCH info Pre

| Information Element/Group name | Need | Multi | Type and reference | Semantics description | Version |
|--------------------------------|--------------------|-------|--|---|---------|
| Uplink DPCH power control info | OP | | Uplink DPCH power control info Pre 10.3.6.93 | | |
| CHOICE <i>mode</i> | MP | | | | |
| >FDD | | | | | |
| >>TFCI existence | MP | | Boolean | TRUE means existence. Default value is TRUE See NOTE 1. | |
| >>Number of TPC bits | CV- <i>No TFCI</i> | | Integer (4) | In bits | REL-7 |
| >>Puncturing Limit | MP | | Real(0.40 ..1 by step of 0.04) | | |
| >TDD | | | | | |
| >>Common timeslot info | MP | | Common Timeslot Info 10.3.6.10 | | |

NOTE 1: Number of FBI bits is not signalled but 0 is implied as transmit diversity cannot be setup here.

| Condition | Explanation |
|----------------|---|
| Single | This IE is mandatory present if the IE "Number of DPDCH" is "1" and not needed otherwise. |
| <i>No TFCI</i> | This IE is optional if the IE 'TFCI existence' is set to FALSE, otherwise it is not needed. |

10.3.6.91 Uplink DPCH power control info

Parameters used by UE to set DPCH initial output power and to use for closed-loop power control in FDD and 1.28 Mcps TDD and parameters for uplink open loop power control in 3.84 Mcps TDD and 7.68 Mcps TDD.

| Information Element/Group name | Need | Multi | Type and reference | Semantics description | Version |
|--------------------------------|-----------------|-------|---------------------------------------|--|---------|
| CHOICE <i>mode</i> | MP | | | | |
| >FDD | | | | | |
| >>DPCCH Power offset | MP | | Integer(-164,..-6 by step of 2) | In dB | |
| >>PC Preamble | MP | | Integer (0..7) | In number of frames | |
| >>SRB delay | MP | | Integer(0..7) | In number of frames | |
| >>Power Control Algorithm | MP | | Enumerated (algorithm 1, algorithm 2) | Specifies algorithm to be used by UE to interpret TPC commands | |
| >>TPC step size | CV- <i>algo</i> | | Integer (1, 2) | In dB | |
| >> Δ_{ACK} | OP | | Integer (0..8) | Refer to quantization of the power offset in [28] | REL-5 |
| >> Δ_{NACK} | OP | | Integer (0..8) | refer to quantization of the power offset in | REL-5 |

| Information Element/Group name | Need | Multi | Type and reference | Semantics description | Version |
|---|------------|--------------|--|--|---------|
| | | | | [28] | |
| >>Ack-Nack repetition factor | OP | | Integer(1..4) | | REL-5 |
| >>HARQ_preamble_mode | MP | | Integer (0, 1) | 1 indicates that preamble and postamble are used on the HS-DPCCH – see [29] | REL-6 |
| >TDD | | | | | |
| >>UL target SIR | OP | | Real (-11 .. 20 by step of 0.5dB) | In dB
For 1.28 Mcps TDD this parameter represents PRX _{DPCHdes} with range Integer(-120...-58 by step of 1) dBm | REL-4 |
| >>CHOICE <i>UL OL PC info</i> | MP | | | | |
| >>>Broadcast UL OL PC info | | | Null | No data | |
| >>>Individually Signalled | OP | | | | |
| >>>>CHOICE <i>TDD option</i> | MP | | | | REL-4 |
| >>>>>3.84 Mcps TDD | | | | | REL-4 |
| >>>>>>Individual timeslot interference info | MP | 1 to <maxTS> | | | |
| >>>>>>>Individual timeslot interference | MP | | Individual timeslot interference 10.3.6.38 | | |
| >>>>>>>DPCH Constant Value | OP | | Constant Value TDD 10.3.6.11a | Quality Margin | |
| >>>>>>>7.68 Mcps TDD | | | | | REL-7 |
| >>>>>>>>Individual timeslot interference info | MP | 1 to <maxTS> | | | REL-7 |
| >>>>>>>>>Individual timeslot interference | MP | | Individual timeslot interference 10.3.6.38 | | REL-7 |
| >>>>>>>>>>DPCH Constant Value | OP | | Constant Value TDD 10.3.6.11a | Quality Margin | REL-7 |
| >>>>>>>>>>>1.28 Mcps TDD | | | | | REL-4 |
| >>>>>>>>>>>>Beacon PL Est. | CV-houtran | | Enumerated (TRUE) | The presence of this IE indicates that the UE may take into account path loss estimated from beacon function physical channels. The absence indicates that UE may not take into account path loss estimated from beacon function physical channels | REL-6 |
| >>>>>>>>>>>>>TPC step size | MP | | Integer(1,2,3) | | REL-4 |
| >>>>>>>>>>>>>>Primary CCPCH Tx Power | OP | | Primary CCPCH Tx Power 10.3.6.59 | For Pathloss Calculation | |

| Condition | Explanation |
|----------------|--|
| <i>algo</i> | The IE is mandatory present if the IE "Power Control Algorithm" is set to "algorithm 1", otherwise the IE is not needed |
| <i>houtran</i> | This IE is optional in Cell Update Confirm, Physical Channel Reconfiguration, Radio Bearer Reconfiguration, Radio Bearer Release, Radio Bearer Setup, Transport Channel Reconfiguration and Uplink Physical Channel Control. The IE is not included in the Handover To UTRAN Command |

10.3.6.91a Uplink DPCH power control info for Common E-DCH

Parameters used by UE to set DPCH initial output power and to use for closed-loop power control in FDD when Enhanced Uplink in CELL_FACH state and Idle mode is applied.

| Information Element/Group name | Need | Multi | Type and reference | Semantics description | Version |
|--------------------------------|----------------|-------|---------------------------------------|--|---------|
| Power Control Algorithm | MP | | Enumerated (algorithm 1, algorithm 2) | Specifies algorithm to be used by UE to interpret TPC commands | REL-8 |
| TPC step size | <i>CV-algo</i> | | Integer (1, 2) | In dB | REL-8 |
| Δ_{ACK} | OP | | Integer (0..8) | Refer to quantization of the power offset in [28] | REL-8 |
| Δ_{NACK} | OP | | Integer (0..8) | refer to quantization of the power offset in [28] | REL-8 |
| Ack-Nack repetition factor | OP | | Integer(1..4) | | REL-8 |

| Condition | Explanation |
|-------------|---|
| <i>algo</i> | The IE is mandatory present if the IE "Power Control Algorithm" is set to "algorithm 1", otherwise the IE is not needed |

10.3.6.92 Uplink DPCH power control info Post

Parameters used by UE to set DPCH initial output power and to use for closed-loop power control.

| Information Element/Group name | Need | Multi | Type and reference | Semantics description | Version |
|--------------------------------|------|-------|---------------------------------|-----------------------|---------|
| CHOICE <i>mode</i> | MP | | | | |
| >FDD | | | | | |
| >>DPCCH Power offset | MP | | Integer(-110..-50 by step of 4) | In dB | |
| >>PC Preamble | MP | | Integer (0..7) | in number of frames | |
| >>SRB delay | MP | | Integer (0..7) | In number of frames | |
| >TDD | | | | | |
| >>UL target SIR | MP | | Real (-11 .. | In dB | |

| Information Element/Group name | Need | Multi | Type and reference | Semantics description | Version |
|--------------------------------|------|-------|--------------------------------|---|---------|
| | | | 20 by step of 0.5dB) | For 1.28 Mcps TDD this parameter represents $PRX_{DPCHdes}$ with range Integer(-120...-58 by step of 1) dBm | REL-4 |
| >>CHOICE <i>TDD option</i> | MP | | | | REL-4 |
| >>>3.84 Mcps TDD | | | | | REL-4 |
| >>>>UL Timeslot Interference | MP | | UL Interference TDD 10.3.6.87a | | |
| >>>7.68 Mcps TDD | | | | | REL-7 |
| >>>>UL Timeslot Interference | MP | | UL Interference TDD 10.3.6.87a | | REL-7 |
| >>>1.28 Mcps TDD | | | | (no data) | REL-4 |

| Condition | Explanation |
|-------------|---|
| <i>algo</i> | The IE is mandatory present if the IE "Power Control Algorithm" is set to "algorithm 1", otherwise the IE is not needed |

10.3.6.93 Uplink DPCH power control info Pre

Parameters used by UE to set DPCH initial output power and to use for closed-loop power control in FDD and parameters for uplink open loop power control in 3.84 Mcps TDD and 7.68 Mcps TDD.

| Information Element/Group name | Need | Multi | Type and reference | Semantics description | Version |
|--------------------------------|----------------|-------|---------------------------------------|--|---------|
| CHOICE <i>mode</i> | MP | | | | |
| >FDD | | | | | |
| >>Power Control Algorithm | MP | | Enumerated (algorithm 1, algorithm 2) | Specifies algorithm to be used by UE to interpret TPC commands | |
| >>TPC step size | <i>CV-algo</i> | | Integer (1, 2) | In dB | |
| >TDD | | | | (No data) | |
| >>CHOICE <i>TDD option</i> | MP | | | | REL-4 |
| >>>3.84 Mcps TDD | | | | | REL-4 |
| >>DPCH Constant Value | MP | | Constant Value TDD 10.3.6.11a | Quality Margin | |
| >>>7.68 Mcps TDD | | | | | REL-7 |
| >>DPCH Constant Value | MP | | Constant Value TDD 10.3.6.11a | Quality Margin | REL-7 |
| >>>1.28 Mcps TDD | | | | (no data) | REL-4 |

| Condition | Explanation |
|-------------|---|
| <i>algo</i> | The IE is mandatory present if the IE "Power Control Algorithm" is set to "algorithm 1", otherwise the IE is not needed |

10.3.6.94 Uplink Timeslots and Codes

NOTE: Only for 1.28 Mcps TDD and 3.84 Mcps TDD.

| Information Element/Group name | Need | Multi | Type and reference | Semantics description |
|----------------------------------|------|----------------|---|--|
| Dynamic SF usage | MP | | Boolean | |
| First Individual timeslot info | MP | | Individual timeslot info 10.3.6.37 | Individual timeslot info for the first timeslot used by the physical layer. |
| First timeslot Code List | MP | 1..2 | | Code list used in the timeslot. given in First individual timeslot info. |
| >Channelisation Code | MP | | Enumerated((1/1),(2/1),(2/2),(4/1)..(4/4),(8/1)..(8/8),(16/1)..(16/16)) | |
| CHOICE <i>more timeslots</i> | MP | | | |
| >No more timeslots | | | | (no data) |
| >Consecutive timeslots | | | | |
| >>Number of additional timeslots | MP | | Integer(1..maxTS-1) | The timeslots used by the physical layer shall be timeslots:
N mod maxTS
(N+1) mod maxTS
...
(N+k) mod maxTS
in that order, where N is the timeslot number in the First individual timeslot info and k the Number of additional timeslots.
The additional timeslots shall use the same parameters (e.g. channelisation codes, midamble shifts etc.) as the first timeslot. |
| >Timeslot list | | | | |
| >>Additional timeslot list | MP | 1 to <maxTS-1> | | The first instance of this parameter corresponds to the timeslot that shall be used second by the physical layer, the second to the timeslot that shall be used third and so on. |
| >>>CHOICE <i>parameters</i> | MP | | | |
| >>>>Same as last | | | | |
| >>>>>Timeslot number | MP | | Timeslot Number 10.3.6.84 | This physical layer shall use the same parameters (e.g. channelisation codes, midamble shifts etc.) for this timeslot as for the last one. |
| >>>>>New parameters | | | | |
| >>>>>Individual timeslot info | MP | | Individual timeslot info 10.3.6.37 | |
| >>>>>Code List | MP | 1..2 | | |
| >>>>>>Channelisation Code | MP | | Enumerated((1/1),(2/1),(2/2),(4/1)..(4/4),(8/1)..(8/8),(16/1)..(16/16)) | |

10.3.6.94a Uplink Timeslots and Codes LCR

NOTE: Only for 1.28 Mcps TDD

| Information Element/Group name | Need | Multi | Type and reference | Semantics description |
|----------------------------------|----------------|----------------|--|--|
| Dynamic SF usage | MP | | Boolean | |
| First Individual timeslot info | MP | | Individual timeslot info
10.3.6.37 | Individual timeslot info for the first timeslot used by the physical layer. |
| First timeslot Code List | MP | 1..2 | | Code list used in the timeslot. given in First individual timeslot info. |
| >Channelisation Code | MP | | Enumerate d((1/1),(2/1),(2/2),(4/1)..(4/4),(8/1)..(8/8),(16/1)..(16/16)) | |
| >PLCCH Info | CV-no_DL_D PCH | | PLCCH Info
10.3.6.50a | |
| CHOICE <i>more timeslots</i> | MP | | | |
| >No more timeslots | | | | (no data) |
| >Consecutive timeslots | | | | |
| >>Number of additional timeslots | MP | | Integer(1..maxTS-1) | The timeslots used by the physical layer shall be timeslots:
N mod maxTS
(N+1) mod maxTS
...
(N+k) mod maxTS
in that order, where N is the timeslot number in the First individual timeslot info and k the Number of additional timeslots.
The additional timeslots shall use the same parameters (e.g. channelisation codes, midamble shifts etc.) as the first timeslot. |
| >Timeslot list | | | | |
| >>Additional timeslot list | MP | 1 to <maxTS-1> | | The first instance of this parameter corresponds to the timeslot that shall be used second by the physical layer, the second to the timeslot that shall be used third and so on. |
| >>>CHOICE <i>parameters</i> | MP | | | |
| >>>>Same as last | | | | |
| >>>>>Timeslot number | MP | | Timeslot Number
10.3.6.84 | This physical layer shall use the same parameters (e.g. channelisation codes, midamble shifts etc.) for this timeslot as for the last one. |
| >>>>>New parameters | | | | |
| >>>>>Individual timeslot info | MP | | Individual timeslot | |

| Information Element/Group name | Need | Multi | Type and reference | Semantics description |
|--------------------------------|-------------------|-------|---|---|
| | | | info
10.3.6.37 | |
| >>>>>Code List | MP | 1..2 | | |
| >>>>>>Channelisation Code | MP | | Enumerate
d((1/1),(2/1),(2/2),(4/1)..(4/4),(8/1)..(8/8),(16/1)..(16/16)) | |
| >>>>>> PLCCH Info | CV-
no_DL_DPCH | | PLCCH
Info
10.3.6.50a | Default is same as set of parameter values as assigned to last timeslot |

| Condition | Explanation |
|-------------------|---|
| <i>No_DL_DPCH</i> | This IE is mandatory present for 1.28 Mcps TDD only in the case that Uplink Timeslots and Codes are assigned for UL DPCH and no DL DPCH is allocated to the UE. |

10.3.6.94b Uplink Timeslots and Codes VHCR

NOTE: Only for 7.68 Mcps TDD

| Information Element/Group name | Need | Multi | Type and reference | Semantics description | Version |
|----------------------------------|------|----------------|---|--|---------|
| Dynamic SF usage | MP | | Boolean | | REL-7 |
| First Individual timeslot info | MP | | Individual timeslot info
10.3.6.37 | Individual timeslot info for the first timeslot used by the physical layer. | REL-7 |
| First timeslot Code List | MP | 1..2 | | Code list used in the timeslot. given in First individual timeslot info. | REL-7 |
| >Channelisation Code | MP | | Enumerated((1/1),(2/1),(2/2),(4/1)..(4/4),(8/1)..(8/8..(16/1) ..(16/16).(32/1)..(32/32)) | | REL-7 |
| CHOICE <i>more timeslots</i> | MP | | | | REL-7 |
| >No more timeslots | | | | (no data) | REL-7 |
| >Consecutive timeslots | | | | | REL-7 |
| >>Number of additional timeslots | MP | | Integer(1..maxTS-1) | The timeslots used by the physical layer shall be timeslots:
N mod maxTS
(N+1) mod maxTS
...
(N+k) mod maxTS
in that order, where N is the timeslot number in the First individual timeslot info and k the Number of additional timeslots.
The additional timeslots shall use the same parameters (e.g. channelisation codes, midamble shifts etc.) as the first timeslot. | REL-7 |
| >Timeslot list | | | | | REL-7 |
| >>Additional timeslot list | MP | 1 to <maxTS-1> | | The first instance of this parameter corresponds to the timeslot that shall be used second by the physical layer, the second to the timeslot that shall be used third and so on. | REL-7 |
| >>>CHOICE <i>parameters</i> | MP | | | | REL-7 |
| >>>>Same as last | | | | | REL-7 |
| >>>>>Timeslot number | MP | | Timeslot Number
10.3.6.84 | This physical layer shall use the same parameters (e.g. channelisation codes, midamble shifts etc.) for this timeslot as for the last one. | REL-7 |
| >>>>>New parameters | | | | | REL-7 |

| Information Element/Group name | Need | Multi | Type and reference | Semantics description | Version |
|--------------------------------|------|-------|---|-----------------------|---------|
| >>>>Individual timeslot info | MP | | Individual timeslot info 10.3.6.37 | | REL-7 |
| >>>>Code List | MP | 1..2 | | | REL-7 |
| >>>>>Channelisation Code | MP | | Enumerated((1/1),(2/1),(2/2),(4/1)..(4/4),(8/1)..(8/8) .(16/1)..(16/16).(32/1)..(32/32)) | | REL-7 |

10.3.6.95 Uplink Timing Advance

NOTE: Only for 3.84 Mcps TDD.

| Information Element/Group name | Need | Multi | Type and reference | Semantics description | Version |
|--------------------------------|------|-------|--------------------|---|---------|
| UL Timing Advance | MP | | Integer (0..63) | Absolute timing advance value to be used to avoid large delay spread at the NodeB | |

10.3.6.95a Extended Uplink Timing Advance

NOTE: Only for 3.84 and 7.68 Mcps TDD.

| Information Element/Group name | Need | Multi | Type and reference | Semantics description | Version |
|--------------------------------|------|-------|--------------------|---|---------|
| CHOICE <i>TDD mode</i> | | | | | REL-7 |
| >3.84 Mcps TDD | | | | | REL-7 |
| >>Extended UL Timing Advance | MP | | Integer (0..255) | Absolute timing advance value to be used to avoid large delay spread at the NodeB | REL-7 |
| >7.68.Mcps TDD | | | | | REL-7 |
| >>Extended UL Timing Advance | MP | | Integer (0..511) | Absolute timing advance value to be used to avoid large delay spread at the NodeB | REL-7 |

10.3.6.96 Uplink Timing Advance Control

NOTE: Only for TDD

| Information Element/Group name | Need | Multi | Type and reference | Semantics description | Version |
|--------------------------------|------|-------|-----------------------|---|---------|
| CHOICE <i>Timing Advance</i> | MP | | | | |
| >Disabled | | | Null | Indicates that no timing advance is applied | |
| >Enabled | | | | | |
| >>CHOICE <i>TDD option</i> | MP | | | | REL-4 |
| >>>3.84 Mcps TDD | | | | | REL-4 |
| >>>>UL Timing Advance | MD | | Uplink Timing Advance | Absolute timing advance value to be used to avoid | |

| Information Element/Group name | Need | Multi | Type and reference | Semantics description | Version |
|--------------------------------------|------|-------|--|---|---------|
| | | | 10.3.6.95 | large delay spread at the NodeB. Default value is the existing value for uplink timing advance. | |
| >>Extended Timing Advance | OP | | Extended UL Timing Advance Control
10.3.6.95a | | REL-7 |
| >>>>Activation Time | OP | | Activation Time
10.3.3.1 | Frame number timing advance is to be applied. This IE is required when a new UL Timing Advance adjustment is specified and Activation Time is not otherwise specified in the RRC message. | |
| >>>7.68 Mcps TDD | | | | | REL-7 |
| >>>>Extended UL Timing Advance | MD | | Extended Uplink Timing Advance
10.3.6.95a | Absolute timing advance value to be used to avoid large delay spread at the NodeB. Default value is the existing value for uplink timing advance. | REL-7 |
| >>>>Activation Time | OP | | Activation Time
10.3.3.1 | Frame number timing advance is to be applied. This IE is required when a new UL Timing Advance adjustment is specified and Activation Time is not otherwise specified in the RRC message. | REL-7 |
| >>1.28 Mcps TDD | | | | (no data) | REL-4 |
| >>>Uplink synchronisation parameters | MD | | | Default: Uplink synchronisation step size is 1. Uplink synchronisation frequency is 1. | REL-4 |
| >>>>Uplink synchronisation step size | MP | | Integer(1..8) | This parameter specifies the step size to be used for the adjustment of the uplink transmission timing | REL-4 |
| >>>>Uplink synchronisation frequency | MP | | Integer(1..8) | This parameter specifies the frequency of the adjustment of the uplink transmission timing | REL-4 |

| Information Element/Group name | Need | Multi | Type and reference | Semantics description | Version |
|--------------------------------|------|-------|------------------------------------|--|---------|
| >>>Synchronisation parameters | OP | | | | |
| >>>>SYNC_UL codes bitmap | MP | | SYNC_UL codes bitmap
10.3.6.78o | | REL-4 |
| >>>>FPACH info | MP | | FPACH info
10.3.6.35a | | REL-4 |
| >>>>PRX _{UpPCHdes} | MP | | Integer(-120...-58 by step of 1) | In dBm | REL-4 |
| >>>>SYNC_UL procedure | MD | | | Default is:
Max SYNC_UL Transmission is 2.
Power Ramp Step is 2. | REL-4 |
| >>>>>Max SYNC_UL Transmissions | MP | | Integer(1,2,4,8) | Maximum numbers of SYNC_UL transmissions in a power ramping sequence. | REL-4 |
| >>>>>Power Ramp Step | MP | | Integer(0,1,2,3) | In dB | REL-4 |

10.3.6.97 E-DCH Info

| Information Element/Group name | Need | Multi | Type and reference | Semantics description | Version |
|--|------|-------|-------------------------------------|---|---------|
| MAC-es/e reset indicator | OP | | Enumerated (TRUE) | TRUE Indicates the MAC-es/e or MAC-i/is entity needs to be reset. | REL-6 |
| CHOICE <i>mode</i> | MP | | | | REL-7 |
| >FDD | | | | | REL-7 |
| >>E-DPCCH info | OP | | E-DPCCH Info
10.3.6.98 | | REL-6 |
| >>E-DPDCH info | OP | | E-DPDCH info
10.3.6.99 | | REL-6 |
| >>>Scheduled Transmission configuration | OP | | | | REL-6 |
| >>>>2ms scheduled transmission grant HARQ process allocation | MD | | Bitstring (8) | MAC-d PDUs belonging to MAC-d flows not configured with a 'Max MAC-e PDU contents size' are only allowed to be transmitted in those processes for which the bit is set to '1'.
Bit 0 corresponds to HARQ process 0, bit 1 corresponds to HARQ process 1,...
Default value is: transmission in all HARQ processes is allowed. Bit 0 is the first/leftmost bit of the bit string. | REL-6 |
| >>>>Serving Grant | OP | | | | REL-6 |
| >>>>>Serving Grant value | MP | | Integer (0..37,38) | (0..37) indicates E-DCH serving grant index as defined in [15]; index 38 means zero grant. | REL-6 |
| >>>>>Primary/Secondary Grant Selector | MP | | Enumerated ('primary', 'secondary') | Indicates whether the Serving Grant is received with a Primary E-RNTI or Secondary E-RNTI | REL-6 |
| >>>>>>UL 16QAM settings | OP | | UL 16QAM settings
10.3.6.86a | Presence of this IE indicates that the UE should operate in 16QAM mode; absence indicates that the UE is not to operate in 16QAM mode. See Note 1. | REL-7 |
| >TDD | | | | | REL-7 |
| >>E-RUCCH info | OP | | E-RUCCH Info
10.3.6.103 | | REL-7 |

| | | | | | |
|---|----|--|---|--|-------|
| >>E-PUCH info | OP | | E-PUCH Info
10.3.6.104 | | REL-7 |
| >>Non-scheduled transmission grant info | OP | | Non-scheduled transmission grant info
10.3.6.41c | | REL-7 |
| NOTE 1: If this IE is not present, the indices signaled on the E-AGCH refer to the Mapping of Absolute Grant Value Table 16B in [27]. | | | | | |

10.3.6.98 E-DPCCH Info

| Information Element/Group name | Need | Multi | Type and reference | Semantics description | Version |
|--------------------------------|------|-------|---|---|---------|
| E-DPCCH/DPCCH power offset | MP | | Integer (0..8) | Refer to quantization of the power offset in [28] | REL-6 |
| Happy bit delay condition | MP | | Enumerated (2ms, 10ms, 20ms, 50ms, 100ms, 200ms, 500ms, 1000ms) | To be used when determining the setting of the happy bit (see [15]) | REL-6 |
| E-TFC Boost Info | OP | | E-TFC Boost Info
10.3.6.106 | Absence of this IE means that boosting of E-DPCCH is disabled | REL-7 |
| E-DPDCH power interpolation | OP | | Boolean | TRUE means E-DPDCH power interpolation formula is used, FALSE means E-DPDCH power extrapolation formula is used for the computation of the gain factor β_{ed} according to [29] | REL-7 |

10.3.6.99 E-DPDCH Info

| Information Element/Group name | Need | Multi | Type and reference | Semantics description | Version |
|-------------------------------------|------|--------|--|--|---------|
| E-TFCI table index | MP | | Integer (0..1) | Indicates which standardised E-TFCI TB size table shall be used. See Note 3. | REL-6 |
| E-DCH minimum set E-TFCI | MD | | Integer (0..127) | See [15]; Absence means no E-DCH minimum set | REL-6 |
| Reference E-TFCIs | MP | 1 to 8 | | See [29] | REL-6 |
| >Reference E-TFCI | MP | | Integer (0..127) | | REL-6 |
| >Reference E-TFCI PO | MP | | Integer (0..29, | Refer to quantization of the power offset in [28] | REL-6 |
| | | | 30, 31) | Values 30 and 31 are only used for E-TFCI > E-TFCI Boost | REL-7 |
| Minimum reduced E-DPDCH gain factor | OP | | Enumerated (8/15, 11/15, 15/15, 21/15, 30/15, 42/15, 60/15, 84/15) | $\beta_{ed,k, reduced, min}$ [29]; the default value is 8/15. If the configurable reduced E-DPDCH gain factor is not supported by the UE, the default value is used. | REL-8 |

| | | | | | |
|--|----|--|--|---|-------|
| Maximum channelisation codes | MP | | Enumerated (sf256, sf128, sf64, sf32, sf16, sf8, sf4, 2sf4, 2sf2, 2sf2and2sf4) | | REL-6 |
| $PL_{non-max}$ | MP | | Real (0.44 ..1.0 by step of 0.04) | As defined in [27] | REL-6 |
| Scheduling Information Configuration | MP | | | | REL-6 |
| >Periodicity for Scheduling Info – no grant | MD | | Enumerated (everyEDCHTTI,4,10,20,50,100,200,500,1000) | Values in ms. Default value is 'no report' NOTE 1. | REL-6 |
| >Periodicity for Scheduling Info – grant | MD | | Enumerated (everyEDCHTTI,4,10,20,50,100,200,500,1000) | Values in ms. Default value is 'no report' NOTE 1. | REL-6 |
| >Power Offset for Scheduling Info | MP | | Integer (0..6) | Only used when no MACd PDUs are included in the same MAC-e or MAC-i PDU. Unit is in dB. | REL-6 |
| 3-Index-Step Threshold | MD | | Integer (0..37) | Refers to an index in the 'SG-Table' (see [15]). Default value is 0. NOTES 2, 3. | REL-6 |
| 2-Index-Step Threshold | MD | | Integer (0..37) | Refers to an index in the 'SG-Table' (see [15]). Default value is 0. NOTES 2, 3. | REL-6 |
| <p>NOTE 1: If the Periodicity is set to 4ms and the E-DCH TTI is set to 10ms, the UE shall interpret the periodicity value as 10ms.</p> <p>NOTE 2: If the 3-index-Step Threshold value is greater than 2-index-Step Threshold, the UE behaviour is unspecified.</p> <p>NOTE 3: If the UE is operating in 16QAM mode, the value of 'E-TFCI table index' is increased by 2, and indices in the SG-Table refer to Scheduling Grant Table 2 in [15].</p> | | | | | |

10.3.6.100 E-AGCH Info

Includes the configuration for the E-DCH related Absolute Grant Channel.

| Information Element/Group name | Need | Multi | Type and reference | Semantics description | Version |
|---|----------------|---------------------|--|---|---------|
| CHOICE <i>mode</i> | MP | | | | REL-7 |
| >FDD | | | | | REL-7 |
| >>E-AGCH Channelisation Code | MP | | Integer (0..255) | | REL-6 |
| >TDD | | | | | REL-7 |
| >>CHOICE TDD Option | MP | | | | REL-7 |
| >>>3.84 Mcps TDD | | | | | REL-7 |
| >>>>Long Term Grant Indicator | MD | | Boolean | FALSE = Short Term
TRUE = Long Term
Default = FALSE (Short Term) | REL-7 |
| >>>>Length of TTRI field | MP | | Integer(1..12) | Indicated length of the bitmap used to indicate which of the timeslots configured for E-DCH are allocated | REL-7 |
| >>>>E-AGCH set configuration | MP | <1 to maxNumE-AGCH> | | | REL-7 |
| >>>>>TS number | MP | | Integer(0..14) | | REL-7 |
| >>>>>Channelisation code | MP | | Enumerated(16/1, 16/2,....16/16) | | REL-7 |
| >>>>>CHOICE Burst Type | | | | | REL-7 |
| >>>>>>Type 1 | | | | | REL-7 |
| >>>>>>>Midamble allocation mode | MP | | Enumerated(Default, Common, UE specific) | | REL-7 |
| >>>>>>>Midamble configuration burst type 1 | MP | | Enumerated(4, 8, 16) | | REL-7 |
| >>>>>>>Midamble shift | CV-UE specific | | Integer(0..15) | | REL-7 |
| >>>>>>>Type 2 | | | | | |
| >>>>>>>>Midamble allocation mode | MP | | Enumerated(Default, Common, UE specific) | | REL-7 |
| >>>>>>>>Midamble configuration burst type 2 | MP | | Enumerated(3, 6) | | REL-7 |
| >>>>>>>>Midamble shift | CV-UE specific | | Integer(0..5) | | REL-7 |
| >>>>E-AGCH BLER target | MP | | Real(-3.15 to 0 step 0.05) | | REL-7 |
| >>>7.68 Mcps TDD | | | | | REL-7 |
| >>>>Long Term Grant Indicator | MD | | Boolean | FALSE = Short Term
TRUE = Long Term
Default = FALSE (Short Term) | REL-7 |
| >>>>Length of TTRI field | MP | | Integer(1..12) | Indicated length of the bitmap used to indicate which of the timeslots configured for E-DCH are allocated | REL-7 |
| >>>>E-AGCH set configuration | MP | <1 to maxNumE-AGCH> | | | REL-7 |

| | | | | | |
|--|----------------|---------------------|--|---|-------|
| >>>>>TS number | MP | | Integer(0..14) | | REL-7 |
| >>>>>Channelisation code | MP | | Enumerated(32/1, 32/2,....32/32) | | REL-7 |
| >>>>>CHOICE Burst Type | | | | | REL-7 |
| >>>>>>Type 1 | | | | | REL-7 |
| >>>>>>>Midamble allocation mode | MP | | Enumerated(Default, Common, UE specific) | | REL-7 |
| >>>>>>>Midamble configuration burst type 1 | MP | | Enumerated(4, 8, 16) | | REL-7 |
| >>>>>>>Midamble shift | CV-UE specific | | Integer(0..15) | | REL-7 |
| >>>>>>>Type 2 | | | | | |
| >>>>>>>>Midamble allocation mode | MP | | Enumerated(Default, Common, UE specific) | | REL-7 |
| >>>>>>>>Midamble configuration burst type 2 | MP | | Enumerated(3, 6) | | REL-7 |
| >>>>>>>>Midamble shift | CV-UE specific | | Integer(0..5) | | REL-7 |
| >>>>>E-AGCH BLER target | MP | | Real(-3.15 to 0 step 0.05) | | REL-7 |
| >>>>1.28 Mcps TDD | | | | | REL-7 |
| >>>>>RDI Indicator | MP | | Boolean | TRUE indicates a RDI field is present on E-AGCH, | REL-7 |
| >>>>>TPC step size | MP | | Integer (1, 2, 3) | dB. | REL-7 |
| >>>>>E-AGCH set configuration | MP | <1 to maxNumE-AGCH> | | | REL-7 |
| >>>>>>>Timeslot number | MP | | Integer (0..6) | | REL-7 |
| >>>>>>>>First Channelisation code | MP | | Enumerated ((16/1) ..(16/16)) | | REL-7 |
| >>>>>>>>Second Channelisation code | MP | | Enumerated ((16/1) ..(16/16)) | | REL-7 |
| >>>>>>>>>Midamble Allocation mode | MP | | Enumerated (Default midamble, Common midamble, UE specific midamble) | | REL-7 |
| >>>>>>>>>Midamble configuration | MP | | Integer (2, 4, 6, 8, 10, 12, 14, 16) | | REL-7 |
| >>>>>>>>>>Midamble Shift | CV-UE specific | | Integer (0..15) | | REL-7 |
| >>>>>>>>>>E-AGCH BLER target | MP | | Real(-3.15 to 0 step 0.05) | | REL-7 |
| >>>>>>>>>>>E-AGCH Inactivity Monitor Threshold | MD | | Enumerated (0, 1, 2, 4, 8, 16, 32, 64, 128, 256, 512, infinity) | Units of subframes. Default value is "8". Four spare values are needed. | REL-8 |

10.3.6.100a E-AGCH Info 1.28Mcps TDD

Includes the configuration for the E-DCH related Absolute Grant Channel.

| Information Element/Group name | Need | Multi | Type and reference | Semantics description | Version |
|--------------------------------|-----------------------|---------------------|--|--|---------|
| RDI Indicator | MP | | Boolean | TRUE indicates a RDI field is present on E-AGCH, | REL-8 |
| TPC step size | MP | | Integer (1, 2, 3) | dB. | REL-8 |
| E-AGCH set configuration | MP | <1 to maxNumE-AGCH> | | | REL-8 |
| >Timeslot number | MP | | Integer (0..6) | | REL-8 |
| >First Channelisation code | MP | | Enumerated ((16/1) ..(16/16)) | | REL-8 |
| >Second Channelisation code | MP | | Enumerated ((16/1) ..(16/16)) | | REL-8 |
| >Midamble Allocation mode | MP | | Enumerated (Default midamble, Common midamble, UE specific midamble) | | REL-8 |
| >Midamble configuration | MP | | Integer (2, 4, 6, 8, 10, 12, 14, 16) | | REL-8 |
| >Midamble Shift | <i>CV-UE specific</i> | | Integer (0..15) | | REL-8 |
| E-AGCH BLER target | MP | | Real(-3.15 to 0 step 0.05) | | REL-8 |

| Condition | Explanation |
|--------------------|--|
| <i>UE specific</i> | This IE is mandatory present when the value of the IE "Midamble Allocation Mode" is "UE specific midamble" and not needed otherwise. |

10.3.6.101 E-HICH Info

Includes the configuration for the E-DCH related HARQ Acknowledgement Indicator Channel.

| Information Element/Group name | Need | Multi | Type and reference | Semantics description | Version |
|--------------------------------|------|---------------------|--------------------------------|--|---------|
| CHOICE <i>mode</i> | MP | | | | REL-7 |
| >FDD | | | | | REL-7 |
| >>Channelisation Code | MP | | Integer (0..127) | | REL-6 |
| >>Signature Sequence | MP | | Integer (0..39) | | REL-6 |
| >TDD | | | | | REL-7 |
| >>CHOICE <i>TDD Option</i> | MP | | | | REL-7 |
| >>>3.84 Mcps TDD | | | | | REL-7 |
| >>>> N_{E-HICH} | MP | | Integer(4..44) | Minimum number of slots between start last active slot of E-DCH TTI and start of ACK/NACK on E-HICH (see[?]) | REL-7 |
| >>>>TS number | MP | | Integer(0..14) | | REL-7 |
| >>>>Channelisation Code | MP | | Enumerated(16/1, 16/2,..16/16) | | REL-7 |
| >>>>Burst type | MP | | Enumerated(Type1, Type2) | | REL-7 |
| >>>>Midambe allocation mode | MP | | Enumerated(Default, Common) | | REL-7 |
| >>>>7.68 Mcps TDD | | | | | REL-7 |
| >>>> N_{E-HICH} | MP | | Integer(4..44) | Minimum number of slots between start last active slot of E-DCH TTI and start of ACK/NACK on E-HICH (see[?]) | REL-7 |
| >>>>TS number | MP | | Integer(0..14) | | REL-7 |
| >>>>Channelisation Code | MP | | Enumerated(32/1, 32/2,..32/32) | | REL-7 |
| >>>>Burst type | MP | | Enumerated(Type1, Type2) | | REL-7 |
| >>>>Midambe allocation mode | MP | | Enumerated(Default, Common) | | REL-7 |
| >>>>1.28 Mcps TDD | | | | | REL-7 |
| >>>> N_{E-HICH} | MP | | Integer (4..15) | Minimum number of slots between start last active slot of E-DCH TTI and start of ACK/NACK on E-HICH | REL-7 |
| >>>>E-HICH set configuration | | <1 to maxNumE-HICH> | | | REL-7 |
| >>>>>EI | MP | | Integer (0..3) | | REL-7 |
| >>>>>Timeslot number | MP | | Integer (0..6) | | REL-7 |
| >>>>>Channelisation code | MP | | Enumerated ((16/1) ..(16/16)) | | REL-7 |
| >>>>>Midamble Allocation mode | MP | | Enumerated (Default midamble, | | REL-7 |

| | | | | | |
|----------------------------|----------------|--|--------------------------------------|--|-------|
| | | | UE specific midamble) | | |
| >>>>Midamble configuration | MP | | Integer (2, 4, 6, 8, 10, 12, 14, 16) | | REL-7 |
| >>>>Midamble Shift | CV-UE specific | | Integer (0..15) | | REL-7 |

10.3.6.101a E-HICH Info 1.28Mcps TDD

Includes the configuration for the E-DCH related HARQ Acknowledgement Indicator Channel.

| Information Element/Group name | Need | Multi | Type and reference | Semantics description | Version |
|--------------------------------|----------------|---------------------|---|---|---------|
| N _{E-HICH} | MP | | Integer (4..15) | Minimum number of slots between start last active slot of E-DCH TTI and start of ACK/NACK on E-HICH | REL-8 |
| E-HICH set configuration | MP | <1 to maxNumE-HICH> | | | REL-8 |
| >EI | MP | | Integer (0..3) | | REL-8 |
| >Timeslot number | MP | | Integer (0..6) | | REL-8 |
| >Channelisation code | MP | | Enumerated ((16/1) ..(16/16)) | | REL-8 |
| >Midamble Allocation mode | MP | | Enumerated (Default midamble, UE specific midamble) | | REL-8 |
| >Midamble configuration | MP | | Integer (2, 4, 6, 8, 10, 12, 14, 16) | | REL-8 |
| >Midamble Shift | CV-UE specific | | Integer (0..15) | | REL-8 |

| Condition | Explanation |
|--------------------|--|
| <i>UE specific</i> | This IE is mandatory present when the value of the IE "Midamble Allocation Mode" is "UE specific midamble" and not needed otherwise. |

10.3.6.102 E-RGCH Info (FDD only)

Includes the configuration for the E-DCH related Relative Grant Channel. The E-RGCH is using the same channelisation code as configured for the E-HICH channel (see subclause 10.3.6.101).

| Information Element/Group name | Need | Multi | Type and reference | Semantics description | Version |
|--------------------------------|------|-------|--------------------|--|---------|
| Signature Sequence | MP | | Integer(0..39) | | REL-6 |
| RG combination index | MP | | Integer(0..5) | Cells with an index equal to the index of the Serving E-DCH cell belong to the Serving E-DCH RLS. The E-RGCH from these cells have RG commands which for the UE are known to be the same as the RG commands from the Serving E-DCH cell. | REL-6 |

10.3.6.103 E-RUCCH Info (TDD only)

| Information Element/Group name | Need | Multi | Type and reference | Semantics description | Version |
|--------------------------------------|------|---------|--|---|---------|
| CHOICE TDD mode | | | | | REL-7 |
| >3.84/7.68 Mcps TDD | | | | | REL-7 |
| >>E-RUCCH constant value | MP | | Integer (-35..10) | Power to be used | REL-7 |
| >>E-RUCCH persistence scaling factor | MP | | Real(0.9..0.2 by step of 0.1) | | REL-7 |
| >>T-RUCCH | MD | | Integer(40..320 by step of 40) | Default =200ms
If T-RUCH expires before Grant is received then uE should send scheduling information again on E-RUCH | REL-7 |
| >>E-RUCCH timeslot number | MD | | Timeslot number
10.3.6.84 | Default is same as PRACH timeslot number | REL-7 |
| >>E-RUCCH midamble | MD | | Enumerated(Direct, Direct/Inverted) | Default is as PRACH midamble | REL-7 |
| >>T-Adv | MD | | Enumerated (1, 2, 4, 8, 16, 32, 128, infinity) | Default is 1 second | REL-7 |
| >>T-SCHED | MD | | Enumerated (0, 40ms, 80ms, 160ms, 250ms, 1sec, 2sec, 4sec) | Default is 0 second (include Scheduling Information in every MAC-e PDU) | REL-7 |
| >>>CHOICE TDD option | | | | | REL-7 |
| >>>3.84 Mcps TDD | | | | | REL-7 |
| >>>>CHOICE SF | MP | | | | REL-7 |
| >>>>>SF16 | | | | | REL-7 |
| >>>>>>Channelisation Code List | MP | 1 to 8 | | | REL-7 |
| >>>>>>>Channelisation code | MP | | Enumerated ((16/1)..(16/8)) | There is a 1:1 mapping between spreading code and midamble shift defined in [30] for channelisation codes (16/1) to (16/8).

NOTE: channelisation codes (16/9) to (16/16) are not to be used. | REL-7 |
| >>>>>>>>SF8 | | | | | REL-7 |
| >>>>>>>>>Channelisation Code List | MP | 1 to 8 | | | REL-7 |
| >>>>>>>>>>>Channelisation Code | MP | | Enumerated((8/1)..(8/8)) | | REL-7 |
| >>>>7.68 Mcps TDD | | | | | REL-7 |
| >>>>>CHOICE SF | MP | | | | REL-7 |
| >>>>>>>>>>>SF32 | | | | | REL-7 |
| >>>>>>>>>>>>>>>Channelisation Code | MP | 1 to 16 | | | REL-7 |

| | | | | | |
|--------------------------------|----|----------------|---|---|-------|
| List | | | | | |
| >>>>>>Channelisation code | MP | | Enumerated ((32/1)...(32/16)) | There is a 1:1 mapping between spreading code and midamble shift defined in [30] for channelisation codes (32/1) to (32/16).

NOTE: channelisation codes (32/17) to (32/32) are not to be used. | REL-7 |
| >>>>>SF16 | | | | | REL-7 |
| >>>>>Channelisation Code List | MP | 1 to 16 | | | REL-7 |
| >>>>>>Channelisation Code | MP | | Enumerated((16/1)..(16/16)) | | REL-7 |
| >1.28 Mcps TDD | | | | | REL-7 |
| >>T-RUCCH | MD | | Enumerated (20, 40, 60, 80, 120, 160, 200, 240, 280, 320, 400, 500, 600, 800, 1000, 2000) | Default = 120 ms
If T-RUCCH expires before Grant is received then UE should send scheduling information again on E-RUCCH | REL-7 |
| >>N-RUCCH | MD | | Integer (0...7) | Default = 3
Maximum number of retransmissions of scheduling information on E-RUCCH | REL-7 |
| >>T-WAIT | MD | | Enumerated (everyEDCH TTI, 40, 80, 160, 320, 640, 1000, 2000) | Values in ms.
Default = 40ms
If T-WAIT expires then UE should send scheduling information on E-RUCCH | REL-7 |
| >>T-SI | MD | | Enumerated (everyEDCH TTI, 20, 40, 60, 80, 160, 200) | Values in ms.
Default = 40ms
If periodic T-SI expires then UE should include scheduling information in a new MAC-e PDU | REL-7 |
| >>Extended Estimation Window | OP | | Integer (2..5) | Values in 5ms TTI.
Indicates how many next consecutive 5ms TTIs the UE should estimate whether there is a Grant valid before sending Scheduling Information via E-RUCCH | REL-7 |
| >>E-RUCCH Access Service class | OP | 1 to <maxASC > | | If only "NumASC+1" (with, NumASC+1 | REL-7 |

| | | | | | |
|---|----|-----------------------------|---|---|-------|
| | | | | < maxASC) ASCs are listed, the remaining (NumASC+2 through maxASC) ASCs are unspecified. | |
| >>>E-RUCCH ASC Setting | MD | | ASC setting
10.3.6.6 | The default values are same as the PRACH ASC. If the "default" is used for the first ASC, the default values are all available signatures and "all available sub-channels" for FDD and "all available channelisation codes" and "all available subchannels" with "subchannel size=Size 1" in TDD. | REL-7 |
| >>E-RUCCH persistence scaling factor list | OP | 1 to
<maxASCp
ersist> | | multiplicity corresponds to the number of E-RUCCH ASCs minus 2 | REL-7 |
| >>>Persistence scaling factor | MP | | Real(0.9..0.2
by step of
0.1) | | REL-7 |
| >>SYNC_UL info | OP | | SYNC_UL
info for E-
RUCCH
10.3.6.78d | | REL-7 |
| >>PRACH Information | OP | 1..<maxPR
ACH_FPA
CH> | | | REL-7 |
| >>>Timeslot number | MP | | Timeslot
number
10.3.6.84 | | REL-7 |
| >>> Channelisation Code List | MP | 1 to 2 | | | REL-7 |
| >>>> Channelisation Code | MP | | Enumerated
((4/1)..(4/4),(
8/1)..(8/8),(1
6/1)..(16/16)) | | REL-7 |
| >>>Midamble Shift and burst type | MP | | Midamble
shift and
burst type
10.3.6.41 | | REL-7 |
| >>>FPACH info | OP | | FPACH info
10.3.6.35a | | REL-7 |

10.3.6.103a E-RUCCH Info 1.28Mcps TDD

| Information Element/Group name | Need | Multi | Type and reference | Semantics description | Version |
|--------------------------------|------|----------------|---|--|---------|
| T-RUCCH | MD | | Enumerated (20, 40, 60, 80, 120, 160, 200, 240, 280, 320, 400, 500, 600, 800, 1000, 2000) | Default = 120 ms
If T-RUCCH expires before Grant is received then UE should send scheduling information again on E-RUCCH | REL-8 |
| N-RUCCH | MD | | Integer (0...7) | Default = 3
Maximum number of retransmissions of scheduling information on E-RUCCH | REL-8 |
| T-WAIT | MD | | Enumerated (everyEDCH TTI, 40, 80, 160, 320, 640, 1000, 2000) | Values in ms.
Default = 40ms
If T-WAIT expires then UE should send scheduling information on E-RUCCH | REL-8 |
| T-SI | MD | | Enumerated (everyEDCH TTI, 20, 40, 60, 80, 160, 200) | Values in ms.
Default = 40ms
If periodic T-SI expires then UE should include scheduling information in a new MAC-e PDU | REL-8 |
| Extended Estimation Window | OP | | Integer (2..5) | Values in 5ms TTI.
Indicates how many next consecutive 5ms TTIs the UE should estimate whether there is a Grant valid before sending Scheduling Information via E-RUCCH | REL-8 |
| E-RUCCH Access Service class | OP | 1 to <maxASC > | | If only "NumASC+1" (with, NumASC+1 < maxASC) ASCs are listed, the remaining (NumASC+2 through maxASC) ASCs are unspecified.
The IE is only included when E-DCH is configured on secondary frequency for a specific UE | REL-8 |
| >E-RUCCH ASC Setting | MD | | ASC setting 10.3.6.6 | The default values are same as the PRACH ASC.
If the "default" is used for the first ASC, the default | REL-8 |

| | | | | | |
|---|----|--------------------------|--|---|-------|
| | | | | values are all available signatures and "all available sub-channels" for FDD and "all available channelisation codes" and "all available subchannels" with "subchannel size=Size 1" in TDD. | |
| E-RUCCH persistence scaling factor list | OP | 1 to <maxASCp
ersist> | | multiplicity corresponds to the number of E-RUCCH ASCs minus 2 | REL-8 |
| >Persistence scaling factor | MP | | Real(0.9..0.2 by step of 0.1) | | REL-8 |
| SYNC_UL info | OP | | SYNC_UL info for E-RUCCH 10.3.6.78d | | REL-8 |
| PRACH Information | OP | 1..<maxPRACH_FPA
CH> | | | REL-8 |
| >Timeslot number | MP | | Timeslot number 10.3.6.84 | | REL-8 |
| > Channelisation Code List | MP | 1 to 2 | | | REL-8 |
| >>Channelisation Code | MP | | Enumerated ((4/1)..(4/4),(8/1)..(8/8),(16/1)..(16/16)) | | REL-8 |
| >Midamble Shift and burst type | MP | | Midamble shift and burst type 10.3.6.41 | | REL-8 |
| >FPACH info | OP | | FPACH info 10.3.6.35a | | REL-8 |

10.3.6.104 E-PUCH Info (TDD only)

| Information Element/Group name | Need | Multi | Type and reference | Semantics description | Version |
|--|----------------|----------------|-----------------------------------|---|---------|
| E-TFCS information | MP | | E-TFCS info
10.3.6.105 | | REL-7 |
| CHOICE TDD mode | | | | | REL-7 |
| >3.84/7.68 Mcps TDD | | | | | REL-7 |
| >>N _{E-UCCH} | MD | | Integer(1..12) | No of slots that are required to carry TPC and TFCI (consecutively allocated slots beginning with the first). Default = 1 (first allocated slot). | REL-7 |
| >>E-PUCH constant value | MP | | Integer (-35..10) | Power to be used | REL-7 |
| >>E-PUCH TS configuration list | MP | <1 to maxTS-2> | | | REL-7 |
| >>>TS number | MP | | Integer(0..14) | | REL-7 |
| >>>>CHOICE <i>Burst Type</i> | MP | | | | REL-7 |
| >>>>>Type 1 | | | | | REL-7 |
| >>>>>>Midamble allocation mode | MP | | Enumerated(Default, UE specific) | | REL-7 |
| >>>>>>>Midamble configuration burst type 1 | MP | | Enumerated(4, 8, 16) | | REL-7 |
| >>>>>>>>Midambe shift | CV-UE specific | | Integer (0..15) | | REL-7 |
| >>>>>>>>>Type 2 | | | | | REL-7 |
| >>>>>>>>>>Midamble allocation mode | MP | | Enumerated(Default, UE specific) | | REL-7 |
| >>>>>>>>>>>Midamble configuration burst type 2 | MP | | Enumerated(3, 6) | | REL-7 |
| >>>>>>>>>>>>Midambe shift | CV-UE specific | | Integer (0..5) | | REL-7 |
| >>E-PUCH code hopping | MP | | Boolean | | REL-7 |
| >>E-PUCH TPC step size | MP | | Integer (1,2,3) | | REL-7 |
| >>Minimum allowed code rate | MP | | Integer (0..63) | Maps 0.055 to 1.0 in steps of 0.015 | REL-7 |
| >>Maximum allowed code rate | MP | | Integer (0..63) | Maps 0.055 to 1.0 in steps of 0.015 | REL-7 |
| >1.28 Mcps TDD | | | | | REL-7 |
| >>SNPL Reporting Type | OP | | Enumerated (type1, type2) | | REL-7 |
| >>PRXdes_base | MP | | Integer (-112..-50 by step of 1) | dBm. Reference desired power level for E-PUCH | REL-7 |
| >>Beacon PL Est. | MD | | Boolean | TRUE indicates that the UE may take into account path loss estimated from beacon function physical channels. Default value is FALSE | REL-7 |
| >>TPC step size | MP | | Integer (1, 2, 3) | dB. | REL-7 |
| >>Pebase power control gap | MD | | Integer | Unit: Number of | REL-7 |

| | | | | | |
|--|--|--|-----------|---|--|
| | | | (1...255) | subframes,
Default value is 1.
Value 255
represents infinite
in which case
closed loop power
control shall
always be used. | |
|--|--|--|-----------|---|--|

| | | | | | |
|---|-----------------------|----------------|---|--|-------|
| >>Uplink synchronisation parameters | MD | | | Default: Uplink synchronisation step size 1. Uplink synchronisation frequency 1. | REL-7 |
| >>>Uplink synchronisation step size | MP | | Integer (1..8) | This parameter specifies the step size to be used for the adjustment of the uplink transmission timing | REL-7 |
| >>>Uplink synchronisation frequency | MP | | Integer (1..8) | This parameter specifies the frequency of the adjustment of the uplink transmission timing | REL-7 |
| >>E-PUCH TS configuration list | MP | <1 to maxTS-1> | | | REL-7 |
| >>>TS number | MP | | Integer (1..5) | | REL-7 |
| >>>Midamble shift and burst type | MP | | | | REL-7 |
| >>>>Midamble Allocation Mode | MP | | Enumerated (Default midamble, UE specific midamble) | | REL-7 |
| >>>>Midamble configuration | MP | | Integer (2, 4, 6, 8, 10, 12, 14, 16) | As defined in [30] | REL-7 |
| >>>>Midamble Shift | <i>CV-UE specific</i> | | Integer (0..15) | | REL-7 |
| >>Minimum allowed code rate | MP | | Integer (0..63) | Maps 0.055 to 1.0 in steps of 0.015 | REL-7 |
| >>Maximum allowed code rate | MP | | Integer (0..63) | Maps 0.055 to 1.0 in steps of 0.015 | REL-7 |
| >>Maximum number of retransmissions for Scheduling Info | MP | | Integer (0..15) | Only used when no MAC-d PDUs are included in the same MAC-e PDU or MAC-i PDU. | REL-7 |
| >>Retransmission Timer for Scheduling Info | MP | | Enumerated (10, 15, 20, 25, 30, 35, 40, 45, 50, 55, 60, 65, 70, 75, 80, 85, 90, 95, 100, 110, 120, 140, 160, 200, 240, 280, 320, 400, 480, 560) | Only used when no MAC-d PDUs are included in the same MAC-e PDU or MAC-i PDU. Unit is ms. | REL-7 |
| Power Offset for Scheduling Info | OP | | Integer (0..6) | If present, this IE should be ignored for LCR TDD. Only used when no MACd PDUs are included in the same MACe PDU. Unit is in dB. | REL-7 |

| Condition | Explanation |
|--------------------|--|
| <i>UE specific</i> | This IE is mandatory present when the value of the IE "Midamble Allocation Mode" is "UE specific midamble" and not needed otherwise. |

10.3.6.104a E-PUCH Info 1.28Mcps TDD

| Information Element/Group name | Need | Multi | Type and reference | Semantics description | Version |
|-----------------------------------|----------------|----------------|---|--|---------|
| E-TFCS information | MP | | E-TFCS info 10.3.6.105 | | REL-8 |
| SNPL Reporting Type | OP | | Enumerated (type1, type2) | | REL-8 |
| PRXdes_base | MP | | Integer (-112..-50 by step of 1) | dBm. Reference desired power level for E-PUCH | REL-8 |
| Beacon PL Est. | MD | | Boolean | TRUE indicates that the UE may take into account path loss estimated from beacon function physical channels. Default value is FALSE | REL-8 |
| TPC step size | MP | | Integer (1, 2, 3) | dB. | REL-8 |
| Pebase power control gap | MD | | Integer (1...255) | Unit: Number of subframes, Default value is 1. Value 255 represents infinite in which case closed loop power control shall always be used. | REL-8 |
| Uplink synchronisation parameters | MD | | | Default: Uplink synchronisation step size 1. Uplink synchronisation frequency 1. | REL-8 |
| >Uplink synchronisation step size | MP | | Integer (1..8) | This parameter specifies the step size to be used for the adjustment of the uplink transmission timing | REL-8 |
| >Uplink synchronisation frequency | MP | | Integer (1..8) | This parameter specifies the frequency of the adjustment of the uplink transmission timing | REL-8 |
| E-PUCH TS configuration list | MP | <1 to maxTS-1> | | | REL-8 |
| >TS number | MP | | Integer (1..5) | | REL-8 |
| >Midamble shift and burst type | MP | | | | REL-8 |
| >>Midamble Allocation Mode | MP | | Enumerated (Default midamble, UE specific midamble) | | REL-8 |
| >>Midamble configuration | MP | | Integer (2, 4, 6, 8, 10, 12, 14, 16) | As defined in [30] | REL-8 |
| >>Midamble Shift | CV-UE specific | | Integer (0..15) | | REL-8 |
| Minimum allowed code rate | MP | | Integer | Maps 0.055 to 1.0 | REL-8 |

| | | | | | |
|---|----|--|---|--|-------|
| | | | (0..63) | in steps of 0.015 | |
| Maximum allowed code rate | MP | | Integer (0..63) | Maps 0.055 to 1.0 in steps of 0.015 | REL-8 |
| Maximum number of retransmissions for Scheduling Info | MP | | Integer (0..15) | Only used when no MAC-d PDUs are included in the same MAC-i PDU. | REL-8 |
| Retransmission Timer for Scheduling Info | MP | | Enumerated (10, 15, 20, 25, 30, 35, 40, 45, 50, 55, 60, 65, 70, 75, 80, 85, 90, 95, 100, 110, 120, 140, 160, 200, 240, 280, 320, 400, 480, 560) | Only used when no MAC-d PDUs are included in the same MAC-i PDU. Unit is ms. | REL-8 |

10.3.6.105 E-TFCS info (TDD only)

| IE/Group Name | Presence | Multi | IE Type and Reference | Semantics Description | Version |
|---------------------------------------|----------|----------|-----------------------|-------------------------------------|---------|
| Reference Beta Information QPSK list | MP | <1 to 8> | | | REL-7 |
| >Reference Code Rate | MP | | Integer (0..10) | Unit: -
Range: 0..1
Step: 0.1 | REL-7 |
| >Reference Beta | MP | | Integer (-15..16) | Unit range -15db to +16db | REL-7 |
| Reference Beta Information 16QAM list | MP | <1 to 8> | | | REL-7 |
| >Reference Code Rate | MP | | Integer (0..10) | Unit: -
Range: 0..1
Step: 0.1 | REL-7 |
| >Reference Beta | MP | | Integer (-15..16) | Unit range -15db to +16db | REL-7 |

10.3.6.106 E-TFC Boost Info

| Information Element/Group name | Need | Multi | Type and reference | Semantics description | Version |
|--------------------------------|-------------------------------|-------|--------------------|--|---------|
| E-TFCI boost | MP | | Integer (0..127) | E-TFCI threshold beyond which boosting of E-DPCCH is enabled | REL-7 |
| Delta T2TP | CV-
<i>E-TFCI boost127</i> | | Integer (0..6) | | REL-7 |

| Condition | Explanation |
|------------------------|---|
| <i>E-TFCI boost127</i> | If E-TFCI-Boost is set to 127 this IE is not needed, otherwise it is mandatory. |

10.3.6.107 Control Channel DRX information 1.28Mcps TDD

NOTE: For 1.28 Mcps TDD only.

| Information Element/Group name | Need | Multi | Type and reference | Semantics description | Version |
|---|------|-------|--|---|---------|
| CHOICE <i>Control Channel DRX operation</i> | MP | | | | REL-8 |
| >Continue Control Channel DRX operation | | | | | REL-8 |
| >>Enabling Delay | OP | | Enumerated (0, 1, 2, 4, 8, 16, 32, 64, 128, infinity) | In radio frames. Six spare values are needed. | REL-8 |
| >New Control Channel DRX operation | | | | | REL-8 |
| >>HS-SCCH DRX information | MP | | HS-SCCH DRX information
1.28 Mcps TDD
10.3.6.108 | | REL-8 |
| >>E-AGCH DRX Information | OP | | E-AGCH DRX information
1.28 Mcps TDD
10.3.6.109 | | REL-8 |
| >>Enabling Delay | MP | | Enumerated (0, 1, 2, 4, 8, 16, 32, 64, 128, infinity) | In radio frames. Six spare values are needed. | REL-8 |

10.3.6.108 HS-SCCH DRX information 1.28 Mcps TDD

NOTE: For 1.28 Mcps TDD only.

| Information Element/Group name | Need | Multi | Type and reference | Semantics description | Version |
|--|------|-------|--|---|---------|
| HS-SCCH DRX cycle | MP | | Enumerated (1, 2, 4, 8, 16, 32, 64) | Units of subframes. One spare value is needed. | REL-8 |
| Inactivity Threshold for HS-SCCH DRX cycle | OP | | Enumerated (1, 2, 4, 8, 16, 32, 64, 128, 256, 512, infinity) | Units of subframes. Five spare values are needed. | REL-8 |
| HS-SCCH DRX Offset | MP | | Integer (0..63) | Units of subframes. Offset of the HS-SCCH DRX cycles. | REL-8 |

10.3.6.109 E-AGCH DRX information 1.28 Mcps TDD

NOTE: For 1.28 Mcps TDD only.

| Information Element/Group name | Need | Multi | Type and reference | Semantics description | Version |
|---|------|-------|---|---|---------|
| CHOICE <i>E-AGCH DRX information type</i> | MP | | | | REL-8 |
| >Same as HS-SCCH | | | | (no data)
Indicate the E-AGCH DRX Cycle and Offset are the same as the HS-SCCH DRX Cycle and Offset, and the E-AGCH Inactivity Monitor Threshold is absent | REL-8 |
| >E-AGCH DRX parameters | | | | | REL-8 |
| >>E-AGCH DRX cycle | MP | | Enumerated (1, 2, 4, 8, 16, 32, 64) | Units of subframes. One spare value is needed. | REL-8 |
| >>E-AGCH Inactivity Monitor Threshold | OP | | Enumerated (0, 1, 2, 4, 8, 16, 32, 64, 128, 256, 512, infinity) | Units of subframes. Four spare values are needed. If it is absent, the same IE in the IE 'E-AGCH Info' is used as E-AGCH inactivity monitor threshold. | REL-8 |
| >>E-AGCH DRX Offset | MP | | Integer (0..63) | Units of subframes. Offset of the E-AGCH DRX cycles. | REL-8 |

10.3.6.110 SPS information 1.28 Mcps TDD

NOTE: For 1.28 Mcps TDD only.

| Information Element/Group name | Need | Multi | Type and reference | Semantics description | Version |
|--------------------------------|------|-------|--|-----------------------|---------|
| E-DCH SPS information | OP | | E-DCH SPS information 1.28 Mcps TDD 10.3.6.111 | | REL-8 |
| HS-DSCH SPS information | OP | | HS-DSCH SPS information 1.28 Mcps TDD 10.3.6.112 | | REL-8 |

10.3.6.111 E-DCH SPS information 1.28 Mcps TDD

NOTE: For 1.28 Mcps TDD only.

| Information Element/Group name | Need | Multi | Type and reference | Semantics description | Version |
|---|-----------------------|-------------------------------|---|--|---------|
| CHOICE <i>E-DCH SPS operation</i> | MP | | | | REL-8 |
| >Continue E-DCH SPS operation | | | | (no data) | REL-8 |
| >New E-DCH SPS operation | | | | | REL-8 |
| >>E-HICH Information | MP | | | | REL-8 |
| >>>CHOICE Configuration Mode | MP | | | | REL-8 |
| >>>>Implicit | | | | | REL-8 |
| >>>>>EI | OP | | Integer (0..3) | If the IE does not exist, UE shall use the same configuration as the E-HICH for non-schedule transmission | REL-8 |
| >>>>Explicit | | | | | REL-8 |
| >>>>>Timeslot number | MP | | Integer (0..6) | | REL-8 |
| >>>>>Channelisation code | MP | | Enumerated ((16/1)..(16/16)) | | REL-8 |
| >>>>>Midamble Allocation mode | MP | | Enumerated (Default midamble, UE specific midamble) | | REL-8 |
| >>>>>Midamble configuration | MP | | Integer (2, 4, 6, 8, 10, 12, 14, 16) | | REL-8 |
| >>>>>Midamble Shift | <i>CV-UE specific</i> | | Integer (0..15) | | REL-8 |
| >>>Signature Sequence Group Index | MP | | Integer (0..19) | | REL-8 |
| >>Transmission Pattern List | OP | 1..<maxEDC HTxPattern-TDD128> | | | REL-8 |
| >>>Repetition period | MP | | Integer (1, 2, 4, 8, 16, 32) | Value 1 indicate continuous | REL-8 |
| >>>Repetition length | MP | | Integer (1..Repetition period – 1) | NOTE: This is empty if repetition period is set to 1. | REL-8 |
| >>Initial SPS info for E-DCH | OP | | | | REL-8 |
| >>>N _{E-UCCH} | MD | | Integer (1..8) | Number of E-UCCH and TPC instances within an E-DCH TTI. Default = 1. | REL-8 |
| >>>Code Resource Information | MP | | Enumerated ((1/1), (2/1),(2/2),(4/1)..(4/4),(8/1)..(8/8),(16/1)..(16/16)) | As defined in [31], indicating which of the Channel Codes configured for E-DCH are allocated for SPS resource | REL-8 |
| >>>Timeslot Resource Related InformationI | MP | | Bit string (5) | As defined in [31], indicating which of the timeslots configured for E-DCH are allocated for SPS resource | REL-8 |
| >>>Power Resource Related Information | MP | | Integer (1..32) | Indicates 0-31 PRRI index defined in [31], which specifies the maximum allowed E-PUCH resource that the UE may use [15]. | REL-8 |
| >>>Activation Time | MP | | Activation time 10.3.3.1 | Specifies the E-PUCH Offset in Radio Frame level. | REL-8 |

| Information Element/Group name | Need | Multi | Type and reference | Semantics description | Version |
|--------------------------------|------|-------|---|--|---------|
| >>>Subframe number | MP | | Integer (0..1) | Specifies the E-PUCH Offset in subframe level. | REL-8 |
| >>>Initial Tx pattern Index | MP | | Integer (0..maxEDCHTx Pattern-TDD128-1) | | REL-8 |

| Condition | Explanation |
|--------------------|--|
| <i>UE specific</i> | If UE specific midamble allocation mode is configured, this IE is mandatory, otherwise it is not needed. |

10.3.6.112 HS-DSCH SPS information 1.28 Mcps TDD

NOTE: For 1.28 Mcps TDD only.

| Information Element/Group name | Need | Multi | Type and reference | Semantics description | Version |
|--|-------|-----------------------------------|---|---|---------|
| CHOICE <i>HS-DSCH SPS operation</i> | MP | | | | REL-8 |
| >Continue HS-DSCH SPS operation | | | | (no data) | REL-8 |
| >New HS-DSCH SPS operation | | | | | REL-8 |
| >>Transport Block Size List | OP | 1..<maxTbsForHS-DSCH-TDD128> | | | REL-8 |
| >>>Transport Block Size Index | MP | | Integer (1..63) | Index of the MAC-hs transport block size as described in [15] | REL-8 |
| >>Receive Pattern List | OP | 1..<maxRxPatternForHSDSCH-TDD128> | | | REL-8 |
| >>>Repetition period | MP | | Integer (1, 2, 4, 8, 16, 32) | Value 1 indicate continuous | REL-8 |
| >>>Repetition length | MP | | Integer (1..Repetition period – 1) | NOTE: This is empty if repetition period is set to 1. | REL-8 |
| >>HARQ Info for Semi-Persistent Scheduling | OP | | | | REL-8 |
| >>>Number of Processes | MP | | Integer (1..8) | | REL-8 |
| >>>Process Memory size | MP | | Integer (800 .. 16000 by step of 800, 17600 .. 32000 by step of 1600, 36000 .. 80000 by step of 4000, 88000 .. 160000 by step of 8000, 176000 .. 304000 by step of 16000) | Maximum number of soft channel bits available in the virtual IR buffer [27] | REL-8 |
| >>HS-SICH List | MP | 1..<maxHSSICH-TDD128> | | | REL-8 |
| >>>CHOICE <i>Configuration Mode</i> | MP | | | | REL-8 |
| >>>>Implicit | | | | | REL-8 |
| >>>>>HS-SCCH Index | MP | | Integer (1..maxHSSCC Hs) | | REL-8 |
| >>>>>Explicit | | | | | REL-8 |
| >>>>>Timeslot number | MP | | Integer (0..6) | | REL-8 |
| >>>>>Channelisation code | MP | | Enumerated ((16/1) ..(16/16)) | | REL-8 |
| >>>>>Midamble Allocation mode | MP | | Enumerated (Default midamble, UE specific midamble) | | REL-8 |
| >>>>>Midamble configuration | MP | | Integer (2, 4, 6, 8, 10, 12, 14, 16) | | REL-8 |
| >>>>>Midamble Shift | CV-UE | | Integer (0..15) | | REL-8 |

| Information Element/Group name | Need | Multi | Type and reference | Semantics description | Version |
|--|------|-------|---|--|---------|
| >>Initial SPS info for HS-DSCH | OP | | | | REL-8 |
| >>>Timeslot Information | MP | | Bit string (5) | As defined in [31], indicating which of the timeslots configured for HS-PDSCH are allocated for SPS resource | REL-8 |
| >>>>Code Resource Information | MP | | | Note 1 | REL-8 |
| >>>>>Start code | MP | | Enumerated ((16/1)..(16/16)) | | REL-8 |
| >>>>>Stop code | MP | | Enumerated ((16/1)..(16/16)) | | REL-8 |
| >>>>Activation Time | MP | | Activation time 10.3.3.1 | Specifies the HS-PDSCH Offset in Radio Frame level. | REL-8 |
| >>>>Subframe number | MP | | Integer (0..1) | Specifies the HS-PDSCH Offset in subframe level. | REL-8 |
| >>>>Initial Transport Block Size Index | MP | | Integer (0..maxTbsForHSDSCH-TDD128-1) | | REL-8 |
| >>>>Initial Rx pattern Index | MP | | Integer (0..maxRxPatternForHSDSCH-TDD128-1) | | REL-8 |
| >>>>HS-SICH Index | MP | | Integer (0..maxHSSICH-TDD128-1) | | REL-8 |
| >>>>Modulation | MP | | Enumerated (QPSK, 16QAM) | | REL-8 |

| Condition | Explanation |
|--------------------|--|
| <i>UE specific</i> | If UE specific midamble allocation mode is configured, this IE is mandatory, otherwise it is not needed. |

NOTE 1: HS-PDSCH channelisation codes are allocated contiguously from a signalled start code to a signalled stop code, and the allocation includes both the start and stop code. If a value of Start code = 16 and Stop code = 1 is signalled, a spreading factor of SF=1 shall be used for the HS-PDSCH resources.

10.3.6.113 Downlink channelisation codes MBSFN IMB

NOTE: 3.84 Mcps TDD MBSFN IMB only.

| Information Element/Group name | Need | Multi | Type and reference | Semantics description | Version |
|--------------------------------|------|-------|--------------------|--|---------|
| First channelisation code | MP | | Integer (1..15) | Channelisation code (F) for SF16 | REL-8 |
| Last channelisation code | OP | | Integer (1..15) | Channelisation code (L) for SF16;
If present: consecutive codes from F to L (modulo 16, excluding code 0) are used;
If absent: only one code (F) is used | REL-8 |

10.3.6.114 Secondary CCPCH frame type 2 info

NOTE: 3.84 Mcps TDD MBSFN IMB only.

| Information Element/Group name | Need | Multi | Type and reference | Semantics description | Version |
|--------------------------------------|------|-------|--|-----------------------|---------|
| Sub-frame number | MP | | Integer (0..4) | | REL-8 |
| Downlink channelisation codes | MP | | Downlink channelisation codes
MBSFN IMB
10.3.6.113 | | REL-8 |
| CHOICE <i>modulation</i> | MP | | | | REL-8 |
| >QPSK | | | | (no data) | REL-8 |
| >16QAM | | | | | REL-8 |
| >>CPICH secondary CCPCH power offset | MP | | Integer (-11..4) | In dB | REL-8 |

10.3.6.115 E-RGCH Info for Common E-DCH

Includes the configuration for the E-DCH related Relative Grant Channel to be used with common E-DCH in CELL_FACH and Idle mode. The E-RGCH is using the same channelisation code as configured for the E-HICH channel (see subclause 10.3.6.116).

| Information Element/Group name | Need | Multi | Type and reference | Semantics description | Version |
|---|------|-------|--------------------|-----------------------|---------|
| Signature Sequence | MD | | Integer(0..39) | NOTE1 | REL-8 |
| NOTE1: The default value is defined by:
Signature Sequence = (offset + common E-DCH resource list position) mod 40
where "offset" is the value of the last occurrence of the IE "Signature Sequence". If "Signature Sequence" is not present in the first occurrence, "offset" is equal to zero.
"common E-DCH resource list position" indicates the Common E-DCH resource Configuration Information number by order of appearance. The value of the "common E-DCH resource list position" is zero for the first occurrence. | | | | | |

10.3.6.116 E-HICH Info for Common E-DCH

Includes the configuration for the E-DCH related HARQ Acknowledgement Indicator Channel.

| Information Element/Group name | Need | Multi | Type and reference | Semantics description | Version |
|---|----------|-------|--------------------|--|---------|
| Channelisation Code | CV-Short | | Integer (0..127) | If this IE is not present, the value is equal to the last occurrence of this IE. | REL-8 |
| Signature Sequence | MD | | Integer (0..39) | NOTE1 | REL-8 |
| NOTE1: The default value is defined by:
Signature Sequence = (offset + common E-DCH resource list position) mod 40
where "offset" is the value of the last occurrence of the IE "Signature Sequence". If "Signature Sequence" is not present in the first occurrence, "offset" is equal to zero.
"common E-DCH resource list position" indicates the Common E-DCH resource Configuration Information number by order of appearance. The value of the "common E-DCH resource list position" is zero for the first occurrence. | | | | | |

| Condition | Explanation |
|-----------|--|
| Short | This IE is mandatory present for the first occurrence. Otherwise, this IE is optional. |

10.3.7 Measurement Information elements

10.3.7.1 Additional measurements list

| Information Element/Group name | Need | Multi | Type and reference | Semantics description |
|----------------------------------|------|--------------------------|-----------------------------------|-----------------------|
| Additional measurements | MP | 1 to <MaxAdditionalMeas> | | |
| >Additional measurement identity | MP | | Measurement identity
10.3.7.48 | |

10.3.7.2 Cell info

Includes non-frequency related cell info used in the IE "inter-frequency cell info list" and "intra frequency cell info list".

| Information Element/Group name | Need | Multi | Type and reference | Semantics description | Version |
|-----------------------------------|------|-------|--|--|---------|
| Cell individual offset | MD | | Real(-10..10 by step of 0.5) | In dB
Default value is 0 dB
Used to offset measured quantity value
If the cell from which this IE has been received is operating in MBSFN mode as indicated in subclause 8.1.1.6.3 the UE behaves as if this IE would not have been received. | |
| Reference time difference to cell | OP | | Reference time difference to cell
10.3.7.60 | In chips.
This IE is absent for serving cell.
If the cell from which this IE has been received is operating in MBSFN mode as indicated in subclause 8.1.1.6.3 the UE behaviour upon reception of this IE is unspecified. | |
| Read SFN indicator | MP | | Boolean | TRUE indicates that read of SFN is requested for the target cell
If the cell from which this IE has been received is operating in MBSFN mode as indicated in subclause 8.1.1.6.3 the UE behaves as if this IE would not have been received. | |

| | | | | | |
|-----------------------------|----|-----------------|-------------------------------------|---|-------|
| CHOICE <i>mode</i> | MP | | | | |
| >FDD | | | | | |
| >>Primary CPICH info | OP | | Primary CPICH info
10.3.6.60 | This IE is absent only if measuring RSSI only (broadband measurement.) | |
| >>Primary CPICH Tx power | OP | | Primary CPICH Tx power
10.3.6.61 | Required if calculating pathloss. | |
| >>TX Diversity Indicator | MP | | Boolean | TRUE indicates that transmit diversity is used. | |
| >TDD | | | | | |
| >>Primary CCPCH info | MP | | Primary CCPCH info
10.3.6.57 | | |
| >>Primary CCPCH TX power | OP | | Primary CCPCH TX power
10.3.6.59 | | |
| >>Timeslot list | OP | 1 to
<maxTS> | | The UE shall report Timeslot ISCP values according the order of the listed Timeslot numbers. If the cell from which this IE has been received is operating in MBSFN mode as indicated in subclause 8.1.1.6.3 the UE behaviour upon reception of this IE is unspecified. | |
| >>>CHOICE <i>TDD option</i> | MP | | | | REL-4 |
| >>>>3.84 Mcps TDD | | | | | REL-4 |
| >>>>>Timeslot number | MP | | Integer (0...14) | Timeslot numbers, for which the UE shall report Timeslot ISCP | |
| >>>>>Burst Type | MD | | Enumerated (Type1, Type2) | Use for Timeslot ISCP measurements only. Default value is "Type1" | |
| >>>>>7.68 Mcps TDD | | | | | REL-7 |
| >>>>>Timeslot number | MP | | Integer (0...14) | Timeslot numbers, for which the UE shall report Timeslot ISCP | REL-7 |
| >>>>>Burst Type | MD | | Enumerated (Type1, Type2) | Use for Timeslot ISCP measurements only. Default value is "Type1" | REL-7 |
| >>>>>1.28 Mcps TDD | | | | | REL-4 |
| >>>>>Timeslot number | MP | | Integer (0...6) | Timeslot numbers, for which the UE | REL-4 |

| | | | | | |
|--------------------------------------|-------------------|--|---|--|--|
| | | | | shall report Timeslot ISCP | |
| Cell Selection and Re-selection Info | CV- <i>BCHopt</i> | | Cell Selection and Re-selection for SIB11/12Info 10.3.2.4 | This IE is absent for the serving cell. If the cell from which this IE has been received is operating in MBSFN mode as indicated in subclause 8.1.1.6.3 the UE behaviour upon reception of this IE is unspecified. | |

| Condition | Explanation |
|---------------|--|
| <i>BCHopt</i> | This IE is Optional when sent in SYSTEM INFORMATION or for 1.28 Mcps TDD when sent in the MEASUREMENT CONTROL, Otherwise, the IE is not needed |

10.3.7.3 Cell measured results

Includes non-frequency related measured results for a cell.

| Information Element/Group name | Need | Multi | Type and reference | Semantics description | Version |
|----------------------------------|-----------------|-------|---|--|---------|
| Cell Identity | OP | | Cell Identity 10.3.2.2 | | |
| Cell synchronisation information | OP | | Cell synchronisation information 10.3.7.6 | | |
| CHOICE <i>mode</i> | MP | | | | |
| >FDD | | | | | |
| >>Primary CPICH info | MP | | Primary CPICH info 10.3.6.60 | | |
| >>CPICH Ec/No | OP | | Integer(0..49) | According to CPICH_Ec/No in [19] and [20]. Fourteen spare values are needed. | |
| >>CPICH RSCP | OP | | Integer(0..91) | According to CPICH_RSCP in [19] and [20]. Thirty-six spare values are needed. | |
| >>Delta _{CPICH RSCP} | CV- <i>RSCP</i> | | Integer(-5..-1) | If present, the actual value of CPICH RSCP = CPICH RSCP+ Delta _{CPICH RSCP} | REL-5 |
| >>Pathloss | OP | | Integer(46..158) | In dB. Fifteen spare values are needed. | |
| >TDD | | | | | |
| >>Cell parameters Id | MP | | Cell parameters Id 10.3.6.9 | | |

| Information Element/Group name | Need | Multi | Type and reference | Semantics description | Version |
|--------------------------------|------|--------------|--------------------------------------|---|---------|
| >>Proposed TGSN | OP | | Integer (0..14) | Proposal for the next TGSN | |
| >>Primary CCPCH RSCP | OP | | Primary CCPCH RSCP info
10.3.7.54 | | |
| >>Pathloss | OP | | Integer(46..158) | In dB.
Fifteen spare values are needed. | |
| >>Timeslot list | OP | 1 to <maxTS> | | | |
| >>>Timeslot ISCP | MP | | Timeslot ISCP Info
10.3.7.65 | The UE shall report the Timeslot ISCP in the same order as indicated in the cell info | |

| Condition | Explanation |
|-------------|---|
| <i>RSCP</i> | This IE is mandatory if the IE "Cell measured results" is included in the IE "Measured Results" (i.e. not included in the IE "Additional Measured Results") and if CPICH RSCP is present and if the value of the CPICH RSCP is below 0. It is not needed otherwise. |

10.3.7.4 Cell measurement event results

Includes non-frequency related cell reporting quantities.

| Information Element/Group name | Need | Multi | Type and reference | Semantics description |
|--------------------------------|------|--------------------|---------------------------------|-----------------------|
| CHOICE <i>mode</i> | MP | | | |
| >FDD | | | | |
| >>Primary CPICH info | MP | 1 to <maxCellMEas> | Primary CPICH info
10.3.6.60 | |
| >TDD | | | | |
| >>Primary CCPCH info | MP | 1 to <maxCellMEas> | Primary CCPCH info
10.3.6.57 | |

10.3.7.5 Cell reporting quantities

Includes non-frequency related cell reporting quantities.

For all boolean types TRUE means inclusion in the report is requested.

| Information Element/Group name | Need | Multi | Type and reference | Semantics description |
|--|------|-------|--------------------|-----------------------|
| Cell synchronisation information reporting indicator | MP | | Boolean | |
| Cell Identity reporting indicator | MP | | Boolean | |
| CHOICE <i>mode</i> | MP | | | |
| >FDD | | | | |
| >>CPICH Ec/N0 reporting indicator | MP | | Boolean | |
| >>CPICH RSCP reporting indicator | MP | | Boolean | |
| >>Pathloss reporting indicator | MP | | Boolean | |
| >TDD | | | | |

| Information Element/Group name | Need | Multi | Type and reference | Semantics description |
|--|------|-------|--------------------|-----------------------|
| >>Timeslot ISCP reporting indicator | MP | | Boolean | |
| >>Proposed TGSN Reporting required | MP | | Boolean | |
| >>Primary CCPCH RSCP reporting indicator | MP | | Boolean | |
| >>Pathloss reporting indicator | MP | | Boolean | |

10.3.7.6 Cell synchronisation information

The IE "Cell synchronisation information" contains the OFF and Tm as defined in [7] and [8] and the four most significant bits of the difference between the 12 least significant bits of the RLC Transparent Mode COUNT-C in the UE and the SFN of the measured cell. It is notified to SRNC by Measurement Report message or Measurement Information Element in other RRC messages

| Information Element/Group name | Need | Multi | Type and reference | Semantics description |
|--------------------------------|------|-------|---------------------------------|-----------------------|
| CHOICE <i>mode</i> | MP | | | |
| >FDD | | | | |
| >>COUNT-C-SFN frame difference | OP | | | |
| >>>COUNT-C-SFN high | MP | | Integer(0..3840 by step of 256) | in frames |
| >>>OFF | MP | | Integer(0..255) | in frames |
| >>Tm | MP | | Integer(0..38399) | in chips |
| >TDD | | | | |
| >>COUNT-C-SFN frame difference | OP | | | |
| >>>COUNT-C-SFN high | MP | | Integer(0..3840 by step of 256) | in frames |
| >>>OFF | MP | | Integer(0..255) | in frames |

10.3.7.6a E-UTRA event results

| Information Element/Group name | Need | Multi | Type and reference | Semantics description | Version |
|--------------------------------|------|--------------------------------------|------------------------------------|---|---------|
| Inter-RAT event identity | MP | | Inter-RAT event identity 10.3.7.24 | | REL-8 |
| E-UTRA events results list | MP | 1 to <maxReported EUTRAFreqs> | | | REL-8 |
| >E-UTRA Carrier Frequency | MP | | Integer (0..65535) | EARFCN of the downlink carrier frequency [64] | REL-8 |
| >Reported cells | MP | 1 to <maxReported EUTRACellPer Freq> | | | REL-8 |
| >>Physical Cell Identity | MP | | Integer (0..503) | | REL-8 |

10.3.7.6b E-UTRA frequency list

Contains the information for the list of measurement objects for E-UTRA measurements.

| Information Element/Group name | Need | Multi | Type and reference | Semantics description | Version |
|--|------|-----------------------------|-------------------------------------|--|---------|
| CHOICE <i>E-UTRA frequency removal</i> | MP | | | | REL-8 |
| >Remove all frequencies | | | | (no data) | REL-8 |
| >Remove some frequencies | | | | | REL-8 |
| >>Removed frequencies | MP | 1 to <maxNumEUTRAFreqs> | | | REL-8 |
| >>>E-UTRA frequencies | MP | | Integer (0..65535) | EARFCN of the downlink carrier frequency [64] | REL-8 |
| >Remove no frequencies | | | | (no data) | REL-8 |
| New frequencies | OP | 1 to <maxNumEUTRAFreqs> | | | REL-8 |
| >E-UTRA carrier frequency | MP | | Integer (0..65535) | EARFCN of the downlink carrier frequency [64] | REL-8 |
| >Measurement Bandwidth | MD | | Enumerated (6, 15, 25, 50, 75, 100) | Measurement bandwidth information common for all neighbouring cells on the carrier frequency. It is defined by the parameter Transmission Bandwidth Configuration, N_{RB} [36.104]. The values indicate the number of resource blocks over which the UE could measure. Default value is 6. | REL-8 |
| >Blacklisted cells list | OP | 1 to <maxEUTRACellsPerFreq> | | A list of blacklisted cells can be signalled per frequency | REL-8 |
| >>Physical Cell identity | MP | | Integer (0..503) | | REL-8 |

10.3.7.6c E-UTRA measured results

| Information Element/Group name | Need | Multi | Type and reference | Semantics description | Version |
|--------------------------------|------|--------------------------------------|--------------------|--|---------|
| E-UTRA measured results list | MP | 1 to <maxReported EUTRAFreqs> | | | REL-8 |
| >E-UTRA Carrier Frequency | MP | | Integer (0..65535) | EARFCN of the downlink carrier frequency [64] | REL-8 |
| >Measured E-UTRA cells | MP | 1 to <maxReported EUTRACellPer Freq> | | | REL-8 |
| >>Physical Cell Identity | MP | | Integer (0..503) | | REL-8 |
| >>RSRP | OP | | Integer (0..97) | This shall be reported if the 'Inter-RAT measurement quantity' IE is set to "RSRP" or the 'Inter-RAT reporting quantity' IE is set to "both". RSRP is mapped to a value between 0 and 97 [36.133]. | REL-8 |
| >>RSRQ | OP | | Integer (0..33) | This quantity shall be reported if the 'Inter-RAT measurement quantity' IE is set to "RSRQ" or the 'Inter-RAT reporting quantity' IE is set to "both". RSRQ_00 to RSRQ_33 in [36.133] are mapped to the value between 0 and 33. RSRQ_34 in [36.133] is mapped to the value 33. | REL-8 |

10.3.7.7 Event results

| Information Element/Group name | Need | Multi | Type and reference | Semantics description |
|--|------|-------|---|--|
| CHOICE <i>event result</i> | MP | | | One spare value is needed. |
| >Intra-frequency measurement event results | | | Intra-frequency measurement event results 10.3.7.37 | |
| >Inter-frequency measurement event results | | | Inter-frequency measurement event results 10.3.7.17 | |
| >Inter-RAT measurement event results | | | Inter-RAT measurement event results 10.3.7.28 | For IS-2000 results, include fields of the <i>Pilot Strength Measurement Message</i> from subclause 2.7.2.3.2.5 of TIA/EIA/IS-2000.5 |
| >Traffic volume measurement event results | | | Traffic volume measurement event | |

| Information Element/Group name | Need | Multi | Type and reference | Semantics description |
|---|------|-------|--|-----------------------|
| | | | results
10.3.7.69 | |
| >Quality measurement event results | | | Quality measurement event results
10.3.7.57 | |
| >UE internal measurement event results | | | UE internal measurement event results
10.3.7.78 | |
| >UE positioning measurement event results | | | UE positioning measurement event results
10.3.7.101 | |

| CHOICE event result | Condition under which the given event result is chosen |
|---|--|
| Intra-frequency measurement event results | If measurement type = intra-frequency measurement |
| Inter-frequency measurement event results | If measurement type = inter-frequency measurement |
| Inter-RAT measurement event results | If measurement type = inter-RAT measurement |
| Traffic volume measurement event results | If measurement type = traffic volume measurement |
| Quality measurement event results | If measurement type = Quality measurement |
| UE internal measurement event results | If measurement type = UE internal measurement |
| UE positioning measurement event results | If measurement type = UE positioning measurement |

10.3.7.8 FACH measurement occasion info

| Information Element/Group name | Need | Multi | Type and reference | Semantics description | Version |
|---|------|---------------------|-------------------------|---|---------|
| FACH Measurement occasion cycle length coefficient | OP | | Integer(1..12) | | |
| Inter-frequency FDD measurement indicator | MP | | Boolean | TRUE means that measurements are required | |
| Inter-frequency TDD 3.84 Mcps measurement indicator | MP | | Boolean | TRUE means that measurements are required | REL-4 |
| Inter-frequency TDD 7.68 Mcps measurement indicator | MP | | Boolean | TRUE means that measurements are required | REL-7 |
| Inter-frequency TDD 1.28 Mcps measurement indicator | MP | | Boolean | TRUE means that measurements are required | REL-4 |
| Inter-RAT measurement indicators | OP | 1 to <maxOther RAT> | | | |
| >RAT type | MP | | Enumerated(GSM, IS2000) | | |

10.3.7.9 Filter coefficient

| Information Element/Group name | Need | Multi | Type and reference | Semantics description |
|--------------------------------|------|-------|---|-----------------------|
| Filter coefficient | MP | | Integer(0, 1, 2, 3, 4, 5, 6, 7, 8, 9, 11, 13, 15, 17, 19) | Default value is 0 |

10.3.7.9a GSM cell group

This IE encodes a list of GSM cells specified by their ARFCN values [45].

| Information Element/Group name | Need | Multi | Type and reference | Semantics description | Version |
|--|------|---------|-------------------------------|--|---------|
| Starting ARFCN | MP | | Integer (0..1023) | First ARFCN value in the set | REL-8 |
| Band Indicator | MP | | Enumerated (dcs1800, pcs1900) | GSM BAND_INDICATOR [45] | REL-8 |
| CHOICE <i>Following ARFCNs</i> | MP | | | | REL-8 |
| >Explicit list | | | | | REL-8 |
| >>List of ARFCNs | MP | 0 to 31 | Integer (0..1023) | Following ARFCN values | REL-8 |
| >Equally spaced | | | | | REL-8 |
| >>ARFCN spacing | MP | | Integer (1..8) | Increment "d" ARFCN values | REL-8 |
| >>Number of following ARFCNs | MP | | Integer (0..31) | Number "n" of following ARFCN values, NOTE 1 | REL-8 |
| >Variable bitmap format | | | | | REL-8 |
| >>Bitmap | MP | | Octet string (1..16) | NOTE 2 | REL-8 |
| >Continuous range | | | | | REL-8 |
| >>Ending ARFCN | MP | | Integer (0..1023) | Last ARFCN value in the set, NOTE 3 | REL-8 |
| NOTE 1: Let the IE "Starting ARFCN" = s. The complete set of (n+1) ARFCN values is defined as: {s, ((s + d) mod 1024), ((s + 2*d) mod 1024) ... ((s + n*d) mod 1024)}. | | | | | |
| NOTE 2: Bitmap representing the following ARFCN values in the set. Let the IE "Starting ARFCN" = s. The first bit of the first octet in the bitmap corresponds to ARFCN = ((s + 1) mod 1024), the next bit to the ARFCN = ((s + 2) mod 1024), and so on. If the bitmap consist of N octets, the last bit of octet N corresponds to ARFCN = ((s + 8*N) mod 1024). The complete set of ARFCN values consists of ARFCN = s and the ARFCN values, where the corresponding bit in the bitmap is set to "1". | | | | | |
| NOTE 3: Let the IEs "Starting ARFCN" = s and "Ending ARFCN" = t. The complete set of ARFCN values is defined as: {s, ((s + 1) mod 1024), ((s + 2) mod 1024) ... ((t - 1) mod 1024), t}. | | | | | |

10.3.7.10 HCS Cell re-selection information

| Information Element/Group name | Need | Multi | Type and reference | Semantics description |
|--------------------------------|-------------------------------|-------|---------------------------------------|---|
| Penalty_time | MD | | Integer(0, 10, 20, 30, 40, 50, 60) | Default value is 0 which means = not used
In seconds |
| Temporary_offsets | <i>CV-Penalty used</i> | | | |
| >Temporary_offset1 | MP | | Integer(3, 6, 9, 12, 15, 18, 21, inf) | [dB] |
| >Temporary_offset2 | <i>CV-FDD-Quality-Measure</i> | | Integer(2, 3, 4, 6, 8, 10, 12, inf) | [dB] |

| Condition | Explanation |
|----------------------------|--|
| <i>Penalty used</i> | This IE is not needed if the IE "Penalty time" equals "not used", else it is mandatory present. |
| <i>FDD-Quality-Measure</i> | This IE is not needed if the IE "Cell selection and reselection quality measure" has the value CPICH RSCP, otherwise the IE is mandatory present. This conditional presence is implemented in ASN.1 by the use of a specific RSCP and EcN0 variant of 10.3.7.10. |

10.3.7.11 HCS neighbouring cell information

| Information Element/Group name | Need | Multi | Type and reference | Semantics description |
|-----------------------------------|------|-------|--|-----------------------|
| HCS_PRIO | MD | | Integer (0..7) | Default value = 0 |
| Qhcs | MD | | Qhcs
10.3.7.54a | Default value = 0 |
| HCS Cell Re-selection Information | MP | | HCS Cell Re-selection Information
10.3.7.10 | |

10.3.7.12 HCS Serving cell information

| Information Element/Group name | Need | Multi | Type and Reference | Semantics description |
|--------------------------------|-----------------------------|-------|--|----------------------------------|
| HCS_PRIO | MD | | Integer (0..7) | Default value = 0 |
| Qhcs | MD | | Qhcs
10.3.7.54a | Default value = 0 |
| T _{CRmax} | MD | | Enumerated(not used, 30, 60, 120, 180, 240) | [s]
Default value is not used |
| N _{CR} | <i>CV-UE speed detector</i> | | Integer(1..16) | Default value = 8 |
| T _{CrmaxHyst} | <i>CV-UE speed detector</i> | | Enumerated(not used, 10, 20, 30, 40, 50, 60, 70) | [s] |

| Condition | Explanation |
|--------------------------|--|
| <i>UE Speed detector</i> | This IE is not needed if T _{CRmax} equals 'not used', else it is mandatory present. |

10.3.7.12a Idle Interval Information

NOTE: Used for TDD only. If the multi-RAT UE needs idle interval for E-UTRAN measurements in CELL_DCH state, this IE may be configured.

| Information Element/Group name | Need | Multi | Type and reference | Semantics description | Version |
|--------------------------------|------|-------|--------------------|--|---------|
| k | MD | | Integer (2..3) | This IE is the coefficient parameter to calculate the idle interval period. Default value is 2. The actual idle interval period equal to 2^k radio frames. | REL-8 |
| Offset | MD | | Integer (0..7) | The idle interval position in the period. Default value is 0. | REL-8 |

10.3.7.13 Inter-frequency cell info list

Contains the information for the list of measurement objects for an inter-frequency measurement.

| Information Element/Group name | Need | Multi | Type and reference | Semantics description | Version |
|--|-------------------|--------------------|-------------------------------|---|---------|
| CHOICE <i>Inter-frequency cell removal</i> | OP | | | | |
| >Remove all inter-frequency cells | | | | No data | |
| >Remove some inter-frequency cells | | | | | |
| >>Removed inter-frequency cells | MP | 1 .. <maxCellMeas> | | | |
| >>>Inter-frequency cell id | MP | | Integer(0 .. <maxCellMeas>-1) | | |
| >No inter-frequency cells removed | | | | No data | |
| New inter-frequency cells | OP | 1 to <maxCellMeas> | | | |
| >Inter-frequency cell id | MD | | Integer(0 .. <maxCellMeas>-1) | | |
| >Frequency info | MD | | Frequency info
10.3.6.36 | Default value is the value of the previous "frequency info" in the list.
NOTE: The first occurrence is then MP. | |
| >Cell info | MP | | Cell info
10.3.7.2 | | |
| >CHOICE <i>mode specific info</i> | MP | | | | REL-7 |
| >>No information | | | | No data for FDD, TDD 3.84 Mcps or TDD 7.68 Mcps | REL-7 |
| >>>TDD 1.28 Mcps | | | | | REL-7 |
| >>>>Intra-SecondaryFrequency Indicator | MP | | Boolean | TRUE means the inter frequency neighbour cell has a secondary frequency which is the same as the current working frequency of UE. | REL-7 |
| Cells for measurement | CV- <i>BCHopt</i> | 1 to <maxCellMeas> | | | |
| >Inter-frequency cell id | MP | | Integer(0 .. <maxCellMeas>-1) | | |

| Condition | Explanation |
|---------------|--|
| <i>BCHopt</i> | This IE is not needed when sent in SYSTEM INFORMATION. Otherwise, the IE is Optional |

10.3.7.14 Inter-frequency event identity

| Information Element/Group name | Need | Multi | Type and reference | Semantics description |
|--------------------------------|------|-------|------------------------------------|------------------------------|
| Inter-frequency event identity | MP | | Enumerated(2a, 2b, 2c, 2d, 2e, 2f) | Two spare values are needed. |

10.3.7.15 Inter-frequency measured results list

| Information Element/Group name | Need | Multi | Type and reference | Semantics description |
|---|------|--------------------|--------------------------------|--|
| Inter-frequency measurement results | OP | 1 to <maxFreq> | | |
| >Frequency info | MD | | Frequency info 10.3.6.36 | Default value is the value of the previous "frequency info" in the list.
NOTE: The first occurrence is then MP. |
| >UTRA carrier RSSI | OP | | Integer(0..76) | According to UTRA_carrier_RSSI_LEV in [19] and [20].
Fifty-one spare values are needed. |
| >Inter-frequency cell measurement results | OP | 1 to <maxCellMeas> | | Only cells for which all reporting quantities are available should be included. |
| >>Cell measured results | MP | | Cell measured results 10.3.7.3 | |

10.3.7.16 Inter-frequency measurement

| Information Element/Group name | Need | Multi | Type and reference | Semantics description | Version |
|--|--------------|-------|--|---|---------|
| Inter-frequency measurement objects list | MP | | Inter-frequency cell info list 10.3.7.13 | | |
| Inter-frequency measurement quantity | OP | | Inter-frequency measurement quantity 10.3.7.18 | | |
| Inter-frequency reporting quantity | OP | | Inter-frequency reporting quantity 10.3.7.21 | | |
| Reporting cell status | CV-reporting | | Reporting cell status 10.3.7.61 | | |
| Measurement validity | OP | | Measurement validity 10.3.7.51 | | |
| Inter-frequency set update | OP | | Inter-frequency set update 10.3.7.22 | | |
| Adjacent frequency index | OP | | Integer (0..<maxCellMeas-1>) | Index to an element in the IE 'New inter-frequency cell' containing a cell on | REL-8 |

| Information Element/Group name | Need | Multi | Type and reference | Semantics description | Version |
|---|------|-------|---|---|---------|
| | | | | the adjacent frequency; index = 0 corresponds to the first element in the IE | |
| CHOICE <i>report criteria</i> | MP | | | | |
| >Intra-frequency measurement reporting criteria | | | Intra-frequency measurement reporting criteria
10.3.7.39 | | |
| >Inter-frequency measurement reporting criteria | | | Inter-frequency measurement reporting criteria
10.3.7.19 | | |
| >Periodical reporting criteria | | | Periodical reporting criteria
10.3.7.53 | | |
| >No reporting | | | | (no data)
Chosen when this measurement only is used as additional measurement to another measurement | |

| Condition | Explanation |
|------------------|--|
| <i>reporting</i> | This IE is optional if the CHOICE " <i>report criteria</i> " is equal to "periodical reporting criteria" or "No reporting", otherwise the IE is not needed |

10.3.7.17 Inter-frequency measurement event results

This IE contains the measurement event results that are reported to UTRAN for inter-frequency measurements.

| Information Element/Group name | Need | Multi | Type and reference | Semantics description |
|--|------|-------------------|---|-----------------------|
| Inter-frequency event identity | MP | | Inter-frequency event identity
10.3.7.14 | |
| Inter-frequency cells | OP | 1 to
<maxFreq> | | |
| >Frequency info | MP | | Frequency info
10.3.6.36 | |
| >Non frequency related measurement event results | MP | | Cell measurement event results
10.3.7.4 | |

10.3.7.18 Inter-frequency measurement quantity

The quantity the UE shall measure in case of inter-frequency measurement. It also includes the filtering of the measurements.

| Information Element/Group name | Need | Multi | Type and reference | Semantics description |
|---|------|-------|---|-----------------------|
| CHOICE <i>reporting criteria</i> | MP | | | |
| >Intra-frequency reporting criteria | | | | |
| >>Intra-frequency measurement quantity | MP | | Intra-frequency measurement quantity
10.3.7.38 | |
| >Inter-frequency reporting criteria | | | | |
| >>Filter coefficient | MP | | Filter coefficient
10.3.7.9 | |
| >>>CHOICE <i>mode</i> | MP | | | |
| >>>>FDD | | | | |
| >>>>>Measurement quantity for frequency quality estimate | MP | | Enumerated(CPICH Ec/N0, CPICH RSCP) | |
| >>>>>TDD | | | | |
| >>>>>>Measurement quantity for frequency quality estimate | MP | | Enumerated(Primary CCPCH RSCP) | |

10.3.7.19 Inter-frequency measurement reporting criteria

The triggering of the event-triggered reporting for an inter-frequency measurements. All events concerning inter-frequency measurements are labelled 2x where x is a,b,c, ...

Event 2a: Change of best frequency.

Event 2b: The estimated quality of the currently used frequency is below a certain threshold **and** the estimated quality of a non-used frequency is above a certain threshold.

Event 2c: The estimated quality of a non-used frequency is above a certain threshold.

Event 2d: The estimated quality of the currently used frequency is below a certain threshold.

Event 2e: The estimated quality of a non-used frequency is below a certain threshold.

Event 2f: The estimated quality of the currently used frequency is above a certain threshold.

| Information Element/Group name | Need | Multi | Type and reference | Semantics description | Version |
|--|-----------------|---------------------|---|--|---------|
| Parameters required for each event | OP | 1 to <maxMeasEvent> | | | |
| >Inter-frequency event identity | MP | | Inter-frequency event identity
10.3.7.14 | | |
| >Threshold used frequency | CV-
clause 0 | | Integer(-115..0) | Ranges used depend on measurement quantity.
CPICH Ec/No -24..0dB
CPICH/Primary CCPCH
RSCP -115..-25dBm | |
| | | | Integer (-120..0) | Ranges used depend on measurement quantity.
CPICH Ec/No -24..0dB
CPICH/Primary CCPCH
RSCP -120..-25dBm | REL-6 |
| >Delta _{Threshold used frequency} | CV-
clause 3 | | Integer(-5..-1) | If present, the actual value of Threshold used frequency = Threshold used frequency + Delta _{Threshold used frequency} | REL-5 |
| | | | | Not used in Release 6 and later | REL-6 |
| >W used frequency | CV-
clause 2 | | Real(0, 0.1..2.0 by step of 0.1) | | |
| >Hysteresis | MP | | Real(0, 0.5..14.5 by step of 0.5) | In event 2a, 2b, 2c, 2d, 2e, 2f | |
| >Time to trigger | MP | | Time to trigger
10.3.7.64 | Indicates the period of time during which the event condition has to be satisfied, before sending a Measurement Report.
Time in ms. | |
| >Reporting cell status | OP | | Reporting cell status
10.3.7.61 | | |
| >Parameters required for each non-used frequency | OP | 1 to <maxFreq> | | In this release, the first listed threshold and W parameter shall apply to all non-used frequencies. | |

| Information Element/Group name | Need | Multi | Type and reference | Semantics description | Version |
|--|------------------------|-------|----------------------------------|---|---------|
| >>Threshold non used frequency | CV-
<i>clause 1</i> | | Integer(-115..0) | Ranges used depend on measurement quantity.
CPICH Ec/No -24..0dB
CPICH/Primary CCPCH RSCP -115..-25dBm.
This IE is not needed if the IE "Inter-frequency event identity" is set to 2a. However, it is specified to be mandatory to align with the ASN.1. | |
| | | | Integer (-120..0) | Ranges used depend on measurement quantity.
CPICH Ec/No -24..0dB
CPICH/Primary CCPCH RSCP -120..-25dBm
This IE is not needed if the IE "Inter-frequency event identity" is set to 2a. | REL-6 |
| >> Delta _{Threshold non used frequency} | CV-
<i>clause 4</i> | | Integer(-5..-1) | If present, the actual value of Threshold non used frequency = Threshold non used frequency + Delta _{Threshold non used frequency} | REL-5 |
| | | | | Not used in Release 6 and later | REL-6 |
| >>W non-used frequency | CV-
<i>clause 1</i> | | Real(0, 0.1..2.0 by step of 0.1) | | |

| Condition | Explanation |
|-----------------|---|
| <i>Clause 0</i> | This IE is mandatory present if the IE "Inter frequency event identity" is set to 2b, 2d, or 2f, otherwise the IE is not needed. |
| <i>Clause 1</i> | This IE is mandatory present if the IE "Inter frequency event identity" is set to 2a, 2b, 2c or 2e, otherwise the IE is not needed |
| <i>Clause 2</i> | This IE is mandatory present if the IE "Inter-frequency event identity" is set to 2a, 2b, 2d or 2f, otherwise the IE is not needed. |
| <i>Clause 3</i> | This IE is optional if the IE "Inter frequency event identity" is set to 2b, 2d, or 2f. Otherwise the IE is not needed.
Note that in order to align with the ASN.1, this IE is always included when the IE 'Delta _{Threshold non used frequency} ' is present, but the value shall be ignored if the "Inter-frequency event identity" is not set to 2b, 2d or 2f. |
| <i>Clause 4</i> | This IE is optional if the IE "Inter frequency event identity" is set to 2a, 2b, 2c or 2e. Otherwise the IE is not needed. |

10.3.7.20 Inter-frequency measurement system information

| Information Element/Group name | Need | Multi | Type and reference | Semantics description | Version |
|--|------|-------|---|-----------------------|---------|
| Inter-frequency cell info list | OP | | Inter-frequency cell info list 10.3.7.13 | | |
| Inter-frequency RACH reporting information | OP | | Inter-frequency RACH reporting information 10.3.7.20a | | REL-6 |

10.3.7.20a Inter-frequency RACH reporting information

Contains the reporting configuration information for an inter-frequency measurement report, which is sent on the RACH.

| Information Element/Group name | Need | Multi | Type and reference | Semantics description | Version |
|--|------|--------|-------------------------------------|---|---------|
| CHOICE <i>mode</i> | MP | | | | REL-6 |
| >FDD | | | | | REL-6 |
| >> Inter-frequency RACH reporting quantity | MP | | Enumerated(CPICH Ec/N0, CPICH RSCP) | | REL-6 |
| >TDD | | | | | REL-6 |
| >>Reporting quantity list | MP | 1 to 2 | | | REL-6 |
| >>> Inter-frequency RACH reporting quantity | MP | | Enumerated(Primary CCPCH RSCP) | | REL-6 |
| Inter-frequency RACH reporting threshold | MP | | Integer(-115..0) | Ranges used depend on measurement quantity.
CPICH Ec/N0 - 24..0dB
CPICH/Primary CCPCH RSCP - 115..-25dBm. | REL-6 |
| Maximum number of inter-frequency RACH reporting cells | MP | | Integer(1..8) | Indicates the total number for all non-used frequencies | REL-6 |

10.3.7.21 Inter-frequency reporting quantity

| Information Element/Group name | Need | Multi | Type and reference | Semantics description |
|---|------|-------|------------------------------------|---|
| UTRA Carrier RSSI | MP | | Boolean | TRUE means report is requested. |
| Frequency quality estimate | MP | | Boolean | TRUE means that report is requested.
This parameter is not used in this release and should be set to FALSE. It shall be ignored by the UE. |
| Non frequency related cell reporting quantities | MP | | Cell reporting quantities 10.3.7.5 | |

10.3.7.22 Inter-frequency SET UPDATE

NOTE 1: Only for FDD.

This information makes it possible to use events defined for Intra-frequency measurement within the same non-used frequency for Inter-frequency measurement reporting criteria.

| Information Element/group name | Need | Multi | Type and reference | Semantics description |
|--------------------------------|------|-------|-----------------------------------|---|
| UE autonomous update mode | MP | | Enumerated (On with no reporting) | Required for backwards compatibility with a UE not supporting this revision of the standard |

10.3.7.23 Inter-RAT cell info list

Contains the information for the list of measurement objects for an inter-RAT measurement.

| Information Element/Group name | Need | Multi | Type and reference | Semantics description | Version |
|---|------|--------------------|--|---|---------|
| CHOICE <i>Inter-RAT cell removal</i> | MP | | | | |
| >Remove all inter-RAT cells | | | | (no data) | |
| >Remove some inter-RAT cells | | | | | |
| >>Removed inter-RAT cells | MP | 1 to <maxCellMeas> | | | |
| >>>Inter-RAT cell id | MP | | Integer(0 .. <maxCellMeas> - 1) | | |
| >Remove no inter-RAT cells | | | | (no data) | |
| New inter-RAT cells | MP | 1 to <maxCellMeas> | | Although this IE is not always required, need is MP to align with ASN.1 | |
| | OP | | | | REL-4 |
| >Inter-RAT cell id | OP | | Integer(0 .. <maxCellMeas> - 1) | | |
| >CHOICE <i>Radio Access Technology</i> | MP | | | | |
| >>GSM | | | | | |
| >>>Cell individual offset | MP | | Integer (-50..50) | In dB
Used to offset measured quantity value | |
| >>>Cell selection and re-selection info | OP | | Cell selection and re-selection info for SIB11/12 10.3.2.4 | See subclause 8.6.7.3 | |
| >>>BSIC | MP | | BSIC 10.3.8.2 | | |
| >>>Band indicator | MP | | Enumerated (DCS 1800 band used, PCS 1900 band used) | Indicates how to interpret the BCCH ARFCN | |
| >>>BCCH ARFCN | MP | | Integer (0..1023) | [45] | |
| >>IS-2000 | | | | | |
| >>>System specific measurement info | MP | | enumerated (frequency, timeslot, | For IS-2000, use fields from TIA/EIA/IS- | |

| Information Element/Group name | Need | Multi | Type and reference | Semantics description | Version |
|--------------------------------|--------------------|--------------------|---------------------------------------|---|---------|
| | | | colour code, output power, PN offset) | 2000.5, subclause 3.7.3.3.2.27, <i>Candidate Frequency Neighbour List Message</i> | |
| >>None | | | (no data) | This value has been introduced to handle the case when IE "New inter-RAT cells" is not required | |
| Cell for measurement | OP | 1 to <maxCellMeas> | | | |
| >Inter-RAT cell id | MP | | Integer(0 .. <maxCellMeas>-1) | | |
| Inter-RAT cell info indication | CV- <i>Message</i> | | Integer (0..3) | NOTE 1 and 2 | REL-5 |

| Condition | Explanation |
|----------------|---|
| <i>Message</i> | The IE is optionally present in the MEASUREMENT CONTROL and in the SRNS RELOCATION INFO messages, otherwise the IE is not needed. |

NOTE 1: The UTRAN may choose not to use the "Inter-RAT cell info indication" value "0" in the MEASUREMENT CONTROL message, to distinguish that case from those cases where the UE receives the IE "Inter-RAT cell info list" in SIB11 or SIB12.

NOTE 2: In case of an SRNS relocation, if the UE has been sent the "Inter-RAT cell info indication" in the MEASUREMENT CONTROL message and the IE "Inter-RAT cell info list" is included in the SRNS RELOCATION INFO sent from the source RNC to the target RNC, the "Inter-RAT cell info indication" should be included in the IE "Inter-RAT cell info list".

NOTE 3: If the UTRAN configures a UE with a "Inter-RAT cell info list" containing a set of GSM cells where one or more cell(s) belong to DCS 1800 band and one or more cell(s) belong to PCS 1900 band, the UE behaviour is unspecified.

10.3.7.24 Inter-RAT event identity

| Information Element/Group name | Need | Multi | Type and reference | Semantics description |
|--------------------------------|------|-------|-----------------------------|-----------------------|
| Inter-RAT event identity | MP | | Enumerated (3a, 3b, 3c, 3d) | |

10.3.7.25 Inter-RAT info

Inter-RAT info defines the target system for redirected cell selection.

| Information Element/Group name | Need | Multi | Type and reference | Semantics description | Version |
|--------------------------------|-----------|-------|--------------------------------|-----------------------|---------|
| Inter-RAT info | MP | | Enumerated (GSM, E-UTRA) | | REL-8 |
| GSM target cell info | CV-GSM | | GSM target cell info 10.3.8.4g | | REL-6 |
| E-UTRA target info | CV-E-UTRA | | E-UTRA target info 10.3.8.4L | | REL-8 |

| Condition | Explanation |
|-----------|--|
| GSM | This IE is optionally present if the IE "Inter-RAT info" is set to "GSM" and not needed otherwise. |
| E-UTRA | This IE is mandatory present if the IE "Inter-RAT info" is set to "E-UTRA" and not needed otherwise. |

10.3.7.26 Inter-RAT measured results list

| Information Element/Group name | Need | Multi | Type and reference | Semantics description |
|--------------------------------|------|----------------------------|-------------------------------------|---|
| Inter-RAT measurement results | OP | 1 to <maxOther RAT-16> | | |
| >CHOICE <i>system</i> | MP | | | One spare value is needed. |
| >>GSM | | | | |
| >>>Measured GSM cells | MP | 1 to <maxReportedGSMCells> | | |
| >>>>GSM carrier RSSI | OP | | bit string(6) | RXLEV is mapped to a value between 0 and 63, [46]. When mapping the RXLEV value to the RSSI bit string, the first/leftmost bit of the bit string contains the most significant bit. |
| >>>>CHOICE <i>BSIC</i> | MP | | | |
| >>>>>Verified BSIC | | | | |
| >>>>>>inter-RAT cell id | MP | | Integer(0..<maxCellMeasurements>-1) | |
| >>>>>>>Non verified BSIC | | | | |
| >>>>>>>>BCCH ARFCN | MP | | Integer (0..1023) | [45] |

10.3.7.27 Inter-RAT measurement

| Information Element/Group name | Need | Multi | Type and reference | Semantics description | Version |
|---|--------------|-------|--|---|---------|
| CHOICE <i>Inter-RAT measurement objects</i> | OP | | | | REL-8 |
| >Inter-RAT cell info list | MP | | Inter-RAT cell info list 10.3.7.23 | | |
| >E-UTRA frequency list | MP | | E-UTRA frequency list 10.3.7.6b | | REL-8 |
| Inter-RAT measurement quantity | OP | | Inter-RAT measurement quantity 10.3.7.29 | | |
| Inter-RAT reporting quantity | OP | | Inter-RAT reporting quantity 10.3.7.32 | | |
| Reporting cell status | CV-reporting | | Reporting cell status 10.3.7.61 | | |
| CHOICE <i>report criteria</i> | MP | | | | |
| >Inter-RAT measurement reporting criteria | | | Inter-RAT measurement reporting criteria 10.3.7.30 | | |
| >Periodical reporting criteria | | | Periodical reporting criteria 10.3.7.53 | | |
| >No reporting | | | | (no data)
Chosen when this measurement only is used as additional measurement to another measurement | |
| Idle Interval Information | OP | | Idle Interval Information 10.3.7.12a | This IE is used for TDD only. | REL-8 |

| Condition | Explanation |
|------------------|--|
| <i>reporting</i> | This IE is optional if the CHOICE " <i>report criteria</i> " is equal to "periodical reporting criteria" or "No reporting", otherwise the IE is not needed |

10.3.7.28 Inter-RAT measurement event results

This IE contains the measurement event results that are reported to UTRAN for inter-RAT measurements.

| Information Element/Group name | Need | Multi | Type and reference | Semantics description |
|--------------------------------|------|--------------------|---------------------------------------|-----------------------|
| Inter-RAT event identity | MP | | Inter-RAT event identity
10.3.7.24 | |
| Cells to report | MP | 1 to <maxCellMeas> | | |
| >CHOICE BSIC | MP | | | |
| >>Verified BSIC | | | | |
| >>>inter-RAT cell id | MP | | Integer(0..<maxCellMeas>-1) | |
| >>Non verified BSIC | | | | |
| >>>BCCH ARFCN | MP | | Integer (0..1023) | [45] |

10.3.7.29 Inter-RAT measurement quantity

The quantity the UE shall measure in case of inter-RAT measurement. It also includes the filtering of the measurements.

| Information Element/Group name | Need | Multi | Type and reference | Semantics description | Version |
|---|------|-------|---|---|---------|
| Measurement quantity for UTRAN quality estimate | OP | | Intra-frequency measurement quantity
10.3.7.38 | | |
| CHOICE <i>system</i> | MP | | | | |
| >GSM | | | | | |
| >>Measurement quantity | MP | | Enumerated (GSM Carrier RSSI) | | |
| >>Filter coefficient | MP | | Filter coefficient
10.3.7.9 | | |
| >>BSIC verification required | MP | | Enumerated (required, not required) | | |
| >IS2000 | | | | | |
| >>TADD E_c/I_0 | MP | | Integer (0..63) | Admission criteria for neighbours, see subclause 2.6.6.2.6 of TIA/EIA/IS-2000.5 | |
| >>TCOMP E_c/I_0 | MP | | Integer (0..15) | Admission criteria for neighbours, see subclause 2.6.6.2.5.2 of TIA/EIA/IS-2000.5 | |

| Information Element/Group name | Need | Multi | Type and reference | Semantics description | Version |
|--------------------------------|------|-------|-----------------------------|---|---------|
| >>SOFT SLOPE | OP | | Integer (0..63) | Admission criteria for neighbours, see subclause 2.6.6.2.3 and 2.6.6.2.5.2 of TIA/EIA/IS-2000.5 | |
| >>ADD_INTERCEPT | OP | | Integer (0..63) | Admission criteria for neighbours, see subclause 2.6.6.2.5.2 of TIA/EIA/IS-2000.5 | |
| >E-UTRA | | | | | REL-8 |
| >>Measurement quantity | MP | | Enumerated (RSRP, RSRQ) | This IE indicates the quantity that the UE uses to determine the event trigger. | REL-8 |
| >>Filter coefficient | MP | | Filter coefficient 10.3.7.9 | | REL-8 |

10.3.7.30 Inter-RAT measurement reporting criteria

The triggering of the event-triggered reporting for an inter-RAT measurement. All events concerning inter-RAT measurements are labelled 3x where x is a,b,c, ...

Event 3a: The estimated quality of the currently used UTRAN frequency is below a certain threshold **and** the estimated quality of the other system is above a certain threshold.

Event 3b: The estimated quality of other system is below a certain threshold.

Event 3c: The estimated quality of other system is above a certain threshold.

Event 3d: Change of best cell in other system.

| Information Element/Group name | Need | Multi | Type and reference | Semantics description |
|------------------------------------|-------------|----------------------|---------------------------------------|---|
| Parameters required for each event | OP | 1 to <maxMeas Event> | | |
| >Inter-RAT event identity | MP | | Inter-RAT event identity
10.3.7.24 | |
| >Threshold own system | CV-clause 0 | | Integer (-115..0) | |
| >W | CV-clause 0 | | Real(0, 0.1..2.0 by step of 0.1) | In event 3a |
| >Threshold other system | CV-clause 1 | | Integer (-115..0) | In event 3a, 3b, 3c
If the other system is EUTRA, the range used depends on: if measurement quantity is RSRQ, range should be (-39..-6), the actual value = Threshold other system/2 [dB], if measurement quantity is RSRP, range should be (-115..-19), the actual value = Threshold other system - 25 [dBm]. |
| >Hysteresis | MP | | Real(0..7.5 by step of 0.5) | |
| >Time to trigger | MP | | Time to trigger
10.3.7.64 | Indicates the period of time during which the event condition has to be satisfied, before sending a Measurement Report. |
| >Reporting cell status | OP | | Reporting cell status
10.3.7.61 | |

| Condition | Explanation |
|-----------|---|
| Clause 0 | The IE is mandatory present if the IE "Inter-RAT event identity" is set to "3a", otherwise the IE is not needed |
| Clause 1 | The IE is mandatory present if the IE "Inter-RAT event identity" is set to 3a, 3b or 3c, otherwise the IE is not needed |

10.3.7.31 Inter-RAT measurement system information

| Information Element/Group name | Need | Multi | Type and reference | Semantics description |
|--------------------------------|------|-------|---------------------------------------|-----------------------|
| Inter-RAT cell info list | OP | | Inter-RAT cell info list
10.3.7.23 | |

10.3.7.32 Inter-RAT reporting quantity

For all boolean types TRUE means inclusion in the report is requested.

| Information Element/Group name | Need | Multi | Type and reference | Semantics description | Version |
|--|------|-------|---|--|---------|
| UTRAN estimated quality | MP | | Boolean | This parameter is not used in this release and should be set to FALSE. | |
| CHOICE <i>system</i> | MP | | | | |
| >GSM | | | | | |
| >>GSM Carrier RSSI Reporting indicator | MP | | Boolean | | |
| >E-UTRA | | | | | REL-8 |
| >>Reporting quantity | MP | | Enumerated ("measurement quantity", "both") | This IE indicates the quantity that the UE reports; if this IE is set to "measurement quantity" the UE reports either RSRP or RSRQ which is indicated in the 'measurement quantity' (see subclause 10.3.7.29); if this IE is set to "both", the UE reports both RSRP and RSRQ. | REL-8 |

10.3.7.33 Intra-frequency cell info list

Contains the information for the list of measurement objects for an intra-frequency measurement.

| Information Element/Group name | Need | Multi | Type and reference | Semantics description |
|--|-------------------|--------------------|---------------------------------|---|
| CHOICE <i>Intra-frequency cell removal</i> | OP | | | Absence of this IE is equivalent to choice "Remove no intra-frequency cells". |
| >Remove all intra-frequency cells | | | | (no data) |
| >Remove some intra-frequency cells | | | | |
| >>Removed intra-frequency cells | MP | 1 to <maxCellMeas> | | |
| >>>Intra-frequency cell id | MP | | Integer(0 .. <maxCellMeas> - 1) | |
| >Remove no intra-frequency cells | | | | (no data) |
| New intra-frequency cells | OP | 1 to <maxCellMeas> | | This information element must be present when "Intra-frequency cell info list" is included in the system information |
| >Intra-frequency cell id | OP | | Integer(0 .. <maxCellMeas> - 1) | |
| >Cell info | MP | | Cell info 10.3.7.2 | This IE must be included for the serving cell when the IE "Intra frequency cell info list" is included in System Information Block type 11. |
| Cells for measurement | CV- <i>BCHopt</i> | 1 to <maxCellMeas> | | |
| >Intra-frequency cell id | MP | | Integer(0 .. <maxCellMeas>-1) | |

| Condition | Explanation |
|---------------|--|
| <i>BCHopt</i> | This IE is not needed when sent in SYSTEM INFORMATION. Otherwise, the IE is Optional |

10.3.7.34 Intra-frequency event identity

| Information Element/Group name | Need | Multi | Type and reference | Semantics description | Version |
|--------------------------------|------|-------|---|--------------------------------|---------|
| Intra-frequency event identity | MP | | Enumerated (1a,1b,1c,1d,1e,1f,1g,1h,1i, | Seven spare values are needed. | REL-6 |
| | | | 1j) | Six spare values are needed. | |

10.3.7.35 Intra-frequency measured results list

| Information Element/Group name | Need | Multi | Type and reference | Semantics description |
|-------------------------------------|------|--------------------|--------------------------------|---|
| Intra-frequency measurement results | OP | 1 to <maxCellMeas> | | |
| >Cell measured results | MP | | Cell measured results 10.3.7.3 | Only cells for which all reporting quantities are available should be included. |

10.3.7.36 Intra-frequency measurement

| Information Element/Group name | Need | Multi | Type and reference | Semantics description | Version |
|---|--------------|-------|--|-----------------------|---------|
| Intra-frequency measurement objects list | OP | | Intra-frequency cell info list 10.3.7.33 | | |
| Intra-frequency measurement quantity | OP | | Intra-frequency measurement quantity 10.3.7.38 | | |
| Intra-frequency reporting quantity | OP | | Intra-frequency reporting quantity 10.3.7.41 | | |
| Reporting cell status | CV-reporting | | Reporting cell status 10.3.7.61 | | |
| Measurement validity | OP | | Measurement validity 10.3.7.51 | | |
| CHOICE <i>report criteria</i> | OP | | | NOTE 1 | |
| | MP | | | | REL-6 |
| | OP | | | | REL-7 |
| >Intra-frequency measurement reporting criteria | | | Intra-frequency measurement reporting criteria 10.3.7.39 | | |

| Information Element/Group name | Need | Multi | Type and reference | Semantics description | Version |
|--------------------------------|------|-------|--|---|---------|
| >Periodical reporting criteria | | | Periodical reporting criteria
10.3.7.53 | | |
| >No reporting | | | | (no data)
Chosen when this measurement only is used as additional measurement to another measurement | |

| Condition | Explanation |
|------------------|--|
| <i>reporting</i> | This IE is optional if the CHOICE " <i>report criteria</i> " is equal to "periodical reporting criteria" or "No reporting", otherwise the IE is not needed |

NOTE 1: The IE "report criteria" is optional in all releases except Rel-6. In Rel-6 the IE "report criteria" is mandatory present in order to align the tabular format with the Rel-6 ASN.1.

10.3.7.37 Intra-frequency measurement event results

This IE contains the measurement event results that are reported to UTRAN for intra-frequency measurements.

| Information Element/Group name | Need | Multi | Type and reference | Semantics description |
|--------------------------------|------|-------|---|-----------------------|
| Intra-frequency event identity | MP | | Intra-frequency event identity
10.3.7.34 | |
| Cell measurement event results | MP | | Cell measurement event results
10.3.7.4 | |

10.3.7.38 Intra-frequency measurement quantity

The quantity the UE shall measure in case of intra-frequency measurement. It also includes the filtering of the measurements.

| Information Element/Group name | Need | Multi | Type and reference | Semantics description |
|--------------------------------|------|--------|---|-----------------------|
| Filter coefficient | MP | | Filter coefficient
10.3.7.9 | |
| CHOICE <i>mode</i> | MP | | | |
| >FDD | | | | |
| >>Measurement quantity | MP | | Enumerated(CPICH Ec/N0, CPICH RSCP, Pathloss) | |
| >TDD | | | | |
| >>Measurement quantity list | MP | 1 to 4 | | |

| Information Element/Group name | Need | Multi | Type and reference | Semantics description |
|--------------------------------|------|-------|--|-----------------------|
| >>>Measurement quantity | MP | | Enumerated(Primary CCPCH RSCP, Pathloss, Timeslot ISCP) | |

10.3.7.39 Intra-frequency measurement reporting criteria

The triggering of the event-triggered reporting for an intra-frequency measurement. All events concerning intra-frequency measurements are labelled 1x where x is a, b, c....

Event 1a: A Primary CPICH enters the Reporting Range (FDD only).

Event 1b: A Primary CPICH leaves the Reporting Range (FDD only).

Event 1c: A Non-active Primary CPICH becomes better than an active Primary CPICH (FDD only).

Event 1d: Change of best cell (FDD only).

Event 1e: A Primary CPICH becomes better than an absolute threshold (FDD only).

Event 1f: A Primary CPICH becomes worse than an absolute threshold (FDD only).

Event 1g: Change of best cell in TDD.

Event 1h: Timeslot ISCP below a certain threshold (TDD only).

Event 1i: Timeslot ISCP above a certain threshold (TDD only).

Event 1j: A Non-active E-DCH but active DCH Primary CPICH becomes better than an active E-DCH Primary CPICH (FDD only).

| Information Element/Group name | Need | Multi | Type and reference | Semantics description | Version |
|------------------------------------|------------------------|---------------------|---|---|---------|
| Parameters required for each event | OP | 1 to <maxMeasEvent> | | | |
| >Intra-frequency event identity | MP | | Intra-frequency event identity 10.3.7.34 | | |
| >Triggering condition 1 | CV-
<i>clause 0</i> | | Enumerated(Active set cells, Monitored set cells, Active set cells and monitored set cells) | Indicates which cells can trigger the event | |

| Information Element/Group name | Need | Multi | Type and reference | Semantics description | Version |
|--|-------------------------|--------------------|---|---|---------|
| >Triggering condition 2 | CV-
<i>clause 6</i> | | Enumerated(Active set cells, Monitored set cells, Active set cells and monitored set cells, Detected set cells, Detected set cells and monitored set cells) | Indicates which cells can trigger the event | |
| | CV-
<i>clause 10</i> | | | | REL-5 |
| >Reporting Range Constant | CV-
<i>clause 2</i> | | Real(0..14.5 by step of 0.5) | In dB. In event 1a,1b. | |
| >Cells forbidden to affect Reporting range | CV-
<i>clause 1</i> | 1 to <maxCellMeas> | | In event 1a,1b | |
| >>CHOICE mode | MP | | | | |
| >>>FDD | | | | | |
| >>>>Primary CPICH info | MP | | Primary CPICH info
10.3.6.60 | | |
| >>>TDD | | | | | |
| >>>>Primary CCPCH info | MP | | Primary CCPCH info
10.3.6.57 | | |
| >W | CV-
<i>clause 2</i> | | Real(0.0..2.0 by step of 0.1) | | |
| >Hysteresis | MP | | Real(0..7.5 by step of 0.5) | In dB. | |
| >Threshold used frequency | CV-
<i>clause 3</i> | | Integer (-115..165) | Range used depend on measurement quantity.
CPICH RSCP -115..-25 dBm
CPICH Ec/No -24..0 dB
Pathloss 30..165dB
ISCP -115..-25 dBm | |
| | | | Integer (-120..165) | Range used depend on measurement quantity.
CPICH RSCP -120..-25 dBm
CPICH Ec/No -24..0 dB
Pathloss 30..165dB
ISCP -120..-25 dBm | REL-6 |
| >Delta _{Threshold used frequency} | CV-
<i>clause 8</i> | | Integer(-5..-1) | If present, the actual value of Threshold used frequency = Threshold used frequency + Delta _{Threshold used frequency} | REL-5 |
| | | | | Not used in Release 6 and later | REL-6 |
| >Reporting deactivation threshold | CV-
<i>clause 4</i> | | Integer(0, 1, 2, 3, 4, 5, 6, 7) | In event 1a
Indicates the maximum number of cells allowed | |

| Information Element/Group name | Need | Multi | Type and reference | Semantics description | Version |
|--------------------------------------|------------------|-------|---|---|---------|
| | | | | in the active set in order for event 1a to occur.
0 means not applicable | |
| >Replacement activation threshold | CV-
clause 5 | | Integer(0, 1, 2, 3, 4, 5, 6, 7) | In event 1c
Indicates the minimum number of cells allowed in the active set in order for event 1c to occur.
0 means not applicable | REL-6 |
| | | | | In event 1j
Indicates the minimum number of cells allowed in the E-DCH active set in order for event 1j to occur.
For event 1j values 5, 6 and 7 are not applicable.
0 means not applicable | |
| >Time to trigger | MP | | Time to trigger
10.3.7.64 | Indicates the period of time during which the event condition has to be satisfied, before sending a Measurement Report.
Time in ms | |
| >Amount of reporting | CV-
clause 7 | | Integer(1, 2, 4, 8, 16, 32, 64, Infinity) | In case the IE "Intra-frequency reporting criteria" is included in the IE "Inter-frequency measurement", this IE is not needed. | |
| >Reporting interval | CV-
clause 7 | | Integer(0, 250, 500, 1000, 2000, 4000, 8000, 16000) | Indicates the interval of periodical reporting when such reporting is triggered by an event.
Interval in milliseconds.
0 means no periodical reporting. In case the IE "Intra-frequency reporting criteria" is included in the IE "Inter-frequency measurement", this IE is not needed. | |
| >Reporting cell status | OP | | Reporting cell status
10.3.7.61 | | |
| >Periodical reporting information-1b | CV-
clause 9 | | Periodical reporting info-1b
10.3.7.53
aa | In case the IE "Intra-frequency reporting criteria" is included in the IE "Inter-frequency measurement", this IE is not needed. | REL-5 |
| >Use CIO | CV-
clause 10 | | Boolean | TRUE indicates that the cell individual offset shall be used for event evaluation | REL-5 |

| Condition | Explanation |
|------------------|--|
| <i>Clause 0</i> | The IE is mandatory present if the IE "Intra-frequency event identity" is set to "1b" or "1f", otherwise the IE is not needed. |
| <i>Clause 1</i> | The IE is optional if the IE "Intra-frequency event identity" is set to "1a" or "1b", otherwise the IE is not needed. |
| <i>Clause 2</i> | The IE is mandatory present if the IE "Intra-frequency event identity" is set to "1a" or "1b", otherwise the IE is not needed. |
| <i>Clause 3</i> | The IE is mandatory present if the IE "Intra-frequency event identity" is set to , "1e", "1f", "1h" or "1i", otherwise the IE is not needed. |
| <i>Clause 4</i> | The IE is mandatory present if the IE "Intra-frequency event identity" is set to "1a", otherwise the IE is not needed. |
| <i>Clause 5</i> | The IE is mandatory present if the IE "Intra-frequency event identity" is set to "1c" or 1j , otherwise the IE is not needed. |
| <i>Clause 6</i> | The IE is mandatory present if the IE "Intra-frequency event identity" is set to "1a" or "1e", otherwise the IE is not needed. |
| <i>Clause 7</i> | The IE is mandatory present if the IE "Intra-frequency event identity" is set to "1a", "1c" or 1j, otherwise the IE is not needed. |
| <i>Clause 8</i> | The IE is optional if the IE "Intra-frequency event identity" is set to "1e", "1f", "1h" or "1i". Otherwise the IE is not needed. |
| <i>Clause 9</i> | The IE is optional if the IE "Intra-frequency event identity" is set to "1b", otherwise the IE is not needed. |
| <i>Clause 10</i> | The IE is optional if the IE "Intra-frequency event identity" is set to "1d", otherwise the IE is not needed. |

10.3.7.40 Intra-frequency measurement system information

| Information Element/Group name | Need | Multi | Type and reference | Semantics description |
|---|------|-------|---|--|
| Intra-frequency measurement identity | MD | | Measurement identity 10.3.7.48 | The intra-frequency measurement identity has default value 1.
If the cell is operating in MBSFN mode as indicated in subclause 8.1.1.6.3 the UE behaviour upon reception of this IE is unspecified. |
| Intra-frequency cell info list | OP | | Intra-frequency cell info list 10.3.7.33 | |
| Intra-frequency measurement quantity | OP | | Intra-frequency measurement quantity 10.3.7.38 | If the cell is operating in MBSFN mode as indicated in subclause 8.1.1.6.3 the UE behaviour upon reception of this IE is unspecified. |
| Intra-frequency reporting quantity for RACH Reporting | OP | | Intra-frequency reporting quantity for RACH Reporting 10.3.7.42 | If the cell is operating in MBSFN mode as indicated in subclause 8.1.1.6.3 the UE behaviour upon reception of this IE is unspecified. |
| Maximum number of reported cells on RACH | OP | | Maximum number of reported cells on RACH | If the cell is operating in MBSFN mode as indicated in subclause 8.1.1.6.3 the UE behaviour upon reception of this IE is unspecified. |

| Information Element/Group name | Need | Multi | Type and reference | Semantics description |
|--|------|-------|---|---|
| Reporting information for state CELL_DCH | OP | | 10.3.7.43
Reporting information for state CELL_DCH 10.3.7.62 | Note 1
If the cell is operating in MBSFN mode as indicated in subclause 8.1.1.6.3 the UE behaviour upon reception of this IE is unspecified. |

NOTE 1: The reporting of intra-frequency measurements is activated when state CELL_DCH is entered.

10.3.7.41 Intra-frequency reporting quantity

Contains the reporting quantity information for an intra-frequency measurement.

| Information Element/Group name | Need | Multi | Type and reference | Semantics description |
|--|------|-------|------------------------------------|-----------------------|
| Reporting quantities for active set cells | MP | | Cell reporting quantities 10.3.7.5 | |
| Reporting quantities for monitored set cells | MP | | Cell reporting quantities 10.3.7.5 | |
| Reporting quantities for detected set cells | OP | | Cell reporting quantities 10.3.7.5 | |

10.3.7.42 Intra-frequency reporting quantity for RACH reporting

Contains the reporting quantity information for an intra-frequency measurement report, which is sent on the RACH.

| Information Element/Group name | Need | Multi | Type and reference | Semantics description |
|--|------|--------|---|-----------------------|
| SFN-SFN observed time difference reporting indicator | MP | | Enumerated(No report, type 1, type 2) | |
| CHOICE <i>mode</i> | MP | | | |
| >FDD | | | | |
| >>Reporting quantity | MP | | Enumerated(CPICH Ec/N0, CPICH RSCP, Pathloss, No report) | |
| >TDD | | | | |
| >>Reporting quantity list | MP | 1 to 2 | | |
| >>>Reporting quantity | MP | | Enumerated(Timeslot ISCP, Primary CCPCH RSCP, No report) | |

10.3.7.43 Maximum number of reported cells on RACH

Contains the maximum number of intra-frequency cells to be reported on RACH.

| Information Element/Group name | Need | Multi | Type and reference | Semantics description |
|----------------------------------|------|-------|--|-----------------------|
| Maximum number of reported cells | MP | | Enumerated (no report, current cell, current cell + best neighbour, current cell+2 best neighbours, ..., current cell+6 best neighbours) | |

10.3.7.43a MBMS preferred frequency information

| Information Element/Group name | Need | Multi | Type and reference | Semantics description | Version |
|--|------|---------------------|---|---|---------|
| MBMS preferred frequency list | MP | 1 to <maxMBMS-Freq> | | | REL-6 |
| >MBMS preferred frequency | OP | | Integer(1 .. <maxMBMS-Freq>) | Absence of this information element means the currently used frequency. Value n corresponds with the n th frequency included in the IE New inter-frequency cells that is specified within SIB 11 | REL-6 |
| >CHOICE <i>Layer convergence information</i> | MP | | | | REL-6 |
| >>No HCS | | | | | REL-6 |
| >>>Qoffmbms | MP | | Enumerated (4, 8, 12, 16, 20, 30, 40, infinity) | The offset in decibel [dB] added to cells on this MBMS preferred frequency | REL-6 |
| >>HCS | | | | | REL-6 |
| >>>HCS_OFF _{mbms} | MP | | Integer (0..7) | Offset added to the normal HCS priority level of cells on this MBMS preferred frequency | REL-6 |
| >MBMS PL Service Restriction Information | OP | | Enumerated (TRUE) | Included if some service restrictions apply for this preferred frequency e.g. congestion | REL-6 |

10.3.7.43b MBSFN inter frequency neighbour list

| Information Element/Group name | Need | Multi | Type and reference | Semantics description | Version |
|--------------------------------------|------|-------------------------|--------------------------|---|---------|
| MBSFN inter frequency neighbour list | MP | 1 to <maxMBSFNclusters> | | | REL-7 |
| >MBSFN frequency | MP | | Frequency info 10.3.6.36 | | REL-7 |
| >IMB indication | OP | | Enumerated (TRUE) | If present: 3.84 Mcps TDD MBSFN IMB is applied on this frequency. | REL-8 |
| >CHOICE MBSFN services notification | MP | | | | REL-7 |
| >>MBSFN services notified | | | | (no data) | REL-7 |
| >>MBSFN services not notified | | | | | REL-7 |
| >>>All MBSFN services notified | OP | | Enumerated (TRUE) | | REL-7 |

10.3.7.44 Measured results

Contains the measured results of the quantity indicated optionally by Reporting Quantity in Measurement Control. "Measured results" can be used for both event trigger mode and periodical reporting mode. For intra-frequency and inter-frequency measurements the list shall be in the order of the value of the measurement quantity (the first cell shall be the best cell). The "best" FDD cell has the largest value when the measurement quantity is "Ec/No" or "RSCP". On the other hand, the "best" cell has the smallest value when the measurement quantity is "Pathloss". The "best" TDD cell has the largest value when measurement quantity is "Primary CCPCH RSCP". For intra-frequency measurements, the ordering shall be applied to all cells included in the IE "Measured results". For inter-frequency measurements, the ordering shall be applied to all cells on the same frequency included in the IE "Measured results". For other measurements, the order of reported measurement objects is not specified.

| Information Element/Group name | Need | Multi | Type and reference | Semantics description |
|--|------|-------|---|----------------------------|
| CHOICE <i>Measurement</i> | MP | | | One spare value is needed. |
| >Intra-frequency measured results list | | | Intra-frequency measured results list 10.3.7.35 | |
| >Inter-frequency measured results list | | | Inter-frequency measured results list 10.3.7.15 | |
| >Inter-RAT measured results list | | | Inter-RAT measured results list 10.3.7.26 | |
| >Traffic volume measured results list | | | Traffic volume measured results list 10.3.7.67 | |
| >Quality measured results list | | | Quality measured results list 10.3.7.55 | |
| >UE Internal measured results | | | UE Internal measured results | |

| Information Element/Group name | Need | Multi | Type and reference | Semantics description |
|----------------------------------|------|-------|---|-----------------------|
| >UE positioning measured results | | | 10.3.7.76
UE positioning measured results
10.3.7.99 | |

10.3.7.45 Measured results on RACH

For measurements on used frequency, this IE contains the measured results on RACH of the quantity indicated by Reporting quantity in the IE "Intra-frequency reporting quantity for RACH Reporting" in system information broadcast on BCH. The list, measurement results for monitored cells (not including the current cell) shall be in the order of the value of the measurement quantity as indicated by Reporting Quantity in the IE "Intra-frequency reporting quantity for RACH Reporting" (the first cell shall be the best cell).

For measurements on non-used frequencies, this IE includes the best cell on each non- used frequency, in order of decreasing quality and up to a maximum number as specified by the IE "Maximum number of inter-frequency RACH reporting cells".

The "best" FDD cell has the largest value when the measurement quantity is "Ec/No" or "RSCP". On the other hand, the "best" cell has the smallest value when the measurement quantity is "Pathloss". The "best" TDD cell has the largest value when measurement quantity is "Primary CCPCH RSCP".

| Information Element/group name | Need | Multi | Type and reference | Semantics description | Version |
|--------------------------------|------|-------|--------------------|-----------------------|---------|
|--------------------------------|------|-------|--------------------|-----------------------|---------|

| Information Element/group name | Need | Multi | Type and reference | Semantics description | Version |
|---|------|---------|--|---|---------|
| Measurement result for current cell | MP | | | | |
| >CHOICE <i>mode</i> | MP | | | | |
| >>FDD | | | | | |
| >>>CHOICE <i>measurement quantity</i> | MP | | | One spare value is needed. | |
| >>>>CPICH Ec/N0 | | | Integer(0..49) | In dB. According to CPICH_Ec/No in [19]. Fourteen spare values are needed. | |
| >>>>CPICH RSCP | | | Integer(0..91) | In dBm. According to CPICH_RSCP_LEV in [19]. Thirty-six spare values are needed. | |
| >>>>Pathloss | | | Integer(46..158) | In dB. Fifteen spare values are needed. | |
| >>TDD | | | | | |
| >>>CHOICE <i>TDD option</i> | MP | | | | REL-4 |
| >>>>3.84 Mcps TDD | | | | | REL-4 |
| >>>>>Timeslot List | OP | 1 to 14 | | | |
| >>>>>>Timeslot ISCP | MP | | Timeslot ISCP info 10.3.7.65 | The UE shall report the Timeslot ISCP in the same order as indicated in the cell info | |
| >>>>7.68 Mcps TDD | | | | | REL-7 |
| >>>>>Timeslot List | OP | 1 to 14 | | | REL-7 |
| >>>>>>Timeslot ISCP | MP | | Timeslot ISCP info 10.3.7.65 | The UE shall report the Timeslot ISCP in the same order as indicated in the cell info | REL-7 |
| >>>>>1.28 Mcps TDD | | | | | REL-4 |
| >>>>>>Timeslot List | OP | 1 to 6 | | | REL-4 |
| >>>>>>>Timeslot ISCP | MP | | Timeslot ISCP info 10.3.7.65 | The UE shall report the Timeslot ISCP in the same order as indicated in the cell info | REL-4 |
| >>>Primary CCPCH RSCP | OP | | Primary CCPCH RSCP info 10.3.7.54 | | |
| Measurement results for monitored cells on used frequency | OP | 1 to 8 | | | |
| >SFN-SFN observed time difference | OP | | SFN-SFN observed time difference 10.3.7.63 | | |
| >CHOICE <i>mode</i> | MP | | | | |
| >>FDD | | | | | |
| >>>Primary CPICH info | MP | | Primary CPICH info | | |

| Information Element/group name | Need | Multi | Type and reference | Semantics description | Version |
|---|------|----------------|-----------------------------------|--|---------|
| | | | 10.3.6.60 | | |
| >>>CHOICE <i>measurement quantity</i> | OP | | | One spare value is needed. | |
| >>>>CPICH Ec/NO | | | Integer(0..49) | In dB. According to CPICH_Ec/No in [19]. Fourteen spare values are needed. | |
| >>>>CPICH RSCP | | | Integer(0..91) | In dBm. According to CPICH_RSCP_LEV in [19]. Thirty-six spare values are needed. | |
| >>>>Pathloss | | | Integer(46..158) | In dB. Fifteen spare values are needed. | |
| >>TDD | | | | | |
| >>>Cell parameters Id | MP | | Cell parameters Id 10.3.6.9 | | |
| >>>Primary CCPCH RSCP | MP | | Primary CCPCH RSCP info 10.3.7.54 | | |
| Measurement results for monitored cells on non-used frequencies | OP | | | | REL-6 |
| >Inter-frequency cell indication-SIB11 | MP | | Integer (0..1) | | REL-6 |
| >Inter-frequency cell indication-SIB12 | MP | | Integer (0..1) | | REL-6 |
| >Inter-frequency cell list | MP | 1 to <maxFreq> | | | REL-6 |
| >>Inter-frequency cell id | MP | | Integer(0 .. <maxCellMeas>-1) | | REL-6 |

NOTE: Monitored cells consist of neighbouring cells.

10.3.7.46 Measurement Command

| Information Element/Group name | Need | Multi | Type and reference | Semantics description |
|--------------------------------|------|-------|------------------------------------|-----------------------|
| Measurement command | MP | | Enumerated(Setup, Modify, Release) | |

10.3.7.47 Measurement control system information

| Information element/Group name | Need | Multi | Type and reference | Semantics description |
|--|------|-------|--|--|
| Use of HCS | MP | | Enumerated (Not used, used) | Indicates if the serving cell belongs to a HCS structure
If the cell is operating in MBSFN mode as indicated in subclause 8.1.1.6.3 the UE behaves as if this IE would not have been received. |
| Cell selection and reselection quality measure | MP | | Enumerated (CPICH Ec/N0, CPICH RSCP) | Choice of measurement (CPICH Ec/N0 or CPICH RSCP) to use as quality measure Q.
NOTE: For TDD, each choice of this parameter represents PCCPCH RSCP.

If the cell is operating in MBSFN mode as indicated in subclause 8.1.1.6.3 the UE behaves as if this IE would not have been received |
| Intra-frequency measurement system information | OP | | Intra-frequency measurement system information 10.3.7.40 | |
| Inter-frequency measurement system information | OP | | Inter-frequency measurement system information 10.3.7.20 | If the cell is operating in MBSFN mode as indicated in subclause 8.1.1.6.3 the UE behaviour upon reception of this IE is unspecified. |
| Inter-RAT measurement system information | OP | | Inter-RAT measurement system information 10.3.7.31 | If the cell is operating in MBSFN mode as indicated in subclause 8.1.1.6.3 the UE behaviour upon reception of this IE is unspecified. |
| Traffic volume measurement system information | OP | | Traffic volume measurement system information 10.3.7.73 | If the cell is operating in MBSFN mode as indicated in subclause 8.1.1.6.3 the UE behaviour upon reception of this IE is unspecified. |

| Condition | Explanation |
|--------------|---|
| <i>MBSFN</i> | This IE is mandatory present in a cell operating in MBSFN mode. |

10.3.7.47a Measurement control system information extension

| Information element/Group name | Need | Multi | Type and reference | Semantics description | Version |
|--|------|--------------------|--|--|---------|
| Intra-frequency cell info list | OP | | | | REL-6 |
| >New intra-frequency cells | MP | 1 to <maxCellMeas> | | | REL-6 |
| >>Intra-frequency cell id | OP | | Integer(0 .. <maxCellMeas> - 1) | | REL-6 |
| >>Cell info | MP | | Cell info 10.3.7.2 | | REL-6 |
| Inter-frequency cell info list | OP | | | | REL-6 |
| >New inter-frequency cells | MP | 1 to <maxCellMeas> | | | REL-6 |
| >>Frequency Info | MD | | Frequency info 10.3.6.36 | Default value is the value of the previous "frequency info" in the list.
NOTE: The first occurrence is then MP. | REL-6 |
| >>Inter-frequency cell id | OP | | Integer(0 .. <maxCellMeas> - 1) | | REL-6 |
| >>Cell info | MP | | Cell info 10.3.7.2 | | REL-6 |
| Inter-RAT cell info list | OP | | | | REL-6 |
| >>New inter-RAT cells | MP | 1 to <maxCellMeas> | | | REL-6 |
| >>Inter-RAT cell id | OP | | Integer(0 .. <maxCellMeas> - 1) | | REL-6 |
| >>CHOICE <i>Radio Access Technology</i> | MP | | | | REL-6 |
| >>>GSM | | | | | REL-6 |
| >>>>Cell individual offset | MP | | Integer (-50..50) | In dB
Used to offset measured quantity value | REL-6 |
| >>>>Cell selection and re-selection info | OP | | Cell selection and re-selection info for SIB11/12 10.3.2.4 | See subclause 8.6.7.3 | REL-6 |
| >>>>BSIC | MP | | BSIC 10.3.8.2 | | REL-6 |
| >>>>Band indicator | MP | | Enumerated (DCS 1800 band used, PCS 1900 band used) | Indicates how to interpret the BCCH ARFCN | REL-6 |
| >>>>BCCH ARFCN | MP | | Integer (0..1023) | [45] | REL-6 |
| >>>IS-2000 | | | | | REL-6 |
| >>>>System specific measurement info | MP | | enumerated (frequency, timeslot, colour code, output power, PN offset) | For IS-2000, use fields from TIA/EIA/IS-2000.5, subclause 3.7.3.3.2.27, <i>Candidate</i> | REL-6 |

| | | | | | |
|---------|--|--|-----------|---|-------|
| | | | | <i>Frequency Neighbour List Message</i> | |
| >>>None | | | (no data) | This value has been introduced to handle the case when IE "New inter-RAT cells" is not required | REL-6 |

10.3.7.48 Measurement Identity

A reference number that is used by the UTRAN at modification and release of the measurement, and by the UE in the measurement report.

| Information Element/Group name | Need | Multi | Type and reference | Semantics description |
|--------------------------------|------|-------|--------------------|-----------------------|
| Measurement identity | MP | | Integer(1..16) | |

10.3.7.49 Measurement reporting mode

Contains the type of Measurement Report transfer mode and the indication of periodical/event trigger.

| Information Element/Group name | Need | Multi | Type and reference | Semantics description |
|---|------|-------|---|-----------------------|
| Measurement Report Transfer Mode | MP | | enumerated (Acknowledged mode RLC, Unacknowledged mode RLC) | |
| Periodical Reporting / Event Trigger Reporting Mode | MP | | Enumerated (Periodical reporting, Event trigger) | |

10.3.7.50 Measurement Type

| Information Element/Group name | Need | Multi | Type and reference | Semantics description |
|--------------------------------|------|-------|--|-----------------------|
| Measurement Type | MP | | Enumerated (Intra-frequency, Inter-frequency, Inter-RAT, Traffic volume, Quality, UE internal, UE positioning) | |

10.3.7.51 Measurement validity

| Information Element/Group name | Need | Multi | Type and reference | Semantics description |
|--------------------------------|------|-------|--|-----------------------|
| UE state | MP | | Enumerated(CELL_DCH, all states except CELL_DCH, all states) | |

10.3.7.52 Void

10.3.7.53 Periodical reporting criteria

Contains the periodical reporting criteria information. It is necessary only in the periodical reporting mode.

| Information Element/Group name | Need | Multi | Type and reference | Semantics description |
|--------------------------------|------|-------|--|--|
| Amount of reporting | MD | | Integer(1, 2, 4, 8, 16, 32, 64, Infinity) | The default value is infinity. |
| Reporting interval | MP | | Integer(250, 500, 1000, 2000, 3000, 4000, 6000, 8000, 12000, 16000, 20000, 24000, 28000, 32000, 64000) | Indicates the interval of periodical report.
Interval in milliseconds |

10.3.7.53aa Periodical reporting info-1b

| Information Element/Group name | Need | Multi | Type and reference | Semantics description | Version |
|--------------------------------|------|-------|---|--|---------|
| Amount of reporting | MP | | Integer(1, 2, 4, 8, 16, 32, 64, Infinity) | | REL-5 |
| Reporting interval | MP | | Integer(0, 250, 500, 1000, 2000, 4000, 8000, 16000) | Indicates the interval of periodical reporting when such reporting is triggered by an event. Interval in milliseconds.
0 means no periodical reporting. | REL-5 |

10.3.7.53a PLMN identities of neighbour cells

This IE contains the PLMN identities of neighbour cells.

| Information Element/Group name | Need | Multi | Type and reference | Semantics description | Version |
|-------------------------------------|------|---------------------|--------------------|-----------------------|---------|
| PLMNs of intra-frequency cells list | OP | 1 to <maxCellsMeas> | | NOTE | |

| Information Element/Group name | Need | Multi | Type and reference | Semantics description | Version |
|--|------|---------------------|--|---|---------|
| >PLMN identity | OP | | PLMN identity
10.3.1.11 | Action when not present is specified in subclause 8.1.1.6.18. | |
| PLMNs of inter-frequency cells list | OP | 1 to <maxCellsMeas> | | NOTE | |
| >PLMN identity | OP | | PLMN identity
10.3.1.11 | Action when not present is specified in subclause 8.1.1.6.18. | |
| PLMNs of inter-RAT cells list | OP | 1 to <maxCellsMeas> | | | |
| >PLMN identity | OP | | PLMN identity
10.3.1.11 | Action when not present is specified in subclause 8.1.1.6.18. | |
| Multiple PLMNs of intra-frequency cells list | OP | 1 to <maxCellsMeas> | | | REL-8 |
| >Multiple PLMN list | OP | 1 to 6 | | Action when not present is specified in subclause 8.1.1.6.18. | REL-8 |
| >> PLMN identity with Optional MCC | MP | | PLMN identity with Optional MCC
10.3.1.11 a | | REL-8 |
| Multiple PLMNs of inter-frequency cells list | OP | 1 to <maxCellsMeas> | | | REL-8 |
| >Multiple PLMN list | OP | 1 to 6 | | Action when not present is specified in subclause 8.1.1.6.18. | REL-8 |
| >> PLMN identity with Optional MCC | MP | | PLMN identity with Optional MCC
10.3.1.11 a | | REL-8 |

NOTE: The IE "PLMNs of intra-frequency cells list" and/or the IE "PLMNs of inter-frequency cells list" can be used when each entry in those lists is either empty or includes a single PLMN identity. If multiple PLMNs need to be indicated in a non-empty entry, the network uses the IE "Multiple PLMNs of intra-frequency cells list" and/or the IE "Multiple PLMNs of inter-frequency cells list" instead.

10.3.7.54 Primary CCPCH RSCP info

NOTE: Only for TDD

| Information Element/Group name | Need | Multi | IE type and reference | Semantics description | Version |
|-------------------------------------|---------|-------|-----------------------|--|---------|
| Primary CCPCH RSCP | MP | | Integer(0..91) | According to P-CCPCH_RSCP_LEV in [19] and [20]. Thirty-six spare values are needed. | |
| Delta _{Primary} CCPCH RSCP | CV-Rel5 | | Integer(-5..-1) | If present, the actual value of Primary CCPCH RSCP = Primary CCPCH RSCP+ Delta _{Primary} CCPCH RSCP | REL-5 |

| Condition | Explanation |
|-----------|---|
| Rel5 | This IE is mandatory if the value of Primary CCPCH RSCP is below 0. Otherwise the IE is not needed. |

10.3.7.54a Qhcs

| Information Element/Group name | Need | Multi | Type and Reference | Semantics description | Version |
|--------------------------------|------|-------|--------------------|--|---------|
| Qhcs | MP | | Integer(0..99) | Qhcs, mapped from CPICH Ec/No (FDD), see [4]
[dB]
0: -24
1: -23.5
2: -23
3: -22.5
...
45: -1.5
46: -1
47: -0.5
48: 0
49: (spare)
...
98: (spare)
99: (spare) | |
| | | | | Qhcs, mapped from CPICH RSCP (FDD), see [4]
[dBm]
0: -115
1: -114
2: -113
:
88: -27
89: -26
90: -(spare)
91: -(spare)
:
98: -(spare)
99: -(spare) | |

| Information Element/Group name | Need | Multi | Type and Reference | Semantics description | Version |
|--------------------------------|---------|-------|--------------------|---|---------|
| | | | | Qhcs, mapped from PCCPCH RSCP (TDD), see [4]
[dBm]
0: -115
1: -114
2: -113
:
88: -27
89: -26
90: -(spare)
91: -(spare)
:
98: -(spare)
99: -(spare) | |
| | | | | Qhcs level, mapped from Averaged received signal level RSSI (GSM), see [4]
[dBm]
0: -110
1: -109
2: -108
:
61: -49
62: -48
63: -47
64: -46
65: -45
66: -44
67: -43
68: -42
69: -41
70: -40
71: -39
72: -38
73: -37
74: -(spare)
:
98: -(spare)
99: -(spare) | |
| Delta _{Qhcs-RSCP} | CV-RSCP | | Integer(-5..-1) | If present, the actual value of Qhcs = Qhcs + Delta _{Qhcs-RSCP} | REL-5 |

| Condition | Explanation |
|-----------|--|
| RSCP | This IE is optional if Qhcs is mapped from CPICH RSCP or PCCPCH RSCP, and if the value of the RSCP is below 0 (-115dBm). It is not needed otherwise. |

10.3.7.55 Quality measured results list

| Information Element/Group name | Need | Multi | Type and reference | Semantics description |
|--------------------------------|------|-----------------|----------------------------|------------------------------|
| BLER measurement results | OP | 1 to <maxTrCH > | | |
| >DL Transport channel identity | MP | | Transport channel identity | transport channel type = DCH |

| Information Element/Group name | Need | Multi | Type and reference | Semantics description |
|--------------------------------|------|------------------|--------------------|---|
| | | | 10.3.5.18 | |
| >DL Transport Channel BLER | OP | | Integer (0..63) | According to BLER_LOG in [19] and [20] |
| CHOICE <i>mode</i> | MP | | | |
| >FDD | | | | No data |
| >TDD | | | | |
| >>SIR measurement results | OP | 1 to <MaxCCTrCH> | | SIR measurements for DL CCTrCH |
| >>>TFCS ID | MP | | Integer(1..8) | |
| >>>Timeslot list | MP | 1 to <maxTS> | | for all timeslot on which the CCTrCH is mapped on |
| >>>>SIR | MP | | Integer(0..63) | According to UE_SIR in [20] |

10.3.7.56 Quality measurement

| Information Element/Group name | Need | Multi | Type and reference | Semantics description |
|---|------|-------|--|---|
| Quality reporting quantity | OP | | Quality reporting quantity 10.3.7.59 | |
| CHOICE <i>report criteria</i> | MP | | | |
| >Quality measurement reporting criteria | | | Quality measurement reporting criteria 10.3.7.58 | Note
Given this choice, the IE "DL Transport Channel BLER" shall be set to FALSE (see subclause 10.3.7.59) |
| >Periodical reporting criteria | | | Periodical reporting criteria 10.3.7.53 | Note |
| >No reporting | | | | Note
(no data)
Chosen when this measurement only is used as additional measurement to another measurement |

NOTE: In this version of the specification, BLER as additional measurement is not supported.

10.3.7.57 Quality measurement event results

| Information Element/Group name | Need | Multi | Type and reference | Semantics description |
|--------------------------------------|------|----------------|--------------------------------------|------------------------------|
| Transport channels causing the event | OP | 1 to <maxTrCH> | | |
| >DL Transport channel identity | MP | | Transport channel identity 10.3.5.18 | transport channel type = DCH |

10.3.7.58 Quality measurement reporting criteria

Event 5a: Number of bad CRCs on a certain transport channel exceeds a threshold.

| Information Element/Group name | Need | Multi | Type and reference | Semantics description |
|--|------|-----------------|--------------------------------------|------------------------------|
| Parameters sent for each transport channel | MP | 1 to <maxTrCH > | | |
| >DL Transport channel identity | MP | | Transport channel identity 10.3.5.18 | transport channel type = DCH |
| >Total CRC | MP | | Integer(1..512) | Number of CRCs |
| >Bad CRC | MP | | Integer(1..512) | Number of CRCs |
| >Pending after trigger | MP | | Integer(1..512) | Number of CRCs |

10.3.7.59 Quality reporting quantity

| Information Element/Group name | Need | Multi | Type and reference | Semantics description |
|---------------------------------------|--------------------------|------------------|--------------------------------------|---|
| DL Transport Channel BLER | MP | | Boolean | TRUE means report requested |
| Transport channels for BLER reporting | <i>CV-BLER reporting</i> | 1 to <maxTrCH > | | The default, if no transport channel identities are present, is that the BLER is reported for all downlink transport channels |
| >DL Transport channel identity | MP | | Transport channel identity 10.3.5.18 | transport channel type = DCH |
| <i>CHOICE mode</i> | MP | | | |
| >FDD | | | | No data |
| >TDD | | | | |
| >>SIR measurement list | OP | 1 to <maxCCTrCH> | | SIR measurements shall be reported for all listed TFCS IDs |
| >>>TFCS ID | MP | | Integer(1..8) | |

| Condition | Explanation |
|-----------------------|---|
| <i>BLER reporting</i> | This IE is not needed if the IE "DL Transport Channel BLER" is FALSE and optional if the IE "DL Transport Channel BLER" is TRUE |

10.3.7.60 Reference time difference to cell

In the System Information message, the reference time difference to cell indicates the timing difference between the primary CCPCH of the current cell and the primary CCPCH of a neighbouring cell..

In the Measurement Control message, the reference time difference to cell indicates the timing difference between UE uplink transmission timing and the primary CCPCH of a neighbouring cell.

| Information Element/Group name | Need | Multi | Type and reference | Semantics description |
|--------------------------------|------|-------|-----------------------------------|-----------------------|
| CHOICE <i>accuracy</i> | MP | | | |
| >40 chips | | | | |
| >>Reference time difference | MP | | Integer(0..38400 by step of 40) | In chips |
| >256 chips | | | | |
| >>Reference time difference | MP | | Integer(0..38400 by step of 256) | In chips |
| >2560 chips | | | | |
| >>Reference time difference | MP | | Integer(0..38400 by step of 2560) | In chips |

10.3.7.61 Reporting Cell Status

Indicates maximum allowed number of cells to report and whether active set cells and/or virtual active set cells and/or monitored set cells on and/or detected set cells used frequency and/or monitored set cells on non used frequency should/should not be included in the IE "Measured results".

| Information Element/Group name | Need | Multi | Type and reference | Semantics description |
|--|------|-------|--|--|
| CHOICE <i>reported cell</i> | MP | | | |
| >Report cells within active set | | | | This choice is not valid for inter-RAT measurements. For inter-frequency measurements it is only valid for reporting events 2D and 2F. See NOTE 1. |
| >>Maximum number of reported cells | MP | | Integer(1..6) | |
| >Report cells within monitored set cells on used frequency | | | | This choice is not valid for inter-RAT or inter-frequency measurements |
| >>Maximum number of reported cells | MP | | Integer(1..6) | |
| >Report cells within active set and/or monitored set cells on used frequency | | | | This choice is not valid for inter-RAT or inter-frequency measurements |
| >>Maximum number of reported cells | MP | | Integer(1..6) | |
| >Report cells within detected set on used frequency | | | | This choice is not valid for inter-RAT or inter-frequency measurements |
| >>Maximum number of reported cells | MP | | Integer(1..6) | |
| >Report cells within monitored set and/or detected set on used frequency | | | | This choice is not valid for inter-RAT or inter-frequency measurements |
| >>Maximum number of reported cells | MP | | Integer(1..6) | |
| >Report all active set cells + cells within monitored set on used frequency | | | | This choice is not valid for inter-RAT or inter-frequency measurements |
| >>Maximum number of reported cells | MP | | Enumerated (virtual/active set cells+1, virtual/active set cells+2,, virtual/active set cells+6) | |
| >Report all active set cells + | | | | This choice is not valid for |

| Information Element/Group name | Need | Multi | Type and reference | Semantics description |
|---|------|-------|--|--|
| cells within detected set on used frequency | | | | inter-RAT or inter-frequency measurements |
| >>Maximum number of reported cells | MP | | Enumerated (virtual/active set cells+1, virtual/active set cells+2,, virtual/active set cells+6) | |
| >Report all active set cells + cells within monitored set and/or detected set on used frequency | | | | This choice is not valid for inter-RAT or inter-frequency measurements |
| >>Maximum number of reported cells | MP | | Enumerated (virtual/active set cells+1, virtual/active set cells+2,, virtual/active set cells+6) | |
| >Report cells within virtual active set | | | | This choice is not valid for intra-frequency or inter-RAT measurements |
| >>Maximum number of reported cells per reported non-used frequency | MP | | Integer(1..6) | |
| >Report cells within monitored set on non-used frequency | | | | This choice is not valid for intra-frequency or inter-RAT measurements |
| >>Maximum number of reported cells per reported non-used frequency | MP | | Integer(1..6) | |
| >Report cells within monitored and/or virtual active set on non-used frequency | | | | This choice is not valid for intra-frequency or inter-RAT measurements |
| >>Maximum number of reported cells per reported non-used frequency | MP | | Integer(1..6) | |
| >Report all virtual active set cells + cells within monitored set on non-used frequency | | | | This choice is not valid for intra-frequency or inter-RAT measurements |
| >>Maximum number of reported cells per reported non-used frequency | MP | | Enumerated (virtual/active set cells+1, virtual/active set cells+2,, virtual/active set cells+6) | |
| >Report cells within active set or within virtual active set or of the other RAT | | | | If this choice is selected for inter-RAT measurements, the UE shall report only cells of the other RAT.
If this choice is selected for intra-frequency measurements, the UE shall report cells within the active set. If this choice is selected for inter-frequency measurements, the UE shall report cells within the virtual active set. |
| >>Maximum number of reported cells | MP | | Integer (1..12) | |
| >Report cells within active | | | | This choice is not valid for |

| Information Element/Group name | Need | Multi | Type and reference | Semantics description |
|--|------|-------|--------------------|---|
| and/or monitored set on used frequency or within virtual active and/or monitored set on non-used frequency | | | | inter-RAT measurements.
If this choice is selected for intra-frequency measurements, the UE shall report cells within the active and/or monitored set.
If this choice is selected for inter-frequency measurements, the UE shall report cells within the virtual active set and/or monitored set on non-used frequency. |
| >>Maximum number of reported cells | MP | | Integer(1..12) | |

NOTE 1: For Inter-frequency reporting events 2D and 2F, only CHOICE "Report cells within active set" is valid.

10.3.7.62 Reporting information for state CELL_DCH

| Information Element/Group name | Need | Multi | Type and reference | Semantics description |
|---|------|-------|---|--|
| Intra-frequency reporting quantity | MP | | Intra-frequency reporting quantity
10.3.7.41 | |
| Measurement Reporting Mode | MP | | Measurement Reporting Mode
10.3.7.49 | |
| CHOICE <i>report criteria</i> | MP | | | |
| >Intra-frequency measurement reporting criteria | | | Intra-frequency measurement reporting criteria
10.3.7.39 | This IE may only contain measurement events from 1A to 1I, but not measurement event 1J. |
| >Periodical reporting criteria | | | Periodical reporting criteria
10.3.7.53 | |

10.3.7.63 SFN-SFN observed time difference

| Information Element/Group name | Need | Multi | Type and reference | Semantics description | Version |
|--------------------------------|------|-------|---------------------|---|---------|
| CHOICE <i>type</i> | MP | | | | |
| >Type 1 | | | Integer(0..9830399) | According to T1_SFNSFN_TIME in [19] and [20].
For FDD and 3.84 Mcps TDD and 7.68 Mcps TDD:
6946816 spare values are needed. | |
| | | | Integer(0..3276799) | For 1.28 Mcps TDD:
13500416 spare values are needed. | Rel-4 |
| >Type 2 | | | Integer(0..40961) | According to T2_SFNSFN_TIME in [19] and [20].
24574 spare values are needed. | |
| | | | Integer(0..27649) | For 1.28 Mcps TDD:
37886 spare values are needed. | Rel-4 |

10.3.7.64 Time to trigger

| Information Element/Group name | Need | Multi | Type and reference | Semantics description |
|--------------------------------|------|-------|---|-----------------------|
| Time to trigger | MP | | Integer(0, 10, 20, 40, 60, 80, 100, 120, 160, 200, 240, 320, 640, 1280, 2560, 5000) | Time in ms |

10.3.7.65 Timeslot ISCP info

NOTE: Only for TDD

| Information Element/Group name | Need | Multi | IE type and reference | Semantics description |
|--------------------------------|------|-------|-----------------------|--|
| Timeslot ISCP | MP | | Integer (0..91) | According to UE_TS_ISCP_LEV in [20]. Thirty-six spare values are needed. |

10.3.7.66 Traffic volume event identity

| Information Element/Group name | Need | Multi | Type and reference | Semantics description |
|--------------------------------|------|-------|--------------------|-----------------------|
| Traffic volume event identity | MP | | Enumerated(4a, 4b) | |

10.3.7.67 Traffic volume measured results list

| Information Element/Group name | Need | Multi | Type and reference | Semantics description |
|------------------------------------|------|--------------|--|---|
| Traffic volume measurement results | OP | 1 to <maxRB> | | |
| >RB Identity | MP | | RB Identity 10.3.4.16 | |
| >RLC Buffers Payload | OP | | Enumerated(0, 4, 8, 16, 32, 64, 128, 256, 512, 1024, 2K, 4K, 8K, 16K, 32K, 64K, 128K, 256K, 512K, 1024K) | In bytes
And N Kbytes = N*1024 bytes.
Twelve spare values are needed. |
| >Average of RLC Buffer Payload | OP | | Enumerated(0, 4, 8, 16, 32, 64, 128, 256, 512, 1024, 2K, 4K, 8K, 16K, 32K, 64K, 128K, 256K, 512K, 1024K) | In bytes
And N Kbytes = N*1024 bytes.
Twelve spare values are needed. |
| >Variance of RLC Buffer Payload | OP | | Enumerated(0, 4, 8, 16, 32, 64, 128, | In bytes
And N Kbytes = N*1024 bytes.
Two spare values are needed. |

| Information Element/Group name | Need | Multi | Type and reference | Semantics description |
|--------------------------------|------|-------|----------------------------------|-----------------------|
| | | | 256, 512, 1024, 2K, 4K, 8K, 16K) | |

10.3.7.68 Traffic volume measurement

| Information Element/Group name | Need | Multi | Type and reference | Semantics description |
|--|------|-------|--|---|
| Traffic volume measurement Object | OP | | Traffic volume measurement Object
10.3.7.70 | |
| Traffic volume measurement quantity | OP | | Traffic volume measurement quantity
10.3.7.71 | |
| Traffic volume reporting quantity | OP | | Traffic volume reporting quantity
10.3.7.74 | |
| Measurement validity | OP | | Measurement validity
10.3.7.51 | |
| <i>CHOICE report criteria</i> | MP | | | |
| >Traffic volume measurement reporting criteria | | | Traffic volume measurement reporting criteria
10.3.7.72 | |
| >Periodical reporting criteria | | | Periodical reporting criteria
10.3.7.53 | |
| >No reporting | | | | (no data)
Chosen when this measurement only is used as additional measurement to another measurement |

10.3.7.69 Traffic volume measurement event results

Contains the event result for a traffic volume measurement.

| Information Element/Group name | Need | Multi | Type and reference | Semantics description |
|---|---------------|-------|----------------------------|---|
| Uplink transport channel type causing the event | MP | | Enumerated(DCH,RACH, USCH) | USCH is TDD only.
RACH is the currently configured default in the uplink.
For 1.28 Mcps TDD, if E-DCH is configured to the UE, and the Uplink transport channel type is USCH and UL Transport Channel identity is 32, it means E-DCH TVM is configured. |
| UL Transport Channel identity | CV-UL-DCH/USC | | Transport channel | |

| Information Element/Group name | Need | Multi | Type and reference | Semantics description |
|--------------------------------|----------|-------|---|-----------------------|
| | <i>H</i> | | identity
10.3.5.18 | |
| Traffic volume event identity | MP | | Traffic
volume
event
identity
10.3.7.66 | |

| Condition | Explanation |
|--------------------|--|
| <i>UL-DCH/USCH</i> | If IE "Uplink transport channel type" is equal to "DCH" or "USCH" (TDD only) this IE is mandatory present. Otherwise the IE is not needed. |

10.3.7.70 Traffic volume measurement object

Contains the measurement object information for a traffic volume measurement.

| Information Element/Group name | Need | Multi | Type and reference | Semantics description |
|------------------------------------|---------------------------------|-----------------------|---|---|
| Traffic volume measurement objects | MP | 1 to
<maxTrCH
> | | |
| >Uplink transport channel type | MP | | Enumerated(
DCH,RACH,
USCH) | USCH is TDD only.
RACH is the currently
configured default in the
uplink.
For 1.28 Mcps TDD, if E-DCH
is configured to the UE, and
the Uplink transport channel
type is USCH and UL
Transport Channel identity is
32, it means E-DCH TVM is
configured. |
| >UL Target Transport Channel ID | <i>CV-UL-
DCH/USC
H</i> | | Transport
channel
identity
10.3.5.18 | |

| Condition | Explanation |
|--------------------|--|
| <i>UL-DCH/USCH</i> | If IE "Uplink transport channel type" is equal to "DCH" or "USCH" (TDD only) this IE is mandatory present. Otherwise the IE is not needed. |

10.3.7.71 Traffic volume measurement quantity

Contains the measurement quantity information for a traffic volume measurement.

| Information Element/Group name | Need | Multi | Type and reference | Semantics description |
|--|--------|-------|---|-----------------------------------|
| Measurement quantity | MP | | Enumerated(RLC buffer payload, Average RLC buffer payload, Variance of RLC buffer payload) | This parameter should be ignored. |
| Time Interval to take an average or a variance | CV-A/V | | Integer(20, 40, ..260, by steps of 20) | In ms |

| Condition | Explanation |
|-----------|--|
| A/V | This IE is mandatory present when "Average RLC buffer" or "Variance of RLC buffer payload" is chosen and not needed otherwise. |

10.3.7.72 Traffic volume measurement reporting criteria

Contains the measurement reporting criteria information for a traffic volume measurement.

Event 4a: Transport Channel Traffic Volume [15] exceeds an absolute threshold.

Event 4b: Transport Channel Traffic Volume [15] becomes smaller than an absolute threshold.

| Information Element/Group name | Need | Multi | Type and reference | Semantics description |
|--|----------------|-------------------------|--|---|
| Parameters sent for each transport channel | OP | 1 to <maxTrCH > | | This IE is always required, need is OP to align with ASN.1 |
| >Uplink transport channel type | OP | | Enumerated(DCH,RACH, USCH) | USCH is TDD only. RACH is the currently configured default in the uplink. For 1.28 Mcps TDD, if E-DCH is configured to the UE, and the Uplink transport channel type is USCH and UL Transport Channel identity is 32, it means E-DCH TVM is configured. |
| >UL Transport Channel ID | CV-UL-DCH/USCH | | Transport channel identity 10.3.5.18 | |
| >Parameters required for each Event | OP | 1 to <maxMeas parEvent> | | |
| >>Traffic volume event identity | MP | | Traffic volume event identity 10.3.7.66 | |
| >>Reporting Threshold | MP | | Enumerated(8,16,32,64,128,256,512,1024,2K,3K,4K,6K,8K,12K,16K,24K,32K,48K,64K,96K,128K,192K,256K,384K,512K,768K) | Threshold in bytes
And N Kbytes = N*1024 bytes |
| >>Time to trigger | OP | | Time to trigger 10.3.7.64 | Indicates the period of time during which the event condition has to be satisfied, before sending a Measurement Report. Time in ms |
| >>Pending time after trigger | OP | | Integer(250, 500, 1000, 2000, 4000, 8000, 16000) | Indicates the period of time during which it is forbidden to send any new measurement reports with the same Traffic volume event identity even if the triggering condition is fulfilled. Time in milliseconds |
| >>Tx interruption after trigger | OP | | Integer (250, 500, 1000, 2000, 4000, 8000, 16000) | Time in milliseconds. Indicates how long the UE shall block DTCH transmissions on the RACH after a measurement report is triggered. |

| Condition | Explanation |
|--------------------|---|
| <i>UL-DCH/USCH</i> | If IE "Uplink transport channel type" is equal to "DCH" or "USCH" (TDD only) this IE is optional. Otherwise the IE is not needed. |

10.3.7.73 Traffic volume measurement system information

| Information Element/Group name | Need | Multi | Type and reference | Semantics description |
|--|------|-------|--|--|
| Traffic volume measurement identity | MD | | Measurement identity
10.3.7.48 | The traffic volume measurement identity has default value 4. |
| Traffic volume measurement object | OP | | Traffic volume measurement object
10.3.7.70 | |
| Traffic volume measurement quantity | OP | | Traffic volume measurement quantity
10.3.7.71 | |
| Traffic volume reporting quantity | OP | | Traffic volume reporting quantity
10.3.7.74 | |
| Measurement validity | OP | | Measurement validity
10.3.7.51 | |
| Measurement Reporting Mode | MP | | Measurement Reporting Mode
10.3.7.49 | |
| <i>CHOICE reporting criteria</i> | MP | | | |
| >Traffic volume measurement reporting criteria | | | Traffic volume measurement reporting criteria
10.3.7.72 | |
| >Periodical reporting criteria | | | Periodical reporting criteria
10.3.7.53 | |

10.3.7.74 Traffic volume reporting quantity

Contains the reporting quantity information for a traffic volume measurement.

For all boolean types TRUE means inclusion in the report is requested.

| Information Element/Group name | Need | Multi | Type and reference | Semantics description |
|--|------|-------|--------------------|-----------------------|
| RLC Buffer Payload for each RB | MP | | Boolean | |
| Average of RLC Buffer Payload for each RB | MP | | Boolean | |
| Variance of RLC Buffer Payload for each RB | MP | | Boolean | |

10.3.7.75 UE internal event identity

| Information Element/Group name | Need | Multi | Type and reference | Semantics description |
|--------------------------------|------|-------|------------------------------------|-----------------------|
| UE internal event identity | MP | | Enumerated(6a,6b,6c,6d,6e, 6f, 6g) | |

10.3.7.76 UE internal measured results

| Information Element/Group name | Need | Multi | Type and reference | Semantics description | Version |
|-------------------------------------|------|--------------|---|---|---------|
| CHOICE <i>mode</i> | MP | | | | |
| >FDD | | | | | |
| >>UE Transmitted Power | OP | | UE Transmitted Power info 10.3.7.85 | | |
| >>>UE Rx-Tx report entries | OP | 1 to <maxRL> | | | |
| >>>>Primary CPICH info | MP | | Primary CPICH info 10.3.6.60 | Primary CPICH info for each cell included in the active set | |
| >>>>UE Rx-Tx time difference type 1 | MP | | UE Rx-Tx time difference type 1 10.3.7.83 | UE Rx-Tx time difference in chip for each RL included in the active set | |
| >TDD | | | | | |
| >>UE Transmitted Power list | OP | 1 to <maxTS> | | UE Transmitted Power for each used uplink timeslot in ascending timeslot number order | |
| >>>>UE Transmitted Power | MP | | UE Transmitted Power info 10.3.7.85 | | |
| >>>>CHOICE <i>TDD option</i> | MP | | | | REL-4 |
| >>>>>3.84 Mcps TDD | | | | | REL-4 |
| >>>>>>Applied TA | OP | | Uplink Timing Advance 10.3.6.95 | Uplink timing advance applied by the UE | |
| >>>>>>Extended Applied TA | OP | | Extended Uplink Timing Advance 10.3.6.95a | Uplink timing advance applied by the UE | REL-7 |
| >>>>>>>7.68 Mcps TDD | | | | | REL-7 |
| >>>>>>>>Extended Applied TA | OP | | Extended Uplink Timing Advance 10.3.6.95a | Uplink timing advance applied by the UE | REL-7 |
| >>>>>>>>>1.28 Mcps TDD | | | | | REL-4 |
| >>>>>>>>>>T _{ADV} | OP | | T _{ADV} info 10.3.7.112 | | REL-4 |

10.3.7.77 UE internal measurement

| Information Element/Group name | Need | Multi | Type and reference | Semantics description |
|---|------|-------|---|---|
| UE internal measurement quantity | OP | | UE internal measurement quantity
10.3.7.79 | |
| UE internal reporting quantity | OP | | UE internal reporting quantity
10.3.7.82 | |
| CHOICE <i>report criteria</i> | MP | | | |
| >UE internal measurement reporting criteria | | | UE internal measurement reporting criteria
10.3.7.80 | |
| >Periodical reporting criteria | | | Periodical reporting criteria
10.3.7.53 | |
| >No reporting | | | | (no data)
Chosen when this measurement only is used as additional measurement to another measurement |

| CHOICE <i>report criteria</i> | Condition under which the given <i>report criteria</i> is chosen |
|--|--|
| UE internal measurement reporting criteria | Chosen when UE internal measurement event triggering is required |
| Periodical reporting criteria | Chosen when periodical reporting is required |
| No reporting | Chosen when this measurement only is used as additional measurement to another measurement |

10.3.7.78 UE internal measurement event results

This IE contains the measurement event results that are reported to UTRAN for UE internal measurements.

| Information Element/Group name | Need | Multi | Type and reference | Semantics description |
|--------------------------------|--------------------|-------|---|-----------------------|
| UE internal event identity | MP | | UE internal event identity
10.3.7.75 | |
| CHOICE <i>mode</i> | MP | | | |
| >FDD | | | | |
| >Primary CPICH info | <i>CV-clause 1</i> | | Primary CPICH info
10.3.6.60 | |
| >TDD | | | | (no data) |

| Condition | Explanation |
|-----------------|---|
| <i>Clause 1</i> | This IE is mandatory present if the IE "UE internal event identity" is set to "6f" or "6g", otherwise the IE is not needed. |

10.3.7.79 UE internal measurement quantity

The quantity the UE shall measure in case of UE internal measurement.

| Information Element/Group name | Need | Multi | Type and reference | Semantics description | Version |
|--------------------------------|------|-------|---|---|---------|
| CHOICE <i>mode</i> | MP | | | | |
| >FDD | | | | | |
| >>Measurement quantity | MP | | Enumerated(UE Transmitted Power, UTRA Carrier RSSI, UE Rx-Tx time difference) | | |
| >TDD | | | | | |
| >>Measurement quantity | MP | | Enumerated(UE Transmitted Power, UTRA Carrier RSSI, T _{ADV}) | Measurement on Timing Advance is for 1.28 Mcps TDD | REL-4 |
| Filter coefficient | OP | | Filter coefficient 10.3.7.9 | If the IE "Measurement quantity" is set to "Rx-Tx time difference" and this IE is present, the UE behaviour is unspecified. | |

10.3.7.80 UE internal measurement reporting criteria

The triggering of the event-triggered reporting for a UE internal measurement. All events concerning UE internal measurements are labelled 6x where x is a, b, c.... In TDD, the events 6a - 6d are measured and reported on timeslot basis.

Event 6a: The UE Transmitted Power becomes larger than an absolute threshold

Event 6b: The UE Transmitted Power becomes less than an absolute threshold

Event 6c: The UE Transmitted Power reaches its minimum value

Event 6d: The UE Transmitted Power reaches its maximum value

Event 6e: The UE RSSI reaches the UEs dynamic receiver range

Event 6f (FDD): The UE Rx-Tx time difference for a RL included in the active set becomes larger than an absolute threshold

Event 6f (1.28 Mcps TDD): The time difference indicated by T_{ADV} becomes larger than an absolute threshold

Event 6g: The UE Rx-Tx time difference for a RL included in the active set becomes less than an absolute threshold

| Information Element/Group name | Need | Multi | Type and reference | Semantics description | Version |
|--|------|----------------------|--------------------------------------|-----------------------|---------|
| Parameters sent for each UE internal measurement event | OP | 1 to <maxMeas Event> | | | |
| >UE internal event identity | MP | | UE internal event identity 10.3.7.75 | | |

| Information Element/Group name | Need | Multi | Type and reference | Semantics description | Version |
|--|-------------|-------|---|--|---------|
| >Time-to-trigger | MP | | Integer(0, 10, 20, 40, 60, 80, 100, 120, 160, 200, 240, 320, 640, 1280, 2560, 5000) | Time in ms. Indicates the period of time between the timing of event detection and the timing of sending Measurement Report. | |
| >UE Transmitted Power Tx power threshold | CV-clause 1 | | Integer(-50..33) | Power in dBm. In event 6a, 6b. | |
| >UE Rx-Tx time difference threshold | CV-clause 2 | | Integer(768..1280) | Time difference in chip. In event 6f, 6g. | |
| >T _{ADV} threshold | CV-clause 3 | | Real (0..63 step 0.125) | Time difference in chip. In event 6f | REL-4 |

| Condition | Explanation |
|-----------|---|
| Clause 1 | The IE is mandatory present if the IE "UE internal event identity" is set to "6a" or "6b", otherwise the IE is not needed. |
| Clause 2 | In FDD, the IE is mandatory present if the IE "UE internal event identity" is set to "6f" or "6g", otherwise the IE is not needed. |
| Clause 3 | In 1.28 Mcps TDD the IE is mandatory present if the IE "UE internal event identity" is set to "6f", otherwise the IE is not needed. |

10.3.7.81 Void

10.3.7.82 UE Internal reporting quantity

For all boolean types TRUE means inclusion in the report is requested.

| Information Element/Group name | Need | Multi | Type and reference | Semantics description | Version |
|--------------------------------|------|-------|--------------------|-----------------------|---------|
| UE Transmitted Power | MP | | Boolean | | |
| CHOICE <i>mode</i> | MP | | | | |
| >FDD | | | | | |
| >>UE Rx-Tx time difference | MP | | Boolean | | |
| >TDD | | | | | |
| >>CHOICE <i>TDD option</i> | | | | | REL-4 |
| >>>3.84 Mcps TDD | | | | | REL-4 |
| >>>>Applied TA | MP | | Boolean | | |
| >>>>7.68 Mcps TDD | | | | | REL-7 |
| >>>>Applied TA | MP | | Boolean | | REL-7 |
| >>>>1.28 Mcps TDD | | | | | REL-4 |
| >>>>T _{ADV} info | MP | | Boolean | | REL-4 |

10.3.7.83 UE Rx-Tx time difference type 1

The difference in time between the UE uplink DPCCH/DPDCH frame transmission and the first detected path (in time), of the downlink DPCH or F-DPCH frame from the measured radio link, as defined in [7]. This measurement is for FDD only.

| Information Element/Group name | Need | Multi | Type and reference | Semantics description |
|---------------------------------|------|-------|--------------------|---|
| UE Rx-Tx time difference type 1 | MP | | Integer(768..1280) | In chips.
511 spare values are needed. |

10.3.7.84 UE Rx-Tx time difference type 2

The difference in time between the UE uplink DPCCH/DPDCH frame transmission and the first detected path (in time), of the downlink DPCH or F-DPCH frame from the measured radio link, as defined in [7].

| Information Element/Group name | Need | Multi | Type and reference | Semantics description |
|---------------------------------|------|-------|--------------------|-----------------------|
| UE Rx-Tx time difference type 2 | MP | | Integer (0..8191) | According to [19]. |

10.3.7.85 UE Transmitted Power info

| Information Element/Group name | Need | Multi | IE type and reference | Semantics description |
|--------------------------------|------|-------|-----------------------|---|
| UE Transmitted Power | MP | | Integer (0..104) | According to UE_TX_POWER in [19] and [20] |

10.3.7.86 UE positioning Ciphering info

This IE contains information for the ciphering of UE positioning assistance data broadcast in System Information.

| Information Element/Group name | Need | Multi | Type and Reference | Semantics description |
|--------------------------------|------|-------|--------------------|---|
| Ciphering Key Flag | MP | | Bit string(1) | |
| Ciphering Serial Number | MP | | Integer(0..65535) | The serial number used in the DES ciphering algorithm |

10.3.7.87 UE positioning Error

| Information Element/Group name | Need | Multi | Type and Reference | Semantics description | Version |
|--|-----------------------------|-------|--|-----------------------|---------|
| Error reason | MP | | Enumerated(Not Enough OTDOA Cells, Not Enough GPS Satellites, Assistance Data Missing, Not Accomplished GPS Timing Of Cell Frames, Undefined Error, Request Denied By User, Not Processed And Timeout, Reference Cell Not Serving Cell, | Note 1 | |
| | | | Not Enough GANSS Satellites, Not Accomplished GANSS Timing Of Cell Frames) | Note 1 | REL-7 |
| GPS Additional Assistance Data Request | CV- <i>GPSdataMissing</i> | | UE positioning GPS Additional Assistance Data Request 10.3.7.88a | | |
| GANSS Additional Assistance Data Request | CV- <i>GANSSdataMissing</i> | | UE positioning GANSS Additional Assistance Data Request 10.3.7.88c | | REL-7 |

NOTE 1: The following table describes each value of the IE "Error reason".

| Value | Indication |
|--|--|
| Not Enough OTDOA Cells | There were not enough cells to be received. |
| Not Enough GPS Satellites | There were not enough GPS satellites to be received. |
| Assistance Data Missing | UE positioning GANSS or/and GPS assistance data missing. |
| Not Accomplished GPS Timing Of Cell Frames | UE was not able to accomplish the GPS timing of cell frames measurement. |
| Undefined Error | Undefined error. |
| Request Denied By User | UE positioning request denied by upper layers. |
| Not Processed And Timeout | UE positioning request not processed by upper layers and timeout. |
| Reference Cell Not Serving Cell | UE was not able to read the SFN of the reference cell. |
| Not Enough GANSS Satellites | There were not enough GANSS satellites to be received. |
| Not Accomplished GANSS Timing Of Cell Frames | UE was not able to accomplish the GANSS timing of cell frames measurement. |

| Condition | Explanation |
|-------------------------|--|
| <i>GPSdataMissing</i> | The IE is optional if the IE "Error reason" is "Assistance Data Missing" and not needed otherwise. |
| <i>GANSSdataMissing</i> | The IE is optional if the IE "Error reason" is "Assistance Data Missing" and not needed otherwise. |

10.3.7.88 UE positioning GPS acquisition assistance

This IE contains parameters that enable fast acquisition of the GPS signals in UE-assisted GPS positioning.

| Information Element/Group name | Need | Multi | Type and Reference | Semantics description | Version |
|--|------|---------------|--|---|---------|
| GPS TOW msec | MP | | Integer(0..6.048*10 ⁸ -1) | GPS Time of Week in milliseconds rounded down to the nearest millisecond unit. It is also the time when satellite information is valid. | |
| UTRAN GPS reference time | OP | | | | |
| >UTRAN GPS timing of cell frames | MP | | Integer(0 ... 2322431999999) | GPS timing of cell frames in steps of 1 chip. | |
| >CHOICE mode | OP | | | | |
| >>FDD | | | | | |
| >>>Primary CPICH Info | MP | | Primary CPICH Info 10.3.6.60 | Identifies the reference cell for the GPS TOW-SFN relationship | |
| >>TDD | | | | | |
| >>>cell parameters id | MP | | Cell parameters id 10.3.6.9 | Identifies the reference cell for the GPS TOW-SFN relationship | |
| >SFN | MP | | Integer(0..4095) | The SFN which the UTRAN GPS timing of cell frames time stamps. | |
| UE Positioning GPS ReferenceTime Uncertainty | OP | | UE positioning GPS reference time uncertainty 10.3.7.96a | | REL-7 |
| Satellite information | MP | 1 to <maxSat> | | | |
| >SatID | MP | | Integer (0..63) | Identifies the satellite and is equal to (SV ID No - 1) where SV ID No is defined in [12]. | |
| >Doppler (0 th order term) | MP | | Real(-5120..5117.5 by step of 2.5) | Hz | |

| Information Element/Group name | Need | Multi | Type and Reference | Semantics description | Version |
|--|------|-------|--|---|---------|
| >Extra Doppler | OP | | | | |
| >>Doppler (1 st order term) | MP | | Real (-0.966..0.483 by step of 0.023) | Hz/s | |
| >>>Doppler Uncertainty | MP | | Enumerated (12.5,25,50,100,200) | Hz.
Three spare values are needed.
The Doppler experienced by a stationary UE is in the range 'Doppler – Doppler Uncertainty' to 'Doppler + Doppler Uncertainty'. | |
| >Code Phase | MP | | Integer(0..1022) | GPS chips.
Increasing binary values of the field signify increasing predicted pseudoranges. | |
| >Integer Code Phase | MP | | Integer(0..19) | Number of code periods that have elapsed since the latest GPS bit boundary, in units of C/A code period. | |
| >GPS Bit number | MP | | Integer(0..3) | Specifies GPS bit number modulo 4 | |
| >Code Phase Search Window | MP | | Integer(1023,1,2,3,4,6,8,12,16,24,32,48,64,96,128,192) | Expected code-phase is in the range 'Code Phase – Code Phase Search Window' to 'Code Phase + Code Phase Search Window'. | |
| >Azimuth and Elevation | OP | | | | |
| >>Azimuth | MP | | Real(0..348.75 by step of 11.25) | Degrees
An angle of x degrees means the satellite azimuth a is in the range $x \leq a < x+11.25$ degrees. | |
| >>>Elevation | MP | | Real(0..78.75 by step of 11.25) | Degrees
An angle of y degrees means the satellite elevation e is in the range $y \leq e < y+11.25$ degrees except for $y=78.75$ where the range is extended to include 90 degrees. | |

10.3.7.88a UE positioning GPS Additional Assistance Data Request

| Information Element/Group name | Need | Multi | Type and Reference | Semantics description |
|----------------------------------|--------------------------------|-------|--------------------|---|
| Almanac | MP | | Boolean | TRUE means requested |
| UTC Model | MP | | Boolean | TRUE means requested |
| Ionospheric model | MP | | Boolean | TRUE means requested |
| Navigation Model | MP | | Boolean | TRUE means requested |
| DGPS Corrections | MP | | Boolean | TRUE means requested |
| Reference Location | MP | | Boolean | TRUE means requested |
| Reference Time | MP | | Boolean | TRUE means requested |
| Acquisition Assistance | MP | | Boolean | TRUE means requested |
| Real-Time Integrity | MP | | Boolean | TRUE means requested |
| Navigation Model Additional data | CV-
<i>Navigation Model</i> | | | this IE is present only if "Navigation Model" is set to TRUE otherwise it is absent |
| >GPS Week | MP | | Integer (0..1023) | |

| Information Element/Group name | Need | Multi | Type and Reference | Semantics description |
|--------------------------------|------|---------------|--------------------|---|
| >GPS_Toe | MP | | Integer (0..167) | GPS time of ephemeris in hours of the latest ephemeris set contained by the UE. Eighty-eight spare values needed. |
| >T-Toe limit | MP | | Integer (0..10) | ephemeris age tolerance of the UE to UTRAN in hours. Five spare values needed. |
| >Satellites list related data | MP | 0 to <maxSat> | | |
| >>SatID | MP | | Integer (0..63) | Identifies the satellite and is equal to (SV ID No - 1) where SV ID No is defined in [12]. |
| >>IODE | MP | | Integer (0..255) | Issue of Data Ephemeris for SatID |

10.3.7.88b UE positioning GANSS reference measurement information

This IE provides reference code and Doppler measurement information of visible satellites of a GNSS constellation. The information enables fast acquisition of the GANSS signals in UE-assisted GANSS positioning. If the IE "UE positioning GPS acquisition assistance" is not included in IE "UE positioning measurement", the Satellite Information is valid at the time as given in the IE "UE positioning GANSS reference time" IE. I.e., if IE "UE positioning GANSS reference measurement information" is included in IE "UE positioning GANSS assistance data" and IE "UE positioning GPS acquisition assistance" is not included in IE "UE positioning measurement", the IE "UE positioning GANSS reference time" shall also be included. If the IE "UE positioning GPS acquisition assistance" is included in IE "UE positioning measurement", the IE "GPS TOW msec" and IE "UTRAN GPS reference time" included in IE "UE positioning GPS acquisition assistance" is also valid for the Satellite information in IE "UE positioning GANSS reference measurement information".

| Information Element/Group name | Need | Multi | Type and Reference | Semantics description | Version |
|--|------|--------------------|------------------------------------|---|---------|
| GANSS Signal ID | OP | | GANSS Signal Id
10.3.3.45a | Absence of this field means the default value as defined in 10.3.3.45a for the GANSS identified by GANSS_ID. If this IE is asked by SIB 15.6, the GANSS shall be solved by the scheduling information. | REL-7 |
| Satellite information | MP | 1 to <maxGANSSSat> | | | REL-7 |
| >SatID | MP | | Integer (0..63) | Identifies the satellite within a GANSS constellation. For coding description, see Note 2. | REL-7 |
| >Doppler (0 th order term) | MP | | Real(-1024..1023.5 by step of 0.5) | m/s
Conversion between m/s and Hz shall be made by using the <i>nominal</i> wavelength of the assisted signal. | REL-7 |
| >Extra Doppler | OP | | | | REL-7 |
| >>Doppler (1 st order term) | MP | | Real (-0.2..0.1 by step of 1/210) | m/s ² | REL-7 |
| >>Doppler Uncertainty | MP | | Enumerated (40,20,10,5, 2.5) | m/s.
The Doppler experienced by a stationary UE is in the range 'Doppler – Doppler Uncertainty' to 'Doppler + Doppler Uncertainty'. Three spare values are needed. | REL-7 |
| >Code Phase | MP | | Integer(0..1023) | ms, scaling factor 2 ⁻¹⁰
<i>Nominal</i> chipping rate of the GNSS signal shall be used in conversion. Increasing binary values of the field signify increasing predicted code phases. | REL-7 |
| >Integer Code Phase | MP | | Integer(0..127) | ms.
Integer code phase (expressed modulo 128 ms) currently being transmitted at the Reference Time included in either IE "UE positioning GANSS reference time" or IE "UE positioning GPS acquisition assistance", as seen by a receiver at the Reference Location. The UE can calculate the expected code phase as | REL-7 |

| Information Element/Group name | Need | Multi | Type and Reference | Semantics description | Version |
|--------------------------------|------|-------|----------------------------------|---|---------|
| | | | | follows:
Reference Time – Integer
Code Phase + Code Phase. | |
| >Code Phase Search Window | MP | | Bit string (5) | Coded expected code-phase is in the range 'Code Phase – Code Phase Search Window' to 'Code Phase + Code Phase Search Window'.
For coding description, see Note 1 | REL-7 |
| >Azimuth and Elevation | OP | | | | REL-7 |
| >>Azimuth | MP | | Real(0..348.75 by step of 11.25) | Degrees
An angle of x degrees means the satellite azimuth a is in the range $x \leq a < x+11.25$ degrees. | REL-7 |
| >>Elevation | MP | | Real(0..78.75 by step of 11.25) | Degrees
An angle of y degrees means the satellite elevation e is in the range $y \leq e < y+11.25$ degrees except for $y=78.75$ where the range is extended to include 90 degrees. | REL-7 |

NOTE 1: Code phase search window parameter format:

| CODE_PHASE_SEARCH_WINDOW | Code Phase Search Window [ms] |
|--------------------------|-------------------------------|
| '00000' | No information |
| '00001' | 0,002 |
| '00010' | 0,004 |
| '00011' | 0,008 |
| '00100' | 0,012 |
| '00101' | 0,016 |
| '00110' | 0,024 |
| '00111' | 0,032 |
| '01000' | 0,048 |
| '01001' | 0,064 |
| '01010' | 0,096 |
| '01011' | 0,128 |
| '01100' | 0,164 |
| '01101' | 0,200 |
| '01110' | 0,250 |
| '01111' | 0,300 |
| '10000' | 0,360 |
| '10001' | 0,420 |
| '10010' | 0,480 |
| '10011' | 0,540 |
| '10100' | 0,600 |
| '10101' | 0,660 |
| '10110' | 0,720 |
| '10111' | 0,780 |
| '11000' | 0,850 |
| '11001' | 1,000 |
| '11010' | 1,150 |
| '11011' | 1,300 |
| '11100' | 1,450 |
| '11101' | 1,600 |
| '11110' | 1,800 |
| '11111' | 2,000 |

NOTE 2: Interpretation of SatID:

| GNSS | Value of SatID | Interpretation of SatID |
|----------------|---------------------------|---|
| Galileo | TBD | TBD |
| Modernized GPS | "0" – "62"
"63" | Satellite PRN Signal No. 1 to 63
Reserved |
| SBAS | "0" – "38"
"39" – "63" | Satellite PRN Signal No. 120 to 158
Reserved |
| QZSS | "0" – "4"
"5" – "63" | Satellite PRN Signal No. 193 to 197
Reserved |
| GLONASS | "0" – "23"
"24" – "63" | Slot Number 1 to 24
Reserved |

10.3.7.88c UE positioning GANSS additional assistance data request

| Information Element/Group name | Need | Multi | Type and Reference | Semantics description | Version |
|---|------------------------|--------------------|--|---|---------|
| GANSS Reference Time | MP | | Boolean | TRUE means requested | REL-7 |
| GANSS Reference Location | MP | | Boolean | TRUE means requested | REL-7 |
| GANSS Ionospheric model | MP | | Boolean | TRUE means requested | REL-7 |
| GANSS Additional Ionospheric Model | OP | | Data ID
Bit String(2) | If present, the UE requests the 'UE positioning GANSS additional ionospheric model' for a 'Data ID' as defined in 10.3.7.92b. | REL-8 |
| GANSS Earth Orientation Parameters | OP | | Enumerated
(TRUE) | If present, the UE requests the 'UE positioning GANSS Earth orientation parameters' | REL-8 |
| GANSS Requested Generic Assistance Data | MP | 1 to
<maxGANSS> | | | REL-7 |
| >GANSS ID | OP | | Integer(0..7) | Absence of this IE means Galileo Values 0-7 reserved for future use. | REL-7 |
| | | | | Absence of this IE means Galileo.
For coding description see NOTE 1 in 10.3.7.90b. | REL-8 |
| >SBAS ID | CV-GANSS-
S-ID-SBAS | | UE positioning
GANSS
SBAS ID
10.3.7.97e | | REL-8 |
| >GANSS Real-Time Integrity | MP | | Boolean | TRUE means requested | REL-7 |
| >DGANSS Signal | OP | | DGANSS
Signal Id
10.3.7.88d | | REL-7 |
| >GANSS Almanac | MP | | Boolean | TRUE means requested | REL-7 |
| | | | | TRUE means requested.
If 'GANSS ID' indicates 'Modernized GPS' or 'QZSS' and IE 'GANSS additional assistance data choices' is not included, the GANSS Almanac model requested is 'Model-4' for Modernized GPS, and 'Model-2' for QZSS, as defined in 10.3.7.89a. | REL-8 |
| >GANSS Navigation Model | MP | | Boolean | TRUE means requested | REL-7 |
| >GANSS Additional Navigation Models | OP | | Enumerated
(TRUE) | If present, the UE requests the 'UE positioning GANSS additional navigation models'.
If 'GANSS ID' indicates 'QZSS' and IE 'GANSS additional assistance data choices' is not included, the GANSS orbit and clock model requested is 'Model-2' as defined in 10.3.7.91e and 10.3.7.91f, respectively. | REL-8 |
| >GANSS Time Model GNSS-GNSS | OP | | BIT STRING
(8) | The reference system for requested GANSS time model GNSS-GNSS is as indicated in IE "GANSS ID". The models are requested for each system with respective bit set to '1'.
Bit 0 is set for GPS,
Bit 1 is set for Galileo.
Other bits are reserved | REL-7 |

| Information Element/Group name | Need | Multi | Type and Reference | Semantics description | Version |
|--|-------------------------------------|--------------------|--------------------------------|--|----------------|
| | | | | Bit 2 is set for QZSS
Bit 3 is set for GLONASS
Other bits are reserved | REL-8 |
| >GANSS Reference Measurement Information | MP | | Boolean | TRUE means requested | REL-7 |
| >GANSS data bits | OP | | | | REL-7 |
| >>GANSS TOD | MP | | INTEGER (0..86399) | This field contains the reference time modulo 86400 seconds of the first data bit of the requested data in integer seconds in GNSS specific system time of the GNSS indicated by IE "GANSS ID". | REL-7 |
| >>>Data bit assistance | MP | | | | REL-7 |
| >>>>GANSS Signal ID | MP | | DGANSS Signal Id
10.3.7.88d | | REL-7 |
| >>>>GANSS Data Bit Interval | MP | | Integer (0..15) | This field represents the time length for which the Data Bit Assistance is requested. The Data Bit Assistance shall be relative to the time interval (GANSS TOD, GANSS TOD + Data Bit Interval).
The Data Bit Interval r , expressed in seconds, is mapped to a binary number K with the following formula:
$r = 0.1 * 2^K$
Value $K=15$ means that the time interval is not specified. | REL-7 |
| >>>>Satellite Information | OP | 1 to <maxGANSSSat> | | | REL-7 |
| >>>>>Satellite ID | MP | | Integer (0..63) | Identifies the satellite for which the Data Bit Assistance request is applicable and is as defined in Note 2 of 10.3.7.88b. | REL-7 |
| >GANSS UTC model | MP | | Boolean | TRUE means Requested | REL-7 |
| >GANSS Additional UTC Models | OP | | Enumerated (TRUE) | If present, the UE requests the 'UE positioning GANSS additional UTC models' | REL-8 |
| >GANSS Auxiliary Information | OP | | Enumerated (TRUE) | If present, the UE requests the 'UE positioning GANSS auxiliary information' | REL-8 |
| >GANSS Navigation Model Additional data | CV-
GANSSNa
vigation
Model | | | | REL-7 |
| >>GANSS Week/Day | MP | | Integer (0..4095) | If 'GANSS ID' does not indicate 'GLONASS', this IE defines the GANSS Week number of the assistance currently held by the MS.
If 'GANSS ID' is set to 'GLONASS', this IE defines the calendar number of day within the four-year interval starting from 1st of January in a leap year, as defined by the parameter N_T in [73] of the assistance currently held by the MS. | REL-7
REL-8 |

| Information Element/Group name | Need | Multi | Type and Reference | Semantics description | Version |
|---|------------------------------|--------------------|--------------------|--|---------|
| >>GANSS_Toe | MP | | Integer (0..167) | If 'GANSS ID' does not indicate 'GLONASS', this IE defines the GANSS time of ephemeris in hours of the latest ephemeris set contained by the UE. | REL-7 |
| | | | | If 'GANSS ID' is set to 'GLONASS', this IE defines the time of ephemeris in units of 15 minutes of the latest ephemeris set contained by the UE (range 0 to 95 representing time values between 0 and 1425 minutes). In this case, values 96 to 167 shall not be used by the sender. | REL-8 |
| >>T-Toe limit | MP | | Integer (0..10) | If 'GANSS ID' does not indicate 'GLONASS', this IE defines the ephemeris age tolerance of the UE to UTRAN in units of hours. Five spare values needed. | REL-7 |
| | | | | If 'GANSS ID' is set to 'GLONASS', this IE defines the ephemeris age tolerance of the UE to UTRAN in units of 30 minutes (range 0 to 10 representing time values of 0 to 300 minutes). | REL-8 |
| >>Satellites list related data | OP | 1 to <maxGANSSSat> | | | REL-7 |
| >>>SatID | MP | | Integer (0..63) | Identifies the satellite and is as defined in Note 2 of 10.3.7.88b. | REL-7 |
| >>>IOD | MP | | Integer (0..1023) | 10 LSBs of Issue of Data for SatID | REL-7 |
| >GANSS additional assistance data choices | CV-
Assistance
Choices | | | | REL-8 |
| >>Orbit Model ID | OP | | Integer (0..7) | This IE may be included if IE "GANSS Navigation Model" is set to TRUE or if the IE 'GANSS Additional Navigation Models' is included and defines the non-native or non-default orbit model number as defined in 10.3.7.91c/10.3.7.91e. | REL-8 |
| >>Clock Model ID | OP | | Integer (0..7) | This IE may be included if IE "GANSS Navigation Model" is set to TRUE or if the IE 'GANSS Additional Navigation Models' is included and defines the non-native or non-default clock model number as defined in 10.3.7.91d/10.3.7.91f. | REL-8 |
| >>UTC Model ID | OP | | Integer (0..7) | This IE may be included if IE 'GANSS Additional UTC Models' is included and defines the non-native or non-default UTC model number as defined in 10.3.7.97d. | REL-8 |

| Information Element/Group name | Need | Multi | Type and Reference | Semantics description | Version |
|--------------------------------|------|-------|--------------------|--|---------|
| >>Almanac Model ID | OP | | Integer (0..7) | This IE may be included if IE 'GANSS Almanac' set to TRUE and defines the non-native or non-default model number as defined in 10.3.7.89a. | REL-8 |

| Condition | Explanation |
|------------------------------|---|
| <i>GANSS-ID-SBAS</i> | This IE is mandatory present if the IE 'GANSS ID' is 'SBAS' and not needed otherwise. |
| <i>GANSSNavigation Model</i> | The IE is mandatory present if the IE "GANSS Navigation Model" is set to TRUE or if the IE 'GANSS Additional Navigation Models' is included and not needed otherwise. |
| <i>AssistanceChoices</i> | This IE is mandatory present if non-native or non-default assistance data choices are requested and not needed otherwise. |

10.3.7.88d DGANSS Signal Id

The DGANSS signal Id refers to the signal for which differential corrections or data bit assistance are required. It depends on the GANSS ID. Each bit refers to a particular signal. When the bit is set to 1, this means that the differential corrections or data bit assistance are requested for this particular signal. Differential corrections or data bit assistance can be requested for several signals using the bit string.

| Information Element/Group name | Need | Multi | Type and Reference | Semantics description | Version |
|--------------------------------|------|-------|--------------------|-----------------------|---------|
| DGANSS Signal Id | MP | | BIT STRING (8) | See Note 1. | REL-7 |

NOTE 1:

| GANSS Id | Bit number | Explanation | Version |
|-------------------|------------|-------------|---------|
| Default : Galileo | 0 | Galileo E1 | REL-7 |
| | 1 | Galileo E5A | |
| | 2 | Galileo E5B | |
| | 3 | Galileo E6 | |
| | 4 | spare | |
| | 5 | Spare | |
| | 6 | Spare | |
| | 7 | Spare | |
| Modernized GPS | 0 | L1C | REL-8 |
| | 1 | L2C | |
| | 2 | L5 | |
| | 3 | Spare | |
| | 4 | Spare | |
| | 5 | Spare | |
| | 6 | Spare | |
| | 7 | Spare | |
| SBAS | 0 | L1 | REL-8 |
| | 1 | Spare | |
| | 2 | Spare | |
| | 3 | Spare | |
| | 4 | Spare | |
| | 5 | Spare | |
| | 6 | Spare | |
| | 7 | Spare | |
| QZSS | 0 | QZS-L1 | REL-8 |
| | 1 | QZS-L1C | |
| | 2 | QZS-L2C | |
| | 3 | QZS-L5 | |
| | 4 | Spare | |
| | 5 | Spare | |
| | 6 | Spare | |
| | 7 | Spare | |
| GLONASS | 0 | G1 | REL-8 |
| | 1 | G2 | |
| | 2 | G3 | |
| | 3 | Spare | |
| | 4 | Spare | |
| | 5 | Spare | |
| | 6 | Spare | |
| | 7 | spare | |

10.3.7.89 UE positioning GPS almanac

This IE contains a reduced-precision subset of the ephemeris and clock correction parameters.

| Information Element/Group name | Need | Multi | Type and Reference | Semantics description |
|--------------------------------|------|---------------|--------------------|--|
| WN _a | MP | | Bit string(8) | Almanac Reference Week [12] |
| Satellite information | MP | 1 to <maxSat> | | |
| >DataID | MP | | Integer(0..3) | See [12] |
| >SatID | MP | | Enumerated(0..63) | Identifies the satellite and is equal to (SV ID No - 1) where SV ID No is defined in [12]. |
| >e | MP | | Bit string(16) | Eccentricity [12] |
| >t _{oa} | MP | | Bit string(8) | Reference Time of Almanac [12] |
| >δi | MP | | Bit string(16) | |
| >OMEGADOT | MP | | Bit string(16) | Longitude of Ascending Node of Orbit Plane at Weekly Epoch (semi-circles/sec) [12] |
| >SV Health | MP | | Bit string(8) | |
| >A ^{1/2} | MP | | Bit string(24) | Semi-Major Axis (meters) ^{1/2} [12] |
| >OMEGA ₀ | MP | | Bit string(24) | Longitude of Ascending Node of Orbit Plane at Weekly Epoch (semi-circles) [12] |
| >M ₀ | MP | | Bit string(24) | Mean Anomaly at Reference Time (semi-circles) [12] |
| >ω | MP | | Bit string(24) | Argument of Perigee (semi-circles) [12] |
| >af ₀ | MP | | Bit string(11) | apparent clock correction [12] |
| >af ₁ | MP | | Bit string(11) | apparent clock correction [12] |
| SV Global Health | OP | | Bit string(364) | This enables GPS time recovery and possibly extended GPS correlation intervals. It is specified in page 25 of subframes 4 and 5 [12] |

10.3.7.89a UE positioning GANSS almanac

This IE contains a reduced-precision subset of the ephemeris and clock correction parameters.

| Information Element/Group name | Need | Multi | Type and Reference | Semantics description | Version |
|--------------------------------------|------|---------------------|-------------------------------------|--|---------|
| Week Number | MP | | Integer(0..255) | Almanac reference week , number of weeks since the beginning of GANSS specific system time (mod 256) | REL-7 |
| | | | | If 'Model 5' or 'Model 6' is included, the UE shall ignore the Week Number. | REL-8 |
| Keplerian parameters ('Model 1') | OP | | | NOTE | REL-7 |
| >T _{oa} | MP | | Integer(0..60 2112 by step of 4096) | Almanac Reference Time common to all satellites in GANSS Almanac using Keplerian Parameters given in GNSS specific system time | REL-7 |
| >IOD _a | MP | | INTEGER(0..3) | Issue-Of –Data, common to all satellites | REL-7 |
| >Satellite information KP | MP | 1 to <maxGAN SSSat> | | Almanacs are in the order of the SV IDs, the smallest ID first. | REL-7 |
| >>SV ID | MP | | Integer (0..63) | Satellite ID, as defined in Note 2 of 10.3.7.88b. | REL-7 |
| >>e | MP | | Bit string(11) | Eccentricity, dimensionless [61] | REL-7 |
| >>δ _i | MP | | Bit string(11) | semi-circles [61] | REL-7 |
| >>OMEGADOT | MP | | Bit string(11) | Longitude of Ascending Node of Orbit Plane at Weekly Epoch (semi-circles/sec) [61] | REL-7 |
| >>SV Health KP | MP | | Bit string(4) | Dimensionless. For GANSS Id referring to Galileo, this is described in [61] | REL-7 |
| >>delta A ^{1/2} | MP | | Bit string(17) | Semi-Major Axis delta (meters) ^{1/2} [61] | REL-7 |
| >>OMEGA ₀ | MP | | Bit string(16) | Longitude of Ascending Node of Orbit Plane at Weekly Epoch (semi-circles) [61] | REL-7 |
| >>M ₀ | MP | | Bit string(16) | Mean Anomaly at Reference Time (semi-circles) [61] | REL-7 |
| >>ω | MP | | Bit string(16) | Argument of Perigee (semi-circles) [61] | REL-7 |
| >>af ₀ | MP | | Bit string(14) | Seconds [61] | REL-7 |
| >>af ₁ | MP | | Bit string(11) | sec/sec [61] | REL-7 |
| NAV Keplerian Parameters ('Model 2') | OP | | | NOTE | REL-8 |
| >T _{oa} | MP | | Integer(0..60 2112 by step of 4096) | Almanac Reference Time | REL-8 |
| >Satellite information NAV-KP | MP | 1 to <maxGAN SSSat> | | | REL-8 |
| >>SV ID | MP | | Integer (0..63) | Satellite ID, as defined in Note 2 of 10.3.7.88b. | REL-8 |
| >>e | MP | | Bit String(16) | Eccentricity, dimensionless [72] | REL-8 |
| >>δ _i | MP | | Bit String(16) | Correction to inclination, semi-circles [72] | REL-8 |
| >>OMEGADOT | MP | | Bit String(16) | Rate of right ascension, semi-circles/sec [72] | REL-8 |
| >>SV Health | MP | | Bit String(8) | Satellite health [72] | REL-8 |
| >>A ^{1/2} | MP | | Bit String(24) | Square root of the semi-major axis, meters ^{1/2} [72] | REL-8 |

| | | | | | |
|--|----|---------------------|-------------------------------------|---|-------|
| >>OMEGA ₀ | MP | | Bit String(24) | Longitude of ascending node of orbit plane at weekly epoch, semi-circles [72] | REL-8 |
| >> ω | MP | | Bit String(24) | Argument of perigee semi-circles [72] | REL-8 |
| >>M ₀ | MP | | Bit String(24) | Mean anomaly at reference time semi-circles [72] | REL-8 |
| >>af ₀ | MP | | Bit String(11) | Apparent satellite clock correction seconds [72] | REL-8 |
| >>af ₁ | MP | | Bit String(11) | Apparent satellite clock correction sec/sec [72] | REL-8 |
| Reduced Keplerian Parameters ('Model 3') | OP | | | NOTE | REL-8 |
| >T _{oa} | MP | | Integer(0..60 2112 by step of 4096) | Almanac Reference Time | REL-8 |
| >Satellite information RED-KP | MP | 1 to <maxGAN SSSat> | | | REL-8 |
| >>SV ID | MP | | Integer (0..63) | Satellite ID, as defined in Note 2 of 10.3.7.88b. | REL-8 |
| >> δ_A | MP | | Bit String(8) | meters [68,69,70,72] | REL-8 |
| >> Ω_0 | MP | | Bit String(7) | semi-circles [68,69,70,72] | REL-8 |
| >> Φ_0 | MP | | Bit String(7) | semi-circles [68,69,70,72] | REL-8 |
| >>L1 Health | MP | | Bit String(1) | dimensionless [68,69,70,72] | REL-8 |
| >>L2 Health | MP | | Bit String(1) | dimensionless [68,69,70,72] | REL-8 |
| >>L5 Health | MP | | Bit String(1) | dimensionless [68,69,70,72] | REL-8 |
| Midi Keplerian Parameters ('Model 4') | OP | | | NOTE | REL-8 |
| >T _{oa} | MP | | Integer(0..60 2112 by step of 4096) | Almanac Reference Time | REL-8 |
| >Satellite information MIDI-KP | MP | 1 to <maxGAN SSSat> | | | REL-8 |
| >>SV ID | MP | | Integer (0..63) | Satellite ID, as defined in Note 2 of 10.3.7.88b. | REL-8 |
| >>e | MP | | Bit String(11) | dimensionless [68,69,70,72] | REL-8 |
| >> δ_i | MP | | Bit String(11) | semi-circles [68,69,70,72] | REL-8 |
| >> Ω_{dot} | MP | | Bit String(11) | semi-circles/sec [68,69,70,72] | REL-8 |
| >>sqrtA | MP | | Bit String(17) | meters ^{1/2} [68,69,70,72] | REL-8 |
| >> Ω_0 | MP | | Bit String(16) | semi-circles [68,69,70,72] | REL-8 |
| >> ω | MP | | Bit String(16) | semi-circles [68,69,70,72] | REL-8 |
| >>M ₀ | MP | | Bit String(16) | semi-circles [68,69,70,72] | REL-8 |
| >>a _{io} | MP | | Bit String(11) | seconds [68,69,70,72] | REL-8 |
| >>a _{r1} | MP | | Bit String(10) | sec/sec [68,69,70,72] | REL-8 |
| >>L1 Health | MP | | Bit String(1) | Dimensionless [68,69,70,72] | REL-8 |
| >>L2 Health | MP | | Bit String(1) | dimensionless [68,69,70,72] | REL-8 |
| >>L5 Health | MP | | Bit String(1) | dimensionless [68,69,70,72] | REL-8 |
| GLONASS Keplerian Parameters ('Model 5') | OP | | | NOTE | REL-8 |
| >Satellite information GLO-KP | MP | 1 to <maxGAN SSSat> | | | REL-8 |
| >>N ^A | MP | | Bit String(11) | days [73] | REL-8 |
| >>n ^A | MP | | Bit String(5) | dimensionless [73] | REL-8 |
| >>H _n ^A | MP | | Bit String(5) | dimensionless [73] | REL-8 |
| >> λ_n^A | MP | | Bit String(21) | semi-circles [73] | REL-8 |
| >>t _{ln} ^A | MP | | Bit String(21) | seconds [73] | REL-8 |
| >> Δi_n^A | MP | | Bit String(18) | semi-circles [73] | REL-8 |
| >> ΔT_n^A | MP | | Bit String(22) | sec/orbit period [73] | REL-8 |
| >> $\Delta T_{DOT_n}^A$ | MP | | Bit String(7) | sec/orbit period ² [73] | REL-8 |

| | | | | | |
|----------------------------------|----|---------------------|-----------------|---|-------|
| >> ϵ_n^A | MP | | Bit String(15) | dimensionless [73] | REL-8 |
| >> ω_n^A | MP | | Bit String(16) | semi-circles [73] | REL-8 |
| >> τ_n^A | MP | | Bit String(10) | seconds [73] | REL-8 |
| >> C_n^A | MP | | Bit String(1) | dimensionless [73] | REL-8 |
| >> M_n^A | OP | | Bit String(2) | dimensionless [73] | REL-8 |
| SBAS ECEF Parameters ('Model 6') | OP | | | NOTE | REL-8 |
| >Satellite information SBAS-ECEF | MP | 1 to <maxGAN SSSat> | | | REL-8 |
| >>Data ID | MP | | Bit String(2) | Dimensionless [71] | |
| >>SV ID | MP | | Integer (0..63) | Satellite ID, as defined in Note 2 of 10.3.7.88b. | REL-8 |
| >>Health | MP | | Bit String(8) | Dimensionless [71] | REL-8 |
| >> X_G | MP | | Bit String(15) | meters [71] | REL-8 |
| >> Y_G | MP | | Bit String(15) | meters [71] | REL-8 |
| >> Z_G | MP | | Bit String(9) | meters [71] | REL-8 |
| >> X_G Rate-of-Change | MP | | Bit String(3) | meters/sec [71] | REL-8 |
| >> Y_G Rate-of-Change | MP | | Bit String(3) | meters/sec [71] | REL-8 |
| >> Z_G Rate-of-Change | MP | | Bit String(4) | meters/sec [71] | REL-8 |
| >> t_0 | MP | | Bit String(11) | seconds [71] | REL-8 |

NOTE: This IE shall contain exactly one of the optional fiels indicated by "NOTE".

10.3.7.90 UE positioning GPS assistance data

This IE contains GPS assistance data.

| Information Element/Group name | Need | Multi | Type and Reference | Semantics description |
|--|------|-------|--|--|
| UE positioning GPS reference time | OP | | UE positioning GPS reference time
10.3.7.96 | |
| UE positioning GPS reference UE position | OP | | Ellipsoid point with altitude and uncertainty ellipsoid
10.3.8.4c | A priori knowledge of UE 3-D position. |
| UE positioning GPS DGPS corrections | OP | | UE positioning GPS DGPS corrections
10.3.7.91 | |
| UE positioning GPS navigation model | OP | | UE positioning GPS navigation model
10.3.7.94 | |
| UE positioning GPS ionospheric model | OP | | UE positioning GPS ionospheric model
10.3.7.92 | |
| UE positioning GPS UTC model | OP | | UE positioning GPS UTC model
10.3.7.97 | |
| UE positioning GPS almanac | OP | | UE | |

| Information Element/Group name | Need | Multi | Type and Reference | Semantics description |
|---|------|-------|--|-----------------------|
| | | | positioning
GPS
almanac
10.3.7.89 | |
| UE positioning GPS acquisition assistance | OP | | UE
positioning
GPS
acquisition
assistance
10.3.7.88 | |
| UE positioning GPS real-time integrity | OP | | UE
positioning
GPS real-
time integrity
10.3.7.95 | |

10.3.7.90a Void

10.3.7.90b UE positioning GANSS assistance data

This IE contains GANSS assistance data.

| Information Element/Group name | Need | Multi | Type and Reference | Semantics description | Version |
|---|--------------------------|-------------------|--|---|---------|
| UE positioning GANSS reference time | OP | | UE positioning GANSS reference time
10.3.7.96o | | REL-7 |
| UE positioning GANSS reference UE position | OP | | Ellipsoid point with altitude and uncertainty ellipsoid
10.3.8.4c | A priori knowledge of UE 3-D position.If IE 'UE positioning GPS assistance data' is present, this IE should not be included to both IEs.
The reference UE position is provided in WGS-84 reference system. | REL-7 |
| UE positioning GANSS ionospheric model | OP | | UE positioning GANSS ionospheric model
10.3.7.92a | | REL-7 |
| UE positioning GANSS additional ionospheric model | OP | | UE positioning GANSS additional ionospheric model
10.3.7.92b | | REL-8 |
| UE positioning GANSS Earth orientation parameters | OP | | UE positioning GANSS Earth orientation parameters
10.3.7.92c | | REL-8 |
| GANSS Generic Assistance Data | OP | 1 to <maxGANSS> | | | REL-7 |
| >GANSS ID | OP | | Integer(0..7) | Absence of this IE means Galileo
Values 0-7 reserved for future use. | REL-7 |
| | | | | Absence of this IE means Galileo.
For coding description see NOTE 1. | REL-8 |
| >UE positioning GANSS SBAS ID | CV-
GANSS-ID
-SBAS | | UE positioning GANSS SBAS ID
10.3.7.97e | | REL-8 |
| >GANSS Time Models | OP | 1 to <maxGANSS-1> | | | REL-7 |
| >>GANSS Time Model | MP | | UE positioning GANSS time model
10.3.7.97a | | REL-7 |
| >UE positioning DGANSS corrections | OP | | UE positioning DGANSS corrections
10.3.7.91b | | REL-7 |
| >UE positioning GANSS navigation model | OP | | UE positioning GANSS | NOTE | REL-7 |

| Information Element/Group name | Need | Multi | Type and Reference | Semantics description | Version |
|---|------|-------|--|-----------------------|---------|
| | | | navigation model
10.3.7.94a | | |
| >UE positioning GANSS additional navigation models | OP | | UE positioning GANSS additional navigation models
10.3.7.94b | NOTE | REL-8 |
| >UE positioning GANSS real-time integrity | OP | | UE positioning GANSS real-time integrity
10.3.7.95b | | REL-7 |
| >UE positioning GANSS data bit assistance | OP | | UE positioning GANSS data bit assistance
10.3.7.97b | | REL-7 |
| >UE positioning GANSS reference measurement information | OP | | UE positioning GANSS reference measurement information
10.3.7.88b | | REL-7 |
| >UE positioning GANSS almanac | OP | | UE positioning GANSS almanac
10.3.7.89a | | REL-7 |
| >UE positioning GANSS UTC model | OP | | UE positioning GANSS UTC model
10.3.7.97c | | REL-7 |
| >UE positioning GANSS additional UTC models | OP | | UE positioning GANSS additional UTC models
10.3.7.97d | | REL-8 |
| >UE positioning GANSS auxiliary information | OP | | UE positioning GANSS auxiliary information
10.3.7.97f | | REL-8 |

NOTE: If included, only one of the optional fields indicated by "NOTE" shall be present.

| Condition | Explanation |
|---------------|--|
| GANSS-ID-SBAS | The IE is mandatory present if the IE "GANSS ID" is "SBAS" and not needed otherwise. |

NOTE 1: Coding of GANSS ID

| Value of GANSS ID | GANSS | Version |
|-------------------|-------------------------|---------|
| 0 | SBAS | REL-8 |
| 1 | Modernized GPS | |
| 2 | QZSS | |
| 3 | GLONASS | |
| 4-7 | Reserved for future use | |

10.3.7.91 UE positioning GPS DGPS corrections

This IE contains DGPS corrections to be used by the UE.

| Information Element/Group name | Need | Multi | Type and Reference | Semantics description |
|--------------------------------|--------------------------|---------------|--|---|
| GPS TOW sec | MP | | Integer(0..604799) | seconds
GPS time-of-week when the DGPS corrections were calculated |
| Status/Health | MP | | Enumerated(UDRE scale 1.0, UDRE scale 0.75, UDRE scale 0.5, UDRE scale 0.3, UDRE scale 0.2, UDRE scale 0.1, no data, invalid data) | |
| DGPS information | CV- <i>Status/Health</i> | 1 to <maxSat> | | If the Cipher information is included these fields are ciphered. |
| >SatID | MP | | Enumerated (0...63) | Identifies the satellite and is equal to (SV ID No - 1) where SV ID No is defined in [12]. |
| >IODE | MP | | Integer(0..255) | |
| >UDRE | MP | | Enumerated(UDRE ≤ 1.0 m, 1.0m < UDRE ≤ 4.0m, 4.0m < UDRE ≤ 8.0m, 8.0m < UDRE) | The value in this field shall be multiplied by the UDRE Scale Factor in the IE Status/Health to determine the final UDRE estimate for the particular satellite. |
| >PRC | MP | | Real(-655.04..655.04 by step of 0.32) | meters (different from [13]) |
| >RRC | MP | | Real(-4.064..4.064 by step of 0.032) | meters/sec (different from [13]) |
| >Delta PRC2 | MP | | Integer(-127..127) | In this version of the protocol this IE should be set to zero and the UE shall ignore it |
| >Delta RRC2 | MP | | Real(-0.224..0.224 by step of 0.032) | In this version of the protocol this IE should be set to zero and the UE shall ignore it |

| Information Element/Group name | Need | Multi | Type and Reference | Semantics description |
|--------------------------------|------|-------|--------------------------------------|---|
| >Delta PRC3 | OP | | Integer(-127..127) | This IE should not be included in this version of the protocol and if received the UE shall ignore it |
| >Delta RRC3 | OP | | Real(-0.224..0.224 by step of 0.032) | This IE should not be included in this version of the protocol and if received the UE shall ignore it |

| Condition | Explanation |
|----------------------|---|
| <i>Status/Health</i> | This IE is mandatory present if "status" is not equal to "no data" or "invalid data", otherwise the IE is not needed. |

10.3.7.91a UE positioning GPS Ephemeris and Clock Correction parameters

This IE contains information for GPS ephemeris and clock correction.

| Information Element/Group name | Need | Multi | Type and Reference | Semantics description |
|--------------------------------|------|-------|--------------------|---|
| C/A or P on L2 | MP | | Bit string(2) | Code(s) on L2 Channel [12] |
| URA Index | MP | | Bit string(4) | User Range Accuracy [12] |
| SV Health | MP | | Bit string(6) | [12] |
| IODC | MP | | Bit string(10) | Issue of Data, Clock [12] |
| L2 P Data Flag | MP | | Bit string(1) | [12] |
| SF 1 Reserved | MP | | Bit string(87) | [12] |
| T _{GD} | MP | | Bit string(8) | Estimated group delay differential [12] |
| t _{oc} | MP | | Bit string(16) | apparent clock correction [12] |
| af ₂ | MP | | Bit string(8) | apparent clock correction [12] |
| af ₁ | MP | | Bit string(16) | apparent clock correction [12] |
| af ₀ | MP | | Bit string(22) | apparent clock correction [12] |
| C _{rs} | MP | | Bit string(16) | Amplitude of the Sine Harmonic Correction Term to the Orbit Radius (meters) [12] |
| Δn | MP | | Bit string(16) | Mean Motion Difference From Computed Value (semi-circles/sec) [12] |
| M ₀ | MP | | Bit string(32) | Mean Anomaly at Reference Time (semi-circles) [12] |
| C _{uc} | MP | | Bit string(16) | Amplitude of the Cosine Harmonic Correction Term To The Argument Of Latitude (radians) [12] |
| e | MP | | Bit string(32) | c |
| C _{us} | MP | | Bit string(16) | Amplitude of the Sine Harmonic Correction Term To The Argument Of Latitude (radians) [12] |
| (A) ^{1/2} | MP | | Bit string(32) | Semi-Major Axis (meters) ^{1/2} [12] |
| t _{oe} | MP | | Bit string(16) | Reference Time Ephemeris [12] |
| Fit Interval Flag | MP | | Bit string(1) | [12] |
| AODO | MP | | Bit string(5) | Age Of Data Offset [12] |
| C _{ic} | MP | | Bit string(16) | Amplitude of the Cosine Harmonic Correction Term To The Angle Of Inclination (radians) [12] |

| Information Element/Group name | Need | Multi | Type and Reference | Semantics description |
|--------------------------------|------|-------|--------------------|---|
| OMEGA ₀ | MP | | Bit string(32) | Longitude of Ascending Node of Orbit Plane at Weekly Epoch (semi-circles) [12] |
| C _{is} | MP | | Bit string(16) | Amplitude of the Sine Harmonic Correction Term To The Angle Of Inclination (radians) [12] |
| i ₀ | MP | | Bit string(32) | Inclination Angle at Reference Time (semi-circles) [12] |
| C _{rc} | MP | | Bit string(16) | Amplitude of the Cosine Harmonic Correction Term to the Orbit Radius (meters) [12] |
| ω | MP | | Bit string(32) | Argument of Perigee (semi-circles) [12] |
| OMEGA _{dot} | MP | | Bit string(24) | Longitude of Ascending Node of Orbit Plane at Weekly Epoch (semi-circles/sec) [12] |
| Idot | MP | | Bit string(14) | Rate of Inclination Angle (semi-circles/sec) [12] |

10.3.7.91b UE positioning DGNSS corrections

This IE contains DGNSS corrections to be used by the UE.

| Information Element/Group name | Need | Multi | Type and Reference | Semantics description | Version |
|--------------------------------|------------------|--------------------|--|---|---------|
| DGANSS Reference Time | MP | | Integer(0..3570 by step of 30) | Seconds.
Time in GNSS system time (modulo 3600 s) when the DGANSS corrections were calculated | REL-7 |
| DGANSS information | MP | 1 to <maxSgnType> | | | REL-7 |
| >GANSS Signal ID | OP | | GANSS Signal Id 10.3.3.45a | Absence of this field means the default value as defined in 10.3.3.45a for the GANSS identified by GANSS_ID. | REL-7 |
| >Status/Health | MP | | Enumerated(UDRE scale 1.0, UDRE scale 0.75, UDRE scale 0.5, UDRE scale 0.3, UDRE scale 0.2, UDRE scale 0.1, no data, invalid data) | | REL-7 |
| >DGANSS signal information | CV-Status/Health | 1 to <maxGANSSSat> | | If the Cipher information is included these fields are ciphered. | REL-7 |
| >>SatID | MP | | Integer (0..63) | Identifies the satellite and is as defined in Note 2 of 10.3.7.88b. | REL-7 |
| >>IOD | MP | | Bit string(10) | 10 LSBs of Issue of Data field, which contains the identity of the GANSS Navigation Model. | REL-7 |
| >>UDRE | MP | | Enumerated(UDRE ≤ 1.0 m, 1.0m < UDRE ≤ 4.0m, 4.0m < UDRE ≤ 8.0m, 8.0m < UDRE) | The value in this field shall be multiplied by the UDRE Scale Factor in the IE Status/Health to determine the final UDRE estimate for the particular satellite. | REL-7 |
| >>PRC | MP | | Real(-655.04..655.04 by step of 0.32) | meters
Pseudo-range corrections are provided with respect to GNSS specific geodetic datum (e.g., PZ-90.02 if GANSS ID indicates GLONASS). | REL-7 |
| >>RRC | MP | | Real(-4.064..4.064 by step of 0.032) | meters/sec
Pseudo-range rate corrections are provided with respect to GNSS specific geodetic datum (e.g., PZ-90.02 if GANSS ID indicates GLONASS). | REL-7 |

| Condition | Explanation |
|---------------|---|
| Status/Health | This IE is mandatory present if "status" is not equal to "no data" or "invalid data", otherwise the IE is not needed. |

10.3.7.91c UE positioning GANSS orbit model

This IE contains information for GANSS orbit model parameters.

| Information Element/Group name | Need | Multi | Type and Reference | Semantics description | Version |
|----------------------------------|------|-------|--------------------|---|---------|
| Keplerian Parameters ('Model 1') | OP | | | NOTE | REL-7 |
| >t _{oe} | MP | | Bit String(14) | Time-of-Ephemeris in seconds, scale factor 60 [61] | REL-7 |
| > ω | MP | | Bit string(32) | Argument of Perigee (semi-circles) [61] | REL-7 |
| > Δn | MP | | Bit string(16) | Mean Motion Difference From Computed Value (semi-circles/sec) [61] | REL-7 |
| >M ₀ | MP | | Bit string(32) | Mean Anomaly at Reference Time (semi-circles) [61] | REL-7 |
| >OMEGA _{dot} | MP | | Bit string(24) | Longitude of Ascending Node of Orbit Plane at Weekly Epoch (semi-circles/sec) [61] | REL-7 |
| >e | MP | | Bit string(32) | Eccentricity, scale factor 2 ⁻³³ [61] | REL-7 |
| >I _{dot} | MP | | Bit string(14) | Rate of Inclination Angle (semi-circles/sec) [61] | REL-7 |
| >sqrtA | MP | | Bit String(32) | Semi-Major Axis in (meters) ^{1/2} , scale factor 2 ⁻¹⁹ [61] | REL-7 |
| >i ₀ | MP | | Bit string(32) | Inclination Angle at Reference Time (semi-circles) [61] | REL-7 |
| >OMEGA ₀ | MP | | Bit string(32) | Longitude of Ascending Node of Orbit Plane at Weekly Epoch (semi-circles) [61] | REL-7 |
| >C _{rs} | MP | | Bit string(16) | Amplitude of the Sine Harmonic Correction Term to the Orbit Radius (meters) [61] | REL-7 |
| >C _{is} | MP | | Bit string(16) | Amplitude of the Sine Harmonic Correction Term To The Angle Of Inclination (radians) [61] | REL-7 |
| >C _{us} | MP | | Bit string(16) | Amplitude of the Sine Harmonic Correction Term To The Argument Of Latitude (radians) [61] | REL-7 |
| >C _{rc} | MP | | Bit string(16) | Amplitude of the Cosine Harmonic Correction Term to the Orbit Radius (meters) [61] | REL-7 |
| >C _{ic} | MP | | Bit string(16) | Amplitude of the Cosine Harmonic Correction Term To The Angle Of Inclination (radians) [61] | REL-7 |
| >C _{uc} | MP | | Bit string(16) | Amplitude of the Cosine Harmonic Correction Term To The Argument Of Latitude (radians) [61] | REL-7 |

NOTE: This IE shall contain exactly one of the optional fiels indicated by "NOTE".

10.3.7.91d UE positioning GANSS clock model

The IE contains fields needed to model the GANSS clock parameters.

| Information Element/Group name | Need | Multi | Type and Reference | Semantics description | Version |
|-----------------------------------|------|--------------------------|--------------------|--|---------|
| Satellite clock model ('Model 1') | MP | 1 to <maxSatClockModels> | | There may be more than one clock model included if defined in SIS ICD (e.g. two for Galileo) | REL-7 |
| >t _{oc} | MP | | BIT STRING(14) | Time-of-Clock in seconds. Scale factor 60 seconds. | REL-7 |
| >a _{f2} | MP | | BIT STRING (12) | sec/sec ² , scale factor 2 ⁻⁶⁵ for Galileo | REL-7 |
| >a _{f1} | MP | | BIT STRING (18) | sec/sec, scale factor 2 ⁻⁴⁵ | REL-7 |
| >a _{f0} | MP | | BIT STRING (28) | sec, scale factor 2 ⁻³³ | REL-7 |
| >T _{GD} | OP | | BIT STRING (10) | sec, scale factor 2 ⁻³² for Galileo | REL-7 |
| >Model ID | OP | | Integer(0..1) | NOTE 1 | REL-7 |

NOTE 1: Coding of Model ID:

| GNSS | Value | Explanation |
|---------|-------|-------------|
| Galileo | 0 | I/Nav |
| | 1 | F/Nav |

10.3.7.91e UE positioning GANSS additional orbit models

This IE contains information for GANSS orbit model parameters.

| Information Element/Group name | Need | Multi | Type and Reference | Semantics description | Version |
|--|------|-------|--------------------|---|---------|
| NAV-Keplerian Parameters ('Model 2') | OP | | | NOTE | REL-8 |
| >URA Index | MP | | Bit String(4) | SV accuracy (dimensionless) [72] | REL-8 |
| >Fit Interval Flag | MP | | Bit String(1) | Fit interval indication (dimensionless) [72] | REL-8 |
| > t_{oe} | MP | | Bit String(16) | Time of ephemeris (seconds) [72] | REL-8 |
| > ω | MP | | Bit String(32) | Argument of perigee (semi-circles) [72] | REL-8 |
| > Δn | MP | | Bit String(16) | Mean motion difference from computed value (semi-circles/sec) [72] | REL-8 |
| > M_0 | MP | | Bit String(32) | Mean anomaly at reference time (semi-circles) [72] | REL-8 |
| >OMEGAdot | MP | | Bit String(24) | Rate of right ascension (semi-circles/sec) [72] | REL-8 |
| >e | MP | | Bit String(32) | Eccentricity (dimensionless) [72] | REL-8 |
| >Idot | MP | | Bit String(14) | Rate of inclination angle (semi-circles/sec) [72] | REL-8 |
| >sqrtA | MP | | Bit String(32) | Square root of semi-major axis (meters ^{1/2}) [72] | REL-8 |
| > i_0 | MP | | Bit String(32) | Inclination angle at reference time (semi-circles) [72] | REL-8 |
| >OMEGA ₀ | MP | | Bit String(32) | Longitude of ascending node of orbit plane at weekly epoch (semi-circles) [72] | REL-8 |
| >C _{rs} | MP | | Bit String(16) | Amplitude of sine harmonic correction term to the orbit radius (meters) [72] | REL-8 |
| >C _{is} | MP | | Bit String(16) | Amplitude of sine harmonic correction term to the angle of inclination (radians) [72] | REL-8 |
| >C _{us} | MP | | Bit String(16) | Amplitude of sine harmonic correction term to the argument of latitude (radians) [72] | REL-8 |
| >C _{rc} | MP | | Bit String(16) | Amplitude of cosine harmonic correction term to the orbit radius (meters) [72] | REL-8 |
| >C _{ic} | MP | | Bit String(16) | Amplitude of cosine harmonic correction term to the angle of inclination (radians) [72] | REL-8 |
| >C _{uc} | MP | | Bit String(16) | Amplitude of cosine harmonic correction term to the argument of latitude (radians) [72] | REL-8 |
| CNAV/CNAV-2 Keplerian Parameters ('Model 3') | OP | | | NOTE | REL-8 |
| > t_{op} | MP | | Bit String(11) | Data predict time of week (seconds) [68,69,70,72] | REL-8 |
| >URA _{oe} Index | MP | | Bit String(5) | SV accuracy (dimensionless) [68,69,70,72] | REL-8 |
| > ΔA | MP | | Bit String(26) | Semi-major axis difference at reference time (meters) [68,69,70,72] | REL-8 |

| Information Element/Group name | Need | Multi | Type and Reference | Semantics description | Version |
|--|------|-------|--------------------|---|---------|
| >A_dot | MP | | Bit String(25) | Chane rate in semi-major axis (meters/sec) [68,69,70,72] | REL-8 |
| > Δn_0 | MP | | Bit String(17) | Mean motion difference from computed value at reference time (semi-circles/sec) [68,69,70,72] | REL-8 |
| > Δn_0 _dot | MP | | Bit String(23) | Rate of mean motion difference from computed value (semi-circles/sec ²) [68,69,70,72] | REL-8 |
| >M _{0-n} | MP | | Bit String(33) | Mean anomaly at reference time (semi-circles) [68,69,70,72] | REL-8 |
| >e _n | MP | | Bit String(33) | Eccentricity (dimensionless) [68,69,70,72] | REL-8 |
| > ω_n | MP | | Bit String(33) | Argument of perigee (semi-circles) [68,69,70,72] | REL-8 |
| > Ω_{0-n} | MP | | Bit String(33) | Reference right ascension angle (semi-circles) [68,69,70,72] | REL-8 |
| > $\Delta\Omega$ _dot | MP | | Bit String(17) | Rate of right ascension difference (semi-circles/sec) [68,69,70,72] | REL-8 |
| >i _{0-n} | MP | | Bit String(33) | Inclination angle at reference time (semi-circles) [68,69,70,72] | REL-8 |
| >i _{0-n} _dot | MP | | Bit String(15) | Rate of inclination angle (semi-circles/sec) [68,69,70,72] | REL-8 |
| >C _{is-n} | MP | | Bit String(16) | Amplitude of sine harmonic correction term to the angle of inclination (radians) [68,69,70,72] | REL-8 |
| >C _{ic-n} | MP | | Bit String(16) | Amplitude of cosine harmonic correction term to the angle of inclination (radians) [68,69,70,72] | REL-8 |
| >C _{rs-n} | MP | | Bit String(24) | Amplitude of sine harmonic correction term to the orbit radius (meters) [68,69,70,72] | REL-8 |
| >C _{rc-n} | MP | | Bit String(24) | Amplitude of cosine harmonic correction term to the orbit radius (meters) [68,69,70,72] | REL-8 |
| >C _{us-n} | MP | | Bit String(21) | Amplitude of sine harmonic correction term to the argument of latitude (radians) [68,69,70,72] | REL-8 |
| >C _{uc-n} | MP | | Bit String(21) | Amplitude of cosine harmonic correction term to the argument of latitude (radians) [68,69,70,72] | REL-8 |
| GLONASS Earth-Centered, Earth-fixed Parameters ('Model 4') | OP | | | NOTE | REL-8 |
| >E _n | MP | | Bit String(5) | Age of data (days) [73] | REL-8 |
| >P1 | MP | | Bit String(2) | Time interval between two adjacent values of t _b (minutes) [73] | REL-8 |

| Information Element/Group name | Need | Multi | Type and Reference | Semantics description | Version |
|---|---------------|-------|--------------------|--|---------|
| >P2 | MP | | Bit String(1) | Change of t_b flag (dimensionless) [73] | REL-8 |
| >M | OP | | Bit String(2) | Type of satellite (dimensionless) [73] | REL-8 |
| > $x_n(t_b)$ | MP | | Bit String(27) | x-coordinate of satellite at time t_b (kilometers) [73] | REL-8 |
| > $\dot{x}_n(t_b)$ | MP | | Bit String(24) | x-coordinate of satellite velocity at time t_b (kilometers/sec) [73] | REL-8 |
| > $\ddot{x}_n(t_b)$ | MP | | Bit String(5) | x-coordinate of satellite acceleration at time t_b (kilometers/sec ²) [73] | REL-8 |
| > $y_n(t_b)$ | MP | | Bit String(27) | y-coordinate of satellite at time t_b (kilometers) [73] | REL-8 |
| > $\dot{y}_n(t_b)$ | MP | | Bit String(24) | y-coordinate of satellite velocity at time t_b (kilometers/sec) [73] | REL-8 |
| > $\ddot{y}_n(t_b)$ | MP | | Bit String(5) | y-coordinate of satellite acceleration at time t_b (kilometers/sec ²) [73] | REL-8 |
| > $z_n(t_b)$ | MP | | Bit String(27) | z-coordinate of satellite at time t_b (kilometers) [73] | REL-8 |
| > $\dot{z}_n(t_b)$ | MP | | Bit String(24) | z-coordinate of satellite velocity at time t_b (kilometers/sec) [73] | REL-8 |
| > $\ddot{z}_n(t_b)$ | MP | | Bit String(5) | z-coordinate of satellite acceleration at time t_b (kilometers/sec ²) [73] | REL-8 |
| SBAS Earth-Centered, Earth-fixed Parameters ('Model 5') | OP | | | NOTE | REL-8 |
| > t_0 | CV-ClockModel | | Bit String(13) | Time of applicability (seconds) [71] | REL-8 |
| >Accuracy | MP | | Bit String(4) | (dimensionless) [71] | REL-8 |
| > X_G | MP | | Bit String(30) | (meters) [71] | REL-8 |
| > Y_G | MP | | Bit String(30) | (meters) [71] | REL-8 |
| > Z_G | MP | | Bit String(25) | (meters) [71] | REL-8 |
| > X_G Rate-of-Change | MP | | Bit String(17) | (meters/sec) [71] | REL-8 |
| > Y_G Rate-of-Change | MP | | Bit String(17) | (meters/sec) [71] | REL-8 |
| > Z_G Rate-of-Change | MP | | Bit String(18) | (meters/sec) [71] | REL-8 |
| > X_G Acceleration | MP | | Bit String(10) | (meters/sec ²) [71] | REL-8 |
| > Y_G Acceleration | MP | | Bit String(10) | (meters/sec ²) [71] | REL-8 |
| > Z_G Acceleration | MP | | Bit String(10) | (meters/sec ²) [71] | REL-8 |

NOTE: This IE shall contain exactly one of the optional fields indicated by "NOTE".

| Condition | Explanation |
|-------------------|--|
| <i>ClockModel</i> | This IE is mandatory present if UE positioning GANSS additional clock models 'Model 5' is not included in UE positioning GANSS additional navigation models, otherwise the IE is not needed. |

10.3.7.91f UE positioning GANSS additional clock models

The IE contains fields needed to model the GANSS clock parameters.

| Information Element/Group name | Need | Multi | Type and Reference | Semantics description | Version |
|-------------------------------------|------|-------|--------------------|---|---------|
| NAV-Clock Model ('Model 2') | OP | | | NOTE | REL-8 |
| >t _{oc} | MP | | Bit String(16) | Time of clock (seconds) [72] | REL-8 |
| >af ₂ | MP | | Bit String(8) | Clock correction polynomial coefficient (sec/sec ²) [72] | REL-8 |
| >af ₁ | MP | | Bit String(16) | Clock correction polynomial coefficient (sec/sec) [72] | REL-8 |
| >af ₀ | MP | | Bit String(22) | Clock correction polynomial coefficient (seconds) [72] | REL-8 |
| >T _{GD} | MP | | Bit String(8) | Group delay (seconds) [72] | REL-8 |
| CNAV/CNAV-2 Clock Model ('Model 3') | OP | | | NOTE | REL-8 |
| >t _{oc} | MP | | Bit String(11) | Clock data reference time of week (seconds) [68, 69, 70, 72] | REL-8 |
| >t _{op} | MP | | Bit String(11) | Clock data predict time of week (seconds) [68, 69, 70, 72] | REL-8 |
| >URA _{oc} Index | MP | | Bit String(5) | SV clock accuracy index (dimensionless) [68, 69, 70, 72] | REL-8 |
| >URA _{oc1} Index | MP | | Bit String(3) | SV clock accuracy change index (dimensionless) [68, 69, 70, 72] | REL-8 |
| >URA _{oc2} Index | MP | | Bit String(3) | SV clock accuracy change rate index (dimensionless) [68, 69, 70, 72] | REL-8 |
| >a _{f2-n} | MP | | Bit String(10) | SV clock drift rate correction coefficient (sec/sec ²) [68, 69, 70, 72] | REL-8 |
| >a _{f1-n} | MP | | Bit String(20) | SV clock drift correction coefficient (sec/sec) [68, 69, 70, 72] | REL-8 |
| >a _{f0-n} | MP | | Bit String(26) | SV clock bias correction coefficient (seconds) [68, 69, 70, 72] | REL-8 |
| >T _{GD} | MP | | Bit String(13) | Group delay correction (seconds) [68, 69, 70, 72] | REL-8 |
| >ISC _{L1CP} | OP | | Bit String(13) | Inter signal group delay correction (seconds) [70, 72] | REL-8 |
| >ISC _{L1CD} | OP | | Bit String(13) | Inter signal group delay correction (seconds) [70, 72] | REL-8 |
| >ISC _{L1C/A} | OP | | Bit String(13) | Inter signal group delay correction (seconds) [68, 69, 72] | REL-8 |
| >ISC _{L2C} | OP | | Bit String(13) | Inter signal group delay correction (seconds) [68, 69, 72] | REL-8 |
| >ISC _{L5I5} | OP | | Bit String(13) | Inter signal group delay correction (seconds) [69, 72] | REL-8 |
| >ISC _{L5Q5} | OP | | Bit String(13) | Inter signal group delay | REL-8 |

| | | | | | |
|---|----|--|----------------|---|-------|
| | | | | correction (seconds) [69, 72] | |
| GLONASS Satellite Clock Model ('Model 4') | OP | | | NOTE | REL-8 |
| $>\tau_n(t_b)$ | MP | | Bit String(22) | Satellite clock offset (seconds) [73] | REL-8 |
| $>\gamma_n(t_b)$ | MP | | Bit String(11) | Relative frequency offset from nominal value (dimensionless) [73] | REL-8 |
| $>\Delta\tau_n$ | OP | | Bit String(5) | Time difference between transmission in G2 and G1 (seconds) [73] | REL-8 |
| SBAS Satellite Clock Model ('Model 5') | OP | | | NOTE | REL-8 |
| $>t_0$ | MP | | Bit String(13) | (seconds) [71] | REL-8 |
| $>a_{Gf0}$ | MP | | Bit String(12) | (seconds) [71] | REL-8 |
| $>a_{Gf1}$ | MP | | Bit String(8) | (sec/sec) [71] | REL-8 |

NOTE: This IE shall contain exactly one of the optional fiels indicated by "NOTE".

10.3.7.92 UE positioning GPS ionospheric model

The IE contains fields needed to model the propagation delays of the GPS signals through the ionosphere.

| Information Element/Group name | Need | Multi | Type and Reference | Semantics description |
|--------------------------------|------|-------|--------------------|-----------------------|
| α_0 | MP | | Bit string(8) | Note 1 |
| α_1 | MP | | Bit string(8) | Note 1 |
| α_2 | MP | | Bit string(8) | Note 1 |
| α_3 | MP | | Bit string(8) | Note 1 |
| β_0 | MP | | Bit string(8) | Note 2 |
| β_1 | MP | | Bit string(8) | Note 2 |
| β_2 | MP | | Bit string(8) | Note 2 |
| β_3 | MP | | Bit string(8) | Note 2 |

NOTE 1: The parameters α_n are the coefficients of a cubic equation representing the amplitude of the vertical delay [12].

NOTE 2: The parameters β_n are the coefficients of a cubic equation representing the period of the ionospheric model [12].

10.3.7.92a UE positioning GANSS ionospheric model

The IE contains fields needed to model the propagation delays of the GANSS signals through the ionosphere.

| Information Element/Group name | Need | Multi | Type and Reference | Semantics description | Version |
|---------------------------------------|------|-------|--------------------|---|---------|
| a_{i0} | MP | | Bit string(12) | This parameter is used as defined in [61] | REL-7 |
| a_{i1} | MP | | Bit string(12) | This parameter is used as defined in [61] | REL-7 |
| a_{i2} | MP | | Bit string(12) | This parameter is used as defined in [61] | REL-7 |
| GANSS Ionosphere Regional Storm Flags | OP | | | | REL-7 |
| >Storm Flag 1 | MP | | Boolean | This parameter is used as defined in [61] | REL-7 |
| >Storm Flag 2 | MP | | Boolean | This parameter is used as defined in [61] | REL-7 |
| >Storm Flag 3 | MP | | Boolean | This parameter is used as defined in [61] | REL-7 |
| >Storm Flag 4 | MP | | Boolean | This parameter is used as defined in [61] | REL-7 |
| >Storm Flag 5 | MP | | Boolean | This parameter is used as defined in [61] | REL-7 |

10.3.7.92b UE positioning GANSS additional ionospheric model

This IE contains parameters to model the propagation delays of the GANSS signals through the ionosphere.

| Information Element/Group name | Need | Multi | Type and Reference | Semantics description | Version |
|--------------------------------|------|-------|--------------------|--|---------|
| Data ID | MP | | Bit String(2) | The value "11" indicates that the parameters have been generated by QZSS, and the parameters have been specialized and are applicable within the area defined in [72]. When Data ID has the value "00" it indicates the parameters are applicable worldwide [72]. All other values for Data ID are reserved. | REL-8 |
| α_0 | MP | | Bit string(8) | seconds [72] | REL-8 |
| α_1 | MP | | Bit string(8) | sec/semi-circle [72] | REL-8 |
| α_2 | MP | | Bit string(8) | sec/(semi-circle) ² [72] | REL-8 |
| α_3 | MP | | Bit string(8) | sec/(semi-circle) ³ [72] | REL-8 |
| β_0 | MP | | Bit string(8) | seconds [72] | REL-8 |
| β_1 | MP | | Bit string(8) | sec/semi-circle [72] | REL-8 |
| β_2 | MP | | Bit string(8) | sec/(semi-circle) ² [72] | REL-8 |
| β_3 | MP | | Bit string(8) | sec/(semi-circle) ³ [72] | REL-8 |

10.3.7.92c UE positioning GANSS Earth orientation parameters

This IE provides parameters to construct the ECEF and ECI coordinate transformation as defined in [68]. The Earth Orientation Parameters (EOP) indicate the relationship between the Earth's rotational axis and WGS-84 reference system.

| Information Element/Group name | Need | Multi | Type and Reference | Semantics description | Version |
|--------------------------------|------|-------|--------------------|--|---------|
| t _{EOP} | MP | | Bit String(16) | EOP data reference time (seconds) [68] | REL-8 |
| PM_X | MP | | Bit String(21) | X-axis polar motion value at reference time (arc-seconds) [68] | REL-8 |
| PM_X_dot | MP | | Bit String(15) | X-axis polar motion drift at reference time (arc-seconds/day) [68] | REL-8 |
| PM_Y | MP | | Bit String(21) | Y-axis polar motion value at reference time (arc-seconds) [68] | REL-8 |
| PM_Y_dot | MP | | Bit String(15) | Y-axis polar motion drift at reference time (arc-seconds/day) [68] | REL-8 |
| ΔUT1 | MP | | Bit String(31) | UT1-UTC difference at reference time (seconds) [68] | REL-8 |
| ΔUT1_dot | MP | | Bit String(19) | Rate of UT1-UTC difference at reference time (seconds/day) [68] | REL-8 |

10.3.7.93 UE positioning GPS measured results

| Information Element/Group name | Need | Multi | Type and Reference | Semantics description | Version |
|--|------|---------------|--|---|---------|
| CHOICE <i>Reference Time</i> | MP | | | | |
| >UTRAN reference time | | | | | |
| >>UE GPS timing of cell frames | MP | | Integer(0..37158911999999) | GPS Time of Week in units of 1/16 th UMTS chips according to [19]. 33209832177664 spare values are needed. | |
| >>CHOICE <i>mode</i> | MP | | | | |
| >>>FDD | | | | | |
| >>>>Primary CPICH Info | MP | | Primary CPICH Info 10.3.6.60 | Identifies the reference cell for the GPS TOW-SFN relationship. | |
| >>>TDD | | | | | |
| >>>>cell parameters id | MP | | Cell parameters id 10.3.6.9 | Identifies the reference cell for the GPS TOW-SFN relationship. | |
| >>Reference SFN | MP | | Integer(0..4095) | The SFN for which the location is valid. This IE indicates the SFN at which the UE timing of cell frames is captured. | |
| >GPS reference time only | | | | | |
| >>GPS TOW msec | MP | | Integer(0..6.048*10 ⁸ -1) | GPS Time of Week in milliseconds (rounded down to the nearest millisecond unit). | |
| UE Positioning GPS ReferenceTime Uncertainty | OP | | UE positioning GPS reference time uncertainty 10.3.7.96a | | REL-7 |
| Measurement Parameters | MP | 1 to <maxSat> | | | |
| >Satellite ID | MP | | Enumerated(0..63) | Identifies the satellite and is equal to (SV ID No - 1) where SV ID No is defined in [12]. | |
| >C/N ₀ | MP | | Integer(0..63) | the estimate of the carrier-to- | |

| Information Element/Group name | Need | Multi | Type and Reference | Semantics description | Version |
|--------------------------------|------|-------|---|---|---------|
| | | | | noise ratio of the received signal from the particular satellite used in the measurement. It is given in units of dB-Hz (typical levels will be in the range of 20 – 50 dB-Hz). | |
| >Doppler | MP | | Integer(-32768..32768) | Hz, scale factor 0.2. | |
| >Whole GPS Chips | MP | | Integer(0..1022) | Unit in GPS chips. Whole value of the UE GPS code-phase measurement, where increasing binary values of the field signify increasing measured pseudoranges. The UE GPS code-phase measurement is divided into the fields 'Whole GPS Chips' and 'Fractional GPS Chips'. | |
| >Fractional GPS Chips | MP | | Integer(0..(2 ¹⁰ -1)) | Scale factor 2 ⁻¹⁰
Fractional value of the UE GPS code-phase measurement. | |
| >Multipath Indicator | MP | | Enumerated(NM, low, medium, high) | Note 1. | |
| >Pseudorange RMS Error | MP | | Enumerated(range index 0..range index 63) | Note 2. | |

NOTE 1: The following table gives the mapping of the multipath indicator field.

| Value | Multipath Indication |
|--------|----------------------|
| NM | Not measured |
| Low | MP error < 5m |
| Medium | 5m < MP error < 43m |
| High | MP error > 43m |

NOTE 2: The following table gives the bitmapping of the Pseudorange RMS Error field.

| Range Index | Mantissa | Exponent | Floating-Point value, x _i | Pseudorange value, P |
|-------------|----------|----------|--------------------------------------|---------------------------------------|
| 0 | 000 | 000 | 0.5 | P < 0.5 |
| 1 | 001 | 000 | 0.5625 | 0.5 ≤ P < 0.5625 |
| l | X | Y | 0.5 * (1 + x/8) * 2 ^y | x _{i-1} ≤ P < x _i |
| 62 | 110 | 111 | 112 | 104 ≤ P < 112 |
| 63 | 111 | 111 | -- | 112 ≤ P |

10.3.7.93a UE positioning GANSS measured results

| Information Element/Group name | Need | Multi | Type and Reference | Semantics description | Version |
|---------------------------------------|------|-------------------|---|---|---------|
| CHOICE Reference Time | MP | | | | REL-7 |
| >UTRAN reference time | | | | | REL-7 |
| >>UE GANSS timing of cell frames | MP | | Integer(0..86399999999750 by step of 250) | GANSS Time of Day in ns | REL-7 |
| >>GANSS Time Id | OP | | INTEGER (0..7) | Absence means Galileo. For coding description see NOTE 2. | |
| >>GANSS TOD Uncertainty | OP | | Integer(0..127) | Coding as in 10.3.7.96a | REL-7 |
| >>CHOICE mode | MP | | | | REL-7 |
| >>>FDD | | | | | REL-7 |
| >>>>Primary CPICH Info | MP | | Primary CPICH Info 10.3.6.60 | Identifies the reference cell for the GANSS TOD-SFN relationship. | REL-7 |
| >>>TDD | | | | | REL-7 |
| >>>>cell parameters id | MP | | Cell parameters id 10.3.6.9 | Identifies the reference cell for the GANSS TOD-SFN relationship. | REL-7 |
| >>Reference SFN | MP | | Integer(0..4095) | The SFN for which the location is valid. This IE indicates the SFN at which the UE timing of cell frames is captured. | REL-7 |
| >GANSS reference time only | | | | | REL-7 |
| >>GANSS Time Id | OP | | INTEGER (0..7) | Absence means Galileo. For coding description see NOTE 2. | |
| >>GANSS TOD msec | MP | | Integer(0..3599999) | GANSS Time of Day (modulo 1 hour) in milliseconds (rounded down to the nearest millisecond unit). | REL-7 |
| >>GANSS TOD Uncertainty | OP | | Integer(0..127) | Coding as in 10.3.7.96a | REL-7 |
| GANSS Generic Measurement Information | MP | 1 to <maxGANSS> | | | REL-7 |
| >GANSS ID | OP | | Integer(0..7) | Absence of this IE means Galileo. For coding description, see Note 1 in 10.3.7.90b. | REL-7 |
| >GANSS Signal Measurement Information | MP | 1 to <maxSgnType> | | | REL-7 |
| >>GANSS Signal ID | OP | | GANSS Signal Id 10.3.3.45a | Absence of this field means the default value as defined in 10.3.3.45a for the GANSS identified by GANSS_ID. | REL-7 |
| >>GANSS Code Phase Ambiguity | OP | | Integer (0..31) | The "GANSS Code Phase Ambiguity" field gives the ambiguity of the code phase measurement. It is given in ms and is an integer between 0 and 31. The Total Code Phase for a satellite k (Satk) is given modulo this "GANSS Code Phase Ambiguity" and is reconstructed with:
Code_Phase_Tot(Satk) = Code_Phase(Satk)+ Integer Code_Phase(Satk)
If there is no code phase ambiguity, the "GANSS Code Phase Ambiguity" shall be set to 0. | REL-7 |

| Information Element/Group name | Need | Multi | Type and Reference | Semantics description | Version |
|--|------|--------------------|---|---|---------|
| | | | | The field is optional. If 'GANSS Code Phase Ambiguity' and 'GANSS Code Phase Ambiguity Extension' is absent, the default value is 1ms. | |
| >>GANSS Code Phase Ambiguity Extension | OP | | Integer(32..127) | If the total GANSS code phase ambiguity is greater than 31 ms, then this field shall be used. The definition is the same as for the "GANSS Code Phase Ambiguity" field except the value range is from 32 to 127 ms. | REL-8 |
| >>GANSS Measurement Parameters | MP | 1 to <maxGANSSSat> | | | REL-7 |
| >>>Satellite ID | MP | | Integer (0..63) | Identifies the satellite and is as defined in Note 2 of 10.3.7.88b. | REL-7 |
| >>>C/N ₀ | MP | | Integer(0..63) | The estimate of the carrier-to-noise ratio of the received signal from the particular satellite used in the measurement. It is given in units of dB-Hz (typical levels will be in the range of 20 – 50 dB-Hz). | REL-7 |
| >>>Multipath Indicator | MP | | Enumerated(NM, low, medium, high) | Coding as in 10.3.7.93 | REL-7 |
| >>>Carrier Quality Indicaton | OP | | Bit string(2) | Note 1 | REL-7 |
| >>>GANSS Code Phase | MP | | Integer(0..2 ²¹ -1) | Scale factor 2 ²¹
Code phase for the particular satellite signal at the time of measurement in the units of milliseconds. Increasing binary values of the field signify increasing measured pseudoranges. GNSS specific code phase measurements (e.g. chips) are converted into unit of ms by dividing the measurements by the nominal values of the measured signal chipping rate. | REL-7 |
| >>>GANSS Integer Code Phase | OP | | Integer(0..63) | In ms
Indicates the integer millisecond part of the code phase, that is expressed modulo the GANSS Code Phase Ambiguity. | REL-7 |
| >>>GANSS Integer Code Phase Extension | OP | | Integer(64..127) | If the total GANSS integer code phase is greater than 63 ms, then this field shall be used. The definition is the same as for the GANSS Integer Code Phase field except the value range is from 64 to 127 ms. | REL-8 |
| >>>Code Phase RMS Error | MP | | Enumerated(range index 0..range index 63) | Coding as in Note 2 of 10.3.7.93 | REL-7 |
| >>>Doppler | MP | | Integer(- | m/s, scale factor 0.04. Doppler | REL-7 |

| Information Element/Group name | Need | Multi | Type and Reference | Semantics description | Version |
|--------------------------------|------|-------|----------------------|--|---------|
| | | | 32768..32767) | measured by the UE for the particular satellite signal | |
| >>>ADR | OP | | Integer(0..33554431) | Meters, scale factor 2 ⁻¹⁰
ADR measurement measured by the UE for the particular satellite signal. | REL-7 |

NOTE 1: Coding of Carrier quality indication:

| MSB | LSB | Explanation |
|-----|-----|------------------------------|
| 0 | | Carrier phase not continuous |
| 1 | | Carrier phase continuous |
| | 0 | Data direct |
| | 1 | Data Inverted |

NOTE 2: Coding of GANSS Time Id:

| Value of GANSS Time id | Explanation | Version |
|------------------------|---------------------|---------|
| 0 | GPS system time | REL-8 |
| 1 | QZSS system time | |
| 2 | GLONASS system time | |
| 3-7 | Reserved | |

10.3.7.94 UE positioning GPS navigation model

This IE contain information required to manage the transfer of precise navigation data to the GPS-capable UE.

| Information Element/Group name | Need | Multi | Type and Reference | Semantics description |
|--|---------------------|---------------|---|--|
| Satellite information | MP | 1 to <maxSat> | | |
| >SatID | MP | | Enumerated(0..63) | Identifies the satellite and is equal to (SV ID No - 1) where SV ID No is defined in [12]. |
| >Satellite Status | MP | | Enumerated(NS_NN, ES_SN, ES_NN, REVD) | NOTE |
| >GPS Ephemeris and Clock Correction parameters | CV-Satellite status | | UE positioning GPS Ephemeris and Clock Correction parameters 10.3.7.91a | |

NOTE: The UE shall interpret enumerated symbols as follows.

| Value | Indication |
|-------|---|
| NS_NN | New satellite, new Navigation Model |
| ES_SN | Existing satellite, same Navigation Model |
| ES_NN | Existing satellite, new Navigation Model |
| REVD | Reserved |

| Condition | Explanation |
|-------------------------|---|
| <i>Satellite status</i> | The IE is not needed if the IE "Satellite status" is ES_SN and mandatory present otherwise. |

10.3.7.94a UE positioning GANSS navigation model

This IE contains information required to manage the transfer of precise navigation data to the GANSS-capable UE.

| Information Element/Group name | Need | Multi | Type and Reference | Semantics description | Version |
|--------------------------------|------|--------------------|---|---|---------|
| Non-Broadcast Indication | OP | | Enumerated (TRUE) | If this IE is present, GANSS navigation model is not derived from satellite broadcast | REL-7 |
| Satellite information | MP | 1 to <maxGANSSSat> | | | REL-7 |
| >SatID | MP | | Integer (0..63) | Identifies the satellite and is as defined in Note 2 of 10.3.7.88b. | REL-7 |
| >SV Health | MP | | Bit string(5) | NOTE | REL-7 |
| >IOD | MP | | Bit string(10) | | REL-7 |
| >GANSS Clock Model | MP | | UE positioning GANSS clock model 10.3.7.91d | | REL-7 |
| > GANSS Orbit Model | MP | | UE positioning GANSS orbit model 10.3.7.91c | | REL-7 |

NOTE: The Health values are GNSS specific. For Galileo, the UE shall interpret bit string as follows:

| Parameter | Bit | Type | Explanation |
|---------------------------|-----|------------|--------------------|
| E5a Data Validity Status | 0 | Boolean | |
| E5b Data Validity Status | 1 | Boolean | |
| E1-B Data Validity Status | 2 | Boolean | |
| E5a Signal Health Status | 3-4 | Bit string | See [61], Table 67 |

10.3.7.94b UE positioning GANSS additional navigation models

This IE contains information required to manage the transfer of precise navigation data to the GANSS-capable UE.

| Information Element/Group name | Need | Multi | Type and Reference | Semantics description | Version |
|--------------------------------|------|---------------------|---|---|---------|
| Non-Broadcast Indication | OP | | Enumerated (TRUE) | If this IE is present, GANSS navigation model is not derived from satellite broadcast | REL-8 |
| Satellite information | MP | 1 to <maxGAN SSSat> | | | REL-8 |
| >SatID | MP | | Integer (0..63) | Identifies the satellite and is as defined in Note 2 of 10.3.7.88b. | REL-8 |
| >SV Health | MP | | Bit string(6) | NOTE 1 | REL-8 |
| >IOD | MP | | Bit string(11) | NOTE 2 | REL-8 |
| >GANSS additional clock models | MP | | UE positioning GANSS additional clock models 10.3.7.91f | | REL-8 |
| >GANSS additional orbit models | MP | | UE positioning GANSS additional orbit models 10.3.7.91e | | REL-8 |

NOTE 1: The SV Health values are GNSS specific as identified by the GANSS ID :

| GANSS | SV Health Bit String(6) | | | | | |
|---------------------|------------------------------------|----------------------------------|-------------------------------|--------------------------------|----------------|----------------|
| | Bit 1 (MSB) | Bit 2 | Bit 3 | Bit 4 | Bit 5 | Bit 6 (LSB) |
| Modernized GPS SBAS | L1C Health [70] | L1 Health [68,69] | L2 Health [68,69] | L5 Health [68,69] | "0" (reserved) | "0" (reserved) |
| QZSS QZS-L1 | Ranging On (0), Off(1) [71] | Corrections On (0), Off (1) [71] | Integrity On (0), Off(1) [71] | SV Health [72] | "0" (reserved) | "0" (reserved) |
| QZSS QZS-L1C/L2C/L5 | L1C Health [72] | L1 Health [72] | L2 Health [72] | L5 Health [72] | "0" (reserved) | "0" (reserved) |
| GLONASS | B _n (MSB) [73, page 23] | | | F _T [73, Table 4.4] | | "0" (reserved) |

NOTE 2: The IOD values are GNSS specific as identified by the GANSS ID :

| GANSS | IOD Bit String(11) | | | | | | | | | | |
|---------------------|--|---------------------------|-------|--------------------------------------|--|-------|-------|-------|-------|--------|--------------|
| | Bit 1 (MSB) | Bit 2 | Bit 3 | Bit 4 | Bit 5 | Bit 6 | Bit 7 | Bit 8 | Bit 9 | Bit 10 | Bit 11 (LSB) |
| Modernized GPS SBAS | t _{oe} (seconds, scale factor 300, range 0 – 604500) [68, 69, 70] | | | | | | | | | | |
| QZSS QZS-L1 | "0" | "0" | "0" | Issue of Data ([71], Message Type 9) | | | | | | | |
| QZSS QZS-L1C/L2C/L5 | "0" | Issue of Data, Clock [72] | | | | | | | | | |
| QZSS QZS-L1C/L2C/L5 | t _{oe} (seconds, scale factor 300, range 0 – 604500) [72] | | | | | | | | | | |
| GLONASS | "0" | "0" | "0" | "0" | t _b (minutes, scale factor 15, range 0 – 1425) [73] | | | | | | |

10.3.7.95 UE positioning GPS real-time integrity

This IE contains parameters that describe the real-time status of the GPS constellation.

| Information Element/Group name | Need | Multi | Type and Reference | Semantics description |
|--------------------------------|------|---------------|--------------------|--|
| Satellite information | MP | 1 to <maxSat> | | |
| >BadSatID | MP | | Enumerated(0..63) | Identifies the satellite and is equal to (SV ID No - 1) where SV ID No is defined in [12]. |

10.3.7.95a Void

10.3.7.95b UE positioning GANSS real-time integrity

This IE contains parameters that describe the real-time status of the GANSS constellation.

| Information Element/Group name | Need | Multi | Type and Reference | Semantics description | Version |
|--------------------------------|------|--------------------|--------------------|--|---------|
| Satellite information | MP | 1 to <maxGANSSSat> | | | REL-7 |
| >Bad GANSS SatID | MP | | Integer (0..63) | Identifies the satellite and is as defined in Note 2 of 10.3.7.88b. | REL-7 |
| >Bad GANSS Signal ID | OP | | Bit string (8) | Absence of this IE means that all signals of the specific SV are bad. NOTE | REL-7 |

NOTE: Coding of Bad GANSS Signal ID

| GNSS | Bit | Explanation | Version |
|----------------|-----|-------------|---------|
| Galileo | 1 | E1 | REL-7 |
| | 2 | E5A | |
| | 3 | E5B | |
| | 4 | E6 | |
| | 5 | E5A + E5B | |
| | 6-8 | Spare | |
| Modernized GPS | 1 | L1C | REL-8 |
| | 2 | L2C | |
| | 3 | L5 | |
| | 4-8 | Spare | |
| SBAS | 1 | L1 | REL-8 |
| | 2-8 | Spare | |
| QZSS | 1 | QZS-L1 | REL-8 |
| | 2 | QZS-L1C | |
| | 3 | QZS-L2C | |
| | 4 | QZS-L5 | |
| | 5-8 | Spare | |
| GLONASS | 1 | G1 | REL-8 |
| | 2 | G2 | |
| | 3 | G3 | |
| | 4-8 | Spare | |

10.3.7.96 UE positioning GPS reference time

| Information Element/Group name | Need | Multi | Type and Reference | Semantics description | Version |
|--------------------------------|------|-------|--------------------------------------|--|---------|
| GPS Week | MP | | Integer(0..1023) | | |
| GPS TOW msec | MP | | Integer(0..6.048*10 ⁸ -1) | GPS Time of Week in milliseconds (rounded down to the nearest millisecond unit). | |

| Information Element/Group name | Need | Multi | Type and Reference | Semantics description | Version |
|---|------|---------------|--|---|---------|
| UTRAN GPS reference time | OP | | | | |
| >UTRAN GPS timing of cell frames | MP | | Integer(0..2322431999999) | UTRAN GPS timing of cell frames in steps of 1 chip | |
| >CHOICE <i>mode</i> | OP | | | | |
| >>FDD | | | | | |
| >>>Primary CPICH Info | MP | | Primary CPICH Info 10.3.6.60 | Identifies the reference cell for the GPS TOW-SFN relationship | |
| >>TDD | | | | | |
| >>>cell parameters id | MP | | Cell parameters id 10.3.6.9 | Identifies the reference cell for the GPS TOW-SFN relationship | |
| >SFN | MP | | Integer(0..4095) | The SFN which the UTRAN GPS timing of cell frames time stamps. | |
| UE Positioning GPS ReferenceTime Uncertainty | OP | | UE positioning GPS reference time uncertainty 10.3.7.96a | NOTE 1 | REL-7 |
| SFN-TOW Uncertainty | OP | | Enumerated (lessThan10, moreThan10) | This field indicates the uncertainty of the relation GPS TOW/SFN. lessThan10 means the relation is accurate to at least 10 ms. NOTE 1 | |
| T _{UTRAN-GPS} drift rate | OP | | Integer (0, 1, 2, 5, 10, 15, 25, 50, -1, -2, -5, -10, -15, -25, -50) | in 1/256 chips per sec. | |
| GPS TOW Assist | OP | 1 to <maxSat> | | | |
| >SatID | MP | | Enumerated(0..63) | Identifies the satellite and is equal to (SV ID No - 1) where SV ID No is defined in [12]. | |
| >TLM Message | MP | | Bit string(14) | | |
| >TLM Reserved | MP | | Bit string(2) | | |
| >Alert | MP | | Boolean | | |
| >Anti-Spoof | MP | | Boolean | | |
| NOTE 1: If the IE "UE Positioning GPS ReferenceTime Uncertainty" is present, the IE "SFN-TOW Uncertainty" is not needed and shall be ignored. | | | | | |

10.3.7.96o UE positioning GANSS reference time

| Information Element/Group name | Need | Multi | Type and Reference | Semantics description | Version |
|-------------------------------------|------|-------|---|---|---------|
| GANSS Day | OP | | Integer(0..8191) | The sequential number of days from the origin of the GNSS system time indicated by GANSS Time ID modulo 8192 days (about 22 years). NOTE. | REL-7 |
| GANSS TOD | MP | | Integer(0..86399) | GANSS Time of Day in seconds | REL-7 |
| GANSS TOD Uncertainty | OP | | Integer(0..127) | Coding as in subclause 10.3.7.96a | REL-7 |
| GANSS Time ID | OP | | Integer (0..7) | Absence of this IE means Galileo, values 0-7 are reserved for future use | REL-7 |
| | | | | Absence of this IE means Galileo,
For coding description see NOTE 2 in 10.3.7.93a. | REL-8 |
| UTRAN GANSS reference time | OP | | | | REL-7 |
| >UTRAN GANSS timing of cell frames | MP | | Integer(0..999999750 by step of 250) | UTRAN GANSS timing of cell frames in steps of 250 ns. Indicates sub-second part of GANSS TOD | REL-7 |
| >CHOICE mode | MP | | | | REL-7 |
| >>FDD | | | | | REL-7 |
| >>>Primary CPICH Info | MP | | Primary CPICH Info 10.3.6.60 | Identifies the reference cell for the GANSS TOD-SFN relationship | REL-7 |
| >>TDD | | | | | REL-7 |
| >>>cell parameters id | MP | | Cell parameters id 10.3.6.9 | Identifies the reference cell for the GANSS TOD-SFN relationship | REL-7 |
| >SFN | MP | | Integer(0..4095) | The SFN which the UTRAN GANSS timing of cell frames time stamps. | REL-7 |
| T _{UTRAN-GANSS} drift rate | OP | | ENUMERATED (0, 1, 2, 5, 10, 15, 25, 50, -1, -2, -5, -10, -15, -25, -50) | in 1/256 chips per sec. One spare value needed. | REL-7 |

NOTE: Definition of GNSS system time origin:

| GNSS | GNSS System Time Origin |
|---------------------|-------------------------------------|
| Galileo System Time | August 22, 1999; 00:00:00 UTC(BIPM) |
| GPS System Time | January 6, 1980; 00:00:00 UTC(USNO) |
| QZSS System Time | January 6, 1980; 00:00:00 UTC(USNO) |
| GLONASS System Time | January 1, 1996; 03:00:00 UTC(RU) |

10.3.7.96a UE positioning GPS reference time uncertainty

| Information Element/Group name | Need | Multi | Type and reference | Semantics description | Version |
|---|------|-------|--------------------|---|---------|
| UE Positioning GPS Reference Time Uncertainty | MP | | Integer (0..127) | <p>This element provides the accuracy of the provided GPS time, or alternatively the accuracy of the provided relation between GPS and UTRAN time. If "GPS TOW" is the provided GPS time, or alternatively the GPS time corresponding to the UTRAN time provided, then the true GPS time lies in the interval ["GPS TOW" - "GPS Reference Time Uncertainty", "GPS TOW" + "GPS Reference Time Uncertainty"].</p> <p>The uncertainty r, expressed in microseconds, is mapped to a number K with the following formula:</p> $r = C * ((1+x)^K - 1)$ <p>with $C = 0.0022$ and $x = 0.18$.</p> <p>To encode any higher value of the uncertainty than that corresponding to $K=127$ in the formula above, or to indicate an undefined value of the "GPS TOW", the same value, $K=127$, shall be used.</p> | REL-7 |

NOTE: This IE is not needed in the SRNS RELOCATION INFO message.

10.3.7.97 UE positioning GPS UTC model

The UTC Model field contains a set of parameters needed to relate GPS time to Universal Time Coordinate (UTC).

| Information Element/Group name | Need | Multi | Type and Reference | Semantics description |
|--------------------------------|------|-------|--------------------|-----------------------|
| A_1 | MP | | Bit string(24) | sec/sec [12] |
| A_0 | MP | | Bit string(32) | seconds [12] |
| t_{ot} | MP | | Bit string(8) | seconds [12] |
| WN_t | MP | | Bit string(8) | weeks [12] |
| Δt_{LS} | MP | | Bit string(8) | seconds [12] |
| WN_{LSF} | MP | | Bit string(8) | weeks [12] |
| DN | MP | | Bit string(8) | days [12] |
| Δt_{LSF} | MP | | Bit string(8) | seconds [12] |

10.3.7.97a UE positioning GANSS time model

The GANSS time model field contains a set of parameters needed to relate GANSS time for the GANSS indicated by "GANSS ID" to selected time reference indicated by "GNSS_TO_ID".

| Information Element/Group name | Need | Multi | Type and Reference | Semantics description | Version |
|---------------------------------|------|-------|-------------------------------------|---|---------|
| GANSS Time Model Reference Time | MP | | Integer(0..604784 by step of 16) | GANSS reference time of week for GANSS Time Model, given in GNSS specific system time, with a 16s scale factor. | REL-7 |
| T _{A0} | MP | | Integer (-2147483648 .. 2147483647) | Seconds, scale factor 2 ⁻³⁵ | REL-7 |
| T _{A1} | OP | | Integer (-8388608 .. 8388607) | sec/sec, scale factor 2 ⁻⁵¹ | REL-7 |
| T _{A2} | OP | | Integer (-64 .. 63) | sec/sec ² , scale factor 2 ⁻⁶⁸ | REL-7 |
| GNSS_TO_ID | MP | | Enumerated (GPS, | GNSS Time Offset ID
Seven spare values needed. | REL-7 |
| | | | Galileo,
QZSS,
GLONASS) | GNSS Time Offset ID
Four spare values needed. | REL-8 |
| Week Number | OP | | Integer(0..8191) | Reference week of GANSS Time Model given in GNSS specific system time | REL-7 |

10.3.7.97b UE positioning GANSS data bit assistance

This element provides data bit assistance data for specific satellite signals for data wipe-off.

| Information Element/Group name | Need | Multi | Type and Reference | Semantics description | Version |
|--------------------------------|------|--------------------|----------------------------|--|----------------|
| GANSS TOD | MP | | Integer(0..59) | Reference time (modulo 1 minute) of the first bit of the data in IE 'Data Bits', in seconds | REL-7 |
| Data Bit Assistance List | MP | 1 to <maxGANSSSat> | | The following fields are present N_Sat times, with $1 \leq N_Sat \leq \text{maxGANSSSat}$ | REL-7 |
| >Satellite ID | MP | | Integer (0..63) | Identifies the satellite and is as defined in Note 2 of 10.3.7.88b. | REL-7 |
| >Data bit assistance Sgn List | MP | 1 to <maxSgnType> | | The following fields are present N_Sgn times, with $1 \leq N_Sgn \leq \text{maxSgnType}$ | REL-7 |
| >>GANSS Signal ID | MP | | GANSS Signal ID 10.3.3.45a | | REL-7 |
| >>Data Bits | MP | | Bit string (1..1024) | <p>Raw data bits as transmitted from a specific satellite at the time indicated by GANSS_TOD.</p> <p>In case of Galileo, it contains the FEC encoded and interleaved modulation symbols. The logical levels 1 and 0 correspond to signal levels -1 and +1, respectively. N_BIT is the actual number of elements in Data bits: $1 \leq N_BIT \leq 1024$.</p> <p>In case of Modernized GPS L1C, it contains the encoded and interleaved modulation symbols as defined in [70] section 3.2.3.1.</p> <p>In case of Modernized GPS L2C, it contains either the NAV data modulation bits, the FEC encoded NAV data modulation symbols, or the FEC encoded CNAV data modulation symbols, dependent on the current signal configuration of this satellite as defined in [68, Table 3-III].</p> <p>In case of Modernized GPS L5, it contains the FEC encoded CNAV data modulation symbols as defined in [69].</p> <p>In case of SBAS, it contains the FEC encoded data modulation symbols as defined in [71].</p> <p>In case of QZSS QZS-L1, it contains the NAV data modulation bits as defined in [72] section 5.2. In case of QZSS QZS-L1C, it contains the encoded and interleaved modulation symbols as defined in [72] section 5.3. In case of QZSS QZS-L2C, it contains the encoded modulation symbols as defined in [72] section 5.5. In case of QZSS QZS-L5, it contains the</p> | REL-7
REL-8 |

| | | | | |
|--|--|--|--|---|
| | | | | encoded modulation symbols as defined in [72] section 5.6. In case of GLONASS, it contains the 100 sps differentially Manchester encoded modulation symbols as defined in [73] section 3.3.2.2. |
|--|--|--|--|---|

10.3.7.97c UE positioning GANSS UTC model

The UTC Model field contains a set of parameters needed to relate GANSS time to Universal Time Coordinate (UTC).

| Information Element/Group name | Need | Multi | Type and Reference | Semantics description |
|--------------------------------|------|-------|--------------------|-----------------------|
| A ₁ | MP | | Bit string(24) | |
| A ₀ | MP | | Bit string(32) | |
| t _{ot} | MP | | Bit string(8) | |
| Δt _{LS} | MP | | Bit string(8) | |
| WN _t | MP | | Bit string(8) | |
| WN _{LSF} | MP | | Bit string(8) | |
| DN | MP | | Bit string(8) | |
| Δt _{LSF} | MP | | Bit string(8) | |

For a GANSS Id referring to Galileo, the definition and the unit of the elements are provided in [61].

10.3.7.97d UE positioning GANSS additional UTC models

This element contains contains several sets of parameters needed to relate GNSS system time to Universal Time Coordinate (UTC), as defined in [68, 69, 70, 71, 72, 73]. Only one parameter set can be included in one UE positioning GANSS additional UTC models and which set of parameters to include depends on the GANSS-ID and UE capabilities.

The UTC time standard, UTC(k), is GNSS specific. E.g., if GANSS ID indicates QZSS, UE positioning GANSS additional UTC models contains a set of parameters needed to relate QZST to UTC(NICT). If GANSS ID indicates Modernized GPS, UE positioning GANSS additional UTC models contains a set of parameters needed to relate GPS system time to UTC(USNO). If GANSS ID indicates GLONASS, UE positioning GANSS additional UTC models contains a set of parameters needed to relate GLONASS system time to UTC(RU). If GANSS ID indicates SBAS, UE positioning GANSS additional UTC models contains a set of parameters needed to relate SBAS network time for the SBAS indicated by SBAS ID to the UTC standard defined by the UTC Standard ID.

| Information Element/Group name | Need | Multi | Type and Reference | Semantics description | Version |
|--------------------------------|------|-------|--------------------|---|---------|
| Model-1 | OP | | | NOTE | REL-8 |
| >A _{0-n} | MP | | Bit String(16) | Bias coefficient of GNSS time scale relative to UTC time scale (seconds) [68,69,70,72] | REL-8 |
| >A _{1-n} | MP | | Bit String(13) | Drift coefficient of GNSS time scale relative to UTC time scale (sec/sec) [68,69,70,72] | REL-8 |
| >A _{2-n} | MP | | Bit String(7) | Drift rate correction coefficient of GNSS time scale relative to UTC time scale (sec/sec ²) [68,69,70,72] | REL-8 |
| >Δt _{LS} | MP | | Bit String(8) | Current or past leap second count (seconds) [68,69,70,72] | REL-8 |
| >t _{ot} | MP | | Bit String(16) | Time data reference time of week (seconds) [68,69,70,72] | REL-8 |
| >WN _{ot} | MP | | Bit String(13) | Time data reference week number (weeks) [68,69,70,72] | REL-8 |
| >WN _{LSF} | MP | | Bit String(8) | Leap second reference week number (weeks) [68,69,70,72] | REL-8 |
| >DN | MP | | Bit String(4) | Leap second reference day number (days) [68,69,70,72] | REL-8 |
| >Δt _{LSF} | MP | | Bit String(8) | Current or future leap second count (seconds) [68,69,70,72] | REL-8 |
| Model-2 | OP | | | NOTE | REL-8 |
| >N ^A | MP | | Bit String(11) | Calendar day number within four-year period beginning since the leap year (days) [73] | REL-8 |
| >τ _c | MP | | Bit String(32) | GLONASS time scale correction to UTC(SU) (seconds) [73] | REL-8 |
| >Delta UT1 | OP | | | | |
| >>B1 | MP | | Bit String(11) | Coefficient to determine ΔUT1 (seconds) [73] | REL-8 |
| >>B2 | MP | | Bit String(10) | Coefficient to determine ΔUT1 (seconds/msd) [73] | REL-8 |
| >KP | OP | | Bit String(2) | Notification of expected leap second correction (dimensionless) [73] | REL-8 |
| Model-3 | OP | | | NOTE | REL-8 |
| >A _{1WNT} | MP | | Bit String(24) | sec/sec ([71], Message Type 12) | REL-8 |
| >A _{0WNT} | MP | | Bit String(32) | seconds ([71], Message Type | REL-8 |

| | | | | | |
|--------------------|----|--|---------------|--|-------|
| >tot | MP | | Bit String(8) | 12)
seconds
([71], Message Type
12) | REL-8 |
| >WN _t | MP | | Bit String(8) | weeks
([71], Message Type
12) | REL-8 |
| >Δt _{LS} | MP | | Bit String(8) | seconds
([71], Message Type
12) | REL-8 |
| >WN _{LSF} | MP | | Bit String(8) | weeks
([71], Message Type
12) | REL-8 |
| >DN | MP | | Bit String(8) | days
([71], Message Type
12) | REL-8 |
| >Δt _{LSF} | MP | | Bit String(8) | seconds
([71], Message Type
12) | REL-8 |
| >UTC Standard ID | MP | | Bit String(3) | dimensionless
NOTE 1 | REL-8 |

NOTE: This IE shall contain exactly one of the optional fields indicated by "NOTE".

NOTE 1: Coding of UTC Standard ID:

| Value of UTC Standard ID | UTC Standard |
|--------------------------|---|
| 0 | UTC as operated by the Communications Research Laboratory (CRL), Tokyo, Japan |
| 1 | UTC as operated by the National Institute of Standards and Technology (NIST) |
| 2 | UTC as operated by the U. S. Naval Observatory (USNO) |
| 3 | UTC as operated by the International Bureau of Weights and Measures (BIPM) |
| 4-7 | Reserved for future definition |

10.3.7.97e UE positioning GANSS SBAS ID

| Information Element/Group name | Need | Multi | Type and Reference | Semantics description | Version |
|--------------------------------|------|-------|--------------------------------------|-------------------------------|---------|
| SBAS ID | MP | | Enumerated(WAAS, EGNOS, MSAS, GAGAN) | Four spare values are needed. | REL-8 |

10.3.7.97f UE positioning GANSS auxiliary information

| Information Element/Group name | Need | Multi | Type and Reference | Semantics description | Version |
|--------------------------------|------|---------------------|--------------------|--|---------|
| CHOICE GANSS-ID | | | | | REL-8 |
| >GANSS-ID-1 | | | | This choice may only be present if GANSS ID indicated 'Modernized GPS' | REL-8 |
| >>Aux Info List | MP | 1 to <maxGANSS Sat> | | | REL-8 |
| >>>Sat ID | MP | | Integer(0..63) | Identifies the satellite and is as defined in Note 2 of 10.3.7.88b. | REL-8 |
| >>>Signals Available | MP | | Bit String(8) | This field indicates the ranging signals supported by the satellite indicated by | REL-8 |

| Information Element/Group name | Need | Multi | Type and Reference | Semantics description | Version |
|--------------------------------|------|---------------------|--------------------|--|---------|
| | | | | Sat ID. This field is given as a bit string as shown in NOTE 1 for Modernized GPS. If a bit is set to "1" it indicates that the satellite identified by Sat ID transmits ranging signals according to the signal correspondence in NOTE 1. If a bit is set to "0" it indicates that the corresponding signal is not supported on the satellite identified by Sat ID | |
| >GANSS-ID-3 | | | | This choice may be present if GANSS ID indicated 'GLONASS' | REL-8 |
| >>Aux Info List | MP | 1 to <maxGANSS Sat> | | | REL-8 |
| >>>Sat ID | MP | | Integer(0..63) | Identifies the satellite and is as defined in Note 2 of 10.3.7.88b. | REL-8 |
| >>>Signals Available | MP | | Bit String(8) | This field indicates the ranging signals supported by the satellite indicated by Sat ID. This field is given as a bit string as shown in NOTE 1 for GLONASS. If a bit is set to "1" it indicates that the satellite identified by Sat ID transmits ranging signals according to the signal correspondence in NOTE 1. If a bit is set to "0" it indicates that the corresponding signal is not supported on the satellite identified by Sat ID. | REL-8 |
| >>>Channel Number | MP | | Integer(-7..13) | This field indicates the GLONASS carrier frequency number of the satellite identified by Sat ID, as defined in [73]. | REL-8 |

NOTE 1: Coding of Signals Available

| GANSS ID | Signals Available Bit String(8) | | | | | | | |
|---------------------|---------------------------------|-------|-------|-------|-------|-------|-------|-------------|
| | Bit 1 (MSB) | Bit 2 | Bit 3 | Bit 4 | Bit 5 | Bit 6 | Bit 7 | Bit 8 (LSB) |
| 1
Modernized GPS | L1C | L2C | L5 | "0" | "0" | "0" | "0" | "0" |
| 3
GLONASS | G1 | G2 | G3 | Spare | Spare | Spare | Spare | Spare |
| | | | | "0" | "0" | "0" | "0" | "0" |
| | | | | Spare | Spare | Spare | Spare | Spare |

10.3.7.98 UE positioning IPDL parameters

This IE contains parameters for the IPDL mode. The use of this parameters is described in [29].

| Information Element/Group name | Need | Multi | Type and Reference | Semantics description | Version |
|--------------------------------|------------|-------|--------------------------------|-----------------------|---------|
| CHOICE <i>mode</i> | | | | | REL-4 |
| >FDD | | | | | REL-4 |
| >>IP spacing | MP | | Integer(5,7,10,15,20,30,40,50) | See [29] | |
| >>IP length | MP | | Integer(5,10) | See [29] | |
| >>IP offset | MP | | Integer(0..9) | See [29] | |
| >>Seed | MP | | Integer(0..63) | See [29] | |
| >TDD | | | | | REL-4 |
| >>IP spacing | MP | | Integer(30,40,50,70,100) | See [33] | REL-4 |
| >>IP_Start | MP | | Integer(0..4095) | See [33] | REL-4 |
| >>IP_Slot | MP | | Integer(0..14) | See [33] | REL-4 |
| >>IP_PCCPCH | CV-channel | | Boolean | See [33] | REL-4 |
| Burst mode parameters | OP | | | | |
| >Burst Start | MP | | Integer(0..15) | See [29] and [33] | |
| >Burst Length | MP | | Integer(10..25) | See [29] and [33] | |
| >Burst freq | MP | | Integer(1..16) | See [29] and [33] | |

| Condition | Explanation |
|----------------|---|
| <i>channel</i> | This IE is present only if the idle slot carries the PCCPCH |

10.3.7.99 UE positioning measured results

| Information Element/Group name | Need | Multi | Type and reference | Semantics description | Version |
|---------------------------------------|------|-------|---|---|---------|
| UE positioning OTDOA measured results | OP | | UE positioning OTDOA measured results
10.3.7.105 | | |
| UE positioning Position estimate info | OP | | UE positioning Position estimate info
10.3.7.109 | | |
| UE positioning GPS measured results | OP | | UE positioning GPS measured results
10.3.7.93 | | |
| UE positioning error | OP | | UE positioning error
10.3.7.87 | Included if UE positioning error occurred | |
| UE positioning GANSS measured results | OP | | UE positioning GANSS measured results
10.3.7.93a | | REL-7 |

10.3.7.100 UE positioning measurement

| Information Element/Group name | Need | Multi | Type and reference | Semantics description | Version |
|--|------|-------|--|-----------------------|---------|
| UE positioning reporting quantity | MP | | UE positioning reporting quantity
10.3.7.111 | | |
| Measurement validity | OP | | Measurement validity
10.3.7.51 | | |
| <i>CHOICE reporting criteria</i> | MP | | | | |
| >UE positioning reporting criteria | | | UE positioning reporting criteria
10.3.7.110 | | |
| >Periodical reporting criteria | | | Periodical reporting criteria
10.3.7.53 | | |
| >No reporting | | | | (no data) | |
| UE positioning OTDOA assistance data for UE-assisted | OP | | UE positioning OTDOA assistance data for UE-assisted
10.3.7.103 | | |
| UE positioning OTDOA assistance data for UE-based | OP | | UE positioning | | |

| Information Element/Group name | Need | Multi | Type and reference | Semantics description | Version |
|--------------------------------------|------|-------|--|-----------------------|---------|
| | | | OTDOA assistance data for UE-based
10.3.7.103a | | |
| UE positioning GPS assistance data | OP | | UE positioning GPS assistance data
10.3.7.90 | | |
| UE positioning GANSS assistance data | OP | | UE positioning GANSS assistance data
10.3.7.90b | | REL-7 |

10.3.7.101 UE positioning measurement event results

This IE contains the measurement event results that are reported to UTRAN for UE positioning measurements.

| Information Element/Group name | Need | Multi | Type and Reference | Semantics description |
|---|------|-------|---|----------------------------|
| CHOICE <i>Event ID</i> | MP | | | One spare value is needed. |
| >7a | | | | |
| >>UE positioning Position estimate info | MP | | UE positioning Position estimate info
10.3.7.109 | |
| >7b | | | | |
| >>UE positioning OTDOA measured results | MP | | UE positioning OTDOA measured results
10.3.7.105 | |
| >7c | | | | |
| >>UE positioning GPS measurement | MP | | UE positioning GPS measured results
10.3.7.93 | |
| >7d | | | | |
| >>UE positioning GANSS measurement | MP | | UE positioning GANSS measured results
10.3.7.93a | |

10.3.7.102 Void

10.3.7.103 UE positioning OTDOA assistance data for UE-assisted

| Information Element/Group name | Need | Multi | Type and Reference | Semantics description |
|---|------|--------------------|---|-----------------------|
| UE positioning OTDOA reference cell info for UE-assisted | OP | | UE positioning OTDOA reference cell info 10.3.7.108 | |
| UE positioning OTDOA neighbour cell list for UE-assisted | OP | 1 to <maxCellMEas> | | |
| >UE positioning OTDOA neighbour cell info for UE-assisted | MP | | UE positioning OTDOA neighbour cell info 10.3.7.106 | |

10.3.7.103a UE positioning OTDOA assistance data for UE-based

| Information Element/Group name | Need | Multi | Type and Reference | Semantics description |
|--|------|--------------------|---|-----------------------|
| UE positioning OTDOA reference cell info for UE-based | OP | | UE positioning OTDOA reference cell info for UE-based 10.3.7.108a | |
| UE positioning OTDOA neighbour cell list for UE-based | OP | 1 to <maxCellMEas> | | |
| >UE positioning OTDOA neighbour cell info for UE-based | MP | | UE positioning OTDOA neighbour cell info for UE-based 10.3.7.106a | |

10.3.7.104 Void

10.3.7.105 UE positioning OTDOA measured results

| Information Element/Group name | Need | Multi | Type and Reference | Semantics description |
|---|------|-------|------------------------------|---|
| SFN | MP | | Integer(0..4095) | SFN during which the last measurement was performed |
| CHOICE <i>mode</i> | | | | |
| >FDD | | | | |
| >>Reference cell id | MP | | Primary CPICH info 10.3.6.60 | |
| >>>UE Rx-Tx time difference type 2 info | MP | | | |
| >>>>UE Rx-Tx time difference type 2 | MP | | UE Rx-Tx time difference | |

| Information Element/Group name | Need | Multi | Type and Reference | Semantics description |
|--|------|--------------------|---|---|
| | | | type 2
10.3.7.84 | |
| >>>UE positioning OTDOA quality | MP | | UE positioning OTDOA quality
10.3.7.107 | Quality of the UE Rx-Tx time difference type 2 measurement from the reference cell. |
| >TDD | | | | (no data) |
| >>Reference cell id | MP | | Cell parameters ID 10.3.6.9 | |
| Neighbours | OP | 1 to <maxCellMeas> | | |
| >CHOICE mode | MP | | | |
| >>FDD | | | | |
| >>>Neighbour Identity | MD | | Primary CPICH info
10.3.6.60 | Default value is the same as in the first set of multiple sets. |
| >>>Frequency info | MD | | Frequency info
10.3.6.36 | Default value is the existing value of frequency information |
| >>>UE Rx-Tx time difference type 2 info | OP | | | Included for cell in the active set excluding the reference cell. |
| >>>>UE Rx-Tx time difference type 2 | MP | | UE Rx-Tx time difference type 2
10.3.7.84 | |
| >>>>UE positioning OTDOA quality | MP | | UE positioning OTDOA quality
10.3.7.107 | Quality of the UE Rx-Tx time difference type 2 measurement from the neighbour cell. |
| >>TDD | | | | |
| >>>Cell and Channel ID | MD | | Cell and Channel Identity info
10.3.6.8a | Default value is the same as in the first set of multiple sets. |
| >>>UARFCN | MP | | Integer (0..16383) | |
| >UE positioning OTDOA quality | MP | | UE positioning OTDOA quality
10.3.7.107 | Quality of the SFN-SFN observed time difference type 2 measurement from the neighbour cell. |
| >SFN-SFN observed time difference type 2 | MP | | SFN-SFN observed time difference
10.3.7.63 | Gives the timing relative to the reference cell. Only type 2 is allowed. |

10.3.7.106 UE positioning OTDOA neighbour cell info

This IE gives approximate cell timing in order to decrease the search window.

| Information Element/Group name | Need | Multi | Type and Reference | Semantics description |
|--------------------------------|------|-------|--------------------|-----------------------|
| CHOICE mode | MP | | | |
| >FDD | | | | |
| >>Primary CPICH info | MP | | Primary CPICH info | |

| Information Element/Group name | Need | Multi | Type and Reference | Semantics description |
|----------------------------------|----------|-------|---|---|
| >TDD | | | 10.3.6.60 | |
| >>cell and channel ID | MP | | Cell and Channel Identity info
10.3.6.8a | Identifies the channel to be measured on. |
| Frequency info | MD | | Frequency info
10.3.6.36 | Default value is the existing value of frequency information |
| IPDL parameters | CV-IPDLs | | UE positioning IPDL parameters
10.3.7.98 | |
| SFN offset | MP | | Integer (0 .. 4095) | Although this IE is not always required, need is MP to align with ASN.1.
Define Tref as the time of beginning of system frame number SFNref of the reference cell. Define Tnc as the beginning of a frame from the neighbour cell occurring immediately after the time Tref. Let the corresponding system frame number be SFNnc. Then SFNnc = SFNref-SFN offset modulo 4096. |
| SFN offset validity | MD | | Enumerated (FALSE) | Absence of this element means SFN offset is valid. FALSE means SFN offset is not valid. |
| SFN-SFN relative time difference | MP | | Integer(0..38399) | Gives the relative timing compared to the reference cell. Equal to $\lfloor (T_{nc} - T_{ref}) * (3.84 * 10^6) \rfloor$ where $\lfloor \cdot \rfloor$ denotes rounding to the nearest lower integer.
In chips, Tnc = the time of beginning of a system frame from the neighbour cell, Tref = the time of beginning of a system frame from the reference cell. |
| SFN-SFN drift | OP | | Integer (0, -1, -2, -3, -4, -5, -8, -10, -15, -25, -35, -50, -65, -80, -100, 1, 2, 3, 4, 5, 8, 10, 15, 25, 35, 50, 65, 80, 100) | in 1/256 chips per second |
| Search Window Size | MP | | Integer(20, 40, 80, 160, 320, 640, 1280, infinity) | In chips. If the value is X then the expected SFN-SFN observed time difference is in the range [RTD-X, RTD+X] where RTD is the value of the field SFN-SFN relative time difference.
Infinity means that the uncertainty is larger than 1280 chips. |
| CHOICE <i>PositioningMode</i> | MP | | | |

| Information Element/Group name | Need | Multi | Type and Reference | Semantics description |
|--------------------------------|------|-------|--------------------|-----------------------|
| >UE based | | | | (no data) |
| >UE assisted | | | | (no data) |

| Condition | Explanation |
|--------------|---|
| <i>IPDLs</i> | This IE is mandatory present if IPDLs are applied and not needed otherwise. |

10.3.7.106a UE positioning OTDOA neighbour cell info for UE-based

This IE gives approximate cell timing in order to decrease the search window, as well as the cell locations and fine cell timing for UE based OTDOA.

| Information Element/Group name | Need | Multi | Type and Reference | Semantics description | Version |
|--|--------|-------|--|--|---------|
| UE positioning OTDOA neighbour cell info | MP | | UE positioning OTDOA neighbour cell info
10.3.7.106 | | |
| Cell Position | MD | | | Default is the same as previous cell | |
| >Relative North | OP | | Integer(-20000..20000) | Seconds of angle, scale factor 0.03. Relative position compared to reference cell. | |
| >Relative East | OP | | Integer(-20000..20000) | Seconds of angle, scale factor 0.03. Relative position compared to reference cell. | |
| >Relative Altitude | OP | | Integer(-4000..4000) | Relative altitude in meters compared to ref. cell. | |
| Fine SFN-SFN | MP | | Real(0..0.9375 in steps of 0.0625) | Gives finer resolution | |
| UE positioning Relative Time Difference Quality | MP | | UE positioning OTDOA quality
10.3.7.109a | Quality of the relative time difference between neighbour and reference cell. | |
| Round Trip Time | OP | | Real (876.00 .. 2923.875 in steps of 0.0625) | In chips. Included if cell is in active set. | |
| Round Trip Time Extension | CV-FDD | | Real (0 .. 4392.125 in steps of 0.0625) | In chips. Included if cell is in active set. Default = 0.
NOTE. | REL-7 |
| NOTE: Total Round Trip Time = IE "Round Trip Time" + IE "Round Trip Time Extension". | | | | | |

| Condition | Explanation |
|------------|--|
| <i>FDD</i> | The IE is optionally present in FDD, otherwise it is not needed. |

10.3.7.107 UE positioning OTDOA quality

| Information Element/Group name | Need | Multi | Type and Reference | Semantics description |
|--------------------------------|------|-------|--------------------|---|
| Std Resolution | MP | | Bit string(2) | Std Resolution field includes the resolution used in Std of OTDOA Measurements field. |

| Information Element/Group name | Need | Multi | Type and Reference | Semantics description |
|--------------------------------|------|-------|--------------------|--|
| | | | | Encoding on two bits as follows:
'00' 10 meters
'01' 20 meters
'10' 30 meters
'11' Reserved |
| Number of OTDOA Measurements | MP | | Bit string(3) | The 'Number of OTDOA measurements' field indicates how many OTDOA measurements have been used in the UE to determine the sample standard deviation of the measurements. Following 3 bit encoding is used:
'001' 5-9
'010' 10-14
'011' 15-24
'100' 25-34
'101' 35-44
'110' 45-54
'111' 55 or more
Special case:
'000': In this case the field 'Std of OTDOA measurements' contains the std of the reported SFN-SFN otd value = $\sqrt{E[(x-\mu)^2]}$, where x is the reported value and $\mu = E[x]$ is the expectation value (i.e. the true value) of x. This std can be used irrespective of the number of measurements and reporting of the number of measurements is not needed. Also other measurements such as Ec/No or Rx levels can be utilised in this case to evaluate the 'Std of OTDOA measurements' reported in this IE. |

| Information Element/Group name | Need | Multi | Type and Reference | Semantics description |
|--------------------------------|------|-------|--------------------|---|
| Std of OTDOA Measurements | MP | | Bit string(5) | Std of OTDOA Measurements field includes sample standard deviation of OTDOA measurements (when number of measurements is reported in 'Number of OTDOA measurements field') or standard deviation of the reported SFN-SFN otd value = $\sqrt{E[(x-\mu)^2]}$, where x is the reported value and $\mu = E[x]$ is the expectation value (i.e. the true value) of x (when '000' is given in 'Number of OTDOA measurements' field).
Following linear 5 bit encoding is used:
'00000' 0 - (R*1-1) meters
'00001' R*1 - (R*2-1) meters
'00010' R*2 - (R*3-1) meters
...
'11111' R*31 meters or more
where R is the resolution defined by Std Resolution field. E.g. R=20 m corresponds to 0-19 m, 20-39 m,...,620+ m. |

10.3.7.108 UE positioning OTDOA reference cell info

This IE defines the cell used for time references in all OTDOA measurements.

| Information Element/Group name | Need | Multi | Type and Reference | Semantics description |
|--------------------------------|------|-------|--|--|
| SFN | OP | | Integer (0..4095) | Time stamp (SFN of Reference Cell) of the SFN-SFN relative time differences and SFN-SFN drift rates. Included if any SFN-SFN drift value is included in IE UE positioning OTDOA neighbour cell info. |
| CHOICE <i>mode</i> | MP | | | |
| >FDD | | | | |
| >>Primary CPICH info | MP | | Primary CPICH info 10.3.6.60 | |
| >TDD | | | | |
| >>cell and channel ID | MP | | Cell and Channel Identity info 10.3.6.8a | Identifies the channel to be measured on. |
| Frequency info | MD | | Frequency info 10.3.6.36 | Default value is the existing value of frequency information. This IE shall always be set to default value |
| CHOICE <i>PositioningMode</i> | MP | | | |
| >UE based | | | | |
| >UE assisted | | | | (no data) |
| IPDL parameters | OP | | UE positioning IPDL parameters 10.3.7.98 | If this element is not included there are no idle periods present |

10.3.7.108a UE positioning OTDOA reference cell info for UE-based

This IE defines the cell used for time references in all OTDOA measurements for UE-based methods.

| Information Element/Group name | Need | Multi | Type and Reference | Semantics description | Version |
|--|--------|-------|---|--|---------|
| UE positioning OTDOA reference cell info | MP | | UE positioning OTDOA reference cell info 10.3.7.108 | | |
| CHOICE <i>Cell Position</i> | OP | | | The position of the antenna that defines the cell. Used for the UE based method. | |
| >Ellipsoid | | | | | |
| >>Ellipsoid point | MP | | Ellipsoid point 10.3.8.4a | | |
| >Ellipsoid with altitude | | | | | |
| >>Ellipsoid point with altitude | MP | | Ellipsoid point with altitude 10.3.8.4b | | |
| Round Trip Time | OP | | Real (876.00 .. 2923.875 in steps of 0.0625) | In chips. | |
| Round Trip Time Extension | CV-FDD | | Real (0 .. 4392.125 in steps of 0.0625) | In chips. Default = 0. NOTE. | REL-7 |
| NOTE: Total Round Trip Time = IE "Round Trip Time" + IE "Round Trip Time Extension". | | | | | |

| Condition | Explanation |
|-----------|--|
| FDD | The IE is optionally present in FDD, otherwise it is not needed. |

10.3.7.109 UE positioning position estimate info

The purpose of this IE is to provide the position estimate from the UE to the network, if the UE is capable of determining its own position.

| Information Element/Group name | Need | Multi | Type and Reference | Semantics description | Version |
|--------------------------------|------|-------|------------------------------|---|---------|
| CHOICE <i>Reference Time</i> | MP | | | | |
| >UTRAN GPS reference time | | | | | |
| >>UE GPS timing of cell frames | MP | | Integer(0.. 3715891199 9999) | GPS Time of Week in units of 1/16 th UMTS chips according to [19]. 33209832177664 spare values are needed. | |
| >>>CHOICE <i>mode</i> | MP | | | | |
| >>>>FDD | | | | | |
| >>>>>Primary CPICH Info | MP | | Primary CPICH Info 10.3.6.60 | Identifies the reference cell for the GPS TOW-SFN relationship | |
| >>>>TDD | | | | | |
| >>>cell parameters id | MP | | Cell parameters id 10.3.6.9 | Identifies the reference cell for the GPS TOW-SFN relationship. | |
| >>>Reference SFN | MP | | Integer(0..40 95) | The SFN for which the location is valid. This IE indicates the SFN at which the UE timing of cell frame is captured. | |
| >GPS reference time only | | | | | |

| Information Element/Group name | Need | Multi | Type and Reference | Semantics description | Version |
|---|------|-------|--|--|---------|
| >>GPS TOW msec | MP | | Integer(0..6.048*10 ⁸ -1) | GPS Time of Week in milliseconds (rounded down to the nearest millisecond unit). | |
| >Cell timing | | | | | |
| >>SFN | MP | | Integer(0..4095) | SFN during which the position was calculated. | |
| >>CHOICE <i>mode</i> | MP | | | | |
| >>>FDD | | | | | |
| >>>>Primary CPICH Info | MP | | Primary CPICH Info 10.3.6.60 | Identifies the reference cell for SFN | |
| >>>TDD | | | | | |
| >>cell parameters id | MP | | Cell parameters id 10.3.6.9 | Identifies reference cell for SFN | |
| >UTRAN GANSS reference time | | | | | REL-7 |
| >>UE GANSS timing of cell frames | MP | | Integer(0..8639999999750 by step of 250) | GANSS Time of Day in ns | REL-7 |
| >>GANSS Time ID | OP | | Integer(0..7) | Absence of this field means Galileo.
For coding description see NOTE 2 in 10.3.7.93a. | REL-7 |
| >>GANSS TOD Uncertainty | OP | | Integer(0..127) | Coding as in 10.3.7.96a | REL-7 |
| >>CHOICE <i>mode</i> | MP | | | | REL-7 |
| >>>FDD | | | | | REL-7 |
| >>>>Primary CPICH Info | MP | | Primary CPICH Info 10.3.6.60 | Identifies the reference cell for the GANSS TOD-SFN relationship | REL-7 |
| >>>TDD | | | | | REL-7 |
| >>>>cell parameters id | MP | | Cell parameters id 10.3.6.9 | Identifies the reference cell for the GANSS TOD-SFN relationship. | REL-7 |
| >>Reference SFN | MP | | Integer(0..4095) | The SFN for which the location is valid. This IE indicates the SFN at which the UE timing of cell frame is captured. | REL-7 |
| >GANSS reference time only | | | | | REL-7 |
| >>GANSS TOD msec | MP | | Integer(0..3599999) | GANSS Time of Day in milliseconds (rounded down to the nearest millisecond unit). | REL-7 |
| >>GANSS Time ID | OP | | Integer(0..7) | Absence of this field means Galileo.
For coding description see NOTE 2 in 10.3.7.93a. | REL-7 |
| CHOICE <i>Position estimate</i> | MP | | | The position estimate is provided in WGS-84 reference system. | |
| >Ellipsoid Point | | | Ellipsoid Point; 10.3.8.4a | | |
| >Ellipsoid point with uncertainty circle | | | Ellipsoid point with uncertainty circle 10.3.8.4d | | |
| >Ellipsoid point with uncertainty ellipse | | | Ellipsoid point with uncertainty ellipse 10.3.8.4e | | |

| Information Element/Group name | Need | Multi | Type and Reference | Semantics description | Version |
|--|----------------------|-------|--|---|---------|
| >Ellipsoid point with altitude | | | Ellipsoid point with altitude
10.3.8.4b | | |
| >Ellipsoid point with altitude and uncertainty ellipsoid | | | Ellipsoid point with altitude and uncertainty ellipsoid
10.3.8.4c | | |
| Position Data | MP | | Bit string(16) | For each bit, if set to "1", indicates that respective GNSS or position system was used for position calculation.
Bit 0: OTDOA
bit 1: GPS
bit 2: Galileo
bit 3-15: reserved | REL-7 |
| | | | | bit 3: SBAS
bit 4: Modernized GPS
bit 5: QZSS
bit 6: GLONASS
bit 7-15: reserved | REL-8 |
| CHOICE <i>Velocity estimate</i> | OP | | | | REL-7 |
| >Horizontal Velocity | | | Horizontal Velocity
10.3.8.4h | | REL-7 |
| >Horizontal with Vertical Velocity | | | Horizontal with Vertical Velocity
10.3.8.4i | | REL-7 |
| >Horizontal Velocity with Uncertainty | | | Horizontal Velocity with Uncertainty
10.3.8.4j | | REL-7 |
| >Horizontal with Vertical Velocity and Uncertainty | | | Horizontal with Vertical Velocity and Uncertainty
10.3.8.4k | | REL-7 |
| UE Positioning GPS ReferenceTime Uncertainty | <i>CV-Tutran-gps</i> | | UE positioning GPS reference time uncertainty
10.3.7.96a | | REL-7 |

| Condition | Explanation |
|-------------------|---|
| <i>Tutran-gps</i> | This IE is optionally present if "UTRAN GPS reference time" is included and not needed otherwise. |

10.3.7.109a UE positioning Relative Time Difference quality

| Information Element/Group name | Need | Multi | Type and Reference | Semantics description |
|---|------|-------|--------------------|---|
| Relative Time Difference Std Resolution | MP | | Bit string(2) | Std Resolution field includes the resolution used in Std of Relative Time Difference field. Encoding on two bits as follows:
'00' 10 meters
'01' 20 meters
'10' 30 meters
'11' Reserved |
| Std of Relative Time Difference | MP | | Bit string(5) | Std of Relative Time difference field includes standard deviation of (SFN-SFN relative time difference + Fine SFN-SFN). Following linear 5 bit encoding is used:
'00000' 0 - (R*1-1) meters
'00001' R*1 - (R*2-1) meters
'00010' R*2 - (R*3-1) meters
...
'11111' R*31 meters or more
where R is the resolution defined by Std Resolution field. E.g. R=20 m corresponds to 0-19 m, 20-39 m,...,620+ m. |

10.3.7.110 UE positioning reporting criteria

The triggering of the event-triggered reporting for a UE positioning measurement.

| Information Element/Group name | Need | Multi | Type and Reference | Semantics description | Version |
|--|------|----------------------|--|---|---------|
| Parameters required for each event | MP | 1 to <maxMeas Event> | | Note: need corrected to MP in Rel-7 to align with ASN.1. | |
| >Amount of reporting | MP | | Integer(1, 2, 4, 8, 16, 32, 64,infinite) | | |
| >Report first fix | MP | | Boolean | If TRUE the UE reports the position once the measurement control is received, and then each time an event is triggered. | |
| >Measurement interval | MP | | Integer(5,15,60,300,900,1800,3600,7200) | Indicates how often the UE should make the measurement
In seconds | |
| >CHOICE Event ID | MP | | | | |
| >>7a | | | | | |
| >>>Threshold Position Change | MP | | Integer(10, 20,30,40,50,100,200,300,500,1000,2000,5000,10000,20000,50000,100000) | Meters. Indicated how much the position should change compared to last reported position fix in order to trigger the event. | |
| >>7b | | | | | |
| >>>Threshold SFN-SFN change | MP | | Real(0.25, 0.5,1,2,3,4, 5,10,20,50, 100,200,500,1000,2000,5000) | Chips. Indicates how much the SFN-SFN measurement of ANY measured cell is allowed to change before the event is triggered. | |
| >>7c | | | | | |
| >>>Threshold SFN-GPS TOW | MP | | Integer(1,2,3,5,10,20, 50,100) | Time in ms. When the GPS TOW and SFN timer has drifted apart more than the specified value the event is triggered. | |
| | | | | Time in micro seconds (NOTE 1). | REL-7 |
| >>7d | | | | | REL-7 |
| >>>Threshold SFN-GANSS TOW | MP | | Integer(1,2,3,5,10,20, 50,100) | Time in micro seconds. When the GANSS TOW and SFN timer has drifted apart more than the specified value the event is triggered. | REL-7 |
| NOTE 1: In previous versions of the protocol, the IE "Threshold SFN-GPS TOW" was provided in units of milli seconds. If the information is provided in units of micro seconds, the UE shall ignore any information provided in units of milli seconds. | | | | | |

10.3.7.111 UE positioning reporting quantity

The purpose of the element is to express the allowed/required location method(s), and to provide information desired QoS.

| Information Element/Group name | Need | Multi | Type and Reference | Semantics description | Version |
|--------------------------------|------|-------|-----------------------------------|-----------------------|---------|
| Method Type | MP | | Enumerated(UE assisted, UE based, | | |

| Information Element/Group name | Need | Multi | Type and Reference | Semantics description | Version |
|------------------------------------|-------------------|-------|--|---|---------|
| | | | UE based is preferred but UE assisted is allowed, UE assisted is preferred but UE based is allowed) | | |
| Positioning Methods | MP | | Enumerated(OTDOA, GPS, OTDOA or GPS, Cell ID) | | |
| Response Time | MP | | Integer(1,2,4, 8, 16, 32, 64, 128) | This IE shall be ignored. | |
| Horizontal Accuracy | CV-
MethodType | | Bit string(7) | The uncertainty is derived from the "uncertainty code" k by $r = 10 * (1.1^k - 1)$ in meters. | |
| Vertical Accuracy | CV-
MethodType | | Bit string(7) | The uncertainty is derived from the "uncertainty code" k by $r = 45 * (1.025^k - 1)$ in meters. | |
| GPS timing of Cell wanted | MP | | Boolean | If TRUE the SRNC wants the UE to report the SFN-GPS timing of the reference cell. This is however optional in the UE. | |
| Multiple Sets | MP | | Boolean | This IE shall be ignored. | |
| Additional Assistance Data Request | MP | | Boolean | TRUE indicates that the UE is requested to send the IE "GPS Additional Assistance Data Request" and/or the IE "GANSS Additional Assistance Data Request" (if the IE 'GANSS Positioning Methods' is included) when the IE "UE positioning Error" is present in the UE positioning measured results. FALSE indicates that the UE shall use the assistance data available. | |
| Environment Characterisation | OP | | Enumerated(possibly heavy multipath and NLOS conditions, no or light multipath and usually LOS conditions, not defined or mixed environment) | One spare value is needed. | |
| Velocity Requested | OP | | Enumerated (TRUE) | If this element is present the UE is requested to send a velocity estimate | REL-7 |

| Information Element/Group name | Need | Multi | Type and Reference | Semantics description | Version |
|---|------|-------|--------------------|---|---------|
| GANSS Positioning Methods | OP | | Bit string(16) | For each bit, if set to "1", indicates that respective GNSS is allowed.
bit 0: GPS
bit 1: Galileo
bit 2-15: reserved for future GNSSes

Note 1 | REL-7 |
| | | | | bit 2: SBAS (WAAS, EGNOS, MSAS, GAGAN)
bit 3: Modernized GPS (L1C, L2C, L5)
bit 4: QZSS
bit 5: GLONASS
bit 6-15: reserved for future GNSSes

Note 1 | REL-8 |
| GANSS timing of Cell wanted | OP | | Bit string(8) | Each bit refers to a GANSS. Bit 0 is for Galileo. Other bits are reserved.
If one bit is set to one the SRNC wants the UE to report the SFN-GANSS timing of the reference cell. This is however optional in the UE. | REL-7 |
| | | | | Bit 1 is for Modernized GPS;
Bit 2 is for QZSS;
Bit 3 is for GLONASS;
Other bits are reserved.
If one bit is set to one the SRNC wants the UE to report the SFN-GANSS timing of the reference cell. This is however optional in the UE.
If more than one bit is set to one, the UE will select the GANSS among the allowed GANSS for the SFN-GANSS timing of the reference cell in the measurement report. | Rel-8 |
| GANSS Carrier-Phase Measurement Requested | OP | | Bit string(8) | Each bit refers to a GANSS. Bit 0 is for Galileo. Other bits are reserved.
This is however optional in the UE. | REL-7 |
| | | | | Bit 1 is for SBAS;
Bit 2 is for Modernized GPS;
Bit 3 is for QZSS;
Bit 4 is for GLONASS;
Other bits are reserved.
This is however optional in the UE. | Rel-8 |
| GANSS Multi-frequency Measurement Requested | OP | | Bit String(8) | Each bit refers to a GANSS. Bit 0 is for Galileo;
Bit 1 is for SBAS;
Bit 2 is for Modernized GPS;
Bit 3 is for QZSS;
Bit 4 is for GLONASS;
Other bits are reserved.
This is however optional in the UE. | REL-8 |

| Condition | Explanation |
|--------------------|---|
| <i>Method Type</i> | The IE is optional if the IE "Method Type" is "UE assisted"; otherwise it is mandatory present. |

NOTE 1: Bit 0 of this bitmap shall not be the only one set to 1.

10.3.7.112 T_{ADV} info

NOTE: Only for 1.28 Mcps TDD.

T_{ADV} indicates the difference between the Rx timing and Tx timing of a UE.

| Information Element/group name | Need | Multi | Type and reference | Semantics description | Version |
|--------------------------------|------|-------|-------------------------------|---|---------|
| T_{ADV} | MP | | Integer (0..2047, 2048..8191) | As defined in [20]. | REL-4 |
| | | | | | REL-7 |
| SFN | MP | | Integer(0..4095) | SFN during which the T_{ADV} measurement was performed. | REL-4 |

10.3.7.113 UTRA priority info list

Contains priority based reselection information for UTRA.

| Information Element/Group name | Need | Multi | Type and reference | Semantics description | Version |
|--------------------------------|------|-----------------------|----------------------------------|--|---------|
| UTRA Serving Cell | MP | | | | REL-8 |
| >priority | MP | | Integer (0..<maxPrio-1>) | 0 is the lowest priority and maxPrio-1 is the highest | REL-8 |
| >S _{prioritysearch1} | MP | | Integer (0..62 by step of 2) | dB | REL-8 |
| >S _{prioritysearch2} | MD | | Integer (0..7 by step of 1) | dB, default value is 0 | REL-8 |
| >Thresh _{serv,low} | MP | | Integer (0..62 by step of 2) | RSCP, dB | REL-8 |
| UTRAN FDD Frequencies | OP | 1 to <maxNumFDDFreqs> | | | REL-8 |
| >UARFCN | MP | | Integer(0..16383) | | REL-8 |
| >priority | MP | | Integer (0..<maxPrio-1>) | 0 is the lowest priority and maxPrio-1 is the highest. | REL-8 |
| >Thresh _{x, high} | MP | | Integer (0..62 by step of 2) | RSCP, dB | REL-8 |
| >Thresh _{x, low} | MP | | Integer (0..62 by step of 2) | RSCP, dB | REL-8 |
| >QqualminFDD | MD | | Integer (-24..0) | Ec/N0, [dB]
Default value is Qqualmin for the serving cell | REL-8 |
| >QrxlevminFDD | MD | | Integer (-119..-25 by step of 2) | RSCP, [dBm]
Default value is Qrxlevmin for the serving cell | REL-8 |
| UTRAN TDD Frequencies | OP | 1 to <maxNumTDDFreqs> | | | REL-8 |
| >UARFCN | MP | | Integer(0..16383) | | REL-8 |
| >priority | MP | | Integer (0..<maxPrio-1>) | 0 is the lowest priority and maxPrio-1 is the highest. | REL-8 |
| >Thresh _{x, high} | MP | | Integer (0..62 by step of 2) | RSCP, dB | REL-8 |
| >Thresh _{x, low} | MP | | Integer (0..62 by step of 2) | RSCP, dB | REL-8 |
| >QrxlevminTDD | MD | | Integer (-119..-25 by step of 2) | RSCP, [dBm]
Default value is Qrxlevmin for the serving cell | REL-8 |

NOTE: The network should ensure that priorities for different Radio Access Technologies are always different.

10.3.7.114 GSM priority info list

Contains priority based reselection information for GSM.

| Information Element/Group name | Need | Multi | Type and reference | Semantics description | Version |
|--------------------------------|------|----------------------------|----------------------------------|--|---------|
| GSM Priority Info | MP | 1 to <maxNum GSMCellGroup> | | | REL-8 |
| >GSM cell group List | MP | | GSM cell group
10.3.7.9a | | REL-8 |
| >priority | MP | | Integer (0..<maxPrio-1>) | 0 is the lowest priority and maxPrio-1 is the highest. | REL-8 |
| >QrxlevminGSM | MP | | Integer (-115..-25 by step of 2) | GSM RSSI, [dBm] | REL-8 |
| >Thresh _{x, high} | MP | | Integer (0..62 by step of 2) | GSM RSSI, dB | REL-8 |
| >Thresh _{x, low} | MP | | Integer (0..62 by step of 2) | GSM RSSI, dB | REL-8 |

NOTE: The network should ensure that priorities for different Radio Access Technologies are always different.

10.3.7.115 E-UTRA frequency and priority info list

Contains information about neighbour E-UTRA frequencies (with associated blacklists), together with priority based reselection information.

| Information Element/Group name | Need | Multi | Type and reference | Semantics description | Version |
|---|------|----------------------------|------------------------------------|--|---------|
| E-UTRA frequency and priority | | 1 to <maxNum EUTRAFreqs> | | | REL-8 |
| >EARFCN | MP | | Integer(0..65535) | EARFCN of the downlink carrier frequency [36.101] | REL-8 |
| >Measurement Bandwidth | MD | | Enumerated(6, 15, 25, 50, 75, 100) | Measurement bandwidth information common for all neighbouring cells on the carrier frequency. It is defined by the parameter Transmission Bandwidth Configuration, N_{RB} [36.104]. The values indicate the number of resource blocks over which the UE could measure. Default value is 6. | REL-8 |
| >priority | MP | | Integer (0..<maxPrio-1>) | 0 is the lowest priority and maxPrio-1 is the highest. | REL-8 |
| >QrxlevminEUTRA | MP | | Integer (-140..-44 by step of 2) | RSRP, [dBm] | REL-8 |
| >Thresh _{x, high} | MP | | Integer (0..62 by step of 2) | RSRP, dB | REL-8 |
| >Thresh _{x, low} | MP | | Integer (0..62 by step of 2) | RSRP, dB | REL-8 |
| >Blacklisted cells per freq list | OP | 1 to <maxEUTRACellPerFreq> | | | REL-8 |
| >>Physical Cell identity | MP | | Integer (0..503) | A list of blacklisted cells can be signalled per frequency | REL-8 |
| >E-UTRA detection | MP | | Boolean | "TRUE" means that the UE may detect the presence of a E-UTRA cell and report to NAS.
NOTE 1. | REL-8 |
| NOTE 1: If the value of 'E-UTRA detection' is not identical across the frequency layers, UE behaviour is unspecified. | | | | | |

NOTE: The network should ensure that priorities for different Radio Access Technologies are always different.

10.3.8 Other Information elements

10.3.8.1 BCCH modification info

Indicates modification of the System Information on BCCH.

| Information Element/Group name | Need | Multi | Type and reference | Semantics description |
|--------------------------------|------|-------|--------------------------------|--|
| MIB Value tag | MP | | MIB Value tag 10.3.8.9 | |
| BCCH modification time | OP | | Integer (0..4088 in step of 8) | All SFN values in which MIB may be mapped are allowed. |

10.3.8.2 BSIC

| Information Element/Group name | Need | Multi | Type and reference | Semantics description |
|---|------|-------|--------------------|--|
| Base transceiver Station Identity Code (BSIC) | MP | | | [11] |
| >Network Colour Code (NCC) | MP | | bit string(3) | The first/leftmost bit of the bit string contains the most significant bit of the NCC. |
| >Base Station Colour Code (BCC) | MP | | bit string(3) | The first/leftmost bit of the bit string contains the most significant bit of the BCC. |

10.3.8.3 CBS DRX Level 1 information

This information element contains the CBS discontinuous reception information to be broadcast for CBS DRX Level 1 calculations in the UE.

| Information Element/Group name | Need | Multi | Type and reference | Semantics description | Version |
|---------------------------------------|---------|-------|-----------------------------------|--|---------|
| Period of CTCH allocation (N) | MP | | Integer (1..256) | $M_{TTI} \leq N \leq 256$,
N multiple of M_{TTI} | |
| CBS frame offset (K) | MP | | Integer (0..255) | $0 \leq K \leq N-1$,
K multiple of M_{TTI} | |
| Period of BMC scheduling messages (P) | CV-SIB5 | | Integer (8, 16, 32, 64, 128, 256) | | REL-6 |

| Condition | Explanation |
|-----------|--|
| SIB5 | The IE is optional when the IE "CBS DRX Level 1 information" in SIB5, otherwise the IE is not needed |

10.3.8.4 Cell Value tag

| Information Element/Group name | Need | Multi | Type and reference | Semantics description |
|--------------------------------|------|-------|--------------------|-----------------------|
| Cell Value tag | MP | | Integer (1..4) | |

10.3.8.4a Ellipsoid point

This IE contains the description of an ellipsoid point as in [24].

| Information Element/Group name | Need | Multi | Type and Reference | Semantics description |
|--------------------------------|------|-------|--|---|
| Latitude sign | MP | | Enumerated (North, South) | |
| Degrees Of Latitude | MP | | Integer (0...2 ²³ -1) | The IE value (<i>N</i>) is derived by this formula:
$N \leq 2^{23} X / 90 < N+1$
<i>X</i> being the latitude in degree (0°.. 90°) |
| Degrees Of Longitude | MP | | Integer (-2 ²³ ...2 ²³ -1) | The IE value (<i>N</i>) is derived by this formula:
$N \leq 2^{24} X / 360 < N+1$
<i>X</i> being the longitude in degree (-180°..+180°) |

10.3.8.4b Ellipsoid point with Altitude

This IE contains the description of an ellipsoid point with altitude as in [24].

| Information Element/Group name | Need | Multi | Type and Reference | Semantics description |
|--------------------------------|------|-------|--|---|
| Latitude sign | MP | | Enumerated (North, South) | |
| Degrees Of Latitude | MP | | Integer (0...2 ²³ -1) | The IE value (<i>N</i>) is derived by this formula:
$N \leq 2^{23} X / 90 < N+1$
<i>X</i> being the latitude in degree (0°.. 90°) |
| Degrees Of Longitude | MP | | Integer (-2 ²³ ...2 ²³ -1) | The IE value (<i>N</i>) is derived by this formula:
$N \leq 2^{24} X / 360 < N+1$
<i>X</i> being the longitude in degree (-180°..+180°) |
| Altitude Direction | MP | | Enumerated (Height, Depth) | |
| Altitude | MP | | Integer (0..2 ¹⁵ -1) | The IE value (<i>N</i>) is derived by this formula:
$N \leq a < N+1$
<i>a</i> being the altitude in metres |

10.3.8.4c Ellipsoid point with Altitude and uncertainty ellipsoid

This IE contains the description of an ellipsoid point with altitude and uncertainty ellipsoid as in [24].

| Information Element/Group name | Need | Multi | Type and Reference | Semantics description |
|--------------------------------|------|-------|----------------------------------|---|
| Latitude sign | MP | | Enumerated (North, South) | |
| Degrees Of Latitude | MP | | Integer (0...2 ²³ -1) | The IE value (<i>N</i>) is derived by this formula:
$N \leq 2^{23} X / 90 < N+1$
<i>X</i> being the latitude in degree (0°.. 90°) |

| Information Element/Group name | Need | Multi | Type and Reference | Semantics description |
|--------------------------------|------|-------|--------------------------------------|---|
| Degrees Of Longitude | MP | | Integer (- $2^{23} \dots 2^{23}-1$) | The IE value (N) is derived by this formula:
$N \leq 2^{24} X / 360 < N+1$
X being the longitude in degree (-180° .. +180°) |
| Altitude Direction | MP | | Enumerated (Height, Depth) | |
| Altitude | MP | | Integer (0.. $2^{15}-1$) | The IE value (N) is derived by this formula:
$N \leq a < N+1$
a being the altitude in metres |
| Uncertainty semi-major | MP | | Integer (0...127) | The uncertainty r is derived from the "uncertainty code" k by
$r = 10x(1.1^k-1)$ |
| Uncertainty semi-minor | MP | | Integer (0...127) | The uncertainty r is derived from the "uncertainty code" k by
$r = 10x(1.1^k-1)$ |
| Orientation of major axis | MP | | Integer (0..89) | The IE value (N) is derived by this formula:
$2N \leq a < 2(N+1)$
a being the orientation in degree (0° .. 179°) |
| Uncertainty Altitude | MP | | Integer(0..127) | The uncertainty in altitude, h , expressed in metres is mapped from the IE value (K), with the following formula:
$h = C((1+x)^K - 1)$ with $C = 45$ and $x = 0.025$. |
| Confidence | MP | | Integer (0..100) | in percentage |

10.3.8.4d Ellipsoid point with uncertainty Circle

This IE contains the description of an ellipsoid point with an uncertainty circle as in [24].

| Information Element/Group name | Need | Multi | Type and Reference | Semantics description |
|--------------------------------|------|-------|--------------------------------------|---|
| Latitude sign | MP | | Enumerated (North, South) | |
| Degrees Of Latitude | MP | | Integer (0... $2^{23}-1$) | The IE value (N) is derived by this formula:
$N \leq 2^{23} X / 90 < N+1$
X being the latitude in degree (0° .. 90°) |
| Degrees Of Longitude | MP | | Integer (- $2^{23} \dots 2^{23}-1$) | The IE value (N) is derived by this formula:
$N \leq 2^{24} X / 360 < N+1$
X being the longitude in degree (-180° .. +180°) |
| Uncertainty Code | MP | | Integer (0...127) | The uncertainty r is derived from the "uncertainty code" k by
$r = 10x(1.1^k-1)$ |

10.3.8.4e Ellipsoid point with uncertainty Ellipse

This IE contains the description of an ellipsoid point with an uncertainty ellipse as in [24].

| Information Element/Group name | Need | Multi | Type and Reference | Semantics description |
|--------------------------------|------|-------|--|--|
| Latitude sign | MP | | Enumerated (North, South) | |
| Degrees Of Latitude | MP | | Integer (0...2 ²³ -1) | The IE value (N) is derived by this formula:
$N \leq 2^{23} X / 90 < N+1$
X being the latitude in degree (0°.. 90°) |
| Degrees Of Longitude | MP | | Integer (-2 ²³ ...2 ²³ -1) | The IE value (N) is derived by this formula:
$N \leq 2^{24} X / 360 < N+1$
X being the longitude in degree (-180° ..+180°) |
| Uncertainty semi-major | MP | | Integer (0...127) | The uncertainty <i>r</i> is derived from the "uncertainty code" <i>k</i> by
$r = 10x(1.1^k - 1)$ |
| Uncertainty semi-minor | MP | | Integer (0...127) | The uncertainty <i>r</i> is derived from the "uncertainty code" <i>k</i> by
$r = 10x(1.1^k - 1)$ |
| Orientation of major axis | MP | | Integer (0..89) | The IE value (N) is derived by this formula:
$2N \leq a < 2(N+1)$
a being the orientation in degree (0°.. 179°) |
| Confidence | MP | | Integer (0..100) | in percentage |

10.3.8.4ea ETWS information

Indication of an ETWS primary notification. The ETWS warning type is used to notify upper layers.

| Information Element/Group name | Need | Multi | Type and reference | Semantics description | Version |
|--------------------------------|------|-------|---------------------|--|---------|
| Warning Type | MP | | Octet string (1..2) | IE "Warning Type" as defined in [77] | REL-8 |
| Message Identifier | MP | | Octet string (2) | IE "Message Identifier" as defined in [77] | REL-8 |
| Serial Number | MP | | Octet string (2) | IE "Serial Number" as defined in [77] | REL-8 |

10.3.8.4eb Void

10.3.8.4f GERAN system information

| Information Element/Group name | Need | Multi | Type and reference | Semantics description | Version |
|--------------------------------|------|--------------------|--------------------|-----------------------|---------|
| >>> GERAN System Info | MP | 1 to <maxGERAN SI> | | | REL-5 |
| >>>> GERAN | MP | | Octet | The first octet | REL-5 |

| Information Element/Group name | Need | Multi | Type and reference | Semantics description | Version |
|--------------------------------|------|-------|--------------------|--|---------|
| system info block | | | string(1..23) | contains octet 1 of the GERAN system information block, the second octet contains octet 2 of the GERAN system information block and so on. | |

10.3.8.4g GSM Target Cell Info

| Information Element/Group name | Need | Multi | Type and reference | Semantics description | Version |
|--------------------------------|------|---------------------------|---|---|---------|
| GSM Target Cell Info List | MP | 1 to <maxGSMTar getCells> | | | REL-6 |
| >BCCH ARFCN | MP | | Integer (0..1023) | [45] | REL-6 |
| >Band indicator | MP | | Enumerated (DCS 1800 band used, PCS 1900 band used) | Indicates how to interpret the BCCH ARFCN | REL-6 |
| >BSIC | OP | | BSIC 10.3.8.2 | | REL-6 |

10.3.8.4h Horizontal Velocity

This IE contains the description of a horizontal velocity as in [24].

| Information Element/Group name | Need | Multi | Type and Reference | Semantics description |
|--------------------------------|------|-------|----------------------------------|---|
| Bearing | MP | | Integer (0...359) | The direction of movement is given in degrees where "0" represents North, "90" represents East, etc. |
| Horizontal Speed | MP | | Integer (0...2 ¹¹ -1) | The relationship between (N) and the horizontal speed (h) in kilometers per hour it describes is:
$N \leq h < N + 0.5$, for (N=0)
$N-0.5 \leq h < N + 0.5$, for (0<N<2 ¹¹ -1)
$N - 0.5 \leq h$, for (N = 2 ¹¹ -1) |

10.3.8.4i Horizontal with Vertical Velocity

This IE contains the description of horizontal with vertical velocity as in [24].

| Information Element/Group name | Need | Multi | Type and Reference | Semantics description |
|--------------------------------|------|-------|-------------------------------|--|
| Vertical Speed direction | MP | | ENUMERATED (upward, downward) | |
| Bearing | MP | | Integer (0...359) | The direction of movement is given in degrees where "0" represents North, "90" represents East, etc. |

| Information Element/Group name | Need | Multi | Type and Reference | Semantics description |
|--------------------------------|------|-------|-------------------------------------|--|
| Horizontal Speed | MP | | Integer
(0...2 ¹¹ -1) | The relationship between (N) and the horizontal speed (h) in kilometers per hour it describes is:
N ≤ h < N + 0.5, for (N=0)
N-0.5 ≤ h < N + 0.5, for (0 < N < 2 ¹¹ -1)
N - 0.5 ≤ h, for (N = 2 ¹¹ -1) |
| Vertical Speed | MP | | Integer
(0..255) | The relationship between (N) and the vertical speed (v) in kilometres per hour it describes is given by the formula:
N ≤ v < N + 0.5, for (N=0)
N-0.5 ≤ v < N + 0.5, for (0 < N < 2 ⁸ -1)
N - 0.5 ≤ v, for (N = 2 ⁸ -1) |

10.3.8.4j Horizontal Velocity with Uncertainty

This IE contains the description of horizontal velocity with uncertainty as in [24].

| Information Element/Group name | Need | Multi | Type and Reference | Semantics description |
|--------------------------------|------|-------|-------------------------------------|---|
| Bearing | MP | | Integer
(0...359) | The direction of movement is given in degrees where "0" represents North, "90" represents East, etc. |
| Horizontal Speed | MP | | Integer
(0...2 ¹¹ -1) | The relationship between (N) and the horizontal speed (h) in kilometers per hour it describes is:
N ≤ h < N + 0.5, for (N=0)
N-0.5 ≤ h < N + 0.5, for (0 < N < 2 ¹¹ -1)
N - 0.5 ≤ h, for (N = 2 ¹¹ -1) |
| Horizontal Uncertainty Speed | MP | | Integer
(0..255) | The IE value is encoded in increments of 1 kilometer per hour. The value of N give the uncertainty speed except for N=255 which indicates that the uncertainty is not specified |

10.3.8.4k Horizontal with Vertical Velocity and Uncertainty

This IE contains the description of horizontal with vertical velocity and uncertainty as in [24].

| Information Element/Group name | Need | Multi | Type and Reference | Semantics description |
|--------------------------------|------|-------|----------------------------------|--|
| Vertical Speed direction | MP | | ENUMERATED
(upward, downward) | |
| Bearing | MP | | Integer
(0...359) | The direction of movement is given in degrees where "0" represents North, "90" represents East, etc. |

| Information Element/Group name | Need | Multi | Type and Reference | Semantics description |
|--------------------------------|------|-------|----------------------------------|--|
| Horizontal Speed | MP | | Integer (0...2 ¹¹ -1) | The relationship between (N) and the horizontal speed (h) in kilometers per hour it describes is:
N ≤ h < N + 0.5, for (N=0)
N-0.5 ≤ h < N + 0.5, for (0 < N < 2 ¹¹ -1)
N - 0.5 ≤ h, for (N = 2 ¹¹ -1) |
| Vertical Speed | MP | | Integer (0..255) | The relationship between (N) and the vertical speed (v) in kilometres per hour it describes is given by the formula:
N ≤ v < N + 0.5, for (N=0)
N-0.5 ≤ v < N + 0.5, for (0 < N < 2 ⁸ -1)
N - 0.5 ≤ v, for (N = 2 ⁸ -1) |
| Horizontal Uncertainty Speed | MP | | Integer (0..255) | The IE value is encoded in increments of 1 kilometer per hour. The value of N give the uncertainty speed except for N=255 which indicates that the uncertainty is not specified |
| Vertical Uncertainty Speed | MP | | Integer (0..255) | The IE value is encoded in increments of 1 kilometer per hour. The value of N give the uncertainty speed except for N=255 which indicates that the uncertainty is not specified |

10.3.8.4L E-UTRA Target Info

| Information Element/Group name | Need | Multi | Type and reference | Semantics description | Version |
|-----------------------------------|------|-----------------------------|--------------------|---|---------|
| E-UTRA Target Frequency Info List | MP | 1 to <maxEUTRA TargetFreqs> | | | REL-8 |
| >DL Carrier frequency | MP | | Integer (0..65535) | EARFCN of the downlink carrier frequency [63] | REL-8 |
| >Blacklisted cells per freq list | OP | 1 to <maxEUTRA CellPerFreq> | | | REL-8 |
| >>Physical Cell identity | MP | | Integer (0..503) | | REL-8 |

10.3.8.4m HNB Name

This information element is used to carry the name of the home NodeB, coded in UTF-8 with variable number of bytes per character [75].

| Information Element/Group name | Need | Multi | Type and reference | Semantics description | Version |
|--------------------------------|------|-------|--------------------|-----------------------|---------|
|--------------------------------|------|-------|--------------------|-----------------------|---------|

| Information Element/Group name | Need | Multi | Type and reference | Semantics description | Version |
|--------------------------------|------|-------|---------------------------------------|---|---------|
| HNB Name | MP | | Octet string (1 to < maxHNBNameSize>) | Carries the name of the Home NodeB with a maximum of maxHNBNameSize octets, using UTF-8 coding. | REL-8 |

10.3.8.5 Inter-RAT change failure

| Information Element/Group name | Need | Multi | Type and reference | Semantics description |
|--------------------------------|------------|-------|--|-------------------------------|
| Inter-RAT change failure cause | MP | | Enumerated(Configuration unacceptable, physical channel failure, protocol error, unspecified) | Four spare values are needed. |
| Protocol error information | CV-ProtErr | | Protocol error information 10.3.8.12 | |

| Condition | Explanation |
|----------------|---|
| <i>ProtErr</i> | The IE is mandatory present if the IE "Inter-RAT change failure cause" has the value "Protocol error" and not needed otherwise. |

10.3.8.6 Inter-RAT handover failure

| Information Element/Group name | Need | Multi | Type and reference | Semantics description |
|----------------------------------|------------|-------|--|--|
| Inter-RAT handover failure cause | MD | | Enumerated(Configuration unacceptable, physical channel failure, protocol error, inter-RAT protocol error, unspecified) | Default value is "unspecified".
Eleven spare values are needed. |
| Protocol error information | CV-ProtErr | | Protocol error information 10.3.8.12 | |

| Condition | Explanation |
|----------------|---|
| <i>ProtErr</i> | The IE is mandatory present if the IE "Inter-RAT handover failure cause" has the value "Protocol error" and not needed otherwise. |

10.3.8.7 Inter-RAT UE radio access capability

This Information Element contains the inter-RAT UE radio access capability that is structured and coded according to the specification used for the corresponding system type.

| Information Element/Group name | Need | Multi | Type and reference | Semantics description | Version |
|--|------|-------------------------------|----------------------|--|---------|
| CHOICE <i>system</i> | MP | | | | |
| >GSM | | | | | |
| >>Mobile Station Classmark 2 | MP | | Octet string (5) | This IE is formatted as 'TLV' and is coded in the same way as the <i>Mobile Station Classmark 2</i> information element in [5]. The first octet is the <i>Mobile station classmark 2 IEI</i> and its value shall be set to 33H (except in the case of NOTE 2). The second octet is the <i>Length of mobile station classmark 2</i> and its value shall be set to 3. The octet 3 contains the first octet of the value part of the <i>Mobile Station Classmark 2</i> information element, the octet 4 contains the second octet of the value part of the <i>Mobile Station Classmark 2</i> information element and so on. For each of these octets, the first/leftmost/ most significant bit of the octet contains b8 of the corresponding octet of the <i>Mobile Station Classmark 2</i> . See NOTE 2. | |
| >>Mobile Station Classmark 3 | MP | | Octet string (1..32) | This IE is formatted as 'V' and is coded in the same way as the value part in the <i>Mobile station classmark 3</i> information element in [5]. The first octet contains octet 1 of the value part of <i>Mobile station classmark 3</i> , the second octet contains octet 2 of the value part of <i>Mobile station classmark 3</i> and so on. See NOTE 1, NOTE 2. | |
| >>MS Radio Access Capability | OP | | Octet string (1..64) | This IE is formatted as 'V' and is coded in the same way as the value part in the <i>MS Radio Access Capability</i> information element in [5]. | REL-6 |
| >GERAN Iu | | | | | REL-5 |
| >>MS GERAN Iu mode Radio Access Capability | MP | | Bit string (1..170) | Formatted and coded according to [53]. The first/leftmost/most significant bit of the bit string contains bit 8 of the first octet of the IE. | REL-5 |
| >cdma2000 | | | | | |
| >>cdma2000Message | MP | 1.to.<maxInterSystemMessages> | | | |
| >>>MSG_TYPE(s) | MP | | Bit string (8) | Formatted and coded according to cdma2000 specifications. The first/leftmost/most significant bit of the bit string contains bit 7 of the MSG_TYPE. | |
| >>>cdma2000MessagePayload(s) | MP | | Bit string (1..512) | Formatted and coded according to cdma2000 specifications. The first/leftmost/most significant bit of the bit string contains bit 7 of the first octet of the cdma2000 message. | |
| >E-UTRA | | | | | REL-8 |
| >>UE E-UTRA Capability | MP | | Octet string | Formatted and coded according to the <i>UE-EUTRA-Capability</i> information element in [67]. The first/leftmost/most significant bit of the first octet of the octetstring contains bit 8 of octet 1 of the | REL-8 |

| Information Element/Group name | Need | Multi | Type and reference | Semantics description | Version |
|---|------|-------|--------------------|--------------------------------|---------|
| | | | | <i>UE-EUTRA-Capability IE.</i> | |
| NOTE 1: The value part is specified by means of CSN.1, which encoding results in a bit string, to which final padding may be appended upto the next octet boundary [5]. The first/ leftmost bit of the CSN.1 bit string is placed in the first/ leftmost/ most significant bit of the first octet. This continues until the last bit of the CSN.1 bit string, which is placed in the last/ rightmost/ least significant bit of the last octet. | | | | | |
| NOTE 2: The information in these IEs is optionally present in the INTER RAT HANDOVER INFO WITH INTER RAT CAPABILITIES message, otherwise it is mandatory present. If the information in the IEs "Mobile Station Classmark 2" and "Mobile Station Classmark 3" is not included, it is indicated by setting the first octet (IEI) of the IE "Mobile Station Classmark 2" to 00H. In this case, the receiver should ignore the value parts of the <i>Mobile Station Classmark 2</i> and the <i>Mobile Station Classmark 3</i> . The contents of those are set to zero. | | | | | |

10.3.8.8 Void

10.3.8.8a Inter-RAT UE security capability

| Information Element/Group name | Need | Multi | Type and reference | Semantics description | Version |
|--------------------------------|------|-------|--------------------|---|---------|
| CHOICE <i>system</i> | MP | | | | |
| >GSM | | | | | |
| >>GSM security capability | MP | | | The value TRUE means that the indicated ciphering algorithm is supported. | |
| >>>A5/7 supported | MP | | Boolean | | |
| >>>A5/6 supported | MP | | Boolean | | |
| >>>A5/5 supported | MP | | Boolean | | |
| >>>A5/4 supported | MP | | Boolean | | |
| >>>A5/3 supported | MP | | Boolean | | |
| >>>A5/2 supported | MP | | Boolean | | |
| >>>A5/1 supported | MP | | Boolean | | |

10.3.8.9 MIB Value tag

| Information Element/Group name | Need | Multi | Type and reference | Semantics description |
|--------------------------------|------|-------|--------------------|-----------------------|
| MIB Value tag | MP | | Integer (1..8) | |

10.3.8.10 PLMN Value tag

| Information Element/Group name | Need | Multi | Type and reference | Semantics description |
|--------------------------------|------|-------|--------------------|-----------------------|
| PLMN Value tag | MP | | Integer (1..256) | |

10.3.8.10a PNBSCH allocation

UTRAN may use this IE to provide silent periods in the cell that may be used for cell synchronisation purposes.

| Information Element/Group name | Need | Multi | Type and reference | Semantics description | Version |
|--------------------------------------|------|-------|---|-----------------------|---------|
| Number of repetitions per SFN period | MP | | Integer(2, 3, 4, 5, 6, 7, 8, 9, 10, 12, 14, 16, 18, 20, 24, 28, 32, 36, 40, 48, 56, 64, 72, 80) | | REL-4 |

10.3.8.11 Predefined configuration identity and value tag

| Information Element/Group name | Need | Multi | Type and reference | Semantics description |
|------------------------------------|------|-------|--|-----------------------|
| Predefined configuration identity | MP | | Predefined configuration identity
10.3.4.5 | |
| Predefined configuration value tag | MP | | Predefined configuration value tag
10.3.4.6 | |

10.3.8.12 Protocol error information

This information element contains diagnostics information returned by the receiver of a message that was not completely understood.

| Information Element/Group name | Need | Multi | Type and reference | Semantics description |
|---|------|-------|-----------------------------------|----------------------------|
| CHOICE <i>diagnostics type</i>
>Protocol error cause | MP | | Protocol error cause
10.3.3.26 | One spare value is needed. |

10.3.8.13 References to other system information blocks

| Information element/Group name | Need | Multi | Type and reference | Semantics description | Version |
|--|------------------|-----------------|--|---|---------|
| References to other system information blocks | MP | 1 to <maxSIB> | | System information blocks for which multiple occurrences are used, may appear more than once in this list | |
| >Scheduling information | MP | | Scheduling information, 10.3.8.16 | | |
| >SIB type SIBs only | MP | | SIB Type SIBs only, 10.3.8.22 | | |
| References to other extension system information blocks | OP | 1 to <maxSIB> | | System information blocks for which multiple occurrences are used, may appear more than once in this list | REL-6 |
| >Scheduling information | MP | | Scheduling information, 10.3.8.16 | | REL-6 |
| >Extension SIB type | MP | | SIB type extension 10.3.8.18b | | REL-6 |
| References to other extension system information blocks ² | OP | 1 to <maxSIB> | | System information blocks for which multiple occurrences are used, may appear more than once in this list | REL-8 |
| >Scheduling information | MP | | Scheduling information, 10.3.8.16 | | REL-8 |
| >Extension SIB type | MP | | SIB type extension ² 10.3.8.18c | | REL-8 |
| References to GANSS system information blocks | OP | 1 to <maxGANSS> | | | REL-8 |
| >GANSS ID | OP | | Integer (0..7) | Absence of this IE means Galileo. Coded as defined in NOTE 1 of 10.3.7.90b | REL-8 |
| >SBAS ID | CV-GANSS-ID-SBAS | | UE positioning GANSS SBAS ID 10.3.7.97e | | REL-8 |
| >GANSS system information blocks scheduling | MP | 1 to <maxSIB> | | System information blocks for which multiple occurrences are used, may appear more than once in this list | REL-8 |
| >>Scheduling information | MP | | Scheduling information, 10.3.8.16 | | REL-8 |
| >>GANSS SIB type | MP | | GANSS SIB type | | REL-8 |

| | | | | | |
|--|--|--|------------|--|--|
| | | | 10.3.8.18d | | |
|--|--|--|------------|--|--|

| Condition | Explanation |
|----------------------|--|
| <i>GANSS-ID-SBAS</i> | This IE is mandatory present if the IE 'GANSS ID' is 'SBAS', and not needed otherwise. |

10.3.8.14 References to other system information blocks and scheduling blocks

| Information element/Group name | Need | Multi | Type and reference | Semantics description | Version |
|--|------------------|-----------------|--|---|---------|
| References to other system information blocks | MP | 1 to <maxSIB> | | System information blocks for which multiple occurrences are used, may appear more than once in this list | |
| >Scheduling information | MP | | Scheduling information, 10.3.8.16 | | |
| >SIB and SB type | MP | | SIB and SB Type, 10.3.8.18a | | |
| References to other extension system information blocks | OP | 1 to <maxSIB> | | System information blocks for which multiple occurrences are used, may appear more than once in this list | REL-6 |
| >Scheduling information | MP | | Scheduling information, 10.3.8.16 | | REL-6 |
| >Extension SIB type | MP | | SIB type extension 10.3.8.18b | | REL-6 |
| References to other extension system information blocks ² | OP | 1 to <maxSIB> | | System information blocks for which multiple occurrences are used, may appear more than once in this list | REL-8 |
| >Scheduling information | MP | | Scheduling information, 10.3.8.16 | | REL-8 |
| >Extension SIB type | MP | | SIB type extension ² 10.3.8.18c | | REL-8 |
| References to GANSS system information blocks | OP | 1 to <maxGANSS> | | | REL-8 |
| >GANSS ID | OP | | Integer (0..7) | Absence of this IE means Galileo. Coded as defined in NOTE 1 of 10.3.7.90b | REL-8 |
| >SBAS ID | CV-GANSS-ID-SBAS | | UE positioning GANSS SBAS ID 10.3.7.97e | | REL-8 |
| >GANSS system information blocks scheduling | MP | 1 to <maxSIB> | | System information blocks for which multiple occurrences are used, may appear more than once in this list | REL-8 |
| >>Scheduling information | MP | | Scheduling information, 10.3.8.16 | | REL-8 |
| >>GANSS SIB type | MP | | GANSS SIB type | | REL-8 |

| | | | | | |
|--|--|--|------------|--|--|
| | | | 10.3.8.18d | | |
|--|--|--|------------|--|--|

| Condition | Explanation |
|---------------|--|
| GANSS-ID-SBAS | This IE is mandatory present if the IE 'GANSS ID' is 'SBAS', and not needed otherwise. |

10.3.8.15 Rplmn information

Contains information to provide faster RPLMN selection in the UE.

| Information Element/Group name | Need | Multi | Type and reference | Semantics description | Version |
|-----------------------------------|------|---------------------------|----------------------|--|---------|
| GSM BA Range | OP | 1 to maxNumG SMFreqRanges | | GSM BA Range | |
| >GSM Lower Range (UARFCN) | MP | | Integer(0..16383) | Lower bound for range of GSM BA freqs | |
| >GSM Upper Range (UARFCN) | MP | | Integer(0..16383) | Upper bound for range of GSM BA freqs | |
| FDD UMTS Frequency list | OP | 1 to maxNumFDDFreqs | | | |
| >UARFCN (Nlow) | MP | | Integer(0..16383) | [21] | |
| >UARFCN (Nupper) | OP | | Integer(0..16383) | [21]
This IE is only needed when the FDD frequency list is specifying a range. | |
| 3.84 Mcps TDD UMTS Frequency list | OP | 1 to maxNumTDDFreqs | | | |
| >UARFCN | MP | | Integer(0..16383) | [22] | |
| 7.68 Mcps TDD UMTS Frequency list | OP | 1 to maxNumTDDFreqs | | | REL-7 |
| >UARFCN | MP | | Integer(0..16383) | [22] | REL-7 |
| 1.28 Mcps TDD UMTS Frequency list | OP | 1 to maxNumTDDFreqs | | | REL-4 |
| >UARFCN | MP | | Integer(0..16383) | [22] | REL-4 |
| CDMA2000 UMTS Frequency list | OP | 1 to maxNumCDMA2000Freqs | | | |
| >BAND_CLASS | MP | | Bit string(5 bits) | TIA/EIA/IS-2000
When mapping the BAND_CLASS to the bit string, the first/leftmost bit of the bit string contains the most significant bit.. | |
| >CDMA_FREQ | MP | | Bit string (11 bits) | TIA/EIA/IS-2000
When mapping the CDMA_FREQ to the bit string, | |

| Information Element/Group name | Need | Multi | Type and reference | Semantics description | Version |
|--------------------------------|------|-------|--------------------|--|---------|
| | | | | the first/leftmost bit of the bit string contains the most significant bit.. | |

10.3.8.16 Scheduling information

| Information Element/Group name | Need | Multi | Type and reference | Semantics description |
|--|------|-------|---|--|
| CHOICE <i>Value tag</i> | OP | | | |
| >PLMN Value tag | | | PLMN Value tag 10.3.8.10 | This IE is included if the following conditions are fulfilled:
the SIB type equals system information block type 1
Note: IE "PLMN value tag" is used for SIB1 but the area scope for SIB 1 is Cell. |
| >Predefined configuration identity and value tag | | | Predefined configuration identity and value tag 10.3.8.11 | This IE is included if the following conditions are fulfilled:
the SIB type equals system information block type 16 |
| >Cell Value tag | | | Cell Value tag 10.3.8.4 | This IE is included if the following conditions are fulfilled:
the SIB type does not equal system information block type 1; and
the area scope for the system information block is set to "cell" in table 8.1.1; and
a value tag is used to indicate changes in the system information block. |
| >SIB occurrence identity and value tag | | | SIB occurrence identity and value tag 10.3.8.20b | This IE is included if the following conditions are fulfilled:
the SIB type equals system information block types 15.2, 15.2bis, 15.2ter, 15.3 and 15.3bis |
| Scheduling | MP | | | |
| >SEG_COUNT | MD | | SEG COUNT 10.3.8.17 | Default value is 1 |
| >SIB_REP | MP | | Integer (4, 8, 16, 32, 64, 128, 256, 512, 1024, 2048, 4096) | Repetition period for the SIB in frames |
| >SIB_POS | MP | | Integer (0 ..Rep-2 by step of 2) | Position of the first segment Rep is the value of the SIB_REP IE |
| >SIB_POS offset info | MD | 1..15 | | see below for default value |
| >>SIB_OFF | MP | | Integer(2..32 by step of 2) | Offset of subsequent segments |

| Field | Default value |
|---------------------|---|
| SIB_POS offset info | The default value is that all segments are consecutive, i.e., that the SIB_OFF = 2 for all segments except when MIB segment/complete MIB is scheduled to be transmitted in between segments from same SIB. In that case, SIB_OFF=4 in between segments which are scheduled to be transmitted at $SFN_{prime} = 8 * n - 2$ and $8 * n + 2$, and SIB_OFF=2 for the rest of the segments. |

10.3.8.17 SEG COUNT

| Information Element/Group name | Need | Multi | Type and reference | Semantics description |
|--------------------------------|------|-------|--------------------|--|
| SEG_COUNT | MP | | Integer (1..16) | Number of segments in the system information block |

10.3.8.18 Segment index

Each system information segment has an individual segment index.

| Information Element/Group name | Need | Multi | Type and reference | Semantics description |
|--------------------------------|------|-------|--------------------|--|
| Segment index | MP | | Integer (1..15) | Segments of a system information block are numbered starting with 0 for the first segment and 1 for the next segment, which can be the first subsequent segment or a last segment. |

10.3.8.18a SIB and SB type

The SIB type identifies a specific system information block.

| Information Element/Group name | Need | Multi | Type and reference | Semantics description |
|--------------------------------|------|-------|-----------------------|-----------------------------|
| SIB and SB type | MP | | Enumerated, see below | Two spare values are needed |

| List of enumerated values | Version |
|---|---------|
| System Information Type 1,
System Information Type 2,
System Information Type 3,
System Information Type 4,
System Information Type 5,
System Information Type 6,
System Information Type 7,
System Information Type 11,
System Information Type 12,
System Information Type 13,
System Information Type 13.1,
System Information Type 13.2,
System Information Type 13.3,
System Information Type 13.4,
System Information Type 14,
System Information Type 15,
System Information Type 15.1,
System Information Type 15.2,
System Information Type 15.3,
System Information Type 15.4,
System Information Type 15.5,
System Information Type 16,
System Information Type 17,
System Information Type 18,
Scheduling Block 1,
Scheduling Block 2, | |
| System Information Type 5bis | REL-6 |

10.3.8.18b SIB type extension

The SIB type identifies a specific extension system information block.

| Information Element/Group name | Need | Multi | Type and reference | Semantics description | Version |
|--------------------------------|------|-------|--------------------------|-----------------------|---------|
| SIB type extension | MP | | Enumerated,
see below | | REL-6 |

| List of enumerated values | Version |
|---|---------|
| System Information Type 11bis | REL-6 |
| System Information Type 15bis,
System Information Type 15.1bis,
System Information Type 15.2bis,
System Information Type 15.3bis,
System Information Type 15.6,
System Information Type 15.7
System Information Type 15.8 | REL-7 |

10.3.8.18c SIB type extension2

The SIB type identifies a specific extension system information block.

| Information Element/Group name | Need | Multi | Type and reference | Semantics description | Version |
|--------------------------------|------|-------|--------------------------|---------------------------------|---------|
| SIB type extension2 | MP | | Enumerated,
see below | Five spare values
are needed | REL-8 |

| List of enumerated values | Version |
|---------------------------------|---------|
| System Information Type 19 | REL-8 |
| System Information Type 15.2ter | |
| System Information Type 20 | |

10.3.8.18d GANSS SIB type

The GANSS SIB type identifies a GANSS specific system information block.

| Information Element/Group name | Need | Multi | Type and reference | Semantics description | Version |
|--------------------------------|------|-------|-----------------------|----------------------------|---------|
| GANSS SIB type | MP | | Enumerated, see below | Nine spare value is needed | REL-8 |

| List of enumerated values | Version |
|---|---------|
| System Information Type 15.1bis,
System Information Type 15.2bis,
System Information Type 15.2ter,
System Information Type 15.3bis,
System Information Type 15.6,
System Information Type 15.7
System Information Type 15.8 | REL-8 |

10.3.8.19 SIB data fixed

Contains the result of a master information block or a system information block after encoding and segmentation. The IE is used for segments with fixed length (segments filling an entire transport block).

| Information Element/Group name | Need | Multi | Type and reference | Semantics description |
|--------------------------------|------|-------|--------------------|--|
| SIB data fixed | MP | | Bit string (222) | The first bit contains the first bit of the segment. |

10.3.8.20 SIB data variable

Contains either a complete system information block or a segment of a system information block. Contains the result of a master information block or a system information block after encoding and segmentation. The IE is used for segments with variable length. The system information blocks are defined in clauses 10.2.48.8.1 to 10.2.48.8.18.

| Information Element/Group name | Need | Multi | Type and reference | Semantics description |
|--------------------------------|------|-------|---------------------|--|
| SIB data variable | MP | | Bit string (1..214) | The first bit contains the first bit of the segment. |

10.3.8.20a SIB occurrence identity

This information element identifies a SIB occurrence for System Information Block types 15.2, 15.2bis, 15.2ter, 15.3 and 15.3bis. For System Information Block type 15.2, 15.2bis and 15.2ter, this identity is assigned to the visible satellite only. Unused identities are claimed by newly rising satellites.

| Information Element/Group name | Need | Multi | Type and reference | Semantics description |
|--------------------------------|------|-------|--------------------|-----------------------|
| SIB occurrence identity | MP | | Integer (0..15) | |

10.3.8.20b SIB occurrence identity and value tag

| Information Element/Group name | Need | Multi | Type and reference | Semantics description |
|--------------------------------|------|-------|--|-----------------------|
| SIB occurrence identity | MP | | SIB occurrence identity
10.3.8.20a | |
| SIB occurrence value tag | MP | | SIB occurrence value tag
10.3.8.20c | |

10.3.8.20c SIB occurrence value tag

This information element is used to identify different versions of SIB occurrence for System Information Block types 15.2, 15.2bis, 15.2ter, 15.3 and 15.3bis.

| Information Element/Group name | Need | Multi | Type and Reference | Semantics description |
|--------------------------------|------|-------|--------------------|-----------------------|
| SIB occurrence value tag | MP | | Integer(0..15) | |

10.3.8.21 SIB type

The SIB type identifies a specific system information block.

| Information Element/Group name | Need | Multi | Type and reference | Semantics description |
|---|------|-------|-----------------------|-----------------------|
| SIB type | MP | | Enumerated, see below | NOTE 1 |
| NOTE 1: If the value "Extension Type" is signalled, the UE shall use the scheduling information in the MIB and, if present, in the SB1 and SB2 to identify the specific type of system information block. | | | | |

| List of enumerated values | Version |
|--|---------|
| Master information block,
System Information Type 1,
System Information Type 2,
System Information Type 3,
System Information Type 4,
System Information Type 5,
System Information Type 6,
System Information Type 7,
System Information Type 11,
System Information Type 12,
System Information Type 13,
System Information Type 13.1,
System Information Type 13.2,
System Information Type 13.3,
System Information Type 13.4,
System Information Type 14,
System Information Type 15,
System Information Type 15.1,
System Information Type 15.2,
System Information Type 15.3,
System Information Type 15.4,
System Information Type 15.5,
System Information Type 16,
System Information Type 17,
System Information Type 18,
Scheduling Block 1,
Scheduling Block 2, | |
| System Information Type 5bis,
Extension Type | REL-6 |

10.3.8.22 SIB type SIBs only

The SIB type identifies a specific system information block.

| Information Element/Group name | Need | Multi | Type and reference | Semantics description |
|--------------------------------|------|-------|-----------------------|------------------------------|
| SIB type SIBs only | MP | | Enumerated, see below | Four spare values are needed |

| List of enumerated values | Version |
|---|---------|
| System Information Type 1,
System Information Type 2,
System Information Type 3,
System Information Type 4,
System Information Type 5,
System Information Type 6,
System Information Type 7,
System Information Type 11,
System Information Type 12,
System Information Type 13,
System Information Type 13.1,
System Information Type 13.2,
System Information Type 13.3,
System Information Type 13.4,
System Information Type 14,
System Information Type 15,
System Information Type 15.1,
System Information Type 15.2,
System Information Type 15.3,
System Information Type 15.4,
System Information Type 15.5,
System Information Type 16,
System Information Type 17,
System Information Type 18, | |
| System Information Type 5bis | REL-6 |

10.3.8.23 UE History Information

| Information element/Group name | Need | Multi | Type and reference | Semantics description | Version |
|--------------------------------|------|-------|------------------------------------|--|---------|
| UE inactivity period | MP | | Integer (1..120) | Provides expired time since last u-plane activity. If the integer value x is between 1 and 59, it represents the expired time x in seconds. If the integer value x is between 60 and 119, it represents the expired time (x-59) in minutes. If integer value is set to 120, no u-plane activity has been for 60 minutes or more. | REL-8 |
| UE Mobility State indicator | OP | | Enumerated (High-mobilityDetected) | Absence of this IE implies that, according to [4] either the High mobility state is not applicable or it has not been detected by the UE. | REL-8 |
| UL data volume history | OP | | Data volume history 10.3.8.24 | | REL-8 |
| DL data volume history | OP | | Data volume history 10.3.8.24 | | REL-8 |

10.3.8.24 Data volume history

| Information element/Group name | Need | Multi | Type and reference | Semantics description | Version |
|--|------|--------------|---|---|---------|
| Data volume monitoring window | MP | | Integer (1..120) | If the integer value x is between 1 and 59, it represents seconds. If the integer value is between 60 and 120, it represents the the value minus 59 in minutes. | REL-8 |
| Data transmission frequency | OP | | Integer (100, 250, 500, 1000, 2000, 5000, 10000, 60000) | In ms | REL-8 |
| >Data transmission frequency granularity | MP | | Integer (100, 250, 500, 1000, 2000, 5000, 10000, 60000) | In ms | REL-8 |
| >Number of data transmission occasions | MP | | Integer (0..610) | Measure of data transmission frequency. The data volume monitoring window is organised in time periods of 'Data transmission frequency granularity', and each transmission within such a period is counted. | REL-8 |
| Data volume per RB | OP | 1 to <maxRB> | | | REL-8 |
| >RB identity | MP | | RB identity 10.3.4.16 | | REL-8 |
| >Data volume | MP | | Integer (0..4294967295) | Data volume monitored during the data volume monitoring window, in byte. | REL-8 |

10.3.9 ANSI-41 Information elements

10.3.9.1 ANSI-41 Core Network Information

| Information element/Group name | Need | Multi | Type and reference | Semantics description |
|--------------------------------|------|-------|--------------------|-----------------------|
| P_REV | MP | | P_REV 10.3.9.10 | |
| MIN_P_REV | MP | | MIN_P_REV 10.3.9.8 | |
| SID | MP | | SID 10.3.9.11 | |
| NID | MP | | NID 10.3.9.9 | |

10.3.9.2 ANSI-41 Global Service Redirection information

This Information Element contains ANSI-41 Global Service Redirection information.

| Information Element/Group name | Need | Multi | Type and reference | Semantics description |
|--|------|-------|---------------------------------|--|
| ANSI-41 Global Service Redirection information | MP | | ANSI-41 NAS parameter, 10.3.9.3 | Formatted and coded according to the 3GPP2 document "G3G CDMA DS on ANSI-41" |

10.3.9.3 ANSI-41 NAS parameter

This Information Element contains ANSI-41 User Zone Identification information.

| Information Element/Group name | Need | Multi | Type and reference | Semantics description |
|--------------------------------|------|-------|-----------------------------|--|
| ANSI-41 NAS parameter | MP | | Bit string (size (1..2048)) | The first bit contains the first bit of the ANSI-41 information. |

10.3.9.4 ANSI-41 NAS system information

This Information Element contains ANSI-41 system information.

| Information Element/Group name | Need | Multi | Type and reference | Semantics description |
|----------------------------------|------|-------|---------------------------------|--|
| NAS (ANSI-41) system information | MP | | ANSI-41 NAS parameter, 10.3.9.3 | Formatted and coded according to the 3GPP2 document "G3G CDMA DS on ANSI-41" |

10.3.9.5 ANSI-41 Private Neighbour List information

This Information Element contains ANSI-41 Private Neighbour List information.

| Information Element/Group name | Need | Multi | Type and reference | Semantics description |
|--|------|-------|---------------------------------|--|
| ANSI-41 Private Neighbour List information | MP | | ANSI-41 NAS parameter, 10.3.9.3 | Formatted and coded according to the 3GPP2 document "G3G CDMA DS on ANSI-41" |

10.3.9.6 ANSI-41 RAND information

This Information Element contains ANSI-41 RAND information.

| Information Element/Group name | Need | Multi | Type and reference | Semantics description |
|--------------------------------|------|-------|---------------------------------|--|
| ANSI-41 RAND information | MP | | ANSI-41 NAS parameter, 10.3.9.3 | Formatted and coded according to the 3GPP2 document "G3G CDMA DS on ANSI-41" |

10.3.9.7 ANSI-41 User Zone Identification information

This Information Element contains ANSI-41 User Zone Identification information.

| Information Element/Group name | Need | Multi | Type and reference | Semantics description |
|--|------|-------|---------------------------------|--|
| ANSI-41 User Zone Identification information | MP | | ANSI-41 NAS parameter, 10.3.9.3 | Formatted and coded according to the 3GPP2 document "G3G CDMA DS on ANSI-41" |

10.3.9.8 MIN_P_REV

This Information Element contains minimum protocol revision level.

| Information Element/Group name | Need | Multi | Type and reference | Semantics description |
|--------------------------------|------|-------|--------------------|---|
| MIN_P_REV | MP | | Bit string (8) | Minimum protocol revision level. The first/leftmost bit of the bit string contains the most significant bit of the MIN_P_REV. |

10.3.9.9 NID

This Information Element contains Network identification.

| Information Element/Group name | Need | Multi | Type and reference | Semantics description |
|--------------------------------|------|-------|--------------------|--|
| NID | MP | | Bit string (16) | Network identification. The first/leftmost bit of the bit string contains the most significant bit of the NID. |

10.3.9.10 P_REV

This Information Element contains protocol revision level.

| Information Element/Group name | Need | Multi | Type and reference | Semantics description |
|--------------------------------|------|-------|--------------------|---|
| P_REV | MP | | Bit string (8) | Protocol revision level. The first/leftmost bit of the bit string contains the most significant bit of the P_REV. |

10.3.9.11 SID

This Information Element contains System identification.

| Information Element/Group name | Need | Multi | Type and reference | Semantics description |
|--------------------------------|------|-------|--------------------|---|
| SID | MP | | Bit string (15) | System identification. The first/leftmost bit of the bit string contains the most significant bit of the SID. |

10.3.9a MBMS Information elements

10.3.9a.1 MBMS Common CCTrCH identity

Identifies a Coded Composite Transport channel configuration included within the MBMS COMMON P-T-M RB INFORMATION message.

| Information element/Group name | Need | Multi | Type and reference | Semantics description | Version |
|--------------------------------|------|-------|--------------------|-----------------------|---------|
| MBMS Common CCTrCh identity | MP | | Integer (1..32) | | REL-6 |

10.3.9a.2 MBMS Common PhyCh identity

Identifies a physical channel configuration included within the MBMS COMMON P-T-M RB INFORMATION message.

| Information element/Group name | Need | Multi | Type and reference | Semantics description | Version |
|--------------------------------|------|-------|--------------------|-----------------------|---------|
| MBMS Common PhyCh identity | MP | | Integer (1..32) | | REL-6 |

10.3.9a.3 MBMS Common RB identity

Identifies a radio bearer channel configuration included within the MBMS COMMON P-T-M RB INFORMATION message.

| Information element/Group name | Need | Multi | Type and reference | Semantics description | Version |
|--------------------------------|------|-------|--------------------|-----------------------|---------|
| MBMS Common RB identity | MP | | Integer (1..32) | | REL-6 |

10.3.9a.4 MBMS Common TrCh identity

Identifies a transport channel configuration included within the MBMS COMMON P-T-M RB INFORMATION message.

| Information element/Group name | Need | Multi | Type and reference | Semantics description | Version |
|--------------------------------|------|-------|--------------------|-----------------------|---------|
| MBMS Common TrCh identity | MP | | Integer (1..32) | | REL-6 |

10.3.9a.5 MBMS Current cell S-CCPCH identity

Identifies one of the current cell's Secondary CCPCH's.

| Information element/Group name | Need | Multi | Type and reference | Semantics description | Version |
|------------------------------------|------|-------|-------------------------|-----------------------|---------|
| MBMS Current cell S-CCPCH identity | MP | | Integer (1..maxSC CPCH) | | REL-6 |

10.3.9a.6 Void

10.3.9a.7 MBMS L1 combining schedule

Includes information about the MBMS L1 combining schedule.

| Information element/Group name | Need | Multi | Type and reference | Semantics description | Version |
|--------------------------------|------|----------------------|---|--|---------|
| MBMS L1 combining cycle length | MP | | Enumerated (32, 64, 128, 256, 512, 1024) | In number of radio frames | REL-6 |
| MBMS L1 combining cycle offset | MD | | Integer (0.. MBMS L1 combining cycle length - 4) by step of 4 | Start of the L1 combining cycle (relative to the timing of the current cell) in number of radio frames. Default value is no offset | REL-6 |
| MTCH L1- combining period list | MP | 1 to < maxMBMS-L1CP> | | One or more periods in which L1 combining is performed | REL-6 |
| >Start | MP | | Integer (0.. MBMS L1 combining cycle length - 4) by step of 4 | Number of frames from the end of the previous combining period or the start of the cycle (for the first period) | REL-6 |
| >Duration | MP | | Integer (4.. MBMS L1 combining cycle length) by step of 4 | Number of frames (see note) | REL-6 |

NOTE: The MTCH L1- combining period should indicate one or more complete TTIs.

10.3.9a.7o MBMS p-t-m activation time

| Information Element/Group name | Need | Multi | Type and reference | Semantics description | Version |
|--------------------------------|--|-------|--------------------|--------------------------------------|---------|
| MBMS p-t-m activation time | MP | | Integer (0..2047) | The 11 LSB of the SFN. Note 1 and 2. | REL-6 |
| Note 1: | The 'MBMS p-t-m activation time' indicates the start of the 10 ms frame corresponding to the indicated SFN value and of the primary CCPCH of the cell where this IE is transmitted. | | | | |
| Note 2: | The range of the 'MBMS p-t-m activation time' is from 10 ms after the beginning of the MCCH modification period wherein it is transmitted and to the end of next following MCCH modification period. The UE shall consider a value out of this range as expired. | | | | |

10.3.9a.7a MBMS p-t-m RB information

Includes information about an MBMS p-t-m radio bearers mapped on a TrCH.

| Information element/Group name | Need | Multi | Type and reference | Semantics description | Version |
|--------------------------------|-----------------|-------|---|---|---------|
| RB information | <i>CV-Curr</i> | | MBMS Common RB identity 10.3.9a.3 | | REL-6 |
| MBMS short transmission ID | MP | | MBMS Short transmission identity 10.3.9a.10 | | REL-6 |
| MBMS logical channel identity | MP | | Integer (1..15) | This identifier is used to distinguish different MTCH mapped on to a TrCh ('MBMS-Id' within the MAC header[15]) | REL-6 |
| L1 combining status | <i>CV-Neigh</i> | | Boolean | The IE is only applicable in case of partial L1 combining, in which case value TRUE means that L1 combining is used for this radio bearer | REL-6 |

| Condition | Explanation |
|--------------|--|
| <i>Curr</i> | The IE is mandatory present if the IE 'MBMS p-t-m RB information list' is included in the MBMS CURRENT CELL P-T-M RB INFORMATION message and not needed otherwise |
| <i>Neigh</i> | The IE is mandatory present if the IE 'MBMS p-t-m RB information list' is included in the MBMS NEIGHBOURING CELL P-T-M RB INFORMATION message and not needed otherwise |

10.3.9a.7b MBMS Selected Service Info

This IE indicates whether the UE has any MBMS Selected Services, and if it does it includes the list of MBMS Selected Services.

| Information element/Group name | Need | Multi | Type and reference | Semantics description | Version |
|--------------------------------|------|-------|--|-----------------------|---------|
| CHOICE <i>Status</i> | | | | | |
| >None | | | | (no data) | |
| >Some | MP | | MBMS Selected Services Full 10.3.9a.7c | | REL-6 |

10.3.9a.7c MBMS Selected Services Full

This IE provides the MBMS Selected Services by means of the full identity.

| Information element/Group name | Need | Multi | Type and reference | Semantics description | Version |
|--------------------------------|------|--------------------------|---------------------------------|-----------------------|---------|
| MBMS Selected Services | MP | 1 to <maxMBMSservSelect> | | | REL-6 |
| >MBMS Selected Service ID | MP | | MBMS service identity 10.3.9a.8 | | REL-6 |

10.3.9a.7d MBMS Selected Services Short

This IE indicates the MBMS Selected Services by means of a short identity to identify the MBMS transmission by referencing the services included in the MBMS MODIFIED SERVICES INFORMATION and the MBMS UNMODIFIED SERVICES INFORMATION messages.

| Information element/Group name | Need | Multi | Type and reference | Semantics description | Version |
|--------------------------------|------|--------------------------|---|---|---------|
| MBMS Selected Services | MP | 1 to <maxMBMSservSelect> | | | REL-6 |
| >MBMS Selected Service ID | MP | | MBMS Short transmission identity 10.3.9a.10 | | REL-6 |
| Modification period identity | MP | | Integer (0..1) | Indicates the modification period the MBMS short transmission identities refer to | REL-6 |

10.3.9a.8 MBMS Service identity

Includes information about the identity of an MBMS service.

| Information element/Group name | Need | Multi | Type and reference | Semantics description | Version |
|---------------------------------|------|-------|----------------------------|--|---------|
| MBMS Service ID | MP | | MBMS Service ID 10.3.9a.8a | | REL-6 |
| CHOICE <i>PLMN identity</i> | MP | | | | REL-6 |
| > <i>SameAsMIB</i> | | | | (No data) The PLMN identity is the same as indicated by the IE 'PLMN identity' in MIB | REL-6 |
| > <i>SameAsMIB-MultiPLMN-Id</i> | | | | | REL-6 |
| >>Multi PLMN id | MP | | Integer (1..5) | The PLMN identity is one of the PLMN identities (1 to 5) in the IE "Multiple PLMN List" in MIB | REL-6 |
| > <i>ExplicitPLMN-Id</i> | | | | | REL-6 |
| >>PLMN identity | MP | | PLMN identity 10.3.1.11 | | REL-6 |

10.3.9a.8a MBMS Service ID

Uniquely identifies an MBMS bearer service within a PLMN.

| Information element/Group name | Need | Multi | Type and reference | Semantics description | Version |
|--------------------------------|------|-------|--------------------|---|---------|
| MBMS Service ID | MP | | Octet string (3) | The content of the MBMS Service ID field is coded as octets 3 to 5 of the IE <i>Temporary Mobile Group Identity</i> [5] | REL-6 |

10.3.9a.9 MBMS Session identity

Includes information about the the identity of a session of an MBMS service.

| Information element/Group name | Need | Multi | Type and reference | Semantics description | Version |
|--------------------------------|------|-------|--------------------|-----------------------|---------|
| MBMS Session ID | MP | | Octet string (1) | | REL-6 |

10.3.9a.10 MBMS Short transmission identity

Includes a short identity of the MBMS transmission identity, which concerns a session of a specific service.

| Information element/Group name | Need | Multi | Type and reference | Semantics description | Version |
|----------------------------------|------|-------|---------------------------------|---|---------|
| MBMS short transmission identity | MP | | Integer (1..maxMBMSservUnmodif) | Reference/ index to a transmission listed in the MBMS MODIFIED SERVICES INFORMATION or MBMS UNMODIFIED SERVICES INFORMATION | REL-6 |

10.3.9a.10a MBMS Soft Combining Timing Offset

Indicates the timing offset applied in the CFN calculation in sub-clause 8.5.15.5 for a secondary CCPCH carrying only MBMS logical channels. It is used for FDD only.

| Information Element/Group name | Need | Multi | Type and reference | Semantics description | Version |
|------------------------------------|------|-------|-------------------------|---|---------|
| >MBMS Soft Combining Timing Offset | MP | | Integer (0, 10, 20, 40) | Timing offset applied in the CFN calculation in sub-clause 8.5.15.5, in ms. | REL-6 |

10.3.9a.11 MBMS specific timers and counters

Includes MBMS specific timers and counters.

| Information element/Group name | Need | Multi | Type and reference | Semantics description | Version |
|--------------------------------|------|-------|---|---|---------|
| T318 | MD | | Integer(25 0... 2000 by step of 250, 3000, 4000, 6000, 8000, 10000, 12000, 16000) | Value in milliseconds. Default value is 1000. | REL-6 |

10.3.9a.12 MBMS Transmission identity

Includes information about the MBMS transmission identity, which concerns a session of a specific service.

| Information element/Group name | Need | Multi | Type and reference | Semantics description | Version |
|--------------------------------|------|-------|---------------------------------|-----------------------|---------|
| MBMS Service ID | MP | | MBMS Service identity 10.3.9a.8 | | REL-6 |
| MBMS Session ID | OP | | MBMS Session identity 10.3.9a.9 | | REL-6 |

10.3.9a.12a MBSFN frequency list

| Information Element/Group name | Need | Multi | Type and reference | Semantics description | Version |
|--------------------------------|------|-------------------------|----------------------------|---|---------|
| MBSFN frequency list | MP | 0 to <maxMBSFNclusters> | | | REL-7 |
| >MBSFN frequency | MP | | Frequency info 10.3.6.36 | | REL-7 |
| >IMB indication | OP | | Enumerated (TRUE) | If present: 3.84 Mcps TDD MBSFN IMB is applied on this frequency. | REL-8 |
| >Cell parameter ID | OP | <0..127> | Cell parameter Id 10.3.6.9 | Only for 1.28 Mcps TDD [32].
NOTE 1 | REL-7 |

NOTE 1: For 1.28 Mcps TDD the IE "Cell Parameter ID" indicates the cell which is providing MBMS service in MBSFN only mode on the corresponding frequency; if it is not included, the IE "MBSFN frequency" indicates the secondary frequency providing MBMS service in non-MBSFN only mode of current multi-frequency cell.

10.3.9a.12b MBSFN TDM Information List

| Information element/Group name | Need | Multi | Type and reference | Semantics description | Version |
|--------------------------------|------|-------------------------------|---|-----------------------|---------|
| MBSFN TDM Information List | MP | 1 to <maxM BMSservUnmodified> | | | REL-7 |
| >MBMS short transmission ID | MP | | MBMS Short transmission identity 10.3.9a.10 | | REL-7 |
| >TDM_Rep | MP | | Integer (2..9) | | REL-7 |
| >TDM_Offset | MP | | Integer (0..8) | | REL-7 |
| >TDM_Length | MP | | Integer (1..8) | | REL-7 |

10.3.9a.13 MCCH configuration information

Includes information about the MCCH configuration.

| Information element/Group name | Need | Multi | Type and reference | Semantics description | Version |
|---------------------------------|---------|-------|--------------------------|---|---------|
| Access Info Period coefficient | MP | | Integer (0..3) | Represents a , the access information coefficient. The number of repetitions per modification period equals 2^a while the actual access information period, in number of frames, equals $MP \text{ DIV } 2^a$ | REL-6 |
| Repetition Period coefficient | MP | | Integer (0..3) | Represents r , the repetition period coefficient. The number of repetitions per modification period equals 2^r while the actual repetition period, in number of frames, equals $MP \text{ DIV } 2^r$ | REL-6 |
| Modification period coefficient | MP | | Integer (7..10) | Represents m , the modification period coefficient. The actual modification period (MP), in number of frames, equals 2^m | REL-6 |
| RLC info | MP | | RLC info MBMS 10.3.4.23a | | REL-6 |
| TCTF presence | CV-MBMS | | Enumerated (FALSE) | By default the TCTF is present even though the FACH only carries one logical channel (type). When this IE is included, the TCTF is absent | REL-6 |

| Condition | Explanation |
|-----------|--|
| MBMS | This IE is not needed if the IE is contained within the IE 'Secondary CCPCH system information', otherwise the IE is optional. |

10.3.9a.14 MICH configuration information

Includes information about the MICH configuration.

| Information element/Group name | Need | Multi | Type and reference | Semantics description | Version |
|---------------------------------|------|--------|--|--|---------|
| MICH Power offset | MP | | MICH Power offset
10.3.9a.15 | | REL-6 |
| CHOICE mode | MP | | | | REL-6 |
| >FDD | | | | | REL-6 |
| >>Channelisation code | MP | | Integer (0..255) | | REL-6 |
| >>Number of NI per frame | MP | | Integer (18, 36, 72, 144) | | REL-6 |
| >>STTD indicator | MP | | STTD Indicator
10.3.6.78 | If the cell is operating in MBSFN mode as indicated in subclause 8.1.1.6.3, the UE behaviour upon reception of this IE is unspecified. | REL-6 |
| >TDD | | | | | REL-6 |
| >>Timeslot number | MP | | Timeslot number
10.3.6.84 | | REL-6 |
| >>Midamble shift and burst type | MP | | Midamble shift and burst type
10.3.6.41 | For 1.28 Mcps TDD, if the cell is operating in MBSFN mode, the UE shall ignore the contents of this IE. | REL-6 |
| >>CHOICE TDD option | MP | | | | REL-6 |
| >>>3.84 Mcps TDD | | | | | REL-6 |
| >>>>Channelisation code | MP | | Enumerated (16/1)...(16/16) | | REL-6 |
| >>>>7.68 Mcps TDD | | | | | REL-7 |
| >>>>Channelisation code | MP | | Enumerated (32/1)...(32/32) | | REL-7 |
| >>>>1.28 Mcps TDD | | | | | REL-6 |
| >>>>Codes list | MP | 1 to 2 | | | REL-6 |
| >>>>>Channelisation code | MP | | Enumerated (16/1)...(16/16) | | REL-6 |
| >>>>> MBSFN Special Time Slot | OP | | Time Slot LCR Extension
10.3.6.83a | For 1.28 Mcps TDD MBSFN only mode, this IE indicates the SCCPCH is deployed on the MBSFN Special Time Slot [30]. The IE "Timeslot number" shall be ignored if this IE appears. | REL-7 |
| >>>>>Repetition period/length | MD | | Enumerated((4/2),(8/2) | Default value is '(64/2)'. Default value is '(64/2)'. | REL-6 |

| | | | | | |
|---|----|--|---|---|-------|
| | | |),
(8/4),(16/2)
, (16/4),
(32/2),(32/
4),(64/2),(6
4/4)) | | |
| >>Offset | MP | | Integer
(0...Repetit
ion period -
1) | SFN mod
Repetitionperiod =
Offset. | REL-6 |
| >>MBMS Notification
indicator length | MD | | Integer (4,
8, 16) | Indicates the length of
one MBMS Notification
indicator in bits. Default
value is 4. | REL-6 |
| >3.84 Mcps TDD MBSFN
IMB | | | | | REL-8 |
| >>Channelisation code | MP | | Integer
(0..255) | SF = 256; only the
channelisation codes 2
to 15 are applicable | REL-8 |
| >>Number of NI per
frame | MP | | Integer
(16, 32, 64,
128) | | REL-8 |

10.3.9a.15 MICH Power offset

This is the power transmitted on the MICH minus power of the Primary CPICH in FDD and Primary CCPCH Tx Power in TDD.

| Information
Element/Group name | Need | Multi | Type and
reference | Semantics
description | Version |
|-----------------------------------|------|-------|-----------------------|--------------------------|---------|
| MICH Power offset | MP | | Integer(-10
.. +5) | Offset in dB | REL-6 |

10.3.9a.16 MSCH configuration information

Includes information about the MSCH configuration.

| Information element/Group name | Need | Multi | Type and reference | Semantics description | Version |
|--------------------------------|------|-------|--|--|---------|
| MSCH Scheduling information | MP | | | For FDD, scheduling information is provided starting at (SFN – (SCTO div 10ms)) mod MSCH_REP = MSCH_OFF
For TDD, scheduling information is provided starting at SFN mod MSCH_REP = MSCH_OFF | REL-6 |
| >Scheduling period | MD | | Enumerated (32, 64, 128, 256, 512, 1024) | The period, in number of frames, between MBMS scheduling messages (MSCH_REP)
Default value is the value included in the MBMS GENERAL INFORMATION message | REL-6 |
| >Scheduling offset | MD | | Integer (0..(MSCH_REP-1)) | The position of MBMS scheduling messages relative to timing of the corresponding cell (MSCH_OFF)
Default value is the value included in the MBMS GENERAL INFORMATION message | REL-6 |
| >RLC info | MD | | RLC info MBMS 10.3.4.23a | Default value is the one included in the MBMS GENERAL INFORMATION message | REL-6 |
| TCTF presence | OP | | Enumerated (FALSE) | By default the TCTF is present even though the FACH only carries one logical channel (type). When this IE is included, the TCTF is absent | REL-6 |

10.3.9a.17 Network Standard Time Information

NOTE: Only for 1.28Mcps TDD

This IE includes information about the Network Standard Time and a related SFN value. If Correlative SFN is absent, the default Correlative SFN is equal to zero, this means the "Network Standard Time" indicate the standard time value when SFN equal zero.

The "Network Standard Time" occupied 40 bits; the format refers to "ETSI EN 300 468 V1.5.1 (2003-05)".

| Information Element/Group name | Need | Multi | Type and reference | Semantics description | Version |
|--------------------------------|------|-------|--------------------|---|---------|
| Network Standard Time | MP | | BIT STRING (40) | Network Standard Time | REL-8 |
| Correlative SFN | OP | | Integer (0..4095) | System frame number which is correlative with Network Standard Time Information. If it is absent, Correlative SFN is equal to zero. | REL-8 |

10.3.10 Multiplicity values and type constraint values

The following table includes constants that are either used as multi bounds (name starting with "max") or as high or low value in a type specification (name starting with "lo" or "hi"). Constants are specified only for values appearing more than once in the RRC specification. In case a constant is related to one or more other constants, an expression is included in the "value" column instead of the actual value.

| Constant | Explanation | Value | Version |
|-----------------------------------|--|-----------------|---------|
| CN information | | | |
| maxCNdomains | Maximum number of CN domains | 4 | |
| UTRAN mobility information | | | |
| maxRAT | Maximum number of Radio Access Technologies | maxOtherRAT + 1 | |
| maxOtherRAT | Maximum number of other Radio Access Technologies | 15 | |
| maxURA | Maximum number of URAs in a cell | 8 | |
| maxInterSysMessages | Maximum number of Inter System Messages | 4 | |
| maxRABsetup | Maximum number of RABs to be established | 16 | |
| maxDedicatedCSGfreq | Maximum number of dedicated CSG frequencies | 4 | REL-8 |
| UE information | | | |
| maxtransactions | Maximum number of parallel RRC transactions in downlink | 25 | |
| maxPDCPalgoType | Maximum number of PDCP algorithm types | 8 | |
| maxFreqBandsFDD | Maximum number of frequency bands supported by the UE as defined in [21] | 8 | |
| maxFreqBandsFDD-ext | Maximum number of frequency bands as defined in [21] and treated by RRC | 22 | REL-6 |
| maxFreqBandsTDD | Maximum number of frequency bands supported by the UE as defined in [22] | 4 | |
| maxFreqBandsTDD-ext | Maximum number of frequency bands supported by the UE as defined in [22] | 16 | REL-8 |
| maxFreqBandsGSM | Maximum number of frequency bands supported by the UE as defined in [45] | 16 | |
| maxFreqBandsEUTRA | Maximum number of frequency bands supported by the UE as defined in [36.101] | 16 | REL-8 |
| maxPage1 | Number of UEs paged in the Paging Type 1 message | 8 | |
| maxSystemCapability | Maximum number of system specific capabilities that can be requested in one message. | 16 | |
| MaxURNtIgroup | Maximum number of U-RNTI groups in one message | 8 | REL-5 |
| maxCommonHRNTI | Maximum number of common H-RNTI per cell | 4 | REL-7 |
| maxERNTIgroup | Maximum number of common E-RNTI group per cell (1.28 Mcps TDD) | 32 | REL-8 |
| maxERNTIperGroup | Maximum number of common E-RNTI in a group (1.28 Mcps TDD) | 2 | REL-8 |
| RB information | | | |
| maxPredefConfig | Maximum number of predefined configurations | 16 | |
| maxRB | Maximum number of RBs | 32 | |
| maxSRBsetup | Maximum number of signalling RBs to be established | 8 | |
| maxRBperRAB | Maximum number of RBs per RAB | 8 | |

| Constant | Explanation | Value | Version |
|--------------------------|--|---|---------|
| maxRBallRABs | Maximum number of non signalling RBs | 27 | |
| maxRBperTrCh | Maximum number of RB per TrCh | 16 | REL-6 |
| maxRBMuxOptions | Maximum number of RB multiplexing options | 8 | |
| maxLoCHperRLC | Maximum number of logical channels per RLC entity | 2 | |
| maxRLCPDUsizePerLogChan | Maximum number of RLC PDU sizes per logical channel mapped on E-DCH | 32 | REL-6 |
| MaxROHC-PacketSizes | Maximum number of packet sizes that are allowed to be produced by ROHC. | 16 | |
| MaxROHC-Profiles | Maximum number of profiles supported by ROHC on a given RB. | 8 | |
| maxRFC 3095-CID | Maximum number of available CID values per radio bearer | 16384 | REL-5 |
| TrCH information | | | |
| maxCommonQueueID | Maximum number of common Mac-ehs queues | 2 | REL-7 |
| maxE-DCHMACdFlow | Maximum number of E-DCH MAC-d flows | 8 | REL-6 |
| MaxHProcesses | Maximum number of H-ARQ processes | 8 | REL-5 |
| MaxHSDSCH_TB_index | Maximum number of TB set size configurations for the HS-DSCH. | 64 (FDD and 1.28 MCPS TDD); 512 (3.84 Mcps TDD); 1024 (7.68 Mcps TDD) | REL-5 |
| maxMACdPDUSizes | Maximum number of MAC-d PDU sizes per queue permitted for MAC-hs | 8 | REL-5 |
| maxTrCH | Maximum number of transport channels used in one direction (UL or DL) | 32 | |
| maxTrCHpreconf | Maximum number of preconfigured Transport channels, per direction | 16 | |
| maxCCTrCH | Maximum number of CCTrCHs | 8 | |
| maxQueueID | Maximum number of Mac-hs queues | 8 | REL-5 |
| MaxTF | Maximum number of different transport formats that can be included in the Transport format set for one transport channel | 32 | |
| maxTFC | Maximum number of Transport Format Combinations | 1024 | |
| maxTFCsub | Maximum number of Transport Format Combinations Subset | 1024 | |
| maxSIBperMsg | Maximum number of complete system information blocks per SYSTEM INFORMATION message | 16 | |
| maxSIB | Maximum number of references to other system information blocks. | 32 | |
| maxSIB-FACH | Maximum number of references to system information blocks on the FACH | 8 | |
| PhyCH information | | | |
| maxHSSCCHs | Maximum number of HSSCCH codes that can be assigned to a UE | 4 | REL-5 |
| maxHS-SCCHLessTrBlk | Maximum number of HS-DSCH Transport Block Sizes used for HS-SCCH-less operation | [4] | REL-7 |
| maxTDD128Carrier | The maximum number of carriers for 1.28 Mcps TDD | 6 | REL-7 |
| maxAC | Maximum number of access classes | 16 | |
| maxASC | Maximum number of access service classes | 8 | |
| maxASCmap | Maximum number of access class to access service classes mappings | 7 | |
| maxASCpersist | Maximum number of access service classes for which persistence scaling factors are specified | 6 | |
| maxPRACH | Maximum number of PRACHs in a cell | 16 | |
| maxEDCHs | Maximum number of common E-DCH resources in a cell | 32 | REL-8 |
| MaxPRACH_FPACH | Maximum number of PRACH / FPACH pairs in a cell (1.28 Mcps TDD) | 8 | REL-4 |
| maxFACHPCH | Maximum number of FACHs and PCHs mapped onto one secondary CCPCHs | 8 | |
| maxRL | Maximum number of radio links | 8 | |

| Constant | Explanation | Value | Version |
|--------------------------------|---|--------------------------------------|---------|
| maxEDCHRL | Maximum number of E-DCH radio links | 4 | REL-6 |
| maxSCCPCH | Maximum number of secondary CCPCHs per cell | 16 | |
| maxDPDCH-UL | Maximum number of DPDCHs per cell | 6 | |
| maxDPCH-DLchan | Maximum number of channelisation codes used for DL DPCH | 8 | |
| maxPUSCH | Maximum number of PUSCHs | (8) | |
| maxPDSCH | Maximum number of PDSCHs | 8 | |
| maxTS | Maximum number of timeslots used in one direction (UL or DL) | 14 (3.84 Mcps TDD and 7.68 Mcps TDD) | |
| | | 6 (1.28 Mcps TDD) | REL-4 |
| hiPUSCHidentities | Maximum number of PUSCH Identities | 64 | |
| hiPDSCHidentities | Maximum number of PDSCH Identities | 64 | |
| maxNumE-AGCH | Maximum number of E-AGCHs (TDD) | 4 | REL-7 |
| maxNumE-HICH | Maximum number of E-HICHs (1.28 Mcps TDD) | 4 | REL-7 |
| maxERUCCH | Maximum number of E-RUCCH on primary frequency (1.28Mcps TDD) | 256 | REL-8 |
| Measurement information | | | |
| maxTGPS | Maximum number of transmission gap pattern sequences | 6 | |
| maxAdditionalMeas | Maximum number of additional measurements for a given measurement identity | 4 | |
| maxMeasEvent | Maximum number of events that can be listed in measurement reporting criteria | 8 | |
| maxMeasParEvent | Maximum number of measurement parameters (e.g. thresholds) per event | 2 | |
| maxMeasIntervals | Maximum number of intervals that define the mapping function between the measurements for the cell quality Q of a cell and the representing quality value | 1 | |
| maxCellMeas | Maximum number of cells to measure | 32 | |
| maxReportedGSMCells | Maximum number of GSM cells to be reported | 8 | |
| maxReportedEUTRAFreqs | Maximum number of E-UTRA frequencies to report | 4 | REL-8 |
| maxReportedEUTRACellperFreq | Maximum number of E-UTRA cells to report per frequency | 4 | REL-8 |
| maxFreq | Maximum number of frequencies to measure | 8 | |
| maxNumPrio | Maximum number of priorities to store | 11 | REL-8 |
| maxPrio | Maximum number of RAT or Frequency Priority levels | 8 | REL-8 |
| maxEUTRACellPerFreq | Maximum number of E-UTRA cells per frequency | 16 | REL-8 |
| maxSat | Maximum number of satellites to measure | 16 | |
| maxGANSSSat | Maximum number of GANSS satellites to measure | 64 | REL-7 |
| maxGANSS | Maximum number of GANSS supported | 8 | REL-7 |
| maxSgnType | Maximum number of additional signals in GANSS to measure | 8 | REL-7 |
| maxSatClockModels | Maximum number of clock models in a GANSS | 4 | REL-7 |
| maxSatAlmanacStorage | Maximum number of satellites for which to store GPS Almanac information | 32 | |
| HiRM | Maximum number that could be set as rate matching attribute for a transport channel | 256 | |
| Frequency information | | | |
| MaxFDDFreqList | Maximum number of FDD carrier frequencies to be stored in USIM | 4 | |
| MaxTDDFreqList | Maximum number of TDD carrier frequencies to be stored in USIM | 4 | |
| MaxFDDFreqCellList | Maximum number of neighbouring FDD cells to be stored in USIM | 32 | |
| MaxTDDFreqCellList | Maximum number of neighbouring TDD cells to be stored in USIM | 32 | |
| MaxGSMCellList | Maximum number of GSM cells to be stored in USIM | 32 | |

| Constant | Explanation | Value | Version |
|--------------------------|---|-------|---------|
| Other information | | | |
| MaxGERANSI | Maximum number of GERAN SI blocks that can be provided as part of NACC information | 8 | REL-5 |
| maxNumGSMFreqRanges | Maximum number of GSM Frequency Ranges to store | 32 | |
| MaxNumFDDFreqs | Maximum number of FDD centre frequencies to store | 8 | |
| MaxNumTDDFreqs | Maximum number of TDD centre frequencies to store | 8 | |
| maxNumCDMA200Freqs | Maximum number of CDMA2000 centre frequencies to store | 8 | |
| maxGSMTargetCells | Maximum number of GSM target cells | 32 | REL-6 |
| maxNumGSMCellGroup | Maximum number of GSM frequency groups to store | 16 | REL-8 |
| maxNumEUTRAFreqs | Maximum number of EUTRA centre frequencies to store | 8 | REL-8 |
| maxEUTRATargetFreqs | Maximum number of target E-UTRA frequencies | 8 | REL-8 |
| maxHNBNameSize | Maximum number of octets for the HNB Name | 48 | REL-8 |
| MBMS information | | | |
| maxMBMS-CommonCCTrCh | Maximum number of CCTrCh configurations included in the MBMS COMMON P-T-M RB INFORMATION message | 32 | REL-6 |
| maxMBMS-CommonPhyCh | Maximum number of PhyCh configurations included in the MBMS COMMON P-T-M RB INFORMATION message | 32 | REL-6 |
| maxMBMS-CommonRB | Maximum number of RB configurations included in the MBMS COMMON P-T-M RB INFORMATION message | 32 | REL-6 |
| maxMBMS-CommonTrCh | Maximum number of TrCh configurations included in the MBMS COMMON P-T-M RB INFORMATION message | 32 | REL-6 |
| maxMBMS-Freq | Maximum number of MBMS preferred frequencies | 4 | REL-6 |
| maxMBMS-L1CP | Maximum number of periods in which layer 1 combining applies | 4 | REL-6 |
| maxMBMSservCount | Maximum number of MBMS services in a Access Info message | 8 | REL-6 |
| maxMBMSservModif | Maximum number of MBMS services in a MBMS MODIFIED SERVICES INFORMATION message | 32 | REL-6 |
| maxMBMSservSched | Maximum number of MBMS services in a MBMS SCHEDULING INFORMATION message | 16 | REL-6 |
| maxMBMSservSelect | Maximum number of MBMS Selected Services in a CELL UPDATE or RRC CONNECTION REQUEST message | 8 | REL-6 |
| maxMBMSservUnmodif | Maximum number of MBMS services in a MBMS UNMODIFIED SERVICES INFORMATION message | 64 | REL-6 |
| maxMBMSTransmis | Maximum number of transmissions for which scheduling information is provided within a scheduling period | 4 | REL-6 |
| maxMBMS-Services | Maximum number of MBMS services the UE stores in the variable MBMS_ACTIVATED_SERVICES | 64 | REL-6 |
| maxMBSFNclusters | Maximum number of MBSFN clusters indicated in system information | 16 | REL-7 |

11 Message and Information element abstract syntax (with ASN.1)

This clause contains definitions for RRC PDUs and IEs using a subset of ASN.1 as specified in [14]. PDU and IE definitions are grouped into separate ASN.1 modules.

11.0 General

Some messages and/or IEs may include one or more IEs with name "dummy" that are included only in the ASN.1. The UE should avoid sending information elements that are named "dummy" to UTRAN. Likewise, UTRAN should avoid sending IEs with name "dummy" to the UE. If the UE anyhow receives an information element named "dummy", it shall ignore the IE and process the rest of the message as if the IE was not included.

NOTE: An IE with name "dummy" concerns an information element that was (erroneously) included in a previous version of the specification and has been removed by replacing it with a dummy with same type.

The UE shall only include the "variable length extension container" when it sends a non critical extension that according to this specification shall be transferred within this container.

If the abstract syntax of an IE is defined using the ASN.1 type "BIT STRING", and this IE corresponds to a functional IE definition in tabular format, in which the significance of bits is semantically defined, the following general rule shall be applied:

The bits in the ASN.1 bit string shall represent the semantics of the functional IE definition in decreasing order of bit significance;

- with the first (or leftmost) bit in the bit string representing the most significant bit; and
- with the last (or rightmost) bit in the bit string representing the least significant bit.

11.1 General message structure

```
Class-definitions DEFINITIONS AUTOMATIC TAGS ::=
```

```
BEGIN
```

```
IMPORTS
```

```

ActiveSetUpdate,
ActiveSetUpdateComplete,
ActiveSetUpdateFailure,
AssistanceDataDelivery,
CellChangeOrderFromUTRAN,
CellChangeOrderFromUTRANFailure,
CellUpdate,
CellUpdateConfirm-CCCH,
CellUpdateConfirm,
CounterCheck,
CounterCheckResponse,
DownlinkDirectTransfer,
ETWSPPrimaryNotificationWithSecurity,
HandoverToUTRANComplete,
InitialDirectTransfer,
HandoverFromUTRANCommand-EUTRA,
HandoverFromUTRANCommand-GERANIu,
HandoverFromUTRANCommand-GSM,
HandoverFromUTRANCommand-CDMA2000,
HandoverFromUTRANFailure,
MBMSAccessInformation,
MBMSCommonPTMRBInformation,
MBMSCurrentCellPTMRBInformation,
MBMSGeneralInformation,
MBMSModificationRequest,
MBMSModifiedServicesInformation,
MBMSNeighbouringCellPTMRBInformation,
MBMSSchedulingInformation,
MBMSUnmodifiedServicesInformation,
MeasurementControl,
MeasurementControlFailure,
MeasurementReport,
PagingType1,
PagingType2,
PhysicalChannelReconfiguration,
PhysicalChannelReconfigurationComplete,
PhysicalChannelReconfigurationFailure,
PhysicalSharedChannelAllocation,
PUSCHCapacityRequest,
```



```

RadioBearerReconfiguration,
RadioBearerReconfigurationComplete,
RadioBearerReconfigurationFailure,
RadioBearerRelease,
RadioBearerReleaseComplete,
RadioBearerReleaseFailure,
RadioBearerSetup,
RadioBearerSetupComplete,
RadioBearerSetupFailure,
RRCConnectionReject,
RRCConnectionRelease,
RRCConnectionRelease-CCCH,
RRCConnectionReleaseComplete,
RRCConnectionRequest,
RRCConnectionSetup,
RRCConnectionSetupComplete,
RRCStatus,
SecurityModeCommand,
SecurityModeComplete,
SecurityModeFailure,
SignallingConnectionRelease,
SignallingConnectionReleaseIndication,
SystemInformation-BCH,
SystemInformation-FACH,
SystemInformationChangeIndication,
TransportChannelReconfiguration,
TransportChannelReconfigurationComplete,
TransportChannelReconfigurationFailure,
TransportFormatCombinationControl,
TransportFormatCombinationControlFailure,
UECapabilityEnquiry,
UECapabilityInformation,
UECapabilityInformationConfirm,
UplinkDirectTransfer,
UplinkPhysicalChannelControl,
URAUpdate,
URAUpdateConfirm,
URAUpdateConfirm-CCCH,
UTRANMobilityInformation,
UTRANMobilityInformationConfirm,
UTRANMobilityInformationFailure
FROM PDU-definitions

-- User Equipment IEs :
  IntegrityCheckInfo
FROM InformationElements;

--*****
--
-- Downlink DCCH messages
--
--*****

DL-DCCH-Message ::= SEQUENCE {
    integrityCheckInfo      IntegrityCheckInfo      OPTIONAL,
    message                  DL-DCCH-MessageType
}

DL-DCCH-MessageType ::= CHOICE {
    activeSetUpdate          ActiveSetUpdate,
    assistanceDataDelivery  AssistanceDataDelivery,
    cellChangeOrderFromUTRAN CellChangeOrderFromUTRAN,
    cellUpdateConfirm       CellUpdateConfirm,
    counterCheck            CounterCheck,
    downlinkDirectTransfer  DownlinkDirectTransfer,
    handoverFromUTRANCommand-GSM HandoverFromUTRANCommand-GSM,
    handoverFromUTRANCommand-CDMA2000 HandoverFromUTRANCommand-CDMA2000,
    measurementControl      MeasurementControl,
    pagingType2            PagingType2,
    physicalChannelReconfiguration PhysicalChannelReconfiguration,
    physicalSharedChannelAllocation PhysicalSharedChannelAllocation,
    radioBearerReconfiguration RadioBearerReconfiguration,
    radioBearerRelease      RadioBearerRelease,
    radioBearerSetup        RadioBearerSetup,
    rrcConnectionRelease    RRCConnectionRelease,
    securityModeCommand     SecurityModeCommand,
    signallingConnectionRelease SignallingConnectionRelease,
    transportChannelReconfiguration TransportChannelReconfiguration,

```

```

transportFormatCombinationControl TransportFormatCombinationControl,
ueCapabilityEnquiry UECapabilityEnquiry,
ueCapabilityInformationConfirm UECapabilityInformationConfirm,
uplinkPhysicalChannelControl UplinkPhysicalChannelControl,
uraUpdateConfirm URAUpdateConfirm,
utranMobilityInformation UTRANMobilityInformation,
handoverFromUTRANCommand-GERANIu HandoverFromUTRANCommand-GERANIu,
mbmsModifiedServicesInformation MBMSModifiedServicesInformation,
etwsPrimaryNotificationWithSecurity ETWSPrimaryNotificationWithSecurity,
handoverFromUTRANCommand-EUTRA HandoverFromUTRANCommand-EUTRA,
spare3 NULL,
spare2 NULL,
spare1 NULL
}

--*****
--
-- Uplink DCCH messages
--
--*****

UL-DCCH-Message ::= SEQUENCE {
    integrityCheckInfo IntegrityCheckInfo OPTIONAL,
    message UL-DCCH-MessageType
}

UL-DCCH-MessageType ::= CHOICE {
    activeSetUpdateComplete ActiveSetUpdateComplete,
    activeSetUpdateFailure ActiveSetUpdateFailure,
    cellChangeOrderFromUTRANFailure CellChangeOrderFromUTRANFailure,
    counterCheckResponse CounterCheckResponse,
    handoverToUTRANComplete HandoverToUTRANComplete,
    initialDirectTransfer InitialDirectTransfer,
    handoverFromUTRANFailure HandoverFromUTRANFailure,
    measurementControlFailure MeasurementControlFailure,
    measurementReport MeasurementReport,
    physicalChannelReconfigurationComplete PhysicalChannelReconfigurationComplete,
    physicalChannelReconfigurationFailure PhysicalChannelReconfigurationFailure,
    radioBearerReconfigurationComplete RadioBearerReconfigurationComplete,
    radioBearerReconfigurationFailure RadioBearerReconfigurationFailure,
    radioBearerReleaseComplete RadioBearerReleaseComplete,
    radioBearerReleaseFailure RadioBearerReleaseFailure,
    radioBearerSetupComplete RadioBearerSetupComplete,
    radioBearerSetupFailure RadioBearerSetupFailure,
    rrcConnectionReleaseComplete RRCConnectionReleaseComplete,
    rrcConnectionSetupComplete RRCConnectionSetupComplete,
    rrcStatus RRCStatus,
    securityModeComplete SecurityModeComplete,
    securityModeFailure SecurityModeFailure,
    signallingConnectionReleaseIndication SignallingConnectionReleaseIndication,
    transportChannelReconfigurationComplete TransportChannelReconfigurationComplete,
    transportChannelReconfigurationFailure TransportChannelReconfigurationFailure,
    transportFormatCombinationControlFailure TransportFormatCombinationControlFailure,
    ueCapabilityInformation UECapabilityInformation,
    uplinkDirectTransfer UplinkDirectTransfer,
    utranMobilityInformationConfirm UTRANMobilityInformationConfirm,
    utranMobilityInformationFailure UTRANMobilityInformationFailure,
    mbmsModificationRequest MBMSModificationRequest,
    spare1 NULL
}

--*****
--
-- Downlink CCCH messages
--
--*****

DL-CCCH-Message ::= SEQUENCE {
    integrityCheckInfo IntegrityCheckInfo OPTIONAL,
    message DL-CCCH-MessageType
}

```

```

DL-CCCH-MessageType ::= CHOICE {
    cellUpdateConfirm           CellUpdateConfirm-CCCH,
    rrcConnectionReject        RRCCConnectionReject,
    rrcConnectionRelease       RRCCConnectionRelease-CCCH,
    rrcConnectionSetup         RRCCConnectionSetup,
    uraUpdateConfirm           URAUpdateConfirm-CCCH,
    -- dummy is not used in the specification. If received it is ignored by the UE.
    -- See TS 23.041 for handling of warning security information by Cell Broadcast Center.
    dummy ETWSPrimaryNotificationWithSecurity,
    spare2                          NULL,
    spare1                          NULL,
}

-----
--
-- Uplink CCCH messages
--
-----

UL-CCCH-Message ::= SEQUENCE {
    integrityCheckInfo          IntegrityCheckInfo          OPTIONAL,
    message                      UL-CCCH-MessageType
}

UL-CCCH-MessageType ::= CHOICE {
    cellUpdate                  CellUpdate,
    rrcConnectionRequest       RRCCConnectionRequest,
    uraUpdate                   URAUpdate,
    spare                        NULL,
}

-----
--
-- PCCH messages
--
-----

PCCH-Message ::= SEQUENCE {
    message                      PCCH-MessageType
}

PCCH-MessageType ::= CHOICE {
    pagingType1                 PagingType1,
    spare                        NULL,
}

-----
--
-- Downlink SHCCH messages
--
-----

DL-SHCCH-Message ::= SEQUENCE {
    message                      DL-SHCCH-MessageType
}

DL-SHCCH-MessageType ::= CHOICE {
    physicalSharedChannelAllocation PhysicalSharedChannelAllocation,
    spare                          NULL,
}

-----
--
-- Uplink SHCCH messages
--
-----

UL-SHCCH-Message ::= SEQUENCE {
    message                      UL-SHCCH-MessageType
}

UL-SHCCH-MessageType ::= CHOICE {
    puschCapacityRequest        PUSCHCapacityRequest,
    spare                        NULL,
}

-----

```

```

--
-- BCCH messages sent on FACH
--
--*****
BCCH-FACH-Message ::= SEQUENCE {
    message          BCCH-FACH-MessageType
}

BCCH-FACH-MessageType ::= CHOICE {
    systemInformation          SystemInformation-FACH,
    systemInformationChangeIndication SystemInformationChangeIndication,
    spare2                     NULL,
    spare1                     NULL
}

--*****
--
-- BCCH messages sent on BCH
--
--*****
BCCH-BCH-Message ::= SEQUENCE {
    message          SystemInformation-BCH
}

--*****
--
-- MCCH messages
--
--*****
MCCH-Message ::= SEQUENCE {
    message          MCCH-MessageType
}

MCCH-MessageType ::= CHOICE {
    mbmsAccessInformation          MBMSAccessInformation,
    mbmsCommonPTMRBInformation    MBMSCommonPTMRBInformation,
    mbmsCurrentCellPTMRBInformation MBMSCurrentCellPTMRBInformation,
    mbmsGeneralInformation        MBMSGeneralInformation,
    mbmsModifiedServicesInformation MBMSModifiedServicesInformation,
    mbmsNeighbouringCellPTMRBInformation MBMSNeighbouringCellPTMRBInformation,
    mbmsUnmodifiedServicesInformation MBMSUnmodifiedServicesInformation,
    spare9                        NULL,
    spare8                        NULL,
    spare7                        NULL,
    spare6                        NULL,
    spare5                        NULL,
    spare4                        NULL,
    spare3                        NULL,
    spare2                        NULL,
    spare1                        NULL
}

--*****
--
-- MSCH messages
--
--*****
MSCH-Message ::= SEQUENCE {
    message          MSCH-MessageType
}

MSCH-MessageType ::= CHOICE {
    mbmsSchedulingInformation    MBMS Scheduling Information,
    spare3                      NULL,
    spare2                      NULL,
    spare1                      NULL
}

END

```

11.2 PDU definitions

```

--*****
--
-- TABULAR: The message type and integrity check info are not
-- visible in this module as they are defined in the class module.
-- Also, all FDD/TDD specific choices have the FDD option first
-- and TDD second, just for consistency.
--
--*****

PDU-definitions DEFINITIONS AUTOMATIC TAGS ::=

BEGIN

--*****
--
-- IE parameter types from other modules
--
--*****

IMPORTS

-- Core Network IEs :
  CN-DomainIdentity,
  CN-InformationInfo,
  CN-InformationInfo-r6,
  CN-InformationInfoFull,
  NAS-Message,
  PagingRecordTypeID,
  PLMN-Identity,
-- UTRAN Mobility IEs :
  CellIdentity,
  CellIdentity-PerRL-List,
  DedicatedPriorityInformation,
  URA-Identity,
-- User Equipment IEs :
  AccessStratumReleaseIndicator,
  ActivationTime,
  C-RNTI,
  CapabilityUpdateRequirement,
  CapabilityUpdateRequirement-r4,
  CapabilityUpdateRequirement-r4-ext,
  CapabilityUpdateRequirement-r5,
  CapabilityUpdateRequirement-v770ext,
  CapabilityUpdateRequirement-v860ext,
  CapabilityUpdateRequirement-r7,
  CapabilityUpdateRequirement-r8,
  CellUpdateCause,
  CellUpdateCause-ext,
  CipheringAlgorithm,
  CipheringAlgorithm-r7,
  CipheringModeInfo,
  CipheringModeInfo-r7,
  DelayRestrictionFlag,
  DL-PhysChCapabilityFDD-v380ext,
  DL-SecondaryCellInfoFDD,
  DL-SecondaryCellInfoFDD-v890ext,
  DSCH-RNTI,
  E-RNTI,
  EstablishmentCause,
  FailureCauseWithProtErr,
  FailureCauseWithProtErrTrId,
  GroupReleaseInformation,
  H-RNTI,
  High-MobilityDetected,
  InitialUE-Identity,
  IntegrityProtActivationInfo,
  IntegrityProtectionModeInfo,
  IntegrityProtectionModeInfo-r7,
  N-308,
  PagingCause,
  PagingRecordList,
  PagingRecord2List-r5,
  PDCP-Capability-v770ext,
  Pre-RedirectionInfo,
  ProtocolErrorIndicator,

```

```

ProtocolErrorIndicatorWithMoreInfo,
RadioFrequencyBandTDDList,
Rb-timer-indicator,
RedirectionInfo,
RedirectionInfo-r6,
RedirectionInfo-v860ext,
RejectionCause,
ReleaseCause,
RF-CapabilityComp,
RRC-StateIndicator,
RRC-TransactionIdentifier,
SecurityCapability,
SR-VCC-Info,
SR-VCC-SecurityRABInfo-v860ext,
START-Value,
STARTList,
SystemSpecificCapUpdateReq-v590ext,
U-RNTI,
U-RNTI-Short,
UESpecificBehaviourInformationIdle,
UESpecificBehaviourInformationInterRAT,
UE-CapabilityContainer-IEs,
UE-ConnTimersAndConstants,
UE-ConnTimersAndConstants-v3a0ext,
UE-ConnTimersAndConstants-v860ext,
UE-ConnTimersAndConstants-r5,
UE-HSPA-Identities-r6,
UE-RadioAccessCapabBandFDDList2,
UE-RadioAccessCapabBandFDDList-ext,
UE-RadioAccessCapability,
UE-RadioAccessCapability-v370ext,
UE-RadioAccessCapability-v380ext,
UE-RadioAccessCapability-v3a0ext,
UE-RadioAccessCapability-v3g0ext,
UE-RadioAccessCapability-v4b0ext,
UE-RadioAccessCapability-v590ext,
UE-RadioAccessCapability-v5c0ext,
UE-RadioAccessCapability-v650ext,
UE-RadioAccessCapability-v680ext,
UE-RadioAccessCapability-v7e0ext,
UE-RadioAccessCapability-v7f0ext,
UE-RadioAccessCapability-v860ext,
UE-RadioAccessCapability-v880ext,
UE-RadioAccessCapability-v890ext,
UE-RadioAccessCapability-v920ext,
UE-RadioAccessCapabilityComp,
UE-RadioAccessCapabilityComp-ext,
UE-RadioAccessCapabilityComp-v770ext,
UE-RadioAccessCapabilityComp2,
UE-RadioAccessCapabilityComp2-v770ext,
UE-RadioAccessCapabilityComp2-v7f0ext,
UE-RadioAccessCapabilityComp2-v860ext,
UE-RadioAccessCapabilityComp2-v920ext,
UE-RadioAccessCapabilityComp-TDD128,
UE-RadioAccessCapabilityInfo-v770ext,
UE-RadioAccessCapabilityInfo-TDD128-v8b0ext,
UE-SecurityInformation,
UE-SecurityInformation2,
UE-SpecificCapabilityInformation-LCRTDD,
URA-UpdateCause,
UTRAN-DRX-CycleLengthCoefficient,
UTRAN-DRX-CycleLengthCoefficient-r7,
WaitTime,
-- Radio Bearer IEs :
DefaultConfigIdentity,
DefaultConfigIdentity-r4,
DefaultConfigIdentity-r5,
DefaultConfigIdentity-r6,
DefaultConfigForCellFACH,
DefaultConfigMode,
DL-CounterSynchronisationInfo,
DL-CounterSynchronisationInfo-r5,
PDCP-ROHC-TargetMode,
PredefinedConfigIdentity,
PredefinedConfigStatusList,
PredefinedConfigStatusListComp,
PredefinedConfigSetWithDifferentValueTag,
RAB-Info,

```

```
RAB-Info-r6,  
RAB-Info-r7,  
RAB-Info-Post,  
RAB-InformationList,  
RAB-InformationList-r6,  
RAB-InformationReconfigList,  
RAB-InformationReconfigList-r8,  
RAB-InformationMBMSPTpList,  
RAB-InformationSetup-r7,  
RAB-InformationSetup-r8,  
RAB-InformationSetup-v820ext,  
RAB-InformationSetupList,  
RAB-InformationSetupList-r4,  
RAB-InformationSetupList-r5,  
RAB-InformationSetupList-r6-ext,  
RAB-InformationSetupList-r6,  
RAB-InformationSetupList-v6b0ext,  
RAB-InformationSetupList-r7,  
RAB-InformationSetupList-r8,  
RAB-InformationSetupList-v820ext,  
RB-ActivationTimeInfoList,  
RB-COUNT-C-InformationList,  
RB-COUNT-C-MSB-InformationList,  
RB-IdentityList,  
RB-InformationAffectedList,  
RB-InformationAffectedList-r5,  
RB-InformationAffectedList-r6,  
RB-InformationAffectedList-r7,  
RB-InformationAffectedList-r8,  
RB-InformationChangedList-r6,  
RB-InformationReconfigList,  
RB-InformationReconfigList-r4,  
RB-InformationReconfigList-r5,  
RB-InformationReconfigList-r6,  
RB-InformationReconfigList-r7,  
RB-InformationReconfigList-r8,  
RB-InformationReleaseList,  
RB-PDCPContextRelocationList,  
SRB-InformationSetupList,  
SRB-InformationSetupList-r5,  
SRB-InformationSetupList-r6,  
SRB-InformationSetupList-r7,  
SRB-InformationSetupList-r8,  
SRB-InformationSetupList2,  
SRB-InformationSetupList2-r6,  
SRB-InformationSetupList2-r7,  
SRB-InformationSetupList2-r8,  
UL-AMR-Rate,  
UL-CounterSynchronisationInfo,  
-- Transport Channel IEs:  
  CPCH-SetID,  
  DL-AddReconfTransChInfo2List,  
  DL-AddReconfTransChInfoList,  
  DL-AddReconfTransChInfoList-r4,  
  DL-AddReconfTransChInfoList-r5,  
  DL-AddReconfTransChInfoList-r7,  
  DL-CommonTransChInfo,  
  DL-CommonTransChInfo-r4,  
  DL-DeletedTransChInfoList,  
  DL-DeletedTransChInfoList-r5,  
  DL-DeletedTransChInfoList-r7,  
  DRAC-StaticInformationList,  
  HARQ-Info-r7,  
  PowerOffsetInfoShort,  
  TFC-Subset,  
  TFCS-Identity,  
  UL-AddReconfTransChInfoList,  
  UL-AddReconfTransChInfoList-r6,  
  UL-AddReconfTransChInfoList-r7,  
  UL-AddReconfTransChInfoList-r8,  
  UL-CommonTransChInfo,  
  UL-CommonTransChInfo-r4,  
  UL-DeletedTransChInfoList,  
  UL-DeletedTransChInfoList-r6,  
-- Physical Channel IEs :  
  Alpha,  
  BEACON-PL-Est,  
  CCTrCH-PowerControlInfo,
```

CCTrCH-PowerControlInfo-r4,
CCTrCH-PowerControlInfo-r5,
CCTrCH-PowerControlInfo-r7,
ConstantValue,
ConstantValueTdd,
ControlChannelDRXInfo-TDD128-r8,
CPCH-SetInfo,
DHS-Sync,
DL-CommonInformation,
DL-CommonInformation-r4,
DL-CommonInformation-r5,
DL-CommonInformation-r6,
DL-CommonInformation-r7,
DL-CommonInformation-r8,
DL-CommonInformationPost,
DL-HSPDSCH-Information,
DL-HSPDSCH-Information-r6,
DL-HSPDSCH-Information-r7,
DL-HSPDSCH-Information-r8,
DL-HSPDSCH-Information-r8-ext,
DL-HSPDSCH-Information-r8-ext2,
DL-HSPDSCH-MultiCarrier-Information,
DL-InformationPerRL-List,
DL-InformationPerRL-List-r4,
DL-InformationPerRL-List-r5,
DL-InformationPerRL-List-r5bis,
DL-InformationPerRL-List-r6,
DL-InformationPerRL-List-r7,
DL-InformationPerRL-List-r8,
DL-InformationPerRL-List-v6b0ext,
DL-InformationPerRL-ListPostFDD,
DL-InformationPerRL-PostTDD,
DL-InformationPerRL-PostTDD-LCR-r4,
DL-MultiCarrier-Information,
DL-PDSCH-Information,
DL-TPC-PowerOffsetPerRL-List,
DLUL-HSPA-Information-r8,
DPC-Mode,
DPCH-CompressedModeStatusInfo,
DTX-DRX-TimingInfo-r7,
DTX-DRX-Info-r7,
DynamicPersistenceLevel,
E-DCH-ReconfigurationInfo,
E-DCH-ReconfigurationInfo-r7,
E-DCH-RL-InfoSameServingCell,
E-TFC-Boost-Info-r7,
E-DPDCH-PowerInterpolation,
EXT-UL-TimingAdvance,
Feedback-cycle-r7,
FrequencyInfo,
FrequencyInfoFDD,
FrequencyInfoTDD,
HARQ-Preamble-Mode,
HS-DSCH-TBSizeTable,
HS-SCCH-LessInfo-r7,
HS-SICH-Power-Control-Info-TDD384,
HS-SICH-Power-Control-Info-TDD768,
MaxAllowedUL-TX-Power,
MIMO-Parameters-r7,
MIMO-Parameters-v7f0ext,
MIMO-Parameters-v7g0ext,
MIMO-Parameters-r8,
OpenLoopPowerControl-IPDL-TDD-r4,
PDSCH-CapacityAllocationInfo,
PDSCH-CapacityAllocationInfo-r4,
PDSCH-CapacityAllocationInfo-r7,
PDSCH-Identity,
Multi-frequencyInfo-LCR-r7,
PrimaryCPICH-Info,
PrimaryCCPCH-TX-Power,
PUSCH-CapacityAllocationInfo,
PUSCH-CapacityAllocationInfo-r4,
PUSCH-CapacityAllocationInfo-r7,
PUSCH-Identity,
PUSCH-SysInfoList-HCR-r5,
PDSCH-SysInfoList-HCR-r5,
RL-AdditionInformationList,
RL-AdditionInformationList-r6,
RL-AdditionInformation-list-v6b0ext,

```

RL-AdditionInformationList-r7,
RL-AdditionInformationList-r8,
RL-AdditionInformationList-v890ext,
RL-RemovalInformationList,
Serving-HSDSCH-CellInformation,
Serving-HSDSCH-CellInformation-r7,
Serving-HSDSCH-CellInformation-r8,
ServingCellChangeParameters,
SpecialBurstScheduling,
SPS-Information-TDD128-r8,
SSDT-Information,
SSDT-Information-r4,
TFC-ControlDuration,
SSDT-UL,
TimingMaintainedSynchInd,
TimeslotList,
TimeslotList-r4,
TX-DiversityMode,
UL-16QAM-Config,
UL-ChannelRequirement,
UL-ChannelRequirement-r4,
UL-ChannelRequirement-r5,
UL-ChannelRequirementWithCPCH-SetID,
UL-ChannelRequirementWithCPCH-SetID-r4,
UL-ChannelRequirementWithCPCH-SetID-r5,
UL-DPCH-Info,
UL-DPCH-Info-r4,
UL-DPCH-Info-r5,
UL-DPCH-Info-r6,
UL-DPCH-Info-r7,
UL-DPCH-InfoPostFDD,
UL-DPCH-InfoPostTDD,
UL-DPCH-InfoPostTDD-LCR-r4,
UL-EDCH-Information-ext,
UL-EDCH-Information-r6,
UL-EDCH-Information-r7,
UL-EDCH-Information-r8,
UL-SynchronisationParameters-r4,
UL-TimingAdvance,
UL-TimingAdvanceControl,
UL-TimingAdvanceControl-r4,
UL-TimingAdvanceControl-r7,
UpPCHposition-LCR,
-- Measurement IEs :
AdditionalMeasurementID-List,
DeltaRSCP,
Frequency-Band,
EventResults,
EventResults-v770ext,
EventResults-v860ext,
EUTRA-EventResults,
EUTRA-MeasuredResults,
Inter-FreqEventCriteriaList-v590ext,
Intra-FreqEventCriteriaList-v590ext,
IntraFreqReportingCriteria-1b-r5,
IntraFreqEvent-1d-r5,
IntraFreqCellID,
InterFreqEventResults-LCR-r4-ext,
InterRATCellInfoIndication,
InterRAT-TargetCellDescription,
MeasuredResults,
MeasuredResults-v390ext,
MeasuredResults-v590ext,
MeasuredResults-v770ext,
MeasuredResults-v860ext,
MeasuredResultsList,
MeasuredResultsList-LCR-r4-ext,
MeasuredResultsList-v770ext,
MeasuredResultsList-v860ext,
MeasuredResultsOnRACH,
MeasuredResultsOnRACH-v790ext,
MeasuredResultsOnRACHinterFreq,
MeasurementCommand,
MeasurementCommand-r4,
MeasurementCommand-r6,
MeasurementCommand-r7,
MeasurementCommand-r8,
MeasurementIdentity,
MeasurementReportingMode,

```

```

NewInterFreqCellList-v7b0ext,
NewInterFreqCellList-LCR-v8a0ext,
NewIntraFreqCellList-LCR-v8a0ext,
PrimaryCCPCH-RSCP,
SFN-Offset-Validity,
TimeslotListWithISCP,
TrafficVolumeMeasuredResultsList,
UE-Positioning-GPS-AssistanceData,
UE-Positioning-GPS-AssistanceData-v770ext,
UE-Positioning-GPS-ReferenceTimeUncertainty,
UE-Positioning-Measurement-v390ext,
UE-Positioning-OTDOA-AssistanceData,
UE-Positioning-OTDOA-AssistanceData-r4ext,
UE-Positioning-OTDOA-AssistanceData-UEB,
UE-Positioning-OTDOA-AssistanceData-UEB-ext,
UE-Positioning-OTDOA-MeasuredResultsTDD-ext,
UE-Positioning-GANSS-AssistanceData,
UE-Positioning-GANSS-AssistanceData-v860ext,
-- Other IEs :
  BCCH-ModificationInfo,
  CDMA2000-MessageList,
  ETWS-Information,
  ETWS-WarningSecurityInfo,
  GSM-TargetCellInfoList,
  GERANIu-MessageList,
  GERAN-SystemInformation,
  GSM-MessageList,
  InterRAT-ChangeFailureCause,
  InterRAT-HO-FailureCause,
  InterRAT-UE-RadioAccessCapabilityList,
  InterRAT-UE-RadioAccessCapability-v590ext,
  InterRAT-UE-SecurityCapList,
  IntraDomainNasNodeSelector,
  MIB-ValueTag,
  ProtocolErrorMoreInformation,
  Rplmn-Information,
  Rplmn-Information-r4,
  SegCount,
  SegmentIndex,
  SFN-Prime,
  SIB-Data-fixed,
  SIB-Data-variable,
  SIB-Type,
-- MBMS IEs:
  MBMS-CellGroupIdentity-r6,
  MBMS-CommonRBInformationList-r6,
  MBMS-CurrentCell-SCCPCHList-r6,
  MBMS-JoinedInformation-r6,
  MBMS-MICHConfigurationInfo-r6,
  MBMS-MICHConfigurationInfo-v770ext,
  MBMS-MICHConfigurationInfo-v890ext,
  MBMS-ModifiedServiceList-r6,
  MBMS-ModifiedServiceList-LCR-v7c0ext,
  MBMS-ModifiedServiceList-v770ext,
  MBMS-MSCH-ConfigurationInfo-r6,
  MBMS-NeighbouringCellSCCPCHList-r6,
  MBMS-NeighbouringCellSCCPCHList-v770ext,
  MBMS-NumberOfNeighbourCells-r6,
  MBMS-PhyChInformationList-r6,
  MBMS-PhyChInformationList-r7,
  MBMS-PhyChInformationList-IMB384,
  MBMS-PL-ServiceRestrictInfo-r6,
  MBMS-PreferredFrequencyList-r6,
  MBMS-PTMActivationTime-r6,
  MBMS-SelectedServiceInfo,
  MBMS-SelectedServicesShort,
  MBMS-ServiceAccessInfoList-r6,
  MBMS-ServiceIdentity-r6,
  MBMS-ServiceSchedulingInfoList-r6,
  MBMS-SIBType5-SCCPCHList-r6,
  MBMS-TimersAndCounters-r6,
  MBMS-TranspChInfoForEachCCTrCh-r6,
  MBMS-TranspChInfoForEachTrCh-r6,
  MBMS-UnmodifiedServiceList-r6,
  MBMS-UnmodifiedServiceList-v770ext,
  MBSFN-ClusterFrequency-r7,
  MBSFN-InterFrequencyNeighbourList-r7,
  MBSFN-InterFrequencyNeighbourList-v860ext,
  MBMS-NetworkStandardTimeInformation-LCR-v890ext,

```

```

MBSFN-TDDInformation-LCR,
MBSFN-TDM-Info-List
FROM InformationElements

maxSIBperMsg,
maxURNTI-Group
FROM Constant-definitions;

-- *****
--
-- ACTIVE SET UPDATE (FDD only)
--
-- *****

ActiveSetUpdate ::= CHOICE {
  r3
    SEQUENCE {
      activeSetUpdate-r3      ActiveSetUpdate-r3-IEs,
      laterNonCriticalExtensions SEQUENCE {
        -- Container for additional R99 extensions
        activeSetUpdate-r3-add-ext BIT STRING OPTIONAL,
        v4b0NonCriticalExtensions SEQUENCE {
          activeSetUpdate-v4b0ext ActiveSetUpdate-v4b0ext-IEs,
          v590NonCriticalExtensions SEQUENCE {
            activeSetUpdate-v590ext ActiveSetUpdate-v590ext-IEs,
            v690NonCriticalExtensions SEQUENCE {
              activeSetUpdate-v690ext ActiveSetUpdate-v690ext-IEs,
              nonCriticalExtensions SEQUENCE {} OPTIONAL
            } OPTIONAL
          } OPTIONAL
        } OPTIONAL
      } OPTIONAL
    },
  later-than-r3
    SEQUENCE {
      rrc-TransactionIdentifier RRC-TransactionIdentifier,
      criticalExtensions CHOICE {
        r6
          SEQUENCE {
            activeSetUpdate-r6      ActiveSetUpdate-r6-IEs,
            activeSetUpdate-r6-add-ext BIT STRING OPTIONAL,
            v6b0NonCriticalExtensions SEQUENCE {
              activeSetUpdate-v6b0ext ActiveSetUpdate-v6b0ext-IEs,
              nonCriticalExtensions SEQUENCE {} OPTIONAL
            } OPTIONAL
          },
        criticalExtensions CHOICE {
          r7
            SEQUENCE {
              activeSetUpdate-r7      ActiveSetUpdate-r7-IEs,
              activeSetUpdate-r7-add-ext BIT STRING OPTIONAL,
              v780NonCriticalExtensions SEQUENCE {
                activeSetUpdate-v780ext ActiveSetUpdate-v780ext-IEs,
                v7f0NonCriticalExtensions SEQUENCE {
                  activeSetUpdate-v7f0ext ActiveSetUpdate-v7f0ext-IEs,
                  v7g0NonCriticalExtensions SEQUENCE {
                    activeSetUpdate-v7g0ext ActiveSetUpdate-v7g0ext-IEs,
                    nonCriticalExtensions SEQUENCE {} OPTIONAL
                  } OPTIONAL
                } OPTIONAL
              } OPTIONAL
            } OPTIONAL
          },
        criticalExtensions CHOICE {
          r8
            SEQUENCE {
              activeSetUpdate-r8      ActiveSetUpdate-r8-IEs,
              -- Container for adding non critical extensions after freezing REL-9
              activeSetUpdate-r8-add-ext BIT STRING OPTIONAL,
              v890NonCriticalExtensions SEQUENCE {
                activeSetUpdate-v890ext ActiveSetUpdate-v890ext-IEs,
                v7g0NonCriticalExtensions SEQUENCE {
                  activeSetUpdate-v7g0ext ActiveSetUpdate-v7g0ext-IEs,
                  nonCriticalExtensions SEQUENCE {} OPTIONAL
                } OPTIONAL
              } OPTIONAL
            } OPTIONAL
          },
        criticalExtensions SEQUENCE {}
      }
    }
}

```

```

ActiveSetUpdate-r3-IEs ::= SEQUENCE {
  -- User equipment IES
  rrc-TransactionIdentifier      RRC-TransactionIdentifier,
  -- dummy and dummy2 are not used in this version of the specification, they should
  -- not be sent and if received they should be ignored.
  dummy                          IntegrityProtectionModeInfo      OPTIONAL,
  dummy2                         CipheringModeInfo              OPTIONAL,
  activationTime                 ActivationTime                  OPTIONAL,
  newU-RNTI                      U-RNTI                  OPTIONAL,
  -- Core network IES
  cn-InformationInfo             CN-InformationInfo      OPTIONAL,
  -- Radio bearer IES
  -- dummy3 is not used in this version of the specification, it should
  -- not be sent and if received it should be ignored.
  dummy3                         DL-CounterSynchronisationInfo  OPTIONAL,
  -- Physical channel IES
  maxAllowedUL-TX-Power         MaxAllowedUL-TX-Power      OPTIONAL,
  rl-AdditionInformationList     RL-AdditionInformationList  OPTIONAL,
  rl-RemovalInformationList     RL-RemovalInformationList  OPTIONAL,
  tx-DiversityMode              TX-DiversityMode           OPTIONAL,
  -- dummy4 is not used in this version of the specification, it should
  -- not be sent and if received it should be ignored.
  dummy4                         SSdT-Information          OPTIONAL
}

ActiveSetUpdate-v4b0ext-IEs ::= SEQUENCE {
  -- Physical channel IES
  -- dummy is not used in this version of the specification, it should
  -- not be sent and if received it should be ignored.
  dummy                          SSdT-UL                  OPTIONAL,
  -- The order of the RLs in IE cell-id-PerRL-List is the same as
  -- in IE RL-AdditionInformationList included in this message
  cell-id-PerRL-List             CellIdentity-PerRL-List    OPTIONAL
}

ActiveSetUpdate-v590ext-IEs ::= SEQUENCE {
  -- Physical channel IES
  dpc-Mode                       DPC-Mode,
  dl-TPC-PowerOffsetPerRL-List   DL-TPC-PowerOffsetPerRL-List  OPTIONAL
}

ActiveSetUpdate-v690ext-IEs ::= SEQUENCE {
  -- Core network IES
  primary-plmn-Identity           PLMN-Identity              OPTIONAL
}

ActiveSetUpdate-r6-IEs ::= SEQUENCE {
  -- User equipment IES
  activationTime                 ActivationTime              OPTIONAL,
  newU-RNTI                     U-RNTI                    OPTIONAL,
  newH-RNTI                     H-RNTI                    OPTIONAL,
  newPrimary-E-RNTI              E-RNTI                    OPTIONAL,
  newSecondary-E-RNTI            E-RNTI                    OPTIONAL,
  -- Core network IES
  cn-InformationInfo             CN-InformationInfo-r6     OPTIONAL,
  -- Physical channel IES
  maxAllowedUL-TX-Power         MaxAllowedUL-TX-Power      OPTIONAL,
  rl-AdditionInformationList     RL-AdditionInformationList-r6  OPTIONAL,
  rl-RemovalInformationList     RL-RemovalInformationList  OPTIONAL,
  tx-DiversityMode              TX-DiversityMode           OPTIONAL,
  dpc-Mode                       DPC-Mode                  OPTIONAL,
  serving-HSDSCH-CellInformation Serving-HSDSCH-CellInformation  OPTIONAL,
  e-dch-ReconfigurationInfo     E-DCH-ReconfigurationInfo  OPTIONAL
}

ActiveSetUpdate-v6b0ext-IEs ::= SEQUENCE {
  -- Physical channel IES
  rl-AdditionInformation-list-v6b0ext  RL-AdditionInformation-list-v6b0ext  OPTIONAL
}

ActiveSetUpdate-r7-IEs ::= SEQUENCE {
  -- User equipment IES
  activationTime                 ActivationTime              OPTIONAL,
  newU-RNTI                     U-RNTI                    OPTIONAL,
  newH-RNTI                     H-RNTI                    OPTIONAL,
  newPrimary-E-RNTI              E-RNTI                    OPTIONAL,
  newSecondary-E-RNTI            E-RNTI                    OPTIONAL,
  -- Core network IES

```

```

    cn-InformationInfo                CN-InformationInfo-r6                OPTIONAL,
-- Physical channel IEs
    dtx-drx-TimingInfo                DTX-DRX-TimingInfo-r7                OPTIONAL,
    dtx-drx-Info                       DTX-DRX-Info-r7                      OPTIONAL,
    hs-scch-LessInfo                  HS-SCCH-LessInfo-r7                  OPTIONAL,
    mimoParameters                     MIMO-Parameters-r7                  OPTIONAL,
    maxAllowedUL-TX-Power              MaxAllowedUL-TX-Power                OPTIONAL,
    rl-AdditionInformationList          RL-AdditionInformationList-r7        OPTIONAL,
    rl-RemovalInformationList           RL-RemovalInformationList            OPTIONAL,
    tx-DiversityMode                   TX-DiversityMode                     OPTIONAL,
    dpc-Mode                           DPC-Mode                             OPTIONAL,
    serving-HSDSCH-CellInformation      Serving-HSDSCH-CellInformation-r7    OPTIONAL,
    e-dch-ReconfigurationInfo          E-DCH-ReconfigurationInfo-r7        OPTIONAL,
    ul-16QAM-Config                    UL-16QAM-Config                      OPTIONAL,
    e-dch-ReconfInfoSameCell           E-DCH-RL-InfoSameServingCell        OPTIONAL,
    e-TFC-Boost-Info                   E-TFC-Boost-Info-r7                  OPTIONAL,
    e-DPDCH-PowerInterpolation         E-DPDCH-PowerInterpolation          OPTIONAL
}

ActiveSetUpdate-v780ext-IEs ::= SEQUENCE {
-- Physical channel IEs
    hs-DSCH-TBSizeTable                HS-DSCH-TBSizeTable                 OPTIONAL
}

ActiveSetUpdate-v7f0ext-IEs ::= SEQUENCE {
-- Physical channel IEs
    mimoParameters                     MIMO-Parameters-v7f0ext             OPTIONAL
}

ActiveSetUpdate-v7g0ext-IEs ::= SEQUENCE {
-- Physical channel IEs
    mimoParameters                     MIMO-Parameters-v7g0ext             OPTIONAL
}

ActiveSetUpdate-r8-IEs ::= SEQUENCE {
-- User equipment IEs
    activationTime                      ActivationTime                        OPTIONAL,
    newU-RNTI                           U-RNTI                              OPTIONAL,
    newH-RNTI                           H-RNTI                              OPTIONAL,
    newPrimary-E-RNTI                   E-RNTI                              OPTIONAL,
    newSecondary-E-RNTI                 E-RNTI                              OPTIONAL,
-- Core network IEs
    cn-InformationInfo                  CN-InformationInfo-r6                OPTIONAL,
-- Physical channel IEs
    dtx-drx-TimingInfo                DTX-DRX-TimingInfo-r7                OPTIONAL,
    dtx-drx-Info                       DTX-DRX-Info-r7                      OPTIONAL,
    hs-scch-LessInfo                  HS-SCCH-LessInfo-r7                  OPTIONAL,
    mimoParameters                     MIMO-Parameters-r8                  OPTIONAL,
    maxAllowedUL-TX-Power              MaxAllowedUL-TX-Power                OPTIONAL,
    rl-AdditionInformationList          RL-AdditionInformationList-r8        OPTIONAL,
    servingCellChangeParameters        ServingCellChangeParameters          OPTIONAL,
    rl-RemovalInformationList           RL-RemovalInformationList            OPTIONAL,
    tx-DiversityMode                   TX-DiversityMode                     OPTIONAL,
    dpc-Mode                           DPC-Mode                             OPTIONAL,
    serving-HSDSCH-CellInformation      Serving-HSDSCH-CellInformation-r8    OPTIONAL,
    e-dch-ReconfigurationInfo          E-DCH-ReconfigurationInfo-r7        OPTIONAL,
    ul-16QAM-Config                    UL-16QAM-Config                      OPTIONAL,
    e-dch-ReconfInfoSameCell           E-DCH-RL-InfoSameServingCell        OPTIONAL,
    e-TFC-Boost-Info                   E-TFC-Boost-Info-r7                  OPTIONAL,
    e-DPDCH-PowerInterpolation         E-DPDCH-PowerInterpolation          OPTIONAL,
    dl-SecondaryCellInfoFDD            DL-SecondaryCellInfoFDD              OPTIONAL
}

ActiveSetUpdate-v890ext-IEs ::= SEQUENCE {
-- User Equipment IEs
    dl-SecondaryCellInfoFDD-v890ext     DL-SecondaryCellInfoFDD-v890ext     OPTIONAL,
-- Physical channel IEs
    mimoParameters                     MIMO-Parameters-v7f0ext             OPTIONAL,
    rl-AdditionInformationList          RL-AdditionInformationList-v890ext   OPTIONAL
}

-- *****
--
-- ACTIVE SET UPDATE COMPLETE (FDD only)
--
-- *****

ActiveSetUpdateComplete ::= SEQUENCE {

```

```

-- User equipment IEs
rrc-TransactionIdentifier      RRC-TransactionIdentifier,
-- dummy is not used in this version of the specification, it should
-- not be sent and if received it should be ignored.
dummy                          IntegrityProtActivationInfo          OPTIONAL,
-- Radio bearer IEs
-- dummy2 and dummy3 are not used in this version of the specification, they should
-- not be sent and if received they should be ignored.
dummy2                          RB-ActivationTimeInfoList          OPTIONAL,
dummy3                          UL-CounterSynchronisationInfo      OPTIONAL,
laterNonCriticalExtensions      SEQUENCE {
  -- Container for additional R99 extensions
  activeSetUpdateComplete-r3-add-ext  BIT STRING          OPTIONAL,
  nonCriticalExtensions              SEQUENCE {} OPTIONAL
}
}

-- *****
--
-- ACTIVE SET UPDATE FAILURE (FDD only)
--
-- *****

ActiveSetUpdateFailure ::= SEQUENCE {
  -- User equipment IEs
  rrc-TransactionIdentifier      RRC-TransactionIdentifier,
  failureCause                   FailureCauseWithProtErr,
  laterNonCriticalExtensions      SEQUENCE {
    -- Container for additional R99 extensions
    activeSetUpdateFailure-r3-add-ext  BIT STRING          OPTIONAL,
    nonCriticalExtensions              SEQUENCE {} OPTIONAL
  } OPTIONAL
}

-- *****
--
-- ASSISTANCE DATA DELIVERY--
-- *****

AssistanceDataDelivery ::= CHOICE {
  r3                             SEQUENCE {
    assistanceDataDelivery-r3      AssistanceDataDelivery-r3-IEs,
    v3a0NonCriticalExtensions      SEQUENCE {
      assistanceDataDelivery-v3a0ext AssistanceDataDelivery-v3a0ext,
      laterNonCriticalExtensions    SEQUENCE {
        -- Container for additional R99 extensions
        assistanceDataDelivery-r3-add-ext  BIT STRING          OPTIONAL,
        v4b0NonCriticalExtensions        SEQUENCE {
          assistanceDataDelivery-v4b0ext AssistanceDataDelivery-v4b0ext-IEs,
          v770NonCriticalExtension        SEQUENCE {
            assistanceDataDelivery-v770ext AssistanceDataDelivery-v770ext-IEs,
            v860NonCriticalExtension      SEQUENCE {
              assistanceDataDelivery-v860ext AssistanceDataDelivery-v860ext-IEs,
              nonCriticalExtensions        SEQUENCE {}          OPTIONAL
            } OPTIONAL
          } OPTIONAL
        } OPTIONAL
      } OPTIONAL
    } OPTIONAL
  },
  later-than-r3                   SEQUENCE {
    rrc-TransactionIdentifier      RRC-TransactionIdentifier,
    criticalExtensions              SEQUENCE {}
  }
}

AssistanceDataDelivery-r3-IEs ::= SEQUENCE {
  -- User equipment IEs
  rrc-TransactionIdentifier      RRC-TransactionIdentifier,
  -- Measurement Information Elements
  ue-positioning-GPS-AssistanceData  UE-Positioning-GPS-AssistanceData          OPTIONAL,
  ue-positioning-OTDOA-AssistanceData-UEB  UE-Positioning-OTDOA-AssistanceData-UEB  OPTIONAL
}

AssistanceDataDelivery-v3a0ext ::= SEQUENCE {
  sfn-Offset-Validity             SFN-Offset-Validity          OPTIONAL
}

```

```

AssistanceDataDelivery-v4b0ext-IEs ::= SEQUENCE {
  ue-Positioning-OTDOA-AssistanceData-r4ext  UE-Positioning-OTDOA-AssistanceData-r4ext  OPTIONAL
}

AssistanceDataDelivery-v770ext-IEs ::= SEQUENCE {
  ue-Positioning-OTDOA-AssistanceData-UEB-ext  UE-Positioning-OTDOA-AssistanceData-UEB-ext  OPTIONAL,
  ue-Positioning-GPS-AssistanceData  UE-Positioning-GPS-AssistanceData-v770ext  OPTIONAL,
  ue-positioning-GANSS-AssistanceData  UE-Positioning-GANSS-AssistanceData  OPTIONAL
}

AssistanceDataDelivery-v860ext-IEs ::= SEQUENCE {
  ue-positioning-GANSS-AssistanceData-v860ext  UE-Positioning-GANSS-AssistanceData-v860ext  OPTIONAL
}

-- *****
--
-- CELL CHANGE ORDER FROM UTRAN
--
-- *****

CellChangeOrderFromUTRAN ::= CHOICE {
  r3  SEQUENCE {
    cellChangeOrderFromUTRAN-IEs  CellChangeOrderFromUTRAN-r3-IEs,
    laterNonCriticalExtensions  SEQUENCE {
      -- Container for additional R99 extensions
      cellChangeOrderFromUTRAN-r3-add-ext  BIT STRING  OPTIONAL,
      v590NonCriticalExtensions  SEQUENCE {
        cellChangeOrderFromUTRAN-v590ext  CellChangeOrderFromUTRAN-v590ext-IEs,
        nonCriticalExtensions  SEQUENCE {} OPTIONAL
      } OPTIONAL
    } OPTIONAL
  },
  later-than-r3  SEQUENCE {
    rrc-TransactionIdentifier  RRC-TransactionIdentifier,
    criticalExtensions  SEQUENCE {}
  }
}

CellChangeOrderFromUTRAN-r3-IEs ::= SEQUENCE {
  -- User equipment IEs
  rrc-TransactionIdentifier  RRC-TransactionIdentifier,
  -- dummy is not used in this version of the specification, it should
  -- not be sent and if received it should be ignored.
  dummy  IntegrityProtectionModeInfo  OPTIONAL,
  activationTime  ActivationTime  OPTIONAL,
  -- the IE rab-InformationList is not used in this version of the specification, it should
  -- not be sent and if received it should be ignored. The IE may be used in a later
  -- version of the protocol and hence it is not changed into a dummy
  rab-InformationList  RAB-InformationList  OPTIONAL,
  interRAT-TargetCellDescription  InterRAT-TargetCellDescription
}

CellChangeOrderFromUTRAN-v590ext-IEs ::= SEQUENCE {
  geran-SystemInfoType  CHOICE {
    sI  GERAN-SystemInformation,
    pSI  GERAN-SystemInformation
  }  OPTIONAL
}

-- *****
--
-- CELL CHANGE ORDER FROM UTRAN FAILURE
--
-- *****

CellChangeOrderFromUTRANFailure ::= CHOICE {
  r3  SEQUENCE {
    cellChangeOrderFromUTRANFailure-r3
  },
  laterNonCriticalExtensions  SEQUENCE {
    -- Container for additional R99 extensions
    cellChangeOrderFromUTRANFailure-r3-add-ext  BIT STRING  OPTIONAL,
    nonCriticalExtensions  SEQUENCE {} OPTIONAL
  }  OPTIONAL
},
-- dummy is not used in this version of the specification and it

```

```

-- should be ignored.
dummy          SEQUENCE {
  rrc-TransactionIdentifier  RRC-TransactionIdentifier,
  criticalExtensions         SEQUENCE {}
}
}

CellChangeOrderFromUTRANFailure-r3-IEs ::= SEQUENCE {
  -- User equipment IEs
  rrc-TransactionIdentifier  RRC-TransactionIdentifier,
  -- dummy is not used in this version of the specification, it should
  -- not be sent and if received it should be ignored.
  dummy                    IntegrityProtectionModeInfo      OPTIONAL,
  interRAT-ChangeFailureCause  InterRAT-ChangeFailureCause
}

-- *****
--
-- CELL UPDATE
--
-- *****

CellUpdate ::= SEQUENCE {
  -- User equipment IEs
  u-RNTI                U-RNTI,
  startList             STARTList,
  am-RLC-ErrorIndicationRb2-3or4  BOOLEAN,
  am-RLC-ErrorIndicationRb5orAbove  BOOLEAN,
  cellUpdateCause      CellUpdateCause,
  -- TABULAR: RRC transaction identifier is nested in FailureCauseWithProtErrTrId
  failureCause         FailureCauseWithProtErrTrId      OPTIONAL,
  rb-timer-indicator   Rb-timer-indicator,
  -- Measurement IEs
  measuredResultsOnRACH  MeasuredResultsOnRACH          OPTIONAL,
  laterNonCriticalExtensions  SEQUENCE {
    -- Container for additional R99 extensions
    -- The cellUpdate-r3-add-ext can be omitted if its inclusion would result in the
    -- size of the message exceeding the maximum PDU size possible for CCCH
    -- transmission
    cellUpdate-r3-add-ext  BIT STRING
                          (CONTAINING CellUpdate-r3-add-ext-IEs)  OPTIONAL,
    v590NonCriticalExtensions  SEQUENCE {
      cellUpdate-v590ext  CellUpdate-v590ext,
      v690NonCriticalExtensions  SEQUENCE {
        cellUpdate-v690ext  CellUpdate-v690ext-IEs,
        v6b0NonCriticalExtensions  SEQUENCE {
          cellUpdate-v6b0ext  CellUpdate-v6b0ext-IEs,
          v770NonCriticalExtensions  SEQUENCE {
            cellUpdate-v770ext  CellUpdate-v770ext-IEs,
            v860NonCriticalExtensions  SEQUENCE {
              cellUpdate-v860ext  CellUpdate-v860ext-IEs,
              nonCriticalExtensions  SEQUENCE {} OPTIONAL
            } OPTIONAL
          } OPTIONAL
        } OPTIONAL
      } OPTIONAL
    } OPTIONAL
  } OPTIONAL
}

CellUpdate-r3-add-ext-IEs ::= SEQUENCE {
  cellUpdate-v7e0ext  CellUpdate-v7e0ext-IEs,
  v7g0NonCriticalExtensions  SEQUENCE {
    cellUpdate-v7g0ext  CellUpdate-v7g0ext-IEs,
    nonCriticalExtensions  SEQUENCE {} OPTIONAL
  } OPTIONAL
}

CellUpdate-v590ext ::= SEQUENCE {
  establishmentCause  EstablishmentCause  OPTIONAL
}

CellUpdate-v690ext-IEs ::= SEQUENCE {
  -- User equipment IEs
  cellUpdateCause-ext  CellUpdateCause-ext      OPTIONAL,
  trafficVolumeIndicator  ENUMERATED { true }  OPTIONAL,
  -- Measurement IEs
  measuredResultsOnRACHinterFreq  MeasuredResultsOnRACHinterFreq  OPTIONAL,

```



```

        reconfigurationStatusIndicator ENUMERATED { true } OPTIONAL
    }
CellUpdate-v6b0ext-IEs ::= SEQUENCE {
    -- MBMS IEs
    -- The mbmsSelectedServices can be omitted if its inclusion would result in the
    -- size of the message exceeding the maximum PDU size possible for CCCH transmission
    mbmsSelectedServices MBMS-SelectedServicesShort OPTIONAL
}
CellUpdate-v770ext-IEs ::= SEQUENCE {
    -- User equipment IEs
    csCallType ENUMERATED { speech, video, other, spare } OPTIONAL,
    hspdschReception-CellFach ENUMERATED { true } OPTIONAL,
    ueMobilityStateIndicator HIGH-MobilityDetected OPTIONAL,
    capabilityChangeIndicator ENUMERATED { true } OPTIONAL
}
CellUpdate-v7e0ext-IEs ::= SEQUENCE {
    -- User equipment IEs
    supportForTwoDRXSchemesInPCH ENUMERATED { true } OPTIONAL
}
CellUpdate-v7g0ext-IEs ::= SEQUENCE {
    -- Measurement IEs
    measuredResultsOnRACH-v7g0ext MeasuredResultsOnRACH-v7g0ext OPTIONAL
}
CellUpdate-v860ext-IEs ::= SEQUENCE {
    -- User equipment IEs
    supportOfCommonEDCH ENUMERATED { true } OPTIONAL,
    supportOfHS-DSCHDRXOperation ENUMERATED { true } OPTIONAL,
    supportOfMACiis ENUMERATED { true } OPTIONAL,
    supportOfSPSOperation ENUMERATED { true } OPTIONAL,
    supportOfControlChannelDRXOperation ENUMERATED { true } OPTIONAL
}
-- *****
--
-- CELL UPDATE CONFIRM
--
-- *****

CellUpdateConfirm ::= CHOICE {
    r3 SEQUENCE {
        cellUpdateConfirm-r3 CellUpdateConfirm-r3-IEs,
        v3a0NonCriticalExtensions SEQUENCE {
            cellUpdateConfirm-v3a0ext CellUpdateConfirm-v3a0ext,
            laterNonCriticalExtensions SEQUENCE {
                -- Container for additional R99 extensions
                cellUpdateConfirm-r3-add-ext BIT STRING OPTIONAL,
                v4b0NonCriticalExtensions SEQUENCE {
                    cellUpdateConfirm-v4b0ext CellUpdateConfirm-v4b0ext-IEs,
                    v590NonCriticalExtensions SEQUENCE {
                        cellUpdateConfirm-v590ext CellUpdateConfirm-v590ext-IEs,
                        v5d0NonCriticalExtensions SEQUENCE {
                            cellUpdateConfirm-v5d0ext CellUpdateConfirm-v5d0ext-IEs,
                            v690NonCriticalExtensions SEQUENCE {
                                cellUpdateConfirm-v690ext CellUpdateConfirm-v690ext-IEs,
                                nonCriticalExtensions SEQUENCE {} OPTIONAL
                            }
                        } OPTIONAL
                    }
                } OPTIONAL
            } OPTIONAL
        } OPTIONAL
    } OPTIONAL
},
    later-than-r3 SEQUENCE {
        rrc-TransactionIdentifier RRC-TransactionIdentifier,
        criticalExtensions CHOICE {
            r4 SEQUENCE {
                cellUpdateConfirm-r4 CellUpdateConfirm-r4-IEs,
                v4d0NonCriticalExtensions SEQUENCE {
                    -- Container for adding non critical extensions after freezing REL-5
                    cellUpdateConfirm-r4-add-ext BIT STRING OPTIONAL,
                    v590NonCriticalExtensions SEQUENCE {
                        cellUpdateConfirm-v590ext CellUpdateConfirm-v590ext-IEs,
                    }
                }
            }
        }
    }
}

```

```

    v5d0NonCriticalExtensstions SEQUENCE {
        cellUpdateConfirm-v5d0ext CellUpdateConfirm-v5d0ext-IEs,
        v690NonCriticalExtensions SEQUENCE {
            cellUpdateConfirm-v690ext CellUpdateConfirm-v690ext-IEs,
            nonCriticalExtensions SEQUENCE {} OPTIONAL
        } OPTIONAL
    } OPTIONAL
},
criticalExtensions CHOICE {
    r5 SEQUENCE {
        cellUpdateConfirm-r5 CellUpdateConfirm-r5-IEs,
        -- Container for adding non critical extensions after freezing REL-6
        cellUpdateConfirm-r5-add-ext BIT STRING OPTIONAL,
        v5d0NonCriticalExtensstions SEQUENCE {
            cellUpdateConfirm-v5d0ext CellUpdateConfirm-v5d0ext-IEs,
            v690NonCriticalExtensions SEQUENCE {
                cellUpdateConfirm-v690ext CellUpdateConfirm-v690ext-IEs,
                nonCriticalExtensions SEQUENCE {} OPTIONAL
            } OPTIONAL
        } OPTIONAL
    },
    criticalExtensions CHOICE {
        r6 SEQUENCE {
            cellUpdateConfirm-r6 CellUpdateConfirm-r6-IEs,
            -- Container for adding non critical extensions after freezing REL-7
            cellUpdateConfirm-r6-add-ext BIT STRING OPTIONAL,
            v6b0NonCriticalExtensions SEQUENCE {
                cellUpdateConfirm-v6b0ext CellUpdateConfirm-v6b0ext-IEs,
                nonCriticalExtensions SEQUENCE {} OPTIONAL
            } OPTIONAL
        },
        criticalExtensions CHOICE {
            r7 SEQUENCE {
                cellUpdateConfirm-r7 CellUpdateConfirm-r7-IEs,
                -- Container for adding non critical extensions after freezing REL-8
                cellUpdateConfirm-r7-add-ext BIT STRING
                    (CONTAINING CellUpdateConfirm-r7-add-ext-IEs) OPTIONAL,
                v780NonCriticalExtensions SEQUENCE {
                    cellUpdateConfirm-v780ext CellUpdateConfirm-v780ext-IEs,
                    v860NonCriticalExtensions SEQUENCE {
                        cellUpdateConfirm-v860ext CellUpdateConfirm-v860ext-IEs,
                        nonCriticalExtensions SEQUENCE {} OPTIONAL
                    } OPTIONAL
                } OPTIONAL
            },
            criticalExtensions CHOICE {
                r8 SEQUENCE {
                    cellUpdateConfirm-r8 CellUpdateConfirm-r8-IEs,
                    -- Container for adding non critical extensions after freezing REL-9
                    cellUpdateConfirm-r8-add-ext BIT STRING OPTIONAL,
                    v7d0NonCriticalExtensions SEQUENCE {
                        cellUpdateConfirm-v7d0ext CellUpdateConfirm-v7d0ext-IEs,
                        v7f0NonCriticalExtensions SEQUENCE {
                            cellUpdateConfirm-v7f0ext CellUpdateConfirm-v7f0ext-IEs,
                            v890NonCriticalExtensions SEQUENCE {
                                cellUpdateConfirm-v890ext
                                    CellUpdateConfirm-v890ext-IEs,
                                v7g0NonCriticalExtensions SEQUENCE {
                                    cellUpdateConfirm-v7g0ext
                                        CellUpdateConfirm-v7g0ext-IEs,
                                    v8a0NonCriticalExtensions SEQUENCE {
                                        cellUpdateConfirm-v8a0ext
                                            CellUpdateConfirm-v8a0ext-IEs,
                                        nonCriticalExtensions SEQUENCE {}
                                    }
                                }
                            } OPTIONAL
                        } OPTIONAL
                    } OPTIONAL
                } OPTIONAL
            },
            criticalExtensions SEQUENCE {}
        }
    }
}
OPTIONAL
    }
}
}
}
}

```

```

    }
  }
}

CellUpdateConfirm-r3-IEs ::= SEQUENCE {
  -- User equipment IES
  rrc-TransactionIdentifier      RRC-TransactionIdentifier,
  integrityProtectionModeInfo    IntegrityProtectionModeInfo      OPTIONAL,
  cipheringModeInfo              CipheringModeInfo                  OPTIONAL,
  activationTime                  ActivationTime                    OPTIONAL,
  new-U-RNTI                      U-RNTI                          OPTIONAL,
  new-C-RNTI                      C-RNTI                          OPTIONAL,
  rrc-StateIndicator              RRC-StateIndicator,
  utran-DRX-CycleLengthCoeff      UTRAN-DRX-CycleLengthCoefficient  OPTIONAL,
  rlc-Re-establishIndicatorRb2-3or4  BOOLEAN,
  rlc-Re-establishIndicatorRb5orAbove  BOOLEAN,
  -- CN information elements
  cn-InformationInfo              CN-InformationInfo              OPTIONAL,
  -- UTRAN mobility IES
  ura-Identity                    URA-Identity                    OPTIONAL,
  -- Radio bearer IES
  rb-InformationReleaseList        RB-InformationReleaseList        OPTIONAL,
  rb-InformationReconfigList       RB-InformationReconfigList       OPTIONAL,
  rb-InformationAffectedList        RB-InformationAffectedList        OPTIONAL,
  dl-CounterSynchronisationInfo    DL-CounterSynchronisationInfo    OPTIONAL,
  -- Transport channel IES
  ul-CommonTransChInfo            UL-CommonTransChInfo            OPTIONAL,
  ul-deletedTransChInfoList        UL-DeletedTransChInfoList        OPTIONAL,
  ul-AddReconfTransChInfoList      UL-AddReconfTransChInfoList      OPTIONAL,
  modeSpecificTransChInfo          CHOICE {
    fdd                            SEQUENCE {
      -- dummy and dummy2 are not used in this version of the specification, they should
      -- not be sent and if received they should be ignored.
      dummy                        CPCH-SetID                      OPTIONAL,
      dummy2                       DRAC-StaticInformationList  OPTIONAL
    },
    tdd                            NULL
  },
  dl-CommonTransChInfo            DL-CommonTransChInfo            OPTIONAL,
  dl-DeletedTransChInfoList        DL-DeletedTransChInfoList        OPTIONAL,
  dl-AddReconfTransChInfoList      DL-AddReconfTransChInfoList      OPTIONAL,
  -- Physical channel IES
  frequencyInfo                   FrequencyInfo                    OPTIONAL,
  maxAllowedUL-TX-Power            MaxAllowedUL-TX-Power            OPTIONAL,
  ul-ChannelRequirement            UL-ChannelRequirement            OPTIONAL,
  modeSpecificPhysChInfo           CHOICE {
    fdd                            SEQUENCE {
      -- dummy is not used in this version of specification, it should
      -- not be sent and if received it should be ignored.
      dummy                        DL-PDSCH-Information            OPTIONAL
    },
    tdd                            NULL
  },
  dl-CommonInformation            DL-CommonInformation            OPTIONAL,
  dl-InformationPerRL-List         DL-InformationPerRL-List         OPTIONAL
}

CellUpdateConfirm-v3a0ext ::= SEQUENCE {
  -- The IE "new-DSCH-RNTI" should not be included in FDD mode, and if received the UE behaviour
  -- is unspecified
  new-DSCH-RNTI                   DSCH-RNTI                        OPTIONAL
}

CellUpdateConfirm-v4b0ext-IEs ::= SEQUENCE {
  -- Physical channel IES
  -- dummy is not used in this version of the specification, it should
  -- not be sent and if received it should be ignored.
  dummy                            SSdT-UL                            OPTIONAL,
  -- The order of the RLs in IE cell-id-PerRL-List is the same as
  -- in IE DL-InformationPerRL-List included in this message
  cell-id-PerRL-List               CellIdentity-PerRL-List           OPTIONAL
}

CellUpdateConfirm-v590ext-IEs ::= SEQUENCE {
  -- Physical channel IES
  dl-TPC-PowerOffsetPerRL-List     DL-TPC-PowerOffsetPerRL-List     OPTIONAL
}

```

```

CellUpdateConfirm-v5d0ext-IEs ::= SEQUENCE {
  --Radio Bearer IEs
  pdcp-ROHC-TargetMode          PDCP-ROHC-TargetMode          OPTIONAL
}
CellUpdateConfirm-r4-IEs ::= SEQUENCE {
  -- User equipment IEs
  integrityProtectionModeInfo    IntegrityProtectionModeInfo    OPTIONAL,
  cipheringModeInfo              CipheringModeInfo                OPTIONAL,
  activationTime                  ActivationTime                    OPTIONAL,
  new-U-RNTI                      U-RNTI                          OPTIONAL,
  new-C-RNTI                      C-RNTI                          OPTIONAL,
  -- The IE "new-DSCH-RNTI" should not be included in FDD mode, and if received
  -- the UE behaviour is unspecified
  new-DSCH-RNTI                  DSCH-RNTI                        OPTIONAL,
  rrc-StateIndicator              RRC-StateIndicator,
  utran-DRX-CycleLengthCoeff      UTRAN-DRX-CycleLengthCoefficient  OPTIONAL,
  rlc-Re-establishIndicatorRb2-3or4  BOOLEAN,
  rlc-Re-establishIndicatorRb5orAbove  BOOLEAN,
  -- CN information elements
  cn-InformationInfo              CN-InformationInfo                OPTIONAL,
  -- UTRAN mobility IEs
  ura-Identity                    URA-Identity                      OPTIONAL,
  -- Radio bearer IEs
  rb-InformationReleaseList        RB-InformationReleaseList         OPTIONAL,
  rb-InformationReconfigList       RB-InformationReconfigList-r4     OPTIONAL,
  rb-InformationAffectedList       RB-InformationAffectedList        OPTIONAL,
  dl-CounterSynchronisationInfo    DL-CounterSynchronisationInfo    OPTIONAL,
  -- Transport channel IEs
  ul-CommonTransChInfo            UL-CommonTransChInfo-r4          OPTIONAL,
  ul-deletedTransChInfoList        UL-DeletedTransChInfoList        OPTIONAL,
  ul-AddReconfTransChInfoList      UL-AddReconfTransChInfoList      OPTIONAL,
  modeSpecificTransChInfo          CHOICE {
    fdd                            SEQUENCE {
      -- dummy and dummy2 are not used in this version of the specification, they should
      -- not be sent and if received they should be ignored.
      dummy                        CPCH-SetID                        OPTIONAL,
      dummy2                       DRAC-StaticInformationList        OPTIONAL
    },
    tdd                            NULL
  },
  dl-CommonTransChInfo            DL-CommonTransChInfo-r4          OPTIONAL,
  dl-DeletedTransChInfoList        DL-DeletedTransChInfoList        OPTIONAL,
  dl-AddReconfTransChInfoList      DL-AddReconfTransChInfoList-r4   OPTIONAL,
  -- Physical channel IEs
  frequencyInfo                    FrequencyInfo                      OPTIONAL,
  maxAllowedUL-TX-Power            MaxAllowedUL-TX-Power             OPTIONAL,
  ul-ChannelRequirement            UL-ChannelRequirement-r4         OPTIONAL,
  modeSpecificPhysChInfo           CHOICE {
    fdd                            SEQUENCE {
      -- dummy is not used in this version of specification, it should
      -- not be sent and if received it should be ignored.
      dummy                        DL-PDSCH-Information              OPTIONAL
    },
    tdd                            NULL
  },
  dl-CommonInformation             DL-CommonInformation-r4          OPTIONAL,
  dl-InformationPerRL-List         DL-InformationPerRL-List-r4     OPTIONAL
}

CellUpdateConfirm-r5-IEs ::= SEQUENCE {
  -- User equipment IEs
  integrityProtectionModeInfo    IntegrityProtectionModeInfo    OPTIONAL,
  cipheringModeInfo              CipheringModeInfo                OPTIONAL,
  activationTime                  ActivationTime                    OPTIONAL,
  new-U-RNTI                      U-RNTI                          OPTIONAL,
  new-C-RNTI                      C-RNTI                          OPTIONAL,
  -- The IE "new-DSCH-RNTI" should not be included in FDD mode, and if received
  -- the UE behaviour is unspecified
  new-DSCH-RNTI                  DSCH-RNTI                        OPTIONAL,
  new-H-RNTI                      H-RNTI                          OPTIONAL,
  rrc-StateIndicator              RRC-StateIndicator,
  utran-DRX-CycleLengthCoeff      UTRAN-DRX-CycleLengthCoefficient  OPTIONAL,
  rlc-Re-establishIndicatorRb2-3or4  BOOLEAN,
  rlc-Re-establishIndicatorRb5orAbove  BOOLEAN,
  -- CN information elements
  cn-InformationInfo              CN-InformationInfo                OPTIONAL,
  -- UTRAN mobility IEs
  ura-Identity                    URA-Identity                      OPTIONAL,

```

```

-- Radio bearer IEs
  rb-InformationReleaseList      RB-InformationReleaseList      OPTIONAL,
  rb-InformationReconfigList     RB-InformationReconfigList-r5     OPTIONAL,
  rb-InformationAffectedList     RB-InformationAffectedList-r5     OPTIONAL,
  dl-CounterSynchronisationInfo DL-CounterSynchronisationInfo-r5  OPTIONAL,
-- Transport channel IEs
  ul-CommonTransChInfo          UL-CommonTransChInfo-r4          OPTIONAL,
  ul-deletedTransChInfoList     UL-DeletedTransChInfoList        OPTIONAL,
  ul-AddReconfTransChInfoList   UL-AddReconfTransChInfoList      OPTIONAL,
  modeSpecificTransChInfo       CHOICE {
    fdd                          SEQUENCE {
      -- dummy and dummy2 are not used in this version of the specification, they should
      -- not be sent and if received they should be ignored.
      dummy                      CPCH-SetID                        OPTIONAL,
      dummy2                    DRAC-StaticInformationList  OPTIONAL
    },
    tdd                          NULL
  },
  dl-CommonTransChInfo          DL-CommonTransChInfo-r4          OPTIONAL,
  dl-DeletedTransChInfoList     DL-DeletedTransChInfoList-r5     OPTIONAL,
  dl-AddReconfTransChInfoList   DL-AddReconfTransChInfoList-r5   OPTIONAL,
-- Physical channel IEs
  frequencyInfo                 FrequencyInfo                     OPTIONAL,
  maxAllowedUL-TX-Power         MaxAllowedUL-TX-Power            OPTIONAL,
  ul-ChannelRequirement         UL-ChannelRequirement-r5         OPTIONAL,
  modeSpecificPhysChInfo        CHOICE {
    fdd                          SEQUENCE {
      -- dummy is not used in this version of specification, it should
      -- not be sent and if received it should be ignored.
      dummy                      DL-PDSCH-Information            OPTIONAL
    },
    tdd                          NULL
  },
  dl-HSPDSCH-Information        DL-HSPDSCH-Information           OPTIONAL,
  dl-CommonInformation          DL-CommonInformation-r5          OPTIONAL,
  dl-InformationPerRL-List      DL-InformationPerRL-List-r5      OPTIONAL
}

```

```

CellUpdateConfirm-r6-IEs ::= SEQUENCE {
-- User equipment IEs
  integrityProtectionModeInfo   IntegrityProtectionModeInfo      OPTIONAL,
  cipheringModeInfo             CipheringModeInfo                 OPTIONAL,
  activationTime                 ActivationTime                     OPTIONAL,
  new-U-RNTI                     U-RNTI                           OPTIONAL,
  new-C-RNTI                     C-RNTI                           OPTIONAL,
  -- The IE "new-DSCH-RNTI" should not be included in FDD mode,
  -- and if received the UE behaviour is unspecified
  new-DSCH-RNTI                 DSCH-RNTI                         OPTIONAL,
  new-H-RNTI                     H-RNTI                           OPTIONAL,
  newPrimary-E-RNTI              E-RNTI                           OPTIONAL,
  newSecondary-E-RNTI            E-RNTI                           OPTIONAL,
  rrc-StateIndicator             RRC-StateIndicator,
  utran-DRX-CycleLengthCoeff     UTRAN-DRX-CycleLengthCoefficient  OPTIONAL,
  rlc-Re-establishIndicatorRb2-3or4  BOOLEAN,
  rlc-Re-establishIndicatorRb5orAbove  BOOLEAN,
-- CN information elements
  cn-InformationInfo             CN-InformationInfo-r6            OPTIONAL,
-- UTRAN mobility IEs
  ura-Identity                   URA-Identity                     OPTIONAL,
-- Radio bearer IEs
  rb-InformationReleaseList      RB-InformationReleaseList        OPTIONAL,
  rb-InformationReconfigList     RB-InformationReconfigList-r6    OPTIONAL,
  rb-InformationAffectedList     RB-InformationAffectedList-r6    OPTIONAL,
  dl-CounterSynchronisationInfo DL-CounterSynchronisationInfo-r5  OPTIONAL,
  pdcp-ROHC-TargetMode          PDCP-ROHC-TargetMode            OPTIONAL,
-- Transport channel IEs
  ul-CommonTransChInfo          UL-CommonTransChInfo-r4          OPTIONAL,
  ul-deletedTransChInfoList     UL-DeletedTransChInfoList-r6    OPTIONAL,
  ul-AddReconfTransChInfoList   UL-AddReconfTransChInfoList-r6  OPTIONAL,
  dl-CommonTransChInfo          DL-CommonTransChInfo-r4          OPTIONAL,
  dl-DeletedTransChInfoList     DL-DeletedTransChInfoList-r5    OPTIONAL,
  dl-AddReconfTransChInfoList   DL-AddReconfTransChInfoList-r5  OPTIONAL,
-- Physical channel IEs
  frequencyInfo                 FrequencyInfo                     OPTIONAL,
  maxAllowedUL-TX-Power         MaxAllowedUL-TX-Power            OPTIONAL,
  ul-DPCH-Info                  UL-DPCH-Info-r6                 OPTIONAL,
  ul-EDCH-Information            UL-EDCH-Information-r6           OPTIONAL,
  dl-HSPDSCH-Information        DL-HSPDSCH-Information-r6        OPTIONAL,

```

```

        dl-CommonInformation          DL-CommonInformation-r6          OPTIONAL,
        dl-InformationPerRL-List      DL-InformationPerRL-List-r6    OPTIONAL,
    -- MBMS IEs
        mbms-PL-ServiceRestrictInfo  MBMS-PL-ServiceRestrictInfo-r6  OPTIONAL
    }

CellUpdateConfirm-v690ext-IEs ::= SEQUENCE {
    -- Core network IEs
        primary-plmn-Identity          PLMN-Identity                OPTIONAL,
    -- Physical channel IEs
        -- The IE harq-Preamble-Mode should not be used in the r3 and r4 versions of the message
        -- If included in the r3 or r4 version of the message, the UE should ignore the IE
        harq-Preamble-Mode             HARQ-Preamble-Mode           OPTIONAL,
        beaconPLEst                    BEACON-PL-Est                OPTIONAL,
        postVerificationPeriod          ENUMERATED { true }          OPTIONAL,
        dhs-sync                        DHS-Sync                      OPTIONAL,
    -- MBMS IEs
        mbms-PL-ServiceRestrictInfo  MBMS-PL-ServiceRestrictInfo-r6  OPTIONAL
    }

CellUpdateConfirm-v6b0ext-IEs ::= SEQUENCE {
    -- Physical channel IEs
        dl-InformationPerRL-List-v6b0ext  DL-InformationPerRL-List-v6b0ext  OPTIONAL
    }

CellUpdateConfirm-r7-IEs ::= SEQUENCE {
    -- User equipment IEs
        integrityProtectionModeInfo     IntegrityProtectionModeInfo-r7    OPTIONAL,
        cipheringModeInfo               CipheringModeInfo-r7              OPTIONAL,
        activationTime                  ActivationTime                     OPTIONAL,
        new-U-RNTI                      U-RNTI                           OPTIONAL,
        new-C-RNTI                      C-RNTI                           OPTIONAL,
        -- The IE "new-DSCH-RNTI" should not be included in FDD mode,
        -- and if received the UE behaviour is unspecified
        new-DSCH-RNTI                  DSCH-RNTI                       OPTIONAL,
        new-H-RNTI                      H-RNTI                           OPTIONAL,
        newPrimary-E-RNTI               E-RNTI                           OPTIONAL,
        newSecondary-E-RNTI             E-RNTI                           OPTIONAL,
        rrc-StateIndicator              RRC-StateIndicator,
        utran-DRX-CycleLengthCoeff      UTRAN-DRX-CycleLengthCoefficient-r7  OPTIONAL,
        waitTime                        WaitTime                          OPTIONAL,
        rlc-Re-establishIndicatorRb2-3or4  BOOLEAN,
        rlc-Re-establishIndicatorRb5orAbove  BOOLEAN,
    -- CN information elements
        cn-InformationInfo              CN-InformationInfo-r6            OPTIONAL,
    -- UTRAN mobility IEs
        ura-Identity                    URA-Identity                    OPTIONAL,
        supportForChangeOfUE-Capability  BOOLEAN                          OPTIONAL,
    -- Radio bearer IEs
        rb-InformationReleaseList       RB-InformationReleaseList        OPTIONAL,
        rb-InformationReconfigList      RB-InformationReconfigList-r7    OPTIONAL,
        rb-InformationAffectedList      RB-InformationAffectedList-r7    OPTIONAL,
        dl-CounterSynchronisationInfo   DL-CounterSynchronisationInfo-r5  OPTIONAL,
        pdcp-ROHC-TargetMode            PDCP-ROHC-TargetMode            OPTIONAL,
    -- Transport channel IEs
        ul-CommonTransChInfo            UL-CommonTransChInfo-r4          OPTIONAL,
        ul-deletedTransChInfoList       UL-DeletedTransChInfoList-r6     OPTIONAL,
        ul-AddReconfTransChInfoList     UL-AddReconfTransChInfoList-r7   OPTIONAL,
        dl-CommonTransChInfo            DL-CommonTransChInfo-r4          OPTIONAL,
        dl-DeletedTransChInfoList       DL-DeletedTransChInfoList-r7     OPTIONAL,
        dl-AddReconfTransChInfoList     DL-AddReconfTransChInfoList-r7   OPTIONAL,
    -- Physical channel IEs
        frequencyInfo                  FrequencyInfo                     OPTIONAL,
        multi-frequencyInfo             Multi-frequencyInfo-LCR-r7       OPTIONAL,
        dtx-drx-TimingInfo              DTX-DRX-TimingInfo-r7           OPTIONAL,
        dtx-drx-Info                    DTX-DRX-Info-r7                 OPTIONAL,
        hs-scch-LessInfo                HS-SCCH-LessInfo-r7             OPTIONAL,
        mimoParameters                  MIMO-Parameters-r7              OPTIONAL,
        maxAllowedUL-TX-Power            MaxAllowedUL-TX-Power            OPTIONAL,
        ul-DPCH-Info                    UL-DPCH-Info-r7                 OPTIONAL,
        ul-EDCH-Information              UL-EDCH-Information-r7           OPTIONAL,
        dl-HSPDSCH-Information          DL-HSPDSCH-Information-r7       OPTIONAL,
        dl-CommonInformation             DL-CommonInformation-r7          OPTIONAL,
        dl-InformationPerRL-List         DL-InformationPerRL-List-r7     OPTIONAL,
    -- MBMS IEs
        mbms-PL-ServiceRestrictInfo  MBMS-PL-ServiceRestrictInfo-r6  OPTIONAL
    }

```

```

CellUpdateConfirm-r7-add-ext-IEs ::= SEQUENCE {
    cellUpdateConfirm-v7d0ext      CellUpdateConfirm-v7d0ext-IEs      OPTIONAL,
    v7f0NonCriticalExtensions      SEQUENCE {
        cellUpdateConfirm-v7f0ext  CellUpdateConfirm-v7f0ext-IEs,
        v7g0NonCriticalExtensions  SEQUENCE {
            cellUpdateConfirm-v7g0ext  CellUpdateConfirm-v7g0ext-IEs,
            nonCriticalExtensions      SEQUENCE {}      OPTIONAL
        }      OPTIONAL
    }      OPTIONAL
}

CellUpdateConfirm-v780ext-IEs ::= SEQUENCE {
    -- Physical channel IES
    hs-DSCH-TBSizeTable            HS-DSCH-TBSizeTable            OPTIONAL
}

CellUpdateConfirm-v7d0ext-IEs ::= SEQUENCE {
    -- Physical channel IES
    ul-EDCH-Information            UL-EDCH-Information-ext      OPTIONAL
}

CellUpdateConfirm-v7f0ext-IEs ::= SEQUENCE {
    -- Physical channel IES
    mimoParameters                MIMO-Parameters-v7f0ext      OPTIONAL
}

CellUpdateConfirm-v7g0ext-IEs ::= SEQUENCE {
    -- Physical channel IES
    mimoParameters                MIMO-Parameters-v7g0ext      OPTIONAL
}

CellUpdateConfirm-r8-IEs ::= SEQUENCE {
    -- User equipment IES
    integrityProtectionModeInfo    IntegrityProtectionModeInfo-r7  OPTIONAL,
    cipheringModeInfo              CipheringModeInfo-r7            OPTIONAL,
    activationTime                  ActivationTime                    OPTIONAL,
    new-U-RNTI                      U-RNTI                          OPTIONAL,
    new-C-RNTI                      C-RNTI                          OPTIONAL,
    -- The IE "new-DSCH-RNTI" should not be included in FDD mode,
    -- and if received the UE behaviour is unspecified
    new-DSCH-RNTI                  DSCH-RNTI                       OPTIONAL,
    new-H-RNTI                      H-RNTI                           OPTIONAL,
    newPrimary-E-RNTI              E-RNTI                           OPTIONAL,
    newSecondary-E-RNTI            E-RNTI                           OPTIONAL,
    rrc-StateIndicator              RRC-StateIndicator,
    utran-DRX-CycleLengthCoeff     UTRAN-DRX-CycleLengthCoefficient-r7  OPTIONAL,
    waitTime                        WaitTime                          OPTIONAL,
    rlc-Re-establishIndicatorRb2-3or4  BOOLEAN,
    rlc-Re-establishIndicatorRb5orAbove  BOOLEAN,
    -- CN information elements
    cn-InformationInfo              CN-InformationInfo-r6          OPTIONAL,
    -- UTRAN mobility IES
    ura-Identity                    URA-Identity                    OPTIONAL,
    supportForChangeOfUE-Capability  BOOLEAN                          OPTIONAL,
    -- Specification mode information
    -- dummy is not used in this version of the specification, it should
    -- not be sent and if received UE behaviour is unspecified.
    dummy                            DefaultConfigForCellFACH        OPTIONAL,
    -- Radio bearer IES
    rab-InformationSetup            RAB-InformationSetup-r8        OPTIONAL,
    rb-InformationReleaseList       RB-InformationReleaseList       OPTIONAL,
    rb-InformationReconfigList      RB-InformationReconfigList-r8   OPTIONAL,
    rb-InformationAffectedList      RB-InformationAffectedList-r8   OPTIONAL,
    dl-CounterSynchronisationInfo   DL-CounterSynchronisationInfo-r5  OPTIONAL,
    pdcp-ROHC-TargetMode           PDCP-ROHC-TargetMode           OPTIONAL,
    -- Transport channel IES
    ul-CommonTransChInfo           UL-CommonTransChInfo-r4        OPTIONAL,
    ul-deletedTransChInfoList       UL-DeletedTransChInfoList-r6    OPTIONAL,
    ul-AddReconfTransChInfoList     UL-AddReconfTransChInfoList-r8  OPTIONAL,
    dl-CommonTransChInfo           DL-CommonTransChInfo-r4        OPTIONAL,
    dl-DeletedTransChInfoList       DL-DeletedTransChInfoList-r7    OPTIONAL,
    dl-AddReconfTransChInfoList     DL-AddReconfTransChInfoList-r7  OPTIONAL,
    -- Physical channel IES
    frequencyInfo                   FrequencyInfo                     OPTIONAL,
    multi-frequencyInfo             Multi-frequencyInfo-LCR-r7      OPTIONAL,
    dtx-drx-TimingInfo              DTX-DRX-TimingInfo-r7          OPTIONAL,
    dtx-drx-Info                    DTX-DRX-Info-r7                OPTIONAL,
    hs-scch-LessInfo                HS-SCCH-LessInfo-r7            OPTIONAL,

```

```

mimoParameters                MIMO-Parameters-r8                OPTIONAL,
maxAllowedUL-TX-Power         MaxAllowedUL-TX-Power         OPTIONAL,
ul-DPCH-Info                  UL-DPCH-Info-r7              OPTIONAL,
ul-EDCH-Information           UL-EDCH-Information-r8       OPTIONAL,
dl-HSPDSCH-Information        DL-HSPDSCH-Information-r8    OPTIONAL,
dl-CommonInformation          DL-CommonInformation-r8      OPTIONAL,
dl-InformationPerRL-List      DL-InformationPerRL-List-r8  OPTIONAL,
dl-SecondaryCellInfoFDD       DL-SecondaryCellInfoFDD      OPTIONAL,
controlChannelDRXInfo-TDD128  ControlChannelDRXInfo-TDD128-r8 OPTIONAL,
sps-Information-TDD128        SPS-Information-TDD128-r8    OPTIONAL,
-- MBMS IEs
  mbms-PL-ServiceRestrictInfo MBMS-PL-ServiceRestrictInfo-r6 OPTIONAL
}

CellUpdateConfirm-v860ext-IEs ::= SEQUENCE {
  rab-InformationSetup          SEQUENCE {
    rab-InformationSetup-r7      RAB-InformationSetup-r7,
    rab-InformationSetup-v820ext RAB-InformationSetup-v820ext
  }
  OPTIONAL
}

CellUpdateConfirm-v890ext-IEs ::= SEQUENCE {
  -- User Equipment IEs
  dl-SecondaryCellInfoFDD-v890ext DL-SecondaryCellInfoFDD-v890ext OPTIONAL,
  -- Physical channel IEs
  dl-HSPDSCH-Information          DL-HSPDSCH-Information-r8-ext OPTIONAL
}

CellUpdateConfirm-v8a0ext-IEs ::= SEQUENCE {
  -- Physical channel IEs
  dl-HSPDSCH-Information          DL-HSPDSCH-Information-r8-ext2 OPTIONAL
}

-- *****
--
-- CELL UPDATE CONFIRM for CCCH
--
-- *****

CellUpdateConfirm-CCCH ::= CHOICE {
  r3 SEQUENCE {
    -- User equipment IEs
    u-RNTI U-RNTI,
    -- The rest of the message is identical to the one sent on DCCH.
    cellUpdateConfirm-r3 CellUpdateConfirm-r3-IEs,
    laterNonCriticalExtensions SEQUENCE {
      -- Container for additional R99 extensions
      cellUpdateConfirm-CCCH-r3-add-ext BIT STRING OPTIONAL,
      v4b0NonCriticalExtensions SEQUENCE {
        cellUpdateConfirm-v4b0ext CellUpdateConfirm-v4b0ext-IEs,
        v590NonCriticalExtensions SEQUENCE {
          cellUpdateConfirm-v590ext CellUpdateConfirm-v590ext-IEs,
          v5d0NonCriticalExtensstions SEQUENCE {
            cellUpdateConfirm-v5d0ext CellUpdateConfirm-v5d0ext-IEs,
            v690NonCriticalExtensions SEQUENCE {
              cellUpdateConfirm-v690ext CellUpdateConfirm-v690ext-IEs,
              nonCriticalExtensions SEQUENCE {} OPTIONAL
            } OPTIONAL
          } OPTIONAL
        } OPTIONAL
      } OPTIONAL
    } OPTIONAL
  } OPTIONAL
},
  later-than-r3 SEQUENCE {
    u-RNTI U-RNTI,
    rrc-TransactionIdentifier RRC-TransactionIdentifier,
    criticalExtensions CHOICE {
      r4 SEQUENCE {
        -- The rest of the message is identical to the one sent on DCCH.
        cellUpdateConfirm-r4 CellUpdateConfirm-r4-IEs,
        v4d0NonCriticalExtensions SEQUENCE {
          -- Container for adding non critical extensions after freezing REL-5
          cellUpdateConfirm-CCCH-r4-add-ext BIT STRING OPTIONAL,
          v590NonCriticalExtensions SEQUENCE {
            cellUpdateConfirm-v590ext CellUpdateConfirm-v590ext-IEs,
            v5d0NonCriticalExtensstions SEQUENCE {
              cellUpdateConfirm-v5d0ext CellUpdateConfirm-v5d0ext-IEs,
              v690NonCriticalExtensions SEQUENCE {

```



```
cellUpdateConfirm-v690ext          CellUpdateConfirm-v690ext-IEs,
  nonCriticalExtensions              SEQUENCE {}           OPTIONAL
    } OPTIONAL
  } OPTIONAL
} OPTIONAL
},
criticalExtensions                  CHOICE {
  r5                                SEQUENCE {
    cellUpdateConfirm-r5              CellUpdateConfirm-r5-IEs,
    cellUpdateConfirm-CCCH-r5-add-ext BIT STRING           OPTIONAL,
    v5d0NonCriticalExtensstions      SEQUENCE {
      cellUpdateConfirm-v5d0ext       CellUpdateConfirm-v5d0ext-IEs,
      v690NonCriticalExtensions      SEQUENCE {
        cellUpdateConfirm-v690ext     CellUpdateConfirm-v690ext-IEs,
        nonCriticalExtensions        SEQUENCE {}           OPTIONAL
      } OPTIONAL
    } OPTIONAL
  } OPTIONAL
},
criticalExtensions                  CHOICE {
  r6                                SEQUENCE {
    cellUpdateConfirm-r6              CellUpdateConfirm-r6-IEs,
    cellUpdateConfirm-r6-add-ext      BIT STRING           OPTIONAL,
    v6b0NonCriticalExtensions        SEQUENCE {
      cellUpdateConfirm-v6b0ext       CellUpdateConfirm-v6b0ext-IEs,
      nonCriticalExtensions          SEQUENCE {}           OPTIONAL
    } OPTIONAL
  } OPTIONAL
},
criticalExtensions                  CHOICE {
  r7                                SEQUENCE {
    cellUpdateConfirm-r7              CellUpdateConfirm-r7-IEs,
    cellUpdateConfirm-r7-add-ext      BIT STRING
    (CONTAINING CellUpdateConfirm-r7-add-ext-IEs) OPTIONAL,
    v780NonCriticalExtensions        SEQUENCE {
      cellUpdateConfirm-v780ext       CellUpdateConfirm-v780ext-IEs,
      v860NonCriticalExtensions      SEQUENCE {
        cellUpdateConfirm-v860ext     CellUpdateConfirm-v860ext-IEs,
        nonCriticalExtensions        SEQUENCE {}           OPTIONAL
      } OPTIONAL
    } OPTIONAL
  } OPTIONAL
},
criticalExtensions                  CHOICE {
  r8                                SEQUENCE {
    cellUpdateConfirm-r8              CellUpdateConfirm-r8-IEs,
    cellUpdateConfirm-r8-add-ext      BIT STRING           OPTIONAL,
    v7d0NonCriticalExtensions        SEQUENCE {
      cellUpdateConfirm-v7d0ext       CellUpdateConfirm-v7d0ext-IEs,
      v890NonCriticalExtensions      SEQUENCE {
        cellUpdateConfirm-v890ext     CellUpdateConfirm-v890ext-IEs,
        v8a0NonCriticalExtensions    SEQUENCE {
          cellUpdateConfirm-v8a0ext   CellUpdateConfirm-v8a0ext-IEs,
          v7f0NonCriticalExtensions  SEQUENCE {
            cellUpdateConfirm-v7f0ext CellUpdateConfirm-v7f0ext-IEs,
            v7g0NonCriticalExtensions SEQUENCE {
              cellUpdateConfirm-v7g0ext CellUpdateConfirm-v7g0ext-IEs,
              nonCriticalExtensions SEQUENCE {}           OPTIONAL
            } OPTIONAL
          } OPTIONAL
        } OPTIONAL
      } OPTIONAL
    } OPTIONAL
  } OPTIONAL
},
criticalExtensions                  SEQUENCE {}
}
}
}
}
}
}
}
}
}
}
}
}
```

-- *****
--
-- COUNTER CHECK

```

--
-- *****
CounterCheck ::= CHOICE {
  r3 SEQUENCE {
    counterCheck-r3 CounterCheck-r3-IEs,
    laterNonCriticalExtensions SEQUENCE {
      -- Container for additional R99 extensions
      counterCheck-r3-add-ext BIT STRING OPTIONAL,
      nonCriticalExtensions SEQUENCE {} OPTIONAL
    } OPTIONAL
  },
  later-than-r3 SEQUENCE {
    rrc-TransactionIdentifier RRC-TransactionIdentifier,
    criticalExtensions SEQUENCE {}
  }
}

CounterCheck-r3-IEs ::= SEQUENCE {
  -- User equipment IEs
  rrc-TransactionIdentifier RRC-TransactionIdentifier,
  -- Radio bearer IEs
  rb-COUNT-C-MSB-InformationList RB-COUNT-C-MSB-InformationList
}

-- *****
--
-- COUNTER CHECK RESPONSE
--
-- *****

CounterCheckResponse ::= SEQUENCE {
  -- User equipment IEs
  rrc-TransactionIdentifier RRC-TransactionIdentifier,
  -- Radio bearer IEs
  rb-COUNT-C-InformationList RB-COUNT-C-InformationList OPTIONAL,
  laterNonCriticalExtensions SEQUENCE {
    -- Container for additional R99 extensions
    counterCheckResponse-r3-add-ext BIT STRING OPTIONAL,
    nonCriticalExtensions SEQUENCE {} OPTIONAL
  } OPTIONAL
}

-- *****
--
-- DOWNLINK DIRECT TRANSFER
--
-- *****

DownlinkDirectTransfer ::= CHOICE {
  r3 SEQUENCE {
    downlinkDirectTransfer-r3 DownlinkDirectTransfer-r3-IEs,
    laterNonCriticalExtensions SEQUENCE {
      -- Container for additional R99 extensions
      downlinkDirectTransfer-r3-add-ext BIT STRING OPTIONAL,
      nonCriticalExtensions SEQUENCE {} OPTIONAL
    } OPTIONAL
  },
  later-than-r3 SEQUENCE {
    rrc-TransactionIdentifier RRC-TransactionIdentifier,
    criticalExtensions SEQUENCE {}
  }
}

DownlinkDirectTransfer-r3-IEs ::= SEQUENCE {
  -- User equipment IEs
  rrc-TransactionIdentifier RRC-TransactionIdentifier,
  -- Core network IEs
  cn-DomainIdentity CN-DomainIdentity,
  nas-Message NAS-Message
}

-- *****
--
-- ETWS PRIMARY NOTIFICATION WITH SECURITY
--
-- *****

```

```

ETWSPimaryNotificationWithSecurity ::= SEQUENCE {
  -- Other IEs
  etws-Information          ETWS-Information,
  -- dummy is not used in the specification. If received it is ignored by the UE.
  -- See TS 23.041 for handling of warning security information by Cell Broadcast Center.
  dummy                    ETWS-WarningSecurityInfo          OPTIONAL,
  -- Non critical extensions
  nonCriticalExtensions    SEQUENCE {}          OPTIONAL
}

-- *****
--
-- HANDOVER TO UTRAN COMMAND
--
-- *****

HandoverToUTRANCommand ::= CHOICE {
  r3 SEQUENCE {
    handoverToUTRANCommand-r3 HandoverToUTRANCommand-r3-IEs,
    nonCriticalExtensions      SEQUENCE {}          OPTIONAL
  },
  criticalExtensions CHOICE {
    r4 SEQUENCE {
      handoverToUTRANCommand-r4 HandoverToUTRANCommand-r4-IEs,
      nonCriticalExtensions      SEQUENCE {}          OPTIONAL
    },
    criticalExtensions CHOICE {
      r5 SEQUENCE {
        handoverToUTRANCommand-r5 HandoverToUTRANCommand-r5-IEs,
        nonCriticalExtensions      SEQUENCE {}          OPTIONAL
      },
      criticalExtensions CHOICE {
        r6 SEQUENCE {
          handoverToUTRANCommand-r6 HandoverToUTRANCommand-r6-IEs,
          v6b0NonCriticalExtensions SEQUENCE {
            handoverToUTRANCommand-v6b0ext HandoverToUTRANCommand-v6b0ext-IEs,
            nonCriticalExtensions          SEQUENCE {}          OPTIONAL
          }
        } OPTIONAL
      },
      criticalExtensions CHOICE {
        r7 SEQUENCE {
          handoverToUTRANCommand-r7 HandoverToUTRANCommand-r7-IEs,
          v780NonCriticalExtensions SEQUENCE {
            handoverToUTRANCommand-v780ext HandoverToUTRANCommand-v780ext-IEs,
            v820NonCriticalExtensions      SEQUENCE {
              handoverToUTRANCommand-v820ext HandoverToUTRANCommand-v820ext-IEs,
              v7d0NonCriticalExtensions    SEQUENCE {
                handoverToUTRANCommand-v7d0ext
                HandoverToUTRANCommand-v7d0ext-IEs,
                nonCriticalExtensions      SEQUENCE {}          OPTIONAL
              }
            } OPTIONAL
          }
        } OPTIONAL
      },
      criticalExtensions CHOICE {
        r8 SEQUENCE {
          handoverToUTRANCommand-r8 HandoverToUTRANCommand-r8-IEs,
          v7d0NonCriticalExtensions SEQUENCE {
            handoverToUTRANCommand-v7d0ext HandoverToUTRANCommand-v7d0ext-IEs,
            v890NonCriticalExtensions      SEQUENCE {
              handoverToUTRANCommand-v890ext
              HandoverToUTRANCommand-v890ext-IEs,
              v8a0NonCriticalExtensions    SEQUENCE {
                handoverToUTRANCommand-v8a0ext
                HandoverToUTRANCommand-v8a0ext-IEs,
                nonCriticalExtensions      SEQUENCE {}          OPTIONAL
              }
            } OPTIONAL
          }
        } OPTIONAL
      },
      criticalExtensions SEQUENCE {}
    }
  }
}

```

```

HandoverToUTRANCommand-r3-IEs ::= SEQUENCE {
  -- User equipment IEs
  new-U-RNTI                U-RNTI-Short,
  -- dummy is not used in this version of specification, it should
  -- not be sent and if received it should be ignored.
  dummy                      ActivationTime                OPTIONAL,
  cipheringAlgorithm        CipheringAlgorithm            OPTIONAL,
  -- Radio bearer IEs
  -- Specification mode information
  specificationMode          CHOICE {
    complete                  SEQUENCE {
      srb-InformationSetupList SRB-InformationSetupList,
      rab-InformationSetupList RAB-InformationSetupList    OPTIONAL,
      ul-CommonTransChInfo    UL-CommonTransChInfo,
      ul-AddReconfTransChInfoList UL-AddReconfTransChInfoList,
      dl-CommonTransChInfo    DL-CommonTransChInfo,
      dl-AddReconfTransChInfoList DL-AddReconfTransChInfoList,
      ul-DPCH-Info            UL-DPCH-Info,
      modeSpecificInfo        CHOICE {
        fdd                    SEQUENCE {
          -- dummy and dummy2 are not used in this version of specification,
          -- they should not be sent and if received they should be ignored.
          dummy                DL-PDSCH-Information OPTIONAL,
          dummy2                CPCH-SetInfo        OPTIONAL
        },
        tdd                    NULL
      },
      dl-CommonInformation    DL-CommonInformation,
      dl-InformationPerRL-List DL-InformationPerRL-List,
      frequencyInfo           FrequencyInfo
    },
    preconfiguration          SEQUENCE {
      predefinedConfigIdentity PredefinedConfigIdentity,
      defaultConfig            SEQUENCE {
        defaultConfigMode    DefaultConfigMode,
        defaultConfigIdentity DefaultConfigIdentity
      }
    },
    rab-Info                  RAB-Info-Post            OPTIONAL,
    modeSpecificInfo          CHOICE {
      fdd                    SEQUENCE {
        ul-DPCH-Info          UL-DPCH-InfoPostFDD,
        dl-CommonInformationPost DL-CommonInformationPost,
        dl-InformationPerRL-List DL-InformationPerRL-ListPostFDD,
        frequencyInfo         FrequencyInfoFDD
      },
      tdd                    SEQUENCE {
        ul-DPCH-Info          UL-DPCH-InfoPostTDD,
        dl-CommonInformationPost DL-CommonInformationPost,
        dl-InformationPerRL-List DL-InformationPerRL-ListPostTDD,
        frequencyInfo         FrequencyInfoTDD,
        primaryCCPCH-TX-Power PrimaryCCPCH-TX-Power
      }
    }
  },
  -- Physical channel IEs
  maxAllowedUL-TX-Power      MaxAllowedUL-TX-Power
}

```

```

HandoverToUTRANCommand-r4-IEs ::= SEQUENCE {
  -- User equipment IEs
  new-U-RNTI                U-RNTI-Short,
  cipheringAlgorithm        CipheringAlgorithm            OPTIONAL,
  -- Radio bearer IEs
  -- Specification mode information
  specificationMode          CHOICE {
    complete                  SEQUENCE {
      srb-InformationSetupList SRB-InformationSetupList,
      rab-InformationSetupList RAB-InformationSetupList-r4    OPTIONAL,
      ul-CommonTransChInfo    UL-CommonTransChInfo-r4,
      ul-AddReconfTransChInfoList UL-AddReconfTransChInfoList,
      dl-CommonTransChInfo    DL-CommonTransChInfo-r4,
      dl-AddReconfTransChInfoList DL-AddReconfTransChInfoList-r4,
    }
  }
}

```

```

        ul-DPCH-Info                UL-DPCH-Info-r4,
modeSpecificInfo                   CHOICE {
    fdd                               SEQUENCE {
        -- dummy and dummy2 are not used in this version of specification,
        -- they should not be sent and if received they should be ignored.
        dummy                          DL-PDSCH-Information OPTIONAL,
        dummy2                          CPCH-SetInfo          OPTIONAL
    },
    tdd                               NULL
},
dl-CommonInformation                DL-CommonInformation-r4,
dl-InformationPerRL-List            DL-InformationPerRL-List-r4,
frequencyInfo                       FrequencyInfo
},
preconfiguration                     SEQUENCE {
-- All IEs that include an FDD/TDD choice are split in two IEs for this message,
-- one for the FDD only elements and one for the TDD only elements, so that one
-- FDD/TDD choice in this level is sufficient.
preConfigMode                       CHOICE {
    predefinedConfigIdentity           PredefinedConfigIdentity,
    defaultConfig                      SEQUENCE {
        defaultConfigMode             DefaultConfigMode,
        defaultConfigIdentity         DefaultConfigIdentity-r4
    }
},
rab-Info                             RAB-Info-Post          OPTIONAL,
modeSpecificInfo                     CHOICE {
    fdd                               SEQUENCE {
        ul-DPCH-Info                  UL-DPCH-InfoPostFDD,
        dl-CommonInformationPost       DL-CommonInformationPost,
        dl-InformationPerRL-List       DL-InformationPerRL-ListPostFDD,
        frequencyInfo                  FrequencyInfoFDD
    },
    tdd                               CHOICE {
        tdd384                         SEQUENCE {
            ul-DPCH-Info                UL-DPCH-InfoPostTDD,
            dl-InformationPerRL          DL-InformationPerRL-PostTDD,
            frequencyInfo                FrequencyInfoTDD,
            primaryCCPCH-TX-Power       PrimaryCCPCH-TX-Power
        },
        tdd128                         SEQUENCE {
            ul-DPCH-Info                UL-DPCH-InfoPostTDD-LCR-r4,
            dl-InformationPerRL          DL-InformationPerRL-PostTDD-LCR-r4,
            frequencyInfo                FrequencyInfoTDD,
            primaryCCPCH-TX-Power       PrimaryCCPCH-TX-Power
        }
    }
}
},
},
},
-- Physical channel IEs
maxAllowedUL-TX-Power                MaxAllowedUL-TX-Power
}

HandoverToUTRANCommand-r5-IEs ::= SEQUENCE {
-- User equipment IEs
new-U-RNTI                           U-RNTI-Short,
cipheringAlgorithm                     CipheringAlgorithm          OPTIONAL,
-- Radio bearer IEs
-- Specification mode information
specificationMode                     CHOICE {
    complete                           SEQUENCE {
        srb-InformationSetupList       SRB-InformationSetupList-r5,
        rab-InformationSetupList       RAB-InformationSetupList-r5          OPTIONAL,
        ul-CommonTransChInfo           UL-CommonTransChInfo-r4,
        ul-AddReconfTransChInfoList    UL-AddReconfTransChInfoList,
        dl-CommonTransChInfo           DL-CommonTransChInfo-r4,
        dl-AddReconfTransChInfoList    DL-AddReconfTransChInfoList-r5,
        ul-DPCH-Info                   UL-DPCH-Info-r5,
        modeSpecificInfo                CHOICE {
            fdd                         SEQUENCE {
                -- dummy and dummy2 are not used in this version of specification,
                -- they should not be sent and if received they should be ignored.
                dummy                    DL-PDSCH-Information OPTIONAL,
                dummy2                    CPCH-SetInfo          OPTIONAL
            },
            tdd                         NULL
        }
    }
},
},

```

```

        dl-CommonInformation          DL-CommonInformation-r4,
        dl-InformationPerRL-List     DL-InformationPerRL-List-r5,
        frequencyInfo                FrequencyInfo
    },
    preconfiguration                  SEQUENCE {
-- All IEs that include an FDD/TDD choice are split in two IEs for this message,
-- one for the FDD only elements and one for the TDD only elements, so that one
-- FDD/TDD choice in this level is sufficient.
        preConfigMode                 CHOICE {
            predefinedConfigIdentity   PredefinedConfigIdentity,
            defaultConfig              SEQUENCE {
                defaultConfigMode      DefaultConfigMode,
                defaultConfigIdentity  DefaultConfigIdentity-r5
            }
        },
        rab-Info                       RAB-Info-Post          OPTIONAL,
        modeSpecificInfo               CHOICE {
            fdd                         SEQUENCE {
                ul-DPCH-Info            UL-DPCH-InfoPostFDD,
                dl-CommonInformationPost DL-CommonInformationPost,
                dl-InformationPerRL-List DL-InformationPerRL-ListPostFDD,
                frequencyInfo           FrequencyInfoFDD
            },
            tdd                         CHOICE {
                tdd384                  SEQUENCE {
                    ul-DPCH-Info        UL-DPCH-InfoPostTDD,
                    dl-InformationPerRL DL-InformationPerRL-PostTDD,
                    frequencyInfo       FrequencyInfoTDD,
                    primaryCCPCH-TX-Power PrimaryCCPCH-TX-Power
                },
                tdd128                  SEQUENCE {
                    ul-DPCH-Info        UL-DPCH-InfoPostTDD-LCR-r4,
                    dl-InformationPerRL DL-InformationPerRL-PostTDD-LCR-r4,
                    frequencyInfo       FrequencyInfoTDD,
                    primaryCCPCH-TX-Power PrimaryCCPCH-TX-Power
                }
            }
        }
    },
}
-- Physical channel IEs
    maxAllowedUL-TX-Power            MaxAllowedUL-TX-Power
}

HandoverToUTRANCommand-r6-IEs ::= SEQUENCE {
-- User equipment IEs
    new-U-RNTI                       U-RNTI-Short,
    cipheringAlgorithm                CipheringAlgorithm          OPTIONAL,
-- Radio bearer IEs
-- Specification mode information
    specificationMode                 CHOICE {
        complete                       SEQUENCE {
            srb-InformationSetupList   SRB-InformationSetupList-r6,
            rab-InformationSetupList   RAB-InformationSetupList-r6    OPTIONAL,
            ul-CommonTransChInfo       UL-CommonTransChInfo-r4,
            ul-AddReconfTransChInfoList UL-AddReconfTransChInfoList-r6,
            dl-CommonTransChInfo       DL-CommonTransChInfo-r4,
            dl-AddReconfTransChInfoList DL-AddReconfTransChInfoList-r5,
            ul-DPCH-Info                UL-DPCH-Info-r6,
            ul-EDCH-Information         UL-EDCH-Information-r6        OPTIONAL,
            dl-HSPDSCH-Information      DL-HSPDSCH-Information-r6     OPTIONAL,
            dl-CommonInformation        DL-CommonInformation-r6,
            dl-InformationPerRL-List    DL-InformationPerRL-List-r6,
            frequencyInfo               FrequencyInfo
        },
        preconfiguration                SEQUENCE {
-- All IEs that include an FDD/TDD choice are split in two IEs for this message,
-- one for the FDD only elements and one for the TDD only elements, so that one
-- FDD/TDD choice in this level is sufficient.
            preConfigMode               CHOICE {
                predefinedConfigIdentity PredefinedConfigIdentity,
                defaultConfig           SEQUENCE {
                    defaultConfigMode    DefaultConfigMode,
                    defaultConfigIdentity DefaultConfigIdentity-r6
                }
            },
            rab-Info                     RAB-Info-Post          OPTIONAL,
            modeSpecificInfo              CHOICE {

```

```

        fdd                               SEQUENCE {
            ul-DPCH-Info                   UL-DPCH-InfoPostFDD,
            dl-CommonInformationPost       DL-CommonInformationPost,
            dl-InformationPerRL-List       DL-InformationPerRL-ListPostFDD,
            frequencyInfo                   FrequencyInfoFDD
        },
        tdd                               CHOICE {
            tdd384                          SEQUENCE {
                ul-DPCH-Info               UL-DPCH-InfoPostTDD,
                dl-InformationPerRL         DL-InformationPerRL-PostTDD,
                frequencyInfo               FrequencyInfoTDD,
                primaryCCPCH-TX-Power      PrimaryCCPCH-TX-Power
            },
            tdd128                          SEQUENCE {
                ul-DPCH-Info               UL-DPCH-InfoPostTDD-LCR-r4,
                dl-InformationPerRL         DL-InformationPerRL-PostTDD-LCR-r4,
                frequencyInfo               FrequencyInfoTDD,
                primaryCCPCH-TX-Power      PrimaryCCPCH-TX-Power
            }
        }
    },
}

-- Physical channel IEs
maxAllowedUL-TX-Power                    MaxAllowedUL-TX-Power
}

HandoverToUTRANCommand-v6b0ext-IEs ::= SEQUENCE {
    ue-hspa-identities                     UE-HSPA-Identities-r6    OPTIONAL
}

HandoverToUTRANCommand-r7-IEs ::= SEQUENCE {
    -- User equipment IEs
    new-U-RNTI                             U-RNTI-Short,
    cipheringAlgorithm                       CipheringAlgorithm-r7    OPTIONAL,
    supportForChangeOfUE-Capability         BOOLEAN,
    new-H-RNTI                              H-RNTI                   OPTIONAL,
    newPrimary-E-RNTI                       E-RNTI                   OPTIONAL,
    newSecondary-E-RNTI                     E-RNTI                   OPTIONAL,
    -- Radio bearer IEs
    -- Specification mode information
    specificationMode                       CHOICE {
        complete                            SEQUENCE {
            srb-InformationSetupList        SRB-InformationSetupList-r7,
            rab-InformationSetupList        RAB-InformationSetupList-r7    OPTIONAL,
            ul-CommonTransChInfo           UL-CommonTransChInfo-r4,
            dl-CommonTransChInfo           DL-CommonTransChInfo-r4,
            dl-AddReconfTransChInfoList    DL-AddReconfTransChInfoList-r7,
            ul-AddReconfTransChInfoList    UL-AddReconfTransChInfoList-r7,
            ul-DPCH-Info                   UL-DPCH-Info-r7,
            ul-EDCH-Information             UL-EDCH-Information-r7    OPTIONAL,
            dl-HSPDSCH-Information         DL-HSPDSCH-Information-r7    OPTIONAL,
            dl-CommonInformation           DL-CommonInformation-r7,
            dl-InformationPerRL-List       DL-InformationPerRL-List-r7,
            frequencyInfo                   FrequencyInfo,
            multi-frequencyInfo            Multi-frequencyInfo-LCR-r7    OPTIONAL
        },
        preconfiguration                    SEQUENCE {
            -- All IEs that include an FDD/TDD choice are split in two IEs for this message,
            -- one for the FDD only elements and one for the TDD only elements, so that one
            -- FDD/TDD choice in this level is sufficient.
            preConfigMode                   CHOICE {
                predefinedConfigIdentity     PredefinedConfigIdentity,
                defaultConfig                SEQUENCE {
                    defaultConfigMode        DefaultConfigMode,
                    defaultConfigIdentity    DefaultConfigIdentity-r6
                }
            },
            rab-Info                         RAB-Info-Post            OPTIONAL,
            modeSpecificInfo                 CHOICE {
                fdd                          SEQUENCE {
                    ul-DPCH-Info             UL-DPCH-InfoPostFDD,
                    dl-CommonInformationPost DL-CommonInformationPost,
                    dl-InformationPerRL-List DL-InformationPerRL-ListPostFDD,
                    frequencyInfo             FrequencyInfoFDD
                },
                tdd                          CHOICE {
                    tdd384                   SEQUENCE {

```

```

        ul-DPCH-Info                UL-DPCH-InfoPostTDD,
        dl-InformationPerRL          DL-InformationPerRL-PostTDD,
        frequencyInfo                FrequencyInfoTDD,
        primaryCCPCH-TX-Power        PrimaryCCPCH-TX-Power
    },
    tdd128                            SEQUENCE {
        ul-DPCH-Info                UL-DPCH-Info-r7,
        dl-InformationPerRL          DL-InformationPerRL-PostTDD-LCR-r4,
        frequencyInfo                FrequencyInfoTDD,
        primaryCCPCH-TX-Power        PrimaryCCPCH-TX-Power,
        multi-frequencyInfo          Multi-frequencyInfo-LCR-r7        OPTIONAL
    },
    tdd768                            SEQUENCE {
        ul-DPCH-Info                UL-DPCH-Info-r7,
        dl-InformationPerRL          DL-InformationPerRL-List-r7,
        frequencyInfo                FrequencyInfoTDD,
        primaryCCPCH-TX-Power        PrimaryCCPCH-TX-Power
    }
}
}
}
},
-- Physical channel IEs
    maxAllowedUL-TX-Power            MaxAllowedUL-TX-Power
}

HandoverToUTRANCommand-v780ext-IEs ::= SEQUENCE {
-- Physical channel IEs
    hs-DSCH-TBSizeTable              HS-DSCH-TBSizeTable                OPTIONAL
}

HandoverToUTRANCommand-v7d0ext-IEs ::= SEQUENCE {
-- Physical channel IEs
    ul-EDCH-Information              UL-EDCH-Information-ext        OPTIONAL
}

HandoverToUTRANCommand-r8-IEs ::= SEQUENCE {
-- User equipment IEs
    new-U-RNTI                       U-RNTI-Short,
    cipheringAlgorithm                CipheringAlgorithm-r7          OPTIONAL,
    supportForChangeOfUE-Capability  BOOLEAN,
    new-H-RNTI                        H-RNTI                        OPTIONAL,
    newPrimary-E-RNTI                 E-RNTI                        OPTIONAL,
    newSecondary-E-RNTI               E-RNTI                        OPTIONAL,
-- Radio bearer IEs
-- Specification mode information
-- dummy is not used in this version of the specification, it should
-- not be sent and if received UE behaviour is unspecified.
    dummy                             DefaultConfigForCellFACH      OPTIONAL,
    specificationMode                 CHOICE {
        complete                       SEQUENCE {
            srb-InformationSetupList    SRB-InformationSetupList-r8,
            rab-InformationSetupList    RAB-InformationSetupList-r8  OPTIONAL,
            ul-CommonTransChInfo        UL-CommonTransChInfo-r4,
            ul-AddReconfTransChInfoList UL-AddReconfTransChInfoList-r8,
            dl-CommonTransChInfo        DL-CommonTransChInfo-r4,
            dl-AddReconfTransChInfoList DL-AddReconfTransChInfoList-r7,
            ul-DPCH-Info                UL-DPCH-Info-r7,
            ul-EDCH-Information          UL-EDCH-Information-r8      OPTIONAL,
            dl-HSPDSCH-Information       DL-HSPDSCH-Information-r8   OPTIONAL,
            dl-CommonInformation         DL-CommonInformation-r8,
            dl-InformationPerRL-List     DL-InformationPerRL-List-r7,
            frequencyInfo                FrequencyInfo,
            multi-frequencyInfo          Multi-frequencyInfo-LCR-r7   OPTIONAL
        },
        preconfiguration                SEQUENCE {
-- All IEs that include an FDD/TDD choice are split in two IEs for this message,
-- one for the FDD only elements and one for the TDD elements, so that one
-- FDD/TDD choice in this level is sufficient.
            preConfigMode               CHOICE {
                predefinedConfigIdentity PredefinedConfigIdentity,
                defaultConfig           SEQUENCE {
                    defaultConfigMode    DefaultConfigMode,
                    defaultConfigIdentity DefaultConfigIdentity-r6,
                    -- dummy is not used in this version of the specification, it should
                    -- not be sent and if received it should be ignored
                    dummy                DLUL-HSPA-Information-r8    OPTIONAL
                }
            }
        }
    }
}

```



```

    },
    rab-Info
    modeSpecificInfo
        fdd
            ul-DPCH-Info
            dl-CommonInformationPost
            dl-InformationPerRL-List
            frequencyInfo
        },
        tdd
            tdd384
                ul-DPCH-Info
                dl-InformationPerRL
                frequencyInfo
                primaryCCPCH-TX-Power
            },
            tdd128
                ul-DPCH-Info
                dl-InformationPerRL
                frequencyInfo
                primaryCCPCH-TX-Power
                multi-frequencyInfo
            },
            tdd768
                ul-DPCH-Info
                dl-InformationPerRL
                frequencyInfo
                primaryCCPCH-TX-Power
            }
        }
    },
    -- Physical channel IEs
    maxAllowedUL-TX-Power
}

HandoverToUTRANCommand-v820ext-IEs ::= SEQUENCE {
    -- Radio bearer IEs
    rab-InformationSetupList
}

HandoverToUTRANCommand-v890ext-IEs ::= SEQUENCE {
    -- Physical channel IEs
    dl-HSPDSCH-Information
}

HandoverToUTRANCommand-v8a0ext-IEs ::= SEQUENCE {
    -- Physical channel IEs
    dl-HSPDSCH-Information
}

-- *****
--
-- HANDOVER TO UTRAN COMPLETE
--
-- *****

HandoverToUTRANComplete ::= SEQUENCE {
    --TABULAR: Integrity protection shall not be performed on this message.
    -- User equipment IEs
    -- TABULAR: startList is conditional on history.
    startList
    -- Radio bearer IEs
    count-C-ActivationTime
    laterNonCriticalExtensions
    -- Container for additional R99 extensions
    handoverToUTRANComplete-r3-add-ext
    nonCriticalExtensions
}

-- *****
--
-- INITIAL DIRECT TRANSFER
--
-- *****

```

```

InitialDirectTransfer ::= SEQUENCE {
  -- Core network IEs
  cn-DomainIdentity          CN-DomainIdentity,
  intraDomainNasNodeSelector IntraDomainNasNodeSelector,
  nas-Message                NAS-Message,
  -- Measurement IEs
  measuredResultsOnRACH      MeasuredResultsOnRACH          OPTIONAL,
  v3a0NonCriticalExtensions  SEQUENCE {
    initialDirectTransfer-v3a0ext InitialDirectTransfer-v3a0ext,
    laterNonCriticalExtensions  SEQUENCE {
      -- Container for additional R99 extensions
      initialDirectTransfer-r3-add-ext BIT STRING
        (CONTAINING InitialDirectTransfer-r3-add-ext-IEs) OPTIONAL,
      v590NonCriticalExtensions SEQUENCE {
        initialDirectTransfer-v590ext InitialDirectTransfer-v590ext,
        v690NonCriticalExtensions SEQUENCE {
          initialDirectTransfer-v690ext InitialDirectTransfer-v690ext-IEs,
          v770NonCriticalExtensions SEQUENCE {
            initialDirectTransfer-v770ext InitialDirectTransfer-v770ext-IEs,
            v860NonCriticalExtensions SEQUENCE {
              initialDirectTransfer-v860ext InitialDirectTransfer-v860ext-IEs,
              nonCriticalExtensions SEQUENCE {} OPTIONAL
            } OPTIONAL
          } OPTIONAL
        } OPTIONAL
      } OPTIONAL
    } OPTIONAL
  } OPTIONAL
}

InitialDirectTransfer-v3a0ext ::= SEQUENCE {
  -- start-value shall always be included in this version of the protocol
  start-Value          START-Value          OPTIONAL
}

InitialDirectTransfer-v590ext ::= SEQUENCE {
  establishmentCause  EstablishmentCause  OPTIONAL
}

InitialDirectTransfer-v690ext-IEs ::= SEQUENCE {
  -- Core network IEs
  plmn-Identity          PLMN-Identity          OPTIONAL,
  -- Measurement IEs
  measuredResultsOnRACHinterFreq MeasuredResultsOnRACHinterFreq  OPTIONAL,
  -- MBMS IEs
  mbms-JoinedInformation MBMS-JoinedInformation-r6  OPTIONAL
}

InitialDirectTransfer-v770ext-IEs ::= SEQUENCE {
  csCallType          ENUMERATED { speech, video, other, spare } OPTIONAL
}

InitialDirectTransfer-v860ext-IEs ::= SEQUENCE {
  supportOfCSG          ENUMERATED { true }          OPTIONAL
}

InitialDirectTransfer-r3-add-ext-IEs ::= SEQUENCE {
  initialDirectTransfer-v7g0ext          InitialDirectTransfer-v7g0ext-IEs,
  nonCriticalExtensions          SEQUENCE {}          OPTIONAL
}

InitialDirectTransfer-v7g0ext-IEs ::= SEQUENCE {
  -- Measurement IEs
  measuredResultsOnRACH-v7g0ext          MeasuredResultsOnRACH-v7g0ext          OPTIONAL
}

-- *****
--
-- HANDOVER FROM UTRAN COMMAND
--
-- *****

HandoverFromUTRANCommand-GSM ::= CHOICE {
  r3          SEQUENCE {
    handoverFromUTRANCommand-GSM-r3
      HandoverFromUTRANCommand-GSM-r3-IEs,
    -- UTRAN should not include the IE laterNonCriticalExtensions when it sets the IE
    -- gsm-message included in handoverFromUTRANCommand-GSM-r3 to single-GSM-Message. The UE
    -- behaviour upon receiving a message with this combination of IE values is unspecified.
  }
}

```

```

laterNonCriticalExtensions SEQUENCE {
  -- Container for additional R99 extensions
  handoverFromUTRANCommand-GSM-r3-add-ext BIT STRING OPTIONAL,
  -- UTRAN may apply the r3 version of the message to perform PS handover
  -- for a single RAB only
  v690NonCriticalExtensions SEQUENCE {
    handoverFromUTRANCommand-GSM-v690ext HandoverFromUTRANCommand-GSM-v690ext-IEs,
    v860NonCriticalExtensions SEQUENCE {
      handoverFromUTRANCommand-GSM-v860ext
        HandoverFromUTRANCommand-GSM-v860ext-IEs,
      nonCriticalExtensions SEQUENCE {} OPTIONAL
    } OPTIONAL
  } OPTIONAL
},
later-than-r3 SEQUENCE {
  rrc-TransactionIdentifier RRC-TransactionIdentifier,
  criticalExtensions CHOICE {
    r6 SEQUENCE {
      handoverFromUTRANCommand-GSM-r6 HandoverFromUTRANCommand-GSM-r6-IEs,
      handoverFromUTRANCommand-GSM-r6-add-ext BIT STRING OPTIONAL,
      v860NonCriticalExtensions SEQUENCE {
        handoverFromUTRANCommand-GSM-v860ext
          HandoverFromUTRANCommand-GSM-v860ext-IEs,
        nonCriticalExtensions SEQUENCE {} OPTIONAL
      } OPTIONAL
    },
    criticalExtensions SEQUENCE {}
  }
}

HandoverFromUTRANCommand-GSM-r3-IEs ::= SEQUENCE {
  -- User equipment IEs
  rrc-TransactionIdentifier RRC-TransactionIdentifier,
  activationTime ActivationTime OPTIONAL,
  -- Radio bearer IEs
  toHandoverRAB-Info RAB-Info OPTIONAL,
  -- Measurement IEs
  frequency-band Frequency-Band,
  -- Other IEs
  gsm-message CHOICE {
    -- In the single-GSM-Message case the following rules apply:
    -- 1> the GSM message directly follows the basic production; the final padding that
    -- results when PER encoding the abstract syntax value is removed prior to appending
    -- the GSM message.
    -- 2> the RRC message excluding the GSM part, does not contain a length determinant;
    -- there is no explicit parameter indicating the size of the included GSM message.
    -- 3> depending on need, final padding (all "0"s) is added to ensure the final result
    -- comprises a full number of octets
    single-GSM-Message SEQUENCE {},
    gsm-MessageList SEQUENCE {
      gsm-Messages GSM-MessageList
    }
  }
}

HandoverFromUTRANCommand-GSM-r6-IEs ::= SEQUENCE {
  -- User equipment IEs
  activationTime ActivationTime OPTIONAL,
  -- Radio bearer IEs
  toHandoverRAB-Info RAB-InformationList-r6 OPTIONAL,
  -- Measurement IEs
  frequency-band Frequency-Band,
  -- Other IEs
  gsm-message CHOICE {
    -- In the single-GSM-Message case the following rules apply:
    -- 1> the GSM message directly follows the basic production; the final padding that
    -- results when PER encoding the abstract syntax value is removed prior to appending
    -- the GSM message.
    -- 2> the RRC message excluding the GSM part, does not contain a length determinant;
    -- there is no explicit parameter indicating the size of the included GSM message.
    -- 3> depending on need, final padding (all "0"s) is added to ensure the final result
    -- comprises a full number of octets
    single-GSM-Message SEQUENCE {},
    gsm-MessageList SEQUENCE {
      gsm-Messages GSM-MessageList
    }
  }
}

```

```

    },
    geran-SystemInfoType          CHOICE {
        sI                        GERAN-SystemInformation,
        pSI                       GERAN-SystemInformation
    } OPTIONAL
}

HandoverFromUTRANCommand-GSM-v690ext-IEs ::= SEQUENCE {
    geran-SystemInfoType          CHOICE {
        sI                        GERAN-SystemInformation,
        pSI                       GERAN-SystemInformation
    } OPTIONAL
}

HandoverFromUTRANCommand-GSM-v860ext-IEs ::= SEQUENCE {
    sr-vcc-SecurityRABInfo        SR-VCC-SecurityRABInfo-v860ext    OPTIONAL
}

HandoverFromUTRANCommand-GERANIu ::= SEQUENCE {
    rrc-TransactionIdentifier      RRC-TransactionIdentifier,
    handoverFromUTRANCommand-GERANIu CHOICE {
        r5                          SEQUENCE {
            handoverFromUTRANCommand-GERANIu-r5
            HandoverFromUTRANCommand-GERANIu-r5-IEs,
            -- UTRAN should not include the IE nonCriticalExtensions when it sets
            -- the IE geranIu-message included in handoverFromUTRANCommand-GERANIu-r5 to
            -- single-GERANIu-Message
            -- The UE behaviour upon receiving a message including this combination of IE values is
            -- not specified
            nonCriticalExtensions    SEQUENCE {} OPTIONAL
        },
        later-than-r5                SEQUENCE {
            criticalExtensions        SEQUENCE {}
        }
    }
}

HandoverFromUTRANCommand-GERANIu-r5-IEs ::= SEQUENCE {
    -- User equipment IEs
    activationTime                  ActivationTime                    OPTIONAL,
    -- Measurement IEs
    frequency-Band                  Frequency-Band,
    -- Other IEs
    geranIu-Message                  CHOICE {
        -- In the single-GERANIu-Message case the following rules apply:
        -- 1> the GERAN Iu message directly follows the basic production; the final padding that
        -- results when PER encoding the abstract syntax value is removed prior to appending
        -- the GERAN Iu message.
        -- 2> the RRC message excluding the GERAN Iu part does not contain a length determinant;
        -- there is no explicit parameter indicating the size of the included GERAN Iu
        -- message.
        -- 3> depending on need, final padding (all "0"s) is added to ensure the final result
        -- comprises a full number of octets.
        single-GERANIu-Message        SEQUENCE {},
        geranIu-MessageList            SEQUENCE {
            geranIu-Messages            GERANIu-MessageList
        }
    }
}

HandoverFromUTRANCommand-CDMA2000 ::= CHOICE {
    r3                               SEQUENCE {
        handoverFromUTRANCommand-CDMA2000-r3
        HandoverFromUTRANCommand-CDMA2000-r3-IEs,
        laterNonCriticalExtensions    SEQUENCE {
            -- Container for additional R99 extensions
            handoverFromUTRANCommand-CDMA2000-r3-add-ext
            nonCriticalExtensions      BIT STRING    OPTIONAL,
            SEQUENCE {}                OPTIONAL
        } OPTIONAL
    },
    later-than-r3                     SEQUENCE {
        rrc-TransactionIdentifier      RRC-TransactionIdentifier,
        criticalExtensions              SEQUENCE {}
    }
}

HandoverFromUTRANCommand-CDMA2000-r3-IEs ::= SEQUENCE {

```

```

-- User equipment IEs
  rrc-TransactionIdentifier      RRC-TransactionIdentifier,
  activationTime                  ActivationTime                      OPTIONAL,
-- Radio bearer IEs
  toHandoverRAB-Info             RAB-Info                          OPTIONAL,
-- Other IEs
  cdma2000-MessageList           CDMA2000-MessageList
}

HandoverFromUTRANCommand-EUTRA ::= SEQUENCE {
  rrc-TransactionIdentifier      RRC-TransactionIdentifier,
  criticalExtensions             CHOICE {
    r8                           SEQUENCE {
      handoverFromUTRANCommand-EUTRA-r8  HandoverFromUTRANCommand-EUTRA-r8-IEs,
      handoverFromUTRANCommand-EUTRA-r8-add-ext
                                     BIT STRING      OPTIONAL,
      nonCriticalExtensions           SEQUENCE {}      OPTIONAL
    },
    criticalExtensions            SEQUENCE {}
  }
}

HandoverFromUTRANCommand-EUTRA-r8-IEs ::= SEQUENCE {
-- User equipment IEs
  activationTime                  ActivationTime                      OPTIONAL,
-- Radio bearer IEs
  toHandoverRAB-Info             RAB-InformationList              OPTIONAL,
-- Other IEs
  eutra-Message                  OCTET STRING
}

-- *****
--
-- HANDOVER FROM UTRAN FAILURE
--
-- *****

HandoverFromUTRANFailure ::= SEQUENCE {
-- User equipment IEs
  rrc-TransactionIdentifier      RRC-TransactionIdentifier,
-- Other IEs
  interRAT-HO-FailureCause       InterRAT-HO-FailureCause          OPTIONAL,
-- In case the interRATMessage to be transferred is for GERAN Iu mode, the
-- message should be placed in the HandoverFromUtranFailure-v590ext-IEs
-- non-critical extension container.
-- In case the interRATMessage to be transferred is for E-UTRA, the
-- message should be placed in the HandoverFromUtranFailure-v860ext-IEs
-- non-critical extension container.
  interRATMessage                CHOICE {
    gsm                           SEQUENCE {
      gsm-MessageList             GSM-MessageList
    },
    cdma2000                       SEQUENCE {
      cdma2000-MessageList        CDMA2000-MessageList
    }
  } OPTIONAL,
  laterNonCriticalExtensions      SEQUENCE {
-- Container for additional R99 extensions
  handoverFromUTRANFailure-r3-add-ext  BIT STRING  OPTIONAL,
  v590NonCriticalExtensions          SEQUENCE {
    handoverFromUTRANFailure-v590ext  HandoverFromUtranFailure-v590ext-IEs,
    v860NonCriticalExtensions         SEQUENCE {
      handoverFromUTRANFailure-v860ext  HandoverFromUtranFailure-v860ext-IEs,
      nonCriticalExtensions             SEQUENCE {}      OPTIONAL
    } OPTIONAL
  } OPTIONAL
} OPTIONAL
}

HandoverFromUtranFailure-v590ext-IEs ::= SEQUENCE {
  geranIu-MessageList            GERANIu-MessageList          OPTIONAL
}

HandoverFromUtranFailure-v860ext-IEs ::= SEQUENCE {
  eutra-Message                  OCTET STRING                      OPTIONAL
}

-- *****

```

```

--
-- INTER RAT HANDOVER INFO
--
-- *****

InterRATHandoverInfo ::= SEQUENCE {
  -- This structure is defined for historical reasons, backward compatibility with 44.018
  predefinedConfigStatusList CHOICE {
    absent NULL,
    present PredefinedConfigStatusList
  },
  uE-SecurityInformation CHOICE {
    absent NULL,
    present UE-SecurityInformation
  },
  ue-CapabilityContainer CHOICE {
    absent NULL,
    -- present is an octet aligned string containing IE UE-RadioAccessCapabilityInfo
    present OCTET STRING (SIZE (0..63))
  },
  -- Non critical extensions
  v390NonCriticalExtensions CHOICE {
    absent NULL,
    present SEQUENCE {
      interRATHandoverInfo-v390ext InterRATHandoverInfo-v390ext-IEs,
      v3a0NonCriticalExtensions SEQUENCE {
        interRATHandoverInfo-v3a0ext InterRATHandoverInfo-v3a0ext-IEs,
        laterNonCriticalExtensions SEQUENCE {
          interRATHandoverInfo-v3d0ext InterRATHandoverInfo-v3d0ext-IEs,
          -- Container for additional R99 extensions
          interRATHandoverInfo-r3-add-ext BIT STRING
            (CONTAINING InterRATHandoverInfo-r3-add-ext-IEs) OPTIONAL,
          v3g0NonCriticalExtensions SEQUENCE {
            interRATHandoverInfo-v3g0ext InterRATHandoverInfo-v3g0ext-IEs,
            v4b0NonCriticalExtensions SEQUENCE {
              interRATHandoverInfo-v4b0ext InterRATHandoverInfo-v4b0ext-IEs,
              v4d0NonCriticalExtensions SEQUENCE {
                interRATHandoverInfo-v4d0ext InterRATHandoverInfo-v4d0ext-IEs,
                -- Reserved for future non critical extension
                v590NonCriticalExtensions SEQUENCE {
                  interRATHandoverInfo-v590ext
                    InterRATHandoverInfo-v590ext-IEs,
                  v690NonCriticalExtensions SEQUENCE {
                    interRATHandoverInfo-v690ext
                      InterRATHandoverInfo-v690ext-IEs,
                    v6b0NonCriticalExtensions
                      InterRATHandoverInfo-NonCriticalExtension-v6b0-IEs OPTIONAL
                    } OPTIONAL
                  } OPTIONAL
                } OPTIONAL
              } OPTIONAL
            } OPTIONAL
          } OPTIONAL
        } OPTIONAL
      } OPTIONAL
    } OPTIONAL
  } OPTIONAL
}

InterRATHandoverInfo-v390ext-IEs ::= SEQUENCE {
  -- User equipment IEs
  ue-RadioAccessCapability-v380ext UE-RadioAccessCapability-v380ext OPTIONAL,
  dl-PhysChCapabilityFDD-v380ext DL-PhysChCapabilityFDD-v380ext
}

InterRATHandoverInfo-v3a0ext-IEs ::= SEQUENCE {
  -- User equipment IEs
  ue-RadioAccessCapability-v3a0ext UE-RadioAccessCapability-v3a0ext OPTIONAL
}

InterRATHandoverInfo-v3d0ext-IEs ::= SEQUENCE {
  -- User equipment IEs
  uESpecificBehaviourInformation1interRAT UESpecificBehaviourInformation1interRAT OPTIONAL
}

InterRATHandoverInfo-v3g0ext-IEs ::= SEQUENCE {
  -- User equipment IEs
  ue-RadioAccessCapability-v3g0ext UE-RadioAccessCapability-v3g0ext OPTIONAL
}

```

```

InterRATHandoverInfo-r3-add-ext-IEs ::= SEQUENCE {
    interRATHandoverInfo-v690ext1      InterRATHandoverInfo-v690ext1-IEs,
    v7e0NonCriticalExtensions           SEQUENCE {
        interRATHandoverInfo-v7e0ext    InterRATHandoverInfo-v7e0ext-IEs,
        v7f0NonCriticalExtensions       SEQUENCE {
            interRATHandoverInfo-v7f0ext InterRATHandoverInfo-v7f0ext-IEs,
            nonCriticalExtensions        SEQUENCE {} OPTIONAL
        } OPTIONAL
    } OPTIONAL
}

InterRATHandoverInfo-v4b0ext-IEs ::= SEQUENCE {
    -- User equipment IEs
    accessStratumReleaseIndicator      AccessStratumReleaseIndicator
}

InterRATHandoverInfo-v4d0ext-IEs ::= SEQUENCE {
    -- User equipment IEs
    tdd128-RF-Capability               RadioFrequencyBandTDDList      OPTIONAL
}

InterRATHandoverInfo-v590ext-IEs ::= SEQUENCE {
    -- User equipment IEs
    predefinedConfigStatusListComp     PredefinedConfigStatusListComp    OPTIONAL,
    ue-RadioAccessCapabilityComp       UE-RadioAccessCapabilityComp      OPTIONAL
}

InterRATHandoverInfo-v690ext1-IEs ::= SEQUENCE {
    -- User equipment IEs
    ue-RadioAccessCapability-v650ext   UE-RadioAccessCapability-v650ext  OPTIONAL
}

InterRATHandoverInfo-v690ext-IEs ::= SEQUENCE {
    -- User equipment IEs
    ue-SecurityInformation2            UE-SecurityInformation2           OPTIONAL,
    ue-RadioAccessCapabilityComp       UE-RadioAccessCapabilityComp-ext  OPTIONAL,
    ue-RadioAccessCapabilityComp2      UE-RadioAccessCapabilityComp2
}

InterRATHandoverInfo-NonCriticalExtension-v6b0-IEs ::= SEQUENCE {
    interRATHandoverInfo-v6b0ext      InterRATHandoverInfo-v6b0ext-IEs,
    v6e0NonCriticalExtensions         SEQUENCE {
        interRATHandoverInfo-v6e0ext  InterRATHandoverInfo-v6e0ext-IEs,
        v770NonCriticalExtensions     SEQUENCE {
            interRATHandoverInfo-v770ext InterRATHandoverInfo-v770ext-IEs,
            v790nonCriticalExtensions  SEQUENCE {
                interRATHandoverInfo-v790ext InterRATHandoverInfo-v790ext-IEs,
                v860NonCriticalExtensions  SEQUENCE {
                    interRATHandoverInfo-v860ext InterRATHandoverInfo-v860ext-IEs,
                    v880NonCriticalExtensions SEQUENCE {
                        interRATHandoverInfo-v880ext InterRATHandoverInfo-v880ext-IEs,
                        v920NonCriticalExtensions SEQUENCE {
                            interRATHandoverInfo-v920ext InterRATHandoverInfo-v920ext-IEs,
                            v8b0NonCriticalExtensions SEQUENCE {
                                interRATHandoverInfo-v8b0ext
                                    InterRATHandoverInfo-v8b0ext-IEs,
                                nonCriticalExtensions
                                    SEQUENCE {} OPTIONAL
                            } OPTIONAL
                        } OPTIONAL
                    } OPTIONAL
                } OPTIONAL
            } OPTIONAL
        } OPTIONAL
    } OPTIONAL
}

InterRATHandoverInfo-v6b0ext-IEs ::= SEQUENCE {
    -- User equipment IEs
    supportForSIB11bis                 ENUMERATED { true }              OPTIONAL
}

InterRATHandoverInfo-v6e0ext-IEs ::= SEQUENCE {
    -- User equipment IEs
    supportForFDPCCH                   ENUMERATED { true }              OPTIONAL
}

InterRATHandoverInfo-v770ext-IEs ::= SEQUENCE {

```

```

    ue-RadioAccessCapabilityInfo      UE-RadioAccessCapabilityInfo-v770ext  OPTIONAL,
    ue-RadioAccessCapabilityComp      UE-RadioAccessCapabilityComp-v770ext  OPTIONAL,
    ue-RadioAccessCapabilityComp2     UE-RadioAccessCapabilityComp2-v770ext OPTIONAL
  }
}

InterRATHandoverInfo-v790ext-IEs ::= SEQUENCE {
  -- User equipment IEs
  supportForEDPCCHPowerBoosting      ENUMERATED { true }      OPTIONAL
}

InterRATHandoverInfo-v7e0ext-IEs ::= SEQUENCE {
  -- User equipment IEs
  ue-RadioAccessCapability           UE-RadioAccessCapability-v7e0ext  OPTIONAL
}

InterRATHandoverInfo-v7f0ext-IEs ::= SEQUENCE {
  -- User equipment IEs
  ue-RadioAccessCapability           UE-RadioAccessCapability-v7f0ext  OPTIONAL,
  ue-RadioAccessCapabilityComp2     UE-RadioAccessCapabilityComp2-v7f0ext OPTIONAL
}

InterRATHandoverInfo-v860ext-IEs ::= SEQUENCE {
  ue-RadioAccessCapabilityInfo       UE-RadioAccessCapability-v860ext  OPTIONAL,
  ue-RadioAccessCapabilityComp2     UE-RadioAccessCapabilityComp2-v860ext OPTIONAL
}

InterRATHandoverInfo-v880ext-IEs ::= SEQUENCE {
  -- UE radio access capability
  ue-RadioAccessCapabilityInfo       UE-RadioAccessCapability-v880ext  OPTIONAL,
  ue-RadioAccessCapabilityInfo-TDD128 UE-RadioAccessCapabilityComp-TDD128 OPTIONAL
}

InterRATHandoverInfo-v920ext-IEs ::= SEQUENCE {
  -- The IE "UE-RadioAccessCapability-v920ext" and "UE-RadioAccessCapabilityComp2-v920ext"
  -- should not be included in this version of specification, and if received they should be
  -- ignored.
  ue-RadioAccessCapabilityInfo       UE-RadioAccessCapability-v920ext  OPTIONAL,
  ue-RadioAccessCapabilityComp2     UE-RadioAccessCapabilityComp2-v920ext  OPTIONAL
}

InterRATHandoverInfo-v8b0ext-IEs ::= SEQUENCE {
  -- UE radio access capability
  ue-RadioAccessCapabilityInfo       UE-RadioAccessCapabilityInfo-TDD128-v8b0ext OPTIONAL
}

-- *****
--
-- MEASUREMENT CONTROL
--
-- *****

MeasurementControl ::= CHOICE {
  -- The Rel-4 functionality of UE Positioning OTDOA AssistanceData TDD is only available
  -- in the later-than-r3 branch of this message (i.e. through the use of the IE
  -- ue-Positioning-OTDOA-AssistanceData-r4)
  r3 SEQUENCE {
    measurementControl-r3           MeasurementControl-r3-IEs,
    v390nonCriticalExtensions       SEQUENCE {
      measurementControl-v390ext     MeasurementControl-v390ext,
      v3a0NonCriticalExtensions      SEQUENCE {
        measurementControl-v3a0ext   MeasurementControl-v3a0ext,
        laterNonCriticalExtensions   SEQUENCE {
          -- Container for additional R99 extensions
          measurementControl-r3-add-ext BIT STRING OPTIONAL,
          v4b0NonCriticalExtensions     SEQUENCE{
            -- The content of the v4b0 non-critical extension has been removed. If sent
            -- to a UE of AS release 4, the UE behaviour is unspecified. A UE of AS
            -- release 5 onward shall comply with the v4b0 and later extensions in this
            -- branch of the message.
            v590NonCriticalExtensions SEQUENCE {
              measurementControl-v590ext MeasurementControl-v590ext-IEs,
              v5b0NonCriticalExtensions SEQUENCE {
                measurementControl-v5b0ext MeasurementControl-v5b0ext-IEs,
                nonCriticalExtensions     SEQUENCE {} OPTIONAL
              }
            } OPTIONAL
          } OPTIONAL
        } OPTIONAL
      } OPTIONAL
    } OPTIONAL
  } OPTIONAL
}

```



```

    }
  },
  later-than-r3 SEQUENCE {
    -- Least significant part of extended "RRC transaction identifier" (Rel-5 onward)
    rrc-TransactionIdentifier RRC-TransactionIdentifier,
    criticalExtensions CHOICE {
      r4 SEQUENCE {
        measurementControl-r4 MeasurementControl-r4-IEs,
        v4d0NonCriticalExtensions SEQUENCE {
          -- Container for adding non critical extensions after freezing REL-5
          measurementControl-r4-add-ext BIT STRING OPTIONAL,
          v590NonCriticalExtensions SEQUENCE {
            measurementControl-v590ext MeasurementControl-v590ext-IEs,
            v5b0NonCriticalExtensions SEQUENCE {
              measurementControl-v5b0ext MeasurementControl-v5b0ext-IEs,
              nonCriticalExtensions SEQUENCE {} OPTIONAL
            } OPTIONAL
          } OPTIONAL
        } OPTIONAL
      } OPTIONAL
    },
    later-than-r4 SEQUENCE {
      -- Most significant part of extended "RRC transaction identifier" (MSP):
      -- extended "RRC transaction identifier" =
      -- rrc-TransactionIdentifier-MSP * 4 + rrc-TransactionIdentifier
      rrc-TransactionIdentifier-MSP RRC-TransactionIdentifier,
      criticalExtensions CHOICE {
        r6 SEQUENCE {
          measurementControl-r6 MeasurementControl-r6-IEs,
          v6a0NonCriticalExtensions SEQUENCE {
            measurementControl-v6a0ext MeasurementControl-v6a0ext-IEs,
            nonCriticalExtensions SEQUENCE {} OPTIONAL
          } OPTIONAL
        },
        criticalExtensions CHOICE {
          r7 SEQUENCE {
            measurementControl-r7 MeasurementControl-r7-IEs,
            -- Container for adding non critical extensions after freezing REL-7
            measurementControl-r7-add-ext BIT STRING OPTIONAL,
            v7b0NonCriticalExtensions SEQUENCE {
              measurementControl-v7b0ext MeasurementControl-v7b0ext-IEs,
              nonCriticalExtensions SEQUENCE {} OPTIONAL
            } OPTIONAL
          },
          criticalExtensions CHOICE {
            r8 SEQUENCE {
              measurementControl-r8 MeasurementControl-r8-IEs,
              -- Container for adding non critical extensions after freezing REL-9
              measurementControl-r8-add-ext BIT STRING OPTIONAL,
              v8a0NonCriticalExtensions SEQUENCE {
                measurementControl-v8a0ext MeasurementControl-v8a0ext-IEs,
                nonCriticalExtensions SEQUENCE {} OPTIONAL
              } OPTIONAL
            }
          }
        },
        criticalExtensions SEQUENCE {}
      }
    }
  }
}

MeasurementControl-r3-IEs ::= SEQUENCE {
  -- User equipment IEs
  rrc-TransactionIdentifier RRC-TransactionIdentifier,
  -- Measurement IEs
  measurementIdentity MeasurementIdentity,
  -- TABULAR: The measurement type is included in MeasurementCommand.
  measurementCommand MeasurementCommand,
  measurementReportingMode MeasurementReportingMode OPTIONAL,
  additionalMeasurementList AdditionalMeasurementID-List OPTIONAL,
  -- Physical channel IEs
  dpch-CompressedModeStatusInfo DPCH-CompressedModeStatusInfo OPTIONAL
}

MeasurementControl-v390ext ::= SEQUENCE {
  ue-Positioning-Measurement-v390ext UE-Positioning-Measurement-v390ext OPTIONAL
}

```

```

}

MeasurementControl-v3a0ext ::= SEQUENCE {
    sfn-Offset-Validity          SFN-Offset-Validity          OPTIONAL
}

MeasurementControl-r4-IEs ::= SEQUENCE {
    -- Measurement IEs
    measurementIdentity          MeasurementIdentity,
    -- TABULAR: The measurement type is included in measurementCommand.
    measurementCommand          MeasurementCommand-r4,
    measurementReportingMode    MeasurementReportingMode    OPTIONAL,
    additionalMeasurementList   AdditionalMeasurementID-List OPTIONAL,
    -- Physical channel IEs
    dpch-CompressedModeStatusInfo DPCH-CompressedModeStatusInfo    OPTIONAL
}

MeasurementControl-v590ext-IEs ::= SEQUENCE {
    measurementCommand-v590ext   CHOICE {
        -- the choice "intra-frequency" shall be used for the case of intra-frequency measurement,
        -- as well as when intra-frequency events are configured for inter-frequency measurement
        intra-frequency          Intra-FreqEventCriteriaList-v590ext,
        inter-frequency          Inter-FreqEventCriteriaList-v590ext
    }
    OPTIONAL,
    intraFreqReportingCriteria-1b-r5 IntraFreqReportingCriteria-1b-r5    OPTIONAL,
    intraFreqEvent-1d-r5           IntraFreqEvent-1d-r5           OPTIONAL,
    -- Most significant part of extended "RRC transaction identifier" (MSP):
    -- extended "RRC transaction identifier" =
    -- rrc-TransactionIdentifier-MSP-v590ext * 4 + rrc-TransactionIdentifier
    rrc-TransactionIdentifier-MSP-v590ext RRC-TransactionIdentifier
}

MeasurementControl-v5b0ext-IEs ::= SEQUENCE {
    interRATCellInfoIndication  InterRATCellInfoIndication    OPTIONAL
}

MeasurementControl-r6-IEs ::= SEQUENCE {
    -- Measurement IEs
    measurementIdentity          MeasurementIdentity,
    -- TABULAR: The measurement type is included in measurementCommand.
    measurementCommand          MeasurementCommand-r6,
    measurementReportingMode    MeasurementReportingMode    OPTIONAL,
    additionalMeasurementList   AdditionalMeasurementID-List OPTIONAL,
    -- Physical channel IEs
    dpch-CompressedModeStatusInfo DPCH-CompressedModeStatusInfo    OPTIONAL
}

MeasurementControl-v6a0ext-IEs ::= SEQUENCE {
    intraFreqReportingCriteria-1b-r5 IntraFreqReportingCriteria-1b-r5    OPTIONAL
}

MeasurementControl-r7-IEs ::= SEQUENCE {
    -- Measurement IEs
    measurementIdentity          MeasurementIdentity,
    -- TABULAR: The measurement type is included in measurementCommand.
    measurementCommand          MeasurementCommand-r7,
    measurementReportingMode    MeasurementReportingMode    OPTIONAL,
    additionalMeasurementList   AdditionalMeasurementID-List OPTIONAL,
    -- Physical channel IEs
    dpch-CompressedModeStatusInfo DPCH-CompressedModeStatusInfo    OPTIONAL
}

MeasurementControl-v7b0ext-IEs ::= SEQUENCE {
    -- Measurement IEs
    newInterFreqCellList        NewInterFreqCellList-v7b0ext    OPTIONAL
}

MeasurementControl-r8-IEs ::= SEQUENCE {
    -- Measurement IEs
    measurementIdentity          MeasurementIdentity,
    -- TABULAR: The measurement type is included in measurementCommand.
    measurementCommand          MeasurementCommand-r8,
    measurementReportingMode    MeasurementReportingMode    OPTIONAL,
    additionalMeasurementList   AdditionalMeasurementID-List OPTIONAL,
    -- Physical channel IEs
    dpch-CompressedModeStatusInfo DPCH-CompressedModeStatusInfo    OPTIONAL
}

```

```

MeasurementControl-v8a0ext-IEs ::= SEQUENCE {
  -- Measurement IEs
  newIntraFreqCellList          NewIntraFreqCellList-LCR-v8a0ext          OPTIONAL,
  newInterFreqCellList          NewInterFreqCellList-LCR-v8a0ext          OPTIONAL
}

-- *****
--
-- MEASUREMENT CONTROL FAILURE
--
-- *****

MeasurementControlFailure ::= SEQUENCE {
  -- User equipment IEs
  -- Least significant part of extended "RRC transaction identifier" (Rel-5 onward)
  rrc-TransactionIdentifier      RRC-TransactionIdentifier,
  failureCause                   FailureCauseWithProtErr,
  laterNonCriticalExtensions      SEQUENCE {
    -- Container for additional R99 extensions
    measurementControlFailure-r3-add-ext      BIT STRING          OPTIONAL,
    v590NonCriticalExtensions                  SEQUENCE {
      measurementControlFailure-v590ext      MeasurementControlFailure-v590ext-IEs,
      nonCriticalExtensions                  SEQUENCE {}          OPTIONAL
    } OPTIONAL
  } OPTIONAL
}

MeasurementControlFailure-v590ext-IEs ::= SEQUENCE {
  -- Most significant part of extended "RRC transaction identifier" (MSP):
  -- extended "RRC transaction identifier" =
  -- rrc-TransactionIdentifier-MSP-v590ext * 4 + rrc-TransactionIdentifier
  -- If the rrc-TransactionIdentifier-MSP-v590ext was not received in the MEASUREMENT CONTROL
  -- message, then the rrc-TransactionIdentifier-MSP-v590ext shall be set to zero
  rrc-TransactionIdentifier-MSP-v590ext      RRC-TransactionIdentifier
}

-- *****
--
-- MEASUREMENT REPORT
--
-- *****

MeasurementReport ::= SEQUENCE {
  -- Measurement IEs
  measurementIdentity             MeasurementIdentity,
  measuredResults                 MeasuredResults                 OPTIONAL,
  measuredResultsOnRACH           MeasuredResultsOnRACH           OPTIONAL,
  additionalMeasuredResults       MeasuredResultsList             OPTIONAL,
  eventResults                    EventResults                 OPTIONAL,
  -- Non-critical extensions
  v390nonCriticalExtensions        SEQUENCE {
    measurementReport-v390ext      MeasurementReport-v390ext,
    laterNonCriticalExtensions      SEQUENCE {
      -- Container for additional R99 extensions
      measurementReport-r3-add-ext  BIT STRING          OPTIONAL,
      v4b0NonCriticalExtensions     SEQUENCE {
        measurementReport-v4b0ext  MeasurementReport-v4b0ext-IEs,
        -- Extension mechanism for non-Rel4 information
        v590NonCriticalExtensions  SEQUENCE {
          measurementReport-v590ext MeasurementReport-v590ext-IEs,
          v5b0NonCriticalExtensions SEQUENCE {
            measurementReport-v5b0ext MeasurementReport-v5b0ext-IEs,
            v690NonCriticalExtensions SEQUENCE {
              measurementReport-v690ext MeasurementReport-v690ext-IEs,
              v770NonCriticalExtensions SEQUENCE {
                measurementReport-v770ext MeasurementReport-v770ext-IEs,
                v860NonCriticalExtensions SEQUENCE {
                  measurementReport-v860ext MeasurementReport-v860ext-IEs,
                  nonCriticalExtensions SEQUENCE {}          OPTIONAL
                } OPTIONAL
              } OPTIONAL
            } OPTIONAL
          } OPTIONAL
        } OPTIONAL
      } OPTIONAL
    } OPTIONAL
  } OPTIONAL
}

```

```

}

MeasurementReport-v390ext ::= SEQUENCE {
    measuredResults-v390ext      MeasuredResults-v390ext      OPTIONAL
}

MeasurementReport-v4b0ext-IEs ::= SEQUENCE {
    interFreqEventResults-LCR      InterFreqEventResults-LCR-r4-ext      OPTIONAL,
    -- additionalMeasuredResults-LCR shall contain measurement results and additional measurement
    -- results list.
    additionalMeasuredResults-LCR  MeasuredResultsList-LCR-r4-ext      OPTIONAL,
    -- dummy is not used in this version of the specification. It should not be sent and
    -- if received it should be ignored.
    dummy                          PrimaryCPICH-Info          OPTIONAL
}

MeasurementReport-v590ext-IEs ::= SEQUENCE {
    measuredResults-v590ext      MeasuredResults-v590ext      OPTIONAL
}

MeasurementReport-v5b0ext-IEs ::= SEQUENCE {
    interRATCellInfoIndication    InterRATCellInfoIndication    OPTIONAL
}

MeasurementReport-v690ext-IEs ::= SEQUENCE {
    measuredResultsOnRACHinterFreq MeasuredResultsOnRACHinterFreq OPTIONAL
}

MeasurementReport-v770ext-IEs ::= SEQUENCE {
    measuredResults                MeasuredResults-v770ext      OPTIONAL,
    additionalMeasuredResults      MeasuredResultsList-v770ext  OPTIONAL,
    eventResults                   EventResults-v770ext         OPTIONAL,
    ue-Positioning-OTDOA-MeasuredResults
                                  UE-Positioning-OTDOA-MeasuredResultsTDD-ext  OPTIONAL
}

MeasurementReport-v860ext-IEs ::= SEQUENCE {
    activationTime                 ActivationTime                 OPTIONAL,
    measuredResults                 MeasuredResults-v860ext      OPTIONAL,
    additionalMeasuredResults       MeasuredResultsList-v860ext  OPTIONAL,
    eventResults                   EventResults-v860ext         OPTIONAL,
    eutra-MeasuredResults           EUTRA-MeasuredResults        OPTIONAL,
    eutra-EventResults             EUTRA-EventResults          OPTIONAL
}

-- *****
--
-- PAGING TYPE 1
--
-- *****

PagingType1 ::= SEQUENCE {
    -- User equipment IEs
    pagingRecordList               PagingRecordList             OPTIONAL,
    -- Other IEs
    bcch-ModificationInfo          BCCH-ModificationInfo        OPTIONAL,
    laterNonCriticalExtensions      SEQUENCE {
        -- Container for additional R99 extensions
        pagingType1-r3-add-ext      BIT STRING                   OPTIONAL,
        v590NonCriticalExtensions  SEQUENCE {
            pagingType1-v590ext     PagingType1-v590ext-IEs,
            v860NonCriticalExtensions
                                  SEQUENCE {
                pagingType1-v860ext PagingType1-v860ext-IEs,
                nonCriticalExtensions
                                  SEQUENCE {} OPTIONAL
            } OPTIONAL
        } OPTIONAL
    } OPTIONAL
}

PagingType1-v590ext-IEs ::= SEQUENCE {
    -- User equipment IEs
    pagingRecord2List              PagingRecord2List-r5         OPTIONAL
}

PagingType1-v860ext-IEs ::= SEQUENCE {
    -- Other IEs
    etws-Information               ETWS-Information            OPTIONAL
}

```

```

-- *****
--
-- PAGING TYPE 2
--
-- *****

PagingType2 ::= SEQUENCE {
  -- User equipment IEs
  rrc-TransactionIdentifier      RRC-TransactionIdentifier,
  pagingCause                    PagingCause,
  -- Core network IEs
  cn-DomainIdentity              CN-DomainIdentity,
  pagingRecordTypeID             PagingRecordTypeID,
  laterNonCriticalExtensions      SEQUENCE {
    -- Container for additional R99 extensions
    pagingType2-r3-add-ext       BIT STRING      OPTIONAL,
    nonCriticalExtensions        SEQUENCE {}      OPTIONAL
  } OPTIONAL
}

-- *****
--
-- PHYSICAL CHANNEL RECONFIGURATION
--
-- *****

PhysicalChannelReconfiguration ::= CHOICE {
  r3                               SEQUENCE {
    physicalChannelReconfiguration-r3
    PhysicalChannelReconfiguration-r3-IEs,
    v3a0NonCriticalExtensions      SEQUENCE {
      physicalChannelReconfiguration-v3a0ext      PhysicalChannelReconfiguration-v3a0ext,
      laterNonCriticalExtensions      SEQUENCE {
        -- Container for additional R99 extensions
        physicalChannelReconfiguration-r3-add-ext      BIT STRING      OPTIONAL,
        v4b0NonCriticalExtensitions      SEQUENCE {
          physicalChannelReconfiguration-v4b0ext
          PhysicalChannelReconfiguration-v4b0ext-IEs,
          v590NonCriticalExtensitions      SEQUENCE {
            physicalChannelReconfiguration-v590ext
            PhysicalChannelReconfiguration-v590ext-IEs,
            v690NonCriticalExtensions      SEQUENCE {
              physicalChannelReconfiguration-v690ext
              PhysicalChannelReconfiguration-v690ext-IEs,
              v770NonCriticalExtensions      SEQUENCE {
                physicalChannelReconfiguration-v770ext
                PhysicalChannelReconfiguration-v770ext-IEs,
                nonCriticalExtensions        SEQUENCE {}      OPTIONAL
              } OPTIONAL
            } OPTIONAL
          } OPTIONAL
        } OPTIONAL
      } OPTIONAL
    } OPTIONAL
  } OPTIONAL
},
  later-than-r3                     SEQUENCE {
    rrc-TransactionIdentifier      RRC-TransactionIdentifier,
    criticalExtensions             CHOICE {
      r4                               SEQUENCE {
        physicalChannelReconfiguration-r4
        PhysicalChannelReconfiguration-r4-IEs,
        v4d0NonCriticalExtensions      SEQUENCE {
          -- Container for adding non critical extensions after freezing REL-5
          physicalChannelReconfiguration-r4-add-ext      BIT STRING      OPTIONAL,
          v590NonCriticalExtensitions      SEQUENCE {
            physicalChannelReconfiguration-v590ext
            PhysicalChannelReconfiguration-v590ext-IEs,
            v690NonCriticalExtensions      SEQUENCE {
              physicalChannelReconfiguration-v690ext
              PhysicalChannelReconfiguration-v690ext-IEs,
              v770NonCriticalExtensions      SEQUENCE {
                physicalChannelReconfiguration-v770ext
                PhysicalChannelReconfiguration-v770ext-IEs,
                nonCriticalExtensions        SEQUENCE {}      OPTIONAL
              } OPTIONAL
            } OPTIONAL
          } OPTIONAL
        } OPTIONAL
      } OPTIONAL
    } OPTIONAL
  } OPTIONAL
}

```

```

    } OPTIONAL
  },
criticalExtensions
  r5 CHOICE {
    SEQUENCE {
      physicalChannelReconfiguration-r5
        PhysicalChannelReconfiguration-r5-IEs,
      -- Container for adding non critical extensions after freezing REL-6
      physicalChannelReconfiguration-r5-add-ext BIT STRING OPTIONAL,
      v690NonCriticalExtensions SEQUENCE {
        physicalChannelReconfiguration-v690ext
          PhysicalChannelReconfiguration-v690ext-IEs,
      v770NonCriticalExtensions SEQUENCE {
        physicalChannelReconfiguration-v770ext
          PhysicalChannelReconfiguration-v770ext-IEs,
        nonCriticalExtensions SEQUENCE {} OPTIONAL
      } OPTIONAL
    } OPTIONAL
  } OPTIONAL
},
criticalExtensions
  r6 CHOICE {
    SEQUENCE {
      physicalChannelReconfiguration-r6
        PhysicalChannelReconfiguration-r6-IEs,
      -- Container for adding non critical extensions after freezing REL-7
      physicalChannelReconfiguration-r6-add-ext BIT STRING OPTIONAL,
      v6b0NonCriticalExtensions SEQUENCE {
        physicalChannelReconfiguration-v6b0ext
          PhysicalChannelReconfiguration-v6b0ext-IEs,
      v770NonCriticalExtensions SEQUENCE {
        physicalChannelReconfiguration-v770ext
          PhysicalChannelReconfiguration-v770ext-IEs,
        nonCriticalExtensions SEQUENCE {} OPTIONAL
      } OPTIONAL
    } OPTIONAL
  } OPTIONAL
},
criticalExtensions
  r7 CHOICE {
    SEQUENCE {
      physicalChannelReconfiguration-r7
        PhysicalChannelReconfiguration-r7-IEs,
      -- Container for adding non critical extensions after freezing REL-8
      physicalChannelReconfiguration-r7-add-ext BIT STRING OPTIONAL,
      v780NonCriticalExtensions SEQUENCE {
        physicalChannelReconfiguration-v780ext
          PhysicalChannelReconfiguration-v780ext-IEs,
      v7d0NonCriticalExtensions SEQUENCE {
        physicalChannelReconfiguration-v7d0ext
          PhysicalChannelReconfiguration-v7d0ext-IEs,
      v7f0NonCriticalExtensions SEQUENCE {
        physicalChannelReconfiguration-v7f0ext
          PhysicalChannelReconfiguration-v7f0ext-IEs,
      v7g0NonCriticalExtensions SEQUENCE {
        physicalChannelReconfiguration-v7g0ext
          PhysicalChannelReconfiguration-v7g0ext-IEs,
        nonCriticalExtensions SEQUENCE {} OPTIONAL
      } OPTIONAL
    } OPTIONAL
  } OPTIONAL
},
criticalExtensions
  r8 CHOICE {
    SEQUENCE {
      physicalChannelReconfiguration-r8
        PhysicalChannelReconfiguration-r8-IEs,
      -- Container for adding non critical extensions after freezing REL-9
      physicalChannelReconfiguration-r8-add-ext BIT STRING OPTIONAL,
      v7d0NonCriticalExtensions SEQUENCE {
        physicalChannelReconfiguration-v7d0ext
          PhysicalChannelReconfiguration-v7d0ext-IEs,
      v7f0NonCriticalExtensions SEQUENCE {
        physicalChannelReconfiguration-v7f0ext
          PhysicalChannelReconfiguration-v7f0ext-IEs,
      v890NonCriticalExtensions SEQUENCE {
        physicalChannelReconfiguration-v890ext
          PhysicalChannelReconfiguration-v890ext-IEs,
      v7g0NonCriticalExtensions SEQUENCE {
        physicalChannelReconfiguration-v7g0ext
          PhysicalChannelReconfiguration-v7g0ext-IEs,
      v8a0NonCriticalExtensions SEQUENCE {
        physicalChannelReconfiguration-v8a0ext

```



```

new-C-RNTI                C-RNTI                OPTIONAL,
-- The IE "new-DSCH-RNTI" should not be included in FDD mode, and if received
-- the UE behaviour is unspecified
new-DSCH-RNTI            DSCH-RNTI                OPTIONAL,
rrc-StateIndicator       RRC-StateIndicator,
utran-DRX-CycleLengthCoeff  UTRAN-DRX-CycleLengthCoefficient  OPTIONAL,
-- Core network IEs
  cn-InformationInfo      CN-InformationInfo      OPTIONAL,
-- UTRAN mobility IEs
  ura-Identity            URA-Identity            OPTIONAL,
-- Radio bearer IEs
  dl-CounterSynchronisationInfo  DL-CounterSynchronisationInfo  OPTIONAL,
-- Physical channel IEs
  frequencyInfo           FrequencyInfo           OPTIONAL,
  maxAllowedUL-TX-Power   MaxAllowedUL-TX-Power   OPTIONAL,
  -- Note: the reference to CPCH in the element name below is incorrect. The name is not
  -- changed to keep it aligned with R99.
  ul-ChannelRequirement   UL-ChannelRequirementWithCPCH-SetID-r4  OPTIONAL,
  modeSpecificInfo        CHOICE {
    fdd                    SEQUENCE {
      -- dummy is not used in this version of specification, it should
      -- not be sent and if received it should be ignored.
      dummy                 DL-PDSCH-Information  OPTIONAL
    },
    tdd                    NULL
  },
  dl-CommonInformation    DL-CommonInformation-r4  OPTIONAL,
  dl-InformationPerRL-List  DL-InformationPerRL-List-r4  OPTIONAL
}

```

```

PhysicalChannelReconfiguration-r5-IEs ::= SEQUENCE {
-- User equipment IEs
  integrityProtectionModeInfo  IntegrityProtectionModeInfo  OPTIONAL,
  cipheringModeInfo            CipheringModeInfo            OPTIONAL,
  activationTime                ActivationTime                OPTIONAL,
  new-U-RNTI                    U-RNTI                    OPTIONAL,
  new-C-RNTI                    C-RNTI                    OPTIONAL,
  -- The IE "new-DSCH-RNTI" should not be included in FDD mode, and if received
  -- the UE behaviour is unspecified
  new-DSCH-RNTI                DSCH-RNTI                OPTIONAL,
  new-H-RNTI                    H-RNTI                    OPTIONAL,
  rrc-StateIndicator           RRC-StateIndicator,
  utran-DRX-CycleLengthCoeff   UTRAN-DRX-CycleLengthCoefficient  OPTIONAL,
-- Core network IEs
  cn-InformationInfo           CN-InformationInfo           OPTIONAL,
-- UTRAN mobility IEs
  ura-Identity                  URA-Identity                  OPTIONAL,
-- Radio bearer IEs
  dl-CounterSynchronisationInfo  DL-CounterSynchronisationInfo-r5  OPTIONAL,
-- Physical channel IEs
  frequencyInfo                 FrequencyInfo                 OPTIONAL,
  maxAllowedUL-TX-Power         MaxAllowedUL-TX-Power         OPTIONAL,
  -- Note: the reference to CPCH in the element name below is incorrect. The name is not
  -- changed to keep it aligned with R99.
  ul-ChannelRequirement         UL-ChannelRequirementWithCPCH-SetID-r5  OPTIONAL,
  modeSpecificInfo              CHOICE {
    fdd                          SEQUENCE {
      -- dummy is not used in this version of specification, it should
      -- not be sent and if received it should be ignored.
      dummy                       DL-PDSCH-Information  OPTIONAL
    },
    tdd                          NULL
  },
  dl-HSPDSCH-Information        DL-HSPDSCH-Information        OPTIONAL,
  dl-CommonInformation          DL-CommonInformation-r5        OPTIONAL,
  dl-InformationPerRL-List      DL-InformationPerRL-List-r5    OPTIONAL
}

```

```

PhysicalChannelReconfiguration-r6-IEs ::= SEQUENCE {
-- User equipment IEs
  integrityProtectionModeInfo  IntegrityProtectionModeInfo  OPTIONAL,
  cipheringModeInfo            CipheringModeInfo            OPTIONAL,
  activationTime                ActivationTime                OPTIONAL,
  delayRestrictionFlag         DelayRestrictionFlag         OPTIONAL,
  new-U-RNTI                    U-RNTI                    OPTIONAL,
  new-C-RNTI                    C-RNTI                    OPTIONAL,
  -- The IE "new-DSCH-RNTI" should not be included in FDD mode,
  -- and if received the UE behaviour is unspecified

```



```

    new-DSCH-RNTI          DSCH-RNTI          OPTIONAL,
    new-H-RNTI             H-RNTI          OPTIONAL,
    newPrimary-E-RNTI     E-RNTI          OPTIONAL,
    newSecondary-E-RNTI   E-RNTI          OPTIONAL,
    rrc-StateIndicator    RRC-StateIndicator,
    utran-DRX-CycleLengthCoeff  UTRAN-DRX-CycleLengthCoefficient  OPTIONAL,
-- Core network IEs
  cn-InformationInfo      CN-InformationInfo-r6      OPTIONAL,
-- UTRAN mobility IEs
  ura-Identity            URA-Identity            OPTIONAL,
-- Radio bearer IEs
  dl-CounterSynchronisationInfo  DL-CounterSynchronisationInfo-r5  OPTIONAL,
-- Physical channel IEs
  frequencyInfo           FrequencyInfo           OPTIONAL,
  maxAllowedUL-TX-Power   MaxAllowedUL-TX-Power   OPTIONAL,
  ul-DPCH-Info            UL-DPCH-Info-r6            OPTIONAL,
  ul-EDCH-Information     UL-EDCH-Information-r6   OPTIONAL,
  dl-HSPDSCH-Information  DL-HSPDSCH-Information-r6  OPTIONAL,
  dl-CommonInformation    DL-CommonInformation-r6  OPTIONAL,
  dl-InformationPerRL-List  DL-InformationPerRL-List-r6  OPTIONAL,
-- MBMS IEs
  mbms-PL-ServiceRestrictInfo  MBMS-PL-ServiceRestrictInfo-r6  OPTIONAL
}

PhysicalChannelReconfiguration-v690ext-IEs ::= SEQUENCE {
-- User Equipment IEs
  delayRestrictionFlag    DelayRestrictionFlag      OPTIONAL,
-- Core network IEs
  primary-plmn-Identity    PLMN-Identity            OPTIONAL,
-- Physical channel IEs
  -- The IE harq-Preamble-Mode should not be used in the r3 and r4 versions of the message
  -- If included in the r3 or r4 version of the message, the UE should ignore the IE
  harq-Preamble-Mode      HARQ-Preamble-Mode        OPTIONAL,
  beaconPLEst              BEACON-PL-Est              OPTIONAL,
  postVerificationPeriod  ENUMERATED { true }      OPTIONAL,
  dhs-sync                  DHS-Sync                    OPTIONAL,
  timingMaintainedSynchInd  TimingMaintainedSynchInd  OPTIONAL,
-- MBMS IEs
  mbms-PL-ServiceRestrictInfo  MBMS-PL-ServiceRestrictInfo-r6  OPTIONAL
}

PhysicalChannelReconfiguration-v6b0ext-IEs ::= SEQUENCE {
-- Physical channel IEs
  dl-InformationPerRL-List-v6b0ext  DL-InformationPerRL-List-v6b0ext  OPTIONAL
}

PhysicalChannelReconfiguration-r7-IEs ::= SEQUENCE {
-- User equipment IEs
  integrityProtectionModeInfo  IntegrityProtectionModeInfo-r7  OPTIONAL,
  cipheringModeInfo            CipheringModeInfo-r7            OPTIONAL,
  activationTime                ActivationTime                    OPTIONAL,
  delayRestrictionFlag          DelayRestrictionFlag            OPTIONAL,
  new-U-RNTI                    U-RNTI                          OPTIONAL,
  new-C-RNTI                    C-RNTI                          OPTIONAL,
  -- The IE "new-DSCH-RNTI" should not be included in FDD mode,
  -- and if received the UE behaviour is unspecified
  new-DSCH-RNTI                DSCH-RNTI                        OPTIONAL,
  new-H-RNTI                    H-RNTI                          OPTIONAL,
  newPrimary-E-RNTI            E-RNTI                          OPTIONAL,
  newSecondary-E-RNTI          E-RNTI                          OPTIONAL,
  rrc-StateIndicator            RRC-StateIndicator,
  ueMobilityStateIndicator      High-MobilityDetected           OPTIONAL,
  utran-DRX-CycleLengthCoeff    UTRAN-DRX-CycleLengthCoefficient-r7  OPTIONAL,
-- Core network IEs
  cn-InformationInfo            CN-InformationInfo-r6            OPTIONAL,
-- UTRAN mobility IEs
  ura-Identity                  URA-Identity                    OPTIONAL,
  supportForChangeOfUE-Capability  BOOLEAN                          OPTIONAL,
  responseToChangeOfUE-Capability  ENUMERATED { true }            OPTIONAL,
-- Radio bearer IEs
  dl-CounterSynchronisationInfo  DL-CounterSynchronisationInfo-r5  OPTIONAL,
-- Physical channel IEs
  frequencyInfo                 FrequencyInfo                     OPTIONAL,
  multi-frequencyInfo            Multi-frequencyInfo-LCR-r7       OPTIONAL,
  dtx-drx-TimingInfo            DTX-DRX-TimingInfo-r7           OPTIONAL,
  dtx-drx-Info                   DTX-DRX-Info-r7                 OPTIONAL,
  hs-scch-LessInfo               HS-SCCH-LessInfo-r7              OPTIONAL,
  mimoParameters                 MIMO-Parameters-r7              OPTIONAL,

```

```

    maxAllowedUL-TX-Power      MaxAllowedUL-TX-Power      OPTIONAL,
    ul-DPCH-Info               UL-DPCH-Info-r7                OPTIONAL,
    ul-EDCH-Information         UL-EDCH-Information-r7        OPTIONAL,
    dl-HSPDSCH-Information     DL-HSPDSCH-Information-r7    OPTIONAL,
    dl-CommonInformation       DL-CommonInformation-r7      OPTIONAL,
    dl-InformationPerRL-List   DL-InformationPerRL-List-r7  OPTIONAL,
  -- MBMS IEs
    mbms-PL-ServiceRestrictInfo MBMS-PL-ServiceRestrictInfo-r6 OPTIONAL
}

PhysicalChannelReconfiguration-v770ext-IEs ::= SEQUENCE {
  -- User equipment IEs
    ueMobilityStateIndicator      High-MobilityDetected          OPTIONAL
}

PhysicalChannelReconfiguration-v780ext-IEs ::= SEQUENCE {
  -- Transport channel IEs
    harqInfo                      HARQ-Info-r7                   OPTIONAL,
  -- Physical channel IEs
    hs-DSCH-TBSizeTable          HS-DSCH-TBSizeTable           OPTIONAL
}

PhysicalChannelReconfiguration-v7d0ext-IEs ::= SEQUENCE {
  -- Physical channel IEs
    ul-EDCH-Information           UL-EDCH-Information-ext       OPTIONAL
}

PhysicalChannelReconfiguration-v7f0ext-IEs ::= SEQUENCE {
  -- Physical channel IEs
    mimoParameters               MIMO-Parameters-v7f0ext      OPTIONAL
}

PhysicalChannelReconfiguration-v7g0ext-IEs ::= SEQUENCE {
  -- Physical channel IEs
    mimoParameters               MIMO-Parameters-v7g0ext      OPTIONAL
}

PhysicalChannelReconfiguration-r8-IEs ::= SEQUENCE {
  -- User equipment IEs
    integrityProtectionModeInfo   IntegrityProtectionModeInfo-r7 OPTIONAL,
    cipheringModeInfo            CipheringModeInfo-r7          OPTIONAL,
    activationTime               ActivationTime                 OPTIONAL,
    delayRestrictionFlag         DelayRestrictionFlag          OPTIONAL,
    new-U-RNTI                   U-RNTI                       OPTIONAL,
    new-C-RNTI                   C-RNTI                       OPTIONAL,
    -- The IE "new-DSCH-RNTI" should not be included in FDD mode,
    -- and if received the UE behaviour is unspecified
    new-DSCH-RNTI                DSCH-RNTI                    OPTIONAL,
    new-H-RNTI                   H-RNTI                       OPTIONAL,
    newPrimary-E-RNTI            E-RNTI                       OPTIONAL,
    newSecondary-E-RNTI          E-RNTI                       OPTIONAL,
    rrc-StateIndicator           RRC-StateIndicator,
    ueMobilityStateIndicator      High-MobilityDetected          OPTIONAL,
    utran-DRX-CycleLengthCoeff   UTRAN-DRX-CycleLengthCoefficient-r7 OPTIONAL,
  -- Core network IEs
    cn-InformationInfo           CN-InformationInfo-r6         OPTIONAL,
  -- UTRAN mobility IEs
    ura-Identity                 URA-Identity                 OPTIONAL,
    supportForChangeOfUE-Capability BOOLEAN                          OPTIONAL,
    responseToChangeOfUE-Capability ENUMERATED { true }              OPTIONAL,
  -- Radio bearer IEs
    dl-CounterSynchronisationInfo DL-CounterSynchronisationInfo-r5 OPTIONAL,
  -- Transport channel IEs
    harqInfo                      HARQ-Info-r7                   OPTIONAL,
  -- Physical channel IEs
    frequencyInfo                FrequencyInfo                   OPTIONAL,
    multi-frequencyInfo           Multi-frequencyInfo-LCR-r7     OPTIONAL,
    dtx-drx-TimingInfo           DTX-DRX-TimingInfo-r7        OPTIONAL,
    dtx-drx-Info                 DTX-DRX-Info-r7              OPTIONAL,
    hs-scch-LessInfo             HS-SCCH-LessInfo-r7          OPTIONAL,
    mimoParameters               MIMO-Parameters-r8           OPTIONAL,
    maxAllowedUL-TX-Power        MaxAllowedUL-TX-Power         OPTIONAL,
    ul-DPCH-Info                 UL-DPCH-Info-r7              OPTIONAL,
    ul-EDCH-Information           UL-EDCH-Information-r8        OPTIONAL,
    dl-HSPDSCH-Information       DL-HSPDSCH-Information-r8     OPTIONAL,
    dl-CommonInformation         DL-CommonInformation-r8       OPTIONAL,
    dl-InformationPerRL-List     DL-InformationPerRL-List-r8   OPTIONAL,
    dl-SecondaryCellInfoFDD       DL-SecondaryCellInfoFDD       OPTIONAL,

```

```

        controlChannelDRXInfo-TDD128      ControlChannelDRXInfo-TDD128-r8      OPTIONAL,
        sps-Information-TDD128             SPS-Information-TDD128-r8             OPTIONAL,
    -- MBMS IEs
        mbms-PL-ServiceRestrictInfo        MBMS-PL-ServiceRestrictInfo-r6        OPTIONAL
    }

PhysicalChannelReconfiguration-v890ext-IEs ::= SEQUENCE {
    -- User Equipment IEs
        dl-SecondaryCellInfoFDD-v890ext    DL-SecondaryCellInfoFDD-v890ext      OPTIONAL,
    -- Physical channel IEs
        dl-HSPDSCH-Information             DL-HSPDSCH-Information-r8-ext        OPTIONAL
    }

PhysicalChannelReconfiguration-v8a0ext-IEs ::= SEQUENCE {
    -- Physical channel IEs
        dl-HSPDSCH-Information             DL-HSPDSCH-Information-r8-ext2       OPTIONAL
    }

-- *****
--
-- PHYSICAL CHANNEL RECONFIGURATION COMPLETE
--
-- *****

PhysicalChannelReconfigurationComplete ::= SEQUENCE {
    -- User equipment IEs
        rrc-TransactionIdentifier          RRC-TransactionIdentifier,
        ul-IntegProtActivationInfo         IntegrityProtActivationInfo           OPTIONAL,
    -- TABULAR: UL-TimingAdvance is applicable for TDD mode only.
        ul-TimingAdvance                   UL-TimingAdvance                     OPTIONAL,
    -- Radio bearer IEs
        count-C-ActivationTime             ActivationTime                         OPTIONAL,
    -- dummy is not used in this version of the specification and
    -- it should be ignored by the receiver.
        dummy                               RB-ActivationTimeInfoList            OPTIONAL,
        ul-CounterSynchronisationInfo      UL-CounterSynchronisationInfo        OPTIONAL,
        laterNonCriticalExtensions         SEQUENCE {
            -- Container for additional R99 extensions
            physicalChannelReconfigurationComplete-r3-add-ext    BIT STRING    OPTIONAL,
            v770NonCriticalExtensions    SEQUENCE {
                physicalChannelReconfigurationComplete-v770ext
                PhysicalChannelReconfigurationComplete-v770ext-IEs,
            } OPTIONAL
        } OPTIONAL
    }

PhysicalChannelReconfigurationComplete-v770ext-IEs ::= SEQUENCE {
    -- TABULAR: EXT-UL-TimingAdvance is applicable for TDD mode only.
        ext-UL-TimingAdvance               EXT-UL-TimingAdvance                 OPTIONAL,
        deferredMeasurementControlReading   ENUMERATED { true }                 OPTIONAL
    }

-- *****
--
-- PHYSICAL CHANNEL RECONFIGURATION FAILURE
--
-- *****

PhysicalChannelReconfigurationFailure ::= SEQUENCE {
    -- User equipment IEs
        rrc-TransactionIdentifier          RRC-TransactionIdentifier           OPTIONAL,
        failureCause                       FailureCauseWithProtErr,
        laterNonCriticalExtensions         SEQUENCE {
            -- Container for additional R99 extensions
            physicalChannelReconfigurationFailure-r3-add-ext    BIT STRING    OPTIONAL,
            nonCriticalExtensions    SEQUENCE {}    OPTIONAL
        } OPTIONAL
    }

-- *****
--
-- PHYSICAL SHARED CHANNEL ALLOCATION (TDD only)
--
-- *****

PhysicalSharedChannelAllocation ::= CHOICE {

```

```

r3
    SEQUENCE {
    physicalSharedChannelAllocation-r3
        PhysicalSharedChannelAllocation-r3-IEs,
    laterNonCriticalExtensions
        SEQUENCE {
        -- Container for additional R99 extensions
        physicalSharedChannelAllocation-r3-add-ext
            BIT STRING
            OPTIONAL,
        nonCriticalExtensions
            SEQUENCE {}
            OPTIONAL
        }
    },
    later-than-r3
        SEQUENCE {
        dsch-RNTI
            DSCH-RNTI
            OPTIONAL,
        rrc-TransactionIdentifier
            RRC-TransactionIdentifier,
        criticalExtensions
            CHOICE {
            r4
                SEQUENCE {
                physicalSharedChannelAllocation-r4
                    PhysicalSharedChannelAllocation-r4-IEs,
                v4d0NonCriticalExtensions
                    SEQUENCE {
                    -- Container for adding non critical extensions after freezing REL-5
                    physicalSharedChannelAllocation-r4-add-ext
                        BIT STRING
                        OPTIONAL,
                    v690NonCriticalExtensions
                        SEQUENCE {
                        physicalSharedChannelAllocation-v690ext
                            PhysicalSharedChannelAllocation-v690ext-IEs,
                            SEQUENCE {}
                            OPTIONAL,
                        v770NonCriticalExtensions
                            SEQUENCE {
                            physicalSharedChannelAllocation-v770ext
                                PhysicalSharedChannelAllocation-v770ext-IEs,
                                SEQUENCE {}
                                OPTIONAL,
                            nonCriticalExtensions
                                SEQUENCE {}
                                OPTIONAL
                            }
                        }
                    }
                }
            }
        },
        criticalExtensions
            SEQUENCE {}
    }
}

PhysicalSharedChannelAllocation-r3-IEs ::= SEQUENCE {
-- TABULAR: Integrity protection shall not be performed on this message.
-- User equipment IEs
    dsch-RNTI
        DSCH-RNTI
        OPTIONAL,
    rrc-TransactionIdentifier
        RRC-TransactionIdentifier,
-- Physical channel IEs
    ul-TimingAdvance
        UL-TimingAdvanceControl
        OPTIONAL,
    pusch-CapacityAllocationInfo
        PUSCH-CapacityAllocationInfo
        OPTIONAL,
    pdsch-CapacityAllocationInfo
        PDSCH-CapacityAllocationInfo
        OPTIONAL,
-- TABULAR: If confirmRequest is not present, the default value "No Confirm"
-- shall be used as specified in 10.2.25.
    confirmRequest
        ENUMERATED {
        confirmPDSCH, confirmPUSCH }
        OPTIONAL,
    trafficVolumeReportRequest
        INTEGER (0..255)
        OPTIONAL,
    iscpTimeslotList
        TimeslotList
        OPTIONAL,
    requestPCCPCHRSCP
        BOOLEAN
}

PhysicalSharedChannelAllocation-r4-IEs ::= SEQUENCE {
-- TABULAR: Integrity protection shall not be performed on this message.
-- Physical channel IEs
    ul-TimingAdvance
        UL-TimingAdvanceControl-r4
        OPTIONAL,
    pusch-CapacityAllocationInfo
        PUSCH-CapacityAllocationInfo-r4
        OPTIONAL,
    pdsch-CapacityAllocationInfo
        PDSCH-CapacityAllocationInfo-r4
        OPTIONAL,
-- TABULAR: If confirmRequest is not present, the default value "No Confirm"
-- shall be used as specified in 10.2.25.
    confirmRequest
        ENUMERATED {
        confirmPDSCH, confirmPUSCH }
        OPTIONAL,
    trafficVolumeReportRequest
        INTEGER (0..255)
        OPTIONAL,
    iscpTimeslotList
        TimeslotList-r4
        OPTIONAL,
    requestPCCPCHRSCP
        BOOLEAN
}

PhysicalSharedChannelAllocation-v690ext-IEs ::= SEQUENCE {
-- Physical Channel IEs
    beaconPLEst
        BEACON-PL-Est
        OPTIONAL
}

PhysicalSharedChannelAllocation-v770ext-IEs ::= SEQUENCE {
    ul-TimingAdvance
        UL-TimingAdvanceControl-r7
        OPTIONAL,
    pusch-CapacityAllocationInfo
        PUSCH-CapacityAllocationInfo-r7
        OPTIONAL,
    pdsch-CapacityAllocationInfo
        PDSCH-CapacityAllocationInfo-r7
        OPTIONAL
}

```

```

-- *****
--
-- PUSCH CAPACITY REQUEST (TDD only)
--
-- *****

PUSCHCapacityRequest ::= SEQUENCE {
  -- User equipment IEs
  dsch-RNTI                DSCH-RNTI                OPTIONAL,
  -- Measurement IEs
  trafficVolume            TrafficVolumeMeasuredResultsList OPTIONAL,
  timeslotListWithISCP    TimeslotListWithISCP    OPTIONAL,
  primaryCCPCH-RSCP       PrimaryCCPCH-RSCP       OPTIONAL,
  allocationConfirmation   CHOICE {
    pdschConfirmation      PDSCH-Identity,
    puschConfirmation      PUSCH-Identity
  } OPTIONAL,
  protocolErrorIndicator  ProtocolErrorIndicatorWithMoreInfo,
  laterNonCriticalExtensions SEQUENCE {
    -- Container for additional R99 extensions
    puschCapacityRequest-r3-add-ext BIT STRING OPTIONAL,
    v590NonCriticalExtensions SEQUENCE {
      puschCapacityRequest-v590ext PUSCHCapacityRequest-v590ext,
      nonCriticalExtensions SEQUENCE {} OPTIONAL
    } OPTIONAL
  } OPTIONAL
}

PUSCHCapacityRequest-v590ext ::= SEQUENCE {
  primaryCCPCH-RSCP-delta DeltaRSCP OPTIONAL
}

-- *****
--
-- RADIO BEARER RECONFIGURATION
--
-- *****

RadioBearerReconfiguration ::= CHOICE {
  r3 SEQUENCE {
    radioBearerReconfiguration-r3 RadioBearerReconfiguration-r3-IEs,
    -- Prefix "v3ao" is used (in one instance) to keep alignment with R99
    v3aoNonCriticalExtensions SEQUENCE {
      radioBearerReconfiguration-v3a0ext RadioBearerReconfiguration-v3a0ext,
      laterNonCriticalExtensions SEQUENCE {
        -- Container for additional R99 extensions
        radioBearerReconfiguration-r3-add-ext BIT STRING OPTIONAL,
        v4b0NonCriticalExtensions SEQUENCE {
          radioBearerReconfiguration-v4b0ext
            RadioBearerReconfiguration-v4b0ext-IEs,
          v590NonCriticalExtensions SEQUENCE {
            radioBearerReconfiguration-v590ext
              RadioBearerReconfiguration-v590ext-IEs,
            v5d0NonCriticalExtensions SEQUENCE {
              radioBearerReconfiguration-v5d0ext
                RadioBearerReconfiguration-v5d0ext-IEs,
            v690NonCriticalExtensions SEQUENCE {
              radioBearerReconfiguration-v690ext
                RadioBearerReconfiguration-v690ext-IEs,
            v770NonCriticalExtensions SEQUENCE {
              radioBearerReconfiguration-v770ext
                RadioBearerReconfiguration-v770ext-IEs,
            nonCriticalExtensions SEQUENCE {} OPTIONAL
          } OPTIONAL
        } OPTIONAL
      } OPTIONAL
    } OPTIONAL
  } OPTIONAL
},
  later-than-r3 SEQUENCE {
    rrc-TransactionIdentifier RRC-TransactionIdentifier,
    criticalExtensions CHOICE {
      r4 SEQUENCE {
        radioBearerReconfiguration-r4 RadioBearerReconfiguration-r4-IEs,
        v4d0NonCriticalExtensions SEQUENCE {

```

```

-- Container for adding non critical extensions after freezing REL-5
radioBearerReconfiguration-r4-add-ext      BIT STRING      OPTIONAL,
v590NonCriticalExtensions                  SEQUENCE {
  radioBearerReconfiguration-v590ext
    RadioBearerReconfiguration-v590ext-IEs,
v5d0NonCriticalExtensstions                SEQUENCE {
  radioBearerReconfiguration-v5d0ext
    RadioBearerReconfiguration-v5d0ext-IEs,
v690NonCriticalExtensions                  SEQUENCE {
  radioBearerReconfiguration-v690ext
    RadioBearerReconfiguration-v690ext-IEs,
v770NonCriticalExtensions                  SEQUENCE {
  radioBearerReconfiguration-v770ext
    RadioBearerReconfiguration-v770ext-IEs,
  nonCriticalExtensions                    SEQUENCE {}      OPTIONAL
} OPTIONAL
} OPTIONAL
} OPTIONAL
},
criticalExtensions                         CHOICE {
  r5
    radioBearerReconfiguration-r5          RadioBearerReconfiguration-r5-IEs,
    -- Container for adding non critical extensions after freezing REL-6
    radioBearerReconfiguration-r5-add-ext  BIT STRING      OPTIONAL,
    v5d0NonCriticalExtensstions            SEQUENCE {
      radioBearerReconfiguration-v5d0ext  RadioBearerReconfiguration-v5d0ext-IEs,
      v690NonCriticalExtensions            SEQUENCE {
        radioBearerReconfiguration-v690ext
          RadioBearerReconfiguration-v690ext-IEs,
      v770NonCriticalExtensions            SEQUENCE {
        radioBearerReconfiguration-v770ext
          RadioBearerReconfiguration-v770ext-IEs,
        nonCriticalExtensions              SEQUENCE {}      OPTIONAL
      } OPTIONAL
    } OPTIONAL
  } OPTIONAL
},
criticalExtensions                         CHOICE {
  r6
    radioBearerReconfiguration-r6          RadioBearerReconfiguration-r6-IEs,
    -- Container for adding non critical extensions after freezing REL-7
    radioBearerReconfiguration-r6-add-ext  BIT STRING      OPTIONAL,
    v6b0NonCriticalExtensions              SEQUENCE {
      radioBearerReconfiguration-v6b0ext
        RadioBearerReconfiguration-v6b0ext-IEs,
    v6f0NonCriticalExtensions              SEQUENCE {
      radioBearerRconfiguration-v6f0ext
        RadioBearerReconfiguration-v6f0ext-IEs,
    v770NonCriticalExtensions              SEQUENCE {
      radioBearerReconfiguration-v770ext
        RadioBearerReconfiguration-v770ext-IEs,
        nonCriticalExtensions              SEQUENCE {}      OPTIONAL
      } OPTIONAL
    } OPTIONAL
  } OPTIONAL
},
criticalExtensions                         CHOICE {
  r7
    radioBearerReconfiguration-r7          RadioBearerReconfiguration-r7-IEs,
    v780NonCriticalExtensions              SEQUENCE {
      radioBearerReconfiguration-v780ext
        RadioBearerReconfiguration-v780ext-IEs,
    v790NonCriticalExtensions              SEQUENCE {
      radioBearerReconfiguration-v790ext
        RadioBearerReconfiguration-v790ext-IEs,
    v7d0NonCriticalExtensions              SEQUENCE {
      radioBearerReconfiguration-v7d0ext
        RadioBearerReconfiguration-v7d0ext-IEs,
    v7f0NonCriticalExtensions              SEQUENCE {
      radioBearerReconfiguration-v7f0ext
        RadioBearerReconfiguration-v7f0ext-IEs,
    v7g0NonCriticalExtensions              SEQUENCE {
      radioBearerReconfiguration-v7g0ext
        RadioBearerReconfiguration-v7g0ext-IEs,
        nonCriticalExtensions              SEQUENCE {}      OPTIONAL
      } OPTIONAL
    } OPTIONAL
  } OPTIONAL
}

```



```

frequencyInfo          FrequencyInfo          OPTIONAL,
maxAllowedUL-TX-Power  MaxAllowedUL-TX-Power  OPTIONAL,
ul-ChannelRequirement  UL-ChannelRequirement  OPTIONAL,
modeSpecificPhysChInfo CHOICE {
  fdd                   SEQUENCE {
    -- dummy is not used in this version of specification, it should
    -- not be sent and if received it should be ignored.
    dummy                DL-PDSCH-Information  OPTIONAL
  },
  tdd                   NULL
},
dl-CommonInformation   DL-CommonInformation  OPTIONAL,
-- NOTE: IE dl-InformationPerRL-List is optional in later versions
-- of this message
dl-InformationPerRL-List DL-InformationPerRL-List
}

RadioBearerReconfiguration-v3a0ext ::= SEQUENCE {
  -- The IE "new-DSCH-RNTI" should not be included in FDD mode, and if received the UE behaviour
  -- is unspecified
  new-DSCH-RNTI          DSCH-RNTI          OPTIONAL
}

RadioBearerReconfiguration-v4b0ext-IEs ::= SEQUENCE {
  -- Physical channel IEs
  -- dummy is not used in this version of the specification, it should
  -- not be sent and if received it should be ignored.
  dummy                  SSdT-UL          OPTIONAL,
  -- The order of the RLs in IE cell-id-PerRL-List is the same as
  -- in IE DL-InformationPerRL-List included in this message
  cell-id-PerRL-List    CellIdentity-PerRL-List  OPTIONAL
}

RadioBearerReconfiguration-v590ext-IEs ::= SEQUENCE {
  -- Physical channel IEs
  dl-TPC-PowerOffsetPerRL-List DL-TPC-PowerOffsetPerRL-List  OPTIONAL
}

RadioBearerReconfiguration-v5d0ext-IEs ::= SEQUENCE {
  --Radio Bearer IEs
  pdcp-ROHC-TargetMode    PDCP-ROHC-TargetMode    OPTIONAL
}

RadioBearerReconfiguration-r4-IEs ::= SEQUENCE {
  -- User equipment IEs
  integrityProtectionModeInfo IntegrityProtectionModeInfo  OPTIONAL,
  cipheringModeInfo        CipheringModeInfo            OPTIONAL,
  activationTime           ActivationTime                OPTIONAL,
  new-U-RNTI               U-RNTI                      OPTIONAL,
  new-C-RNTI               C-RNTI                      OPTIONAL,
  -- The IE "new-DSCH-RNTI" should not be included in FDD mode, and if received
  -- the UE behaviour is unspecified
  new-DSCH-RNTI           DSCH-RNTI                    OPTIONAL,
  rrc-StateIndicator       RRC-StateIndicator,          OPTIONAL,
  utran-DRX-CycleLengthCoeff UTRAN-DRX-CycleLengthCoefficient  OPTIONAL,
  -- Core network IEs
  cn-InformationInfo       CN-InformationInfo            OPTIONAL,
  -- UTRAN mobility IEs
  ura-Identity             URA-Identity                  OPTIONAL,
  -- Radio bearer IEs
  rab-InformationReconfigList RAB-InformationReconfigList  OPTIONAL,
  rb-InformationReconfigList RB-InformationReconfigList-r4  OPTIONAL,
  rb-InformationAffectedList RB-InformationAffectedList    OPTIONAL,
  -- Transport channel IEs
  ul-CommonTransChInfo     UL-CommonTransChInfo-r4          OPTIONAL,
  ul-deletedTransChInfoList UL-DeletedTransChInfoList    OPTIONAL,
  ul-AddReconfTransChInfoList UL-AddReconfTransChInfoList  OPTIONAL,
  -- 'dummy', 'dummy1' and 'dummy2' are not used in this version of the specification,
  -- they should not be sent and if received they should be ignored.
  dummy                    CHOICE {
    fdd                     SEQUENCE {
      dummy1                CPCH-SetID                OPTIONAL,
      dummy2                DRAC-StaticInformationList  OPTIONAL
    },
    tdd                     NULL
  }
  dl-CommonTransChInfo     DL-CommonTransChInfo-r4          OPTIONAL,
  dl-DeletedTransChInfoList DL-DeletedTransChInfoList    OPTIONAL,
}

```



```

    dl-AddReconfTransChInfoList      DL-AddReconfTransChInfoList-r4      OPTIONAL,
-- Physical channel IEs
frequencyInfo                        FrequencyInfo                        OPTIONAL,
maxAllowedUL-TX-Power                MaxAllowedUL-TX-Power                OPTIONAL,
ul-ChannelRequirement                UL-ChannelRequirement-r4            OPTIONAL,
modeSpecificPhysChInfo               CHOICE {
    fdd                               SEQUENCE {
        -- dummy is not used in this version of specification, it should
        -- not be sent and if received it should be ignored.
        dummy                          DL-PDSCH-Information                OPTIONAL
    },
    tdd                               NULL
},
dl-CommonInformation                 DL-CommonInformation-r4              OPTIONAL,
dl-InformationPerRL-List              DL-InformationPerRL-List-r4          OPTIONAL
}

RadioBearerReconfiguration-r5-IEs ::= SEQUENCE {
-- User equipment IEs
integrityProtectionModeInfo          IntegrityProtectionModeInfo          OPTIONAL,
cipheringModeInfo                    CipheringModeInfo                    OPTIONAL,
activationTime                        ActivationTime                        OPTIONAL,
new-U-RNTI                            U-RNTI                              OPTIONAL,
new-C-RNTI                            C-RNTI                              OPTIONAL,
-- The IE "new-DSCH-RNTI" should not be included in FDD mode, and if received
-- the UE behaviour is unspecified
new-DSCH-RNTI                        DSCH-RNTI                           OPTIONAL,
new-H-RNTI                            H-RNTI                              OPTIONAL,
rrc-StateIndicator                   RRC-StateIndicator,
utran-DRX-CycleLengthCoeff            UTRAN-DRX-CycleLengthCoefficient    OPTIONAL,
-- Core network IEs
cn-InformationInfo                    CN-InformationInfo                  OPTIONAL,
-- UTRAN mobility IEs
ura-Identity                          URA-Identity                        OPTIONAL,
-- Specification mode information
specificationMode                     CHOICE {
    complete                           SEQUENCE {
        -- Radio bearer IEs
        rab-InformationReconfigList     RAB-InformationReconfigList         OPTIONAL,
        rb-InformationReconfigList       RB-InformationReconfigList-r5       OPTIONAL,
        rb-InformationAffectedList       RB-InformationAffectedList-r5       OPTIONAL,
        rb-PDCPContextRelocationList    RB-PDCPContextRelocationList       OPTIONAL,
        -- Transport channel IEs
        ul-CommonTransChInfo            UL-CommonTransChInfo-r4            OPTIONAL,
        ul-deletedTransChInfoList        UL-DeletedTransChInfoList          OPTIONAL,
        ul-AddReconfTransChInfoList      UL-AddReconfTransChInfoList        OPTIONAL,
        -- 'dummy', 'dummy1' and 'dummy2' are not used in this version of the
        -- specification, they should not be sent and if received they should be ignored.
        dummy                            CHOICE {
            fdd                           SEQUENCE {
                dummy1                     CPCH-SetID                          OPTIONAL,
                dummy2                     DRAC-StaticInformationList          OPTIONAL
            },
            tdd                           NULL
        }
    },
    dl-CommonTransChInfo                 DL-CommonTransChInfo-r4            OPTIONAL,
    dl-DeletedTransChInfoList             DL-DeletedTransChInfoList-r5       OPTIONAL,
    dl-AddReconfTransChInfoList           DL-AddReconfTransChInfoList-r5     OPTIONAL
},
preconfiguration                       SEQUENCE {
-- All IEs that include an FDD/TDD choice are split in two IEs for this message,
-- one for the FDD only elements and one for the TDD only elements, so that one
-- FDD/TDD choice in this level is sufficient.
preConfigMode                           CHOICE {
    predefinedConfigIdentity              PredefinedConfigIdentity,
    defaultConfig                         SEQUENCE {
        defaultConfigMode                 DefaultConfigMode,
        defaultConfigIdentity              DefaultConfigIdentity-r5
    }
}
},
-- Physical channel IEs
frequencyInfo                            FrequencyInfo                            OPTIONAL,
maxAllowedUL-TX-Power                      MaxAllowedUL-TX-Power                      OPTIONAL,
ul-ChannelRequirement                      UL-ChannelRequirement-r5                  OPTIONAL,
modeSpecificPhysChInfo                     CHOICE {
    fdd                                    SEQUENCE {

```

```

        -- dummy is not used in this version of specification, it should
        -- not be sent and if received it should be ignored.
        dummy                DL-PDSCH-Information                OPTIONAL
    },
    tdd                      NULL
},
dl-HSPDSCH-Information      DL-HSPDSCH-Information            OPTIONAL,
dl-CommonInformation        DL-CommonInformation-r5            OPTIONAL,
dl-InformationPerRL-List    DL-InformationPerRL-List-r5        OPTIONAL
}

RadioBearerReconfiguration-r6-IEs ::= SEQUENCE {
    -- User equipment IEs
    integrityProtectionModeInfo    IntegrityProtectionModeInfo    OPTIONAL,
    cipheringModeInfo              CipheringModeInfo                OPTIONAL,
    activationTime                  ActivationTime                    OPTIONAL,
    delayRestrictionFlag            DelayRestrictionFlag              OPTIONAL,
    new-U-RNTI                      U-RNTI                          OPTIONAL,
    new-C-RNTI                      C-RNTI                          OPTIONAL,
    -- The IE "new-DSCH-RNTI" should not be included in FDD mode,
    -- and if received the UE behaviour is unspecified
    new-DSCH-RNTI                  DSCH-RNTI                        OPTIONAL,
    new-H-RNTI                      H-RNTI                          OPTIONAL,
    newPrimary-E-RNTI              E-RNTI                          OPTIONAL,
    newSecondary-E-RNTI            E-RNTI                          OPTIONAL,
    rrc-StateIndicator              RRC-StateIndicator,
    utran-DRX-CycleLengthCoeff      UTRAN-DRX-CycleLengthCoefficient  OPTIONAL,
    -- Core network IEs
    cn-InformationInfo              CN-InformationInfo-r6            OPTIONAL,
    -- UTRAN mobility IEs
    ura-Identity                    URA-Identity                    OPTIONAL,
    -- Specification mode information
    specificationMode                CHOICE {
        complete                    SEQUENCE {
            -- Radio bearer IEs
            rab-InformationReconfigList    RAB-InformationReconfigList    OPTIONAL,
            rb-InformationReconfigList      RB-InformationReconfigList-r6   OPTIONAL,
            rb-InformationAffectedList      RB-InformationAffectedList-r6   OPTIONAL,
            rb-PDCPContextRelocationList    RB-PDCPContextRelocationList    OPTIONAL,
            pdcp-ROHC-TargetMode           PDCP-ROHC-TargetMode           OPTIONAL,
            -- Transport channel IEs
            ul-CommonTransChInfo            UL-CommonTransChInfo-r4         OPTIONAL,
            ul-deletedTransChInfoList        UL-DeletedTransChInfoList-r6    OPTIONAL,
            ul-AddReconfTransChInfoList      UL-AddReconfTransChInfoList-r6  OPTIONAL,
            dl-CommonTransChInfo            DL-CommonTransChInfo-r4         OPTIONAL,
            dl-DeletedTransChInfoList        DL-DeletedTransChInfoList-r5    OPTIONAL,
            dl-AddReconfTransChInfoList      DL-AddReconfTransChInfoList-r5  OPTIONAL
        },
        preconfiguration                SEQUENCE {
            -- All IEs that include an FDD/TDD choice are split in two IEs for this message,
            -- one for the FDD only elements and one for the TDD only elements, so that one
            -- FDD/TDD choice in this level is sufficient.
            preConfigMode                  CHOICE {
                predefinedConfigIdentity      PredefinedConfigIdentity,
                defaultConfig                  SEQUENCE {
                    defaultConfigMode          DefaultConfigMode,
                    defaultConfigIdentity      DefaultConfigIdentity-r6
                }
            }
        }
    },
    -- Physical channel IEs
    frequencyInfo                    FrequencyInfo                      OPTIONAL,
    maxAllowedUL-TX-Power              MaxAllowedUL-TX-Power              OPTIONAL,
    ul-DPCH-Info                       UL-DPCH-Info-r6                   OPTIONAL,
    ul-EDCH-Information                UL-EDCH-Information-r6            OPTIONAL,
    dl-HSPDSCH-Information              DL-HSPDSCH-Information-r6         OPTIONAL,
    dl-CommonInformation                DL-CommonInformation-r6           OPTIONAL,
    dl-InformationPerRL-List            DL-InformationPerRL-List-r6       OPTIONAL,
    -- MBMS IEs
    mbms-PL-ServiceRestrictInfo        MBMS-PL-ServiceRestrictInfo-r6    OPTIONAL
}

RadioBearerReconfiguration-v690ext-IEs ::= SEQUENCE {
    -- User Equipment IEs
    delayRestrictionFlag              DelayRestrictionFlag              OPTIONAL,
    -- Core network IEs
    primary-plmn-Identity              PLMN-Identity                    OPTIONAL,

```

```

-- Physical channel IEs
-- The IE harq-Preamble-Mode should not be used in the r3 and r4 versions of the message
-- If included in the r3 or r4 version of the message, the UE should ignore the IE
harq-Preamble-Mode          HARQ-Preamble-Mode          OPTIONAL,
beaconPLEst                 BEACON-PL-Est             OPTIONAL,
postVerificationPeriod      ENUMERATED { true }   OPTIONAL,
dhs-sync                    DHS-Sync             OPTIONAL,
timingMaintainedSynchInd    TimingMaintainedSynchInd  OPTIONAL,
-- MBMS IEs
mbms-PL-ServiceRestrictInfo MBMS-PL-ServiceRestrictInfo-r6  OPTIONAL
}

RadioBearerReconfiguration-v6b0ext-IEs ::= SEQUENCE {
-- Physical channel IEs
dl-InformationPerRL-List-v6b0ext    DL-InformationPerRL-List-v6b0ext    OPTIONAL
}

RadioBearerReconfiguration-v6f0ext-IEs ::= SEQUENCE {
-- Specification mode information
specificationMode                  CHOICE {
complete                            SEQUENCE {
-- Radio bearer IEs
rab-InformationMBMSptpList          RAB-InformationMBMSptpList          OPTIONAL
}
}
}

RadioBearerReconfiguration-r7-IEs ::= SEQUENCE {
-- User equipment IEs
integrityProtectionModeInfo        IntegrityProtectionModeInfo-r7      OPTIONAL,
cipheringModeInfo                  CipheringModeInfo-r7                OPTIONAL,
activationTime                      ActivationTime                        OPTIONAL,
delayRestrictionFlag               DelayRestrictionFlag                 OPTIONAL,
new-U-RNTI                          U-RNTI                              OPTIONAL,
new-C-RNTI                          C-RNTI                              OPTIONAL,
-- The IE "new-DSCH-RNTI" should not be included in FDD mode,
-- and if received the UE behaviour is unspecified
new-DSCH-RNTI                      DSCH-RNTI                           OPTIONAL,
new-H-RNTI                          H-RNTI                              OPTIONAL,
newPrimary-E-RNTI                  E-RNTI                              OPTIONAL,
newSecondary-E-RNTI                E-RNTI                              OPTIONAL,
rrc-StateIndicator                 RRC-StateIndicator,
ueMobilityStateIndicator            High-MobilityDetected                OPTIONAL,
utran-DRX-CycleLengthCoeff         UTRAN-DRX-CycleLengthCoefficient-r7  OPTIONAL,
-- Core network IEs
cn-InformationInfo                  CN-InformationInfo-r6                OPTIONAL,
-- UTRAN mobility IEs
ura-Identity                        URA-Identity                         OPTIONAL,
supportForChangeOfUE-Capability     BOOLEAN                              OPTIONAL,
responseToChangeOfUE-Capability     ENUMERATED { true }                 OPTIONAL,
-- Specification mode information
specificationMode                    CHOICE {
complete                            SEQUENCE {
-- Radio bearer IEs
rab-InformationReconfigList         RAB-InformationReconfigList         OPTIONAL,
rab-InformationMBMSptpList          RAB-InformationMBMSptpList          OPTIONAL,
rb-InformationReconfigList          RB-InformationReconfigList-r7       OPTIONAL,
rb-InformationAffectedList          RB-InformationAffectedList-r7       OPTIONAL,
rb-PDCPContextRelocationList       RB-PDCPContextRelocationList       OPTIONAL,
pdcp-ROHC-TargetMode                PDCP-ROHC-TargetMode                OPTIONAL,
-- Transport channel IEs
ul-CommonTransChInfo                UL-CommonTransChInfo-r4             OPTIONAL,
ul-deletedTransChInfoList           UL-DeletedTransChInfoList-r6        OPTIONAL,
ul-AddReconfTransChInfoList         UL-AddReconfTransChInfoList-r7      OPTIONAL,
dl-CommonTransChInfo                DL-CommonTransChInfo-r4             OPTIONAL,
dl-DeletedTransChInfoList           DL-DeletedTransChInfoList-r7        OPTIONAL,
dl-AddReconfTransChInfoList         DL-AddReconfTransChInfoList-r7      OPTIONAL
},
preconfiguration                    SEQUENCE {
-- All IEs that include an FDD/TDD choice are split in two IEs for this message,
-- one for the FDD only elements and one for the TDD only elements, so that one
-- FDD/TDD choice in this level is sufficient.
preConfigMode                        CHOICE {
predefinedConfigIdentity             PredefinedConfigIdentity,
defaultConfig                        SEQUENCE {
defaultConfigMode                    DefaultConfigMode,
defaultConfigIdentity                DefaultConfigIdentity-r6
}
}
}
}

```

```

    }
  },
}
-- Physical channel IEs
frequencyInfo          FrequencyInfo          OPTIONAL,
multi-frequencyInfo    Multi-frequencyInfo-LCR-r7  OPTIONAL,
dtx-drx-TimingInfo     DTX-DRX-TimingInfo-r7      OPTIONAL,
dtx-drx-Info           DTX-DRX-Info-r7          OPTIONAL,
hs-scch-LessInfo       HS-SCCH-LessInfo-r7       OPTIONAL,
mimoParameters         MIMO-Parameters-r7      OPTIONAL,
maxAllowedUL-TX-Power  MaxAllowedUL-TX-Power    OPTIONAL,
ul-DPCH-Info           UL-DPCH-Info-r7          OPTIONAL,
ul-EDCH-Information    UL-EDCH-Information-r7    OPTIONAL,
dl-HSPDSCH-Information DL-HSPDSCH-Information-r7  OPTIONAL,
dl-CommonInformation    DL-CommonInformation-r7   OPTIONAL,
dl-InformationPerRL-List DL-InformationPerRL-List-r7  OPTIONAL,
-- MBMS IEs
mbms-PL-ServiceRestrictInfo MBMS-PL-ServiceRestrictInfo-r6  OPTIONAL
}

RadioBearerReconfiguration-v770ext-IEs ::= SEQUENCE {
-- User equipment IEs
ueMobilityStateIndicator      High-MobilityDetected      OPTIONAL
}

RadioBearerReconfiguration-v780ext-IEs ::= SEQUENCE {
-- Physical channel IEs
hs-DSCH-TBSizeTable          HS-DSCH-TBSizeTable        OPTIONAL
}

RadioBearerReconfiguration-v790ext-IEs ::= SEQUENCE {
-- Container for adding non critical extensions after freezing REL-8
radioBearerReconfiguration-r7-add-ext  BIT STRING      OPTIONAL
}

RadioBearerReconfiguration-v7d0ext-IEs ::= SEQUENCE {
-- Physical channel IEs
ul-EDCH-Information          UL-EDCH-Information-ext    OPTIONAL
}

RadioBearerReconfiguration-v7f0ext-IEs ::= SEQUENCE {
-- Physical channel IEs
mimoParameters              MIMO-Parameters-v7f0ext    OPTIONAL
}

RadioBearerReconfiguration-v7g0ext-IEs ::= SEQUENCE {
-- Physical channel IEs
mimoParameters              MIMO-Parameters-v7g0ext    OPTIONAL
}

RadioBearerReconfiguration-r8-IEs ::= SEQUENCE {
-- User equipment IEs
integrityProtectionModeInfo  IntegrityProtectionModeInfo-r7  OPTIONAL,
cipheringModeInfo            CipheringModeInfo-r7            OPTIONAL,
activationTime                ActivationTime                    OPTIONAL,
delayRestrictionFlag         DelayRestrictionFlag            OPTIONAL,
new-U-RNTI                    U-RNTI                          OPTIONAL,
new-C-RNTI                    C-RNTI                          OPTIONAL,
-- The IE "new-DSCH-RNTI" should not be included in FDD mode,
-- and if received the UE behaviour is unspecified
new-DSCH-RNTI                DSCH-RNTI                      OPTIONAL,
new-H-RNTI                    H-RNTI                          OPTIONAL,
newPrimary-E-RNTI            E-RNTI                          OPTIONAL,
newSecondary-E-RNTI          E-RNTI                          OPTIONAL,
rrc-StateIndicator           RRC-StateIndicator,
ueMobilityStateIndicator      High-MobilityDetected          OPTIONAL,
utran-DRX-CycleLengthCoeff    UTRAN-DRX-CycleLengthCoefficient-r7  OPTIONAL,
-- Core network IEs
cn-InformationInfo           CN-InformationInfo-r6          OPTIONAL,
-- UTRAN mobility IEs
ura-Identity                  URA-Identity                    OPTIONAL,
supportForChangeOfUE-Capability BOOLEAN                          OPTIONAL,
responseToChangeOfUE-Capability ENUMERATED { true }      OPTIONAL,
-- Specification mode information
-- dummy is not used in this version of the specification, it should
-- not be sent and if received UE behaviour is unspecified.
dummy                          DefaultConfigForCellFACH        OPTIONAL,
specificationMode              CHOICE {

```

```

complete                               SEQUENCE {
-- Radio bearer IEs
  rab-InformationReconfigList           RAB-InformationReconfigList-r8      OPTIONAL,
  rab-InformationMBMSPTpList           RAB-InformationMBMSPTpList         OPTIONAL,
  rb-InformationReconfigList           RB-InformationReconfigList-r8      OPTIONAL,
  rb-InformationAffectedList           RB-InformationAffectedList-r8      OPTIONAL,
  rb-PDCPContextRelocationList        RB-PDCPContextRelocationList      OPTIONAL,
  pdcp-ROHC-TargetMode                PDCP-ROHC-TargetMode              OPTIONAL,
-- Transport channel IEs
  ul-CommonTransChInfo                 UL-CommonTransChInfo-r4           OPTIONAL,
  ul-deletedTransChInfoList           UL-DeletedTransChInfoList-r6      OPTIONAL,
  ul-AddReconfTransChInfoList         UL-AddReconfTransChInfoList-r8    OPTIONAL,
  dl-CommonTransChInfo                 DL-CommonTransChInfo-r4           OPTIONAL,
  dl-DeletedTransChInfoList           DL-DeletedTransChInfoList-r7      OPTIONAL,
  dl-AddReconfTransChInfoList         DL-AddReconfTransChInfoList-r7    OPTIONAL
},
preconfiguration                       SEQUENCE {
-- All IEs that include an FDD/TDD choice are split in two IEs for this message,
-- one for the FDD only elements and one for the TDD only elements, so that one
-- FDD/TDD choice in this level is sufficient.
  preConfigMode                        CHOICE {
    predefinedConfigIdentity           PredefinedConfigIdentity,
    defaultConfig                     SEQUENCE {
      defaultConfigMode               DefaultConfigMode,
      defaultConfigIdentity           DefaultConfigIdentity-r6
    }
  }
},
-- Physical channel IEs
  frequencyInfo                       FrequencyInfo                       OPTIONAL,
  multi-frequencyInfo                 Multi-frequencyInfo-LCR-r7         OPTIONAL,
  dtx-drx-TimingInfo                 DTX-DRX-TimingInfo-r7             OPTIONAL,
  dtx-drx-Info                       DTX-DRX-Info-r7                   OPTIONAL,
  hs-sch-LessInfo                    HS-SCCH-LessInfo-r7               OPTIONAL,
  mimoParameters                     MIMO-Parameters-r8                OPTIONAL,
  maxAllowedUL-TX-Power               MaxAllowedUL-TX-Power              OPTIONAL,
  ul-DPCH-Info                       UL-DPCH-Info-r7                   OPTIONAL,
  ul-EDCH-Information                 UL-EDCH-Information-r8            OPTIONAL,
  dl-HSPDSCH-Information              DL-HSPDSCH-Information-r8         OPTIONAL,
  dl-CommonInformation               DL-CommonInformation-r8            OPTIONAL,
  dl-InformationPerRL-List            DL-InformationPerRL-List-r8        OPTIONAL,
  dl-SecondaryCellInfoFDD             DL-SecondaryCellInfoFDD            OPTIONAL,
  controlChannelDRXInfo-TDD128        ControlChannelDRXInfo-TDD128-r8    OPTIONAL,
  sps-Information-TDD128              SPS-Information-TDD128-r8         OPTIONAL,
-- MBMS IEs
  mbms-PL-ServiceRestrictInfo        MBMS-PL-ServiceRestrictInfo-r6    OPTIONAL
}

RadioBearerReconfiguration-v890ext-IEs ::= SEQUENCE {
-- User Equipment IEs
  dl-SecondaryCellInfoFDD-v890ext     DL-SecondaryCellInfoFDD-v890ext    OPTIONAL,
-- Physical channel IEs
  dl-HSPDSCH-Information              DL-HSPDSCH-Information-r8-ext      OPTIONAL
}

RadioBearerReconfiguration-v8a0ext-IEs ::= SEQUENCE {
-- Physical channel IEs
  dl-HSPDSCH-Information              DL-HSPDSCH-Information-r8-ext2     OPTIONAL
}

-- *****
--
-- RADIO BEARER RECONFIGURATION COMPLETE
--
-- *****

RadioBearerReconfigurationComplete ::= SEQUENCE {
-- User equipment IEs
  rrc-TransactionIdentifier           RRC-TransactionIdentifier,
  ul-IntegProtActivationInfo          IntegrityProtActivationInfo         OPTIONAL,
-- TABULAR: UL-TimingAdvance is applicable for TDD mode only.
  ul-TimingAdvance                   UL-TimingAdvance                   OPTIONAL,
-- Radio bearer IEs
  count-C-ActivationTime              ActivationTime                       OPTIONAL,
-- dummy is not used in this version of the specification and
-- it should be ignored by the receiver.
  dummy                               RB-ActivationTimeInfoList          OPTIONAL,

```

```

    ul-CounterSynchronisationInfo    UL-CounterSynchronisationInfo    OPTIONAL,
    laterNonCriticalExtensions        SEQUENCE {
      -- Container for additional R99 extensions
      radioBearerReconfigurationComplete-r3-add-ext    BIT STRING    OPTIONAL,
      v770NonCriticalExtensions        SEQUENCE {
        radioBearerReconfigurationComplete-v770ext
          nonCriticalExtensions        RadioBearerReconfigurationComplete-v770ext-IEs,
          SEQUENCE {} OPTIONAL
        } OPTIONAL
      } OPTIONAL
  }

RadioBearerReconfigurationComplete-v770ext-IEs ::= SEQUENCE {
  -- TABULAR: EXT-UL-TimingAdvance is applicable for TDD mode only.
  ext-UL-TimingAdvance                EXT-UL-TimingAdvance    OPTIONAL,
  deferredMeasurementControlReading    ENUMERATED { true }    OPTIONAL
}

-- *****
--
-- RADIO BEARER RECONFIGURATION FAILURE
--
-- *****

RadioBearerReconfigurationFailure ::= SEQUENCE {
  -- User equipment IEs
  rrc-TransactionIdentifier            RRC-TransactionIdentifier,
  failureCause                         FailureCauseWithProtErr,
  -- Radio bearer IEs
  potentiallySuccessfulBearerList      RB-IdentityList                OPTIONAL,
  laterNonCriticalExtensions            SEQUENCE {
    -- Container for additional R99 extensions
    radioBearerReconfigurationFailure-r3-add-ext    BIT STRING    OPTIONAL,
    nonCriticalExtensions                    SEQUENCE {} OPTIONAL
  } OPTIONAL
}

-- *****
--
-- RADIO BEARER RELEASE
--
-- *****

RadioBearerRelease ::= CHOICE {
  r3                                     SEQUENCE {
    radioBearerRelease-r3                RadioBearerRelease-r3-IEs,
    v3a0NonCriticalExtensions            SEQUENCE {
      radioBearerRelease-v3a0ext          RadioBearerRelease-v3a0ext,
      laterNonCriticalExtensions          SEQUENCE {
        -- Container for additional R99 extensions
        radioBearerRelease-r3-add-ext    BIT STRING    OPTIONAL,
        v4b0NonCriticalExtensions        SEQUENCE {
          radioBearerRelease-v4b0ext      RadioBearerRelease-v4b0ext-IEs,
          v590NonCriticalExtensions        SEQUENCE {
            radioBearerRelease-v590ext    RadioBearerRelease-v590ext-IEs,
            v690NonCriticalExtensions      SEQUENCE {
              radioBearerRelease-v690ext  RadioBearerRelease-v690ext-IEs,
              v770NonCriticalExtensions    SEQUENCE {
                radioBearerRelease-v770ext  RadioBearerRelease-v770ext-IEs,
                nonCriticalExtensions      SEQUENCE {} OPTIONAL
              } OPTIONAL
            } OPTIONAL
          } OPTIONAL
        } OPTIONAL
      } OPTIONAL
    } OPTIONAL
  } OPTIONAL
},
  later-than-r3                          SEQUENCE {
    rrc-TransactionIdentifier            RRC-TransactionIdentifier,
    criticalExtensions                   CHOICE {
      r4                                  SEQUENCE {
        radioBearerRelease-r4            RadioBearerRelease-r4-IEs,
        v4d0NonCriticalExtensions        SEQUENCE {
          -- Container for adding non critical extensions after freezing REL-5
          radioBearerRelease-r4-add-ext    BIT STRING    OPTIONAL,
          v590NonCriticalExtensions        SEQUENCE {
            radioBearerRelease-v590ext    RadioBearerRelease-v590ext-IEs,
            v690NonCriticalExtensions      SEQUENCE {

```

```

        radioBearerRelease-v690ext      RadioBearerRelease-v690ext-IEs,
        v770NonCriticalExtensions      SEQUENCE {
            radioBearerRelease-v770ext  RadioBearerRelease-v770ext-IEs,
            nonCriticalExtensions       SEQUENCE {} OPTIONAL
        } OPTIONAL
    } OPTIONAL
},
criticalExtensions      CHOICE {
    r5                    SEQUENCE {
        radioBearerRelease-r5      RadioBearerRelease-r5-IEs,
        -- Container for adding non critical extensions after freezing REL-6
        radioBearerRelease-r5-add-ext  BIT STRING OPTIONAL,
        v690NonCriticalExtensions  SEQUENCE {
            radioBearerRelease-v690ext  RadioBearerRelease-v690ext-IEs,
            v770NonCriticalExtensions  SEQUENCE {
                radioBearerRelease-v770ext  RadioBearerRelease-v770ext-IEs,
                nonCriticalExtensions       SEQUENCE {} OPTIONAL
            } OPTIONAL
        } OPTIONAL
    } OPTIONAL
},
criticalExtensions      CHOICE {
    r6                    SEQUENCE {
        radioBearerRelease-r6      RadioBearerRelease-r6-IEs,
        -- Container for adding non critical extensions after freezing REL-7
        radioBearerRelease-r6-add-ext  BIT STRING OPTIONAL,
        v6b0NonCriticalExtensions  SEQUENCE {
            radioBearerRelease-v6b0ext  RadioBearerRelease-v6b0ext-IEs,
            v770NonCriticalExtensions  SEQUENCE {
                radioBearerRelease-v770ext  RadioBearerRelease-v770ext-IEs,
                nonCriticalExtensions       SEQUENCE {} OPTIONAL
            } OPTIONAL
        } OPTIONAL
    } OPTIONAL
},
criticalExtensions      CHOICE {
    r7                    SEQUENCE {
        radioBearerRelease-r7      RadioBearerRelease-r7-IEs,
        -- Container for adding non critical extensions after freezing REL-8
        radioBearerRelease-r7-add-ext  BIT STRING OPTIONAL,
        v780NonCriticalExtensions  SEQUENCE {
            radioBearerRelease-v780ext  RadioBearerRelease-v780ext-IEs,
            v7d0NonCriticalExtensions  SEQUENCE {
                radioBearerRelease-v7d0ext  RadioBearerRelease-v7d0ext-IEs,
                v7f0NonCriticalExtensions  SEQUENCE {
                    radioBearerRelease-v7f0ext  RadioBearerRelease-v7f0ext-IEs,
                    v7g0NonCriticalExtensions  SEQUENCE {
                        radioBearerRelease-v7g0ext  RadioBearerRelease-v7g0ext-IEs,
                        nonCriticalExtensions  SEQUENCE {} OPTIONAL
                    } OPTIONAL
                } OPTIONAL
            } OPTIONAL
        } OPTIONAL
    } OPTIONAL
},
criticalExtensions      CHOICE {
    r8                    SEQUENCE {
        radioBearerRelease-r8      RadioBearerRelease-r8-IEs,
        -- Container for adding non critical extensions after freezing REL-9
        radioBearerRelease-r8-add-ext  BIT STRING OPTIONAL,
        v7d0NonCriticalExtensions  SEQUENCE {
            radioBearerRelease-v7d0ext  RadioBearerRelease-v7d0ext-IEs,
            v7f0NonCriticalExtensions  SEQUENCE {
                radioBearerRelease-v7f0ext  RadioBearerRelease-v7f0ext-IEs,
                v890NonCriticalExtensions  SEQUENCE {
                    radioBearerRelease-v890ext  RadioBearerRelease-v890ext-IEs,
                    v7g0NonCriticalExtensions  SEQUENCE {
                        radioBearerRelease-v7g0ext  RadioBearerRelease-v7g0ext-IEs,
                        v8a0NonCriticalExtensions  SEQUENCE {
                            radioBearerRelease-v8a0ext  RadioBearerRelease-v8a0ext-IEs,
                            nonCriticalExtensions  SEQUENCE {} OPTIONAL
                        } OPTIONAL
                    } OPTIONAL
                } OPTIONAL
            } OPTIONAL
        } OPTIONAL
    } OPTIONAL
}

```

```

    } OPTIONAL
  },
  criticalExtensions SEQUENCE {}
}
}
}
}
}
}
}
}
}

RadioBearerRelease-r3-IEs ::= SEQUENCE {
  -- User equipment IEs
  rrc-TransactionIdentifier RRC-TransactionIdentifier,
  integrityProtectionModeInfo IntegrityProtectionModeInfo OPTIONAL,
  cipheringModeInfo CipheringModeInfo OPTIONAL,
  activationTime ActivationTime OPTIONAL,
  new-U-RNTI U-RNTI OPTIONAL,
  new-C-RNTI C-RNTI OPTIONAL,
  rrc-StateIndicator RRC-StateIndicator,
  utran-DRX-CycleLengthCoeff UTRAN-DRX-CycleLengthCoefficient OPTIONAL,
  -- Core network IEs
  cn-InformationInfo CN-InformationInfo OPTIONAL,
  signallingConnectionRelIndication CN-DomainIdentity OPTIONAL,
  -- UTRAN mobility IEs
  ura-Identity URA-Identity OPTIONAL,
  -- Radio bearer IEs
  rab-InformationReconfigList RAB-InformationReconfigList OPTIONAL,
  rb-InformationReleaseList RB-InformationReleaseList,
  rb-InformationAffectedList RB-InformationAffectedList OPTIONAL,
  dl-CounterSynchronisationInfo DL-CounterSynchronisationInfo OPTIONAL,
  -- Transport channel IEs
  ul-CommonTransChInfo UL-CommonTransChInfo OPTIONAL,
  ul-deletedTransChInfoList UL-DeletedTransChInfoList OPTIONAL,
  ul-AddReconfTransChInfoList UL-AddReconfTransChInfoList OPTIONAL,
  -- 'dummy', 'dummy1' and 'dummy2' are not used in this version of the specification,
  -- they should not be sent and if received they should be ignored.
  dummy CHOICE {
    fdd SEQUENCE {
      dummy1 CPCH-SetID OPTIONAL,
      dummy2 DRAC-StaticInformationList OPTIONAL
    },
    tdd NULL
  } OPTIONAL,
  dl-CommonTransChInfo DL-CommonTransChInfo OPTIONAL,
  dl-DeletedTransChInfoList DL-DeletedTransChInfoList OPTIONAL,
  dl-AddReconfTransChInfoList DL-AddReconfTransChInfo2List OPTIONAL,
  -- Physical channel IEs
  frequencyInfo FrequencyInfo OPTIONAL,
  maxAllowedUL-TX-Power MaxAllowedUL-TX-Power OPTIONAL,
  ul-ChannelRequirement UL-ChannelRequirement OPTIONAL,
  modeSpecificPhysChInfo CHOICE {
    fdd SEQUENCE {
      -- dummy is not used in this version of specification, it should
      -- not be sent and if received it should be ignored.
      dummy DL-PDSCH-Information OPTIONAL
    },
    tdd NULL
  },
  dl-CommonInformation DL-CommonInformation OPTIONAL,
  dl-InformationPerRL-List DL-InformationPerRL-List OPTIONAL
}

RadioBearerRelease-v3a0ext ::= SEQUENCE {
  -- The IE "new-DSCH-RNTI" should not be included in FDD mode, and if received the UE behaviour
  -- is unspecified
  new-DSCH-RNTI DSCH-RNTI OPTIONAL
}

RadioBearerRelease-v4b0ext-IEs ::= SEQUENCE {
  -- Physical channel IEs
  -- dummy is not used in this version of the specification, it should
  -- not be sent and if received it should be ignored.
  dummy SSdT-UL OPTIONAL,
  -- The order of the RLs in IE cell-id-PerRL-List is the same as
  -- in IE DL-InformationPerRL-List included in this message
  cell-id-PerRL-List CellIdentity-PerRL-List OPTIONAL
}

```



```

RadioBearerRelease-v590ext-IEs ::= SEQUENCE {
  -- Physical channel IEs
  dl-TPC-PowerOffsetPerRL-List    DL-TPC-PowerOffsetPerRL-List    OPTIONAL
}

RadioBearerRelease-r4-IEs ::= SEQUENCE {
  -- User equipment IEs
  integrityProtectionModeInfo      IntegrityProtectionModeInfo      OPTIONAL,
  cipheringModeInfo                CipheringModeInfo                OPTIONAL,
  activationTime                    ActivationTime                    OPTIONAL,
  new-U-RNTI                       U-RNTI                          OPTIONAL,
  new-C-RNTI                       C-RNTI                          OPTIONAL,
  -- The IE "new-DSCH-RNTI" should not be included in FDD mode, and if received
  -- the UE behaviour is unspecified
  new-DSCH-RNTI                   DSCH-RNTI                       OPTIONAL,
  rrc-StateIndicator               RRC-StateIndicator,
  utran-DRX-CycleLengthCoeff       UTRAN-DRX-CycleLengthCoefficient OPTIONAL,
  -- Core network IEs
  cn-InformationInfo               CN-InformationInfo               OPTIONAL,
  signallingConnectionRelIndication CN-DomainIdentity              OPTIONAL,
  -- UTRAN mobility IEs
  ura-Identity                     URA-Identity                    OPTIONAL,
  -- Radio bearer IEs
  rab-InformationReconfigList      RAB-InformationReconfigList      OPTIONAL,
  rb-InformationReleaseList        RB-InformationReleaseList,
  rb-InformationAffectedList       RB-InformationAffectedList       OPTIONAL,
  dl-CounterSynchronisationInfo    DL-CounterSynchronisationInfo    OPTIONAL,
  -- Transport channel IEs
  ul-CommonTransChInfo            UL-CommonTransChInfo-r4         OPTIONAL,
  ul-deletedTransChInfoList       UL-DeletedTransChInfoList       OPTIONAL,
  ul-AddReconfTransChInfoList     UL-AddReconfTransChInfoList     OPTIONAL,
  -- 'dummy', 'dummy1' and 'dummy2' are not used in this version of the specification,
  -- they should not be sent and if received they should be ignored.
  dummy                            CHOICE {
    fdd                             SEQUENCE {
      dummy1                        CPCH-SetID                      OPTIONAL,
      dummy2                        DRAC-StaticInformationList      OPTIONAL
    },
    tdd                             NULL
  } OPTIONAL,
  dl-CommonTransChInfo            DL-CommonTransChInfo-r4         OPTIONAL,
  dl-DeletedTransChInfoList       DL-DeletedTransChInfoList       OPTIONAL,
  dl-AddReconfTransChInfoList     DL-AddReconfTransChInfoList-r4  OPTIONAL,
  -- Physical channel IEs
  frequencyInfo                   FrequencyInfo                    OPTIONAL,
  maxAllowedUL-TX-Power           MaxAllowedUL-TX-Power           OPTIONAL,
  ul-ChannelRequirement           UL-ChannelRequirement-r4        OPTIONAL,
  modeSpecificPhysChInfo         CHOICE {
    fdd                             SEQUENCE {
      -- dummy is not used in this version of specification, it should
      -- not be sent and if received it should be ignored.
      dummy                         DL-PDSCH-Information            OPTIONAL
    },
    tdd                             NULL
  },
  dl-CommonInformation            DL-CommonInformation-r4         OPTIONAL,
  dl-InformationPerRL-List        DL-InformationPerRL-List-r4     OPTIONAL
}

RadioBearerRelease-r5-IEs ::= SEQUENCE {
  -- User equipment IEs
  integrityProtectionModeInfo      IntegrityProtectionModeInfo      OPTIONAL,
  cipheringModeInfo                CipheringModeInfo                OPTIONAL,
  activationTime                    ActivationTime                    OPTIONAL,
  new-U-RNTI                       U-RNTI                          OPTIONAL,
  new-C-RNTI                       C-RNTI                          OPTIONAL,
  -- The IE "new-DSCH-RNTI" should not be included in FDD mode,
  -- and if received the UE behaviour is unspecified
  new-DSCH-RNTI                   DSCH-RNTI                       OPTIONAL,
  new-H-RNTI                       H-RNTI                          OPTIONAL,
  rrc-StateIndicator               RRC-StateIndicator,
  utran-DRX-CycleLengthCoeff       UTRAN-DRX-CycleLengthCoefficient OPTIONAL,
  -- Core network IEs
  cn-InformationInfo               CN-InformationInfo               OPTIONAL,
  signallingConnectionRelIndication CN-DomainIdentity              OPTIONAL,
  -- UTRAN mobility IEs
  ura-Identity                     URA-Identity                    OPTIONAL,

```

```

-- Radio bearer IEs
  rab-InformationReconfigList      RAB-InformationReconfigList      OPTIONAL,
  rb-InformationReleaseList        RB-InformationReleaseList,
  rb-InformationAffectedList       RB-InformationAffectedList-r5    OPTIONAL,
  dl-CounterSynchronisationInfo    DL-CounterSynchronisationInfo-r5 OPTIONAL,
-- Transport channel IEs
  ul-CommonTransChInfo            UL-CommonTransChInfo-r4          OPTIONAL,
  ul-deletedTransChInfoList        UL-DeletedTransChInfoList        OPTIONAL,
  ul-AddReconfTransChInfoList      UL-AddReconfTransChInfoList      OPTIONAL,
  -- 'dummy', 'dummy1' and 'dummy2' are not used in this version of the specification,
  -- they should not be sent and if received they should be ignored.
  dummy                            CHOICE {
    fdd                             SEQUENCE {
      dummy1                        CPCH-SetID                        OPTIONAL,
      dummy2                        DRAC-StaticInformationList      OPTIONAL
    },
    tdd                             NULL
  }
  dl-CommonTransChInfo            DL-CommonTransChInfo-r4          OPTIONAL,
  dl-DeletedTransChInfoList        DL-DeletedTransChInfoList-r5     OPTIONAL,
  dl-AddReconfTransChInfoList      DL-AddReconfTransChInfoList-r5   OPTIONAL,
-- Physical channel IEs
  frequencyInfo                   FrequencyInfo                      OPTIONAL,
  maxAllowedUL-TX-Power            MaxAllowedUL-TX-Power            OPTIONAL,
  ul-ChannelRequirement            UL-ChannelRequirement-r5         OPTIONAL,
  modeSpecificPhysChInfo          CHOICE {
    fdd                             SEQUENCE {
      -- dummy is not used in this version of specification, it should
      -- not be sent and if received it should be ignored.
      dummy                          DL-PDSCH-Information            OPTIONAL
    },
    tdd                             NULL
  },
  dl-HSPDSCH-Information          DL-HSPDSCH-Information           OPTIONAL,
  dl-CommonInformation            DL-CommonInformation-r5          OPTIONAL,
  dl-InformationPerRL-List        DL-InformationPerRL-List-r5     OPTIONAL
}

RadioBearerRelease-v690ext-IEs ::= SEQUENCE {
-- Core network IEs
  primary-plmn-Identity           PLMN-Identity                    OPTIONAL,
-- Physical channel IEs
  -- The IE harq-Preamble-Mode should not be used in the r3 and r4 versions of the message
  -- If included in the r3 or r4 version of the message, the UE should ignore the IE
  harq-Preamble-Mode              HARQ-Preamble-Mode              OPTIONAL,
  beaconPLEst                     BEACON-PL-Est                   OPTIONAL,
  postVerificationPeriod          ENUMERATED { true }             OPTIONAL,
  dhs-sync                         DHS-Sync                        OPTIONAL,
  timingMaintainedSynchInd        TimingMaintainedSynchInd        OPTIONAL,
-- MBMS IEs
  mbms-PL-ServiceRestrictInfo     MBMS-PL-ServiceRestrictInfo-r6  OPTIONAL,
  mbms-RB-ListReleasedToChangeTransferMode
                                  RB-InformationReleaseList      OPTIONAL
}

RadioBearerRelease-r6-IEs ::= SEQUENCE {
-- User equipment IEs
  integrityProtectionModeInfo      IntegrityProtectionModeInfo      OPTIONAL,
  cipheringModeInfo               CipheringModeInfo                OPTIONAL,
  activationTime                  ActivationTime                    OPTIONAL,
  new-U-RNTI                      U-RNTI                          OPTIONAL,
  new-C-RNTI                      C-RNTI                          OPTIONAL,
  -- The IE "new-DSCH-RNTI" should not be included in FDD mode,
  -- and if received the UE behaviour is unspecified
  new-DSCH-RNTI                  DSCH-RNTI                       OPTIONAL,
  new-H-RNTI                      H-RNTI                          OPTIONAL,
  newPrimary-E-RNTI              E-RNTI                          OPTIONAL,
  newSecondary-E-RNTI            E-RNTI                          OPTIONAL,
  rrc-StateIndicator              RRC-StateIndicator,
  utran-DRX-CycleLengthCoeff      UTRAN-DRX-CycleLengthCoefficient OPTIONAL,
-- Core network IEs
  cn-InformationInfo              CN-InformationInfo-r6            OPTIONAL,
  signallingConnectionRelIndication
                                  CN-DomainIdentity                OPTIONAL,
-- UTRAN mobility IEs
  ura-Identity                    URA-Identity                    OPTIONAL,
-- Radio bearer IEs
  rab-InformationReconfigList      RAB-InformationReconfigList      OPTIONAL,
  rb-InformationReleaseList        RB-InformationReleaseList,

```

```

    rb-InformationReconfigList      RB-InformationReconfigList-r6      OPTIONAL,
    rb-InformationAffectedList      RB-InformationAffectedList-r6      OPTIONAL,
    dl-CounterSynchronisationInfo  DL-CounterSynchronisationInfo-r5  OPTIONAL,
-- Transport channel IEs
    ul-CommonTransChInfo           UL-CommonTransChInfo-r4           OPTIONAL,
    ul-deletedTransChInfoList      UL-DeletedTransChInfoList-r6     OPTIONAL,
    ul-AddReconfTransChInfoList    UL-AddReconfTransChInfoList-r6   OPTIONAL,
    dl-CommonTransChInfo           DL-CommonTransChInfo-r4           OPTIONAL,
    dl-DeletedTransChInfoList      DL-DeletedTransChInfoList-r5     OPTIONAL,
    dl-AddReconfTransChInfoList    DL-AddReconfTransChInfoList-r5   OPTIONAL,
-- Physical channel IEs
    frequencyInfo                  FrequencyInfo                       OPTIONAL,
    maxAllowedUL-TX-Power          MaxAllowedUL-TX-Power              OPTIONAL,
    ul-DPCH-Info                   UL-DPCH-Info-r6                   OPTIONAL,
    ul-EDCH-Information            UL-EDCH-Information-r6            OPTIONAL,
    dl-HSPDSCH-Information         DL-HSPDSCH-Information-r6        OPTIONAL,
    dl-CommonInformation           DL-CommonInformation-r6           OPTIONAL,
    dl-InformationPerRL-List       DL-InformationPerRL-List-r6       OPTIONAL,
-- MBMS IEs
    mbms-PL-ServiceRestrictInfo    MBMS-PL-ServiceRestrictInfo-r6   OPTIONAL,
    mbms-RB-ListReleasedToChangeTransferMode
                                   RB-InformationReleaseList         OPTIONAL
}

RadioBearerRelease-v6b0ext-IEs ::= SEQUENCE {
-- Physical channel IEs
    dl-InformationPerRL-List-v6b0ext  DL-InformationPerRL-List-v6b0ext  OPTIONAL
}

RadioBearerRelease-r7-IEs ::= SEQUENCE {
-- User equipment IEs
    integrityProtectionModeInfo     IntegrityProtectionModeInfo-r7    OPTIONAL,
    cipheringModeInfo               CipheringModeInfo-r7              OPTIONAL,
    activationTime                   ActivationTime                     OPTIONAL,
    new-U-RNTI                       U-RNTI                            OPTIONAL,
    new-C-RNTI                       C-RNTI                            OPTIONAL,
-- The IE "new-DSCH-RNTI" should not be included in FDD mode,
-- and if received the UE behaviour is unspecified
    new-DSCH-RNTI                   DSCH-RNTI                         OPTIONAL,
    new-H-RNTI                       H-RNTI                            OPTIONAL,
    newPrimary-E-RNTI                E-RNTI                            OPTIONAL,
    newSecondary-E-RNTI              E-RNTI                            OPTIONAL,
    rrc-StateIndicator               RRC-StateIndicator,
    ueMobilityStateIndicator         High-MobilityDetected             OPTIONAL,
    utran-DRX-CycleLengthCoeff      UTRAN-DRX-CycleLengthCoefficient-r7 OPTIONAL,
-- Core network IEs
    cn-InformationInfo               CN-InformationInfo-r6             OPTIONAL,
    signallingConnectionRelIndication CN-DomainIdentity                 OPTIONAL,
-- UTRAN mobility IEs
    ura-Identity                     URA-Identity                      OPTIONAL,
    supportForChangeOfUE-Capability  BOOLEAN                           OPTIONAL,
-- Radio bearer IEs
    rab-InformationReconfigList      RAB-InformationReconfigList       OPTIONAL,
    rb-InformationReleaseList        RB-InformationReleaseList,
    rb-InformationReconfigList      RB-InformationReconfigList-r7     OPTIONAL,
    rb-InformationAffectedList      RB-InformationAffectedList-r7     OPTIONAL,
    dl-CounterSynchronisationInfo  DL-CounterSynchronisationInfo-r5  OPTIONAL,
-- Transport channel IEs
    ul-CommonTransChInfo           UL-CommonTransChInfo-r4           OPTIONAL,
    ul-deletedTransChInfoList      UL-DeletedTransChInfoList-r6     OPTIONAL,
    ul-AddReconfTransChInfoList    UL-AddReconfTransChInfoList-r7   OPTIONAL,
    dl-CommonTransChInfo           DL-CommonTransChInfo-r4           OPTIONAL,
    dl-DeletedTransChInfoList      DL-DeletedTransChInfoList-r7     OPTIONAL,
    dl-AddReconfTransChInfoList    DL-AddReconfTransChInfoList-r7   OPTIONAL,
-- Physical channel IEs
    frequencyInfo                  FrequencyInfo                       OPTIONAL,
    multi-frequencyInfo             Multi-frequencyInfo-LCR-r7        OPTIONAL,
    dtx-drx-TimingInfo              DTX-DRX-TimingInfo-r7            OPTIONAL,
    dtx-drx-Info                    DTX-DRX-Info-r7                  OPTIONAL,
    hs-scch-LessInfo                HS-SCCH-LessInfo-r7              OPTIONAL,
    mimoParameters                  MIMO-Parameters-r7               OPTIONAL,
    maxAllowedUL-TX-Power          MaxAllowedUL-TX-Power              OPTIONAL,
    ul-DPCH-Info                   UL-DPCH-Info-r7                   OPTIONAL,
    ul-EDCH-Information            UL-EDCH-Information-r7            OPTIONAL,
    dl-HSPDSCH-Information         DL-HSPDSCH-Information-r7        OPTIONAL,
    dl-CommonInformation           DL-CommonInformation-r7           OPTIONAL,
    dl-InformationPerRL-List       DL-InformationPerRL-List-r7       OPTIONAL,
-- MBMS IEs

```

```

        mbms-PL-ServiceRestrictInfo      MBMS-PL-ServiceRestrictInfo-r6      OPTIONAL,
        mbms-RB-ListReleasedToChangeTransferMode
                                          RB-InformationReleaseList      OPTIONAL
    }

RadioBearerRelease-v770ext-IEs ::= SEQUENCE {
    -- User equipment IEs
        ueMobilityStateIndicator          High-MobilityDetected              OPTIONAL
    }

RadioBearerRelease-v780ext-IEs ::= SEQUENCE {
    -- Physical channel IEs
        hs-DSCH-TBSizeTable              HS-DSCH-TBSizeTable              OPTIONAL
    }

RadioBearerRelease-v7d0ext-IEs ::= SEQUENCE {
    -- Physical channel IEs
        ul-EDCH-Information              UL-EDCH-Information-ext          OPTIONAL
    }

RadioBearerRelease-v7f0ext-IEs ::= SEQUENCE {
    -- Physical channel IEs
        mimoParameters                   MIMO-Parameters-v7f0ext          OPTIONAL
    }

RadioBearerRelease-v7g0ext-IEs ::= SEQUENCE {
    -- Physical channel IEs
        mimoParameters                   MIMO-Parameters-v7g0ext          OPTIONAL
    }

RadioBearerRelease-r8-IEs ::= SEQUENCE {
    -- User equipment IEs
        integrityProtectionModeInfo      IntegrityProtectionModeInfo-r7    OPTIONAL,
        cipheringModeInfo                CipheringModeInfo-r7              OPTIONAL,
        activationTime                    ActivationTime                      OPTIONAL,
        new-U-RNTI                        U-RNTI                            OPTIONAL,
        new-C-RNTI                        C-RNTI                            OPTIONAL,
        -- The IE "new-DSCH-RNTI" should not be included in FDD mode,
        -- and if received the UE behaviour is unspecified
        new-DSCH-RNTI                    DSCH-RNTI                        OPTIONAL,
        new-H-RNTI                        H-RNTI                            OPTIONAL,
        newPrimary-E-RNTI                 E-RNTI                            OPTIONAL,
        newSecondary-E-RNTI               E-RNTI                            OPTIONAL,
        rrc-StateIndicator                 RRC-StateIndicator,
        ueMobilityStateIndicator          High-MobilityDetected              OPTIONAL,
        utran-DRX-CycleLengthCoeff       UTRAN-DRX-CycleLengthCoefficient-r7 OPTIONAL,
    -- Core network IEs
        cn-InformationInfo                 CN-InformationInfo-r6            OPTIONAL,
        signallingConnectionRelIndication CN-DomainIdentity              OPTIONAL,
    -- UTRAN mobility IEs
        ura-Identity                      URA-Identity                    OPTIONAL,
        supportForChangeOfUE-Capability   BOOLEAN                          OPTIONAL,
    -- Radio bearer IEs
        rab-InformationReconfigList       RAB-InformationReconfigList-r8    OPTIONAL,
        rb-InformationReleaseList         RB-InformationReleaseList,
        rb-InformationReconfigList       RB-InformationReconfigList-r8    OPTIONAL,
        rb-InformationAffectedList       RB-InformationAffectedList-r8    OPTIONAL,
        dl-CounterSynchronisationInfo     DL-CounterSynchronisationInfo-r5  OPTIONAL,
    -- Transport channel IEs
        ul-CommonTransChInfo             UL-CommonTransChInfo-r4          OPTIONAL,
        ul-deletedTransChInfoList        UL-DeletedTransChInfoList-r6     OPTIONAL,
        ul-AddReconfTransChInfoList      UL-AddReconfTransChInfoList-r8   OPTIONAL,
        dl-CommonTransChInfo             DL-CommonTransChInfo-r4          OPTIONAL,
        dl-DeletedTransChInfoList        DL-DeletedTransChInfoList-r7     OPTIONAL,
        dl-AddReconfTransChInfoList      DL-AddReconfTransChInfoList-r7   OPTIONAL,
    -- Physical channel IEs
        frequencyInfo                     FrequencyInfo                      OPTIONAL,
        multi-frequencyInfo               Multi-frequencyInfo-LCR-r7       OPTIONAL,
        dtx-drx-TimingInfo                DTX-DRX-TimingInfo-r7           OPTIONAL,
        dtx-drx-Info                      DTX-DRX-Info-r7                 OPTIONAL,
        hs-scch-LessInfo                  HS-SCCH-LessInfo-r7             OPTIONAL,
        mimoParameters                   MIMO-Parameters-r8              OPTIONAL,
        maxAllowedUL-TX-Power             MaxAllowedUL-TX-Power            OPTIONAL,
        ul-DPCH-Info                      UL-DPCH-Info-r7                 OPTIONAL,
        ul-EDCH-Information               UL-EDCH-Information-r8          OPTIONAL,
        dl-HSPDSCH-Information            DL-HSPDSCH-Information-r8       OPTIONAL,
        dl-CommonInformation              DL-CommonInformation-r8         OPTIONAL,
        dl-InformationPerRL-List          DL-InformationPerRL-List-r8     OPTIONAL,

```

```

    dl-SecondaryCellInfoFDD          DL-SecondaryCellInfoFDD          OPTIONAL,
    controlChannelDRXInfo-TDD128     ControlChannelDRXInfo-TDD128-r8    OPTIONAL,
    sps-Information-TDD128           SPS-Information-TDD128-r8         OPTIONAL,
-- MBMS IEs
    mbms-PL-ServiceRestrictInfo      MBMS-PL-ServiceRestrictInfo-r6    OPTIONAL,
    mbms-RB-ListReleasedToChangeTransferMode
                                     RB-InformationReleaseList      OPTIONAL
}

RadioBearerRelease-v890ext-IEs ::= SEQUENCE {
-- User Equipment IEs
    dl-SecondaryCellInfoFDD-v890ext  DL-SecondaryCellInfoFDD-v890ext    OPTIONAL,
-- Physical channel IEs
    dl-HSPDSCH-Information           DL-HSPDSCH-Information-r8-ext     OPTIONAL
}

RadioBearerRelease-v8a0ext-IEs ::= SEQUENCE {
-- Physical channel IEs
    dl-HSPDSCH-Information           DL-HSPDSCH-Information-r8-ext2    OPTIONAL
}

-- *****
--
-- RADIO BEARER RELEASE COMPLETE
--
-- *****

RadioBearerReleaseComplete ::= SEQUENCE {
-- User equipment IEs
    rrc-TransactionIdentifier        RRC-TransactionIdentifier,
    ul-IntegProtActivationInfo       IntegrityProtActivationInfo        OPTIONAL,
-- TABULAR: UL-TimingAdvance is applicable for TDD mode only.
    ul-TimingAdvance                UL-TimingAdvance                  OPTIONAL,
-- Radio bearer IEs
    count-C-ActivationTime           ActivationTime                      OPTIONAL,
-- dummy is not used in this version of the specification and
-- it should be ignored by the receiver.
    dummy                            RB-ActivationTimeInfoList        OPTIONAL,
    ul-CounterSynchronisationInfo     UL-CounterSynchronisationInfo     OPTIONAL,
    laterNonCriticalExtensions        SEQUENCE {
-- Container for additional R99 extensions
        radioBearerReleaseComplete-r3-add-ext  BIT STRING  OPTIONAL,
        v770NonCriticalExtensions             SEQUENCE {
            radioBearerReleaseComplete-v770ext
                RadioBearerReleaseComplete-v770ext-IEs,
        } OPTIONAL
    } OPTIONAL
}

RadioBearerReleaseComplete-v770ext-IEs ::= SEQUENCE {
-- TABULAR: EXT-UL-TimingAdvance is applicable for TDD mode only.
    ext-UL-TimingAdvance             EXT-UL-TimingAdvance             OPTIONAL,
    deferredMeasurementControlReading  ENUMERATED { true }             OPTIONAL
}

-- *****
--
-- RADIO BEARER RELEASE FAILURE
--
-- *****

RadioBearerReleaseFailure ::= SEQUENCE {
-- User equipment IEs
    rrc-TransactionIdentifier        RRC-TransactionIdentifier,
    failureCause                     FailureCauseWithProtErr,
-- Radio bearer IEs
    potentiallySuccessfulBearerList  RB-IdentityList                  OPTIONAL,
    laterNonCriticalExtensions        SEQUENCE {
-- Container for additional R99 extensions
        radioBearerReleaseFailure-r3-add-ext  BIT STRING  OPTIONAL,
        nonCriticalExtensions                 SEQUENCE {}  OPTIONAL
    } OPTIONAL
}

-- *****
--
-- RADIO BEARER SETUP

```

```

--
-- *****
RadioBearerSetup ::= CHOICE {
  r3
    SEQUENCE {
      radioBearerSetup-r3          RadioBearerSetup-r3-IEs,
      v3a0NonCriticalExtensions    SEQUENCE {
        radioBearerSetup-v3a0ext  RadioBearerSetup-v3a0ext,
        laterNonCriticalExtensions SEQUENCE {
          -- Container for additional R99 extensions
          radioBearerSetup-r3-add-ext BIT STRING OPTIONAL,
          v4b0NonCriticalExtensions  SEQUENCE {
            radioBearerSetup-v4b0ext  RadioBearerSetup-v4b0ext-IEs,
            v590NonCriticalExtensions SEQUENCE {
              radioBearerSetup-v590ext  RadioBearerSetup-v590ext-IEs,
              v5d0NonCriticalExtensstions SEQUENCE {
                radioBearerSetup-v5d0ext  RadioBearerSetup-v5d0ext-IEs,
                v690NonCriticalExtensions SEQUENCE {
                  radioBearerSetup-v690ext  RadioBearerSetup-v690ext-IEs,
                  nonCriticalExtensions    SEQUENCE {} OPTIONAL
                } OPTIONAL
              } OPTIONAL
            } OPTIONAL
          } OPTIONAL
        } OPTIONAL
      } OPTIONAL
    } OPTIONAL
  },
  later-than-r3
    SEQUENCE {
      rrc-TransactionIdentifier  RRC-TransactionIdentifier,
      criticalExtensions         CHOICE {
        r4
          SEQUENCE {
            radioBearerSetup-r4          RadioBearerSetup-r4-IEs,
            v4d0NonCriticalExtensions    SEQUENCE {
              -- Container for adding non critical extensions after freezing REL-5
              radioBearerSetup-r4-add-ext BIT STRING OPTIONAL,
              v590NonCriticalExtensions  SEQUENCE {
                radioBearerSetup-v590ext  RadioBearerSetup-v590ext-IEs,
                v5d0NonCriticalExtensstions SEQUENCE {
                  radioBearerSetup-v5d0ext  RadioBearerSetup-v5d0ext-IEs,
                  v690NonCriticalExtensions SEQUENCE {
                    radioBearerSetup-v690ext  RadioBearerSetup-v690ext-IEs,
                    nonCriticalExtensions    SEQUENCE {} OPTIONAL
                  } OPTIONAL
                } OPTIONAL
              } OPTIONAL
            } OPTIONAL
          } OPTIONAL
        },
        criticalExtensions         CHOICE {
          r5
            SEQUENCE {
              radioBearerSetup-r5          RadioBearerSetup-r5-IEs,
              -- Container for adding non critical extensions after freezing REL-6
              radioBearerSetup-r5-add-ext  BIT STRING OPTIONAL,
              v5d0NonCriticalExtensstions SEQUENCE {
                radioBearerSetup-v5d0ext  RadioBearerSetup-v5d0ext-IEs,
                v690NonCriticalExtensions SEQUENCE {
                  radioBearerSetup-v690ext  RadioBearerSetup-v690ext-IEs,
                  nonCriticalExtensions    SEQUENCE {} OPTIONAL
                } OPTIONAL
              } OPTIONAL
            } OPTIONAL
          },
          criticalExtensions         CHOICE {
            r6
              SEQUENCE {
                radioBearerSetup-r6          RadioBearerSetup-r6-IEs,
                -- Container for adding non critical extensions after freezing REL-7
                radioBearerSetup-r6-add-ext  BIT STRING OPTIONAL,
                v6b0NonCriticalExtensions    SEQUENCE {
                  radioBearerSetup-v6b0ext  RadioBearerSetup-v6b0ext-IEs,
                  nonCriticalExtensions    SEQUENCE {} OPTIONAL
                } OPTIONAL
              } OPTIONAL
            },
            criticalExtensions         CHOICE {
              r7
                SEQUENCE {
                  radioBearerSetup-r7          RadioBearerSetup-r7-IEs,
                  -- Container for adding non critical extensions after freezing REL-8
                  radioBearerSetup-r7-add-ext  BIT STRING
                  (CONTAINING RadioBearerSetup-r7-add-ext-IEs) OPTIONAL,
                  v780NonCriticalExtensions  SEQUENCE {
                    radioBearerSetup-v780ext  RadioBearerSetup-v780ext-IEs,

```



```

    ul-ChannelRequirement          UL-ChannelRequirement          OPTIONAL,
    modeSpecificPhysChInfo         CHOICE {
        fdd                        SEQUENCE {
            -- dummy is not used in this version of specification, it should
            -- not be sent and if received it should be ignored.
            dummy                    DL-PDSCH-Information          OPTIONAL
        },
        tdd                        NULL
    },
    dl-CommonInformation            DL-CommonInformation            OPTIONAL,
    dl-InformationPerRL-List        DL-InformationPerRL-List        OPTIONAL
}

RadioBearerSetup-v3a0ext ::= SEQUENCE {
    -- The IE "new-DSCH-RNTI" should not be included in FDD mode, and if received the UE behaviour
    -- is unspecified
    new-DSCH-RNTI                  DSCH-RNTI                      OPTIONAL
}

RadioBearerSetup-v4b0ext-IEs ::= SEQUENCE {
    -- Physical channel IEs
    -- dummy is not used in this version of the specification, it should
    -- not be sent and if received it should be ignored.
    dummy                          SSdT-UL                          OPTIONAL,
    -- The order of the RLs in IE cell-id-PerRL-List is the same as
    -- in IE DL-InformationPerRL-List included in this message
    cell-id-PerRL-List              CellIdentity-PerRL-List          OPTIONAL
}

RadioBearerSetup-v590ext-IEs ::= SEQUENCE {
    -- Physical channel IEs
    dl-TPC-PowerOffsetPerRL-List    DL-TPC-PowerOffsetPerRL-List    OPTIONAL
}

RadioBearerSetup-v5d0ext-IEs ::= SEQUENCE {
    --Radio Bearer IEs
    pdcp-ROHC-TargetMode            PDCP-ROHC-TargetMode            OPTIONAL
}

RadioBearerSetup-r4-IEs ::= SEQUENCE {
    -- User equipment IEs
    integrityProtectionModeInfo     IntegrityProtectionModeInfo      OPTIONAL,
    cipheringModeInfo               CipheringModeInfo                 OPTIONAL,
    activationTime                   ActivationTime                     OPTIONAL,
    new-U-RNTI                       U-RNTI                           OPTIONAL,
    new-C-RNTI                       C-RNTI                           OPTIONAL,
    -- The IE "new-DSCH-RNTI" should not be included in FDD mode, and if received
    -- the UE behaviour is unspecified
    new-DSCH-RNTI                   DSCH-RNTI                         OPTIONAL,
    rrc-StateIndicator               RRC-StateIndicator,              OPTIONAL,
    utran-DRX-CycleLengthCoeff       UTRAN-DRX-CycleLengthCoefficient  OPTIONAL,
    -- UTRAN mobility IEs
    ura-Identity                     URA-Identity                     OPTIONAL,
    -- Core network IEs
    cn-InformationInfo               CN-InformationInfo               OPTIONAL,
    -- Radio bearer IEs
    srb-InformationSetupList         SRB-InformationSetupList         OPTIONAL,
    rab-InformationSetupList         RAB-InformationSetupList-r4     OPTIONAL,
    rb-InformationAffectedList       RB-InformationAffectedList       OPTIONAL,
    dl-CounterSynchronisationInfo    DL-CounterSynchronisationInfo    OPTIONAL,
    -- Transport channel IEs
    ul-CommonTransChInfo             UL-CommonTransChInfo-r4         OPTIONAL,
    ul-deletedTransChInfoList        UL-DeletedTransChInfoList       OPTIONAL,
    ul-AddReconfTransChInfoList      UL-AddReconfTransChInfoList     OPTIONAL,
    -- 'dummy', 'dummy1' and 'dummy2' are not used in this version of the specification,
    -- they should not be sent and if received they should be ignored.
    dummy                            CHOICE {
        fdd                          SEQUENCE {
            dummy1                    CPCH-SetID                       OPTIONAL,
            dummy2                    DRAC-StaticInformationList        OPTIONAL
        },
        tdd                          NULL
    }
    dl-CommonTransChInfo             DL-CommonTransChInfo-r4         OPTIONAL,
    dl-DeletedTransChInfoList        DL-DeletedTransChInfoList       OPTIONAL,
    dl-AddReconfTransChInfoList-r4   DL-AddReconfTransChInfoList-r4  OPTIONAL,
    -- Physical channel IEs
    frequencyInfo                    FrequencyInfo                     OPTIONAL,

```



```

maxAllowedUL-TX-Power          MaxAllowedUL-TX-Power          OPTIONAL,
ul-ChannelRequirement          UL-ChannelRequirement-r4          OPTIONAL,
modeSpecificPhysChInfo        CHOICE {
  fdd                          SEQUENCE {
    -- dummy is not used in this version of specification, it should
    -- not be sent and if received it should be ignored.
    dummy                      DL-PDSCH-Information          OPTIONAL
  },
  tdd                          NULL
},
dl-CommonInformation          DL-CommonInformation-r4          OPTIONAL,
dl-InformationPerRL-List      DL-InformationPerRL-List-r4      OPTIONAL
}

RadioBearerSetup-r5-IEs ::= SEQUENCE {
  -- User equipment IEs
  integrityProtectionModeInfo IntegrityProtectionModeInfo    OPTIONAL,
  cipheringModeInfo          CipheringModeInfo              OPTIONAL,
  activationTime             ActivationTime                  OPTIONAL,
  new-U-RNTI                 U-RNTI                        OPTIONAL,
  new-C-RNTI                 C-RNTI                        OPTIONAL,
  -- The IE "new-DSCH-RNTI" should not be included in FDD mode, and if received
  -- the UE behaviour is unspecified
  new-DSCH-RNTI             DSCH-RNTI                      OPTIONAL,
  new-H-RNTI                 H-RNTI                        OPTIONAL,
  rrc-StateIndicator         RRC-StateIndicator,
  utran-DRX-CycleLengthCoeff UTRAN-DRX-CycleLengthCoefficient OPTIONAL,
  -- UTRAN mobility IEs
  ura-Identity               URA-Identity                    OPTIONAL,
  -- Core network IEs
  cn-InformationInfo         CN-InformationInfo              OPTIONAL,
  -- Radio bearer IEs
  srb-InformationSetupList   SRB-InformationSetupList-r5    OPTIONAL,
  rab-InformationSetupList   RAB-InformationSetupList-r5    OPTIONAL,
  rb-InformationAffectedList RB-InformationAffectedList-r5  OPTIONAL,
  dl-CounterSynchronisationInfo DL-CounterSynchronisationInfo-r5 OPTIONAL,
  -- Transport channel IEs
  ul-CommonTransChInfo       UL-CommonTransChInfo-r4        OPTIONAL,
  ul-deletedTransChInfoList  UL-DeletedTransChInfoList      OPTIONAL,
  ul-AddReconfTransChInfoList UL-AddReconfTransChInfoList    OPTIONAL,
  -- 'dummy', 'dummy1' and 'dummy2' are not used in this version of the specification,
  -- they should not be sent and if received they should be ignored.
  dummy                      CHOICE {
    fdd                      SEQUENCE {
      dummy1                  CPCH-SetID                    OPTIONAL,
      dummy2                  DRAC-StaticInformationList  OPTIONAL
    },
    tdd                      NULL
  }
  dl-CommonTransChInfo       DL-CommonTransChInfo-r4        OPTIONAL,
  dl-DeletedTransChInfoList  DL-DeletedTransChInfoList-r5    OPTIONAL,
  dl-AddReconfTransChInfoList DL-AddReconfTransChInfoList-r5  OPTIONAL,
  -- Physical channel IEs
  frequencyInfo              FrequencyInfo                    OPTIONAL,
  maxAllowedUL-TX-Power      MaxAllowedUL-TX-Power          OPTIONAL,
  ul-ChannelRequirement      UL-ChannelRequirement-r5        OPTIONAL,
  modeSpecificPhysChInfo     CHOICE {
    fdd                      SEQUENCE {
      -- dummy is not used in this version of specification, it should
      -- not be sent and if received it should be ignored.
      dummy                  DL-PDSCH-Information          OPTIONAL
    },
    tdd                      NULL
  },
  dl-HSPDSCH-Information     DL-HSPDSCH-Information          OPTIONAL,
  dl-CommonInformation       DL-CommonInformation-r5        OPTIONAL,
  dl-InformationPerRL-List   DL-InformationPerRL-List-r5    OPTIONAL
}

RadioBearerSetup-v690ext-IEs ::= SEQUENCE {
  -- Core network IEs
  primary-plmn-Identity      PLMN-Identity                    OPTIONAL,
  -- Physical channel IEs
  -- The IE harq-Preamble-Mode should not be used in the r3 and r4 versions of the message
  -- If included in the r3 or r4 version of the message, the UE should ignore the IE
  harq-Preamble-Mode        HARQ-Preamble-Mode              OPTIONAL,
  beaconPLEst               BEACON-PL-Est                    OPTIONAL,
  postVerificationPeriod     ENUMERATED { true }                OPTIONAL,

```

```

    dhs-sync                DHS-Sync                OPTIONAL,
    timingMaintainedSynchInd TimingMaintainedSynchInd  OPTIONAL,
-- Radio bearer IEs
    rab-InformationSetupList RAB-InformationSetupList-r6-ext  OPTIONAL,
-- MBMS IEs
    mbms-PL-ServiceRestrictInfo MBMS-PL-ServiceRestrictInfo-r6  OPTIONAL
}

RadioBearerSetup-r6-IEs ::= SEQUENCE {
-- User equipment IEs
    integrityProtectionModeInfo IntegrityProtectionModeInfo  OPTIONAL,
    cipheringModeInfo          CipheringModeInfo                OPTIONAL,
    activationTime              ActivationTime                    OPTIONAL,
    new-U-RNTI                  U-RNTI                          OPTIONAL,
    new-C-RNTI                  C-RNTI                          OPTIONAL,
    -- The IE "new-DSCH-RNTI" should not be included in FDD mode,
    -- and if received the UE behaviour is unspecified
    new-DSCH-RNTI              DSCH-RNTI                        OPTIONAL,
    new-H-RNTI                  H-RNTI                          OPTIONAL,
    newPrimary-E-RNTI           E-RNTI                          OPTIONAL,
    newSecondary-E-RNTI         E-RNTI                          OPTIONAL,
    rrc-StateIndicator          RRC-StateIndicator,
    utran-DRX-CycleLengthCoeff UTRAN-DRX-CycleLengthCoefficient  OPTIONAL,
-- UTRAN mobility IEs
    ura-Identity                URA-Identity                    OPTIONAL,
-- Core network IEs
    cn-InformationInfo          CN-InformationInfo-r6        OPTIONAL,
    specificationMode           CHOICE {
        complete                SEQUENCE {
-- Radio bearer IEs
            srb-InformationSetupList SRB-InformationSetupList-r6  OPTIONAL,
            rab-InformationSetupList RAB-InformationSetupList-r6  OPTIONAL,
            rab-InformationReconfigList RAB-InformationReconfigList  OPTIONAL,
            rb-InformationReconfigList RB-InformationReconfigList-r6  OPTIONAL,
            rb-InformationAffectedList RB-InformationAffectedList-r6  OPTIONAL,
            dl-CounterSynchronisationInfo DL-CounterSynchronisationInfo-r5  OPTIONAL,
            pdcp-ROHC-TargetMode PDCP-ROHC-TargetMode  OPTIONAL,
-- Transport channel IEs
            ul-CommonTransChInfo UL-CommonTransChInfo-r4  OPTIONAL,
            ul-deletedTransChInfoList UL-DeletedTransChInfoList-r6  OPTIONAL,
            ul-AddReconfTransChInfoList UL-AddReconfTransChInfoList-r6  OPTIONAL,
            dl-CommonTransChInfo DL-CommonTransChInfo-r4  OPTIONAL,
            dl-DeletedTransChInfoList DL-DeletedTransChInfoList-r5  OPTIONAL,
            dl-AddReconfTransChInfoList DL-AddReconfTransChInfoList-r5  OPTIONAL
        },
        -- dummy is not used in this version of the specification
        -- if it is sent, the UE behaviour is unspecified.
        dummy                    SEQUENCE {
            rab-Info              RAB-Info-r6,
            defaultConfigMode      DefaultConfigMode,
            defaultConfigIdentity  DefaultConfigIdentity-r6,
            rb-InformationChangedList RB-InformationChangedList-r6  OPTIONAL,
            powerOffsetInfoShort   PowerOffsetInfoShort
        }
    },
-- Physical channel IEs
    frequencyInfo              FrequencyInfo                    OPTIONAL,
    maxAllowedUL-TX-Power       MaxAllowedUL-TX-Power  OPTIONAL,
    ul-DPCH-Info                UL-DPCH-Info-r6          OPTIONAL,
    ul-EDCH-Information          UL-EDCH-Information-r6  OPTIONAL,
    dl-HSPDSCH-Information       DL-HSPDSCH-Information-r6  OPTIONAL,
    dl-CommonInformation         DL-CommonInformation-r6  OPTIONAL,
    dl-InformationPerRL-List     DL-InformationPerRL-List-r6  OPTIONAL,
-- MBMS IEs
    mbms-PL-ServiceRestrictInfo MBMS-PL-ServiceRestrictInfo-r6  OPTIONAL
}

RadioBearerSetup-v6b0ext-IEs ::= SEQUENCE {
-- Physical channel IEs
    dl-InformationPerRL-List-v6b0ext DL-InformationPerRL-List-v6b0ext  OPTIONAL,
-- MBMS IEs
    -- The order of the RABs in IE rab-InformationSetupListExt is the same as
    -- in IE rab-InformationSetupList that is included in this message
    rab-InformationSetupListExt RAB-InformationSetupList-v6b0ext  OPTIONAL
}

RadioBearerSetup-r7-IEs ::= SEQUENCE {
-- User equipment IEs

```

```

integrityProtectionModeInfo      IntegrityProtectionModeInfo-r7      OPTIONAL,
cipheringModeInfo                CipheringModeInfo-r7                OPTIONAL,
activationTime                   ActivationTime                       OPTIONAL,
new-U-RNTI                       U-RNTI                             OPTIONAL,
new-C-RNTI                       C-RNTI                             OPTIONAL,
-- The IE "new-DSCH-RNTI" should not be included in FDD mode,
-- and if received the UE behaviour is unspecified
new-DSCH-RNTI                   DSCH-RNTI                          OPTIONAL,
new-H-RNTI                       H-RNTI                             OPTIONAL,
newPrimary-E-RNTI               E-RNTI                             OPTIONAL,
newSecondary-E-RNTI             E-RNTI                             OPTIONAL,
rrc-StateIndicator              RRC-StateIndicator,
utran-DRX-CycleLengthCoeff      UTRAN-DRX-CycleLengthCoefficient-r7 OPTIONAL,
-- UTRAN mobility IEs
ura-Identity                     URA-Identity                       OPTIONAL,
supportForChangeOfUE-Capability BOOLEAN                             OPTIONAL,
-- Core network IEs
cn-InformationInfo              CN-InformationInfo-r6              OPTIONAL,
specificationMode               CHOICE {
  complete                       SEQUENCE {
    -- Radio bearer IEs
    srb-InformationSetupList      SRB-InformationSetupList-r7      OPTIONAL,
    rab-InformationSetupList      RAB-InformationSetupList-r7      OPTIONAL,
    rab-InformationReconfigList   RAB-InformationReconfigList     OPTIONAL,
    rb-InformationReconfigList     RB-InformationReconfigList-r7    OPTIONAL,
    rb-InformationAffectedList     RB-InformationAffectedList-r7    OPTIONAL,
    dl-CounterSynchronisationInfo DL-CounterSynchronisationInfo-r5 OPTIONAL,
    pdcp-ROHC-TargetMode         PDCP-ROHC-TargetMode            OPTIONAL,
    -- Transport channel IEs
    ul-CommonTransChInfo         UL-CommonTransChInfo-r4         OPTIONAL,
    ul-deletedTransChInfoList     UL-DeletedTransChInfoList-r6    OPTIONAL,
    ul-AddReconfTransChInfoList   UL-AddReconfTransChInfoList-r7  OPTIONAL,
    dl-CommonTransChInfo         DL-CommonTransChInfo-r4         OPTIONAL,
    dl-DeletedTransChInfoList     DL-DeletedTransChInfoList-r7    OPTIONAL,
    dl-AddReconfTransChInfoList   DL-AddReconfTransChInfoList-r7  OPTIONAL
  },
  -- dummy is not used in this version of the specification
  -- if it is sent, the UE behaviour is unspecified.
  dummy                          NULL
},
-- Physical channel IEs
frequencyInfo                   FrequencyInfo                       OPTIONAL,
multi-frequencyInfo             Multi-frequencyInfo-LCR-r7        OPTIONAL,
dtx-drx-TimingInfo             DTX-DRX-TimingInfo-r7            OPTIONAL,
dtx-drx-Info                   DTX-DRX-Info-r7                  OPTIONAL,
hs-scch-LessInfo               HS-SCCH-LessInfo-r7              OPTIONAL,
mimoParameters                 MIMO-Parameters-r7               OPTIONAL,
maxAllowedUL-TX-Power           MaxAllowedUL-TX-Power             OPTIONAL,
ul-DPCH-Info                   UL-DPCH-Info-r7                  OPTIONAL,
ul-EDCH-Information             UL-EDCH-Information-r7           OPTIONAL,
dl-HSPDSCH-Information         DL-HSPDSCH-Information-r7        OPTIONAL,
dl-CommonInformation            DL-CommonInformation-r7           OPTIONAL,
dl-InformationPerRL-List        DL-InformationPerRL-List-r7      OPTIONAL,
-- MBMS IEs
mbms-PL-ServiceRestrictInfo     MBMS-PL-ServiceRestrictInfo-r6   OPTIONAL
}

RadioBearerSetup-r7-add-ext-IEs ::= SEQUENCE {
  radioBearerSetup-v7d0ext       RadioBearerSetup-v7d0ext-IEs     OPTIONAL,
  v7f0NonCriticalExtensions      SEQUENCE {
    radioBearerSetup-v7f0ext      RadioBearerSetup-v7f0ext-IEs,
    v7g0NonCriticalExtensions     SEQUENCE {
      radioBearerSetup-v7g0ext    RadioBearerSetup-v7g0ext-IEs,
      nonCriticalExtensions       SEQUENCE {} OPTIONAL
    } OPTIONAL
  } OPTIONAL
}

RadioBearerSetup-v780ext-IEs ::= SEQUENCE {
  -- Physical channel IEs
  hs-DSCH-TBSizeTable            HS-DSCH-TBSizeTable              OPTIONAL
}

RadioBearerSetup-v7d0ext-IEs ::= SEQUENCE {
  -- Physical channel IEs
  ul-EDCH-Information            UL-EDCH-Information-ext          OPTIONAL
}

```

```

RadioBearerSetup-v7f0ext-IEs ::= SEQUENCE {
  -- Physical channel IEs
  mimoParameters          MIMO-Parameters-v7f0ext          OPTIONAL
}

RadioBearerSetup-v7g0ext-IEs ::= SEQUENCE {
  -- Physical channel IEs
  mimoParameters          MIMO-Parameters-v7g0ext          OPTIONAL
}

RadioBearerSetup-r8-IEs ::= SEQUENCE {
  -- User equipment IEs
  integrityProtectionModeInfo    IntegrityProtectionModeInfo-r7    OPTIONAL,
  cipheringModeInfo              CipheringModeInfo-r7              OPTIONAL,
  sr-vcc-Info                    SR-VCC-Info                    OPTIONAL,
  activationTime                  ActivationTime                    OPTIONAL,
  new-U-RNTI                      U-RNTI                      OPTIONAL,
  new-C-RNTI                      C-RNTI                      OPTIONAL,
  -- The IE "new-DSCH-RNTI" should not be included in FDD mode,
  -- and if received the UE behaviour is unspecified
  new-DSCH-RNTI                  DSCH-RNTI                    OPTIONAL,
  new-H-RNTI                      H-RNTI                      OPTIONAL,
  newPrimary-E-RNTI              E-RNTI                      OPTIONAL,
  newSecondary-E-RNTI            E-RNTI                      OPTIONAL,
  rrc-StateIndicator              RRC-StateIndicator,
  utran-DRX-CycleLengthCoeff      UTRAN-DRX-CycleLengthCoefficient-r7  OPTIONAL,
  -- UTRAN mobility IEs
  ura-Identity                    URA-Identity                    OPTIONAL,
  supportForChangeOfUE-Capability BOOLEAN                      OPTIONAL,
  -- Core network IEs
  cn-InformationInfo              CN-InformationInfo-r6              OPTIONAL,
  -- Radio bearer IEs
  srb-InformationSetupList        SRB-InformationSetupList-r8        OPTIONAL,
  rab-InformationSetupList        RAB-InformationSetupList-r8        OPTIONAL,
  rab-InformationReconfigList     RAB-InformationReconfigList-r8     OPTIONAL,
  rb-InformationReconfigList      RB-InformationReconfigList-r8     OPTIONAL,
  rb-InformationAffectedList      RB-InformationAffectedList-r8     OPTIONAL,
  dl-CounterSynchronisationInfo   DL-CounterSynchronisationInfo-r5   OPTIONAL,
  pdcp-ROHC-TargetMode            PDCP-ROHC-TargetMode            OPTIONAL,
  -- Transport channel IEs
  ul-CommonTransChInfo            UL-CommonTransChInfo-r4            OPTIONAL,
  ul-deletedTransChInfoList       UL-DeletedTransChInfoList-r6       OPTIONAL,
  ul-AddReconfTransChInfoList     UL-AddReconfTransChInfoList-r8     OPTIONAL,
  dl-CommonTransChInfo            DL-CommonTransChInfo-r4            OPTIONAL,
  dl-DeletedTransChInfoList       DL-DeletedTransChInfoList-r7       OPTIONAL,
  dl-AddReconfTransChInfoList     DL-AddReconfTransChInfoList-r7     OPTIONAL,
  -- Physical channel IEs
  frequencyInfo                   FrequencyInfo                     OPTIONAL,
  multi-frequencyInfo             Multi-frequencyInfo-LCR-r7        OPTIONAL,
  dtx-drx-TimingInfo              DTX-DRX-TimingInfo-r7            OPTIONAL,
  dtx-drx-Info                    DTX-DRX-Info-r7                  OPTIONAL,
  hs-scch-LessInfo                HS-SCCH-LessInfo-r7              OPTIONAL,
  mimoParameters                  MIMO-Parameters-r8                OPTIONAL,
  maxAllowedUL-TX-Power            MaxAllowedUL-TX-Power            OPTIONAL,
  ul-DPCH-Info                    UL-DPCH-Info-r7                  OPTIONAL,
  ul-EDCH-Information              UL-EDCH-Information-r8            OPTIONAL,
  dl-HSPDSCH-Information           DL-HSPDSCH-Information-r8         OPTIONAL,
  dl-CommonInformation             DL-CommonInformation-r8           OPTIONAL,
  dl-InformationPerRL-List         DL-InformationPerRL-List-r8       OPTIONAL,
  dl-SecondaryCellInfoFDD          DL-SecondaryCellInfoFDD           OPTIONAL,
  controlChannelDRXInfo-TDD128    ControlChannelDRXInfo-TDD128-r8   OPTIONAL,
  sps-Information-TDD128           SPS-Information-TDD128-r8         OPTIONAL,
  -- MBMS IEs
  mbms-PL-ServiceRestrictInfo     MBMS-PL-ServiceRestrictInfo-r6    OPTIONAL
}

RadioBearerSetup-v820ext-IEs ::= SEQUENCE {
  -- Radio bearer IEs
  rab-InformationSetupList        RAB-InformationSetupList-v820ext    OPTIONAL
}

RadioBearerSetup-v890ext-IEs ::= SEQUENCE {
  -- User Equipment IEs
  dl-SecondaryCellInfoFDD-v890ext  DL-SecondaryCellInfoFDD-v890ext    OPTIONAL,
  -- Physical channel IEs
  dl-HSPDSCH-Information           DL-HSPDSCH-Information-r8-ext      OPTIONAL
}

```

```

RadioBearerSetup-v8a0ext-IEs ::= SEQUENCE {
    -- Physical channel IEs
    dl-HSPDSCH-Information          DL-HSPDSCH-Information-r8-ext2    OPTIONAL
}

-- *****
--
-- RADIO BEARER SETUP COMPLETE
--
-- *****

RadioBearerSetupComplete ::= SEQUENCE {
    -- User equipment IEs
    rrc-TransactionIdentifier      RRC-TransactionIdentifier,
    ul-IntegProtActivationInfo     IntegrityProtActivationInfo    OPTIONAL,
    -- TABULAR: UL-TimingAdvance is applicable for TDD mode only.
    ul-TimingAdvance              UL-TimingAdvance                OPTIONAL,
    start-Value                   START-Value                    OPTIONAL,
    -- Radio bearer IEs
    count-C-ActivationTime        ActivationTime                OPTIONAL,
    -- dummy is not used in this version of the specification and
    -- it should be ignored by the receiver.
    dummy                          RB-ActivationTimeInfoList    OPTIONAL,
    ul-CounterSynchronisationInfo  UL-CounterSynchronisationInfo  OPTIONAL,
    laterNonCriticalExtensions     SEQUENCE {
        -- Container for additional R99 extensions
        radioBearerSetupComplete-r3-add-ext    BIT STRING    OPTIONAL,
        v770NonCriticalExtensions            SEQUENCE {
            radioBearerSetupComplete-v770ext
                RadioBearerSetupComplete-v770ext-IEs,
                SEQUENCE {}    OPTIONAL
        }    OPTIONAL
    }    OPTIONAL
}

RadioBearerSetupComplete-v770ext-IEs ::= SEQUENCE {
    -- TABULAR: EXT-UL-TimingAdvance is applicable for TDD mode only.
    ext-UL-TimingAdvance          EXT-UL-TimingAdvance    OPTIONAL,
    deferredMeasurementControlReading  ENUMERATED { true }    OPTIONAL
}

-- *****
--
-- RADIO BEARER SETUP FAILURE
--
-- *****

RadioBearerSetupFailure ::= SEQUENCE {
    -- User equipment IEs
    rrc-TransactionIdentifier      RRC-TransactionIdentifier,
    failureCause                  FailureCauseWithProtErr,
    -- Radio bearer IEs
    potentiallySuccessfulBearerList  RB-IdentityList    OPTIONAL,
    laterNonCriticalExtensions     SEQUENCE {
        -- Container for additional R99 extensions
        radioBearerSetupFailure-r3-add-ext    BIT STRING    OPTIONAL,
        nonCriticalExtensions              SEQUENCE {}    OPTIONAL
    }    OPTIONAL
}

-- *****
--
-- RRC CONNECTION REJECT
--
-- *****

RRCConnectionReject ::= CHOICE {
    r3                            SEQUENCE {
        rrcConnectionReject-r3          RRCConnectionReject-r3-IEs,
        laterNonCriticalExtensions      SEQUENCE {
            -- Container for additional R99 extensions
            rrcConnectionReject-r3-add-ext    BIT STRING    OPTIONAL,
            v690NonCriticalExtensions        SEQUENCE {
                rrcConnectionReject-v690ext    RRCConnectionReject-v690ext-IEs,
                v6f0NonCriticalExtensions      SEQUENCE {
                    rrcConnectionReject-v6f0ext    RRCConnectionReject-v6f0ext-IEs,
                    v860NonCriticalExtensions      SEQUENCE {
                        rrcConnectionReject-v860ext    RRCConnectionReject-v860ext-IEs,

```

```

        nonCriticalExtensions          SEQUENCE {}          OPTIONAL
    } OPTIONAL
} OPTIONAL
},
later-than-r3                          SEQUENCE {
    initialUE-Identity                 InitialUE-Identity,
    rrc-TransactionIdentifier          RRC-TransactionIdentifier,
    criticalExtensions                 SEQUENCE {}
}
}

RRCConnectionReject-r3-IEs ::= SEQUENCE {
    -- TABULAR: Integrity protection shall not be performed on this message.
    -- User equipment IEs
    initialUE-Identity                 InitialUE-Identity,
    rrc-TransactionIdentifier          RRC-TransactionIdentifier,
    rejectionCause                     RejectionCause,
    waitTime                           WaitTime,
    redirectionInfo                    RedirectionInfo          OPTIONAL
}

RRCConnectionReject-v690ext-IEs ::= SEQUENCE {
    redirectionInfo-v690ext            GSM-TargetCellInfoList    OPTIONAL
}

RRCConnectionReject-v6f0ext-IEs ::= SEQUENCE {
    countingCompletion                 ENUMERATED { true }      OPTIONAL
}

RRCConnectionReject-v860ext-IEs ::= SEQUENCE {
    redirectionInfo                    RedirectionInfo-v860ext  OPTIONAL
}

-- *****
--
-- RRC CONNECTION RELEASE
--
-- *****

RRCConnectionRelease ::= CHOICE {
    r3                                  SEQUENCE {
        rrcConnectionRelease-r3        RRCConnectionRelease-r3-IEs,
        laterNonCriticalExtensions      SEQUENCE {
            -- Container for additional R99 extensions
            rrcConnectionRelease-r3-add-ext BIT STRING    OPTIONAL,
            v690NonCriticalExtensions     SEQUENCE {
                rrcConnectionRelease-v690ext RRCConnectionRelease-v690ext-IEs,
                v770NonCriticalExtensions     SEQUENCE {
                    rrcConnectionRelease-v770ext RRCConnectionRelease-v770ext-IEs,
                    v860NonCriticalExtensions     SEQUENCE {
                        rrcConnectionRelease-v860ext RRCConnectionRelease-v860ext-IEs,
                        nonCriticalExtensions     SEQUENCE {}    OPTIONAL
                    } OPTIONAL
                } OPTIONAL
            } OPTIONAL
        } OPTIONAL
    } OPTIONAL
},
later-than-r3                          SEQUENCE {
    rrc-TransactionIdentifier          RRC-TransactionIdentifier,
    criticalExtensions                 CHOICE {
        r4                              SEQUENCE {
            rrcConnectionRelease-r4        RRCConnectionRelease-r4-IEs,
            v4d0NonCriticalExtensions      SEQUENCE {
                -- Container for adding non critical extensions after freezing REL-6
                rrcConnectionRelease-r4-add-ext BIT STRING    OPTIONAL,
                v690NonCriticalExtensions     SEQUENCE {
                    rrcConnectionRelease-v690ext RRCConnectionRelease-v690ext-IEs,
                    v770NonCriticalExtensions     SEQUENCE {
                        rrcConnectionRelease-v770ext RRCConnectionRelease-v770ext-IEs,
                        v860NonCriticalExtensions     SEQUENCE {
                            rrcConnectionRelease-v860ext RRCConnectionRelease-v860ext-IEs,
                            nonCriticalExtensions     SEQUENCE {}    OPTIONAL
                        } OPTIONAL
                    } OPTIONAL
                } OPTIONAL
            } OPTIONAL
        } OPTIONAL
    } OPTIONAL
} OPTIONAL
}

```

```

    },
    criticalExtensions          SEQUENCE {}
  }
}

RRCConnectionRelease-r3-IEs ::= SEQUENCE {
  -- User equipment IEs
  rrc-TransactionIdentifier    RRC-TransactionIdentifier,
  -- n-308 is conditional on the UE state
  n-308                        N-308                      OPTIONAL,
  releaseCause                 ReleaseCause,
  rplmn-information            Rplmn-Information          OPTIONAL
}

RRCConnectionRelease-r4-IEs ::= SEQUENCE {
  -- User equipment IEs
  -- n-308 is conditional on the UE state.
  n-308                        N-308                      OPTIONAL,
  releaseCause                 ReleaseCause,
  rplmn-information            Rplmn-Information-r4       OPTIONAL
}

RRCConnectionRelease-v690ext-IEs ::= SEQUENCE {
  redirectionInfo-v690ext      RedirectionInfo-r6      OPTIONAL
}

RRCConnectionRelease-v770ext-IEs ::= SEQUENCE {
  -- User equipment IEs
  ueMobilityStateIndicator     High-MobilityDetected    OPTIONAL
}

RRCConnectionRelease-v860ext-IEs ::= SEQUENCE {
  -- Other IEs
  redirectionInfo              RedirectionInfo-v860ext    OPTIONAL
}

-- *****
--
-- RRC CONNECTION RELEASE for CCCH
--
-- *****

RRCConnectionRelease-CCCH ::= CHOICE {
  r3                            SEQUENCE {
    rrcConnectionRelease-CCCH-r3  RRCConnectionRelease-CCCH-r3-IEs,
    laterNonCriticalExtensions     SEQUENCE {
      -- Container for additional R99 extensions
      rrcConnectionRelease-CCCH-r3-add-ext    BIT STRING    OPTIONAL,
      v690NonCriticalExtensions             SEQUENCE {
        rrcConnectionRelease-v690ext        RRCConnectionRelease-CCCH-v690ext-IEs,
        v860NonCriticalExtensions           SEQUENCE {
          rrcConnectionRelease-v860ext      RRCConnectionRelease-CCCH-v860ext-IEs,
          nonCriticalExtensions              SEQUENCE {} OPTIONAL
        } OPTIONAL
      } OPTIONAL
    } OPTIONAL
  } OPTIONAL
},
  later-than-r3                 SEQUENCE {
    u-RNTI                       U-RNTI,
    rrc-TransactionIdentifier      RRC-TransactionIdentifier,
    criticalExtensions             CHOICE {
      r4                            SEQUENCE {
        rrcConnectionRelease-CCCH-r4        RRCConnectionRelease-CCCH-r4-IEs,
        v4d0NonCriticalExtensions           SEQUENCE {
          -- Container for adding non critical extensions after freezing REL-5
          rrcConnectionRelease-CCCH-r4-add-ext    BIT STRING    OPTIONAL,
          v690NonCriticalExtensions             SEQUENCE {
            rrcConnectionRelease-v690ext        RRCConnectionRelease-CCCH-v690ext-IEs,
            v860NonCriticalExtensions           SEQUENCE {
              rrcConnectionRelease-v860ext      RRCConnectionRelease-CCCH-v860ext-IEs,
              nonCriticalExtensions              SEQUENCE {}    OPTIONAL
            } OPTIONAL
          } OPTIONAL
        } OPTIONAL
      } OPTIONAL
    } OPTIONAL
  } OPTIONAL
},
  criticalExtensions             SEQUENCE {
    -- TABULAR: CHOICE IdentityType (U-RNTI, GroupIdentity) is replaced with the

```

```

-- optional element groupIdentity, since the U-RNTI is mandatory in ASN.1.
-- In case CHOICE IdentityType is equal to GroupIdentity the value of the U-RNTI
-- shall be ignored by a UE complying with this version of the message.
groupIdentity      SEQUENCE ( SIZE (1 .. maxURNTI-Group) ) OF
                    GroupReleaseInformation      OPTIONAL,
criticalExtensions CHOICE {
  r5 SEQUENCE {
    rrcConnectionRelease-CCCH-r5      RRCConnectionRelease-CCCH-r5-IEs,
    -- Container for adding non critical extensions after freezing REL-6
    rrcConnectionRelease-CCCH-r5-add-ext BIT STRING      OPTIONAL,
    v690NonCriticalExtensions SEQUENCE {
      rrcConnectionRelease-v690ext      RRCConnectionRelease-CCCH-v690ext-IEs,
      v860NonCriticalExtensions SEQUENCE {
        rrcConnectionRelease-v860ext
        nonCriticalExtensions SEQUENCE {} OPTIONAL
      } OPTIONAL
    } OPTIONAL
  },
  criticalExtensions SEQUENCE {}
}
}
}
}
}

RRCConnectionRelease-CCCH-r3-IEs ::= SEQUENCE {
  -- User equipment IEs
  u-RNTI U-RNTI,
  -- The rest of the message is identical to the one sent on DCCH.
  rrcConnectionRelease RRCConnectionRelease-r3-IEs
}

RRCConnectionRelease-CCCH-r4-IEs ::= SEQUENCE {
  -- The rest of the message is identical to the one sent on DCCH.
  rrcConnectionRelease RRCConnectionRelease-r4-IEs
}

-- The R5 and R4 sequence of IEs are identical in this message
RRCConnectionRelease-CCCH-r5-IEs ::= RRCConnectionRelease-CCCH-r4-IEs

-- The R6 non-critical extension is identical to the one sent on DCCH.
RRCConnectionRelease-CCCH-v690ext-IEs ::= RRCConnectionRelease-v690ext-IEs

-- The R8 non-critical extension is identical to the one sent on DCCH.
RRCConnectionRelease-CCCH-v860ext-IEs ::= RRCConnectionRelease-v860ext-IEs

-- *****
--
-- RRC CONNECTION RELEASE COMPLETE
--
-- *****

RRCConnectionReleaseComplete ::= SEQUENCE {
  -- User equipment IEs
  rrc-TransactionIdentifier RRC-TransactionIdentifier,
  errorIndication FailureCauseWithProtErr OPTIONAL,
  laterNonCriticalExtensions SEQUENCE {
    -- Container for additional R99 extensions
    rrcConnectionReleaseComplete-r3-add-ext BIT STRING OPTIONAL,
    nonCriticalExtensions SEQUENCE {} OPTIONAL
  } OPTIONAL
}

-- *****
--
-- RRC CONNECTION REQUEST
--
-- *****

RRCConnectionRequest ::= SEQUENCE {
  -- TABULAR: Integrity protection shall not be performed on this message.
  -- User equipment IEs
  initialUE-Identity InitialUE-Identity,
  establishmentCause EstablishmentCause,
  -- protocolErrorIndicator is MD, but for compactness reasons no default value
  -- has been assigned to it.
  protocolErrorIndicator ProtocolErrorIndicator,

```



```

-- Measurement IEs
measuredResultsOnRACH      MeasuredResultsOnRACH      OPTIONAL,
-- Non critical Extensions
v3d0NonCriticalExtensions  SEQUENCE {
  rrcConnectionRequest-v3d0ext  RRCConnectionRequest-v3d0ext-IEs,
  -- Reserved for future non critical extension
  v4b0NonCriticalExtensions    SEQUENCE {
    rrcConnectionRequest-v4b0ext  RRCConnectionRequest-v4b0ext-IEs,
    v590NonCriticalExtensions    SEQUENCE {
      rrcConnectionRequest-v590ext  RRCConnectionRequest-v590ext-IEs,
      v690NonCriticalExtensions    SEQUENCE {
        rrcConnectionRequest-v690ext  RRCConnectionRequest-v690ext-IEs,
        -- Reserved for future non critical extension
        v6b0NonCriticalExtensions    SEQUENCE {
          rrcConnectionRequest-v6b0ext  RRCConnectionRequest-v6b0ext-IEs,
          v6e0NonCriticalExtensions    SEQUENCE {
            rrcConnectionRequest-v6e0ext  RRCConnectionRequest-v6e0ext-IEs,
            v770NonCriticalExtensions    SEQUENCE {
              rrcConnectionRequest-v770ext  RRCConnectionRequest-v770ext-IEs,
              v7b0NonCriticalExtensions  SEQUENCE {
                rrcConnectionRequest-v7b0ext  RRCConnectionRequest-v7b0ext-IEs,
                v860NonCriticalExtensions  SEQUENCE {
                  rrcConnectionRequest-v860ext  RRCConnectionRequest-v860ext-IEs,
                  v7e0NonCriticalExtensions  SEQUENCE {
                    rrcConnectionRequest-v7e0ext  RRCConnectionRequest-v7e0ext-IEs,
                    v7g0NonCriticalExtensions  SEQUENCE {
                      rrcConnectionRequest-v7g0ext  RRCConnectionRequest-v7g0ext-IEs,
                      nonCriticalExtensions  SEQUENCE {} OPTIONAL
                    } OPTIONAL
                  } OPTIONAL
                } OPTIONAL
              } OPTIONAL
            } OPTIONAL
          } OPTIONAL
        } OPTIONAL
      } OPTIONAL
    } OPTIONAL
  } OPTIONAL
} OPTIONAL
}
}

RRCConnectionRequest-v3d0ext-IEs ::= SEQUENCE {
  -- User equipment IEs
  ueSpecificBehaviourInformationIdle  UESpecificBehaviourInformationIdle  OPTIONAL
}

RRCConnectionRequest-v4b0ext-IEs ::= SEQUENCE {
  -- User equipment IEs
  accessStratumReleaseIndicator  AccessStratumReleaseIndicator
}

RRCConnectionRequest-v590ext-IEs ::= SEQUENCE {
  -- User equipment IEs
  predefinedConfigStatusInfo  BOOLEAN
}

RRCConnectionRequest-v690ext-IEs ::= SEQUENCE {
  -- User equipment IEs
  ueCapabilityIndication  ENUMERATED { hsdch, hsdch-edch }  OPTIONAL,
  -- Measurement IEs
  measuredResultsOnRACHinterFreq  MeasuredResultsOnRACHinterFreq  OPTIONAL,
  domainIndicator  CHOICE {
    cs-domain  SEQUENCE {
      csCallType  ENUMERATED {speech, video, other, spare }
    },
    ps-domain  NULL
  }
}

RRCConnectionRequest-v6b0ext-IEs ::= SEQUENCE {
  -- MBMS IEs
  mbmsSelectedServices  MBMS-SelectedServicesShort  OPTIONAL
}

```

```

RRCConnectionRequest-v6e0ext-IEs ::= SEQUENCE {
  -- User equipment IEs
  supportForFDPCH          ENUMERATED { true }          OPTIONAL
}

RRCConnectionRequest-v770ext-IEs ::= SEQUENCE {
  -- User equipment IEs
  ueMobilityStateIndicator      High-MobilityDetected      OPTIONAL,
  hspdschReception-CellFach     ENUMERATED { true }     OPTIONAL,
  mac-ehsSupport                ENUMERATED { true }     OPTIONAL,
  discontinuousDpcchTransmission ENUMERATED { true }     OPTIONAL
}

RRCConnectionRequest-v7b0ext-IEs ::= SEQUENCE {
  -- User equipment IEs
  supportForE-FDPCH            ENUMERATED { true }          OPTIONAL
}

RRCConnectionRequest-v7e0ext-IEs ::= SEQUENCE {
  supportForCSVoiceoverHSPA     ENUMERATED { true }          OPTIONAL
}

RRCConnectionRequest-v7g0ext-IEs ::= SEQUENCE {
  -- Measurement IEs
  measuredResultsOnRACH-v7g0ext MeasuredResultsOnRACH-v7g0ext OPTIONAL
}

RRCConnectionRequest-v860ext-IEs ::= SEQUENCE {
  -- User equipment IEs
  supportOfCommonEDCH          ENUMERATED { true }          OPTIONAL,
  multiCellSupport              ENUMERATED { true }          OPTIONAL,
  pre-redirectioInfo            Pre-RedirectioInfo            OPTIONAL,
  supportOfMACiis               ENUMERATED { true }          OPTIONAL,
  supportOfSPSOperation         ENUMERATED { true }          OPTIONAL
}

-- *****
--
-- RRC CONNECTION SETUP
--
-- *****

RRCConnectionSetup ::= CHOICE {
  r3          SEQUENCE {
    rrcConnectionSetup-r3          RRCConnectionSetup-r3-IEs,
    laterNonCriticalExtensions      SEQUENCE {
      -- Container for additional R99 extensions
      rrcConnectionSetup-r3-add-ext BIT STRING          OPTIONAL,
      v4b0NonCriticalExtensions     SEQUENCE {
        rrcConnectionSetup-v4b0ext RRCConnectionSetup-v4b0ext-IEs,
        v590NonCriticalExtensions  SEQUENCE {
          rrcConnectionSetup-v590ext RRCConnectionSetup-v590ext-IEs,
          v690NonCriticalExtensions SEQUENCE {
            rrcConnectionSetup-v690ext RRCConnectionSetup-v690ext-IEs,
            nonCriticalExtensions     SEQUENCE {}          OPTIONAL
          } OPTIONAL
        } OPTIONAL
      } OPTIONAL
    } OPTIONAL
  } OPTIONAL
},
  later-than-r3 SEQUENCE {
    initialUE-Identity      InitialUE-Identity,
    rrc-TransactionIdentifier RRC-TransactionIdentifier,
    criticalExtensions       CHOICE {
      r4          SEQUENCE {
        rrcConnectionSetup-r4          RRCConnectionSetup-r4-IEs,
        v4d0NonCriticalExtensions     SEQUENCE {
          -- Container for adding non critical extensions after freezing REL-5
          rrcConnectionSetup-r4-add-ext BIT STRING          OPTIONAL,
          v590NonCriticalExtensions     SEQUENCE {
            rrcConnectionSetup-v590ext RRCConnectionSetup-v590ext-IEs,
            v690NonCriticalExtensions SEQUENCE {
              rrcConnectionSetup-v690ext RRCConnectionSetup-v690ext-IEs,
              nonCriticalExtensions     SEQUENCE {}          OPTIONAL
            } OPTIONAL
          } OPTIONAL
        } OPTIONAL
      } OPTIONAL
    } OPTIONAL
  } OPTIONAL
}

```

```

    },
    criticalExtensions
      r5
        CHOICE {
          SEQUENCE {
            rrcConnectionSetup-r5          RRCConnectionSetup-r5-IEs,
            -- Container for adding non critical extensions after freezing REL-6
            rrcConnectionSetup-r5-add-ext  BIT STRING          OPTIONAL,
            v690NonCriticalExtensions      SEQUENCE {
              rrcConnectionSetup-v690ext   RRCConnectionSetup-v690ext-IEs,
              nonCriticalExtensions        SEQUENCE {}          OPTIONAL
            } OPTIONAL
          }
        },
    criticalExtensions
      r6
        CHOICE {
          SEQUENCE {
            rrcConnectionSetup-r6          RRCConnectionSetup-r6-IEs,
            -- Container for adding non critical extensions after freezing REL-7
            rrcConnectionSetup-r6-add-ext  BIT STRING          OPTIONAL,
            v6b0NonCriticalExtensions      SEQUENCE {
              rrcConnectionSetup-v6b0ext   RRCConnectionSetup-v6b0ext-IEs,
              nonCriticalExtensions        SEQUENCE {}          OPTIONAL
            } OPTIONAL
          }
        },
    criticalExtensions
      r7
        CHOICE {
          SEQUENCE {
            rrcConnectionSetup-r7          RRCConnectionSetup-r7-IEs,
            -- Container for adding non critical extensions after freezing REL-8
            rrcConnectionSetup-r7-add-ext  BIT STRING          OPTIONAL,
            v780NonCriticalExtensions      SEQUENCE {
              rrcConnectionSetup-v780ext   RRCConnectionSetup-v780ext-IEs,
              v7d0NonCriticalExtensions    SEQUENCE {
                rrcConnectionSetup-v7d0ext RRCConnectionSetup-v7d0ext-IEs,
                nonCriticalExtensions      SEQUENCE {}          OPTIONAL
              } OPTIONAL
            } OPTIONAL
          }
        },
    criticalExtensions
      r8
        CHOICE {
          SEQUENCE {
            rrcConnectionSetup-r8          RRCConnectionSetup-r8-IEs,
            -- Container for adding non critical extensions after freezing REL-9
            rrcConnectionSetup-r8-add-ext  BIT STRING          OPTIONAL,
            v7d0NonCriticalExtensions      SEQUENCE {
              rrcConnectionSetup-v7d0ext   RRCConnectionSetup-v7d0ext-IEs,
              v890NonCriticalExtensions    SEQUENCE {
                rrcConnectionSetup-v890ext RRCConnectionSetup-v890ext-IEs,
                v8a0NonCriticalExtensions  SEQUENCE {
                  rrcConnectionSetup-v8a0ext RRCConnectionSetup-v8a0ext-IEs,
                  nonCriticalExtensions    SEQUENCE {}          OPTIONAL
                } OPTIONAL
              } OPTIONAL
            } OPTIONAL
          }
        },
    criticalExtensions
      SEQUENCE {}
    }
  }
}

```

```

RRCConnectionSetup-r3-IEs ::= SEQUENCE {
  -- TABULAR: Integrity protection shall not be performed on this message.
  -- User equipment IEs
  initialUE-Identity          InitialUE-Identity,
  rrc-TransactionIdentifier    RRC-TransactionIdentifier,
  activationTime               ActivationTime          OPTIONAL,
  new-U-RNTI                  U-RNTI,
  new-c-RNTI                   C-RNTI              OPTIONAL,
  rrc-StateIndicator           RRC-StateIndicator,
  utran-DRX-CycleLengthCoeff  UTRAN-DRX-CycleLengthCoefficient,
  -- TABULAR: If capabilityUpdateRequirement is not present, the default value
  -- defined in 10.3.3.2 shall be used.
  capabilityUpdateRequirement CapabilityUpdateRequirement OPTIONAL,
  -- Radio bearer IEs
  srb-InformationSetupList     SRB-InformationSetupList2,
  -- Transport channel IEs
  ul-CommonTransChInfo        UL-CommonTransChInfo   OPTIONAL,
}

```

```

-- NOTE: ul-AddReconfTransChInfoList should be optional in later versions of
-- this message
ul-AddReconfTransChInfoList      UL-AddReconfTransChInfoList,
dl-CommonTransChInfo             DL-CommonTransChInfo             OPTIONAL,
-- NOTE: dl-AddReconfTransChInfoList should be optional in later versions
-- of this message
dl-AddReconfTransChInfoList      DL-AddReconfTransChInfoList,
-- Physical channel IEs
frequencyInfo                    FrequencyInfo                    OPTIONAL,
maxAllowedUL-TX-Power            MaxAllowedUL-TX-Power            OPTIONAL,
ul-ChannelRequirement            UL-ChannelRequirement            OPTIONAL,
dl-CommonInformation             DL-CommonInformation            OPTIONAL,
dl-InformationPerRL-List         DL-InformationPerRL-List         OPTIONAL
}

RRCConnectionSetup-v4b0ext-IEs ::= SEQUENCE {
  capabilityUpdateRequirement-r4-ext  CapabilityUpdateRequirement-r4-ext  OPTIONAL,
  -- Physical channel IEs
  -- dummy is not used in this version of the specification, it should
  -- not be sent and if received it should be ignored.
  dummy                             SSDT-UL                             OPTIONAL,
  -- The order of the RLS in IE cell-id-PerRL-List is the same as
  -- in IE DL-InformationPerRL-List included in this message
  cell-id-PerRL-List               CellIdentity-PerRL-List           OPTIONAL
}

RRCConnectionSetup-v590ext-IEs ::= SEQUENCE {
  -- User equipment IEs
  systemSpecificCapUpdateReq       SystemSpecificCapUpdateReq-v590ext  OPTIONAL,
  -- Physical channel IEs
  dl-TPC-PowerOffsetPerRL-List     DL-TPC-PowerOffsetPerRL-List       OPTIONAL
}

RRCConnectionSetup-r4-IEs ::= SEQUENCE {
  -- TABULAR: Integrity protection shall not be performed on this message.
  activationTime                   ActivationTime                       OPTIONAL,
  new-U-RNTI                       U-RNTI,
  new-c-RNTI                       C-RNTI                             OPTIONAL,
  rrc-StateIndicator               RRC-StateIndicator,
  utran-DRX-CycleLengthCoeff       UTRAN-DRX-CycleLengthCoefficient,
  -- TABULAR: If capabilityUpdateRequirement is not present, the default value
  -- defined in 10.3.3.2 shall be used.
  capabilityUpdateRequirement       CapabilityUpdateRequirement-r4       OPTIONAL,
  -- Radio bearer IEs
  srb-InformationSetupList         SRB-InformationSetupList2,
  -- Transport channel IEs
  ul-CommonTransChInfo             UL-CommonTransChInfo-r4            OPTIONAL,
  ul-AddReconfTransChInfoList      UL-AddReconfTransChInfoList        OPTIONAL,
  dl-CommonTransChInfo             DL-CommonTransChInfo-r4            OPTIONAL,
  dl-AddReconfTransChInfoList      DL-AddReconfTransChInfoList-r4     OPTIONAL,
  -- Physical channel IEs
  frequencyInfo                    FrequencyInfo                        OPTIONAL,
  maxAllowedUL-TX-Power            MaxAllowedUL-TX-Power              OPTIONAL,
  ul-ChannelRequirement            UL-ChannelRequirement-r4           OPTIONAL,
  dl-CommonInformation             DL-CommonInformation-r4            OPTIONAL,
  dl-InformationPerRL-List         DL-InformationPerRL-List-r4        OPTIONAL
}

RRCConnectionSetup-r5-IEs ::= SEQUENCE {
  -- TABULAR: Integrity protection shall not be performed on this message.
  activationTime                   ActivationTime                       OPTIONAL,
  new-U-RNTI                       U-RNTI,
  new-c-RNTI                       C-RNTI                             OPTIONAL,
  rrc-StateIndicator               RRC-StateIndicator,
  utran-DRX-CycleLengthCoeff       UTRAN-DRX-CycleLengthCoefficient,
  -- TABULAR: If capabilityUpdateRequirement is not present, the default value
  -- defined in 10.3.3.2 shall be used.
  capabilityUpdateRequirement       CapabilityUpdateRequirement-r5       OPTIONAL,
  -- Specification mode information
  specificationMode                 CHOICE {
    complete                         SEQUENCE {
      -- Radio bearer IEs
      srb-InformationSetupList       SRB-InformationSetupList2,
      -- Transport channel IEs
      ul-CommonTransChInfo           UL-CommonTransChInfo-r4            OPTIONAL,
      ul-AddReconfTransChInfoList    UL-AddReconfTransChInfoList        OPTIONAL,
      dl-CommonTransChInfo           DL-CommonTransChInfo-r4            OPTIONAL,
      dl-AddReconfTransChInfoList    DL-AddReconfTransChInfoList-r4     OPTIONAL
    }
  }
}

```

```

    },
    preconfiguration          SEQUENCE {
      -- All IEs that include an FDD/TDD choice are split in two IEs for this message,
      -- one for the FDD only elements and one for the TDD only elements, so that one
      -- FDD/TDD choice in this level is sufficient.
      preConfigMode          CHOICE {
        predefinedConfigIdentity      PredefinedConfigIdentity,
        defaultConfig                SEQUENCE {
          defaultConfigMode          DefaultConfigMode,
          defaultConfigIdentity      DefaultConfigIdentity-r5
        }
      }
    }
  },
  -- Physical channel IEs
  frequencyInfo              FrequencyInfo              OPTIONAL,
  maxAllowedUL-TX-Power      MaxAllowedUL-TX-Power      OPTIONAL,
  ul-ChannelRequirement      UL-ChannelRequirement-r4   OPTIONAL,
  dl-CommonInformation        DL-CommonInformation-r4    OPTIONAL,
  dl-InformationPerRL-List    DL-InformationPerRL-List-r5bis OPTIONAL
}

RRCConnectionSetup-v690ext-IEs ::= SEQUENCE {
  -- Physical Channel IEs
  beaconPLEst                BEACON-PL-Est              OPTIONAL,
  postVerificationPeriod      ENUMERATED { true }        OPTIONAL
}

RRCConnectionSetup-r6-IEs ::= SEQUENCE {
  -- TABULAR: Integrity protection shall not be performed on this message.
  activationTime              ActivationTime             OPTIONAL,
  new-U-RNTI                  U-RNTI,
  new-c-RNTI                  C-RNTI                   OPTIONAL,
  new-H-RNTI                  H-RNTI                   OPTIONAL,
  newPrimary-E-RNTI           E-RNTI                    OPTIONAL,
  newSecondary-E-RNTI         E-RNTI                    OPTIONAL,
  rrc-StateIndicator          RRC-StateIndicator,
  utran-DRX-CycleLengthCoeff  UTRAN-DRX-CycleLengthCoefficient,
  -- TABULAR: If capabilityUpdateRequirement is not present, the default value
  -- defined in 10.3.3.2 shall be used.
  capabilityUpdateRequirement CapabilityUpdateRequirement-r5 OPTIONAL,
  -- Specification mode information
  specificationMode           CHOICE {
    complete                   SEQUENCE {
      -- Radio bearer IEs
      srb-InformationSetupList  SRB-InformationSetupList2-r6,
      -- Transport channel IEs
      ul-CommonTransChInfo      UL-CommonTransChInfo-r4          OPTIONAL,
      ul-AddReconfTransChInfoList UL-AddReconfTransChInfoList-r6    OPTIONAL,
      dl-CommonTransChInfo      DL-CommonTransChInfo-r4          OPTIONAL,
      dl-AddReconfTransChInfoList DL-AddReconfTransChInfoList-r5    OPTIONAL
    }
  },
  preconfiguration          SEQUENCE {
    -- All IEs that include an FDD/TDD choice are split in two IEs for this message,
    -- one for the FDD only elements and one for the TDD only elements, so that one
    -- FDD/TDD choice in this level is sufficient.
    preConfigMode          CHOICE {
      predefinedConfigIdentity      PredefinedConfigIdentity,
      defaultConfig                SEQUENCE {
        defaultConfigMode          DefaultConfigMode,
        defaultConfigIdentity      DefaultConfigIdentity-r6
      }
    }
  }
},
-- Physical channel IEs
frequencyInfo              FrequencyInfo              OPTIONAL,
maxAllowedUL-TX-Power      MaxAllowedUL-TX-Power      OPTIONAL,
ul-DPCH-Info              UL-DPCH-Info-r6            OPTIONAL,
ul-EDCH-Information        UL-EDCH-Information-r6    OPTIONAL,
dl-HSPDSCH-Information     DL-HSPDSCH-Information-r6    OPTIONAL,
dl-CommonInformation        DL-CommonInformation-r6    OPTIONAL,
dl-InformationPerRL-List    DL-InformationPerRL-List-r6    OPTIONAL
}

RRCConnectionSetup-v6b0ext-IEs ::= SEQUENCE {
  -- Physical channel IEs
  dl-InformationPerRL-List-v6b0ext  DL-InformationPerRL-List-v6b0ext  OPTIONAL
}

```

```

}

RRCConnectionSetup-r7-IEs ::= SEQUENCE {
  -- TABULAR: Integrity protection shall not be performed on this message.
  activationTime           ActivationTime           OPTIONAL,
  new-U-RNTI               U-RNTI,
  new-c-RNTI               C-RNTI                 OPTIONAL,
  new-H-RNTI               H-RNTI                 OPTIONAL,
  newPrimary-E-RNTI       E-RNTI                 OPTIONAL,
  newSecondary-E-RNTI     E-RNTI                 OPTIONAL,
  rrc-StateIndicator       RRC-StateIndicator,
  utran-DRX-CycleLengthCoeff  UTRAN-DRX-CycleLengthCoefficient-r7,
  -- TABULAR: If capabilityUpdateRequirement is not present, the default value
  -- defined in 10.3.3.2 shall be used.
  capabilityUpdateRequirement  CapabilityUpdateRequirement-r7  OPTIONAL,
  supportForChangeOfUE-Capability BOOLEAN,
  -- Specification mode information
  specificationMode        CHOICE {
    complete                SEQUENCE {
      -- Radio bearer IEs
      srb-InformationSetupList  SRB-InformationSetupList2-r7,
      -- Transport channel IEs
      ul-CommonTransChInfo      UL-CommonTransChInfo-r4           OPTIONAL,
      ul-AddReconfTransChInfoList  UL-AddReconfTransChInfoList-r7  OPTIONAL,
      dl-CommonTransChInfo        DL-CommonTransChInfo-r4           OPTIONAL,
      dl-AddReconfTransChInfoList  DL-AddReconfTransChInfoList-r7  OPTIONAL
    },
    preconfiguration          SEQUENCE {
      -- All IEs that include an FDD/TDD choice are split in two IEs for this message,
      -- one for the FDD only elements and one for the TDD only elements, so that one
      -- FDD/TDD choice in this level is sufficient.
      preConfigMode           CHOICE {
        predefinedConfigIdentity  PredefinedConfigIdentity,
        defaultConfig            SEQUENCE {
          defaultConfigMode      DefaultConfigMode,
          defaultConfigIdentity  DefaultConfigIdentity-r6
        }
      }
    }
  },
  -- Physical channel IEs
  frequencyInfo             FrequencyInfo           OPTIONAL,
  multi-frequencyInfo       Multi-frequencyInfo-LCR-r7  OPTIONAL,
  dtx-drx-TimingInfo        DTX-DRX-TimingInfo-r7  OPTIONAL,
  dtx-drx-Info              DTX-DRX-Info-r7          OPTIONAL,
  hs-scch-LessInfo          HS-SCCH-LessInfo-r7        OPTIONAL,
  maxAllowedUL-TX-Power     MaxAllowedUL-TX-Power      OPTIONAL,
  ul-DPCH-Info              UL-DPCH-Info-r7            OPTIONAL,
  ul-EDCH-Information        UL-EDCH-Information-r7      OPTIONAL,
  dl-HSPDSCH-Information    DL-HSPDSCH-Information-r7    OPTIONAL,
  dl-CommonInformation       DL-CommonInformation-r7      OPTIONAL,
  dl-InformationPerRL-List   DL-InformationPerRL-List-r7  OPTIONAL
}

RRCConnectionSetup-v780ext-IEs ::= SEQUENCE {
  -- Physical channel IEs
  hs-DSCH-TBSizeTable       HS-DSCH-TBSizeTable       OPTIONAL
}

RRCConnectionSetup-v7d0ext-IEs ::= SEQUENCE {
  -- Physical channel IEs
  ul-EDCH-Information        UL-EDCH-Information-ext  OPTIONAL
}

RRCConnectionSetup-r8-IEs ::= SEQUENCE {
  -- TABULAR: Integrity protection shall not be performed on this message.
  activationTime           ActivationTime           OPTIONAL,
  new-U-RNTI               U-RNTI,
  new-c-RNTI               C-RNTI                 OPTIONAL,
  new-H-RNTI               H-RNTI                 OPTIONAL,
  newPrimary-E-RNTI       E-RNTI                 OPTIONAL,
  newSecondary-E-RNTI     E-RNTI                 OPTIONAL,
  rrc-StateIndicator       RRC-StateIndicator,
  utran-DRX-CycleLengthCoeff  UTRAN-DRX-CycleLengthCoefficient-r7,
  -- TABULAR: If capabilityUpdateRequirement is not present, the default value
  -- defined in 10.3.3.2 shall be used.
  capabilityUpdateRequirement  CapabilityUpdateRequirement-r8  OPTIONAL,
  supportForChangeOfUE-Capability BOOLEAN,

```

```

-- Specification mode information
-- dummy is not used in this version of the specification, it should
-- not be sent and if received UE behaviour is unspecified.
dummy                DefaultConfigForCellFACH                OPTIONAL,
specificationMode    CHOICE {
  complete            SEQUENCE {
    -- Radio bearer IEs
    srb-InformationSetupList    SRB-InformationSetupList2-r8,
    -- Transport channel IEs
    ul-CommonTransChInfo        UL-CommonTransChInfo-r4                OPTIONAL,
    ul-AddReconfTransChInfoList    UL-AddReconfTransChInfoList-r8    OPTIONAL,
    dl-CommonTransChInfo        DL-CommonTransChInfo-r4                OPTIONAL,
    dl-AddReconfTransChInfoList    DL-AddReconfTransChInfoList-r7    OPTIONAL
  },
  preconfiguration      SEQUENCE {
    -- All IEs that include an FDD/TDD choice are split in two IEs for this message,
    -- one for the FDD only elements and one for the TDD only elements, so that one
    -- FDD/TDD choice in this level is sufficient.
    preConfigMode        CHOICE {
      predefinedConfigIdentity    PredefinedConfigIdentity,
      defaultConfig            SEQUENCE {
        defaultConfigMode        DefaultConfigMode,
        defaultConfigIdentity    DefaultConfigIdentity-r6
      }
    }
  }
},
-- Physical channel IEs
frequencyInfo          FrequencyInfo                OPTIONAL,
multi-frequencyInfo    Multi-frequencyInfo-LCR-r7    OPTIONAL,
dtx-drx-TimingInfo     DTX-DRX-TimingInfo-r7          OPTIONAL,
dtx-drx-Info           DTX-DRX-Info-r7              OPTIONAL,
hs-scch-LessInfo       HS-SCCH-LessInfo-r7          OPTIONAL,
maxAllowedUL-TX-Power  MaxAllowedUL-TX-Power          OPTIONAL,
ul-DPCH-Info           UL-DPCH-Info-r7              OPTIONAL,
ul-EDCH-Information    UL-EDCH-Information-r8        OPTIONAL,
dl-HSPDSCH-Information DL-HSPDSCH-Information-r8      OPTIONAL,
dl-CommonInformation   DL-CommonInformation-r8       OPTIONAL,
dl-InformationPerRL-List DL-InformationPerRL-List-r8          OPTIONAL,
dl-SecondaryCellInfoFDD DL-SecondaryCellInfoFDD          OPTIONAL,
sps-Information-TDD128 SPS-Information-TDD128-r8          OPTIONAL
}

RRCConnectionSetup-v890ext-IEs ::= SEQUENCE {
  -- User Equipment IEs
  dl-SecondaryCellInfoFDD-v890ext    DL-SecondaryCellInfoFDD-v890ext    OPTIONAL,
  -- Physical channel IEs
  dl-HSPDSCH-Information             DL-HSPDSCH-Information-r8-ext    OPTIONAL
}

RRCConnectionSetup-v8a0ext-IEs ::= SEQUENCE {
  -- Physical channel IEs
  dl-HSPDSCH-Information             DL-HSPDSCH-Information-r8-ext2    OPTIONAL
}

-- *****
--
-- RRC CONNECTION SETUP COMPLETE
--
-- *****

RRCConnectionSetupComplete ::= SEQUENCE {
  -- TABULAR: Integrity protection shall not be performed on this message.
  -- User equipment IEs
  rrc-TransactionIdentifier          RRC-TransactionIdentifier,
  startList                          STARTList,
  ue-RadioAccessCapability           UE-RadioAccessCapability                OPTIONAL,
  -- Other IEs
  ue-RATSpecificCapability           InterRAT-UE-RadioAccessCapabilityList    OPTIONAL,
  -- Non critical extensions
  v370NonCriticalExtensions          SEQUENCE {
    rrcConnectionSetupComplete-v370ext RRCConnectionSetupComplete-v370ext,
    v380NonCriticalExtensions          SEQUENCE {
      rrcConnectionSetupComplete-v380ext RRCConnectionSetupComplete-v380ext-IEs,
      -- Reserved for future non critical extension
      v3a0NonCriticalExtensions          SEQUENCE {
        rrcConnectionSetupComplete-v3a0ext RRCConnectionSetupComplete-v3a0ext-IEs,
        laterNonCriticalExtensions          SEQUENCE {

```

```
-- Container for additional R99 extensions
rrcConnectionSetupComplete-r3-add-ext BIT STRING
(CONTAINING RRCConnectionSetupComplete-r3-add-ext-IEs) OPTIONAL,
v3g0NonCriticalExtensions SEQUENCE {
  rrcConnectionSetupComplete-v3g0ext RRCConnectionSetupComplete-v3g0ext-IEs,
  v4b0NonCriticalExtensions SEQUENCE {
    rrcConnectionSetupComplete-v4b0ext
    RRCConnectionSetupComplete-v4b0ext-IEs,
  v590NonCriticalExtensions SEQUENCE {
    rrcConnectionSetupComplete-v590ext
    RRCConnectionSetupComplete-v590ext-IEs,
  v5c0NonCriticalExtensions SEQUENCE {
    rrcConnectionSetupComplete-v5c0ext
    RRCConnectionSetupComplete-v5c0ext-IEs,
  v690NonCriticalExtensions SEQUENCE {
    rrcConnectionSetupComplete-v690ext
    RRCConnectionSetupComplete-v690ext-IEs,
  v770NonCriticalExtensions SEQUENCE {
    rrcConnectionSetupComplete-v770ext
    RRCConnectionSetupComplete-v770ext-IEs,
    nonCriticalExtensions SEQUENCE {} OPTIONAL
  } OPTIONAL
} OPTIONAL
} OPTIONAL
} OPTIONAL
} OPTIONAL
} OPTIONAL
} OPTIONAL
}
}

RRCConnectionSetupComplete-v370ext ::= SEQUENCE {
  -- User equipment IEs
  ue-RadioAccessCapability-v370ext UE-RadioAccessCapability-v370ext OPTIONAL
}

RRCConnectionSetupComplete-v380ext-IEs ::= SEQUENCE {
  -- User equipment IEs
  ue-RadioAccessCapability-v380ext UE-RadioAccessCapability-v380ext OPTIONAL,
  dl-PhysChCapabilityFDD-v380ext DL-PhysChCapabilityFDD-v380ext
}

RRCConnectionSetupComplete-v3a0ext-IEs ::= SEQUENCE {
  -- User equipment IEs
  ue-RadioAccessCapability-v3a0ext UE-RadioAccessCapability-v3a0ext OPTIONAL
}

RRCConnectionSetupComplete-v3g0ext-IEs ::= SEQUENCE {
  -- User equipment IEs
  ue-RadioAccessCapability-v3g0ext UE-RadioAccessCapability-v3g0ext OPTIONAL
}

RRCConnectionSetupComplete-r3-add-ext-IEs ::= SEQUENCE {
  rrcConnectionSetupComplete-v650ext RRCConnectionSetupComplete-v650ext-IEs OPTIONAL,
  v680NonCriticalExtensions SEQUENCE {
    rrcConnectionSetupComplete-v680ext RRCConnectionSetupComplete-v680ext-IEs,
    v7e0NonCriticalExtensions SEQUENCE {
      rrcConnectionSetupComplete-v7e0ext RRCConnectionSetupComplete-v7e0ext-IEs,
      v7f0NonCriticalExtensions SEQUENCE {
        rrcConnectionSetupComplete-v7f0ext
        RRCConnectionSetupComplete-v7f0ext-IEs,
      nonCriticalExtensions SEQUENCE {} OPTIONAL
      } OPTIONAL
    } OPTIONAL
  } OPTIONAL
}

RRCConnectionSetupComplete-v4b0ext-IEs ::= SEQUENCE {
  -- User equipment IEs
  ue-RadioAccessCapability-v4b0ext UE-RadioAccessCapability-v4b0ext OPTIONAL
}

RRCConnectionSetupComplete-v590ext-IEs ::= SEQUENCE {
  -- User equipment IEs
  ue-RadioAccessCapability-v590ext UE-RadioAccessCapability-v590ext OPTIONAL,
  -- Other IEs
```



```

    ue-RATSpecificCapability-v590ext          InterRAT-UE-RadioAccessCapability-v590ext  OPTIONAL
  }
RRCConnectionSetupComplete-v5c0ext-IEs ::= SEQUENCE {
  -- User equipment IEs
  ue-RadioAccessCapability-v5c0ext          UE-RadioAccessCapability-v5c0ext      OPTIONAL
}
RRCConnectionSetupComplete-v650ext-IEs ::= SEQUENCE {
  -- User equipment IEs
  ue-RadioAccessCapability-v650ext          UE-RadioAccessCapability-v650ext
}
RRCConnectionSetupComplete-v680ext-IEs ::= SEQUENCE {
  -- User equipment IEs
  ue-RadioAccessCapability-v680ext          UE-RadioAccessCapability-v680ext
}
RRCConnectionSetupComplete-v690ext-IEs ::= SEQUENCE {
  -- User equipment IEs
  ueCapabilityContainer                      BIT STRING
                                             (CONTAINING UE-CapabilityContainer-IEs) OPTIONAL
}
RRCConnectionSetupComplete-v770ext-IEs ::= SEQUENCE {
  deferredMeasurementControlReading          ENUMERATED { true }                      OPTIONAL
}
RRCConnectionSetupComplete-v7e0ext-IEs ::= SEQUENCE {
  -- User equipment IEs
  ue-RadioAccessCapability                  UE-RadioAccessCapability-v7e0ext
}
RRCConnectionSetupComplete-v7f0ext-IEs ::= SEQUENCE {
  -- User equipment IEs
  ue-RadioAccessCapability                  UE-RadioAccessCapability-v7f0ext      OPTIONAL
}
-- *****
--
-- RRC FAILURE INFO
--
-- *****

RRC-FailureInfo ::= CHOICE {
  r3
    SEQUENCE {
      rRC-FailureInfo-r3                      SEQUENCE {
        laterNonCriticalExtensions            SEQUENCE {
          -- Container for additional R99 extensions
          rrc-FailureInfo-r3-add-ext          BIT STRING          OPTIONAL,
          nonCriticalExtensions              SEQUENCE {}          OPTIONAL
        } OPTIONAL
      },
      criticalExtensions                      SEQUENCE {}
    }
}
RRC-FailureInfo-r3-IEs ::= SEQUENCE {
  -- Non-RRC IEs
  failureCauseWithProtErr                    FailureCauseWithProtErr
}
-- *****
--
-- RRC STATUS
--
-- *****

RRCStatus ::= SEQUENCE {
  -- Other IEs
  -- TABULAR: Identification of received message is nested in
  -- ProtocolErrorMoreInformation
  protocolErrorInformation                    ProtocolErrorMoreInformation,
  laterNonCriticalExtensions                  SEQUENCE {
    -- Container for additional R99 extensions
    rrcStatus-r3-add-ext                      BIT STRING          OPTIONAL,
    nonCriticalExtensions                    SEQUENCE {}          OPTIONAL
  } OPTIONAL
}

```

```

-- *****
--
-- SECURITY MODE COMMAND
--
-- *****

SecurityModeCommand ::= CHOICE {
  r3          SEQUENCE {
    securityModeCommand-r3          SecurityModeCommand-r3-IEs,
    laterNonCriticalExtensions      SEQUENCE {
      -- Container for additional R99 extensions
      securityModeCommand-r3-add-ext  BIT STRING      OPTIONAL,
      nonCriticalExtensions          SEQUENCE {}      OPTIONAL
    } OPTIONAL
  },
  later-than-r3          SEQUENCE {
    rrc-TransactionIdentifier      RRC-TransactionIdentifier,
    criticalExtensions            CHOICE {
      r7          SEQUENCE {
        securityModeCommand-r7          SecurityModeCommand-r7-IEs,
        -- Container for adding non critical extensions after freezing REL-8
        securityModeCommand-r7-add-ext  BIT STRING      OPTIONAL,
        nonCriticalExtensions          SEQUENCE {}      OPTIONAL
      },
      criticalExtensions            SEQUENCE {}
    }
  }
}

SecurityModeCommand-r3-IEs ::= SEQUENCE {
-- TABULAR: Integrity protection shall always be performed on this message.
-- User equipment IEs
  rrc-TransactionIdentifier      RRC-TransactionIdentifier,
  securityCapability              SecurityCapability,
  cipheringModeInfo              CipheringModeInfo          OPTIONAL,
  integrityProtectionModeInfo    IntegrityProtectionModeInfo  OPTIONAL,
-- Core network IEs
  cn-DomainIdentity              CN-DomainIdentity,
-- Other IEs
  ue-SystemSpecificSecurityCap    InterRAT-UE-SecurityCapList  OPTIONAL
}

SecurityModeCommand-r7-IEs ::= SEQUENCE {
-- TABULAR: Integrity protection shall always be performed on this message.
-- User equipment IEs
  securityCapability              SecurityCapability,
  cipheringModeInfo              CipheringModeInfo-r7        OPTIONAL,
  integrityProtectionModeInfo    IntegrityProtectionModeInfo-r7  OPTIONAL,
-- Core network IEs
  cn-DomainIdentity              CN-DomainIdentity,
-- Other IEs
  ue-SystemSpecificSecurityCap    InterRAT-UE-SecurityCapList  OPTIONAL
}

-- *****
--
-- SECURITY MODE COMPLETE
--
-- *****

SecurityModeComplete ::= SEQUENCE {
-- TABULAR: Integrity protection shall always be performed on this message.

-- User equipment IEs
  rrc-TransactionIdentifier      RRC-TransactionIdentifier,
  ul-IntegProtActivationInfo      IntegrityProtActivationInfo  OPTIONAL,
-- Radio bearer IEs
  rb-UL-CiphActivationTimeInfo    RB-ActivationTimeInfoList  OPTIONAL,
  laterNonCriticalExtensions      SEQUENCE {
    -- Container for additional R99 extensions
    securityModeComplete-r3-add-ext  BIT STRING      OPTIONAL,
    nonCriticalExtensions          SEQUENCE {}      OPTIONAL
  } OPTIONAL
}

-- *****
--

```

```

-- SECURITY MODE FAILURE
--
-- *****
SecurityModeFailure ::= SEQUENCE {
  -- User equipment IEs
  rrc-TransactionIdentifier      RRC-TransactionIdentifier,
  failureCause                   FailureCauseWithProtErr,
  laterNonCriticalExtensions     SEQUENCE {
    -- Container for additional R99 extensions
    securityModeFailure-r3-add-ext  BIT STRING      OPTIONAL,
    nonCriticalExtensions           SEQUENCE {}      OPTIONAL
  } OPTIONAL
}

-- *****
--
-- SIGNALLING CONNECTION RELEASE
--
-- *****

SignallingConnectionRelease ::= CHOICE {
  r3                             SEQUENCE {
    signallingConnectionRelease-r3 SignallingConnectionRelease-r3-IEs,
    laterNonCriticalExtensions     SEQUENCE {
      -- Container for additional R99 extensions
      signallingConnectionRelease-r3-add-ext  BIT STRING      OPTIONAL,
      nonCriticalExtensions           SEQUENCE {}      OPTIONAL
    } OPTIONAL
  },
  later-than-r3                  SEQUENCE {
    rrc-TransactionIdentifier      RRC-TransactionIdentifier,
    criticalExtensions            SEQUENCE {}
  }
}

SignallingConnectionRelease-r3-IEs ::= SEQUENCE {
  -- User equipment IEs
  rrc-TransactionIdentifier      RRC-TransactionIdentifier,
  -- Core network IEs
  cn-DomainIdentity             CN-DomainIdentity
}

-- *****
--
-- SIGNALLING CONNECTION RELEASE INDICATION
--
-- *****

SignallingConnectionReleaseIndication ::= SEQUENCE {
  -- Core network IEs
  cn-DomainIdentity             CN-DomainIdentity,
  laterNonCriticalExtensions     SEQUENCE {
    -- Container for additional R99 extensions
    signallingConnectionReleaseIndication-r3-add-ext  BIT STRING      OPTIONAL,
    v860nonCriticalExtensions     SEQUENCE {
      signallingConnectionReleaseIndication-v860ext
      SignallingConnectionReleaseIndication-v860ext,
      nonCriticalExtensions       SEQUENCE {}      OPTIONAL
    } OPTIONAL
  } OPTIONAL
}

SignallingConnectionReleaseIndication-v860ext ::= SEQUENCE {
  signallingConnectionReleaseIndicationCause
  ENUMERATED { uERequestedPSDataSessionEnd, anyOtherCause }
}

-- *****
--
-- SYSTEM INFORMATION for BCH
--
-- *****

SystemInformation-BCH ::= SEQUENCE {
  -- Other information elements
  sfn-Prime                    SFN-Prime,
  payload                       CHOICE {

```

```

noSegment                NULL,
firstSegment             FirstSegment,
subsequentSegment       SubsequentSegment,
lastSegmentShort        LastSegmentShort,
lastAndFirst            SEQUENCE {
    lastSegmentShort    LastSegmentShort,
    firstSegment        FirstSegmentShort
},
lastAndComplete         SEQUENCE {
    lastSegmentShort    LastSegmentShort,
    completeSIB-List    CompleteSIB-List
},
lastAndCompleteAndFirst SEQUENCE {
    lastSegmentShort    LastSegmentShort,
    completeSIB-List    CompleteSIB-List,
    firstSegment        FirstSegmentShort
},
completeSIB-List        CompleteSIB-List,
completeAndFirst        SEQUENCE {
    completeSIB-List    CompleteSIB-List,
    firstSegment        FirstSegmentShort
},
completeSIB              CompleteSIB,
lastSegment              LastSegment,
spare5                   NULL,
spare4                   NULL,
spare3                   NULL,
spare2                   NULL,
spare1                   NULL
}
}

```

```

-- *****
--
-- SYSTEM INFORMATION for FACH
--
-- *****

```

```

SystemInformation-FACH ::= SEQUENCE {
    -- Other information elements
    payload CHOICE {
        noSegment                NULL,
        firstSegment             FirstSegment,
        subsequentSegment       SubsequentSegment,
        lastSegmentShort        LastSegmentShort,
        lastAndFirst            SEQUENCE {
            lastSegmentShort    LastSegmentShort,
            firstSegment        FirstSegmentShort
        },
        lastAndComplete         SEQUENCE {
            lastSegmentShort    LastSegmentShort,
            completeSIB-List    CompleteSIB-List
        },
        lastAndCompleteAndFirst SEQUENCE {
            lastSegmentShort    LastSegmentShort,
            completeSIB-List    CompleteSIB-List,
            firstSegment        FirstSegmentShort
        },
        completeSIB-List        CompleteSIB-List,
        completeAndFirst        SEQUENCE {
            completeSIB-List    CompleteSIB-List,
            firstSegment        FirstSegmentShort
        },
        completeSIB              CompleteSIB,
        lastSegment              LastSegment,
        spare5                   NULL,
        spare4                   NULL,
        spare3                   NULL,
        spare2                   NULL,
        spare1                   NULL
    }
}

```

```

-- *****
--
-- First segment
--
-- *****

```

```

FirstSegment ::=
    -- Other information elements
    sib-Type          SIB-Type,
    seg-Count         SegCount,
    sib-Data-fixed    SIB-Data-fixed
}

-- *****
--
-- First segment (short)
--
-- *****

FirstSegmentShort ::=
    -- Other information elements
    sib-Type          SIB-Type,
    seg-Count         SegCount,
    sib-Data-variable SIB-Data-variable
}

-- *****
--
-- Subsequent segment
--
-- *****

SubsequentSegment ::=
    -- Other information elements
    sib-Type          SIB-Type,
    segmentIndex      SegmentIndex,
    sib-Data-fixed    SIB-Data-fixed
}

-- *****
--
-- Last segment
--
-- *****

LastSegment ::=
    -- Other information elements
    sib-Type          SIB-Type,
    segmentIndex      SegmentIndex,
    -- For sib-Data-fixed, in case the SIB data is less than 222 bits, padding
    -- shall be used. The same padding bits shall be used as defined in clause 12.1
    sib-Data-fixed    SIB-Data-fixed
}

LastSegmentShort ::=
    -- Other information elements
    sib-Type          SIB-Type,
    segmentIndex      SegmentIndex,
    sib-Data-variable SIB-Data-variable
}

-- *****
--
-- Complete SIB
--
-- *****

CompleteSIB-List ::=
    SEQUENCE (SIZE (1..maxSIBperMsg)) OF
        CompleteSIBshort

CompleteSIB ::=
    -- Other information elements
    sib-Type          SIB-Type,
    -- For sib-Data-fixed, in case the SIB data is less than 226 bits, padding
    -- shall be used. The same padding bits shall be used as defined in clause 12.1
    sib-Data-fixed    BIT STRING (SIZE (226))
}

CompleteSIBshort ::=
    -- Other information elements
    sib-Type          SIB-Type,
    sib-Data-variable SIB-Data-variable
}

```

```

-- *****
--
-- SYSTEM INFORMATION CHANGE INDICATION
--
-- *****

SystemInformationChangeIndication ::= SEQUENCE {
  -- Other IEs
  bcch-ModificationInfo          BCCH-ModificationInfo,
  laterNonCriticalExtensions      SEQUENCE {
    -- Container for additional R99 extensions
    systemInformationChangeIndication-r3-add-ext  BIT STRING      OPTIONAL,
    v860NonCriticalExtensions      SEQUENCE {
      systemInformationChangeIndication-v860ext
      SystemInformationChangeIndication-v860ext-IEs,
      nonCriticalExtensions        SEQUENCE {}      OPTIONAL
    } OPTIONAL
  } OPTIONAL
}

SystemInformationChangeIndication-v860ext-IEs ::= SEQUENCE {
  -- Other IEs
  etws-Information              ETWS-Information          OPTIONAL
}

-- *****
--
-- TRANSPORT CHANNEL RECONFIGURATION
--
-- *****

TransportChannelReconfiguration ::= CHOICE {
  r3                             SEQUENCE {
    transportChannelReconfiguration-r3
    TransportChannelReconfiguration-r3-IEs,
    v3a0NonCriticalExtensions     SEQUENCE {
      transportChannelReconfiguration-v3a0ext
      TransportChannelReconfiguration-v3a0ext,
      laterNonCriticalExtensions  SEQUENCE {
        -- Container for additional R99 extensions
        transportChannelReconfiguration-r3-add-ext  BIT STRING      OPTIONAL,
        v4b0NonCriticalExtensions  SEQUENCE {
          transportChannelReconfiguration-v4b0ext
          TransportChannelReconfiguration-v4b0ext-IEs,
          v590NonCriticalExtensions  SEQUENCE {
            transportChannelReconfiguration-v590ext
            TransportChannelReconfiguration-v590ext-IEs,
            v690NonCriticalExtensions  SEQUENCE {
              transportChannelReconfiguration-v690ext
              TransportChannelReconfiguration-v690ext-IEs,
              v770NonCriticalExtensions  SEQUENCE {
                transportChannelReconfiguration-v770ext
                TransportChannelReconfiguration-v770ext-IEs,
                nonCriticalExtensions  SEQUENCE {}      OPTIONAL
              } OPTIONAL
            } OPTIONAL
          } OPTIONAL
        } OPTIONAL
      } OPTIONAL
    } OPTIONAL
  } OPTIONAL
},
  later-than-r3                  SEQUENCE {
    rrc-TransactionIdentifier     RRC-TransactionIdentifier,
    criticalExtensions            CHOICE {
      r4                          SEQUENCE {
        transportChannelReconfiguration-r4
        TransportChannelReconfiguration-r4-IEs,
        v4d0NonCriticalExtensions  SEQUENCE {
          -- Container for adding non critical extensions after freezing REL-5
          transportChannelReconfiguration-r4-add-ext  BIT STRING      OPTIONAL,
          v590NonCriticalExtensions  SEQUENCE {
            transportChannelReconfiguration-v590ext
            TransportChannelReconfiguration-v590ext-IEs,
            v690NonCriticalExtensions  SEQUENCE {
              transportChannelReconfiguration-v690ext
              TransportChannelReconfiguration-v690ext-IEs,
              v770NonCriticalExtensions  SEQUENCE {

```

```

        transportChannelReconfiguration-v770ext
            TransportChannelReconfiguration-v770ext-IEs,
        nonCriticalExtensions SEQUENCE {} OPTIONAL
    } OPTIONAL
} OPTIONAL
},
criticalExtensions CHOICE {
    r5 SEQUENCE {
        transportChannelReconfiguration-r5
            TransportChannelReconfiguration-r5-IEs,
        -- Container for adding non critical extensions after freezing REL-6
        transportChannelReconfiguration-r5-add-ext BIT STRING OPTIONAL,
        v690NonCriticalExtensions SEQUENCE {
            transportChannelReconfiguration-v690ext
                TransportChannelReconfiguration-v690ext-IEs,
            v770NonCriticalExtensions SEQUENCE {
                transportChannelReconfiguration-v770ext
                    TransportChannelReconfiguration-v770ext-IEs,
                nonCriticalExtensions SEQUENCE {} OPTIONAL
            } OPTIONAL
        } OPTIONAL
    },
    r6 SEQUENCE {
        transportChannelReconfiguration-r6
            TransportChannelReconfiguration-r6-IEs,
        -- Container for adding non critical extensions after freezing REL-7
        transportChannelReconfiguration-r6-add-ext BIT STRING OPTIONAL,
        v6b0NonCriticalExtensions SEQUENCE {
            transportChannelReconfiguration-v6b0ext
                TransportChannelReconfiguration-v6b0ext-IEs,
            v770NonCriticalExtensions SEQUENCE {
                transportChannelReconfiguration-v770ext
                    TransportChannelReconfiguration-v770ext-IEs,
                nonCriticalExtensions SEQUENCE {} OPTIONAL
            } OPTIONAL
        } OPTIONAL
    },
    r7 SEQUENCE {
        transportChannelReconfiguration-r7
            TransportChannelReconfiguration-r7-IEs,
        -- Container for adding non critical extensions after freezing REL-8
        transportChannelReconfiguration-r7-add-ext BIT STRING OPTIONAL,
        v780NonCriticalExtensions SEQUENCE {
            transportChannelReconfiguration-v780ext
                TransportChannelReconfiguration-v780ext-IEs,
            v7d0NonCriticalExtensions SEQUENCE {
                transportChannelReconfiguration-v7d0ext
                    TransportChannelReconfiguration-v7d0ext-IEs,
            v7f0NonCriticalExtensions SEQUENCE {
                transportChannelReconfiguration-v7f0ext
                    TransportChannelReconfiguration-v7f0ext-IEs,
            v7g0NonCriticalExtensions SEQUENCE {
                transportChannelReconfiguration-v7g0ext
                    TransportChannelReconfiguration-v7g0ext-IEs,
                nonCriticalExtensions SEQUENCE {} OPTIONAL
            } OPTIONAL
        } OPTIONAL
    } OPTIONAL
    },
    r8 SEQUENCE {
        transportChannelReconfiguration-r8
            TransportChannelReconfiguration-r8-IEs,
        -- Container for adding non critical extensions after freezing REL-9
        transportChannelReconfiguration-r8-add-ext BIT STRING OPTIONAL,
        v7d0NonCriticalExtensions SEQUENCE {
            transportChannelReconfiguration-v7d0ext
                TransportChannelReconfiguration-v7d0ext-IEs,
            v7f0NonCriticalExtensions SEQUENCE {
                transportChannelReconfiguration-v7f0ext
                    TransportChannelReconfiguration-v7f0ext-IEs,
            v890NonCriticalExtensions SEQUENCE {

```



```

-- dummy is not used in this version of the specification, it should
-- not be sent and if received it should be ignored.
dummy                SSDT-UL                OPTIONAL,
-- The order of the RLs in IE cell-id-PerRL-List is the same as
-- in IE DL-InformationPerRL-List included in this message
cell-id-PerRL-List  CellIdentity-PerRL-List  OPTIONAL
}

TransportChannelReconfiguration-v590ext-IEs ::= SEQUENCE {
-- Physical channel IEs
  dl-TPC-PowerOffsetPerRL-List  DL-TPC-PowerOffsetPerRL-List  OPTIONAL
}

TransportChannelReconfiguration-r4-IEs ::= SEQUENCE {
-- User equipment IEs
  integrityProtectionModeInfo    IntegrityProtectionModeInfo    OPTIONAL,
  cipheringModeInfo              CipheringModeInfo              OPTIONAL,
  activationTime                  ActivationTime                  OPTIONAL,
  new-U-RNTI                      U-RNTI                        OPTIONAL,
  new-C-RNTI                      C-RNTI                        OPTIONAL,
-- The IE "new-DSCH-RNTI" should not be included in FDD mode, and if received
-- the UE behaviour is unspecified
  new-DSCH-RNTI                  DSCH-RNTI                      OPTIONAL,
  rrc-StateIndicator              RRC-StateIndicator,
  utran-DRX-CycleLengthCoeff      UTRAN-DRX-CycleLengthCoefficient  OPTIONAL,
-- Core network IEs
  cn-InformationInfo              CN-InformationInfo            OPTIONAL,
-- UTRAN mobility IEs
  ura-Identity                    URA-Identity                  OPTIONAL,
-- Radio bearer IEs
  dl-CounterSynchronisationInfo  DL-CounterSynchronisationInfo  OPTIONAL,
-- Transport channel IEs
  ul-CommonTransChInfo            UL-CommonTransChInfo-r4       OPTIONAL,
  ul-AddReconfTransChInfoList     UL-AddReconfTransChInfoList   OPTIONAL,
-- 'dummy', 'dummy1' and 'dummy2' are not used in this version of the specification,
-- they should not be sent and if received they should be ignored.
  dummy                           CHOICE {
    fdd                            SEQUENCE {
      dummy1                       CPCH-SetID                     OPTIONAL,
      dummy2                       DRAC-StaticInformationList     OPTIONAL
    },
    tdd                            NULL
  }
  dl-CommonTransChInfo            DL-CommonTransChInfo-r4       OPTIONAL,
  dl-AddReconfTransChInfoList     DL-AddReconfTransChInfoList-r4  OPTIONAL,
-- Physical channel IEs
  frequencyInfo                   FrequencyInfo                   OPTIONAL,
  maxAllowedUL-TX-Power            MaxAllowedUL-TX-Power          OPTIONAL,
  ul-ChannelRequirement            UL-ChannelRequirement-r4       OPTIONAL,
  modeSpecificPhysChInfo          CHOICE {
    fdd                            SEQUENCE {
      -- dummy is not used in this version of specification, it should
      -- not be sent and if received it should be ignored.
      dummy                        DL-PDSCH-Information          OPTIONAL
    },
    tdd                            NULL
  },
  dl-CommonInformation            DL-CommonInformation-r4        OPTIONAL,
  dl-InformationPerRL-List        DL-InformationPerRL-List-r4    OPTIONAL
}

TransportChannelReconfiguration-r5-IEs ::= SEQUENCE {
-- User equipment IEs
  integrityProtectionModeInfo    IntegrityProtectionModeInfo    OPTIONAL,
  cipheringModeInfo              CipheringModeInfo              OPTIONAL,
  activationTime                  ActivationTime                  OPTIONAL,
  new-U-RNTI                      U-RNTI                        OPTIONAL,
  new-C-RNTI                      C-RNTI                        OPTIONAL,
-- The IE "new-DSCH-RNTI" should not be included in FDD mode, and if received
-- the UE behaviour is unspecified
  new-DSCH-RNTI                  DSCH-RNTI                      OPTIONAL,
  new-H-RNTI                      H-RNTI                        OPTIONAL,
  rrc-StateIndicator              RRC-StateIndicator,
  utran-DRX-CycleLengthCoeff      UTRAN-DRX-CycleLengthCoefficient  OPTIONAL,
-- Core network IEs
  cn-InformationInfo              CN-InformationInfo            OPTIONAL,
-- UTRAN mobility IEs
  ura-Identity                    URA-Identity                  OPTIONAL,

```

```

-- Radio bearer IEs
  dl-CounterSynchronisationInfo  DL-CounterSynchronisationInfo-r5  OPTIONAL,
-- Transport channel IEs
  ul-CommonTransChInfo           UL-CommonTransChInfo-r4           OPTIONAL,
  ul-AddReconfTransChInfoList    UL-AddReconfTransChInfoList    OPTIONAL,
  -- 'dummy', 'dummy1' and 'dummy2' are not used in this version of the specification,
  -- they should not be sent and if received they should be ignored.
  dummy                           CHOICE {
    fdd                            SEQUENCE {
      dummy1                       CPCH-SetID                       OPTIONAL,
      dummy2                       DRAC-StaticInformationList    OPTIONAL
    },
    tdd                            NULL
  }
  dl-CommonTransChInfo           DL-CommonTransChInfo-r4           OPTIONAL,
  dl-AddReconfTransChInfoList    DL-AddReconfTransChInfoList-r5    OPTIONAL,
-- Physical channel IEs
  frequencyInfo                  FrequencyInfo                    OPTIONAL,
  maxAllowedUL-TX-Power          MaxAllowedUL-TX-Power          OPTIONAL,
  ul-ChannelRequirement          UL-ChannelRequirement-r5        OPTIONAL,
  modeSpecificPhysChInfo        CHOICE {
    fdd                            SEQUENCE {
      -- dummy is not used in this version of specification, it should
      -- not be sent and if received it should be ignored.
      dummy                        DL-PDSCH-Information            OPTIONAL
    },
    tdd                            NULL
  },
  dl-HSPDSCH-Information         DL-HSPDSCH-Information         OPTIONAL,
  dl-CommonInformation          DL-CommonInformation-r5        OPTIONAL,
  dl-InformationPerRL-List      DL-InformationPerRL-List-r5    OPTIONAL
}

TransportChannelReconfiguration-v690ext-IEs ::= SEQUENCE {
-- User Equipment IEs
  delayRestrictionFlag          DelayRestrictionFlag            OPTIONAL,
-- Core network IEs
  primary-plmn-Identity         PLMN-Identity                  OPTIONAL,
-- Physical channel IEs
  -- The IE harq-Preamble-Mode should not be used in the r3 and r4 versions of the message
  -- If included in the r3 or r4 version of the message, the UE should ignore the IE
  harq-Preamble-Mode           HARQ-Preamble-Mode              OPTIONAL,
  beaconPLEst                  BEACON-PL-Est                  OPTIONAL,
  postVerificationPeriod        ENUMERATED { true }             OPTIONAL,
  dhs-sync                      DHS-Sync                        OPTIONAL,
  timingMaintainedSynchInd     TimingMaintainedSynchInd       OPTIONAL,
-- MBMS IEs
  mbms-PL-ServiceRestrictInfo  MBMS-PL-ServiceRestrictInfo-r6  OPTIONAL
}

TransportChannelReconfiguration-r6-IEs ::= SEQUENCE {
-- User equipment IEs
  integrityProtectionModeInfo   IntegrityProtectionModeInfo     OPTIONAL,
  cipheringModeInfo            CipheringModeInfo                OPTIONAL,
  activationTime                ActivationTime                    OPTIONAL,
  delayRestrictionFlag          DelayRestrictionFlag            OPTIONAL,
  new-U-RNTI                    U-RNTI                          OPTIONAL,
  new-C-RNTI                    C-RNTI                          OPTIONAL,
  -- The IE "new-DSCH-RNTI" should not be included in FDD mode,
  -- and if received the UE behaviour is unspecified
  new-DSCH-RNTI                DSCH-RNTI                       OPTIONAL,
  new-H-RNTI                    H-RNTI                          OPTIONAL,
  newPrimary-E-RNTI            E-RNTI                          OPTIONAL,
  newSecondary-E-RNTI          E-RNTI                          OPTIONAL,
  rrc-StateIndicator           RRC-StateIndicator,
  utran-DRX-CycleLengthCoeff    UTRAN-DRX-CycleLengthCoefficient  OPTIONAL,
-- Core network IEs
  cn-InformationInfo            CN-InformationInfo-r6           OPTIONAL,
-- UTRAN mobility IEs
  ura-Identity                  URA-Identity                    OPTIONAL,
-- Radio bearer IEs
  dl-CounterSynchronisationInfo DL-CounterSynchronisationInfo-r5  OPTIONAL,
-- Transport channel IEs
  ul-CommonTransChInfo         UL-CommonTransChInfo-r4         OPTIONAL,
  ul-AddReconfTransChInfoList  UL-AddReconfTransChInfoList-r6  OPTIONAL,
  dl-CommonTransChInfo         DL-CommonTransChInfo-r4         OPTIONAL,
  dl-AddReconfTransChInfoList  DL-AddReconfTransChInfoList-r5  OPTIONAL,
-- Physical channel IEs

```

```

    frequencyInfo          FrequencyInfo          OPTIONAL,
    maxAllowedUL-TX-Power  MaxAllowedUL-TX-Power  OPTIONAL,
    ul-DPCH-Info           UL-DPCH-Info-r6        OPTIONAL,
    ul-EDCH-Information    UL-EDCH-Information-r6  OPTIONAL,
    dl-HSPDSCH-Information DL-HSPDSCH-Information-r6  OPTIONAL,
    dl-CommonInformation   DL-CommonInformation-r6  OPTIONAL,
    dl-InformationPerRL-List DL-InformationPerRL-List-r6  OPTIONAL,
  -- MBMS IEs
    mbms-PL-ServiceRestrictInfo MBMS-PL-ServiceRestrictInfo-r6  OPTIONAL
}

TransportChannelReconfiguration-v6b0ext-IEs ::= SEQUENCE {
  -- Physical channel IEs
    dl-InformationPerRL-List-v6b0ext  DL-InformationPerRL-List-v6b0ext  OPTIONAL
}

TransportChannelReconfiguration-r7-IEs ::= SEQUENCE {
  -- User equipment IEs
    integrityProtectionModeInfo  IntegrityProtectionModeInfo-r7  OPTIONAL,
    cipheringModeInfo            CipheringModeInfo-r7            OPTIONAL,
    activationTime               ActivationTime                   OPTIONAL,
    delayRestrictionFlag         DelayRestrictionFlag           OPTIONAL,
    new-U-RNTI                   U-RNTI                         OPTIONAL,
    new-C-RNTI                   C-RNTI                         OPTIONAL,
    -- The IE "new-DSCH-RNTI" should not be included in FDD mode,
    -- and if received the UE behaviour is unspecified
    new-DSCH-RNTI               DSCH-RNTI                       OPTIONAL,
    new-H-RNTI                   H-RNTI                         OPTIONAL,
    newPrimary-E-RNTI           E-RNTI                         OPTIONAL,
    newSecondary-E-RNTI         E-RNTI                         OPTIONAL,
    rrc-StateIndicator          RRC-StateIndicator,
    ueMobilityStateIndicator     High-MobilityDetected          OPTIONAL,
    utran-DRX-CycleLengthCoeff  UTRAN-DRX-CycleLengthCoefficient-r7  OPTIONAL,
  -- Core network IEs
    cn-InformationInfo          CN-InformationInfo-r6          OPTIONAL,
  -- UTRAN mobility IEs
    ura-Identity                URA-Identity                   OPTIONAL,
    supportForChangeOfUE-Capability BOOLEAN                          OPTIONAL,
    responseToChangeOfUE-Capability ENUMERATED { true }          OPTIONAL,
  -- Radio bearer IEs
    dl-CounterSynchronisationInfo DL-CounterSynchronisationInfo-r5  OPTIONAL,
  -- Transport channel IEs
    ul-CommonTransChInfo        UL-CommonTransChInfo-r4        OPTIONAL,
    ul-AddReconfTransChInfoList UL-AddReconfTransChInfoList-r7  OPTIONAL,
    dl-CommonTransChInfo        DL-CommonTransChInfo-r4        OPTIONAL,
    dl-AddReconfTransChInfoList DL-AddReconfTransChInfoList-r7  OPTIONAL,
  -- Physical channel IEs
    frequencyInfo              FrequencyInfo                    OPTIONAL,
    multi-frequencyInfo         Multi-frequencyInfo-LCR-r7     OPTIONAL,
    dtx-drx-TimingInfo         DTX-DRX-TimingInfo-r7         OPTIONAL,
    dtx-drx-Info               DTX-DRX-Info-r7              OPTIONAL,
    hs-scch-LessInfo           HS-SCCH-LessInfo-r7           OPTIONAL,
    mimoParameters             MIMO-Parameters-r7           OPTIONAL,
    maxAllowedUL-TX-Power      MaxAllowedUL-TX-Power         OPTIONAL,
    ul-DPCH-Info               UL-DPCH-Info-r7              OPTIONAL,
    ul-EDCH-Information         UL-EDCH-Information-r7        OPTIONAL,
    dl-HSPDSCH-Information     DL-HSPDSCH-Information-r7     OPTIONAL,
    dl-CommonInformation        DL-CommonInformation-r7       OPTIONAL,
    dl-InformationPerRL-List    DL-InformationPerRL-List-r7   OPTIONAL,
  -- MBMS IEs
    mbms-PL-ServiceRestrictInfo MBMS-PL-ServiceRestrictInfo-r6  OPTIONAL
}

TransportChannelReconfiguration-v770ext-IEs ::= SEQUENCE {
  -- User equipment IEs
    ueMobilityStateIndicator     High-MobilityDetected          OPTIONAL
}

TransportChannelReconfiguration-v780ext-IEs ::= SEQUENCE {
  -- Physical channel IEs
    hs-DSCH-TBSizeTable         HS-DSCH-TBSizeTable           OPTIONAL
}

TransportChannelReconfiguration-v7d0ext-IEs ::= SEQUENCE {
  -- Physical channel IEs
    ul-EDCH-Information          UL-EDCH-Information-ext       OPTIONAL
}

```

```

TransportChannelReconfiguration-v7f0ext-IEs ::= SEQUENCE {
  -- Physical channel IEs
  mimoParameters          MIMO-Parameters-v7f0ext          OPTIONAL
}

TransportChannelReconfiguration-v7g0ext-IEs ::= SEQUENCE {
  -- Physical channel IEs
  mimoParameters          MIMO-Parameters-v7g0ext          OPTIONAL
}

TransportChannelReconfiguration-r8-IEs ::= SEQUENCE {
  -- User equipment IEs
  integrityProtectionModeInfo    IntegrityProtectionModeInfo-r7    OPTIONAL,
  cipheringModeInfo              CipheringModeInfo-r7              OPTIONAL,
  activationTime                  ActivationTime                    OPTIONAL,
  delayRestrictionFlag            DelayRestrictionFlag              OPTIONAL,
  new-U-RNTI                      U-RNTI                      OPTIONAL,
  new-C-RNTI                      C-RNTI                      OPTIONAL,
  -- The IE "new-DSCH-RNTI" should not be included in FDD mode,
  -- and if received the UE behaviour is unspecified
  new-DSCH-RNTI                  DSCH-RNTI                    OPTIONAL,
  new-H-RNTI                      H-RNTI                      OPTIONAL,
  newPrimary-E-RNTI               E-RNTI                      OPTIONAL,
  newSecondary-E-RNTI             E-RNTI                      OPTIONAL,
  rrc-StateIndicator              RRC-StateIndicator,
  ueMobilityStateIndicator        High-MobilityDetected        OPTIONAL,
  utran-DRX-CycleLengthCoeff      UTRAN-DRX-CycleLengthCoefficient-r7  OPTIONAL,
  -- Core network IEs
  cn-InformationInfo              CN-InformationInfo-r6        OPTIONAL,
  -- UTRAN mobility IEs
  ura-Identity                    URA-Identity                OPTIONAL,
  supportForChangeOfUE-Capability BOOLEAN                      OPTIONAL,
  responseToChangeOfUE-Capability ENUMERATED { true }         OPTIONAL,
  -- Radio bearer IEs
  dl-CounterSynchronisationInfo    DL-CounterSynchronisationInfo-r5  OPTIONAL,
  -- Transport channel IEs
  ul-CommonTransChInfo            UL-CommonTransChInfo-r4        OPTIONAL,
  ul-AddReconfTransChInfoList      UL-AddReconfTransChInfoList-r8    OPTIONAL,
  dl-CommonTransChInfo            DL-CommonTransChInfo-r4        OPTIONAL,
  dl-AddReconfTransChInfoList      DL-AddReconfTransChInfoList-r7    OPTIONAL,
  -- Physical channel IEs
  frequencyInfo                    FrequencyInfo                  OPTIONAL,
  multi-frequencyInfo              Multi-frequencyInfo-LCR-r7      OPTIONAL,
  dtx-drx-TimingInfo              DTX-DRX-TimingInfo-r7         OPTIONAL,
  dtx-drx-Info                    DTX-DRX-Info-r7              OPTIONAL,
  hs-scch-LessInfo                HS-SCCH-LessInfo-r7           OPTIONAL,
  mimoParameters                  MIMO-Parameters-r8           OPTIONAL,
  maxAllowedUL-TX-Power            MaxAllowedUL-TX-Power         OPTIONAL,
  ul-DPCH-Info                    UL-DPCH-Info-r7              OPTIONAL,
  ul-EDCH-Information              UL-EDCH-Information-r8        OPTIONAL,
  dl-HSPDSCH-Information           DL-HSPDSCH-Information-r8     OPTIONAL,
  dl-CommonInformation             DL-CommonInformation-r8       OPTIONAL,
  dl-InformationPerRL-List         DL-InformationPerRL-List-r8   OPTIONAL,
  dl-SecondaryCellInfoFDD          DL-SecondaryCellInfoFDD       OPTIONAL,
  controlChannelDRXInfo-TDD128     ControlChannelDRXInfo-TDD128-r8  OPTIONAL,
  sps-Information-TDD128           SPS-Information-TDD128-r8     OPTIONAL,
  -- MBMS IEs
  mbms-PL-ServiceRestrictInfo      MBMS-PL-ServiceRestrictInfo-r6  OPTIONAL
}

TransportChannelReconfiguration-v890ext-IEs ::= SEQUENCE {
  -- User Equipment IEs
  dl-SecondaryCellInfoFDD-v890ext    DL-SecondaryCellInfoFDD-v890ext    OPTIONAL,
  -- Physical channel IEs
  dl-HSPDSCH-Information            DL-HSPDSCH-Information-r8-ext      OPTIONAL
}

TransportChannelReconfiguration-v8a0ext-IEs ::= SEQUENCE {
  -- Physical channel IEs
  dl-HSPDSCH-Information            DL-HSPDSCH-Information-r8-ext2     OPTIONAL
}

-- *****
--
-- TRANSPORT CHANNEL RECONFIGURATION COMPLETE
--
-- *****

```

```

TransportChannelReconfigurationComplete ::= SEQUENCE {
  -- User equipment IEs
  rrc-TransactionIdentifier      RRC-TransactionIdentifier,
  ul-IntegProtActivationInfo     IntegrityProtActivationInfo      OPTIONAL,
  -- TABULAR: UL-TimingAdvance is applicable for TDD mode only.
  ul-TimingAdvance              UL-TimingAdvance                OPTIONAL,
  -- Radio bearer IEs
  count-C-ActivationTime        ActivationTime                OPTIONAL,
  -- dummy is not used in this version of the specification and
  -- it should be ignored by the receiver.
  dummy                          RB-ActivationTimeInfoList     OPTIONAL,
  ul-CounterSynchronisationInfo  UL-CounterSynchronisationInfo  OPTIONAL,
  laterNonCriticalExtensions     SEQUENCE {
    -- Container for additional R99 extensions
    transportChannelReconfigurationComplete-r3-add-ext      BIT STRING      OPTIONAL,
    v770NonCriticalExtensions SEQUENCE {
      transportChannelReconfigurationComplete-v770ext
      TransportChannelReconfigurationComplete-v770ext-IEs,
      nonCriticalExtensions SEQUENCE {} OPTIONAL
    } OPTIONAL
  } OPTIONAL
}

TransportChannelReconfigurationComplete-v770ext-IEs ::= SEQUENCE {
  -- TABULAR: EXT-UL-TimingAdvance is applicable for TDD mode only.
  ext-UL-TimingAdvance      EXT-UL-TimingAdvance  OPTIONAL,
  deferredMeasurementControlReading  ENUMERATED { true }  OPTIONAL
}

-- *****
--
-- TRANSPORT CHANNEL RECONFIGURATION FAILURE
--
-- *****

TransportChannelReconfigurationFailure ::= SEQUENCE {
  -- User equipment IEs
  rrc-TransactionIdentifier      RRC-TransactionIdentifier,
  failureCause                  FailureCauseWithProtErr,
  laterNonCriticalExtensions     SEQUENCE {
    -- Container for additional R99 extensions
    transportChannelReconfigurationFailure-r3-add-ext      BIT STRING      OPTIONAL,
    nonCriticalExtensions SEQUENCE {} OPTIONAL
  } OPTIONAL
}

-- *****
--
-- TRANSPORT FORMAT COMBINATION CONTROL in AM or UM RLC mode
--
-- *****

TransportFormatCombinationControl ::= SEQUENCE {
  -- rrc-TransactionIdentifier is always included in this version of the specification
  rrc-TransactionIdentifier      RRC-TransactionIdentifier      OPTIONAL,
  modeSpecificInfo              CHOICE {
    fdd                          NULL,
    tdd                          SEQUENCE {
      tfcs-ID                    TFCS-Identity  OPTIONAL
    }
  },
  dpch-TFCS-InUplink            TFC-Subset,
  activationTimeForTFCSsubset    ActivationTime                OPTIONAL,
  tfc-ControlDuration            TFC-ControlDuration          OPTIONAL,
  laterNonCriticalExtensions     SEQUENCE {
    -- Container for additional R99 extensions
    transportFormatCombinationControl-r3-add-ext      BIT STRING      OPTIONAL,
    v820NonCriticalExtensions SEQUENCE {
      transportformatcombinationcontrol-v820ext
      TransportFormatCombinationControl-v820ext-IEs,
      nonCriticalExtensions SEQUENCE {} OPTIONAL
    } OPTIONAL
  } OPTIONAL
}

TransportFormatCombinationControl-v820ext-IEs ::= SEQUENCE {
  -- Transport Format Combination Control IEs
  ul-AMR-Rate                    UL-AMR-Rate                OPTIONAL
}

```

```

}

-- *****
--
-- TRANSPORT FORMAT COMBINATION CONTROL FAILURE
--
-- *****

TransportFormatCombinationControlFailure ::= SEQUENCE {
    -- User equipment IEs
    rrc-TransactionIdentifier      RRC-TransactionIdentifier,
    failureCause                   FailureCauseWithProtErr,
    laterNonCriticalExtensions      SEQUENCE {
        -- Container for additional R99 extensions
        transportFormatCombinationControlFailure-r3-add-ext  BIT STRING      OPTIONAL,
        nonCriticalExtensions      SEQUENCE {}      OPTIONAL
    }      OPTIONAL
}

-- *****
--
-- UE CAPABILITY ENQUIRY
--
-- *****

UECapabilityEnquiry ::= CHOICE {
    r3          SEQUENCE {
        ueCapabilityEnquiry-r3          UECapabilityEnquiry-r3-IEs,
        laterNonCriticalExtensions      SEQUENCE {
            -- Container for additional R99 extensions
            ueCapabilityEnquiry-r3-add-ext  BIT STRING      OPTIONAL,
            v4b0NonCriticalExtensions      SEQUENCE {
                ueCapabilityEnquiry-v4b0ext  UECapabilityEnquiry-v4b0ext-IEs,
                v590NonCriticalExtensions    SEQUENCE {
                    ueCapabilityEnquiry-v590ext  UECapabilityEnquiry-v590ext-IEs,
                    v770NonCriticalExtensions    SEQUENCE {
                        ueCapabilityEnquiry-v770ext  UECapabilityEnquiry-v770ext-IEs,
                        v860NonCriticalExtensions    SEQUENCE {
                            ueCapabilityEnquiry-v860ext  UECapabilityEnquiry-v860ext-IEs,
                            nonCriticalExtensions      SEQUENCE {}      OPTIONAL
                        }      OPTIONAL
                    }      OPTIONAL
                }      OPTIONAL
            }      OPTIONAL
        }      OPTIONAL
    },
    later-than-r3          SEQUENCE {
        rrc-TransactionIdentifier      RRC-TransactionIdentifier,
        criticalExtensions              SEQUENCE {}
    }
}

UECapabilityEnquiry-r3-IEs ::= SEQUENCE {
    -- User equipment IEs
    rrc-TransactionIdentifier      RRC-TransactionIdentifier,
    capabilityUpdateRequirement    CapabilityUpdateRequirement
}

UECapabilityEnquiry-v4b0ext-IEs ::= SEQUENCE {
    capabilityUpdateRequirement-r4-ext  CapabilityUpdateRequirement-r4-ext
}

UECapabilityEnquiry-v590ext-IEs ::= SEQUENCE {
    systemSpecificCapUpdateReq        SystemSpecificCapUpdateReq-v590ext
}

UECapabilityEnquiry-v770ext-IEs ::= SEQUENCE {
    capabilityUpdateRequirement        CapabilityUpdateRequirement-v770ext      OPTIONAL
}

UECapabilityEnquiry-v860ext-IEs ::= SEQUENCE {
    capabilityUpdateRequirement        CapabilityUpdateRequirement-v860ext      OPTIONAL
}

-- *****
--
-- UE CAPABILITY INFORMATION
--

```

```

-- *****
UECapabilityInformation ::= SEQUENCE {
  -- User equipment IEs
  rrc-TransactionIdentifier      RRC-TransactionIdentifier      OPTIONAL,
  ue-RadioAccessCapability       UE-RadioAccessCapability       OPTIONAL,
  -- Other IEs
  ue-RATSpecificCapability       InterRAT-UE-RadioAccessCapabilityList  OPTIONAL,
  v370NonCriticalExtensions      SEQUENCE {
    ueCapabilityInformation-v370ext UECapabilityInformation-v370ext,
    v380NonCriticalExtensions      SEQUENCE {
      ueCapabilityInformation-v380ext UECapabilityInformation-v380ext-IEs,
      v3a0NonCriticalExtensions      SEQUENCE {
        ueCapabilityInformation-v3a0ext UECapabilityInformation-v3a0ext-IEs,
        laterNonCriticalExtensions      SEQUENCE {
          -- Container for additional R99 extensions
          ueCapabilityInformation-r3-add-ext BIT STRING
            (CONTAINING UECapabilityInformation-r3-add-ext-IEs) OPTIONAL,
          -- Reserved for future non critical extension
          v4b0NonCriticalExtensions      SEQUENCE {
            ueCapabilityInformation-v4b0ext UECapabilityInformation-v4b0ext,
            v590NonCriticalExtensions      SEQUENCE {
              ueCapabilityInformation-v590ext UECapabilityInformation-v590ext,
              v5c0NonCriticalExtensions      SEQUENCE {
                ueCapabilityInformation-v5c0ext
                UECapabilityInformation-v5c0ext,
                v690NonCriticalExtensions      SEQUENCE {
                  ueCapabilityInformation-v690ext
                  UECapabilityInformation-v690ext-IEs,
                  nonCriticalExtensions      SEQUENCE {} OPTIONAL
                } OPTIONAL
              } OPTIONAL
            } OPTIONAL
          } OPTIONAL
        } OPTIONAL
      } OPTIONAL
    } OPTIONAL
  } OPTIONAL
}

UECapabilityInformation-v370ext ::= SEQUENCE {
  -- User equipment IEs
  ue-RadioAccessCapability-v370ext      UE-RadioAccessCapability-v370ext      OPTIONAL
}

UECapabilityInformation-v380ext-IEs ::= SEQUENCE {
  -- User equipment IEs
  ue-RadioAccessCapability-v380ext      UE-RadioAccessCapability-v380ext      OPTIONAL,
  dl-PhysChCapabilityFDD-v380ext      DL-PhysChCapabilityFDD-v380ext
}

UECapabilityInformation-v3a0ext-IEs ::= SEQUENCE {
  -- User equipment IEs
  ue-RadioAccessCapability-v3a0ext      UE-RadioAccessCapability-v3a0ext      OPTIONAL
}

UECapabilityInformation-r3-add-ext-IEs ::= SEQUENCE {
  ueCapabilityInformation-v650ext      UECapabilityInformation-v650ext-IEs      OPTIONAL,
  v680NonCriticalExtensions      SEQUENCE {
    ueCapabilityInformation-v680ext      UECapabilityInformation-v680ext-IEs,
    v7e0NonCriticalExtensions      SEQUENCE {
      ueCapabilityInformation-v7e0ext      UECapabilityInformation-v7e0ext-IEs,
      v7f0NonCriticalExtensions      SEQUENCE {
        ueCapabilityInformation-v7f0ext      UECapabilityInformation-v7f0ext-IEs,
        nonCriticalExtensions      SEQUENCE {} OPTIONAL
      } OPTIONAL
    } OPTIONAL
  } OPTIONAL
}

UECapabilityInformation-v4b0ext ::= SEQUENCE {
  -- User equipment IEs
  ue-RadioAccessCapability-v4b0ext      UE-RadioAccessCapability-v4b0ext      OPTIONAL
}

UECapabilityInformation-v590ext ::= SEQUENCE {
  -- User equipment IEs
  ue-RadioAccessCapability-v3g0ext      UE-RadioAccessCapability-v3g0ext      OPTIONAL,

```

```

        ue-RadioAccessCapability-v590ext      UE-RadioAccessCapability-v590ext      OPTIONAL,
-- Other IEs
        ue-RATSpecificCapability-v590ext      InterRAT-UE-RadioAccessCapability-v590ext  OPTIONAL
    }
UECapabilityInformation-v5c0ext ::= SEQUENCE {
-- User equipment IEs
    ue-RadioAccessCapability-v5c0ext          UE-RadioAccessCapability-v5c0ext          OPTIONAL
}
UECapabilityInformation-v650ext-IEs ::= SEQUENCE {
    ue-RadioAccessCapability-v650ext          UE-RadioAccessCapability-v650ext
}
UECapabilityInformation-v680ext-IEs ::= SEQUENCE {
-- User equipment IEs
    ue-RadioAccessCapability-v680ext          UE-RadioAccessCapability-v680ext
}
UECapabilityInformation-v690ext-IEs ::= SEQUENCE {
-- User equipment IEs
    ueCapabilityContainer                      BIT STRING
                                              (CONTAINING UE-CapabilityContainer-IEs) OPTIONAL
}
UECapabilityInformation-v7e0ext-IEs ::= SEQUENCE {
-- User equipment IEs
    ue-RadioAccessCapability                  UE-RadioAccessCapability-v7e0ext
}
UECapabilityInformation-v7f0ext-IEs ::= SEQUENCE {
-- User equipment IEs
    ue-RadioAccessCapability                  UE-RadioAccessCapability-v7f0ext      OPTIONAL
}

-- *****
--
-- UE CAPABILITY INFORMATION CONFIRM
--
-- *****

UECapabilityInformationConfirm ::= CHOICE {
    r3          SEQUENCE {
        ueCapabilityInformationConfirm-r3
        ueCapabilityInformationConfirm-r3-IEs,
        laterNonCriticalExtensions          SEQUENCE {
            -- Container for additional R99 extensions
            ueCapabilityInformationConfirm-r3-add-ext          BIT STRING      OPTIONAL,
            v770NonCriticalExtensions          SEQUENCE {
                ueCapabilityInformationConfirm-v770ext          UE-CapabilityInformationConfirm-v770ext-IEs,
                nonCriticalExtensions          SEQUENCE {}      OPTIONAL
            }      OPTIONAL
        }      OPTIONAL
    },
    later-than-r3          SEQUENCE {
        rrc-TransactionIdentifier          RRC-TransactionIdentifier,
        criticalExtensions          SEQUENCE {}
    }
}

UECapabilityInformationConfirm-r3-IEs ::= SEQUENCE {
-- User equipment IEs
    rrc-TransactionIdentifier          RRC-TransactionIdentifier
}

UECapabilityInformationConfirm-v770ext-IEs ::= SEQUENCE {
-- User equipment IEs
    acceptanceOfChangeOfCapability          ENUMERATED {
        refused, accepted, acceptedWithReconfigurationToFollow
    }      OPTIONAL
}

-- *****
--
-- UPLINK DIRECT TRANSFER
--
-- *****

```



```

UplinkDirectTransfer ::= SEQUENCE {
  -- Core network IEs
  cn-DomainIdentity          CN-DomainIdentity,
  nas-Message                NAS-Message,
  -- Measurement IEs
  measuredResultsOnRACH      MeasuredResultsOnRACH          OPTIONAL,
  laterNonCriticalExtensions SEQUENCE {
    -- Container for additional R99 extensions
    uplinkDirectTransfer-r3-add-ext BIT STRING          OPTIONAL,
    v690NonCriticalExtensions SEQUENCE {
      uplinkDirectTransfer-v690ext UplinkDirectTransfer-v690ext-IEs,
      v7g0NonCriticalExtensions SEQUENCE {
        uplinkDirectTransfer-v7g0ext UplinkDirectTransfer-v7g0ext-IEs,
        nonCriticalExtensions SEQUENCE {}          OPTIONAL
      }
    }
  }
}

UplinkDirectTransfer-v690ext-IEs ::= SEQUENCE {
  -- Measurement IEs
  measuredResultsOnRACHinterFreq MeasuredResultsOnRACHinterFreq          OPTIONAL
}

UplinkDirectTransfer-v7g0ext-IEs ::= SEQUENCE {
  -- Measurement IEs
  measuredResultsOnRACH-v7g0ext MeasuredResultsOnRACH-v7g0ext          OPTIONAL
}

-- *****
--
-- UPLINK PHYSICAL CHANNEL CONTROL
--
-- *****

UplinkPhysicalChannelControl ::= CHOICE {
  r3 SEQUENCE {
    uplinkPhysicalChannelControl-r3 UplinkPhysicalChannelControl-r3-IEs,
    laterNonCriticalExtensions SEQUENCE {
      -- Container for additional R99 extensions
      uplinkPhysicalChannelControl-r3-add-ext BIT STRING          OPTIONAL,
      v4b0NonCriticalExtensions SEQUENCE {
        uplinkPhysicalChannelControl-v4b0ext UplinkPhysicalChannelControl-v4b0ext-IEs,
        -- Extension mechanism for non-release 4 information
        noncriticalExtensions SEQUENCE {}          OPTIONAL
      }
    }
  },
  later-than-r3 SEQUENCE {
    rrc-TransactionIdentifier RRC-TransactionIdentifier,
    criticalExtensions CHOICE {
      r4 SEQUENCE {
        uplinkPhysicalChannelControl-r4 UplinkPhysicalChannelControl-r4-IEs,
        v4d0NonCriticalExtensions SEQUENCE {
          -- Container for adding non critical extensions after freezing REL-5
          uplinkPhysicalChannelControl-r4-add-ext BIT STRING          OPTIONAL,
          v690NonCriticalExtensions SEQUENCE {
            uplinkPhysicalChannelControl-v690ext
              UplinkPhysicalChannelControl-v690ext-IEs,
            nonCriticalExtensions SEQUENCE {}          OPTIONAL
          }
        }
      }
    }
  },
  criticalExtensions CHOICE {
    r5 SEQUENCE {
      uplinkPhysicalChannelControl-r5 UplinkPhysicalChannelControl-r5-IEs,
      -- Container for adding non critical extensions after freezing REL-6
      uplinkPhysicalChannelControl-r5-add-ext BIT STRING          OPTIONAL,
      v690NonCriticalExtensions SEQUENCE {
        uplinkPhysicalChannelControl-v690ext
          UplinkPhysicalChannelControl-v690ext-IEs,
        v6a0NonCriticalExtensions SEQUENCE {
          uplinkPhysicalChannelControl-v6a0ext
            UplinkPhysicalChannelControl-v6a0ext-IEs,
          nonCriticalExtensions SEQUENCE {}          OPTIONAL
        }
      }
    }
  }
}

```

```

        criticalExtensions          CHOICE {
            r7                       SEQUENCE {
                uplinkPhysicalChannelControl-r7 UplinkPhysicalChannelControl-r7-IEs,
                -- Container for adding non critical extensions after freezing REL-8
                uplinkPhysicalChannelControl-r7-add-ext BIT STRING OPTIONAL,
                nonCriticalExtensions          SEQUENCE {} OPTIONAL
            },
            criticalExtensions          SEQUENCE {}
        }
    }
}

UplinkPhysicalChannelControl-r3-IEs ::= SEQUENCE {
    -- User equipment IEs
    rrc-TransactionIdentifier          RRC-TransactionIdentifier,
    -- Physical channel IEs
    ccTrCH-PowerControlInfo           CCTrCH-PowerControlInfo          OPTIONAL,
    timingAdvance                     UL-TimingAdvanceControl          OPTIONAL,
    alpha                              Alpha                          OPTIONAL,
    specialBurstScheduling             SpecialBurstScheduling          OPTIONAL,
    prach-ConstantValue               ConstantValueTdd                OPTIONAL,
    pusch-ConstantValue               ConstantValueTdd                OPTIONAL
}

UplinkPhysicalChannelControl-v4b0ext-IEs ::= SEQUENCE {
    -- In case of TDD, openLoopPowerControl-IPDL-TDD is included instead of IE
    -- up-IPDL-Parameters in up-OTDOA-AssistanceData
    openLoopPowerControl-IPDL-TDD     OpenLoopPowerControl-IPDL-TDD-r4 OPTIONAL
}

UplinkPhysicalChannelControl-r4-IEs ::= SEQUENCE {
    -- Physical channel IEs
    ccTrCH-PowerControlInfo           CCTrCH-PowerControlInfo-r4      OPTIONAL,
    specialBurstScheduling             SpecialBurstScheduling          OPTIONAL,
    tddOption                          CHOICE {
        tdd384                         SEQUENCE {
            timingAdvance              UL-TimingAdvanceControl-r4     OPTIONAL,
            alpha                      Alpha                          OPTIONAL,
            prach-ConstantValue        ConstantValueTdd                OPTIONAL,
            pusch-ConstantValue        ConstantValueTdd                OPTIONAL,
            openLoopPowerControl-IPDL-TDD OpenLoopPowerControl-IPDL-TDD-r4 OPTIONAL
        },
        tdd128                         SEQUENCE {
            ul-SynchronisationParameters UL-SynchronisationParameters-r4 OPTIONAL
        }
    }
}

UplinkPhysicalChannelControl-r5-IEs ::= SEQUENCE {
    -- Physical channel IEs
    ccTrCH-PowerControlInfo           CCTrCH-PowerControlInfo-r5      OPTIONAL,
    specialBurstScheduling             SpecialBurstScheduling          OPTIONAL,
    tddOption                          CHOICE {
        tdd384                         SEQUENCE {
            timingAdvance              UL-TimingAdvanceControl-r4     OPTIONAL,
            alpha                      Alpha                          OPTIONAL,
            prach-ConstantValue        ConstantValueTdd                OPTIONAL,
            pusch-ConstantValue        ConstantValueTdd                OPTIONAL,
            openLoopPowerControl-IPDL-TDD OpenLoopPowerControl-IPDL-TDD-r4 OPTIONAL,
            hs-SICH-PowerControl        HS-SICH-Power-Control-Info-TDD384 OPTIONAL
        },
        tdd128                         SEQUENCE {
            ul-SynchronisationParameters UL-SynchronisationParameters-r4 OPTIONAL
        }
    }
}

UplinkPhysicalChannelControl-v690ext-IEs ::= SEQUENCE {
    -- Physical Channel IEs
    beaconPLEst                       BEACON-PL-Est                  OPTIONAL
}

UplinkPhysicalChannelControl-v6a0ext-IEs ::= SEQUENCE {
    -- Physical Channel IEs
    desired-HS-SICH-PowerLevel        INTEGER (-120..-58)            OPTIONAL,
    tpc-Step-Size                     ENUMERATED { s1, s2, s3 , spare1 } OPTIONAL
}

```

```

}

UplinkPhysicalChannelControl-r7-IEs ::= SEQUENCE {
  -- Physical channel IEs
  ccTrCH-PowerControlInfo          CCTrCH-PowerControlInfo-r7          OPTIONAL,
  specialBurstScheduling            SpecialBurstScheduling            OPTIONAL,
  tddOption                         CHOICE {
    tdd384                          SEQUENCE {
      timingAdvance                  UL-TimingAdvanceControl-r4    OPTIONAL,
      alpha                          Alpha                          OPTIONAL,
      prach-ConstantValue            ConstantValueTdd              OPTIONAL,
      pusch-ConstantValue            ConstantValueTdd              OPTIONAL,
      openLoopPowerControl-IPDL-TDD  OpenLoopPowerControl-IPDL-TDD-r4  OPTIONAL,
      hs-SICH-PowerControl            HS-SICH-Power-Control-Info-TDD384  OPTIONAL
    },
    tdd768                          SEQUENCE {
      timingAdvance                  UL-TimingAdvanceControl-r7    OPTIONAL,
      alpha                          Alpha                          OPTIONAL,
      prach-ConstantValue            ConstantValueTdd              OPTIONAL,
      pusch-ConstantValue            ConstantValueTdd              OPTIONAL,
      openLoopPowerControl-IPDL-TDD  OpenLoopPowerControl-IPDL-TDD-r4  OPTIONAL,
      hs-SICH-PowerControl            HS-SICH-Power-Control-Info-TDD768  OPTIONAL
    },
    tdd128                          SEQUENCE {
      ul-SynchronisationParameters  UL-SynchronisationParameters-r4  OPTIONAL,
      desired-HS-SICH-PowerLevel     INTEGER (-120..-58)             OPTIONAL,
      tpc-Step-Size                  ENUMERATED { s1, s2, s3 , spare1 }  OPTIONAL
    }
  }
}

-- *****
--
-- URA UPDATE
--
-- *****

URAUUpdate ::= SEQUENCE {
  -- User equipment IEs
  u-RNTI                          U-RNTI,
  ura-UpdateCause                  URA-UpdateCause,
  protocolErrorIndicator            ProtocolErrorIndicatorWithMoreInfo,
  laterNonCriticalExtensions        SEQUENCE {
    -- Container for additional R99 extensions
    uraUpdate-r3-add-ext            BIT STRING
    (CONTAINING URAUpdate-r3-add-ext-IEs)  OPTIONAL,
    v770NonCriticalExtensions      SEQUENCE {
      uraUpdate-v770ext            UraUpdate-v770ext-IEs,
      v860NonCriticalExtensions    SEQUENCE {
        uraUpdate-v860ext          URAUpdate-v860ext-IEs,
        nonCriticalExtensions      SEQUENCE {}  OPTIONAL
      }  OPTIONAL
    }  OPTIONAL
  }  OPTIONAL
}

URAUUpdate-r3-add-ext-IEs ::= SEQUENCE {
  uraUpdate-v7e0ext                URAUpdate-v7e0ext-IEs,
  nonCriticalExtensions             SEQUENCE {}  OPTIONAL
}

UraUpdate-v770ext-IEs ::= SEQUENCE {
  -- User equipment IEs
  support-hsdschReception-CellUraPch  ENUMERATED { true }  OPTIONAL,
  support-hsdschReception-CellFach    ENUMERATED { true }  OPTIONAL
}

URAUUpdate-v7e0ext-IEs ::= SEQUENCE {
  -- User equipment IEs
  supportForTwoDRXSchemesInPCH        ENUMERATED { true }  OPTIONAL
}

URAUUpdate-v860ext-IEs ::= SEQUENCE {
  -- User equipment IEs
  supportOfHS-DSCHDRXOperation        ENUMERATED { true }  OPTIONAL,
  supportOfCommonEDCH                 ENUMERATED { true }  OPTIONAL,
  supportOfMACiis                      ENUMERATED { true }  OPTIONAL
}

```

```

-- *****
--
-- URA UPDATE CONFIRM
--
-- *****

URAUUpdateConfirm ::= CHOICE {
  r3
    SEQUENCE {
      uraUpdateConfirm-r3
        URAUpdateConfirm-r3-IEs,
      laterNonCriticalExtensions
        SEQUENCE {
          -- Container for additional R99 extensions
          uraUpdateConfirm-r3-add-ext
            BIT STRING OPTIONAL,
          v690NonCriticalExtensions
            SEQUENCE {
              uraUpdateConfirm-v690ext
                URAUpdateConfirm-v690ext-IEs,
              nonCriticalExtensions
                SEQUENCE {} OPTIONAL
            } OPTIONAL
        } OPTIONAL
    },
  later-than-r3
    SEQUENCE {
      rrc-TransactionIdentifier
        RRC-TransactionIdentifier,
      criticalExtensions
        CHOICE {
          r5
            SEQUENCE {
              uraUpdateConfirm-r5
                URAUpdateConfirm-r5-IEs,
              v690NonCriticalExtensions
                SEQUENCE {
                  uraUpdateConfirm-v690ext
                    URAUpdateConfirm-v690ext-IEs,
                  nonCriticalExtensions
                    SEQUENCE {} OPTIONAL
                } OPTIONAL
            },
          criticalExtensions
            CHOICE {
              r7
                SEQUENCE {
                  uraUpdateConfirm-r7
                    URAUpdateConfirm-r7-IEs,
                  -- Container for adding non critical extensions after freezing REL-8
                  uraUpdateConfirm-r7-add-ext
                    BIT STRING OPTIONAL,
                  v860NonCriticalExtensions
                    SEQUENCE {
                      uraUpdateConfirm-v860ext
                        URAUpdateConfirm-v860ext-IEs,
                      nonCriticalExtensions
                        SEQUENCE {} OPTIONAL
                    } OPTIONAL
                },
              criticalExtensions
                SEQUENCE {}
            }
        }
    }
}

URAUUpdateConfirm-r3-IEs ::= SEQUENCE {
  -- User equipment IEs
  rrc-TransactionIdentifier
    RRC-TransactionIdentifier,
  integrityProtectionModeInfo
    IntegrityProtectionModeInfo OPTIONAL,
  cipheringModeInfo
    CipheringModeInfo OPTIONAL,
  new-U-RNTI
    U-RNTI OPTIONAL,
  new-C-RNTI
    C-RNTI OPTIONAL,
  rrc-StateIndicator
    RRC-StateIndicator,
  utran-DRX-CycleLengthCoeff
    UTRAN-DRX-CycleLengthCoefficient OPTIONAL,
  -- CN information elements
  cn-InformationInfo
    CN-InformationInfo OPTIONAL,
  -- UTRAN mobility IEs
  ura-Identity
    URA-Identity OPTIONAL,
  -- Radio bearer IEs
  dl-CounterSynchronisationInfo
    DL-CounterSynchronisationInfo OPTIONAL
}

URAUUpdateConfirm-r5-IEs ::= SEQUENCE {
  -- User equipment IEs
  integrityProtectionModeInfo
    IntegrityProtectionModeInfo OPTIONAL,
  cipheringModeInfo
    CipheringModeInfo OPTIONAL,
  new-U-RNTI
    U-RNTI OPTIONAL,
  new-C-RNTI
    C-RNTI OPTIONAL,
  rrc-StateIndicator
    RRC-StateIndicator,
  utran-DRX-CycleLengthCoeff
    UTRAN-DRX-CycleLengthCoefficient OPTIONAL,
  -- CN information elements
  cn-InformationInfo
    CN-InformationInfo OPTIONAL,
  -- UTRAN mobility IEs
  ura-Identity
    URA-Identity OPTIONAL,
  -- Radio bearer IEs
  dl-CounterSynchronisationInfo
    DL-CounterSynchronisationInfo-r5 OPTIONAL
}

```

```

URAUUpdateConfirm-v690ext-IEs ::= SEQUENCE {
  -- Core network IEs
  primary-plmn-Identity          PLMN-Identity          OPTIONAL
}

URAUUpdateConfirm-r7-IEs ::= SEQUENCE {
  -- User equipment IEs
  integrityProtectionModeInfo    IntegrityProtectionModeInfo-r7    OPTIONAL,
  cipheringModeInfo              CipheringModeInfo-r7              OPTIONAL,
  new-U-RNTI                     U-RNTI                          OPTIONAL,
  new-C-RNTI                     C-RNTI                          OPTIONAL,
  rrc-StateIndicator             RRC-StateIndicator,
  utran-DRX-CycleLengthCoeff     UTRAN-DRX-CycleLengthCoefficient-r7 OPTIONAL,
  -- CN information elements
  cn-InformationInfo             CN-InformationInfo              OPTIONAL,
  primary-plmn-Identity          PLMN-Identity                  OPTIONAL,
  -- UTRAN mobility IEs
  ura-Identity                   URA-Identity                    OPTIONAL,
  supportForChangeOfUE-Capability BOOLEAN                      OPTIONAL,
  -- Radio bearer IEs
  dl-CounterSynchronisationInfo DL-CounterSynchronisationInfo-r5 OPTIONAL
}

URAUUpdateConfirm-v860ext-IEs ::= SEQUENCE {
  -- User equipment IEs
  new-H-RNTI                     H-RNTI                          OPTIONAL,
  newPrimary-E-RNTI              E-RNTI                          OPTIONAL,
  -- Specification mode information
  -- dummy is not used in this version of the specification, it should
  -- not be sent and if received UE behaviour is unspecified.
  dummy                           DefaultConfigForCellFACH        OPTIONAL
}

-- *****
--
-- URA UPDATE CONFIRM for CCCH
--
-- *****

URAUUpdateConfirm-CCCH ::= CHOICE {
  r3                               SEQUENCE {
    uraUpdateConfirm-CCCH-r3      URAUpdateConfirm-CCCH-r3-IEs,
    laterNonCriticalExtensions    SEQUENCE {
      -- Container for additional R99 extensions
      uraUpdateConfirm-CCCH-r3-add-ext BIT STRING          OPTIONAL,
      v690NonCriticalExtensions    SEQUENCE {
        uraUpdateConfirm-v690ext    URAUpdateConfirm-v690ext-IEs,
        v860NonCriticalExtensions   SEQUENCE {
          uraUpdateConfirm-v860ext  URAUpdateConfirm-v860ext-IEs,
          nonCriticalExtensions     SEQUENCE {}          OPTIONAL
        }
      }
    }
  } OPTIONAL
},
  later-than-r3                   SEQUENCE {
    u-RNTI                        U-RNTI,
    rrc-TransactionIdentifier      RRC-TransactionIdentifier,
    criticalExtensions             SEQUENCE {}
  }
}

URAUUpdateConfirm-CCCH-r3-IEs ::= SEQUENCE {
  -- User equipment IEs
  u-RNTI                          U-RNTI,
  -- The rest of the message is identical to the one sent on DCCH.
  uraUpdateConfirm                URAUpdateConfirm-r3-IEs
}

-- *****
--
-- UTRAN MOBILITY INFORMATION
--
-- *****

UTRANMobilityInformation ::= CHOICE {
  r3                               SEQUENCE {
    utranMobilityInformation-r3    UTRANMobilityInformation-r3-IEs,
    v3a0NonCriticalExtensions      SEQUENCE {

```

```

    utranMobilityInformation-v3a0ext    UTRANMobilityInformation-v3a0ext-IEs,
    laterNonCriticalExtensions          SEQUENCE {
      -- Container for additional R99 extensions
      utranMobilityInformation-r3-add-ext    BIT STRING        OPTIONAL,
      v690NonCriticalExtensions            SEQUENCE {
        utranMobilityInformation-v690ext    UtranMobilityInformation-v690ext-IEs,
        v860NonCriticalExtensions          SEQUENCE {
          utranMobilityInformation-v860ext    UTRANMobilityInformation-v860ext1-IEs,
          nonCriticalExtensions              SEQUENCE {}        OPTIONAL
        }
      }
    }
  }
},
later-than-r3                          SEQUENCE {
  rrc-TransactionIdentifier              RRC-TransactionIdentifier,
  criticalExtensions                      CHOICE {
    r5                                    SEQUENCE {
      utranMobilityInformation-r5          UTRANMobilityInformation-r5-IEs,
      v690NonCriticalExtensions            SEQUENCE {
        utranMobilityInformation-v690ext    UtranMobilityInformation-v690ext-IEs,
        v860NonCriticalExtentions          SEQUENCE {
          utranMobilityInformation-v860ext    UTRANMobilityInformation-v860ext1-IEs,
          nonCriticalExtensions              SEQUENCE {}        OPTIONAL
        }
      }
    }
  }
},
criticalExtensions                      CHOICE {
  r7                                    SEQUENCE {
    utranMobilityInformation-r7            UTRANMobilityInformation-r7-IEs,
    -- Container for adding non critical extensions after freezing REL-8
    utranMobilityInformation-r7-add-ext    BIT STRING        OPTIONAL,
    v860NonCriticalExtensions              SEQUENCE {
      utranMobilityInformation-v860ext      UTRANMobilityInformation-v860ext2-IEs,
      nonCriticalExtensions                  SEQUENCE {}        OPTIONAL
    }
  }
},
criticalExtensions                      SEQUENCE {}
}
}
}

UTRANMobilityInformation-r3-IEs ::= SEQUENCE {
  -- User equipment IEs
  rrc-TransactionIdentifier              RRC-TransactionIdentifier,
  integrityProtectionModeInfo            IntegrityProtectionModeInfo    OPTIONAL,
  cipheringModeInfo                      CipheringModeInfo                OPTIONAL,
  new-U-RNTI                              U-RNTI                          OPTIONAL,
  new-C-RNTI                              C-RNTI                          OPTIONAL,
  ue-ConnTimersAndConstants                UE-ConnTimersAndConstants        OPTIONAL,
  -- CN information elements
  cn-InformationInfo                      CN-InformationInfoFull           OPTIONAL,
  -- UTRAN mobility IEs
  ura-Identity                            URA-Identity                     OPTIONAL,
  -- Radio bearer IEs
  dl-CounterSynchronisationInfo          DL-CounterSynchronisationInfo    OPTIONAL,
  -- Extension mechanism for non- release99 information
  nonCriticalExtensions                    SEQUENCE {}                      OPTIONAL
}

UTRANMobilityInformation-v3a0ext-IEs ::= SEQUENCE {
  ue-ConnTimersAndConstants-v3a0ext      UE-ConnTimersAndConstants-v3a0ext
}

UTRANMobilityInformation-r5-IEs ::= SEQUENCE {
  -- User equipment IEs
  integrityProtectionModeInfo            IntegrityProtectionModeInfo        OPTIONAL,
  cipheringModeInfo                      CipheringModeInfo                  OPTIONAL,
  new-U-RNTI                              U-RNTI                            OPTIONAL,
  new-C-RNTI                              C-RNTI                            OPTIONAL,
  ue-ConnTimersAndConstants                UE-ConnTimersAndConstants-r5      OPTIONAL,
  -- CN information elements
  cn-InformationInfo                      CN-InformationInfoFull             OPTIONAL,
  -- UTRAN mobility IEs
  ura-Identity                            URA-Identity                       OPTIONAL,
  -- Radio bearer IEs
  dl-CounterSynchronisationInfo          DL-CounterSynchronisationInfo-r5  OPTIONAL
}

```

```

}

UtranMobilityInformation-v690ext-IEs ::= SEQUENCE {
  -- Core network IEs
  primary-plmn-Identity          PLMN-Identity          OPTIONAL
}

UTRANMobilityInformation-r7-IEs ::= SEQUENCE {
  -- User equipment IEs
  integrityProtectionModeInfo    IntegrityProtectionModeInfo-r7    OPTIONAL,
  cipheringModeInfo              CipheringModeInfo-r7              OPTIONAL,
  new-U-RNTI                      U-RNTI                      OPTIONAL,
  new-C-RNTI                      C-RNTI                      OPTIONAL,
  new-H-RNTI                      H-RNTI                      OPTIONAL,
  ue-ConnTimersAndConstants      UE-ConnTimersAndConstants-r5    OPTIONAL,
  -- CN information elements
  cn-InformationInfo              CN-InformationInfoFull          OPTIONAL,
  primary-plmn-Identity          PLMN-Identity          OPTIONAL,
  -- UTRAN mobility IEs
  ura-Identity                    URA-Identity                    OPTIONAL,
  supportForChangeOfUE-Capability BOOLEAN              OPTIONAL,
  -- Radio bearer IEs
  dl-CounterSynchronisationInfo  DL-CounterSynchronisationInfo-r5  OPTIONAL
}

UTRANMobilityInformation-v860ext1-IEs ::= SEQUENCE {
  -- User equipment IEs
  -- UE shall take into account the following ue-ConnTimersAndConstants
  -- only when ue-ConnTimersAndConstants IE is present in
  -- UTRANMobilityInformation-r3-IEs or UTRANMobilityInformation-r5-IEs.
  -- Otherwise, UE shall discard it.
  ue-ConnTimersAndConstants      UE-ConnTimersAndConstants-v860ext
}

UTRANMobilityInformation-v860ext2-IEs ::= SEQUENCE {
  -- User equipment IEs
  newPrimary-E-RNTI              E-RNTI                      OPTIONAL,
  -- UE shall take into account the following ue-ConnTimersAndConstants
  -- only when ue-ConnTimersAndConstants IE is present in
  -- UTRANMobilityInformation-r7-IEs. Otherwise, UE shall discard it.
  ue-ConnTimersAndConstants      UE-ConnTimersAndConstants-v860ext,
  -- UTRAN Mobility IEs
  dedicatedPriorityInformation    DedicatedPriorityInformation    OPTIONAL
}

-- *****
--
-- UTRAN MOBILITY INFORMATION CONFIRM
--
-- *****

UTRANMobilityInformationConfirm ::= SEQUENCE {
  -- User equipment IEs
  rrc-TransactionIdentifier      RRC-TransactionIdentifier,
  ul-IntegProtActivationInfo     IntegrityProtActivationInfo    OPTIONAL,
  -- Radio bearer IEs
  count-C-ActivationTime        ActivationTime                  OPTIONAL,
  -- dummy is not used in this version of the specification and
  -- it should be ignored by the receiver.
  dummy                          RB-ActivationTimeInfoList      OPTIONAL,
  ul-CounterSynchronisationInfo  UL-CounterSynchronisationInfo  OPTIONAL,
  laterNonCriticalExtensions     SEQUENCE {
    -- Container for additional R99 extensions
    utranMobilityInformationConfirm-r3-add-ext    BIT STRING    OPTIONAL,
    v770NonCriticalExtension                     SEQUENCE {
      utranMobilityInformationConfirm-v770ext
    }
  }
  nonCriticalExtensions          UTRANMobilityInformationConfirm-v770ext-IEs,
  } OPTIONAL
}

UTRANMobilityInformationConfirm-v770ext-IEs ::= SEQUENCE {
  deferredMeasurementControlReading  ENUMERATED { true }    OPTIONAL
}

-- *****
--

```

```

-- UTRAN MOBILITY INFORMATION FAILURE
--
-- *****
UTRANMobilityInformationFailure ::= SEQUENCE {
  -- UE information elements
  rrc-TransactionIdentifier      RRC-TransactionIdentifier,
  failureCause                   FailureCauseWithProtErr,
  laterNonCriticalExtensions     SEQUENCE {
    -- Container for additional R99 extensions
    utranMobilityInformationFailure-r3-add-ext  BIT STRING  OPTIONAL,
    nonCriticalExtensions             SEQUENCE {}    OPTIONAL
  }  OPTIONAL
}

-- *****
--
-- MBMS ACCESS INFORMATION
--
-- *****

MBMSAccessInformation ::= SEQUENCE {
  -- Access Information IEs
  mbms-ServiceAccessInfoList      MBMS-ServiceAccessInfoList-r6,
  -- Non critical extensions
  nonCriticalExtensions            SEQUENCE {}    OPTIONAL
}

-- *****
--
-- MBMS COMMON PTM RB INFORMATION
--
-- *****

MBMSCommonPTMRBInformation ::= SEQUENCE {
  -- Common PTM RB Information IEs
  mbms-CommonRBInformationList     MBMS-CommonRBInformationList-r6,
  mbms-TranspChInfoForEachTrCh     MBMS-TranspChInfoForEachTrCh-r6,
  mbms-TranspChInfoForEachCCTrCh   MBMS-TranspChInfoForEachCCTrCh-r6  OPTIONAL,
  -- For FDD and TDD 3.84Mcps in a cell operating in MBSFN only mode and for TDD 7.68Mcps the
  -- IE mbms-PhyChInformationList shall be ignored.
  mbms-PhyChInformationList        MBMS-PhyChInformationList-r6,
  -- Non critical extensions
  v770NonCriticalExtensions        SEQUENCE {
    mbmsCommonPTMRBInformation-v770ext
                                MBMSCommonPTMRBInformation-v770ext-IEs,
    v780NonCriticalExtensions      SEQUENCE {
      mbmsCommonPTMRBInformation-v780ext
                                MBMSCommonPTMRBInformation-v780ext-IEs,
      v860NonCriticalExtensions    SEQUENCE {
        mbmsCommonPTMRBInformation-v860ext
                                MBMSCommonPTMRBInformation-v860ext-IEs,
        nonCriticalExtensions      SEQUENCE {}    OPTIONAL
      }  OPTIONAL
    }  OPTIONAL
  }  OPTIONAL
}

MBMSCommonPTMRBInformation-v770ext-IEs ::= SEQUENCE {
  -- TABULAR: CHOICE mode == "FDD or TDD"
  mbms-PhyChInformationList-r7     MBMS-PhyChInformationList-r7  OPTIONAL
}

MBMSCommonPTMRBInformation-v780ext-IEs ::= SEQUENCE {
  mbsfn-TDDInformation-LCR         MBSFN-TDDInformation-LCR  OPTIONAL
}

MBMSCommonPTMRBInformation-v860ext-IEs ::= SEQUENCE {
  -- TABULAR: CHOICE mode == "3.84 Mcps TDD IMB"
  mbms-PhyChInformationList        MBMS-PhyChInformationList-IMB384  OPTIONAL
}

-- *****
--
-- MBMS CURRENT CELL PTM RB INFORMATION
--
-- *****

```



```

MBMSCurrentCellPTMRBInformation ::= SEQUENCE {
  -- Current Cell PTM RB Information IES
  mbms-CurrentCell-SCCPCHList      MBMS-CurrentCell-SCCPCHList-r6      OPTIONAL,
  mbms-SIBType5-SCCPCHList        MBMS-SIBType5-SCCPCHList-r6      OPTIONAL,
  -- Non critical extensions
  v770NonCriticalExtensions        SEQUENCE {
    mbmsCurrentCellPTMRBInfo-v770ext
    nonCriticalExtensions          SEQUENCE {}      OPTIONAL
  }
  OPTIONAL
}

MBMSCurrentCellPTMRBInfo-v770ext-IEs ::= SEQUENCE {
  mbsfn-TDM-Info-List              MBSFN-TDM-Info-List              OPTIONAL
}

-- *****
--
-- MBMS GENERAL INFORMATION
--
-- *****

MBMSGeneralInformation ::= SEQUENCE {
  -- MBMS General Information IES
  mbms-PreferredFrequencyInfo      MBMS-PreferredFrequencyList-r6    OPTIONAL,
  mbms-TimersAndCounters           MBMS-TimersAndCounters-r6,
  michConfigurationInfo            MBMS-MICHConfigurationInfo-r6,
  cellGroupIdentity                MBMS-CellGroupIdentity-r6,
  mschDefaultConfigurationInfo     MBMS-MSCH-ConfigurationInfo-r6    OPTIONAL,
  -- Non critical extensions
  v6b0NonCriticalExtensions        SEQUENCE {
    mbmsGeneralInformation-v6b0ext  MBMSGeneralInformation-v6b0ext-IEs,
    v770NonCriticalExtensions       SEQUENCE {
      mbmsGeneralInformation-v770ext MBMSGeneralInformation-v770ext-IEs,
      v860NonCriticalExtensions     SEQUENCE {
        mbmsGeneralInformation-v860ext MBMSGeneralInformation-v860ext-IEs,
        v890NonCriticalExtensions    SEQUENCE {
          mbmsGeneralInformation-v890ext MBMSGeneralInformation-v890ext-IEs,
          nonCriticalExtensions      SEQUENCE {}      OPTIONAL
        }
        OPTIONAL
      }
      OPTIONAL
    }
    OPTIONAL
  }
  OPTIONAL
}

MBMSGeneralInformation-v6b0ext-IEs ::= SEQUENCE {
  indicateChangeInSelectedServices  BOOLEAN
}

MBMSGeneralInformation-v770ext-IEs ::= SEQUENCE {
  mbmsMICHConfiguration            MBMS-MICHConfigurationInfo-v770ext  OPTIONAL,
  mbsfnInterFrequencyNeighbourList MBSFN-InterFrequencyNeighbourList-r7  OPTIONAL
}

MBMSGeneralInformation-v860ext-IEs ::= SEQUENCE {
  mbsfnInterFrequencyNeighbourList MBSFN-InterFrequencyNeighbourList-v860ext  OPTIONAL
}

MBMSGeneralInformation-v890ext-IEs ::= SEQUENCE {
  mbmsNetworkStandardTimeInformation-LCR
  mbmsMICHConfiguration            MBMS-NetworkStandardTimeInformation-LCR-v890ext  OPTIONAL,
  MBMS-MICHConfigurationInfo-v890ext  OPTIONAL
}

-- *****
--
-- MBMS MODIFICATION REQUEST
--
-- *****

MBMSModificationRequest ::= SEQUENCE {
  -- MBMS Modification Request IES
  mbms-PreferredFreqRequest        MBMS-ServiceIdentity-r6          OPTIONAL,
  rb-InformationReleaseList        RB-InformationReleaseList        OPTIONAL,
  -- Non critical extensions
  v6b0NonCriticalExtensions        SEQUENCE {

```

```

        mbmsModificationRequest-v6b0ext MBMSModificationRequest-v6b0ext-IEs,
        v6f0NonCriticalExtensions SEQUENCE {
            mbmsModificationRequest-v6f0ext MBMSModificationRequest-v6f0ext-IEs,
            nonCriticalExtensions SEQUENCE {} OPTIONAL
        }
    }
}

MBMSModificationRequest-v6b0ext-IEs ::= SEQUENCE {
    mbmsSelectedServiceInfo MBMS-SelectedServiceInfo
}

MBMSModificationRequest-v6f0ext-IEs ::= SEQUENCE {
    mbmsSupportOfServiceChangeForAPtPRB ENUMERATED { true } OPTIONAL
}

-- *****
--
-- MBMS MODIFIED SERVICES INFORMATION
--
-- *****

MBMSModifiedServicesInformation ::= SEQUENCE {
    -- MBMS Modified Services Information IEs
    modifiedServiceList MBMS-ModifiedServiceList-r6 OPTIONAL,
    mbms-ReacquireMCCH ENUMERATED { true } OPTIONAL,
    mbms-DynamicPersistenceLevel DynamicPersistenceLevel OPTIONAL,
    endOfModifiedMCCHInformation INTEGER (1..16) OPTIONAL,
    mbmsNumberOfNeighbourCells MBMS-NumberOfNeighbourCells-r6,
    mbms-AllUnmodifiedPTMServices ENUMERATED { true } OPTIONAL,
    mbms-PTMActivationTime MBMS-PTMActivationTime-r6 OPTIONAL,
    -- Non critical extensions
    v770NonCriticalExtensions SEQUENCE {
        mbmsModifiedServicesInformation-v770ext
        MBMSModifiedServicesInformation-v770ext-IEs,
    v7c0NonCriticalExtensions SEQUENCE {
        mbmsModifiedServicesInformation-v7c0ext
        MBMSModifiedServicesInformation-v7c0ext-IEs,
        nonCriticalExtensions SEQUENCE {} OPTIONAL
    }
    }
}

MBMSModifiedServicesInformation-v770ext-IEs ::= SEQUENCE {
    modifiedServiceList MBMS-ModifiedServiceList-v770ext OPTIONAL,
    mib-ValueTag MIB-ValueTag OPTIONAL
}

MBMSModifiedServicesInformation-v7c0ext-IEs ::= SEQUENCE {
    modifiedServiceList MBMS-ModifiedServiceList-LCR-v7c0ext OPTIONAL
}

-- *****
--
-- MBMS NEIGHBOURING CELL PTM RB INFORMATION
--
-- *****

MBMSNeighbouringCellPTMRBInformation ::= SEQUENCE {
    -- MBMS Neighbouring Cell PTM RB Information IEs
    neighbouringCellIdentity IntraFreqCellID,
    neighbouringCellSCCPCHList MBMS-NeighbouringCellSCCPCHList-r6,
    -- Non critical extensions
    v770NonCriticalExtensions SEQUENCE {
        mbmsNeighbouringCellPTMRBInformation-v770ext
        MBMSNeighbouringCellPTMRBInformation-v770ext-IEs,
    nonCriticalExtensions SEQUENCE {} OPTIONAL
    }
}

MBMSNeighbouringCellPTMRBInformation-v770ext-IEs ::= SEQUENCE {
    -- The "choice_PhyCH" in the tabular is realized by using the following IE due to the
    -- constraint in the ASN.1 implementation.
    neighbouringCellSCCPCHList MBMS-NeighbouringCellSCCPCHList-v770ext OPTIONAL
}

-- *****

```

```

--
-- MBMS SCHEDULING INFORMATION
--
-- *****
MBMSSchedulingInformation ::= SEQUENCE {
  -- MBMS Scheduling Information IEs
  serviceSchedulingInfoList      MBMS-ServiceSchedulingInfoList-r6,
  -- Non critical extensions
  nonCriticalExtensions           SEQUENCE {}      OPTIONAL
}
--
-- *****
--
-- MBMS UNMODIFIED SERVICES INFORMATION
--
-- *****
MBMSUnmodifiedServicesInformation ::= SEQUENCE {
  -- MBMS Unmodified Services Information IEs
  unmodifiedServiceList          MBMS-UnmodifiedServiceList-r6      OPTIONAL,
  -- Non critical extensions
  v770NonCriticalExtensions      SEQUENCE {
    mbmsUnmodifiedServicesInformation-v770ext
                                MBMSUnmodifiedServicesInformation-v770ext-IEs,
    nonCriticalExtensions         SEQUENCE {}      OPTIONAL
  }
  OPTIONAL
}
MBMSUnmodifiedServicesInformation-v770ext-IEs ::= SEQUENCE {
  unmodifiedServiceList          MBMS-UnmodifiedServiceList-v770ext  OPTIONAL
}
END

```

11.3 Information element definitions

InformationElements DEFINITIONS AUTOMATIC TAGS ::=

BEGIN

IMPORTS

```

  hiPDSCHidentities,
  hiPUSCHidentities,
  hiRM,
  maxAC,
  maxAdditionalMeas,
  maxASC,
  maxASCmap,
  maxASCpersist,
  maxCCTrCH,
  maxCellMeas,
  maxCellMeas-1,
  maxCNdomains,
  maxCommonHRNTI,
  maxCommonQueueID,
  maxCPCHsets,
  maxDedicatedCSGFreq,
  maxDPCH-DLchan,
  maxDPDCH-UL,
  maxDRACclasses,
  maxE-DCHMACdFlow,
  maxE-DCHMACdFlow-1,
  maxEDCHs,
  maxEDCHTxPattern-TDD128,
  maxEDCHTxPattern-TDD128-1,
  maxERNTIgroup,
  maxERNTIperGroup,
  maxERUCCH,
  maxEUTRACellPerFreq,
  maxEUTRATargetFreqs,
  maxFACHPCH,
  maxFreq,
  maxFreqBandsEUTRA,
  maxFreqBandsFDD,
  maxFreqBandsFDD-ext,

```

maxFreqBandsTDD,
maxFreqBandsTDD-ext,
maxFreqBandsGSM,
maxGANSS,
maxGANSS-1,
maxGANSSSat,
maxGANSSSat-1,
maxGERAN-SI,
maxHNBNameSize,
maxHProcesses,
maxHSDSCHTBIndex,
maxHSDSCHTBIndex-tdd384,
maxHSSCCHs,
maxHSSCCHs-1,
maxHSSICH-TDD128,
maxHSSICH-TDD128-1,
maxHS-SCCHLessTrBlk,
maxInterSysMessages,
maxLoCHperRLC,
maxMAC-d-PDUsizes,
maxMBMS-CommonCCTrCh,
maxMBMS-CommonPhyCh,
maxMBMS-CommonRB,
maxMBMS-CommonTrCh,
maxMBMS-Freq,
maxMBMS-L1CP,
maxMBMSservCount,
maxMBMSservModif,
maxMBMSservSched,
maxMBMSservSelect,
maxMBMSservUnmodif,
maxMBMSTransmis,
maxMBSFNclusters,
maxMeasEvent,
maxMeasIntervals,
maxMeasParEvent,
maxNumCDMA2000Freqs,
maxNumE-AGCH,
maxNumE-HICH,
maxNumEUTRAFreqs,
maxNumFDDFreqs,
maxNumGSMCellGroup,
maxNumGSMFreqRanges,
maxGSMTargetCells,
maxNumTDDFreqs,
maxOtherRAT,
maxOtherRAT-16,
maxPage1,
maxPCPCH-APsig,
maxPCPCH-APsubCh,
maxPCPCH-CDsig,
maxPCPCH-CDsubCh,
maxPCPCH-SF,
maxPCPCHs,
maxPDCPAlgoType,
maxPDSCH,
maxPDSCH-TFCIgroups,
maxPRACH,
maxPRACH-FPACH,
maxPredefConfig,
maxPrio,
maxPrio-1,
maxPUSCH,
maxQueueIDs,
maxRABsetup,
maxRAT,
maxRB,
maxRBallRABs,
maxRBperTrCh,
maxRBMuxOptions,
maxRBperRAB,
maxReportedEUTRAFreqs,
maxReportedEUTRACellPerFreq,
maxReportedGSMCells,
maxRLCPDUsizePerLogChan,
maxSRBsetup,
maxRL,
maxRL-1,
maxEDCHRL,

```

maxROHC-PacketSizes-r4,
maxROHC-Profile-r4,
maxRxPatternForHSDSCH-TDD128,
maxRxPatternForHSDSCH-TDD128-1,
maxSat,
maxSatClockModels,
maxSCCPCH,
maxSgnType,
maxSIB,
maxSIB-FACH,
maxSystemCapability,
maxTDD128Carrier,
maxTbsForHSDSCH-TDD128,
maxTbsForHSDSCH-TDD128-1,
maxTF,
maxTF-CPCH,
maxTFC,
maxTFCsub,
maxTFCI-2-Combs,
maxTGPS,
maxTrCH,
maxTrCHpreconf,
maxTS,
maxTS-1,
maxTS-2,
maxTS-LCR,
maxTS-LCR-1,
maxURA,
maxURNТИ-Group
FROM Constant-definitions;

```

```

-- *****
--
-- CORE NETWORK INFORMATION ELEMENTS (10.3.1)
--
-- *****

```

```

Ansi-41-IDNNS ::= BIT STRING (SIZE (14))

CN-DomainIdentity ::= ENUMERATED {
    cs-domain,
    ps-domain }

CN-DomainInformation ::= SEQUENCE {
    cn-DomainIdentity CN-DomainIdentity,
    cn-DomainSpecificNAS-Info NAS-SystemInformationGSM-MAP
}

CN-DomainInformationFull ::= SEQUENCE {
    cn-DomainIdentity CN-DomainIdentity,
    cn-DomainSpecificNAS-Info NAS-SystemInformationGSM-MAP,
    cn-DRX-CycleLengthCoeff CN-DRX-CycleLengthCoefficient
}

CN-DomainInformationList ::= SEQUENCE (SIZE (1..maxCNdomains)) OF
    CN-DomainInformation

CN-DomainInformationListFull ::= SEQUENCE (SIZE (1..maxCNdomains)) OF
    CN-DomainInformationFull

CN-DomainSysInfo ::= SEQUENCE {
    cn-DomainIdentity CN-DomainIdentity,
    cn-Type CHOICE {
        gsm-MAP NAS-SystemInformationGSM-MAP,
        ansi-41 NAS-SystemInformationANSI-41
    },
    cn-DRX-CycleLengthCoeff CN-DRX-CycleLengthCoefficient
}

CN-DomainSysInfoList ::= SEQUENCE (SIZE (1..maxCNdomains)) OF
    CN-DomainSysInfo

CN-InformationInfo ::= SEQUENCE {
    plmn-Identity PLMN-Identity OPTIONAL,
    cn-CommonGSM-MAP-NAS-SysInfo NAS-SystemInformationGSM-MAP OPTIONAL,
    cn-DomainInformationList CN-DomainInformationList OPTIONAL
}

CN-InformationInfo-r6 ::= SEQUENCE {

```

```

    plmn-Identity          PLMN-Identity          OPTIONAL,
    cn-CommonGSM-MAP-NAS-SysInfo  NAS-SystemInformationGSM-MAP  OPTIONAL,
    cn-DomainInformationList      CN-DomainInformationList      OPTIONAL,
    primary-plmn-Identity        PLMN-Identity          OPTIONAL
}

CN-InformationInfoFull ::= SEQUENCE {
    plmn-Identity          PLMN-Identity          OPTIONAL,
    cn-CommonGSM-MAP-NAS-SysInfo  NAS-SystemInformationGSM-MAP  OPTIONAL,
    cn-DomainInformationListFull  CN-DomainInformationListFull  OPTIONAL
}

Digit ::= INTEGER (0..9)

Gsm-map-IDNNS ::= SEQUENCE {
    routingbasis          CHOICE {
        localPTMSI          SEQUENCE {
            routingparameter RoutingParameter
        },
        tMSIofsamePLMN      SEQUENCE {
            routingparameter RoutingParameter
        },
        tMSIofdifferentPLMN SEQUENCE {
            routingparameter RoutingParameter
        },
        iMSIresponsetopaging SEQUENCE {
            routingparameter RoutingParameter
        },
        iMSIcauseUEinitiatedEvent SEQUENCE {
            routingparameter RoutingParameter
        },
        iMEI                SEQUENCE {
            routingparameter RoutingParameter
        },
        spare2              SEQUENCE {
            routingparameter RoutingParameter
        },
        spare1              SEQUENCE {
            routingparameter RoutingParameter
        }
    },
    -- dummy is not used in this version of the specification and
    -- it should be ignored by the receiver.
    dummy                  BOOLEAN
}

IMEI ::= SEQUENCE (SIZE (15)) OF
    IMEI-Digit

IMEI-Digit ::= INTEGER (0..15)

IMSI-GSM-MAP ::= SEQUENCE (SIZE (6..21)) OF
    Digit

IntraDomainNasNodeSelector ::= SEQUENCE {
    version          CHOICE {
        release99    SEQUENCE {
            cn-Type          CHOICE {
                gsm-Map-IDNNS      Gsm-map-IDNNS,
                ansi-41-IDNNS     Ansi-41-IDNNS
            }
        },
        later          SEQUENCE {
            futurecoding      BIT STRING (SIZE (15))
        }
    }
}

LAI ::= SEQUENCE {
    plmn-Identity    PLMN-Identity,
    lac              BIT STRING (SIZE (16))
}

LocationRegistrationAccessClassBarredList ::= SEQUENCE (SIZE (15)) OF
    AccessClassBarred

LocationRegistrationParameters ::= CHOICE {
    noRestriction    NULL,

```

```

    restriction                               LocationRegistrationAccessClassBarredList
}
MCC ::= SEQUENCE (SIZE (3)) OF
        Digit
MNC ::= SEQUENCE (SIZE (2..3)) OF
        Digit
MultiplePLMN-List-r6 ::= SEQUENCE {
    mibPLMN-Identity          BOOLEAN,
    multiplePLMNs             SEQUENCE (SIZE (1..5)) OF
                               PLMN-IdentityWithOptionalMCC-r6
}
NAS-Message ::= OCTET STRING (SIZE (1..4095))
NAS-Synchronisation-Indicator ::= BIT STRING(SIZE(4))
NAS-SystemInformationGSM-MAP ::= OCTET STRING (SIZE (1..8))
P-TMSI-GSM-MAP ::= BIT STRING (SIZE (32))
PagingPermissionWithAccessControlForSharedNetwork ::= CHOICE {
    pagingPermissionWithAccessControlList PagingPermissionWithAccessControlList,
    pagingPermissionWithAccessControlForAll PagingPermissionWithAccessControlParameters
}
PagingPermissionWithAccessControlList ::= SEQUENCE {
    pagingPermissionWithAccessControlParametersForOperator1
        PagingPermissionWithAccessControlParameters OPTIONAL,
    pagingPermissionWithAccessControlParametersForOperator2
        PagingPermissionWithAccessControlParameters OPTIONAL,
    pagingPermissionWithAccessControlParametersForOperator3
        PagingPermissionWithAccessControlParameters OPTIONAL,
    pagingPermissionWithAccessControlParametersForOperator4
        PagingPermissionWithAccessControlParameters OPTIONAL,
    pagingPermissionWithAccessControlParametersForOperator5
        PagingPermissionWithAccessControlParameters OPTIONAL
}
PagingPermissionWithAccessControlParameters ::= SEQUENCE {
    pagingResponseRestrictionIndicator    ENUMERATED {all, cS, pS, none},
    locationRegistrationRestrictionIndicator    ENUMERATED {all, cS, pS},
    locationRegistration                    LocationRegistrationParameters
}
PagingRecordTypeID ::= ENUMERATED {
    imsi-GSM-MAP,
    tmsi-GSM-MAP-P-TMSI,
    imsi-DS-41,
    tmsi-DS-41 }
PLMN-Identity ::= SEQUENCE {
    mcc      MCC,
    mnc      MNC
}
PLMN-IdentityWithOptionalMCC-r6 ::= SEQUENCE {
    mcc      MCC OPTIONAL,
    mnc      MNC
}
PLMN-Type ::= CHOICE {
    gsm-MAP SEQUENCE {
        plmn-Identity    PLMN-Identity
    },
    ansi-41 SEQUENCE {
        p-REV            P-REV,
        min-P-REV        Min-P-REV,
        sid              SID,
        nid              NID
    },
    gsm-MAP-and-ANSI-41 SEQUENCE {
        plmn-Identity    PLMN-Identity,
        p-REV            P-REV,
        min-P-REV        Min-P-REV,
        sid              SID,
    }
}

```

```

        nid                NID
    },
    spare                NULL
}

RAB-Identity ::=
    gsm-MAP-RAB-Identity    CHOICE {
        BIT STRING (SIZE (8)),
        ansi-41-RAB-Identity    BIT STRING (SIZE (8))
    }

RAI ::=
    lai                SEQUENCE {
        LAI,
        rac                RoutingAreaCode
    }

RoutingAreaCode ::=
    BIT STRING (SIZE (8))

RoutingParameter ::=
    BIT STRING (SIZE (10))

TMSI-GSM-MAP ::=
    BIT STRING (SIZE (32))

-- *****
--
--     UTRAN MOBILITY INFORMATION ELEMENTS (10.3.2)
--
-- *****

AccessClassBarred ::=
    ENUMERATED {
        barred, notBarred }

AccessClassBarredList ::=
    SEQUENCE (SIZE (maxAC)) OF
        AccessClassBarred

AllowedIndicator ::=
    ENUMERATED {
        allowed, notAllowed }

CellAccessRestriction ::=
    SEQUENCE {
        cellBarred                CellBarred,
        cellReservedForOperatorUse    ReservedIndicator,
        cellReservationExtension        ReservedIndicator,
        -- NOTE: IE accessClassBarredList should not be included if the IE CellAccessRestriction
        -- is included in the IE SysInfoType4
        accessClassBarredList        AccessClassBarredList                OPTIONAL
    }

CellAccessRestriction-v870ext ::=
    SEQUENCE {
        cellReservedForCSG        ENUMERATED { true }                OPTIONAL
    }

CellBarred ::=
    CHOICE {
        barred                SEQUENCE {
            intraFreqCellReselectionInd        AllowedIndicator,
            t-Barred                T-Barred
        },
        notBarred                NULL
    }

CellIdentity ::=
    BIT STRING (SIZE (28))

CellIdentity-PerRL-List ::=
    SEQUENCE (SIZE (1..maxRL)) OF CellIdentity

CellSelectReselectInfoSIB-3-4 ::=
    SEQUENCE {
        mappingInfo                MappingInfo                OPTIONAL,
        cellSelectQualityMeasure        CHOICE {
            cpich-Ec-N0                SEQUENCE {
                -- Default value for q-HYST-2-S is q-HYST-1-S
                q-HYST-2-S                Q-Hyst-S                OPTIONAL
            },
            cpich-RSCP                NULL
        },
        modeSpecificInfo        CHOICE {
            fdd                SEQUENCE {
                s-Intrasearch                S-SearchQual                OPTIONAL,
                s-Intersearch                S-SearchQual                OPTIONAL,
                s-SearchHCS                S-SearchRXLEV                OPTIONAL,
                rat-List                RAT-FDD-InfoList                OPTIONAL,
                q-QualMin                Q-QualMin,
                q-RxlevMin                Q-RxlevMin
            }
        }
    }

```



```

    },
    tdd
        s-Intrasearch          S-SearchRXLEV          OPTIONAL,
        s-Intersearch         S-SearchRXLEV          OPTIONAL,
        s-SearchHCS           S-SearchRXLEV          OPTIONAL,
        rat-List              RAT-TDD-InfoList          OPTIONAL,
        q-RxlevMin            Q-RxlevMin
    }
},
q-Hyst-l-S                  Q-Hyst-S,
t-Reselection-S           T-Reselection-S,
hcs-ServingCellInformation HCS-ServingCellInformation OPTIONAL,
maxAllowedUL-TX-Power     MaxAllowedUL-TX-Power
}

CSG-DedicatedFrequencyInfoList ::= SEQUENCE (SIZE (1..maxDedicatedCSGFreq)) OF
    FrequencyInfo

CSG-Identity ::=
    BIT STRING (SIZE (27))

CSG-PSCSplitInfo ::=
    SEQUENCE {
        -- Actual value = IE value * 8
        startPSC
            INTEGER (0..63),
        numberOfPSCs
            ENUMERATED { psc5, psc10, psc15, psc20,
                psc30, psc40, psc50, psc64, psc80,
                psc120, psc160, psc256, alltheRest,
                spare3, spare2, spare1 },
        -- Actual value = IE value * 8
        pscRange2Offset
            INTEGER (1..63)
    }

DomainSpecificAccessRestrictionForSharedNetwork-v670ext ::= CHOICE {
    domainSpecificAccessRestrictionList
        DomainSpecificAccessRestrictionList-v670ext,
    domainSpecificAccessRestrictionParametersForAll
        DomainSpecificAccessRestrictionParam-v670ext
}

DomainSpecificAccessRestrictionList-v670ext ::= SEQUENCE {
    domainSpecificAccessRestrictionParametersForOperator1
        DomainSpecificAccessRestrictionParam-v670ext OPTIONAL,
    domainSpecificAccessRestrictionParametersForOperator2
        DomainSpecificAccessRestrictionParam-v670ext OPTIONAL,
    domainSpecificAccessRestrictionParametersForOperator3
        DomainSpecificAccessRestrictionParam-v670ext OPTIONAL,
    domainSpecificAccessRestrictionParametersForOperator4
        DomainSpecificAccessRestrictionParam-v670ext OPTIONAL,
    domainSpecificAccessRestrictionParametersForOperator5
        DomainSpecificAccessRestrictionParam-v670ext OPTIONAL
}

DomainSpecificAccessRestrictionParam-v670ext ::= SEQUENCE {
    csDomainSpecificAccessRestriction
        DomainSpecificAccessRestriction-v670ext,
    psDomainSpecificAccessRestriction
        DomainSpecificAccessRestriction-v670ext
}

DomainSpecificAccessRestriction-v670ext ::= CHOICE {
    noRestriction
        NULL,
    restriction
        SEQUENCE {
            domainSpecficAccessClassBarredList
                AccessClassBarredList OPTIONAL
        }
}

MapParameter ::=
    INTEGER (0..127)

Mapping ::=
    SEQUENCE {
        rat
            RAT,
        mappingFunctionParameterList
            MappingFunctionParameterList
    }

Mapping-LCR-r4 ::=
    SEQUENCE {
        mappingFunctionParameterList
            MappingFunctionParameterList
    }

MappingFunctionParameter ::=
    SEQUENCE {
        functionType
            MappingFunctionType,
        mapParameter1
            MapParameter OPTIONAL,
        mapParameter2
            MapParameter,
        -- The presence of upperLimit is conditional on the number of repetition
    }

```

```

    upperLimit                                UpperLimit                                OPTIONAL
}

MappingFunctionParameterList ::= SEQUENCE (SIZE (1..maxMeasIntervals)) OF
    MappingFunctionParameter

MappingFunctionType ::= ENUMERATED {
    linear,
    functionType2,
    functionType3,
    functionType4 }

-- In MappingInfo list, mapping for FDD and 3.84Mcps TDD is defined.
-- For 1.28Mcps TDD, Mapping-LCR-r4 is used instead.
MappingInfo ::= SEQUENCE (SIZE (1..maxRAT)) OF
    Mapping

OccurrenceSequenceNumberOfPICH ::= INTEGER (1..maxSCCPCH)

DedicatedPriorityInformation ::= SEQUENCE {
    action CHOICE {
        clearDedicatedPriorities NULL,
        configureDedicatedPriorities SEQUENCE {
            t-322 T-322 OPTIONAL,
            priorityLevelList PriorityLevelList OPTIONAL,
            eutraDetection BOOLEAN
        }
    }
}

PriorityLevel ::= SEQUENCE {
    priority INTEGER (0..maxPrio-1) OPTIONAL,
    radioAccessTechnology CHOICE {
        ultraFDD SEQUENCE (SIZE (1..maxNumFDDFreqs)) OF SEQUENCE{
            uarfcn UARFCN
        },
        ultraTDD SEQUENCE (SIZE (1..maxNumTDDFreqs)) OF SEQUENCE{
            uarfcn UARFCN
        },
        eutra SEQUENCE (SIZE (1..maxNumEUTRAFreqs)) OF SEQUENCE{
            earfcn EARFCN
        },
        gsm SEQUENCE {
            gsm-CellGroup GSM-CellGroup
        }
    }
}

PriorityLevelList ::= SEQUENCE (SIZE (1..maxPrio)) OF
    PriorityLevel

-- Actual value Q-Hyst-S = IE value * 2
Q-Hyst-S ::= INTEGER (0..20)

Q-Hyst-S-Fine ::= INTEGER (0..40)

RAT ::= ENUMERATED {
    ultra-FDD,
    ultra-TDD,
    gsm,
    cdma2000 }

RAT-FDD-Info ::= SEQUENCE {
    rat-Identifier RAT-Identifier,
    s-SearchRAT S-SearchQual,
    s-HCS-RAT S-SearchRXLEV OPTIONAL,
    s-Limit-SearchRAT S-SearchQual
}

RAT-FDD-InfoList ::= SEQUENCE (SIZE (1..maxOtherRAT)) OF
    RAT-FDD-Info

RAT-Identifier ::= ENUMERATED {
    gsm, cdma2000 }

RAT-TDD-Info ::= SEQUENCE {
    rat-Identifier RAT-Identifier,
    s-SearchRAT S-SearchRXLEV,

```

```

    s-HCS-RAT                S-SearchRXLEV                OPTIONAL,
    s-Limit-SearchRAT        S-SearchRXLEV
}

RAT-TDD-InfoList ::=
    SEQUENCE (SIZE (1..maxOtherRAT)) OF
        RAT-TDD-Info

ReservedIndicator ::=
    ENUMERATED {
        reserved,
        notReserved }

-- Actual value S-SearchQual = IE value * 2
S-SearchQual ::=
    INTEGER (-16..10)

-- Actual value S-SearchRXLEV = (IE value * 2) + 1
S-SearchRXLEV ::=
    INTEGER (-53..45)

-- Actual value ScalingFactor = IE value * 0.1
SpeedDependentScalingFactor ::=
    INTEGER (0..10)

T-Barred ::=
    ENUMERATED {
        s10, s20, s40, s80,
        s160, s320, s640, s1280 }

T-Reselection-S ::=
    INTEGER (0..31)

-- Actual value T-Reselection-S-Fine = IE value * 0.2
T-Reselection-S-Fine ::=
    INTEGER (0..31)

-- Actual value ScalingFactor = IE value * 0.25
TreselectionScalingFactor ::=
    INTEGER (4..19)

-- For UpperLimit, the used range depends on the RAT used.
UpperLimit ::=
    INTEGER (1..91)

URA-Identity ::=
    BIT STRING (SIZE (16))

URA-IdentityList ::=
    SEQUENCE (SIZE (1..maxURA)) OF
        URA-Identity

-- *****
--
--     USER EQUIPMENT INFORMATION ELEMENTS (10.3.3)
--
-- *****

AccessStratumReleaseIndicator ::=
    ENUMERATED {
        rel-4, rel-5, rel-6, rel-7, rel-8,
        spare11, spare10, spare9, spare8,
        spare7, spare6, spare5, spare4, spare3,
        spare2, spare1 }

-- TABULAR : for ActivationTime, value 'now' always appear as default, and is encoded
-- by absence of the field
ActivationTime ::=
    INTEGER (0..255)

BackoffControlParams ::=
    SEQUENCE {
        n-AP-RetransMax        N-AP-RetransMax,
        n-AccessFails          N-AccessFails,
        nf-BO-NoAICH           NF-BO-NoAICH,
        ns-BO-Busy             NS-BO-Busy,
        nf-BO-AllBusy          NF-BO-AllBusy,
        nf-BO-Mismatch         NF-BO-Mismatch,
        t-CPCH                 T-CPCH
    }

C-RNTI ::=
    BIT STRING (SIZE (16))

CapabilityUpdateRequirement ::=
    SEQUENCE {
        ue-RadioCapabilityFDDUpdateRequirement    BOOLEAN,
        -- ue-RadioCapabilityTDDUpdateRequirement is for 3.84Mcps TDD update requirement
        ue-RadioCapabilityTDDUpdateRequirement    BOOLEAN,
        systemSpecificCapUpdateReqList           SystemSpecificCapUpdateReqList    OPTIONAL
    }

CapabilityUpdateRequirement-r4-ext ::=
    SEQUENCE {
        ue-RadioCapabilityUpdateRequirement-TDD128    BOOLEAN
    }

```

```

CapabilityUpdateRequirement-r4 ::= SEQUENCE {
    ue-RadioCapabilityFDDUpdateRequirement-FDD    BOOLEAN,
    ue-RadioCapabilityTDDUpdateRequirement-TDD384  BOOLEAN,
    ue-RadioCapabilityTDDUpdateRequirement-TDD128  BOOLEAN,
    systemSpecificCapUpdateReqList                SystemSpecificCapUpdateReqList    OPTIONAL
}

CapabilityUpdateRequirement-r5 ::= SEQUENCE {
    ue-RadioCapabilityFDDUpdateRequirement-FDD    BOOLEAN,
    ue-RadioCapabilityTDDUpdateRequirement-TDD384  BOOLEAN,
    ue-RadioCapabilityTDDUpdateRequirement-TDD128  BOOLEAN,
    systemSpecificCapUpdateReqList                SystemSpecificCapUpdateReqList-r5    OPTIONAL
}

CapabilityUpdateRequirement-v770ext ::= SEQUENCE {
}

CapabilityUpdateRequirement-r7 ::= SEQUENCE {
    ue-RadioCapabilityFDDUpdateRequirement-FDD    BOOLEAN,
    ue-RadioCapabilityTDDUpdateRequirement-TDD384  BOOLEAN,
    ue-RadioCapabilityTDDUpdateRequirement-TDD768  BOOLEAN,
    ue-RadioCapabilityTDDUpdateRequirement-TDD128  BOOLEAN,
    systemSpecificCapUpdateReqList                SystemSpecificCapUpdateReqList-r5    OPTIONAL
}

CapabilityUpdateRequirement-v860ext ::= SEQUENCE {
    -- If both IEs are present, the elements in the IE SystemSpecificCapUpdateReqList-r8
    -- shall be appended to the elements in the IE SystemSpecificCapUpdateReqList
    systemSpecificCapUpdateReqList                SystemSpecificCapUpdateReqList-r8    OPTIONAL
}

CapabilityUpdateRequirement-r8 ::= SEQUENCE {
    ue-RadioCapabilityFDDUpdateRequirement-FDD    BOOLEAN,
    ue-RadioCapabilityTDDUpdateRequirement-TDD384  BOOLEAN,
    ue-RadioCapabilityTDDUpdateRequirement-TDD768  BOOLEAN,
    ue-RadioCapabilityTDDUpdateRequirement-TDD128  BOOLEAN,
    systemSpecificCapUpdateReqList                SystemSpecificCapUpdateReqList-r8    OPTIONAL
}

-- If the IE CellUpdateCause has the value 'cellUpdateCause-ext', the actual value is
-- defined in the IE CellUpdateCause-ext.
CellUpdateCause ::=
    ENUMERATED {
        cellReselection,
        periodicalCellUpdate,
        uplinkDataTransmission,
        utran-pagingResponse,
        re-enteredServiceArea,
        radiolinkFailure,
        rlc-unrecoverableError,
        cellUpdateCause-ext }

-- The IE CellUpdateCause-ext shall be present, if the IE CellUpdateCause has the
-- value 'cellUpdateCause-ext'.
-- dummy is not used in this version of the specification, it should not be sent
-- and if received it should be ignored by the receiver.
CellUpdateCause-ext ::=
    ENUMERATED {
        mbms-Reception,
        mbms-PTP-RB-Request,
        dummy,
        spare1 }

ChipRateCapability ::=
    ENUMERATED {
        mcps3-84, mcps1-28 }

CipheringAlgorithm ::=
    ENUMERATED {
        uea0, uea1 }

CipheringAlgorithm-r7 ::=
    ENUMERATED {
        uea0, uea1, uea2 }

CipheringModeCommand ::=
    CHOICE {
        startRestart
        dummy
        CipheringAlgorithm,
        NULL
    }

```

```

CipheringModeCommand-r7 ::= SEQUENCE {
    startRestart
    CipheringAlgorithm-r7
}

CipheringModeInfo ::= SEQUENCE {
    -- TABULAR: The ciphering algorithm is included in the CipheringModeCommand.
    cipheringModeCommand CipheringModeCommand,
    activationTimeForDPCH ActivationTime OPTIONAL,
    rb-DL-CiphActivationTimeInfo RB-ActivationTimeInfoList OPTIONAL
}

CipheringModeInfo-r7 ::= SEQUENCE {
    -- TABULAR: The ciphering algorithm is included in the CipheringModeCommand.
    cipheringModeCommand CipheringModeCommand-r7,
    activationTimeForDPCH ActivationTime OPTIONAL,
    rb-DL-CiphActivationTimeInfo RB-ActivationTimeInfoList OPTIONAL
}

CN-DRX-CycleLengthCoefficient ::= INTEGER (6..9)

CN-PagedUE-Identity ::= CHOICE {
    imsi-GSM-MAP IMSI-GSM-MAP,
    tmsi-GSM-MAP TMSI-GSM-MAP,
    p-TMSI-GSM-MAP P-TMSI-GSM-MAP,
    imsi-DS-41 IMSI-DS-41,
    tmsi-DS-41 TMSI-DS-41,
    spare3 NULL,
    spare2 NULL,
    spare1 NULL
}

CompressedModeMeasCapability ::= SEQUENCE {
    fdd-Measurements BOOLEAN,
    -- TABULAR: The IEs tdd-Measurements, gsm-Measurements and multiCarrierMeasurements
    -- are made optional since they are conditional based on another information element.
    -- Their absence corresponds to the case where the condition is not true.
    -- The IE 'tdd-Measurements' applies to either or both TDD 3.84 Mcps and TDD 7.68 Mcps,
    -- depending on the RF capability conditions.
    tdd-Measurements BOOLEAN OPTIONAL,
    gsm-Measurements GSM-Measurements OPTIONAL,
    multiCarrierMeasurements BOOLEAN OPTIONAL
}

CompressedModeMeasCapability-LCR-r4 ::= SEQUENCE {
    tdd128-Measurements BOOLEAN OPTIONAL
}

CompressedModeMeasCapability-v860ext ::= SEQUENCE {
    adjacentFrequencyMeasurements ENUMERATED { true } OPTIONAL
}

CompressedModeMeasCapabEUTRA ::= SEQUENCE {
    radioFrequencyBandEUTRA RadioFrequencyBandEUTRA,
    compressedMode BOOLEAN
}

CompressedModeMeasCapabEUTRAList ::= SEQUENCE (SIZE (1..maxFreqBandsEUTRA)) OF
    CompressedModeMeasCapabEUTRA

CompressedModeMeasCapabFDDList ::= SEQUENCE (SIZE (1..maxFreqBandsFDD)) OF
    CompressedModeMeasCapabFDD

CompressedModeMeasCapabFDDList2 ::= SEQUENCE (SIZE (1..maxFreqBandsFDD)) OF
    CompressedModeMeasCapabFDD2

CompressedModeMeasCapabFDDList-ext ::= SEQUENCE (SIZE (1..maxFreqBandsFDD)) OF
    CompressedModeMeasCapabFDD-ext

CompressedModeMeasCapabFDD ::= SEQUENCE {
    radioFrequencyBandFDD RadioFrequencyBandFDD OPTIONAL,
    dl-MeasurementsFDD BOOLEAN,
    ul-MeasurementsFDD BOOLEAN
}

CompressedModeMeasCapabFDD2 ::= SEQUENCE {
    -- UE may omit both IEs if this IE indicates the compressed mode capability within the same
    -- frequency band. Otherwise, the UE shall include either one of the following OPTIONAL IEs.
    radioFrequencyBandFDD RadioFrequencyBandFDD OPTIONAL,

```

```

    radioFrequencyBandFDD2          RadioFrequencyBandFDD2  OPTIONAL,
    dl-MeasurementsFDD              BOOLEAN,
    ul-MeasurementsFDD              BOOLEAN
}

CompressedModeMeasCapabFDD-ext ::= SEQUENCE {
    radioFrequencyBandFDD2          RadioFrequencyBandFDD2,
    dl-MeasurementsFDD              BOOLEAN,
    ul-MeasurementsFDD              BOOLEAN
}

CompressedModeMeasCapabTDDList ::= SEQUENCE (SIZE (1..maxFreqBandsTDD)) OF
    CompressedModeMeasCapabTDD

CompressedModeMeasCapabTDD ::= SEQUENCE {
    radioFrequencyBandTDD          RadioFrequencyBandTDD,
    dl-MeasurementsTDD             BOOLEAN,
    ul-MeasurementsTDD             BOOLEAN
}

CompressedModeMeasCapabGSMList ::= SEQUENCE (SIZE (1..maxFreqBandsGSM)) OF
    CompressedModeMeasCapabGSM

CompressedModeMeasCapabGSM ::= SEQUENCE {
    radioFrequencyBandGSM          RadioFrequencyBandGSM,
    dl-MeasurementsGSM             BOOLEAN,
    ul-MeasurementsGSM             BOOLEAN
}

CompressedModeMeasCapabMC ::= SEQUENCE {
    dl-MeasurementsMC              BOOLEAN,
    ul-MeasurementsMC              BOOLEAN
}

CPCH-Parameters ::= SEQUENCE {
    initialPriorityDelayList        InitialPriorityDelayList          OPTIONAL,
    backoffControlParams            BackoffControlParams,
    -- TABULAR: TPC step size nested inside PowerControlAlgorithm
    powerControlAlgorithm           PowerControlAlgorithm,
    dl-DPCCH-BER                    DL-DPCCH-BER
}

DL-CapabilityWithSimultaneousHS-DSCHConfig ::= ENUMERATED{kbps32, kbps64, kbps128, kbps384}

DL-DPCCH-BER ::= INTEGER (0..63)

DL-PhysChCapabilityFDD ::= SEQUENCE {
    -- The IE "maxNoDPCH-PDSCH-Codes" only gives information on the maximum number of DPCH Codes.
    maxNoDPCH-PDSCH-Codes          INTEGER (1..8),
    maxNoPhysChBitsReceived        MaxNoPhysChBitsReceived,
    supportForSF-512                BOOLEAN,
    -- dummy and dummy2 are not used in this version of the specification
    -- and if received they should be ignored.
    dummy                            BOOLEAN,
    dummy2                            SimultaneousSCCPCH-DPCH-Reception
}

DL-PhysChCapabilityFDD-v380ext ::= SEQUENCE {
    -- dummy is not used in this version of the specification, it should
    -- not be sent and if received it should be ignored.
    dummy                            SupportOfDedicatedPilotsForChEstimation  OPTIONAL
}

SupportOfDedicatedPilotsForChEstimation ::= ENUMERATED { true }

DL-PhysChCapabilityFDD-v770ext ::= SEQUENCE {
    hsdSCH-physical-layer-category-ext  HSDSCH-physical-layer-category-ext  OPTIONAL,
    hsscchlessHsdSCHoperation            ENUMERATED { true }                OPTIONAL,
    enhancedFdpch                        ENUMERATED { true }                OPTIONAL,
    hsdSCHReception-CellFach             ENUMERATED { true }                OPTIONAL,
    hsdSCHReception-CellUraPch          ENUMERATED { true }                OPTIONAL
}

DL-PhysChCapabilityFDD-v860ext ::= SEQUENCE {
    hsdSCH-physical-layer-category-ext2  HSDSCH-physical-layer-category-ext2  OPTIONAL,
    supportOfTargetCellPreConfig         ENUMERATED { true }                OPTIONAL,
    supportOfHsdSCHDrxOperation          ENUMERATED { true }                OPTIONAL
}

```

```

DL-PhysChCapabilityTDD ::= SEQUENCE {
    maxTS-PerFrame           MaxTS-PerFrame,
    maxPhysChPerFrame       MaxPhysChPerFrame,
    minimumSF               MinimumSF-DL,
    supportOfPDSCH          BOOLEAN,
    maxPhysChPerTS         MaxPhysChPerTS
}

DL-PhysChCapabilityTDD-LCR-r4 ::= SEQUENCE {
    maxTS-PerSubFrame       MaxTS-PerSubFrame-r4,
    maxPhysChPerSubFrame   MaxPhysChPerSubFrame-r4,
    minimumSF               MinimumSF-DL,
    supportOfPDSCH          BOOLEAN,
    maxPhysChPerTS         MaxPhysChPerTS,
    supportOf8PSK           BOOLEAN
}

DL-PhysChCapabilityTDD-128-v770ext ::= SEQUENCE {
    multiCarrier-physical-layer-category MultiCarrier-HSDSCH-physical-layer-category OPTIONAL
}

DL-PhysChCapabilityTDD-128-v860ext ::= SEQUENCE {
    hSDSCH-physical-layer-category-extension HSDSCH-physical-layer-category-extension OPTIONAL,
    multiCarrier-physical-layer-category-extension MultiCarrier-HSDSCH-physical-layer-category-extension OPTIONAL,
    supportOfSFModeForHSPDSCHDualStream ENUMERATED { sf1, sf1sf16 } OPTIONAL
}

DL-PhysChCapabilityTDD-768 ::= SEQUENCE {
    maxTS-PerFrame           MaxTS-PerFrame,
    maxPhysChPerFrame       MaxPhysChPerFrame-768,
    minimumSF               MinimumSF-DL-768,
    supportOfPDSCH          BOOLEAN,
    tdd768-hspdsch          CHOICE {
        supported           HSDSCH-physical-layer-category,
        unsupported         NULL
    },
    maxPhysChPerTS         MaxPhysChPerTS-768
}

DL-PhysChCapabilityInfoTDD-768 ::= SEQUENCE {
    maxTS-PerFrame           MaxTS-PerFrame,
    maxPhysChPerFrame       MaxPhysChPerFrame-768,
    minimumSF               MinimumSF-DL-768,
    supportOfPDSCH          BOOLEAN,
    maxPhysChPerTS         MaxPhysChPerTS-768
}

DL-TransChCapability ::= SEQUENCE {
    maxNoBitsReceived       MaxNoBits,
    maxConvCodeBitsReceived MaxNoBits,
    turboDecodingSupport    TurboSupport,
    maxSimultaneousTransChs MaxSimultaneousTransChsDL,
    maxSimultaneousCCTrCH-Count MaxSimultaneousCCTrCH-Count,
    maxReceivedTransportBlocks MaxTransportBlocksDL,
    maxNumberOfTFC          MaxNumberOfTFC-DL,
    maxNumberOfTF           MaxNumberOfTF
}

DRAC-SysInfo ::= SEQUENCE {
    transmissionProbability TransmissionProbability,
    maximumBitRate         MaximumBitRate
}

DRAC-SysInfoList ::= SEQUENCE (SIZE (1..maxDRACclasses)) OF
    DRAC-SysInfo

DSCH-RNTI ::= BIT STRING (SIZE (16))

DelayRestrictionFlag ::= ENUMERATED { true }

E-RNTI ::= BIT STRING (SIZE (16))

ESN-DS-41 ::= BIT STRING (SIZE (32))

EstablishmentCause ::= ENUMERATED {

```

```

        originatingConversationalCall,
        originatingStreamingCall,
        originatingInteractiveCall,
        originatingBackgroundCall,
        originatingSubscribedTrafficCall,
        terminatingConversationalCall,
        terminatingStreamingCall,
        terminatingInteractiveCall,
        terminatingBackgroundCall,
        emergencyCall,
        interRAT-CellReselection,
        interRAT-CellChangeOrder,
        registration,
        detach,
        originatingHighPrioritySignalling,
        originatingLowPrioritySignalling,
        callRe-establishment,
        terminatingHighPrioritySignalling,
        terminatingLowPrioritySignalling,
        terminatingCauseUnknown,
        mbms-Reception,
        mbms-PTP-RB-Request,
        spare10,
        spare9,
        spare8,
        spare7,
        spare6,
        spare5,
        spare4,
        spare3,
        spare2,
        spare1 }

FailureCauseWithProtErr ::= CHOICE {
    configurationUnsupported          NULL,
    physicalChannelFailure           NULL,
    incompatibleSimultaneousReconfiguration
                                     NULL,
    compressedModeRuntimeError       TGPSI,
    protocolError                    ProtocolErrorInformation,
    cellUpdateOccurred              NULL,
    invalidConfiguration             NULL,
    configurationIncomplete          NULL,
    unsupportedMeasurement           NULL,
    mbmsSessionAlreadyReceivedCorrectly NULL,
    lowerPriorityMBMSService         NULL,
    spare5                           NULL,
    spare4                           NULL,
    spare3                           NULL,
    spare2                           NULL,
    spare1                           NULL
}

FailureCauseWithProtErrTrId ::= SEQUENCE {
    rrc-TransactionIdentifier        RRC-TransactionIdentifier,
    failureCause                     FailureCauseWithProtErr
}

GANSS-Mode ::= ENUMERATED {
    networkBased,
    uEBased,
    both,
    none }

GroupIdentityWithReleaseInformation ::= SEQUENCE {
    rrc-ConnectionReleaseInformation RRC-ConnectionReleaseInformation,
    groupReleaseInformation          GroupReleaseInformation
}

GroupReleaseInformation ::= SEQUENCE {
    uRNTI-Group                      U-RNTI-Group
}

GSM-Measurements ::= SEQUENCE {
    gsm900                            BOOLEAN,
    dcs1800                            BOOLEAN,
    gsm1900                            BOOLEAN
}

```



```

H-RNTI ::= BIT STRING (SIZE (16))

High-MobilityDetected ::= ENUMERATED { high-MobilityDetected }

HSDSCH-physical-layer-category ::= INTEGER (1..64)

HSDSCH-physical-layer-category-ext ::= INTEGER (1..20)

HSDSCH-physical-layer-category-ext2 ::= INTEGER (21..24)

HSDSCH-physical-layer-category-ext3 ::= INTEGER (25..28)

HSDSCH-physical-layer-category-extension ::= INTEGER (1..64)

MultiCarrier-HSDSCH-physical-layer-category ::= INTEGER (1..64)

MultiCarrier-HSDSCH-physical-layer-category-extension ::= INTEGER (1..36)

UESpecificBehaviourInformationIdle ::= BIT STRING (SIZE (4))

UESpecificBehaviourInformationInterRAT ::= BIT STRING (SIZE (8))

IdleIntervalMeasCapabEUTRA ::= SEQUENCE {
    radioFrequencyBandEUTRA      RadioFrequencyBandEUTRA,
    idleInterval                  BOOLEAN
}

IdleIntervalMeasCapabEUTRAList ::= SEQUENCE (SIZE (1..maxFreqBandsEUTRA)) OF
    IdleIntervalMeasCapabEUTRA

IMSI-and-ESN-DS-41 ::= SEQUENCE {
    imsi-DS-41                    IMSI-DS-41,
    esn-DS-41                      ESN-DS-41
}

IMSI-DS-41 ::= OCTET STRING (SIZE (5..7))

InitialPriorityDelayList ::= SEQUENCE (SIZE (1..maxASC)) OF
    NS-IP

InitialUE-Identity ::= CHOICE {
    imsi                            IMSI-GSM-MAP,
    tmsi-and-LAI                    TMSI-and-LAI-GSM-MAP,
    p-TMSI-and-RAI                  P-TMSI-and-RAI-GSM-MAP,
    imei                             IMEI,
    esn-DS-41                        ESN-DS-41,
    imsi-DS-41                       IMSI-DS-41,
    imsi-and-ESN-DS-41              IMSI-and-ESN-DS-41,
    tmsi-DS-41                       TMSI-DS-41
}

IntegrityCheckInfo ::= SEQUENCE {
    messageAuthenticationCode      MessageAuthenticationCode,
    rrc-MessageSequenceNumber      RRC-MessageSequenceNumber
}

IntegrityProtActivationInfo ::= SEQUENCE {
    rrc-MessageSequenceNumberList  RRC-MessageSequenceNumberList
}

IntegrityProtectionAlgorithm ::= ENUMERATED {
    uia1
}

IntegrityProtectionAlgorithm-r7 ::= ENUMERATED {
    uia1, uia2
}

IntegrityProtectionModeCommand ::= CHOICE {
    startIntegrityProtection      SEQUENCE {
        integrityProtInitNumber  IntegrityProtInitNumber
    },
    modify                          SEQUENCE {
        dl-IntegrityProtActivationInfo IntegrityProtActivationInfo
    }
}

IntegrityProtectionModeInfo ::= SEQUENCE {
    -- TABULAR: DL integrity protection activation info and Integrity

```

```

-- protection intialisation number have been nested inside
-- IntegrityProtectionModeCommand.
integrityProtectionModeCommand IntegrityProtectionModeCommand,
integrityProtectionAlgorithm IntegrityProtectionAlgorithm OPTIONAL
}

IntegrityProtectionModeInfo-r7 ::= SEQUENCE {
-- TABULAR: DL integrity protection activation info and Integrity
-- protection intialisation number have been nested inside
-- IntegrityProtectionModeCommand.
integrityProtectionModeCommand IntegrityProtectionModeCommand,
integrityProtectionAlgorithm IntegrityProtectionAlgorithm-r7 OPTIONAL
}

IntegrityProtInitNumber ::= BIT STRING (SIZE (32))

-- dummy is not used in this version of the specification, it should
-- not be sent and if received it should be ignored.
MaxHcContextSpace ::= ENUMERATED {
dummy, by1024, by2048, by4096,
by8192 }

MaxHcContextSpace-r5-ext ::= ENUMERATED {
by16384, by32768, by65536, by131072 }

MaxROHC-ContextSessions-r4 ::= ENUMERATED {
s2, s4, s8, s12, s16, s24, s32, s48,
s64, s128, s256, s512, s1024, s16384 }

MaximumAM-EntityNumberRLC-Cap ::= ENUMERATED {
dummy, am4, am5, am6,
am8, am16, am30 }

-- Actual value MaximumBitRate = IE value * 16
MaximumBitRate ::= INTEGER (0..32)

MaximumRLC-WindowSize ::= ENUMERATED { mws2047, mws4095 }

MaxNoDPDCH-BitsTransmitted ::= ENUMERATED {
b600, b1200, b2400, b4800,
b9600, b19200, b28800, b38400,
b48000, b57600 }

MaxNoBits ::= ENUMERATED {
b640, b1280, b2560, b3840, b5120,
b6400, b7680, b8960, b10240,
b20480, b40960, b81920, b163840 }

MaxNoPhysChBitsReceived ::= ENUMERATED {
dummy, b1200, b2400, b3600,
b4800, b7200, b9600, b14400,
b19200, b28800, b38400, b48000,
b57600, b67200, b76800 }

MaxNoSCCPCH-RL ::= ENUMERATED {
r11 }

MaxNumberOfTF ::= ENUMERATED {
tf32, tf64, tf128, tf256,
tf512, tf1024 }

MaxNumberOfTFC-DL ::= ENUMERATED {
tfc16, tfc32, tfc48, tfc64, tfc96,
tfc128, tfc256, tfc512, tfc1024 }

MaxNumberOfTFC-UL ::= ENUMERATED {
dummy1, dummy2, tfc16, tfc32, tfc48, tfc64,
tfc96, tfc128, tfc256, tfc512, tfc1024 }

-- the values 1 to 4 for MaxPhysChPerFrame are not used in this version of the protocol
MaxPhysChPerFrame ::= INTEGER (1..224)

MaxPhysChPerFrame-768 ::= INTEGER (1..448)

MaxPhysChPerSubFrame-r4 ::= INTEGER (1..96)

MaxPhysChPerTimeslot ::= ENUMERATED {

```

```

        ts1, ts2 }

MaxPhysChPerTimeslot-LCR-r7 ::=      INTEGER (1..4)

-- the values 1 to 4 for MaxPhysChPerTS are not used in this version of the protocol
MaxPhysChPerTS ::=                  INTEGER (1..16)

MaxPhysChPerTS-768 ::=              INTEGER (1..32)

MaxSimultaneousCCTrCH-Count ::=     INTEGER (1..8)

MaxSimultaneousTransChsDL ::=       ENUMERATED {
        e4, e8, e16, e32 }

MaxSimultaneousTransChsUL ::=       ENUMERATED {
        dummy, e4, e8, e16, e32 }

MaxTransportBlocksDL ::=            ENUMERATED {
        tb4, tb8, tb16, tb32, tb48,
        tb64, tb96, tb128, tb256, tb512 }

MaxTransportBlocksUL ::=            ENUMERATED {
        dummy, tb4, tb8, tb16, tb32, tb48,
        tb64, tb96, tb128, tb256, tb512 }

MaxTS-PerFrame ::=                  INTEGER (1..14)

MaxTS-PerSubFrame-r4 ::=            INTEGER (1..6)

-- TABULAR: MeasurementCapability contains dependencies to UE-MultiModeRAT-Capability,
-- the conditional fields have been left mandatory for now.
MeasurementCapability ::=            SEQUENCE {
        downlinkCompressedMode        CompressedModeMeasCapability,
        uplinkCompressedMode          CompressedModeMeasCapability
}

MeasurementCapabilityExt ::=         SEQUENCE{
        compressedModeMeasCapabFDDList    CompressedModeMeasCapabFDDList,
        compressedModeMeasCapabTDDList    CompressedModeMeasCapabTDDList    OPTIONAL,
        compressedModeMeasCapabGSMLList   CompressedModeMeasCapabGSMLList   OPTIONAL,
        compressedModeMeasCapabMC         CompressedModeMeasCapabMC         OPTIONAL
}

MeasurementCapabilityExt2 ::=        SEQUENCE{
        compressedModeMeasCapabFDDList2    CompressedModeMeasCapabFDDList2,
        compressedModeMeasCapabTDDList     CompressedModeMeasCapabTDDList     OPTIONAL,
        compressedModeMeasCapabGSMLList    CompressedModeMeasCapabGSMLList    OPTIONAL,
        compressedModeMeasCapabMC         CompressedModeMeasCapabMC         OPTIONAL
}

MeasurementCapabilityExt3 ::=        SEQUENCE {
        compressedModeMeasCapabEUTRAList    CompressedModeMeasCapabEUTRAList    OPTIONAL
}

MeasurementCapability-r4-ext ::=     SEQUENCE {
        downlinkCompressedMode-LCR          CompressedModeMeasCapability-LCR-r4,
        uplinkCompressedMode-LCR           CompressedModeMeasCapability-LCR-r4
}

MeasurementCapability-v860ext ::=    SEQUENCE {
        downlinkCompressedMode              CompressedModeMeasCapability-v860ext
}

MeasurementCapabilityTDD ::=         SEQUENCE {
        idleIntervalMeasCapabEUTRAList     IdleIntervalMeasCapabEUTRAList     OPTIONAL
}

MessageAuthenticationCode ::=       BIT STRING (SIZE (32))

MinimumSF-DL ::=                     ENUMERATED {
        sf1, sf16 }

MinimumSF-DL-768 ::=                ENUMERATED {
        sf1, sf32 }

MinimumSF-UL ::=                     ENUMERATED {
        sf1, sf2, sf4, sf8, dummy }

```

```

MultiModeCapability ::=
    ENUMERATED {
        tdd, fdd, fdd-tdd }

MultiRAT-Capability ::=
    SEQUENCE {
        supportOfGSM          BOOLEAN,
        supportOfMulticarrier  BOOLEAN
    }

MultiModeRAT-Capability-v590ext ::= SEQUENCE {
    supportOfUTRAN-ToGERAN-NACC  BOOLEAN
}

MultiModeRAT-Capability-v680ext ::= SEQUENCE {
    supportOfHandoverToGAN      ENUMERATED { doesSupportHandoverToGAN }    OPTIONAL
}

MultiModeRAT-Capability-v770ext ::= SEQUENCE {
    supportOfPSHandoverToGAN    ENUMERATED { doesSupportPSHandoverToGAN }  OPTIONAL
}

MultiModeRAT-Capability-v860ext ::= SEQUENCE {
    supportOfEUTRAFDD           ENUMERATED { doesSupportEUTRAFDD }          OPTIONAL,
    supportOfInterRATHOToEUTRAFDD  ENUMERATED { doesSupportInterRATHOToEUTRAFDD }  OPTIONAL,
    supportOfEUTRATDD           ENUMERATED { doesSupportEUTRATDD }          OPTIONAL,
    supportOfInterRATHOToEUTRATDD  ENUMERATED { doesSupportInterRATHOToEUTRATDD }  OPTIONAL,
    eutraFeatureGroupIndicators  BIT STRING (SIZE (4))                      OPTIONAL
}

N-300 ::=
    INTEGER (0..7)

N-301 ::=
    INTEGER (0..7)

N-302 ::=
    INTEGER (0..7)

N-304 ::=
    INTEGER (0..7)

N-308 ::=
    INTEGER (1..8)

N-310 ::=
    INTEGER (0..7)

N-312 ::=
    ENUMERATED {
        s1, s50, s100, s200, s400,
        s600, s800, s1000 }

N-312ext ::=
    ENUMERATED {
        s2, s4, s10, s20 }

N-312-r5 ::=
    ENUMERATED {
        s1, s2, s4, s10, s20,
        s50, s100, s200, s400,
        s600, s800, s1000 }

N-313 ::=
    ENUMERATED {
        s1, s2, s4, s10, s20,
        s50, s100, s200 }

N-315 ::=
    ENUMERATED {
        s1, s50, s100, s200, s400,
        s600, s800, s1000 }

N-315ext ::=
    ENUMERATED {
        s2, s4, s10, s20 }

N-315-r5 ::=
    ENUMERATED {
        s1, s2, s4, s10, s20,
        s50, s100, s200, s400,
        s600, s800, s1000 }

N-AccessFails ::=
    INTEGER (1..64)

N-AP-RetransMax ::=
    INTEGER (1..64)

NetworkAssistedGANSS-Supported-List ::= SEQUENCE (SIZE (1..maxGANSS)) OF SEQUENCE {
    gANSS-Id          ENUMERATED {
        sbas, modernizedGPS, qzss, glonass, spare4,
        spare3, spare2, spare1 }    OPTIONAL,
    gANSS-Mode        GANSS-Mode,
}

```

```

    gANSS-SignalId          GANSS-Signal-Id          OPTIONAL,
    supportForUE-GANSS-TimingOfCellFrames  BOOLEAN,
    supportForUE-GANSS-CarrierPhaseMeasurement  BOOLEAN          OPTIONAL
}

-- Each element in the NetworkAssistedGANSS-Supported-List-v860ext provides extension information
-- to the corresponding element (position) in the NetworkAssistedGANSS-Supported-List
NetworkAssistedGANSS-Supported-List-v860ext ::= SEQUENCE (SIZE (1..maxGANSS)) OF SEQUENCE {
    sbas-Ids                BIT STRING (SIZE (8))          OPTIONAL,
    gANSS-SignalIds        BIT STRING (SIZE (8))          OPTIONAL,
    non-native-AD-choices-supported  ENUMERATED { true }  OPTIONAL
}

NetworkAssistedGPS-Supported ::= ENUMERATED {
    networkBased,
    ue-Based,
    bothNetworkAndUE-Based,
    noNetworkAssistedGPS }

NF-BO-AllBusy ::= INTEGER (0..31)
NF-BO-NoAICH ::= INTEGER (0..31)
NF-BO-Mismatch ::= INTEGER (0..127)
NS-BO-Busy ::= INTEGER (0..63)
NS-IP ::= INTEGER (0..28)

P-TMSI-and-RAI-GSM-MAP ::= SEQUENCE {
    p-TMSI
    rai
}

PagingCause ::= ENUMERATED {
    terminatingConversationalCall,
    terminatingStreamingCall,
    terminatingInteractiveCall,
    terminatingBackgroundCall,
    terminatingHighPrioritySignalling,
    terminatingLowPrioritySignalling,
    terminatingCauseUnknown,
    spare
}

PagingRecord ::= CHOICE {
    cn-Identity          SEQUENCE {
        pagingCause      PagingCause,
        cn-DomainIdentity  CN-DomainIdentity,
        cn-pagedUE-Identity  CN-PagedUE-Identity
    },
    utran-Identity      SEQUENCE {
        u-RNTI            U-RNTI,
        cn-OriginatedPage-connectedMode-UE SEQUENCE {
            pagingCause      PagingCause,
            cn-DomainIdentity  CN-DomainIdentity,
            pagingRecordTypeID  PagingRecordTypeID
        }
    }
} OPTIONAL

PagingRecord2-r5 ::= CHOICE {
    utran-SingleUE-Identity SEQUENCE {
        u-RNTI            U-RNTI,
        cn-OriginatedPage-connectedMode-UE SEQUENCE {
            pagingCause      PagingCause,
            cn-DomainIdentity  CN-DomainIdentity,
            pagingRecordTypeID  PagingRecordTypeID
        }
    } OPTIONAL,
    rrc-ConnectionReleaseInformation  RRC-ConnectionReleaseInformation
},
    utran-GroupIdentity          SEQUENCE ( SIZE (1 .. maxURNTI-Group) ) OF
        GroupIdentityWithReleaseInformation
}

PagingRecordList ::= SEQUENCE (SIZE (1..maxPage1)) OF
    PagingRecord

```

```

PagingRecord2List-r5 ::=          SEQUENCE (SIZE (1..maxPage1)) OF
                                   PagingRecord2-r5

PDCP-Capability ::=              SEQUENCE {
  losslessSRNS-RelocationSupport  BOOLEAN,
  -- If present, the "maxHcContextSpace" in the IE "PDCP-Capability-r5-ext" overrides the
  -- "supported" value in this IE. The value in this IE may be used by a pre-REL-5 UTRAN.
  supportForRfc2507                CHOICE {
    notSupported                    NULL,
    supported                        MaxHcContextSpace
  }
}

PDCP-Capability-r4-ext ::=        SEQUENCE {
  supportForRfc3095                CHOICE {
    notSupported                    NULL,
    supported                        SEQUENCE {
      maxROHC-ContextSessions      MaxROHC-ContextSessions-r4  DEFAULT s16,
      reverseCompressionDepth      INTEGER (0..65535)          DEFAULT 0
    }
  }
}

PDCP-Capability-r5-ext ::=        SEQUENCE {
  supportForRfc3095ContextRelocation  BOOLEAN,
  maxHcContextSpace                    MaxHcContextSpace-r5-ext  OPTIONAL
}

PDCP-Capability-r5-ext2 ::=       SEQUENCE {
  losslessDLRLC-PDUSizeChange        ENUMERATED { true }          OPTIONAL
}

PDCP-Capability-v770ext ::=       SEQUENCE {
  supportForCSVoiceoverHSPA          ENUMERATED { true }          OPTIONAL
}

PhysicalChannelCapability ::=      SEQUENCE {
  fddPhysChCapability                SEQUENCE {
    downlinkPhysChCapability          DL-PhysChCapabilityFDD,
    uplinkPhysChCapability            UL-PhysChCapabilityFDD
  }
  -- tddPhysChCapability describes the 3.84Mcps TDD physical channel capability
  tddPhysChCapability                SEQUENCE {
    downlinkPhysChCapability          DL-PhysChCapabilityTDD,
    uplinkPhysChCapability            UL-PhysChCapabilityTDD
  }
}

PhysicalChannelCapability-v770ext ::= SEQUENCE {
  fddPhysChCapability                SEQUENCE {
    downlinkPhysChCapability          DL-PhysChCapabilityFDD-v770ext,
    uplinkPhysChCapability            UL-PhysChCapabilityFDD-v770ext
  }
  OPTIONAL,
  tddPhysChCapability-384             SEQUENCE {
    -- No TDD384 DL physical channel capability extension
    uplinkPhysChCapability            UL-PhysChCapabilityTDD-384-v770ext
  }
  OPTIONAL,
  tddPhysChCapability-768             SEQUENCE {
    downlinkPhysChCapability          DL-PhysChCapabilityTDD-768,
    uplinkPhysChCapability            UL-PhysChCapabilityTDD-768
  }
  OPTIONAL,
  tddPhysChCapability-128            SEQUENCE {
    downlinkPhysChCapability          DL-PhysChCapabilityTDD-128-v770ext,
    uplinkPhysChCapability            UL-PhysChCapabilityTDD-128-v770ext
  }
  OPTIONAL
}

PhysicalChannelCapability-v860ext ::= SEQUENCE {
  fddPhysChCapability                SEQUENCE {
    downlinkPhysChCapability          DL-PhysChCapabilityFDD-v860ext
  }
  OPTIONAL,
  tddPhysChCapability-128            SEQUENCE {
    downlinkPhysChCapability          DL-PhysChCapabilityTDD-128-v860ext
  }
  OPTIONAL
}

PhysicalChannelCapabilityInfo-v770ext ::= SEQUENCE {
  tddPhysChCapability-768            SEQUENCE {

```

```

        downlinkPhysChCapability          DL-PhysChCapabilityInfoTDD-768,
        uplinkPhysChCapability            UL-PhysChCapabilityTDD
    }
    OPTIONAL,
    tddPhysChCapability-128                SEQUENCE {
        uplinkPhysChCapability            UL-PhysChCapabilityInfoTDD-128-v770ext
    }
    OPTIONAL
}

-- PhysicalChannelCapability-LCR-r4 describes the 1.28Mcps TDD physical channel capability
PhysicalChannelCapability-LCR-r4 ::= SEQUENCE {
    tdd128-PhysChCapability                SEQUENCE {
        downlinkPhysChCapability          DL-PhysChCapabilityTDD-LCR-r4,
        uplinkPhysChCapability            UL-PhysChCapabilityTDD-LCR-r4
    }
    OPTIONAL
}

-- PhysicalChannelCapability-hspdsch-r5 describes the HS-PDSCH physical channel capability
PhysicalChannelCapability-hspdsch-r5 ::= SEQUENCE {
    fdd-hspdsch                            CHOICE {
        supported                          SEQUENCE {
            -- hsdSCH-physical-layer-category values shall be restricted to the range [1..12]
            -- even if the UE physical capability category is above 12.
            hsdSCH-physical-layer-category HSDSCH-physical-layer-category,
            -- dummy and dummy2 are not used in this version of the specification
            -- and if received they should be ignored.
            dummy                           BOOLEAN,
            dummy2                           BOOLEAN
        },
        unsupported                          NULL
    },
    tdd384-hspdsch                          CHOICE {
        supported                          HSDSCH-physical-layer-category,
        unsupported                          NULL
    },
    tdd128-hspdsch                          CHOICE {
        supported                          HSDSCH-physical-layer-category,
        unsupported                          NULL
    }
}

PNBSCH-Allocation-r4 ::= SEQUENCE {
    numberOfRepetitionsPerSFNPeriod ENUMERATED {
        c2, c3, c4, c5, c6, c7, c8, c9, c10,
        c12, c14, c16, c18, c20, c24, c28, c32,
        c36, c40, c48, c56, c64, c72, c80 }
}

Pre-RedirectionInfo ::= SEQUENCE {
    supportEUTRA-FDD                       BOOLEAN,
    supportEUTRA-TDD                       BOOLEAN
}

ProtocolErrorCause ::= ENUMERATED {
    asn1-ViolationOrEncodingError,
    messageTypeNonexistent,
    messageNotCompatibleWithReceiverState,
    ie-ValueNotComprehended,
    informationElementMissing,
    messageExtensionNotComprehended,
    spare2, spare1 }

ProtocolErrorIndicator ::= ENUMERATED {
    noError, errorOccurred }

ProtocolErrorIndicatorWithMoreInfo ::= CHOICE {
    noError                                NULL,
    errorOccurred                          SEQUENCE {
        rrc-TransactionIdentifier          RRC-TransactionIdentifier,
        protocolErrorInformation          ProtocolErrorInformation
    }
}

ProtocolErrorMoreInformation ::= SEQUENCE {
    diagnosticsType                        CHOICE {
        type1                              CHOICE {
            asn1-ViolationOrEncodingError  NULL,
            messageTypeNonexistent          NULL,

```

```

        messageNotCompatibleWithReceiverState
        ie-ValueNotComprehended      IdentificationOfReceivedMessage,
        conditionalInformationElementError IdentificationOfReceivedMessage,
        messageExtensionNotComprehended IdentificationOfReceivedMessage,
        spare1                        NULL,
        spare2                        NULL
    },
    spare                            NULL
}
}

RadioFrequencyBandEUTRA ::=          INTEGER (1..64)

RadioFrequencyBandFDD ::=            ENUMERATED {
    -- fdd2100, fdd1900, fdd1800 correspond to Band I, Band II and Band III respectively
    fdd2100,
    fdd1900,
    fdd1800,
    bandVI,
    bandIV,
    bandV,
    bandVII,
    extension-indicator }

RadioFrequencyBandFDD2 ::=           ENUMERATED {
    bandVIII,
    bandIX,
    bandX,
    bandXI,
    bandXII,
    bandXIII,
    bandXIV,
    bandXV,
    bandXVI,
    bandXVII,
    bandXVIII,
    bandXIX,
    bandXX,
    bandXXI,
    bandXXII,
    extension-indicator }

RadioFrequencyBandTDDList ::=        ENUMERATED {
    a, b, c, ab, ac, bc, abc, spare }

RadioFrequencyBandTDDList-r7 ::=     ENUMERATED {
    a, b, c, d, ab, ac, ad, bc, bd, cd, abc, abd, acd, bcd,
    abcd, notabcd }

RadioFrequencyBandTDDext ::=         ENUMERATED {
    e, f, g, h, i, j, k, l, m, n, o, p, spare4, spare3,
    spare2, spare1 }

RadioFrequencyBandTDDextList ::=     SEQUENCE (SIZE (1..maxFreqBandsTDD-ext)) OF
    RadioFrequencyBandTDDext

RadioFrequencyBandTDD ::=            ENUMERATED {
    a, b, c, d }

RadioFrequencyBandGSM ::=            ENUMERATED {
    gsm450,
    gsm480,
    gsm850,
    gsm900P,
    gsm900E,
    gsm1800,
    gsm1900,
    spare9, spare8, spare7, spare6, spare5,
    spare4, spare3, spare2, spare1}

Rb-timer-indicator ::=              SEQUENCE {
    t314-expired      BOOLEAN,
    t315-expired      BOOLEAN }

Re-EstablishmentTimer ::=           ENUMERATED {
    useT314, useT315
}

```



```

RedirectionInfo ::=
    frequencyInfo
    interRATInfo
}
CHOICE {
    FrequencyInfo,
    InterRATInfo
}

RedirectionInfo-r6 ::=
    frequencyInfo
    interRATInfo
}
CHOICE {
    FrequencyInfo,
    InterRATInfo-r6
}

RedirectionInfo-v860ext ::=
    -- CHOICE frequencyInfo is provided in IE RedirectionInfo or IE RedirectionInfo-r6
    frequencyInfo
    interRATInfo
}
CHOICE {
    NULL,
    InterRATInfo-v860ext
}

RejectionCause ::=
    congestion,
    unspecified
}
ENUMERATED {

ReleaseCause ::=
    normalEvent,
    unspecified,
    pre-emptiveRelease,
    congestion,
    re-establishmentReject,
    directedsignallingconnectionre-establishment,
    userInactivity,
    spare
}
ENUMERATED {

RF-Capability ::=
    fddRF-Capability
    ue-PowerClass
    txRxFrequencySeparation
}
SEQUENCE {
    SEQUENCE {
        UE-PowerClass,
        TxRxFrequencySeparation
    }
    OPTIONAL,
    SEQUENCE {
        ue-PowerClass
        radioFrequencyTDDBandList
        chipRateCapability
    }
    OPTIONAL
}

RF-Capability-r4-ext ::=
    tddRF-Capability
    ue-PowerClass
    radioFrequencyBandTDDList
    chipRateCapability
}
SEQUENCE {
    SEQUENCE {
        UE-PowerClass,
        RadioFrequencyBandTDDList,
        ChipRateCapability
    }
    OPTIONAL
}

RF-Capability-v770ext ::=
    -- If TDD384 and/or TDD128 RF capability is indicated in IEs 'RF-Capability' or
    -- 'RF-Capability-r4-ext', the corresponding IE 'RadioFrequencyBandTDDList-r7' shall
    -- be included in this IE.
    tdd384RF-Capability
    tdd768RF-Capability
    ue-PowerClass
    radioFrequencyBandTDDList
    -- The element 'chipRateCapability' = 'mcps7-68'
}
OPTIONAL,
tdd128RF-Capability
RadioFrequencyBandTDDList-r7
SEQUENCE {
    UE-PowerClass,
    RadioFrequencyBandTDDList-r7
}
OPTIONAL,
OPTIONAL

RF-Capability-v860ext ::=
    tdd128RF-Capability
    tdd384RF-Capability
    tdd768RF-Capability
}
SEQUENCE {
    RadioFrequencyBandTDDextList
    RadioFrequencyBandTDDextList
    RadioFrequencyBandTDDextList
}
OPTIONAL,
OPTIONAL,
OPTIONAL

RLC-Capability ::=
    -- If present, the "totalRLC-AM-BufferSize" in the IE "RLC-Capability-r5-ext" overrides the
    -- corresponding value in this IE. The value in this IE may be used by a pre-REL-5 UTRAN.
    totalRLC-AM-BufferSize
    maximumRLC-WindowSize
    maximumAM-EntityNumber
}
SEQUENCE {
    TotalRLC-AM-BufferSize,
    MaximumRLC-WindowSize,
    MaximumAM-EntityNumberRLC-Cap
}

```

```

RLC-Capability-r5-ext ::= SEQUENCE {
    totalRLC-AM-BufferSize          TotalRLC-AM-BufferSize-r5-ext    OPTIONAL
}

RLC-Capability-v770ext ::= SEQUENCE {
    supportOfTwoLogicalChannel      BOOLEAN
}

RRC-ConnectionReleaseInformation ::= CHOICE {
    noRelease                        NULL,
    release                          SEQUENCE {
        releaseCause                ReleaseCause
    }
}

RRC-MessageSequenceNumber ::= INTEGER (0..15)

RRC-MessageSequenceNumberList ::= SEQUENCE (SIZE (4..5)) OF
    RRC-MessageSequenceNumber

RRC-StateIndicator ::= ENUMERATED {
    cell-DCH, cell-FACH, cell-PCH, ura-PCH }

RRC-TransactionIdentifier ::= INTEGER (0..3)

S-RNTI ::= BIT STRING (SIZE (20))

S-RNTI-2 ::= BIT STRING (SIZE (10))

SecurityCapability ::= SEQUENCE {
    cipheringAlgorithmCap           BIT STRING {
        -- For each bit value "0" means false/ not supported
        spare15(0),
        spare14(1),
        spare13(2),
        spare12(3),
        spare11(4),
        spare10(5),
        spare9(6),
        spare8(7),
        spare7(8),
        spare6(9),
        spare5(10),
        spare4(11),
        spare3(12),
        uea2(13),
        uea1(14),
        uea0(15)
    } (SIZE (16)),
    integrityProtectionAlgorithmCap BIT STRING {
        -- For each bit value "0" means false/ not supported
        spare15(0),
        spare14(1),
        spare13(2),
        spare12(3),
        spare11(4),
        spare10(5),
        spare9(6),
        spare8(7),
        spare7(8),
        spare6(9),
        spare5(10),
        spare4(11),
        spare3(12),
        uia2(13),
        uia1(14),
        spare0(15)
    } (SIZE (16))
}

Serving-HSDSCH-CellInformation ::= SEQUENCE {
    deltaACK                        DeltaACK                OPTIONAL,
    deltaNACK                       DeltaNACK                OPTIONAL,
    harq-Preamble-Mode              HARQ-Preamble-Mode,
    primaryCPICH-Info               PrimaryCPICH-Info    OPTIONAL,
    dl-hspdsch-Information           DL-HSPDSCH-Information OPTIONAL,
    harqInfo                         HARQ-Info             OPTIONAL,
}

```

```

    mac-hsResetIndicator          ENUMERATED { true }          OPTIONAL
  }

  Serving-HSDSCH-CellInformation-r7 ::= SEQUENCE {
    deltaACK                      DeltaACK                  OPTIONAL,
    deltaNACK                     DeltaNACK                 OPTIONAL,
    harq-Preamble-Mode            HARQ-Preamble-Mode,
    primaryCPICH-Info             PrimaryCPICH-Info      OPTIONAL,
    dl-hspdsch-Information        DL-HSPDSCH-Information-r7  OPTIONAL,
    harqInfo                      HARQ-Info-r7           OPTIONAL,
    mac-hsResetIndicator          ENUMERATED { true }          OPTIONAL
  }

  Serving-HSDSCH-CellInformation-r8 ::= SEQUENCE {
    deltaACK                      DeltaACK                  OPTIONAL,
    deltaNACK                     DeltaNACK                 OPTIONAL,
    harq-Preamble-Mode            HARQ-Preamble-Mode,
    primaryCPICH-Info             PrimaryCPICH-Info      OPTIONAL,
    dl-hspdsch-Information        DL-HSPDSCH-Information-r8  OPTIONAL,
    harqInfo                      HARQ-Info-r7           OPTIONAL,
    mac-hsResetIndicator          ENUMERATED { true }          OPTIONAL
  }

  SimultaneousSCCPCH-DPCH-Reception ::= CHOICE {
    notSupported                  NULL,
    supported                     SEQUENCE {
      maxNoSCCPCH-RL             MaxNoSCCPCH-RL,
      -- simultaneousSCCPCH-DPCH-DPDCH-Reception is applicable only if
      -- the IE Support of PDSCH = TRUE
      -- Note: the reference to DPDCH in the element name below is incorrect (see tabular). The
      -- name is not changed, to keep it aligned with R99.
      simultaneousSCCPCH-DPCH-DPDCH-Reception    BOOLEAN
    }
  }

  SRNC-Identity ::= BIT STRING (SIZE (12))

  SR-VCC-Info ::= SEQUENCE {
    nonce                         BIT STRING (SIZE (128))          OPTIONAL
  }

  SR-VCC-SecurityRABInfo-v860ext ::= SEQUENCE {
    sr-vcc-Info                  SR-VCC-Info,
    rab-InfoReplace              RAB-InfoReplace
  }

  START-Value ::= BIT STRING (SIZE (20))

  STARTList ::= SEQUENCE (SIZE (1..maxCNdomains)) OF
    STARTSingle

  STARTSingle ::= SEQUENCE {
    cn-DomainIdentity            CN-DomainIdentity,
    start-Value                  START-Value
  }

  SystemSpecificCapUpdateReq ::= ENUMERATED {
    gsm }

  SystemSpecificCapUpdateReq-v590ext ::= ENUMERATED {
    geranIu }

  SystemSpecificCapUpdateReq-r5 ::= ENUMERATED {
    gsm, geranIu }

  SystemSpecificCapUpdateReq-r8 ::= ENUMERATED {
    gsm, geranIu, eutra, spare5,
    spare4, spare3, spare2, spare1 }

  SystemSpecificCapUpdateReqList ::= SEQUENCE (SIZE (1..maxSystemCapability)) OF
    SystemSpecificCapUpdateReq

  SystemSpecificCapUpdateReqList-r5 ::= SEQUENCE (SIZE (1..maxSystemCapability)) OF
    SystemSpecificCapUpdateReq-r5

  SystemSpecificCapUpdateReqList-r8 ::= SEQUENCE (SIZE (1..maxSystemCapability)) OF
    SystemSpecificCapUpdateReq-r8

```

```

T-300 ::=
    ENUMERATED {
        ms100, ms200, ms400, ms600, ms800,
        ms1000, ms1200, ms1400, ms1600,
        ms1800, ms2000, ms3000, ms4000,
        ms6000, ms8000 }

T-301 ::=
    ENUMERATED {
        ms100, ms200, ms400, ms600, ms800,
        ms1000, ms1200, ms1400, ms1600,
        ms1800, ms2000, ms3000, ms4000,
        ms6000, ms8000, spare }

T-302 ::=
    ENUMERATED {
        ms100, ms200, ms400, ms600, ms800,
        ms1000, ms1200, ms1400, ms1600,
        ms1800, ms2000, ms3000, ms4000,
        ms6000, ms8000, spare }

T-304 ::=
    ENUMERATED {
        ms100, ms200, ms400,
        ms1000, ms2000, spare3, spare2, spare1 }

T-305 ::=
    ENUMERATED {
        noUpdate, m5, m10, m30,
        m60, m120, m360, m720 }

T-307 ::=
    ENUMERATED {
        s5, s10, s15, s20,
        s30, s40, s50, spare }

T-308 ::=
    ENUMERATED {
        ms40, ms80, ms160, ms320 }

T-309 ::=
    INTEGER (1..8)

T-310 ::=
    ENUMERATED {
        ms40, ms80, ms120, ms160,
        ms200, ms240, ms280, ms320 }

T-311 ::=
    ENUMERATED {
        ms250, ms500, ms750, ms1000,
        ms1250, ms1500, ms1750, ms2000 }

-- The value 0 for T-312 is not used in this version of the specification
T-312 ::=
    INTEGER (0..15)

T-313 ::=
    INTEGER (0..15)

T-314 ::=
    ENUMERATED {
        s0, s2, s4, s6, s8,
        s12, s16, s20 }

T-315 ::=
    ENUMERATED {
        s0, s10, s30, s60, s180,
        s600, s1200, s1800 }

T-316 ::=
    ENUMERATED {
        s0, s10, s20, s30, s40,
        s50, s-inf, spare }

-- All the values are changed to "infinity" in Rel-5
T-317 ::=
    ENUMERATED {
        infinity0, infinity1, infinity2, infinity3, infinity4,
        infinity5, infinity6, infinity7}

T-318 ::=
    ENUMERATED {
        ms250, ms500, ms750, ms1000, ms1250, ms1500,
        ms1750, ms2000, ms3000, ms4000, ms6000, ms8000,
        ms10000, ms12000, ms16000 }

T-319 ::=
    ENUMERATED {
        ms80, ms160, ms320, ms640, ms1280, ms2560, ms5120 }

T-321 ::=
    ENUMERATED {
        ms100, ms200, ms400, ms800 }

T-322 ::=
    ENUMERATED { m5, m10, m20, m30, m60,
        m120, m180, spare1 }

```

```

T-323 ::= ENUMERATED { s0, s5, s10, s20, s30, s60, s90, s120 }

T-CPCH ::= ENUMERATED {
    ct0, ct1 }

TMSI-and-LAI-GSM-MAP ::= SEQUENCE {
    tmsi      TMSI-GSM-MAP,
    lai       LAI
}

TMSI-DS-41 ::= OCTET STRING (SIZE (2..17))

TotalRLC-AM-BufferSize ::= ENUMERATED {
    dummy, kb10, kb50, kb100,
    kb150, kb500, kb1000, spare }

TotalRLC-AM-BufferSize-r5-ext ::= ENUMERATED {
    kb200, kb300, kb400, kb750 }

-- Actual value TransmissionProbability = IE value * 0.125
TransmissionProbability ::= INTEGER (1..8)

TransportChannelCapability ::= SEQUENCE {
    dl-TransChCapability  DL-TransChCapability,
    ul-TransChCapability  UL-TransChCapability
}

TurboSupport ::= CHOICE {
    notSupported  NULL,
    supported     MaxNoBits
}

-- Values defined as spare shall not be sent in this version of the protocol. If a spare value is
-- received, it should be interpreted as 'default-RxTX-separation'.
TxRxFrequencySeparation ::= ENUMERATED {
    default-TxRx-separation, spare2, spare1 }

U-RNTI ::= SEQUENCE {
    srnc-Identity  SRNC-Identity,
    s-RNTI         S-RNTI
}

U-RNTI-Group ::= CHOICE {
-- TABULAR: not following the tabular strictly, but this will most likely save bits
    all          NULL,
    u-RNTI-BitMaskIndex-b1  BIT STRING (SIZE (31)),
    u-RNTI-BitMaskIndex-b2  BIT STRING (SIZE (30)),
    u-RNTI-BitMaskIndex-b3  BIT STRING (SIZE (29)),
    u-RNTI-BitMaskIndex-b4  BIT STRING (SIZE (28)),
    u-RNTI-BitMaskIndex-b5  BIT STRING (SIZE (27)),
    u-RNTI-BitMaskIndex-b6  BIT STRING (SIZE (26)),
    u-RNTI-BitMaskIndex-b7  BIT STRING (SIZE (25)),
    u-RNTI-BitMaskIndex-b8  BIT STRING (SIZE (24)),
    u-RNTI-BitMaskIndex-b9  BIT STRING (SIZE (23)),
    u-RNTI-BitMaskIndex-b10 BIT STRING (SIZE (22)),
    u-RNTI-BitMaskIndex-b11 BIT STRING (SIZE (21)),
    u-RNTI-BitMaskIndex-b12 BIT STRING (SIZE (20)),
    u-RNTI-BitMaskIndex-b13 BIT STRING (SIZE (19)),
    u-RNTI-BitMaskIndex-b14 BIT STRING (SIZE (18)),
    u-RNTI-BitMaskIndex-b15 BIT STRING (SIZE (17)),
    u-RNTI-BitMaskIndex-b16 BIT STRING (SIZE (16)),
    u-RNTI-BitMaskIndex-b17 BIT STRING (SIZE (15)),
    u-RNTI-BitMaskIndex-b18 BIT STRING (SIZE (14)),
    u-RNTI-BitMaskIndex-b19 BIT STRING (SIZE (13)),
    u-RNTI-BitMaskIndex-b20 BIT STRING (SIZE (12)),
    u-RNTI-BitMaskIndex-b21 BIT STRING (SIZE (11)),
    u-RNTI-BitMaskIndex-b22 BIT STRING (SIZE (10)),
    u-RNTI-BitMaskIndex-b23 BIT STRING (SIZE (9)),
    u-RNTI-BitMaskIndex-b24 BIT STRING (SIZE (8)),
    u-RNTI-BitMaskIndex-b25 BIT STRING (SIZE (7)),
    u-RNTI-BitMaskIndex-b26 BIT STRING (SIZE (6)),
    u-RNTI-BitMaskIndex-b27 BIT STRING (SIZE (5)),
    u-RNTI-BitMaskIndex-b28 BIT STRING (SIZE (4)),
    u-RNTI-BitMaskIndex-b29 BIT STRING (SIZE (3)),
    u-RNTI-BitMaskIndex-b30 BIT STRING (SIZE (2)),
    u-RNTI-BitMaskIndex-b31 BIT STRING (SIZE (1))
}

```

```

U-RNTI-Short ::= SEQUENCE {
    srcn-Identity          SRNC-Identity,
    s-RNTI-2              S-RNTI-2
}

UE-CapabilityContainer-IEs ::= SEQUENCE {
    -- Container for transparent transfer of capability information not related to
    -- features for which early implementation is desired
    ue-RadioAccessCapability-v690ext    UE-RadioAccessCapability-v690ext,
    ue-RATSpecificCapability-v690ext    InterRAT-UE-RadioAccessCapability-v690ext    OPTIONAL,
    v6b0NonCriticalExtensions          SEQUENCE {
        ue-RadioAccessCapability-v6b0ext    UE-RadioAccessCapability-v6b0ext-IEs,
        v6e0NonCriticalExtensions          SEQUENCE {
            ue-RadioAccessCapability-v6e0ext    UE-RadioAccessCapability-v6e0ext-IEs,
            v770NonCriticalExtensions          SEQUENCE {
                ue-RadioAccessCapability-v770ext    UE-RadioAccessCapability-v770ext-IEs,
                v790NonCriticalExtensions          SEQUENCE {
                    ue-RadioAccessCapability-v790ext    UE-RadioAccessCapability-v790ext-IEs,
                    v860NonCriticalExtensions          SEQUENCE {
                        ue-RadioAccessCapability-v860ext    UE-RadioAccessCapability-v860ext-IEs,
                        ue-RATSpecificCapability-v860ext    InterRAT-UE-RadioAccessCapability-v860ext    OPTIONAL,
                        v880NonCriticalExtensions          SEQUENCE {
                            ue-RadioAccessCapability-v880ext    UE-RadioAccessCapability-v880ext-IEs,
                            v890NonCriticalExtensions          SEQUENCE {
                                ue-RadioAccessCapability-v890ext    UE-RadioAccessCapability-v890ext-IEs,
                                nonCriticalExtensions          SEQUENCE {} OPTIONAL
                            } OPTIONAL
                        } OPTIONAL
                    } OPTIONAL
                } OPTIONAL
            } OPTIONAL
        } OPTIONAL
    } OPTIONAL
}

UE-RadioAccessCapability-v6b0ext-IEs ::= SEQUENCE {
    -- User equipment IEs
    supportForSIB11bis          ENUMERATED { true }          OPTIONAL
}

UE-RadioAccessCapability-v6e0ext-IEs ::= SEQUENCE {
    -- User equipment IEs
    supportForFDPCH            ENUMERATED { true }          OPTIONAL
}

UE-RadioAccessCapability-v770ext-IEs ::= SEQUENCE {
    -- User equipment IEs
    pdcp-Capability            PDCP-Capability-v770ext          OPTIONAL,
    rlc-Capability             RLC-Capability-v770ext,
    rf-Capability              RF-Capability-v770ext          OPTIONAL,
    physicalChannelCapability    PhysicalChannelCapability-v770ext,
    multiModeRAT-Capability      MultiModeRAT-Capability-v770ext,
    ue-PositioningCapability      UE-PositioningCapability-v770ext,
    mac-ehsSupport              ENUMERATED { true }          OPTIONAL,
    ue-specificCapabilityInformation    UE-SpecificCapabilityInformation-LCRTDD    OPTIONAL
}

UE-RadioAccessCapability-v790ext-IEs ::= SEQUENCE {
    -- User equipment IEs
    supportForEDPCCHPowerBoosting    ENUMERATED { true }          OPTIONAL
}

UE-RadioAccessCapability-v860ext-IEs ::= SEQUENCE {
    -- UE radio access capability
    rf-Capability              RF-Capability-v860ext          OPTIONAL,
    physicalChannelCapability    PhysicalChannelCapability-v860ext,
    multiModeRAT-Capability      MultiModeRAT-Capability-v860ext,
    ue-PositioningCapability      UE-PositioningCapability-v860ext,
    measurementCapability        MeasurementCapability-v860ext          OPTIONAL,
    measurementCapabilityTDD      MeasurementCapabilityTDD          OPTIONAL,
    supportOfCommonEDCH          ENUMERATED { true }          OPTIONAL,
    supportOfMACiis              ENUMERATED { true }          OPTIONAL,
    supportOfSPSOperation        ENUMERATED { true }          OPTIONAL,
}

```

```

        supportOfControlChannelDRXOperation ENUMERATED { true }           OPTIONAL,
        supportOfCSG                        ENUMERATED { true }           OPTIONAL,
    -- UE radio access capability extension
        ue-RadioAccessCapabBandFDDList3     UE-RadioAccessCapabBandFDDList3  OPTIONAL
    }

UE-RadioAccessCapability-v880ext-IEs ::= SEQUENCE {
    -- UE radio access capability
        supportForPriorityReselectionInUTRAN  ENUMERATED { true }         OPTIONAL
    }

UE-RadioAccessCapability-v890ext-IEs ::= SEQUENCE {
    -- UE radio access capability
        supportCellSpecificTxDiversityinDC-Operation  ENUMERATED { true }  OPTIONAL
    }

UE-ConnTimersAndConstants ::=          SEQUENCE {
    -- Optional is used also for parameters for which the default value is the last one read in SIB1
    -- t-301 and n-301 should not be used by the UE in this version of the specification
        t-301          T-301          DEFAULT ms2000,
        n-301          N-301          DEFAULT 2,
        t-302          T-302          DEFAULT ms4000,
        n-302          N-302          DEFAULT 3,
        t-304          T-304          DEFAULT ms2000,
        n-304          N-304          DEFAULT 2,
        t-305          T-305          DEFAULT m30,
        t-307          T-307          DEFAULT s30,
        t-308          T-308          DEFAULT ms160,
        t-309          T-309          DEFAULT 5,
        t-310          T-310          DEFAULT ms160,
        n-310          N-310          DEFAULT 4,
        t-311          T-311          DEFAULT ms2000,
        t-312          T-312          DEFAULT 1,
        -- n-312 shall be ignored if n-312 in UE-ConnTimersAndConstants-v3a0ext is present, and the
        -- value of that element shall be used instead.
        n-312          N-312          DEFAULT s1,
        t-313          T-313          DEFAULT 3,
        n-313          N-313          DEFAULT s20,
        t-314          T-314          DEFAULT s12,
        t-315          T-315          DEFAULT s180,
        -- n-315 shall be ignored if n-315 in UE-ConnTimersAndConstants-v3a0ext is present, and the
        -- value of that element shall be used instead.
        n-315          N-315          DEFAULT s1,
        t-316          T-316          DEFAULT s30,
        t-317          T-317          DEFAULT infinity4
    }

UE-ConnTimersAndConstants-v3a0ext ::=          SEQUENCE {
        n-312          N-312ext          OPTIONAL,
        n-315          N-315ext          OPTIONAL
    }

UE-ConnTimersAndConstants-r5 ::=          SEQUENCE {
    -- Optional is used also for parameters for which the default value is the last one read in SIB1
    -- t-301 and n-301 should not be used by the UE in this version of the specification
        t-301          T-301          DEFAULT ms2000,
        n-301          N-301          DEFAULT 2,
        t-302          T-302          DEFAULT ms4000,
        n-302          N-302          DEFAULT 3,
        t-304          T-304          DEFAULT ms2000,
        n-304          N-304          DEFAULT 2,
        t-305          T-305          DEFAULT m30,
        t-307          T-307          DEFAULT s30,
        t-308          T-308          DEFAULT ms160,
        t-309          T-309          DEFAULT 5,
        t-310          T-310          DEFAULT ms160,
        n-310          N-310          DEFAULT 4,
        t-311          T-311          DEFAULT ms2000,
        t-312          T-312          DEFAULT 1,
        n-312          N-312-r5          DEFAULT s1,
        t-313          T-313          DEFAULT 3,
        n-313          N-313          DEFAULT s20,
        t-314          T-314          DEFAULT s12,
        t-315          T-315          DEFAULT s180,
        n-315          N-315-r5          DEFAULT s1,
        t-316          T-316          DEFAULT s30,
        t-317          T-317          DEFAULT infinity4
    }

```

```

UE-ConnTimersAndConstants-v860ext ::= SEQUENCE {
    t-323                T-323                OPTIONAL
}

UE-GANSSPositioning-Capability ::= SEQUENCE {
    networkAssistedGANSS-supportedList NetworkAssistedGANSS-Supported-List OPTIONAL
}

UE-GANSSPositioning-Capability-v860ext-IEs ::= SEQUENCE {
    networkAssistedGANSS-supportedList NetworkAssistedGANSS-Supported-List-v860ext OPTIONAL
}

UE-IdleTimersAndConstants ::= SEQUENCE {
    t-300                T-300,
    n-300                N-300,
    t-312                T-312,
    -- n-312 shall be ignored if n-312 in UE-IdleTimersAndConstants-v3a0ext is present, and the
    -- value of that element shall be used instead.
    n-312                N-312
}

UE-HSPA-Identities-r6 ::= SEQUENCE {
    new-H-RNTI           H-RNTI                OPTIONAL,
    newPrimary-E-RNTI   E-RNTI                OPTIONAL,
    newSecondary-E-RNTI E-RNTI                OPTIONAL
}

UE-IdleTimersAndConstants-v3a0ext ::= SEQUENCE {
    n-312                N-312ext            OPTIONAL
}

UE-MultiModeRAT-Capability ::= SEQUENCE {
    multiRAT-CapabilityList MultiRAT-Capability,
    multiModeCapability     MultiModeCapability
}

UE-PowerClass ::= INTEGER (1..4)

UE-PowerClassExt ::= ENUMERATED {class1, class2, class3, class4,
    spare4, spare3, spare2, spare1 }

UE-RadioAccessCapability ::= SEQUENCE {
    -- UE-RadioAccessCapability is compatible with R99, although accessStratumReleaseIndicator
    -- is removed from this IE, since its encoding did not result in bits. The
    -- accessStratumReleaseIndicator is provided in the relevant REL-4 extension IEs.
    pdcp-Capability      PDCP-Capability,
    rlc-Capability        RLC-Capability,
    transportChannelCapability TransportChannelCapability,
    rf-Capability         RF-Capability,
    physicalChannelCapability PhysicalChannelCapability,
    ue-MultiModeRAT-Capability UE-MultiModeRAT-Capability,
    securityCapability    SecurityCapability,
    ue-positioning-Capability UE-Positioning-Capability,
    measurementCapability MeasurementCapability OPTIONAL
}

UE-RadioAccessCapabilityInfo ::= SEQUENCE {
    ue-RadioAccessCapability UE-RadioAccessCapability,
    ue-RadioAccessCapability-v370ext UE-RadioAccessCapability-v370ext
}

UE-RadioAccessCapability-v370ext ::= SEQUENCE {
    ue-RadioAccessCapabBandFDDList UE-RadioAccessCapabBandFDDList
}

UE-RadioAccessCapability-v380ext ::= SEQUENCE {
    ue-PositioningCapabilityExt-v380 UE-PositioningCapabilityExt-v380
}

UE-RadioAccessCapability-v3a0ext ::= SEQUENCE {
    ue-PositioningCapabilityExt-v3a0 UE-PositioningCapabilityExt-v3a0
}

UE-RadioAccessCapability-v3g0ext ::= SEQUENCE {
    ue-PositioningCapabilityExt-v3g0 UE-PositioningCapabilityExt-v3g0
}

```



```

UE-RadioAccessCapability-v650ext ::= SEQUENCE {
    ue-RadioAccessCapabBandFDDList2
    -- This IE shall be included if the UE also supports Band I-VII
    ue-RadioAccessCapabBandFDDList-ext  UE-RadioAccessCapabBandFDDList-ext  OPTIONAL
}

UE-RadioAccessCapability-v690ext ::= SEQUENCE {
    physicalchannelcapability-edch  PhysicalChannelCapability-edch-r6,
    -- TABULAR: deviceType is MD in tabular description
    -- Default value is 'doesBenefitFromBatteryConsumptionOptimisation'
    deviceType      ENUMERATED { doesNotBenefitFromBatteryConsumptionOptimisation } OPTIONAL
}

UE-RadioAccessCapability-v7e0ext ::= SEQUENCE {
    -- User equipment IEs
    supportForTwoDRXschemesInPCH      ENUMERATED { true }          OPTIONAL,
    supportEDPDCHPowerInterpolation    ENUMERATED { true }          OPTIONAL
}

UE-RadioAccessCapability-v7f0ext ::= SEQUENCE {
    supportofTxDivOnNonMIMOChannel      ENUMERATED { true }          OPTIONAL,
    -- IE physicalChannelCapability-LCR and ue-RadioAccessCapabilityComp-TDD128 shall only be
    -- included in InterRATHandoverInfo for 1.28 Mcps TDD, otherwise these IEs are not needed here.
    physicalChannelCapability-LCR        PhysicalChannelCapability-LCR-r4      OPTIONAL,
    ue-RadioAccessCapabilityComp-TDD128  UE-RadioAccessCapabilityComp-TDD128-v7f0ext  OPTIONAL
}

UE-RadioAccessCapabilityInfo-v770ext ::= SEQUENCE {
    rf-Capability      RF-Capability-v770ext          OPTIONAL,
    physicalChannelCapabilityInfo-v770ext,
    ganssSupportIndication  ENUMERATED { true }      OPTIONAL,
    mac-ehsSupport          ENUMERATED { true }      OPTIONAL,
    ue-SpecificCapabilityInformation  UE-SpecificCapabilityInformation-LCRTDD  OPTIONAL
}

UE-RadioAccessCapabilityInfo-TDD128-v8b0ext ::= SEQUENCE {
    -- INTER RAT HANDOVER INFO
    measurementCapabilityTDD      MeasurementCapabilityTDD          OPTIONAL,
    hSDSCH-physical-layer-category-extension  HSDSCH-physical-layer-category-extension  OPTIONAL
}

UE-RadioAccessCapability-v860ext ::= SEQUENCE {
    ue-RadioAccessCapabBandFDDList3  UE-RadioAccessCapabBandFDDList3
}

UE-RadioAccessCapability-v880ext ::= SEQUENCE {
    -- INTER RAT HANDOVER INFO
    supportForPriorityReselectionInUTRAN  ENUMERATED { true }          OPTIONAL
}

UE-RadioAccessCapability-v890ext ::= SEQUENCE {
    -- UE radio access capability
    supportCellSpecificTxDiversityinDC-Operation  ENUMERATED { true }          OPTIONAL
}

UE-RadioAccessCapability-v920ext ::= SEQUENCE {
    supportOfenhancedTS0      ENUMERATED { true }          OPTIONAL
}

UE-RadioAccessCapabBandFDDList2 ::= SEQUENCE (SIZE (1..maxFreqBandsFDD)) OF
    UE-RadioAccessCapabBandFDD2

UE-RadioAccessCapabBandFDDList3 ::= SEQUENCE (SIZE (1..maxFreqBandsFDD)) OF
    UE-RadioAccessCapabBandFDD3

UE-RadioAccessCapabBandFDD2 ::= SEQUENCE {
    radioFrequencyBandFDD2      RadioFrequencyBandFDD2,
    fddRF-Capability            SEQUENCE {
        ue-PowerClass          UE-PowerClassExt,
        txRxFrequencySeparation  TxRxFrequencySeparation
    } OPTIONAL,
    measurementCapability2      MeasurementCapabilityExt2
}

UE-RadioAccessCapabBandFDD3 ::= SEQUENCE {
    -- UE may omit both IEs if this IE indicates the same compressed
    -- mode capability for all supported UTRA bands

```

```

-- Otherwise, the UE shall include either one of the following OPTIONAL IEs.
radioFrequencyBandFDD                RadioFrequencyBandFDD        OPTIONAL,
radioFrequencyBandFDD2                RadioFrequencyBandFDD2        OPTIONAL,
measurementCapability3                MeasurementCapabilityExt3
}

UE-PositioningCapabilityExt-v380 ::= SEQUENCE {
  rx-tx-TimeDifferenceType2Capable    BOOLEAN
}

UE-PositioningCapabilityExt-v3a0 ::= SEQUENCE {
  validity-CellPCH-UraPCH            ENUMERATED { true }
}

UE-PositioningCapabilityExt-v3g0 ::= SEQUENCE {
  sfn-sfnType2Capability              ENUMERATED { true }
}

UE-PositioningCapability-v770ext ::= SEQUENCE {
  ue-GANSSPositioning-Capability     UE-GANSSPositioning-Capability  OPTIONAL
}

UE-PositioningCapability-v860ext ::= SEQUENCE {
  ue-GANSSPositioning-Capability-v860ext
  UE-GANSSPositioning-Capability-v860ext-IEs  OPTIONAL
}

UE-RadioAccessCapabBandFDDList ::= SEQUENCE (SIZE (1..maxFreqBandsFDD)) OF
  UE-RadioAccessCapabBandFDD

UE-RadioAccessCapabBandFDDList-ext ::= SEQUENCE (SIZE (1..maxFreqBandsFDD)) OF
  UE-RadioAccessCapabBandFDD-ext

UE-RadioAccessCapabBandFDD ::= SEQUENCE{
  radioFrequencyBandFDD              RadioFrequencyBandFDD,
  fddRF-Capability                   SEQUENCE {
    ue-PowerClass                    UE-PowerClassExt,
    txRxFrequencySeparation          TxRxFrequencySeparation
  }
  measurementCapability               MeasurementCapabilityExt  OPTIONAL,
}

UE-RadioAccessCapabBandFDD-ext ::= SEQUENCE {
  radioFrequencyBandFDD              RadioFrequencyBandFDD,
  compressedModeMeasCapabFDDList-ext CompressedModeMeasCapabFDDList-ext
}

UE-RadioAccessCapability-v4b0ext ::= SEQUENCE {
  pdcp-Capability-r4-ext             PDCP-Capability-r4-ext,
  tdd-CapabilityExt                  SEQUENCE {
    rf-Capability                    RF-Capability-r4-ext,
    physicalChannelCapability-LCR     PhysicalChannelCapability-LCR-r4,
    measurementCapability-r4-ext      MeasurementCapability-r4-ext
  }
  -- IE " AccessStratumReleaseIndicator" is not needed in RRC CONNECTION SETUP COMPLETE
  accessStratumReleaseIndicator      AccessStratumReleaseIndicator  OPTIONAL
}

UE-RadioAccessCapabilityComp ::= SEQUENCE {
  totalAM-RLCMemoryExceeds10kB      BOOLEAN,
  rf-CapabilityComp                  RF-CapabilityComp
}

UE-RadioAccessCapabilityComp-ext ::= SEQUENCE {
  rf-CapabilityFDDComp               RF-CapabBandListFDDComp-ext
}

UE-RadioAccessCapabilityComp-TDD128-v7f0ext ::= SEQUENCE {
  hSDSCH-physical-layer-category     HSDSCH-physical-layer-category  OPTIONAL,
  multiCarrier-physical-layer-category
  MultiCarrier-HSDSCH-physical-layer-category  OPTIONAL,
  tdd-edch-PhysicalLayerCategory     INTEGER (1..6)                 OPTIONAL,
  dl-CapabilityWithSimultaneousHS-DSCHConfig
  DL-CapabilityWithSimultaneousHS-DSCHConfig  OPTIONAL,
  supportForCSVoiceoverHSPA          ENUMERATED { true }            OPTIONAL,
  totalRLC-AM-BufferSize              TotalRLC-AM-BufferSize-r5-ext  OPTIONAL
}

```

```

UE-RadioAccessCapabilityComp-v770ext ::= SEQUENCE {
    rf-CapabilityComp                RF-CapabilityComp-v770ext,
    securityCapabilityIndication      ENUMERATED { true }           OPTIONAL,
    ganssSupportIndication            ENUMERATED { true }           OPTIONAL,
    mac-ehsSupport                    ENUMERATED { true }           OPTIONAL
}

UE-RadioAccessCapabilityComp2 ::= SEQUENCE {
    fddPhysicalChannelCapab-hspdsch-edch SEQUENCE {
        dl-CapabilityWithSimultaneousHS-DSCHConfig
            DL-CapabilityWithSimultaneousHS-DSCHConfig OPTIONAL,
        physicalChannelCapabComp-hspdsch-r6 HSDSCH-physical-layer-category,
        physicalChannelCapability-edch-r6 PhysicalChannelCapability-edch-r6
    }
    OPTIONAL
}

UE-RadioAccessCapabilityComp2-v770ext ::= SEQUENCE {
    hsdSCH-physical-layer-category-ext HSDSCH-physical-layer-category-ext OPTIONAL,
    edch-PhysicalLayerCategory-extension INTEGER (7) OPTIONAL,
    hsscchlessHsdSCHOperation          ENUMERATED { true }           OPTIONAL,
    enhancedFdpch                      ENUMERATED { true }           OPTIONAL,
    hsdSCHReception-CellFach           ENUMERATED { true }           OPTIONAL,
    hsdSCHReception-CellUraPch        ENUMERATED { true }           OPTIONAL,
    discontinuousDpccchTransmission    ENUMERATED { true }           OPTIONAL,
    slotFormat4                        ENUMERATED { true }           OPTIONAL,
    pdcp-Capability                    PDCP-Capability-v770ext OPTIONAL
}

UE-RadioAccessCapabilityComp2-v7f0ext ::= SEQUENCE {
    supportOfTxDivOnNonMIMOChannel     ENUMERATED { true }           OPTIONAL
}

UE-RadioAccessCapabilityComp2-v860ext ::= SEQUENCE {
    hsdSCH-physical-layer-category-ext2 HSDSCH-physical-layer-category-ext2 OPTIONAL,
    supportOfMACiis                    ENUMERATED { true }           OPTIONAL
}

UE-RadioAccessCapabilityComp2-v920ext ::= SEQUENCE {
    hsdSCH-physical-layer-category-ext3 HSDSCH-physical-layer-category-ext3 OPTIONAL,
    edch-PhysicalLayerCategory-extension2 INTEGER (8..9) OPTIONAL
}

UE-RadioAccessCapabilityComp-TDD128 ::= SEQUENCE {
    tdd128RF-Capability                RadioFrequencyBandTDDextList OPTIONAL,
    supportOfSFModeForHSPDSCHDualStream ENUMERATED { sf1, sf1sf16 } OPTIONAL,
    supportOfCommonEDCH                ENUMERATED { true }           OPTIONAL,
    supportOfMACiis                    ENUMERATED { true }           OPTIONAL,
    supportOfSPSOperation               ENUMERATED { true }           OPTIONAL,
    supportOfControlChannelDRXOperation ENUMERATED { true }           OPTIONAL
}

RF-CapabilityComp ::= SEQUENCE {
    fdd CHOICE {
        notSupported NULL,
        supported     RF-CapabBandListFDDComp
    },
    tdd384-RF-Capability CHOICE {
        notSupported NULL,
        supported     RadioFrequencyBandTDDList
    },
    tdd128-RF-Capability CHOICE {
        notSupported NULL,
        supported     RadioFrequencyBandTDDList
    }
}

RF-CapabilityComp-v770ext ::= SEQUENCE {
    -- If support of TDD384 and/or TDD128 RF capability is indicated in IEs 'RF-CapabilityComp',
    -- the corresponding IE 'RadioFrequencyBandTDDList-r7' shall be included in this IE.
    tdd384-RF-Capability RadioFrequencyBandTDDList-r7 OPTIONAL,
    tdd768-RF-Capability CHOICE {
        notSupported NULL,
        supported     RadioFrequencyBandTDDList-r7
    },
    tdd128-RF-Capability RadioFrequencyBandTDDList-r7 OPTIONAL
}

```

```

-- NOTE: This IE defines the supported TX/RX frequency separation for the respective supported
-- frequency band. Values defined as spare shall not be sent in this version of the protocol.
-- If a spare value is received, it should be interpreted as 'default-RxTX-separation'.
RF-CapabBandFDDComp ::=          ENUMERATED { notSupported,
                                           default-TxRx-separation, spare2, spare1 }

RF-CapabBandListFDDComp ::=      SEQUENCE (SIZE (1..maxFreqBandsFDD)) OF
-- The first entry corresponds with the first value of IE RadioFrequencyBandFDD,
-- fdd2100, and so on. No more than seven entries should be included in this IE. The
-- 8'th entry, if present, shall be ignored.
-- An extension of this IE may be provided using the IE 'RF-CapabBandListFDDComp-ext'.
RF-CapabBandFDDComp

RF-CapabBandListFDDComp-ext ::=  SEQUENCE (SIZE (1..maxFreqBandsFDD-ext)) OF
-- The first entry corresponds with the first value of IE RadioFrequencyBandFDD2,
-- bandVIII, and so on.
RF-CapabBandFDDComp

UE-RadioAccessCapability-v590ext ::= SEQUENCE {
  dl-CapabilityWithSimultaneousHS-DSCHConfig
                                     DL-CapabilityWithSimultaneousHS-DSCHConfig OPTIONAL,
  pdcp-Capability-r5-ext             PDCP-Capability-r5-ext,
  rlc-Capability-r5-ext              RLC-Capability-r5-ext,
  physicalChannelCapability          PhysicalChannelCapability-hspdsch-r5,
  multiModerAT-Capability-v590ext   MultiModerAT-Capability-v590ext
}

UE-RadioAccessCapability-v5c0ext ::= SEQUENCE {
  pdcp-Capability-r5-ext2           PDCP-Capability-r5-ext2
}

UE-RadioAccessCapability-v680ext ::= SEQUENCE {
  multiModerAT-Capability-v680ext   MultiModerAT-Capability-v680ext
}

UL-PhysChCapabilityFDD ::=        SEQUENCE {
  maxNoDPDCH-BitsTransmitted        MaxNoDPDCH-BitsTransmitted,
  -- dummy is not used in this version of the specification and
  -- it should be ignored by the receiver.
  dummy                              BOOLEAN
}

UL-PhysChCapabilityFDD-r6 ::=     SEQUENCE {
  maxNoDPDCH-BitsTransmitted        MaxNoDPDCH-BitsTransmitted,
  physicalchannelcapability-edch     PhysicalChannelCapability-edch-r6
}

UL-PhysChCapabilityFDD-v770ext ::= SEQUENCE {
  edch-PhysicalLayerCategory-extension INTEGER (7)                OPTIONAL,
  discontinuousDpcchTransmission    ENUMERATED { true }          OPTIONAL,
  slotFormat4                       ENUMERATED { true }           OPTIONAL
}

UL-PhysChCapabilityTDD ::=        SEQUENCE {
  maxTS-PerFrame                    MaxTS-PerFrame,
  maxPhysChPerTimeslot              MaxPhysChPerTimeslot,
  minimumSF                          MinimumSF-UL,
  supportOfPUSCH                    BOOLEAN
}

UL-PhysChCapabilityTDD-384-v770ext ::= SEQUENCE {
  tdd384-edch                       CHOICE {
    supported                        SEQUENCE {
      tdd-edch-PhysicalLayerCategory INTEGER (1..16)
    },
    unsupported                       NULL
  }
}

UL-PhysChCapabilityTDD-LCR-r4 ::= SEQUENCE {
  maxTS-PerSubFrame                 MaxTS-PerSubFrame-r4,
  maxPhysChPerTimeslot              MaxPhysChPerTimeslot,
  minimumSF                          MinimumSF-UL,
  supportOfPUSCH                    BOOLEAN,
  supportOf8PSK                     BOOLEAN
}

UL-PhysChCapabilityTDD-128-v770ext ::= SEQUENCE {

```

```

maxPhysChPerTimeslot          MaxPhysChPerTimeslot-LCR-r7,
tdd128-edch                   CHOICE {
  supported                    SEQUENCE {
    tdd-edch-PhysicalLayerCategory  INTEGER (1..6)
  },
  unsupported                   NULL
}
}

UL-PhysChCapabilityInfoTDD-128-v770ext ::= SEQUENCE {
  maxPhysChPerTimeslot          MaxPhysChPerTimeslot-LCR-r7
}

UL-PhysChCapabilityTDD-768 ::= SEQUENCE {
  maxTS-PerFrame                MaxTS-PerFrame,
  maxPhysChPerTimeslot          MaxPhysChPerTimeslot,
  minimumSF                     MinimumSF-UL,
  supportOfPUSCH                BOOLEAN,
  tdd384-edch                   CHOICE {
    supported                    SEQUENCE {
      tdd-edch-PhysicalLayerCategory  INTEGER (1..16)
    },
    unsupported                   NULL
  }
}

PhysicalChannelCapability-edch-r6 ::= SEQUENCE {
  fdd-edch                      CHOICE {
    supported                    SEQUENCE {
      edch-PhysicalLayerCategory      INTEGER (1..16)
    },
    unsupported                   NULL
  }
}

UL-TransChCapability ::= SEQUENCE {
  maxNoBitsTransmitted          MaxNoBits,
  maxConvCodeBitsTransmitted    MaxNoBits,
  turboEncodingSupport          TurboSupport,
  maxSimultaneousTransChs       MaxSimultaneousTransChsUL,
  modeSpecificInfo              CHOICE {
    fdd                          NULL,
    tdd                          SEQUENCE {
      maxSimultaneousCCTrCH-Count    MaxSimultaneousCCTrCH-Count
    }
  },
  maxTransmittedBlocks          MaxTransportBlocksUL,
  maxNumberOfTFC                MaxNumberOfTFC-UL,
  maxNumberOfTF                 MaxNumberOfTF
}

UE-Positioning-Capability ::= SEQUENCE {
  standaloneLocMethodsSupported  BOOLEAN,
  ue-BasedOTDOA-Supported        BOOLEAN,
  networkAssistedGPS-Supported   NetworkAssistedGPS-Supported,
  supportForUE-GPS-TimingOfCellFrames  BOOLEAN,
  supportForIPDL                 BOOLEAN
}

UE-SecurityInformation ::= SEQUENCE {
  start-CS                       START-Value
}

UE-SecurityInformation2 ::= SEQUENCE {
  start-PS                       START-Value
}

UE-SpecificCapabilityInformation-LCRTDD ::= ENUMERATED {
  nF,
  nFMc-TriRx-UniTx,
  nFMc-TriRx-TriTx,
  nFMc-HexRx-UniTx,
  nFMc-HexRx-TriTx,
  nFMc-HexRx-HexTx,
  spare10,
  spare9,
  spare8,
  spare7,
}

```

```

        spare6,
        spare5,
        spare4,
        spare3,
        spare2,
        spare1 }

URA-UpdateCause ::= ENUMERATED {
    changeOfURA,
    periodicURAUpdate,
    dummy,
    spare1 }

UTRAN-DRX-CycleLengthCoefficient ::= INTEGER (3..9)

UTRAN-DRX-CycleLengthCoefficient-r7 ::= SEQUENCE {
    drx-CycleLengthCoefficient    INTEGER (3..9),
    drx-CycleLengthCoefficient2    INTEGER (3..9)                OPTIONAL,
    timeForDRXCycle2              T-319                        OPTIONAL
}

WaitTime ::= INTEGER (0..15)

-- *****
--
-- RADIO BEARER INFORMATION ELEMENTS (10.3.4)
--
-- *****

AlgorithmSpecificInfo ::= CHOICE {
    rfc2507-Info
}

AlgorithmSpecificInfo-r4 ::= CHOICE {
    rfc2507-Info
    rfc3095-Info
}

CID-InclusionInfo-r4 ::= ENUMERATED {
    pdcp-Header,
    rfc3095-PacketFormat }

CommonRBMappingInfo ::= SEQUENCE {
    logicalChannelIdentity
    mac-ehs-QueueId
}

-- Upper limit of COUNT-C is 2^32 - 1
COUNT-C ::= INTEGER (0..4294967295)

-- Upper limit of COUNT-C-MSB is 2^25 - 1
COUNT-C-MSB ::= INTEGER (0..33554431)

CS-HSPA-Information ::= SEQUENCE {
    ul-AMR-Rate                UL-AMR-Rate                OPTIONAL,
    maxCS-Delay                MaxCS-Delay
}

DefaultConfigForCellFACH ::= SEQUENCE {
    defaultConfigMode
    defaultConfigIdForCellFACH
}

DefaultConfigIdentity ::= INTEGER (0..10)

DefaultConfigIdentity-r4 ::= INTEGER (0..12)

DefaultConfigIdentity-r5 ::= INTEGER (0..13)

-- DefaultConfigIdentity-r6 values 23..31 are spare and shall not be used in this version of
-- the protocol
DefaultConfigIdentity-r6 ::= INTEGER (0..31)

-- DefaultConfigIdForCellFACH values 1..15 are spare and shall not be used in this version of
-- the protocol
DefaultConfigIdForCellFACH ::= INTEGER (0..15)

DefaultConfigMode ::= ENUMERATED {

```

```

        fdd,
        tdd }

DDI ::= INTEGER (0..62)

DL-AM-RLC-Mode ::= SEQUENCE {
    inSequenceDelivery      BOOLEAN,
    receivingWindowSize     ReceivingWindowSize,
    dl-RLC-StatusInfo      DL-RLC-StatusInfo
}

DL-AM-RLC-Mode-r5 ::= SEQUENCE {
    dl-RLC-PDU-size        OctetModeRLC-SizeInfoType1,
    inSequenceDelivery      BOOLEAN,
    receivingWindowSize     ReceivingWindowSize,
    dl-RLC-StatusInfo      DL-RLC-StatusInfo
}

DL-AM-RLC-Mode-r7 ::= SEQUENCE {
    dl-RLC-PDU-size        CHOICE {
        fixedSize          OctetModeRLC-SizeInfoType1,
        flexibleSize       ENUMERATED { size7, size15 }
    },
    inSequenceDelivery      BOOLEAN,
    receivingWindowSize     ReceivingWindowSize,
    dl-RLC-StatusInfo      DL-RLC-StatusInfo
}

DL-CounterSynchronisationInfo ::= SEQUENCE {
    rB-WithPDCP-InfoList   RB-WithPDCP-InfoList OPTIONAL
}

DL-CounterSynchronisationInfo-r5 ::= SEQUENCE {
    rb-WithPDCP-InfoList   RB-WithPDCP-InfoList OPTIONAL,
    rb-PDCPContextRelocationList RB-PDCPContextRelocationList OPTIONAL
}

DL-LogicalChannelMapping ::= SEQUENCE {
    -- TABULAR: DL-TransportChannelType contains TransportChannelIdentity as well.
    dl-TransportChannelType DL-TransportChannelType,
    logicalChannelIdentity   LogicalChannelIdentity OPTIONAL
}

DL-LogicalChannelMapping-r5 ::= SEQUENCE {
    -- TABULAR: DL-TransportChannelType contains TransportChannelIdentity as well.
    dl-TransportChannelType DL-TransportChannelType-r5,
    logicalChannelIdentity   LogicalChannelIdentity OPTIONAL
}

DL-LogicalChannelMapping-r7 ::= SEQUENCE {
    -- TABULAR: DL-TransportChannelType contains TransportChannelIdentity as well.
    dl-TransportChannelType DL-TransportChannelType-r7,
    logicalChannelIdentity   LogicalChannelIdentity OPTIONAL
}

DL-LogicalChannelMappingList ::= SEQUENCE (SIZE (1..maxLoCHperRLC)) OF
    DL-LogicalChannelMapping

DL-LogicalChannelMappingList-r5 ::= SEQUENCE (SIZE (1..maxLoCHperRLC)) OF
    DL-LogicalChannelMapping-r5

DL-LogicalChannelMappingList-r7 ::= SEQUENCE (SIZE (1..maxLoCHperRLC)) OF
    DL-LogicalChannelMapping-r7

DL-Reception-Window-Size-r6 ::= ENUMERATED { size32, size48, size64, size80, size96, size112 }

DL-RFC3095-r4 ::= SEQUENCE {
    -- dummy is not used in this version of the specification and shall be ignored by the receiver.
    dummy          CID-InclusionInfo-r4,
    max-CID        INTEGER (1..16383)          DEFAULT 15,
    reverseDecompressionDepth INTEGER (0..65535)    DEFAULT 0
}

DL-RLC-Mode ::= CHOICE {
    dl-AM-RLC-Mode    DL-AM-RLC-Mode,
    dl-UM-RLC-Mode    NULL,
    dl-TM-RLC-Mode    DL-TM-RLC-Mode
}

```

```

DL-RLC-Mode-r5 ::= CHOICE {
    dl-AM-RLC-Mode DL-AM-RLC-Mode-r5,
    dl-UM-RLC-Mode DL-UM-RLC-Mode-r5,
    dl-TM-RLC-Mode DL-TM-RLC-Mode
}

DL-RLC-Mode-r6 ::= CHOICE {
    dl-AM-RLC-Mode DL-AM-RLC-Mode-r5,
    dl-UM-RLC-Mode DL-UM-RLC-Mode-r6,
    dl-TM-RLC-Mode DL-TM-RLC-Mode
}

DL-RLC-Mode-r7 ::= CHOICE {
    dl-AM-RLC-Mode DL-AM-RLC-Mode-r7,
    dl-UM-RLC-Mode DL-UM-RLC-Mode-r6,
    dl-TM-RLC-Mode DL-TM-RLC-Mode
}

DL-RLC-StatusInfo ::= SEQUENCE {
    timerStatusProhibit TimerStatusProhibit OPTIONAL,
    -- dummy is not used in this version of the specification, it should not be sent
    -- and if received they should be ignored.
    dummy TimerEPC OPTIONAL,
    missingPDU-Indicator BOOLEAN,
    timerStatusPeriodic TimerStatusPeriodic OPTIONAL
}

DL-TM-RLC-Mode ::= SEQUENCE {
    segmentationIndication BOOLEAN
}

DL-TransportChannelType ::= CHOICE {
    dch TransportChannelIdentity,
    fach NULL,
    -- The choice "dsch" should not be used in FDD mode, and if received
    -- the UE behaviour is unspecified.
    dsch TransportChannelIdentity,
    -- The choice "dch-and-dsch" should not be used in FDD mode, and if received the UE
    -- behaviour is unspecified
    dch-and-dsch TransportChannelIdentityDCHandDSCH
}

DL-TransportChannelType-r5 ::= CHOICE {
    dch TransportChannelIdentity,
    fach NULL,
    -- The choice "dsch" should not be used in FDD mode, and if received
    -- the UE behaviour is unspecified.
    dsch TransportChannelIdentity,
    -- The choice "dch-and-dsch" should not be used in FDD mode, and if received the UE
    -- behaviour is unspecified
    dch-and-dsch TransportChannelIdentityDCHandDSCH,
    hsdSCH MAC-d-FlowIdentity,
    dch-and-hsdSCH MAC-d-FlowIdentityDCHandHSDSCH
}

DL-TransportChannelType-r7 ::= CHOICE {
    dch TransportChannelIdentity,
    fach NULL,
    -- The choice "dsch" should not be used in FDD mode, and if received
    -- the UE behaviour is unspecified.
    dsch TransportChannelIdentity,
    -- The choice "dch-and-dsch" should not be used in FDD mode, and if received the UE
    -- behaviour is unspecified
    dch-and-dsch TransportChannelIdentityDCHandDSCH,
    hsdSCH CHOICE {
        mac-hs MAC-d-FlowIdentity,
        mac-ehs MAC-ehs-QueueId
    },
    dch-and-hsdSCH CHOICE {
        mac-hs MAC-d-FlowIdentityDCHandHSDSCH,
        mac-ehs MAC-ehs-QueueIdDCHandHSDSCH
    }
}

DL-UM-RLC-LI-size ::= ENUMERATED {
    size7, size15 }

```



```

DL-UM-RLC-Mode-r5 ::= SEQUENCE {
    dl-UM-RLC-LI-size
}

DL-UM-RLC-Mode-r6 ::= SEQUENCE {
    dl-UM-RLC-LI-size,
    dl-Reception-Window-Size DL-Reception-Window-Size-r6 OPTIONAL
}

ExpectReordering ::= ENUMERATED {
    reorderingNotExpected,
    reorderingExpected }

ExplicitDiscard ::= SEQUENCE {
    timerMRW,
    timerDiscard,
    maxMRW
}

HeaderCompressionInfo ::= SEQUENCE {
    algorithmSpecificInfo
}

HeaderCompressionInfoList ::= SEQUENCE (SIZE (1..maxPDCPALgoType)) OF
    HeaderCompressionInfo

HeaderCompressionInfo-r4 ::= SEQUENCE {
    algorithmSpecificInfo-r4
}

HeaderCompressionInfoList-r4 ::= SEQUENCE (SIZE (1..maxPDCPALgoType)) OF
    HeaderCompressionInfo-r4

LogicalChannelIdentity ::= INTEGER (1..15)

LosslessSRNS-RelocSupport ::= CHOICE {
    supported MaxPDCP-SN-WindowSize,
    notSupported NULL
}

MAC-d-HFN-initial-value ::= BIT STRING (SIZE (24))

MAC-LogicalChannelPriority ::= INTEGER (1..8)

-- Actual value MaxCS-Delay = (IE value * 10) + 20
MaxCS-Delay ::= INTEGER (0..18)

MaxDAT ::= ENUMERATED {
    dat1, dat2, dat3, dat4, dat5, dat6,
    dat7, dat8, dat9, dat10, dat15, dat20,
    dat25, dat30, dat35, dat40 }

MaxDAT-Retransmissions ::= SEQUENCE {
    maxDAT,
    timerMRW,
    maxMRW
}

MaxMRW ::= ENUMERATED {
    mm1, mm4, mm6, mm8, mm12, mm16,
    mm24, mm32 }

MaxPDCP-SN-WindowSize ::= ENUMERATED {
    sn255, sn65535 }

MaxRST ::= ENUMERATED {
    rst1, rst4, rst6, rst8, rst12,
    rst16, rst24, rst32 }

NoExplicitDiscard ::= ENUMERATED {
    dt10, dt20, dt30, dt40, dt50,
    dt60, dt70, dt80, dt90, dt100 }

PDCP-Info ::= SEQUENCE {
    losslessSRNS-RelocSupport LosslessSRNS-RelocSupport OPTIONAL,
    -- TABULAR: pdcp-PDU-Header is MD in the tabular format and it can be encoded
    -- in one bit, so the OPTIONAL is removed for compactness.
    pdcp-PDU-Header PDCP-PDU-Header,

```

```

    headerCompressionInfoList          HeaderCompressionInfoList          OPTIONAL
  }
PDCP-Info-r4 ::=                      SEQUENCE {
  losslessSRNS-RelocSupport            LosslessSRNS-RelocSupport            OPTIONAL,
  -- TABULAR: pdcP-PDU-Header is MD in the tabular format and it can be encoded
  -- in one bit, so the OPTIONAL is removed for compactness.
  pdcP-PDU-Header                      PDCP-PDU-Header,
  headerCompressionInfoList            HeaderCompressionInfoList-r4        OPTIONAL
}
PDCP-InfoReconfig ::=                SEQUENCE {
  pdcP-Info                            PDCP-Info,
  -- dummy is not used in this version of the specification and
  -- it should be ignored.
  dummy                                INTEGER (0..65535)
}
PDCP-InfoReconfig-r4 ::=              SEQUENCE {
  pdcP-Info                            PDCP-Info-r4
}
PDCP-PDU-Header ::=                  ENUMERATED {
  present, absent }
PDCP-ROHC-TargetMode ::=              ENUMERATED { o-Mode, r-Mode }
PDCP-SN-Info ::=                      INTEGER (0..65535)
Poll-PDU ::=                          ENUMERATED {
  pdu1, pdu2, pdu4, pdu8, pdu16,
  pdu32, pdu64, pdu128 }
Poll-SDU ::=                          ENUMERATED {
  sdu1, sdu4, sdu16, sdu64 }
PollingInfo ::=                      SEQUENCE {
  timerPollProhibit                    TimerPollProhibit                    OPTIONAL,
  timerPoll                            TimerPoll                            OPTIONAL,
  poll-PDU                             Poll-PDU                             OPTIONAL,
  poll-SDU                             Poll-SDU                             OPTIONAL,
  lastTransmissionPDU-Poll              BOOLEAN,
  lastRetransmissionPDU-Poll            BOOLEAN,
  pollWindow                            PollWindow                            OPTIONAL,
  timerPollPeriodic                    TimerPollPeriodic                    OPTIONAL
}
PollWindow ::=                       ENUMERATED {
  pw50, pw60, pw70, pw80, pw85,
  pw90, pw95, pw99 }
PredefinedConfigIdentity ::=           INTEGER (0..15)
PredefinedConfigValueTag ::=           INTEGER (0..15)
PredefinedRB-Configuration ::=         SEQUENCE {
  re-EstablishmentTimer                Re-EstablishmentTimer,
  srb-InformationList                  SRB-InformationSetupList,
  rb-InformationList                    RB-InformationSetupList
}
PreDefRadioConfiguration ::=           SEQUENCE {
  -- Radio bearer IEs
  predefinedRB-Configuration            PredefinedRB-Configuration,
  -- Transport channel IEs
  preDefTransChConfiguration            PreDefTransChConfiguration,
  -- Physical channel IEs
  preDefPhyChConfiguration              PreDefPhyChConfiguration
}
PreDefRadioConfiguration-v770ext ::= SEQUENCE {
  -- Physical channel IEs
  preDefPhyChConfiguration              PreDefPhyChConfiguration-v770ext
}
PredefinedConfigStatusList ::=         SEQUENCE (SIZE (maxPredefConfig)) OF
  PredefinedConfigStatusInfo

```

```

PredefinedConfigStatusInfo ::= CHOICE {
    storedWithValueTagSameAsPrevious    NULL,
    other                                CHOICE {
        notStored                        NULL,
        storedWithDifferentValueTag      PredefinedConfigValueTag
    }
}

PredefinedConfigStatusListComp ::= SEQUENCE {
    setsWithDifferentValueTag            PredefinedConfigSetsWithDifferentValueTag,
    otherEntries                         PredefinedConfigStatusListVarSz          OPTIONAL
}

PredefinedConfigSetsWithDifferentValueTag ::= SEQUENCE (SIZE (1..2)) OF
    PredefinedConfigSetWithDifferentValueTag

PredefinedConfigSetWithDifferentValueTag ::= SEQUENCE {
    startPosition                        INTEGER (0..10)          DEFAULT 0,
    -- numberOfEntries                    INTEGER (6..16),
    -- numberOfEntries is covered by the size of the list in IE PredefinedConfigValueTagList
    valueTagList                         PredefinedConfigValueTagList
}

PredefinedConfigValueTagList ::= SEQUENCE (SIZE (1..maxPredefConfig)) OF
    PredefinedConfigValueTag

PredefinedConfigStatusListVarSz ::= SEQUENCE (SIZE (1..maxPredefConfig)) OF
    PredefinedConfigStatusInfo

RAB-Info ::= SEQUENCE {
    rab-Identity                         RAB-Identity,
    cn-DomainIdentity                    CN-DomainIdentity,
    nas-Synchronisation-Indicator        NAS-Synchronisation-Indicator    OPTIONAL,
    re-EstablishmentTimer                Re-EstablishmentTimer
}

RAB-Info-r6-ext ::= SEQUENCE {
    mbms-SessionIdentity                 MBMS-SessionIdentity            OPTIONAL
}

RAB-Info-v6b0ext ::= SEQUENCE {
    mbms-ServiceIdentity                 OCTET STRING (SIZE (3))
}

RAB-Info-r6 ::= SEQUENCE {
    rab-Identity                         RAB-Identity,
    mbms-SessionIdentity                 MBMS-SessionIdentity            OPTIONAL,
    cn-DomainIdentity                    CN-DomainIdentity,
    nas-Synchronisation-Indicator        NAS-Synchronisation-Indicator    OPTIONAL,
    re-EstablishmentTimer                Re-EstablishmentTimer
}

RAB-Info-r7 ::= SEQUENCE {
    rab-Identity                         RAB-Identity,
    mbms-SessionIdentity                 MBMS-SessionIdentity            OPTIONAL,
    mbms-ServiceIdentity                 OCTET STRING (SIZE (3))          OPTIONAL,
    cn-DomainIdentity                    CN-DomainIdentity,
    nas-Synchronisation-Indicator        NAS-Synchronisation-Indicator    OPTIONAL,
    re-EstablishmentTimer                Re-EstablishmentTimer
}

RAB-InfoReplace ::= SEQUENCE {
    rab-Identity                         RAB-Identity,
    cn-DomainIdentity                    CN-DomainIdentity
}

RAB-InformationList ::= SEQUENCE (SIZE (1..maxRABsetup)) OF
    RAB-Info

RAB-InformationList-r6 ::= SEQUENCE (SIZE (1..maxRABsetup)) OF
    RAB-Info-r6

RAB-InformationReconfigList ::= SEQUENCE (SIZE (1..maxRABsetup)) OF
    RAB-InformationReconfig

RAB-InformationReconfigList-r8 ::= SEQUENCE (SIZE (1..maxRABsetup)) OF
    RAB-InformationReconfig-r8

```

```

RAB-InformationReconfig ::= SEQUENCE {
    rab-Identity          RAB-Identity,
    cn-DomainIdentity    CN-DomainIdentity,
    nas-Synchronisation-Indicator NAS-Synchronisation-Indicator
}

RAB-InformationReconfig-r8 ::= SEQUENCE {
    rab-Identity          RAB-Identity,
    cn-DomainIdentity    CN-DomainIdentity,
    nas-Synchronisation-Indicator NAS-Synchronisation-Indicator,
    cs-HSPA-Information  CS-HSPA-Information OPTIONAL
}

RAB-Info-Post ::= SEQUENCE {
    rab-Identity          RAB-Identity,
    cn-DomainIdentity    CN-DomainIdentity,
    nas-Synchronisation-Indicator NAS-Synchronisation-Indicator OPTIONAL
}

RAB-InformationMBMSPTp ::= SEQUENCE {
    rb-Identity          RB-Identity,
    mbms-ServiceIdentity OCTET STRING (SIZE (3)),
    mbms-SessionIdentity MBMS-SessionIdentity OPTIONAL
}

RAB-InformationMBMSPTpList ::= SEQUENCE (SIZE (1..maxMBMSservSelect)) OF
    RAB-InformationMBMSPTp

RAB-InformationSetup ::= SEQUENCE {
    rab-Info             RAB-Info,
    rb-InformationSetupList RB-InformationSetupList
}

RAB-InformationSetup-r4 ::= SEQUENCE {
    rab-Info             RAB-Info,
    rb-InformationSetupList RB-InformationSetupList-r4
}

RAB-InformationSetup-r5 ::= SEQUENCE {
    rab-Info             RAB-Info,
    rb-InformationSetupList RB-InformationSetupList-r5
}

RAB-InformationSetup-r6-ext ::= SEQUENCE {
    rab-Info-r6-ext     RAB-Info-r6-ext
}

RAB-InformationSetup-r6 ::= SEQUENCE {
    rab-Info             RAB-Info-r6,
    rb-InformationSetupList RB-InformationSetupList-r6
}

RAB-InformationSetup-v6b0ext ::= SEQUENCE {
    rab-Info-v6b0ext     RAB-Info-v6b0ext OPTIONAL
}

RAB-InformationSetup-r7 ::= SEQUENCE {
    rab-Info             RAB-Info-r7,
    rb-InformationSetupList RB-InformationSetupList-r7
}

RAB-InformationSetup-r8 ::= SEQUENCE {
    rab-Info             RAB-Info-r7,
    cs-HSPA-Information  CS-HSPA-Information OPTIONAL,
    rab-InfoReplace      RAB-InfoReplace OPTIONAL,
    rb-InformationSetupList RB-InformationSetupList-r8
}

RAB-InformationSetup-v820ext ::= SEQUENCE {
    cs-HSPA-Information  CS-HSPA-Information OPTIONAL
}

RAB-InformationSetupList ::= SEQUENCE (SIZE (1..maxRABsetup)) OF
    RAB-InformationSetup

RAB-InformationSetupList-r4 ::= SEQUENCE (SIZE (1..maxRABsetup)) OF
    RAB-InformationSetup-r4

```

```

RAB-InformationSetupList-r5 ::= SEQUENCE (SIZE (1..maxRABsetup)) OF
                                RAB-InformationSetup-r5

RAB-InformationSetupList-r6 ::= SEQUENCE (SIZE (1..maxRABsetup)) OF
                                RAB-InformationSetup-r6

-- The IE 'RAB-InformationSetupList-r6-ext' provides elements of extension information, which
-- are added to the corresponding elements of the IE 'RAB-InformationSetupList/-r4/-r5'.
RAB-InformationSetupList-r6-ext ::= SEQUENCE (SIZE (1..maxRABsetup)) OF
                                    RAB-InformationSetup-r6-ext

RAB-InformationSetupList-v6b0ext ::= SEQUENCE (SIZE (1..maxRABsetup)) OF
                                      RAB-InformationSetup-v6b0ext

RAB-InformationSetupList-r7 ::= SEQUENCE (SIZE (1..maxRABsetup)) OF
                                RAB-InformationSetup-r7

RAB-InformationSetupList-r8 ::= SEQUENCE (SIZE (1..maxRABsetup)) OF
                                RAB-InformationSetup-r8

RAB-InformationSetupList-v820ext ::= SEQUENCE (SIZE (1..maxRABsetup)) OF
                                      RAB-InformationSetup-v820ext

RB-ActivationTimeInfo ::= SEQUENCE {
    rb-Identity          RB-Identity,
    rlc-SequenceNumber  RLC-SequenceNumber
}

RB-ActivationTimeInfoList ::= SEQUENCE (SIZE (1..maxRB)) OF
                              RB-ActivationTimeInfo

RB-COUNT-C-Information ::= SEQUENCE {
    rb-Identity          RB-Identity,
    count-C-UL          COUNT-C,
    count-C-DL          COUNT-C
}

RB-COUNT-C-InformationList ::= SEQUENCE (SIZE (1..maxRBallRABs)) OF
                              RB-COUNT-C-Information

RB-COUNT-C-MSB-Information ::= SEQUENCE {
    rb-Identity          RB-Identity,
    count-C-MSB-UL      COUNT-C-MSB,
    count-C-MSB-DL      COUNT-C-MSB
}

RB-COUNT-C-MSB-InformationList ::= SEQUENCE (SIZE (1..maxRBallRABs)) OF
                                   RB-COUNT-C-MSB-Information

RB-Identity ::= INTEGER (1..32)

RB-IdentityList ::= SEQUENCE (SIZE (1..maxRB)) OF
                   RB-Identity

RB-InformationAffected ::= SEQUENCE {
    rb-Identity          RB-Identity,
    rb-MappingInfo      RB-MappingInfo
}

RB-InformationAffected-r5 ::= SEQUENCE {
    rb-Identity          RB-Identity,
    rb-MappingInfo      RB-MappingInfo-r5
}

RB-InformationAffected-r6 ::= SEQUENCE {
    rb-Identity          RB-Identity,
    rb-MappingInfo      RB-MappingInfo-r6
}

RB-InformationAffected-r7 ::= SEQUENCE {
    rb-Identity          RB-Identity,
    rb-MappingInfo      RB-MappingInfo-r7
}

RB-InformationAffected-r8 ::= SEQUENCE {
    rb-Identity          RB-Identity,
    rb-MappingInfo      RB-MappingInfo-r8
}

```

```

}

RB-InformationAffectedList ::= SEQUENCE (SIZE (1..maxRB)) OF
    RB-InformationAffected

RB-InformationAffectedList-r5 ::= SEQUENCE (SIZE (1..maxRB)) OF
    RB-InformationAffected-r5

RB-InformationAffectedList-r6 ::= SEQUENCE (SIZE (1..maxRB)) OF
    RB-InformationAffected-r6

RB-InformationAffectedList-r7 ::= SEQUENCE (SIZE (1..maxRB)) OF
    RB-InformationAffected-r7

RB-InformationAffectedList-r8 ::= SEQUENCE (SIZE (1..maxRB)) OF
    RB-InformationAffected-r8

RB-InformationChanged-r6 ::= SEQUENCE {
    rb-Identity
    rb-Change
        release
        re-mapToDefaultRb
    }
}

RB-InformationChangedList-r6 ::= SEQUENCE (SIZE (1..maxRB)) OF
    RB-InformationChanged-r6

RB-InformationReconfig ::= SEQUENCE {
    rb-Identity
    pdcp-Info
    pdcp-SN-Info
    rlc-Info
    rb-MappingInfo
    rb-StopContinue
}

RB-InformationReconfig-r4 ::= SEQUENCE {
    rb-Identity
    pdcp-Info
    pdcp-SN-Info
    rlc-Info
    rb-MappingInfo
    rb-StopContinue
}

RB-InformationReconfig-r5 ::= SEQUENCE {
    rb-Identity
    pdcp-Info
    pdcp-SN-Info
    rlc-Info
    rb-MappingInfo
    rb-StopContinue
}

RB-InformationReconfig-r6 ::= SEQUENCE {
    rb-Identity
    pdcp-Info
    pdcp-SN-Info
    rlc-Info
    rb-MappingInfo
    rb-StopContinue
}

RB-InformationReconfig-r7 ::= SEQUENCE {
    rb-Identity
    pdcp-Info
    pdcp-SN-Info
    rlc-Info
    rb-MappingInfo
    rb-StopContinue
}

RB-InformationReconfig-r8 ::= SEQUENCE {
    rb-Identity
    pdcp-Info
    pdcp-SN-Info
    rlc-Info
}

```

| | | |
|-----------------------------------|---|-----------|
| rb-MappingInfo | RB-MappingInfo-r8 | OPTIONAL, |
| rb-StopContinue | RB-StopContinue | OPTIONAL |
| } | | |
| RB-InformationReconfigList ::= | SEQUENCE (SIZE (1..maxRB)) OF
RB-InformationReconfig | |
| RB-InformationReconfigList-r4 ::= | SEQUENCE (SIZE (1..maxRB)) OF
RB-InformationReconfig-r4 | |
| RB-InformationReconfigList-r5 ::= | SEQUENCE (SIZE (1..maxRB)) OF
RB-InformationReconfig-r5 | |
| RB-InformationReconfigList-r6 ::= | SEQUENCE (SIZE (1..maxRB)) OF
RB-InformationReconfig-r6 | |
| RB-InformationReconfigList-r7 ::= | SEQUENCE (SIZE (1..maxRB)) OF
RB-InformationReconfig-r7 | |
| RB-InformationReconfigList-r8 ::= | SEQUENCE (SIZE (1..maxRB)) OF
RB-InformationReconfig-r8 | |
| RB-InformationReleaseList ::= | SEQUENCE (SIZE (1..maxRB)) OF
RB-Identity | |
| RB-InformationSetup ::= | SEQUENCE {
RB-Identity,
PDCP-Info
RLC-InfoChoice,
RB-MappingInfo | OPTIONAL, |
| } | | |
| RB-InformationSetup-r4 ::= | SEQUENCE {
RB-Identity,
PDCP-Info-r4
RLC-InfoChoice,
RB-MappingInfo | OPTIONAL, |
| } | | |
| RB-InformationSetup-r5 ::= | SEQUENCE {
RB-Identity,
PDCP-Info-r4
RLC-InfoChoice-r5,
RB-MappingInfo-r5 | OPTIONAL, |
| } | | |
| RB-InformationSetup-r6 ::= | SEQUENCE {
RB-Identity,
PDCP-Info-r4
RLC-InfoChoice-r6,
RB-MappingInfo-r6 | OPTIONAL, |
| } | | |
| RB-InformationSetup-r7 ::= | SEQUENCE {
RB-Identity,
PDCP-Info-r4
RLC-InfoChoice-r7,
RB-MappingInfo-r7 | OPTIONAL, |
| } | | |
| RB-InformationSetup-r8 ::= | SEQUENCE {
RB-Identity,
PDCP-Info-r4
RLC-InfoChoice-r7,
RB-MappingInfo-r8 | OPTIONAL, |
| } | | |
| RB-InformationSetupList ::= | SEQUENCE (SIZE (1..maxRBperRAB)) OF
RB-InformationSetup | |
| RB-InformationSetupList-r4 ::= | SEQUENCE (SIZE (1..maxRBperRAB)) OF
RB-InformationSetup-r4 | |
| RB-InformationSetupList-r5 ::= | SEQUENCE (SIZE (1..maxRBperRAB)) OF
RB-InformationSetup-r5 | |
| RB-InformationSetupList-r6 ::= | SEQUENCE (SIZE (1..maxRBperRAB)) OF
RB-InformationSetup-r6 | |

| | | |
|----------------------------------|--|---|
| RB-InformationSetupList-r7 ::= | SEQUENCE (SIZE (1..maxRBperRAB)) OF
RB-InformationSetup-r7 | |
| RB-InformationSetupList-r8 ::= | SEQUENCE (SIZE (1..maxRBperRAB)) OF
RB-InformationSetup-r8 | |
| RB-MappingInfo ::= | SEQUENCE (SIZE (1..maxRBMuxOptions)) OF
RB-MappingOption | |
| RB-MappingInfo-r5 ::= | SEQUENCE (SIZE (1..maxRBMuxOptions)) OF
RB-MappingOption-r5 | |
| RB-MappingInfo-r6 ::= | SEQUENCE (SIZE (1..maxRBMuxOptions)) OF
RB-MappingOption-r6 | |
| RB-MappingInfo-r7 ::= | SEQUENCE (SIZE (1..maxRBMuxOptions)) OF
RB-MappingOption-r7 | |
| RB-MappingInfo-r8 ::= | SEQUENCE (SIZE (1..maxRBMuxOptions)) OF
RB-MappingOption-r8 | |
| RB-MappingOption ::= | SEQUENCE {
ul-LogicalChannelMappings
dl-LogicalChannelMappingList
} | OPTIONAL,
OPTIONAL |
| RB-MappingOption-r5 ::= | SEQUENCE {
ul-LogicalChannelMappings
dl-LogicalChannelMappingList
} | OPTIONAL,
OPTIONAL |
| RB-MappingOption-r6 ::= | SEQUENCE {
ul-LogicalChannelMappings
dl-LogicalChannelMappingList
} | OPTIONAL,
OPTIONAL |
| RB-MappingOption-r7 ::= | SEQUENCE {
ul-LogicalChannelMappings
dl-LogicalChannelMappingList
} | OPTIONAL,
OPTIONAL |
| RB-MappingOption-r8 ::= | SEQUENCE {
ul-LogicalChannelMappings
dl-LogicalChannelMappingList
} | OPTIONAL,
OPTIONAL |
| RB-PDCPContextRelocation ::= | SEQUENCE {
rb-Identity
dl-RFC3095-Context-Relocation
ul-RFC3095-Context-Relocation
} | RB-Identity,
BOOLEAN,
BOOLEAN |
| RB-PDCPContextRelocationList ::= | SEQUENCE (SIZE (1..maxRBallRABs)) OF
RB-PDCPContextRelocation | |
| RB-StopContinue ::= | ENUMERATED {
stopRB, continueRB } | |
| RB-WithPDCP-Info ::= | SEQUENCE {
rb-Identity
pdcP-SN-Info
} | RB-Identity,
PDCP-SN-Info |
| RB-WithPDCP-InfoList ::= | SEQUENCE (SIZE (1..maxRBallRABs)) OF
RB-WithPDCP-Info | |
| ReceivingWindowSize ::= | ENUMERATED {
rw1, rw8, rw16, rw32, rw64, rw128, rw256,
rw512, rw768, rw1024, rw1536, rw2047,
rw2560, rw3072, rw3584, rw4095 } | |
| RFC2507-Info ::= | SEQUENCE {
f-MAX-PERIOD
f-MAX-TIME
max-HEADER
tcp-SPACE
non-TCP-SPACE | INTEGER (1..65535) DEFAULT 256,
INTEGER (1..255) DEFAULT 5,
INTEGER (60..65535) DEFAULT 168,
INTEGER (3..255) DEFAULT 15,
INTEGER (3..65535) DEFAULT 15, |

```

-- TABULAR: expectReordering has only two possible values, so using Optional or Default
-- would be wasteful
expectReordering          ExpectReordering
}

RFC3095-Info-r4 ::=          SEQUENCE {
    rohcProfileList          ROHC-ProfileList-r4,
    ul-RFC3095              UL-RFC3095-r4          OPTIONAL,
    dl-RFC3095              DL-RFC3095-r4          OPTIONAL
}

RLC-Info ::=                SEQUENCE {
    ul-RLC-Mode              UL-RLC-Mode          OPTIONAL,
    dl-RLC-Mode              DL-RLC-Mode          OPTIONAL
}

RLC-Info-r5 ::=            SEQUENCE {
    ul-RLC-Mode              UL-RLC-Mode          OPTIONAL,
    dl-RLC-Mode              DL-RLC-Mode-r5       OPTIONAL,
    rlc-OneSidedReEst        BOOLEAN
}

RLC-Info-r6 ::=            SEQUENCE {
    ul-RLC-Mode              UL-RLC-Mode          OPTIONAL,
    dl-RLC-Mode              DL-RLC-Mode-r6       OPTIONAL,
    rlc-OneSidedReEst        BOOLEAN,
    altE-bitInterpretation   ENUMERATED { true }  OPTIONAL
}

RLC-Info-r7 ::=            SEQUENCE {
    ul-RLC-Mode              UL-RLC-Mode          OPTIONAL,
    dl-RLC-Mode              DL-RLC-Mode-r7       OPTIONAL,
    rlc-OneSidedReEst        BOOLEAN,
    altE-bitInterpretation   ENUMERATED { true }  OPTIONAL,
    useSpecialValueOfHEField ENUMERATED { true }  OPTIONAL
}

RLC-Info-MCCH-r6 ::=       SEQUENCE {
    dl-UM-RLC-LI-size        DL-UM-RLC-LI-size,
    dl-UM-RLC-OutOSeqDelivery-Info UM-RLC-OutOSeqDelivery-Info-r6  OPTIONAL
}

RLC-Info-MSCH-r6 ::=       SEQUENCE {
    dl-UM-RLC-LI-size        DL-UM-RLC-LI-size
}

RLC-Info-MTCH-r6 ::=       SEQUENCE {
    dl-UM-RLC-LI-size        DL-UM-RLC-LI-size,
    dl-UM-RLC-DuplAvoid-Reord-Info UM-RLC-DuplAvoid-Reord-Info-r6  OPTIONAL
}

RLC-InfoChoice ::=         CHOICE {
    rlc-Info                  RLC-Info,
    same-as-RB                 RB-Identity
}

RLC-InfoChoice-r5 ::=      CHOICE {
    rlc-Info                  RLC-Info-r5,
    same-as-RB                 RB-Identity
}

RLC-InfoChoice-r6 ::=      CHOICE {
    rlc-Info                  RLC-Info-r6,
    same-as-RB                 RB-Identity
}

RLC-InfoChoice-r7 ::=      CHOICE {
    rlc-Info                  RLC-Info-r7,
    same-as-RB                 RB-Identity
}

RLC-PDU-Size ::=           OctetModeRLC-SizeInfoType1

RLC-PDU-SizeConstraint ::= SEQUENCE {
    lengthIndicatorSize       ENUMERATED { size7, size15 }  OPTIONAL,
    -- the actual values are (IE value * 8) + 16
    minRLC-PDU-Size          INTEGER (0..1503),
    largestRLC-PDU-Size      INTEGER (0..1503)
}

```

```

}
RLC-PDU-SizeList ::= SEQUENCE (SIZE (1..maxRLCPDUsizePerLogChan)) OF
    RLC-PDU-Size
RLC-SequenceNumber ::= INTEGER (0..4095)
RLC-SizeInfo ::= SEQUENCE {
    rlc-SizeIndex INTEGER (1..maxTF)
}
RLC-SizeExplicitList ::= SEQUENCE (SIZE (1..maxTF)) OF
    RLC-SizeInfo
ROHC-Profile-r4 ::= INTEGER (1..3)
ROHC-ProfileList-r4 ::= SEQUENCE (SIZE (1..maxROHC-Profile-r4)) OF
    ROHC-Profile-r4
ROHC-PacketSize-r4 ::= INTEGER (2..1500)
ROHC-PacketSizeList-r4 ::= SEQUENCE (SIZE (1..maxROHC-PacketSizes-r4)) OF
    ROHC-PacketSize-r4
SRB-InformationSetup ::= SEQUENCE {
    -- The default value for rb-Identity is the smallest value not used yet.
    rb-Identity RB-Identity OPTIONAL,
    rlc-InfoChoice RLC-InfoChoice,
    rb-MappingInfo RB-MappingInfo
}
SRB-InformationSetup-r5 ::= SEQUENCE {
    -- The default value for rb-Identity is the smallest value not used yet.
    rb-Identity RB-Identity OPTIONAL,
    rlc-InfoChoice RLC-InfoChoice-r5,
    rb-MappingInfo RB-MappingInfo-r5
}
SRB-InformationSetup-r6 ::= SEQUENCE {
    -- The default value for rb-Identity is the smallest value not used yet.
    rb-Identity RB-Identity OPTIONAL,
    rlc-InfoChoice RLC-InfoChoice-r6,
    rb-MappingInfo RB-MappingInfo-r6
}
SRB-InformationSetup-r7 ::= SEQUENCE {
    -- The default value for rb-Identity is the smallest value not used yet.
    rb-Identity RB-Identity OPTIONAL,
    rlc-InfoChoice RLC-InfoChoice-r7,
    rb-MappingInfo RB-MappingInfo-r7
}
SRB-InformationSetup-r8 ::= SEQUENCE {
    -- The default value for rb-Identity is the smallest value not used yet.
    rb-Identity RB-Identity OPTIONAL,
    rlc-InfoChoice RLC-InfoChoice-r7,
    rb-MappingInfo RB-MappingInfo-r8
}
SRB-InformationSetupList ::= SEQUENCE (SIZE (1..maxSRBsetup)) OF
    SRB-InformationSetup
SRB-InformationSetupList-r5 ::= SEQUENCE (SIZE (1..maxSRBsetup)) OF
    SRB-InformationSetup-r5
SRB-InformationSetupList-r6 ::= SEQUENCE (SIZE (1..maxSRBsetup)) OF
    SRB-InformationSetup-r6
SRB-InformationSetupList-r7 ::= SEQUENCE (SIZE (1..maxSRBsetup)) OF
    SRB-InformationSetup-r7
SRB-InformationSetupList-r8 ::= SEQUENCE (SIZE (1..maxSRBsetup)) OF
    SRB-InformationSetup-r8
SRB-InformationSetupList2 ::= SEQUENCE (SIZE (3..4)) OF
    SRB-InformationSetup
SRB-InformationSetupList2-r6 ::= SEQUENCE (SIZE (3..4)) OF

```

```

SRB-InformationSetup-r6

SRB-InformationSetupList2-r7 ::= SEQUENCE (SIZE (3..4)) OF
    SRB-InformationSetup-r7

SRB-InformationSetupList2-r8 ::= SEQUENCE (SIZE (3..4)) OF
    SRB-InformationSetup-r8

TimerDAR-r6 ::= ENUMERATED {
    ms40, ms80, ms120, ms160, ms240, ms320, ms480, ms640,
    ms960, ms1280, ms1920, ms2560, ms3840, ms5120 }

TimerDiscard ::= ENUMERATED {
    td0-1, td0-25, td0-5, td0-75,
    td1, td1-25, td1-5, td1-75,
    td2, td2-5, td3, td3-5, td4,
    td4-5, td5, td7-5 }

TimerEPC ::= ENUMERATED {
    te50, te60, te70, te80, te90,
    te100, te120, te140, te160, te180,
    te200, te300, te400, te500, te700,
    te900 }

TimerMRW ::= ENUMERATED {
    te50, te60, te70, te80, te90, te100,
    te120, te140, te160, te180, te200,
    te300, te400, te500, te700, te900 }

TimerOSD-r6 ::= ENUMERATED {
    ms40, ms80, ms120, ms160, ms240, ms320, ms480, ms640,
    ms960, ms1280, ms1920, ms2560, ms3840, ms5120 }

TimerPoll ::= ENUMERATED {
    tp10, tp20, tp30, tp40, tp50,
    tp60, tp70, tp80, tp90, tp100,
    tp110, tp120, tp130, tp140, tp150,
    tp160, tp170, tp180, tp190, tp200,
    tp210, tp220, tp230, tp240, tp250,
    tp260, tp270, tp280, tp290, tp300,
    tp310, tp320, tp330, tp340, tp350,
    tp360, tp370, tp380, tp390, tp400,
    tp410, tp420, tp430, tp440, tp450,
    tp460, tp470, tp480, tp490, tp500,
    tp510, tp520, tp530, tp540, tp550,
    tp600, tp650, tp700, tp750, tp800,
    tp850, tp900, tp950, tp1000 }

TimerPollPeriodic ::= ENUMERATED {
    tper100, tper200, tper300, tper400,
    tper500, tper750, tper1000, tper2000 }

TimerPollProhibit ::= ENUMERATED {
    tpp10, tpp20, tpp30, tpp40, tpp50,
    tpp60, tpp70, tpp80, tpp90, tpp100,
    tpp110, tpp120, tpp130, tpp140, tpp150,
    tpp160, tpp170, tpp180, tpp190, tpp200,
    tpp210, tpp220, tpp230, tpp240, tpp250,
    tpp260, tpp270, tpp280, tpp290, tpp300,
    tpp310, tpp320, tpp330, tpp340, tpp350,
    tpp360, tpp370, tpp380, tpp390, tpp400,
    tpp410, tpp420, tpp430, tpp440, tpp450,
    tpp460, tpp470, tpp480, tpp490, tpp500,
    tpp510, tpp520, tpp530, tpp540, tpp550,
    tpp600, tpp650, tpp700, tpp750, tpp800,
    tpp850, tpp900, tpp950, tpp1000 }

TimerRST ::= ENUMERATED {
    tr50, tr100, tr150, tr200, tr250, tr300,
    tr350, tr400, tr450, tr500, tr550,
    tr600, tr700, tr800, tr900, tr1000 }

TimerStatusPeriodic ::= ENUMERATED {
    tsp100, tsp200, tsp300, tsp400, tsp500,
    tsp750, tsp1000, tsp2000 }

TimerStatusProhibit ::= ENUMERATED {
    tsp10, tsp20, tsp30, tsp40, tsp50,

```

```

tsp60,tsp70,tsp80,tsp90,tsp100,
tsp110,tsp120,tsp130,tsp140,tsp150,
tsp160,tsp170,tsp180,tsp190,tsp200,
tsp210,tsp220,tsp230,tsp240,tsp250,
tsp260,tsp270,tsp280,tsp290,tsp300,
tsp310,tsp320,tsp330,tsp340,tsp350,
tsp360,tsp370,tsp380,tsp390,tsp400,
tsp410,tsp420,tsp430,tsp440,tsp450,
tsp460,tsp470,tsp480,tsp490,tsp500,
tsp510,tsp520,tsp530,tsp540,tsp550,
tsp600,tsp650,tsp700,tsp750,tsp800,
tsp850,tsp900,tsp950,tsp1000 }

TransmissionRLC-Discard ::=          CHOICE {
    timerBasedExplicit
    timerBasedNoExplicit
    maxDAT-Retransmissions
    noDiscard
}

TransmissionWindowSize ::=          ENUMERATED {
    tw1, tw8, tw16, tw32, tw64, tw128, tw256,
    tw512, tw768, tw1024, tw1536, tw2047,
    tw2560, tw3072, tw3584, tw4095 }

-- Actual bit rate per each value is defined in [62] and [63]
UL-AMR-Rate ::=                     ENUMERATED {
    t0, t1, t2, t3, t4, t5, t6, t7, t8, spare7, spare6, spare5,
    spare4, spare3, spare2, spare1 }

UL-AM-RLC-Mode ::=                 SEQUENCE {
    transmissionRLC-Discard
    transmissionWindowSize
    timerRST
    max-RST
    pollingInfo
}

UL-CounterSynchronisationInfo ::=  SEQUENCE {
    rB-WithPDCP-InfoList
    startList
}

UL-LogicalChannelMapping ::=        SEQUENCE {
    -- TABULAR: UL-TransportChannelType contains TransportChannelIdentity as well.
    ul-TransportChannelType
    logicalChannelIdentity
    rlc-SizeList
    allSizes
    configured
    explicitList
    },
    mac-LogicalChannelPriority
}

UL-LogicalChannelMapping-r6 ::=     SEQUENCE {
    ul-TrCH-Type
    dch-rach-usch
    -- TABULAR: UL-TransportChannelType contains TransportChannelIdentity as well.
    ul-TransportChannelType
    logicalChannelIdentity
    rlc-SizeList
    allSizes
    configured
    explicitList
    },
    e-dch
    logicalChannelIdentity
    e-DCH-MAC-d-FlowIdentity
    ddi
    rlc-PDU-SizeList
    includeInSchedulingInfo
    },
    mac-LogicalChannelPriority
}

```

```

UL-LogicalChannelMapping-r8 ::= SEQUENCE {
  ul-TrCH-Type CHOICE {
    dch-rach-usch SEQUENCE {
      -- TABULAR: UL-TransportChannelType contains TransportChannelIdentity as well.
      ul-TransportChannelType UL-TransportChannelType,
      logicalChannelIdentity LogicalChannelIdentity OPTIONAL,
      rlc-SizeList CHOICE {
        allSizes NULL,
        configured NULL,
        explicitList RLC-SizeExplicitList
      }
    },
    e-dch SEQUENCE {
      logicalChannelIdentity LogicalChannelIdentity,
      e-DCH-MAC-d-FlowIdentity E-DCH-MAC-d-FlowIdentity,
      rlc-PDU-Size CHOICE {
        fixedSize SEQUENCE {
          ddi DDI,
          rlc-PDU-SizeList RLC-PDU-SizeList
        },
        flexibleSize RLC-PDU-SizeConstraint
      },
      includeInSchedulingInfo BOOLEAN
    }
  },
  mac-LogicalChannelPriority MAC-LogicalChannelPriority
}

UL-LogicalChannelMappingList ::= SEQUENCE {
  -- rlc-LogicalChannelMappingIndicator shall be set to TRUE in this version
  -- of the specification
  rlc-LogicalChannelMappingIndicator BOOLEAN,
  ul-LogicalChannelMapping SEQUENCE (SIZE (maxLoCHperRLC)) OF
  UL-LogicalChannelMapping
}

UL-LogicalChannelMappingList-r6 ::= SEQUENCE {
  -- rlc-LogicalChannelMappingIndicator shall be set to TRUE in this version
  -- of the specification
  rlc-LogicalChannelMappingIndicator BOOLEAN,
  ul-LogicalChannelMapping SEQUENCE (SIZE (maxLoCHperRLC)) OF
  UL-LogicalChannelMapping-r6
}

UL-LogicalChannelMappingList-r8 ::= SEQUENCE {
  -- rlc-LogicalChannelMappingIndicator shall be set to TRUE in this version
  -- of the specification
  rlc-LogicalChannelMappingIndicator BOOLEAN,
  ul-LogicalChannelMapping SEQUENCE (SIZE (maxLoCHperRLC)) OF
  UL-LogicalChannelMapping-r8
}

UL-LogicalChannelMappings ::= CHOICE {
  oneLogicalChannel UL-LogicalChannelMapping,
  twoLogicalChannels UL-LogicalChannelMappingList
}

UL-LogicalChannelMappings-r6 ::= CHOICE {
  oneLogicalChannel UL-LogicalChannelMapping-r6,
  twoLogicalChannels UL-LogicalChannelMappingList-r6
}

UL-LogicalChannelMappings-r8 ::= CHOICE {
  oneLogicalChannel UL-LogicalChannelMapping-r8,
  twoLogicalChannels UL-LogicalChannelMappingList-r8
}

UL-RFC3095-r4 ::= SEQUENCE {
  -- dummy1 is not used in this version of the specification and shall be ignored by the receiver.
  dummy1 CID-InclusionInfo-r4,
  max-CID INTEGER (1..16383) DEFAULT 15,
  -- dummy is not used in this version of the specification and
  -- it should be ignored by the receiver.
  dummy ROHC-PacketSizeList-r4
}

UL-RLC-Mode ::= CHOICE {
  ul-AM-RLC-Mode UL-AM-RLC-Mode,

```

```

    ul-UM-RLC-Mode          UL-UM-RLC-Mode,
    ul-TM-RLC-Mode          UL-TM-RLC-Mode,
    spare                    NULL
}

UL-TM-RLC-Mode ::=          SEQUENCE {
    transmissionRLC-Discard  TransmissionRLC-Discard  OPTIONAL,
    segmentationIndication  BOOLEAN
}

UL-UM-RLC-Mode ::=          SEQUENCE {
    transmissionRLC-Discard  TransmissionRLC-Discard  OPTIONAL
}

UL-TransportChannelType ::= CHOICE {
    dch                      TransportChannelIdentity,
    rach                     NULL,
    -- dummy is not used in this version of the specification and
    -- if received the UE behaviour is not specified.
    dummy                    NULL,
    usch                     TransportChannelIdentity
}

UM-RLC-DuplAvoid-Reord-Info-r6 ::= SEQUENCE {
    timer-DAR                TimerDAR-r6,
    widowSize-DAR           WindowSizeDAR-r6
}

UM-RLC-OutOSeqDelivery-Info-r6 ::= SEQUENCE {
    timer-OSD                TimerOSD-r6
    widowSize-OSD           WindowSizeOSD-r6
}

WindowSizeDAR-r6 ::=        ENUMERATED {
    ws4, ws8, ws16, ws32, ws40, ws48,
    ws56, ws64 }

WindowSizeOSD-r6 ::=        ENUMERATED {
    ws8, ws16, ws32, ws40, ws48,
    ws56, ws64 }

-- *****
--
--     TRANSPORT CHANNEL INFORMATION ELEMENTS (10.3.5)
--
-- *****

AddOrReconfMAC-dFlow ::=    SEQUENCE {
    mac-hs-AddReconfQueue-List  MAC-hs-AddReconfQueue-List  OPTIONAL,
    mac-hs-DelQueue-List        MAC-hs-DelQueue-List        OPTIONAL
}

AddOrReconfMAC-ehs-ReordQ ::= SEQUENCE {
    mac-ehs-AddReconfQueue-List  MAC-ehs-AddReconfReordQ-List  OPTIONAL,
    -- dummy is not used in this version of the specification, it should
    -- not be sent and if received it should be ignored.
    dummy                        MAC-ehs-DelReordQ-List        OPTIONAL
}

AllowedTFC-List ::=          SEQUENCE (SIZE (1..maxTFC)) OF
    TFC-Value

AllowedTFI-List ::=          SEQUENCE (SIZE (1..maxTF)) OF
    INTEGER (0..31)

BitModeRLC-SizeInfo ::=     CHOICE {
    sizeType1                 INTEGER (0..127),
    -- Actual value sizeType2 = (part1 * 8) + 128 + part2
    sizeType2                 SEQUENCE {
        part1                 INTEGER (0..15),
        part2                 INTEGER (1..7)
    },
    -- Actual value sizeType3 = (part1 * 16) + 256 + part2
    sizeType3                 SEQUENCE {
        part1                 INTEGER (0..47),
        part2                 INTEGER (1..15)
    },
    -- Actual value sizeType4 = (part1 * 64) + 1024 + part2
}

```

```

    sizeType4                               SEQUENCE {
      part1                                  INTEGER (0..62),
      part2                                  INTEGER (1..63)
    }
  }
}
-- Actual value BLER-QualityValue = IE value * 0.1
BLER-QualityValue ::=                       INTEGER (-63..0)

ChannelCodingType ::=                       CHOICE {
  -- noCoding is only used for TDD in this version of the specification,
  -- otherwise it should be ignored
  noCoding                                  NULL,
  convolutional                             CodingRate,
  turbo                                     NULL
}

CodingRate ::=                               ENUMERATED {
  half,
  third
}

Common-E-DCH-MAC-d-Flow ::=                 SEQUENCE {
  mac-d-FlowIdentity                       E-DCH-MAC-d-FlowIdentity,
  mac-d-FlowPowerOffset                    E-DCH-MAC-d-FlowPowerOffset,
  mac-d-FlowMaxRetrans                     E-DCH-MAC-d-FlowMaxRetrans,
  mac-d-FlowMultiplexingList              E-DCH-MAC-d-FlowMultiplexingList OPTIONAL,
  e-dch-mac-d-flow-retransmission-timer    E-DCH-MAC-d-FlowRetransTimer OPTIONAL
}

Common-E-DCH-MAC-d-FlowList ::=             SEQUENCE (SIZE (1..maxE-DCHMACdFlow)) OF
  Common-E-DCH-MAC-d-Flow

CommonDynamicTF-Info ::=                   SEQUENCE {
  rlc-Size                                  CHOICE {
    fdd                                     SEQUENCE {
      octetModeRLC-SizeInfoType2           OctetModeRLC-SizeInfoType2
    },
    tdd                                     SEQUENCE {
      commonTDD-Choice                     CHOICE {
        bitModeRLC-SizeInfo                BitModeRLC-SizeInfo,
        octetModeRLC-SizeInfoType1         OctetModeRLC-SizeInfoType1
      }
    }
  },
  numberOfTbSizeList                       SEQUENCE (SIZE (1..maxTF)) OF
    NumberOFTransportBlocks,
  logicalChannelList                       LogicalChannelList
}

CommonDynamicTF-Info-DynamicTTI ::=        SEQUENCE {
  commonTDD-Choice                         CHOICE {
    bitModeRLC-SizeInfo                    BitModeRLC-SizeInfo,
    octetModeRLC-SizeInfoType1             OctetModeRLC-SizeInfoType1
  },
  numberOfTbSizeAndTTIList                 NumberOFTransportBlocksAndTTIList,
  logicalChannelList                       LogicalChannelList
}

CommonDynamicTF-InfoList ::=               SEQUENCE (SIZE (1..maxTF)) OF
  CommonDynamicTF-Info

CommonDynamicTF-InfoList-DynamicTTI ::=    SEQUENCE (SIZE (1..maxTF)) OF
  CommonDynamicTF-Info-DynamicTTI

CommonTransChTFS ::=                       SEQUENCE {
  tti                                       CHOICE {
    tti10                                   CommonDynamicTF-InfoList,
    tti20                                   CommonDynamicTF-InfoList,
    tti40                                   CommonDynamicTF-InfoList,
    tti80                                   CommonDynamicTF-InfoList,
    dynamic                                  CommonDynamicTF-InfoList-DynamicTTI
  },
  semistaticTF-Information                 SemistaticTF-Information
}

CommonTransChTFS-LCR ::=                   SEQUENCE {
  tti                                       CHOICE {
    tti15                                   CommonDynamicTF-InfoList,

```

```

        tti10                CommonDynamicTF-InfoList,
        tti20                CommonDynamicTF-InfoList,
        tti40                CommonDynamicTF-InfoList,
        tti80                CommonDynamicTF-InfoList,
        dynamic              CommonDynamicTF-InfoList-DynamicTTI
    },
    semistaticTF-Information SemistaticTF-Information
}

Common-MAC-ehs-ReorderingQueue ::= SEQUENCE {
    mac-ehs-QueueId          MAC-ehs-QueueId,
    t1-ReleaseTimer          T1-ReleaseTimer,
    reorderingResetTimer     Treset-ResetTimer                      OPTIONAL,
    mac-ehsWindowSize        MAC-hs-WindowSize
}

Common-MAC-ehs-ReorderingQueueList ::= SEQUENCE (SIZE (1..maxCommonQueueID)) OF
Common-MAC-ehs-ReorderingQueue

CPCH-SetID ::=
INTEGER (1..maxCPCHsets)

CRC-Size ::=
ENUMERATED {
    crc0, crc8, crc12, crc16, crc24 }

DedicatedDynamicTF-Info ::=
SEQUENCE {
    rlc-Size                 CHOICE {
        bitMode              BitModeRLC-SizeInfo,
        octetModeType1       OctetModeRLC-SizeInfoType1
    },
    numberOfTbSizeList       SEQUENCE (SIZE (1..maxTF)) OF
        NumberOfTransportBlocks,
    logicalChannelList       LogicalChannelList
}

DedicatedDynamicTF-Info-DynamicTTI ::= SEQUENCE {
    rlc-Size                 CHOICE {
        bitMode              BitModeRLC-SizeInfo,
        octetModeType1       OctetModeRLC-SizeInfoType1
    },
    numberOfTbSizeAndTTIList NumberOfTbSizeAndTTIList,
    logicalChannelList       LogicalChannelList
}

DedicatedDynamicTF-InfoList ::= SEQUENCE (SIZE (1..maxTF)) OF
DedicatedDynamicTF-Info

DedicatedDynamicTF-InfoList-DynamicTTI ::= SEQUENCE (SIZE (1..maxTF)) OF
DedicatedDynamicTF-Info-DynamicTTI

DedicatedTransChTFS ::=
SEQUENCE {
    tti                      CHOICE {
        tti10                DedicatedDynamicTF-InfoList,
        tti20                DedicatedDynamicTF-InfoList,
        tti40                DedicatedDynamicTF-InfoList,
        tti80                DedicatedDynamicTF-InfoList,
        dynamic              DedicatedDynamicTF-InfoList-DynamicTTI
    },
    semistaticTF-Information SemistaticTF-Information
}

-- The maximum allowed size of DL-AddReconfTransChInfo2List sequence is 16
DL-AddReconfTransChInfo2List ::= SEQUENCE (SIZE (1..maxTrCHpreconf)) OF
DL-AddReconfTransChInformation2

-- The maximum allowed size of DL-AddReconfTransChInfoList sequence is 16
DL-AddReconfTransChInfoList ::= SEQUENCE (SIZE (1..maxTrCHpreconf)) OF
DL-AddReconfTransChInformation

-- The maximum allowed size of DL-AddReconfTransChInfoList-r4 sequence is 16
DL-AddReconfTransChInfoList-r4 ::= SEQUENCE (SIZE (1..maxTrCHpreconf)) OF
DL-AddReconfTransChInformation-r4

-- The maximum allowed size of DL-AddReconfTransChInfoList-r5 sequence is 16
DL-AddReconfTransChInfoList-r5 ::= SEQUENCE (SIZE (1..maxTrCHpreconf)) OF
DL-AddReconfTransChInformation-r5

-- The maximum allowed size of DL-AddReconfTransChInfoList-r7 sequence is 16
DL-AddReconfTransChInfoList-r7 ::= SEQUENCE (SIZE (1..maxTrCHpreconf)) OF

```

DL-AddReconfTransChInformation-r7

```

-- ASN.1 for IE "Added or Reconfigured DL TrCH information"
-- in case of messages other than: Radio Bearer Release message and
-- Radio Bearer Reconfiguration message
DL-AddReconfTransChInformation ::= SEQUENCE {
    dl-TransportChannelType          DL-TrCH-Type,
    dl-transportChannelIdentity      TransportChannelIdentity,
    tfs-SignallingMode              CHOICE {
        explicit-config             TransportFormatSet,
        sameAsULTrCH               UL-TransportChannelIdentity
    },
    dch-QualityTarget               QualityTarget                OPTIONAL,
    -- dummy is not used in this version of the specification, it should
    -- not be sent and if received it should be ignored.
    dummy                           TM-SignallingInfo           OPTIONAL
}

DL-AddReconfTransChInformation-r4 ::= SEQUENCE {
    dl-TransportChannelType          DL-TrCH-Type,
    dl-transportChannelIdentity      TransportChannelIdentity,
    tfs-SignallingMode              CHOICE {
        explicit-config             TransportFormatSet,
        sameAsULTrCH               UL-TransportChannelIdentity
    },
    dch-QualityTarget               QualityTarget                OPTIONAL
}

DL-AddReconfTransChInformation-r5 ::= SEQUENCE {
    dl-TransportChannelType          DL-TrCH-TypeId1-r5,
    tfs-SignallingMode              CHOICE {
        explicit-config             TransportFormatSet,
        sameAsULTrCH               UL-TransportChannelIdentity,
        hsdSCH                      HSDSCH-Info
    },
    dch-QualityTarget               QualityTarget                OPTIONAL
}

DL-AddReconfTransChInformation-r7 ::= SEQUENCE {
    dl-TransportChannelType          DL-TrCH-TypeId1-r5,
    tfs-SignallingMode              CHOICE {
        explicit-config             TransportFormatSet,
        sameAsULTrCH               UL-TransportChannelIdentity,
        hsdSCH                      HSDSCH-Info-r7
    },
    dch-QualityTarget               QualityTarget                OPTIONAL
}

-- ASN.1 for IE "Added or Reconfigured DL TrCH information"
-- in case of Radio Bearer Release message and
-- Radio Bearer Reconfiguration message
DL-AddReconfTransChInformation2 ::= SEQUENCE {
    dl-TransportChannelType          DL-TrCH-Type,
    transportChannelIdentity        TransportChannelIdentity,
    tfs-SignallingMode              CHOICE {
        explicit-config             TransportFormatSet,
        sameAsULTrCH               UL-TransportChannelIdentity
    },
    qualityTarget                   QualityTarget                OPTIONAL
}

DL-CommonTransChInfo ::= SEQUENCE {
    sccpch-TFCS                     TFCS                        OPTIONAL,
    -- modeSpecificInfo should be optional. A new version of this IE should be defined
    -- to be used in later versions of messages using this IE
    modeSpecificInfo                 CHOICE {
        fdd                           SEQUENCE {
            dl-Parameters              CHOICE {
                dl-DCH-TFCS            TFCS,
                sameAsUL               NULL
            }
        },
        tdd                           SEQUENCE {
            individualDL-CCTrCH-InfoList IndividualDL-CCTrCH-InfoList OPTIONAL
        }
    }
}

```

```

DL-CommonTransChInfo-r4 ::= SEQUENCE {
    sccpch-TFCS                TFCS                OPTIONAL,
    modeSpecificInfo           CHOICE {
        fdd                     SEQUENCE {
            dl-Parameters       CHOICE {
                dl-DCH-TFCS     SEQUENCE {
                    tfcs         TFCS                OPTIONAL
                },
                sameAsUL        NULL                OPTIONAL
            }
        },
        tdd                     SEQUENCE {
            individualDL-CCTrCH-InfoList IndividualDL-CCTrCH-InfoList OPTIONAL
        }
    } OPTIONAL
}

DL-DeletedTransChInfoList ::= SEQUENCE (SIZE (1..maxTrCH)) OF
    DL-TransportChannelIdentity

DL-DeletedTransChInfoList-r5 ::= SEQUENCE (SIZE (1..maxTrCH)) OF
    DL-TransportChannelIdentity-r5

DL-DeletedTransChInfoList-r7 ::= SEQUENCE (SIZE (1..maxTrCH)) OF
    DL-TransportChannelIdentity-r7

DL-TransportChannelIdentity ::= SEQUENCE {
    dl-TransportChannelType    DL-TrCH-Type,
    dl-TransportChannelIdentity TransportChannelIdentity
}

DL-TransportChannelIdentity-r5 ::= SEQUENCE {
    dl-TransportChannelType    DL-TrCH-TypeId2-r5
}

DL-TransportChannelIdentity-r7 ::= SEQUENCE {
    dl-TransportChannelType    DL-TrCH-TypeId2-r7
}

-- The choice "dsch" should not be used in FDD mode, and if received the UE behaviour is unspecified
DL-TrCH-Type ::= ENUMERATED {dch, dsch}

DL-TrCH-TypeId1-r5 ::= CHOICE {
    dch                TransportChannelIdentity,
    -- The choice "dsch" should not be used in FDD mode, and if received
    -- the UE behaviour is unspecified.
    dsch                TransportChannelIdentity,
    hsdSCH              NULL
}

DL-TrCH-TypeId2-r5 ::= CHOICE {
    dch                TransportChannelIdentity,
    -- The choice "dsch" should not be used in FDD mode, and if received
    -- the UE behaviour is unspecified.
    dsch                TransportChannelIdentity,
    hsdSCH              MAC-d-FlowIdentity
}

DL-TrCH-TypeId2-r7 ::= CHOICE {
    dch                TransportChannelIdentity,
    -- The choice "dsch" should not be used in FDD mode, and if received
    -- the UE behaviour is unspecified.
    dsch                TransportChannelIdentity,
    hsdSCH              CHOICE {
        mac-hs          MAC-d-FlowIdentity,
        mac-ehs         MAC-ehs-QueueId
    }
}

DRAC-ClassIdentity ::= INTEGER (1..maxDRACclasses)

DRAC-StaticInformation ::= SEQUENCE {
    transmissionTimeValidity    TransmissionTimeValidity,
    timeDurationBeforeRetry     TimeDurationBeforeRetry,
    drac-ClassIdentity          DRAC-ClassIdentity
}

```

```

DRAC-StaticInformationList ::= SEQUENCE (SIZE (1..maxTrCH)) OF
    DRAC-StaticInformation

E-DCH-AddReconf-MAC-d-Flow ::= SEQUENCE {
    mac-d-FlowIdentity          E-DCH-MAC-d-FlowIdentity,
    mac-d-FlowPowerOffset      E-DCH-MAC-d-FlowPowerOffset      OPTIONAL,
    mac-d-FlowMaxRetrans       E-DCH-MAC-d-FlowMaxRetrans       OPTIONAL,
    mac-d-FlowMultiplexingList E-DCH-MAC-d-FlowMultiplexingList OPTIONAL,
    transmissionGrantType      CHOICE {
        non-ScheduledTransGrantInfo SEQUENCE {
            maxMAC-e-PDUContents      INTEGER (1..19982),
            ms2-NonSchedTransmGrantHARQAlloc BIT STRING (SIZE (8))      OPTIONAL
        },
        scheduledTransmissionGrantInfo NULL
    }
} OPTIONAL

E-DCH-AddReconf-MAC-d-Flow-r7 ::= SEQUENCE {
    mac-d-FlowIdentity          E-DCH-MAC-d-FlowIdentity,
    mac-d-FlowPowerOffset      E-DCH-MAC-d-FlowPowerOffset      OPTIONAL,
    mac-d-FlowMaxRetrans       E-DCH-MAC-d-FlowMaxRetrans       OPTIONAL,
    mac-d-FlowRetransTimer     E-DCH-MAC-d-FlowRetransTimer     OPTIONAL,
    mac-d-FlowMultiplexingList E-DCH-MAC-d-FlowMultiplexingList OPTIONAL,
    transmissionGrantType      CHOICE {
        non-ScheduledTransGrantInfo SEQUENCE {
            modeSpecificInfo          CHOICE {
                fdd SEQUENCE {
                    maxMAC-e-PDUContents      INTEGER (1..19982),
                    ms2-NonSchedTransmGrantHARQAlloc BIT STRING (SIZE (8))      OPTIONAL
                },
                tdd NULL
            }
        },
        scheduledTransmissionGrantInfo NULL
    }
} OPTIONAL

E-DCH-AddReconf-MAC-d-FlowList ::= SEQUENCE (SIZE (1..maxE-DCHMACdFlow)) OF
    E-DCH-AddReconf-MAC-d-Flow

E-DCH-AddReconf-MAC-d-FlowList-r7 ::= SEQUENCE (SIZE (1..maxE-DCHMACdFlow)) OF
    E-DCH-AddReconf-MAC-d-Flow-r7

E-DCH-MAC-d-FlowIdentity ::= INTEGER (0..maxE-DCHMACdFlow-1)

E-DCH-MAC-d-FlowMaxRetrans ::= INTEGER (0..15)

E-DCH-MAC-d-FlowMultiplexingList ::= BIT STRING (SIZE (maxE-DCHMACdFlow))

E-DCH-MAC-d-FlowPowerOffset ::= INTEGER (0..6)

E-DCH-MAC-d-FlowRetransTimer ::= ENUMERATED {
    ms10, ms15, ms20, ms25, ms30, ms35, ms40, ms45, ms50,
    ms55, ms60, ms65, ms70, ms75, ms80, ms85, ms90, ms95,
    ms100, ms110, ms120, ms140, ms160, ms200, ms240, ms280,
    ms320, ms400, ms480, ms560 }

E-DCH-TTI ::= ENUMERATED { tti2, tti10 }

ExplicitTFCS-Configuration ::= CHOICE {
    complete          TFCS-ReconfAdd,
    addition          TFCS-ReconfAdd,
    removal          TFCS-RemovalList,
    replacement      SEQUENCE {
        tfcsRemoval    TFCS-RemovalList,
        tfcsAdd        TFCS-ReconfAdd
    }
}

GainFactor ::= INTEGER (0..15)

GainFactorInformation ::= CHOICE {
    signalledGainFactors    SignalledGainFactors,
    computedGainFactors     ReferenceTFC-ID
}

HSDSCH-Info ::= SEQUENCE {

```

```

    harqInfo
    addOrReconfMAC-dFlow
}

HSDSCH-Info-r7 ::=
    harqInfo
    dl-MAC-HeaderType
        mac-hs
        mac-ehs
    } OPTIONAL
}

HARQ-Info ::=
    numberOfProcesses
    memoryPartitioning
        implicit
        explicit
    }
}

HARQ-Info-r7 ::=
    numberOfProcesses
    memoryPartitioning
        implicit
        explicit
        memorySize
    additionalMemorySizesForMIMO
}
}

HARQMemorySize ::=
    ENUMERATED {
        hms800, hms1600, hms2400, hms3200, hms4000,
        hms4800, hms5600, hms6400, hms7200, hms8000,
        hms8800, hms9600, hms10400, hms11200, hms12000,
        hms12800, hms13600, hms14400, hms15200, hms16000,
        hms17600, hms19200, hms20800, hms22400, hms24000,
        hms25600, hms27200, hms28800, hms30400, hms32000,
        hms36000, hms40000, hms44000, hms48000, hms52000,
        hms56000, hms60000, hms64000, hms68000, hms72000,
        hms76000, hms80000, hms88000, hms96000, hms104000,
        hms112000, hms120000, hms128000, hms136000, hms144000,
        hms152000, hms160000, hms176000, hms192000, hms208000,
        hms224000, hms240000, hms256000, hms272000, hms288000,
        hms304000 }

IndividualDL-CCTrCH-Info ::=
    dl-TFCS-Identity
    tfcs-SignallingMode
        explicit-config
        sameAsUL
    }
}

IndividualDL-CCTrCH-InfoList ::= SEQUENCE (SIZE (1..maxCCTrCH)) OF
    IndividualDL-CCTrCH-Info

IndividualUL-CCTrCH-Info ::= SEQUENCE {
    ul-TFCS-Identity
    ul-TFCS
    tfc-Subset
}

IndividualUL-CCTrCH-InfoList ::= SEQUENCE (SIZE (1..maxCCTrCH)) OF
    IndividualUL-CCTrCH-Info

LogicalChannelByRB ::= SEQUENCE {
    rb-Identity
    logChOfRb
} OPTIONAL

LogicalChannelList ::= CHOICE {
    allSizes
    configured
}

```

```

        explicitList                SEQUENCE (SIZE (1..15)) OF
                                     LogicalChannelByRB
    }

MAC-d-FlowIdentityDCHandHSDSCH ::= SEQUENCE {
    dch-transport-ch-id             TransportChannelIdentity,
    hsdSCH-mac-d-flow-id           MAC-d-FlowIdentity
}

MAC-d-FlowIdentity ::=              INTEGER (0..7)

MAC-d-PDU-SizeInfo-List ::=        SEQUENCE (SIZE(1.. maxMAC-d-PDU-sizes)) OF
                                     MAC-d-PDUsizeInfo

--MAC-d-Pdu sizes need to be defined
MAC-d-PDUsizeInfo ::=              SEQUENCE{
    mac-d-PDU-Size                 INTEGER (1..5000),
    mac-d-PDU-Index                INTEGER (0..7)
}

MAC-hs-AddReconfQueue-List ::=     SEQUENCE (SIZE(1..maxQueueIDs)) OF
                                     MAC-hs-AddReconfQueue

MAC-hs-AddReconfQueue ::=          SEQUENCE {
    mac-hsQueueId                  INTEGER (0..7),
    mac-dFlowId                    MAC-d-FlowIdentity,
    reorderingReleaseTimer         T1-ReleaseTimer,
    mac-hsWindowSize               MAC-hs-WindowSize,
    mac-d-PDU-SizeInfo-List        MAC-d-PDU-SizeInfo-List           OPTIONAL
}

MAC-hs-DelQueue-List ::=           SEQUENCE (SIZE(1..maxQueueIDs)) OF
                                     MAC-hs-DelQueue

MAC-hs-DelQueue ::=                SEQUENCE {
    mac-hsQueueId                  INTEGER (0..7)
}

MAC-ehs-AddReconfReordQ-List ::=  SEQUENCE (SIZE(1..maxQueueIDs)) OF
                                     MAC-ehs-AddReconfReordQ

MAC-ehs-AddReconfReordQ ::=        SEQUENCE {
    mac-ehs-QueueId                MAC-ehs-QueueId,
    reorderingReleaseTimer         T1-ReleaseTimer,
    reorderingResetTimer           Treset-ResetTimer           OPTIONAL,
    mac-ehsWindowSize             MAC-hs-WindowSize
}

MAC-ehs-DelReordQ-List ::=         SEQUENCE (SIZE(1..maxQueueIDs)) OF
                                     MAC-ehs-DelReordQ

MAC-ehs-DelReordQ ::=              SEQUENCE {
    mac-ehs-QueueId                MAC-ehs-QueueId
}

MAC-ehs-QueueIdDCHandHSDSCH ::=    SEQUENCE {
    dch-transport-ch-id             TransportChannelIdentity,
    hsdSCH-mac-ehs-QueueId         MAC-ehs-QueueId
}

MAC-ehs-QueueId ::=                INTEGER (0..7)

MAC-hs-WindowSize ::=              ENUMERATED {
    mws4, mws6, mws8, mws12, mws16, mws24, mws32 }

NumberOfTbSizeAndTTIList ::=       SEQUENCE (SIZE (1..maxTF)) OF SEQUENCE {
    numberOfTransportBlocks         NumberOfTransportBlocks,
    transmissionTimeInterval        TransmissionTimeInterval
}

MessType ::=                        ENUMERATED {
    transportFormatCombinationControl }

Non-allowedTFC-List ::=            SEQUENCE (SIZE (1..maxTFC)) OF
                                     TFC-Value

NumberOfTransportBlocks ::=         CHOICE {
    zero                            NULL,
}

```

```

    one                NULL,
    small              INTEGER (2..17),
    large              INTEGER (18..512)
}

OctetModeRLC-SizeInfoType1 ::= CHOICE {
    -- Actual size = (8 * sizeType1) + 16
    sizeType1          INTEGER (0..31),
    sizeType2          SEQUENCE {
        -- Actual size = (32 * part1) + 272 + (part2 * 8)
        part1           INTEGER (0..23),
        part2           INTEGER (1..3)           OPTIONAL
    },
    sizeType3          SEQUENCE {
        -- Actual size = (64 * part1) + 1040 + (part2 * 8)
        part1           INTEGER (0..61),
        part2           INTEGER (1..7)           OPTIONAL
    }
}

OctetModeRLC-SizeInfoType2 ::= CHOICE {
    -- Actual size = (sizeType1 * 8) + 48
    sizeType1          INTEGER (0..31),
    -- Actual size = (sizeType2 * 16) + 312
    sizeType2          INTEGER (0..63),
    -- Actual size = (sizeType3 * 64) + 1384
    sizeType3          INTEGER (0..56)
}

PowerOffsetInfoShort ::= SEQUENCE {
    referenceTFC       TFC-Value,
    modeSpecificInfo   CHOICE {
        fdd             SEQUENCE {
            gainFactorBetaC GainFactor
        },
        tdd             NULL
    },
    gainFactorBetaD    GainFactor
}

PowerOffsetInformation ::= SEQUENCE {
    gainFactorInformation GainFactorInformation,
    -- PowerOffsetPp-m is always absent in TDD
    powerOffsetPp-m      PowerOffsetPp-m           OPTIONAL
}

PowerOffsetPp-m ::= INTEGER (-5..10)

PreDefTransChConfiguration ::= SEQUENCE {
    ul-CommonTransChInfo    UL-CommonTransChInfo,
    ul-AddReconfTrChInfoList UL-AddReconfTransChInfoList,
    dl-CommonTransChInfo    DL-CommonTransChInfo,
    dl-TrChInfoList         DL-AddReconfTransChInfoList
}

QualityTarget ::= SEQUENCE {
    bler-QualityValue       BLER-QualityValue
}

RateMatchingAttribute ::= INTEGER (1..hiRM)

ReferenceTFC-ID ::= INTEGER (0..3)

RestrictedTrChInfo ::= SEQUENCE {
    ul-TransportChannelType UL-TrCH-Type,
    restrictedTrChIdentity  TransportChannelIdentity,
    allowedTFI-List         AllowedTFI-List           OPTIONAL
}

RestrictedTrChInfoList ::= SEQUENCE (SIZE (1..maxTrCH)) OF
    RestrictedTrChInfo

SemistaticTF-Information ::= SEQUENCE {
    -- TABULAR: Transmission time interval has been included in the IE CommonTransChTFS.
    channelCodingType      ChannelCodingType,
    rateMatchingAttribute  RateMatchingAttribute,
    crc-Size               CRC-Size
}

```

```

}

SignalledGainFactors ::=
    modeSpecificInfo
        fdd
            gainFactorBetaC
        },
        tdd
    },
    gainFactorBetaD
    referenceTFC-ID
}

SEQUENCE {
    CHOICE {
        SEQUENCE {
            GainFactor
        }
        NULL
    }
    GainFactor,
    ReferenceTFC-ID
    OPTIONAL
}

SplitTFCI-Signalling ::=
    splitType
    tfci-Field2-Length
    tfci-Field1-Information
    tfci-Field2-Information
}

SEQUENCE {
    SplitType
    INTEGER (1..10)
    ExplicitTFCS-Configuration
    TFCI-Field2-Information
}
OPTIONAL,
OPTIONAL,
OPTIONAL,
OPTIONAL

SplitType ::=
    hardSplit, logicalSplit
}

ENUMERATED {
    hardSplit, logicalSplit
}

T1-ReleaseTimer ::=
    rt10, rt20, rt30, rt40, rt50,
    rt60, rt70, rt80, rt90, rt100,
    rt120, rt140, rt160, rt200, rt300,
    rt400
}

ENUMERATED {
    rt10, rt20, rt30, rt40, rt50,
    rt60, rt70, rt80, rt90, rt100,
    rt120, rt140, rt160, rt200, rt300,
    rt400
}

TFC-Subset ::=
    minimumAllowedTFC-Number
    allowedTFC-List
    non-allowedTFC-List
    restrictedTrChInfoList
    fullTFCS
}

CHOICE {
    TFC-Value,
    AllowedTFC-List,
    Non-allowedTFC-List,
    RestrictedTrChInfoList,
    NULL
}

TFC-SubsetList ::=
    modeSpecificInfo
        fdd
            tdds-ID
        },
        tdd
    },
    tfcs-ID
}

SEQUENCE (SIZE (1.. maxTFCsub)) OF SEQUENCE {
    CHOICE {
        NULL,
        SEQUENCE {
            TFCS-Identity
        }
    }
    TFC-Subset
}
OPTIONAL

TFC-Value ::=
    INTEGER (0..1023)

TFCI-Field2-Information ::=
    tfci-Range
    explicit-config
}

CHOICE {
    TFCI-RangeList,
    ExplicitTFCS-Configuration
}

TFCI-Range ::=
    maxTFCIField2Value
    tfcs-InfoForDSCH
}

SEQUENCE {
    INTEGER (1..1023),
    TFCS-InfoForDSCH
}

TFCI-RangeList ::=
    SEQUENCE (SIZE (1..maxPDSCH-TFCIgroups)) OF
        TFCI-Range

TFCs ::=
    normalTFCI-Signalling
    -- dummy is not used in this version of specification, it should
    -- not be sent and if received the UE behaviour is not specified.
    dummy
}

CHOICE {
    ExplicitTFCS-Configuration,
    SplitTFCI-Signalling
}

TFCS-Identity ::=
    tfcs-ID
    sharedChannelIndicator
}

SEQUENCE {
    TFCS-IdentityPlain
    BOOLEAN
}
DEFAULT 1,

TFCS-IdentityPlain ::=
    INTEGER (1..8)

TFCS-InfoForDSCH ::=
    ctfc2bit
}

CHOICE {
    INTEGER (0..3),
}

```

```

ctfc4bit          INTEGER (0..15),
ctfc6bit          INTEGER (0..63),
ctfc8bit          INTEGER (0..255),
ctfc12bit         INTEGER (0..4095),
ctfc16bit         INTEGER (0..65535),
ctfc24bit         INTEGER (0..16777215)
}

TFCS-ReconfAdd ::= SEQUENCE {
  ctfcSize CHOICE {
    ctfc2Bit SEQUENCE (SIZE (1..maxTFC)) OF SEQUENCE {
      ctfc2 INTEGER (0..3),
      powerOffsetInformation PowerOffsetInformation OPTIONAL
    },
    ctfc4Bit SEQUENCE (SIZE (1..maxTFC)) OF SEQUENCE {
      ctfc4 INTEGER (0..15),
      powerOffsetInformation PowerOffsetInformation OPTIONAL
    },
    ctfc6Bit SEQUENCE (SIZE (1..maxTFC)) OF SEQUENCE {
      ctfc6 INTEGER (0..63),
      powerOffsetInformation PowerOffsetInformation OPTIONAL
    },
    ctfc8Bit SEQUENCE (SIZE (1..maxTFC)) OF SEQUENCE {
      ctfc8 INTEGER (0..255),
      powerOffsetInformation PowerOffsetInformation OPTIONAL
    },
    ctfc12Bit SEQUENCE (SIZE (1..maxTFC)) OF SEQUENCE {
      ctfc12 INTEGER (0..4095),
      powerOffsetInformation PowerOffsetInformation OPTIONAL
    },
    ctfc16Bit SEQUENCE (SIZE (1..maxTFC)) OF SEQUENCE {
      ctfc16 INTEGER (0..65535),
      powerOffsetInformation PowerOffsetInformation OPTIONAL
    },
    ctfc24Bit SEQUENCE (SIZE (1..maxTFC)) OF SEQUENCE {
      ctfc24 INTEGER (0..16777215),
      powerOffsetInformation PowerOffsetInformation OPTIONAL
    }
  }
}

TFCS-Removal ::= SEQUENCE {
  tfci INTEGER (0..1023)
}

TFCS-RemovalList ::= SEQUENCE (SIZE (1..maxTFC)) OF
  TFCS-Removal

TimeDurationBeforeRetry ::= INTEGER (1..256)

TM-SignallingInfo ::= SEQUENCE {
  messType MessType,
  tm-SignallingMode CHOICE {
    mode1 NULL,
    mode2 SEQUENCE {
      -- in ul-controlledTrChList, TrCH-Type is always DCH
      ul-controlledTrChList UL-ControlledTrChList
    }
  }
}

TransmissionTimeInterval ::= ENUMERATED {
  tti10, tti20, tti40, tti80 }

TransmissionTimeValidity ::= INTEGER (1..256)

TransportChannelIdentity ::= INTEGER (1..32)

TransportChannelIdentityDCHandDSCH ::= SEQUENCE {
  dch-transport-ch-id TransportChannelIdentity,
  dsch-transport-ch-id TransportChannelIdentity
}

TransportFormatSet ::= CHOICE {
  dedicatedTransChTFS DedicatedTransChTFS,
  commonTransChTFS CommonTransChTFS
}

```



```

TransportFormatSet-LCR ::= CHOICE {
    dedicatedTransChTFS
    commonTransChTFS-LCR
}

Treset-ResetTimer ::= ENUMERATED {
    rt1, rt2, rt3, rt4 }

-- The maximum allowed size of UL-AddReconfTransChInfoList sequence is 16
UL-AddReconfTransChInfoList ::= SEQUENCE (SIZE (1..maxTrCHpreconf)) OF
    UL-AddReconfTransChInformation

-- The maximum allowed size of UL-AddReconfTransChInfoList-r6 sequence is 32
UL-AddReconfTransChInfoList-r6 ::= SEQUENCE (SIZE (1..maxTrCH)) OF
    UL-AddReconfTransChInformation-r6

-- The maximum allowed size of UL-AddReconfTransChInfoList-r7 sequence is 32
UL-AddReconfTransChInfoList-r7 ::= SEQUENCE (SIZE (1..maxTrCH)) OF
    UL-AddReconfTransChInformation-r7

-- The maximum allowed size of UL-AddReconfTransChInfoList-r8 sequence is 32
UL-AddReconfTransChInfoList-r8 ::= SEQUENCE (SIZE (1..maxTrCH)) OF
    UL-AddReconfTransChInformation-r8

UL-AddReconfTransChInformation ::= SEQUENCE {
    ul-TransportChannelType      UL-TrCH-Type,
    transportChannelIdentity     TransportChannelIdentity,
    transportFormatSet           TransportFormatSet
}

UL-AddReconfTransChInformation-r6 ::= CHOICE {
    dch-usch                     SEQUENCE {
        ul-TransportChannelType      UL-TrCH-Type,
        transportChannelIdentity     TransportChannelIdentity,
        transportFormatSet           TransportFormatSet
    },
    e-dch                         SEQUENCE {
        tti                          E-DCH-TTI,
        harq-Info                    ENUMERATED { rv0, rvtable },
        addReconf-MAC-d-FlowList     E-DCH-AddReconf-MAC-d-FlowList OPTIONAL
    }
}

UL-AddReconfTransChInformation-r7 ::= CHOICE {
    dch-usch                     SEQUENCE {
        ul-TransportChannelType      UL-TrCH-Type,
        transportChannelIdentity     TransportChannelIdentity,
        transportFormatSet           TransportFormatSet
    },
    e-dch                         SEQUENCE {
        modeSpecific                 CHOICE {
            fdd                       SEQUENCE {
                tti                    E-DCH-TTI
            },
            tdd                       NULL
        },
        harq-Info                    ENUMERATED { rv0, rvtable },
        addReconf-MAC-d-FlowList     E-DCH-AddReconf-MAC-d-FlowList-r7 OPTIONAL
    }
}

UL-AddReconfTransChInformation-r8 ::= CHOICE {
    dch-usch                     SEQUENCE {
        ul-TransportChannelType      UL-TrCH-Type,
        transportChannelIdentity     TransportChannelIdentity,
        transportFormatSet           TransportFormatSet
    },
    e-dch                         SEQUENCE {
        ul-MAC-HeaderType            ENUMERATED { mac-iis } OPTIONAL,
        modeSpecific                 CHOICE {
            fdd                       SEQUENCE {
                tti                    E-DCH-TTI
            },
            tdd                       NULL
        },
        harq-Info                    ENUMERATED { rv0, rvtable },
        addReconf-MAC-d-FlowList     E-DCH-AddReconf-MAC-d-FlowList-r7 OPTIONAL
    }
}

```

```

    }
  }
}

UL-CommonTransChInfo ::= SEQUENCE {
  -- TABULAR: tfc-subset is applicable to FDD only, TDD specifies tfc-subset in individual
  -- CTrCH Info.
  tfc-Subset TFC-Subset OPTIONAL,
  prach-TFCS TFCS OPTIONAL,
  modeSpecificInfo CHOICE {
    fdd SEQUENCE {
      ul-TFCS TFCS
    },
    tdd SEQUENCE {
      individualUL-CCTrCH-InfoList IndividualUL-CCTrCH-InfoList OPTIONAL
    }
  }
}

UL-CommonTransChInfo-r4 ::= SEQUENCE {
  -- TABULAR: tfc-subset is applicable to FDD only, TDD specifies tfc-subset in individual
  -- CTrCH Info.
  tfc-Subset TFC-Subset OPTIONAL,
  prach-TFCS TFCS OPTIONAL,
  modeSpecificInfo CHOICE {
    fdd SEQUENCE {
      ul-TFCS TFCS
    },
    tdd SEQUENCE {
      individualUL-CCTrCH-InfoList IndividualUL-CCTrCH-InfoList OPTIONAL
    }
  }
}

tfc-SubsetList TFC-SubsetList OPTIONAL,
}

-- In UL-ControlledTrChList, TrCH-Type is always DCH
UL-ControlledTrChList ::= SEQUENCE (SIZE (1..maxTrCH)) OF
  TransportChannelIdentity

UL-DeletedTransChInfoList ::= SEQUENCE (SIZE (1..maxTrCH)) OF
  UL-TransportChannelIdentity

UL-DeletedTransChInfoList-r6 ::= SEQUENCE (SIZE (1..maxTrCH)) OF
  UL-TransportChannelIdentity-r6

UL-TransportChannelIdentity ::= SEQUENCE {
  ul-TransportChannelType UL-TrCH-Type,
  ul-TransportChannelIdentity TransportChannelIdentity
}

UL-TransportChannelIdentity-r6 ::= CHOICE {
  dch-usch SEQUENCE {
    ul-TransportChannelType UL-TrCH-Type,
    ul-TransportChannelIdentity TransportChannelIdentity
  },
  e-dch E-DCH-MAC-d-FlowIdentity
}

UL-TrCH-Type ::= ENUMERATED {dch, usch}

USCH-TransportChannelsInfo ::= SEQUENCE (SIZE (1..maxTrCH)) OF
  SEQUENCE {
    usch-TransportChannelIdentity TransportChannelIdentity,
    usch-TFS TransportFormatSet
  }
}

-- *****
--
-- PHYSICAL CHANNEL INFORMATION ELEMENTS (10.3.6)
--
-- *****

ACK-NACK-repetitionFactor ::= INTEGER(1..4)

AC-To-ASC-Mapping ::= INTEGER (0..7)

AC-To-ASC-MappingTable ::= SEQUENCE (SIZE (maxASCmap)) OF

```

```

AC-To-ASC-Mapping

AccessServiceClass-FDD ::=
    availableSignatureStartIndex
    availableSignatureEndIndex

    assignedSubChannelNumber

}

AccessServiceClass-TDD ::=
    channelisationCodeIndices

    subchannelSize
        size1
        size2
        size4
        size8

}

}

AccessServiceClass-TDD-r7 ::=
    channelisationCodeIndices

    subchannelSize
        size1
        size2

}

```

```

SEQUENCE {
    INTEGER (0..15),
    INTEGER (0..15),

    BIT STRING {
        b3(0),
        b2(1),
        b1(2),
        b0(3)
    } (SIZE(4))
}

SEQUENCE {
    BIT STRING {
        chCodeIndex7(0),
        chCodeIndex6(1),
        chCodeIndex5(2),
        chCodeIndex4(3),
        chCodeIndex3(4),
        chCodeIndex2(5),
        chCodeIndex1(6),
        chCodeIndex0(7)
    } (SIZE(8)) OPTIONAL,

    CHOICE {
        NULL,
        SEQUENCE {
            -- subch0 means bitstring '01' in the tabular, subch1 means bitsring '10'
            subchannels
                ENUMERATED { subch0, subch1 } OPTIONAL
        },
        SEQUENCE {
            BIT STRING {
                subCh3(0),
                subCh2(1),
                subCh1(2),
                subCh0(3)
            } (SIZE(4)) OPTIONAL
        }
    },

    SEQUENCE {
        BIT STRING {
            subCh7(0),
            subCh6(1),
            subCh5(2),
            subCh4(3),
            subCh3(4),
            subCh2(5),
            subCh1(6),
            subCh0(7)
        } (SIZE(8)) OPTIONAL
    }
}

SEQUENCE {
    BIT STRING {
        chCodeIndex15(0),
        chCodeIndex14(1),
        chCodeIndex13(2),
        chCodeIndex12(3),
        chCodeIndex11(4),
        chCodeIndex10(5),
        chCodeIndex9(6),
        chCodeIndex8(7),
        chCodeIndex7(8),
        chCodeIndex6(9),
        chCodeIndex5(10),
        chCodeIndex4(11),
        chCodeIndex3(12),
        chCodeIndex2(13),
        chCodeIndex1(14),
        chCodeIndex0(15)
    } (SIZE(16)) OPTIONAL,

    CHOICE {
        NULL,
        SEQUENCE {
            -- subch0 means bitstring '01' in the tabular, subch1 means bitsring '10'
            subchannels
                ENUMERATED { subch0, subch1 } OPTIONAL
        }
    }
}

```

```

    },
    size4
        subchannels
        SEQUENCE {
            BIT STRING {
                subCh3 (0),
                subCh2 (1),
                subCh1 (2),
                subCh0 (3)
            } (SIZE(4))
        } OPTIONAL
    },
    size8
        subchannels
        SEQUENCE {
            BIT STRING {
                subCh7 (0),
                subCh6 (1),
                subCh5 (2),
                subCh4 (3),
                subCh3 (4),
                subCh2 (5),
                subCh1 (6),
                subCh0 (7)
            } (SIZE(8))
        } OPTIONAL
    },
    size16
        subchannels
        SEQUENCE {
            BIT STRING {
                subCh15 (0),
                subCh14 (1),
                subCh13 (2),
                subCh12 (3),
                subCh11 (4),
                subCh10 (5),
                subCh9 (6),
                subCh8 (7),
                subCh7 (8),
                subCh6 (9),
                subCh5 (10),
                subCh4 (11),
                subCh3 (12),
                subCh2 (13),
                subCh1 (14),
                subCh0 (15)
            } (SIZE(16))
        } OPTIONAL
    }
}

AccessServiceClass-TDD-LCR-r4 ::= SEQUENCE {
    availableSYNC-UlCodesIndics
        BIT STRING {
            sulCodeIndex7 (0),
            sulCodeIndex6 (1),
            sulCodeIndex5 (2),
            sulCodeIndex4 (3),
            sulCodeIndex3 (4),
            sulCodeIndex2 (5),
            sulCodeIndex1 (6),
            sulCodeIndex0 (7)
        } (SIZE(8))
        OPTIONAL,
    subchannelSize
        CHOICE {
            size1
                NULL,
            size2
                SEQUENCE {
                    -- subch0 means bitstring '01' in the tabular, subch1 means bitstring '10'.
                    subchannels
                        ENUMERATED { subch0, subch1 } OPTIONAL
                }
        },
    size4
        subchannels
        SEQUENCE {
            BIT STRING {
                subCh3 (0),
                subCh2 (1),
                subCh1 (2),
                subCh0 (3)
            } (SIZE(4))
        } OPTIONAL
    },
    size8
        subchannels
        SEQUENCE {
            BIT STRING {
                subCh7 (0),
                subCh6 (1),
                subCh5 (2),
                subCh4 (3),
                subCh3 (4),
                subCh2 (5),
                subCh1 (6),
            }

```

```

        subCh0(7)
    } (SIZE(8)) OPTIONAL
}
}
}
ActivationTimeOffset ::= INTEGER (0 .. 255)
AdditionalPRACH-TF-and-TFCS-CCCH-IEs ::= SEQUENCE {
    powerOffsetInformation          PowerOffsetInformation,
    dynamicTFInformationCCCH       DynamicTFInformationCCCH
}
AdditionalPRACH-TF-and-TFCS-CCCH ::= SEQUENCE {
    additionalPRACH-TF-and-TFCS-CCCH-IEs  AdditionalPRACH-TF-and-TFCS-CCCH-IEs  OPTIONAL
}
-- The order is the same as in the PRACH-SystemInformationList
AdditionalPRACH-TF-and-TFCS-CCCH-List ::= SEQUENCE (SIZE (1..maxPRACH)) OF
    AdditionalPRACH-TF-and-TFCS-CCCH

AICH-Info ::= SEQUENCE {
    channelisationCode256          ChannelisationCode256,
    sttd-Indicator                 BOOLEAN,
    aich-TransmissionTiming        AICH-TransmissionTiming
}
AICH-PowerOffset ::= INTEGER (-22..5)
AICH-TransmissionTiming ::= ENUMERATED {
    e0, e1 }
AllocationPeriodInfo ::= SEQUENCE {
    allocationActivationTime        INTEGER (0..255),
    allocationDuration              INTEGER (1..256)
}
-- Actual value Alpha = IE value * 0.125
Alpha ::= INTEGER (0..8)
AP-AICH-ChannelisationCode ::= INTEGER (0..255)
AP-PreambleScramblingCode ::= INTEGER (0..79)
AP-Signature ::= INTEGER (0..15)
AP-Signature-VCAM ::= SEQUENCE {
    ap-Signature                    AP-Signature,
    availableAP-SubchannelList      AvailableAP-SubchannelList OPTIONAL
}
AP-Subchannel ::= INTEGER (0..11)
ASCSetting-FDD ::= SEQUENCE {
    -- TABULAR: accessServiceClass-FDD is MD in tabular description
    -- Default value is previous ASC
    -- If this is the first ASC, the default value is all available signature and sub-channels
    accessServiceClass-FDD          AccessServiceClass-FDD  OPTIONAL
}
ASCSetting-TDD ::= SEQUENCE {
    -- TABULAR: accessServiceClass-TDD is MD in tabular description
    -- Default value is previous ASC
    -- If this is the first ASC, the default value is all available channelisation codes and
    -- all available sub-channels with subchannelSize=size1.
    accessServiceClass-TDD          AccessServiceClass-TDD  OPTIONAL
}
ASCSetting-TDD-r7 ::= SEQUENCE {
    -- TABULAR: accessServiceClass-TDD is MD in tabular description
    -- Default value is previous ASC
    -- If this is the first ASC, the default value is all available channelisation codes and
    -- all available sub-channels with subchannelSize=size1.
    accessServiceClass-TDD          AccessServiceClass-TDD-r7  OPTIONAL
}
ASCSetting-TDD-LCR-r4 ::= SEQUENCE {
```

```

-- TABULAR: accessServiceClass-TDD-LCR is MD in tabular description
-- Default value is previous ASC
-- If this is the first ASC, the default value is all available SYNC_UL codes and
-- all available sub-channels with subchannelSize=size1.
accessServiceClass-TDD-LCR          AccessServiceClass-TDD-LCR-r4    OPTIONAL
}

AvailableAP-Signature-VCAMList ::= SEQUENCE (SIZE (1..maxPCPCH-APsig)) OF
    AP-Signature-VCAM

AvailableAP-SignatureList ::= SEQUENCE (SIZE (1..maxPCPCH-APsig)) OF
    AP-Signature

AvailableAP-SubchannelList ::= SEQUENCE (SIZE (1..maxPCPCH-APsubCh)) OF
    AP-Subchannel

AvailableMinimumSF-ListVCAM ::= SEQUENCE (SIZE (1..maxPCPCH-SF)) OF
    AvailableMinimumSF-VCAM

AvailableMinimumSF-VCAM ::= SEQUENCE {
    minimumSpreadingFactor      MinimumSpreadingFactor,
    nf-Max                      NF-Max,
    maxAvailablePCPCH-Number    MaxAvailablePCPCH-Number,
    availableAP-Signature-VCAMList AvailableAP-Signature-VCAMList
}

AvailableSignatures ::= BIT STRING {
    signature15 (0),
    signature14 (1),
    signature13 (2),
    signature12 (3),
    signature11 (4),
    signature10 (5),
    signature9 (6),
    signature8 (7),
    signature7 (8),
    signature6 (9),
    signature5 (10),
    signature4 (11),
    signature3 (12),
    signature2 (13),
    signature1 (14),
    signature0 (15)
} (SIZE (16))

AvailableSubChannelNumbers ::= BIT STRING {
    subCh11 (0),
    subCh10 (1),
    subCh9 (2),
    subCh8 (3),
    subCh7 (4),
    subCh6 (5),
    subCh5 (6),
    subCh4 (7),
    subCh3 (8),
    subCh2 (9),
    subCh1 (10),
    subCh0 (11)
} (SIZE (12))

BEACON-PL-Est ::= ENUMERATED { true }

BurstType ::= ENUMERATED {
    type1, type2 }

-- Actual value Bler-Target = IE value * 0.05
Bler-Target ::= INTEGER (-63..0)

CCTrCH-PowerControlInfo ::= SEQUENCE {
    tfcs-Identity          TFCS-Identity          OPTIONAL,
    ul-DPCH-PowerControlInfo UL-DPCH-PowerControlInfo
}

CCTrCH-PowerControlInfo-r4 ::= SEQUENCE {
    tfcs-Identity          TFCS-Identity          OPTIONAL,
    ul-DPCH-PowerControlInfo-r4 UL-DPCH-PowerControlInfo-r4
}

```

| | | | |
|------------------------------------|---|--|-------------------------------------|
| CCTrCH-PowerControlInfo-r5 ::= | SEQUENCE {
tfcs-Identity
ul-DPCH-PowerControlInfo
} | TFCS-Identity
UL-DPCH-PowerControlInfo-r5 | OPTIONAL, |
| CCTrCH-PowerControlInfo-r7 ::= | SEQUENCE {
tfcs-Identity
ul-DPCH-PowerControlInfo
} | TFCS-Identity
UL-DPCH-PowerControlInfo-r7 | OPTIONAL, |
| CD-AccessSlotSubchannel ::= | INTEGER (0..11) | | |
| CD-AccessSlotSubchannelList ::= | SEQUENCE (SIZE (1..maxPCPCH-CDsubCh)) OF
CD-AccessSlotSubchannel | | |
| CD-CA-ICH-ChannelisationCode ::= | INTEGER (0..255) | | |
| CD-PreambleScramblingCode ::= | INTEGER (0..79) | | |
| CD-SignatureCode ::= | INTEGER (0..15) | | |
| CD-SignatureCodeList ::= | SEQUENCE (SIZE (1..maxPCPCH-CDsig)) OF
CD-SignatureCode | | |
| CellAndChannelIdentity ::= | SEQUENCE {
-- burstType may be set to either value and should be ignored by the receiver for 1.28 Mcps TDD.
burstType
midambleShift
timeslot
cellParametersID
} | BurstType,
MidambleShiftLong,
TimeslotNumber,
CellParametersID | |
| CellParametersID ::= | INTEGER (0..127) | | |
| Cfntargetsfnframeoffset ::= | INTEGER(0..255) | | |
| ChannelAssignmentActive ::= | CHOICE {
notActive
isActive
} | NULL,
AvailableMinimumSF-ListVCAM | |
| ChannelisationCode256 ::= | INTEGER (0..255) | | |
| ChannelReqParamsForUCSM ::= | SEQUENCE {
availableAP-SignatureList
availableAP-SubchannelList
} | AvailableAP-SignatureList,
AvailableAP-SubchannelList | OPTIONAL |
| ClosedLoopTimingAdjMode ::= | ENUMERATED {
slot1, slot2 }
} | | |
| CodeNumberDSCH ::= | INTEGER (0..255) | | |
| CodeRange ::= | SEQUENCE {
pdsch-CodeMapList
} | PDSCH-CodeMapList | |
| CodeResourceInformation-TDD128 ::= | SEQUENCE {
start-code
stop-code
} | HS-ChannelisationCode-LCR,
HS-ChannelisationCode-LCR | |
| CodeWordSet ::= | ENUMERATED {
longCWS,
mediumCWS,
shortCWS,
ssdtOff }
} | | |
| Common-E-DCH-ResourceInfoList ::= | SEQUENCE {
s-offset
f-dpch-ChannelisationCodeNumber
e-RGCH-Information
e-high-Info
ul-DPCH-CodeInfoForCommonEDCH
} | INTEGER (0..9)
INTEGER (0..255)
E-RGCH-Information-CommonEdch
E-HICH-Information-CommonEdch,
UL-DPCH-CodeInfoForCommonEDCH | OPTIONAL,
OPTIONAL,
OPTIONAL, |
| Common-E-RNTI-Info ::= | SEQUENCE (SIZE (1..maxERUCCH)) OF
SEQUENCE { | | |

```

starting-E-RNTI                E-RNTI,
number-of-group                INTEGER (1..maxERNTIgroup),
number-of-ENRTI-per-group      INTEGER (1..maxERNTIperGroup)
}

-- For FDD, the network should not include the IE CommonEDCHSystemInfo.
-- Instead, the IE commonEDCHSystemInfoFDD should be used.
-- If included, the UE behavior is unspecified.
CommonEDCHSystemInfo ::= SEQUENCE {
  ul-InterferenceForCommonEDCH      UL-Interference                OPTIONAL,
  common-E-DCH-MAC-d-FlowList        Common-E-DCH-MAC-d-FlowList,
  modeSpecificInfo                   CHOICE {
    dummy                             SEQUENCE {},
    tdd                                CHOICE {
      tdd768 NULL,
      tdd384 NULL,
      tdd128 SEQUENCE {
        e-RUCCH-Info                E-RUCCH-Info-TDD128,
        e-PUCH-Info                 E-PUCH-Info-TDD128,
        e-hich-Information           E-HICH-Information-TDD128,
        e-agch-Information           E-AGCH-Information-TDD128,
        harq-Info                   ENUMERATED { rv0, rvtable },
        ccch-transmission-Info       SEQUENCE {
          common-e-rnti-Info         Common-E-RNTI-Info,
          harq-MaximumNumberOfRetransmissions INTEGER (0..7),
          harq-retransmission-timer  ENUMERATED {
            ms10, ms15, ms20, ms25,
            ms30, ms35, ms40, ms45,
            ms50, ms55, ms60, ms65,
            ms70, ms75, ms80, ms85,
            ms90, ms95, ms100, ms110,
            ms120, ms140, ms160 },
          harq-power-offset          INTEGER (0..6)
        }
      }
    }
  }
}

CommonEDCHSystemInfoFDD ::= SEQUENCE {
  ul-InterferenceForCommonEDCH      UL-Interference                OPTIONAL,
  common-E-DCH-MAC-d-FlowList        Common-E-DCH-MAC-d-FlowList,
  prach-PreambleForEnhancedUplink    PRACH-PreambleForEnhancedUplink,
  initialServingGrantValue           INTEGER (0..37),
  e-dch-TTI                          E-DCH-TTI,
  e-agch-Information                 E-AGCH-Information,
  harq-Info                          ENUMERATED { rv0, rvtable },
  ul-DPCHpowerControlInfoForCommonEDCH UL-DPCHpowerControlInfoForCommonEDCH,
  e-dpcch-Info                      E-DPCCH-Info-r7,
  e-dpdch-Info                      E-DPDCH-Info-r8,
  -- Actual value dl-FDPCH-TPCcommandErrorRate = IE value * 0.01
  dl-FDPCH-TPCcommandErrorRate       INTEGER (1..10),
  additional-E-DCH-TransmitBackoff    INTEGER (0..15),
  max-CCCH-ResourceAllocation         ENUMERATED {
    tti8, tti12, tti16, tti20, tti24, tti32,
    tti40, tti80 },
  max-PeriodForCollisionResolution    INTEGER (8..24),
  e-dch-TransmitContinuationOffset    ENUMERATED {
    tti0, tti4, tti8, tti16, tti24, tti40,
    tti80, infinity },
  ack-nack-support-on-HS-DPCCH        BOOLEAN,
  measurement-Feedback-Info           Measurement-Feedback-Info-r7    OPTIONAL,
  common-E-DCH-ResourceInfoList       SEQUENCE (SIZE (1..maxEDCHs)) OF
    Common-E-DCH-ResourceInfoList
}

CommonTimeslotInfo ::= SEQUENCE {
  -- TABULAR: secondInterleavingMode is MD, but since it can be encoded in a single
  -- bit it is not defined as OPTIONAL.
  secondInterleavingMode              SecondInterleavingMode,
  tfci-Coding                        TFCCI-Coding                    OPTIONAL,
  puncturingLimit                    PuncturingLimit,
  repetitionPeriodAndLength          RepetitionPeriodAndLength    OPTIONAL
}

CommonTimeslotInfoMBMS ::= SEQUENCE {
  -- TABULAR: secondInterleavingMode is MD, but since it can be encoded in a single

```



```

-- bit it is not defined as OPTIONAL.
secondInterleavingMode      SecondInterleavingMode,
tfci-Coding                  TFCI-Coding                      OPTIONAL,
puncturingLimit              PuncturingLimit
}

CommonTimeslotInfoSCCPCH ::= SEQUENCE {
-- TABULAR: secondInterleavingMode is MD, but since it can be encoded in a single
-- bit it is not defined as OPTIONAL.
secondInterleavingMode      SecondInterleavingMode,
tfci-Coding                  TFCI-Coding                      OPTIONAL,
puncturingLimit              PuncturingLimit,
repetitionPeriodLengthAndOffset RepetitionPeriodLengthAndOffset OPTIONAL
}

ConstantValue ::= INTEGER (-35..-10)

ConstantValueTdd ::= INTEGER (-35..10)

ControlChannelDRXCycle-TDD128 ::= ENUMERATED {
sub-frames-1, sub-frames-2, sub-frames-4, sub-frames-8,
sub-frames-16, sub-frames-32, sub-frames-64, spare1 }

ControlChannelDRXInfo-TDD128-r8 ::= SEQUENCE {
controlChannelDrxOperation CHOICE {
continue SEQUENCE {
enablingDelay EnablingDelay-TDD128 OPTIONAL
},
newOperation SEQUENCE {
hs-SCCH-Drx-Info HS-SCCH-DRX-Info-TDD128,
e-AGCH-Drx-Info E-AGCH-DRX-Info-TDD128 OPTIONAL,
enablingDelay EnablingDelay-TDD128
}
}
}

CPCH-PersistenceLevels ::= SEQUENCE {
cpch-SetID CPCH-SetID,
dynamicPersistenceLevelTF-List DynamicPersistenceLevelTF-List
}

CPCH-PersistenceLevelsList ::= SEQUENCE (SIZE (1..maxCPCHsets)) OF
CPCH-PersistenceLevels

CPCH-SetInfo ::= SEQUENCE {
cpch-SetID CPCH-SetID,
transportFormatSet TransportFormatSet,
tfcs TFCS,
ap-PreambleScramblingCode AP-PreambleScramblingCode,
ap-AICH-ChannelisationCode AP-AICH-ChannelisationCode,
cd-PreambleScramblingCode CD-PreambleScramblingCode,
cd-CA-ICH-ChannelisationCode CD-CA-ICH-ChannelisationCode,
cd-AccessSlotSubchannelList CD-AccessSlotSubchannelList OPTIONAL,
cd-SignatureCodeList CD-SignatureCodeList OPTIONAL,
deltaPp-m DeltaPp-m,
ul-DPCCH-SlotFormat UL-DPCCH-SlotFormat,
n-StartMessage N-StartMessage,
n-EOT N-EOT,
-- TABULAR: VCAM info has been nested inside ChannelAssignmentActive,
-- which in turn is mandatory since it's only a binary choice.
channelAssignmentActive ChannelAssignmentActive,
cpch-StatusIndicationMode CPCH-StatusIndicationMode,
pcpch-ChannelInfoList PCPCH-ChannelInfoList
}

CPCH-SetInfoList ::= SEQUENCE (SIZE (1..maxCPCHsets)) OF
CPCH-SetInfo

CPCH-StatusIndicationMode ::= ENUMERATED {
pa-mode,
pamsf-mode }

CQI-DTX-Timer ::= ENUMERATED {
sub-frames-0,
sub-frames-1,
sub-frames-2,
sub-frames-4,
sub-frames-8,

```

```

sub-frames-16,
sub-frames-32,
sub-frames-64,
sub-frames-128,
sub-frames-256,
sub-frames-512,
sub-frames-Infinity,
spare4,
spare3,
spare2,
spare1 }

CQI-RepetitionFactor ::=          INTEGER(1..4)

CSICH-PowerOffset ::=            INTEGER (-10..5)

-- DefaultDPCH-OffsetValueFDD and DefaultDPCH-OffsetValueTDD corresponds to
-- IE "Default DPCH Offset Value" depending on the mode.
-- Actual value DefaultDPCH-OffsetValueFDD = IE value * 512
DefaultDPCH-OffsetValueFDD ::=   INTEGER (0..599)

DefaultDPCH-OffsetValueTDD ::=   INTEGER (0..7)

DeltaPp-m ::=                    INTEGER (-10..10)

DeltaCQI ::=                     INTEGER (0..8)

DeltaNACK ::=                    INTEGER (0..8)

DeltaACK ::=                     INTEGER (0..8)

-- Actual value DeltaSIR = IE value * 0.1
DeltaSIR ::=                     INTEGER (0..30)

DHS-Sync ::=                     INTEGER (-20..10)

DL-CCTrCh ::=                   SEQUENCE {
    tfcs-ID                       TFCS-IdentityPlain           DEFAULT 1,
    timeInfo                      TimeInfo,
    commonTimeslotInfo            CommonTimeslotInfo         OPTIONAL,
    dl-CCTrCH-TimeslotsCodes     DownlinkTimeslotsCodes   OPTIONAL,
    ul-CCTrChTPCList             UL-CCTrChTPCList           OPTIONAL
}

DL-CCTrCh-r4 ::=                SEQUENCE {
    tfcs-ID                       TFCS-IdentityPlain           DEFAULT 1,
    timeInfo                      TimeInfo,
    commonTimeslotInfo            CommonTimeslotInfo         OPTIONAL,
    tddOption                     CHOICE {
        tdd384                    SEQUENCE {
            dl-CCTrCH-TimeslotsCodes DownlinkTimeslotsCodes OPTIONAL
        },
        tdd128                    SEQUENCE {
            dl-CCTrCH-TimeslotsCodes DownlinkTimeslotsCodes-LCR-r4 OPTIONAL
        }
    },
    ul-CCTrChTPCList             UL-CCTrChTPCList           OPTIONAL
}

DL-CCTrCh-r7 ::=                SEQUENCE {
    tfcs-ID                       TFCS-IdentityPlain           DEFAULT 1,
    timeInfo                      TimeInfo,
    commonTimeslotInfo            CommonTimeslotInfo         OPTIONAL,
    tddOption                     CHOICE {
        tdd384                    SEQUENCE {
            dl-CCTrCH-TimeslotsCodes DownlinkTimeslotsCodes-r7 OPTIONAL
        },
        tdd768                    SEQUENCE {
            dl-CCTrCH-TimeslotsCodes DownlinkTimeslotsCodes-VHCR   OPTIONAL
        },
        tdd128                    SEQUENCE {
            dl-CCTrCH-TimeslotsCodes DownlinkTimeslotsCodes-LCR-r4 OPTIONAL
        }
    },
    ul-CCTrChTPCList             UL-CCTrChTPCList           OPTIONAL
}

DL-CCTrChList ::=              SEQUENCE (SIZE (1..maxCCTrCH)) OF

```

```

DL-CCTrCh
DL-CCTrChList-r7 ::= SEQUENCE (SIZE (1..maxCCTrCH)) OF
                    DL-CCTrCh-r7
DL-CCTrChList-r4 ::= SEQUENCE (SIZE (1..maxCCTrCH)) OF
                    DL-CCTrCh-r4
DL-CCTrChListToRemove ::= SEQUENCE (SIZE (1..maxCCTrCH)) OF
                        TFCS-IdentityPlain
DL-ChannelisationCode ::= SEQUENCE {
    secondaryScramblingCode SecondaryScramblingCode OPTIONAL,
    sf-AndCodeNumber SF512-AndCodeNumber,
    scramblingCodeChange ScramblingCodeChange OPTIONAL
}
DL-ChannelisationCodeList ::= SEQUENCE (SIZE (1..maxDPCH-DLchan)) OF
                            DL-ChannelisationCode
DL-CommonInformation ::= SEQUENCE {
    dl-DPCH-InfoCommon DL-DPCH-InfoCommon OPTIONAL,
    modeSpecificInfo CHOICE {
        fdd SEQUENCE {
            defaultDPCH-OffsetValue DefaultDPCH-OffsetValueFDD OPTIONAL,
            dpch-CompressedModeInfo DPCH-CompressedModeInfo OPTIONAL,
            tx-DiversityMode TX-DiversityMode OPTIONAL,
            -- dummy is not used in this version of the specification, it should
            -- not be sent and if received it should be ignored.
            dummy SSdT-Information OPTIONAL
        },
        tdd SEQUENCE {
            defaultDPCH-OffsetValue DefaultDPCH-OffsetValueTDD OPTIONAL
        }
    }
}
DL-CommonInformation-r4 ::= SEQUENCE {
    dl-DPCH-InfoCommon DL-DPCH-InfoCommon-r4 OPTIONAL,
    modeSpecificInfo CHOICE {
        fdd SEQUENCE {
            defaultDPCH-OffsetValue DefaultDPCH-OffsetValueFDD OPTIONAL,
            dpch-CompressedModeInfo DPCH-CompressedModeInfo OPTIONAL,
            tx-DiversityMode TX-DiversityMode OPTIONAL,
            -- dummy is not used in this version of the specification, it should
            -- not be sent and if received it should be ignored.
            dummy SSdT-Information-r4 OPTIONAL
        },
        tdd SEQUENCE {
            tddOption CHOICE {
                tdd384 NULL,
                tdd128 SEQUENCE {
                    tstd-Indicator BOOLEAN
                }
            },
            defaultDPCH-OffsetValue DefaultDPCH-OffsetValueTDD OPTIONAL
        }
    }
}
DL-CommonInformation-r5 ::= SEQUENCE {
    dl-DPCH-InfoCommon DL-DPCH-InfoCommon-r4 OPTIONAL,
    modeSpecificInfo CHOICE {
        fdd SEQUENCE {
            defaultDPCH-OffsetValue DefaultDPCH-OffsetValueFDD OPTIONAL,
            dpch-CompressedModeInfo DPCH-CompressedModeInfo OPTIONAL,
            tx-DiversityMode TX-DiversityMode OPTIONAL,
            -- dummy is not used in this version of the specification, it should
            -- not be sent and if received it should be ignored.
            dummy SSdT-Information-r4 OPTIONAL
        },
        tdd SEQUENCE {
            tddOption CHOICE {
                tdd384 NULL,
                tdd128 SEQUENCE {
                    tstd-Indicator BOOLEAN
                }
            }
        }
    }
}

```

```

        },
        defaultDPCH-OffsetValue          DefaultDPCH-OffsetValueTDD  OPTIONAL
    }
},
mac-hsResetIndicator                    ENUMERATED { true }          OPTIONAL
}

DL-CommonInformation-r6 ::=             SEQUENCE {
    dl-dpchInfoCommon                   CHOICE {
        dl-DPCH-InfoCommon              DL-DPCH-InfoCommon-r6,
        dl-FDPCH-InfoCommon              DL-FDPCH-InfoCommon-r6
    }
    modeSpecificInfo                     CHOICE {
        fdd                               SEQUENCE {
            defaultDPCH-OffsetValue      DefaultDPCH-OffsetValueFDD  OPTIONAL,
            dpch-CompressedModeInfo      DPCH-CompressedModeInfo    OPTIONAL,
            tx-DiversityMode              TX-DiversityMode            OPTIONAL
        },
        tdd                               SEQUENCE {
            tddOption                     CHOICE {
                tdd384                     NULL,
                tdd128                     SEQUENCE {
                    tstd-Indicator          BOOLEAN
                }
            }
        },
        defaultDPCH-OffsetValue          DefaultDPCH-OffsetValueTDD  OPTIONAL
    }
},
mac-hsResetIndicator                    ENUMERATED { true }          OPTIONAL,
postVerificationPeriod                  ENUMERATED { true }          OPTIONAL
}

DL-CommonInformation-r7 ::=             SEQUENCE {
    dl-dpchInfoCommon                   CHOICE {
        dl-DPCH-InfoCommon              DL-DPCH-InfoCommon-r6,
        dl-FDPCH-InfoCommon              DL-FDPCH-InfoCommon-r6
    }
    modeSpecificInfo                     CHOICE {
        fdd                               SEQUENCE {
            defaultDPCH-OffsetValue      DefaultDPCH-OffsetValueFDD  OPTIONAL,
            dpch-CompressedModeInfo      DPCH-CompressedModeInfo    OPTIONAL,
            tx-DiversityMode              TX-DiversityMode            OPTIONAL
        },
        tdd                               SEQUENCE {
            tddOption                     CHOICE {
                tdd384                     NULL,
                tdd768                     NULL,
                tdd128                     SEQUENCE {
                    tstd-Indicator          BOOLEAN
                }
            }
        },
        defaultDPCH-OffsetValue          DefaultDPCH-OffsetValueTDD  OPTIONAL
    }
},
mac-hsResetIndicator                    ENUMERATED { true }          OPTIONAL,
postVerificationPeriod                  ENUMERATED { true }          OPTIONAL
}

DL-CommonInformation-r8 ::=             SEQUENCE {
    dl-dpchInfoCommon                   CHOICE {
        dl-DPCH-InfoCommon              DL-DPCH-InfoCommon-r6,
        dl-FDPCH-InfoCommon              DL-FDPCH-InfoCommon-r6
    }
    modeSpecificInfo                     CHOICE {
        fdd                               SEQUENCE {
            defaultDPCH-OffsetValue      DefaultDPCH-OffsetValueFDD  OPTIONAL,
            dpch-CompressedModeInfo      DPCH-CompressedModeInfo-r8  OPTIONAL,
            tx-DiversityMode              TX-DiversityMode            OPTIONAL
        },
        tdd                               SEQUENCE {
            tddOption                     CHOICE {
                tdd384                     NULL,
                tdd768                     NULL,
                tdd128                     SEQUENCE {
                    tstd-Indicator          BOOLEAN
                }
            }
        },
        defaultDPCH-OffsetValue          DefaultDPCH-OffsetValueTDD  OPTIONAL
    }
}

```

```

    },
    mac-hsResetIndicator          ENUMERATED { true }          OPTIONAL,
    postVerificationPeriod        ENUMERATED { true }          OPTIONAL
  }

DL-CommonInformationPost ::=      SEQUENCE {
  dl-DPCH-InfoCommon             DL-DPCH-InfoCommonPost
}

DL-CommonInformationPredef ::=    SEQUENCE {
  dl-DPCH-InfoCommon             DL-DPCH-InfoCommonPredef  OPTIONAL
}

DL-CompressedModeMethod ::=      ENUMERATED {
  -- dummy is not used in this version of the specification, it should
  -- not be sent and if received the UE behaviour is not specified.
  dummy, sf-2,
  higherLayerScheduling }

DL-DPCH-InfoCommon ::=          SEQUENCE {
  cfnHandling                     CHOICE {
    maintain                       NULL,
    initialise                      SEQUENCE {
      -- IE dummy is not used in this version of the specification
      -- The IE should not be sent and if received it should be ignored
      dummy                        Cfntargetsfnsframeoffset  OPTIONAL
    }
  },
  modeSpecificInfo                CHOICE {
    fdd                            SEQUENCE {
      dl-DPCH-PowerControlInfo     DL-DPCH-PowerControlInfo      OPTIONAL,
      powerOffsetPilot-pdpdch       PowerOffsetPilot-pdpdch,
      dl-rate-matching-restriction  Dl-rate-matching-restriction  OPTIONAL,
      -- TABULAR: The number of pilot bits is nested inside the spreading factor.
      spreadingFactorAndPilot       SF512-AndPilot,
      positionFixedOrFlexible       PositionFixedOrFlexible,
      tfci-Existence                BOOLEAN
    },
    tdd                            SEQUENCE {
      dl-DPCH-PowerControlInfo     DL-DPCH-PowerControlInfo      OPTIONAL
    }
  }
}

DL-DPCH-InfoCommon-r4 ::=       SEQUENCE {
  cfnHandling                     CHOICE {
    maintain                       NULL,
    initialise                      SEQUENCE {
      -- IE dummy is not used in this version of the specification
      -- The IE should not be sent and if received it should be ignored
      dummy                        Cfntargetsfnsframeoffset  OPTIONAL
    }
  },
  modeSpecificInfo                CHOICE {
    fdd                            SEQUENCE {
      dl-DPCH-PowerControlInfo     DL-DPCH-PowerControlInfo      OPTIONAL,
      powerOffsetPilot-pdpdch       PowerOffsetPilot-pdpdch,
      dl-rate-matching-restriction  Dl-rate-matching-restriction  OPTIONAL,
      -- TABULAR: The number of pilot bits is nested inside the spreading factor.
      spreadingFactorAndPilot       SF512-AndPilot,
      positionFixedOrFlexible       PositionFixedOrFlexible,
      tfci-Existence                BOOLEAN
    },
    tdd                            SEQUENCE {
      dl-DPCH-PowerControlInfo     DL-DPCH-PowerControlInfo      OPTIONAL
    }
  },
  -- The IE mac-d-HFN-initial-value should be absent in the RRCConnectionSetup-r4-IEs or
  -- RRCConnectionSetup-r5-IEs or HandoverToUTRANCommand-r4-IEs or HandoverToUTRANCommand-r5-IEs and
  -- if the IE is included, the general error handling for conditional IEs applies.
  mac-d-HFN-initial-value         MAC-d-HFN-initial-value    OPTIONAL
}

DL-DPCH-InfoCommon-r6 ::=       SEQUENCE {
  cfnHandling                     CHOICE {
    maintain

```

```

        timingmaintainedsynchind          TimingMaintainedSynchInd          OPTIONAL
    },
    initialise                             NULL
},
modeSpecificInfo                          CHOICE {
    fdd                                     SEQUENCE {
        dl-DPCH-PowerControlInfo          DL-DPCH-PowerControlInfo          OPTIONAL,
        powerOffsetPilot-pdpdch          PowerOffsetPilot-pdpdch,
        dl-rate-matching-restriction      Dl-rate-matching-restriction      OPTIONAL,
        -- TABULAR: The number of pilot bits is nested inside the spreading factor.
        spreadingFactorAndPilot           SF512-AndPilot,
        positionFixedOrFlexible           PositionFixedOrFlexible,
        tfci-Existence                     BOOLEAN
    },
    tdd                                     SEQUENCE {
        dl-DPCH-PowerControlInfo          DL-DPCH-PowerControlInfo          OPTIONAL
    }
},
-- The IE mac-d-HFN-initial-value should be absent in the RRCConnectionSetup and the
-- HandoverToUTRANCommand messages. If the IE is included, the general error handling
-- for conditional IEs applies.
mac-d-HFN-initial-value                   MAC-d-HFN-initial-value           OPTIONAL
}

DL-DPCH-InfoCommonPost ::=                SEQUENCE {
    dl-DPCH-PowerControlInfo              DL-DPCH-PowerControlInfo          OPTIONAL
}

DL-DPCH-InfoCommonPredef ::=              SEQUENCE {
    modeSpecificInfo                      CHOICE {
        fdd                               SEQUENCE {
            -- TABULAR: The number of pilot bits is nested inside the spreading factor.
            spreadingFactorAndPilot        SF512-AndPilot,
            positionFixedOrFlexible        PositionFixedOrFlexible,
            tfci-Existence                  BOOLEAN
        },
        tdd                               SEQUENCE {
            commonTimeslotInfo             CommonTimeslotInfo
        }
    }
}

DL-DPCH-InfoPerRL ::=                    CHOICE {
    fdd                                    SEQUENCE {
        pCPICH-UsageForChannelEst         PCPICH-UsageForChannelEst,
        dpch-FrameOffset                  DPCH-FrameOffset,
        secondaryCPICH-Info                SecondaryCPICH-Info                OPTIONAL,
        dl-ChannelisationCodeList         DL-ChannelisationCodeList,
        tpc-CombinationIndex              TPC-CombinationIndex,
        -- dummy is not used in this version of the specification, it should
        -- not be sent and if received it should be ignored.
        dummy                              SSdT-CellIdentity                 OPTIONAL,
        closedLoopTimingAdjMode            ClosedLoopTimingAdjMode            OPTIONAL
    },
    tdd                                    SEQUENCE {
        dl-CCTrChListToEstablish           DL-CCTrChList                     OPTIONAL,
        dl-CCTrChListToRemove              DL-CCTrChListToRemove             OPTIONAL
    }
}

DL-DPCH-InfoPerRL-r4 ::=                  CHOICE {
    fdd                                    SEQUENCE {
        pCPICH-UsageForChannelEst         PCPICH-UsageForChannelEst,
        dpch-FrameOffset                  DPCH-FrameOffset,
        secondaryCPICH-Info                SecondaryCPICH-Info                OPTIONAL,
        dl-ChannelisationCodeList         DL-ChannelisationCodeList,
        tpc-CombinationIndex              TPC-CombinationIndex,
        -- dummy is not used in this version of the specification, it should
        -- not be sent and if received it should be ignored.
        dummy                              SSdT-CellIdentity                 OPTIONAL,
        closedLoopTimingAdjMode            ClosedLoopTimingAdjMode            OPTIONAL
    },
    tdd                                    SEQUENCE {
        dl-CCTrChListToEstablish           DL-CCTrChList-r4                   OPTIONAL,
        dl-CCTrChListToRemove              DL-CCTrChListToRemove             OPTIONAL
    }
}

```

```

DL-DPCH-InfoPerRL-r5 ::= CHOICE {
  fdd SEQUENCE {
    pCPICH-UsageForChannelEst PCPICH-UsageForChannelEst,
    dpch-FrameOffset DPCH-FrameOffset,
    secondaryCPICH-Info SecondaryCPICH-Info OPTIONAL,
    dl-ChannelisationCodeList DL-ChannelisationCodeList,
    tpc-CombinationIndex TPC-CombinationIndex,
    powerOffsetTPC-pdpdch PowerOffsetTPC-pdpdch OPTIONAL,
    -- dummy is not used in this version of the specification, it should
    -- not be sent and if received it should be ignored.
    dummy SSDT-CellIdentity OPTIONAL,
    closedLoopTimingAdjMode ClosedLoopTimingAdjMode OPTIONAL
  },
  tdd SEQUENCE {
    dl-CCTrChListToEstablish DL-CCTrChList-r4 OPTIONAL,
    dl-CCTrChListToRemove DL-CCTrChListToRemove OPTIONAL
  }
}

DL-DPCH-InfoPerRL-r6 ::= CHOICE {
  fdd SEQUENCE {
    pCPICH-UsageForChannelEst PCPICH-UsageForChannelEst,
    dpch-FrameOffset DPCH-FrameOffset,
    secondaryCPICH-Info SecondaryCPICH-Info OPTIONAL,
    dl-ChannelisationCodeList DL-ChannelisationCodeList,
    tpc-CombinationIndex TPC-CombinationIndex,
    powerOffsetTPC-pdpdch PowerOffsetTPC-pdpdch OPTIONAL,
    closedLoopTimingAdjMode ClosedLoopTimingAdjMode OPTIONAL
  },
  tdd SEQUENCE {
    dl-CCTrChListToEstablish DL-CCTrChList-r4 OPTIONAL,
    dl-CCTrChListToRemove DL-CCTrChListToRemove OPTIONAL
  }
}

DL-DPCH-InfoPerRL-r7 ::= CHOICE {
  fdd SEQUENCE {
    pCPICH-UsageForChannelEst PCPICH-UsageForChannelEst,
    dpch-FrameOffset DPCH-FrameOffset,
    secondaryCPICH-Info SecondaryCPICH-Info OPTIONAL,
    dl-ChannelisationCodeList DL-ChannelisationCodeList,
    tpc-CombinationIndex TPC-CombinationIndex,
    powerOffsetTPC-pdpdch PowerOffsetTPC-pdpdch OPTIONAL,
    closedLoopTimingAdjMode ClosedLoopTimingAdjMode OPTIONAL
  },
  tdd SEQUENCE {
    dl-CCTrChListToEstablish DL-CCTrChList-r7 OPTIONAL,
    dl-CCTrChListToRemove DL-CCTrChListToRemove OPTIONAL
  }
}

DL-FDPCH-InfoPerRL-r6 ::= SEQUENCE {
  pCPICH-UsageForChannelEst PCPICH-UsageForChannelEst,
  fdpch-FrameOffset DPCH-FrameOffset,
  secondaryCPICH-Info SecondaryCPICH-Info OPTIONAL,
  secondaryScramblingCode SecondaryScramblingCode OPTIONAL,
  dl-ChannelisationCode INTEGER (0..255),
  tpc-CombinationIndex TPC-CombinationIndex
}

DL-FDPCH-InfoPerRL-r7 ::= SEQUENCE {
  pCPICH-UsageForChannelEst PCPICH-UsageForChannelEst,
  fdpch-FrameOffset DPCH-FrameOffset,
  fdpch-SlotFormat FDPCH-SlotFormat OPTIONAL,
  secondaryCPICH-Info SecondaryCPICH-Info OPTIONAL,
  secondaryScramblingCode SecondaryScramblingCode OPTIONAL,
  dl-ChannelisationCode INTEGER (0..255),
  tpc-CombinationIndex TPC-CombinationIndex,
  sttdIndication STTDIndication OPTIONAL
}

DL-DPCH-InfoPerRL-PostFDD ::= SEQUENCE {
  pCPICH-UsageForChannelEst PCPICH-UsageForChannelEst,
  dl-ChannelisationCode DL-ChannelisationCode,
  tpc-CombinationIndex TPC-CombinationIndex
}

DL-DPCH-InfoPerRL-PostTDD ::= SEQUENCE {

```

```

    dl-DPCH-TimeslotsCodes                DownlinkTimeslotsCodes
}

DL-DPCH-InfoPerRL-PostTDD-LCR-r4 ::= SEQUENCE {
    dl-CCTrCH-TimeslotsCodes              DownlinkTimeslotsCodes-LCR-r4
}

DL-DPCH-PowerControlInfo ::= SEQUENCE {
    modeSpecificInfo                       CHOICE {
        fdd                                SEQUENCE {
            dpc-Mode                       DPC-Mode
        },
        tdd                                SEQUENCE {
            tpc-StepSizeTDD                 TPC-StepSizeTDD           OPTIONAL
        }
    }
}

DL-FDPCH-InfoCommon-r6 ::= SEQUENCE {
    cfnHandling                            CHOICE {
        maintain                           SEQUENCE {
            timingmaintainedsynchind       TimingMaintainedSynchInd     OPTIONAL
        },
        initialise                          NULL
    },
    dl-FDPCH-PowerControlInfo              DL-DPCH-PowerControlInfo     OPTIONAL,
    -- Actual value dl-FDPCH-TPCcommandErrorRate = IE value * 0.01
    -- dl-FDPCH-TPCcommandErrorRate values 11..16 are spare and shall not be used in this version of
    -- the protocol.
    -- In addition, this IE shall always be included otherwise the UE behaviour is unspecified.
    dl-FDPCH-TPCcommandErrorRate          INTEGER (1..16)           OPTIONAL
}

DL-FrameType ::= ENUMERATED {
    dl-FrameTypeA, dl-FrameTypeB }

DL-HSPDSCH-Information ::= SEQUENCE {
    hs-scch-Info                           HS-SCCH-Info           OPTIONAL,
    measurement-feedback-Info              Measurement-Feedback-Info OPTIONAL,
    modeSpecificInfo                       CHOICE {
        tdd                                CHOICE {
            tdd384                          SEQUENCE {
                dl-HSPDSCH-TS-Configuration DL-HSPDSCH-TS-Configuration OPTIONAL
            },
            tdd128                          SEQUENCE {
                hs-PDSCH-Midamble-Configuration-tdd128
                HS-PDSCH-Midamble-Configuration-TDD128           OPTIONAL
            }
        }
    },
    fdd                                      NULL
}

DL-HSPDSCH-Information-r6 ::= SEQUENCE {
    hs-scch-Info                           HS-SCCH-Info-r6       OPTIONAL,
    measurement-feedback-Info              Measurement-Feedback-Info OPTIONAL,
    modeSpecificInfo                       CHOICE {
        tdd                                CHOICE {
            tdd384                          SEQUENCE {
                dl-HSPDSCH-TS-Configuration DL-HSPDSCH-TS-Configuration OPTIONAL
            },
            tdd128                          SEQUENCE {
                hs-PDSCH-Midamble-Configuration-tdd128
                HS-PDSCH-Midamble-Configuration-TDD128           OPTIONAL
            }
        }
    },
    fdd                                      NULL
}

DL-HSPDSCH-Information-r7 ::= SEQUENCE {
    hs-scch-Info                           HS-SCCH-Info-r7       OPTIONAL,
    measurement-feedback-Info              Measurement-Feedback-Info-r7 OPTIONAL,
    modeSpecificInfo                       CHOICE {
        tdd                                CHOICE {
            tdd384                          SEQUENCE {
                dl-HSPDSCH-TS-Configuration DL-HSPDSCH-TS-Configuration OPTIONAL
            },

```



```

        tdd768                               SEQUENCE {
            dl-HSPDSCH-TS-Configuration       DL-HSPDSCH-TS-Configuration-VHCR   OPTIONAL
        },
        tdd128                               SEQUENCE {
            hs-PDSCH-Midamble-Configuration-tdd128
            HS-PDSCH-Midamble-Configuration-TDD128                               OPTIONAL,
            dl-MultiCarrier-Information       DL-MultiCarrier-Information         OPTIONAL
        }
    },
    fdd                                       SEQUENCE {
        dl-64QAM-Configured                  ENUMERATED { true }                    OPTIONAL
    }
}

DL-HSPDSCH-Information-r8 ::= SEQUENCE {
    hs-scch-Info                             HS-SCCH-Info-r7                       OPTIONAL,
    measurement-feedback-Info               Measurement-Feedback-Info-r7          OPTIONAL,
    modeSpecificInfo                         CHOICE {
        tdd                                   CHOICE {
            tdd384                           SEQUENCE {
                dl-HSPDSCH-TS-Configuration DL-HSPDSCH-TS-Configuration OPTIONAL
            },
            tdd768                           SEQUENCE {
                dl-HSPDSCH-TS-Configuration DL-HSPDSCH-TS-Configuration-VHCR   OPTIONAL
            },
            tdd128                           SEQUENCE {
                hs-PDSCH-Midamble-Configuration-tdd128
                HS-PDSCH-Midamble-Configuration-TDD128                               OPTIONAL,
                dl-MultiCarrier-Information DL-MultiCarrier-Information         OPTIONAL
            }
        },
        fdd                                   SEQUENCE {
            dl-64QAM-Configured              ENUMERATED { true }                    OPTIONAL,
            hs-DSCH-TBSizeTable              HS-DSCH-TBSizeTable                   OPTIONAL
        }
    }
}

DL-HSPDSCH-Information-r8-ext ::= SEQUENCE {
    modeSpecificInfo                         CHOICE {
        tdd                                   CHOICE {
            tdd384                           NULL,
            tdd768                           NULL,
            tdd128                           SEQUENCE {
                outofSyncWindow              OutofSyncWindow                       OPTIONAL
            }
        },
        fdd                                   NULL
    }
}

DL-HSPDSCH-Information-r8-ext2 ::= SEQUENCE {
    hs-scch-Info                             HS-SCCH-Info-r8-ext                   OPTIONAL
}

DL-HSPDSCH-MultiCarrier-Information ::= SEQUENCE (SIZE (1..maxTDD128Carrier)) OF
    SEQUENCE {
        uarfcn-Carrier                       UARFCN,
        harqInfo                             HARQ-Info                             OPTIONAL,
        hs-PDSCH-Midamble-Configuration     HS-PDSCH-Midamble-Configuration-TDD128 OPTIONAL,
        hs-SCCH-TDD128-MultiCarrier         SEQUENCE (SIZE (1..maxHSSCCHs)) OF
            HS-SCCH-TDD128-MultiCarrier     OPTIONAL
    }
}

-- The IE 'DL-HSPDSCH-TS-Configuration' applies to tdd-384 REL-5 onward
DL-HSPDSCH-TS-Configuration ::= SEQUENCE (SIZE (1..maxTS-1)) OF
    SEQUENCE {
        timeslot                             TimeslotNumber,
        midambleShiftAndBurstType            MidambleShiftAndBurstType-DL
    }
}

-- The IE 'DL-HSPDSCH-TS-Configuration-VHCR' applies to tdd-768 REL-7 onward
DL-HSPDSCH-TS-Configuration-VHCR ::= SEQUENCE (SIZE (1..maxTS-1)) OF
    SEQUENCE {
        timeslot                             TimeslotNumber,
        midambleShiftAndBurstType            MidambleShiftAndBurstType-DL-VHCR
    }
}

```

```

DL-InformationPerRL ::=
    modeSpecificInfo
        fdd
            primaryCPICH-Info
                -- dummy1 and dummy 2 are not used in this version of specification, they should
                -- not be sent and if received they should be ignored.
                dummy1
                dummy2
            },
            tdd
                PrimaryCCPCH-Info
        },
    dl-DPCH-InfoPerRL
        -- dummy is not used in this version of the specification, it should
        -- not be sent and if received it should be ignored.
    dummy
        SCCPCH-InfoForFACH
}

DL-InformationPerRL-r4 ::=
    modeSpecificInfo
        fdd
            primaryCPICH-Info
                -- dummy1 and dummy 2 are not used in this version of specification, they should
                -- not be sent and if received they should be ignored.
                dummy1
                dummy2
            },
            tdd
                PrimaryCCPCH-Info-r4
        },
    dl-DPCH-InfoPerRL
        -- dummy is not used in this version of the specification, it should
        -- not be sent and if received it should be ignored.
    dummy
        SCCPCH-InfoForFACH-r4
    cell-id
        CellIdentity
}

DL-InformationPerRL-r5 ::=
    modeSpecificInfo
        fdd
            primaryCPICH-Info
                -- dummy1 and dummy 2 are not used in this version of specification, they should
                -- not be sent and if received they should be ignored.
                dummy1
                dummy2
            servingHSDSCH-RL-indicator
            },
            tdd
                PrimaryCCPCH-Info-r4
        },
    dl-DPCH-InfoPerRL
        -- dummy is not used in this version of the specification, it should
        -- not be sent and if received it should be ignored.
    dummy
        SCCPCH-InfoForFACH-r4
    cell-id
        CellIdentity
}

DL-InformationPerRL-r5bis ::=
    modeSpecificInfo
        fdd
            primaryCPICH-Info
                -- dummy1 and dummy 2 are not used in this version of specification, they should
                -- not be sent and if received they should be ignored.
                dummy1
                dummy2
            },
            tdd
                PrimaryCCPCH-Info-r4
        },
    dl-DPCH-InfoPerRL
        -- dummy is not used in this version of the specification, it should
        -- not be sent and if received it should be ignored.
    dummy
        SCCPCH-InfoForFACH-r4
    cell-id
        CellIdentity
}

DL-InformationPerRL-r6 ::=
    modeSpecificInfo
        fdd
            primaryCPICH-Info
            servingHSDSCH-RL-indicator
        },
        tdd
            PrimaryCPICH-Info,
            BOOLEAN,
        },
    dl-DPCH-InfoPerRL
        -- dummy is not used in this version of the specification, it should
        -- not be sent and if received it should be ignored.
    dummy
        SCCPCH-InfoForFACH-r4
    cell-id
        CellIdentity
}

```

```

        servingEDCH-RL-indicator          BOOLEAN
    },
    tdd                                    PrimaryCCPCH-Info-r4
},
dl-dpchInfo                              CHOICE {
    dl-DPCH-InfoPerRL                    DL-DPCH-InfoPerRL-r6,
    dl-FDPCH-InfoPerRL                    DL-FDPCH-InfoPerRL-r6
}
e-AGCH-Information                       E-AGCH-Information          OPTIONAL,
e-HICH-Info                              CHOICE {                    OPTIONAL,
    e-HICH-Information                    E-HICH-Information,
    releaseIndicator                      NULL
} OPTIONAL,
e-RGCH-Info                              CHOICE {
    e-RGCH-Information                    E-RGCH-Information,
    releaseIndicator                      NULL
} OPTIONAL,
cell-id                                  CellIdentity                OPTIONAL
}

DL-InformationPerRL-v6b0ext ::=          SEQUENCE {
    sttdIndication                        STTDIndication              OPTIONAL
}

DL-InformationPerRL-r7 ::=              SEQUENCE {
    modeSpecificInfo                     CHOICE {
        fdd                               SEQUENCE {
            primaryCPICH-Info             PrimaryCPICH-Info,
            servingHSDSCH-RL-indicator    BOOLEAN,
            servingEDCH-RL-indicator     BOOLEAN
        },
        tdd                               PrimaryCCPCH-Info-r4
    },
    dl-dpchInfo                          CHOICE {
        dl-DPCH-InfoPerRL                DL-DPCH-InfoPerRL-r7,
        dl-FDPCH-InfoPerRL                DL-FDPCH-InfoPerRL-r7
    }
    e-AGCH-Information                   E-AGCH-Information-r7      OPTIONAL,
    modeSpecificInfo2                    CHOICE {
        fdd                               SEQUENCE {
            e-HICH-Info                   CHOICE {
                e-HICH-Information        E-HICH-Information,
                releaseIndicator          NULL
            } OPTIONAL,
            e-RGCH-Info                   CHOICE {
                e-RGCH-Information        E-RGCH-Information,
                releaseIndicator          NULL
            } OPTIONAL
        },
        tdd                               CHOICE {
            tdd384-tdd768                 SEQUENCE {
                e-HICH-Info               E-HICH-Information-TDD384-768  OPTIONAL
            },
            tdd128                         SEQUENCE {
                e-HICH-Info               E-HICH-Information-TDD128  OPTIONAL
            }
        }
    },
    cell-id                              CellIdentity                OPTIONAL
}

DL-InformationPerRL-r8 ::=              SEQUENCE {
    modeSpecificInfo                     CHOICE {
        fdd                               SEQUENCE {
            primaryCPICH-Info             PrimaryCPICH-Info,
            servingHSDSCH-RL-indicator    BOOLEAN,
            servingEDCH-RL-indicator     BOOLEAN
        },
        tdd                               PrimaryCCPCH-Info-r4
    },
    dl-dpchInfo                          CHOICE {
        dl-DPCH-InfoPerRL                DL-DPCH-InfoPerRL-r7,
        dl-FDPCH-InfoPerRL                DL-FDPCH-InfoPerRL-r7
    }
    e-AGCH-Information                   E-AGCH-Information-r8      OPTIONAL,
    modeSpecificInfo2                    CHOICE {
        fdd                               SEQUENCE {
            e-HICH-Info                   CHOICE {

```

```

        e-HICH-Information          E-HICH-Information,
        releaseIndicator            NULL
    } OPTIONAL,
    e-RGCH-Info                    CHOICE {
        e-RGCH-Information          E-RGCH-Information,
        releaseIndicator            NULL
    } OPTIONAL
},
tdd                                CHOICE {
    tdd384-tdd768                 SEQUENCE {
        e-HICH-Info                E-HICH-Information-TDD384-768    OPTIONAL
    },
    tdd128                         SEQUENCE {
        e-HICH-Info                E-HICH-Information-TDD128    OPTIONAL
    }
},
cell-id                            CellIdentity                            OPTIONAL
}

DL-InformationPerRL-List ::= SEQUENCE (SIZE (1..maxRL)) OF
    DL-InformationPerRL

DL-InformationPerRL-List-r4 ::= SEQUENCE (SIZE (1..maxRL)) OF
    DL-InformationPerRL-r4

DL-InformationPerRL-List-r5 ::= SEQUENCE (SIZE (1..maxRL)) OF
    DL-InformationPerRL-r5

DL-InformationPerRL-List-r6 ::= SEQUENCE (SIZE (1..maxRL)) OF
    DL-InformationPerRL-r6

DL-InformationPerRL-List-v6b0ext ::= SEQUENCE (SIZE (1..maxRL)) OF
    DL-InformationPerRL-v6b0ext

DL-InformationPerRL-List-r5bis ::= SEQUENCE (SIZE (1..maxRL)) OF
    DL-InformationPerRL-r5bis

DL-InformationPerRL-List-r7 ::= SEQUENCE (SIZE (1..maxRL)) OF
    DL-InformationPerRL-r7

DL-InformationPerRL-List-r8 ::= SEQUENCE (SIZE (1..maxRL)) OF
    DL-InformationPerRL-r8

DL-InformationPerRL-ListPostFDD ::= SEQUENCE (SIZE (1..maxRL)) OF
    DL-InformationPerRL-PostFDD

DL-InformationPerRL-PostFDD ::= SEQUENCE {
    primaryCPICH-Info              PrimaryCPICH-Info,
    dl-DPCH-InfoPerRL              DL-DPCH-InfoPerRL-PostFDD
}

DL-InformationPerRL-PostTDD ::= SEQUENCE {
    primaryCCPCH-Info              PrimaryCCPCH-InfoPost,
    dl-DPCH-InfoPerRL              DL-DPCH-InfoPerRL-PostTDD
}

DL-InformationPerRL-PostTDD-LCR-r4 ::= SEQUENCE {
    primaryCCPCH-Info              PrimaryCCPCH-InfoPostTDD-LCR-r4,
    dl-DPCH-InfoPerRL              DL-DPCH-InfoPerRL-PostTDD-LCR-r4
}

--for 1.28Mcps TDD Multi-Carrier
DL-MultiCarrier-Information ::= SEQUENCE {
    tsn-Length                      ENUMERATED { tsn-6bits, tsn-9bits }    OPTIONAL,
    multiCarrierNumber              INTEGER (1..maxTDD128Carrier)        OPTIONAL,
    dl-HSPDSCH-MultiCarrier-Information DL-HSPDSCH-MultiCarrier-Information    OPTIONAL
}

DL-PDSCH-Information ::= SEQUENCE {
    -- dummy1 and dummy 2 are not used in this version of specification, it should
    -- not be sent and if received it should be ignored.
    dummy1                          PDSCH-SHO-DCH-Info                OPTIONAL,
    dummy2                          PDSCH-CodeMapping                OPTIONAL
}

Dl-rate-matching-restriction ::= SEQUENCE {
    restrictedTrCH-InfoList          RestrictedTrCH-InfoList                OPTIONAL
}

```

```

}

DL-SecondaryCellInfoFDD ::= CHOICE {
    continue                NULL,
    newConfiguration       SEQUENCE {
        new-H-RNTI          H-RNTI,
        dl-64QAM-Configured  ENUMERATED { true }           OPTIONAL,
        hs-DSCH-TBSizeTable HS-DSCH-TBSizeTable           OPTIONAL,
        primaryCPICH-Info    PrimaryCPICH-Info,
        dl-ScramblingCode    SecondaryScramblingCode       OPTIONAL,
        hs-SCCHChannelisationCodeInfo SEQUENCE (SIZE (1..maxHSSCCHs)) OF
            HS-SCCH-Codes,
            MeasurementPowerOffset,
            UARFCN
    }
}

DL-SecondaryCellInfoFDD-v890ext ::= SEQUENCE {
    differentTxModeFromServingHS-DSCHCell    ENUMERATED { different }    OPTIONAL
}

DL-TPC-PowerOffsetPerRL ::= SEQUENCE {
    powerOffsetTPC-pdpdch    PowerOffsetTPC-pdpdch    OPTIONAL
}

-- NOTE: The radio links in the following list have a one-to-one mapping with the
-- radio links in the message.
DL-TPC-PowerOffsetPerRL-List ::= SEQUENCE (SIZE (1..maxRL)) OF
    DL-TPC-PowerOffsetPerRL

DL-TS-ChannelisationCode ::= ENUMERATED {
    cc16-1, cc16-2, cc16-3, cc16-4,
    cc16-5, cc16-6, cc16-7, cc16-8,
    cc16-9, cc16-10, cc16-11, cc16-12,
    cc16-13, cc16-14, cc16-15, cc16-16 }

DL-TS-ChannelisationCode-VHCR ::= ENUMERATED {
    cc32-1, cc32-2, cc32-3, cc32-4,
    cc132-5, cc32-6, cc32-7, cc32-8,
    cc32-9, cc32-10, cc32-11, cc32-12,
    cc32-13, cc32-14, cc32-15, cc32-16,
    cc32-17, cc32-18, cc32-19, cc32-20,
    cc32-21, cc32-22, cc32-23, cc32-24,
    cc32-25, cc32-26, cc32-27, cc32-28,
    cc32-29, cc32-30, cc32-31, cc32-32 }

DL-TS-ChannelisationCodesShort ::= SEQUENCE {
    codesRepresentation CHOICE {
        consecutive SEQUENCE {
            firstChannelisationCode    DL-TS-ChannelisationCode,
            lastChannelisationCode     DL-TS-ChannelisationCode
        },
        bitmap BIT STRING {
            chCode16-SF16(0),
            chCode15-SF16(1),
            chCode14-SF16(2),
            chCode13-SF16(3),
            chCode12-SF16(4),
            chCode11-SF16(5),
            chCode10-SF16(6),
            chCode9-SF16(7),
            chCode8-SF16(8),
            chCode7-SF16(9),
            chCode6-SF16(10),
            chCode5-SF16(11),
            chCode4-SF16(12),
            chCode3-SF16(13),
            chCode2-SF16(14),
            chCode1-SF16(15)
        } (SIZE (16))
    }
}

DL-TS-ChannelisationCodesShort-VHCR ::= SEQUENCE {
    codesRepresentation CHOICE {
        consecutive SEQUENCE {
            firstChannelisationCode    DL-TS-ChannelisationCode-VHCR,
            lastChannelisationCode     DL-TS-ChannelisationCode-VHCR
        }
    }
}

```

```

    },
    bitmap
}

BIT STRING {
    chCode32-SF32 (0),
    chCode31-SF32 (1),
    chCode30-SF32 (2),
    chCode29-SF32 (3),
    chCode28-SF32 (4),
    chCode27-SF32 (5),
    chCode26-SF32 (6),
    chCode25-SF32 (7),
    chCode24-SF32 (8),
    chCode23-SF32 (9),
    chCode22-SF32 (10),
    chCode21-SF32 (11),
    chCode20-SF32 (12),
    chCode19-SF32 (13),
    chCode18-SF32 (14),
    chCode17-SF32 (15),
    chCode16-SF32 (16),
    chCode15-SF32 (17),
    chCode14-SF32 (18),
    chCode13-SF32 (19),
    chCode12-SF32 (20),
    chCode11-SF32 (21),
    chCode10-SF32 (22),
    chCode9-SF32 (23),
    chCode8-SF32 (24),
    chCode7-SF32 (25),
    chCode6-SF32 (26),
    chCode5-SF32 (27),
    chCode4-SF32 (28),
    chCode3-SF32 (29),
    chCode2-SF32 (30),
    chCode1-SF32 (31)
} (SIZE (32))
}

DL-ChannelCodes-MBSFN-IMB384 ::= SEQUENCE {
    firstChannelisationCode    INTEGER (1..15),
    lastChannelisationCode     INTEGER (1..15)                OPTIONAL
}

DLUL-HSPA-Information-r8 ::= SEQUENCE {
    ul-EDCH-Information        UL-EDCH-Information-r8,
    dl-CommonInformation       DL-CommonInformation-r8,
    dl-InformationPerRL-List   DL-InformationPerRL-List-r7,
    dl-HSPDSCH-Information     DL-HSPDSCH-Information-r8
}

DownlinkAdditionalTimeslots ::= SEQUENCE {
    parameters                 CHOICE {
        sameAsLast             SEQUENCE {
            timeslotNumber     TimeslotNumber
        },
        newParameters          SEQUENCE {
            individualTimeslotInfo IndividualTimeslotInfo,
            dl-TS-ChannelisationCodesShort DL-TS-ChannelisationCodesShort
        }
    }
}

DownlinkAdditionalTimeslots-VHCR ::= SEQUENCE {
    parameters                 CHOICE {
        sameAsLast             SEQUENCE {
            timeslotNumber     TimeslotNumber
        },
        newParameters          SEQUENCE {
            individualTimeslotInfo IndividualTimeslotInfo-VHCR,
            dl-TS-ChannelisationCodesShort DL-TS-ChannelisationCodesShort-VHCR
        }
    }
}

DownlinkAdditionalTimeslots-LCR-r4 ::= SEQUENCE {
    parameters                 CHOICE {
        sameAsLast             SEQUENCE {
            timeslotNumber     TimeslotNumber-LCR-r4
        }
    }
}

```

```

    },
    newParameters
        individualTimeslotInfo      IndividualTimeslotInfo-LCR-r4,
        dl-TS-ChannelisationCodesShort DL-TS-ChannelisationCodesShort
    }
}

DownlinkAdditionalTimeslots-r7 ::= SEQUENCE {
    parameters CHOICE {
        sameAsLast SEQUENCE {
            timeslotNumber TimeslotNumber
        },
        newParameters SEQUENCE {
            individualTimeslotInfo IndividualTimeslotInfo-r7,
            dl-TS-ChannelisationCodesShort DL-TS-ChannelisationCodesShort
        }
    }
}

DownlinkTimeslotsCodes ::= SEQUENCE {
    firstIndividualTimeslotInfo IndividualTimeslotInfo,
    dl-TS-ChannelisationCodesShort DL-TS-ChannelisationCodesShort,
    moreTimeslots CHOICE {
        noMore NULL,
        additionalTimeslots CHOICE {
            consecutive INTEGER (1..maxTS-1),
            timeslotList SEQUENCE (SIZE (1..maxTS-1)) OF
                DownlinkAdditionalTimeslots
        }
    }
}

DownlinkTimeslotsCodes-VHCR ::= SEQUENCE {
    firstIndividualTimeslotInfo IndividualTimeslotInfo-VHCR,
    dl-TS-ChannelisationCodesShort DL-TS-ChannelisationCodesShort-VHCR,
    moreTimeslots CHOICE {
        noMore NULL,
        additionalTimeslots CHOICE {
            consecutive INTEGER (1..maxTS-1),
            timeslotList SEQUENCE (SIZE (1..maxTS-1)) OF
                DownlinkAdditionalTimeslots-VHCR
        }
    }
}

DownlinkTimeslotsCodes-LCR-r4 ::= SEQUENCE {
    firstIndividualTimeslotInfo IndividualTimeslotInfo-LCR-r4,
    dl-TS-ChannelisationCodesShort DL-TS-ChannelisationCodesShort,
    moreTimeslots CHOICE {
        noMore NULL,
        additionalTimeslots CHOICE {
            consecutive INTEGER (1..maxTS-LCR-1),
            timeslotList SEQUENCE (SIZE (1..maxTS-LCR-1)) OF
                DownlinkAdditionalTimeslots-LCR-r4
        }
    }
}

DownlinkTimeslotsCodes-r7 ::= SEQUENCE {
    firstIndividualTimeslotInfo IndividualTimeslotInfo-r7,
    dl-TS-ChannelisationCodesShort DL-TS-ChannelisationCodesShort,
    moreTimeslots CHOICE {
        noMore NULL,
        additionalTimeslots CHOICE {
            consecutive INTEGER (1..maxTS-1),
            timeslotList SEQUENCE (SIZE (1..maxTS-1)) OF
                DownlinkAdditionalTimeslots-r7
        }
    }
}

DPC-Mode ::= ENUMERATED {
    singleTPC,
    tpcTripletInSoft }

-- Actual value DPCCH-PowerOffset = IE value * 2
DPCCH-PowerOffset ::= INTEGER (-82..-3)

```

```

-- Actual value DPCH-PowerOffset2 = 2 + (IE value * 4)
DPCH-PowerOffset2 ::= INTEGER (-28..-13)

DPCH-CompressedModeInfo ::= SEQUENCE {
    tgp-SequenceList          TGP-SequenceList
}

DPCH-CompressedModeInfo-r8 ::= SEQUENCE {
    tgp-SequenceList          TGP-SequenceList-r8
}

DPCH-CompressedModeStatusInfo ::= SEQUENCE {
    tgps-Reconfiguration-CFN    TGPS-Reconfiguration-CFN,
    tgp-SequenceShortList      SEQUENCE (SIZE (1..maxTGPS)) OF
                                TGP-SequenceShort
}

-- Actual value DPCH-FrameOffset = IE value * 256
DPCH-FrameOffset ::= INTEGER (0..149)

FDPCH-SlotFormat ::= INTEGER (0..9)

UE-DRX-Cycle-InactivityThreshold ::= ENUMERATED {
    sub-frames-0,
    sub-frames-1,
    sub-frames-2,
    sub-frames-4,
    sub-frames-8,
    sub-frames-16,
    sub-frames-32,
    sub-frames-64,
    sub-frames-128,
    sub-frames-256,
    sub-frames-512,
    spare5,
    spare4,
    spare3,
    spare2,
    spare1 }

DRX-Info ::= SEQUENCE {
    ue-drx-Cycle                UE-DRX-Cycle,
    ue-drx-Cycle-InactivityThreshold UE-DRX-Cycle-InactivityThreshold,
    ue-GrantMonitoring-InactivityThreshold
                                UE-GrantMonitoring-InactivityThreshold,
    ue-drx-GrantMonitoring      BOOLEAN
}

DSCH-Mapping ::= SEQUENCE {
    maxTFPI-Field2Value        MaxTFPI-Field2Value,
    spreadingFactor            SF-PDSCH,
    codeNumber                  CodeNumberDSCH,
    multiCodeInfo              MultiCodeInfo
}

DSCH-MappingList ::= SEQUENCE (SIZE (1..maxPDSCH-TFCIgroups)) OF
    DSCH-Mapping

DSCH-RadioLinkIdentifier ::= INTEGER (0..511)

DSCH-TransportChannelsInfo ::= SEQUENCE (SIZE (1..maxTrCH)) OF
    SEQUENCE {
        dsch-transport-channel-identity TransportChannelIdentity,
        dsch-TFS                        TransportFormatSet
    }

DTX-DRX-Info-r7 ::= SEQUENCE {
    dtx-Info                    DTX-Info                                OPTIONAL,
    drx-Info                    DRX-Info                                OPTIONAL,
    uplink-DPCCHSlotFormatInformation Uplink-DPCCH-Slot-Format-Information
}

DTX-E-DCH-TTI-10ms ::= SEQUENCE {
    ue-dtx-Cycle1-10ms          UE-DTX-Cycle1-10ms,
    ue-dtx-Cycle2-10ms          UE-DTX-Cycle2-10ms,
    mac-dtx-Cycle-10ms          MAC-DTX-Cycle-10ms
}

```



```

DTX-E-DCH-TTI-2ms ::= SEQUENCE {
    ue-dtx-Cycle1-2ms      UE-DTX-Cycle1-2ms,
    ue-dtx-Cycle2-2ms      UE-DTX-Cycle2-2ms,
    mac-dtx-Cycle-2ms      MAC-DTX-Cycle-2ms
}

DTX-Info ::= SEQUENCE {
    e-dch-TTI-Length      CHOICE {
        dtx-e-dch-TTI-10ms  DTX-E-DCH-TTI-10ms,
        dtx-e-dch-TTI-2ms    DTX-E-DCH-TTI-2ms
    },
    ue-dtx-cycle2InactivityThreshold  UE-DTX-Cycle2InactivityThreshold,
    ue-dtx-cycle2DefaultSG            INTEGER (0..38) OPTIONAL,
    -- if ue-dtx-long-preamble-length is not present, the value is '2 slots'
    ue-dtx-long-preamble-length        UE-DTX-long-preamble-length OPTIONAL,
    mac-InactivityThreshold            MAC-InactivityThreshold,
    cqi-dtx-Timer                     CQI-DTX-Timer,
    ue-dpcch-Burst1                   UE-DPCCH-Burst,
    ue-dpcch-Burst2                   UE-DPCCH-Burst
}

DurationTimeInfo ::= INTEGER (1..4096)

DynamicPersistenceLevel ::= INTEGER (1..8)

DynamicPersistenceLevelList ::= SEQUENCE (SIZE (1..maxPRACH)) OF
    DynamicPersistenceLevel

DynamicPersistenceLevelTF-List ::= SEQUENCE (SIZE (1..maxTF-CPCH)) OF
    DynamicPersistenceLevel

DynamicTFInformationCCCH ::= SEQUENCE {
    octetModeRLC-SizeInfoType2      OctetModeRLC-SizeInfoType2
}

E-AGCH-ChannelisationCode ::= INTEGER (0..255)

E-AGCH-DRX-Info-TDD128 ::= SEQUENCE {
    e-AGCH-DRX-InfoType             CHOICE {
        sameAsHS-SCCH              NULL,
        e-AGCH-DRX-Parameters      SEQUENCE {
            e-AGCH-DRX-Cycle        ControlChannelDRXCycle-TDD128,
            e-AGCH-InactivityMonitorThreshold  E-AGCH-InactivityMonitorThreshold-TDD128
        } OPTIONAL,
        e-AGCH-DRX-Offset          INTEGER (0..63)
    }
}

E-AGCH-InactivityMonitorThreshold-TDD128 ::= ENUMERATED {
    radio-frames-0, radio-frames-1, radio-frames-2,
    radio-frames-4, radio-frames-8, radio-frames-16,
    radio-frames-32, radio-frames-64, radio-frames-128,
    radio-frames-256, radio-frames-512,
    spare5, spare4, spare3, spare2, infinity }

E-AGCH-Individual ::= SEQUENCE {
    tS-number                      INTEGER (0..14),
    channelisation-code            DL-TS-ChannelisationCode,
    midambleShiftAndBurstType      MidambleShiftAndBurstType-EDCH
}

E-AGCH-Individual-VHCR ::= SEQUENCE {
    tS-number                      INTEGER (0..14),
    channelisation-code            DL-TS-ChannelisationCode-VHCR,
    midambleShiftAndBurstType      MidambleShiftAndBurstType-EDCH
}

E-AGCH-Individual-LCR ::= SEQUENCE {
    timeslotNumber                TimeslotNumber-LCR-r4,
    firstChannelisationCode        HS-ChannelisationCode-LCR,
    secondChannelisationCode       HS-ChannelisationCode-LCR,
    midambleAllocationMode         CHOICE {
        defaultMidamble            NULL,
        commonMidamble             NULL,
        ueSpecificMidamble         INTEGER (0..15)
    },
    -- Actual value midambleConfiguration = IE value * 2
}

```

```

    midambleConfiguration          INTEGER (1..8)
  }
E-AGCH-Information ::=          SEQUENCE {
  e-AGCH-ChannelisationCode      E-AGCH-ChannelisationCode
}
E-AGCH-Information-r7 ::=      SEQUENCE {
  modeSpecific                    CHOICE {
    fdd                            SEQUENCE {
      e-AGCH-ChannelisationCode    E-AGCH-ChannelisationCode
    },
    tdd                            CHOICE {
      tdd384                        SEQUENCE {
        long-Term-Grant-Indicator  BOOLEAN          OPTIONAL,
        length-of-TTRI-field        INTEGER (1..12),
        e-AGCH-Set-Config           E-AGCH-Set-Config,
        e-AGCH-BLER-Target          Bler-Target
      },
      tdd768                        SEQUENCE {
        long-Term-Grant-Indicator  BOOLEAN          OPTIONAL,
        length-of-TTRI-field        INTEGER (1..12),
        e-AGCH-Set-Config           E-AGCH-Set-Config-VHCR,
        e-AGCH-BLER-Target          Bler-Target
      },
      tdd128                        SEQUENCE {
        rdi-Indicator              BOOLEAN,
        tpc-StepSize               TPC-StepSizeTDD,
        e-AGCH-Set-Config           E-AGCH-Set-Config-LCR,
        e-AGCH-BLER-Target          Bler-Target
      }
    }
  }
}
E-AGCH-Information-r8 ::=      SEQUENCE {
  modeSpecific                    CHOICE {
    fdd                            SEQUENCE {
      e-AGCH-ChannelisationCode    E-AGCH-ChannelisationCode
    },
    tdd                            CHOICE {
      tdd384                        SEQUENCE {
        long-Term-Grant-Indicator  BOOLEAN          OPTIONAL,
        length-of-TTRI-field        INTEGER (1..12),
        e-AGCH-Set-Config           E-AGCH-Set-Config,
        e-AGCH-BLER-Target          Bler-Target
      },
      tdd768                        SEQUENCE {
        long-Term-Grant-Indicator  BOOLEAN          OPTIONAL,
        length-of-TTRI-field        INTEGER (1..12),
        e-AGCH-Set-Config           E-AGCH-Set-Config-VHCR,
        e-AGCH-BLER-Target          Bler-Target
      },
      tdd128                        SEQUENCE {
        rdi-Indicator              BOOLEAN,
        tpc-StepSize               TPC-StepSizeTDD,
        e-AGCH-Set-Config           E-AGCH-Set-Config-LCR,
        e-AGCH-BLER-Target          Bler-Target,
        e-AGCH-InactivityMonitorThreshold  E-AGCH-InactivityMonitorThreshold-TDD128
                                          OPTIONAL
      }
    }
  }
}
E-AGCH-Information-TDD128 ::=  SEQUENCE {
  rdi-Indicator                   BOOLEAN,
  tpc-StepSize                   TPC-StepSizeTDD,
  e-AGCH-Set-Config              E-AGCH-Set-Config-LCR,
  e-AGCH-BLER-Target             Bler-Target
}
E-AGCH-Set-Config ::=          SEQUENCE (SIZE (1..maxNumE-AGCH)) OF
  E-AGCH-Individual
E-AGCH-Set-Config-VHCR ::=     SEQUENCE (SIZE (1..maxNumE-AGCH)) OF
  E-AGCH-Individual-VHCR

```

```

E-AGCH-Set-Config-LCR ::= SEQUENCE (SIZE (1..maxNumE-AGCH)) OF
                           E-AGCH-Individual-LCR

E-DCH-MinimumSet-E-TFCI ::= INTEGER (0..127)

E-DCH-ReconfigurationInfo ::= SEQUENCE {
    e-DCH-RL-InfoNewServingCell E-DCH-RL-InfoNewServingCell OPTIONAL,
    e-DCH-RL-InfoOtherCellList SEQUENCE (SIZE (1..maxEDCHRL)) OF
                                E-DCH-RL-InfoOtherCell OPTIONAL
}

E-DCH-ReconfigurationInfo-r7 ::= SEQUENCE {
    e-DCH-RL-InfoNewServingCell E-DCH-RL-InfoNewServingCell-r7 OPTIONAL,
    e-DCH-RL-InfoOtherCellList SEQUENCE (SIZE (1..maxEDCHRL)) OF
                                E-DCH-RL-InfoOtherCell OPTIONAL
}

E-DCH-RL-InfoNewServingCell ::= SEQUENCE {
    primaryCPICH-Info PrimaryCPICH-Info,
    e-AGCH-Information E-AGCH-Information,
    servingGrant SEQUENCE {
        value INTEGER (0..38) OPTIONAL,
        primary-Secondary-GrantSelector ENUMERATED { primary, secondary }
    } OPTIONAL,
    e-DPCCH-DPCCH-PowerOffset E-DPCCH-DPCCH-PowerOffset OPTIONAL,
    reference-E-TFCIs E-DPCCH-Reference-E-TFCIList OPTIONAL,
    powerOffsetForSchedInfo INTEGER (0..6) OPTIONAL,
    threeIndexStepThreshold INTEGER (0..37) OPTIONAL,
    twoIndexStepThreshold INTEGER (0..37) OPTIONAL,
    e-HICH-Information E-HICH-Information OPTIONAL,
    e-RGCH-Info CHOICE {
        e-RGCH-Information E-RGCH-Information,
        releaseIndicator NULL
    } OPTIONAL
}

E-DCH-RL-InfoNewServingCell-r7 ::= SEQUENCE {
    primaryCPICH-Info PrimaryCPICH-Info,
    e-AGCH-Information E-AGCH-Information,
    servingGrant SEQUENCE {
        value INTEGER (0..38) OPTIONAL,
        primary-Secondary-GrantSelector ENUMERATED { primary, secondary }
    } OPTIONAL,
    e-DPCCH-DPCCH-PowerOffset E-DPCCH-DPCCH-PowerOffset OPTIONAL,
    reference-E-TFCIs E-DPCCH-Reference-E-TFCIList-r7 OPTIONAL,
    powerOffsetForSchedInfo INTEGER (0..6) OPTIONAL,
    threeIndexStepThreshold INTEGER (0..37) OPTIONAL,
    twoIndexStepThreshold INTEGER (0..37) OPTIONAL,
    e-HICH-Information E-HICH-Information OPTIONAL,
    e-RGCH-Info CHOICE {
        e-RGCH-Information E-RGCH-Information,
        releaseIndicator NULL
    } OPTIONAL
}

E-DCH-RL-InfoOtherCell ::= SEQUENCE {
    primaryCPICH-Info PrimaryCPICH-Info,
    e-HICH-Info CHOICE {
        e-HICH-Information E-HICH-Information,
        releaseIndicator NULL
    } OPTIONAL,
    e-RGCH-Info CHOICE {
        e-RGCH-Information E-RGCH-Information,
        releaseIndicator NULL
    } OPTIONAL
}

E-DCH-RL-InfoSameServingCell ::= SEQUENCE {
    e-DPCCH-DPCCH-PowerOffset E-DPCCH-DPCCH-PowerOffset OPTIONAL,
    reference-E-TFCIs E-DPCCH-Reference-E-TFCIList-r7 OPTIONAL
}

E-DCH-SPS-Information-TDD128 ::= SEQUENCE {
    e-dch-SPS-Operation CHOICE {
        continue NULL,
        newOperation E-DCH-SPS-NewOperation-TDD128
    }
}

```

```

E-DCH-SPS-NewOperation-TDD128 ::= SEQUENCE {
  e-hich-Info          E-HICH-Information-For-SPS-TDD128,
  e-dch-TxPattern      E-DCH-TxPatternList-TDD128          OPTIONAL,
  initialSPSInfoForEDCH SEQUENCE {
    n-E-UCCH          INTEGER (1..8),
    codeResourceInfo  UL-TS-ChannelisationCode,
    timeslotResourceRelatedInfo BIT STRING (SIZE (5)),
    powerResourceRelatedInfo  INTEGER (1..32),
    activationTime     ActivationTime,
    subframeNum        INTEGER (0..1),
    initialTxPatternIndex INTEGER (0..maxEDCHTxPattern-TDD128-1)
  }
  OPTIONAL
}

E-DCH-TxPatternList-TDD128 ::= SEQUENCE (SIZE (1..maxEDCHTxPattern-TDD128)) OF
  SEQUENCE {
    repetitionPeriodAndLength RepetitionPeriodAndLengthForSPS
  }

E-DPCCH-Info ::= SEQUENCE {
  e-DPCCH-DPCCH-PowerOffset E-DPCCH-DPCCH-PowerOffset,
  happyBit-DelayCondition   HappyBit-DelayCondition
}

E-DPCCH-Info-r7 ::= SEQUENCE {
  e-DPCCH-DPCCH-PowerOffset E-DPCCH-DPCCH-PowerOffset,
  happyBit-DelayCondition   HappyBit-DelayCondition,
  e-TFC-Boost-Info         E-TFC-Boost-Info-r7          OPTIONAL,
  e-DPDCH-PowerInterpolation E-DPDCH-PowerInterpolation  OPTIONAL
}

E-DPCCH-DPCCH-PowerOffset ::= INTEGER (0..8)

E-DPDCH-Info ::= SEQUENCE {
  e-TFCI-TableIndex      E-TFCI-TableIndex,
  e-DCH-MinimumSet-E-TFCI E-DCH-MinimumSet-E-TFCI          OPTIONAL,
  reference-E-TFCIs      E-DPDCH-Reference-E-TFCIList,
  maxChannelisationCodes E-DPDCH-MaxChannelisationCodes,
  pl-NonMax              E-DPDCH-PL-NonMax,
  schedulingInfoConfiguration E-DPDCH-SchedulingInfoConfiguration,
  threeIndexStepThreshold INTEGER (0..37)          OPTIONAL,
  twoIndexStepThreshold  INTEGER (0..37)          OPTIONAL
}

E-DPDCH-Info-r7 ::= SEQUENCE {
  e-TFCI-TableIndex      E-TFCI-TableIndex,
  e-DCH-MinimumSet-E-TFCI E-DCH-MinimumSet-E-TFCI          OPTIONAL,
  reference-E-TFCIs      E-DPDCH-Reference-E-TFCIList-r7,
  maxChannelisationCodes E-DPDCH-MaxChannelisationCodes,
  pl-NonMax              E-DPDCH-PL-NonMax,
  schedulingInfoConfiguration E-DPDCH-SchedulingInfoConfiguration,
  threeIndexStepThreshold INTEGER (0..37)          OPTIONAL,
  twoIndexStepThreshold  INTEGER (0..37)          OPTIONAL
}

E-DPDCH-Info-r8 ::= SEQUENCE {
  e-TFCI-TableIndex      E-TFCI-TableIndex,
  e-DCH-MinimumSet-E-TFCI E-DCH-MinimumSet-E-TFCI          OPTIONAL,
  reference-E-TFCIs      E-DPDCH-Reference-E-TFCIList-r7,
  minReduced-E-DPDCH-GainFactor MinReduced-E-DPDCH-GainFactor  OPTIONAL,
  maxChannelisationCodes E-DPDCH-MaxChannelisationCodes,
  pl-NonMax              E-DPDCH-PL-NonMax,
  schedulingInfoConfiguration E-DPDCH-SchedulingInfoConfiguration,
  threeIndexStepThreshold INTEGER (0..37)          OPTIONAL,
  twoIndexStepThreshold  INTEGER (0..37)          OPTIONAL
}

E-DPDCH-PeriodicityOfSchedInfo ::= ENUMERATED {
  everyEDCHTTI, ms4, ms10, ms20, ms50, ms100, ms200, ms500,
  ms1000 }

-- The actual value of E-DPDCH-PL-NonMax is: IE value * 0.04
E-DPDCH-PL-NonMax ::= INTEGER (11..25)

E-DPDCH-PowerInterpolation ::= BOOLEAN

E-DPDCH-Reference-E-TFCI ::= SEQUENCE {

```

```

reference-E-TFCI                INTEGER (0..127),
reference-E-TFCI-PO              INTEGER (0..29)
}

E-DPDCH-Reference-E-TFCI-r7 ::= SEQUENCE {
    reference-E-TFCI                INTEGER (0..127),
    reference-E-TFCI-PO-r7          INTEGER (0..31)
}

E-DPDCH-Reference-E-TFCIList ::= SEQUENCE (SIZE (1..8)) OF E-DPDCH-Reference-E-TFCI

E-DPDCH-Reference-E-TFCIList-r7 ::= SEQUENCE (SIZE (1..8)) OF E-DPDCH-Reference-E-TFCI-r7

E-DPDCH-SchedulingInfoConfiguration ::= SEQUENCE {
    periodicityOfSchedInfo-NoGrant  E-DPDCH-PeriodicityOfSchedInfo    OPTIONAL,
    periodicityOfSchedInfo-Grant     E-DPDCH-PeriodicityOfSchedInfo    OPTIONAL,
    powerOffsetForSchedInfo          INTEGER (0..6)
}

E-DPDCH-SchedulingTransmConfiguration ::= SEQUENCE {
    ms2-SchedTransmGrantHARQAlloc    BIT STRING (SIZE (8))              OPTIONAL,
    servingGrant                      SEQUENCE {
        value                          INTEGER (0..38),
        primary-Secondary-GrantSelector  ENUMERATED { primary, secondary }
    }
    OPTIONAL
}

E-DPDCH-MaxChannelisationCodes ::= ENUMERATED {
    sf256, sf128, sf64, sf32, sf16, sf8, sf4, sf4x2,
    sf2x2, sf4x2-and-sf2x2 }

E-HICH-ChannelisationCode ::= INTEGER (0..127)

E-HICH-Information ::= SEQUENCE {
    channelisationCode                E-HICH-ChannelisationCode,
    signatureSequence                 E-HICH-RGCH-SignatureSequence
}

E-HICH-Information-CommonEdch ::= SEQUENCE {
    channelisationCode                E-HICH-ChannelisationCode    OPTIONAL,
    signatureSequence                 E-HICH-RGCH-SignatureSequence  OPTIONAL
}

E-HICH-Information-TDD384-768 ::= SEQUENCE {
    n-E-HICH                          INTEGER (4..44),
    tS-Number                          INTEGER (0..14),
    modeSpecificInfo                   CHOICE {
        tdd384                          DL-TS-ChannelisationCode,
        tdd768                          DL-TS-ChannelisationCode-VHCR
    },
    burst-Type                          ENUMERATED { type1, type2 },
    midamble-Allocation-Mode            ENUMERATED { default, common }
}

E-HICH-Information-LCR ::= SEQUENCE {
    ei                                  INTEGER (0..3),
    timeslotNumber                      TimeslotNumber-LCR-r4,
    channelisation-Code                 HS-ChannelisationCode-LCR,
    midambleAllocationMode              CHOICE {
        defaultMidamble                 NULL,
        ueSpecificMidamble               INTEGER (0..15)
    },
    -- Actual value midambleConfiguration = IE value * 2
    midambleConfiguration               INTEGER (1..8)
}

E-HICH-Information-TDD128 ::= SEQUENCE {
    n-E-HICH                          INTEGER (4..15),
    e-HICH-InfoList                     E-HICH-Information-LCR-List
}

E-HICH-Information-LCR-List ::= SEQUENCE (SIZE (1..maxNumE-HICH)) OF
    E-HICH-Information-LCR

E-HICH-RGCH-SignatureSequence ::= INTEGER (0..39)

E-HICH-Information-For-SPS-TDD128 ::= SEQUENCE {
    configurationmode                   CHOICE{

```

```

    implicit SEQUENCE {
      ei INTEGER (0..3) OPTIONAL
    },
    explicit SEQUENCE {
      timeslotNumber TimeslotNumber-LCR-r4,
      channelisation-Code HS-ChannelisationCode-LCR,
      midambleAllocationMode CHOICE {
        defaultMidamble NULL,
        ueSpecificMidamble INTEGER (0..15)
      },
      -- Actual value midambleConfiguration = IE value * 2
      midambleConfiguration INTEGER (1..8)
    }
  },
  signatureSequenceGroupIndex INTEGER (0..19)
}

E-PUCH-Info ::= SEQUENCE {
  e-TFCS-Info E-TFCS-Info,
  modeSpecificInfo CHOICE {
    tdd348-tdd768 SEQUENCE {
      noSlotsForTFCIandTPC INTEGER (1..12),
      e-PUCH-ContantValue INTEGER (-35..10),
      e-PUCH-TS-ConfigurationList SEQUENCE (SIZE (1..maxTS-2)) OF E-PUCH-TS-Slots,
      e-PUCH-CodeHopping BOOLEAN,
      e-PUCH-TPC-Step-Size INTEGER (1..3),
      minimum-Allowed-Code-Rate INTEGER (0..63),
      maximum-Allowed-Code-Rate INTEGER (0..63)
    },
    tdd128 SEQUENCE {
      snpl-ReportType ENUMERATED { type1, type2 } OPTIONAL,
      prxBASEdes INTEGER (-112..-50),
      beaconPLEst BOOLEAN OPTIONAL,
      tpc-StepSize TPC-StepSizeTDD,
      pebase-PowerControlGAP PowerControlGAP OPTIONAL,
      ul-SynchronisationParameters UL-SynchronisationParameters-r4 OPTIONAL,
      e-PUCH-TS-ConfigurationList SEQUENCE (SIZE (1..maxTS-LCR-1)) OF
        E-PUCH-TS-Slots-LCR,
      minimum-Allowed-Code-Rate INTEGER (0..63),
      maximum-Allowed-Code-Rate INTEGER (0..63),
      maximumNumOfRetransSchedInfo INTEGER (0..15),
      retransTimerForSchedInfo ENUMERATED { ms10, ms15, ms20, ms25, ms30, ms35,
        ms40, ms45, ms50, ms55, ms60, ms65, ms70, ms75,
        ms80, ms85, ms90, ms95, ms100, ms110, ms120,
        ms140, ms160, ms200, ms240, ms280, ms320, ms400,
        ms480, ms560 }
    }
  },
  -- For 3.84/7.68 TDD only, should be ignored for 1.28Mcps TDD mode
  powerOffsetForSchedInfo INTEGER (0..6) OPTIONAL
}

E-PUCH-Info-TDD128 ::= SEQUENCE {
  e-TFCS-Info E-TFCS-Info,
  snpl-ReportType ENUMERATED { type1, type2 } OPTIONAL,
  prxBASEdes INTEGER (-112..-50),
  beaconPLEst BOOLEAN OPTIONAL,
  tpc-StepSize TPC-StepSizeTDD,
  pebase-PowerControlGAP INTEGER (1..255) OPTIONAL,
  ul-SynchronisationParameters UL-SynchronisationParameters-r4 OPTIONAL,
  e-PUCH-TS-ConfigurationList SEQUENCE (SIZE (1..maxTS-LCR-1)) OF
    E-PUCH-TS-Slots-LCR,
  minimum-Allowed-Code-Rate INTEGER (0..63),
  maximum-Allowed-Code-Rate INTEGER (0..63),
  maximumNumOfRetransSchedInfo INTEGER (0..15),
  retransTimerForSchedInfo ENUMERATED { ms10, ms15, ms20, ms25, ms30, ms35,
    ms40, ms45, ms50, ms55, ms60, ms65, ms70, ms75,
    ms80, ms85, ms90, ms95, ms100, ms110, ms120,
    ms140, ms160, ms200, ms240, ms280, ms320, ms400,
    ms480, ms560 },
  -- dummy is not used in this version of the specification, it should
  -- not be sent and if received it should be ignored.
  dummy INTEGER (0..6) OPTIONAL
}

E-PUCH-TS-Slots ::= SEQUENCE {
  ts-Number INTEGER (0..14),
  midambleShiftAndBurstType MidambleShiftAndBurstType-EDCH
}

```

```

}

E-PUCH-TS-Slots-LCR ::= SEQUENCE {
    timeslotNumber          TimeslotNumber-LCR-r4,
    midambleAllocationMode CHOICE {
        defaultMidamble     NULL,
        ueSpecificMidamble   INTEGER (0..15)
    },
    -- Actual value midambleConfiguration = IE value * 2
    midambleConfiguration   INTEGER (1..8)
}

E-RGCH-CombinationIndex ::= INTEGER (0..5)

E-RGCH-Information ::= SEQUENCE {
    signatureSequence        E-HICH-RGCH-SignatureSequence,
    rg-CombinationIndex      E-RGCH-CombinationIndex
}

E-RGCH-Information-CommonEdch ::= SEQUENCE {
    signatureSequence        E-HICH-RGCH-SignatureSequence          OPTIONAL
}

E-RUCCH-AccessServiceClass ::= PRACH-Partitioning-LCR-r4

E-RUCCH-Info ::= SEQUENCE {
    modeSpecificInfo        CHOICE {
        tdd384-tdd768       SEQUENCE {
            e-RUCCH-ConstantValue      INTEGER (-35..10),
            e-RUCCH-PersistenceScalingFactor PersistenceScalingFactor,
            t-RUCCH                  ENUMERATED { ms40, ms80, ms120, ms160, ms200,
                                                ms240, ms280, ms320 }          OPTIONAL,
            e-RUCCH-TS-Number          INTEGER (0..14)                    OPTIONAL,
            e-RUCCH-Midamble           ENUMERATED { direct, direct-Inverted } OPTIONAL,
            t-adv                      ENUMERATED { sec1, sec2, sec4, sec8, sec16,
                                                sec32, sec128, infinity }    OPTIONAL,
            t-SCHED                    ENUMERATED { zero, ms40, ms80, ms160, ms250,
                                                sec1, sec2, sec4 }          OPTIONAL,
            modeSpecificInfo           CHOICE {
                tdd384                CHOICE {
                    sF16              SEQUENCE (SIZE (1..8)) OF SF16Codes,
                    sF8               SEQUENCE (SIZE (1..8)) OF SF8Codes
                },
                tdd768                CHOICE {
                    sF32              SEQUENCE (SIZE (1..16)) OF SF32Codes,
                    sF816             SEQUENCE (SIZE (1..16)) OF SF16Codes2
                }
            }
        },
        tdd128                 SEQUENCE {
            t-RUCCH              ENUMERATED { ms20, ms40, ms60, ms80, ms120,
                                                ms160, ms200, ms240, ms280, ms320,
                                                ms400, ms500, ms600, ms800, ms1000,
                                                ms2000 }          OPTIONAL,
            n-RUCCH              INTEGER (0..7)                    OPTIONAL,
            t-WAIT               ENUMERATED { everyEDCHTTI, ms40, ms80, ms160,
                                                ms320, ms640, ms1000, ms2000 }    OPTIONAL,
            t-SI                 ENUMERATED { everyEDCHTTI, ms20, ms40, ms60, ms80,
                                                ms160, ms200 }          OPTIONAL,
            extendedEstimationWindow  INTEGER (2..5)                    OPTIONAL,
            e-RUCCH-AccessServiceClass E-RUCCH-AccessServiceClass    OPTIONAL,
            e-RUCCH-PersistenceScalingFactor PersistenceScalingFactorList OPTIONAL,
            sync-UL-InfoForE-RUCCH    SYNC-UL-InfoForE-RUCCH        OPTIONAL,
            prach-information          PRACH-Information-LCR-List      OPTIONAL
        }
    },
    t-RUCCH                    SEQUENCE {
        t-RUCCH              ENUMERATED { ms20, ms40, ms60, ms80, ms120,
                                                ms160, ms200, ms240, ms280, ms320,
                                                ms400, ms500, ms600, ms800, ms1000,
                                                ms2000 }          OPTIONAL,
        n-RUCCH              INTEGER (0..7)                    OPTIONAL,
        t-WAIT               ENUMERATED { everyEDCHTTI, ms40, ms80, ms160,
                                                ms320, ms640, ms1000, ms2000 }    OPTIONAL,
        t-SI                 ENUMERATED { everyEDCHTTI, ms20, ms40, ms60, ms80,
                                                ms160, ms200 }          OPTIONAL
    }
}

E-RUCCH-Info-TDD128 ::= SEQUENCE {
    t-RUCCH                    ENUMERATED { ms20, ms40, ms60, ms80, ms120,
                                                ms160, ms200, ms240, ms280, ms320,
                                                ms400, ms500, ms600, ms800, ms1000,
                                                ms2000 }          OPTIONAL,
    n-RUCCH                    INTEGER (0..7)                    OPTIONAL,
    t-WAIT                     ENUMERATED { everyEDCHTTI, ms40, ms80, ms160,
                                                ms320, ms640, ms1000, ms2000 }    OPTIONAL,
    t-SI                       ENUMERATED { everyEDCHTTI, ms20, ms40, ms60, ms80,
                                                ms160, ms200 }          OPTIONAL
}

```

```

    extendedEstimationWindow          INTEGER (2..5)                                OPTIONAL,
    e-RUCCH-AccessServiceClass         E-RUCCH-AccessServiceClass                  OPTIONAL,
    e-RUCCH-PersistenceScalingFactor   PersistenceScalingFactorList                OPTIONAL,
    sync-UL-InfoForE-RUCCH            SYNC-UL-InfoForE-RUCCH                      OPTIONAL,
    prach-information                  PRACH-Information-LCR-List                  OPTIONAL
}

E-TFC-Boost-Info-r7 ::= SEQUENCE {
    e-TFCI-Boost          INTEGER (0..127),
    delta-T2TP           INTEGER (0..6)           OPTIONAL
}

E-TFCI-TableIndex ::= INTEGER (0..1)

E-TFCS-Info ::= SEQUENCE {
    reference-Beta-QPSK-List SEQUENCE (SIZE (1..8)) OF Reference-Beta-QPSK,
    reference-Beta-16QAM-List SEQUENCE (SIZE (1..8)) OF Reference-Beta-16QAM
}

EARFCN ::= INTEGER (0..65535)

EnablingDelay ::= ENUMERATED {
    radio-frames-0,
    radio-frames-1,
    radio-frames-2,
    radio-frames-4,
    radio-frames-8,
    radio-frames-16,
    radio-frames-32,
    radio-frames-64,
    radio-frames-128,
    spare7,
    spare6,
    spare5,
    spare4,
    spare3,
    spare2,
    spare1 }

EnablingDelay-TDD128 ::= ENUMERATED {
    radio-frames-0, radio-frames-1, radio-frames-2,
    radio-frames-4, radio-frames-8, radio-frames-16,
    radio-frames-32, radio-frames-64, radio-frames-128,
    spare7, spare6, spare5, spare4, spare3, spare2,
    infinity }

EXT-UL-TimingAdvance ::= SEQUENCE {
    modeSpecificInfo CHOICE {
        tdd384 SEQUENCE {
            ex-ul-TimingAdvance INTEGER (0..255)
        },
        tdd768 SEQUENCE {
            ex-ul-TimingAdvance INTEGER (0..511)
        }
    }
}

FACH-PCH-Information ::= SEQUENCE {
    transportFormatSet TransportFormatSet,
    transportChannelIdentity TransportChannelIdentity,
    ctch-Indicator BOOLEAN
}

FACH-PCH-InformationList ::= SEQUENCE (SIZE (1..maxFACHPCH)) OF
    FACH-PCH-Information

Feedback-cycle ::= ENUMERATED {
    fc0, fc2, fc4, fc8, fc10, fc20, fc40, fc80, fc160}

Feedback-cycle-r7 ::= ENUMERATED {
    fc0, fc2, fc4, fc8, fc10, fc20, fc40, fc80, fc160,
    fc16, fc32, fc64, spare4, spare3, spare2, spare1 }

FPACH-Info-r4 ::= SEQUENCE {
    timeslot TimeslotNumber-LCR-r4,
    channelisationCode TDD-FPACH-CCode16-r4,
    midambleShiftAndBurstType MidambleShiftAndBurstType-LCR-r4,
    wi Wi-LCR
}

```



```

}

FrequencyInfo ::=
    modeSpecificInfo
    fdd
    tdd
}

FrequencyInfoFDD ::=
    uarfcn-UL
    uarfcn-DL
}

FrequencyInfoTDD ::=
    uarfcn-Nt
}

HappyBit-DelayCondition ::=
    ENUMERATED {
        ms2, ms10, ms20, ms50, ms100, ms200, ms500, ms1000 }

HARQ-Preamble-Mode ::=
    INTEGER (0..1)

HS-ChannelisationCode-LCR ::=
    ENUMERATED {
        cc16-1, cc16-2, cc16-3, cc16-4,
        cc16-5, cc16-6, cc16-7, cc16-8,
        cc16-9, cc16-10, cc16-11, cc16-12,
        cc16-13, cc16-14, cc16-15, cc16-16 }

HS-ChannelisationCodeSetInfo-LCR ::= SEQUENCE {
    startCode
    stopCode
}

HS-DSCH-CommonSystemInformation ::= SEQUENCE {
    ccch-MappingInfo
    srb1-MappingInfo
    common-MAC-ehs-ReorderingQueueList
    hs-scch-SystemInfo
    harq-SystemInfo
    common-H-RNTI-information
    bcchSpecific-H-RNTI
}

HS-DSCH-CommonSystemInformation-TDD128 ::= SEQUENCE {
    ccch-MappingInfo
    srb1-MappingInfo
    common-MAC-ehs-ReorderingQueueList
    hs-scch-SystemInfo-tdd128
    harq-SystemInfo
    hs-pdsch-Midamble-Configuration-TDD128
    common-H-RNTI-information
    bcchSpecific-H-RNTI
}

HS-DSCH-DrxBurstFach ::=
    ENUMERATED {
        f1, f2, f4, f8, f16, spare3, spare2, spare1 }

HS-DSCH-DrxCycleFach-info ::=
    t-321
    hs-dsch-DrxCycleFach
    hs-dsch-DrxBurstFach
    drxInterruption-hs-dsch
}

HS-DSCH-DrxCycleFach-info-TDD128 ::=
    t-321
    hs-dsch-DrxCycleFach
    hs-dsch-DrxBurstFach
}

HS-DSCH-DrxCycleFach ::=
    ENUMERATED {
        f4, f8, f16, f32 }

HS-DSCH-PagingSystemInformation ::=
    dlScramblingCode
    pich-ForHSDPASupportedPagingList
}

```

```

    numberOfPcchTransmissions      INTEGER(1..5),
    transportBlockSizeList         SEQUENCE (SIZE (1..2)) OF
                                   TransportBlockSizeIndex
}

HS-DSCH-PagingSystemInformation-TDD128 ::= SEQUENCE {
    pich-ForHsdSCHList             SEQUENCE (SIZE (1..maxSCCPCH)) OF
                                   PICH-ForHSDPASupportedPaging-TDD128,
    dtch-DCCH-reception-window-size INTEGER (1..16),
    pcch-InformationList           PCCH-InformationList                OPTIONAL
}

HS-DSCH-RxPatternList-TDD128 ::= SEQUENCE (SIZE (1..maxRxPatternForHSDSCH-TDD128)) OF
    SEQUENCE {
        repetitionPeriodAndLength RepetitionPeriodAndLengthForSPS
    }
}

HS-DSCH-TBSizeTable ::= ENUMERATED { octetAligned }

HS-DSCH-TbsList-TDD128 ::= SEQUENCE (SIZE (1..maxTbsForHSDSCH-TDD128)) OF
    SEQUENCE {
        hs-dsch-TBSizeIndex      INTEGER (1..63)
    }
}

HS-DSCH-SPS-Information-TDD128 ::= SEQUENCE {
    hs-dsch-SPS-Operation      CHOICE {
        continue                NULL,
        newOperation            HS-DSCH-SPS-NewOperation-TDD128
    }
}

HS-DSCH-SPS-NewOperation-TDD128 ::= SEQUENCE {
    hs-dsch-TbsList            HS-DSCH-TbsList-TDD128                OPTIONAL,
    hs-dsch-RxPatternList      HS-DSCH-RxPatternList-TDD128         OPTIONAL,
    hARQInfoForSPS             SEQUENCE {
        numberOfProcesses        INTEGER (1..8),
        memorySize              HARQMemorySize
    }
    OPTIONAL,
    hs-sich-List                HS-SICH-List-TDD128,
    initialSPSInfoForHSDSCH     SEQUENCE {
        timeslotInfo             BIT STRING (SIZE (5)),
        codeResourceInfo         HS-ChannelisationCodeSetInfo-LCR,
        activationTime           ActivationTime,
        sfNum                    INTEGER (0..1),
        initialRxPatternIndex    INTEGER (0..maxRxPatternForHSDSCH-TDD128-1),
        initialTfsIndex          INTEGER (0..maxTbsForHSDSCH-TDD128-1),
        modulation               ENUMERATED { modQPSK, mod16QAM },
        hs-sich-Index            INTEGER (0..maxHSSICH-TDD128-1)
    }
    OPTIONAL
}

HS-PDSCH-Midamble-Configuration-TDD128 ::= SEQUENCE {
    midambleAllocationMode      CHOICE{
        defaultMidamble         NULL,
        commonMidamble          NULL,
        ueSpecificMidamble      INTEGER (0..15)
    },
    -- Actual value midambleConfiguration = IE value * 2
    midambleConfiguration      INTEGER (1..8)
}

HS-SCCH-Info ::= SEQUENCE {
    modeSpecificInfo            CHOICE {
        fdd                     SEQUENCE {
            hs-SCCHChannelisationCodeInfo SEQUENCE (SIZE (1..maxHSSCCHs)) OF
                                   HS-SCCH-Codes,
            dl-ScramblingCode      SecondaryScramblingCode                OPTIONAL
        },
        tdd                     CHOICE {
            tdd384                SEQUENCE {
                nack-ack-power-offset INTEGER (-7..8),
                hs-SICH-PowerControl-Info HS-SICH-Power-Control-Info-TDD384,
                hs-SCCH-SetConfiguration SEQUENCE (SIZE (1..maxHSSCCHs)) OF
                                   HS-SCCH-TDD384
            },
            tdd128                SEQUENCE (SIZE (1..maxHSSCCHs)) OF
                                   HS-SCCH-TDD128
        }
    }
}

```

```

}
}
}
HS-SCCH-Info-r6 ::=
modeSpecificInfo
  fdd
    hs-SCCHChannelisationCodeInfo SEQUENCE (SIZE (1..maxHSSCCHs)) OF
      HS-SCCH-Codes,
    dl-ScramblingCode SecondaryScramblingCode OPTIONAL
  },
  tdd
    tdd384
      nack-ack-power-offset INTEGER (-7..8),
      hs-SICH-PowerControl-Info HS-SICH-Power-Control-Info-TDD384,
      dhs-sync DHS-Sync OPTIONAL,
      bler-target Bler-Target,
      hs-SCCH-SetConfiguration SEQUENCE (SIZE (1..maxHSSCCHs)) OF
        HS-SCCH-TDD384-r6
    },
    tdd128
      nack-ack-power-offset INTEGER (-7..8),
      power-level-HSSICH INTEGER (-120..-58),
      tpc-step-size ENUMERATED { s1, s2, s3 , spare1 },
      bler-target Bler-Target,
      hs-SCCH-SetConfiguration SEQUENCE (SIZE (1..maxHSSCCHs)) OF
        HS-SCCH-TDD128-r6
    }
  }
}
}
}
HS-SCCH-Info-r7 ::=
modeSpecificInfo
  fdd
    hs-SCCHChannelisationCodeInfo SEQUENCE (SIZE (1..maxHSSCCHs)) OF
      HS-SCCH-Codes,
    dl-ScramblingCode SecondaryScramblingCode OPTIONAL
  },
  tdd
    tdd384
      nack-ack-power-offset INTEGER (-7..8),
      hs-SICH-PowerControl-Info HS-SICH-Power-Control-Info-TDD384,
      dhs-sync DHS-Sync OPTIONAL,
      bler-target Bler-Target,
      hs-SCCH-SetConfiguration SEQUENCE (SIZE (1..maxHSSCCHs)) OF
        HS-SCCH-TDD384-r6
    },
    tdd768
      nack-ack-power-offset INTEGER (-7..8),
      hs-SICH-PowerControl-Info HS-SICH-Power-Control-Info-TDD768,
      dhs-sync DHS-Sync OPTIONAL,
      bler-target Bler-Target,
      hs-SCCH-SetConfiguration SEQUENCE (SIZE (1..maxHSSCCHs)) OF
        HS-SCCH-TDD768
    },
    tdd128
      nack-ack-power-offset INTEGER (-7..8),
      power-level-HSSICH INTEGER (-120..-58),
      tpc-step-size ENUMERATED { s1, s2, s3 , spare1 },
      bler-target Bler-Target,
      powerControlGAP PowerControlGAP OPTIONAL,
      pathlossCompensationSwitch BOOLEAN OPTIONAL,
      hs-SCCH-SetConfiguration SEQUENCE (SIZE (1..maxHSSCCHs)) OF
        HS-SCCH-TDD128-r6
    }
  }
}
}
}
}
HS-SCCH-Info-r8-ext ::=
modeSpecificInfo
  fdd
  },
  tdd
    tdd384
    tdd768
    tdd128
      hs-SCCH-tpc-step-size
        ENUMERATED { s1, s2, s3 , spare1 } OPTIONAL
    }
  }
}
}
}

```

```

    }
  }
}

HS-SCCH-DRX-InactivityThreshold-TDD128 ::= ENUMERATED {
    sub-frames-1, sub-frames-2, sub-frames-4,
    sub-frames-8, sub-frames-16, sub-frames-32,
    sub-frames-64, sub-frames-128, sub-frames-256,
    sub-frames-512,
    spare6, spare5, spare4, spare3, spare2,
    infinity }

HS-SCCH-DRX-Info-TDD128 ::= SEQUENCE {
    hs-SCCH-DRX-Cycle          ControlChannelDRXCycle-TDD128,
    hs-SCCH-DRX-InactivityThreshold HS-SCCH-DRX-InactivityThreshold-TDD128 OPTIONAL,
    hs-SCCH-DRX-Offset        INTEGER (0..63)
}

HS-SCCH-Codes ::= INTEGER (0..127)

HS-SCCH-Less-NewOperation ::= SEQUENCE {
    hs-pdsch-CodeIndex      INTEGER (1..15),
    hs-scch-LessTFSList    HS-SCCH-LessTFSList
}

HS-SCCH-LessInfo-r7 ::= SEQUENCE {
    hs-scchLessOperation    CHOICE {
        continue            NULL,
        newOperation        HS-SCCH-Less-NewOperation
    }
}

HS-SCCH-LessTFSList ::= SEQUENCE (SIZE (1..maxHS-SCCHLessTrBlk)) OF
    SEQUENCE {
        hs-scch-LessTFSI    INTEGER (1..90),
        hs-scch-LessSecondCodeSupport BOOLEAN
    }
}

HS-SCCH-SystemInfo ::= SEQUENCE {
    dl-ScramblingCode      SecondaryScramblingCode OPTIONAL,
    hs-SCCHChannelisationCodeInfo SEQUENCE (SIZE (1..maxHSSCCHs)) OF
        HS-SCCH-Codes
}

HS-SCCH-SystemInfo-TDD128 ::= SEQUENCE {
    hs-SCCH-SetConfiguration SEQUENCE (SIZE (1..maxHSSCCHs)) OF
        HS-SCCH-TDD128-r6,
    power-level-HSSICH      INTEGER (-120..-58),
    nack-ack-power-offset   INTEGER (-7..8),
    tpc-step-size           ENUMERATED { s1, s2, s3 , spare1 },
    bler-target             Bler-Target,
    power-control-gap       INTEGER (1..255) OPTIONAL,
    pathloss-compensation-switch BOOLEAN OPTIONAL
}

HS-SCCH-TDD128 ::= SEQUENCE {
    timeslotNumber          TimeslotNumber-LCR-r4,
    firstChannelisationCode HS-ChannelisationCode-LCR,
    secondChannelisationCode HS-ChannelisationCode-LCR,
    midambleAllocationMode CHOICE {
        defaultMidamble    NULL,
        commonMidamble     NULL,
        ueSpecificMidamble INTEGER (0..15)
    },
    -- Actual value midambleConfiguration = IE value * 2
    midambleConfiguration  INTEGER (1..8),
    bler-target            Bler-Target,
    hs-sich-configuration  HS-SICH-Configuration-TDD128
}

HS-SCCH-TDD128-r6 ::= SEQUENCE {
    timeslotNumber          TimeslotNumber-LCR-r4,
    firstChannelisationCode HS-ChannelisationCode-LCR,
    secondChannelisationCode HS-ChannelisationCode-LCR,
    midambleAllocationMode CHOICE {
        defaultMidamble    NULL,
        commonMidamble     NULL,
        ueSpecificMidamble INTEGER (0..15)
    }
}

```

```

    },
    -- Actual value midambleConfiguration = IE value * 2
    midambleConfiguration          INTEGER (1..8),
    hs-sich-configuration          HS-SICH-Configuration-TDD128-r6
}

--for TDD128 Multi-Carrier
HS-SCCH-TDD128-MultiCarrier ::= SEQUENCE {
    uarfcn-HS-SCCH-Rx              UARFCN,
    timeslotNumber                 TimeslotNumber-LCR-r4,
    firstChannelisationCode        HS-ChannelisationCode-LCR,
    secondChannelisationCode       HS-ChannelisationCode-LCR,
    midambleAllocationMode         CHOICE {
        defaultMidamble            NULL,
        commonMidamble             NULL,
        ueSpecificMidamble         INTEGER(0..15)
    },
    -- Actual value midambleConfiguration = IE value * 2
    midambleConfiguration          INTEGER (1..8),
    bler-target                    Bler-Target,
    hs-sich-configuration          HS-SICH-Configuration-TDD128
}

HS-SICH-Configuration-TDD128 ::= SEQUENCE {
    timeslotNumber                 TimeslotNumber-LCR-r4,
    channelisationCode             HS-ChannelisationCode-LCR,
    midambleAllocationMode         CHOICE {
        defaultMidamble            NULL,
        ueSpecificMidamble         SEQUENCE {
            midambleShift          MidambleShiftLong
        }
    },
    -- Actual value midambleConfiguration = IE value * 2
    midambleConfiguration          INTEGER (1..8),
    nack-ack-power-offset          INTEGER (-7..8),
    power-level-HSSICH             INTEGER (-120..-58),
    tpc-step-size                  ENUMERATED { s1, s2, s3 , spare1}
}

HS-SICH-Configuration-TDD128-r6 ::= SEQUENCE {
    timeslotNumber                 TimeslotNumber-LCR-r4,
    channelisationCode             HS-ChannelisationCode-LCR,
    midambleAllocationMode         CHOICE {
        defaultMidamble            NULL,
        ueSpecificMidamble         SEQUENCE {
            midambleShift          MidambleShiftLong
        }
    },
    -- Actual value midambleConfiguration = IE value * 2
    midambleConfiguration          INTEGER (1..8)
}

HS-SICH-List-TDD128 ::= SEQUENCE (SIZE (1..maxHSSICH-TDD128)) OF
    CHOICE {
        implicit                    SEQUENCE {
            hs-SCCH-Index           INTEGER (0..maxHSSCHs-1)
        },
        explicit                    SEQUENCE {
            hs-SICH-Info            HS-SICH-Configuration-TDD128-r6
        }
    }

--The order of the list corresponds to the order of HS-SCCHs in HS-SCCH info
HS-SICH-ReferenceSignalInfoList ::= SEQUENCE ( SIZE (1.. maxHSSCHs)) OF
    SEQUENCE {
        -- Actual value midambleConfiguration = IE value * 2
        midambleConfiguration       INTEGER (1..8),
        midambleShift               INTEGER (0..15),
        timeSlot                    INTEGER (1..5)
    }

HS-SCCH-TDD384 ::= SEQUENCE {
    timeslotNumber                 TimeslotNumber,
    channelisationCode             DL-TS-ChannelisationCode,
    midambleAllocationMode         CHOICE {
        defaultMidamble            NULL,
        commonMidamble             NULL,
        ueSpecificMidamble         SEQUENCE {

```

```

        midambleShift
    }
},
midambleconfiguration
bler-target
hs-sich-configuration
}

HS-SCCH-TDD384-r6 ::= SEQUENCE {
    timeslotNumber
    channelisationCode
    midambleAllocationMode
        defaultMidamble
        commonMidamble
        ueSpecificMidamble
        midambleShift
    },
midambleconfiguration
hs-sich-configuration
}

HS-SCCH-TDD768 ::= SEQUENCE {
    timeslotNumber
    channelisationCode
    midambleAllocationMode
        defaultMidamble
        commonMidamble
        ueSpecificMidamble
        midambleShift
    },
midambleconfiguration
hs-sich-configuration
}

HS-SICH-Configuration-TDD384 ::= SEQUENCE {
    timeslotNumber
    channelisationCode
    midambleAllocationMode
        defaultMidamble
        ueSpecificMidamble
        midambleShift
    },
midambleconfiguration
}

HS-SICH-Configuration-TDD768 ::= SEQUENCE {
    timeslotNumber
    channelisationCode
    midambleAllocationMode
        defaultMidamble
        ueSpecificMidamble
        midambleShift
    },
midambleconfiguration
}

HS-SICH-Power-Control-Info-TDD384 ::= SEQUENCE {
    -- Actual value ul-target-SIR = IE value * 0.5
    ul-target-SIR INTEGER (-22..40),
    -- Note: IE 'ConstantValue' is used (instead of IE 'ConstantValueTDD') to keep
    -- compatibility with REL-5
    hs-sich-ConstantValue ConstantValue
}

HS-SICH-Power-Control-Info-TDD768 ::= SEQUENCE {
    -- Actual value ul-target-SIR = IE value * 0.5
    ul-target-SIR INTEGER (-22..40),
    -- Note: IE 'ConstantValue' is used (instead of IE 'ConstantValueTDD') to keep
    -- compatibility with REL-5
    hs-sich-ConstantValue ConstantValue
}

IndividualTimeslotInfo ::= SEQUENCE {
    timeslotNumber

```

```

    tfci-Existence                BOOLEAN,
    midambleShiftAndBurstType     MidambleShiftAndBurstType
}

IndividualTimeslotInfo-VHCR ::= SEQUENCE {
    timeslotNumber                TimeslotNumber,
    tfci-Existence                BOOLEAN,
    midambleShiftAndBurstType-VHCR MidambleShiftAndBurstType-VHCR
}

IndividualTimeslotInfo-LCR-r4 ::= SEQUENCE {
    timeslotNumber                TimeslotNumber-LCR-r4,
    tfci-Existence                BOOLEAN,
    midambleShiftAndBurstType     MidambleShiftAndBurstType-LCR-r4,
    modulation                    ENUMERATED { mod-QPSK, mod-8PSK },
    ss-TPC-Symbols                ENUMERATED { zero, one, sixteenOverSF },
    additionalSS-TPC-Symbols      INTEGER(1..15) OPTIONAL
}

IndividualTimeslotInfo-LCR-r4-ext ::= SEQUENCE {
-- timeslotNumber and tfci-Existence is taken from IndividualTimeslotInfo.
-- midambleShiftAndBurstType in IndividualTimeslotInfo shall be ignored.
    midambleShiftAndBurstType     MidambleShiftAndBurstType-LCR-r4,
    modulation                    ENUMERATED { mod-QPSK, mod-8PSK },
    ss-TPC-Symbols                ENUMERATED { zero, one, sixteenOverSF }
}

IndividualTimeslotInfo-r7 ::= SEQUENCE {
    timeslotNumber                TimeslotNumber,
    tfci-Existence                BOOLEAN,
    midambleShiftAndBurstType     MidambleShiftAndBurstType-r7
}

IndividualTS-Interference ::= SEQUENCE {
    timeslot                      TimeslotNumber,
    ul-TimeslotInterference       TDD-UL-Interference
}

IndividualTS-InterferenceList ::= SEQUENCE (SIZE (1..maxTS)) OF
    IndividualTS-Interference

ITP ::= ENUMERATED {
    mode0, mode1 }

NidentifyAbort ::= INTEGER (1..128)

MAC-DTX-Cycle-10ms ::= ENUMERATED {
    sub-frames-5,
    sub-frames-10,
    sub-frames-20,
    spare1 }

MAC-DTX-Cycle-2ms ::= ENUMERATED {
    sub-frames-1,
    sub-frames-4,
    sub-frames-5,
    sub-frames-8,
    sub-frames-10,
    sub-frames-16,
    sub-frames-20,
    spare1 }

MAC-InactivityThreshold ::= ENUMERATED {
    e-dch-tti-1,
    e-dch-tti-2,
    e-dch-tti-4,
    e-dch-tti-8,
    e-dch-tti-16,
    e-dch-tti-32,
    e-dch-tti-64,
    e-dch-tti-128,
    e-dch-tti-256,
    e-dch-tti-512,
    e-dch-tti-Infinity,
    spare5,
    spare4,
    spare3,
    spare2,
}

```

```

        spare1 }

MaxAllowedUL-TX-Power ::= INTEGER (-50..33)

MaxAvailablePCPCH-Number ::= INTEGER (1..64)
MaxPowerIncrease-r4 ::= INTEGER (0..3)

MaxTFCI-Field2Value ::= INTEGER (1..1023)

Measurement-Feedback-Info ::= SEQUENCE {
    modeSpecificInfo CHOICE {
        fdd SEQUENCE {
            measurementPowerOffset MeasurementPowerOffset,
            feedback-cycle Feedback-cycle,
            cqi-RepetitionFactor CQI-RepetitionFactor,
            deltaCQI DeltaCQI
        },
        tdd NULL
    }
}

Measurement-Feedback-Info-r7 ::= SEQUENCE {
    modeSpecificInfo CHOICE {
        fdd SEQUENCE {
            measurementPowerOffset MeasurementPowerOffset,
            feedback-cycle Feedback-cycle-r7,
            cqi-RepetitionFactor CQI-RepetitionFactor,
            deltaCQI DeltaCQI
        },
        tdd NULL
    }
}

MidambleConfigurationBurstTypeLand3 ::= ENUMERATED {ms4, ms8, ms16}

MidambleConfigurationBurstType1 ::= ENUMERATED {ms4, ms8, ms16}

MidambleConfigurationBurstType2 ::= ENUMERATED {ms3, ms6}

MidambleConfigurationBurstType2-VHCR ::= ENUMERATED {ms4, ms8}

MidambleShiftAndBurstType ::= SEQUENCE {
    burstType CHOICE {
        type1 SEQUENCE {
            midambleConfigurationBurstTypeLand3 MidambleConfigurationBurstTypeLand3,
            midambleAllocationMode CHOICE {
                defaultMidamble NULL,
                commonMidamble NULL,
                ueSpecificMidamble SEQUENCE {
                    midambleShift MidambleShiftLong
                }
            }
        },
        type2 SEQUENCE {
            midambleConfigurationBurstType2 MidambleConfigurationBurstType2,
            midambleAllocationMode CHOICE {
                defaultMidamble NULL,
                commonMidamble NULL,
                ueSpecificMidamble SEQUENCE {
                    midambleShift MidambleShiftShort
                }
            }
        },
        type3 SEQUENCE {
            midambleConfigurationBurstTypeLand3 MidambleConfigurationBurstTypeLand3,
            midambleAllocationMode CHOICE {
                defaultMidamble NULL,
                ueSpecificMidamble SEQUENCE {
                    midambleShift MidambleShiftLong
                }
            }
        }
    }
}

MidambleShiftAndBurstType-VHCR ::= SEQUENCE {
    burstType CHOICE {
        type1 SEQUENCE {

```



```

midambleConfigurationBurstType1and3 MidambleConfigurationBurstType1and3,
midambleAllocationMode              CHOICE {
    defaultMidamble                   NULL,
    commonMidamble                    NULL,
    ueSpecificMidamble                SEQUENCE {
        midambleShift                 MidambleShiftLong
    }
},
type2                                SEQUENCE {
midambleConfigurationBurstType2     MidambleConfigurationBurstType2-VHCR,
midambleAllocationMode              CHOICE {
    defaultMidamble                   NULL,
    commonMidamble                    NULL,
    ueSpecificMidamble                SEQUENCE {
        midambleShift                 MidambleShiftShort-VHCR
    }
},
type3                                SEQUENCE {
midambleConfigurationBurstType1and3 MidambleConfigurationBurstType1and3,
midambleAllocationMode              CHOICE {
    defaultMidamble                   NULL,
    ueSpecificMidamble                SEQUENCE {
        midambleShift                 MidambleShiftLong
    }
},
-- mbsfnBurstType4 is only used DL
mbsfnBurstType4                     NULL
}

MidambleShiftAndBurstType-r7 ::= SEQUENCE {
    burstType                         CHOICE {
        type1                         SEQUENCE {
midambleConfigurationBurstType1and3 MidambleConfigurationBurstType1and3,
midambleAllocationMode              CHOICE {
    defaultMidamble                   NULL,
    commonMidamble                    NULL,
    ueSpecificMidamble                SEQUENCE {
        midambleShift                 MidambleShiftLong
    }
},
        type2                         SEQUENCE {
midambleConfigurationBurstType2     MidambleConfigurationBurstType2,
midambleAllocationMode              CHOICE {
    defaultMidamble                   NULL,
    commonMidamble                    NULL,
    ueSpecificMidamble                SEQUENCE {
        midambleShift                 MidambleShiftShort
    }
},
        type3                         SEQUENCE {
midambleConfigurationBurstType1and3 MidambleConfigurationBurstType1and3,
midambleAllocationMode              CHOICE {
    defaultMidamble                   NULL,
    ueSpecificMidamble                SEQUENCE {
        midambleShift                 MidambleShiftLong
    }
},
-- mbsfnBurstType4 is only used DL
mbsfnBurstType4                     NULL
    }
}

MidambleShiftAndBurstType-DL ::= SEQUENCE {
    burstType                         CHOICE {
        type1                         SEQUENCE {
midambleConfigurationBurstType1and3 MidambleConfigurationBurstType1and3,
midambleAllocationMode              CHOICE {
    defaultMidamble                   NULL,
    commonMidamble                    NULL,
    ueSpecificMidamble                SEQUENCE {
        midambleShift                 MidambleShiftLong
    }
}

```

```

    }
  },
  type2 SEQUENCE {
    midambleConfigurationBurstType2 MidambleConfigurationBurstType2,
    midambleAllocationMode CHOICE {
      defaultMidamble NULL,
      commonMidamble NULL,
      ueSpecificMidamble SEQUENCE {
        midambleShift MidambleShiftShort
      }
    }
  }
}

MidambleShiftAndBurstType-DL-VHCR ::= SEQUENCE {
  burstType CHOICE {
    type1 SEQUENCE {
      midambleConfigurationBurstType1and3 MidambleConfigurationBurstType1and3,
      midambleAllocationMode CHOICE {
        defaultMidamble NULL,
        commonMidamble NULL,
        ueSpecificMidamble SEQUENCE {
          midambleShift MidambleShiftLong
        }
      }
    }
  },
  type2 SEQUENCE {
    midambleConfigurationBurstType2 MidambleConfigurationBurstType2-VHCR,
    midambleAllocationMode CHOICE {
      defaultMidamble NULL,
      commonMidamble NULL,
      ueSpecificMidamble SEQUENCE {
        midambleShift MidambleShiftShort-VHCR
      }
    }
  }
}

MidambleShiftAndBurstType-LCR-r4 ::= SEQUENCE {
  midambleAllocationMode CHOICE {
    defaultMidamble NULL,
    commonMidamble NULL,
    ueSpecificMidamble SEQUENCE {
      midambleShift INTEGER (0..15)
    }
  }
},
-- Actual value midambleConfiguration = IE value * 2
midambleConfiguration INTEGER (1..8)
}

MidambleShiftAndBurstType-EDCH ::= SEQUENCE {
  burstType CHOICE {
    type1 SEQUENCE {
      midambleConfigurationBurstType1 MidambleConfigurationBurstType1,
      midambleAllocationMode CHOICE {
        defaultMidamble NULL,
        commonMidamble NULL,
        ueSpecificMidamble SEQUENCE {
          midambleShift MidambleShiftLong
        }
      }
    }
  },
  type2 SEQUENCE {
    midambleConfigurationBurstType2 MidambleConfigurationBurstType2,
    midambleAllocationMode CHOICE {
      defaultMidamble NULL,
      commonMidamble NULL,
      ueSpecificMidamble SEQUENCE {
        midambleShift MidambleShiftShort
      }
    }
  }
}
}

```

```

MidambleShiftLong ::= INTEGER (0..15)

MidambleShiftShort ::= INTEGER (0..5)

MidambleShiftShort-VHCR ::= INTEGER (0..7)

MIMO-N-M-Ratio ::= ENUMERATED {
    mnm12, mnm23, mnm34, mnm45, mnm56,
    mnm67, mnm78, mnm89, mnm910, mnm11 }

MIMO-Operation ::= ENUMERATED {
    start, continue }

MIMO-Parameters-r7 ::= SEQUENCE {
    mimoOperation MIMO-Operation,
    mimoN-M-Ratio MIMO-N-M-Ratio OPTIONAL,
    mimoPilotConfiguration MIMO-PilotConfiguration OPTIONAL
}

MIMO-Parameters-v7f0ext ::= MIMO-PilotConfiguration-v7f0ext

MIMO-Parameters-v7g0ext ::= SEQUENCE {
    precodingWeightSetRestriction ENUMERATED { true } OPTIONAL
}

MIMO-Parameters-r8 ::= SEQUENCE {
    mimoOperation MIMO-Operation,
    modeSpecificInfo CHOICE {
        fdd SEQUENCE {
            mimoN-M-Ratio MIMO-N-M-Ratio OPTIONAL,
            mimoPilotConfiguration MIMO-PilotConfiguration OPTIONAL
        },
        tdd CHOICE {
            tdd128 SEQUENCE {
                mimoSFModeForHSPDSCHDualStream ENUMERATED {sf1, sf1sf16},
                hs-sich-ReferenceSignalInfoList HS-SICH-ReferenceSignalInfoList OPTIONAL
            },
            tdd384-tdd768 NULL
        }
    }
}

MIMO-PilotConfiguration ::= SEQUENCE {
    secondCPICH-Pattern CHOICE {
        normalPattern NULL,
        diversityPattern SEQUENCE {
            channelisationCode ChannelisationCode256
        }
    }
}

MIMO-PilotConfiguration-v7f0ext ::= SEQUENCE {
    s-cpich-PowerOffset-Mimo S-CPICH-PowerOffset-MIMO OPTIONAL
}

MinimumSpreadingFactor ::= ENUMERATED {
    sf4, sf8, sf16, sf32,
    sf64, sf128, sf256 }

MinReduced-E-DPDCH-GainFactor ::= ENUMERATED {
    m8-15, m11-15, m15-15, m21-15, m30-15,
    m42-15, m60-15, m84-15 }

MultiCodeInfo ::= INTEGER (1..16)

-- These IEs are applied for 1.28 Mcps TDD only
Multi-frequencyInfo-LCR-r7 ::= SEQUENCE {
    -- If the secondary frequency is present, it indicates working frequency
    secondFrequencyInfo FrequencyInfoTDD OPTIONAL,
    fPachFrequencyInfo FrequencyInfoTDD OPTIONAL,
    --If a cell UpPCH uses other uplink service timeslot, it indicates the UpPCH position
    upPCHpositionInfo UpPCHposition-LCR OPTIONAL
}

N-EOT ::= INTEGER (0..7)

N-GAP ::= ENUMERATED {

```

```

        f2, f4, f8 }

N-PCH ::= INTEGER (1..8)

N-StartMessage ::= INTEGER (1..8)

NB01 ::= INTEGER (0..50)

NewTiming ::= SEQUENCE {
    enablingDelay          EnablingDelay,
    ue-dtx-drx-Offset     UE-DTX-DRX-Offset
}

NF-Max ::= INTEGER (1..64)

Non-ScheduledTransGrantInfoTDD ::= CHOICE {
    tdd384-768             SEQUENCE {
        timeslotResourceRelatedInfo  BIT STRING (SIZE (13)),
        powerResourceRelatedInfo     INTEGER (1..32),
        activationTime                ActivationTime,
        repetitionPeriodAndLength    RepetitionPeriodAndLength OPTIONAL,
        codeResourceInfo              UL-TS-ChannelisationCode
    },
    tdd128                 SEQUENCE {
        n-E-UCCH                INTEGER (1..8)          OPTIONAL,
        n-E-HICH                INTEGER (4..15)          OPTIONAL,
        timeslotResourceRelatedInfo  BIT STRING (SIZE (5)),
        powerResourceRelatedInfo     INTEGER (1..32),
        activationTime                ActivationTime,
        sfNum                    INTEGER (0..1),
        repetitionPeriodAndLength    RepetitionPeriodAndLength OPTIONAL,
        codeResourceInfo              UL-TS-ChannelisationCode,
        e-HICH-Info              SEQUENCE {
            timeslotNumber          TimeslotNumber-LCR-r4,
            channelisation-Code     HS-ChannelisationCode-LCR,
            midambleAllocationMode  CHOICE {
                defaultMidamble    NULL,
                ueSpecificMidamble  INTEGER (0..15)
            },
            -- Actual value midambleConfiguration = IE value * 2
            midambleConfiguration  INTEGER (1..8),
            signatureSequenceGroupIndex  INTEGER (0..19)
        }
    }
}

Non-ScheduledTransGrantInfoTDD-ext ::= CHOICE {
    tdd384-768             NULL,
    tdd128                 SEQUENCE {
        t-SI-nst              ENUMERATED {
            everyEDCHTTI, ms20, ms40, ms60, ms80, ms160,
            ms200 }
        OPTIONAL
    }
}

NumberOfDPDCH ::= INTEGER (1..maxDPDCH-UL)

NumberOfFBI-Bits ::= INTEGER (1..2)

NumberOfTPC-Bits ::= ENUMERATED { tpc4 }

OpenLoopPowerControl-TDD ::= SEQUENCE {
    primaryCCPCH-TX-Power      PrimaryCCPCH-TX-Power,
    -- alpha, prach-ConstantValue, dpch-ConstantValue and pusch-ConstantValue
    -- shall be ignored in 1.28Mcps TDD mode.
    alpha                      Alpha OPTIONAL,
    prach-ConstantValue        ConstantValueTdd,
    dpch-ConstantValue         ConstantValueTdd,
    pusch-ConstantValue        ConstantValueTdd OPTIONAL
}

OpenLoopPowerControl-IPDL-TDD-r4 ::= SEQUENCE {
    ipdl-alpha                 Alpha,
    maxPowerIncrease           MaxPowerIncrease-r4
}

OutOfSyncWindow ::= ENUMERATED {
    ms40, ms80, ms160, ms320,

```

```

ms640, spare3, spare2, spare1 }

PagingIndicatorLength ::=      ENUMERATED {
                                pi4, pi8, pi16 }

PC-Preamble ::=                INTEGER (0..7)

PCCH-InformationList ::=      SEQUENCE {
    paging-associatedHspdschInfo SEQUENCE (SIZE (1.. maxSCCPCH)) OF
                                SEQUENCE {
                                    hs-pdsch-MidambleConfiguration HS-PDSCH-Midamble-Configuration-TDD128,
                                    timeslotResourceRelatedInfo      BIT STRING (SIZE (6)),
                                    codeResourceInformation           CodeResourceInformation-TDD128
                                },
    paging-sub-Channel-size      INTEGER (1..3),
    transportBlockSizeList       SEQUENCE (SIZE (1..2)) OF TransportBlockSizeIndex
}

PCP-Length ::=                ENUMERATED {
                                as0, as8 }

PCPCH-ChannelInfo ::=        SEQUENCE {
    pcpch-UL-ScramblingCode      INTEGER (0..79),
    pcpch-DL-ChannelisationCode  INTEGER (0..511),
    pcpch-DL-ScramblingCode      SecondaryScramblingCode          OPTIONAL,
    pcp-Length                   PCP-Length,
    ucsM-Info                    UCSM-Info                       OPTIONAL
}

PCPCH-ChannelInfoList ::=    SEQUENCE (SIZE (1..maxPCPCHs)) OF
                                PCPCH-ChannelInfo

PCPICH-UsageForChannelEst ::= ENUMERATED {
                                maybeUsed,
                                shallNotBeUsed }

PDSCH-CapacityAllocationInfo ::= SEQUENCE {
    -- pdsch-PowerControlInfo is conditional on new-configuration branch below, if this
    -- selected the IE is OPTIONAL otherwise it should not be sent
    pdsch-PowerControlInfo       PDSCH-PowerControlInfo          OPTIONAL,
    pdsch-AllocationPeriodInfo   AllocationPeriodInfo,
    configuration                 CHOICE {
        old-Configuration         SEQUENCE {
            tfcs-ID               TFCS-IdentityPlain            DEFAULT 1,
            pdsch-Identity        PDSCH-Identity
        },
        new-Configuration         SEQUENCE {
            pdsch-Info            PDSCH-Info,
            pdsch-Identity        PDSCH-Identity                OPTIONAL
        }
    }
}

PDSCH-CapacityAllocationInfo-r4 ::= SEQUENCE {
    pdsch-AllocationPeriodInfo   AllocationPeriodInfo,
    configuration                 CHOICE {
        old-Configuration         SEQUENCE {
            tfcs-ID               TFCS-IdentityPlain            DEFAULT 1,
            pdsch-Identity        PDSCH-Identity
        },
        new-Configuration         SEQUENCE {
            pdsch-Info            PDSCH-Info-r4,
            pdsch-Identity        PDSCH-Identity                OPTIONAL,
            pdsch-PowerControlInfo PDSCH-PowerControlInfo       OPTIONAL
        }
    }
}

PDSCH-CapacityAllocationInfo-r7 ::= SEQUENCE {
    pdsch-AllocationPeriodInfo   AllocationPeriodInfo,
    configuration                 CHOICE {
        old-Configuration         SEQUENCE {
            tfcs-ID               TFCS-IdentityPlain            DEFAULT 1,
            pdsch-Identity        PDSCH-Identity
        },
        new-Configuration         SEQUENCE {
            pdsch-Info            PDSCH-Info-r7,
            pdsch-Identity        PDSCH-Identity                OPTIONAL,

```

```

        pdsch-PowerControlInfo                PDSCH-PowerControlInfo    OPTIONAL
    }
}

PDSCH-CodeInfo ::=
    spreadingFactor
    codeNumber
    multiCodeInfo
}

PDSCH-CodeInfoList ::=
    SEQUENCE (SIZE (1..maxTFCI-2-Combs)) OF
        PDSCH-CodeInfo

PDSCH-CodeMap ::=
    spreadingFactor
    multiCodeInfo
    codeNumberStart
    codeNumberStop
}

PDSCH-CodeMapList ::=
    SEQUENCE (SIZE (1..maxPDSCH-TFCIgroups)) OF
        PDSCH-CodeMap

PDSCH-CodeMapping ::=
    dl-ScramblingCode
    signallingMethod
    codeRange
    tfci-Range
    explicit-config
    replace
}

PDSCH-Identity ::=
    INTEGER (1..hiPDSCHidentities)

PDSCH-Info ::=
    tfcs-ID
    commonTimeslotInfo
    pdsch-TimeslotsCodes
}

PDSCH-Info-r4 ::=
    tfcs-ID
    commonTimeslotInfo
    tddOption
    tdd384
        pdsch-TimeslotsCodes
    },
    tdd128
        pdsch-TimeslotsCodes
}

PDSCH-Info-r7 ::=
    tfcs-ID
    commonTimeslotInfo
    tddOption
    tdd384
        pdsch-TimeslotsCodes
    },
    tdd768
        pdsch-TimeslotsCodes
    },
    tdd128
        pdsch-TimeslotsCodes
}

PDSCH-Info-LCR-r4 ::=
    tfcs-ID
    commonTimeslotInfo
    pdsch-TimeslotsCodes
}

PDSCH-PowerControlInfo ::=

```

| | | |
|---------------------------------------|---------------------------------------|-----------------------|
| tpc-StepSizeTDD | TPC-StepSizeTDD | OPTIONAL, |
| ul-CCTrChTPCList | UL-CCTrChTPCList | OPTIONAL |
| } | | |
| PDSCH-SHO-DCH-Info ::= | SEQUENCE { | |
| dsch-RadioLinkIdentifier | DSCH-RadioLinkIdentifier, | |
| rl-IdentifierList | RL-IdentifierList | OPTIONAL |
| } | | |
| PDSCH-SysInfo ::= | SEQUENCE { | |
| pdsch-Identity | PDSCH-Identity, | |
| pdsch-Info | PDSCH-Info, | |
| dsch-TFS | TransportFormatSet | OPTIONAL, |
| dsch-TFCS | TFCS | OPTIONAL |
| } | | |
| PDSCH-SysInfo-VHCR-r7 ::= | SEQUENCE { | |
| pdsch-Identity | PDSCH-Identity, | |
| pdsch-Info | PDSCH-Info-r7, | |
| dsch-TransportChannelsInfo | DSCH-TransportChannelsInfo | OPTIONAL, |
| dsch-TFCS | TFCS | OPTIONAL |
| } | | |
| PDSCH-SysInfo-HCR-r5 ::= | SEQUENCE { | |
| pdsch-Identity | PDSCH-Identity, | |
| pdsch-Info | PDSCH-Info, | |
| dsch-TransportChannelsInfo | DSCH-TransportChannelsInfo | OPTIONAL, |
| dsch-TFCS | TFCS | OPTIONAL |
| } | | |
| PDSCH-SysInfo-LCR-r4 ::= | SEQUENCE { | |
| pdsch-Identity | PDSCH-Identity, | |
| pdsch-Info | PDSCH-Info-LCR-r4, | |
| dsch-TFS | TransportFormatSet | OPTIONAL, |
| dsch-TFCS | TFCS | OPTIONAL |
| } | | |
| PDSCH-SysInfoList ::= | SEQUENCE (SIZE (1..maxPDSCH)) OF | |
| | PDSCH-SysInfo | |
| PDSCH-SysInfoList-VHCR-r7 ::= | SEQUENCE (SIZE (1..maxPDSCH)) OF | PDSCH-SysInfo-VHCR-r7 |
| PDSCH-SysInfoList-HCR-r5 ::= | SEQUENCE (SIZE (1..maxPDSCH)) OF | PDSCH-SysInfo-HCR-r5 |
| PDSCH-SysInfoList-LCR-r4 ::= | SEQUENCE (SIZE (1..maxPDSCH)) OF | PDSCH-SysInfo-LCR-r4 |
| PDSCH-SysInfoList-SFN ::= | SEQUENCE (SIZE (1..maxPDSCH)) OF | |
| | SEQUENCE { | |
| pdsch-SysInfo | PDSCH-SysInfo, | |
| sfn-TimeInfo | SFN-TimeInfo | OPTIONAL |
| } | | |
| PDSCH-SysInfoList-SFN-HCR-r5 ::= | SEQUENCE (SIZE (1..maxPDSCH)) OF | |
| | SEQUENCE { | |
| pdsch-SysInfo | PDSCH-SysInfo-HCR-r5, | |
| sfn-TimeInfo | SFN-TimeInfo | OPTIONAL |
| } | | |
| PDSCH-SysInfoList-SFN-LCR-r4 ::= | SEQUENCE (SIZE (1..maxPDSCH)) OF | |
| | SEQUENCE { | |
| pdsch-SysInfo | PDSCH-SysInfo-LCR-r4, | |
| sfn-TimeInfo | SFN-TimeInfo | OPTIONAL |
| } | | |
| PersistenceScalingFactor ::= | ENUMERATED { | |
| | psf0-9, psf0-8, psf0-7, psf0-6, | |
| | psf0-5, psf0-4, psf0-3, psf0-2 } | |
| PersistenceScalingFactorList ::= | SEQUENCE (SIZE (1..maxASCPersist)) OF | |
| | PersistenceScalingFactor | |
| PI-CountPerFrame ::= | ENUMERATED { | |
| | e18, e36, e72, e144 } | |
| PichChannelisationCodeList-LCR-r4 ::= | SEQUENCE (SIZE (1..2)) OF | |
| | DL-TS-ChannelisationCode | |

```

PICH-ForHSDPASupportedPaging ::= SEQUENCE {
    hsdpa-AssociatedPichInfo          PICH-Info,
    hs-pdschChannelisationCode      INTEGER(1..15)
}

PICH-ForHSDPASupportedPaging-TDD128 ::= CHOICE {
    implicit SEQUENCE {
        occurrenceSequenceNumberOfPICH OccurrenceSequenceNumberOfPICH OPTIONAL
    },
    explicit PICH-Info-LCR-r4
}

PICH-Info ::= CHOICE {
    fdd SEQUENCE {
        channelisationCode256 ChannelisationCode256,
        pi-CountPerFrame      PI-CountPerFrame,
        sttd-Indicator        BOOLEAN
    },
    tdd SEQUENCE {
        channelisationCode      TDD-PICH-CCode OPTIONAL,
        timeslot                TimeslotNumber   OPTIONAL,
        midambleShiftAndBurstType MidambleShiftAndBurstType,
        repetitionPeriodLengthOffset RepPerLengthOffset-PICH OPTIONAL,
        pagingIndicatorLength    PagingIndicatorLength DEFAULT pi4,
        n-GAP                    N-GAP          DEFAULT f4,
        n-PCH                     N-PCH         DEFAULT 2
    }
}

PICH-Info-HCR-VHCR-r7 ::= SEQUENCE {
    channelisationCode CHOICE {
        tdd384 TDD-PICH-CCode,
        tdd768 TDD768-PICH-CCode
    } OPTIONAL,
    timeslot TimeslotNumber OPTIONAL,
    midambleShiftAndBurstType MidambleShiftAndBurstType,
    repetitionPeriodLengthOffset RepPerLengthOffset-PICH OPTIONAL,
    pagingIndicatorLength    PagingIndicatorLength DEFAULT pi4,
    n-GAP                    N-GAP          DEFAULT f4,
    n-PCH                     N-PCH         DEFAULT 2
}

PICH-Info-LCR-r4 ::= SEQUENCE {
    timeslot TimeslotNumber-LCR-r4 OPTIONAL,
    pichChannelisationCodeList-LCR-r4 PichChannelisationCodeList-LCR-r4,
    midambleShiftAndBurstType MidambleShiftAndBurstType-LCR-r4,
    repetitionPeriodLengthOffset RepPerLengthOffset-PICH OPTIONAL,
    pagingIndicatorLength    PagingIndicatorLength DEFAULT pi4,
    n-GAP                    N-GAP          DEFAULT f4,
    n-PCH                     N-PCH         DEFAULT 2
}

PICH-PowerOffset ::= INTEGER (-10..5)

PilotBits128 ::= ENUMERATED {
    pb4, pb8 }

PilotBits256 ::= ENUMERATED {
    pb2, pb4, pb8 }

-- Actual measurement power offset value = IE value * 0.5
MeasurementPowerOffset ::= INTEGER (-12..26)

PLCCH-Info ::= SEQUENCE {
    plcchSequenceNumber INTEGER(1..14),
    timeslotNumber      TimeslotNumber-LCR-r4,
    channelisationCode  DL-TS-ChannelisationCode,
    tpcCommandTargetRate TPC-CommandTargetRate
}

PositionFixedOrFlexible ::= ENUMERATED {
    fixed,
    flexible }

PowerControlAlgorithm ::= CHOICE {
    algorithm1 TPC-StepSizeFDD,
    algorithm2 NULL
}

```



```

PowerControlGAP ::= INTEGER (0..255)

PowerOffsetPilot-pdpdch ::= INTEGER (0..24)

PowerOffsetTPC-pdpdch ::= INTEGER (0..24)

PowerRampStep ::= INTEGER (1..8)

PRACH-ChanCodes-LCR-r4 ::= SEQUENCE (SIZE (1..4)) OF
    TDD-PRACH-CCode-LCR-r4

PRACH-ChanCodes-List-LCR ::= SEQUENCE (SIZE (1..2)) OF
    TDD-PRACH-CCode-LCR-r4

PRACH-Definition-LCR-r4 ::= SEQUENCE {
    timeslot TimeslotNumber-PRACH-LCR-r4,
    prach-ChanCodes-LCR PRACH-ChanCodes-LCR-r4,
    midambleShiftAndBurstType MidambleShiftAndBurstType-LCR-r4,
    fpach-Info FPACH-Info-r4
}

PRACH-Information-LCR ::= SEQUENCE {
    timeslot TimeslotNumber-PRACH-LCR-r4,
    prach-ChanCodes-list-LCR PRACH-ChanCodes-List-LCR,
    midambleShiftAndBurstType MidambleShiftAndBurstType-LCR-r4,
    fpach-Info FPACH-Info-r4 OPTIONAL
}

PRACH-Information-LCR-List ::= SEQUENCE (SIZE (1..maxPRACH-FPACH)) OF
    PRACH-Information-LCR

PRACH-Midamble ::= ENUMERATED {
    direct,
    direct-Inverted }

PRACH-Partitioning ::= CHOICE {
    fdd SEQUENCE (SIZE (1..maxASC)) OF
        -- TABULAR: If only "NumASC+1" (with, NumASC+1 < maxASC) ASCSetting-FDD are listed,
        -- the remaining (NumASC+2 through maxASC) ASCs are unspecified.
        ASCSetting-FDD,
    tdd SEQUENCE (SIZE (1..maxASC)) OF
        -- TABULAR: If only "NumASC+1" (with, NumASC+1 < maxASC) ASCSetting-TDD are listed,
        -- the remaining (NumASC+2 through maxASC) ASCs are unspecified.
        ASCSetting-TDD
}

PRACH-Partitioning-r7 ::= CHOICE {
    fdd SEQUENCE (SIZE (1..maxASC)) OF
        -- TABULAR: If only "NumASC+1" (with, NumASC+1 < maxASC) ASCSetting-FDD are listed,
        -- the remaining (NumASC+2 through maxASC) ASCs are unspecified.
        ASCSetting-FDD,
    tdd SEQUENCE (SIZE (1..maxASC)) OF
        -- TABULAR: If only "NumASC+1" (with, NumASC+1 < maxASC) ASCSetting-TDD are listed,
        -- the remaining (NumASC+2 through maxASC) ASCs are unspecified.
        ASCSetting-TDD-r7
}

PRACH-Partitioning-LCR-r4 ::= SEQUENCE (SIZE (1..maxASC)) OF
    -- TABULAR: If only "NumASC+1" (with, NumASC+1 < maxASC) ASCSetting-TDD-LCR-r4 are listed,
    -- the remaining (NumASC+2 through maxASC) ASCs are unspecified.
    ASCSetting-TDD-LCR-r4

PRACH-PowerOffset ::= SEQUENCE {
    powerRampStep PowerRampStep,
    preambleRetransMax PreambleRetransMax
}

PRACH-PreambleForEnhancedUplink ::= SEQUENCE {
    availableSignatures AvailableSignatures OPTIONAL,
    e-ai-Indication BOOLEAN,
    preambleScramblingCodeWordNumber PreambleScramblingCodeWordNumber OPTIONAL,
    availableSubChannelNumbers AvailableSubChannelNumbers OPTIONAL,
    prach-Partitioning PRACH-Partitioning-r7 OPTIONAL,
    persistenceScalingFactorList PersistenceScalingFactorList OPTIONAL,
    ac-To-ASC-MappingTable AC-To-ASC-MappingTable OPTIONAL,
    primaryCPICH-TX-Power PrimaryCPICH-TX-Power OPTIONAL,
    constantValue ConstantValue OPTIONAL,
}

```

```

prach-PowerOffset          PRACH-PowerOffset          OPTIONAL,
rach-TransmissionParameters RACH-TransmissionParameters OPTIONAL,
aich-Info                  AICH-Info                  OPTIONAL,
powerOffsetPp-e           INTEGER (-5..10)
}

PRACH-RACH-Info ::=
  modeSpecificInfo
  fdd
    availableSignatures      AvailableSignatures,
    availableSF              SF-PRACH,
    preambleScramblingCodeWordNumber PreambleScramblingCodeWordNumber,
    puncturingLimit          PuncturingLimit,
    availableSubChannelNumbers AvailableSubChannelNumbers
  },
  tdd
    timeslot                 TimeslotNumber,
    channelisationCodeList   TDD-PRACH-CCodeList,
    prach-Midamble           PRACH-Midamble
  }
}

PRACH-RACH-Info-VHCR-r7 ::= SEQUENCE {
  timeslot                 TimeslotNumber,
  channelisationCodeList   TDD768-PRACH-CCodeList,
  prach-Midamble           PRACH-Midamble
}

PRACH-RACH-Info-LCR-v770ext ::= SEQUENCE {
  e-RUCCH-Sync-UL-Codes-Bitmap Sync-UL-Codes-Bitmap
}

PRACH-RACH-Info-LCR-r4 ::= SEQUENCE {
  sync-UL-Info             SYNC-UL-Info-r4,
  prach-DefinitionList     SEQUENCE (SIZE (1..maxPRACH-FPACH)) OF
    PRACH-Definition-LCR-r4
}

PRACH-SystemInformation ::= SEQUENCE {
  prach-RACH-Info          PRACH-RACH-Info,
  transportChannelIdentity TransportChannelIdentity,
  rach-TransportFormatSet  TransportFormatSet          OPTIONAL,
  rach-TFCS                TFCS                      OPTIONAL,
  prach-Partitioning       PRACH-Partitioning          OPTIONAL,
  persistenceScalingFactorList PersistenceScalingFactorList OPTIONAL,
  ac-To-ASC-MappingTable   AC-To-ASC-MappingTable   OPTIONAL,
  modeSpecificInfo         CHOICE {
    fdd
      primaryCPICH-TX-Power PrimaryCPICH-TX-Power  OPTIONAL,
      constantValue          ConstantValue          OPTIONAL,
      prach-PowerOffset      PRACH-PowerOffset    OPTIONAL,
      rach-TransmissionParameters RACH-TransmissionParameters OPTIONAL,
      aich-Info              AICH-Info              OPTIONAL
    },
    tdd                      NULL
  }
}

PRACH-SystemInformation-VHCR-r7 ::= SEQUENCE {
  prach-RACH-Info          PRACH-RACH-Info-VHCR-r7,
  prach-Partitioning       PRACH-Partitioning-r7          OPTIONAL
}

PRACH-SystemInformation-LCR-r4 ::= SEQUENCE {
  prach-RACH-Info-LCR     PRACH-RACH-Info-LCR-r4,
  rach-TransportFormatSet-LCR TransportFormatSet-LCR          OPTIONAL,
  prach-Partitioning-LCR  PRACH-Partitioning-LCR-r4          OPTIONAL
}

PRACH-SystemInformation-LCR-v770ext ::= SEQUENCE {
  prach-RACH-Info-LCR     PRACH-RACH-Info-LCR-v770ext
}

PRACH-SystemInformationList ::= SEQUENCE (SIZE (1..maxPRACH)) OF
  PRACH-SystemInformation

PRACH-SystemInformationList-VHCR-r7 ::= SEQUENCE (SIZE (1..maxPRACH)) OF

```

```

PRACH-SystemInformation-VHCR-r7

PRACH-SystemInformationList-LCR-r4 ::= SEQUENCE (SIZE (1..maxPRACH)) OF
    PRACH-SystemInformation-LCR-r4

PRACH-SystemInformationList-LCR-v770ext ::= SEQUENCE (SIZE (1..maxPRACH)) OF
    PRACH-SystemInformation-LCR-v770ext

PreambleRetransMax ::=
    INTEGER (1..64)

PreambleScramblingCodeWordNumber ::=
    INTEGER (0..15)

PreDefPhyChConfiguration ::=
    SEQUENCE {
        ul-DPCH-InfoPredef          UL-DPCH-InfoPredef,
        dl-CommonInformationPredef  DL-CommonInformationPredef  OPTIONAL
    }

PreDefPhyChConfiguration-v770ext ::= SEQUENCE {
    ul-DPCH-InfoPredef          UL-DPCH-InfoPredef-v770ext
}

PrimaryCCPCH-Info ::=
    CHOICE {
        fdd
            tx-DiversityIndicator
            },
        tdd
            -- syncCase should be ignored for 1.28Mcps TDD mode
            syncCase
                syncCase1
                    timeslot
                    },
                syncCase2
                    timeslotSync2
                    }
            }
            cellParametersID          CellParametersID          OPTIONAL,
            sctd-Indicator            BOOLEAN                    OPTIONAL,
    }

PrimaryCCPCH-Info-r4 ::=
    CHOICE {
        fdd
            tx-DiversityIndicator
            },
        tdd
            tddOption
                tdd384-tdd768
                syncCase
                    syncCase1
                        timeslot
                        },
                    syncCase2
                        timeslotSync2
                        }
                }
                },
                tdd128
                tstd-Indicator
                }
            },
            cellParametersID          CellParametersID          OPTIONAL,
            sctd-Indicator            BOOLEAN                    OPTIONAL,
    }

PrimaryCCPCH-Info-LCR-r4 ::=
    SEQUENCE {
        tstd-Indicator          BOOLEAN,
        cellParametersID        CellParametersID          OPTIONAL,
        sctd-Indicator          BOOLEAN
    }

-- For 1.28Mcps TDD, the following IE includes elements for the PCCPCH Info additional to those
-- in PrimaryCCPCH-Info
PrimaryCCPCH-Info-LCR-r4-ext ::=
    SEQUENCE {
        tstd-Indicator          BOOLEAN
    }

PrimaryCCPCH-InfoPost ::=
    SEQUENCE {

```

```

syncCase CHOICE {
  syncCase1 SEQUENCE {
    timeslot TimeslotNumber
  },
  syncCase2 SEQUENCE {
    timeslotSync2 TimeslotSync2
  }
},
cellParametersID CellParametersID,
sctd-Indicator BOOLEAN
}

PrimaryCCPCH-InfoPostTDD-LCR-r4 ::= SEQUENCE {
  tstd-Indicator BOOLEAN,
  cellParametersID CellParametersID,
  sctd-Indicator BOOLEAN
}

PrimaryCCPCH-TX-Power ::= INTEGER (6..43)

PrimaryCPICH-Info ::= SEQUENCE {
  primaryScramblingCode PrimaryScramblingCode
}

PrimaryCPICH-TX-Power ::= INTEGER (-10..50)

PrimaryScramblingCode ::= INTEGER (0..511)

PuncturingLimit ::= ENUMERATED {
  pl0-40, pl0-44, pl0-48, pl0-52, pl0-56,
  pl0-60, pl0-64, pl0-68, pl0-72, pl0-76,
  pl0-80, pl0-84, pl0-88, pl0-92, pl0-96, pl1 }

PUSCH-CapacityAllocationInfo ::= SEQUENCE {
  pusch-Allocation CHOICE {
    pusch-AllocationPending NULL,
    pusch-AllocationAssignment SEQUENCE {
      pusch-AllocationPeriodInfo AllocationPeriodInfo,
      pusch-PowerControlInfo UL-TargetSIR OPTIONAL,
      configuration CHOICE {
        old-Configuration SEQUENCE {
          tfcs-ID TFCS-IdentityPlain DEFAULT 1,
          pusch-Identity PUSCH-Identity
        },
        new-Configuration SEQUENCE {
          pusch-Info PUSCH-Info,
          pusch-Identity PUSCH-Identity OPTIONAL
        }
      }
    }
  }
}

PUSCH-CapacityAllocationInfo-r4 ::= SEQUENCE {
  pusch-Allocation CHOICE {
    pusch-AllocationPending NULL,
    pusch-AllocationAssignment SEQUENCE {
      pusch-AllocationPeriodInfo AllocationPeriodInfo,
      pusch-PowerControlInfo PUSCH-PowerControlInfo-r4 OPTIONAL,
      configuration CHOICE {
        old-Configuration SEQUENCE {
          tfcs-ID TFCS-IdentityPlain DEFAULT 1,
          pusch-Identity PUSCH-Identity
        },
        new-Configuration SEQUENCE {
          pusch-Info PUSCH-Info-r4,
          pusch-Identity PUSCH-Identity OPTIONAL
        }
      }
    }
  }
}

PUSCH-CapacityAllocationInfo-r7 ::= SEQUENCE {
  pusch-Allocation CHOICE {
    pusch-AllocationPending NULL,
    pusch-AllocationAssignment SEQUENCE {
      pusch-AllocationPeriodInfo AllocationPeriodInfo,

```

```

    pusch-PowerControlInfo
    configuration
      old-Configuration
        tfcs-ID
        pusch-Identity
      },
      new-Configuration
        pusch-Info
        pusch-Identity
    }
  }
}

PUSCH-Identity ::= INTEGER (1..hiPUSCHidentities)

PUSCH-Info ::= SEQUENCE {
  tfcs-ID TFCS-IdentityPlain DEFAULT 1,
  commonTimeslotInfo CommonTimeslotInfo OPTIONAL,
  pusch-TimeslotsCodes UplinkTimeslotsCodes OPTIONAL
}

PUSCH-Info-r4 ::= SEQUENCE {
  tfcs-ID TFCS-IdentityPlain DEFAULT 1,
  commonTimeslotInfo CommonTimeslotInfo OPTIONAL,
  tddOption CHOICE {
    tdd384 SEQUENCE {
      pusch-TimeslotsCodes UplinkTimeslotsCodes OPTIONAL
    },
    tdd128 SEQUENCE {
      pusch-TimeslotsCodes UplinkTimeslotsCodes-LCR-r4 OPTIONAL
    }
  }
}

PUSCH-Info-VHCR ::= SEQUENCE {
  tfcs-ID TFCS-IdentityPlain DEFAULT 1,
  commonTimeslotInfo CommonTimeslotInfo OPTIONAL,
  pusch-TimeslotsCodes-VHCR UplinkTimeslotsCodes-VHCR OPTIONAL
}

PUSCH-Info-LCR-r4 ::= SEQUENCE {
  tfcs-ID TFCS-IdentityPlain DEFAULT 1,
  commonTimeslotInfo CommonTimeslotInfo OPTIONAL,
  pusch-TimeslotsCodes UplinkTimeslotsCodes-LCR-r4 OPTIONAL
}

PUSCH-PowerControlInfo-r4 ::= SEQUENCE {
  -- The IE ul-TargetSIR corresponds to PRX-PUSCHdes for 1.28Mcps TDD
  -- Actual value PRX-PUSCHdes = (value of IE "ul-TargetSIR" - 120)
  ul-TargetSIR UL-TargetSIR,
  tddOption CHOICE {
    tdd384 NULL,
    tdd128 SEQUENCE {
      tpc-StepSize TPC-StepSizeTDD OPTIONAL
    }
  }
}

PUSCH-PowerControlInfo-r7 ::= SEQUENCE {
  -- The IE ul-TargetSIR corresponds to PRX-PUSCHdes for 1.28Mcps TDD
  -- Actual value PRX-PUSCHdes = (value of IE "ul-TargetSIR" - 120)
  ul-TargetSIR UL-TargetSIR,
  tddOption CHOICE {
    tdd384 NULL,
    tdd768 NULL,
    tdd128 SEQUENCE {
      tpc-StepSize TPC-StepSizeTDD OPTIONAL
    }
  }
}

PUSCH-SysInfo ::= SEQUENCE {
  pusch-Identity PUSCH-Identity,
  pusch-Info PUSCH-Info,
  usch-TFS TransportFormatSet OPTIONAL,
}

```

| | | |
|---|----------------------------------|----------------------|
| usch-TFCS
} | TFCS | OPTIONAL |
| PUSCH-SysInfo-VHCR ::= | SEQUENCE { | |
| pusch-Identity | PUSCH-Identity, | |
| pusch-Info-VHCR | PUSCH-Info-VHCR, | |
| usch-TransportChannelsInfo | USCH-TransportChannelsInfo | OPTIONAL, |
| usch-TFCS | TFCS | OPTIONAL |
| } | | |
| PUSCH-SysInfo-HCR-r5 ::= | SEQUENCE { | |
| pusch-Identity | PUSCH-Identity, | |
| pusch-Info | PUSCH-Info, | |
| usch-TransportChannelsInfo | USCH-TransportChannelsInfo | OPTIONAL, |
| usch-TFCS | TFCS | OPTIONAL |
| } | | |
| PUSCH-SysInfo-LCR-r4 ::= | SEQUENCE { | |
| pusch-Identity | PUSCH-Identity, | |
| pusch-Info | PUSCH-Info-LCR-r4, | |
| usch-TFS | TransportFormatSet | OPTIONAL, |
| usch-TFCS | TFCS | OPTIONAL |
| } | | |
| PUSCH-SysInfoList ::= | SEQUENCE (SIZE (1..maxPUSCH)) OF | |
| | PUSCH-SysInfo | |
| PUSCH-SysInfoList-HCR-r5 ::= | SEQUENCE (SIZE (1..maxPUSCH)) OF | PUSCH-SysInfo-HCR-r5 |
| PUSCH-SysInfoList-LCR-r4 ::= | SEQUENCE (SIZE (1..maxPUSCH)) OF | PUSCH-SysInfo-LCR-r4 |
| PUSCH-SysInfoList-SFN ::= | SEQUENCE (SIZE (1..maxPUSCH)) OF | |
| pusch-SysInfo | SEQUENCE { | |
| sfm-TimeInfo | PUSCH-SysInfo, | |
| | SFN-TimeInfo | OPTIONAL |
| } | | |
| PUSCH-SysInfoList-SFN-HCR-r5 ::= | SEQUENCE (SIZE (1..maxPUSCH)) OF | |
| pusch-SysInfo | SEQUENCE { | |
| sfm-TimeInfo | PUSCH-SysInfo-HCR-r5, | |
| | SFN-TimeInfo | OPTIONAL |
| } | | |
| PUSCH-SysInfoList-SFN-LCR-r4 ::= | SEQUENCE (SIZE (1..maxPUSCH)) OF | |
| pusch-SysInfo | SEQUENCE { | |
| sfm-TimeInfo | PUSCH-SysInfo-LCR-r4, | |
| | SFN-TimeInfo | OPTIONAL |
| } | | |
| PUSCH-SysInfoList-SFN-VHCR ::= | SEQUENCE (SIZE (1..maxPUSCH)) OF | |
| pusch-SysInfo-VHCR | SEQUENCE { | |
| sfm-TimeInfo | PUSCH-SysInfo-VHCR, | |
| | SFN-TimeInfo | OPTIONAL |
| } | | |
| RACH-TransmissionParameters ::= | SEQUENCE { | |
| mmax | INTEGER (1..32), | |
| nb01Min | NB01, | |
| nb01Max | NB01 | |
| } | | |
| ReducedScramblingCodeNumber ::= | INTEGER (0..8191) | |
| Reference-Beta-QPSK ::= | SEQUENCE { | |
| reference-Code-Rate | INTEGER (0..10), | |
| reference-Beta | INTEGER (-15..16) | |
| } | | |
| Reference-Beta-16QAM ::= | SEQUENCE { | |
| reference-Code-Rate | INTEGER (0..10), | |
| reference-Beta | INTEGER (-15..16) | |
| } | | |
| RepetitionPeriodAndLength ::= | CHOICE { | |
| repetitionPeriod1 | NULL, | |
| -- repetitionPeriod2 could just as well be NULL also. | | |
| repetitionPeriod2 | INTEGER (1..1), | |

```

    repetitionPeriod4          INTEGER (1..3),
    repetitionPeriod8          INTEGER (1..7),
    repetitionPeriod16         INTEGER (1..15),
    repetitionPeriod32         INTEGER (1..31),
    repetitionPeriod64         INTEGER (1..63)
}

RepetitionPeriodLengthAndOffset ::= CHOICE {
    repetitionPeriod1          NULL,
    repetitionPeriod2          SEQUENCE {
        length                  NULL,
        offset                   INTEGER (0..1)
    },
    repetitionPeriod4          SEQUENCE {
        length                   INTEGER (1..3),
        offset                    INTEGER (0..3)
    },
    repetitionPeriod8          SEQUENCE {
        length                   INTEGER (1..7),
        offset                    INTEGER (0..7)
    },
    repetitionPeriod16         SEQUENCE {
        length                   INTEGER (1..15),
        offset                    INTEGER (0..15)
    },
    repetitionPeriod32         SEQUENCE {
        length                   INTEGER (1..31),
        offset                    INTEGER (0..31)
    },
    repetitionPeriod64         SEQUENCE {
        length                   INTEGER (1..63),
        offset                    INTEGER (0..63)
    }
}

RepetitionPeriodAndLengthForSPS ::= CHOICE {
    repetitionPeriod1          NULL,
    -- repetitionPeriod2 could just as well be NULL also.
    repetitionPeriod2          INTEGER (1..1),
    repetitionPeriod4          INTEGER (1..3),
    repetitionPeriod8          INTEGER (1..7),
    repetitionPeriod16         INTEGER (1..15),
    repetitionPeriod32         INTEGER (1..31)
}

ReplacedPDSCH-CodeInfo ::=          SEQUENCE {
    tfci-Field2                MaxTFCI-Field2Value,
    spreadingFactor             SF-PDSCH,
    codeNumber                  CodeNumberDSCH,
    multiCodeInfo               MultiCodeInfo
}

ReplacedPDSCH-CodeInfoList ::=      SEQUENCE (SIZE (1..maxTFCI-2-Combs)) OF
    ReplacedPDSCH-CodeInfo

RepPerLengthOffset-PICH ::=         CHOICE {
    rpp4-2                      INTEGER (0..3),
    rpp8-2                      INTEGER (0..7),
    rpp8-4                      INTEGER (0..7),
    rpp16-2                     INTEGER (0..15),
    rpp16-4                     INTEGER (0..15),
    rpp32-2                     INTEGER (0..31),
    rpp32-4                     INTEGER (0..31),
    rpp64-2                     INTEGER (0..63),
    rpp64-4                     INTEGER (0..63)
}

RepPerLengthOffset-MICH ::=         CHOICE {
    rpp4-2                      INTEGER (0..3),
    rpp8-2                      INTEGER (0..7),
    rpp8-4                      INTEGER (0..7),
    rpp16-2                     INTEGER (0..15),
    rpp16-4                     INTEGER (0..15),
    rpp32-2                     INTEGER (0..31),
    rpp32-4                     INTEGER (0..31),
    rpp64-2                     INTEGER (0..63),
    rpp64-4                     INTEGER (0..63)
}

```

```

RestrictedTrCH ::=
  dl-restrictedTrCh-Type          SEQUENCE {
    restrictedDL-TrCH-Identity    DL-TrCH-Type,
    allowedTFIList                TransportChannelIdentity,
  }                               AllowedTFI-List

RestrictedTrCH-InfoList ::=      SEQUENCE (SIZE(1..maxTrCH)) OF
  RestrictedTrCH

RL-AdditionInformation ::=      SEQUENCE {
  primaryCPICH-Info              PrimaryCPICH-Info,
  dl-DPCH-InfoPerRL              DL-DPCH-InfoPerRL,
  -- dummy and dummy2 are not used in this version of specification
  -- and the IEs should be ignored.
  dummy                           BOOLEAN,
  dummy2                           SCCPCH-InfoForFACH          OPTIONAL
}

RL-AdditionInformation-r6 ::=    SEQUENCE {
  primaryCPICH-Info              PrimaryCPICH-Info,
  cell-Id                         CellIdentity                OPTIONAL,
  dl-dpchInfo                     CHOICE {
    dl-DPCH-InfoPerRL            DL-DPCH-InfoPerRL-r5,
    dl-FDPCH-InfoPerRL            DL-FDPCH-InfoPerRL-r6
  },
  e-HICH-Information              E-HICH-Information          OPTIONAL,
  e-RGCH-Information              E-RGCH-Information          OPTIONAL
}

RL-AdditionInformation-r7 ::=    SEQUENCE {
  primaryCPICH-Info              PrimaryCPICH-Info,
  cell-Id                         CellIdentity                OPTIONAL,
  dl-dpchInfo                     CHOICE {
    dl-DPCH-InfoPerRL            DL-DPCH-InfoPerRL-r5,
    dl-FDPCH-InfoPerRL            DL-FDPCH-InfoPerRL-r7
  },
  e-HICH-Information              E-HICH-Information          OPTIONAL,
  e-RGCH-Information              E-RGCH-Information          OPTIONAL
}

RL-AdditionInformation-r8 ::=    SEQUENCE {
  primaryCPICH-Info              PrimaryCPICH-Info,
  cell-Id                         CellIdentity                OPTIONAL,
  dl-dpchInfo                     CHOICE {
    dl-DPCH-InfoPerRL            DL-DPCH-InfoPerRL-r5,
    dl-FDPCH-InfoPerRL            DL-FDPCH-InfoPerRL-r7
  },
  e-HICH-Information              E-HICH-Information          OPTIONAL,
  e-RGCH-Information              E-RGCH-Information          OPTIONAL,
  targetCellPreconfigInfo        TargetCellPreconfigInfo  OPTIONAL
}

RL-AdditionInformation-v6b0ext ::= SEQUENCE {
  sttdIndication                  STTDIndication          OPTIONAL
}

RL-AdditionInformation-v890ext ::= SEQUENCE {
  targetCellPreconfigInfo        TargetCellPreconfigInfo-v890ext  OPTIONAL
}

RL-AdditionInformationList ::=  SEQUENCE (SIZE (1..maxRL-1)) OF
  RL-AdditionInformation

RL-AdditionInformationList-r6 ::= SEQUENCE (SIZE (1..maxRL-1)) OF
  RL-AdditionInformation-r6

RL-AdditionInformationList-r7 ::= SEQUENCE (SIZE (1..maxRL-1)) OF
  RL-AdditionInformation-r7

RL-AdditionInformation-list-v6b0ext ::= SEQUENCE (SIZE (1..maxRL)) OF
  RL-AdditionInformation-v6b0ext

RL-AdditionInformationList-r8 ::= SEQUENCE (SIZE(1..maxRL-1)) OF
  RL-AdditionInformation-r8

RL-AdditionInformationList-v890ext ::= SEQUENCE (SIZE (1..maxRL-1)) OF
  RL-AdditionInformation-v890ext

```



```

RL-IdentififierList ::= SEQUENCE (SIZE (1..maxRL)) OF
    PrimaryCPICH-Info

RL-RemovalInformationList ::= SEQUENCE (SIZE (1..maxRL)) OF
    PrimaryCPICH-Info

RPP ::= ENUMERATED {
    mode0, mode1 }

S-Field ::= ENUMERATED {
    e1bit, e2bits }

SCCPCH-ChannelisationCode ::= ENUMERATED {
    cc16-1, cc16-2, cc16-3, cc16-4,
    cc16-5, cc16-6, cc16-7, cc16-8,
    cc16-9, cc16-10, cc16-11, cc16-12,
    cc16-13, cc16-14, cc16-15, cc16-16 }

SCCPCH-ChannelisationCode-VHCR ::= ENUMERATED {
    cc32-1, cc32-2, cc32-3, cc32-4,
    cc32-5, cc32-6, cc32-7, cc32-8,
    cc32-9, cc32-10, cc32-11, cc32-12,
    cc32-13, cc32-14, cc32-15, cc32-16,
    cc32-17, cc32-18, cc32-19, cc32-20,
    cc32-21, cc32-22, cc32-23, cc32-24,
    cc32-25, cc32-26, cc32-27, cc32-28,
    cc32-29, cc32-30, cc32-31, cc32-32 }

SCCPCH-ChannelisationCodeList ::= SEQUENCE (SIZE (1..16)) OF
    SCCPCH-ChannelisationCode

SCCPCH-ChannelisationCodeList-VHCR ::= SEQUENCE (SIZE (1..32)) OF
    SCCPCH-ChannelisationCode-VHCR

SCCPCH-InfoForFACH ::= SEQUENCE {
    secondaryCCPCH-Info SecondaryCCPCH-Info,
    tfcs TFCS,
    modeSpecificInfo CHOICE {
        fdd SEQUENCE {
            fach-PCH-InformationList FACH-PCH-InformationList,
            sib-ReferenceListFACH SIB-ReferenceListFACH
        },
        tdd SEQUENCE {
            fach-PCH-InformationList FACH-PCH-InformationList
        }
    }
}

SCCPCH-InfoForFACH-r4 ::= SEQUENCE {
    secondaryCCPCH-Info SecondaryCCPCH-Info-r4,
    tfcs TFCS,
    fach-PCH-InformationList FACH-PCH-InformationList,
    modeSpecificInfo CHOICE {
        fdd SEQUENCE {
            sib-ReferenceListFACH SIB-ReferenceListFACH
        },
        tdd NULL
    }
}

SCCPCH-SystemInformation ::= SEQUENCE {
    secondaryCCPCH-Info SecondaryCCPCH-Info, OPTIONAL,
    tfcs TFCS, OPTIONAL,
    fach-PCH-InformationList FACH-PCH-InformationList, OPTIONAL,
    pich-Info PICH-Info OPTIONAL
}

SCCPCH-SystemInformation-LCR-r4-ext ::= SEQUENCE {
    secondaryCCPCH-LCR-Extensions SecondaryCCPCH-Info-LCR-r4-ext,
    -- pich-Info in the SCCPCH-SystemInformation IE shall be absent,
    -- and instead the following used.
    pich-Info PICH-Info-LCR-r4 OPTIONAL
}

SCCPCH-SystemInformation-HCR-VHCR-r7 ::= SEQUENCE {
    secondaryCCPCH-Info SecondaryCCPCH-Info-HCR-VHCR-r7,
    tfcs TFCS, OPTIONAL,
}

```

```

    fach-PCH-InformationList      FACH-PCH-InformationList      OPTIONAL,
    pich-Info                     PICH-Info-HCR-VHCR-r7         OPTIONAL
}

SCCPCH-SystemInformationList ::= SEQUENCE (SIZE (1..maxSCCPCH)) OF
    SCCPCH-SystemInformation

SCCPCH-SystemInformationList-HCR-VHCR-r7 ::= SEQUENCE (SIZE (1..maxSCCPCH)) OF
    SCCPCH-SystemInformation-HCR-VHCR-r7

-- SCCPCH-SystemInformationList-LCR-r4-ext includes elements additional to those in
-- SCCPCH-SystemInformationList for the 1.28Mcps TDD. The order of the IEs
-- indicates which SCCPCH-SystemInformation-LCR-r4-ext IE extends which
-- SCCPCH-SystemInformation IE.
SCCPCH-SystemInformationList-LCR-r4-ext ::= SEQUENCE (SIZE (1..maxSCCPCH)) OF
    SCCPCH-SystemInformation-LCR-r4-ext

-- The SCCPCH-SystemInformation-MBMS-r6 is used for an S-CCPCH dedicated for MBMS purposes.
SCCPCH-SystemInformation-MBMS-r6 ::= SEQUENCE {
    secondaryCCPCHInfo-MBMS      SecondaryCCPCHInfo-MBMS-r6,
    transportFormatCombinationSet TFCS,
    fachCarryingMCCH             SEQUENCE {
        mcch-transportFormatSet  TransportFormatSet,
        mcch-ConfigurationInfo    MBMS-MCCH-ConfigurationInfo-r6
    },
    fachCarryingMTCH-List        MBMS-FACHCarryingMTCH-List      OPTIONAL,
    -- If schedulingInformation is provided
    fachCarryingMSCH             SEQUENCE {
        msch-transportFormatSet  TransportFormatSet,
        -- dummy is not used in this version of the specification, it should
        -- not be sent and if received it should be ignored.
        dummy                     MBMS-MSCH-ConfigurationInfo-r6
    }
    OPTIONAL
}

-- The SCCPCH-SystemInformation-MBMS-r7 is used for an S-CCPCH dedicated for MBMS purposes.
SCCPCH-SystemInformation-MBMS-r7 ::= SEQUENCE {
    secondaryCCPCHInfo-MBMS      SecondaryCCPCHInfo-MBMS-r7,
    transportFormatCombinationSet TFCS,
    fachCarryingMCCH             SEQUENCE {
        mcch-transportFormatSet  TransportFormatSet,
        mcch-ConfigurationInfo    MBMS-MCCH-ConfigurationInfo-r6
    },
    fachCarryingMTCH-List        MBMS-FACHCarryingMTCH-List      OPTIONAL,
    -- If schedulingInformation is provided
    fachCarryingMSCH             SEQUENCE {
        msch-transportFormatSet  TransportFormatSet
    }
    OPTIONAL
}

S-CPICH-PowerOffset-MIMO ::= INTEGER (-6..0)

ScramblingCodeChange ::= ENUMERATED {
    codeChange, noCodeChange }

ScramblingCodeType ::= ENUMERATED {
    shortSC,
    longSC }

SecondaryCCPCH-Info ::= SEQUENCE {
    modeSpecificInfo            CHOICE {
        fdd                     SEQUENCE {
            -- dummy1 is not used in this version of the specification and should be ignored.
            dummy1              PCPICH-UsageForChannelEst,
            -- dummy2 is not used in this version of the specification. It should not
            -- be sent and if received it should be ignored.
            dummy2              SecondaryCPICH-Info      OPTIONAL,
            secondaryScramblingCode SecondaryScramblingCode  OPTIONAL,
            sttd-Indicator       BOOLEAN,
            sf-AndCodeNumber     SF256-AndCodeNumber,
            pilotSymbolExistence BOOLEAN,
            tfci-Existence       BOOLEAN,
            positionFixedOrFlexible PositionFixedOrFlexible,
            timingOffset         TimingOffset          DEFAULT 0
        },
        tdd                     SEQUENCE {
            -- TABULAR: the offset is included in CommonTimeslotInfoSCCPCH
            commonTimeslotInfo   CommonTimeslotInfoSCCPCH,

```

```

        individualTimeslotInfo      IndividualTimeslotInfo,
        channelisationCode          SCCPCH-ChannelisationCodeList
    }
}

SecondaryCCPCH-Info-r4 ::= SEQUENCE {
    modeSpecificInfo              CHOICE {
        fdd                        SEQUENCE {
            secondaryScramblingCode      SecondaryScramblingCode      OPTIONAL,
            sttd-Indicator                BOOLEAN,
            sf-AndCodeNumber              SF256-AndCodeNumber,
            pilotSymbolExistence          BOOLEAN,
            tfci-Existence                BOOLEAN,
            positionFixedOrFlexible       PositionFixedOrFlexible,
            timingOffset                  TimingOffset                  DEFAULT 0
        },
        tdd                          SEQUENCE {
            -- TABULAR: the offset is included in CommonTimeslotInfoSCCPCH
            commonTimeslotInfo            CommonTimeslotInfoSCCPCH,
            tddOption                     CHOICE {
                tdd384                   SEQUENCE {
                    individualTimeslotInfo      IndividualTimeslotInfo
                },
                tdd128                   SEQUENCE {
                    individualTimeslotInfo      IndividualTimeslotInfo-LCR-r4
                }
            },
            channelisationCode            SCCPCH-ChannelisationCodeList
        }
    }
}

SecondaryCCPCH-Info-HCR-VHCR-r7 ::= SEQUENCE {
    modeSpecificInfo              CHOICE {
        tdd384                      SEQUENCE {
            individualTimeslotInfo          IndividualTimeslotInfo-r7,
            channelisationCode              SCCPCH-ChannelisationCodeList
        },
        tdd768                      SEQUENCE {
            individualTimeslotInfo          IndividualTimeslotInfo-VHCR,
            channelisationCode              SCCPCH-ChannelisationCodeList-VHCR
        }
    }
}

SecondaryCCPCH-Info-LCR-r4-ext ::= SEQUENCE {
    individualTimeslotLCR-Ext        IndividualTimeslotInfo-LCR-r4-ext
}

SecondaryCCPCHFrameType2Info ::= SEQUENCE {
    subFrameNumber                 INTEGER (0..4),
    dl-ChannelisationCodes          DL-ChannelCodes-MBSFN-IMB384,
    modulation                      CHOICE {
        modQPSK                       NULL,
        mod16QAM                       SEQUENCE {
            cpich-SecCCPCH-PowerOffset      INTEGER (-11..4)
        }
    }
}

SecondaryCCPCHInfo-MBMS-r6 ::= SEQUENCE {
    modeSpecificInfo              CHOICE {
        fdd                          SEQUENCE {
            secondaryScramblingCode      SecondaryScramblingCode      OPTIONAL,
            sttd-Indicator                BOOLEAN,
            sf-AndCodeNumber              SF256-AndCodeNumber,
            timingOffset                  TimingOffset                  DEFAULT 0
        },
        tdd384                        SEQUENCE {
            commonTimeslotInfoMBMS        CommonTimeslotInfoMBMS,
            downlinkTimeslotsCodes        DownlinkTimeslotsCodes
        },
        tdd128                        SEQUENCE {
            commonTimeslotInfoMBMS        CommonTimeslotInfoMBMS,
            downlinkTimeslotsCodes        DownlinkTimeslotsCodes-LCR-r4
        }
    }
}

```

```

}

SecondaryCCPCHInfo-MBMS-r7 ::= SEQUENCE {
  modeSpecificInfo CHOICE {
    -- The CHOICE fdd is used for both "fdd" and "3.84 Mcps TDD MBSFN IMB"
    fdd SEQUENCE {
      -- The IE secondaryScramblingCode is not applicable for "3.84 Mcps TDD MBSFN IMB"
      secondaryScramblingCode SecondaryScramblingCode OPTIONAL,
      -- The IE sttd-Indicator is not applicable for cells operating in MBSFN mode,
      -- the UE behaviour is unspecified
      sttd-Indicator BOOLEAN,
      sf-AndCodeNumber SF256-AndCodeNumber,
      -- The IE timingOffset is not applicable for "3.84 Mcps TDD MBSFN IMB"
      timingOffset TimingOffset DEFAULT 0,
      modulation CHOICE {
        modQPSK NULL,
        -- The CHOICE mod16QAM is not applicable for MCCH in "3.84 Mcps TDD MBSFN IMB"
        mod16QAM INTEGER (-11..4)
      } OPTIONAL
    },
    tdd384 SEQUENCE {
      commonTimeslotInfoMBMS CommonTimeslotInfoMBMS,
      downlinkTimeslotsCodes DownlinkTimeslotsCodes-r7,
      modulation ENUMERATED { modQPSK, mod16QAM }
    },
    tdd768 SEQUENCE {
      commonTimeslotInfoMBMS CommonTimeslotInfoMBMS,
      downlinkTimeslotsCodes DownlinkTimeslotsCodes-VHCR,
      modulation ENUMERATED { modQPSK, mod16QAM }
    },
    tdd128 SEQUENCE {
      commonTimeslotInfoMBMS CommonTimeslotInfoMBMS,
      downlinkTimeslotsCodes DownlinkTimeslotsCodes-LCR-r4,
      mbsfnSpecialTimeSlot TimeSlotLCR-ext OPTIONAL,
      modulation ENUMERATED { modQPSK, mod16QAM }
    }
  }
}

SecondaryCCPCHInfoDiff-MBMS ::= SEQUENCE {
  secondaryScramblingCode SecondaryScramblingCode OPTIONAL,
  sttd-Indicator BOOLEAN,
  sf-AndCodeNumber SF256-AndCodeNumber OPTIONAL,
  timingOffset TimingOffset OPTIONAL
}

SecondaryCPICH-Info ::= SEQUENCE {
  secondaryDL-ScramblingCode SecondaryScramblingCode OPTIONAL,
  channelisationCode ChannelisationCode256
}

SecondaryScramblingCode ::= INTEGER (1..15)

SecondInterleavingMode ::= ENUMERATED {
  frameRelated, timeslotRelated }

ServingCellChangeMACreset ::= BOOLEAN

ServingCellChangeMsgType ::= ENUMERATED {
  radioBearerSetup,
  radioBearerReconfiguration,
  transportChannelReconfiguration,
  physicalChannelReconfiguration }

ServingCellChangeParameters ::= SEQUENCE {
  servingCellChangeMACreset ServingCellChangeMACreset,
  servingCellChangeMsgType ServingCellChangeMsgType,
  servingCellChangeTrId ServingCellChangeTrId
}

ServingCellChangeTrId ::= INTEGER (0..3)

SF8Codes ::= ENUMERATED {
  cc8-1, cc8-2, cc8-3, cc8-4, cc8-5, cc8-6, cc8-7, cc8-8}

SF16Codes ::= ENUMERATED {
  cc16-1, cc16-2, cc16-3, cc16-4, cc16-5, cc16-6, cc16-7,
  cc16-8}

```

```

SF16Codes2 ::=
    ENUMERATED {
        cc16-1, cc16-2, cc16-3, cc16-4, cc16-5, cc16-6, cc16-7,
        cc16-8, cc16-9, cc16-10, cc16-11, cc16-12, cc16-13, cc16-14,
        cc16-15, cc16-16}

SF32Codes ::=
    ENUMERATED {
        cc32-1, cc32-2, cc32-3, cc32-4, cc32-5, cc32-6, cc32-7,
        cc32-8, cc32-9, cc32-10, cc32-11, cc32-12, cc32-13, cc32-14,
        cc32-15, cc32-16}

-- SF256-AndCodeNumber encodes both "Spreading factor" and "Code Number"
SF256-AndCodeNumber ::=
    CHOICE {
        sf4          INTEGER (0..3),
        sf8          INTEGER (0..7),
        sf16         INTEGER (0..15),
        sf32         INTEGER (0..31),
        sf64         INTEGER (0..63),
        sf128        INTEGER (0..127),
        sf256        INTEGER (0..255)
    }

-- SF512-AndCodeNumber encodes both "Spreading factor" and "Code Number"
SF512-AndCodeNumber ::=
    CHOICE {
        sf4          INTEGER (0..3),
        sf8          INTEGER (0..7),
        sf16         INTEGER (0..15),
        sf32         INTEGER (0..31),
        sf64         INTEGER (0..63),
        sf128        INTEGER (0..127),
        sf256        INTEGER (0..255),
        sf512        INTEGER (0..511)
    }

-- SF512-AndPilot encodes both "Spreading factor" and "Number of bits for Pilot bits"
SF512-AndPilot ::=
    CHOICE {
        sfd4         NULL,
        sfd8         NULL,
        sfd16        NULL,
        sfd32        NULL,
        sfd64        NULL,
        sfd128       PilotBits128,
        sfd256       PilotBits256,
        sfd512       NULL
    }

SF-PDSCH ::=
    ENUMERATED {
        sfp4, sfp8, sfp16, sfp32,
        sfp64, sfp128, sfp256 }

SF-PRACH ::=
    ENUMERATED {
        sfpr32, sfpr64, sfpr128, sfpr256 }

SFN-TimeInfo ::=
    SEQUENCE {
        activationTimeSFN    INTEGER (0..4095),
        physChDuration       DurationTimeInfo
    }

-- actual scheduling value = 2(signalled value +1) and is the periodicity of sending
-- special burst frames
SpecialBurstScheduling ::=
    INTEGER (0..7)

SpreadingFactor ::=
    ENUMERATED {
        sf4, sf8, sf16, sf32,
        sf64, sf128, sf256 }

SPS-Information-TDD128-r8 ::=
    SEQUENCE {
        e-dch-SPS-Info      E-DCH-SPS-Information-TDD128          OPTIONAL,
        hs-dsch-SPS-Info    HS-DSCH-SPS-Information-TDD128      OPTIONAL
    }

SRB-delay ::=
    INTEGER (0..7)

SSDT-CellIdentity ::=
    ENUMERATED {
        ssdt-id-a, ssdt-id-b, ssdt-id-c,
        ssdt-id-d, ssdt-id-e, ssdt-id-f,
        ssdt-id-g, ssdt-id-h }

SSDT-Information ::=
    SEQUENCE {

```

```

    s-Field                S-Field,
    codeWordSet            CodeWordSet
}

SSDT-Information-r4 ::= SEQUENCE {
    s-Field                S-Field,
    codeWordSet            CodeWordSet,
    ssdt-UL-r4             SSDT-UL                                OPTIONAL
}

SSDT-UL ::= ENUMERATED {
    ul, ul-AndDL }

STTDIndication ::= ENUMERATED { true }

SynchronisationParameters-r4 ::= SEQUENCE {
    sync-UL-CodesBitmap    BIT STRING {
        code7(0),
        code6(1),
        code5(2),
        code4(3),
        code3(4),
        code2(5),
        code1(6),
        code0(7)
    } (SIZE (8)),
    fpach-Info             FPACH-Info-r4,
    -- Actual value prxUpPCHdes = IE value - 120
    prxUpPCHdes            INTEGER (0..62),
    sync-UL-Procedure      SYNC-UL-Procedure-r4                    OPTIONAL
}

Sync-UL-Codes-Bitmap ::= BIT STRING {
    code7(0),
    code6(1),
    code5(2),
    code4(3),
    code3(4),
    code2(5),
    code1(6),
    code0(7)
} (SIZE (8))

SYNC-UL-Procedure-r4 ::= SEQUENCE {
    max-SYNC-UL-Transmissions    ENUMERATED { tr1, tr2, tr4, tr8 },
    powerRampStep                INTEGER (0..3)
}

SYNC-UL-Info-r4 ::= SEQUENCE {
    sync-UL-Codes-Bitmap        Sync-UL-Codes-Bitmap,
    -- Actual value prxUpPCHdes = IE value - 120
    prxUpPCHdes                INTEGER (0..62),
    powerRampStep              INTEGER (0..3),
    max-SYNC-UL-Transmissions    ENUMERATED { tr1, tr2, tr4, tr8 },
    mmax                       INTEGER(1..32)
}

SYNC-UL-InfoForE-RUCCH ::= SEQUENCE {
    prxUpPCHdes                INTEGER (0..62)                                OPTIONAL,
    powerRampStep              INTEGER (0..3)                                OPTIONAL,
    max-SYNC-UL-Transmissions    ENUMERATED { tr1, tr2, tr4, tr8 }          OPTIONAL,
    e-RUCCH-Sync-UL-Codes-Bitmap Sync-UL-Codes-Bitmap,
    mmax                       INTEGER(1..32)
}

TargetCellPreconfigInfo ::= SEQUENCE {
    activationTimeOffset        ActivationTimeOffset                                OPTIONAL,
    new-H-RNTI                  H-RNTI,
    newPrimary-E-RNTI           E-RNTI                                OPTIONAL,
    newSecondary-E-RNTI         E-RNTI                                OPTIONAL,
    serving-HSDSCH-CellInformation Serving-HSDSCH-CellInformation-r8,
    e-dch-ReconfigurationInfo    E-DCH-ReconfigurationInfo-r7,
    dtx-drx-TimingInfo          DTX-DRX-TimingInfo-r7                                OPTIONAL,
    dtx-drx-Info                DTX-DRX-Info-r7                                OPTIONAL,
    hs-scch-LessInfo            HS-SCCH-LessInfo-r7                                OPTIONAL,
    mimoParameters              MIMO-Parameters-r8                                OPTIONAL,
    dl-SecondaryCellInfoFDD      DL-SecondaryCellInfoFDD                                OPTIONAL
}

```

```

TargetCellPreconfigInfo-v890ext ::= MIMO-Parameters-v7f0ext

TDD-FPACH-CCode16-r4 ::= ENUMERATED {
    cc16-1, cc16-2, cc16-3, cc16-4,
    cc16-5, cc16-6, cc16-7, cc16-8,
    cc16-9, cc16-10, cc16-11, cc16-12,
    cc16-13, cc16-14, cc16-15, cc16-16 }

TDD-UL-Interference ::= INTEGER (-110..-52)

TDD-PICH-CCode ::= ENUMERATED {
    cc16-1, cc16-2, cc16-3, cc16-4,
    cc16-5, cc16-6, cc16-7, cc16-8,
    cc16-9, cc16-10, cc16-11, cc16-12,
    cc16-13, cc16-14, cc16-15, cc16-16 }

TDD768-PICH-CCode ::= ENUMERATED {
    cc32-1, cc32-2, cc32-3, cc32-4,
    cc32-5, cc32-6, cc32-7, cc32-8,
    cc32-9, cc32-10, cc32-11, cc32-12,
    cc32-13, cc32-14, cc32-15, cc32-16,
    cc32-17, cc32-18, cc32-19, cc32-20,
    cc32-21, cc32-22, cc32-23, cc32-24,
    cc32-25, cc32-26, cc32-27, cc32-28,
    cc32-29, cc32-30, cc32-31, cc32-32 }

TDD-MBSFNInformation ::= SEQUENCE (SIZE (1..maxTS)) OF
    TDD-MBSFNInfo

TDD-MBSFNInfo ::= SEQUENCE {
    timeSlotNumber
        TimeslotNumber,
    cellParametersID
        CellParametersID
}

TDD-PRACH-CCode8 ::= ENUMERATED {
    cc8-1, cc8-2, cc8-3, cc8-4,
    cc8-5, cc8-6, cc8-7, cc8-8 }

TDD-PRACH-CCode16 ::= ENUMERATED {
    cc16-1, cc16-2, cc16-3, cc16-4,
    cc16-5, cc16-6, cc16-7, cc16-8,
    cc16-9, cc16-10, cc16-11, cc16-12,
    cc16-13, cc16-14, cc16-15, cc16-16 }

TDD-PRACH-CCode-PCR-r4 ::= ENUMERATED {
    cc4-1, cc4-2, cc4-3, cc4-4,
    cc8-1, cc8-2, cc8-3, cc8-4,
    cc8-5, cc8-6, cc8-7, cc8-8,
    cc16-1, cc16-2, cc16-3, cc16-4,
    cc16-5, cc16-6, cc16-7, cc16-8,
    cc16-9, cc16-10, cc16-11, cc16-12,
    cc16-13, cc16-14, cc16-15, cc16-16 }

TDD-PRACH-CCodeList ::= CHOICE {
    sf8
        SEQUENCE (SIZE (1..8)) OF
            TDD-PRACH-CCode8,
    -- Channelisation codes cc16-9, cc16-10, cc16-11, cc16-12, cc16-13, cc16-14,
    -- cc16-15 and cc16-16 shall not be used
    sf16
        SEQUENCE (SIZE (1..8)) OF
            TDD-PRACH-CCode16
}

TDD768-PRACH-CCode16 ::= ENUMERATED {
    cc16-1, cc16-2, cc16-3, cc16-4,
    cc16-5, cc16-6, cc16-7, cc16-8,
    cc16-9, cc16-10, cc16-11, cc16-12,
    cc16-13, cc16-14, cc16-15, cc16-16 }

TDD768-PRACH-CCode32 ::= ENUMERATED {
    cc32-1, cc32-2, cc32-3, cc32-4,
    cc32-5, cc32-6, cc32-7, cc32-8,
    cc32-9, cc32-10, cc32-11, cc32-12,
    cc32-13, cc32-14, cc32-15, cc32-16 }

TDD768-PRACH-CCodeList ::= CHOICE {
    sf32
        SEQUENCE (SIZE (1..16)) OF
            TDD768-PRACH-CCode32,
}

```

```

-- Channelisation codes cc32-17, cc32-18, cc32-19, cc32-20, cc32-21, cc32-22,
-- cc32-23, cc32-24, cc32-25, cc32-26, cc32-27, cc32-28, cc32-29, cc32-30, cc32-31
-- and cc32-32 shall not be used
    sf16                                SEQUENCE (SIZE (1..16)) OF
                                        TDD768-PRACH-CCode16
}

TFC-ControlDuration ::=                 ENUMERATED {
                                        tfc-cd1, tfc-cd2, tfc-cd4, tfc-cd8,
                                        tfc-cd16, tfc-cd24, tfc-cd32,
                                        tfc-cd48, tfc-cd64, tfc-cd128,
                                        tfc-cd192, tfc-cd256, tfc-cd512 }

TFCI-Coding ::=                         ENUMERATED {
                                        tfci-bits-4, tfci-bits-8,
                                        tfci-bits-16, tfci-bits-32 }

TGCFN ::=                               INTEGER (0..255)

-- In TGD, value 270 represents "undefined" in the tabular description.
TGD ::=                                 INTEGER (15..270)

TGL ::=                                 INTEGER (1..14)

TGMP ::=                                ENUMERATED {
                                        tdd-Measurement, fdd-Measurement,
                                        gsm-CarrierRSSIMeasurement,
                                        gsm-initialBSICIdentification, gsmBSICReconfirmation,
                                        multi-carrier }

TGMP-r8 ::=                             ENUMERATED {
                                        tdd-Measurement, fdd-Measurement,
                                        gsm-CarrierRSSIMeasurement,
                                        gsm-initialBSICIdentification, gsmBSICReconfirmation,
                                        multi-carrier, e-UTRA, spare }

TGP-Sequence ::=                       SEQUENCE {
    tgpsi                                TGPSI,
    tgps-Status                           CHOICE {
        activate                          SEQUENCE {
            tgcfn                          TGCFN
        },
        deactivate                          NULL
    },
    tgps-ConfigurationParams              TGPS-ConfigurationParams      OPTIONAL
}

TGP-Sequence-r8 ::=                   SEQUENCE {
    tgpsi                                TGPSI,
    tgps-Status                           CHOICE {
        activate                          SEQUENCE {
            tgcfn                          TGCFN
        },
        deactivate                          NULL
    },
    tgps-ConfigurationParams              TGPS-ConfigurationParams-r8  OPTIONAL
}

TGPS-Reconfiguration-CFN ::=          INTEGER (0..255)

TGP-SequenceList ::=                  SEQUENCE (SIZE (1..maxTGPS)) OF
                                        TGP-Sequence

TGP-SequenceList-r8 ::=                SEQUENCE (SIZE (1..maxTGPS)) OF
                                        TGP-Sequence-r8

TGP-SequenceShort ::=                  SEQUENCE {
    tgpsi                                TGPSI,
    tgps-Status                           CHOICE {
        activate                          SEQUENCE {
            tgcfn                          TGCFN
        },
        deactivate                          NULL
    }
}

TGPL ::=                               INTEGER (1..144)

```



```

-- TABULAR: In TGPRC, value 0 represents "infinity" in the tabular description.
TGPRC ::=
    INTEGER (0..511)

TGPS-ConfigurationParams ::=
    SEQUENCE {
        tgmpp
        tgprc
        tgsn
        tgl1
        tgl2
        tgd
        tgpl1
        -- dummy is not used in this version of the specification, it should
        -- not be sent and if received it shall be ignored.
        dummy
        rpp
        itp
        -- TABULAR: Compressed mode method is nested inside UL-DL-Mode
        ul-DL-Mode
        dl-FrameType
        deltaSIR1
        deltaSIRAfter1
        deltaSIR2
        deltaSIRAfter2
        nidentifyAbort
        treconfirmAbort
    }

TGPS-ConfigurationParams-r8 ::=
    SEQUENCE {
        tgmpp
        tgprc
        tgsn
        tgl1
        tgl2
        tgd
        tgpl1
        rpp
        itp
        -- TABULAR: Compressed mode method is nested inside UL-DL-Mode
        ul-DL-Mode
        dl-FrameType
        deltaSIR1
        deltaSIRAfter1
        deltaSIR2
        deltaSIRAfter2
        nidentifyAbort
        treconfirmAbort
    }

TGPSI ::=
    INTEGER (1..maxTGPS)

TGSN ::=
    INTEGER (0..14)

TimeInfo ::=
    SEQUENCE {
        activationTime
        durationTimeInfo
    }

TimeSlotLCR-ext ::=
    ENUMERATED {
        ts7, spare3, spare2, spare1
    }

TimeslotList ::=
    SEQUENCE (SIZE (1..maxTS)) OF
        TimeslotNumber

TimeslotList-r4 ::=
    CHOICE {
        -- the choice for 7.68 Mcps TDD is as for 3.84 Mcps TDD --
        tdd384
            SEQUENCE (SIZE (1..maxTS)) OF
                TimeslotNumber,
        tdd128
            SEQUENCE (SIZE (1..maxTS-LCR)) OF
                TimeslotNumber-LCR-r4
    }

-- If TimeslotNumber is included for a 1.28Mcps TDD description, it shall take values from 0..6
TimeslotNumber ::=
    INTEGER (0..14)

TimeslotNumber-LCR-r4 ::=
    INTEGER (0..6)

TimeslotNumber-PRACH-LCR-r4 ::=
    INTEGER (1..6)

```

```

TimeslotSync2 ::=                INTEGER (0..6)

DTX-DRX-TimingInfo-r7 ::=        SEQUENCE {
    timing                        CHOICE {
        continue                  NULL,
        newTiming                 NewTiming
    }
}

-- Actual value TimingOffset = IE value * 256
TimingOffset ::=                INTEGER (0..149)

TimingMaintainedSynchInd ::=     ENUMERATED { false }

TPC-CombinationIndex ::=         INTEGER (0..5)

TPC-CommandTargetRate ::=        INTEGER (0..10)

-- Actual value TPC-StepSizeFDD = IE value + 1
TPC-StepSizeFDD ::=              INTEGER (0..1)

TPC-StepSizeTDD ::=              INTEGER (1..3)

TransportBlockSizeIndex ::=      INTEGER (1..32)

-- Actual value TreconfirmAbort = IE value * 0.5 seconds
TreconfirmAbort ::=              INTEGER (1..20)

TX-DiversityMode ::=             ENUMERATED {
    noDiversity,
    sttd,
    closedLoopModel1,
    -- dummy is not used in this version of the specification, it should
    -- not be sent and if received it should be ignored.
    dummy }

UARFCN ::=                       INTEGER (0..16383)

UCSM-Info ::=                    SEQUENCE {
    minimumSpreadingFactor        MinimumSpreadingFactor,
    nf-Max                        NF-Max,
    channelReqParamsForUCSM       ChannelReqParamsForUCSM
}

UE-DPCCH-Burst ::=               ENUMERATED {
    sub-frames-1,
    sub-frames-2,
    sub-frames-5,
    spare1 }

UE-DRX-Cycle ::=                 ENUMERATED {
    sub-frames-4,
    sub-frames-5,
    sub-frames-8,
    sub-frames-10,
    sub-frames-16,
    sub-frames-20,
    spare2,
    spare1 }

UE-DTX-Cycle1-10ms ::=           ENUMERATED {
    sub-frames-1,
    sub-frames-5,
    sub-frames-10,
    sub-frames-20 }

UE-DTX-Cycle1-2ms ::=            ENUMERATED {
    sub-frames-1,
    sub-frames-4,
    sub-frames-5,
    sub-frames-8,
    sub-frames-10,
    sub-frames-16,
    sub-frames-20,
    spare1 }

UE-DTX-Cycle2-10ms ::=           ENUMERATED {
    sub-frames-5,

```

```

sub-frames-10,
sub-frames-20,
sub-frames-40,
sub-frames-80,
sub-frames-160,
spare2,
spare1 }

UE-DTX-Cycle2-2ms ::= ENUMERATED {
sub-frames-4,
sub-frames-5,
sub-frames-8,
sub-frames-10,
sub-frames-16,
sub-frames-20,
sub-frames-32,
sub-frames-40,
sub-frames-64,
sub-frames-80,
sub-frames-128,
sub-frames-160,
spare4,
spare3,
spare2,
spare1 }

UE-DTX-Cycle2InactivityThreshold ::= ENUMERATED {
e-dch-tti-1,
e-dch-tti-4,
e-dch-tti-8,
e-dch-tti-16,
e-dch-tti-32,
e-dch-tti-64,
e-dch-tti-128,
e-dch-tti-256,
spare8,
spare7,
spare6,
spare5,
spare4,
spare3,
spare2,
spare1 }

UE-DTX-long-preamble-length ::= ENUMERATED {
slots-4,
slots-15 }

UE-DTX-DRX-Offset ::= INTEGER (0..159)

UE-GrantMonitoring-InactivityThreshold ::= ENUMERATED {
e-dch-tti-0,
e-dch-tti-1,
e-dch-tti-2,
e-dch-tti-4,
e-dch-tti-8,
e-dch-tti-16,
e-dch-tti-32,
e-dch-tti-64,
e-dch-tti-128,
e-dch-tti-256,
spare6,
spare5,
spare4,
spare3,
spare2,
spare1 }

UL-16QAM-Config ::= SEQUENCE {
ul-16QAM-Settings UL-16QAM-Settings OPTIONAL,
e-TFCI-TableIndex E-TFCI-TableIndex OPTIONAL,
mac-es-e-resetIndicator ENUMERATED { true } OPTIONAL
}

UL-16QAM-Settings ::= SEQUENCE {
beta-EG-Gain-E-AGCH-Table-Selection INTEGER (0..1)
}

```

```

UL-CCTrCH ::=
    tfcs-ID
    ul-TargetSIR
    timeInfo
    commonTimeslotInfo
    ul-CCTrCH-TimeslotsCodes
}
SEQUENCE {
    TFCS-IdentityPlain
    UL-TargetSIR,
    TimeInfo,
    CommonTimeslotInfo
    UplinkTimeslotsCodes
}
DEFAULT 1,
OPTIONAL,
OPTIONAL

UL-CCTrCH-r4 ::=
    tfcs-ID
    -- The IE ul-TargetSIR corresponds to PRX-DPCHdes for 1.28Mcps TDD
    -- Actual value PRX-DPCHdes = (value of IE "ul-TargetSIR" - 120)
    ul-TargetSIR
    timeInfo
    commonTimeslotInfo
    tddOption
    tdd384
        ul-CCTrCH-TimeslotsCodes
    },
    tdd128
        ul-CCTrCH-TimeslotsCodes
}
SEQUENCE {
    TFCS-IdentityPlain
    UL-TargetSIR,
    TimeInfo,
    CommonTimeslotInfo
    CHOICE {
        SEQUENCE {
            UplinkTimeslotsCodes
        }
        SEQUENCE {
            UplinkTimeslotsCodes-LCR-r4
        }
    }
}
DEFAULT 1,
OPTIONAL,
OPTIONAL

UL-CCTrCH-r7 ::=
    tfcs-ID
    -- The IE ul-TargetSIR corresponds to PRX-DPCHdes for 1.28Mcps TDD
    -- Actual value PRX-DPCHdes = (value of IE "ul-TargetSIR" - 120)
    ul-TargetSIR
    timeInfo
    commonTimeslotInfo
    tddOption
    tdd384
        ul-CCTrCH-TimeslotsCodes
    },
    tdd768
        ul-CCTrCH-TimeslotsCodes
    },
    tdd128
        ul-CCTrCH-TimeslotsCodes
}
SEQUENCE {
    TFCS-IdentityPlain
    UL-TargetSIR,
    TimeInfo,
    CommonTimeslotInfo
    CHOICE {
        SEQUENCE {
            UplinkTimeslotsCodes
        }
        SEQUENCE {
            UplinkTimeslotsCodes-VHCR
        }
        SEQUENCE {
            UplinkTimeslotsCodes-LCR-r7
        }
    }
}
DEFAULT 1,
OPTIONAL,
OPTIONAL

UL-CCTrCHList ::=
    SEQUENCE (SIZE (1..maxCCTrCH)) OF
        UL-CCTrCH

UL-CCTrCHList-r4 ::=
    SEQUENCE (SIZE (1..maxCCTrCH)) OF
        UL-CCTrCH-r4

UL-CCTrCHList-r7 ::=
    SEQUENCE (SIZE (1..maxCCTrCH)) OF
        UL-CCTrCH-r7

UL-CCTrCHListToRemove ::=
    SEQUENCE (SIZE (1..maxCCTrCH)) OF
        TFCS-IdentityPlain

UL-CCTrChTPCList ::=
    SEQUENCE (SIZE (0..maxCCTrCH)) OF
        TFCS-Identity

UL-ChannelRequirement ::=
    ul-DPCH-Info
    -- dummy is not used in this version of the specification, it should
    -- not be sent and if received the UE behaviour is not specified.
    dummy
}
CHOICE {
    UL-DPCH-Info,
    CPCH-SetInfo
}

UL-ChannelRequirement-r4 ::=
    ul-DPCH-Info
    -- dummy is not used in this version of the specification, it should
    -- not be sent and if received the UE behaviour is not specified.
    dummy
}
CHOICE {
    UL-DPCH-Info-r4,
    CPCH-SetInfo
}

UL-ChannelRequirement-r5 ::=
    ul-DPCH-Info
    -- dummy is not used in this version of the specification, it should
    -- not be sent and if received the UE behaviour is not specified.
}
CHOICE {
    UL-DPCH-Info-r5,
}

```

```

    dummy                CPCH-SetInfo
}

-- Note: the reference to CPCH in the element name below is incorrect. The name is not
-- changed to keep it aligned with R99.
UL-ChannelRequirementWithCPCH-SetID ::= CHOICE {
    ul-DPCH-Info          UL-DPCH-Info,
    -- dummy1 and dummy 2 are not used in this version of the specification, they should
    -- not be sent and if received the UE behaviour is not specified.
    dummy1                CPCH-SetInfo,
    dummy2                CPCH-SetID
}

-- Note: the reference to CPCH in the element name below is incorrect. The name is not
-- changed to keep it aligned with R99.
UL-ChannelRequirementWithCPCH-SetID-r4 ::= CHOICE {
    ul-DPCH-Info          UL-DPCH-Info-r4,
    -- dummy1 and dummy2 are not used in this version of the specification, they
    -- should not be sent and if received the UE behaviour is not specified.
    dummy1                CPCH-SetInfo,
    dummy2                CPCH-SetID
}

-- Note: the reference to CPCH in the element name below is incorrect. The name is not
-- changed to keep it aligned with R99.
UL-ChannelRequirementWithCPCH-SetID-r5 ::= CHOICE {
    ul-DPCH-Info          UL-DPCH-Info-r5,
    -- dummy1 and dummy2 are not used in this version of the specification, they should
    -- not be sent and if received the UE behaviour is not specified.
    dummy1                CPCH-SetInfo,
    dummy2                CPCH-SetID
}

UL-CompressedModeMethod ::= ENUMERATED {
    sf-2,
    higherLayerScheduling }

UL-DL-Mode ::= CHOICE {
    ul                    UL-CompressedModeMethod,
    dl                    DL-CompressedModeMethod,
    ul-and-dl             SEQUENCE {
        ul                UL-CompressedModeMethod,
        dl                DL-CompressedModeMethod
    }
}

UL-DPCH-SlotFormat ::= ENUMERATED {
    slf0, slf1, slf2 }

UL-DPCH-CodeInfoForCommonEDCH ::= SEQUENCE {
    ul-DPCHscramblingCodeType ScramblingCodeType,
    ul-DPCHscramblingCode     UL-ScramblingCode OPTIONAL
}

UL-DPCH-Info ::= SEQUENCE {
    ul-DPCH-PowerControlInfo UL-DPCH-PowerControlInfo OPTIONAL,
    modeSpecificInfo         CHOICE {
        fdd                  SEQUENCE {
            scramblingCodeType ScramblingCodeType,
            scramblingCode     UL-ScramblingCode,
            numberOfDPDCH      NumberOfDPDCH DEFAULT 1,
            spreadingFactor    SpreadingFactor,
            tfci-Existence     BOOLEAN,
            -- numberOfFBI-Bits is conditional based on history
            numberOfFBI-Bits   NumberOfFBI-Bits OPTIONAL,
            puncturingLimit    PuncturingLimit
        },
        tdd                  SEQUENCE {
            ul-TimingAdvance   UL-TimingAdvanceControl OPTIONAL,
            ul-CCTrCHList      UL-CCTrCHList OPTIONAL,
            ul-CCTrCHListToRemove UL-CCTrCHListToRemove OPTIONAL
        }
    }
}

UL-DPCH-Info-r4 ::= SEQUENCE {
    ul-DPCH-PowerControlInfo UL-DPCH-PowerControlInfo-r4 OPTIONAL,
    modeSpecificInfo         CHOICE {
        fdd                  SEQUENCE {

```

```

        scramblingCodeType          ScramblingCodeType,
        scramblingCode              UL-ScramblingCode,
        numberOfDPDCH               NumberOfDPDCH                DEFAULT 1,
        spreadingFactor             SpreadingFactor,
        tfci-Existence              BOOLEAN,
        -- numberOfFBI-Bits is conditional based on history
        numberOfFBI-Bits            NumberOfFBI-Bits                OPTIONAL,
        puncturingLimit             PuncturingLimit
    },
    tdd                             SEQUENCE {
        ul-TimingAdvance            UL-TimingAdvanceControl-r4    OPTIONAL,
        ul-CCTrCHList               UL-CCTrCHList-r4        OPTIONAL,
        ul-CCTrCHListToRemove       UL-CCTrCHListToRemove    OPTIONAL
    }
}

UL-DPCH-Info-r5 ::=
    ul-DPCH-PowerControlInfo        SEQUENCE {
    modeSpecificInfo                 UL-DPCH-PowerControlInfo-r5    OPTIONAL,
    fdd                              CHOICE {
        scramblingCodeType          ScramblingCodeType,
        scramblingCode              UL-ScramblingCode,
        numberOfDPDCH               NumberOfDPDCH                DEFAULT 1,
        spreadingFactor             SpreadingFactor,
        tfci-Existence              BOOLEAN,
        -- numberOfFBI-Bits is conditional based on history
        numberOfFBI-Bits            NumberOfFBI-Bits                OPTIONAL,
        puncturingLimit             PuncturingLimit
    },
    tdd                             SEQUENCE {
        ul-TimingAdvance            UL-TimingAdvanceControl-r4    OPTIONAL,
        ul-CCTrCHList               UL-CCTrCHList-r4        OPTIONAL,
        ul-CCTrCHListToRemove       UL-CCTrCHListToRemove    OPTIONAL
    }
}

UL-DPCH-Info-r6 ::=
    ul-DPCH-PowerControlInfo        SEQUENCE {
    modeSpecificInfo                 UL-DPCH-PowerControlInfo-r6    OPTIONAL,
    fdd                              CHOICE {
        scramblingCodeType          ScramblingCodeType,
        scramblingCode              UL-ScramblingCode,
        dpdchPresence               CHOICE {
            present                 SEQUENCE {
                numberOfDPDCH       NumberOfDPDCH                DEFAULT 1,
                spreadingFactor     SpreadingFactor,
                tfci-Existence      BOOLEAN,
                -- numberOfFBI-Bits is conditional based on history
                numberOfFBI-Bits    NumberOfFBI-Bits                OPTIONAL,
                puncturingLimit     PuncturingLimit
            },
            notPresent              SEQUENCE {
                tfci-Existence      BOOLEAN,
                -- numberOfFBI-Bits is conditional based on history
                numberOfFBI-Bits    NumberOfFBI-Bits                OPTIONAL
            }
        }
    },
    tdd                             SEQUENCE {
        ul-TimingAdvance            UL-TimingAdvanceControl-r4    OPTIONAL,
        ul-CCTrCHList               UL-CCTrCHList-r4        OPTIONAL,
        ul-CCTrCHListToRemove       UL-CCTrCHListToRemove    OPTIONAL
    }
}

UL-DPCH-Info-r7 ::=
    ul-DPCH-PowerControlInfo        SEQUENCE {
    modeSpecificInfo                 UL-DPCH-PowerControlInfo-r7    OPTIONAL,
    fdd                              CHOICE {
        scramblingCodeType          ScramblingCodeType,
        scramblingCode              UL-ScramblingCode,
        dpdchPresence               CHOICE {
            present                 SEQUENCE {
                numberOfDPDCH       NumberOfDPDCH                DEFAULT 1,
                spreadingFactor     SpreadingFactor,

```

```

        tfci-Existence                BOOLEAN,
        -- numberOfFBI-Bits is conditional based on history
        numberOfFBI-Bits                NumberOfFBI-Bits                OPTIONAL,
        numberOfTPC-Bits                NumberOfTPC-Bits                OPTIONAL,
        puncturingLimit                PuncturingLimit
    },
    notPresent                          SEQUENCE {
        tfci-Existence                BOOLEAN,
        -- numberOfFBI-Bits is conditional based on history
        numberOfFBI-Bits                NumberOfFBI-Bits                OPTIONAL,
        numberOfTPC-Bits                NumberOfTPC-Bits                OPTIONAL
    }
},
tdd                                     SEQUENCE {
    ul-TimingAdvance                  UL-TimingAdvanceControl-r7    OPTIONAL,
    ul-CCTrCHList                     UL-CCTrCHList-r7            OPTIONAL,
    ul-CCTrCHListToRemove              UL-CCTrCHListToRemove      OPTIONAL
}
}
}

UL-DPCH-InfoPostFDD ::=                SEQUENCE {
    ul-DPCH-PowerControlInfo          UL-DPCH-PowerControlInfoPostFDD,
    scramblingCodeType                ScramblingCodeType,
    reducedScramblingCodeNumber        ReducedScramblingCodeNumber,
    spreadingFactor                    SpreadingFactor
}

UL-DPCH-InfoPostTDD ::=                SEQUENCE {
    ul-DPCH-PowerControlInfo          UL-DPCH-PowerControlInfoPostTDD,
    ul-TimingAdvance                  UL-TimingAdvanceControl      OPTIONAL,
    ul-CCTrCH-TimeslotsCodes          UplinkTimeslotsCodes
}

UL-DPCH-InfoPostTDD-LCR-r4 ::=         SEQUENCE {
    ul-DPCH-PowerControlInfo          UL-DPCH-PowerControlInfoPostTDD-LCR-r4,
    ul-TimingAdvance                  UL-TimingAdvanceControl-LCR-r4    OPTIONAL,
    ul-CCTrCH-TimeslotsCodes          UplinkTimeslotsCodes-LCR-r4
}

UL-DPCH-InfoPredef ::=                SEQUENCE {
    ul-DPCH-PowerControlInfo          UL-DPCH-PowerControlInfoPredef,
    modeSpecificInfo                  CHOICE {
        fdd                            SEQUENCE {
            tfci-Existence              BOOLEAN,
            puncturingLimit              PuncturingLimit
        },
        tdd                            SEQUENCE {
            commonTimeslotInfo          CommonTimeslotInfo
        }
    }
}

UL-DPCH-InfoPredef-v770ext ::=         SEQUENCE {
    modeSpecificInfo                  CHOICE {
        fdd                            SEQUENCE {
            numberOfTPC-Bits            NumberOfTPC-Bits                OPTIONAL
        },
        tdd                            NULL
    }
}

UL-DPCH-PowerControlInfo ::=           CHOICE {
    fdd                                SEQUENCE {
        dpccch-PowerOffset              DPCCCH-PowerOffset,
        pc-Preamble                     PC-Preamble,
        srb-delay                       SRB-delay,
        -- TABULAR: TPC step size nested inside PowerControlAlgorithm
        powerControlAlgorithm            PowerControlAlgorithm
    },
    tdd                                SEQUENCE {
        ul-TargetSIR                    UL-TargetSIR                    OPTIONAL,
        ul-OL-PC-Signalling              CHOICE {
            broadcast-UL-OL-PC-info      NULL,
            individuallySignalled        SEQUENCE {
                individualTS-InterferenceList IndividualTS-InterferenceList,
                dpch-ConstantValue       ConstantValueTdd,
            }
        }
    }
}

```

```

    primaryCCPCH-TX-Power                    PrimaryCCPCH-TX-Power
  }
}
}
}
OPTIONAL

UL-DPCH-PowerControlInfo-r4 ::= CHOICE {
  fdd                                       SEQUENCE {
    dpcch-PowerOffset                      DPCCCH-PowerOffset,
    pc-Preamble                            PC-Preamble,
    srb-delay                              SRB-delay,
    -- TABULAR: TPC step size nested inside PowerControlAlgorithm
    powerControlAlgorithm                  PowerControlAlgorithm
  },
  tdd                                       SEQUENCE {
    -- The IE ul-TargetSIR corresponds to PRX-DPCHdes for 1.28Mcps TDD
    -- Actual value PRX-DPCHdes = (value of IE "ul-TargetSIR" - 120)
    ul-TargetSIR                          UL-TargetSIR OPTIONAL,
    ul-OL-PC-Signalling                    CHOICE {
      broadcast-UL-OL-PC-info              NULL,
      individuallySignalled                SEQUENCE {
        tddOption                          CHOICE {
          tdd384                            SEQUENCE {
            individualTS-InterferenceList  IndividualTS-InterferenceList,
            dpch-ConstantValue             ConstantValue
          },
          tdd128                            SEQUENCE {
            tpc-StepSize                    TPC-StepSizeTDD
          }
        }
      },
      primaryCCPCH-TX-Power                PrimaryCCPCH-TX-Power
    }
  }
}
}
}

UL-DPCH-PowerControlInfo-r5 ::= CHOICE {
  fdd                                       SEQUENCE {
    dpcch-PowerOffset                      DPCCCH-PowerOffset,
    pc-Preamble                            PC-Preamble,
    srb-delay                              SRB-delay,
    -- TABULAR: TPC step size nested inside PowerControlAlgorithm
    powerControlAlgorithm                  PowerControlAlgorithm,
    deltaACK                               DeltaACK OPTIONAL,
    deltaNACK                              DeltaNACK OPTIONAL,
    ack-NACK-repetition-factor             ACK-NACK-repetitionFactor OPTIONAL
  },
  tdd                                       SEQUENCE {
    -- The IE ul-TargetSIR corresponds to PRX-DPCHdes for 1.28Mcps TDD
    -- Actual value PRX-DPCHdes = (value of IE "ul-TargetSIR" - 120)
    ul-TargetSIR                          UL-TargetSIR OPTIONAL,
    ul-OL-PC-Signalling                    CHOICE {
      broadcast-UL-OL-PC-info              NULL,
      individuallySignalled                SEQUENCE {
        tddOption                          CHOICE {
          tdd384                            SEQUENCE {
            individualTS-InterferenceList  IndividualTS-InterferenceList,
            dpch-ConstantValue             ConstantValue
          },
          tdd128                            SEQUENCE {
            tpc-StepSize                    TPC-StepSizeTDD
          }
        }
      },
      primaryCCPCH-TX-Power                PrimaryCCPCH-TX-Power
    }
  }
}
}
}

UL-DPCH-PowerControlInfo-r6 ::= CHOICE {
  fdd                                       SEQUENCE {
    dpcch-PowerOffset                      DPCCCH-PowerOffset,
    pc-Preamble                            PC-Preamble,
    srb-delay                              SRB-delay,
    -- TABULAR: TPC step size nested inside PowerControlAlgorithm
    powerControlAlgorithm                  PowerControlAlgorithm,
    deltaACK                               DeltaACK OPTIONAL,
    deltaNACK                              DeltaNACK OPTIONAL,

```



```

        ack-NACK-repetition-factor      ACK-NACK-repetitionFactor  OPTIONAL,
        harq-Preamble-Mode              HARQ-Preamble-Mode
    },
    tdd                                  SEQUENCE {
        -- The IE ul-TargetSIR corresponds to PRX-DPCHdes for 1.28Mcps TDD
        -- Actual value PRX-DPCHdes = (value of IE "ul-TargetSIR" - 120)
        ul-TargetSIR                    UL-TargetSIR                OPTIONAL,
        ul-OL-PC-Signalling              CHOICE {
            broadcast-UL-OL-PC-info      NULL,
            individuallySignalled        SEQUENCE {
                tddOption                CHOICE {
                    tdd384                SEQUENCE {
                        individualTS-InterferenceList  IndividualTS-InterferenceList,
                        dpch-ConstantValue            ConstantValue
                    },
                    tdd128                SEQUENCE {
                        beaconPLEst          BEACON-PL-Est          OPTIONAL,
                        tpc-StepSize        TPC-StepSizeTDD
                    }
                }
            },
            primaryCCPCH-TX-Power        PrimaryCCPCH-TX-Power
        }
    }
}

UL-DPCH-PowerControlInfo-r7 ::= CHOICE {
    fdd                                  SEQUENCE {
        dpch-PowerOffset                DPCCH-PowerOffset,
        pc-Preamble                      PC-Preamble,
        srb-delay                        SRB-delay,
        -- TABULAR: TPC step size nested inside PowerControlAlgorithm
        powerControlAlgorithm            PowerControlAlgorithm,
        deltaACK                         DeltaACK          OPTIONAL,
        deltaNACK                        DeltaNACK        OPTIONAL,
        ack-NACK-repetition-factor        ACK-NACK-repetitionFactor  OPTIONAL,
        harq-Preamble-Mode              HARQ-Preamble-Mode
    },
    tdd                                  SEQUENCE {
        -- The IE ul-TargetSIR corresponds to PRX-DPCHdes for 1.28Mcps TDD
        -- Actual value PRX-DPCHdes = (value of IE "ul-TargetSIR" - 120)
        ul-TargetSIR                    UL-TargetSIR                OPTIONAL,
        ul-OL-PC-Signalling              CHOICE {
            broadcast-UL-OL-PC-info      NULL,
            individuallySignalled        SEQUENCE {
                tddOption                CHOICE {
                    tdd384                SEQUENCE {
                        individualTS-InterferenceList  IndividualTS-InterferenceList,
                        dpch-ConstantValue            ConstantValue
                    },
                    tdd768                SEQUENCE {
                        individualTS-InterferenceList  IndividualTS-InterferenceList,
                        dpch-ConstantValue            ConstantValue
                    },
                    tdd128                SEQUENCE {
                        beaconPLEst          BEACON-PL-Est          OPTIONAL,
                        tpc-StepSize        TPC-StepSizeTDD
                    }
                }
            },
            primaryCCPCH-TX-Power        PrimaryCCPCH-TX-Power
        }
    }
}

UL-DPCHpowerControlInfoForCommonEDCH ::= SEQUENCE {
    -- TABULAR: TPC step size nested inside PowerControlAlgorithm
    powerControlAlgorithm            PowerControlAlgorithm,
    deltaACK                         DeltaACK          OPTIONAL,
    deltaNACK                        DeltaNACK        OPTIONAL,
    ack-NACK-repetition-factor        ACK-NACK-repetitionFactor  OPTIONAL
}

UL-DPCH-PowerControlInfoPostFDD ::= SEQUENCE {
    -- DPCCH-PowerOffset2 has a smaller range to save bits
    dpch-PowerOffset                DPCCH-PowerOffset2,
    pc-Preamble                      PC-Preamble,
    srb-delay                        SRB-delay
}

```

```

}

UL-DPCH-PowerControlInfoPostTDD ::= SEQUENCE {
    ul-TargetSIR                UL-TargetSIR,
    ul-TimeslotInterference     TDD-UL-Interference
}

UL-DPCH-PowerControlInfoPostTDD-LCR-r4 ::= SEQUENCE {
    -- The IE ul-TargetSIR corresponds to PRX-DPCHdes for 1.28Mcps TDD
    -- Actual value PRX-DPCHdes = (value of IE "ul-TargetSIR" - 120)
    ul-TargetSIR                UL-TargetSIR
}

UL-DPCH-PowerControlInfoPredef ::= CHOICE {
    fdd                          SEQUENCE {
        -- TABULAR: TPC step size nested inside PowerControlAlgorithm
        powerControlAlgorithm    PowerControlAlgorithm
    },
    tdd                          SEQUENCE {
        -- dpch-ConstantValue shall be ignored if in 1.28Mcps TDD mode.
        dpch-ConstantValue       ConstantValueTdd
    }
}

UL-EDCH-Information-ext ::= CHOICE {
    fdd                          NULL,
    tdd                          SEQUENCE {
        non-ScheduledTransGrantInfo    Non-ScheduledTransGrantInfoTDD-ext    OPTIONAL
    }
}

UL-EDCH-Information-r6 ::= SEQUENCE {
    mac-es-e-resetIndicator       ENUMERATED { true }                OPTIONAL,
    e-DPCCH-Info                 E-DPCCH-Info                OPTIONAL,
    e-DPDCH-Info                 E-DPDCH-Info                OPTIONAL,
    schedulingTransmConfiguration E-DPDCH-SchedulingTransmConfiguration    OPTIONAL
}

UL-EDCH-Information-r7 ::= SEQUENCE {
    mac-es-e-resetIndicator       ENUMERATED { true }                OPTIONAL,
    modeSpecificInfo             CHOICE {
        fdd                      SEQUENCE {
            e-DPCCH-Info         E-DPCCH-Info-r7                OPTIONAL,
            e-DPDCH-Info         E-DPDCH-Info-r7                OPTIONAL,
            schedulingTransmConfiguration    E-DPDCH-SchedulingTransmConfiguration    OPTIONAL,
            ul-16QAM-Settings    UL-16QAM-Settings                OPTIONAL
        },
        tdd                      SEQUENCE {
            e-RUCCH-Info         E-RUCCH-Info                OPTIONAL,
            e-PUCH-Info         E-PUCH-Info                OPTIONAL,
            non-ScheduledTransGrantInfo    Non-ScheduledTransGrantInfoTDD    OPTIONAL
        }
    }
}

UL-EDCH-Information-r8 ::= SEQUENCE {
    mac-es-e-resetIndicator       ENUMERATED { true }                OPTIONAL,
    modeSpecificInfo             CHOICE {
        fdd                      SEQUENCE {
            e-DPCCH-Info         E-DPCCH-Info-r7                OPTIONAL,
            e-DPDCH-Info         E-DPDCH-Info-r8                OPTIONAL,
            schedulingTransmConfiguration    E-DPDCH-SchedulingTransmConfiguration    OPTIONAL,
            ul-16QAM-Settings    UL-16QAM-Settings                OPTIONAL
        },
        tdd                      SEQUENCE {
            e-RUCCH-Info         E-RUCCH-Info                OPTIONAL,
            e-PUCH-Info         E-PUCH-Info                OPTIONAL,
            non-ScheduledTransGrantInfo    Non-ScheduledTransGrantInfoTDD    OPTIONAL
        }
    }
}

UL-Interference ::= INTEGER (-110..-70)

UL-ScramblingCode ::= INTEGER (0..16777215)

```

```

UL-SynchronisationParameters-r4 ::= SEQUENCE {
    stepSize          INTEGER (1..8),
    frequency         INTEGER (1..8)
}

-- Actual value UL-TargetSIR = (IE value * 0.5) - 11
UL-TargetSIR ::= INTEGER (0..62)

UL-TimingAdvance ::= INTEGER (0..63)

UL-TimingAdvanceControl ::= CHOICE {
    disabled          NULL,
    enabled           SEQUENCE {
        ul-TimingAdvance          UL-TimingAdvance          OPTIONAL,
        activationTime             ActivationTime             OPTIONAL
    }
}

UL-TimingAdvanceControl-r4 ::= CHOICE {
    disabled          NULL,
    enabled           SEQUENCE {
        tddOption      CHOICE {
            tdd384     SEQUENCE {
                ul-TimingAdvance          UL-TimingAdvance          OPTIONAL,
                activationTime             ActivationTime             OPTIONAL
            },
            tdd128     SEQUENCE {
                ul-SynchronisationParameters          UL-SynchronisationParameters-r4 OPTIONAL,
                synchronisationParameters             SynchronisationParameters-r4 OPTIONAL
            }
        }
    }
}

UL-TimingAdvanceControl-r7 ::= CHOICE {
    disabled          NULL,
    enabled           SEQUENCE {
        tddOption      CHOICE {
            tdd384     SEQUENCE {
                ul-TimingAdvance          UL-TimingAdvance          OPTIONAL,
                ext-UL-TimingAdvance      EXT-UL-TimingAdvance      OPTIONAL,
                activationTime             ActivationTime             OPTIONAL
            },
            tdd768     SEQUENCE {
                ext-UL-TimingAdvance      EXT-UL-TimingAdvance      OPTIONAL,
                activationTime             ActivationTime             OPTIONAL
            },
            tdd128     SEQUENCE {
                ul-SynchronisationParameters          UL-SynchronisationParameters-r4 OPTIONAL,
                synchronisationParameters             SynchronisationParameters-r4 OPTIONAL
            }
        }
    }
}

UL-TimingAdvanceControl-LCR-r4 ::= CHOICE {
    disabled          NULL,
    enabled           SEQUENCE {
        ul-SynchronisationParameters          UL-SynchronisationParameters-r4 OPTIONAL,
        synchronisationParameters             SynchronisationParameters-r4 OPTIONAL
    }
}

UL-TS-ChannelisationCode ::= ENUMERATED {
    cc1-1, cc2-1, cc2-2,
    cc4-1, cc4-2, cc4-3, cc4-4,
    cc8-1, cc8-2, cc8-3, cc8-4,
    cc8-5, cc8-6, cc8-7, cc8-8,
    cc16-1, cc16-2, cc16-3, cc16-4,
    cc16-5, cc16-6, cc16-7, cc16-8,
    cc16-9, cc16-10, cc16-11, cc16-12,
    cc16-13, cc16-14, cc16-15, cc16-16 }

UL-TS-ChannelisationCodeList ::= SEQUENCE (SIZE (1..2)) OF
    UL-TS-ChannelisationCode

UL-TS-ChannelisationCodeList-r7 ::= SEQUENCE (SIZE (1..2)) OF
    SEQUENCE {

```

```

        ul-TS-Channelisation-Code
        plcch-info
    }

UL-TS-ChannelisationCode-VHCR ::=
    ENUMERATED {
        cc1-1, cc2-1, cc2-2,
        cc4-1, cc4-2, cc4-3, cc4-4,
        cc8-1, cc8-2, cc8-3, cc8-4,
        cc8-5, cc8-6, cc8-7, cc8-8,
        cc16-1, cc16-2, cc16-3, cc16-4,
        cc16-5, cc16-6, cc16-7, cc16-8,
        cc16-9, cc16-10, cc16-11, cc16-12,
        cc16-13, cc16-14, cc16-15, cc16-16,
        cc32-1, cc32-2, cc32-3, cc32-4,
        cc32-5, cc32-6, cc32-7, cc32-8,
        cc32-9, cc32-10, cc32-11, cc32-12,
        cc32-13, cc32-14, cc32-15, cc32-16,
        cc32-17, cc32-18, cc32-19, cc32-20,
        cc32-21, cc32-22, cc32-23, cc32-24,
        cc32-25, cc32-26, cc32-27, cc32-28,
        cc32-29, cc32-30, cc32-31, cc32-32 }

UL-TS-ChannelisationCodeList-VHCR ::= SEQUENCE (SIZE (1..2)) OF
    UL-TS-ChannelisationCode-VHCR

Uplink-DPCCH-Slot-Format-Information ::= ENUMERATED {
    slot-format-1,
    -- dummy is not used in this version of
    -- specification, it should not be sent and if
    -- received it should be ignored.
    dummy,
    slot-format-4,
    spare1 }

UplinkAdditionalTimeslots ::= SEQUENCE {
    parameters CHOICE {
        sameAsLast SEQUENCE {
            timeslotNumber TimeslotNumber
        },
        newParameters SEQUENCE {
            individualTimeslotInfo IndividualTimeslotInfo,
            ul-TS-ChannelisationCodeList UL-TS-ChannelisationCodeList
        }
    }
}

UplinkAdditionalTimeslots-LCR-r4 ::= SEQUENCE {
    parameters CHOICE {
        sameAsLast SEQUENCE {
            timeslotNumber TimeslotNumber
        },
        newParameters SEQUENCE {
            individualTimeslotInfo IndividualTimeslotInfo-LCR-r4,
            ul-TS-ChannelisationCodeList UL-TS-ChannelisationCodeList
        }
    }
}

UplinkAdditionalTimeslots-LCR-r7 ::= SEQUENCE {
    parameters CHOICE {
        sameAsLast SEQUENCE {
            timeslotNumber TimeslotNumber
            -- plcch-info assigned as previously defined slot
        },
        newParameters SEQUENCE {
            individualTimeslotInfo IndividualTimeslotInfo-LCR-r4,
            ul-TS-ChannelisationCodeList UL-TS-ChannelisationCodeList-r7
        }
    }
}

UplinkAdditionalTimeslots-VHCR ::= SEQUENCE {
    parameters CHOICE {
        sameAsLast SEQUENCE {
            timeslotNumber TimeslotNumber
        },
        newParameters SEQUENCE {
            individualTimeslotInfo IndividualTimeslotInfo-VHCR,

```

```

        ul-TS-ChannelisationCodeList      UL-TS-ChannelisationCodeList
    }
}

UplinkTimeslotsCodes ::=                SEQUENCE {
    dynamicSFusage                        BOOLEAN,
    firstIndividualTimeslotInfo           IndividualTimeslotInfo,
    ul-TS-ChannelisationCodeList          UL-TS-ChannelisationCodeList,
    moreTimeslots                          CHOICE {
        noMore                             NULL,
        additionalTimeslots                 CHOICE {
            consecutive                     SEQUENCE {
                numAdditionalTimeslots      INTEGER (1..maxTS-1)
            },
            timeslotList                    SEQUENCE (SIZE (1..maxTS-1)) OF
                UplinkAdditionalTimeslots
        }
    }
}

UplinkTimeslotsCodes-VHCR ::=           SEQUENCE {
    dynamicSFusage                        BOOLEAN,
    firstIndividualTimeslotInfo           IndividualTimeslotInfo-VHCR,
    ul-TS-ChannelisationCodeList          UL-TS-ChannelisationCodeList-VHCR,
    moreTimeslots                          CHOICE {
        noMore                             NULL,
        additionalTimeslots                 CHOICE {
            consecutive                     SEQUENCE {
                numAdditionalTimeslots      INTEGER (1..maxTS-1)
            },
            timeslotList                    SEQUENCE (SIZE (1..maxTS-1)) OF
                UplinkAdditionalTimeslots-VHCR
        }
    }
}

UplinkTimeslotsCodes-LCR-r4 ::=         SEQUENCE {
    dynamicSFusage                        BOOLEAN,
    firstIndividualTimeslotInfo           IndividualTimeslotInfo-LCR-r4,
    ul-TS-ChannelisationCodeList          UL-TS-ChannelisationCodeList,
    moreTimeslots                          CHOICE {
        noMore                             NULL,
        additionalTimeslots                 CHOICE {
            consecutive                     SEQUENCE {
                numAdditionalTimeslots      INTEGER (1..maxTS-LCR-1)
            },
            timeslotList                    SEQUENCE (SIZE (1..maxTS-LCR-1)) OF
                UplinkAdditionalTimeslots-LCR-r4
        }
    }
}

UplinkTimeslotsCodes-LCR-r7 ::=         SEQUENCE {
    dynamicSFusage                        BOOLEAN,
    firstIndividualTimeslotInfo           IndividualTimeslotInfo-LCR-r4,
    ul-TS-ChannelisationCodeList          UL-TS-ChannelisationCodeList-r7,
    moreTimeslots                          CHOICE {
        noMore                             NULL,
        additionalTimeslots                 CHOICE {
            consecutive                     SEQUENCE {
                -- the choice of 'consecutive' is not needed because there is only 1 option.
                numAdditionalTimeslots      INTEGER (1..maxTS-LCR-1)
            },
            timeslotList                    SEQUENCE (SIZE (1..maxTS-LCR-1)) OF
                UplinkAdditionalTimeslots-LCR-r7
        }
    }
}

UpPCHposition-LCR ::=                   INTEGER (0..127)

Wi-LCR ::=                               INTEGER (1..4)

-- *****
--
-- MEASUREMENT INFORMATION ELEMENTS (10.3.7)
--

```

```

-- *****
AcquisitionSatInfo ::= SEQUENCE {
    satID                SatID,
    -- Actual value dopplerOthOrder = IE value * 2.5
    dopplerOthOrder      INTEGER (-2048..2047),
    extraDopplerInfo     ExtraDopplerInfo OPTIONAL,
    codePhase            INTEGER (0..1022),
    integerCodePhase     INTEGER (0..19),
    gps-BitNumber        INTEGER (0..3),
    codePhaseSearchWindow CodePhaseSearchWindow,
    azimuthAndElevation  AzimuthAndElevation OPTIONAL
}

AcquisitionSatInfoList ::= SEQUENCE (SIZE (1..maxSat)) OF
    AcquisitionSatInfo

AdditionalMeasurementID-List ::= SEQUENCE (SIZE (1..maxAdditionalMeas)) OF
    MeasurementIdentity

AlmanacSatInfo ::= SEQUENCE {
    dataID              INTEGER (0..3),
    satID              SatID,
    e                  BIT STRING (SIZE (16)),
    t-oa              BIT STRING (SIZE (8)),
    deltaI            BIT STRING (SIZE (16)),
    omegaDot         BIT STRING (SIZE (16)),
    satHealth        BIT STRING (SIZE (8)),
    a-Sqrt           BIT STRING (SIZE (24)),
    omega0           BIT STRING (SIZE (24)),
    m0              BIT STRING (SIZE (24)),
    omega            BIT STRING (SIZE (24)),
    af0             BIT STRING (SIZE (11)),
    af1             BIT STRING (SIZE (11))
}

AlmanacSatInfoList ::= SEQUENCE (SIZE (1..maxSat)) OF
    AlmanacSatInfo

ALM-ECEFSbasAlmanacSet ::= SEQUENCE {
    sat-info-SBAscefcList GANSS-SAT-Info-Almanac-SBAscefcList
}

ALM-GlonassAlmanacSet ::= SEQUENCE {
    sat-info-GLOkpList GANSS-SAT-Info-Almanac-GLOkpList
}

ALM-keplerianParameters ::= SEQUENCE {
    -- time of week by 4096s steps
    t-oa              INTEGER (0..147),
    iod-a            INTEGER (0..3),
    sat-info-kpList  GANSS-SAT-Info-Almanac-KpList
}

ALM-MidiAlmanacSet ::= SEQUENCE {
    -- time of week by 4096s steps
    t-oa              INTEGER (0..147),
    sat-info-MIDIkpList GANSS-SAT-Info-Almanac-MIDIkpList
}

ALM-NAVKeplerianSet ::= SEQUENCE {
    -- time of week by 4096s steps
    t-oa              INTEGER (0..147),
    sat-info-NAVkpList GANSS-SAT-Info-Almanac-NAVkpList
}

ALM-ReducedKeplerianSet ::= SEQUENCE {
    -- time of week by 4096s steps
    t-oa              INTEGER (0..147),
    sat-info-REDkpList GANSS-SAT-Info-Almanac-REDkpList
}

AuxInfoGANSS-ID1 ::= SEQUENCE (SIZE (1..maxGANSSSat)) OF AuxInfoGANSS-ID1-element

AuxInfoGANSS-ID1-element ::= SEQUENCE {
    svID              INTEGER (0..63),
    signalsAvailable  BIT STRING (SIZE (8))
}

```

```

}

AuxInfoGANSS-ID3 ::= SEQUENCE (SIZE (1.. maxGANSSSat)) OF AuxInfoGANSS-ID3-element

AuxInfoGANSS-ID3-element ::= SEQUENCE {
    svID INTEGER (0..63),
    signalsAvailable BIT STRING (SIZE (8)),
    channelNumber INTEGER (-7..13)
}

AverageRLC-BufferPayload ::= ENUMERATED {
    pla0, pla4, pla8, pla16, pla32,
    pla64, pla128, pla256, pla512,
    pla1024, pla2k, pla4k, pla8k, pla16k,
    pla32k, pla64k, pla128k, pla256k,
    pla512k, pla1024k, spare12, spare11,
    spare10, spare9, spare8, spare7, spare6,
    spare5, spare4, spare3, spare2, spare1 }

AzimuthAndElevation ::= SEQUENCE {
    -- Actual value azimuth = IE value * 11.25
    azimuth INTEGER (0..31),
    -- Actual value elevation = IE value * 11.25
    elevation INTEGER (0..7)
}

BadSatList ::= SEQUENCE (SIZE (1..maxSat)) OF
    INTEGER (0..63)

Frequency-Band ::= ENUMERATED {
    dcs1800BandUsed, pcs1900BandUsed }

BCCH-ARFCN ::= INTEGER (0..1023)

BLER-MeasurementResults ::= SEQUENCE {
    transportChannelIdentity TransportChannelIdentity,
    dl-TransportChannelBLER DL-TransportChannelBLER OPTIONAL
}

BLER-MeasurementResultsList ::= SEQUENCE (SIZE (1..maxTrCH)) OF
    BLER-MeasurementResults

BLER-TransChIdList ::= SEQUENCE (SIZE (1..maxTrCH)) OF
    TransportChannelIdentity

BSIC-VerificationRequired ::= ENUMERATED {
    required, notRequired }

BSICReported ::= CHOICE {
    -- Value maxCellMeas is not allowed for verifiedBSIC
    verifiedBSIC INTEGER (0..maxCellMeas),
    nonVerifiedBSIC BCCH-ARFCN
}

BurstModeParameters ::= SEQUENCE {
    burstStart INTEGER (0..15),
    burstLength INTEGER (10..25),
    burstFreq INTEGER (1..16)
}

CellDCH-ReportCriteria ::= CHOICE {
    intraFreqReportingCriteria IntraFreqReportingCriteria,
    periodicalReportingCriteria PeriodicalReportingCriteria
}

CellDCH-ReportCriteria-LCR-r4 ::= CHOICE {
    intraFreqReportingCriteria IntraFreqReportingCriteria-LCR-r4,
    periodicalReportingCriteria PeriodicalReportingCriteria
}

-- Actual value CellIndividualOffset = IE value * 0.5
CellIndividualOffset ::= INTEGER (-20..20)

CellInfo ::= SEQUENCE {
    cellIndividualOffset CellIndividualOffset DEFAULT 0,
    referenceTimeDifferenceToCell ReferenceTimeDifferenceToCell OPTIONAL,
    modeSpecificInfo CHOICE {

```

```

    fdd
        primaryCPICH-Info
        primaryCPICH-TX-Power
        readSFN-Indicator
        tx-DiversityIndicator
    },
    tdd
        primaryCCPCH-Info
        primaryCCPCH-TX-Power
        timeslotInfoList
        readSFN-Indicator
    }
}

CellInfo-r4 ::=
    cellIndividualOffset
    referenceTimeDifferenceToCell
    modeSpecificInfo
    fdd
        primaryCPICH-Info
        primaryCPICH-TX-Power
        readSFN-Indicator
        tx-DiversityIndicator
    },
    tdd
        primaryCCPCH-Info
        primaryCCPCH-TX-Power
        timeslotInfoList
        readSFN-Indicator
    }
}

CellInfo-LCR-r8-ext ::=
    cellSelectionReselectionInfo
}

CellInfoSI-RSCP ::=
    cellIndividualOffset
    referenceTimeDifferenceToCell
    modeSpecificInfo
    fdd
        primaryCPICH-Info
        primaryCPICH-TX-Power
        readSFN-Indicator
        tx-DiversityIndicator
    },
    tdd
        primaryCCPCH-Info
        primaryCCPCH-TX-Power
        timeslotInfoList
        readSFN-Indicator
    },
    cellSelectionReselectionInfo
}

CellInfoSI-RSCP-LCR-r4 ::=
    cellIndividualOffset
    referenceTimeDifferenceToCell
    primaryCCPCH-Info
    primaryCCPCH-TX-Power
    timeslotInfoList
    readSFN-Indicator
    cellSelectionReselectionInfo
}

CellInfoSI-ECN0 ::=
    cellIndividualOffset
    referenceTimeDifferenceToCell
    modeSpecificInfo
    fdd
        primaryCPICH-Info
        primaryCPICH-TX-Power
        readSFN-Indicator
        tx-DiversityIndicator

```

SEQUENCE {

PrimaryCPICH-Info OPTIONAL,

PrimaryCPICH-TX-Power OPTIONAL,

BOOLEAN,

BOOLEAN

SEQUENCE {

PrimaryCCPCH-Info,

PrimaryCCPCH-TX-Power OPTIONAL,

TimeslotInfoList OPTIONAL,

BOOLEAN

SEQUENCE {

CellIndividualOffset DEFAULT 0,

ReferenceTimeDifferenceToCell OPTIONAL,

CHOICE {

SEQUENCE {

PrimaryCPICH-Info OPTIONAL,

PrimaryCPICH-TX-Power OPTIONAL,

BOOLEAN,

BOOLEAN

SEQUENCE {

PrimaryCCPCH-Info-r4,

PrimaryCCPCH-TX-Power OPTIONAL,

TimeslotInfoList-r4 OPTIONAL,

BOOLEAN

CellSelectReselectInfoMC-RSCP OPTIONAL

SEQUENCE {

CellIndividualOffset DEFAULT 0,

ReferenceTimeDifferenceToCell OPTIONAL,

CHOICE {

SEQUENCE {

PrimaryCPICH-Info OPTIONAL,

PrimaryCPICH-TX-Power OPTIONAL,

BOOLEAN,

BOOLEAN

SEQUENCE {

PrimaryCCPCH-Info,

PrimaryCCPCH-TX-Power OPTIONAL,

TimeslotInfoList OPTIONAL,

BOOLEAN

CellSelectReselectInfoSIB-11-12-RSCP OPTIONAL

SEQUENCE {

CellIndividualOffset DEFAULT 0,

ReferenceTimeDifferenceToCell OPTIONAL,

PrimaryCCPCH-Info-LCR-r4,

PrimaryCCPCH-TX-Power OPTIONAL,

TimeslotInfoList-LCR-r4 OPTIONAL,

BOOLEAN,

CellSelectReselectInfoSIB-11-12-RSCP OPTIONAL

SEQUENCE {

CellIndividualOffset DEFAULT 0,

ReferenceTimeDifferenceToCell OPTIONAL,

CHOICE {

SEQUENCE {

PrimaryCPICH-Info OPTIONAL,

PrimaryCPICH-TX-Power OPTIONAL,

BOOLEAN,

BOOLEAN

```

    },
    tdd
        primaryCCPCH-Info
        primaryCCPCH-TX-Power
        timeslotInfoList
        readSFN-Indicator
    },
},
cellSelectionReselectionInfo      CellSelectReselectInfoSIB-11-12-ECN0      OPTIONAL
}

CellInfoSI-ECN0-LCR-r4 ::=
cellIndividualOffset              CellIndividualOffset              DEFAULT 0,
referenceTimeDifferenceToCell     ReferenceTimeDifferenceToCell     OPTIONAL,
primaryCCPCH-Info                 PrimaryCCPCH-Info-LCR-r4,
primaryCCPCH-TX-Power             PrimaryCCPCH-TX-Power             OPTIONAL,
timeslotInfoList                  TimeslotInfoList-LCR-r4          OPTIONAL,
readSFN-Indicator                 BOOLEAN,
cellSelectionReselectionInfo      CellSelectReselectInfoSIB-11-12-ECN0      OPTIONAL
}

CellInfoSI-HCS-RSCP ::=
cellIndividualOffset              CellIndividualOffset              DEFAULT 0,
referenceTimeDifferenceToCell     ReferenceTimeDifferenceToCell     OPTIONAL,
modeSpecificInfo
    fdd
        primaryCPICH-Info
        primaryCPICH-TX-Power
        readSFN-Indicator
        tx-DiversityIndicator
    },
    tdd
        primaryCCPCH-Info
        primaryCCPCH-TX-Power
        timeslotInfoList
        readSFN-Indicator
    },
},
cellSelectionReselectionInfo      CellSelectReselectInfoSIB-11-12-HCS-RSCP      OPTIONAL
}

CellInfoSI-HCS-RSCP-LCR-r4 ::=
cellIndividualOffset              CellIndividualOffset              DEFAULT 0,
referenceTimeDifferenceToCell     ReferenceTimeDifferenceToCell     OPTIONAL,
primaryCCPCH-Info                 PrimaryCCPCH-Info-LCR-r4,
primaryCCPCH-TX-Power             PrimaryCCPCH-TX-Power             OPTIONAL,
timeslotInfoList                  TimeslotInfoList-LCR-r4          OPTIONAL,
readSFN-Indicator                 BOOLEAN,
cellSelectionReselectionInfo      CellSelectReselectInfoSIB-11-12-HCS-RSCP      OPTIONAL
}

CellInfoSI-HCS-ECN0 ::=
cellIndividualOffset              CellIndividualOffset              DEFAULT 0,
referenceTimeDifferenceToCell     ReferenceTimeDifferenceToCell     OPTIONAL,
modeSpecificInfo
    fdd
        primaryCPICH-Info
        primaryCPICH-TX-Power
        readSFN-Indicator
        tx-DiversityIndicator
    },
    tdd
        primaryCCPCH-Info
        primaryCCPCH-TX-Power
        timeslotInfoList
        readSFN-Indicator
    },
},
cellSelectionReselectionInfo      CellSelectReselectInfoSIB-11-12-HCS-ECN0      OPTIONAL
}

CellInfoSI-HCS-ECN0-LCR-r4 ::=
cellIndividualOffset              CellIndividualOffset              DEFAULT 0,
referenceTimeDifferenceToCell     ReferenceTimeDifferenceToCell     OPTIONAL,
primaryCCPCH-Info                 PrimaryCCPCH-Info-LCR-r4,
primaryCCPCH-TX-Power             PrimaryCCPCH-TX-Power             OPTIONAL,
timeslotInfoList                  TimeslotInfoList-LCR-r4          OPTIONAL,
readSFN-Indicator                 BOOLEAN,

```

```

    cellSelectionReselectionInfo          CellSelectReselectInfoSIB-11-12-HCS-ECNO    OPTIONAL
}

CellMeasuredResults ::=                SEQUENCE {
    cellIdentity                        CellIdentity                                OPTIONAL,
    -- dummy is not used in this version of the specification, it should
    -- not be sent and if received it should be ignored.
    dummy                               SFN-SFN-ObsTimeDifference                    OPTIONAL,
    cellSynchronisationInfo             CellSynchronisationInfo                  OPTIONAL,
    modeSpecificInfo                    CHOICE {
        fdd                               SEQUENCE {
            primaryCPICH-Info             PrimaryCPICH-Info,
            cpich-Ec-N0                   CPICH-Ec-N0                             OPTIONAL,
            cpich-RSCP                     CPICH-RSCP                               OPTIONAL,
            pathloss                       Pathloss                                  OPTIONAL
        },
        tdd                               SEQUENCE {
            cellParametersID              CellParametersID,
            proposedTGSN                  TGSN                                     OPTIONAL,
            primaryCCPCH-RSCP             PrimaryCCPCH-RSCP                       OPTIONAL,
            pathloss                      Pathloss                                 OPTIONAL,
            timeslotISCP-List             TimeslotISCP-List                       OPTIONAL
        }
    }
}

CellMeasurementEventResults ::=        CHOICE {
    fdd                                  SEQUENCE (SIZE (1..maxCellMeas)) OF
        PrimaryCPICH-Info,
    tdd                                  SEQUENCE (SIZE (1..maxCellMeas)) OF
        PrimaryCCPCH-Info
}

CellMeasurementEventResults-LCR-r4 ::= SEQUENCE (SIZE (1..maxCellMeas)) OF
    PrimaryCCPCH-Info-LCR-r4

CellReportingQuantities ::=            SEQUENCE {
    -- dummy is not used in this version of the specification
    -- and if received it should be ignored.
    dummy                               SFN-SFN-OTD-Type,
    cellIdentity-reportingIndicator      BOOLEAN,
    cellSynchronisationInfoReportingIndicator    BOOLEAN,
    modeSpecificInfo                    CHOICE {
        fdd                               SEQUENCE {
            cpich-Ec-N0-reportingIndicator    BOOLEAN,
            cpich-RSCP-reportingIndicator      BOOLEAN,
            pathloss-reportingIndicator        BOOLEAN
        },
        tdd                               SEQUENCE {
            timeslotISCP-reportingIndicator    BOOLEAN,
            proposedTGSN-ReportingRequired    BOOLEAN,
            primaryCCPCH-RSCP-reportingIndicator    BOOLEAN,
            pathloss-reportingIndicator        BOOLEAN
        }
    }
}

CellSelectReselectInfoMC-RSCP ::=      SEQUENCE {
    q-OffsetS-N                         Q-OffsetS-N                             DEFAULT 0,
    maxAllowedUL-TX-Power                MaxAllowedUL-TX-Power                   OPTIONAL,
    hcs-NeighbouringCellInformation-RSCP  HCS-NeighbouringCellInformation-RSCP    OPTIONAL,
    modeSpecificInfo                    CHOICE {
        fdd                               SEQUENCE {
            q-QualMin                      Q-QualMin                               OPTIONAL,
            q-RxlevMin                     Q-RxlevMin                               OPTIONAL
        },
        tdd                               SEQUENCE {
            q-RxlevMin                     Q-RxlevMin                               OPTIONAL
        },
        gsm                               SEQUENCE {
            q-RxlevMin                     Q-RxlevMin                               OPTIONAL
        }
    }
}

CellSelectReselectInfoSIB-11-12 ::=    SEQUENCE {
    q-Offset1S-N                         Q-OffsetS-N                             DEFAULT 0,

```

```

q-Offset2S-N                Q-OffsetS-N                OPTIONAL,
maxAllowedUL-TX-Power        MaxAllowedUL-TX-Power    OPTIONAL,
hcs-NeighbouringCellInformation-RSCP
                             HCS-NeighbouringCellInformation-RSCP  OPTIONAL,
modeSpecificInfo            CHOICE {
  fdd                        SEQUENCE {
    q-QualMin                Q-QualMin                OPTIONAL,
    q-RxlevMin                Q-RxlevMin                OPTIONAL
  },
  tdd                        SEQUENCE {
    q-RxlevMin                Q-RxlevMin                OPTIONAL
  },
  gsm                        SEQUENCE {
    q-RxlevMin                Q-RxlevMin                OPTIONAL
  }
}
}

CellSelectReselectInfoSIB-11-12-RSCP ::= SEQUENCE {
  q-OffsetS-N                Q-OffsetS-N                DEFAULT 0,
  maxAllowedUL-TX-Power        MaxAllowedUL-TX-Power    OPTIONAL,
  modeSpecificInfo            CHOICE {
    fdd                        SEQUENCE {
      q-QualMin                Q-QualMin                OPTIONAL,
      q-RxlevMin                Q-RxlevMin                OPTIONAL
    },
    tdd                        SEQUENCE {
      q-RxlevMin                Q-RxlevMin                OPTIONAL
    },
    gsm                        SEQUENCE {
      q-RxlevMin                Q-RxlevMin                OPTIONAL
    }
  }
}

CellSelectReselectInfoSIB-11-12-ECN0 ::= SEQUENCE {
  q-Offset1S-N                Q-OffsetS-N                DEFAULT 0,
  q-Offset2S-N                Q-OffsetS-N                DEFAULT 0,
  maxAllowedUL-TX-Power        MaxAllowedUL-TX-Power    OPTIONAL,
  modeSpecificInfo            CHOICE {
    fdd                        SEQUENCE {
      q-QualMin                Q-QualMin                OPTIONAL,
      q-RxlevMin                Q-RxlevMin                OPTIONAL
    },
    tdd                        SEQUENCE {
      q-RxlevMin                Q-RxlevMin                OPTIONAL
    },
    gsm                        SEQUENCE {
      q-RxlevMin                Q-RxlevMin                OPTIONAL
    }
  }
}

CellSelectReselectInfoSIB-11-12-HCS-RSCP ::= SEQUENCE {
  q-OffsetS-N                Q-OffsetS-N                DEFAULT 0,
  maxAllowedUL-TX-Power        MaxAllowedUL-TX-Power    OPTIONAL,
  hcs-NeighbouringCellInformation-RSCP
                             HCS-NeighbouringCellInformation-RSCP  OPTIONAL,
  modeSpecificInfo            CHOICE {
    fdd                        SEQUENCE {
      q-QualMin                Q-QualMin                OPTIONAL,
      q-RxlevMin                Q-RxlevMin                OPTIONAL
    },
    tdd                        SEQUENCE {
      q-RxlevMin                Q-RxlevMin                OPTIONAL
    },
    gsm                        SEQUENCE {
      q-RxlevMin                Q-RxlevMin                OPTIONAL
    }
  }
}

CellSelectReselectInfoSIB-11-12-HCS-ECN0 ::= SEQUENCE {
  q-Offset1S-N                Q-OffsetS-N                DEFAULT 0,
  q-Offset2S-N                Q-OffsetS-N                DEFAULT 0,
  maxAllowedUL-TX-Power        MaxAllowedUL-TX-Power    OPTIONAL,
  hcs-NeighbouringCellInformation-ECN0
                             HCS-NeighbouringCellInformation-ECN0  OPTIONAL,

```

```

modeSpecificInfo CHOICE {
  fdd SEQUENCE {
    q-QualMin Q-QualMin OPTIONAL,
    q-RxlevMin Q-RxlevMin OPTIONAL
  },
  tdd SEQUENCE {
    q-RxlevMin Q-RxlevMin OPTIONAL
  },
  gsm SEQUENCE {
    q-RxlevMin Q-RxlevMin OPTIONAL
  }
}

CellSelectReselectInfo-v590ext ::= SEQUENCE {
  deltaQrxlevmin DeltaQrxlevmin OPTIONAL,
  deltaQhcs DeltaRSCP OPTIONAL
}

CellSelectReselectInfoPCHFACH-v5b0ext ::= SEQUENCE {
  q-Hyst-1-S-PCH Q-Hyst-S-Fine OPTIONAL,
  q-Hyst-1-S-FACH Q-Hyst-S-Fine OPTIONAL,
  q-Hyst-2-S-PCH Q-Hyst-S-Fine OPTIONAL,
  q-Hyst-2-S-FACH Q-Hyst-S-Fine OPTIONAL,
  t-Reselection-S-PCH T-Reselection-S OPTIONAL,
  t-Reselection-S-FACH T-Reselection-S-Fine OPTIONAL
}

CellSelectReselectInfoTresselectionScaling-v5c0ext ::= SEQUENCE {
  -- For speed detection, the same HCS parameters are utilised
  non-HCS-t-CR-Max T-CRMax OPTIONAL,
  speedDependentScalingFactor SpeedDependentScalingFactor OPTIONAL,
  interFrequencyTresselectionScalingFactor TresselectionScalingFactor OPTIONAL,
  interRATTresselectionScalingFactor TresselectionScalingFactor OPTIONAL
}

CellsForInterFreqMeasList ::= SEQUENCE (SIZE (1..maxCellMeas)) OF
  InterFreqCellID
CellsForInterRATMeasList ::= SEQUENCE (SIZE (1..maxCellMeas)) OF
  InterRATCellID
CellsForIntraFreqMeasList ::= SEQUENCE (SIZE (1..maxCellMeas)) OF
  IntraFreqCellID

CellSynchronisationInfo ::= SEQUENCE {
  modeSpecificInfo CHOICE {
    fdd SEQUENCE {
      countC-SFN-Frame-difference CountC-SFN-Frame-difference OPTIONAL,
      tm INTEGER(0..38399)
    },
    tdd SEQUENCE {
      countC-SFN-Frame-difference CountC-SFN-Frame-difference OPTIONAL
    }
  }
}

CellToReport ::= SEQUENCE {
  bsicReported BSICReported
}

CellToReportList ::= SEQUENCE (SIZE (1..maxCellMeas)) OF
  CellToReport

CNAVclockModel ::= SEQUENCE {
  cnavToc BIT STRING (SIZE (11)),
  cnavTop BIT STRING (SIZE (11)),
  cnavURA0 BIT STRING (SIZE (5)),
  cnavURA1 BIT STRING (SIZE (3)),
  cnavURA2 BIT STRING (SIZE (3)),
  cnavAf2 BIT STRING (SIZE (10)),
  cnavAf1 BIT STRING (SIZE (20)),
  cnavAf0 BIT STRING (SIZE (26)),
  cnavTgd BIT STRING (SIZE (13)),
  cnavISCl1cp BIT STRING (SIZE (13)) OPTIONAL,
  cnavISCl1cd BIT STRING (SIZE (13)) OPTIONAL,
  cnavISCl1ca BIT STRING (SIZE (13)) OPTIONAL,
  cnavISCl2c BIT STRING (SIZE (13)) OPTIONAL,
  cnavISCl5i5 BIT STRING (SIZE (13)) OPTIONAL,
  cnavISCl5q5 BIT STRING (SIZE (13)) OPTIONAL
}

```

```

}

CodePhaseSearchWindow ::=          ENUMERATED {
                                     w1023, w1, w2, w3, w4, w6, w8,
                                     w12, w16, w24, w32, w48, w64,
                                     w96, w128, w192 }

CountC-SFN-Frame-difference ::= SEQUENCE {
    -- Actual value countC-SFN-High = IE value * 256
    countC-SFN-High          INTEGER(0..15),
    off                      INTEGER(0..255)
}

-- SPARE: CPICH-Ec-No, Max = 49
-- Values above Max are spare
CPICH-Ec-N0 ::=                   INTEGER (0..63)

-- SPARE: CPICH- RSCP, Max = 91
-- Values above Max are spare
CPICH-RSCP ::=                   INTEGER (0..127)

DataBitAssistance ::=             SEQUENCE {
    ganss-signal-id          GANSS-Signal-Id,
    data-bits                BIT STRING (SIZE (1..1024))
}

DataBitAssistanceList ::=        SEQUENCE (SIZE (1..maxGANSSSat)) OF
    DataBitAssistanceSat

DataBitAssistanceSat ::=         SEQUENCE {
    satID                    INTEGER(0..63),
    dataBitAssistanceSgnList DataBitAssistanceSgnList
}

DataBitAssistanceSgnList ::=     SEQUENCE (SIZE (1..maxSgnType)) OF
    DataBitAssistance

DeltaPRC ::=                     INTEGER (-127..127)

--Actual value DeltaQrxlevmin = IE value * 2
DeltaQrxlevmin ::=              INTEGER (-2..-1)

DeltaRSCP ::=                   INTEGER (-5..-1)

DeltaRSCPPerCell ::=            SEQUENCE {
    deltaRSCP                DeltaRSCP    OPTIONAL
}

-- Actual value DeltaRRC = IE value * 0.032
DeltaRRC ::=                    INTEGER (-7..7)

DeltaUT1 ::=                   SEQUENCE {
    b1                       BIT STRING (SIZE (11)),
    b2                       BIT STRING (SIZE (10))
}

DGANSSInfo ::=                 SEQUENCE {
    ganssSignalId            GANSS-Signal-Id          OPTIONAL,
    ganssStatusHealth        GANSS-Status-Health,
    dgansssignalInformationList DGANSSSignalInformationList  OPTIONAL
}

DGANSSInfoList ::=            SEQUENCE (SIZE (1..maxSgnType)) OF
    DGANSSInfo

DGANSSSignalInformation ::=     SEQUENCE {
    satId                    INTEGER (0..63),
    iode-dganss              BIT STRING (SIZE (10)),
    udre                     UDRE,
    ganss-prc                 INTEGER (-2047..2047),      -- scale factor 0.32
    ganss-rrc                 INTEGER (-127..127)        -- scale factor 0.032
}

DGANSSSignalInformationList ::= SEQUENCE (SIZE (1..maxGANSSSat)) OF
    DGANSSSignalInformation

DGANSS-Sig-Id-Req ::=          BIT STRING (SIZE (8))

```

```

DGPS-CorrectionSatInfo ::=          SEQUENCE {
    satID                SatID,
    iode                 IODE,
    udre                 UDRE,
    prc                  PRC,
    rrc                  RRC,
    -- dummy1 and dummy2 are not used in this version of the specification and should be ignored.
    dummy1               DeltaPRC,
    dummy2               DeltaRRC,
    -- dummy3 and dummy4 are not used in this version of the specification. They should not
    -- be sent and if received they should be ignored.
    dummy3               DeltaPRC      OPTIONAL,
    dummy4               DeltaRRC      OPTIONAL
}

DGPS-CorrectionSatInfoList ::=      SEQUENCE (SIZE (1..maxSat)) OF
                                     DGPS-CorrectionSatInfo

DiffCorrectionStatus ::=            ENUMERATED {
    udre-1-0, udre-0-75, udre-0-5, udre-0-3,
    udre-0-2, udre-0-1, noData, invalidData }

DL-TransportChannelBLER ::=        INTEGER (0..63)

DopplerUncertainty ::=             ENUMERATED {
    hz12-5, hz25, hz50, hz100, hz200,
    spare3, spare2, spare1 }

EllipsoidPoint ::=                 SEQUENCE {
    latitudeSign         ENUMERATED { north, south },
    latitude             INTEGER (0..8388607),
    longitude            INTEGER (-8388608..8388607)
}

EllipsoidPointAltitude ::=         SEQUENCE {
    latitudeSign         ENUMERATED { north, south },
    latitude             INTEGER (0..8388607),
    longitude            INTEGER (-8388608..8388607),
    altitudeDirection   ENUMERATED {height, depth},
    altitude             INTEGER (0..32767)
}

EllipsoidPointAltitudeEllipsoide ::= SEQUENCE {
    latitudeSign         ENUMERATED { north, south },
    latitude             INTEGER (0..8388607),
    longitude            INTEGER (-8388608..8388607),
    altitudeDirection   ENUMERATED {height, depth},
    altitude             INTEGER (0..32767),
    uncertaintySemiMajor INTEGER (0..127),
    uncertaintySemiMinor INTEGER (0..127),
    -- Actual value orientationMajorAxis = IE value * 2
    orientationMajorAxis INTEGER (0..89),
    uncertaintyAltitude INTEGER (0..127),
    confidence           INTEGER (0..100)
}

EllipsoidPointUncertCircle ::=     SEQUENCE {
    latitudeSign         ENUMERATED { north, south },
    latitude             INTEGER (0..8388607),
    longitude            INTEGER (-8388608..8388607),
    uncertaintyCode      INTEGER (0..127)
}

EllipsoidPointUncertEllipse ::=    SEQUENCE {
    latitudeSign         ENUMERATED { north, south },
    latitude             INTEGER (0..8388607),
    longitude            INTEGER (-8388608..8388607),
    uncertaintySemiMajor INTEGER (0..127),
    uncertaintySemiMinor INTEGER (0..127),
    -- Actual value orientationMajorAxis = IE value * 2
    orientationMajorAxis INTEGER (0..89),
    confidence           INTEGER (0..100)
}

```

```

EnvironmentCharacterisation ::=      ENUMERATED {
                                        possibleHeavyMultipathNLOS,
                                        lightMultipathLOS,
                                        notDefined,
                                        spare }

Eutra-EventResult ::=                SEQUENCE {
    earfcn                             EARFCN,
    reportedCells                       SEQUENCE (SIZE (1..maxReportedEUTRACellPerFreq)) OF
                                        EUTRA-PhysicalCellIdentity
}

Eutra-EventResultList ::=            SEQUENCE (SIZE (1..maxReportedEUTRAFreqs)) OF
                                        Eutra-EventResult

EUTRA-EventResults ::=              SEQUENCE {
    eventID                             EventIDInterRAT,
    eutra-EventResultsList              Eutra-EventResultList
}

EUTRA-FrequencyAndPriorityInfo ::=  SEQUENCE {
    earfcn                             EARFCN,
    measurementBandwidth                EUTRA-MeasurementBandwidth          OPTIONAL,
    priority                            INTEGER (0..maxPrio-1),
    -- Actual value = IE value * 2
    qRxLevMinEUTRA                      INTEGER (-70..-22),
    -- Actual value = IE value * 2
    threshXhigh                          INTEGER (0..31),
    -- Actual value = IE value * 2
    threshXlow                           INTEGER (0..31),
    eutra-blackListedCellList            EUTRA-BlacklistedCellPerFreqList    OPTIONAL,
    eutraDetection                       BOOLEAN
}

EUTRA-FrequencyAndPriorityInfoList ::= SEQUENCE (SIZE (1..maxNumEUTRAFreqs)) OF
                                        EUTRA-FrequencyAndPriorityInfo

EUTRA-FrequencyList ::=             SEQUENCE {
    eutraFrequencyRemoval                EUTRA-FrequencyRemoval,
    eutraNewFrequencies                  EUTRA-FrequencyInfoList            OPTIONAL
}

EUTRA-MeasuredCells ::=            SEQUENCE {
    physicalCellIdentity                 EUTRA-PhysicalCellIdentity,
    rSRP                                INTEGER (0..97)          OPTIONAL,
    rSRQ                                INTEGER (0..33)         OPTIONAL
}

Eutra-MeasuredResult ::=           SEQUENCE {
    earfcn                             EARFCN,
    measuredEUTRACells                  SEQUENCE (SIZE (1..maxReportedEUTRACellPerFreq)) OF
                                        EUTRA-MeasuredCells
}

Eutra-MeasuredResultList ::=       SEQUENCE (SIZE (1..maxReportedEUTRAFreqs)) OF
                                        Eutra-MeasuredResult

EUTRA-MeasuredResults ::=          SEQUENCE {
    eutraMeasuredResultList              Eutra-MeasuredResultList
}

EUTRA-FrequencyRemoval ::=         CHOICE {
    removeAllFrequencies                 NULL,
    removeSomeFrequencies                SEQUENCE (SIZE (1..maxNumEUTRAFreqs)) OF
                                        EARFCN,
    removeNoFrequencies                  NULL
}

EUTRA-FrequencyInfoList ::=        SEQUENCE (SIZE (1..maxNumEUTRAFreqs)) OF
                                        EUTRA-FrequencyInfo

EUTRA-FrequencyInfo ::=            SEQUENCE {
    earfcn                             EARFCN,
    measurementBandwidth                EUTRA-MeasurementBandwidth          OPTIONAL,
    eutra-blackListedCellList            EUTRA-BlacklistedCellPerFreqList    OPTIONAL
}

```

```

EUTRA-MeasurementBandwidth ::= ENUMERATED { mbw6, mbw15, mbw25, mbw50, mbw75, mbw100 }

Event1a ::= SEQUENCE {
    triggeringCondition      TriggeringCondition2,
    reportingRange          ReportingRange,
    forbiddenAffectCellList ForbiddenAffectCellList      OPTIONAL,
    w                       W,
    reportDeactivationThreshold ReportDeactivationThreshold,
    reportingAmount         ReportingAmount,
    reportingInterval       ReportingInterval
}

Event1a-r4 ::= SEQUENCE {
    triggeringCondition      TriggeringCondition2,
    reportingRange          ReportingRange,
    forbiddenAffectCellList ForbiddenAffectCellList-r4    OPTIONAL,
    w                       W,
    reportDeactivationThreshold ReportDeactivationThreshold,
    reportingAmount         ReportingAmount,
    reportingInterval       ReportingInterval
}

Event1a-LCR-r4 ::= SEQUENCE {
    triggeringCondition      TriggeringCondition2,
    reportingRange          ReportingRange,
    forbiddenAffectCellList ForbiddenAffectCellList-LCR-r4  OPTIONAL,
    w                       W,
    reportDeactivationThreshold ReportDeactivationThreshold,
    reportingAmount         ReportingAmount,
    reportingInterval       ReportingInterval
}

Event1b ::= SEQUENCE {
    triggeringCondition      TriggeringCondition1,
    reportingRange          ReportingRange,
    forbiddenAffectCellList ForbiddenAffectCellList      OPTIONAL,
    w                       W
}

Event1b-r4 ::= SEQUENCE {
    triggeringCondition      TriggeringCondition1,
    reportingRange          ReportingRange,
    forbiddenAffectCellList ForbiddenAffectCellList-r4    OPTIONAL,
    w                       W
}

Event1b-r7 ::= SEQUENCE {
    triggeringCondition      TriggeringCondition1,
    reportingRange          ReportingRange,
    forbiddenAffectCellList ForbiddenAffectCellList-r4    OPTIONAL,
    w                       W,
    periodicReportingInfo-1b PeriodicReportingInfo-1b    OPTIONAL
}

Event1b-LCR-r4 ::= SEQUENCE {
    triggeringCondition      TriggeringCondition1,
    reportingRange          ReportingRange,
    forbiddenAffectCellList ForbiddenAffectCellList-LCR-r4  OPTIONAL,
    w                       W
}

Event1c ::= SEQUENCE {
    replacementActivationThreshold ReplacementActivationThreshold,
    reportingAmount         ReportingAmount,
    reportingInterval       ReportingInterval
}

Event1d ::= SEQUENCE {
    triggeringCondition      TriggeringCondition2      OPTIONAL,
    useCIO                  BOOLEAN                  OPTIONAL
}

Event1e ::= SEQUENCE {
    triggeringCondition      TriggeringCondition2,
    thresholdUsedFrequency  ThresholdUsedFrequency
}

Event1e-r6 ::= SEQUENCE {

```



```

    triggeringCondition      TriggeringCondition2,
    thresholdUsedFrequency  ThresholdUsedFrequency-r6
}

Event1f ::=
    triggeringCondition      TriggeringCondition1,
    thresholdUsedFrequency  ThresholdUsedFrequency
}

Event1f-r6 ::=
    triggeringCondition      TriggeringCondition1,
    thresholdUsedFrequency  ThresholdUsedFrequency-r6
}

Event1j-r6 ::=
    replacementActivationThreshold  ReplacementActivationThreshold,
    reportingAmount                 ReportingAmount,
    reportingInterval                ReportingInterval
}

Event2a ::=
    -- dummy is not used in this version of the specification and should be ignored
    dummy                          Threshold,
    usedFreqW                       W,
    hysteresis                       HysteresisInterFreq,
    timeToTrigger                    TimeToTrigger,
    reportingCellStatus              ReportingCellStatus          OPTIONAL,
    nonUsedFreqParameterList        NonUsedFreqParameterList    OPTIONAL
}

Event2a-r6 ::=
    usedFreqW                       W,
    hysteresis                       HysteresisInterFreq,
    timeToTrigger                    TimeToTrigger,
    reportingCellStatus              ReportingCellStatus          OPTIONAL,
    nonUsedFreqParameterList        NonUsedFreqWList-r6         OPTIONAL
}

Event2b ::=
    usedFreqThreshold               Threshold,
    usedFreqW                       W,
    hysteresis                       HysteresisInterFreq,
    timeToTrigger                    TimeToTrigger,
    reportingCellStatus              ReportingCellStatus          OPTIONAL,
    nonUsedFreqParameterList        NonUsedFreqParameterList    OPTIONAL
}

Event2b-r6 ::=
    usedFreqThreshold               Threshold-r6,
    usedFreqW                       W,
    hysteresis                       HysteresisInterFreq,
    timeToTrigger                    TimeToTrigger,
    reportingCellStatus              ReportingCellStatus          OPTIONAL,
    nonUsedFreqParameterList        NonUsedFreqParameterList-r6  OPTIONAL
}

Event2c ::=
    hysteresis                       HysteresisInterFreq,
    timeToTrigger                    TimeToTrigger,
    reportingCellStatus              ReportingCellStatus          OPTIONAL,
    nonUsedFreqParameterList        NonUsedFreqParameterList    OPTIONAL
}

Event2c-r6 ::=
    hysteresis                       HysteresisInterFreq,
    timeToTrigger                    TimeToTrigger,
    reportingCellStatus              ReportingCellStatus          OPTIONAL,
    nonUsedFreqParameterList        NonUsedFreqParameterList-r6  OPTIONAL
}

Event2d ::=
    usedFreqThreshold               Threshold,
    usedFreqW                       W,
    hysteresis                       HysteresisInterFreq,
    timeToTrigger                    TimeToTrigger,
    reportingCellStatus              ReportingCellStatus          OPTIONAL
}

```

| | | |
|--------------------------|--|-----------|
| Event2d-r6 ::= | SEQUENCE { | |
| usedFreqThreshold | Threshold-r6, | |
| usedFreqW | W, | |
| hysteresis | HysteresisInterFreq, | |
| timeToTrigger | TimeToTrigger, | |
| reportingCellStatus | ReportingCellStatus | OPTIONAL |
| } | | |
| Event2e ::= | SEQUENCE { | |
| hysteresis | HysteresisInterFreq, | |
| timeToTrigger | TimeToTrigger, | |
| reportingCellStatus | ReportingCellStatus | OPTIONAL, |
| nonUsedFreqParameterList | NonUsedFreqParameterList | OPTIONAL |
| } | | |
| Event2e-r6 ::= | SEQUENCE { | |
| hysteresis | HysteresisInterFreq, | |
| timeToTrigger | TimeToTrigger, | |
| reportingCellStatus | ReportingCellStatus | OPTIONAL, |
| nonUsedFreqParameterList | NonUsedFreqParameterList-r6 | OPTIONAL |
| } | | |
| Event2f ::= | SEQUENCE { | |
| usedFreqThreshold | Threshold, | |
| usedFreqW | W, | |
| hysteresis | HysteresisInterFreq, | |
| timeToTrigger | TimeToTrigger, | |
| reportingCellStatus | ReportingCellStatus | OPTIONAL |
| } | | |
| Event2f-r6 ::= | SEQUENCE { | |
| usedFreqThreshold | Threshold-r6, | |
| usedFreqW | W, | |
| hysteresis | HysteresisInterFreq, | |
| timeToTrigger | TimeToTrigger, | |
| reportingCellStatus | ReportingCellStatus | OPTIONAL |
| } | | |
| Event3a ::= | SEQUENCE { | |
| thresholdOwnSystem | Threshold, | |
| w | W, | |
| thresholdOtherSystem | Threshold, | |
| hysteresis | Hysteresis, | |
| timeToTrigger | TimeToTrigger, | |
| reportingCellStatus | ReportingCellStatus | OPTIONAL |
| } | | |
| Event3b ::= | SEQUENCE { | |
| thresholdOtherSystem | Threshold, | |
| hysteresis | Hysteresis, | |
| timeToTrigger | TimeToTrigger, | |
| reportingCellStatus | ReportingCellStatus | OPTIONAL |
| } | | |
| Event3c ::= | SEQUENCE { | |
| thresholdOtherSystem | Threshold, | |
| hysteresis | Hysteresis, | |
| timeToTrigger | TimeToTrigger, | |
| reportingCellStatus | ReportingCellStatus | OPTIONAL |
| } | | |
| Event3d ::= | SEQUENCE { | |
| hysteresis | Hysteresis, | |
| timeToTrigger | TimeToTrigger, | |
| reportingCellStatus | ReportingCellStatus | OPTIONAL |
| } | | |
| EventIDInterFreq ::= | ENUMERATED { | |
| | e2a, e2b, e2c, e2d, e2e, e2f, spare2, spare1 } | |
| EventIDInterRAT ::= | ENUMERATED { | |
| | e3a, e3b, e3c, e3d } | |
| EventIDIntraFreq ::= | ENUMERATED { | |
| | e1a, e1b, e1c, e1d, e1e, | |
| | e1f, e1g, e1h, e1i, e1j, | |
| | spare6, spare5, spare4, spare3, spare2, | |

```

        spare1 }

EventResults ::=
    CHOICE {
        intraFreqEventResults      IntraFreqEventResults,
        interFreqEventResults      InterFreqEventResults,
        interRATEventResults      InterRATEventResults,
        trafficVolumeEventResults  TrafficVolumeEventResults,
        qualityEventResults        QualityEventResults,
        ue-InternalEventResults    UE-InternalEventResults,
        ue-positioning-MeasurementEventResults UE-Positioning-MeasurementEventResults,
        spare                       NULL
    }

EventResults-v770ext ::=
    CHOICE {
        ue-positioning-MeasurementEventResults UE-Positioning-MeasurementEventResults-v770ext
    }

EventResults-v860ext ::=
    CHOICE {
        ue-positioning-MeasurementEventResults UE-Positioning-MeasurementEventResults-v860ext
    }

ExtraDoppler ::=
    SEQUENCE {
        -- Doppler 1st order term, -0.2..+0.1 m/s2
        -- ( = -42..+21 with 1/210 m/s2 resolution)
        dopplerFirstOrder          INTEGER (-42.. 21),
        dopplerUncertainty         ENUMERATED { dopU40, dopU20, dopU10, dopU5, dopU2-5,
                                                spare3, spare2, spare1 }
    }

ExtraDopplerInfo ::=
    SEQUENCE {
        -- Actual value doppler1stOrder = IE value * 0.023
        doppler1stOrder            INTEGER (-42..21),
        dopplerUncertainty         DopplerUncertainty
    }

FACH-MeasurementOccasionInfo ::=
    SEQUENCE {
        fACH-meas-occasion-coeff    INTEGER (1..12)                OPTIONAL,
        inter-freq-FDD-meas-ind     BOOLEAN,
        -- inter-freq-TDD-meas-ind is for 3.84Mcps TDD and 7.68 Mcps TDD. For 1.28Mcps TDD, the IE in
        -- FACH-MeasurementOccasionInfo-LCR-r4-ext is used.
        inter-freq-TDD-meas-ind     BOOLEAN,
        inter-RAT-meas-ind          SEQUENCE (SIZE (1..maxOtherRAT)) OF
                                    RAT-Type                OPTIONAL
    }

FACH-MeasurementOccasionInfo-LCR-r4-ext ::= SEQUENCE {
    inter-freq-TDD128-meas-ind     BOOLEAN
}

FilterCoefficient ::=
    ENUMERATED {
        fc0, fc1, fc2, fc3, fc4, fc5,
        fc6, fc7, fc8, fc9, fc11, fc13,
        fc15, fc17, fc19, spare1 }

-- Actual value FineSFN-SFN = IE value * 0.0625
FineSFN-SFN ::=
    INTEGER (0..15)

ForbiddenAffectCell ::=
    CHOICE {
        fdd      PrimaryCPICH-Info,
        tdd      PrimaryCCPCH-Info
    }

ForbiddenAffectCell-r4 ::=
    CHOICE {
        fdd      PrimaryCPICH-Info,
        tdd      PrimaryCCPCH-Info-r4
    }

ForbiddenAffectCell-LCR-r4 ::=
    SEQUENCE {
        tdd      PrimaryCCPCH-Info-LCR-r4
    }

ForbiddenAffectCellList ::=
    SEQUENCE (SIZE (1..maxCellMeas)) OF
        ForbiddenAffectCell

ForbiddenAffectCellList-r4 ::=
    SEQUENCE (SIZE (1..maxCellMeas)) OF
        ForbiddenAffectCell-r4

ForbiddenAffectCellList-LCR-r4 ::=
    SEQUENCE (SIZE (1..maxCellMeas)) OF

```

ForbiddenAffectCell-LCR-r4

```

FreqQualityEstimateQuantity-FDD ::= ENUMERATED {
    cpich-Ec-N0,
    cpich-RSCP }

FreqQualityEstimateQuantity-TDD ::= ENUMERATED {
    primaryCCPCH-RSCP }

GanssDataBits ::= SEQUENCE {
    ganssTod          INTEGER (0..86399),
    dataBitAssistance ReqDataBitAssistance
}

GANSSDecipheringKeys ::= SEQUENCE {
    currentDecipheringKey BIT STRING (SIZE (56)),
    nextDecipheringKey   BIT STRING (SIZE (56))
}

GANSSGenericData ::= SEQUENCE {
    ganssID                INTEGER (0..7)                OPTIONAL,
    ganssTimeModelsList   GANSSTimeModelsList          OPTIONAL,
    uePositioningDGANSSCorrections UE-Positioning-DGANSSCorrections OPTIONAL,
    uePositioningGANSSNavigationModel UE-Positioning-GANSS-NavigationModel OPTIONAL,
    uePositioningGANSSRealTimeIntegrity UE-Positioning-GANSS-RealTimeIntegrity OPTIONAL,
    uePositioningGANSSDataBitAssistance UE-Positioning-GANSS-Data-Bit-Assistance OPTIONAL,
    uePositioningGANSSReferenceMeasurementInfo UE-Positioning-GANSS-ReferenceMeasurementInfo OPTIONAL,
    uePositioningGANSSAlmanac UE-Positioning-GANSS-Almanac OPTIONAL,
    uePositioningGANSSUTCModel UE-Positioning-GANSS-UTCModel OPTIONAL
}

GANSSGenericData-v860ext ::= SEQUENCE {
    uePositiningGANSSsbasID UE-Positioning-GANSS-SBAS-ID OPTIONAL,
    uePositioningGANSSAddNavigationModels UE-Positioning-GANSS-AddNavigationModels OPTIONAL,
    uePositioningGANSSAlmanac UE-Positioning-GANSS-Almanac-v860ext OPTIONAL,
    uePositioningGANSSAddUTCModels UE-Positioning-GANSS-AddUTCModels OPTIONAL,
    uePositioningGANSSAuxiliaryInfo UE-Positioning-GANSS-AuxiliaryInfo OPTIONAL
}

GANSSGenericData-r8 ::= SEQUENCE {
    ganssID                INTEGER (0..7)                OPTIONAL,
    uePositiningGANSSsbasID UE-Positioning-GANSS-SBAS-ID OPTIONAL,
    ganssTimeModelsList   GANSSTimeModelsList          OPTIONAL,
    uePositioningDGANSSCorrections UE-Positioning-DGANSSCorrections OPTIONAL,
    uePositioningGANSSNavigationModel UE-Positioning-GANSS-NavigationModel OPTIONAL,
    uePositioningGANSSAddNavigationModels UE-Positioning-GANSS-AddNavigationModels OPTIONAL,
    uePositioningGANSSRealTimeIntegrity UE-Positioning-GANSS-RealTimeIntegrity OPTIONAL,
    uePositioningGANSSDataBitAssistance UE-Positioning-GANSS-Data-Bit-Assistance OPTIONAL,
    uePositioningGANSSReferenceMeasurementInfo UE-Positioning-GANSS-ReferenceMeasurementInfo OPTIONAL,
    uePositioningGANSSAlmanac UE-Positioning-GANSS-Almanac-r8 OPTIONAL,
    uePositioningGANSSUTCModel UE-Positioning-GANSS-UTCModel OPTIONAL,
    uePositioningGANSSAddUTCModels UE-Positioning-GANSS-AddUTCModels OPTIONAL,
    uePositioningGANSSAuxiliaryInfo UE-Positioning-GANSS-AuxiliaryInfo OPTIONAL
}

GANSSGenericDataList ::= SEQUENCE (SIZE (1..maxGANSS)) OF
    GANSSGenericData

GANSSGenericDataList-v860ext ::= SEQUENCE (SIZE (1..maxGANSS)) OF
    GANSSGenericData-v860ext

GANSSGenericDataList-r8 ::= SEQUENCE (SIZE (1..maxGANSS)) OF
    GANSSGenericData-r8

GANSSGenericMeasurementInfo ::= SEQUENCE (SIZE (1..maxGANSS)) OF SEQUENCE {
    ganssID                INTEGER (0..7)                OPTIONAL,
    ganssMeasurementSignalList GANSSMeasurementSignalList
}

GANSSGenericMeasurementInfo-v860ext ::= SEQUENCE (SIZE (1..maxGANSS)) OF SEQUENCE {
    ganssMeasurementSignalList GANSSMeasurementSignalList-v860ext
}

GANSSMeasurementParameters ::= SEQUENCE (SIZE (1..maxGANSSSat)) OF SEQUENCE {

```

```

    satId                INTEGER (0..63),
    cSurNzero            INTEGER (0..63),
    multipathIndicator   ENUMERATED { nm, low, medium, high },
    carrierQualityIndication BIT STRING (SIZE (2)) OPTIONAL,
    ganssCodePhase       INTEGER (0..2097151),
    ganssIntegerCodePhase INTEGER (0..63) OPTIONAL,
    codePhaseRmsError    INTEGER (0..63),
    doppler              INTEGER (-32768..32767),
    adr                 INTEGER (0..33554431) OPTIONAL
}

GANSSMeasurementParameters-v860ext ::= SEQUENCE (SIZE (1..maxGANSSSat)) OF SEQUENCE {
    ganssIntegerCodePhaseExt    INTEGER (64..127) OPTIONAL
}

GANSSMeasurementSignalList ::= SEQUENCE (SIZE (1..maxSgnType)) OF SEQUENCE {
    ganssSignalId              GANSS-Signal-Id OPTIONAL,
    ganssCodePhaseAmbiguity    INTEGER (0..31) OPTIONAL,
    ganssMeasurementParameters GANSSMeasurementParameters
}

GANSSMeasurementSignalList-v860ext ::= SEQUENCE (SIZE (1..maxSgnType)) OF SEQUENCE {
    ganssCodePhaseAmbiguityExt INTEGER (32..127) OPTIONAL,
    ganssMeasurementParameters GANSSMeasurementParameters-v860ext
}

GanssNavigationModelAdditionalData ::= SEQUENCE {
    ganssWeek                INTEGER (0..4095),
    ganssToe                 INTEGER (0..167),
    t-toeLimit               INTEGER (0..10),
    satellitesListRelatedDataList SatellitesListRelatedDataList OPTIONAL
}

GANSSReferenceTimeOnly ::= SEQUENCE {
    gANSS-tod                INTEGER (0..3599999),
    gANSS-timeId             INTEGER (0..7) OPTIONAL,
    gANSS-tod-uncertainty    INTEGER (0..127) OPTIONAL
}

GanssReqGenericData ::= SEQUENCE {
    ganssId                  INTEGER (0..7) OPTIONAL,
    ganssRealTimeIntegrity   BOOLEAN,
    ganssDifferentialCorrection DGANSS-Sig-Id-Req OPTIONAL,
    ganssAlmanac             BOOLEAN,
    ganssNavigationModel     BOOLEAN,
    ganssTimeModelGNSS-GNSS BIT STRING (SIZE (8)) OPTIONAL,
    ganssReferenceMeasurementInfo BOOLEAN,
    ganssDataBits            GanssDataBits OPTIONAL,
    ganssUTCModel            BOOLEAN,
    ganssNavigationModelAdditionalData GanssNavigationModelAdditionalData OPTIONAL
}

GanssReqGenericData-v860ext ::= SEQUENCE {
    sbasId                  UE-Positioning-GANSS-SBAS-ID OPTIONAL,
    ganssAddNavigationModel ENUMERATED { true } OPTIONAL,
    ganssAddUTCModel        ENUMERATED { true } OPTIONAL,
    ganssAuxInfo            ENUMERATED { true } OPTIONAL,
    ganssAddADchoices       SEQUENCE {
        orbitModelID        INTEGER (0..7) OPTIONAL,
        clockModelID        INTEGER (0..7) OPTIONAL,
        utcModelID           INTEGER (0..7) OPTIONAL,
        almanacModelID       INTEGER (0..7) OPTIONAL
    } OPTIONAL
}

GanssRequestedGenericAssistanceDataList ::= SEQUENCE (SIZE (1..maxGANSS)) OF
    GanssReqGenericData

GanssRequestedGenericAssistanceDataList-v860ext ::= SEQUENCE (SIZE (1..maxGANSS)) OF
    GanssReqGenericData-v860ext

GANSSSatelliteInformation ::= SEQUENCE {
    ganssSatId              INTEGER (0..63),
    dopplerZeroOrder        INTEGER (-2048..2047), -- scale factor 0.5m/s
    extraDoppler            ExtraDoppler OPTIONAL,
    codePhase               INTEGER (0..1023),
    integerCodePhase        INTEGER (0..127),
    codePhaseSearchWindow  BIT STRING (SIZE (5)),

```

```

    azimuthhandElevation                AzimuthAndElevation                OPTIONAL
}

GANSSSatelliteInformationList ::= SEQUENCE (SIZE (1..maxGANSSSat)) OF
    GANSSSatelliteInformation

GANSSTimeModelsList ::= SEQUENCE (SIZE (1..maxGANSS-1)) OF
    UE-Positioning-GANSS-TimeModel

GANSS-SAT-Info-Almanac-GLOkp ::= SEQUENCE {
    gloAlmNA                BIT STRING (SIZE (11)),
    gloAlmNA                BIT STRING (SIZE (5)),
    gloAlmHA                BIT STRING (SIZE (5)),
    gloAlmLambdaA          BIT STRING (SIZE (21)),
    gloAlmTlambdaA         BIT STRING (SIZE (21)),
    gloAlmDeltaIA          BIT STRING (SIZE (18)),
    gloAkmDeltaTA          BIT STRING (SIZE (22)),
    gloAlmDeltaTdotA       BIT STRING (SIZE (7)),
    gloAlmEpsilonA         BIT STRING (SIZE (15)),
    gloAlmOmegaA           BIT STRING (SIZE (16)),
    gloAlmTauA             BIT STRING (SIZE (10)),
    gloAlmCA               BIT STRING (SIZE (1)),
    gloAlmMA               BIT STRING (SIZE (2))
} OPTIONAL

GANSS-SAT-Info-Almanac-Kp ::= SEQUENCE {
    svId                    INTEGER (0..63),
    ganss-alm-e             BIT STRING (SIZE (11)),
    ganss-delta-I-alm      BIT STRING (SIZE (11)),
    ganss-omegadot-alm     BIT STRING (SIZE (11)),
    ganss-svhealth-alm    BIT STRING (SIZE (4)),
    ganss-delta-a-sqrt-alm BIT STRING (SIZE (17)),
    ganss-omegazer-alm    BIT STRING (SIZE (16)),
    ganss-m-zero-alm      BIT STRING (SIZE (16)),
    ganss-omega-alm       BIT STRING (SIZE (16)),
    ganss-af-zero-alm     BIT STRING (SIZE (14)),
    ganss-af-one-alm      BIT STRING (SIZE (11))
}

GANSS-SAT-Info-Almanac-MIDIkp ::= SEQUENCE {
    svID                    INTEGER (0..63),
    midiAlmE               BIT STRING (SIZE (11)),
    midiAlmDeltaI          BIT STRING (SIZE (11)),
    midiAlmOmegaDot        BIT STRING (SIZE (11)),
    midiAlmSqrtA           BIT STRING (SIZE (17)),
    midiAlmOmega0          BIT STRING (SIZE (16)),
    midiAlmOmega           BIT STRING (SIZE (16)),
    midiAlmMo              BIT STRING (SIZE (16)),
    midiAlmaf0             BIT STRING (SIZE (11)),
    midiAlmaf1             BIT STRING (SIZE (10)),
    midiAlmL1Health        BIT STRING (SIZE (1)),
    midiAlmL2Health        BIT STRING (SIZE (1)),
    midiAlmL5Health        BIT STRING (SIZE (1))
}

GANSS-SAT-Info-Almanac-NAVkp ::= SEQUENCE {
    svID                    INTEGER (0..63),
    navAlmE                BIT STRING (SIZE (16)),
    navAlmDeltaI           BIT STRING (SIZE (16)),
    navAlmOMEGADOT        BIT STRING (SIZE (16)),
    navAlmSVHealth        BIT STRING (SIZE (8)),
    navAlmSqrtA           BIT STRING (SIZE (24)),
    navAlmOMEGAo          BIT STRING (SIZE (24)),
    navAlmOmega           BIT STRING (SIZE (24)),
    navAlmMo              BIT STRING (SIZE (24)),
    navAlmaf0             BIT STRING (SIZE (11)),
    navAlmaf1             BIT STRING (SIZE (11))
}

GANSS-SAT-Info-Almanac-REDkp ::= SEQUENCE {
    svID                    INTEGER (0..63),
    redAlmDeltaA           BIT STRING (SIZE (8)),
    redAlmOmega0           BIT STRING (SIZE (7)),
    redAlmPhi0            BIT STRING (SIZE (7)),
    redAlmL1Health        BIT STRING (SIZE (1)),
    redAlmL2Health        BIT STRING (SIZE (1)),
    redAlmL5Health        BIT STRING (SIZE (1))
}

```

```

GANSS-SAT-Info-Almanac-SBAscecef ::= SEQUENCE {
    sbasAlmDataID          BIT STRING (SIZE (2)),
    svID                   INTEGER (0..63),
    sbasAlmHealth          BIT STRING (SIZE (8)),
    sbasAlmXg              BIT STRING (SIZE (15)),
    sbasAlmYg              BIT STRING (SIZE (15)),
    sbasAlmZg              BIT STRING (SIZE (9)),
    sbasAlmXgdot           BIT STRING (SIZE (3)),
    sbasAlmYgdot           BIT STRING (SIZE (3)),
    sbasAlmZgdot           BIT STRING (SIZE (4)),
    sbasAlmTo              BIT STRING (SIZE (11))
}

GANSS-SAT-Info-Almanac-GLOkpList ::= SEQUENCE (SIZE (1..maxGANSSSat)) OF
    GANSS-SAT-Info-Almanac-GLOkp

GANSS-SAT-Info-Almanac-KpList ::= SEQUENCE (SIZE (1..maxGANSSSat)) OF
    GANSS-SAT-Info-Almanac-Kp

GANSS-SAT-Info-Almanac-MIDIkpList ::= SEQUENCE (SIZE (1..maxGANSSSat)) OF
    GANSS-SAT-Info-Almanac-MIDIkp

GANSS-SAT-Info-Almanac-NAVkpList ::= SEQUENCE (SIZE (1..maxGANSSSat)) OF
    GANSS-SAT-Info-Almanac-NAVkp

GANSS-SAT-Info-Almanac-REDkpList ::= SEQUENCE (SIZE (1..maxGANSSSat)) OF
    GANSS-SAT-Info-Almanac-REDkp

GANSS-SAT-Info-Almanac-SBAscecefList ::= SEQUENCE (SIZE (1..maxGANSSSat)) OF
    GANSS-SAT-Info-Almanac-SBAscecef

Ganss-Sat-Info-AddNav ::= SEQUENCE {
    satId                   INTEGER (0..63),
    svHealth                BIT STRING (SIZE (6)),
    iod                     BIT STRING (SIZE (11)),
    ganssClockModel         UE-Positioning-GANSS-AddClockModels,
    ganssOrbitModel         UE-Positioning-GANSS-AddOrbitModels
}

Ganss-Sat-Info-Nav ::= SEQUENCE {
    satId                   INTEGER (0..63),
    svHealth                BIT STRING (SIZE (5)),
    iod                     BIT STRING (SIZE (10)),
    ganssClockModel         UE-Positioning-GANSS-ClockModel,
    ganssOrbitModel         UE-Positioning-GANSS-OrbitModel
}

Ganss-Sat-Info-AddNavList ::= SEQUENCE (SIZE (1..maxGANSSSat)) OF
    Ganss-Sat-Info-AddNav

Ganss-Sat-Info-NavList ::= SEQUENCE (SIZE (1..maxGANSSSat)) OF
    Ganss-Sat-Info-Nav

GANSS-Signal-Id ::= INTEGER (0..7)

GANSS-Status-Health ::= ENUMERATED {
    udre-scale-1dot0,
    udre-scale-0dot75,
    udre-scale-0dot5,
    udre-scale-0dot3,
    udre-scale-0dot2,
    udre-scale-0dot1,
    no-data,
    invalid-data }

GANSS-Storm-Flag ::= SEQUENCE {
    storm-flag-one         BOOLEAN,
    storm-flag-two         BOOLEAN,
    storm-flag-three       BOOLEAN,
    storm-flag-four        BOOLEAN,
    storm-flag-five        BOOLEAN
}

GLONASSclockModel ::= SEQUENCE {
    gloTau                  BIT STRING (SIZE (22)),
    gloGamma                BIT STRING (SIZE (11)),
    gloDeltaTau             BIT STRING (SIZE (5))
}
OPTIONAL

```

```

}

GPS-MeasurementParam ::=
    satelliteID          INTEGER (0..63),
    c-N0                 INTEGER (0..63),
    doppler              INTEGER (-32768..32768),
    wholeGPS-Chips       INTEGER (0..1022),
    fractionalGPS-Chips  INTEGER (0..1023),
    multipathIndicator    MultipathIndicator,
    pseudorangeRMS-Error INTEGER (0..63)
}

GPS-MeasurementParamList ::=
    SEQUENCE (SIZE (1..maxSat)) OF
        GPS-MeasurementParam

GSM-CarrierRSSI ::=
    BIT STRING (SIZE (6))

GSM-CellGroup ::=
    SEQUENCE {
        startingARFCN      BCCH-ARFCN,
        bandIndicator      ENUMERATED { dcs1800, pcs1900 },
        followingARFCNs    CHOICE {
            explicitListOfARFCNs SEQUENCE (SIZE (0..31)) OF BCCH-ARFCN,
            equallySpacedARFCNs  SEQUENCE {
                arfcn-Spacing      INTEGER (1..8),
                numberOfFollowingARFCNs INTEGER (0..31)
            },
            variableBitMapOfARFCNs OCTET STRING (SIZE (1..16)),
            continuousRangeOfARFCNs SEQUENCE {
                endingARFCN        BCCH-ARFCN
            }
        }
    }

GSM-MeasuredResults ::=
    SEQUENCE {
        gsm-CarrierRSSI      GSM-CarrierRSSI          OPTIONAL,
        -- dummy is not used in this version of the specification, it should
        -- not be sent and if received it should be ignored.
        dummy                INTEGER (46..173)        OPTIONAL,
        bsicReported        BSICReported,
        -- dummy2 is not used in this version of the specification, it should
        -- not be sent and if received it should be ignored.
        dummy2              ObservedTimeDifferenceToGSM OPTIONAL
    }

GSM-MeasuredResultsList ::=
    SEQUENCE (SIZE (1..maxReportedGSMCells)) OF
        GSM-MeasuredResults

GPS-TOW-1msec ::=
    INTEGER (0..604799999)

GPS-TOW-1sec ::=
    INTEGER (0..604799)

GPS-TOW-Assist ::=
    SEQUENCE {
        satID              SatID,
        tlm-Message        BIT STRING (SIZE (14)),
        tlm-Reserved       BIT STRING (SIZE (2)),
        alert              BOOLEAN,
        antiSpoof          BOOLEAN
    }

GPS-TOW-AssistList ::=
    SEQUENCE (SIZE (1..maxSat)) OF
        GPS-TOW-Assist

GSM-CellID ::=
    SEQUENCE {
        gsm-CellID        INTEGER (0..maxCellMeas-1)
    }

GSM-PriorityInfo ::=
    SEQUENCE {
        gsmCellGroup      GSM-CellGroup,
        priority          INTEGER (0..maxPrio-1),
        -- Actual value = IE value * 2 + 1
        qRxLevMinGSM      INTEGER (-58..-13),
        -- Actual value = IE value * 2
        threshXhigh       INTEGER (0..31),
        -- Actual value = IE value * 2
        threshXlow        INTEGER (0..31)
    }

GSM-PriorityInfoList ::=
    SEQUENCE (SIZE (1..maxNumGSMCellGroup)) OF

```

GSM-PriorityInfo

```

GSMCellGroupingList ::=          SEQUENCE (SIZE (1..maxCellMeas)) OF
                                   GSM-CellID

HCS-CellReselectInformation-RSCP ::=          SEQUENCE {
  -- TABULAR: The default value for penaltyTime is "notUsed"
  -- Temporary offset is nested inside PenaltyTime-RSCP
  penaltyTime                      PenaltyTime-RSCP
}

HCS-CellReselectInformation-ECNO ::=          SEQUENCE {
  -- TABULAR: The default value for penaltyTime is "notUsed"
  -- Temporary offset is nested inside PenaltyTime-ECNO
  penaltyTime                      PenaltyTime-ECNO
}

HCS-NeighbouringCellInformation-RSCP ::= SEQUENCE {
  hcs-PRIO                          HCS-PRIO                      DEFAULT 0,
  q-HCS                              Q-HCS                      DEFAULT 0,
  hcs-CellReselectInformation        HCS-CellReselectInformation-RSCP
}

HCS-NeighbouringCellInformation-ECNO ::= SEQUENCE {
  hcs-PRIO                          HCS-PRIO                      DEFAULT 0,
  q-HCS                              Q-HCS                      DEFAULT 0,
  hcs-CellReselectInformation        HCS-CellReselectInformation-ECNO
}

HCS-PRIO ::=                       INTEGER (0..7)

HCS-ServingCellInformation ::=       SEQUENCE {
  hcs-PRIO                          HCS-PRIO                      DEFAULT 0,
  q-HCS                              Q-HCS                      DEFAULT 0,
  t-CR-Max                          T-CRMax                       OPTIONAL
}

HorizontalVelocity ::=              SEQUENCE {
  bearing                            INTEGER (0..359),
  horizontalSpeed                    INTEGER (0..2047)
}

HorizontalWithVerticalVelocity ::=   SEQUENCE {
  verticalSpeedDirection             ENUMERATED { upward, downward },
  bearing                            INTEGER (0..359),
  horizontalSpeed                    INTEGER (0..2047),
  verticalSpeed                      INTEGER (0..255)
}

HorizontalVelocityWithUncertainty ::= SEQUENCE {
  bearing                            INTEGER (0..359),
  horizontalSpeed                    INTEGER (0..2047),
  horizontalSpeedUncertainty         INTEGER (0..255)
}

HorizontalWithVerticalVelocityAndUncertainty ::= SEQUENCE {
  verticalSpeedDirection             ENUMERATED { upward, downward },
  bearing                            INTEGER (0..359),
  horizontalSpeed                    INTEGER (0..2047),
  verticalSpeed                      INTEGER (0..255),
  horizontalUncertaintySpeed         INTEGER (0..255),
  verticalUncertaintySpeed           INTEGER (0..255)
}

-- Actual value Hysteresis = IE value * 0.5
Hysteresis ::=                     INTEGER (0..15)

-- Actual value HysteresisInterFreq = IE value * 0.5
HysteresisInterFreq ::=            INTEGER (0..29)

IdleIntervalInfo ::=               SEQUENCE {
  k                                  INTEGER (2..3)                OPTIONAL,
  offset                             INTEGER (0..7)                OPTIONAL
}

InterFreqCell ::=                  SEQUENCE {
  frequencyInfo                      FrequencyInfo,
  nonFreqRelatedEventResults         CellMeasurementEventResults
}

```

```

}

InterFreqCell-LCR-r4 ::= SEQUENCE {
    frequencyInfo          FrequencyInfo,
    nonFreqRelatedEventResults CellMeasurementEventResults-LCR-r4
}

InterFreqCellID ::= INTEGER (0..maxCellMeas-1)

InterFreqCellInfoList ::= SEQUENCE {
    removedInterFreqCellList      OPTIONAL,
    newInterFreqCellList          OPTIONAL,
    cellsForInterFreqMeasList     OPTIONAL
}

InterFreqCellInfoList-r4 ::= SEQUENCE {
    removedInterFreqCellList      OPTIONAL,
    newInterFreqCellList-r4      OPTIONAL,
    cellsForInterFreqMeasList     OPTIONAL
}

InterFreqCellInfoList-r8 ::= SEQUENCE {
    removedInterFreqCellList      OPTIONAL,
    newInterFreqCellList-r8      OPTIONAL,
    cellsForInterFreqMeasList     OPTIONAL
}

InterFreqCellInfoSI-List-RSCP ::= SEQUENCE {
    removedInterFreqCellList      OPTIONAL,
    newInterFreqCellList          OPTIONAL,
    newInterFreqCellSI-List-RSCP
}

InterFreqCellInfoSI-List-ECNO ::= SEQUENCE {
    removedInterFreqCellList      OPTIONAL,
    newInterFreqCellList          OPTIONAL,
    newInterFreqCellSI-List-ECNO
}

InterFreqCellInfoSI-List-HCS-RSCP ::= SEQUENCE {
    removedInterFreqCellList      OPTIONAL,
    newInterFreqCellList          OPTIONAL,
    newInterFreqCellSI-List-HCS-RSCP
}

InterFreqCellInfoSI-List-HCS-ECNO ::= SEQUENCE {
    removedInterFreqCellList      OPTIONAL,
    newInterFreqCellList          OPTIONAL,
    newInterFreqCellSI-List-HCS-ECNO
}

InterFreqCellInfoSI-List-RSCP-LCR ::= SEQUENCE {
    removedInterFreqCellList      OPTIONAL,
    newInterFreqCellList          OPTIONAL,
    newInterFreqCellSI-List-RSCP-LCR-r4
}

InterFreqCellInfoSI-List-ECNO-LCR ::= SEQUENCE {
    removedInterFreqCellList      OPTIONAL,
    newInterFreqCellList          OPTIONAL,
    newInterFreqCellSI-List-ECNO-LCR-r4
}

InterFreqCellInfoSI-List-HCS-RSCP-LCR ::= SEQUENCE {
    removedInterFreqCellList      OPTIONAL,
    newInterFreqCellList          OPTIONAL,
    newInterFreqCellSI-List-HCS-RSCP-LCR-r4
}

InterFreqCellInfoSI-List-HCS-ECNO-LCR ::= SEQUENCE {
    removedInterFreqCellList      OPTIONAL,
    newInterFreqCellList          OPTIONAL,
    newInterFreqCellSI-List-HCS-ECNO-LCR-r4
}

InterFreqCellList ::= SEQUENCE (SIZE (1..maxFreq)) OF
    InterFreqCell

InterFreqCellList-LCR-r4-ext ::= SEQUENCE (SIZE (1..maxFreq)) OF
    InterFreqCell-LCR-r4

InterFreqCellMeasuredResultsList ::= SEQUENCE (SIZE (1..maxCellMeas)) OF
    CellMeasuredResults

InterFreqEvent ::= CHOICE {
    event2a      Event2a,
    event2b      Event2b,
    event2c      Event2c,
}

```

```

    event2d          Event2d,
    event2e          Event2e,
    event2f          Event2f
}

InterFreqEvent-r6 ::= CHOICE {
    event2a          Event2a-r6,
    event2b          Event2b-r6,
    event2c          Event2c-r6,
    event2d          Event2d-r6,
    event2e          Event2e-r6,
    event2f          Event2f-r6
}

InterFreqEventList ::= SEQUENCE (SIZE (1..maxMeasEvent)) OF
    InterFreqEvent

InterFreqEventList-r6 ::= SEQUENCE (SIZE (1..maxMeasEvent)) OF
    InterFreqEvent-r6

--Following IE shall be used regardless of CPICH RSCP(FDD) or Primary CCPCH RSCP(TDD)
--The order of the list corresponds to the order of the cells in InterFrequencyMeasuredResultsList
--The IE is only used for measured results and not for additional measured results.
InterFrequencyMeasuredResultsList-v590ext ::= SEQUENCE (SIZE (1..maxCellMeas)) OF
    DeltaRSCPPerCell

Inter-FreqEventCriteria-v590ext ::= SEQUENCE {
    thresholdUsedFrequency-delta          DeltaRSCP,
    thresholdNonUsedFrequency-deltaList   ThresholdNonUsedFrequency-deltaList   OPTIONAL
}

--The order of the list corresponds to the order of the events in Inter-FreqEventList
Inter-FreqEventCriteriaList-v590ext ::= SEQUENCE (SIZE (1..maxMeasEvent)) OF
    Inter-FreqEventCriteria-v590ext

--The order of the list corresponds to the order of relevant events in Intra-FreqEventCriteriaList
--i.e. the first element of the list corresponds to the first occurrence of event 1e, 1f, 1h, 1i,
--the second element of the list corresponds to the second occurrence of event 1e, 1f, 1h, 1i
Intra-FreqEventCriteriaList-v590ext ::= SEQUENCE (SIZE (1..maxMeasEvent)) OF
    DeltaRSCP

--Following IE shall be used regardless of CPICH RSCP(FDD) or Primary CCPCH RSCP(TDD)
--The order of the list corresponds to the order of the cells in IntraFrequencyMeasuredResultsList
--The IE is only used for measured results and not for additional measured results.
IntraFrequencyMeasuredResultsList-v590ext ::= SEQUENCE (SIZE (1..maxCellMeas)) OF
    DeltaRSCPPerCell

IntraFreqReportingCriteria-1b-r5 ::= SEQUENCE {
    periodicReportingInfo-1b          PeriodicReportingInfo-1b
}

PeriodicReportingInfo-1b ::= SEQUENCE {
    reportingAmount          ReportingAmount,
    reportingInterval        ReportingInterval
}

InterFreqEventResults ::= SEQUENCE {
    eventID          EventIDInterFreq,
    interFreqCellList          InterFreqCellList          OPTIONAL
}

InterFreqEventResults-LCR-r4-ext ::= SEQUENCE {
    eventID          EventIDInterFreq,
    interFreqCellList          InterFreqCellList-LCR-r4-ext          OPTIONAL
}

InterFreqMeasQuantity ::= SEQUENCE {
    reportingCriteria          CHOICE {
        intraFreqReportingCriteria          SEQUENCE {
            intraFreqMeasQuantity          IntraFreqMeasQuantity
        },
        interFreqReportingCriteria          SEQUENCE {
            filterCoefficient          FilterCoefficient          DEFAULT fc0,
            modeSpecificInfo          CHOICE {
                fdd          SEQUENCE {
                    freqQualityEstimateQuantity-FDD          FreqQualityEstimateQuantity-FDD
                },
                tdd          SEQUENCE {

```

```

        freqQualityEstimateQuantity-TDD      FreqQualityEstimateQuantity-TDD
    }
}
}

InterFreqMeasuredResults ::= SEQUENCE {
    frequencyInfo              FrequencyInfo              OPTIONAL,
    ultra-CarrierRSSI          UTRA-CarrierRSSI          OPTIONAL,
    interFreqCellMeasuredResultsList InterFreqCellMeasuredResultsList OPTIONAL
}

InterFreqMeasuredResultsList ::= SEQUENCE (SIZE (1..maxFreq)) OF
    InterFreqMeasuredResults

InterFreqMeasurementSysInfo-RSCP ::= SEQUENCE {
    interFreqCellInfoSI-List      InterFreqCellInfoSI-List-RSCP      OPTIONAL
}

InterFreqMeasurementSysInfo-ECN0 ::= SEQUENCE {
    interFreqCellInfoSI-List      InterFreqCellInfoSI-List-ECN0      OPTIONAL
}

InterFreqMeasurementSysInfo-HCS-RSCP ::= SEQUENCE {
    interFreqCellInfoSI-List      InterFreqCellInfoSI-List-HCS-RSCP  OPTIONAL
}

InterFreqMeasurementSysInfo-HCS-ECN0 ::= SEQUENCE {
    interFreqCellInfoSI-List      InterFreqCellInfoSI-List-HCS-ECN0  OPTIONAL
}

InterFreqMeasurementSysInfo-RSCP-LCR-r4 ::= SEQUENCE {
    interFreqCellInfoSI-List      InterFreqCellInfoSI-List-RSCP-LCR   OPTIONAL
}

InterFreqMeasurementSysInfo-ECN0-LCR-r4 ::= SEQUENCE {
    interFreqCellInfoSI-List      InterFreqCellInfoSI-List-ECN0-LCR   OPTIONAL
}

InterFreqMeasurementSysInfo-HCS-RSCP-LCR-r4 ::= SEQUENCE {
    interFreqCellInfoSI-List      InterFreqCellInfoSI-List-HCS-RSCP-LCR  OPTIONAL
}

InterFreqMeasurementSysInfo-HCS-ECN0-LCR-r4 ::= SEQUENCE {
    interFreqCellInfoSI-List      InterFreqCellInfoSI-List-HCS-ECN0-LCR  OPTIONAL
}

InterFreqRACHRepCellsList ::= SEQUENCE (SIZE (1..maxFreq)) OF
    InterFreqCellID

Dummy-InterFreqRACHReportingInfo ::= SEQUENCE {
    modeSpecificInfo           CHOICE {
        fdd                     SEQUENCE {
            interFreqRepQuantityRACH-FDD InterFreqRepQuantityRACH-FDD
        },
        tdd                     SEQUENCE {
            interFreqRepQuantityRACH-TDDList InterFreqRepQuantityRACH-TDDList
        },
        interFreqRACHReportingThreshold Threshold,
        maxReportedCellsOnRACHinterFreq MaxReportedCellsOnRACHinterFreq
    }
}

InterFreqRACHReportingInfo ::= SEQUENCE {
    modeSpecificInfo           CHOICE {
        fdd                     SEQUENCE {
            interFreqRepQuantityRACH-FDD InterFreqRepQuantityRACH-FDD
        },
        tdd                     SEQUENCE {
            interFreqRepQuantityRACH-TDDList InterFreqRepQuantityRACH-TDDList
        },
        interFreqRACHReportingThreshold Threshold,
        maxReportedCellsOnRACHinterFreq MaxReportedCellsOnRACHinterFreq
    }
}

```

```

InterFreqReportCriteria ::= CHOICE {
    intraFreqReportingCriteria
    interFreqReportingCriteria
    periodicalReportingCriteria
    noReporting
}

InterFreqReportCriteria-r4 ::= CHOICE {
    intraFreqReportingCriteria-r4
    interFreqReportingCriteria
    periodicalReportingCriteria
    noReporting
}

InterFreqReportCriteria-r6 ::= CHOICE {
    intraFreqReportingCriteria-r6
    interFreqReportingCriteria-r6
    periodicalReportingCriteria
    noReporting
}

InterFreqReportCriteria-r7 ::= CHOICE {
    intraFreqReportingCriteria-r7
    interFreqReportingCriteria-r6
    periodicalReportingCriteria
    noReporting
}

InterFreqReportingCriteria ::= SEQUENCE {
    interFreqEventList
} OPTIONAL

InterFreqReportingCriteria-r6 ::= SEQUENCE {
    interFreqEventList-r6
} OPTIONAL

InterFreqReportingQuantity ::= SEQUENCE {
    ultra-Carrier-RSSI
    frequencyQualityEstimate
    nonFreqRelatedQuantities
}

InterFreqRepQuantityRACH-FDD ::= ENUMERATED {
    cpich-EcN0, cpich-RSCP }

-- dummy is not used in this version of the specification, it should
-- not be sent and if received the UE behaviour is not specified.
InterFreqRepQuantityRACH-TDD ::= ENUMERATED {
    dummy,
    primaryCCPCH-RSCP }

InterFreqRepQuantityRACH-TDDList ::= SEQUENCE (SIZE (1..2)) OF
    InterFreqRepQuantityRACH-TDD

InterFrequencyMeasurement ::= SEQUENCE {
    interFreqCellInfoList
    interFreqMeasQuantity
    interFreqReportingQuantity
    measurementValidity
    interFreqSetUpdate
    reportCriteria
} OPTIONAL,
OPTIONAL,
OPTIONAL,
OPTIONAL,
OPTIONAL,
OPTIONAL,

InterFrequencyMeasurement-r4 ::= SEQUENCE {
    interFreqCellInfoList-r4
    interFreqMeasQuantity
    interFreqReportingQuantity
    measurementValidity
    interFreqSetUpdate
    reportCriteria
} OPTIONAL,
OPTIONAL,
OPTIONAL,
OPTIONAL,
OPTIONAL,
OPTIONAL,

InterFrequencyMeasurement-r6 ::= SEQUENCE {
    interFreqCellInfoList-r4
    interFreqMeasQuantity
    interFreqReportingQuantity
    measurementValidity
    interFreqSetUpdate
} OPTIONAL,
OPTIONAL,
OPTIONAL,
OPTIONAL,
OPTIONAL,
OPTIONAL,

```

```

    reportCriteria                InterFreqReportCriteria-r6
  }

InterFrequencyMeasurement-r7 ::= SEQUENCE {
    interFreqCellInfoList        InterFreqCellInfoList-r4,
    interFreqMeasQuantity         InterFreqMeasQuantity           OPTIONAL,
    interFreqReportingQuantity    InterFreqReportingQuantity      OPTIONAL,
    measurementValidity           MeasurementValidity             OPTIONAL,
    interFreqSetUpdate            UE-AutonomousUpdateMode         OPTIONAL,
    reportCriteria                InterFreqReportCriteria-r7
}

InterFrequencyMeasurement-r8 ::= SEQUENCE {
    interFreqCellInfoList        InterFreqCellInfoList-r8,
    interFreqMeasQuantity         InterFreqMeasQuantity           OPTIONAL,
    interFreqReportingQuantity    InterFreqReportingQuantity      OPTIONAL,
    measurementValidity           MeasurementValidity             OPTIONAL,
    interFreqSetUpdate            UE-AutonomousUpdateMode         OPTIONAL,
    adjacentFrequencyIndex        INTEGER (0..31)                 OPTIONAL,
    reportCriteria                InterFreqReportCriteria-r7
}

InterRAT-TargetCellDescription ::= SEQUENCE {
    technologySpecificInfo        CHOICE {
        gsm                       SEQUENCE {
            bsic                   BSIC,
            frequency-band         Frequency-Band,
            bcch-ARFCN            BCCH-ARFCN,
            ncMode                 NC-Mode                OPTIONAL
        },
        is-2000                   NULL,
        spare2                     NULL,
        spare1                     NULL
    }
}

InterRATCellID ::= INTEGER (0..maxCellMeas-1)

InterRATCellInfoIndication ::= INTEGER (0..3)

InterRATCellInfoList ::= SEQUENCE {
    removedInterRATCellList       RemovedInterRATCellList,
    -- NOTE: Future revisions of dedicated messages including IE newInterRATCellList
    -- should use a corrected version of this IE
    newInterRATCellList           NewInterRATCellList,
    cellsForInterRATMeasList      CellsForInterRATMeasList      OPTIONAL
}

InterRATCellInfoList-B ::= SEQUENCE {
    removedInterRATCellList       RemovedInterRATCellList,
    -- NOTE: IE newInterRATCellList should be optional. However, system information
    -- does not support message versions. Hence, this can not be corrected
    newInterRATCellList           NewInterRATCellList-B
}

InterRATCellInfoList-r4 ::= SEQUENCE {
    removedInterRATCellList       RemovedInterRATCellList,
    newInterRATCellList           NewInterRATCellList           OPTIONAL,
    cellsForInterRATMeasList      CellsForInterRATMeasList      OPTIONAL
}

InterRATCellInfoList-r6 ::= SEQUENCE {
    removedInterRATCellList       RemovedInterRATCellList,
    newInterRATCellList           NewInterRATCellList           OPTIONAL,
    cellsForInterRATMeasList      CellsForInterRATMeasList      OPTIONAL,
    interRATCellInfoIndication-r6 InterRATCellInfoIndication    OPTIONAL
}

InterRATCellIndividualOffset ::= INTEGER (-50..50)

InterRATEvent ::= CHOICE {
    event3a                       Event3a,
    event3b                       Event3b,
    event3c                       Event3c,
    event3d                       Event3d
}

InterRATEventList ::= SEQUENCE (SIZE (1..maxMeasEvent)) OF

```

```

InterRATEvent
InterRATEventResults ::= SEQUENCE {
    eventID          EventIDInterRAT,
    cellToReportList CellToReportList
}

InterRATInfo ::= ENUMERATED {
    gsm
}

InterRATInfo-r6 ::= SEQUENCE {
    rat          InterRATInfo,
    gsm-TargetCellInfoList GSM-TargetCellInfoList OPTIONAL
}

InterRATInfo-v860ext ::= CHOICE {
    -- CHOICE gsm is provided in IE InterRATInfo or IE InterRATInfo-r6
    gsm          NULL,
    eutra        SEQUENCE {
        eutra-TargetFreqInfoList EUTRA-TargetFreqInfoList
    }
}

InterRATMeasQuantity ::= SEQUENCE {
    measQuantityUTRAN-QualityEstimate IntraFreqMeasQuantity OPTIONAL,
    ratSpecificInfo CHOICE {
        gsm SEQUENCE {
            measurementQuantity MeasurementQuantityGSM,
            filterCoefficient   FilterCoefficient   DEFAULT fc0,
            bsic-VerificationRequired BSIC-VerificationRequired
        },
        is-2000 SEQUENCE {
            tadd-EcIo          INTEGER (0..63),
            tcomp-EcIo         INTEGER (0..15),
            softSlope           INTEGER (0..63) OPTIONAL,
            addIntercept        INTEGER (0..63) OPTIONAL
        }
    }
}

InterRATMeasQuantity-r8 ::= SEQUENCE {
    measQuantityUTRAN-QualityEstimate IntraFreqMeasQuantity OPTIONAL,
    ratSpecificInfo CHOICE {
        gsm SEQUENCE {
            measurementQuantity MeasurementQuantityGSM,
            filterCoefficient   FilterCoefficient   DEFAULT fc0,
            bsic-VerificationRequired BSIC-VerificationRequired
        },
        is-2000 SEQUENCE {
            tadd-EcIo          INTEGER (0..63),
            tcomp-EcIo         INTEGER (0..15),
            softSlope           INTEGER (0..63) OPTIONAL,
            addIntercept        INTEGER (0..63) OPTIONAL
        },
        e-UTRA SEQUENCE {
            measurementQuantity MeasurementQuantityEUTRA,
            filterCoefficient   FilterCoefficient   DEFAULT fc0
        }
    }
}

InterRATMeasuredResults ::= CHOICE {
    gsm          GSM-MeasuredResultsList,
    spare        NULL
}

InterRATMeasuredResultsList ::= SEQUENCE (SIZE (1..maxOtherRAT-16)) OF
    InterRATMeasuredResults

InterRATMeasurement ::= SEQUENCE {
    interRATCellInfoList InterRATCellInfoList OPTIONAL,
    interRATMeasQuantity InterRATMeasQuantity OPTIONAL,
    interRATReportingQuantity InterRATReportingQuantity OPTIONAL,
    reportCriteria InterRATReportCriteria
}

InterRATMeasurement-r4 ::= SEQUENCE {
    interRATCellInfoList InterRATCellInfoList-r4 OPTIONAL,

```

```

interRATMeasQuantity          InterRATMeasQuantity          OPTIONAL,
interRATReportingQuantity    InterRATReportingQuantity    OPTIONAL,
reportCriteria                InterRATReportCriteria
}

InterRATMeasurement-r6 ::= SEQUENCE {
    interRATCellInfoList      InterRATCellInfoList-r6      OPTIONAL,
    interRATMeasQuantity      InterRATMeasQuantity          OPTIONAL,
    interRATReportingQuantity InterRATReportingQuantity    OPTIONAL,
    reportCriteria            InterRATReportCriteria
}

InterRATMeasurement-r8 ::= SEQUENCE {
    interRATMeasurementObjects CHOICE {
        interRATCellInfoList      InterRATCellInfoList-r6,
        eutra-FrequencyList       EUTRA-FrequencyList
    } OPTIONAL,
    interRATMeasQuantity-r8      InterRATMeasQuantity-r8      OPTIONAL,
    interRATReportingQuantity-r8 InterRATReportingQuantity-r8 OPTIONAL,
    reportCriteria               InterRATReportCriteria,
    idleIntervalInfo            IdleIntervalInfo              OPTIONAL
}

InterRATMeasurementSysInfo ::= SEQUENCE {
    interRATCellInfoList      InterRATCellInfoList          OPTIONAL
}

InterRATMeasurementSysInfo-B ::= SEQUENCE {
    interRATCellInfoList      InterRATCellInfoList-B      OPTIONAL
}

InterRATReportCriteria ::= CHOICE {
    interRATReportingCriteria  InterRATReportingCriteria,
    periodicalReportingCriteria PeriodicalWithReportingCellStatus,
    noReporting                ReportingCellStatusOpt
}

InterRATReportingCriteria ::= SEQUENCE {
    interRATEventList          InterRATEventList          OPTIONAL
}

InterRATReportingQuantity ::= SEQUENCE {
    utran-EstimatedQuality     BOOLEAN,
    ratSpecificInfo            CHOICE {
        gsm                     SEQUENCE {
            -- dummy and dummy2 are not used in this version of the specification
            -- and when received they should be ignored.
            dummy                BOOLEAN,
            dummy2               BOOLEAN,
            gsm-Carrier-RSSI     BOOLEAN
        }
    }
}

InterRATReportingQuantity-r8 ::= SEQUENCE {
    utran-EstimatedQuality     BOOLEAN,
    ratSpecificInfo            CHOICE {
        gsm                     SEQUENCE {
            gsm-Carrier-RSSI     BOOLEAN
        },
        eutra                    SEQUENCE {
            reportingQuantity     ENUMERATED { measurementQuantity,
            both }
        }
    }
}

IntraFreqCellID ::= INTEGER (0..maxCellMeas-1)

IntraFreqCellInfoList ::= SEQUENCE {
    removedIntraFreqCellList  RemovedIntraFreqCellList    OPTIONAL,
    newIntraFreqCellList      NewIntraFreqCellList        OPTIONAL,
    cellsForIntraFreqMeasList CellsForIntraFreqMeasList  OPTIONAL
}

IntraFreqCellInfoList-r4 ::= SEQUENCE {
    removedIntraFreqCellList  RemovedIntraFreqCellList    OPTIONAL,
    newIntraFreqCellList      NewIntraFreqCellList-r4        OPTIONAL,
}

```



```

    cellsForIntraFreqMeasList          CellsForIntraFreqMeasList          OPTIONAL
  }

  IntraFreqCellInfoSI-List-RSCP ::= SEQUENCE {
    removedIntraFreqCellList          RemovedIntraFreqCellList          OPTIONAL,
    newIntraFreqCellList              NewIntraFreqCellSI-List-RSCP
  }

  IntraFreqCellInfoSI-List-ECN0 ::= SEQUENCE {
    removedIntraFreqCellList          RemovedIntraFreqCellList          OPTIONAL,
    newIntraFreqCellList              NewIntraFreqCellSI-List-ECN0
  }

  IntraFreqCellInfoSI-List-HCS-RSCP ::= SEQUENCE {
    removedIntraFreqCellList          RemovedIntraFreqCellList          OPTIONAL,
    newIntraFreqCellList              NewIntraFreqCellSI-List-HCS-RSCP
  }

  IntraFreqCellInfoSI-List-HCS-ECN0 ::= SEQUENCE {
    removedIntraFreqCellList          RemovedIntraFreqCellList          OPTIONAL,
    newIntraFreqCellList              NewIntraFreqCellSI-List-HCS-ECN0
  }

  IntraFreqCellInfoSI-List-RSCP-LCR-r4 ::= SEQUENCE {
    removedIntraFreqCellList          RemovedIntraFreqCellList          OPTIONAL,
    newIntraFreqCellList              NewIntraFreqCellSI-List-RSCP-LCR-r4
  }

  IntraFreqCellInfoSI-List-ECN0-LCR-r4 ::= SEQUENCE {
    removedIntraFreqCellList          RemovedIntraFreqCellList          OPTIONAL,
    newIntraFreqCellList              NewIntraFreqCellSI-List-ECN0-LCR-r4
  }

  IntraFreqCellInfoSI-List-HCS-RSCP-LCR-r4 ::= SEQUENCE {
    removedIntraFreqCellList          RemovedIntraFreqCellList          OPTIONAL,
    newIntraFreqCellList              NewIntraFreqCellSI-List-HCS-RSCP-LCR-r4
  }

  IntraFreqCellInfoSI-List-HCS-ECN0-LCR-r4 ::= SEQUENCE {
    removedIntraFreqCellList          RemovedIntraFreqCellList          OPTIONAL,
    newIntraFreqCellList              NewIntraFreqCellSI-List-HCS-ECN0-LCR-r4
  }

  IntraFreqEvent ::= CHOICE {
    e1a                               Event1a,
    e1b                               Event1b,
    e1c                               Event1c,
    e1d                               NULL,
    e1e                               Event1e,
    e1f                               Event1f,
    e1g                               NULL,
    e1h                               ThresholdUsedFrequency,
    e1i                               ThresholdUsedFrequency
  }

  IntraFreqEvent-r4 ::= CHOICE {
    e1a                               Event1a-r4,
    e1b                               Event1b-r4,
    e1c                               Event1c,
    e1d                               NULL,
    e1e                               Event1e,
    e1f                               Event1f,
    e1g                               NULL,
    e1h                               ThresholdUsedFrequency,
    e1i                               ThresholdUsedFrequency
  }

  IntraFreqEvent-LCR-r4 ::= CHOICE {
    e1a                               Event1a-LCR-r4,
    e1b                               Event1b-LCR-r4,
    e1c                               Event1c,
    e1d                               NULL,
    e1e                               Event1e,
    e1f                               Event1f,
    e1g                               NULL,
    e1h                               ThresholdUsedFrequency,
    e1i                               ThresholdUsedFrequency
  }

```

```

IntraFreqEvent-r6 ::= CHOICE {
    e1a          Event1a-r4,
    e1b          Event1b-r4,
    e1c          Event1c,
    e1d          Event1d,
    e1e          Event1e-r6,
    e1f          Event1f-r6,
    e1g          NULL,
    e1h          ThresholdUsedFrequency-r6,
    e1i          ThresholdUsedFrequency-r6,
    e1j          Event1j-r6
}

IntraFreqEvent-r7 ::= CHOICE {
    e1a          Event1a-r4,
    e1b          Event1b-r7,
    e1c          Event1c,
    e1d          Event1d,
    e1e          Event1e-r6,
    e1f          Event1f-r6,
    e1g          NULL,
    e1h          ThresholdUsedFrequency-r6,
    e1i          ThresholdUsedFrequency-r6,
    e1j          Event1j-r6
}

IntraFreqEvent-ld-r5 ::= SEQUENCE {
    triggeringCondition TriggeringCondition2 OPTIONAL,
    useCIO              BOOLEAN             OPTIONAL
}

IntraFreqEventCriteria ::= SEQUENCE {
    event          IntraFreqEvent,
    hysteresis     Hysteresis,
    timeToTrigger TimeToTrigger,
    reportingCellStatus ReportingCellStatus OPTIONAL
}

IntraFreqEventCriteria-r4 ::= SEQUENCE {
    event          IntraFreqEvent-r4,
    hysteresis     Hysteresis,
    timeToTrigger TimeToTrigger,
    reportingCellStatus ReportingCellStatus OPTIONAL
}

IntraFreqEventCriteria-LCR-r4 ::= SEQUENCE {
    event          IntraFreqEvent-LCR-r4,
    hysteresis     Hysteresis,
    timeToTrigger TimeToTrigger,
    reportingCellStatus ReportingCellStatus OPTIONAL
}

IntraFreqEventCriteria-r6 ::= SEQUENCE {
    event          IntraFreqEvent-r6,
    hysteresis     Hysteresis,
    timeToTrigger TimeToTrigger,
    reportingCellStatus ReportingCellStatus OPTIONAL
}

IntraFreqEventCriteria-r7 ::= SEQUENCE {
    event          IntraFreqEvent-r7,
    hysteresis     Hysteresis,
    timeToTrigger TimeToTrigger,
    reportingCellStatus ReportingCellStatus OPTIONAL
}

IntraFreqEventCriteriaList ::= SEQUENCE (SIZE (1..maxMeasEvent)) OF
    IntraFreqEventCriteria

IntraFreqEventCriteriaList-r4 ::= SEQUENCE (SIZE (1..maxMeasEvent)) OF
    IntraFreqEventCriteria-r4

IntraFreqEventCriteriaList-LCR-r4 ::= SEQUENCE (SIZE (1..maxMeasEvent)) OF
    IntraFreqEventCriteria-LCR-r4

IntraFreqEventCriteriaList-r6 ::= SEQUENCE (SIZE (1..maxMeasEvent)) OF
    IntraFreqEventCriteria-r6

```

```

IntraFreqEventCriteriaList-r7 ::= SEQUENCE (SIZE (1..maxMeasEvent)) OF
                                   IntraFreqEventCriteria-r7

IntraFreqEventResults ::= SEQUENCE {
    eventID                      EventIDIntraFreq,
    cellMeasurementEventResults CellMeasurementEventResults
}

IntraFreqMeasQuantity ::= SEQUENCE {
    filterCoefficient            FilterCoefficient                DEFAULT fc0,
    modeSpecificInfo            CHOICE {
        fdd                     SEQUENCE {
            intraFreqMeasQuantity-FDD IntraFreqMeasQuantity-FDD
        },
        tdd                     SEQUENCE {
            intraFreqMeasQuantity-TDDList IntraFreqMeasQuantity-TDDList
        }
    }
}

-- If IntraFreqMeasQuantity-FDD is used in InterRATMeasQuantity, then only
-- cpich-Ec-N0 and cpich-RSCP are allowed.
-- dummy is not used in this version of the specification, it should
-- not be sent and if received the UE behaviour is not specified.
IntraFreqMeasQuantity-FDD ::= ENUMERATED {
    cpich-Ec-N0,
    cpich-RSCP,
    pathloss,
    dummy }

IntraFreqMeasQuantity-FDD-sib3 ::= ENUMERATED {
    cpich-Ec-N0, cpich-RSCP }

-- dummy is not used in this version of the specification, it should
-- not be sent and if received the UE behaviour is not specified.
IntraFreqMeasQuantity-TDD ::= ENUMERATED {
    primaryCCPCH-RSCP,
    pathloss,
    timeslotISCP,
    dummy }

IntraFreqMeasQuantity-TDDList ::= SEQUENCE (SIZE (1..4)) OF
                                   IntraFreqMeasQuantity-TDD

IntraFreqMeasQuantity-TDD-sib3List ::= SEQUENCE (SIZE (1..2)) OF
                                        ENUMERATED { primaryCCPCH-RSCP, timeslotISCP }

IntraFreqMeasuredResultsList ::= SEQUENCE (SIZE (1..maxCellMeas)) OF
                                   CellMeasuredResults

IntraFreqMeasurementSysInfo-RSCP ::= SEQUENCE {
    intraFreqMeasurementID      MeasurementIdentity        DEFAULT 1,
    intraFreqCellInfoSI-List    IntraFreqCellInfoSI-List-RSCP   OPTIONAL,
    intraFreqMeasQuantity       IntraFreqMeasQuantity            OPTIONAL,
    intraFreqReportingQuantityForRACH IntraFreqReportingQuantityForRACH OPTIONAL,
    maxReportedCellsOnRACH      MaxReportedCellsOnRACH         OPTIONAL,
    reportingInfoForCellDCH     ReportingInfoForCellDCH         OPTIONAL
}

IntraFreqMeasurementSysInfo-ECN0 ::= SEQUENCE {
    intraFreqMeasurementID      MeasurementIdentity        DEFAULT 1,
    intraFreqCellInfoSI-List    IntraFreqCellInfoSI-List-ECN0   OPTIONAL,
    intraFreqMeasQuantity       IntraFreqMeasQuantity            OPTIONAL,
    intraFreqReportingQuantityForRACH IntraFreqReportingQuantityForRACH OPTIONAL,
    maxReportedCellsOnRACH      MaxReportedCellsOnRACH         OPTIONAL,
    reportingInfoForCellDCH     ReportingInfoForCellDCH         OPTIONAL
}

IntraFreqMeasurementSysInfo-HCS-RSCP ::= SEQUENCE {
    intraFreqMeasurementID      MeasurementIdentity        DEFAULT 1,
    intraFreqCellInfoSI-List    IntraFreqCellInfoSI-List-HCS-RSCP OPTIONAL,
    intraFreqMeasQuantity       IntraFreqMeasQuantity            OPTIONAL,
    intraFreqReportingQuantityForRACH IntraFreqReportingQuantityForRACH OPTIONAL,
    maxReportedCellsOnRACH      MaxReportedCellsOnRACH         OPTIONAL,
    reportingInfoForCellDCH     ReportingInfoForCellDCH         OPTIONAL
}

```

```

IntraFreqMeasurementSysInfo-HCS-ECNO ::= SEQUENCE {
    intraFreqMeasurementID      MeasurementIdentity          DEFAULT 1,
    intraFreqCellInfoSI-List     IntraFreqCellInfoSI-List-HCS-ECNO  OPTIONAL,
    intraFreqMeasQuantity        IntraFreqMeasQuantity           OPTIONAL,
    intraFreqReportingQuantityForRACH IntraFreqReportingQuantityForRACH  OPTIONAL,
    maxReportedCellsOnRACH       MaxReportedCellsOnRACH           OPTIONAL,
    reportingInfoForCellDCH       ReportingInfoForCellDCH           OPTIONAL
}

IntraFreqMeasurementSysInfo-RSCP-LCR-r4 ::= SEQUENCE {
    intraFreqMeasurementID      MeasurementIdentity          DEFAULT 1,
    intraFreqCellInfoSI-List     IntraFreqCellInfoSI-List-RSCP-LCR-r4  OPTIONAL,
    intraFreqMeasQuantity        IntraFreqMeasQuantity           OPTIONAL,
    intraFreqReportingQuantityForRACH IntraFreqReportingQuantityForRACH  OPTIONAL,
    maxReportedCellsOnRACH       MaxReportedCellsOnRACH           OPTIONAL,
    reportingInfoForCellDCH       ReportingInfoForCellDCH-LCR-r4  OPTIONAL
}

IntraFreqMeasurementSysInfo-ECNO-LCR-r4 ::= SEQUENCE {
    intraFreqMeasurementID      MeasurementIdentity          DEFAULT 1,
    intraFreqCellInfoSI-List     IntraFreqCellInfoSI-List-ECNO-LCR-r4  OPTIONAL,
    intraFreqMeasQuantity        IntraFreqMeasQuantity           OPTIONAL,
    intraFreqReportingQuantityForRACH IntraFreqReportingQuantityForRACH  OPTIONAL,
    maxReportedCellsOnRACH       MaxReportedCellsOnRACH           OPTIONAL,
    reportingInfoForCellDCH       ReportingInfoForCellDCH-LCR-r4  OPTIONAL
}

IntraFreqMeasurementSysInfo-HCS-RSCP-LCR-r4 ::= SEQUENCE {
    intraFreqMeasurementID      MeasurementIdentity          DEFAULT 1,
    intraFreqCellInfoSI-List     IntraFreqCellInfoSI-List-HCS-RSCP-LCR-r4  OPTIONAL,
    intraFreqMeasQuantity        IntraFreqMeasQuantity           OPTIONAL,
    intraFreqReportingQuantityForRACH IntraFreqReportingQuantityForRACH  OPTIONAL,
    maxReportedCellsOnRACH       MaxReportedCellsOnRACH           OPTIONAL,
    reportingInfoForCellDCH       ReportingInfoForCellDCH-LCR-r4  OPTIONAL
}

IntraFreqMeasurementSysInfo-HCS-ECNO-LCR-r4 ::= SEQUENCE {
    intraFreqMeasurementID      MeasurementIdentity          DEFAULT 1,
    intraFreqCellInfoSI-List     IntraFreqCellInfoSI-List-HCS-ECNO-LCR-r4  OPTIONAL,
    intraFreqMeasQuantity        IntraFreqMeasQuantity           OPTIONAL,
    intraFreqReportingQuantityForRACH IntraFreqReportingQuantityForRACH  OPTIONAL,
    maxReportedCellsOnRACH       MaxReportedCellsOnRACH           OPTIONAL,
    reportingInfoForCellDCH       ReportingInfoForCellDCH-LCR-r4  OPTIONAL
}

IntraFreqReportCriteria ::= CHOICE {
    intraFreqReportingCriteria
    periodicalReportingCriteria
    noReporting
}

IntraFreqReportCriteria-r4 ::= CHOICE {
    intraFreqReportingCriteria-r4
    periodicalReportingCriteria
    noReporting
}

IntraFreqReportCriteria-r6 ::= CHOICE {
    intraFreqReportingCriteria-r6
    periodicalReportingCriteria
    noReporting
}

IntraFreqReportCriteria-r7 ::= CHOICE {
    intraFreqReportingCriteria-r7
    periodicalReportingCriteria
    noReporting
}

IntraFreqReportingCriteria ::= SEQUENCE {
    eventCriteriaList      IntraFreqEventCriteriaList  OPTIONAL
}

IntraFreqReportingCriteria-r4 ::= SEQUENCE {
    eventCriteriaList      IntraFreqEventCriteriaList-r4  OPTIONAL
}

IntraFreqReportingCriteria-LCR-r4 ::= SEQUENCE {

```

```

    eventCriteriaList          IntraFreqEventCriteriaList-LCR-r4  OPTIONAL
  }

IntraFreqReportingCriteria-r6 ::= SEQUENCE {
    eventCriteriaList          IntraFreqEventCriteriaList-r6  OPTIONAL
}

IntraFreqReportingCriteria-r7 ::= SEQUENCE {
    eventCriteriaList          IntraFreqEventCriteriaList-r7  OPTIONAL
}

IntraFreqReportingQuantity ::= SEQUENCE {
    activeSetReportingQuantities CellReportingQuantities,
    monitoredSetReportingQuantities CellReportingQuantities,
    detectedSetReportingQuantities CellReportingQuantities  OPTIONAL
}

IntraFreqReportingQuantityForRACH ::= SEQUENCE {
    sfn-SFN-OTD-Type          SFN-SFN-OTD-Type,
    modeSpecificInfo          CHOICE {
        fdd                    SEQUENCE {
            intraFreqRepQuantityRACH-FDD IntraFreqRepQuantityRACH-FDD
        },
        tdd                    SEQUENCE {
            intraFreqRepQuantityRACH-TDDList IntraFreqRepQuantityRACH-TDDList
        }
    }
}

IntraFreqRepQuantityRACH-FDD ::= ENUMERATED {
    cpich-EcN0, cpich-RSCP,
    pathloss, noReport }

IntraFreqRepQuantityRACH-TDD ::= ENUMERATED {
    timeslotISCP,
    primaryCCPCH-RSCP,
    noReport }

IntraFreqRepQuantityRACH-TDDList ::= SEQUENCE (SIZE (1..2)) OF
    IntraFreqRepQuantityRACH-TDD

IntraFrequencyMeasurement ::= SEQUENCE {
    intraFreqCellInfoList      IntraFreqCellInfoList          OPTIONAL,
    intraFreqMeasQuantity      IntraFreqMeasQuantity          OPTIONAL,
    intraFreqReportingQuantity IntraFreqReportingQuantity    OPTIONAL,
    measurementValidity        MeasurementValidity            OPTIONAL,
    reportCriteria              IntraFreqReportCriteria        OPTIONAL
}

IntraFrequencyMeasurement-r4 ::= SEQUENCE {
    intraFreqCellInfoList      IntraFreqCellInfoList-r4          OPTIONAL,
    intraFreqMeasQuantity      IntraFreqMeasQuantity          OPTIONAL,
    intraFreqReportingQuantity IntraFreqReportingQuantity    OPTIONAL,
    measurementValidity        MeasurementValidity            OPTIONAL,
    reportCriteria              IntraFreqReportCriteria-r4    OPTIONAL
}

IntraFrequencyMeasurement-r6 ::= SEQUENCE {
    intraFreqCellInfoList      IntraFreqCellInfoList-r4          OPTIONAL,
    intraFreqMeasQuantity      IntraFreqMeasQuantity          OPTIONAL,
    intraFreqReportingQuantity IntraFreqReportingQuantity    OPTIONAL,
    measurementValidity        MeasurementValidity            OPTIONAL,
    -- reportCriteria is optional in later versions of this message
    reportCriteria              IntraFreqReportCriteria-r6
}

IntraFrequencyMeasurement-r7 ::= SEQUENCE {
    intraFreqCellInfoList      IntraFreqCellInfoList-r4          OPTIONAL,
    intraFreqMeasQuantity      IntraFreqMeasQuantity          OPTIONAL,
    intraFreqReportingQuantity IntraFreqReportingQuantity    OPTIONAL,
    measurementValidity        MeasurementValidity            OPTIONAL,
    reportCriteria              IntraFreqReportCriteria-r7    OPTIONAL
}

IODE ::= INTEGER (0..255)

IP-Length ::= ENUMERATED {
    ip15, ip110 }

```

```

IP-PCCPCH-r4 ::= BOOLEAN

IP-Spacing ::= ENUMERATED {
    e5, e7, e10, e15, e20,
    e30, e40, e50 }

IP-Spacing-TDD ::= ENUMERATED {
    e30, e40, e50, e70, e100}

IS-2000SpecificMeasInfo ::= ENUMERATED {
    frequency, timeslot, colourcode,
    outputpower, pn-Offset }

KeplerianParameters ::= SEQUENCE {
    toe-nav BIT STRING (SIZE (14)),
    ganss-omega-nav BIT STRING (SIZE (32)),
    delta-n-nav BIT STRING (SIZE (16)),
    m-zero-nav BIT STRING (SIZE (32)),
    omegadot-nav BIT STRING (SIZE (24)),
    ganss-e-nav BIT STRING (SIZE (32)),
    idot-nav BIT STRING (SIZE (14)),
    a-sqrt-nav BIT STRING (SIZE (32)),
    i-zero-nav BIT STRING (SIZE (32)),
    omega-zero-nav BIT STRING (SIZE (32)),
    c-rs-nav BIT STRING (SIZE (16)),
    c-is-nav BIT STRING (SIZE (16)),
    c-us-nav BIT STRING (SIZE (16)),
    c-rc-nav BIT STRING (SIZE (16)),
    c-ic-nav BIT STRING (SIZE (16)),
    c-uc-nav BIT STRING (SIZE (16))
}

MaxNumberOfReportingCellsType1 ::= ENUMERATED {
    e1, e2, e3, e4, e5, e6}

MaxNumberOfReportingCellsType2 ::= ENUMERATED {
    e1, e2, e3, e4, e5, e6, e7, e8, e9, e10, e11, e12}

MaxNumberOfReportingCellsType3 ::= ENUMERATED {
    viactCellsPlus1,
    viactCellsPlus2,
    viactCellsPlus3,
    viactCellsPlus4,
    viactCellsPlus5,
    viactCellsPlus6 }

MaxReportedCellsOnRACH ::= ENUMERATED {
    noReport,
    currentCell,
    currentAnd-1-BestNeighbour,
    currentAnd-2-BestNeighbour,
    currentAnd-3-BestNeighbour,
    currentAnd-4-BestNeighbour,
    currentAnd-5-BestNeighbour,
    currentAnd-6-BestNeighbour }

MaxReportedCellsOnRACHinterFreq ::= INTEGER (1..8)

MeasuredResults ::= CHOICE {
    intraFreqMeasuredResultsList IntraFreqMeasuredResultsList,
    interFreqMeasuredResultsList InterFreqMeasuredResultsList,
    interRATMeasuredResultsList InterRATMeasuredResultsList,
    trafficVolumeMeasuredResultsList TrafficVolumeMeasuredResultsList,
    qualityMeasuredResults QualityMeasuredResults,
    ue-InternalMeasuredResults UE-InternalMeasuredResults,
    ue-positioning-MeasuredResults UE-Positioning-MeasuredResults,
    spare NULL
}

MeasuredResults-v390ext ::= SEQUENCE {
    ue-positioning-MeasuredResults-v390ext UE-Positioning-MeasuredResults-v390ext
}

MeasuredResults-v590ext ::= CHOICE {
    intraFrequencyMeasuredResultsList IntraFrequencyMeasuredResultsList-v590ext,
    interFrequencyMeasuredResultsList InterFrequencyMeasuredResultsList-v590ext
}

```

```

}

MeasuredResults-v770ext ::= CHOICE {
    ueInternalMeasuredResults          UE-InternalMeasuredResults-v770ext,
    ue-positioning-MeasuredResults     UE-Positioning-MeasuredResults-v770ext
}

MeasuredResults-v860ext ::= CHOICE {
    ue-positioning-MeasuredResults     UE-Positioning-MeasuredResults-v860ext
}

MeasuredResults-LCR-r4 ::=          CHOICE {
    intraFreqMeasuredResultsList      IntraFreqMeasuredResultsList,
    interFreqMeasuredResultsList      InterFreqMeasuredResultsList,
    interRATMeasuredResultsList       InterRATMeasuredResultsList,
    trafficVolumeMeasuredResultsList   TrafficVolumeMeasuredResultsList,
    qualityMeasuredResults             QualityMeasuredResults,
    ue-InternalMeasuredResults         UE-InternalMeasuredResults-LCR-r4,
    ue-positioning-MeasuredResults     UE-Positioning-MeasuredResults,
    spare                              NULL
}

MeasuredResultsList ::=              SEQUENCE (SIZE (1..maxAdditionalMeas)) OF
                                     MeasuredResults

MeasuredResultsList-LCR-r4-ext ::=   SEQUENCE (SIZE (1..maxAdditionalMeas)) OF
                                     MeasuredResults-LCR-r4

MeasuredResultsList-v770ext ::=      SEQUENCE (SIZE (1..maxAdditionalMeas)) OF SEQUENCE {
    -- The 'measuredResults' element shall be present, if 'v770' extended measurement results
    -- associated with the corresponding element in the IE 'MeasuredResultList' shall be
    -- provided, otherwise it is not needed
    measuredResults                   MeasuredResults-v770ext          OPTIONAL
}

MeasuredResultsList-v860ext ::=      SEQUENCE (SIZE (1..maxAdditionalMeas)) OF SEQUENCE {
    -- The 'measuredResults' element shall be present, if 'v860' extended measurement results
    -- associated with the corresponding element in the IE 'MeasuredResultList' shall be
    -- provided, otherwise it is not needed
    measuredResults                   MeasuredResults-v860ext        OPTIONAL
}

MeasuredResultsOnRACH ::=            SEQUENCE {
    currentCell                       SEQUENCE {
        modeSpecificInfo              CHOICE {
            fdd                       SEQUENCE {
                measurementQuantity    CHOICE {
                    cpich-Ec-NO        CPICH-Ec-NO,
                    cpich-RSCP          CPICH-RSCP,
                    pathloss            Pathloss,
                    spare               NULL
                }
            },
            tdd                       SEQUENCE {
                -- For 3.84 Mcps, 7.68 Mcps and 1.28 Mcps TDD
                timeslotISCP           TimeslotISCP-List          OPTIONAL,
                primaryCCPCH-RSCP      PrimaryCCPCH-RSCP        OPTIONAL
            }
        },
        monitoredCells                 MonitoredCellRACH-List        OPTIONAL
    }
}

MeasuredResultsOnRACH-v7g0ext ::=    SEQUENCE {
    currentCell-DeltaRSCP              DeltaRSCPPerCell          OPTIONAL,
    monitoredCellRACH-List-v7g0ext     MonitoredCellRACH-List-v7g0ext  OPTIONAL
}

--The order of the list corresponds to the order of the cells in MonitoredCellRACH-List
MonitoredCellRACH-List-v7g0ext ::=   SEQUENCE (SIZE (1..8)) OF
                                     DeltaRSCPPerCell

MeasuredResultsOnRACHinterFreq ::=   SEQUENCE {
    interFreqCellIndication-SIB11     INTEGER (0..1),
    interFreqCellIndication-SIB12     INTEGER (0..1),
    interFreqRACHRepCellsList         InterFreqRACHRepCellsList
}

```

```

MeasurementCommand ::=
    CHOICE {
        setup
        modify
            measurementType
        },
        release
    }

MeasurementCommand-r4 ::=
    CHOICE {
        MeasurementType-r4,
        SEQUENCE {
            MeasurementType-r4
        }
    }

MeasurementCommand-r6 ::=
    CHOICE {
        MeasurementType-r6,
        SEQUENCE {
            MeasurementType-r6
        }
    }

MeasurementCommand-r7 ::=
    CHOICE {
        MeasurementType-r7,
        SEQUENCE {
            MeasurementType-r7
        }
    }

MeasurementCommand-r8 ::=
    CHOICE {
        MeasurementType-r8,
        SEQUENCE {
            MeasurementType-r8
        }
    }

MeasurementControlSysInfo ::= SEQUENCE {
    -- CHOICE cellSelectQualityMeasure represents PCCPCH-RSCP in TDD mode.
    use-of-HCS CHOICE {
        hcs-not-used SEQUENCE {
            cellSelectQualityMeasure CHOICE {
                cpich-RSCP SEQUENCE {
                    intraFreqMeasurementSysInfo IntraFreqMeasurementSysInfo-RSCP OPTIONAL,
                    interFreqMeasurementSysInfo InterFreqMeasurementSysInfo-RSCP OPTIONAL
                },
                cpich-Ec-NO SEQUENCE {
                    intraFreqMeasurementSysInfo IntraFreqMeasurementSysInfo-ECNO OPTIONAL,
                    interFreqMeasurementSysInfo InterFreqMeasurementSysInfo-ECNO OPTIONAL
                }
            },
            interRATMeasurementSysInfo InterRATMeasurementSysInfo-B OPTIONAL
        },
        hcs-used SEQUENCE {
            cellSelectQualityMeasure CHOICE {
                cpich-RSCP SEQUENCE {
                    intraFreqMeasurementSysInfo IntraFreqMeasurementSysInfo-HCS-RSCP OPTIONAL,
                    interFreqMeasurementSysInfo InterFreqMeasurementSysInfo-HCS-RSCP OPTIONAL
                },
                cpich-Ec-NO SEQUENCE {
                    intraFreqMeasurementSysInfo IntraFreqMeasurementSysInfo-HCS-ECNO OPTIONAL,
                    interFreqMeasurementSysInfo InterFreqMeasurementSysInfo-HCS-ECNO OPTIONAL
                }
            },
            interRATMeasurementSysInfo InterRATMeasurementSysInfo OPTIONAL
        }
    },
    trafficVolumeMeasSysInfo TrafficVolumeMeasSysInfo OPTIONAL,
    -- dummy is not used in this version of specification and it shall be ignored by the UE.
    dummy UE-InternalMeasurementSysInfo OPTIONAL
}

MeasurementControlSysInfoExtension ::= SEQUENCE {
    -- CHOICE cellSelectQualityMeasure represents PCCPCH-RSCP in TDD mode.
    use-of-HCS CHOICE {

```



```

hcs-not-used          SEQUENCE {
  cellSelectQualityMeasure CHOICE {
    cpich-RSCP          SEQUENCE {
      newIntraFreqCellList      NewIntraFreqCellSI-List-RSCP  OPTIONAL,
      newInterFreqCellList      NewInterFreqCellSI-List-RSCP  OPTIONAL
    },
    cpich-Ec-N0          SEQUENCE {
      newIntraFreqCellList      NewIntraFreqCellSI-List-ECN0  OPTIONAL,
      newInterFreqCellList      NewInterFreqCellSI-List-ECN0  OPTIONAL
    }
  },
  newInterRATCellList      NewInterRATCellList      OPTIONAL
},
hcs-used              SEQUENCE {
  cellSelectQualityMeasure CHOICE {
    cpich-RSCP          SEQUENCE {
      newIntraFreqCellList      NewIntraFreqCellSI-List-HCS-RSCP  OPTIONAL,
      newInterFreqCellList      NewInterFreqCellSI-List-HCS-RSCP  OPTIONAL
    },
    cpich-Ec-N0          SEQUENCE {
      newIntraFreqCellList      NewIntraFreqCellSI-List-HCS-ECN0  OPTIONAL,
      newInterFreqCellList      NewInterFreqCellSI-List-HCS-ECN0  OPTIONAL
    }
  },
  newInterRATCellList      NewInterRATCellList      OPTIONAL
}
}
}

```

```

MeasurementControlSysInfoExtensionAddon-r5 ::= SEQUENCE {
  --The order of the list corresponds to the order of cell in newIntraFrequencyCellInfoList
  newIntraFrequencyCellInfoListAddon-r5 SEQUENCE (SIZE (1..maxCellMeas)) OF
    CellSelectReselectInfo-v590ext OPTIONAL,
  --The order of the list corresponds to the order of cell in newInterFrequencyCellInfoList
  newInterFrequencyCellInfoListAddon-r5 SEQUENCE (SIZE (1..maxCellMeas)) OF
    CellSelectReselectInfo-v590ext OPTIONAL,
  --The order of the list corresponds to the order of cell in newInterRATCellInfoList
  newInterRATCellInfoListAddon-r5 SEQUENCE (SIZE (1..maxCellMeas)) OF
    CellSelectReselectInfo-v590ext OPTIONAL
}

```

```

MeasurementControlSysInfoExtension-LCR-r4 ::= SEQUENCE {
  -- CHOICE cellSelectQualityMeasure represents PCCPCH-RSCP in TDD mode.
  use-of-HCS CHOICE {
    hcs-not-used SEQUENCE {
      cellSelectQualityMeasure CHOICE {
        cpich-RSCP          SEQUENCE {
          newIntraFreqCellList      NewIntraFreqCellSI-List-RSCP-LCR-r4 OPTIONAL,
          newInterFreqCellList      NewInterFreqCellSI-List-RSCP-LCR-r4 OPTIONAL
        },
        cpich-Ec-N0          SEQUENCE {
          newIntraFreqCellList      NewIntraFreqCellSI-List-ECN0-LCR-r4 OPTIONAL,
          newInterFreqCellList      NewInterFreqCellSI-List-ECN0-LCR-r4 OPTIONAL
        }
      },
      newInterRATCellList      NewInterRATCellList      OPTIONAL
    },
    hcs-used SEQUENCE {
      cellSelectQualityMeasure CHOICE {
        cpich-RSCP          SEQUENCE {
          newIntraFreqCellList      NewIntraFreqCellSI-List-HCS-RSCP-LCR-r4 OPTIONAL,
          newInterFreqCellList      NewInterFreqCellSI-List-HCS-RSCP-LCR-r4 OPTIONAL
        },
        cpich-Ec-N0          SEQUENCE {
          newIntraFreqCellList      NewIntraFreqCellSI-List-HCS-ECN0-LCR-r4 OPTIONAL,
          newInterFreqCellList      NewInterFreqCellSI-List-HCS-ECN0-LCR-r4 OPTIONAL
        }
      },
      newInterRATCellList      NewInterRATCellList      OPTIONAL
    }
  }
}
}
}

```

```

MeasurementControlSysInfo-LCR-r4-ext ::= SEQUENCE {
  -- CHOICE use-of-HCS shall have the same value as the use-of-HCS
  -- in MeasurementControlSysInfo
  -- CHOICE cellSelectQualityMeasure represents PCCPCH-RSCP in TDD mode.
  use-of-HCS CHOICE {

```

```

hcs-not-used          SEQUENCE {
-- CHOICE cellSelectQualityMeasure shall have the same value as the
-- cellSelectQualityMeasure in MeasurementControlSysInfo
cellSelectQualityMeasure CHOICE {
  cpich-RSCP          SEQUENCE {
    intraFreqMeasurementSysInfo IntraFreqMeasurementSysInfo-RSCP-LCR-r4 OPTIONAL,
    interFreqMeasurementSysInfo InterFreqMeasurementSysInfo-RSCP-LCR-r4 OPTIONAL
  },
  cpich-Ec-N0        SEQUENCE {
    intraFreqMeasurementSysInfo IntraFreqMeasurementSysInfo-ECN0-LCR-r4 OPTIONAL,
    interFreqMeasurementSysInfo InterFreqMeasurementSysInfo-ECN0-LCR-r4 OPTIONAL
  }
},
},
hcs-used              SEQUENCE {
-- CHOICE cellSelectQualityMeasure shall have the same value as the
-- cellSelectQualityMeasure in MeasurementControlSysInfo
cellSelectQualityMeasure CHOICE {
  cpich-RSCP          SEQUENCE {
    intraFreqMeasurementSysInfo IntraFreqMeasurementSysInfo-HCS-RSCP-LCR-r4 OPTIONAL,
    interFreqMeasurementSysInfo InterFreqMeasurementSysInfo-HCS-RSCP-LCR-r4 OPTIONAL
  },
  cpich-Ec-N0        SEQUENCE {
    intraFreqMeasurementSysInfo IntraFreqMeasurementSysInfo-HCS-ECN0-LCR-r4 OPTIONAL,
    interFreqMeasurementSysInfo InterFreqMeasurementSysInfo-HCS-ECN0-LCR-r4 OPTIONAL
  }
},
},
},
}

MeasurementIdentity ::= INTEGER (1..16)

MeasurementQuantityGSM ::= ENUMERATED {
  gsm-CarrierRSSI,
  dummy }

MeasurementQuantityEUTRA ::= ENUMERATED {
  rrsp,
  rsrq }

MeasurementReportingMode ::= SEQUENCE {
  measurementReportTransferMode TransferMode,
  periodicalOrEventTrigger PeriodicalOrEventTrigger
}

MeasurementType ::= CHOICE {
  intraFrequencyMeasurement IntraFrequencyMeasurement,
  interFrequencyMeasurement InterFrequencyMeasurement,
  interRATMeasurement InterRATMeasurement,
  ue-positioning-Measurement UE-Positioning-Measurement,
  trafficVolumeMeasurement TrafficVolumeMeasurement,
  qualityMeasurement QualityMeasurement,
  ue-InternalMeasurement UE-InternalMeasurement
}

MeasurementType-r4 ::= CHOICE {
  intraFrequencyMeasurement IntraFrequencyMeasurement-r4,
  interFrequencyMeasurement InterFrequencyMeasurement-r4,
  interRATMeasurement InterRATMeasurement-r4,
  up-Measurement UE-Positioning-Measurement-r4,
  trafficVolumeMeasurement TrafficVolumeMeasurement,
  qualityMeasurement QualityMeasurement,
  ue-InternalMeasurement UE-InternalMeasurement-r4
}

MeasurementType-r6 ::= CHOICE {
  intraFrequencyMeasurement IntraFrequencyMeasurement-r6,
  interFrequencyMeasurement InterFrequencyMeasurement-r6,
  interRATMeasurement InterRATMeasurement-r6,
  up-Measurement UE-Positioning-Measurement-r4,
  trafficVolumeMeasurement TrafficVolumeMeasurement,
  qualityMeasurement QualityMeasurement,
  ue-InternalMeasurement UE-InternalMeasurement-r4
}

MeasurementType-r7 ::= CHOICE {
  intraFrequencyMeasurement IntraFrequencyMeasurement-r7,

```

```

interFrequencyMeasurement      InterFrequencyMeasurement-r7,
interRATMeasurement           InterRATMeasurement-r6,
up-Measurement                 UE-Positioning-Measurement-r7,
trafficVolumeMeasurement      TrafficVolumeMeasurement,
qualityMeasurement            QualityMeasurement,
ue-InternalMeasurement        UE-InternalMeasurement-r4
}

MeasurementType-r8 ::=
  intraFrequencyMeasurement    IntraFrequencyMeasurement-r7,
  interFrequencyMeasurement    InterFrequencyMeasurement-r8,
  interRATMeasurement         InterRATMeasurement-r8,
  up-Measurement               UE-Positioning-Measurement-r8,
  trafficVolumeMeasurement    TrafficVolumeMeasurement,
  qualityMeasurement           QualityMeasurement,
  ue-InternalMeasurement      UE-InternalMeasurement-r4
}

MeasurementValidity ::=
  ue-State                     SEQUENCE {
                                ENUMERATED {
                                  cell-DCH, all-But-Cell-DCH, all-States }
                                }
}

MonitoredCellRACH-List ::=
  SEQUENCE (SIZE (1..8)) OF
    MonitoredCellRACH-Result

MonitoredCellRACH-Result ::=
  sfm-SFM-ObsTimeDifference    SFM-SFM-ObsTimeDifference          OPTIONAL,
  modeSpecificInfo            CHOICE {
    fdd                        SEQUENCE {
      primaryCPICH-Info       PrimaryCPICH-Info,
      measurementQuantity     CHOICE {
        cpich-Ec-NO           CPICH-Ec-NO,
        cpich-RSCP            CPICH-RSCP,
        pathloss               Pathloss,
        spare                  NULL
      }
    },
    tdd                        SEQUENCE {
      cellParametersID        CellParametersID,
      primaryCCPCH-RSCP       PrimaryCCPCH-RSCP
    }
  }
}

MultipathIndicator ::=
  ENUMERATED {
    nm,
    low,
    medium,
    high }

N-CR-T-CRMaxHyst ::=
  n-CR                         INTEGER (1..16)          DEFAULT 8,
  t-CRMaxHyst                  T-CRMaxHyst
}

NAVclockModel ::=
  navToc                       BIT STRING (SIZE (16)),
  navaf2                       BIT STRING (SIZE (8)),
  navaf1                       BIT STRING (SIZE (16)),
  navaf0                       BIT STRING (SIZE (22)),
  navTgd                       BIT STRING (SIZE (8))
}

NavigationModelSatInfo ::=
  satID                         SatID,
  satelliteStatus               SatelliteStatus,
  ephemerisParameter           EphemerisParameter          OPTIONAL
}

NavigationModelSatInfoList ::=
  SEQUENCE (SIZE (1..maxSat)) OF
    NavigationModelSatInfo

NavModel-CNAVKeplerianSet ::=
  cnavTop                       BIT STRING (SIZE (11)),
  cnavURAindex                 BIT STRING (SIZE (5)),
  cnavDeltaA                    BIT STRING (SIZE (26)),
  cnavAdot                      BIT STRING (SIZE (25)),

```

```

    cnavDeltaNo          BIT STRING (SIZE (17)),
    cnavDeltaNoDot       BIT STRING (SIZE (23)),
    cnavMo               BIT STRING (SIZE (33)),
    cnavE               BIT STRING (SIZE (33)),
    cnavOmega           BIT STRING (SIZE (33)),
    cnavOMEGA0          BIT STRING (SIZE (33)),
    cnavDeltaOmegaDot   BIT STRING (SIZE (17)),
    cnavIo              BIT STRING (SIZE (33)),
    cnavIoDot           BIT STRING (SIZE (15)),
    cnavCis             BIT STRING (SIZE (16)),
    cnavCic             BIT STRING (SIZE (16)),
    cnavCrs             BIT STRING (SIZE (24)),
    cnavCrc             BIT STRING (SIZE (24)),
    cnavCus             BIT STRING (SIZE (21)),
    cnavCuc             BIT STRING (SIZE (21))
}

NavModel-GLONASsecef ::= SEQUENCE {
    gloEn          BIT STRING (SIZE (5)),
    gloP1         BIT STRING (SIZE (2)),
    gloP2         BIT STRING (SIZE (1)),
    gloM          BIT STRING (SIZE (2))                OPTIONAL,
    gloX          BIT STRING (SIZE (27)),
    gloXdot       BIT STRING (SIZE (24)),
    gloXdotdot    BIT STRING (SIZE (5)),
    gloY          BIT STRING (SIZE (27)),
    gloYdot       BIT STRING (SIZE (24)),
    gloYdotdot    BIT STRING (SIZE (5)),
    gloZ          BIT STRING (SIZE (27)),
    gloZdot       BIT STRING (SIZE (24)),
    gloZdotdot    BIT STRING (SIZE (5))
}

NavModel-NAVKeplerianSet ::= SEQUENCE {
    navURA       BIT STRING (SIZE (4)),
    navFitFlag    BIT STRING (SIZE (1)),
    navToe        BIT STRING (SIZE (16)),
    navOmega      BIT STRING (SIZE (32)),
    navDeltaN     BIT STRING (SIZE (16)),
    navM0         BIT STRING (SIZE (32)),
    navOmegaADot  BIT STRING (SIZE (24)),
    navE          BIT STRING (SIZE (32)),
    navIDot       BIT STRING (SIZE (14)),
    navAPowerHalf BIT STRING (SIZE (32)),
    navI0         BIT STRING (SIZE (32)),
    navOmegaA0    BIT STRING (SIZE (32)),
    navCrs        BIT STRING (SIZE (16)),
    navCis        BIT STRING (SIZE (16)),
    navCus        BIT STRING (SIZE (16)),
    navCrc        BIT STRING (SIZE (16)),
    navCic        BIT STRING (SIZE (16)),
    navCuc        BIT STRING (SIZE (16))
}

NavModel-SBASsecef ::= SEQUENCE {
    sbasTo        BIT STRING (SIZE (13))                OPTIONAL,
    sbasAccuracy  BIT STRING (SIZE (4)),
    sbasXg        BIT STRING (SIZE (30)),
    sbasYg        BIT STRING (SIZE (30)),
    sbasZg        BIT STRING (SIZE (25)),
    sbasXgDot     BIT STRING (SIZE (17)),
    sbasYgDot     BIT STRING (SIZE (17)),
    sbasZgDot     BIT STRING (SIZE (18)),
    sbasXgDotDot  BIT STRING (SIZE (10)),
    sbasYgDotDot  BIT STRING (SIZE (10)),
    sbasZgDotDot  BIT STRING (SIZE (10))
}

EphemerisParameter ::= SEQUENCE {
    codeOnL2      BIT STRING (SIZE (2)),
    uraIndex      BIT STRING (SIZE (4)),
    satHealth     BIT STRING (SIZE (6)),
    iodc          BIT STRING (SIZE (10)),
    l2Pflag       BIT STRING (SIZE (1)),
    sf1Revd       SubFrame1Reserved,
    t-GD          BIT STRING (SIZE (8)),
    t-oc          BIT STRING (SIZE (16)),
    af2           BIT STRING (SIZE (8)),

```

```

af1 BIT STRING (SIZE (16)),
af0 BIT STRING (SIZE (22)),
c-rs BIT STRING (SIZE (16)),
delta-n BIT STRING (SIZE (16)),
m0 BIT STRING (SIZE (32)),
c-uc BIT STRING (SIZE (16)),
e BIT STRING (SIZE (32)),
c-us BIT STRING (SIZE (16)),
a-Sqrt BIT STRING (SIZE (32)),
t-oe BIT STRING (SIZE (16)),
fitInterval BIT STRING (SIZE (1)),
aodo BIT STRING (SIZE (5)),
c-ic BIT STRING (SIZE (16)),
omega0 BIT STRING (SIZE (32)),
c-is BIT STRING (SIZE (16)),
i0 BIT STRING (SIZE (32)),
c-rc BIT STRING (SIZE (16)),
omega BIT STRING (SIZE (32)),
omegaDot BIT STRING (SIZE (24)),
iDot BIT STRING (SIZE (14))
}
NC-Mode ::= BIT STRING (SIZE (3))

Neighbour ::= SEQUENCE {
  modeSpecificInfo CHOICE {
    fdd SEQUENCE {
      neighbourIdentity PrimaryCPICH-Info OPTIONAL,
      ue-RX-TX-TimeDifferenceType2Info UE-RX-TX-TimeDifferenceType2Info OPTIONAL
    },
    tdd SEQUENCE {
      neighbourAndChannelIdentity CellAndChannelIdentity OPTIONAL
    }
  },
  neighbourQuality NeighbourQuality,
  sfn-SFN-ObsTimeDifference2 SFN-SFN-ObsTimeDifference2}

Neighbour-v390ext ::= SEQUENCE {
  modeSpecificInfo CHOICE {
    fdd SEQUENCE {
      frequencyInfo FrequencyInfo
    },
    tdd NULL
  }
}

NeighbourList ::= SEQUENCE (SIZE (1..maxCellMeas)) OF Neighbour

Neighbour-TDD-r7 ::= SEQUENCE {
  uarfcn UARFCN OPTIONAL
}

-- The order of the cells in IE NeighbourList-TDD-r7 shall be the
-- same as the order in IE NeighbourList
NeighbourList-TDD-r7 ::= SEQUENCE (SIZE (1..maxCellMeas)) OF Neighbour-TDD-r7

-- The order of the cells in IE NeighbourList-v390ext shall be the
-- same as the order in IE NeighbourList
NeighbourList-v390ext ::= SEQUENCE (SIZE (1..maxCellMeas)) OF Neighbour-v390ext

NeighbourQuality ::= SEQUENCE {
  ue-Positioning-OTDOA-Quality UE-Positioning-OTDOA-Quality
}

NewInterFreqCell ::= SEQUENCE {
  interFreqCellID InterFreqCellID OPTIONAL,
  frequencyInfo FrequencyInfo OPTIONAL,
  cellInfo CellInfo
}

NewInterFreqCell-r4 ::= SEQUENCE {
  interFreqCellID InterFreqCellID OPTIONAL,
  frequencyInfo FrequencyInfo OPTIONAL,
  cellInfo-r4 CellInfo-r4
}

NewInterFreqCell-v7b0ext ::= SEQUENCE {

```

```

    intraSecondaryFreqIndicator      BOOLEAN
  }

NewInterFreqCell-r8 ::= SEQUENCE {
    interFreqCellID                  InterFreqCellID          OPTIONAL,
    frequencyInfo                    FrequencyInfo            OPTIONAL,
    cellInfo                          CellInfo-r4,
    modeSpecificInfo                 CHOICE {
        noInfo                       NULL,
        tdd128                       SEQUENCE {
            intraSecondaryFreqIndicator  BOOLEAN
        }
    }
}

NewInterFreqCell-LCR-v8a0ext ::= SEQUENCE {
    cellInfo-LCR-r8                  CellInfo-LCR-r8-ext      OPTIONAL
}

NewInterFreqCellList ::= SEQUENCE (SIZE (1..maxCellMeas)) OF
    NewInterFreqCell

NewInterFreqCellList-r4 ::= SEQUENCE (SIZE (1..maxCellMeas)) OF
    NewInterFreqCell-r4

-- The order of the list corresponds to the order of cells in newInterFreqCellList
NewInterFreqCellList-v7b0ext ::= SEQUENCE (SIZE (1..maxCellMeas)) OF
    NewInterFreqCell-v7b0ext

-- The order of the list corresponds to the order of cells in newInterFreqCellList
NewInterFreqCellList-LCR-v8a0ext ::= SEQUENCE (SIZE (1..maxCellMeas)) OF
    NewInterFreqCell-LCR-v8a0ext

NewInterFreqCellList-r8 ::= SEQUENCE (SIZE (1..maxCellMeas)) OF
    NewInterFreqCell-r8

NewInterFreqCellSI-RSCP ::= SEQUENCE {
    interFreqCellID                  InterFreqCellID          OPTIONAL,
    frequencyInfo                    FrequencyInfo            OPTIONAL,
    cellInfo                          CellInfoSI-RSCP
}

NewInterFreqCellSI-ECN0 ::= SEQUENCE {
    interFreqCellID                  InterFreqCellID          OPTIONAL,
    frequencyInfo                    FrequencyInfo            OPTIONAL,
    cellInfo                          CellInfoSI-ECN0
}

NewInterFreqCellSI-HCS-RSCP ::= SEQUENCE {
    interFreqCellID                  InterFreqCellID          OPTIONAL,
    frequencyInfo                    FrequencyInfo            OPTIONAL,
    cellInfo                          CellInfoSI-HCS-RSCP
}

NewInterFreqCellSI-HCS-ECN0 ::= SEQUENCE {
    interFreqCellID                  InterFreqCellID          OPTIONAL,
    frequencyInfo                    FrequencyInfo            OPTIONAL,
    cellInfo                          CellInfoSI-HCS-ECN0
}

NewInterFreqCellSI-RSCP-LCR-r4 ::= SEQUENCE {
    interFreqCellID                  InterFreqCellID          OPTIONAL,
    frequencyInfo                    FrequencyInfo            OPTIONAL,
    cellInfo                          CellInfoSI-RSCP-LCR-r4
}

NewInterFreqCellSI-ECN0-LCR-r4 ::= SEQUENCE {
    interFreqCellID                  InterFreqCellID          OPTIONAL,
    frequencyInfo                    FrequencyInfo            OPTIONAL,
    cellInfo                          CellInfoSI-ECN0-LCR-r4
}

NewInterFreqCellSI-HCS-RSCP-LCR-r4 ::= SEQUENCE {
    interFreqCellID                  InterFreqCellID          OPTIONAL,
    frequencyInfo                    FrequencyInfo            OPTIONAL,
    cellInfo                          CellInfoSI-HCS-RSCP-LCR-r4
}

```

```

NewInterFreqCellSI-HCS-ECNO-LCR-r4 ::= SEQUENCE {
    interFreqCellID          InterFreqCellID          OPTIONAL,
    frequencyInfo            FrequencyInfo            OPTIONAL,
    cellInfo                  CellInfoSI-HCS-ECNO-LCR-r4
}

NewInterFreqCellSI-List-ECNO ::= SEQUENCE (SIZE (1..maxCellMeas)) OF
NewInterFreqCellSI-ECNO

NewInterFreqCellSI-List-HCS-RSCP ::= SEQUENCE (SIZE (1..maxCellMeas)) OF
NewInterFreqCellSI-HCS-RSCP

NewInterFreqCellSI-List-HCS-ECNO ::= SEQUENCE (SIZE (1..maxCellMeas)) OF
NewInterFreqCellSI-HCS-ECNO

NewInterFreqCellSI-List-RSCP ::= SEQUENCE (SIZE (1..maxCellMeas)) OF
NewInterFreqCellSI-RSCP

NewInterFreqCellSI-List-ECNO-LCR-r4 ::= SEQUENCE (SIZE (1..maxCellMeas)) OF
NewInterFreqCellSI-ECNO-LCR-r4

NewInterFreqCellSI-List-HCS-RSCP-LCR-r4 ::= SEQUENCE (SIZE (1..maxCellMeas)) OF
NewInterFreqCellSI-HCS-RSCP-LCR-r4

NewInterFreqCellSI-List-HCS-ECNO-LCR-r4 ::= SEQUENCE (SIZE (1..maxCellMeas)) OF
NewInterFreqCellSI-HCS-ECNO-LCR-r4

NewInterFreqCellSI-List-RSCP-LCR-r4 ::= SEQUENCE (SIZE (1..maxCellMeas)) OF
NewInterFreqCellSI-RSCP-LCR-r4

NewInterRATCell ::= SEQUENCE {
    interRATCellID          InterRATCellID          OPTIONAL,
    technologySpecificInfo CHOICE {
        gsm SEQUENCE {
            cellSelectionReselectionInfo CellSelectReselectInfoSIB-11-12 OPTIONAL,
            interRATCellIndividualOffset InterRATCellIndividualOffset,
            bsic BSIC,
            frequency-band Frequency-Band,
            bcch-ARFCN BCCH-ARFCN,
            -- dummy is not used in this version of the specification, it should
            -- not be sent and if received it should be ignored.
            dummy NULL OPTIONAL
        },
        is-2000 SEQUENCE {
            is-2000SpecificMeasInfo IS-2000SpecificMeasInfo
        },
        -- ASN.1 inconsistency: NewInterRATCellList should be optional within
        -- InterRATCellInfoList. The UE shall consider IE NewInterRATCell with
        -- technologySpecificInfo set to "absent" as valid and handle the
        -- message as if the IE NewInterRATCell was absent
        absent NULL,
        spare1 NULL
    }
}

NewInterRATCell-B ::= SEQUENCE {
    interRATCellID          InterRATCellID          OPTIONAL,
    technologySpecificInfo CHOICE {
        gsm SEQUENCE {
            cellSelectionReselectionInfo CellSelectReselectInfoSIB-11-12 OPTIONAL,
            interRATCellIndividualOffset InterRATCellIndividualOffset,
            bsic BSIC,
            frequency-band Frequency-Band,
            bcch-ARFCN BCCH-ARFCN,
            -- dummy is not used in this version of the specification, it should
            -- not be sent and if received it should be ignored.
            dummy NULL OPTIONAL
        },
        is-2000 SEQUENCE {
            is-2000SpecificMeasInfo IS-2000SpecificMeasInfo
        },
        -- ASN.1 inconsistency: NewInterRATCellList-B should be optional within
        -- InterRATCellInfoList-B. The UE shall consider IE NewInterRATCell-B with
        -- technologySpecificInfo set to "absent" as valid and handle the
        -- message as if the IE NewInterRATCell-B was absent
        absent NULL,
        spare1 NULL
    }
}

```

```

}
NewInterRATCellList ::= SEQUENCE (SIZE (1..maxCellMeas)) OF
                        NewInterRATCell

NewInterRATCellList-B ::= SEQUENCE (SIZE (1..maxCellMeas)) OF
                        NewInterRATCell-B

NewIntraFreqCell ::= SEQUENCE {
    intraFreqCellID      IntraFreqCellID      OPTIONAL,
    cellInfo             CellInfo
}

NewIntraFreqCell-r4 ::= SEQUENCE {
    intraFreqCellID      IntraFreqCellID      OPTIONAL,
    cellInfo             CellInfo-r4
}

NewIntraFreqCellList ::= SEQUENCE (SIZE (1..maxCellMeas)) OF
                        NewIntraFreqCell

NewIntraFreqCellList-r4 ::= SEQUENCE (SIZE (1..maxCellMeas)) OF
                        NewIntraFreqCell-r4

NewIntraFreqCell-LCR-v8a0ext ::= SEQUENCE {
    cellInfo-LCR-r8      CellInfo-LCR-r8-ext   OPTIONAL
}

-- The order of the list corresponds to the order of cells in newIntraFreqCellList
NewIntraFreqCellList-LCR-v8a0ext ::= SEQUENCE (SIZE (1..maxCellMeas)) OF
                        NewIntraFreqCell-LCR-v8a0ext

NewIntraFreqCellSI-RSCP ::= SEQUENCE {
    intraFreqCellID      IntraFreqCellID      OPTIONAL,
    cellInfo             CellInfoSI-RSCP
}

NewIntraFreqCellSI-ECN0 ::= SEQUENCE {
    intraFreqCellID      IntraFreqCellID      OPTIONAL,
    cellInfo             CellInfoSI-ECN0
}

NewIntraFreqCellSI-HCS-RSCP ::= SEQUENCE {
    intraFreqCellID      IntraFreqCellID      OPTIONAL,
    cellInfo             CellInfoSI-HCS-RSCP
}

NewIntraFreqCellSI-HCS-ECN0 ::= SEQUENCE {
    intraFreqCellID      IntraFreqCellID      OPTIONAL,
    cellInfo             CellInfoSI-HCS-ECN0
}

NewIntraFreqCellSI-RSCP-LCR-r4 ::= SEQUENCE {
    intraFreqCellID      IntraFreqCellID      OPTIONAL,
    cellInfo             CellInfoSI-RSCP-LCR-r4
}

NewIntraFreqCellSI-ECN0-LCR-r4 ::= SEQUENCE {
    intraFreqCellID      IntraFreqCellID      OPTIONAL,
    cellInfo             CellInfoSI-ECN0-LCR-r4
}

NewIntraFreqCellSI-HCS-RSCP-LCR-r4 ::= SEQUENCE {
    intraFreqCellID      IntraFreqCellID      OPTIONAL,
    cellInfo             CellInfoSI-HCS-RSCP-LCR-r4
}

NewIntraFreqCellSI-HCS-ECN0-LCR-r4 ::= SEQUENCE {
    intraFreqCellID      IntraFreqCellID      OPTIONAL,
    cellInfo             CellInfoSI-HCS-ECN0-LCR-r4
}

NewIntraFreqCellSI-List-RSCP ::= SEQUENCE (SIZE (1..maxCellMeas)) OF
                        NewIntraFreqCellSI-RSCP

NewIntraFreqCellSI-List-ECN0 ::= SEQUENCE (SIZE (1..maxCellMeas)) OF
                        NewIntraFreqCellSI-ECN0

NewIntraFreqCellSI-List-HCS-RSCP ::= SEQUENCE (SIZE (1..maxCellMeas)) OF
                        NewIntraFreqCellSI-HCS-RSCP

```



```

NewIntraFreqCellSI-List-HCS-ECN0 ::= SEQUENCE (SIZE (1..maxCellMeas)) OF
NewIntraFreqCellSI-HCS-ECN0

NewIntraFreqCellSI-List-RSCP-LCR-r4 ::= SEQUENCE (SIZE (1..maxCellMeas)) OF
NewIntraFreqCellSI-RSCP-LCR-r4

NewIntraFreqCellSI-List-ECN0-LCR-r4 ::= SEQUENCE (SIZE (1..maxCellMeas)) OF
NewIntraFreqCellSI-ECN0-LCR-r4

NewIntraFreqCellSI-List-HCS-RSCP-LCR-r4 ::= SEQUENCE (SIZE (1..maxCellMeas)) OF
NewIntraFreqCellSI-HCS-RSCP-LCR-r4

NewIntraFreqCellSI-List-HCS-ECN0-LCR-r4 ::= SEQUENCE (SIZE (1..maxCellMeas)) OF
NewIntraFreqCellSI-HCS-ECN0-LCR-r4

-- IE "nonUsedFreqThreshold" is not needed in case of event 2a
-- In case of event 2a UTRAN should include value 0 within IE "nonUsedFreqThreshold"
-- In case of event 2a, the UE shall be ignore IE "nonUsedFreqThreshold"
-- In later versions of the message including this IE, a special version of
-- IE "NonUsedFreqParameterList" may be defined for event 2a, namely a
-- version not including IE "nonUsedFreqThreshold"
NonUsedFreqParameter ::= SEQUENCE {
    nonUsedFreqThreshold Threshold,
    nonUsedFreqW W
}

NonUsedFreqParameter-r6 ::= SEQUENCE {
    nonUsedFreqThreshold Threshold-r6,
    nonUsedFreqW W
}

NonUsedFreqParameterList ::= SEQUENCE (SIZE (1..maxFreq)) OF
NonUsedFreqParameter

NonUsedFreqParameterList-r6 ::= SEQUENCE (SIZE (1..maxFreq)) OF
NonUsedFreqParameter-r6

NonUsedFreqWList-r6 ::= SEQUENCE (SIZE (1..maxFreq)) OF W

ObservedTimeDifferenceToGSM ::= INTEGER (0..4095)

OTDOA-SearchWindowSize ::= ENUMERATED {
    c20, c40, c80, c160, c320,
    c640, c1280, moreThan1280 }

-- SPARE: Pathloss, Max = 158
-- Values above Max are spare
Pathloss ::= INTEGER (46..173)

PenaltyTime-RSCP ::= CHOICE {
    notUsed NULL,
    pt10 TemporaryOffset1,
    pt20 TemporaryOffset1,
    pt30 TemporaryOffset1,
    pt40 TemporaryOffset1,
    pt50 TemporaryOffset1,
    pt60 TemporaryOffset1
}

PenaltyTime-ECN0 ::= CHOICE {
    notUsed NULL,
    pt10 TemporaryOffsetList,
    pt20 TemporaryOffsetList,
    pt30 TemporaryOffsetList,
    pt40 TemporaryOffsetList,
    pt50 TemporaryOffsetList,
    pt60 TemporaryOffsetList
}

PendingTimeAfterTrigger ::= ENUMERATED {
    ptat0-25, ptat0-5, ptat1,
    ptat2, ptat4, ptat8, ptat16 }

PeriodicalOrEventTrigger ::= ENUMERATED {
    periodical,
    eventTrigger }

```

```

PeriodicalReportingCriteria ::= SEQUENCE {
    reportingAmount          ReportingAmount          DEFAULT ra-Infinity,
    reportingInterval        ReportingIntervalLong
}

PeriodicalWithReportingCellStatus ::= SEQUENCE {
    periodicalReportingCriteria PeriodicalReportingCriteria,
    reportingCellStatus        ReportingCellStatus        OPTIONAL
}

PLMNIdentitiesOfNeighbourCells ::= SEQUENCE {
    plmnsOfIntraFreqCellsList PLMNsOfIntraFreqCellsList    OPTIONAL,
    plmnsOfInterFreqCellsList PLMNsOfInterFreqCellsList    OPTIONAL,
    plmnsOfInterRATCellsList  PLMNsOfInterRATCellsList    OPTIONAL
}

PLMNIdentitiesOfNeighbourCells-v860ext ::= SEQUENCE {
    multipleplmnsOfIntraFreqCellsList MultiplePLMNsOfIntraFreqCellsList    OPTIONAL,
    multipleplmnsOfInterFreqCellsList MultiplePLMNsOfInterFreqCellsList    OPTIONAL
}

PLMNsOfInterFreqCellsList ::= SEQUENCE (SIZE (1..maxCellMeas)) OF
    SEQUENCE {
        plmn-Identity          PLMN-Identity          OPTIONAL
    }

MultiplePLMNsOfInterFreqCellsList ::= SEQUENCE (SIZE (1..maxCellMeas)) OF
    SEQUENCE {
        multiplePLMN-list      SEQUENCE (SIZE (1..6)) OF
                                PLMN-IdentityWithOptionalMCC-r6    OPTIONAL
    }

PLMNsOfIntraFreqCellsList ::= SEQUENCE (SIZE (1..maxCellMeas)) OF
    SEQUENCE {
        plmn-Identity          PLMN-Identity          OPTIONAL
    }

MultiplePLMNsOfIntraFreqCellsList ::= SEQUENCE (SIZE (1..maxCellMeas)) OF
    SEQUENCE {
        multiplePLMN-list      SEQUENCE (SIZE (1..6)) OF
                                PLMN-IdentityWithOptionalMCC-r6    OPTIONAL
    }

PLMNsOfInterRATCellsList ::= SEQUENCE (SIZE (1..maxCellMeas)) OF
    SEQUENCE {
        plmn-Identity          PLMN-Identity          OPTIONAL
    }

PositionEstimate ::= CHOICE {
    ellipsoidPoint          EllipsoidPoint,
    ellipsoidPointUncertCircle EllipsoidPointUncertCircle,
    ellipsoidPointUncertEllipse EllipsoidPointUncertEllipse,
    ellipsoidPointAltitude EllipsoidPointAltitude,
    ellipsoidPointAltitudeEllipse EllipsoidPointAltitudeEllipsoide
}

PositioningMethod ::= ENUMERATED {
    otdoa,
    gps,
    otdoaOrGPS, cellID }

-- Actual value PRC = IE value * 0.32
PRC ::= INTEGER (-2047..2047)

-- SPARE: PrimaryCCPCH-RSCP, Max = 91
-- Values above Max are spare
PrimaryCCPCH-RSCP ::= INTEGER (0..127)

Q-HCS ::= INTEGER (0..99)

Q-OffsetS-N ::= INTEGER (-50..50)

Q-QualMin ::= INTEGER (-24..0)

Q-QualMin-Offset ::= INTEGER (1..16)

-- Actual value Q-RxlevMin = (IE value * 2) + 1
Q-RxlevMin ::= INTEGER (-58..-13)

```

```

-- Actual value Q-RxlevMin-Offset = (IE value * 2)
Q-RxlevMin-Offset ::= INTEGER (1..8)

QualityEventResults ::= SEQUENCE (SIZE (1..maxTrCH)) OF
    TransportChannelIdentity

QualityMeasuredResults ::= SEQUENCE {
    blerMeasurementResultsList    BLER-MeasurementResultsList    OPTIONAL,
    modeSpecificInfo              CHOICE {
        fdd                        NULL,
        tdd                        SEQUENCE {
            sir-MeasurementResults    SIR-MeasurementList    OPTIONAL
        }
    }
}

QualityMeasurement ::= SEQUENCE {
    qualityReportingQuantity    QualityReportingQuantity    OPTIONAL,
    reportCriteria              QualityReportCriteria
}

QualityReportCriteria ::= CHOICE {
    qualityReportingCriteria    QualityReportingCriteria,
    periodicalReportingCriteria PeriodicalReportingCriteria,
    noReporting                 NULL
}

QualityReportingCriteria ::= SEQUENCE (SIZE (1..maxTrCH)) OF
    QualityReportingCriteriaSingle

QualityReportingCriteriaSingle ::= SEQUENCE {
    transportChannelIdentity    TransportChannelIdentity,
    totalCRC                    INTEGER (1..512),
    badCRC                      INTEGER (1..512),
    pendingAfterTrigger        INTEGER (1..512)
}

QualityReportingQuantity ::= SEQUENCE {
    dl-TransChBLER              BOOLEAN,
    bler-dl-TransChIdList       BLER-TransChIdList    OPTIONAL,
    modeSpecificInfo            CHOICE {
        fdd                      NULL,
        tdd                      SEQUENCE {
            sir-TFCS-List        SIR-TFCS-List    OPTIONAL
        }
    }
}

RAT-Type ::= ENUMERATED {
    gsm, is2000
}

ReferenceCellPosition ::= CHOICE {
    ellipsoidPoint              EllipsoidPoint,
    ellipsoidPointWithAltitude EllipsoidPointAltitude
}

-- ReferenceLocation, as defined in 23.032
ReferenceLocation ::= SEQUENCE {
    ellipsoidPointAltitudeEllipsoide EllipsoidPointAltitudeEllipsoide
}

ReferenceLocationGANSS ::= SEQUENCE {
    ellipsoidPointAltitudeEllipsoide EllipsoidPointAltitudeEllipsoide
}

ReferenceTimeDifferenceToCell ::= CHOICE {
    -- Actual value accuracy40 = IE value * 40
    accuracy40                  INTEGER (0..960),
    -- Actual value accuracy256 = IE value * 256
    accuracy256                 INTEGER (0..150),
    -- Actual value accuracy2560 = IE value * 2560
    accuracy2560                INTEGER (0..15)
}

RemovedInterFreqCellList ::= CHOICE {
    removeAllInterFreqCells    NULL,
    removeSomeInterFreqCells   SEQUENCE (SIZE (1..maxCellMeas)) OF
}

```

```

        InterFreqCellID,
    }
    removeNoInterFreqCells          NULL
}

RemovedInterRATCellList ::= CHOICE {
    removeAllInterRATCells          NULL,
    removeSomeInterRATCells        SEQUENCE (SIZE (1..maxCellMeas)) OF
                                    InterRATCellID,
    removeNoInterRATCells          NULL
}

RemovedIntraFreqCellList ::= CHOICE {
    removeAllIntraFreqCells        NULL,
    removeSomeIntraFreqCells      SEQUENCE (SIZE (1..maxCellMeas)) OF
                                    IntraFreqCellID,
    removeNoIntraFreqCells        NULL
}

ReplacementActivationThreshold ::= ENUMERATED {
    notApplicable, t1, t2,
    t3, t4, t5, t6, t7 }

ReportDeactivationThreshold ::= ENUMERATED {
    notApplicable, t1, t2,
    t3, t4, t5, t6, t7 }

ReportingAmount ::= ENUMERATED {
    ra1, ra2, ra4, ra8, ra16, ra32,
    ra64, ra-Infinity }

ReportingCellStatus ::= CHOICE{
    withinActiveSet                  MaxNumberOfReportingCellsType1,
    withinMonitoredSetUsedFreq      MaxNumberOfReportingCellsType1,
    withinActiveAndOrMonitoredUsedFreq MaxNumberOfReportingCellsType1,
    withinDetectedSetUsedFreq      MaxNumberOfReportingCellsType1,
    withinMonitoredAndOrDetectedUsedFreq
                                    MaxNumberOfReportingCellsType1,
    allActiveplusMonitoredSet       MaxNumberOfReportingCellsType3,
    allActivePlusDetectedSet        MaxNumberOfReportingCellsType3,
    allActivePlusMonitoredAndOrDetectedSet
                                    MaxNumberOfReportingCellsType3,
    withinVirtualActSet              MaxNumberOfReportingCellsType1,
    withinMonitoredSetNonUsedFreq   MaxNumberOfReportingCellsType1,
    withinMonitoredAndOrVirtualActiveSetNonUsedFreq
                                    MaxNumberOfReportingCellsType1,
    allVirtualActSetplusMonitoredSetNonUsedFreq
                                    MaxNumberOfReportingCellsType3,
    withinActSetOrVirtualActSet-InterRATcells
                                    MaxNumberOfReportingCellsType2,
    withinActSetAndOrMonitoredUsedFreqOrVirtualActSetAndOrMonitoredNonUsedFreq
                                    MaxNumberOfReportingCellsType2
}

ReportingCellStatusOpt ::= SEQUENCE {
    reportingCellStatus              ReportingCellStatus          OPTIONAL
}

ReportingInfoForCellDCH ::= SEQUENCE {
    intraFreqReportingQuantity      IntraFreqReportingQuantity,
    measurementReportingMode        MeasurementReportingMode,
    reportCriteria                  CellDCH-ReportCriteria
}

ReportingInfoForCellDCH-LCR-r4 ::= SEQUENCE {
    intraFreqReportingQuantity      IntraFreqReportingQuantity,
    measurementReportingMode        MeasurementReportingMode,
    reportCriteria                  CellDCH-ReportCriteria-LCR-r4
}

ReportingInterval ::= ENUMERATED {
    noPeriodicalreporting, ri0-25,
    ri0-5, ri1, ri2, ri4, ri8, ri16 }

ReportingIntervalLong ::= ENUMERATED {
    ril0, ril0-25, ril0-5, ril1,
    ril2, ril3, ril4, ril6, ril8,
    ril12, ril16, ril20, ril24,
}

```

```

        ril28, ril32, ril64 }
-- When the value "ril0" is used, the UE behaviour is not
-- defined.

-- Actual value ReportingRange = IE value * 0.5
ReportingRange ::=
    INTEGER (0..29)

ReqDataBitAssistance ::=
    SEQUENCE {
        ganssSignalID
            DGANSS-Sig-Id-Req,
        ganssDataBitInterval
            INTEGER (0..15),
        ganssSatelliteInfo
            SEQUENCE (SIZE (1..maxGANSSSat)) OF INTEGER(0..63) OPTIONAL
    }

RL-AdditionInfoList ::=
    SEQUENCE (SIZE (1..maxRL)) OF
        PrimaryCPICH-Info

RL-InformationLists ::=
    SEQUENCE {
        rl-AdditionInfoList
            RL-AdditionInfoList
            OPTIONAL,
        rl-RemovalInformationList
            RL-RemovalInformationList
            OPTIONAL
    }

RLC-BuffersPayload ::=
    ENUMERATED {
        pl0, pl4, pl8, pl16, pl32,
        pl64, pl128, pl256, pl512, pl1024,
        pl2k, pl4k, pl8k, pl16k, pl32k,
        pl64k, pl128k, pl256k, pl512k, pl1024k,
        spare12, spare11, spare10, spare9, spare8,
        spare7, spare6, spare5, spare4, spare3,
        spare2, spare1 }

-- Actual value RRC = IE value * 0.032
RRC ::=
    INTEGER (-127..127)

SatData ::=
    SEQUENCE{
        satID
            SatID,
        iode
            IODE
    }

SatDataList ::=
    SEQUENCE (SIZE (0..maxSat)) OF
        SatData

SatellitesListRelatedData ::=
    SEQUENCE {
        satId
            INTEGER (0..63),
        iod
            INTEGER (0..1023)
    }

SatellitesListRelatedDataList ::=
    SEQUENCE (SIZE (1..maxGANSSSat)) OF
        SatellitesListRelatedData

SatelliteStatus ::=
    ENUMERATED {
        ns-NN-U,
        es-SN,
        es-NN-U,
        rev2,
        rev }

Satellite-clock-model ::=
    SEQUENCE {
        t-oc
            BIT STRING (SIZE (14)),
        af2
            BIT STRING (SIZE (12)),
        af1
            BIT STRING (SIZE (18)),
        af0
            BIT STRING (SIZE (28)),
        tgd
            BIT STRING (SIZE (10))
            OPTIONAL,
        model-id
            INTEGER (0..1)
            OPTIONAL
    }

Satellite-clock-modelList ::=
    SEQUENCE (SIZE (1..maxSatClockModels)) OF Satellite-clock-model

-- Identifies the satellite and is equal to (SV ID No - 1) where SV ID No is defined in [12].
SatID ::=
    INTEGER (0..63)

SBASclockModel ::=
    SEQUENCE {
        sbasTo
            BIT STRING (SIZE (13)),
        sbasAgfo
            BIT STRING (SIZE (12)),
        sbasAgf1
            BIT STRING (SIZE (8))
    }

SFN-Offset-Validity ::=
    ENUMERATED { false }

```

```

SFN-SFN-Drift ::=
    ENUMERATED {
        sfnsfndrift0, sfnsfndrift1, sfnsfndrift2,
        sfnsfndrift3, sfnsfndrift4, sfnsfndrift5,
        sfnsfndrift8, sfnsfndrift10, sfnsfndrift15,
        sfnsfndrift25, sfnsfndrift35, sfnsfndrift50,
        sfnsfndrift65, sfnsfndrift80, sfnsfndrift100,
        sfnsfndrift-1, sfnsfndrift-2, sfnsfndrift-3,
        sfnsfndrift-4, sfnsfndrift-5, sfnsfndrift-8,
        sfnsfndrift-10, sfnsfndrift-15, sfnsfndrift-25,
        sfnsfndrift-35, sfnsfndrift-50, sfnsfndrift-65,
        sfnsfndrift-80, sfnsfndrift-100}

SFN-SFN-ObsTimeDifference ::=
    CHOICE {
        type1
        type2
    }

-- SPARE: SFN-SFN-ObsTimeDifference1, Max = 9830399
-- For 1.28Mcps TDD, Max value of SFN-SFN-ObsTimeDifference1 is 3276799.
-- Values above Max are spare
SFN-SFN-ObsTimeDifference1 ::=
    INTEGER (0..16777215)

-- SPARE: SFN-SFN-ObsTimeDifference2, Max = 40961
-- For 1.28Mcps TDD, Max value of SFN-SFN-ObsTimeDifference2 is 27649.
-- Values above Max are spare
SFN-SFN-ObsTimeDifference2 ::=
    INTEGER (0..65535)

SFN-SFN-OTD-Type ::=
    ENUMERATED {
        noReport,
        type1,
        type2 }

SFN-SFN-RelTimeDifference1 ::=
    SEQUENCE {
        sfn-Offset
        sfnsfn-Reltimedifference
    }

SFN-TOW-Uncertainty ::=
    ENUMERATED {
        lessThan10,
        moreThan10 }

SIR ::=
    INTEGER (0..63)

SIR-MeasurementList ::=
    SEQUENCE (SIZE (1..maxCCTrCH)) OF
        SIR-MeasurementResults

SIR-MeasurementResults ::=
    SEQUENCE {
        tfcs-ID
        sir-TimeslotList
    }

SIR-TFCS ::=
    TFCS-IdentityPlain

SIR-TFCS-List ::=
    SEQUENCE (SIZE (1..maxCCTrCH)) OF
        SIR-TFCS

SIR-TimeslotList ::=
    SEQUENCE (SIZE (1..maxTS)) OF
        SIR

-- SubFrame1Reserved, reserved bits in subframe 1 of the GPS navigation message
SubFrame1Reserved ::=
    SEQUENCE {
        reserved1
        reserved2
        reserved3
        reserved4
    }

T-ADVinfo ::=
    SEQUENCE {
        t-ADV
        sfnsfn
    }

T-ADVinfo-ext ::=
    SEQUENCE {
        t-ADV
        INTEGER (0..8191),
    }

```

```

    sfn                                INTEGER (0..4095)
}

T-CRMax ::=
    notUsed
    t30
    t60
    t120
    t180
    t240
}

T-CRMaxHyst ::=
    CHOICE {
        NULL,
        N-CR-T-CRMaxHyst,
        N-CR-T-CRMaxHyst,
        N-CR-T-CRMaxHyst,
        N-CR-T-CRMaxHyst,
        N-CR-T-CRMaxHyst
    }

TemporaryOffset1 ::=
    ENUMERATED {
        notUsed, t10, t20, t30,
        t40, t50, t60, t70 }

TemporaryOffset2 ::=
    ENUMERATED {
        to3, to6, to9, to12, to15,
        to18, to21, infinite }

TemporaryOffsetList ::=
    SEQUENCE {
        temporaryOffset1
        temporaryOffset2
    }

Threshold ::=
    INTEGER (-115..0)

Threshold-r6 ::=
    INTEGER (-120..0)

-- The order of the list corresponds to the order of frequency defined in Inter-FreqEventCriteria
ThresholdNonUsedFrequency-deltaList ::= SEQUENCE (SIZE (1..maxFreq)) OF
    DeltaRSCPPerCell

ThresholdPositionChange ::=
    ENUMERATED {
        pc10, pc20, pc30, pc40, pc50,
        pc100, pc200, pc300, pc500,
        pc1000, pc2000, pc5000, pc10000,
        pc20000, pc50000, pc100000 }

ThresholdsSFN-GANSS-TOW ::=
    ENUMERATED {
        us1, us2, us3, us5, us10,
        us20, us50, us100 }

ThresholdsSFN-GPS-TOW ::=
    ENUMERATED {
        ms1, ms2, ms3, ms5, ms10,
        ms20, ms50, ms100 }

ThresholdsSFN-GPS-TOW-us ::=
    ENUMERATED {
        us1, us2, us3, us5, us10,
        us20, us50, us100 }

ThresholdsSFN-SFN-Change ::=
    ENUMERATED {
        c0-25, c0-5, c1, c2, c3, c4, c5,
        c10, c20, c50, c100, c200, c500,
        c1000, c2000, c5000 }

ThresholdUsedFrequency ::=
    INTEGER (-115..165)

ThresholdUsedFrequency-r6 ::=
    INTEGER (-120..165)

-- Actual value TimeInterval = IE value * 20.
TimeInterval ::=
    INTEGER (1..13)

TimeslotInfo ::=
    SEQUENCE {
        timeslotNumber
        burstType
    }

TimeslotInfo-LCR-r4 ::=
    SEQUENCE {
        timeslotNumber
        TimeslotNumber-LCR-r4
    }

TimeslotInfoList ::=
    SEQUENCE (SIZE (1..maxTS)) OF

```

```

TimeslotInfo

TimeslotInfoList-LCR-r4 ::= SEQUENCE (SIZE (1..maxTS-LCR)) OF
    TimeslotInfo-LCR-r4

TimeslotInfoList-r4 ::= CHOICE {
    -- the choice for 7.68 Mcps TDD is the same as for 3.84 Mcps TDD --
    tdd384 SEQUENCE (SIZE (1..maxTS)) OF
        TimeslotInfo,
    tdd128 SEQUENCE (SIZE (1..maxTS-LCR)) OF
        TimeslotInfo-LCR-r4
}

-- SPARE: TimeslotISCP, Max = 91
-- Values above Max are spare
TimeslotISCP ::= INTEGER (0..127)

-- TimeslotISCP-List shall not include more than 6 elements in 1.28Mcps TDD mode.
TimeslotISCP-List ::= SEQUENCE (SIZE (1..maxTS)) OF
    TimeslotISCP

TimeslotListWithISCP ::= SEQUENCE (SIZE (1..maxTS)) OF
    TimeslotWithISCP

TimeslotWithISCP ::= SEQUENCE {
    timeslot
    timeslotISCP
}

TimeToTrigger ::= ENUMERATED {
    ttt0, ttt10, ttt20, ttt40, ttt60,
    ttt80, ttt100, ttt120, ttt160,
    ttt200, ttt240, ttt320, ttt640,
    ttt1280, ttt2560, ttt5000 }

TrafficVolumeEventParam ::= SEQUENCE {
    eventID TrafficVolumeEventType,
    reportingThreshold TrafficVolumeThreshold,
    timeToTrigger TimeToTrigger OPTIONAL,
    pendingTimeAfterTrigger PendingTimeAfterTrigger OPTIONAL,
    tx-InterruptionAfterTrigger TX-InterruptionAfterTrigger OPTIONAL
}

TrafficVolumeEventResults ::= SEQUENCE {
    ul-transportChannelCausingEvent UL-TrCH-Identity,
    trafficVolumeEventIdentity TrafficVolumeEventType
}

TrafficVolumeEventType ::= ENUMERATED {
    e4a,
    e4b }

TrafficVolumeMeasQuantity ::= CHOICE {
    rlc-BufferPayload NULL,
    averageRLC-BufferPayload TimeInterval,
    varianceOfRLC-BufferPayload TimeInterval
}

TrafficVolumeMeasSysInfo ::= SEQUENCE {
    trafficVolumeMeasurementID MeasurementIdentity DEFAULT 4,
    trafficVolumeMeasurementObjectList TrafficVolumeMeasurementObjectList OPTIONAL,
    trafficVolumeMeasQuantity TrafficVolumeMeasQuantity OPTIONAL,
    trafficVolumeReportingQuantity TrafficVolumeReportingQuantity OPTIONAL,
    -- dummy is not used in this version of specification, it should
    -- not be sent and if received it should be ignored.
    dummy TrafficVolumeReportingCriteria OPTIONAL,
    measurementValidity MeasurementValidity OPTIONAL,
    measurementReportingMode MeasurementReportingMode,
    reportCriteriaSysInf TrafficVolumeReportCriteriaSysInfo
}

TrafficVolumeMeasuredResults ::= SEQUENCE {
    rb-Identity RB-Identity,
    rlc-BuffersPayload RLC-BuffersPayload OPTIONAL,
    averageRLC-BufferPayload AverageRLC-BufferPayload OPTIONAL,
    varianceOfRLC-BufferPayload VarianceOfRLC-BufferPayload OPTIONAL
}

```



```

}

TrafficVolumeMeasuredResultsList ::= SEQUENCE (SIZE (1..maxRB)) OF
    TrafficVolumeMeasuredResults

TrafficVolumeMeasurement ::= SEQUENCE {
    trafficVolumeMeasurementObjectList TrafficVolumeMeasurementObjectList OPTIONAL,
    trafficVolumeMeasQuantity          TrafficVolumeMeasQuantity          OPTIONAL,
    trafficVolumeReportingQuantity     TrafficVolumeReportingQuantity  OPTIONAL,
    measurementValidity                MeasurementValidity              OPTIONAL,
    reportCriteria                     TrafficVolumeReportCriteria
}

TrafficVolumeMeasurementObjectList ::= SEQUENCE (SIZE (1..maxTrCH)) OF
    UL-TrCH-Identity

TrafficVolumeReportCriteria ::= CHOICE {
    trafficVolumeReportingCriteria    TrafficVolumeReportingCriteria,
    periodicalReportingCriteria       PeriodicalReportingCriteria,
    noReporting                       NULL
}

TrafficVolumeReportCriteriaSysInfo ::= CHOICE {
    trafficVolumeReportingCriteria    TrafficVolumeReportingCriteria,
    periodicalReportingCriteria       PeriodicalReportingCriteria
}

TrafficVolumeReportingCriteria ::= SEQUENCE {
    -- NOTE: transChCriteriaList should be mandatory in later versions of this message
    transChCriteriaList               TransChCriteriaList              OPTIONAL
}

TrafficVolumeReportingQuantity ::= SEQUENCE {
    rlc-RB-BufferPayload              BOOLEAN,
    rlc-RB-BufferPayloadAverage       BOOLEAN,
    rlc-RB-BufferPayloadVariance      BOOLEAN
}

TrafficVolumeThreshold ::= ENUMERATED {
    th8, th16, th32, th64, th128,
    th256, th512, th1024, th2k, th3k,
    th4k, th6k, th8k, th12k, th16k,
    th24k, th32k, th48k, th64k, th96k,
    th128k, th192k, th256k, th384k,
    th512k, th768k }

TransChCriteria ::= SEQUENCE {
    ul-transportChannelID             UL-TrCH-Identity                 OPTIONAL,
    eventSpecificParameters           SEQUENCE (SIZE (1..maxMeasParEvent)) OF
    TrafficVolumeEventParam           OPTIONAL
}

TransChCriteriaList ::= SEQUENCE (SIZE (1..maxTrCH)) OF
    TransChCriteria

TransferMode ::= ENUMERATED {
    acknowledgedModeRLC,
    unacknowledgedModeRLC }

TransmittedPowerThreshold ::= INTEGER (-50..33)

TriggeringCondition1 ::= ENUMERATED {
    activeSetCellsOnly,
    monitoredSetCellsOnly,
    activeSetAndMonitoredSetCells }

TriggeringCondition2 ::= ENUMERATED {
    activeSetCellsOnly,
    monitoredSetCellsOnly,
    activeSetAndMonitoredSetCells,
    detectedSetCellsOnly,
    detectedSetAndMonitoredSetCells }

Tutran-Ganss-DriftRate ::= ENUMERATED {
    ugdr0, ugdr1, ugdr2, ugdr5, ugdr10, ugdr15 , ugdr25,
    ugdr50, ugdr-1, ugdr-2, ugdr-5, ugdr-10, ugdr-15,
    ugdr-25, ugdr-50, spare }

```

```

TX-InterruptionAfterTrigger ::=      ENUMERATED {
                                        txiat0-25, txiat0-5, txiat1,
                                        txiat2, txiat4, txiat8, txiat16 }

UDRE ::=                              ENUMERATED {
                                        lessThan1,
                                        between1-and-4,
                                        between4-and-8,
                                        over8 }

UE-6AB-Event ::=                     SEQUENCE {
    timeToTrigger                      TimeToTrigger,
    transmittedPowerThreshold          TransmittedPowerThreshold
}

UE-6FG-Event ::=                     SEQUENCE {
    timeToTrigger                      TimeToTrigger,
    -- in 1.28 Mcps TDD ue-RX-TX-TimeDifferenceThreshold corresponds to TADV Threshold
    ue-RX-TX-TimeDifferenceThreshold  UE-RX-TX-TimeDifferenceThreshold
}

-- dummy and dummy2 are not used in this version of the specification, they should
-- not be sent and if received the UE behaviour is not specified.
UE-AutonomousUpdateMode ::=         CHOICE {
    dummy                              NULL,
    onWithNoReporting                  NULL,
    dummy2                             RL-InformationLists
}

UE-InternalEventParam ::=           CHOICE {
    event6a                           UE-6AB-Event,
    event6b                           UE-6AB-Event,
    event6c                           TimeToTrigger,
    event6d                           TimeToTrigger,
    event6e                           TimeToTrigger,
    event6f                           UE-6FG-Event,
    event6g                           UE-6FG-Event
}

UE-InternalEventParamList ::=       SEQUENCE (SIZE (1..maxMeasEvent)) OF
    UE-InternalEventParam

UE-InternalEventResults ::=         CHOICE {
    event6a                           NULL,
    event6b                           NULL,
    event6c                           NULL,
    event6d                           NULL,
    event6e                           NULL,
    event6f                           PrimaryCPICH-Info,
    event6g                           PrimaryCPICH-Info,
    spare                             NULL
}

UE-InternalMeasQuantity ::=         SEQUENCE {
    measurementQuantity                UE-MeasurementQuantity,
    filterCoefficient                  FilterCoefficient                DEFAULT fc0
}

UE-InternalMeasuredResults ::=      SEQUENCE {
    modeSpecificInfo                   CHOICE {
        fdd                           SEQUENCE {
            ue-TransmittedPowerFDD    UE-TransmittedPower        OPTIONAL,
            ue-RX-TX-ReportEntryList  UE-RX-TX-ReportEntryList   OPTIONAL
        },
        tdd                           SEQUENCE {
            ue-TransmittedPowerTDD-List UE-TransmittedPowerTDD-List OPTIONAL,
            appliedTA                  UL-TimingAdvance           OPTIONAL
        }
    }
}

UE-InternalMeasuredResults-LCR-r4 ::= SEQUENCE {
    ue-TransmittedPowerTDD-List        UE-TransmittedPowerTDD-List   OPTIONAL,
    -- If TA value is not greater than 2047, then use this IE to report.
    t-ADVinfo                          T-ADVinfo                    OPTIONAL
}

UE-InternalMeasuredResults-v770ext ::= SEQUENCE {

```

```

modeSpecificInfo          CHOICE {
  tdd384-768              SEQUENCE {
    appliedTA              EXT-UL-TimingAdvance          OPTIONAL
  },
  tdd128                  SEQUENCE {
    -- If TA value is greater than 2047, then use this IE to report
    t-ADVinfo              T-ADVinfo-ext                OPTIONAL
  }
}
}

UE-InternalMeasurement ::= SEQUENCE {
  ue-InternalMeasQuantity  UE-InternalMeasQuantity          OPTIONAL,
  ue-InternalReportingQuantity UE-InternalReportingQuantity  OPTIONAL,
  reportCriteria           UE-InternalReportCriteria
}

UE-InternalMeasurement-r4 ::= SEQUENCE {
  ue-InternalMeasQuantity  UE-InternalMeasQuantity          OPTIONAL,
  ue-InternalReportingQuantity UE-InternalReportingQuantity-r4  OPTIONAL,
  reportCriteria           UE-InternalReportCriteria
}

UE-InternalMeasurementSysInfo ::= SEQUENCE {
  ue-InternalMeasurementID MeasurementIdentity          DEFAULT 5,
  ue-InternalMeasQuantity  UE-InternalMeasQuantity
}

UE-InternalReportCriteria ::= CHOICE {
  ue-InternalReportingCriteria UE-InternalReportingCriteria,
  periodicalReportingCriteria  PeriodicalReportingCriteria,
  noReporting                   NULL
}

UE-InternalReportingCriteria ::= SEQUENCE {
  ue-InternalEventParamList UE-InternalEventParamList          OPTIONAL
}

UE-InternalReportingQuantity ::= SEQUENCE {
  ue-TransmittedPower        BOOLEAN,
  modeSpecificInfo           CHOICE {
    fdd                      SEQUENCE {
      ue-RX-TX-TimeDifference  BOOLEAN
    },
    tdd                      SEQUENCE {
      appliedTA                BOOLEAN
    }
  }
}

UE-InternalReportingQuantity-r4 ::= SEQUENCE {
  ue-TransmittedPower        BOOLEAN,
  modeSpecificInfo           CHOICE {
    fdd                      SEQUENCE {
      ue-RX-TX-TimeDifference  BOOLEAN
    },
    tdd                      SEQUENCE {
      tddOption               CHOICE {
        -- appliedTA applies to both 3.84 Mcps TDD and to 7.68 Mcps TDD.
        -- Therefore, no additional choice of TDD mode is necessary
        tdd384                 SEQUENCE {
          appliedTA             BOOLEAN
        },
        tdd128                 SEQUENCE {
          t-ADVinfo             BOOLEAN
        }
      }
    }
  }
}

-- TABULAR: UE-MeasurementQuantity, for 3.84 Mcps TDD only the first two values
-- ue-TransmittedPower and ultra-Carrier-RSSI are used.
-- For 1.28 Mcps TDD ue-RX-TX-TimeDifference corresponds to T-ADV in the tabular
UE-MeasurementQuantity ::= ENUMERATED {
  ue-TransmittedPower,
  ultra-Carrier-RSSI,
  ue-RX-TX-TimeDifference }

```

```

UE-RX-TX-ReportEntry ::=          SEQUENCE {
    primaryCPICH-Info              PrimaryCPICH-Info,
    ue-RX-TX-TimeDifferenceType1   UE-RX-TX-TimeDifferenceType1
}

UE-RX-TX-ReportEntryList ::=      SEQUENCE (SIZE (1..maxRL)) OF
    UE-RX-TX-ReportEntry

-- SPARE: UE-RX-TX-TimeDifferenceType1, Max = 1280
-- Values above Max are spare
UE-RX-TX-TimeDifferenceType1 ::=  INTEGER (768..1791)

UE-RX-TX-TimeDifferenceType2 ::=  INTEGER (0..8191)

UE-RX-TX-TimeDifferenceType2Info ::= SEQUENCE {
    ue-RX-TX-TimeDifferenceType2   UE-RX-TX-TimeDifferenceType2,
    neighbourQuality               NeighbourQuality
}

-- In 1.28 Mcps TDD, actual value for
-- T-ADV Threshold = (UE-RX-TX-TimeDifferenceThreshold - 768) * 0.125
UE-RX-TX-TimeDifferenceThreshold ::= INTEGER (768..1280)

UE-TransmittedPower ::=          INTEGER (0..104)

UE-TransmittedPowerTDD-List ::=  SEQUENCE (SIZE (1..maxTS)) OF
    UE-TransmittedPower

UL-TrCH-Identity ::=             CHOICE{
    dch                            TransportChannelIdentity,
    -- Note: the reference to CPCH in the element name below is incorrect. The name is not changed
    -- to keep it aligned with R99.
    rachorcpch                     NULL,
    usch                            TransportChannelIdentity
}

UE-Positioning-Accuracy ::=      BIT STRING (SIZE (7))

UE-Positioning-CipherParameters ::= SEQUENCE {
    cipheringKeyFlag               BIT STRING (SIZE (1)),
    cipheringSerialNumber         INTEGER (0..65535)
}

UE-Positioning-DGANSSCorrections ::= SEQUENCE {
    dganssreferencetime            INTEGER (0..119),          -- scale factor 30s
    dganssInfoList                DGANSSInfoList
}

UE-Positioning-Error ::=        SEQUENCE {
    errorReason                    UE-Positioning-ErrorCause,
    ue-positioning-GPS-additionalAssistanceDataRequest
    UE-Positioning-GPS-AdditionalAssistanceDataRequest OPTIONAL
}

UE-Positioning-Error-r7 ::=     SEQUENCE {
    errorReason                    UE-Positioning-ErrorCause-r7,
    ue-positioning-GPS-additionalAssistanceDataRequest
    UE-Positioning-GPS-AdditionalAssistanceDataRequest OPTIONAL,
    ue-positioning-GANSS-additionalAssistanceDataRequest
    UE-Positioning-GANSS-AdditionalAssistanceDataRequest OPTIONAL
}

UE-Positioning-Error-v860ext ::= SEQUENCE {
    ue-positioning-GANSS-additionalAssistanceDataRequest
    UE-Positioning-GANSS-AdditionalAssistanceDataRequest-v860ext OPTIONAL
}

UE-Positioning-ErrorCause ::=   ENUMERATED {
    notEnoughOTDOA-Cells,
    notEnoughGPS-Satellites,
    assistanceDataMissing,
    notAccomplishedGPS-TimingOfCellFrames,
    undefinedError,
    requestDeniedByUser,
    notProcessedAndTimeout,
}

```

```

referenceCellNotServingCell }

UE-Positioning-ErrorCause-r7 ::= ENUMERATED {
    notEnoughOTDOA-Cells,
    notEnoughGPS-Satellites,
    assistanceDataMissing,
    notAccomplishedGPS-TimingOfCellFrames,
    undefinedError,
    requestDeniedByUser,
    notProcessedAndTimeout,
    referenceCellNotServingCell,
    notEnoughGANSS-Satellites,
    notAccomplishedGANSS-TimingOfCellFrames,
    spare6, spare5, spare4, spare3, spare2, spare1 }

UE-Positioning-EventParam ::= SEQUENCE {
    reportingAmount ReportingAmount,
    reportFirstFix BOOLEAN,
    measurementInterval UE-Positioning-MeasurementInterval,
    eventSpecificInfo UE-Positioning-EventSpecificInfo
}

UE-Positioning-EventParam-r7 ::= SEQUENCE {
    reportingAmount ReportingAmount,
    reportFirstFix BOOLEAN,
    measurementInterval UE-Positioning-MeasurementInterval,
    eventSpecificInfo UE-Positioning-EventSpecificInfo-r7
}

UE-Positioning-EventParamList ::= SEQUENCE (SIZE (1..maxMeasEvent)) OF
    UE-Positioning-EventParam

UE-Positioning-EventParamList-r7 ::= SEQUENCE (SIZE (1..maxMeasEvent)) OF
    UE-Positioning-EventParam-r7

UE-Positioning-EventSpecificInfo ::= CHOICE {
    e7a ThresholdPositionChange,
    e7b ThresholdSFN-SFN-Change,
    e7c ThresholdSFN-GPS-TOW
}

UE-Positioning-EventSpecificInfo-r7 ::= CHOICE {
    e7a ThresholdPositionChange,
    e7b ThresholdSFN-SFN-Change,
    e7c ThresholdSFN-GPS-TOW-us,
    e7d ThresholdSFN-GANSS-TOW
}

-- This IE, if included, shall contain exactly one of the optional elements
UE-Positioning-GANSS-AddUTCModels ::= SEQUENCE {
    utcModel1 UTCmodelSet1 OPTIONAL,
    utcModel2 UTCmodelSet2 OPTIONAL,
    utcModel3 UTCmodelSet3 OPTIONAL
}

UE-Positioning-GANSS-Almanac ::= SEQUENCE{
    ganss-wk-number INTEGER (0..255),
    alm-keplerianParameters ALM-keplerianParameters OPTIONAL
}

-- This IE, if included, shall contain exactly one of the optional elements
UE-Positioning-GANSS-Almanac-v860ext ::= SEQUENCE {
    alm-keplerianNAVALmanac ALM-NAVKeplerianSet OPTIONAL,
    alm-keplerianReducedAlmanac ALM-ReducedKeplerianSet OPTIONAL,
    alm-keplerianMidiAlmanac ALM-MidiAlmanacSet OPTIONAL,
    alm-keplerianGLONASS ALM-GlonassAlmanacSet OPTIONAL,
    alm-ecefsBASAlmanac ALM-ECEFSbasAlmanacSet OPTIONAL
}

UE-Positioning-GANSS-Almanac-r8 ::= SEQUENCE{
    ganss-wk-number INTEGER (0..255),
    alm-keplerianParameters ALM-keplerianParameters OPTIONAL,
    alm-keplerianNAVALmanac ALM-NAVKeplerianSet OPTIONAL,
    alm-keplerianReducedAlmanac ALM-ReducedKeplerianSet OPTIONAL,
    alm-keplerianMidiAlmanac ALM-MidiAlmanacSet OPTIONAL,
    alm-keplerianGLONASS ALM-GlonassAlmanacSet OPTIONAL,
    alm-ecefsBASAlmanac ALM-ECEFSbasAlmanacSet OPTIONAL
}

```

```

UE-Positioning-GANSS-AdditionalAssistanceDataRequest ::= SEQUENCE {
    ganssReferenceTime          BOOLEAN,
    ganssreferenceLocation      BOOLEAN,
    ganssIonosphericModel       BOOLEAN,
    ganssRequestedGenericAssistanceDataList GanssRequestedGenericAssistanceDataList
}

UE-Positioning-GANSS-AdditionalAssistanceDataRequest-v860ext ::= SEQUENCE {
    ganssAddIonoModelReq        BIT STRING (SIZE (2))          OPTIONAL,
    ganssEOPreq                 ENUMERATED { true }           OPTIONAL,
    ganssRequestedGenericAssistanceDataList GanssRequestedGenericAssistanceDataList-v860ext
}

UE-Positioning-GANSS-AddIonoModel ::= SEQUENCE {
    dataID                      BIT STRING (SIZE (2)),
    alpha-beta-parameters       UE-Positioning-GPS-IonosphericModel
}

UE-Positioning-GANSS-AddNavigationModels ::= SEQUENCE {
    non-broadcastIndication     ENUMERATED { true }           OPTIONAL,
    ganssSatInfoNavList         Ganss-Sat-Info-AddNavList
}

UE-Positioning-GANSS-AssistanceData ::= SEQUENCE {
    ue-positioning-GANSS-ReferenceTime UE-Positioning-GANSS-ReferenceTime    OPTIONAL,
    uePositioningGanssReferencePosition ReferenceLocationGANSS                OPTIONAL,
    uePositioningGanssIonosphericModel UE-Positioning-GANSS-IonosphericModel  OPTIONAL,
    ganssGenericDataList              GANSSGenericDataList                  OPTIONAL
}

UE-Positioning-GANSS-AssistanceData-v860ext ::= SEQUENCE {
    uePositioningGanssAddIonoModel      UE-Positioning-GANSS-AddIonoModel      OPTIONAL,
    uePositioningGanssEarthOrientationPara UE-Positioning-GANSS-EarthOrientPara  OPTIONAL,
    ganssGenericDataList                 GANSSGenericDataList-v860ext          OPTIONAL
}

UE-Positioning-GANSS-AssistanceData-r8 ::= SEQUENCE {
    ue-positioning-GANSS-ReferenceTime UE-Positioning-GANSS-ReferenceTime    OPTIONAL,
    uePositioningGanssReferencePosition ReferenceLocationGANSS                OPTIONAL,
    uePositioningGanssIonosphericModel UE-Positioning-GANSS-IonosphericModel  OPTIONAL,
    uePositioningGanssAddIonoModel      UE-Positioning-GANSS-AddIonoModel      OPTIONAL,
    uePositioningGanssEarthOrientationPara UE-Positioning-GANSS-EarthOrientPara  OPTIONAL,
    ganssGenericDataList                 GANSSGenericDataList-r8              OPTIONAL
}

UE-Positioning-GANSS-AuxiliaryInfo ::= CHOICE {
    -- This choice may only be present if GANSS ID indicates Modernized GPS
    ganssID1      AuxInfoGANSS-ID1,
    -- This choice may only be present if GANSS ID indicates GLONASS
    ganssID3      AuxInfoGANSS-ID3
}

UE-Positioning-GANSS-ClockModel ::= SEQUENCE {
    satellite-clock-modelList      Satellite-clock-modelList
}

-- This IE, if included, shall contain exactly one of the optional elements
UE-Positioning-GANSS-AddClockModels ::= SEQUENCE {
    navClockModel      NAVclockModel          OPTIONAL,
    cnavClockModel     CNAVclockModel         OPTIONAL,
    glonassClockModel  GLONASSclockModel      OPTIONAL,
    sbasClockModel     SBASclockModel         OPTIONAL
}

-- This IE, if included, shall contain exactly one of the optional elements
UE-Positioning-GANSS-AddOrbitModels ::= SEQUENCE {
    navKeplerianSet      NavModel-NAVKeplerianSet    OPTIONAL,
    cnavKeplerianSet     NavModel-CNAVKeplerianSet   OPTIONAL,
    glonassECEF          NavModel-GLONASSsecef       OPTIONAL,
    sbasECEF             NavModel-SBASsecef          OPTIONAL
}

UE-Positioning-GANSS-Data ::= SEQUENCE {
    ganssDataCipheringInfo      UE-Positioning-CipherParameters    OPTIONAL,
    ganssDecipheringKeys        GANSSDecipheringKeys                OPTIONAL,
}

```

```

    uePositioningGanssReferenceTime      UE-Positioning-GANSS-ReferenceTime      OPTIONAL,
    uePositioningGanssReferencePosition  ReferenceLocationGANSS                   OPTIONAL,
    uePositioningGanssIonosphericModel  UE-Positioning-GANSS-IonosphericModel  OPTIONAL,
    ganssGenericDataList                 GANSSGenericDataList                     OPTIONAL
  }
UE-Positioning-GANSS-Data-Bit-Assistance ::= SEQUENCE {
  ganss-tod                INTEGER (0..59),
  dataBitAssistanceList    DataBitAssistanceList
}
UE-Positioning-GANSS-EarthOrientPara ::= SEQUENCE {
  teop                    BIT STRING (SIZE (16)),
  pmX                     BIT STRING (SIZE (21)),
  pmXdot                  BIT STRING (SIZE (15)),
  pmY                     BIT STRING (SIZE (21)),
  pmYdot                  BIT STRING (SIZE (15)),
  deltaUT1                BIT STRING (SIZE (31)),
  deltaUT1dot             BIT STRING (SIZE (19))
}
UE-Positioning-GANSS-IonosphericModel ::= SEQUENCE {
  alpha-zero-ionos        BIT STRING (SIZE (12)),
  alpha-one-ionos         BIT STRING (SIZE (12)),
  alpha-two-ionos         BIT STRING (SIZE (12)),
  gANSS-storm-flags       GANSS-Storm-Flag                        OPTIONAL
}
UE-Positioning-GANSS-MeasuredResults ::= SEQUENCE {
  referenceTime            CHOICE {
    utran-GANSSReferenceTimeResult    UTRAN-GANSSReferenceTime,
    ganssReferenceTimeOnly            GANSSReferenceTimeOnly
  },
  ganssGenericMeasurementInfo        GANSSGenericMeasurementInfo
}
UE-Positioning-GANSS-MeasuredResults-v860ext ::= SEQUENCE {
  ganssGenericMeasurementInfo        GANSSGenericMeasurementInfo-v860ext
}
UE-Positioning-GANSS-NavigationModel ::= SEQUENCE {
  non-broadcastIndication            ENUMERATED { true }                        OPTIONAL,
  ganssSatInfoNavList                Ganss-Sat-Info-NavList
}
UE-Positioning-GANSS-OrbitModel ::= SEQUENCE {
  keplerianParameters                KeplerianParameters                        OPTIONAL
}
UE-Positioning-GANSS-RealTimeIntegrity ::= SEQUENCE (SIZE (1..maxGANSSSat)) OF SEQUENCE {
  bad-ganss-satId                    INTEGER (0..63),
  bad-ganss-signalId                 BIT STRING (SIZE (8))                        OPTIONAL
}
UE-Positioning-GANSS-ReferenceMeasurementInfo ::= SEQUENCE {
  ganssSignalId                      GANSS-Signal-Id                            OPTIONAL,
  satelliteInformationList            GANSSSatelliteInformationList
}
UE-Positioning-GANSS-ReferenceTime ::= SEQUENCE {
  ganssDay                            INTEGER (0..8191)                            OPTIONAL,
  ganssTod                             INTEGER (0..86399),
  ganssTodUncertainty                  INTEGER (0..127)                            OPTIONAL,
  ganssTimeId                          INTEGER (0..7)                              OPTIONAL,
  utran-ganssreferenceTime              SEQUENCE {
    timingOfCellFrames                INTEGER (0..3999999),
    mode                               CHOICE {
      fdd                             SEQUENCE {
        primary-CPICH-Info            PrimaryCPICH-Info
      },
      tdd                             SEQUENCE {
        cellParameters                 CellParametersID
      }
    },
    referenceSfn                       INTEGER (0..4095)
  } OPTIONAL,
  tutran-ganss-driftRate                Tutran-Ganss-DriftRate                        OPTIONAL
}

```

```

UE-Positioning-GANSS-SBAS-ID ::=      ENUMERATED {
                                        waas,
                                        egnos,
                                        msas,
                                        gagan,
                                        spare4,
                                        spare3,
                                        spare2,
                                        spare1 }

UE-Positioning-GANSS-TimeModel ::= SEQUENCE {
    ganss-timeModelreferenceTime      INTEGER (0..37799),           -- scale factor 16s
    ganss-t-a0                         INTEGER (-2147483648..2147483647), -- scale factor 2-35
    -- 'ganss-t-a1' scale factor 2-51
    ganss-t-a1                         INTEGER (-8388608..8388607)         OPTIONAL,
    -- 'ganss-t-a2' scale factor 2-68
    ganss-t-a2                         INTEGER (-64..63)                   OPTIONAL,
    gnss-to-id                         ENUMERATED { gps, galileo, qzss,
                                                    glonass, spare4, spare3, spare2, spare1 },
    ganss-wk-number                    INTEGER (0..8191)                   OPTIONAL
}

UE-Positioning-GANSS-TimeModels ::= SEQUENCE (SIZE (1..maxGANSS-1)) OF
    UE-Positioning-GANSS-TimeModel

UE-Positioning-GANSS-UTCModel ::= SEQUENCE {
    a-one-utc                          BIT STRING (SIZE (24)),
    a-zero-utc                         BIT STRING (SIZE (32)),
    t-ot-utc                          BIT STRING (SIZE (8)),
    delta-t-ls-utc                    BIT STRING (SIZE (8)),
    w-n-t-utc                         BIT STRING (SIZE (8)),
    w-n-lsf-utc                       BIT STRING (SIZE (8)),
    dn-utc                            BIT STRING (SIZE (8)),
    delta-t-lsf-utc                   BIT STRING (SIZE (8))
}

UE-Positioning-GPS-AcquisitionAssistance ::= SEQUENCE {
    gps-ReferenceTime                 GPS-TOW-1msec,
    utran-GPSReferenceTime            UTRAN-GPSReferenceTime           OPTIONAL,
    satelliteInformationList          AcquisitionSatInfoList
}

UE-Positioning-GPS-AcquisitionAssistance-v770ext ::= SEQUENCE {
    ue-Positioning-GPS-ReferenceTimeUncertainty
    UE-Positioning-GPS-ReferenceTimeUncertainty   OPTIONAL
}

UE-Positioning-GPS-AcquisitionAssistance-r7 ::= SEQUENCE {
    gps-ReferenceTime                 GPS-TOW-1msec,
    utran-GPSReferenceTime            UTRAN-GPSReferenceTime           OPTIONAL,
    ue-Positioning-GPS-ReferenceTimeUncertainty
    UE-Positioning-GPS-ReferenceTimeUncertainty   OPTIONAL,
    satelliteInformationList          AcquisitionSatInfoList
}

UE-Positioning-GPS-AdditionalAssistanceDataRequest ::= SEQUENCE {
    almanacRequest                    BOOLEAN,
    utcModelRequest                   BOOLEAN,
    ionosphericModelRequest           BOOLEAN,
    navigationModelRequest            BOOLEAN,
    dgpsCorrectionsRequest            BOOLEAN,
    referenceLocationRequest           BOOLEAN,
    referenceTimeRequest               BOOLEAN,
    aquisitionAssistanceRequest       BOOLEAN,
    realTimeIntegrityRequest          BOOLEAN,
    navModelAddDataRequest            UE-Positioning-GPS-NavModelAddDataReq   OPTIONAL
}

UE-Positioning-GPS-Almanac ::= SEQUENCE {
    wn-a                              BIT STRING (SIZE (8)),
    almanacSatInfoList                AlmanacSatInfoList,
    sv-GlobalHealth                   BIT STRING (SIZE (364))           OPTIONAL
}

UE-Positioning-GPS-AssistanceData ::= SEQUENCE {
    ue-positioning-GPS-ReferenceTime
    UE-Positioning-GPS-ReferenceTime   OPTIONAL,

```



```

ue-positioning-GPS-ReferenceLocation      ReferenceLocation      OPTIONAL,
ue-positioning-GPS-DGPS-Corrections      UE-Positioning-GPS-DGPS-Corrections  OPTIONAL,
ue-positioning-GPS-NavigationModel       UE-Positioning-GPS-NavigationModel   OPTIONAL,
ue-positioning-GPS-IonosphericModel      UE-Positioning-GPS-IonosphericModel  OPTIONAL,
ue-positioning-GPS-UTC-Model             UE-Positioning-GPS-UTC-Model         OPTIONAL,
ue-positioning-GPS-Almanac               UE-Positioning-GPS-Almanac          OPTIONAL,
ue-positioning-GPS-AcquisitionAssistance UE-Positioning-GPS-AcquisitionAssistance  OPTIONAL,
ue-positioning-GPS-Real-timeIntegrity    BadSatList            OPTIONAL,
-- dummy is not used in this version of the specification, it should
-- not be sent and if received it should be ignored.
dummy      UE-Positioning-GPS-ReferenceCellInfo      OPTIONAL
}

UE-Positioning-GPS-AssistanceData-v770ext ::= SEQUENCE {
  ue-positioning-GPS-ReferenceTime      UE-Positioning-GPS-ReferenceTime-v770ext  OPTIONAL,
  ue-positioning-GPS-AcquisitionAssistance
                                          UE-Positioning-GPS-AcquisitionAssistance-v770ext  OPTIONAL
}

UE-Positioning-GPS-AssistanceData-r7 ::= SEQUENCE {
  ue-positioning-GPS-ReferenceTime      UE-Positioning-GPS-ReferenceTime-r7      OPTIONAL,
  ue-positioning-GPS-ReferenceLocation  ReferenceLocation                        OPTIONAL,
  ue-positioning-GPS-DGPS-Corrections  UE-Positioning-GPS-DGPS-Corrections     OPTIONAL,
  ue-positioning-GPS-NavigationModel    UE-Positioning-GPS-NavigationModel       OPTIONAL,
  ue-positioning-GPS-IonosphericModel   UE-Positioning-GPS-IonosphericModel     OPTIONAL,
  ue-positioning-GPS-UTC-Model          UE-Positioning-GPS-UTC-Model            OPTIONAL,
  ue-positioning-GPS-Almanac            UE-Positioning-GPS-Almanac              OPTIONAL,
  ue-positioning-GPS-AcquisitionAssistance
                                          UE-Positioning-GPS-AcquisitionAssistance-r7  OPTIONAL,
  ue-positioning-GPS-Real-timeIntegrity BadSatList                                OPTIONAL
}

UE-Positioning-GPS-DGPS-Corrections ::= SEQUENCE {
  gps-TOW      GPS-TOW-1sec,
  statusHealth DiffCorrectionStatus,
  dgps-CorrectionSatInfoList DGPS-CorrectionSatInfoList
}

UE-Positioning-GPS-IonosphericModel ::= SEQUENCE {
  alpha0      BIT STRING (SIZE (8)),
  alpha1      BIT STRING (SIZE (8)),
  alpha2      BIT STRING (SIZE (8)),
  alpha3      BIT STRING (SIZE (8)),
  beta0       BIT STRING (SIZE (8)),
  beta1       BIT STRING (SIZE (8)),
  beta2       BIT STRING (SIZE (8)),
  beta3       BIT STRING (SIZE (8))
}

UE-Positioning-GPS-MeasurementResults ::= SEQUENCE {
  referenceTime      CHOICE {
    utran-GPSReferenceTimeResult      UTRAN-GPSReferenceTimeResult,
    gps-ReferenceTimeOnly              GPS-TOW-1msec
  },
  gps-MeasurementParamList      GPS-MeasurementParamList
}

UE-Positioning-GPS-MeasurementResults-v770ext ::= SEQUENCE {
  ue-Positioning-GPS-ReferenceTimeUncertainty
                                          UE-Positioning-GPS-ReferenceTimeUncertainty  OPTIONAL
}

UE-Positioning-GPS-NavigationModel ::= SEQUENCE {
  navigationModelSatInfoList      NavigationModelSatInfoList
}

UE-Positioning-GPS-NavModelAddDataReq ::= SEQUENCE {
  gps-Week      INTEGER (0..1023),
  -- SPARE: gps-Toe, Max = 167
  -- Values above Max are spare
  gps-Toe      INTEGER (0..255),
  -- SPARE: tToeLimit, Max = 10
  -- Values above Max are spare
  tToeLimit    INTEGER (0..15),
  satDataList SatDataList
}

```

```

UE-Positioning-GPS-ReferenceCellInfo ::= SEQUENCE {
    modeSpecificInfo CHOICE {
        fdd SEQUENCE {
            referenceIdentity PrimaryCPICH-Info
        },
        tdd SEQUENCE {
            referenceIdentity CellParametersID
        }
    }
}

UE-Positioning-GPS-ReferenceTime ::= SEQUENCE {
    gps-Week INTEGER (0..1023),
    gps-tow-1msec GPS-TOW-1msec,
    utran-GPSReferenceTime UTRAN-GPSReferenceTime OPTIONAL,
    sfn-tow-Uncertainty SFN-TOW-Uncertainty OPTIONAL,
    utran-GPS-DriftRate UTRAN-GPS-DriftRate OPTIONAL,
    gps-TOW-AssistList GPS-TOW-AssistList OPTIONAL
}

UE-Positioning-GPS-ReferenceTime-v770ext ::= SEQUENCE {
    ue-Positioning-GPS-ReferenceTimeUncertainty
    UE-Positioning-GPS-ReferenceTimeUncertainty OPTIONAL
}

UE-Positioning-GPS-ReferenceTime-r7 ::= SEQUENCE {
    gps-Week INTEGER (0..1023),
    gps-tow-1msec GPS-TOW-1msec,
    utran-GPSReferenceTime UTRAN-GPSReferenceTime OPTIONAL,
    ue-Positioning-GPS-ReferenceTimeUncertainty
    UE-Positioning-GPS-ReferenceTimeUncertainty OPTIONAL,
    sfn-tow-Uncertainty SFN-TOW-Uncertainty OPTIONAL,
    utran-GPS-DriftRate UTRAN-GPS-DriftRate OPTIONAL,
    gps-TOW-AssistList GPS-TOW-AssistList OPTIONAL
}

UE-Positioning-GPS-ReferenceTimeUncertainty ::= INTEGER (0..127)

UE-Positioning-GPS-UTC-Model ::= SEQUENCE {
    a1 BIT STRING (SIZE (24)),
    a0 BIT STRING (SIZE (32)),
    t-ot BIT STRING (SIZE (8)),
    wn-t BIT STRING (SIZE (8)),
    delta-t-LS BIT STRING (SIZE (8)),
    wn-lsf BIT STRING (SIZE (8)),
    dn BIT STRING (SIZE (8)),
    delta-t-LSF BIT STRING (SIZE (8))
}

UE-Positioning-IPDL-Parameters ::= SEQUENCE {
    ip-Spacing IP-Spacing,
    ip-Length IP-Length,
    ip-Offset INTEGER (0..9),
    seed INTEGER (0..63),
    burstModeParameters BurstModeParameters OPTIONAL
}

UE-Positioning-IPDL-Parameters-r4 ::= SEQUENCE {
    modeSpecificInfo CHOICE {
        fdd SEQUENCE {
            ip-Spacing IP-Spacing,
            ip-Length IP-Length,
            ip-Offset INTEGER (0..9),
            seed INTEGER (0..63)
        },
        tdd SEQUENCE {
            ip-Spacing-TDD IP-Spacing-TDD,
            ip-slot INTEGER (0..14),
            ip-Start INTEGER (0..4095),
            ip-PCCPCG IP-PCCPCH-r4 OPTIONAL
        }
    },
    burstModeParameters BurstModeParameters OPTIONAL
}

UE-Positioning-IPDL-Parameters-TDD-r4-ext ::= SEQUENCE {
    ip-Spacing IP-Spacing-TDD,
    ip-slot INTEGER (0..14),
}

```

```

ip-Start                INTEGER (0..4095),
ip-PCCPCG                IP-PCCPCH-r4                OPTIONAL,
burstModeParameters     BurstModeParameters
}

UE-Positioning-MeasuredResults ::= SEQUENCE {
    ue-positioning-OTDOA-Measurement    UE-Positioning-OTDOA-Measurement    OPTIONAL,
    -- Extended 'ue-positioning-PositionEstimateInfo' information may be provided using IE
    -- 'UE-Positioning-PositionEstimateInfo-v770ext' in IE 'UE-Positioning-MeasuredResults-v770ext'.
    ue-positioning-PositionEstimateInfo UE-Positioning-PositionEstimateInfo    OPTIONAL,
    ue-positioning-GPS-Measurement      UE-Positioning-GPS-MeasurementResults    OPTIONAL,
    -- The 'ue-positioning-Error' information may be provided using IE 'UE-Positioning-Error-r7' in
    -- IE 'UE-Positioning-MeasuredResults-v770ext'.
    -- If IE 'UE-Positioning-Error-r7' is present, the corresponding IE 'UE-Positioning-Error' shall
    -- be excluded.
    ue-positioning-Error                UE-Positioning-Error                OPTIONAL
}

UE-Positioning-MeasuredResults-v770ext ::= SEQUENCE {
    ue-positioning-PositionEstimateInfo UE-Positioning-PositionEstimateInfo-v770ext    OPTIONAL,
    ue-positioning-GPS-Measurement      UE-Positioning-GPS-MeasurementResults-v770ext
                                        OPTIONAL,
    ue-positioning-Error                UE-Positioning-Error-r7                OPTIONAL,
    ue-positioning-Ganss-MeasuredResults UE-Positioning-GANSS-MeasuredResults    OPTIONAL
}

UE-Positioning-MeasuredResults-v390ext ::= SEQUENCE {
    ue-Positioning-OTDOA-Measurement-v390ext    UE-Positioning-OTDOA-Measurement-v390ext
}

UE-Positioning-MeasuredResults-v860ext ::= SEQUENCE {
    ue-positioning-Error                UE-Positioning-Error-v860ext                OPTIONAL,
    ue-positioning-Ganss-MeasurementResults UE-Positioning-GANSS-MeasuredResults-v860ext    OPTIONAL
}

UE-Positioning-Measurement ::= SEQUENCE {
    ue-positioning-ReportingQuantity    UE-Positioning-ReportingQuantity,
    reportCriteria                      UE-Positioning-ReportCriteria,
    ue-positioning-OTDOA-AssistanceData UE-Positioning-OTDOA-AssistanceData    OPTIONAL,
    ue-positioning-GPS-AssistanceData   UE-Positioning-GPS-AssistanceData        OPTIONAL
}

UE-Positioning-Measurement-v390ext ::= SEQUENCE {
    ue-positioning-ReportingQuantity-v390ext    UE-Positioning-ReportingQuantity-v390ext    OPTIONAL,
    measurementValidity                      MeasurementValidity                        OPTIONAL,
    ue-positioning-OTDOA-AssistanceData-UEB    UE-Positioning-OTDOA-AssistanceData-UEB    OPTIONAL
}

UE-Positioning-Measurement-r4 ::= SEQUENCE {
    ue-positioning-ReportingQuantity    UE-Positioning-ReportingQuantity-r4,
    measurementValidity                MeasurementValidity                        OPTIONAL,
    reportCriteria                      UE-Positioning-ReportCriteria,
    ue-positioning-OTDOA-AssistanceData UE-Positioning-OTDOA-AssistanceData-r4    OPTIONAL,
    ue-positioning-GPS-AssistanceData   UE-Positioning-GPS-AssistanceData        OPTIONAL
}

UE-Positioning-Measurement-r7 ::= SEQUENCE {
    ue-positioning-ReportingQuantity    UE-Positioning-ReportingQuantity-r7,
    measurementValidity                MeasurementValidity                        OPTIONAL,
    reportCriteria                      UE-Positioning-ReportCriteria-r7,
    ue-positioning-OTDOA-AssistanceData UE-Positioning-OTDOA-AssistanceData-r7    OPTIONAL,
    ue-positioning-GPS-AssistanceData   UE-Positioning-GPS-AssistanceData-r7     OPTIONAL,
    ue-positioning-GANSS-AssistanceData UE-Positioning-GANSS-AssistanceData      OPTIONAL
}

UE-Positioning-Measurement-r8 ::= SEQUENCE {
    ue-positioning-ReportingQuantity    UE-Positioning-ReportingQuantity-r8,
    measurementValidity                MeasurementValidity                        OPTIONAL,
    reportCriteria                      UE-Positioning-ReportCriteria-r7,
    ue-positioning-OTDOA-AssistanceData UE-Positioning-OTDOA-AssistanceData-r7    OPTIONAL,
    ue-positioning-GPS-AssistanceData   UE-Positioning-GPS-AssistanceData-r7     OPTIONAL,
    ue-positioning-GANSS-AssistanceData UE-Positioning-GANSS-AssistanceData-r8    OPTIONAL
}

UE-Positioning-MeasurementEventResults ::= CHOICE {
    -- In case of 'event7a' reporting, if IE 'UE-Positioning-PositionEstimateInfo' is not needed,
    -- CHOICE shall be set to 'additionalOrReplacedPosMeasEvent' and the 'event7a' shall be included

```

```

-- in IE 'UE-Positioning-MeasurementEventResults-v770ext'.
event7a                UE-Positioning-PositionEstimateInfo,
event7b                UE-Positioning-OTDOA-Measurement,
event7c                UE-Positioning-GPS-MeasurementResults,
-- If CHOICE is set to 'additionalOrReplacedPosMeasEvent',
-- IE 'UE-Positioning-MeasurementEventResults-v770ext' shall be present.
additionalOrReplacedPosMeasEvent  NULL
}

UE-Positioning-MeasurementEventResults-v770ext ::= CHOICE {
  event7a                UE-Positioning-PositionEstimateInfo-v770ext,
  event7c                UE-Positioning-GPS-MeasurementResults-v770ext,
  event7d                UE-Positioning-GANSS-MeasuredResults,
  spare                 NULL
}

UE-Positioning-MeasurementEventResults-v860ext ::= CHOICE {
  event7d                UE-Positioning-GANSS-MeasuredResults-v860ext
}

UE-Positioning-MeasurementInterval ::= ENUMERATED {
  e5, e15, e60, e300,
  e900, e1800, e3600, e7200 }

UE-Positioning-MethodType ::= ENUMERATED {
  ue-Assisted,
  ue-Based,
  ue-BasedPreferred,
  ue-AssistedPreferred }

UE-Positioning-OTDOA-AssistanceData ::= SEQUENCE {
  ue-positioning-OTDOA-ReferenceCellInfo                UE-Positioning-OTDOA-ReferenceCellInfo                OPTIONAL,
  ue-positioning-OTDOA-NeighbourCellList                UE-Positioning-OTDOA-NeighbourCellList                OPTIONAL
}

UE-Positioning-OTDOA-AssistanceData-r4 ::= SEQUENCE {
  ue-positioning-OTDOA-ReferenceCellInfo                UE-Positioning-OTDOA-ReferenceCellInfo-r4                OPTIONAL,
  ue-positioning-OTDOA-NeighbourCellList                UE-Positioning-OTDOA-NeighbourCellList-r4                OPTIONAL
}

UE-Positioning-OTDOA-AssistanceData-r4ext ::= SEQUENCE {
  -- In case of TDD these IPDL parameters shall be used for the reference cell instead of
  -- IPDL Parameters in IE UE-Positioning-OTDOA-ReferenceCellInfo
  ue-Positioning-IPDL-Parameters-TDD-r4-ext                UE-Positioning-IPDL-Parameters-TDD-r4-ext                OPTIONAL,
  -- These IPDL parameters shall be used for the neighbour cells in case of TDD instead of
  -- IPDL Parameters in IE UE-Positioning-OTDOA-NeighbourCellInfoList. The cells shall be
  -- listed in the same order as in IE UE-Positioning-OTDOA-NeighbourCellInfoList
  ue-Positioning-IPDL-Parameters-TDDList-r4-ext                UE-Positioning-IPDL-Parameters-TDDList-r4-ext                OPTIONAL
}

UE-Positioning-OTDOA-AssistanceData-UEB ::= SEQUENCE {
  ue-positioning-OTDOA-ReferenceCellInfo-UEB                UE-Positioning-OTDOA-ReferenceCellInfo-UEB                OPTIONAL,
  ue-positioning-OTDOA-NeighbourCellList-UEB                UE-Positioning-OTDOA-NeighbourCellList-UEB                OPTIONAL
}

UE-Positioning-OTDOA-AssistanceData-UEB-ext ::= SEQUENCE {
  ue-positioning-OTDOA-ReferenceCellInfo-UEB-ext                UE-Positioning-OTDOA-ReferenceCellInfo-UEB-ext                OPTIONAL,
  ue-positioning-OTDOA-NeighbourCellList-UEB-ext                UE-Positioning-OTDOA-NeighbourCellList-UEB-ext                OPTIONAL
}

UE-Positioning-OTDOA-AssistanceData-r7 ::= SEQUENCE {
  ue-positioning-OTDOA-ReferenceCellInfo                UE-Positioning-OTDOA-ReferenceCellInfo-r7                OPTIONAL,
  ue-positioning-OTDOA-NeighbourCellList                UE-Positioning-OTDOA-NeighbourCellList-r7                OPTIONAL
}

UE-Positioning-IPDL-Parameters-TDDList-r4-ext ::= SEQUENCE (SIZE (1..maxCellMeas)) OF
  UE-Positioning-IPDL-Parameters-TDD-r4-ext

```

```

UE-Positioning-OTDOA-MeasuredResultsTDD-ext ::= SEQUENCE {
  neighbourList      NeighbourList-TDD-r7      OPTIONAL
}

UE-Positioning-OTDOA-Measurement ::=
  SEQUENCE {
    sfn              INTEGER (0..4095),
    modeSpecificInfo CHOICE {
      fdd            SEQUENCE {
        referenceCellIdentity      PrimaryCPICH-Info,
        ue-RX-TX-TimeDifferenceType2Info UE-RX-TX-TimeDifferenceType2Info
      },
      tdd            SEQUENCE {
        referenceCellIdentity      CellParametersID
      }
    },
    neighbourList      NeighbourList      OPTIONAL
  }

UE-Positioning-OTDOA-Measurement-v390ext ::= SEQUENCE {
  neighbourList-v390ext NeighbourList-v390ext
}

UE-Positioning-OTDOA-NeighbourCellInfo ::= SEQUENCE {
  modeSpecificInfo CHOICE {
    fdd            SEQUENCE {
      primaryCPICH-Info      PrimaryCPICH-Info
    },
    tdd            SEQUENCE {
      cellAndChannelIdentity CellAndChannelIdentity
    }
  },
  frequencyInfo      FrequencyInfo      OPTIONAL,
  ue-positioning-IPDL-Parameters UE-Positioning-IPDL-Parameters OPTIONAL,
  sfn-SFN-RelTimeDifference SFN-SFN-RelTimeDifference1,
  sfn-SFN-Drift      SFN-SFN-Drift      OPTIONAL,
  searchWindowSize   OTDOA-SearchWindowSize,
  positioningMode    CHOICE {
    ueBased          SEQUENCE {},
    ueAssisted       SEQUENCE {}
  }
}

UE-Positioning-OTDOA-NeighbourCellInfo-r4 ::= SEQUENCE {
  modeSpecificInfo CHOICE {
    fdd            SEQUENCE {
      primaryCPICH-Info      PrimaryCPICH-Info
    },
    tdd            SEQUENCE {
      cellAndChannelIdentity CellAndChannelIdentity
    }
  },
  frequencyInfo      FrequencyInfo      OPTIONAL,
  ue-positioning-IPDL-Parameters UE-Positioning-IPDL-Parameters-r4 OPTIONAL,
  sfn-SFN-RelTimeDifference SFN-SFN-RelTimeDifference1,
  sfn-Offset-Validity SFN-Offset-Validity OPTIONAL,
  sfn-SFN-Drift      SFN-SFN-Drift      OPTIONAL,
  searchWindowSize   OTDOA-SearchWindowSize,
  positioningMode    CHOICE {
    ueBased          SEQUENCE {
      relativeNorth      INTEGER (-20000..20000)      OPTIONAL,
      relativeEast       INTEGER (-20000..20000)      OPTIONAL,
      relativeAltitude   INTEGER (-4000..4000)         OPTIONAL,
      fineSFN-SFN       FineSFN-SFN                 OPTIONAL,
      -- actual value roundTripTime = (IE value * 0.0625) + 876
      roundTripTime      INTEGER (0.. 32766)          OPTIONAL
    },
    ueAssisted         SEQUENCE {}
  }
}

UE-Positioning-OTDOA-NeighbourCellInfo-UEB ::= SEQUENCE {
  modeSpecificInfo CHOICE {
    fdd            SEQUENCE {
      primaryCPICH-Info      PrimaryCPICH-Info
    },
    tdd            SEQUENCE {
      cellAndChannelIdentity CellAndChannelIdentity
    }
  }
}

```

```

    },
    frequencyInfo                FrequencyInfo                OPTIONAL,
    ue-positioning-IPDL-Parameters UE-Positioning-IPDL-Parameters OPTIONAL,
    sfn-SFN-RelTimeDifference     SFN-SFN-RelTimeDifference1,
    sfn-SFN-Drift                 SFN-SFN-Drift                OPTIONAL,
    searchWindowSize              OTDOA-SearchWindowSize,
    relativeNorth                 INTEGER (-20000..20000)        OPTIONAL,
    relativeEast                  INTEGER (-20000..20000)        OPTIONAL,
    relativeAltitude              INTEGER (-4000..4000)         OPTIONAL,
    fineSFN-SFN                   FineSFN-SFN,
    -- actual value roundTripTime = (IE value * 0.0625) + 876
    roundTripTime                 INTEGER (0..32766)           OPTIONAL
}

UE-Positioning-OTDOA-NeighbourCellInfo-UEB-ext ::= SEQUENCE {
    -- actual value roundTripTimeExtension = (IE value * 0.0625)
    roundTripTimeExtension        INTEGER (0..70274)           OPTIONAL
}

UE-Positioning-OTDOA-NeighbourCellInfo-r7 ::= SEQUENCE {
    modeSpecificInfo              CHOICE {
        fdd                        SEQUENCE {
            primaryCPICH-Info      PrimaryCPICH-Info
        },
        tdd                        SEQUENCE {
            cellAndChannelIdentity CellAndChannelIdentity
        }
    },
    frequencyInfo                FrequencyInfo                OPTIONAL,
    ue-positioning-IPDL-Parameters UE-Positioning-IPDL-Parameters-r4 OPTIONAL,
    sfn-SFN-RelTimeDifference     SFN-SFN-RelTimeDifference1,
    sfn-Offset-Validity           SFN-Offset-Validity        OPTIONAL,
    sfn-SFN-Drift                 SFN-SFN-Drift                OPTIONAL,
    searchWindowSize              OTDOA-SearchWindowSize,
    positioningMode               CHOICE {
        ueBased                    SEQUENCE {
            relativeNorth          INTEGER (-20000..20000)        OPTIONAL,
            relativeEast           INTEGER (-20000..20000)        OPTIONAL,
            relativeAltitude       INTEGER (-4000..4000)         OPTIONAL,
            fineSFN-SFN            FineSFN-SFN                OPTIONAL,
            -- actual value roundTripTime = (IE value * 0.0625) + 876
            roundTripTime          INTEGER (0.. 32766)           OPTIONAL,
            -- actual value roundTripTimeExtension = (IE value * 0.0625)
            roundTripTimeExtension INTEGER (0..70274)           OPTIONAL
        }
    },
    ueAssisted                    SEQUENCE {}
}

UE-Positioning-OTDOA-NeighbourCellList ::= SEQUENCE (SIZE (1..maxCellMeas)) OF
    UE-Positioning-OTDOA-NeighbourCellInfo

UE-Positioning-OTDOA-NeighbourCellList-r4 ::= SEQUENCE (SIZE (1..maxCellMeas)) OF
    UE-Positioning-OTDOA-NeighbourCellInfo-r4

UE-Positioning-OTDOA-NeighbourCellList-UEB ::= SEQUENCE (SIZE (1..maxCellMeas)) OF
    UE-Positioning-OTDOA-NeighbourCellInfo-UEB

-- The order of the list corresponds to the order of UE-Positioning-OTDOA-NeighbourCellInfo-UEB
-- in UE-Positioning-OTDOA-NeighbourCellList-UEB
UE-Positioning-OTDOA-NeighbourCellList-UEB-ext ::= SEQUENCE (SIZE (1..maxCellMeas)) OF
    UE-Positioning-OTDOA-NeighbourCellInfo-UEB-ext

UE-Positioning-OTDOA-NeighbourCellList-r7 ::= SEQUENCE (SIZE (1..maxCellMeas)) OF
    UE-Positioning-OTDOA-NeighbourCellInfo-r7

UE-Positioning-OTDOA-Quality ::= SEQUENCE {
    stdResolution                 BIT STRING (SIZE (2)),
    numberOfOTDOA-Measurements    BIT STRING (SIZE (3)),
    stdOfOTDOA-Measurements       BIT STRING (SIZE (5))
}

UE-Positioning-OTDOA-ReferenceCellInfo ::= SEQUENCE {
    sfn                            INTEGER (0..4095)           OPTIONAL,
    modeSpecificInfo CHOICE {
        fdd                        SEQUENCE {
            primaryCPICH-Info      PrimaryCPICH-Info
        },

```

```

        tdd
        cellAndChannelIdentity
    }
},
frequencyInfo
positioningMode CHOICE {
    ueBased
    ueAssisted
},
ue-positioning-IPDL-Parameters
}

UE-Positioning-OTDOA-ReferenceCellInfo-r4 ::= SEQUENCE {
    sfn
        INTEGER (0..4095)
    modeSpecificInfo CHOICE {
        fdd
            primaryCPICH-Info
        },
        tdd
            cellAndChannelIdentity
    },
    frequencyInfo
    positioningMode CHOICE {
        ueBased
            cellPosition
                -- actual value roundTripTime = (IE value * 0.0625) + 876
                roundTripTime
            },
        ueAssisted
    },
    ue-positioning-IPDL-Parameters
}

UE-Positioning-OTDOA-ReferenceCellInfo-UEB ::= SEQUENCE {
    sfn
        INTEGER (0..4095)
    modeSpecificInfo CHOICE {
        fdd
            primaryCPICH-Info
        },
        tdd
            cellAndChannelIdentity
    },
    frequencyInfo
    cellPosition
        -- actual value roundTripTime = (IE value * 0.0625) + 876
        roundTripTime
    ue-positioning-IPDL-Parameters
}

UE-Positioning-OTDOA-ReferenceCellInfo-UEB-ext ::= SEQUENCE {
    -- actual value roundTripTimeExtension = (IE value * 0.0625)
    roundTripTimeExtension
}

UE-Positioning-OTDOA-ReferenceCellInfo-r7 ::= SEQUENCE {
    sfn
        INTEGER (0..4095)
    modeSpecificInfo
        CHOICE {
            fdd
                primaryCPICH-Info
            },
            tdd
                cellAndChannelIdentity
        }
    },
    frequencyInfo
    positioningMode
        ueBased
            cellPosition
                -- actual value roundTripTime = (IE value * 0.0625) + 876
                roundTripTime
                -- actual value roundTripTimeExtension = (IE value * 0.0625)
                roundTripTimeExtension
            },
        ueAssisted
    },
    ue-positioning-IPDL-Parameters
}

```

```

}
UE-Positioning-PositionEstimateInfo ::= SEQUENCE {
  referenceTime CHOICE {
    utran-GPSReferenceTimeResult UTRAN-GPSReferenceTimeResult,
    gps-ReferenceTimeOnly GPS-TOW-1msec,
    cell-Timing SEQUENCE {
      sfn INTEGER (0..4095),
      modeSpecificInfo CHOICE {
        fdd SEQUENCE {
          primaryCPICH-Info PrimaryCPICH-Info
        },
        tdd SEQUENCE {
          cellAndChannelIdentity CellAndChannelIdentity
        }
      }
    }
  },
  positionEstimate PositionEstimate
}

UE-Positioning-PositionEstimateInfo-v770ext ::= SEQUENCE {
  referenceTimeOptions CHOICE {
    -- If 'earlier-than-r7', IE 'UE-Positioning-PositionEstimateInfo' shall be included.
    earlier-than-r7 NULL,
    -- If 'r7', the corresponding IE 'UE-Positioning-PositionEstimateInfo' shall be excluded.
    r7 SEQUENCE {
      referenceTime CHOICE {
        utran-GANSSReferenceTimeResult UTRAN-GANSSReferenceTime,
        ganssReferenceTimeOnly GANSSReferenceTimeOnly
      },
      positionEstimate PositionEstimate
    }
  },
  positionData BIT STRING (SIZE (16)),
  velocityEstimate VelocityEstimate OPTIONAL,
  ue-Positioning-GPS-ReferenceTimeUncertainty UE-Positioning-GPS-ReferenceTimeUncertainty OPTIONAL
}

UE-Positioning-ReportCriteria ::= CHOICE {
  ue-positioning-ReportingCriteria UE-Positioning-EventParamList,
  periodicalReportingCriteria PeriodicalReportingCriteria,
  noReporting NULL
}

UE-Positioning-ReportCriteria-r7 ::= CHOICE {
  ue-positioning-ReportingCriteria UE-Positioning-EventParamList-r7,
  periodicalReportingCriteria PeriodicalReportingCriteria,
  noReporting NULL
}

UE-Positioning-ReportingQuantity ::= SEQUENCE {
  methodType UE-Positioning-MethodType,
  positioningMethod PositioningMethod,
  -- dummy1 is not used in this version of specification and it should
  -- be ignored.
  dummy1 UE-Positioning-ResponseTime,
  horizontal-Accuracy UE-Positioning-Accuracy OPTIONAL,
  gps-TimingOfCellWanted BOOLEAN,
  -- dummy2 is not used in this version of specification and it should
  -- be ignored.
  dummy2 BOOLEAN,
  additionalAssistanceDataRequest BOOLEAN,
  environmentCharacterisation EnvironmentCharacterisation OPTIONAL
}

UE-Positioning-ReportingQuantity-v390ext ::= SEQUENCE {
  vertical-Accuracy UE-Positioning-Accuracy
}

UE-Positioning-ReportingQuantity-r4 ::= SEQUENCE {
  methodType UE-Positioning-MethodType,
  positioningMethod PositioningMethod,
  horizontalAccuracy UE-Positioning-Accuracy OPTIONAL,
  verticalAccuracy UE-Positioning-Accuracy OPTIONAL,
  gps-TimingOfCellWanted BOOLEAN,
  additionalAssistanceDataReq BOOLEAN,
}

```



```

    environmentCharacterisation      EnvironmentCharacterisation      OPTIONAL
  }

UE-Positioning-ReportingQuantity-r7 ::= SEQUENCE {
  methodType                       UE-Positioning-MethodType,
  positioningMethod                 PositioningMethod,
  horizontalAccuracy                UE-Positioning-Accuracy      OPTIONAL,
  verticalAccuracy                  UE-Positioning-Accuracy      OPTIONAL,
  gps-TimingOfCellWanted           BOOLEAN,
  additionalAssistanceDataReq       BOOLEAN,
  environmentCharacterisation       EnvironmentCharacterisation   OPTIONAL,
  velocityRequested                 ENUMERATED { true }         OPTIONAL,
  gANSSPositioningMethods          BIT STRING (SIZE (16))      OPTIONAL,
  gANSSTimingOfCellWanted          BIT STRING (SIZE (8))       OPTIONAL,
  gANSSCarrierPhaseMeasurementRequested
                                   BIT STRING (SIZE (8))       OPTIONAL
}

UE-Positioning-ReportingQuantity-r8 ::= SEQUENCE {
  methodType                       UE-Positioning-MethodType,
  positioningMethod                 PositioningMethod,
  horizontalAccuracy                UE-Positioning-Accuracy      OPTIONAL,
  verticalAccuracy                  UE-Positioning-Accuracy      OPTIONAL,
  gps-TimingOfCellWanted           BOOLEAN,
  additionalAssistanceDataReq       BOOLEAN,
  environmentCharacterisation       EnvironmentCharacterisation   OPTIONAL,
  velocityRequested                 ENUMERATED { true }         OPTIONAL,
  gANSSPositioningMethods          BIT STRING (SIZE (16))      OPTIONAL,
  gANSSTimingOfCellWanted          BIT STRING (SIZE (8))       OPTIONAL,
  gANSSCarrierPhaseMeasurementRequested
                                   BIT STRING (SIZE (8))       OPTIONAL,
  gANSSMultiFreqMeasurementRequested
                                   BIT STRING (SIZE (8))       OPTIONAL
}

UE-Positioning-ResponseTime ::=
                                   ENUMERATED {
                                   s1, s2, s4, s8, s16,
                                   s32, s64, s128 }

UTCmodelSet1 ::=
  utcA0                             BIT STRING (SIZE (16)),
  utcA1                             BIT STRING (SIZE (13)),
  utcA2                             BIT STRING (SIZE (7)),
  utcDeltaTls                       BIT STRING (SIZE (8)),
  utcTot                             BIT STRING (SIZE (16)),
  utcWNot                           BIT STRING (SIZE (13)),
  utcWNlsf                          BIT STRING (SIZE (8)),
  utcDN                              BIT STRING (SIZE (4)),
  utcDeltaTlsf                      BIT STRING (SIZE (8))
}

UTCmodelSet2 ::=
  nA                                BIT STRING (SIZE (11)),
  tauC                              BIT STRING (SIZE (32)),
  deltaUT1                          DeltaUT1                       OPTIONAL,
  kp                                BIT STRING (SIZE (2))         OPTIONAL
}

UTCmodelSet3 ::=
  utcAlwnt                          BIT STRING (SIZE (24)),
  utcA0wnt                          BIT STRING (SIZE (32)),
  utcTot                             BIT STRING (SIZE (8)),
  utcWNt                             BIT STRING (SIZE (8)),
  utcDeltaTls                       BIT STRING (SIZE (8)),
  utcWNlsf                          BIT STRING (SIZE (8)),
  utcDN                              BIT STRING (SIZE (8)),
  utcDeltaTlsf                      BIT STRING (SIZE (8)),
  utcStandardID                    BIT STRING (SIZE (3))
}

-- SPARE: UTRA-CarrierRSSI, Max = 76
-- Values above Max are spare
UTRA-CarrierRSSI ::= INTEGER (0..127)

UTRAN-GANSSReferenceTime ::= SEQUENCE {
  ue-GANSSTimingOfCellFrames       SEQUENCE {
    -- Actual value [ns] = (ms-Part * 4294967296 + ls-Part) * 250
    -- Actual values [ns] > 8639999999750 are reserved and are considered a protocol error
    ms-Part                        INTEGER (0..80),

```

```

    ls-Part                INTEGER (0..4294967295)
  },
  gANSS-TimeId            INTEGER (0..7)                OPTIONAL,
  gANSS-TimeUncertainty   INTEGER (0..127)            OPTIONAL,
  mode                    CHOICE {
    fdd                    SEQUENCE {
      primary-CPICH-Info   PrimaryCPICH-Info
    },
    tdd                    SEQUENCE {
      cellParameters       CellParametersID
    }
  },
  referenceSfn            INTEGER (0..4095)
}

UTRAN-FDD-FrequencyList ::= SEQUENCE (SIZE(1..maxNumFDDFreqs)) OF
  UTRAN-FDD-Frequency

UTRAN-FDD-Frequency ::= SEQUENCE {
  uarfcn                  UARFCN,
  priority                INTEGER (0..maxPrio-1),
  -- Actual value = IE value * 2
  threshXhigh            INTEGER (0..31),
  -- Actual value = IE value * 2
  threshXlow             INTEGER (0..31),
  qQualMinFDD            INTEGER (-24..0)                OPTIONAL,
  -- Actual value = IE value * 2 + 1
  qRxLevMinFDD           INTEGER (-60..-13)              OPTIONAL
}

UTRAN-TDD-FrequencyList ::= SEQUENCE (SIZE(1..maxNumTDDFreqs)) OF
  UTRAN-TDD-Frequency

UTRAN-TDD-Frequency ::= SEQUENCE {
  uarfcn                  UARFCN,
  priority                INTEGER (0..maxPrio-1),
  -- Actual value = IE value * 2
  threshXhigh            INTEGER (0..31),
  -- Actual value = IE value * 2
  threshXlow             INTEGER (0..31),
  -- Actual value = IE value * 2 + 1
  qRxLevMinTDD           INTEGER (-60..-13)              OPTIONAL
}

UTRAN-GPS-DriftRate ::= ENUMERATED {
  utran-GPSDrift0, utran-GPSDrift1, utran-GPSDrift2,
  utran-GPSDrift5, utran-GPSDrift10, utran-GPSDrift15,
  utran-GPSDrift25, utran-GPSDrift50, utran-GPSDrift-1,
  utran-GPSDrift-2, utran-GPSDrift-5, utran-GPSDrift-10,
  utran-GPSDrift-15, utran-GPSDrift-25, utran-GPSDrift-50}

UTRAN-GPSReferenceTime ::= SEQUENCE {
  -- For utran-GPSTimingOfCell values above 2322431999999 are not
  -- used in this version of the specification
  -- Actual value utran-GPSTimingOfCell = (ms-part * 4294967296) + ls-part
  utran-GPSTimingOfCell SEQUENCE {
    ms-part              INTEGER (0..1023),
    ls-part              INTEGER (0..4294967295)
  },
  modeSpecificInfo      CHOICE {
    fdd                  SEQUENCE {
      referenceIdentity  PrimaryCPICH-Info
    },
    tdd                  SEQUENCE {
      referenceIdentity  CellParametersID
    }
  }
  OPTIONAL,
  sfn                   INTEGER (0..4095)
}

UTRAN-GPSReferenceTimeResult ::= SEQUENCE {
  -- For ue-GPSTimingOfCell values above 371589119999999 are not
  -- used in this version of the specification
  -- Actual value ue-GPSTimingOfCell = (ms-part * 4294967296) + ls-part
  ue-GPSTimingOfCell SEQUENCE {
    ms-part              INTEGER (0.. 16383),
    ls-part              INTEGER (0..4294967295)
  },
}

```

```

modeSpecificInfo          CHOICE {
  fdd                      SEQUENCE {
    referenceIdentity      PrimaryCPICH-Info
  },
  tdd                      SEQUENCE {
    referenceIdentity      CellParametersID
  }
},
sfn                       INTEGER (0..4095)
}

UTRA-PriorityInfoList ::= SEQUENCE {
  utra-ServingCell        SEQUENCE {
    priority               INTEGER (0..maxPrio-1),
    -- Actual value = IE value * 2
    s-PrioritySearch1     INTEGER (0..31),
    -- Actual value = IE value
    s-PrioritySearch2     INTEGER (0..7) OPTIONAL,
    -- Actual value = IE value * 2
    threshServingLow      INTEGER (0..31)
  },
  utran-FDD-FrequencyList UTRAN-FDD-FrequencyList OPTIONAL,
  utran-TDD-FrequencyList UTRAN-TDD-FrequencyList OPTIONAL
}

VarianceOfRLC-BufferPayload ::= ENUMERATED {
  plv0, plv4, plv8, plv16, plv32, plv64,
  plv128, plv256, plv512, plv1024,
  plv2k, plv4k, plv8k, plv16k, spare2, spare1 }

VelocityEstimate ::= CHOICE {
  horizontalVelocity      HorizontalVelocity,
  horizontalWithVerticalVelocity HorizontalWithVerticalVelocity,
  horizontalVelocityWithUncertainty HorizontalVelocityWithUncertainty,
  horizontalWithVerticalVelocityAndUncertainty HorizontalWithVerticalVelocityAndUncertainty
}

-- Actual value W = IE value * 0.1
W ::= INTEGER (0..20)

-- *****
--
-- OTHER INFORMATION ELEMENTS (10.3.8)
--
-- *****

BCC ::= INTEGER (0..7)

BCCH-ModificationInfo ::= SEQUENCE {
  mib-ValueTag           MIB-ValueTag,
  bcch-ModificationTime  BCCH-ModificationTime OPTIONAL
}

-- Actual value BCCH-ModificationTime = IE value * 8
BCCH-ModificationTime ::= INTEGER (0..511)

BSIC ::= SEQUENCE {
  ncc                    NCC,
  bcc                    BCC
}

CBS-DRX-Level1Information ::= SEQUENCE {
  ctch-AllocationPeriod  INTEGER (1..256),
  cbs-FrameOffset        INTEGER (0..255)
}

CBS-DRX-Level1Information-extension-r6 ::= ENUMERATED {p8, p16, p32, p64, p128, p256}

CDMA2000-Message ::= SEQUENCE {
  msg-Type               BIT STRING (SIZE (8)),
  payload                BIT STRING (SIZE (1..512))
}

CDMA2000-MessageList ::= SEQUENCE (SIZE (1..maxInterSysMessages)) OF
  CDMA2000-Message

CDMA2000-UMTS-Frequency-List ::= SEQUENCE (SIZE (1..maxNumCDMA2000Freqs)) OF
  FrequencyInfoCDMA2000

```

```

CellValueTag ::=                               INTEGER (1..4)

DataTransmFrequency ::=                       SEQUENCE {
  dataTransmFreqGranularity                   ENUMERATED { ms100, ms250, ms500, ms1000,
                                                    ms2000, ms5000, ms10000, ms60000 },
  numberOfDataTransmOcc                       INTEGER (1..610)
}

DataVolumeHistory ::=                         SEQUENCE {
  dataVolumeMonitoringWindow                 INTEGER (1..120),
  dataTransmFrequency                       DataTransmFrequency           OPTIONAL,
  dataVolumePerRB                           DataVolumePerRB-List         OPTIONAL
}

DataVolumePerRB ::=                           SEQUENCE {
  rb-Identity                               RB-Identity,
  dataVolume                                 INTEGER (0..4294967295)
}

DataVolumePerRB-List ::=                     SEQUENCE (SIZE (1..maxRB)) OF DataVolumePerRB

DeferredMeasurementControlReadingSupport ::= SEQUENCE {
  -- If modeSpecificInfo is not present, deferred SIB11, SIB11bis and SIB12 reading
  -- with default measurement quantities applies
  modeSpecificInfo                           CHOICE {
    fdd                                       SEQUENCE {
      intraFreqMeasQuantity-FDD              IntraFreqMeasQuantity-FDD-sib3
    },
    tdd                                       SEQUENCE {
      intraFreqMeasQuantity-TDDList          IntraFreqMeasQuantity-TDD-sib3List
    }
  } OPTIONAL
}

ETWS-Information ::=                         SEQUENCE {
  warningType                                OCTET STRING (SIZE (1..2)),
  messageIdentifier                          OCTET STRING (SIZE (2)),
  serialNumber                               OCTET STRING (SIZE (2))
}

-- This IE is not used in the specification.
ETWS-WarningSecurityInfo ::=                OCTET STRING

EUTRA-BlacklistedCell ::=                   SEQUENCE {
  physicalCellIdentity                       EUTRA-PhysicalCellIdentity
}

EUTRA-BlacklistedCellPerFreqList ::=        SEQUENCE (SIZE (1..maxEUTRACellPerFreq)) OF
  EUTRA-BlacklistedCell

EUTRA-PhysicalCellIdentity ::=              INTEGER (0..503)

EUTRA-RadioAccessCapability ::=             SEQUENCE {
  ue-EUTRA-Capability                       OCTET STRING
}

EUTRA-TargetFreqInfoList ::=               SEQUENCE (SIZE (1..maxEUTRATargetFreqs)) OF
  EUTRA-TargetFreqInfo

EUTRA-TargetFreqInfo ::=                   SEQUENCE {
  dlEUTRACarrierFreq                        EARFCN,
  eutraBlacklistedCellPerFreqList           EUTRA-BlacklistedCellPerFreqList  OPTIONAL
}

--Actual value = 2^(IE value)
ExpirationTimeFactor ::=                    INTEGER (1..8)

ExtGANSS-SchedulingInfo ::=                 SEQUENCE {
  extensionGANSS-SIBType                    SIB-TypeExtGANSS,
  schedulingInfo                             SchedulingInformation,
  valueTagInfo                               ValueTagInfo
}

-- For each extended GANSS SIB type the value tag information is added at the end
ExtGANSS-SIBTypeInfoSchedulingInfoList ::= SEQUENCE (SIZE (1..maxGANSS)) OF
  ExtGANSS-SIBTypeInfoSchedulingInfo

```

```

ExtGANSS-SIBTypeInfoSchedulingInfo ::= SEQUENCE {
    ganssID          INTEGER (0..7)          OPTIONAL,
    sbasID           UE-Positioning-GANSS-SBAS-ID  OPTIONAL,
    ganssScheduling SEQUENCE (SIZE (1..maxSIB)) OF
                    ExtGANSS-SchedulingInfo
}

-- For each extended SIB type the value tag information is added at the end
ExtSIBTypeInfoSchedulingInfo-List ::= SEQUENCE (SIZE (1..maxSIB)) OF
                                       ExtSIBTypeInfoSchedulingInfo

ExtSIBTypeInfoSchedulingInfo ::= SEQUENCE {
    extensionSIB-Type SIB-TypeExt,
    schedulingInfo    SchedulingInformation,
    valueTagInfo      ValueTagInfo
}

-- For each extended SIB type the value tag information is added at the end
ExtSIBTypeInfoSchedulingInfo-List2 ::= SEQUENCE (SIZE (1..maxSIB)) OF
                                       ExtSIBTypeInfoSchedulingInfo2

ExtSIBTypeInfoSchedulingInfo2 ::= SEQUENCE {
    extensionSIB-Type2 SIB-TypeExt2,
    schedulingInfo     SchedulingInformation,
    valueTagInfo       ValueTagInfo
}

FDD-UMTS-Frequency-List ::= SEQUENCE (SIZE (1..maxNumFDDFreqs)) OF
    -- NOTE1: The IE "UARFCN (Nlow)" corresponds to
    -- "uarfcn-DL" in FrequencyInfoFDD.
    -- NOTE2: The IE "UARFCN (Nupper)" corresponds to
    -- "uarfcn-UL" in FrequencyInfoFDD.
    FrequencyInfoFDD

FrequencyInfoCDMA2000 ::= SEQUENCE {
    band-Class    BIT STRING (SIZE (5)),
    cdma-Freq     BIT STRING (SIZE(11))
}

GERAN-SystemInfoBlock ::= OCTET STRING (SIZE (1..23))

GERAN-SystemInformation ::= SEQUENCE (SIZE (1..maxGERAN-SI)) OF GERAN-SystemInfoBlock

GSM-BA-Range ::= SEQUENCE {
    gsmLowRangeUARFCN UARFCN,
    gsmUpRangeUARFCN  UARFCN
}

GSM-BA-Range-List ::= SEQUENCE (SIZE (1..maxNumGSMFreqRanges)) OF
    GSM-BA-Range

-- This IE is formatted as 'TLV' and is coded in the same way as the Mobile Station Classmark 2
-- information element in [5]. The first octet is the Mobile station classmark 2 IEI and its value
-- shall be set to 33H. The second octet is the Length of mobile station classmark 2 and its value
-- shall be set to 3. The octet 3 contains the first octet of the value part of the Mobile Station
-- Classmark 2 information element, the octet 4 contains the second octet of the value part of the
-- Mobile Station Classmark 2 information element and so on. For each of these octets, the first/
-- leftmost/ most significant bit of the octet contains b8 of the corresponding octet of the Mobile
-- Station Classmark 2.
GSM-Classmark2 ::= OCTET STRING (SIZE (5))

-- This IE is formatted as 'V' and is coded in the same way as the value part in the Mobile station
-- classmark 3 information element in [5]
-- The value part is specified by means of CSN.1, which encoding results in a bit string, to which
-- final padding may be appended upto the next octet boundary [5]. The first/ leftmost bit of the
-- CSN.1 bit string is placed in the first/ leftmost/ most significant bit of the first
-- octet. This continues until the last bit of the CSN.1 bit string, which is placed in the last/
-- rightmost/ least significant bit of the last octet.
GSM-Classmark3 ::= OCTET STRING (SIZE (1..32))

GSM-MessageList ::= SEQUENCE (SIZE (1..maxInterSysMessages)) OF
    BIT STRING (SIZE (1..512))

GSM-MS-RadioAccessCapability ::= OCTET STRING (SIZE (1..64))

GsmSecurityCapability ::= BIT STRING {
    -- For each bit value "0" means false/ not supported

```

```

        a5-7(0),
        a5-6(1),
        a5-5(2),
        a5-4(3),
        a5-3(4),
        a5-2(5),
        a5-1(6)
    } (SIZE (7))

GSM-TargetCellInfoList ::= SEQUENCE (SIZE (1..maxGSMTargetCells)) OF
    GSM-TargetCellInfo

GSM-TargetCellInfo ::= SEQUENCE {
    bcch-ARFCN          BCCH-ARFCN,
    frequency-band     Frequency-Band,
    bsic                BSIC          OPTIONAL
}

HNBNName ::= OCTET STRING (SIZE(1..maxHNBNNameSize))

IdentificationOfReceivedMessage ::= SEQUENCE {
    rrc-TransactionIdentifier RRC-TransactionIdentifier,
    receivedMessageType      ReceivedMessageType
}

InterRAT-ChangeFailureCause ::= CHOICE {
    configurationUnacceptable NULL,
    physicalChannelFailure   NULL,
    protocolError            ProtocolErrorInformation,
    unspecified              NULL,
    spare4                   NULL,
    spare3                   NULL,
    spare2                   NULL,
    spare1                   NULL
}

GERANIu-MessageList ::= SEQUENCE (SIZE (1..maxInterSysMessages)) OF
    BIT STRING (SIZE (1..32768))

GERANIu-RadioAccessCapability ::= BIT STRING (SIZE (1..170))

InterRAT-UE-RadioAccessCapability ::= CHOICE {
    gsm                SEQUENCE {
        gsm-Classmark2  GSM-Classmark2,
        gsm-Classmark3  GSM-Classmark3
    },
    cdma2000           SEQUENCE {
        cdma2000-MessageList CDMA2000-MessageList
    }
}

InterRAT-UE-RadioAccessCapabilityList ::= SEQUENCE (SIZE(1..maxInterSysMessages)) OF
    InterRAT-UE-RadioAccessCapability

InterRAT-UE-RadioAccessCapability-v590ext ::= SEQUENCE {
    geranIu-RadioAccessCapability GERANIu-RadioAccessCapability
}

InterRAT-UE-RadioAccessCapability-v690ext ::= SEQUENCE {
    supportOfInter-RAT-PS-Handover ENUMERATED { doesSupporInter-RAT-PS-Handover } OPTIONAL,
    gsm-MS-RadioAccessCapability    GSM-MS-RadioAccessCapability
}

InterRAT-UE-RadioAccessCapability-v860ext ::= SEQUENCE {
    eutra-RadioAccessCapability EUTRA-RadioAccessCapability OPTIONAL
}

InterRAT-UE-SecurityCapability ::= CHOICE {
    gsm                SEQUENCE {
        gsmSecurityCapability GsmSecurityCapability
    }
}

InterRAT-UE-SecurityCapList ::= SEQUENCE (SIZE(1..maxInterSysMessages)) OF
    InterRAT-UE-SecurityCapability

InterRAT-HO-FailureCause ::= CHOICE {

```

```

configurationUnacceptable          NULL,
physicalChannelFailure             NULL,
protocolError                     ProtocolErrorInformation,
interRAT-ProtocolError            NULL,
unspecified                       NULL,
spare11                           NULL,
spare10                           NULL,
spare9                             NULL,
spare8                             NULL,
spare7                             NULL,
spare6                             NULL,
spare5                             NULL,
spare4                             NULL,
spare3                             NULL,
spare2                             NULL,
spare1                             NULL
}

MasterInformationBlock ::= SEQUENCE {
    mib-ValueTag                   MIB-ValueTag,
    -- TABULAR: The PLMN identity and ANSI-41 core network information
    -- are included in PLMN-Type.
    plmn-Type                       PLMN-Type,
    sibSb-ReferenceList             SIBSb-ReferenceList,
    -- Extension mechanism for non- release99 information
    v690NonCriticalExtensions       SEQUENCE {
        masterInformationBlock-v690ext MasterInformationBlock-v690ext,
        v6b0NonCriticalExtensions     SEQUENCE {
            masterInformationBlock-v6b0ext MasterInformationBlock-v6b0ext-IEs,
            v860NonCriticalExtensions     SEQUENCE {
                masterInformationBlock-v860ext MasterInformationBlock-v860ext-IEs,
                nonCriticalExtensions       SEQUENCE {} OPTIONAL
            } OPTIONAL
        } OPTIONAL
    } OPTIONAL
}

MasterInformationBlock-v690ext ::= SEQUENCE {
    multiplePLMN-List              MultiplePLMN-List-r6          OPTIONAL
}

MasterInformationBlock-v6b0ext-IEs ::= SEQUENCE {
    extSIBTypeInfoSchedulingInfo-List ExtSIBTypeInfoSchedulingInfo-List OPTIONAL
}

MasterInformationBlock-v860ext-IEs ::= SEQUENCE {
    extSIBTypeInfoSchedulingInfo-List ExtSIBTypeInfoSchedulingInfo-List2 OPTIONAL,
    extGANSS-SIBTypeInfoSchedulingInfoList
    ExtGANSS-SIBTypeInfoSchedulingInfoList OPTIONAL,
    csg-Indicator                  ENUMERATED { true }          OPTIONAL
}

MIB-ValueTag ::= INTEGER (1..8)

NCC ::= INTEGER (0..7)

PLMN-ValueTag ::= INTEGER (1..256)

PredefinedConfigIdentityAndValueTag ::= SEQUENCE {
    predefinedConfigIdentity        PredefinedConfigIdentity,
    predefinedConfigValueTag        PredefinedConfigValueTag
}

ProtocolErrorInformation ::= SEQUENCE {
    diagnosticsType                 CHOICE {
        type1                       SEQUENCE {
            protocolErrorCause      ProtocolErrorCause
        },
        spare                        NULL
    }
}

ReceivedMessageType ::= ENUMERATED {
    activeSetUpdate,
    cellChangeOrderFromUTRAN,
    cellUpdateConfirm,
    counterCheck,
}

```

```

        downlinkDirectTransfer,
        interRATHandoverCommand,
        measurementControl,
        pagingType2,
        physicalChannelReconfiguration,
        physicalSharedChannelAllocation,
        radioBearerReconfiguration,
        radioBearerRelease,
        radioBearerSetup,
        rrcConnectionRelease,
        rrcConnectionReject,
        rrcConnectionSetup,
        securityModeCommand,
        signallingConnectionRelease,
        transportChannelReconfiguration,
        transportFormatCombinationControl,
        ueCapabilityEnquiry,
        ueCapabilityInformationConfirm,
        uplinkPhysicalChannelControl,
        uraUpdateConfirm,
        utranMobilityInformation,
        assistanceDataDelivery,
        spare6, spare5, spare4, spare3, spare2,
        spare1
    }
}

Rplmn-Information ::=          SEQUENCE {
    gsm-BA-Range-List          GSM-BA-Range-List          OPTIONAL,
    fdd-UMTS-Frequency-List    FDD-UMTS-Frequency-List    OPTIONAL,
    tdd-UMTS-Frequency-List    TDD-UMTS-Frequency-List    OPTIONAL,
    cdma2000-UMTS-Frequency-List CDMA2000-UMTS-Frequency-List    OPTIONAL
}

Rplmn-Information-r4 ::=      SEQUENCE {
    gsm-BA-Range-List          GSM-BA-Range-List          OPTIONAL,
    fdd-UMTS-Frequency-List    FDD-UMTS-Frequency-List    OPTIONAL,
    -- the option is the same for 7.68 Mcps TDD as for 3.84 Mcps TDD
    -- i.e. TDD-UMTS-Frequency-List applies
    tdd384-UMTS-Frequency-List TDD-UMTS-Frequency-List    OPTIONAL,
    tdd128-UMTS-Frequency-List TDD-UMTS-Frequency-List    OPTIONAL,
    cdma2000-UMTS-Frequency-List CDMA2000-UMTS-Frequency-List    OPTIONAL
}

SchedulingInformation ::=     SEQUENCE {
    scheduling                  SEQUENCE {
        segCount                SegCount                DEFAULT 1,
        sib-Pos                  CHOICE {
            -- The element name indicates the repetition period and the value
            -- (multiplied by two) indicates the position of the first segment.
            rep4                  INTEGER (0..1),
            rep8                  INTEGER (0..3),
            rep16                 INTEGER (0..7),
            rep32                 INTEGER (0..15),
            rep64                 INTEGER (0..31),
            rep128                INTEGER (0..63),
            rep256                INTEGER (0..127),
            rep512                INTEGER (0..255),
            rep1024               INTEGER (0..511),
            rep2048               INTEGER (0..1023),
            rep4096               INTEGER (0..2047)
        },
        sib-PosOffsetInfo        SibOFF-List                OPTIONAL
    }
}

SchedulingInformationSIB ::=  SEQUENCE {
    sib-Type                    SIB-TypeAndTag,
    scheduling                  SchedulingInformation
}

SchedulingInformationSIBSb ::= SEQUENCE {
    sibSb-Type                  SIBSb-TypeAndTag,
    scheduling                  SchedulingInformation
}

SegCount ::=                  INTEGER (1..16)

SegmentIndex ::=              INTEGER (1..15)

```



```

-- Actual value SFN-Prime = 2 * IE value
SFN-Prime ::= INTEGER (0..2047)

SIB-Data-fixed ::= BIT STRING (SIZE (222))

SIB-Data-variable ::= BIT STRING (SIZE (1..214))

SIBOccurIdentity ::= INTEGER (0..15)

SIBOccurrenceIdentityAndValueTag ::= SEQUENCE {
    sibOccurIdentity          SIBOccurIdentity,
    sibOccurValueTag         SIBOccurValueTag
}

SIBOccurValueTag ::= INTEGER (0..15)

SIB-ReferenceList ::= SEQUENCE (SIZE (1..maxSIB)) OF
    SchedulingInformationSIB

SIBSb-ReferenceList ::= SEQUENCE (SIZE (1..maxSIB)) OF
    SchedulingInformationSIBSb

SIB-ReferenceListFACH ::= SEQUENCE (SIZE (1..maxSIB-FACH)) OF
    SchedulingInformationSIB

SIB-Type ::= ENUMERATED {
    masterInformationBlock,
    systemInformationBlockType1,
    systemInformationBlockType2,
    systemInformationBlockType3,
    systemInformationBlockType4,
    systemInformationBlockType5,
    systemInformationBlockType6,
    systemInformationBlockType7,
    -- dummy, dummy2 and dummy3 are not used in this version of the specification,
    -- they should not be sent. If they are received they should be ignored
    dummy,
    dummy2,
    dummy3,
    systemInformationBlockType11,
    systemInformationBlockType12,
    systemInformationBlockType13,
    systemInformationBlockType13-1,
    systemInformationBlockType13-2,
    systemInformationBlockType13-3,
    systemInformationBlockType13-4,
    systemInformationBlockType14,
    systemInformationBlockType15,
    systemInformationBlockType15-1,
    systemInformationBlockType15-2,
    systemInformationBlockType15-3,
    systemInformationBlockType16,
    systemInformationBlockType17,
    systemInformationBlockType15-4,
    systemInformationBlockType18,
    schedulingBlock1,
    schedulingBlock2,
    systemInformationBlockType15-5,
    systemInformationBlockType5bis,
    extensionType }

SIB-TypeAndTag ::= CHOICE {
    sysInfoType1          PLMN-ValueTag,
    sysInfoType2          CellValueTag,
    sysInfoType3          CellValueTag,
    sysInfoType4          CellValueTag,
    sysInfoType5          CellValueTag,
    sysInfoType6          CellValueTag,
    sysInfoType7          NULL,
    -- dummy, dummy2 and dummy3 are not used in this version of the specification,
    -- they should not be sent. If they are received the UE behaviour is not specified.
    dummy                 CellValueTag,
    dummy2                NULL,
    dummy3                NULL,
    sysInfoType11        CellValueTag,

```

```

sysInfoType12          CellValueTag,
sysInfoType13          CellValueTag,
sysInfoType13-1       CellValueTag,
sysInfoType13-2       CellValueTag,
sysInfoType13-3       CellValueTag,
sysInfoType13-4       CellValueTag,
sysInfoType14          NULL,
sysInfoType15          CellValueTag,
sysInfoType16          PredefinedConfigIdentityAndValueTag,
sysInfoType17          NULL,
sysInfoType15-1       CellValueTag,
sysInfoType15-2       SIBOccurrenceIdentityAndValueTag,
sysInfoType15-3       SIBOccurrenceIdentityAndValueTag,
sysInfoType15-4       CellValueTag,
sysInfoType18          CellValueTag,
sysInfoType15-5       CellValueTag,
sysInfoType5bis       CellValueTag,
spare4                 NULL,
spare3                 NULL,
spare2                 NULL,
spare1                 NULL
}

SIBSb-TypeAndTag ::= CHOICE {
  sysInfoType1          PLMN-ValueTag,
  sysInfoType2          CellValueTag,
  sysInfoType3          CellValueTag,
  sysInfoType4          CellValueTag,
  sysInfoType5          CellValueTag,
  sysInfoType6          CellValueTag,
  sysInfoType7          NULL,
  -- dummy, dummy2 and dummy3 are not used in this version of the specification,
  -- they should not be sent. If they are received the UE behaviour is not specified.
  dummy                 CellValueTag,
  dummy2                NULL,
  dummy3                NULL,
  sysInfoType11         CellValueTag,
  sysInfoType12         CellValueTag,
  sysInfoType13         CellValueTag,
  sysInfoType13-1       CellValueTag,
  sysInfoType13-2       CellValueTag,
  sysInfoType13-3       CellValueTag,
  sysInfoType13-4       CellValueTag,
  sysInfoType14         NULL,
  sysInfoType15         CellValueTag,
  sysInfoType16         PredefinedConfigIdentityAndValueTag,
  sysInfoType17         NULL,
  sysInfoTypeSB1        CellValueTag,
  sysInfoTypeSB2        CellValueTag,
  sysInfoType15-1       CellValueTag,
  sysInfoType15-2       SIBOccurrenceIdentityAndValueTag,
  sysInfoType15-3       SIBOccurrenceIdentityAndValueTag,
  sysInfoType15-4       CellValueTag,
  sysInfoType18         CellValueTag,
  sysInfoType15-5       CellValueTag,
  sysInfoType5bis       CellValueTag,
  spare2                NULL,
  spare1                NULL
}

SIB-TypeExt ::= CHOICE {
  systemInfoType11bis  NULL,
  systemInfoType15bis  NULL,
  systemInfoType15-1bis NULL,
  systemInfoType15-2bis NULL,
  systemInfoType15-3bis NULL,
  systemInfoType15-6   NULL,
  systemInfoType15-7   NULL,
  systemInfoType15-8   NULL
}

SIB-TypeExt2 ::= CHOICE {
  systemInfoType19      NULL,
  systemInfoType15-2ter NULL,
  systemInfoType20      NULL,
  spare5                NULL,
  spare4                NULL,
  spare3                NULL,

```

```

    spare2                NULL,
    spare1                NULL
}

SIB-TypeExtGANSS ::= CHOICE {
    systemInfoType15-1bis  NULL,
    systemInfoType15-2bis  NULL,
    systemInfoType15-2ter  NULL,
    systemInfoType15-3bis  NULL,
    systemInfoType15-6     NULL,
    systemInfoType15-7     NULL,
    systemInfoType15-8     NULL,
    spare9                 NULL,
    spare8                 NULL,
    spare7                 NULL,
    spare6                 NULL,
    spare5                 NULL,
    spare4                 NULL,
    spare3                 NULL,
    spare2                 NULL,
    spare1                 NULL
}

SibOFF ::= ENUMERATED {
    so2, so4, so6, so8, so10,
    so12, so14, so16, so18,
    so20, so22, so24, so26,
    so28, so30, so32 }

SibOFF-List ::= SEQUENCE (SIZE (1..15)) OF
    SibOFF

SysInfoType1 ::= SEQUENCE {
    -- Core network IEs
    cn-CommonGSM-MAP-NAS-SysInfo  NAS-SystemInformationGSM-MAP,
    cn-DomainSysInfoList          CN-DomainSysInfoList,
    -- User equipment IEs
    ue-ConnTimersAndConstants      UE-ConnTimersAndConstants          OPTIONAL,
    ue-IdleTimersAndConstants      UE-IdleTimersAndConstants          OPTIONAL,
    -- Extension mechanism for non- release99 information
    v3a0NonCriticalExtensions      SEQUENCE {
        sysInfoType1-v3a0ext       SysInfoType1-v3a0ext-IEs,
        v860NonCriticalExtensions  SEQUENCE {
            sysInfoType1-v860ext   SysInfoType1-v860ext-IEs,
            nonCriticalExtensions  SEQUENCE {} OPTIONAL
        } OPTIONAL
    }
}

SysInfoType1-v3a0ext-IEs ::= SEQUENCE {
    ue-ConnTimersAndConstants-v3a0ext  UE-ConnTimersAndConstants-v3a0ext,
    ue-IdleTimersAndConstants-v3a0ext  UE-IdleTimersAndConstants-v3a0ext
}

SysInfoType1-v860ext-IEs ::= SEQUENCE {
    ue-ConnTimersAndConstants          UE-ConnTimersAndConstants-v860ext
}

SysInfoType2 ::= SEQUENCE {
    -- UTRAN mobility IEs
    ura-IdentityList                  URA-IdentityList,
    -- Extension mechanism for non- release99 information
    nonCriticalExtensions              SEQUENCE {} OPTIONAL
}

SysInfoType3 ::= SEQUENCE {
    sib4indicator                      BOOLEAN,
    -- UTRAN mobility IEs
    cellIdentity                       CellIdentity,
    cellSelectReselectInfo              CellSelectReselectInfoSIB-3-4,
    cellAccessRestriction                CellAccessRestriction,
    -- Extension mechanism for non- release99 information
    v4b0NonCriticalExtensions           SEQUENCE {
        sysInfoType3-v4b0ext           SysInfoType3-v4b0ext-IEs,
        v590NonCriticalExtension       SEQUENCE {
            sysInfoType3-v590ext       SysInfoType3-v590ext,
            v5c0NoncriticalExtension    SEQUENCE {
                sysInfoType3-v5c0ext   SysInfoType3-v5c0ext-IEs,
            }
        }
    }
}

```

```

v670NonCriticalExtension SEQUENCE {
  sysInfoType3-v670ext SysInfoType3-v670ext,
  v770NonCriticalExtension SEQUENCE {
    sysInfoType3-v770ext SysInfoType3-v770ext-IEs,
    v830NonCriticalExtension SEQUENCE {
      sysInfoType3-v830ext SysInfoType3-v830ext-IEs,
      v860NonCriticalExtension SEQUENCE {
        sysInfoType3-v860ext SysInfoType3-v860ext-IEs,
        v870NonCriticalExtension SEQUENCE {
          sysInfoType3-v870ext SysInfoType3-v870ext-IEs,
          nonCriticalExtensions SEQUENCE {} OPTIONAL
        } OPTIONAL
      } OPTIONAL
    } OPTIONAL
  } OPTIONAL
} OPTIONAL

SysInfoType3-v4b0ext-IEs ::= SEQUENCE {
  mapping-LCR Mapping-LCR-r4 OPTIONAL
}

SysInfoType3-v590ext ::= SEQUENCE {
  cellSelectReselectInfo-v590ext CellSelectReselectInfo-v590ext OPTIONAL
}

SysInfoType3-v5c0ext-IEs ::= SEQUENCE {
  cellSelectReselectInfoTreselectionScaling-v5c0ext CellSelectReselectInfoTreselectionScaling-v5c0ext OPTIONAL
}

SysInfoType3-v670ext ::= SEQUENCE {
  domainSpecificAccessRestrictionParametersForPLMNOfMIB
    DomainSpecificAccessRestrictionParam-v670ext OPTIONAL,
  domainSpecificAccessRestrictionForSharedNetwork
    DomainSpecificAccessRestrictionForSharedNetwork-v670ext OPTIONAL
}

SysInfoType3-v770ext-IEs ::= SEQUENCE {
  deferredMeasurementControlReadingSupport DeferredMeasurementControlReadingSupport OPTIONAL,
  q-QualMin-Offset Q-QualMin-Offset OPTIONAL,
  q-RxlevMin-Offset Q-RxlevMin-Offset OPTIONAL,
  mbsfnOnlyService MBSFNOnlyService OPTIONAL
}

SysInfoType3-v830ext-IEs ::= SEQUENCE {
  pagingPermissionWithAccessControlParametersForPLMNOfMIB
    PagingPermissionWithAccessControlParameters OPTIONAL,
  pagingPermissionWithAccessControlParametersForSharedNetwork
    PagingPermissionWithAccessControlForSharedNetwork OPTIONAL
}

SysInfoType3-v860ext-IEs ::= SEQUENCE {
  csgIdentity CSG-Identity OPTIONAL,
  csg-PSCSPLITInfo CSG-PSCSPLITInfo OPTIONAL
}

SysInfoType3-v870ext-IEs ::= SEQUENCE {
  cellAccessRestriction CellAccessRestriction-v870ext OPTIONAL
}

SysInfoType4 ::= SEQUENCE {
  -- UTRAN mobility IEs
  cellIdentity CellIdentity,
  cellSelectReselectInfo CellSelectReselectInfoSIB-3-4,
  cellAccessRestriction CellAccessRestriction,
  -- Extension mechanism for non- release99 information
  v4b0NonCriticalExtensions SEQUENCE {
    sysInfoType4-v4b0ext SysInfoType4-v4b0ext-IEs,
    v590NonCriticalExtension SEQUENCE {
      sysInfoType4-v590ext SysInfoType4-v590ext,
      v5b0NonCriticalExtension SEQUENCE {
        sysInfoType4-v5b0ext SysInfoType4-v5b0ext-IEs,
        v5c0NonCriticalExtension SEQUENCE {

```

```

        sysInfoType4-v5c0ext
        nonCriticalExtensions
    } OPTIONAL
} OPTIONAL
} OPTIONAL
}

SysInfoType4-v4b0ext-IEs ::= SEQUENCE {
    mapping-LCR Mapping-LCR-r4 OPTIONAL
}

SysInfoType4-v590ext ::= SEQUENCE {
    cellSelectReselectInfo-v590ext CellSelectReselectInfo-v590ext OPTIONAL
}

SysInfoType4-v5b0ext-IEs ::= SEQUENCE {
    cellSelectReselectInfoPCHFACH-v5b0ext CellSelectReselectInfoPCHFACH-v5b0ext OPTIONAL
}

SysInfoType4-v5c0ext-IEs ::= SEQUENCE {
    cellSelectReselectInfoTreselectionScaling-v5c0ext CellSelectReselectInfoTreselectionScaling-v5c0ext OPTIONAL
}

SysInfoType5 ::= SEQUENCE {
    sib6indicator BOOLEAN,
    -- Physical channel IEs
    pich-PowerOffset PICH-PowerOffset,
    modeSpecificInfo CHOICE {
        fdd SEQUENCE {
            aich-PowerOffset AICH-PowerOffset
        },
        tdd SEQUENCE {
            -- If PDSCH/PUSCH is configured for 1.28Mcps or 7.68Mcps TDD, the following IEs should be absent
            -- and the info included in the respective tdd128SpecificInfo or tdd768SpecificInfo instead.
            -- If PDSCH/PUSCH is configured for 3.84Mcps TDD in R5, HCR-r5-SpecificInfo should also be
            -- included.
            pusch-SysInfoList-SFN PUSCH-SysInfoList-SFN OPTIONAL,
            pdsch-SysInfoList-SFN PDSCH-SysInfoList-SFN OPTIONAL,
            openLoopPowerControl-TDD OpenLoopPowerControl-TDD
        }
    },
    primaryCCPCH-Info PrimaryCCPCH-Info OPTIONAL,
    prach-SystemInformationList PRACH-SystemInformationList,
    sccpch-SystemInformationList SCCPCH-SystemInformationList,
    -- cbs-DRX-Level1Information is conditional on any of the CTCH indicator IEs in
    -- sccpch-SystemInformationList
    cbs-DRX-Level1Information CBS-DRX-Level1Information OPTIONAL,
    -- Extension mechanism for non- release99 information
    v4b0NonCriticalExtensions SEQUENCE {
        sysInfoType5-v4b0ext SysInfoType5-v4b0ext-IEs OPTIONAL,
    -- Extension mechanism for non- rel-4 information
        v590NonCriticalExtensions SEQUENCE {
            sysInfoType5-v590ext SysInfoType5-v590ext-IEs OPTIONAL,
            v650NonCriticalExtensions SEQUENCE {
                sysInfoType5-v650ext SysInfoType5-v650ext-IEs OPTIONAL,
                v680NonCriticalExtensions SEQUENCE {
                    sysInfoType5-v680ext SysInfoType5-v680ext-IEs OPTIONAL,
                    v690NonCriticalExtensions SEQUENCE {
                        sysInfoType5-v690ext SysInfoType5-v690ext-IEs,
                        v770NonCriticalExtensions SEQUENCE {
                            sysInfoType5-v770ext SysInfoType5-v770ext-IEs,
                            v860NonCriticalExtensions SEQUENCE {
                                sysInfoType5-v860ext SysInfoType5-v860ext-IEs,
                                v890NonCriticalExtensions SEQUENCE {
                                    sysInfoType5-v890ext SysInfoType5-v890ext-IEs,
                                    v8b0NonCriticalExtensions SEQUENCE {
                                        sysInfoType5-v8b0ext
                                            SysInfoType5-v8b0ext-IEs,
                                        v8d0NonCriticalExtensions SEQUENCE {
                                            sysInfoType5-v8d0ext
                                                SysInfoType5-v8d0ext-
IEs,
                                            nonCriticalExtensions SEQUENCE {} OPTIONAL
                                        } OPTIONAL
                                    }
                                }
                            }
                        }
                    }
                }
            }
        }
    } OPTIONAL
} OPTIONAL

```

```
        }
      }
    } OPTIONAL
  } OPTIONAL
}

SysInfoType5-v4b0ext-IEs ::= SEQUENCE {
--The following IE PNBSCH-Allocation-r4 shall be used for 3.84Mcps TDD only.
pNBSCH-Allocation-r4          PNBSCH-Allocation-r4          OPTIONAL,
-- In case of TDD, the following IE is included instead of the
-- IE up-IPDL-Parameter in up-OTDOA-AssistanceData.
openLoopPowerControl-IPDL-TDD OpenLoopPowerControl-IPDL-TDD-r4 OPTIONAL,
-- If SysInfoType5 is sent to describe a 1.28Mcps TDD cell, the IE PRACH-RACH-Info included in
-- PRACH-SystemInformationList shall be ignored, the IE PRACH-Partitioning and the
-- IE rach-TransportFormatSet shall be absent and the corresponding IE in the following
-- PRACH-SystemInformationList-LCR-r4 shall be used
prach-SystemInformationList-LCR-r4 PRACH-SystemInformationList-LCR-r4 OPTIONAL,
tdd128SpecificInfo                SEQUENCE {
  pusSch-SysInfoList-SFN           PUSCH-SysInfoList-SFN-LCR-r4   OPTIONAL,
  pdsch-SysInfoList-SFN           PDSCH-SysInfoList-SFN-LCR-r4   OPTIONAL,
  pCCPCH-LCR-Extensions           PrimaryCCPCH-Info-LCR-r4-ext   OPTIONAL,
  sCCPCH-LCR-ExtensionsList       SCCPCH-SystemInformationList-LCR-r4-ext
}
frequencyBandIndicator          RadioFrequencyBandFDD          OPTIONAL
}

SysInfoType5-v590ext-IEs ::= SEQUENCE {
  hcr-r5-SpecificInfo           SEQUENCE {
    pusSch-SysInfoList-SFN       PUSCH-SysInfoList-SFN-HCR-r5   OPTIONAL,
    pdsch-SysInfoList-SFN       PDSCH-SysInfoList-SFN-HCR-r5   OPTIONAL
  }
}

SysInfoType5-v650ext-IEs ::= SEQUENCE {
  frequencyBandIndicator2       RadioFrequencyBandFDD2
}

SysInfoType5-v680ext-IEs ::= SEQUENCE {
-- TABULAR: HSDPA Cell Indicator is MD in tabular description
-- Default value is 'HSDPA Capability not indicated'
  hsdpa-CellIndicator           ENUMERATED { hsdpa-CapableCell }   OPTIONAL
}

SysInfoType5-v690ext-IEs ::= SEQUENCE {
-- TABULAR: E-DCH Cell Indicator is MD in tabular description
-- Default value is 'E-DCH Capability not indicated'
  edch-CellIndicator            ENUMERATED { edch-CapableCell }   OPTIONAL,
  sccpCh-SystemInformation-MBMS CHOICE {
    mcchOnSCCPCHUsedForNonMBMS   MBMS-MCCH-ConfigurationInfo-r6,
    mcchOnSCCPCHUsedOnlyForMBMS  SCCPCH-SystemInformation-MBMS-r6
  } OPTIONAL,
  additionalPRACH-TF-and-TFCS-CCCH-List AdditionalPRACH-TF-and-TFCS-CCCH-List OPTIONAL,
  cBS-DRX-Level1Information-extension CBS-DRX-Level1Information-extension-r6 OPTIONAL
}

SysInfoType5-v770ext-IEs ::= SEQUENCE {
  modeSpecificInfo             CHOICE {
    fdd                         SEQUENCE {
      hs-dsch-CommonSystemInformation HS-DSCH-CommonSystemInformation,
      hs-dsch-PagingSystemInformation HS-DSCH-PagingSystemInformation OPTIONAL
    },
    tdd768                      SEQUENCE {
      pusSch-SysInfoList-SFN         PUSCH-SysInfoList-SFN-VHCR     OPTIONAL,
      pdsch-SysInfoList-SFN         PDSCH-SysInfoList-SFN-VHCR-r7  OPTIONAL,
      -- If SysInfoType5 is sent to configure a 7.68Mcps TDD cell, the 'prach-RACH-Info' in
      -- IE PRACH-SystemInformationList shall be ignored, 'prach-Partitioning' shall be absent
      -- and the corresponding IE in the following IE PRACH-SystemInformationList-VHCR-r7
      -- shall be used instead.
      prach-SystemInformationList     PRACH-SystemInformationList-VHCR-r7 OPTIONAL
    },
    tdd128                      SEQUENCE {
      prach-SystemInformationList     PRACH-SystemInformationList-LCR-v770ext OPTIONAL
    }
  } OPTIONAL,
}
```

```

-- If SysInfoType5 is sent to configure a 7.68 Mcps TDD cell (in any mode) or a 3.84 Mcps TDD
-- cell operating in MBSFN mode, IE SCCPCH-SystemInformationList-HCR-VHCR-r7 is used, otherwise
-- IE SCCPCH-SystemInformationList-r6 is used.
sccpch-SystemInformationList          SCCPCH-SystemInformationList-HCR-VHCR-r7    OPTIONAL,
sccpch-SystemInformation-MBMS          CHOICE {
  -- If choice is 'mcchOnSCCPCHusedForNonMBMS', IE MBMS-MCCH-ConfigurationInfo-r6 is used.
  -- If choice is 'mcchOnSCCPCHusedOnlyForMBMS', IE MBMS-MCCH-ConfigurationInfo-r7 is used
  -- to configure a 7.68Mcps TDD cell or a cell operating in MBSFN mode, otherwise IE
  -- SCCPCH-SystemInformation-MBMS-r6 is used.
  mcchOnSCCPCHusedOnlyForMBMS        SCCPCH-SystemInformation-MBMS-r7
}
OPTIONAL,
tDD-MBSFNInformation                  TDD-MBSFNInformation                    OPTIONAL
}

SysInfoType5-v860ext-IEs ::= SEQUENCE {
  -- The field 'dummy' shall be marked absent in SysInfoType5 and SysInfoType5bis. A failure to
  -- comply with this requirement may prevent the UE to receive any service in the cell. The UE
  -- may treat the cell as barred.
  dummy                               SEQUENCE { }                               OPTIONAL,
  modeSpecificInfo                    CHOICE {
    fdd                                SEQUENCE {
      hs-dsch-DrxCellfach-info        HS-DSCH-DrxCellfach-info              OPTIONAL
    },
    tdd128                             SEQUENCE {
      hs-dsch-CommonSysInfo           SEQUENCE {
        hs-dsch-CommonSystemInformation HS-DSCH-CommonSystemInformation-TDD128,
        hs-dsch-PagingSystemInformation HS-DSCH-PagingSystemInformation-TDD128 OPTIONAL
      }
      OPTIONAL,
      hs-dsch-DrxCellfach-info        HS-DSCH-DrxCellfach-info-TDD128      OPTIONAL
    }
  }
}

SysInfoType5-v890ext-IEs ::= SEQUENCE {
  secondFrequencyInfo                 FrequencyInfoTDD                        OPTIONAL,
  commonEDCHSystemInfo                CommonEDCHSystemInfo                   OPTIONAL
}

SysInfoType5-v8b0ext-IEs ::= SEQUENCE {
  tresetUsageIndicator                ENUMERATED { true }                    OPTIONAL,
  upPCHpositionInfo                   UpPCHposition-LCR                      OPTIONAL
}

SysInfoType5-v8d0ext-IEs ::= SEQUENCE {
  commonEDCHSystemInfoFDD              CommonEDCHSystemInfoFDD                OPTIONAL
}

-- SysInfoType5bis uses the same structure as SysInfoType5
SysInfoType5bis ::= SysInfoType5

SysInfoType6 ::=
  SEQUENCE {
    -- Physical channel IEs
    pich-PowerOffset                   PICH-PowerOffset,
    modeSpecificInfo                   CHOICE {
      fdd                               SEQUENCE {
        aich-PowerOffset               AICH-PowerOffset,
        -- dummy is not used in this version of specification, it should
        -- not be sent and if received it should be ignored.
        dummy                           CSICH-PowerOffset                    OPTIONAL
      },
      tdd                               SEQUENCE {
        -- If PDSCH/PUSCH is configured for 1.28Mcps TDD, pusch-SysInfoList-SFN,
        -- pdsch-SysInfoList-SFN and openLoopPowerControl-TDD should be absent
        -- and the info included in the tdd128SpecificInfo instead.
        -- If PDSCH/PUSCH is configured for 7.68Mcps TDD, pusch-SysInfoList-SFN
        -- and pdsch-SysInfoList-SFN should be absent and the info included in the
        -- tdd768SpecificInfo instead.
        -- If PDSCH/PUSCH is configured for 3.84Mcps TDD in R5, HCR-r5-SpecificInfo should
        -- also be included.
        pusch-SysInfoList-SFN          PUSCH-SysInfoList-SFN                 OPTIONAL,
        pdsch-SysInfoList-SFN          PDSCH-SysInfoList-SFN                 OPTIONAL,
        openLoopPowerControl-TDD        OpenLoopPowerControl-TDD
      }
    },
    primaryCCPCH-Info                  PrimaryCCPCH-Info                       OPTIONAL,
    prach-SystemInformationList         PRACH-SystemInformationList             OPTIONAL,
    sccpch-SystemInformationList         SCCPCH-SystemInformationList            OPTIONAL,
    cbs-DRX-Level1Information            CBS-DRX-Level1Information               OPTIONAL,

```

```

-- Conditional on any of the CTCH indicator IEs in
-- sCCPCH-SystemInformationList
-- Extension mechanism for non- release99 information
v4b0NonCriticalExtensions SEQUENCE {
  sysInfoType6-v4b0ext SysInfoType6-v4b0ext-IEs OPTIONAL,
-- Extension mechanism for non- rel-4 information
v590NonCriticalExtensions SEQUENCE {
  sysInfoType6-v590ext SysInfoType6-v590ext-IEs OPTIONAL,
v650nonCriticalExtensions SEQUENCE {
  sysInfoType6-v650ext SysInfoType6-v650ext-IEs OPTIONAL,
v690nonCriticalExtensions SEQUENCE {
  sysInfoType6-v690ext SysInfoType6-v690ext-IEs,
v770NonCriticalExtensions SEQUENCE {
  sysInfoType6-v770ext SysInfoType6-v770ext-IEs,
  nonCriticalExtensions SEQUENCE {} OPTIONAL
} OPTIONAL
} OPTIONAL
} OPTIONAL
} OPTIONAL
} OPTIONAL
}
}
}

SysInfoType6-v4b0ext-IEs ::= SEQUENCE {
-- openLoopPowerControl-IPDL-TDD is present only if IPDLs are applied for TDD
openLoopPowerControl-IPDL-TDD OpenLoopPowerControl-IPDL-TDD-r4 OPTIONAL,
-- If SysInfoType6 is sent to describe a 1.28Mcps TDD cell, the IE PRACH-RACH-Info included
-- in PRACH-SystemInformationList shall be ignored, the IE PRACH-Partitioning and the
-- IE rach-TransportFormatSet shall be absent and the corresponding IEs in the following
-- PRACH-SystemInformationList-LCR-r4 shall be used
prach-SystemInformationList-LCR-r4 PRACH-SystemInformationList-LCR-r4 OPTIONAL,
tdd128SpecificInfo SEQUENCE {
  pusch-SysInfoList-SFN PUSCH-SysInfoList-SFN-LCR-r4 OPTIONAL,
  pdsch-SysInfoList-SFN PDSCH-SysInfoList-SFN-LCR-r4 OPTIONAL,
  pCCPCH-LCR-Extensions PrimaryCCPCH-Info-LCR-r4-ext OPTIONAL,
  sCCPCH-LCR-ExtensionsList SCCPCH-SystemInformationList-LCR-r4-ext OPTIONAL
}
frequencyBandIndicator RadioFrequencyBandFDD OPTIONAL
}

SysInfoType6-v590ext-IEs ::= SEQUENCE {
  hcr-r5-SpecificInfo SEQUENCE {
    pusch-SysInfoList-SFN PUSCH-SysInfoList-SFN-HCR-r5 OPTIONAL,
    pdsch-SysInfoList-SFN PDSCH-SysInfoList-SFN-HCR-r5 OPTIONAL
  }
}

SysInfoType6-v650ext-IEs ::= SEQUENCE {
  frequencyBandIndicator2 RadioFrequencyBandFDD2
}

SysInfoType6-v690ext-IEs ::= SEQUENCE {
  additionalPRACH-TF-and-TFCS-CCCH-List AdditionalPRACH-TF-and-TFCS-CCCH-List OPTIONAL
}

SysInfoType6-v770ext-IEs ::= SEQUENCE {
  tdd768SpecificInfo SEQUENCE {
    pusch-SysInfoList-SFN PUSCH-SysInfoList-SFN-VHCR OPTIONAL,
    pdsch-SysInfoList-SFN PDSCH-SysInfoList-SFN-VHCR-r7 OPTIONAL,
    -- If SysInfoType6 is sent to configure a 7.68Mcps TDD cell, the 'prach-RACH-Info' in
    -- IE PRACH-SystemInformationList shall be ignored, 'prach-Partitioning' shall be absent
    -- and the corresponding IE in the following IE PRACH-SystemInformationList-VHCR-r7
    -- shall be used instead.
    prach-SystemInformationList PRACH-SystemInformationList-VHCR-r7 OPTIONAL
  }
  -- If SysInfoType6 is sent to configure a 7.68 Mcps TDD cell,
  -- IE SCCPCH-SystemInformationList-HCR-VHCR-r7 is used, otherwise
  -- IE SCCPCH-SystemInformationList-r6 is used.
  sccpch-SystemInformationList SCCPCH-SystemInformationList-HCR-VHCR-r7 OPTIONAL
}

SysInfoType7 ::= SEQUENCE {
  -- Physical channel IEs
  modeSpecificInfo CHOICE {
    fdd SEQUENCE {
      ul-Interference UL-Interference
    },
    tdd NULL
  },
}

```



```

prach-Information-SIB5-List      DynamicPersistenceLevelList,
prach-Information-SIB6-List      DynamicPersistenceLevelList      OPTIONAL,
expirationTimeFactor            ExpirationTimeFactor          OPTIONAL,
-- Extension mechanism for non- release99 information
nonCriticalExtensions            SEQUENCE {}                          OPTIONAL
}

-- This IE is not used in this version of the specification.
-- It was kept only for backwards compatibility reasons
SysInfoType8 ::= SEQUENCE {
  -- User equipment IEs
  -- dummy1, dummy2, dummy3 are not used in this version of the specification and
  -- they should be ignored by the receiver.
  dummy1                          CPCH-Parameters,
  -- Physical channel IEs
  dummy2                          CPCH-SetInfoList,
  dummy3                          CSICH-PowerOffset,
  -- Extension mechanism for non- release99 information
  nonCriticalExtensions            SEQUENCE {}                          OPTIONAL
}

-- This IE is not used in this version of the specification.
-- It was kept only for backwards compatibility reasons
SysInfoType9 ::= SEQUENCE {
  -- Physical channel IEs
  -- dummy is not used in this version of the specification and
  -- it should be ignored by the receiver.
  dummy                          CPCH-PersistenceLevelsList,
  -- Extension mechanism for non- release99 information
  nonCriticalExtensions            SEQUENCE {}                          OPTIONAL
}

-- This IE is not used in this version of the specification.
-- It was kept only for backwards compatibility reasons
SysInfoType10 ::= SEQUENCE {
  -- User equipment IEs
  -- dummy is not used in this version of the specification, it should
  -- not be sent and if received it should be ignored.
  dummy                          DRAC-SysInfoList,
  -- Extension mechanism for non- release99 information
  nonCriticalExtensions            SEQUENCE {}                          OPTIONAL
}

SysInfoType11 ::= SEQUENCE {
  sib12indicator                  BOOLEAN,
  -- Measurement IEs
  fach-MeasurementOccasionInfo    FACH-MeasurementOccasionInfo      OPTIONAL,
  measurementControlSysInfo       MeasurementControlSysInfo,
  -- Extension mechanism for non- release99 information
  v4b0NonCriticalExtensions        SEQUENCE {
    sysInfoType11-v4b0ext          SysInfoType11-v4b0ext-IEs          OPTIONAL,
    v590NonCriticalExtension        SEQUENCE {
      sysInfoType11-v590ext        SysInfoType11-v590ext-IEs,
      v690NonCriticalExtensions    SEQUENCE {
        sysInfoType11-v690ext      SysInfoType11-v690ext-IEs,
        v6b0NonCriticalExtensions SEQUENCE {
          sysInfoType11-v6b0ext    SysInfoType11-v6b0ext-IEs,
          v770NonCriticalExtensions SEQUENCE {
            sysInfoType11-v770ext  SysInfoType11-v770ext-IEs,
            v7b0NonCriticalExtensions SEQUENCE {
              sysInfoType11-v7b0ext SysInfoType11-v7b0ext-IEs,
              v860NonCriticalExtensions SEQUENCE {
                sysInfoType11-v860ext SysInfoType11-v860ext-IEs,
                nonCriticalExtensions SEQUENCE {}          OPTIONAL
              }
            }
          }
        }
      }
    }
  }
}

SysInfoType11-v4b0ext-IEs ::= SEQUENCE {
  fach-MeasurementOccasionInfo-LCR-Ext FACH-MeasurementOccasionInfo-LCR-r4-ext OPTIONAL,
  measurementControlSysInfo-LCR        MeasurementControlSysInfo-LCR-r4-ext
}

```

```

SysInfoType11-v590ext-IEs ::= SEQUENCE {
  --The order of the list corresponds to the order of cell in newIntraFrequencyCellInfoList
  newIntraFrequencyCellInfoList-v590ext SEQUENCE (SIZE (1..maxCellMeas)) OF
    CellSelectReselectInfo-v590ext OPTIONAL,
  --The order of the list corresponds to the order of cell in newInterFrequencyCellInfoList
  newInterFrequencyCellInfoList-v590ext SEQUENCE (SIZE (1..maxCellMeas)) OF
    CellSelectReselectInfo-v590ext OPTIONAL,
  --The order of the list corresponds to the order of cell in newInterRATCellInfoList
  newInterRATCellInfoList-v590ext SEQUENCE (SIZE (1..maxCellMeas)) OF
    CellSelectReselectInfo-v590ext OPTIONAL,
  intraFreqEventCriteriaList-v590ext Intra-FreqEventCriteriaList-v590ext OPTIONAL,
  intraFreqReportingCriteria-1b-r5 IntraFreqReportingCriteria-1b-r5 OPTIONAL,
  intraFreqEvent-1d-r5 IntraFreqEvent-1d-r5 OPTIONAL
}

SysInfoType11-v690ext-IEs ::= SEQUENCE {
  -- dummy is not used in this version of the specification. If received, the UE behaviour
  -- is not specified.
  dummy Dummy-InterFreqRACHReportingInfo OPTIONAL
}

SysInfoType11-v6b0ext-IEs ::= SEQUENCE {
  -- Measurement IEs
  interFreqRACHReportingInfo InterFreqRACHReportingInfo OPTIONAL
}

SysInfoType11-v770ext-IEs ::= SEQUENCE {
  -- Measurement IEs
  mbsfnFrequencyList MBSFNFrequencyList OPTIONAL
}

SysInfoType11-v7b0ext-IEs ::= SEQUENCE {
  -- Measurement IEs
  newInterFreqCellList NewInterFreqCellList-v7b0ext OPTIONAL
}

SysInfoType11-v860ext-IEs ::= SEQUENCE {
  -- Measurement IEs
  mbsfnFrequencyList MBSFNFrequencyList-v860ext OPTIONAL
}

SysInfoType11bis ::= SEQUENCE {
  -- Measurement IEs
  measurementControlSysInfo MeasurementControlSysInfoExtension OPTIONAL,
  measurementControlSysInfo-LCR MeasurementControlSysInfoExtension-LCR-r4 OPTIONAL,
  measurementControlSysInfoExtensionAddon-r5
    MeasurementControlSysInfoExtensionAddon-r5 OPTIONAL,
  -- Extension mechanism for non-release99 information
  v7b0NonCriticalExtensions SEQUENCE {
    sysInfoType11bis-v7b0ext SysInfoType11bis-v7b0ext-IEs,
    v860NonCriticalExtensions SEQUENCE {
      sysInfoType11bis-v860ext SysInfoType11bis-v860ext-IEs,
      nonCriticalExtensions SEQUENCE {} OPTIONAL
    } OPTIONAL
  } OPTIONAL
}

SysInfoType11bis-v7b0ext-IEs ::= SEQUENCE {
  -- Measurement IEs
  newInterFreqCellList NewInterFreqCellList-v7b0ext OPTIONAL
}

SysInfoType11bis-v860ext-IEs ::= SEQUENCE {
  -- UTRAN mobility IEs
  csg-PSCSplitInfo CSG-PSCSplitInfo OPTIONAL,
  csg-DedicatedFrequencyInfoList CSG-DedicatedFrequencyInfoList OPTIONAL
}

SysInfoType12 ::= SEQUENCE {
  -- Measurement IEs
  fach-MeasurementOccasionInfo FACH-MeasurementOccasionInfo OPTIONAL,
  measurementControlSysInfo MeasurementControlSysInfo,
  -- Extension mechanism for non- release99 information
  v4b0NonCriticalExtensions SEQUENCE {
    sysInfoType12-v4b0ext SysInfoType12-v4b0ext-IEs OPTIONAL,
    v590NonCriticalExtension SEQUENCE {
      sysInfoType12-v590ext SysInfoType12-v590ext-IEs,
      v690NonCriticalExtensions SEQUENCE {

```

```

        sysInfoType12-v690ext          SysInfoType12-v690ext-IEs,
        v6b0NonCriticalExtensions      SEQUENCE {
            sysInfoType12-v6b0ext      SysInfoType12-v6b0ext-IEs,
            v7b0NonCriticalExtensions  SEQUENCE {
                sysInfoType12-v7b0ext  SysInfoType12-v7b0ext-IEs,
                nonCriticalExtensions  SEQUENCE {}              OPTIONAL
            }
        }
    }
}

SysInfoType12-v4b0ext-IEs ::= SEQUENCE {
    fach-MeasurementOccasionInfo-LCR-Ext  FACH-MeasurementOccasionInfo-LCR-r4-ext OPTIONAL,
    measurementControlSysInfo-LCR        MeasurementControlSysInfo-LCR-r4-ext
}

SysInfoType12-v590ext-IEs ::= SEQUENCE {
    --The order of the list corresponds to the order of cell in newIntraFrequencyCellInfoList
    newIntraFrequencyCellInfoList-v590ext SEQUENCE (SIZE (1..maxCellMeas)) OF
        CellSelectReselectInfo-v590ext OPTIONAL,
    --The order of the list corresponds to the order of cell in newInterFrequencyCellInfoList
    newInterFrequencyCellInfoList-v590ext SEQUENCE (SIZE (1..maxCellMeas)) OF
        CellSelectReselectInfo-v590ext OPTIONAL,
    --The order of the list corresponds to the order of cell in newInterRATCellInfoList
    newInterRATCellInfoList-v590ext      SEQUENCE (SIZE (1..maxCellMeas)) OF
        CellSelectReselectInfo-v590ext OPTIONAL,
    intraFreqEventCriteriaList-v590ext    Intra-FreqEventCriteriaList-v590ext  OPTIONAL,
    intraFreqReportingCriteria-1b-r5      IntraFreqReportingCriteria-1b-r5     OPTIONAL,
    intraFreqEvent-1d-r5                  IntraFreqEvent-1d-r5                 OPTIONAL
}

SysInfoType12-v690ext-IEs ::= SEQUENCE {
    -- dummy is not used in this version of the specification. If received, the UE behaviour
    -- is not specified.
    dummy                                Dummy-InterFreqRACHReportingInfo    OPTIONAL
}

SysInfoType12-v6b0ext-IEs ::= SEQUENCE {
    -- Measurement IEs
    interFreqRACHReportingInfo           InterFreqRACHReportingInfo           OPTIONAL
}

SysInfoType12-v7b0ext-IEs ::= SEQUENCE {
    -- Measurement IEs
    newInterFreqCellList                 NewInterFreqCellList-v7b0ext        OPTIONAL
}

SysInfoType13 ::= SEQUENCE {
    -- Core network IEs
    cn-DomainSysInfoList                 CN-DomainSysInfoList,
    -- User equipment IEs
    ue-IdleTimersAndConstants             UE-IdleTimersAndConstants           OPTIONAL,
    capabilityUpdateRequirement           CapabilityUpdateRequirement           OPTIONAL,
    -- Extension mechanism for non- release99 information
    v3a0NonCriticalExtensions             SEQUENCE {
        sysInfoType13-v3a0ext             SysInfoType13-v3a0ext-IEs,
        v4b0NonCriticalExtensions         SEQUENCE {
            sysInfoType13-v4b0ext         SysInfoType13-v4b0ext-IEs,
            -- Extension mechanism for non- release99 information
            v770NonCriticalExtensions     SEQUENCE {
                sysInfoType13-v770ext     SysInfoType13-v770ext-IEs,
                nonCriticalExtensions     SEQUENCE {}              OPTIONAL
            }
        }
    }
}

SysInfoType13-v3a0ext-IEs ::= SEQUENCE {
    ue-IdleTimersAndConstants-v3a0ext    UE-IdleTimersAndConstants-v3a0ext
}

SysInfoType13-v4b0ext-IEs ::= SEQUENCE {
    capabilityUpdateRequirement-r4Ext     CapabilityUpdateRequirement-r4-ext   OPTIONAL
}

SysInfoType13-v770ext-IEs ::= SEQUENCE {

```

```

    capabilityUpdateRequirement          CapabilityUpdateRequirement-v770ext OPTIONAL
  }
SysInfoType13-1 ::=                      SEQUENCE {
  -- ANSI-41 IEs
  ansi-41-RAND-Information              ANSI-41-RAND-Information,
  -- Extension mechanism for non- release99 information
  nonCriticalExtensions                 SEQUENCE {}                                OPTIONAL
}
SysInfoType13-2 ::=                      SEQUENCE {
  -- ANSI-41 IEs
  ansi-41-UserZoneID-Information        ANSI-41-UserZoneID-Information,
  -- Extension mechanism for non- release99 information
  nonCriticalExtensions                 SEQUENCE {}                                OPTIONAL
}
SysInfoType13-3 ::=                      SEQUENCE {
  -- ANSI-41 IEs
  ansi-41-PrivateNeighbourListInfo     ANSI-41-PrivateNeighbourListInfo,
  -- Extension mechanism for non- release99 information
  nonCriticalExtensions                 SEQUENCE {}                                OPTIONAL
}
SysInfoType13-4 ::=                      SEQUENCE {
  -- ANSI-41 IEs
  ansi-41-GlobalServiceRedirectInfo     ANSI-41-GlobalServiceRedirectInfo,
  -- Extension mechanism for non- release99 information
  nonCriticalExtensions                 SEQUENCE {}                                OPTIONAL
}
SysInfoType14 ::=                      SEQUENCE {
  -- Physical channel IEs
  individualTS-InterferenceList        IndividualTS-InterferenceList,
  expirationTimeFactor                 ExpirationTimeFactor                                OPTIONAL,
  -- Extension mechanism for non- release99 information
  nonCriticalExtensions                 SEQUENCE {}                                OPTIONAL
}
SysInfoType15 ::=                      SEQUENCE {
  -- Measurement IEs
  ue-positioning-GPS-CipherParameters  UE-Positioning-CipherParameters                OPTIONAL,
  ue-positioning-GPS-ReferenceLocation  ReferenceLocation,
  ue-positioning-GPS-ReferenceTime      UE-Positioning-GPS-ReferenceTime,
  ue-positioning-GPS-Real-timeIntegrity BadSatList                                OPTIONAL,
  -- Extension mechanism for non- release99 information
  v4b0NonCriticalExtensions            SEQUENCE {
    sysInfoType15-v4b0ext              SysInfoType15-v4b0ext-IEs,
    -- Extension mechanism for non- release4 information
    v770NonCriticalExtensions          SEQUENCE {
      sysInfoType15-v770ext            SysInfoType15-v770ext-IEs,
      nonCriticalExtensions            SEQUENCE {}                                OPTIONAL
    } OPTIONAL
  } OPTIONAL
}
SysInfoType15-v4b0ext-IEs ::= SEQUENCE {
  up-IPDL-Parameters-TDD              UE-Positioning-IPDL-Parameters-TDD-r4-ext    OPTIONAL
}
SysInfoType15-v770ext-IEs ::= SEQUENCE {
  -- Measurement IEs
  ue-Positioning-GPS-ReferenceTime     UE-Positioning-GPS-ReferenceTime-v770ext
}
SysInfoType15bis ::=                   SEQUENCE {
  -- Measurement IEs
  ue-positioning-GANSS-ReferencePosition ReferenceLocationGANSS,
  ue-positioning-GANSS-ReferenceTime    UE-Positioning-GANSS-ReferenceTime,
  ue-positioning-GANSS-IonosphericModel UE-Positioning-GANSS-IonosphericModel    OPTIONAL,
  -- Extension mechanism for non-release99 information
  v860NonCriticalExtensions            SEQUENCE {
    sysInfoType15bis-v860ext          SysInfoType15bis-v860ext-IEs,
    nonCriticalExtensions             SEQUENCE {}                                OPTIONAL
  } OPTIONAL
}

```

```

SysInfoType15bis-v860ext-IEs ::= SEQUENCE {
  -- Measurement IEs
  ue-Positioning-GANSS-AddIonoModel  UE-Positioning-GANSS-AddIonoModel      OPTIONAL,
  ue-Positioning-GANSS-EarthOrientationPara
                                     UE-Positioning-GANSS-EarthOrientPara    OPTIONAL
}

SysInfoType15-1 ::=
  SEQUENCE {
  -- DGPS corrections
  ue-positioning-GPS-DGPS-Corrections  UE-Positioning-GPS-DGPS-Corrections,
  -- Extension mechanism for non- release99 information
  nonCriticalExtensions  SEQUENCE {}          OPTIONAL
}

SysInfoType15-1bis ::=
  SEQUENCE {
  -- Measurement IEs
  ue-positioning-GANSS-DGANSS-Corrections UE-Positioning-DGANSSCorrections,
  -- Extension mechanism for non-release99 information
  nonCriticalExtensions  SEQUENCE {}          OPTIONAL
}

SysInfoType15-2 ::=
  SEQUENCE {
  -- Ephemeris and clock corrections
  transmissionTOW          GPS-TOW-1sec,
  satID                    SatID,
  ephemerisParameter      EphemerisParameter,
  -- Extension mechanism for non- release99 information
  nonCriticalExtensions    SEQUENCE {}          OPTIONAL
}

SysInfoType15-2bis ::=
  SEQUENCE {
  -- Measurement IEs
  ue-positioning-GANSS-navigationModel  UE-Positioning-GANSS-NavigationModel,
  -- Extension mechanism for non-release99 information
  nonCriticalExtensions  SEQUENCE {}          OPTIONAL
}

SysInfoType15-2ter ::=
  SEQUENCE {
  -- Measurement IEs
  ue-positioning-GANSS-AddNavigationModels  UE-Positioning-GANSS-AddNavigationModels,
  -- Extension mechanism for non-release99 information
  nonCriticalExtensions  SEQUENCE {}          OPTIONAL
}

SysInfoType15-3 ::=
  SEQUENCE {
  -- Almanac and other data
  transmissionTOW          GPS-TOW-1sec,
  ue-positioning-GPS-Almanac  UE-Positioning-GPS-Almanac      OPTIONAL,
  ue-positioning-GPS-IonosphericModel UE-Positioning-GPS-IonosphericModel  OPTIONAL,
  ue-positioning-GPS-UTC-Model  UE-Positioning-GPS-UTC-Model  OPTIONAL,
  satMask                      BIT STRING (SIZE (1..32))  OPTIONAL,
  lsbTOW                      BIT STRING (SIZE (8))      OPTIONAL,
  -- Extension mechanism for non- release99 information
  nonCriticalExtensions    SEQUENCE {}          OPTIONAL
}

SysInfoType15-3bis ::=
  SEQUENCE {
  -- Measurement IEs
  ue-positioning-GANSS-Almanac  UE-Positioning-GANSS-Almanac      OPTIONAL,
  ue-positioning-GANSS-TimeModels UE-Positioning-GANSS-TimeModels  OPTIONAL,
  ue-positioning-GANSS-UTC-Model UE-Positioning-GANSS-UTCModel    OPTIONAL,
  -- Extension mechanism for non-release99 information
  v860NonCriticalExtensions  SEQUENCE {
    sysInfoType15-3bis-v860ext  SysInfoType15-3bis-v860ext-IEs,
    nonCriticalExtensions        SEQUENCE {}          OPTIONAL
  }  OPTIONAL
}

SysInfoType15-3bis-v860ext-IEs ::= SEQUENCE {
  -- Measurement IEs
  ue-Positioning-GANSS-Almanac  UE-Positioning-GANSS-Almanac-v860ext  OPTIONAL,
  ue-Positioning-GANSS-AddUTCModels  UE-Positioning-GANSS-AddUTCModels  OPTIONAL,
  ue-Positioning-GANSS-AuxiliaryInfo  UE-Positioning-GANSS-AuxiliaryInfo  OPTIONAL
}

SysInfoType15-4 ::=
  SEQUENCE {
  -- Measurement IEs
  ue-positioning-OTDOA-CipherParameters  UE-Positioning-CipherParameters  OPTIONAL,

```

```

    ue-positioning-OTDOA-AssistanceData    UE-Positioning-OTDOA-AssistanceData,
    v3a0NonCriticalExtensions              SEQUENCE {
        sysInfoType15-4-v3a0ext           SysInfoType15-4-v3a0ext,
        -- Extension mechanism for non- release99 information
        v4b0NonCriticalExtensions          SEQUENCE {
            sysInfoType15-4-v4b0ext       SysInfoType15-4-v4b0ext,
            nonCriticalExtensions          SEQUENCE {} OPTIONAL
        } OPTIONAL
    } OPTIONAL
}

SysInfoType15-4-v3a0ext ::= SEQUENCE {
    sfn-Offset-Validity                    SFN-Offset-Validity    OPTIONAL
}

SysInfoType15-4-v4b0ext ::= SEQUENCE {
    ue-Positioning-OTDOA-AssistanceData-r4ext    UE-Positioning-OTDOA-AssistanceData-r4ext    OPTIONAL
}

SysInfoType15-5 ::= SEQUENCE {
    -- Measurement IEs
    ue-positioning-OTDOA-AssistanceData-UEB      UE-Positioning-OTDOA-AssistanceData-UEB,
    v3a0NonCriticalExtensions                    SEQUENCE {
        sysInfoType15-5-v3a0ext                 SysInfoType15-5-v3a0ext,
        -- Extension mechanism for non- release99 information
        v770NonCriticalExtensions              SEQUENCE {
            sysInfoType15-5-v770ext             SysInfoType15-5-v770ext-IEs,
            nonCriticalExtensions              SEQUENCE {} OPTIONAL
        } OPTIONAL
    } OPTIONAL
}

SysInfoType15-5-v3a0ext ::= SEQUENCE {
    sfn-Offset-Validity                    SFN-Offset-Validity    OPTIONAL
}

SysInfoType15-5-v770ext-IEs ::= SEQUENCE {
    ue-Positioning-OTDOA-AssistanceData-UEB-ext    UE-Positioning-OTDOA-AssistanceData-UEB-ext    OPTIONAL
}

SysInfoType15-6 ::= SEQUENCE {
    -- Measurement IEs
    ue-positioning-GANSS-TOD                INTEGER (0..86399),
    ue-positioning-GANSS-ReferenceMeasurementInformation
                                             UE-Positioning-GANSS-ReferenceMeasurementInfo,
    -- Extension mechanism for non-release99 information
    nonCriticalExtensions                    SEQUENCE {} OPTIONAL
}

SysInfoType15-7 ::= SEQUENCE {
    -- Measurement IEs
    ue-positioning-GANSS-DataBitAssistance    UE-Positioning-GANSS-Data-Bit-Assistance,
    -- Extension mechanism for non-release99 information
    nonCriticalExtensions                    SEQUENCE {} OPTIONAL
}

SysInfoType15-8 ::= SEQUENCE {
    -- Measurement IEs
    ue-positioning-GANSS-DataCipherringInfo    UE-Positioning-CipherParameters OPTIONAL,
    ue-positioning-GANSS-realTimeIntegrity    UE-Positioning-GANSS-RealTimeIntegrity OPTIONAL,
    -- Extension mechanism for non-release99 information
    nonCriticalExtensions                    SEQUENCE {} OPTIONAL
}

SysInfoType16 ::= SEQUENCE {
    -- Radio bearer IEs
    preDefinedRadioConfiguration            PreDefRadioConfiguration,
    -- Extension mechanism for non- release99 information
    v770NonCriticalExtensions              SEQUENCE {
        sysInfoType16-v770ext                 SysInfoType16-v770ext-IEs,
        nonCriticalExtensions              SEQUENCE {} OPTIONAL
    } OPTIONAL
}

SysInfoType16-v770ext-IEs ::= SEQUENCE {
    preDefinedRadioConfiguration            PreDefRadioConfiguration-v770ext
}

```

```

SysInfoType17 ::=
    -- Physical channel IEs
    -- If PDSCH/PUSCH is configured for 1.28Mcps or 7.68Mcps TDD, pusch-SysInfoList and
    -- pdsch-SysInfoList should be absent and the info included in the respective
    -- tdd128SpecificInfo or tdd768SpecificInfo instead.
    -- If PDSCH/PUSCH is configured for 3.84Mcps TDD in R5, HCR-r5-SpecificInfo should also be
    -- included.
    pusch-SysInfoList          PUSCH-SysInfoList          OPTIONAL,
    pdsch-SysInfoList          PDSCH-SysInfoList          OPTIONAL,
    -- Extension mechanism for non-release99 information
    v4b0NonCriticalExtensions SEQUENCE {
        sysInfoType17-v4b0ext SysInfoType17-v4b0ext-IEs,
        v590NonCriticalExtensions SEQUENCE {
            sysInfoType17-v590ext SysInfoType17-v590ext-IEs OPTIONAL,
            v770NonCriticalExtensions SEQUENCE {
                sysInfoType17-v770ext SysInfoType17-v770ext-IEs,
                nonCriticalExtensions SEQUENCE {} OPTIONAL
            } OPTIONAL
        } OPTIONAL
    } OPTIONAL
}

SysInfoType17-v4b0ext-IEs ::= SEQUENCE {
    tdd128SpecificInfo SEQUENCE {
        pusch-SysInfoList PUSCH-SysInfoList-LCR-r4 OPTIONAL,
        pdsch-SysInfoList PDSCH-SysInfoList-LCR-r4 OPTIONAL
    } OPTIONAL
}

SysInfoType17-v590ext-IEs ::= SEQUENCE {
    hcr-r5-SpecificInfo SEQUENCE {
        pusch-SysInfoList PUSCH-SysInfoList-HCR-r5 OPTIONAL,
        pdsch-SysInfoList PDSCH-SysInfoList-HCR-r5 OPTIONAL
    } OPTIONAL
}

SysInfoType17-v770ext-IEs ::= SEQUENCE {
    tdd768SpecificInfo SEQUENCE {
        pusch-SysInfoList-SFN PUSCH-SysInfoList-SFN-VHCR OPTIONAL,
        pdsch-SysInfoList-SFN PDSCH-SysInfoList-VHCR-r7 OPTIONAL
    } OPTIONAL
}

SysInfoType18 ::=
    idleModePLMNIdentities PLMNIdentitiesOfNeighbourCells OPTIONAL,
    connectedModePLMNIdentities PLMNIdentitiesOfNeighbourCells OPTIONAL,
    -- Extension mechanism for non-release99 information
    v6b0NonCriticalExtensions SEQUENCE {
        sysInfoType18-v6b0ext SysInfoType18-v6b0ext,
        v860NonCriticalExtensions SEQUENCE {
            sysInfoType18-v860ext SysInfoType18-v860ext,
            nonCriticalExtensions SEQUENCE {} OPTIONAL
        } OPTIONAL
    } OPTIONAL
}

SysInfoType18-v6b0ext ::= SEQUENCE {
    idleModePLMNIdentitiesSIB11bis PLMNIdentitiesOfNeighbourCells OPTIONAL,
    connectedModePLMNIdentitiesSIB11bis PLMNIdentitiesOfNeighbourCells OPTIONAL
}

SysInfoType18-v860ext ::= SEQUENCE {
    idleModePLMNIdentities PLMNIdentitiesOfNeighbourCells-v860ext OPTIONAL,
    connectedModePLMNIdentities PLMNIdentitiesOfNeighbourCells-v860ext OPTIONAL
}

SysInfoType19 ::= SEQUENCE {
    -- Measurement IEs
    utra-PriorityInfoList UTRA-PriorityInfoList,
    gsm-PriorityInfoList GSM-PriorityInfoList OPTIONAL,
    eutra-FrequencyAndPriorityInfoList EUTRA-FrequencyAndPriorityInfoList OPTIONAL,
    -- Extension mechanism for non-release8 information
    nonCriticalExtensions SEQUENCE {} OPTIONAL
}

SysInfoType20 ::= SEQUENCE {
    hNBName HNBName OPTIONAL,

```

```

        nonCriticalExtensions          SEQUENCE {}                               OPTIONAL
    }

SysInfoTypeSB1 ::=                      SEQUENCE {
    -- Other IEs
    sib-ReferenceList                  SIB-ReferenceList,
    -- Extension mechanism for non- release99 information
    v6b0NonCriticalExtensions          SEQUENCE {
        sysInfoTypeSB1-v6b0ext        SysInfoTypeSB1-v6b0ext,
        v860NonCriticalExtensions     SEQUENCE {
            sysInfoTypeSB1-v860ext    SysInfoTypeSB1-v860ext,
            nonCriticalExtensions     SEQUENCE {}                               OPTIONAL
        }
    }
    }
    OPTIONAL

SysInfoTypeSB1-v6b0ext ::=              SEQUENCE {
    extSIBTypeInfoSchedulingInfo-List  ExtSIBTypeInfoSchedulingInfo-List  OPTIONAL
}

SysInfoTypeSB1-v860ext ::=              SEQUENCE {
    extSIBTypeInfoSchedulingInfo-List  ExtSIBTypeInfoSchedulingInfo-List2  OPTIONAL,
    extGANSS-SIBTypeInfoSchedulingInfoList  ExtGANSS-SIBTypeInfoSchedulingInfoList  OPTIONAL
}

SysInfoTypeSB2 ::=                      SEQUENCE {
    -- Other IEs
    sib-ReferenceList                  SIB-ReferenceList,
    -- Extension mechanism for non- release99 information
    v6b0NonCriticalExtensions          SEQUENCE {
        sysInfoTypeSB2-v6b0ext        SysInfoTypeSB2-v6b0ext,
        v860NonCriticalExtensions     SEQUENCE {
            sysInfoTypeSB2-v860ext    SysInfoTypeSB2-v860ext,
            nonCriticalExtensions     SEQUENCE {}                               OPTIONAL
        }
    }
    }
    OPTIONAL

SysInfoTypeSB2-v6b0ext ::=              SEQUENCE {
    extSIBTypeInfoSchedulingInfo-List  ExtSIBTypeInfoSchedulingInfo-List  OPTIONAL
}

SysInfoTypeSB2-v860ext ::=              SEQUENCE {
    extSIBTypeInfoSchedulingInfo-List  ExtSIBTypeInfoSchedulingInfo-List2  OPTIONAL,
    extGANSS-SIBTypeInfoSchedulingInfoList  ExtGANSS-SIBTypeInfoSchedulingInfoList  OPTIONAL
}

TDD-UMTS-Frequency-List ::=            SEQUENCE (SIZE (1..maxNumTDDFreqs)) OF
                                        FrequencyInfoTDD

UE-HistoryInformation ::=                SEQUENCE {
    ue-InactivityPeriod                INTEGER (1..120),
    ue-MobilityStateIndicator           High-MobilityDetected                OPTIONAL,
    ul-dataVolumeHistory                DataVolumeHistory                    OPTIONAL,
    dl-dataVolumeHistory                DataVolumeHistory                    OPTIONAL
}

-- For systemInformationBlockType11bis the Value Tag Info "CellValueTag" is used
ValueTagInfo ::= CHOICE {
    none                                NULL,
    cellValueTag                        CellValueTag,
    plmn-ValueTag                       PLMN-ValueTag,
    sIBOccurrenceIdentityAndValueTag    SIBOccurrenceIdentityAndValueTag
}

-- *****
--
-- ANSI-41 INFORMATION ELEMENTS (10.3.9)
--
-- *****

ANSI-41-GlobalServiceRedirectInfo ::=  ANSI-41-NAS-Parameter
ANSI-41-PrivateNeighbourListInfo ::=   ANSI-41-NAS-Parameter
ANSI-41-RAND-Information ::=           ANSI-41-NAS-Parameter
ANSI-41-UserZoneID-Information ::=     ANSI-41-NAS-Parameter
ANSI-41-NAS-Parameter ::=              BIT STRING (SIZE (1..2048))

```



```

Min-P-REV ::= BIT STRING (SIZE (8))

NAS-SystemInformationANSI-41 ::= ANSI-41-NAS-Parameter
NID ::= BIT STRING (SIZE (16))

P-REV ::= BIT STRING (SIZE (8))

SID ::= BIT STRING (SIZE (15))

-- *****
--
--      MBMS INFORMATION ELEMENTS (10.3.9a)
--
-- *****

MBMS-AccessProbabilityFactor ::= ENUMERATED {
    apf0, apf32, apf64, apf96, apf128, apf160, apf192,
    apf224, apf256, apf288, apf320, apf352, apf384, apf416,
    apf448, apf480, apf512, apf544, apf576, apf608, apf640,
    apf672, apf704, apf736, apf768, apf800, apf832, apf864,
    apf896, apf928, apf960, apf1000 }

MBMS-CellGroupIdentity-r6 ::= BIT STRING (SIZE (12))

MBMS-CommonCCTrChIdentity ::= INTEGER (1..32)

MBMS-CommonPhyChIdentity ::= INTEGER (1..32)

MBMS-CommonRBIdentity ::= INTEGER (1..32)

MBMS-CommonRBInformation-r6 ::= SEQUENCE {
    commonRBIdentity      MBMS-CommonRBIdentity,
    pdcp-Info             PDCP-Info-r4,
    rlc-Info              RLC-Info-MTCH-r6
}

MBMS-CommonRBInformationList-r6 ::= SEQUENCE (SIZE (1..maxMBMS-CommonRB)) OF
    MBMS-CommonRBInformation-r6

MBMS-CommonTrChIdentity ::= INTEGER (1..32)

MBMS-ConnectedModeCountingScope ::= SEQUENCE {
    countingForUraPCH      BOOLEAN,
    countingForCellPCH     BOOLEAN,
    countingForCellFACH    BOOLEAN
}

MBMS-CurrentCell-SCCPCH-r6 ::= SEQUENCE {
    sccpchIdentity          MBMS-SCCPCHIdentity          OPTIONAL,
    secondaryCCPCH-Info    MBMS-CommonPhyChIdentity,
    softComb-TimingOffset  MBMS-SoftComb-TimingOffset    OPTIONAL,
    -- If the IE transpCh-InfoCommonForAllTrCh is absent, the default TFCS as specified
    -- in 14.10.1 applies
    transpCh-InfoCommonForAllTrCh MBMS-CommonCCTrChIdentity    OPTIONAL,
    transpCHInformation     MBMS-TrCHInformation-CurrList
}

MBMS-CurrentCell-SCCPCHList-r6 ::= SEQUENCE (SIZE (1..maxSCCPCH)) OF
    MBMS-CurrentCell-SCCPCH-r6

MBMS-FACHCarryingMTCH-List ::= SEQUENCE (SIZE (1..maxFACHPCH)) OF
    TransportFormatSet

MBMS-JoinedInformation-r6 ::= SEQUENCE {
    p-TMSI                  P-TMSI-GSM-MAP          OPTIONAL
}

MBMS-L1CombiningSchedule-32 ::= SEQUENCE {
    -- Actual L1 combining schedule values (offset, start, duration) = IE value * 4
    cycleOffset             INTEGER (0..7)          OPTIONAL,
    mtch-L1CombiningPeriodList SEQUENCE (SIZE (1..maxMBMS-L1CP)) OF SEQUENCE {
        periodStart        INTEGER (0..7),
        periodDuration     INTEGER (1..8)
    }
}

MBMS-L1CombiningSchedule-64 ::= SEQUENCE {

```

```

-- Actual L1 combining schedule values (offset, start, duration) = IE value * 4
cycleOffset                INTEGER (0..15)                OPTIONAL,
mtch-L1CombiningPeriodList SEQUENCE (SIZE (1..maxMBMS-L1CP)) OF SEQUENCE {
  periodStart              INTEGER (0..15),
  periodDuration           INTEGER (1..16)
}
}

MBMS-L1CombiningSchedule-128 ::= SEQUENCE {
-- Actual L1 combining schedule values (offset, start, duration) = IE value * 4
cycleOffset                INTEGER (0..31)                OPTIONAL,
mtch-L1CombiningPeriodList SEQUENCE (SIZE (1..maxMBMS-L1CP)) OF SEQUENCE {
  periodStart              INTEGER (0..31),
  periodDuration           INTEGER (1..32)
}
}

MBMS-L1CombiningSchedule-256 ::= SEQUENCE {
-- Actual L1 combining schedule values (offset, start, duration) = IE value * 4
cycleOffset                INTEGER (0..63)                OPTIONAL,
mtch-L1CombiningPeriodList SEQUENCE (SIZE (1..maxMBMS-L1CP)) OF SEQUENCE {
  periodStart              INTEGER (0..63),
  periodDuration           INTEGER (1..64)
}
}

MBMS-L1CombiningSchedule-512 ::= SEQUENCE {
-- Actual L1 combining schedule values (offset, start, duration) = IE value * 4
cycleOffset                INTEGER (0..127)               OPTIONAL,
mtch-L1CombiningPeriodList SEQUENCE (SIZE (1..maxMBMS-L1CP)) OF SEQUENCE {
  periodStart              INTEGER (0..127),
  periodDuration           INTEGER (1..128)
}
}

MBMS-L1CombiningSchedule-1024 ::= SEQUENCE {
-- Actual L1 combining schedule values (offset, start, duration) = IE value * 4
cycleOffset                INTEGER (0..255)               OPTIONAL,
mtch-L1CombiningPeriodList SEQUENCE (SIZE (1..maxMBMS-L1CP)) OF SEQUENCE {
  periodStart              INTEGER (0..255),
  periodDuration           INTEGER (1..256)
}
}

MBMS-L1CombiningSchedule ::= CHOICE {
  cycleLength-32           MBMS-L1CombiningSchedule-32,
  cycleLength-64           MBMS-L1CombiningSchedule-64,
  cycleLength-128          MBMS-L1CombiningSchedule-128,
  cycleLength-256          MBMS-L1CombiningSchedule-256,
  cycleLength-512          MBMS-L1CombiningSchedule-512,
  cycleLength-1024         MBMS-L1CombiningSchedule-1024
}

MBMS-L1CombiningTransmTimeDiff ::= INTEGER (0..3)

MBMS-L23Configuration ::= CHOICE {
  sameAsCurrent            SEQUENCE {
    currentCell-SCCPCH      MBMS-SCCPCHIdentity,
    msch-ConfigurationInfo  MBMS-MSCH-ConfigurationInfo-r6    OPTIONAL
  },
  different                 SEQUENCE {
    -- If the IE transpCh-InfoCommonForAllTrCh is absent, the default TFCS as specified
    -- in 14.10.1 applies
    transpCh-InfoCommonForAllTrCh MBMS-CommonCCTrChIdentity    OPTIONAL,
    transpCHInformation            MBMS-TrCHInformation-NeighbList
  }
}

MBMS-LogicalChIdentity ::= INTEGER (1..15)

MBMS-MCCH-ConfigurationInfo-r6 ::= SEQUENCE {
  accessInfoPeriodCoefficient    INTEGER (0..3),
  repetitionPeriodCoefficient    INTEGER (0..3),
  modificationPeriodCoefficient INTEGER (7..10),
  rlc-Info                       RLC-Info-MCCH-r6,
  tctf-Presence                  MBMS-TCTF-Presence            OPTIONAL
}

```

```

MBMS-MICHConfigurationInfo-r6 ::= SEQUENCE {
  michPowerOffset          MBMS-MICHPowerOffset,
  mode                     CHOICE {
    fdd                     SEQUENCE {
      channelisationCode256      ChannelisationCode256,
      ni-CountPerFrame           MBMS-NI-CountPerFrame,
      sttd-Indicator             BOOLEAN
    },
    -- The CHOICE tdd384 is used for both tdd384 and tdd768. If IE
    -- 'MBMS-MICHConfigurationInfo-v770ext' is not present, tdd384 applies.
    tdd384                   SEQUENCE {
      timeslot                 TimeslotNumber,
      midambleShiftAndBurstType MidambleShiftAndBurstType,
      channelisationCode       DL-TS-ChannelisationCode,
      repetitionPeriodLengthOffset RepPerLengthOffset-MICH OPTIONAL,
      mbmsNotificationIndLength MBMS-MICHNotificationIndLength DEFAULT mn4
    },
    tdd128                   SEQUENCE {
      timeslot                 TimeslotNumber-LCR-r4,
      midambleShiftAndBurstType MidambleShiftAndBurstType-LCR-r4,
      channelisationCodeList   SEQUENCE (SIZE (1..2)) OF
                               DL-TS-ChannelisationCode,
      repetitionPeriodLengthOffset RepPerLengthOffset-MICH OPTIONAL,
      mbmsNotificationIndLength MBMS-MICHNotificationIndLength DEFAULT mn4
    }
  }
}

MBMS-MICHConfigurationInfo-v770ext ::= SEQUENCE {
  mode                     CHOICE {
    -- For tdd384, IE 'MidambleShiftAndBurstType-r7' replaces IE 'MidambleShiftAndBurstType'
    -- in IE 'MBMS-MICHConfigurationInfo-r6'. IE 'MidambleShiftAndBurstType' shall be ignored.
    tdd384                 SEQUENCE {
      midambleShiftAndBurstType MidambleShiftAndBurstType-r7
    },
    -- For tdd768, the CHOICE tdd384 in IE 'MBMS-MICHConfigurationInfo-r6' applies, except
    -- that IE 'MidambleShiftAndBurstType-VHCR' replaces IE 'MidambleShiftAndBurstType'. IE
    -- 'MidambleShiftAndBurstType' shall be ignored.
    tdd768                 SEQUENCE {
      midambleShiftAndBurstType MidambleShiftAndBurstType-VHCR
    },
    tdd128                 SEQUENCE {
      mbsfnSpecialTimeSlot     TimeSlotLCR-ext OPTIONAL
    }
  }
}

MBMS-MICHConfigurationInfo-v890ext ::= SEQUENCE {
  mode                     CHOICE {
    imb384                 SEQUENCE {
      channelisationCode256      ChannelisationCode256,
      ni-CountPerFrame           MBMS-NI-CountPerFrame-IMB384
    }
  }
}

MBMS-MICHNotificationIndLength ::= ENUMERATED { mn4, mn8, mn16 }

MBMS-MICHPowerOffset ::= INTEGER (-10..5)

MBMS-ModifedService-r6 ::= SEQUENCE {
  mbms-TransmissionIdentity MBMS-TransmissionIdentity,
  mbms-RequiredUEAction     MBMS-RequiredUEAction-Mod,
  mbms-PreferredFrequency    CHOICE {
    mcch                     MBMS-PFLIndex,
    dcch                     MBMS-PFLInfo
  }
  OPTIONAL,
  --dummy is not used. If received it shall be ignored.
  dummy                     ENUMERATED { true } OPTIONAL,
  continueMCCHReading       BOOLEAN
}

MBMS-ModifedServiceList-r6 ::= SEQUENCE (SIZE (1..maxMBMsservModif)) OF
  MBMS-ModifedService-r6

MBMS-ModifiedService-v770ext ::= SEQUENCE {
  mbsfnClusterFrequency     MBSFN-ClusterFrequency-r7 OPTIONAL
}

```

```

MBMS-ModifiedService-LCR-v7c0ext ::= SEQUENCE {
    rbReleaseCause          MBMS-PTM-RBReleaseCause-LCR-r7          OPTIONAL
}

-- IE 'MBMS-ModifiedServiceList-v770ext' contains a list of extension data
-- associated with the MBMS transmission identities at the corresponding
-- positions in IE 'MBMS-ModifiedServiceList-r6'
MBMS-ModifiedServiceList-v770ext ::= SEQUENCE (SIZE (1..maxMBMSservModif)) OF
    MBMS-ModifiedService-v770ext

-- IE 'MBMS-ModifiedServiceList-LCR-v7c0ext' contains a list of extension data
-- associated with the MBMS transmission identities at the corresponding
-- positions in IE 'MBMS-ModifiedServiceList-r6'
MBMS-ModifiedServiceList-LCR-v7c0ext ::= SEQUENCE (SIZE (1..maxMBMSservModif)) OF
    MBMS-ModifiedService-LCR-v7c0ext

MBMS-MSCH-ConfigurationInfo-r6 ::= SEQUENCE {
    mschSchedulingInfo      MBMS-MSCHSchedulingInfo                OPTIONAL,
    rlc-Info                 RLC-Info-MSCH-r6                      OPTIONAL,
    tctf-Presence           MBMS-TCTF-Presence                    OPTIONAL
}

MBMS-MSCHSchedulingInfo ::= CHOICE {
    schedulingPeriod-32-Offset    INTEGER (0..31),
    schedulingPeriod-64-Offset    INTEGER (0..63),
    schedulingPeriod-128-Offset   INTEGER (0..127),
    schedulingPeriod-256-Offset   INTEGER (0..255),
    schedulingPeriod-512-Offset   INTEGER (0..511),
    schedulingPeriod-1024-Offset  INTEGER (0..1023)
}

MBMS-NeighbouringCellSCCPCH-r6 ::= SEQUENCE {
    secondaryCCPCH-Info          MBMS-CommonPhyChIdentity,
    secondaryCCPCHPwrOffsetDiff MBMS-SCCPCHPwrOffsetDiff          OPTIONAL,
    layer1Combining              CHOICE {
        fdd                      SEQUENCE {
            softComb-TimingOffset    MBMS-SoftComb-TimingOffset,
            mbms-L1CombiningTransmTimeDiff MBMS-L1CombiningTransmTimeDiff,
            mbms-L1CombiningSchedule MBMS-L1CombiningSchedule    OPTIONAL
        },
        tdd                      NULL
    } OPTIONAL,
    mbms-L23Configuration        MBMS-L23Configuration
}

MBMS-NeighbouringCellSCCPCH-v770ext ::= SEQUENCE {
    secondaryCCPCH-Info          MBMS-CommonPhyChIdentity          OPTIONAL,
    secondaryCCPCH-InfoDiff      SecondaryCCPCHInfoDiff-MBMS,
    secondaryCCPCHPwrOffsetDiff  MBMS-SCCPCHPwrOffsetDiff          OPTIONAL,
    layer1Combining              CHOICE {
        fdd                      SEQUENCE {
            softComb-TimingOffset    MBMS-SoftComb-TimingOffset,
            mbms-L1CombiningTransmTimeDiff MBMS-L1CombiningTransmTimeDiff,
            mbms-L1CombiningSchedule MBMS-L1CombiningSchedule    OPTIONAL
        },
        tdd                      NULL
    } OPTIONAL,
    mbms-L23Configuration        MBMS-L23Configuration
}

MBMS-NeighbouringCellSCCPCHList-r6 ::= SEQUENCE (SIZE (1..maxSCCPCH)) OF
    MBMS-NeighbouringCellSCCPCH-r6

-- IE "MBMS-NeighbouringCellSCCPCHList-v770ext" may be received as an extension of the IE
-- "MBMS-NeighbouringCellSCCPCHList-r6". When both lists are received in the same message
-- and the total number of list elements is greater than constant value 'maxSCCPCH', the
-- UE behaviour is unspecified.
MBMS-NeighbouringCellSCCPCHList-v770ext ::= SEQUENCE (SIZE (1..maxSCCPCH)) OF
    MBMS-NeighbouringCellSCCPCH-v770ext

MBMS-NetworkStandardTimeInformation-LCR-v890ext ::= SEQUENCE {
    networkStandardTime          BIT STRING (SIZE (40)),
    correlativeSFN               INTEGER (0..4095)                  OPTIONAL
}

MBMS-NI-CountPerFrame ::= ENUMERATED { ni18, ni36, ni72, ni144 }

```

```

MBMS-NI-CountPerFrame-IMB384 ::= ENUMERATED { ni16, ni32, ni64, ni128 }

MBMS-NumberOfNeighbourCells-r6 ::= INTEGER (0..32)

MBMS-PFLIndex ::= INTEGER (1..maxMBMS-Freq)

MBMS-PFLInfo ::= FrequencyInfo

MBMS-PhyChInformation-IMB384 ::= SEQUENCE {
    mbms-CommonPhyChIdentity      MBMS-CommonPhyChIdentity,
    secondaryCCPCHInfo-MBMS      SecondaryCCPCHFrameType2Info
}

MBMS-PhyChInformationList-IMB384 ::= SEQUENCE (SIZE (1..maxMBMS-CommonPhyCh)) OF
    MBMS-PhyChInformation-IMB384

MBMS-PhyChInformation-r6 ::= SEQUENCE {
    mbms-CommonPhyChIdentity      MBMS-CommonPhyChIdentity,
    secondaryCCPCHInfo-MBMS-r6    SecondaryCCPCHInfo-MBMS-r6
}

MBMS-PhyChInformation-r7 ::= SEQUENCE {
    mbms-CommonPhyChIdentity      MBMS-CommonPhyChIdentity,
    secondaryCCPCHInfo-MBMS-r7    SecondaryCCPCHInfo-MBMS-r7
}

MBMS-PhyChInformationList-r6 ::= SEQUENCE (SIZE (1..maxMBMS-CommonPhyCh)) OF
    MBMS-PhyChInformation-r6

MBMS-PhyChInformationList-r7 ::= SEQUENCE (SIZE (1..maxMBMS-CommonPhyCh)) OF
    MBMS-PhyChInformation-r7

MBMS-PL-ServiceRestrictInfo-r6 ::= ENUMERATED { true }

MBMS-PreferredFrequencyInfo-r6 ::= SEQUENCE {
    mbmsPreferredFrequency          INTEGER (1..maxMBMS-Freq)          OPTIONAL,
    layerConvergenceInformation     CHOICE {
        mbms-Qoffset              MBMS-Qoffset,
        mbms-HCSoffset            INTEGER (0..7)
    },
    mbms-PL-ServiceRestrictInfo    MBMS-PL-ServiceRestrictInfo-r6  OPTIONAL
}

MBMS-PreferredFrequencyList-r6 ::= SEQUENCE (SIZE (1..maxMBMS-Freq)) OF
    MBMS-PreferredFrequencyInfo-r6

MBMS-PTMActivationTime-r6 ::= INTEGER (0..2047)

MBMS-PTM-RBInformation-C ::= SEQUENCE {
    rbInformation                  MBMS-CommonRBIdentity,
    shortTransmissionID           MBMS-ShortTransmissionID,
    logicalChIdentity             MBMS-LogicalChIdentity
}

MBMS-PTM-RBInformation-CList ::= SEQUENCE (SIZE (1..maxRBperTrCh)) OF
    MBMS-PTM-RBInformation-C

MBMS-PTM-RBInformation-N ::= SEQUENCE {
    shortTransmissionID          MBMS-ShortTransmissionID,
    logicalChIdentity            MBMS-LogicalChIdentity,
    layer1-CombiningStatus       BOOLEAN
}

MBMS-PTM-RBInformation-NList ::= SEQUENCE (SIZE (1..maxRBperTrCh)) OF
    MBMS-PTM-RBInformation-N

MBMS-PTM-RBReleaseCause-LCR-r7 ::= ENUMERATED {
    normalRelease, outOfMBMSServiceCoverageInRAN,
    networkAbnormalRelease,
    spare5, spare4, spare3, spare2, spare1 }

MBMS-Qoffset ::= ENUMERATED { q4, q8, q12, q16, q20, q30, q40, qInfinity }

MBMS-RequiredUEAction-Mod ::= ENUMERATED {
    none,
    acquireCountingInfo,
    acquireCountingInfoPTM-RBsUnmodified,
    acquirePTM-RBInfo,
    requestPTPRB,
}

```

```

        releasePTM-RB }

MBMS-RequiredUEAction-UMod ::=      ENUMERATED {
        none,
        acquirePTM-RBInfo,
        requestPTPRB }

MBMS-SCCPCHIdentity ::=             INTEGER (1..maxSCCPCH)

MBMS-SCCPCHPwrOffsetDiff ::=        ENUMERATED { mcpo-minus6, mcpo-minus3, mcpo-plus3, mcpo-plus6 }

MBMS-SelectedServiceInfo ::=        SEQUENCE {
    status                            CHOICE {
        none                            NULL,
        some                            MBMS-SelectedServicesListFull
    }
}

MBMS-SelectedServicesListFull ::=    SEQUENCE (SIZE (1..maxMBMsservSelect)) OF
    MBMS-ServiceIdentity-r6

MBMS-SelectedServicesListShort ::=   SEQUENCE (SIZE (1..maxMBMsservSelect)) OF
    MBMS-ShortTransmissionID

MBMS-SelectedServicesShort ::=       SEQUENCE {
    mbms-SelectedServicesList         MBMS-SelectedServicesListShort,
    modificationPeriodIdentity        INTEGER (0..1)
}

MBMS-ServiceAccessInfo-r6 ::=        SEQUENCE {
    shortTransmissionID               MBMS-ShortTransmissionID,
    accessprobabilityFactor-Idle      MBMS-AccessProbabilityFactor,
    accessprobabilityFactor-Connected MBMS-AccessProbabilityFactor        OPTIONAL,
    mbms-ConnectedModeCountingScope   MBMS-ConnectedModeCountingScope
}

MBMS-ServiceAccessInfoList-r6 ::=    SEQUENCE (SIZE (1..maxMBMsservCount)) OF
    MBMS-ServiceAccessInfo-r6

MBMS-ServiceIdentity-r6 ::=          SEQUENCE {
    serviceIdentity                    OCTET STRING (SIZE (3)),
    plmn-Identity                       CHOICE {
        -- The 'sameAsMIB-PLMN-Id' choice refers to the 'PLMN Identity' (R99) in MIB.
        sameAsMIB-PLMN-Id              NULL,
        other                           CHOICE {
            -- The 'sameAsMIB-MultiPLMN-Id' choice refers to one of the (1..5) PLMN Identities
            -- provided in the 'Multiple PLMN List' (REL-6) in MIB.
            sameAsMIB-MultiPLMN-Id     INTEGER (1..5),
            explicitPLMN-Id            PLMN-Identity
        }
    }
}

MBMS-ServiceSchedulingInfo-r6 ::=    SEQUENCE {
    mbms-TransmissionIdentity          MBMS-TransmissionIdentity,
    mbms-ServiceTransmInfoList         MBMS-ServiceTransmInfoList        OPTIONAL,
    nextSchedulingperiod                INTEGER (0..31)
}

MBMS-ServiceSchedulingInfoList-r6 ::= SEQUENCE (SIZE (1..maxMBMsservSched)) OF
    MBMS-ServiceSchedulingInfo-r6

MBMS-ServiceTransmInfo ::=           SEQUENCE {
    -- Actual values (start, duration) = IE values * 4
    start                               INTEGER (0..255),
    duration                             INTEGER (1..256)
}

MBMS-ServiceTransmInfoList ::=       SEQUENCE (SIZE (1..maxMBMSTransmis)) OF
    MBMS-ServiceTransmInfo

MBMS-SessionIdentity ::=             OCTET STRING (SIZE (1))

MBMS-ShortTransmissionID ::=         INTEGER (1..maxMBMsservUnmodif)

MBMS-SIBType5-SCCPCH-r6 ::=         SEQUENCE {
    sccpchIdentity                     MBMS-SCCPCHIdentity,
    transpCHInformation                 MBMS-TrCHInformation-SIB5List
}

```

```

}
MBMS-SIBType5-SCCPCHList-r6 ::= SEQUENCE (SIZE (1..maxSCCPCH)) OF
    MBMS-SIBType5-SCCPCH-r6
MBMS-SoftComb-TimingOffset ::= ENUMERATED { ms0, ms10, ms20, ms40 }
MBMS-TCTF-Presence ::= ENUMERATED { false }
MBMS-TimersAndCounters-r6 ::= SEQUENCE {
    t-318 T-318 DEFAULT ms1000
}
MBMS-TransmissionIdentity ::= SEQUENCE {
    mbms-ServiceIdentity MBMS-ServiceIdentity-r6,
    mbms-SessionIdentity MBMS-SessionIdentity OPTIONAL
}
MBMS-TranspChInfoForCCTrCh-r6 ::= SEQUENCE {
    commonCCTrChIdentity MBMS-CommonCCTrChIdentity,
    transportFormatCombinationSet TFCS
}
MBMS-TranspChInfoForEachCCTrCh-r6 ::= SEQUENCE (SIZE (1..maxMBMS-CommonCCTrCh)) OF
    MBMS-TranspChInfoForCCTrCh-r6
MBMS-TranspChInfoForEachTrCh-r6 ::= SEQUENCE (SIZE (1..maxMBMS-CommonTrCh)) OF
    MBMS-TranspChInfoForTrCh-r6
MBMS-TranspChInfoForTrCh-r6 ::= SEQUENCE {
    commonTrChIdentity MBMS-CommonTrChIdentity,
    transportFormatSet TransportFormatSet
}
MBMS-TrCHInformation-Curr ::= SEQUENCE {
    transpCh-Info MBMS-CommonTrChIdentity,
    rbInformation MBMS-PTM-RBInformation-CList OPTIONAL,
    msch-ConfigurationInfo MBMS-MSCH-ConfigurationInfo-r6 OPTIONAL
}
MBMS-TrCHInformation-CurrList ::= SEQUENCE (SIZE (1..maxFACHPCH)) OF
    MBMS-TrCHInformation-Curr
MBMS-TrCHInformation-Neighb ::= SEQUENCE {
    transpCh-Info MBMS-CommonTrChIdentity,
    transpCh-CombiningStatus BOOLEAN,
    rbInformation MBMS-PTM-RBInformation-NList OPTIONAL,
    msch-ConfigurationInfo MBMS-MSCH-ConfigurationInfo-r6 OPTIONAL
}
MBMS-TrCHInformation-NeighbList ::= SEQUENCE (SIZE (1..maxFACHPCH)) OF
    MBMS-TrCHInformation-Neighb
MBMS-TrCHInformation-SIB5 ::= SEQUENCE {
    transpCh-Identity INTEGER (1..maxFACHPCH),
    rbInformation MBMS-PTM-RBInformation-CList OPTIONAL,
    msch-ConfigurationInfo MBMS-MSCH-ConfigurationInfo-r6 OPTIONAL
}
MBMS-TrCHInformation-SIB5List ::= SEQUENCE (SIZE (1..maxFACHPCH)) OF
    MBMS-TrCHInformation-SIB5
MBMS-UnmodifiedService-r6 ::= SEQUENCE {
    mbms-TransmissionIdentity MBMS-TransmissionIdentity,
    mbms-RequiredUEAction MBMS-RequiredUEAction-UMod,
    mbms-PreferredFrequency MBMS-PFLIndex OPTIONAL
}
MBMS-UnmodifiedServiceList-r6 ::= SEQUENCE (SIZE (1..maxMBMsservUnmodif)) OF
    MBMS-UnmodifiedService-r6
MBMS-UnmodifiedService-v770ext ::= SEQUENCE {
    mbsfnClusterFrequency MBSFN-ClusterFrequency-r7 OPTIONAL
}
-- IE 'MBMS-UnmodifiedServiceList-v770ext' contains a list of extension data
-- associated with the MBMS transmission identities at the corresponding

```

```

-- positions in IE 'MBMS-UnmodifiedServiceList-r6'
MBMS-UnmodifiedServiceList-v770ext ::= SEQUENCE (SIZE (1..maxMBMSservUnmodif)) OF
    MBMS-UnmodifiedService-v770ext

MBSFN-ClusterFrequency-r7 ::=          INTEGER (1..maxMBSFNClusters)

MBSFNFrequency ::=                      SEQUENCE {
    frequencyInfo                        FrequencyInfo,
    -- IE "cellParameterID" is used only for MBSFN clusters operating in 1.28 Mcps TDD mode.
    cellParametersID                     CellParametersID          OPTIONAL
}

MBSFNFrequency-v860ext ::=             SEQUENCE {
    imb-Indication                       ENUMERATED { true }          OPTIONAL
}

MBSFNFrequencyList ::=                 SEQUENCE (SIZE (0..maxMBSFNClusters)) OF
    MBSFNFrequency

-- List of extensions to the corresponding elements of IE "MBSFNFrequencyList"
MBSFNFrequencyList-v860ext ::=         SEQUENCE (SIZE (0..maxMBSFNClusters)) OF
    MBSFNFrequency-v860ext

MBSFNOnlyService ::=                   ENUMERATED {true}

MBSFNservicesNotNotified-r7 ::=        SEQUENCE {
    notificationOfAllMBSFNservicesInTheBand
                                         ENUMERATED { true }          OPTIONAL
}

MBSFNInterFrequencyNeighbour-r7 ::=    SEQUENCE {
    mbsfnFrequency                       FrequencyInfo,
    mbsfnServicesNotification             CHOICE {
        mbsfnServicesNotified            NULL,
        mbsfnServicesNotNotified        MBSFNservicesNotNotified-r7
    }
}

MBSFNInterFrequencyNeighbour-v860ext ::= SEQUENCE {
    imb-Indication                       ENUMERATED { true }          OPTIONAL
}

MBSFN-InterFrequencyNeighbourList-r7 ::= SEQUENCE (SIZE (1..maxMBSFNClusters)) OF
    MBSFNInterFrequencyNeighbour-r7

-- List of extensions to the corresponding elements of IE "MBSFN-InterFrequencyNeighbourList-r7"
MBSFN-InterFrequencyNeighbourList-v860ext ::= SEQUENCE (SIZE (1..maxMBSFNClusters)) OF
    MBSFNInterFrequencyNeighbour-v860ext

MBSFN-TDDInformation ::=                SEQUENCE (SIZE (1..maxTS)) OF
    MBSFN-TDDTimeSlotInfo

MBSFN-TDDInformation-LCR ::=            SEQUENCE (SIZE (1..maxMBSFNClusters)) OF
    MBSFN-TDDTimeSlotInfo-LCR

MBSFN-TDDTimeSlotInfo ::=              SEQUENCE {
    timeSlotNumber                       TimeslotNumber-LCR-r4,
    cellParametersID                     CellParametersID
}

MBSFN-TDDTimeSlotInfo-LCR ::=           SEQUENCE {
    frequencyIndex                       INTEGER (1..maxMBSFNClusters),
    timeSlotList                         MBSFN-TDDInformation
}

MBSFN-TDM-Info ::=                      SEQUENCE {
    shortTransmissionID                  MBMS-ShortTransmissionID,
    tDMPeriod                            INTEGER (2..9),
    tDMOffset                             INTEGER (0..8),
    tDMLength                             INTEGER (1..8)
}

MBSFN-TDM-Info-List ::=                 SEQUENCE (SIZE (1..maxMBMSservUnmodif)) OF
    MBSFN-TDM-Info

```

END

11.4 Constant definitions

Constant-definitions DEFINITIONS AUTOMATIC TAGS ::=

BEGIN

```

hipDSCHidentities          INTEGER ::= 64
hiPUSCHidentities          INTEGER ::= 64
hiRM                        INTEGER ::= 256
maxAC                       INTEGER ::= 16
maxAdditionalMeas           INTEGER ::= 4
maxASC                      INTEGER ::= 8
maxASCmap                   INTEGER ::= 7
maxASCpersist              INTEGER ::= 6
maxCCTrCH                   INTEGER ::= 8
maxCellMeas                 INTEGER ::= 32
maxCellMeas-1              INTEGER ::= 31
maxCNgdomains               INTEGER ::= 4
maxCommonHRNTI             INTEGER ::= 4
maxCommonQueueID           INTEGER ::= 2
maxCPCsets                  INTEGER ::= 16
maxDedicatedCSGFreq        INTEGER ::= 4
maxDPCH-DLchan             INTEGER ::= 8
maxDPDCH-UL                INTEGER ::= 6
maxDRACclasses             INTEGER ::= 8
maxE-DCHMACdFlow           INTEGER ::= 8
maxE-DCHMACdFlow-1         INTEGER ::= 7
maxEUTRACellPerFreq        INTEGER ::= 16
maxEUTRATargetFreqs        INTEGER ::= 8
maxEDCHRL                   INTEGER ::= 4
maxEDCHs                    INTEGER ::= 32
maxEDCHTxPattern-TDD128    INTEGER ::= 4 -- maxEDCHTxPattern-TDD128    should be 3
maxEDCHTxPattern-TDD128-1  INTEGER ::= 3 -- maxEDCHTxPattern-TDD128-1  should be 2
maxERNTIgroup              INTEGER ::= 32
maxERNTIperGroup           INTEGER ::= 2
maxERUCCH                   INTEGER ::= 256
maxFACHPCH                  INTEGER ::= 8
maxFreq                     INTEGER ::= 8
maxFreqBandsEUTRA           INTEGER ::= 16
maxFreqBandsFDD             INTEGER ::= 8
maxFreqBandsFDD-ext         INTEGER ::= 15 -- maxFreqBandsFDD-ext ::= 22 - (maxFreqBandsFDD - 1)
maxFreqBandsTDD             INTEGER ::= 4
maxFreqBandsTDD-ext         INTEGER ::= 16
maxFreqBandsGSM             INTEGER ::= 16
maxGANSS                    INTEGER ::= 8
maxGANSS-1                  INTEGER ::= 7
maxGANSSSat                 INTEGER ::= 64
maxGANSSSat-1               INTEGER ::= 63
maxGERAN-SI                 INTEGER ::= 8
maxGSMTargetCells          INTEGER ::= 32
maxHNBNameSize              INTEGER ::= 48
maxHProcesses               INTEGER ::= 8
maxHS-SCCHLessTrBlk        INTEGER ::= 4
maxHSDSCHTBIndex           INTEGER ::= 64
maxHSDSCHTBIndex-tdd384    INTEGER ::= 512
maxHSSCCHs                  INTEGER ::= 4
maxHSSCCHs-1                INTEGER ::= 3
maxHSSICH-TDD128           INTEGER ::= 4
maxHSSICH-TDD128-1         INTEGER ::= 3
maxInterSysMessages        INTEGER ::= 4
maxLoChperRLC               INTEGER ::= 2
maxMAC-d-PDUsizes           INTEGER ::= 8
maxMBMS-CommonCCTrCh       INTEGER ::= 32
maxMBMS-CommonPhyCh        INTEGER ::= 32
maxMBMS-CommonRB           INTEGER ::= 32
maxMBMS-CommonTrCh         INTEGER ::= 32
maxMBMS-Freq                INTEGER ::= 4
maxMBMS-L1CP                INTEGER ::= 4
maxMBMsservCount           INTEGER ::= 8
maxMBMsservModif           INTEGER ::= 32
maxMBMsservSched            INTEGER ::= 16
maxMBMsservSelect           INTEGER ::= 8
maxMBMsservUnmodif         INTEGER ::= 64
maxMBMSTransmis             INTEGER ::= 4
maxMBSFNClusters           INTEGER ::= 16
maxMeasEvent                INTEGER ::= 8
maxMeasIntervals            INTEGER ::= 3

```

```

maxMeasParEvent          INTEGER ::= 2
maxNumCDMA2000Freqs     INTEGER ::= 8
maxNumE-AGCH             INTEGER ::= 4
maxNumE-HICH             INTEGER ::= 4
maxNumEUTRAFreqs        INTEGER ::= 8
maxNumGSMCellGroup      INTEGER ::= 16
maxNumGSMFreqRanges     INTEGER ::= 32
maxNumFDDFreqs          INTEGER ::= 8
maxNumTDDFreqs          INTEGER ::= 8
maxNoOfMeas             INTEGER ::= 16
maxOtherRAT             INTEGER ::= 15
maxOtherRAT-16          INTEGER ::= 16
maxPage1                INTEGER ::= 8
maxPCPCH-APsig          INTEGER ::= 16
maxPCPCH-APsubCh        INTEGER ::= 12
maxPCPCH-CDsig          INTEGER ::= 16
maxPCPCH-CDsubCh        INTEGER ::= 12
maxPCPCH-SF             INTEGER ::= 7
maxPCPCHs               INTEGER ::= 64
maxPDCPAlgoType         INTEGER ::= 8
maxPDSCH                INTEGER ::= 8
maxPDSCH-TFCIgroups     INTEGER ::= 256
maxPRACH                INTEGER ::= 16
maxPRACH-FPACH          INTEGER ::= 8
maxPredefConfig         INTEGER ::= 16
maxPrio                 INTEGER ::= 8
maxPrio-1               INTEGER ::= 7
maxPUSCH                INTEGER ::= 8
maxQueueIDs             INTEGER ::= 8
maxRABsetup             INTEGER ::= 16
maxRAT                  INTEGER ::= 16
maxRB                   INTEGER ::= 32
maxRBallRABs            INTEGER ::= 27
maxRBMuxOptions         INTEGER ::= 8
maxRBperRAB             INTEGER ::= 8
maxRBperTrCh            INTEGER ::= 16
maxReportedEUTRACellPerFreq INTEGER ::= 4
maxReportedEUTRAFreqs  INTEGER ::= 4
maxReportedGSMCells     INTEGER ::= 8
maxRL                   INTEGER ::= 8
maxRL-1                 INTEGER ::= 7
maxRLCPDUsSizePerLogChan INTEGER ::= 32
maxRFC3095-CID          INTEGER ::= 16384
maxROHC-PacketSizes-r4  INTEGER ::= 16
maxROHC-Profile-r4      INTEGER ::= 8
maxRxPatternForHSDSCH-TDD128 INTEGER ::= 4 -- maxRxPatternForHSDSCH-TDD128 should be 3
maxRxPatternForHSDSCH-TDD128-1 INTEGER ::= 3 -- maxRxPatternForHSDSCH-TDD128-1 should be 2
maxSat                  INTEGER ::= 16
maxSatClockModels       INTEGER ::= 4
maxSCCPCH               INTEGER ::= 16
maxSgnType              INTEGER ::= 8
maxSIB                  INTEGER ::= 32
maxSIB-FACH             INTEGER ::= 8
maxSIBperMsg            INTEGER ::= 16
maxSRBsetup             INTEGER ::= 8
maxSystemCapability     INTEGER ::= 16
maxTDD128Carrier        INTEGER ::= 6
maxTbsForHSDSCH-TDD128  INTEGER ::= 4
maxTbsForHSDSCH-TDD128-1 INTEGER ::= 3
maxTF                   INTEGER ::= 32
maxTF-CPCH              INTEGER ::= 16
maxTFC                  INTEGER ::= 1024
maxTFCsub               INTEGER ::= 1024
maxTFCI-2-Combs         INTEGER ::= 512
maxTGPS                 INTEGER ::= 6
maxTrCH                 INTEGER ::= 32
-- maxTrCHpreconf should be 16 but has been set to 32 for compatibility
maxTrCHpreconf          INTEGER ::= 32
maxTS                   INTEGER ::= 14
maxTS-1                 INTEGER ::= 13
maxTS-2                 INTEGER ::= 12
maxTS-LCR               INTEGER ::= 6
maxTS-LCR-1             INTEGER ::= 5
maxURA                  INTEGER ::= 8
maxURNNTI-Group         INTEGER ::= 8

```

END

11.5 RRC information between network nodes

Internode-definitions DEFINITIONS AUTOMATIC TAGS ::=

BEGIN

IMPORTS

HandoverToUTRANCommand,
 MeasurementReport,
 PhysicalChannelReconfiguration,
 RadioBearerReconfiguration,
 RadioBearerRelease,
 RadioBearerSetup,
 RRCConnectionSetupComplete-r3-add-ext-IEs,
 RRC-FailureInfo,
 TransportChannelReconfiguration,
 UECapabilityInformation-r3-add-ext-IEs

FROM PDU-definitions

-- Core Network IEs :
 CN-DomainIdentity,
 CN-DomainInformationList,
 CN-DomainInformationListFull,
 CN-DRX-CycleLengthCoefficient,
 NAS-SystemInformationGSM-MAP,
-- UTRAN Mobility IEs :
 CellIdentity,
 URA-Identity,
-- User Equipment IEs :
 AccessStratumReleaseIndicator,
 C-RNTI,
 ChipRateCapability,
 DL-CapabilityWithSimultaneousHS-DSCHConfig,
 DL-PhysChCapabilityFDD-v380ext,
 DL-PhysChCapabilityTDD,
 DL-PhysChCapabilityTDD-LCR-r4,
 GSM-Measurements,
 HSDSCH-physical-layer-category,
 FailureCauseWithProtErr,
 MaxHcContextSpace,
 MaximumAM-EntityNumberRLC-Cap,
 MaximumRLC-WindowSize,
 MaxNoPhysChBitsReceived,
 MaxNoDPDCH-BitsTransmitted,
 MaxPhysChPerFrame,
 MaxPhysChPerSubFrame-r4,
 MaxPhysChPerTS,
 MaxROHC-ContextSessions-r4,
 MaxTS-PerFrame,
 MaxTS-PerSubFrame-r4,
 MinimumSF-DL,
 MultiModeCapability,
 MultiRAT-Capability,
 NetworkAssistedGPS-Supported,
 PhysicalChannelCapability-edch-r6,
 RadioFrequencyBandTDDList,
 RLC-Capability,
 RRC-MessageSequenceNumber,
 SecurityCapability,
 SimultaneousSCCPCH-DPCH-Reception,
 STARTList,
 STARTSingle,
 START-Value,
 SupportOfDedicatedPilotsForChEstimation,
 T-305,
 TransportChannelCapability,
 TxRxFrequencySeparation,
 U-RNTI,
 UE-CapabilityContainer-IEs,
 UE-GANSSPositioning-Capability,
 UE-MultiModeRAT-Capability,
 UE-PowerClassExt,
 UE-RadioAccessCapabBandFDDList,
 UE-RadioAccessCapabBandFDDList2,
 UE-RadioAccessCapabBandFDDList-ext,
 UE-RadioAccessCapability,

```
UE-RadioAccessCapability-v370ext,  
UE-RadioAccessCapability-v380ext,  
UE-RadioAccessCapability-v3a0ext,  
UE-RadioAccessCapability-v3g0ext,  
UE-RadioAccessCapability-v4b0ext,  
UE-RadioAccessCapability-v590ext,  
UE-RadioAccessCapability-v5c0ext,  
UE-RadioAccessCapability-v7e0ext,  
UE-RadioAccessCapability-v7f0ext,  
UL-PhysChCapabilityFDD,  
UL-PhysChCapabilityFDD-r6,  
UL-PhysChCapabilityTDD,  
UL-PhysChCapabilityTDD-LCR-r4,  
-- Radio Bearer IEs :  
  PDCP-ROHC-TargetMode,  
  PredefinedConfigStatusList,  
  PredefinedConfigValueTag,  
  RAB-InformationSetupList,  
  RAB-InformationSetupList-r4,  
  RAB-InformationSetupList-r5,  
  RAB-InformationSetupList-r6-ext,  
  RAB-InformationSetupList-r6,  
  RAB-InformationSetupList-v6b0ext,  
  RAB-InformationSetupList-r7,  
  RAB-InformationSetupList-r8,  
  RAB-InformationSetupList-v820ext,  
  RB-Identity,  
  SRB-InformationSetupList,  
  SRB-InformationSetupList-r5,  
  SRB-InformationSetupList-r6,  
  SRB-InformationSetupList-r7,  
  SRB-InformationSetupList-r8,  
-- Transport Channel IEs :  
  CPCH-SetID,  
  DL-CommonTransChInfo,  
  DL-CommonTransChInfo-r4,  
  DL-AddReconfTransChInfoList,  
  DL-AddReconfTransChInfoList-r4,  
  DL-AddReconfTransChInfoList-r5,  
  DL-AddReconfTransChInfoList-r7,  
  DRAC-StaticInformationList,  
  UL-CommonTransChInfo,  
  UL-CommonTransChInfo-r4,  
  UL-AddReconfTransChInfoList,  
  UL-AddReconfTransChInfoList-r6,  
  UL-AddReconfTransChInfoList-r7,  
  UL-AddReconfTransChInfoList-r8,  
-- Physical Channel IEs :  
  PrimaryCPICH-Info,  
  TPC-CombinationIndex,  
  ScramblingCodeChange,  
  TGCFN,  
  TGPSI,  
  TGPS-ConfigurationParams,  
  TGPS-ConfigurationParams-r8,  
-- Measurement IEs :  
  EventIj-r6,  
  Hysteresis,  
  Inter-FreqEventCriteriaList-v590ext,  
  Intra-FreqEventCriteriaList-v590ext,  
  IntraFreqEvent-1d-r5,  
  IntraFreqReportingCriteria-1b-r5,  
  InterRATCellInfoIndication,  
  MeasuredResultsOnRACHinterFreq,  
  MeasurementIdentity,  
  MeasurementReportingMode,  
  MeasurementType,  
  MeasurementType-r4,  
  MeasurementType-r6,  
  MeasurementType-r7,  
  MeasurementType-r8,  
  AdditionalMeasurementID-List,  
  PositionEstimate,  
  ReportingCellStatus,  
  ThresholdSFN-GPS-TOW-us,  
  TimeToTrigger,  
-- MBMS IEs :  
  MBMS-JoinedInformation-r6,
```

```

    MBMS-SelectedServiceInfo,
-- Other IEs :
    GERANu-RadioAccessCapability,
    GSM-MS-RadioAccessCapability,
    InterRAT-UE-RadioAccessCapabilityList,
    InterRAT-UE-RadioAccessCapability-v590ext,
    InterRAT-UE-RadioAccessCapability-v690ext,
    InterRAT-UE-RadioAccessCapability-v860ext,
    UE-HistoryInformation,
    UESpecificBehaviourInformationIdle,
    UESpecificBehaviourInformationInterRAT

FROM InformationElements

    maxCNdomains,
    maxEDCHRL,
    maxGANSS,
    maxNoOfMeas,
    maxRB,
    maxRBallRABs,
    maxRFC3095-CID,
    maxSRBsetup,
    maxRL,
    maxTGPS
FROM Constant-definitions;

-- Part 1: Class definitions similar to what has been defined in 11.1 for RRC messages
-- Information that is transferred in the same direction and across the same path is grouped

-- *****
--
-- RRC information, to target RNC
--
-- *****
-- RRC Information to target RNC sent either from source RNC or from another RAT

ToTargetRNC-Container ::= CHOICE {
    interRATHandoverInfo          InterRATHandoverInfoWithInterRATCapabilities-r3,
    srncRelocation                SRNC-RelocationInfo-r3,
    rfc3095-ContextInfo           RFC3095-ContextInfo-r5,
    extension                     NULL
}

-- *****
--
-- RRC information, target RNC to source RNC
--
-- *****

TargetRNC-ToSourceRNC-Container ::= CHOICE {
    radioBearerSetup              RadioBearerSetup,
    radioBearerReconfiguration    RadioBearerReconfiguration,
    radioBearerRelease            RadioBearerRelease,
    transportChannelReconfiguration TransportChannelReconfiguration,
    physicalChannelReconfiguration PhysicalChannelReconfiguration,
    rrc-FailureInfo               RRC-FailureInfo,
    -- IE dl-DCCHmessage consists of an octet string that includes the IE DL-DCCH-Message
    dl-DCCHmessage                OCTET STRING,
    extension                     NULL
}

-- Part 2: Container definitions, similar to the PDU definitions in 11.2 for RRC messages
-- In alphabetical order

-- *****
--
-- Handover to UTRAN information
--
-- *****

InterRATHandoverInfoWithInterRATCapabilities-r3 ::= CHOICE {
    r3                             SEQUENCE {
        -- IE InterRATHandoverInfoWithInterRATCapabilities-r3-IEs also
        -- includes non critical extensions
        interRATHandoverInfo-r3    InterRATHandoverInfoWithInterRATCapabilities-r3-IEs,
        v390NonCriticalExtensions  SEQUENCE {

```

```

        interRATHandoverInfoWithInterRATCapabilities-v390ext
            InterRATHandoverInfoWithInterRATCapabilities-v390ext-IEs,
        -- Reserved for future non critical extension
        v690NonCriticalExtensions SEQUENCE {
            interRATHandoverInfoWithInterRATCapabilities-v690ext
                InterRATHandoverInfoWithInterRATCapabilities-v690ext-IEs,
            v860NonCriticalExtensions SEQUENCE {
                interRATHandoverInfoWithInterRATCapabilities-v860ext
                    InterRATHandoverInfoWithInterRATCapabilities-v860ext-IEs,
                nonCriticalExtensions SEQUENCE {} OPTIONAL
            } OPTIONAL
        } OPTIONAL
    },
    criticalExtensions SEQUENCE {}
}

InterRATHandoverInfoWithInterRATCapabilities-r3-IEs ::= SEQUENCE {
    -- The order of the IEs may not reflect the tabular format
    -- but has been chosen to simplify the handling of the information in the BSC
    -- Other IEs
    ue-RATSpecificCapability InterRAT-UE-RadioAccessCapabilityList OPTIONAL,
    -- interRATHandoverInfo, Octet string is used to obtain 8 bit length field prior to
    -- actual information. This makes it possible for BSS to transparently handle information
    -- received via GSM air interface even when it includes non critical extensions.
    -- The octet string shall include the InterRATHandoverInfo information
    -- The BSS can re-use the 44.018 length field received from the MS
    interRATHandoverInfo OCTET STRING (SIZE (0..255))
}

InterRATHandoverInfoWithInterRATCapabilities-v390ext-IEs ::= SEQUENCE {
    -- User equipment IEs
    failureCauseWithProtErr FailureCauseWithProtErr OPTIONAL
}

InterRATHandoverInfoWithInterRATCapabilities-v690ext-IEs ::= SEQUENCE {
    -- Other IEs
    ue-RATSpecificCapability-v690ext InterRAT-UE-RadioAccessCapability-v690ext OPTIONAL
}

InterRATHandoverInfoWithInterRATCapabilities-v860ext-IEs ::= SEQUENCE {
    -- Other IEs
    ue-RATSpecificCapability InterRAT-UE-RadioAccessCapability-v860ext OPTIONAL
}

-- *****
--
-- RFC3095 context, source RNC to target RNC
--
-- *****

RFC3095-ContextInfo-r5 ::= CHOICE {
    r5 SEQUENCE {
        rFC3095-ContextInfoList-r5 RFC3095-ContextInfoList-r5,
        -- Reserved for future non critical extension
        nonCriticalExtensions SEQUENCE {} OPTIONAL
    },
    criticalExtensions SEQUENCE {}
}

RFC3095-ContextInfoList-r5 ::= SEQUENCE (SIZE (1..maxRBallRABs)) OF
    RFC3095-ContextInfo

-- *****
--
-- SRNC Relocation information
--
-- *****

SRNC-RelocationInfo-r3 ::= CHOICE {
    r3 SEQUENCE {
        sRNC-RelocationInfo-r3 SRNC-RelocationInfo-r3-IEs,
        v380NonCriticalExtensions SEQUENCE {
            sRNC-RelocationInfo-v380ext SRNC-RelocationInfo-v380ext-IEs,
            -- Reserved for future non critical extension
            v390NonCriticalExtensions SEQUENCE {
                sRNC-RelocationInfo-v390ext SRNC-RelocationInfo-v390ext-IEs,
            }
        }
    }
}

```

```

v3a0NonCriticalExtensions SEQUENCE {
  sRNC-RelocationInfo-v3a0ext SRNC-RelocationInfo-v3a0ext-IEs,
  v3b0NonCriticalExtensions SEQUENCE {
    sRNC-RelocationInfo-v3b0ext SRNC-RelocationInfo-v3b0ext-IEs,
    v3c0NonCriticalExtensions SEQUENCE {
      sRNC-RelocationInfo-v3c0ext SRNC-RelocationInfo-v3c0ext-IEs,
      laterNonCriticalExtensions SEQUENCE {
        sRNC-RelocationInfo-v3d0ext SRNC-RelocationInfo-v3d0ext-IEs,
        -- Container for additional R99 extensions
        sRNC-RelocationInfo-r3-add-ext BIT STRING
          (CONTAINING SRNC-RelocationInfo-v3h0ext-IEs) OPTIONAL,
        v3g0NonCriticalExtensions SEQUENCE {
          sRNC-RelocationInfo-v3g0ext SRNC-RelocationInfo-v3g0ext-IEs,
          v4b0NonCriticalExtensions SEQUENCE {
            sRNC-RelocationInfo-v4b0ext SRNC-RelocationInfo-v4b0ext-IEs,
            v590NonCriticalExtensions SEQUENCE {
              sRNC-RelocationInfo-v590ext
                SRNC-RelocationInfo-v590ext-IEs,
              v5a0NonCriticalExtensions SEQUENCE {
                sRNC-RelocationInfo-v5a0ext
                  SRNC-RelocationInfo-v5a0ext-IEs,
                v5b0NonCriticalExtensions SEQUENCE {
                  sRNC-RelocationInfo-v5b0ext
                    SRNC-RelocationInfo-v5b0ext-IEs,
                  v5c0NonCriticalExtensions SEQUENCE {
                    sRNC-RelocationInfo-v5c0ext
                      SRNC-RelocationInfo-v5c0ext-IEs,
                    v690NonCriticalExtensions SEQUENCE {
                      sRNC-RelocationInfo-v690ext
                        SRNC-RelocationInfo-v690ext-IEs,
                      v6b0NonCriticalExtensions SEQUENCE {
                        sRNC-RelocationInfo-v6b0ext
                          SRNC-RelocationInfo-v6b0ext-IEs,
                        v770NonCriticalExtensions SEQUENCE {
                          sRNC-RelocationInfo-v770ext
                            SRNC-RelocationInfo-v770ext-IEs,
                          v7e0NonCriticalExtensions SEQUENCE {
                            sRNC-RelocationInfo-v7e0ext
                              SRNC-RelocationInfo-v7e0ext-IEs,
                            v7f0NonCriticalExtensions SEQUENCE {
                              sRNC-RelocationInfo-v7f0ext
                                SRNC-RelocationInfo-v7f0ext-IEs,
                              nonCriticalExtensions SEQUENCE {} OPTIONAL
                            } OPTIONAL
                          } OPTIONAL
                        } OPTIONAL
                      } OPTIONAL
                    } OPTIONAL
                  } OPTIONAL
                } OPTIONAL
              } OPTIONAL
            } OPTIONAL
          } OPTIONAL
        } OPTIONAL
      } OPTIONAL
    } OPTIONAL
  } OPTIONAL
} OPTIONAL
},
later-than-r3 CHOICE {
  r4 SEQUENCE {
    sRNC-RelocationInfo-r4 SRNC-RelocationInfo-r4-IEs,
    v4d0NonCriticalExtensions SEQUENCE {
      sRNC-RelocationInfo-v4d0ext SRNC-RelocationInfo-v4d0ext-IEs,
      -- Container for adding non critical extensions after freezing REL-5
      sRNC-RelocationInfo-r4-add-ext BIT STRING OPTIONAL,
      v590NonCriticalExtensions SEQUENCE {
        sRNC-RelocationInfo-v590ext SRNC-RelocationInfo-v590ext-IEs,
        v5a0NonCriticalExtensions SEQUENCE {
          sRNC-RelocationInfo-v5a0ext SRNC-RelocationInfo-v5a0ext-IEs,
          v5b0NonCriticalExtensions SEQUENCE {
            sRNC-RelocationInfo-v5b0ext SRNC-RelocationInfo-v5b0ext-IEs,
            v5c0NonCriticalExtensions SEQUENCE {
              sRNC-RelocationInfo-v5c0ext SRNC-RelocationInfo-v5c0ext-IEs,
              v690NonCriticalExtensions SEQUENCE {

```

```

        sRNC-RelocationInfo-v690ext        SRNC-RelocationInfo-v690ext-IEs,
v6b0NonCriticalExtensions                SEQUENCE {
        sRNC-RelocationInfo-v6b0ext
        SRNC-RelocationInfo-v6b0ext-IEs,
v770NonCriticalExtensions                SEQUENCE {
        sRNC-RelocationInfo-v770ext
        SRNC-RelocationInfo-v770ext-IEs,
v7e0NonCriticalExtensions                SEQUENCE {
        sRNC-RelocationInfo-v7e0ext
        SRNC-RelocationInfo-v7e0ext-IEs,
v7f0NonCriticalExtensions                SEQUENCE {
        sRNC-RelocationInfo-v7f0ext
        SRNC-RelocationInfo-v7f0ext-IEs,
        nonCriticalExtensions                SEQUENCE {} OPTIONAL
    } OPTIONAL
  } OPTIONAL
} OPTIONAL
} OPTIONAL
} OPTIONAL
},
criticalExtensions                       CHOICE {
r5                                         SEQUENCE {
sRNC-RelocationInfo-r5                    SRNC-RelocationInfo-r5-IEs,
sRNC-RelocationInfo-r5-add-ext            BIT STRING OPTIONAL,
v5a0NonCriticalExtensions                SEQUENCE {
sRNC-RelocationInfo-v5a0ext              SRNC-RelocationInfo-v5a0ext-IEs,
v5b0NonCriticalExtensions                SEQUENCE {
sRNC-RelocationInfo-v5b0ext              SRNC-RelocationInfo-v5b0ext-IEs,
v5c0NonCriticalExtensions                SEQUENCE {
sRNC-RelocationInfo-v5c0ext              SRNC-RelocationInfo-v5c0ext-IEs,
v690NonCriticalExtensions                SEQUENCE {
sRNC-RelocationInfo-v690ext              SRNC-RelocationInfo-v690ext-IEs,
v6b0NonCriticalExtensions                SEQUENCE {
sRNC-RelocationInfo-v6b0ext              SRNC-RelocationInfo-v6b0ext-IEs,
v770NonCriticalExtensions                SEQUENCE {
sRNC-RelocationInfo-v770ext
SRNC-RelocationInfo-v770ext-IEs,
v7e0NonCriticalExtensions                SEQUENCE {
sRNC-RelocationInfo-v7e0ext
SRNC-RelocationInfo-v7e0ext-IEs,
v7f0NonCriticalExtensions                SEQUENCE {
sRNC-RelocationInfo-v7f0ext
SRNC-RelocationInfo-v7f0ext-IEs,
        nonCriticalExtensions                SEQUENCE {} OPTIONAL
    } OPTIONAL
  } OPTIONAL
} OPTIONAL
} OPTIONAL
} OPTIONAL
} OPTIONAL
},
criticalExtensions                       CHOICE {
r6                                         SEQUENCE {
sRNC-RelocationInfo-r6                    SRNC-RelocationInfo-r6-IEs,
sRNC-RelocationInfo-r6-add-ext            BIT STRING
(CONTAINING SRNC-RelocationInfo-r6-add-ext-IEs) OPTIONAL,
v6b0NonCriticalExtensions                SEQUENCE {
sRNC-RelocationInfo-v6b0ext              SRNC-RelocationInfo-v6b0ext-IEs,
v770NonCriticalExtensions                SEQUENCE {
sRNC-RelocationInfo-v770ext              SRNC-RelocationInfo-v770ext-IEs,
v820NonCriticalExtensions                SEQUENCE {
srnc-RelocationInfo-v820ext              SRNC-RelocationInfo-v820ext-IEs,
v860NonCriticalExtensions                SEQUENCE {
sRNC-RelocationInfo-v860ext              SRNC-RelocationInfo-v860ext-IEs,
        nonCriticalExtensions                SEQUENCE {} OPTIONAL
    } OPTIONAL
  } OPTIONAL
} OPTIONAL
} OPTIONAL
},
criticalExtensions                       CHOICE {

```



```

    r7 SEQUENCE {
      sRNC-RelocationInfo-r7 SRNC-RelocationInfo-r7-IEs,
      sRNC-RelocationInfo-r7-add-ext BIT STRING
        (CONTAINING SRNC-RelocationInfo-r7-add-ext-IEs) OPTIONAL,
      v820NonCriticalExtensions SEQUENCE {
        sRNC-RelocationInfo-v820ext SRNC-RelocationInfo-v820ext-IEs,
        v860NonCriticalExtensions SEQUENCE {
          sRNC-RelocationInfo-v860ext SRNC-RelocationInfo-v860ext-IEs,
          nonCriticalExtensions SEQUENCE {} OPTIONAL
        } OPTIONAL
      } OPTIONAL
    },
    criticalExtensions CHOICE {
      r8 SEQUENCE {
        sRNC-RelocationInfo-r8 SRNC-RelocationInfo-r8-IEs,
        sRNC-RelocationInfo-r8-add-ext BIT STRING OPTIONAL,
        v7e0NonCriticalExtensions SEQUENCE {
          sRNC-RelocationInfo-v7e0ext SRNC-RelocationInfo-v7e0ext-IEs,
          v7f0NonCriticalExtensions SEQUENCE {
            sRNC-RelocationInfo-v7f0ext
              SRNC-RelocationInfo-v7f0ext-IEs,
            v8d0NonCriticalExtensions SEQUENCE {
              sRNC-RelocationInfo-v8d0ext
                SRNC-RelocationInfo-v8d0ext-IEs,
              nonCriticalExtensions SEQUENCE {} OPTIONAL
            } OPTIONAL
          } OPTIONAL
        } OPTIONAL
      },
      criticalExtensions SEQUENCE {}
    }
  }
}

```

```

SRNC-RelocationInfo-r3-IEs ::= SEQUENCE {
  -- Non-RRC IEs
  stateOfRRC StateOfRRC,
  stateOfRRC-Procedure StateOfRRC-Procedure,
  -- Ciphering related information IEs
  -- If the extension v380 is included use the extension for the ciphering status per CN domain
  cipheringStatus CipheringStatus,
  -- If ciphering status is started and the IE latestConfiguredCN-Domain should be included,
  -- the IE cn-DomainIdentity (in SRNC-RelocationInfo-v380ext-IEs) shall be used instead.
  calculationTimeForCiphering CalculationTimeForCiphering OPTIONAL,
  -- The order of occurrence in the IE cipheringInfoPerRB-List is the
  -- same as the RBs in SRB-InformationSetupList in RAB-InformationSetupList.
  -- The signalling RBs are supposed to be listed
  -- first. Only UM and AM RBs that are ciphered are listed here
  cipheringInfoPerRB-List CipheringInfoPerRB-List OPTIONAL,
  count-C-List COUNT-C-List OPTIONAL,
  integrityProtectionStatus IntegrityProtectionStatus,
  -- In the IE srb-SpecificIntegrityProtInfo, the first information listed corresponds to
  -- signalling radio bearer RB0 and after the order of occurrence is the same as the SRBs in
  -- SRB-InformationSetupList
  -- The target RNC may ignore the IE srb-SpecificIntegrityProtInfo if the
  -- IE integrityProtectionStatus has the value "not started".
  srb-SpecificIntegrityProtInfo SRB-SpecificIntegrityProtInfoList,
  implementationSpecificParams ImplementationSpecificParams OPTIONAL,
  -- User equipment IEs
  u-RNTI U-RNTI,
  c-RNTI C-RNTI OPTIONAL,
  ue-RadioAccessCapability UE-RadioAccessCapability,
  ue-Positioning-LastKnownPos UE-Positioning-LastKnownPos OPTIONAL,
  -- Other IEs
  ue-RATSpecificCapability InterRAT-UE-RadioAccessCapabilityList OPTIONAL,
  -- UTRAN mobility IEs
  ura-Identity URA-Identity OPTIONAL,
  -- Core network IEs
  cn-CommonGSM-MAP-NAS-SysInfo NAS-SystemInformationGSM-MAP,
  cn-DomainInformationList CN-DomainInformationList OPTIONAL,
  -- Measurement IEs
  ongoingMeasRepList OngoingMeasRepList OPTIONAL,
  -- Radio bearer IEs
  predefinedConfigStatusList PredefinedConfigStatusList,
  srb-InformationList SRB-InformationSetupList,

```

```

    rab-InformationList          RAB-InformationSetupList          OPTIONAL,
-- Transport channel IEs
    ul-CommonTransChInfo        UL-CommonTransChInfo          OPTIONAL,
    ul-TransChInfoList          UL-AddReconfTransChInfoList  OPTIONAL,
    modeSpecificInfo            CHOICE {
        fdd                    SEQUENCE {
            -- dummy and dummy2 are not used in this version of the specification, they should
            -- not be sent and if received they should be ignored.
            dummy                CPCH-SetID                OPTIONAL,
            dummy2              DRAC-StaticInformationList  OPTIONAL
        },
        tdd                    NULL
    },
    dl-CommonTransChInfo        DL-CommonTransChInfo          OPTIONAL,
    dl-TransChInfoList          DL-AddReconfTransChInfoList  OPTIONAL,
-- Measurement report
    measurementReport           MeasurementReport            OPTIONAL
}

SRNC-RelocationInfo-v380ext-IEs ::= SEQUENCE {
-- Ciphering related information IEs
-- In the SRNC-RelocationInfo-r3-IEs, the IE 'cn-DomainIdentity' is used to represent the
-- IE 'Latest configured CN domain' in the tabular.
    cn-DomainIdentity           CN-DomainIdentity,
    cipheringStatusList         CipheringStatusList
}

SRNC-RelocationInfo-v390ext-IEs ::= SEQUENCE {
    cn-DomainInformationList-v390ext  CN-DomainInformationList-v390ext  OPTIONAL,
    ue-RadioAccessCapability-v370ext  UE-RadioAccessCapability-v370ext  OPTIONAL,
    ue-RadioAccessCapability-v380ext  UE-RadioAccessCapability-v380ext  OPTIONAL,
    dl-PhysChCapabilityFDD-v380ext    DL-PhysChCapabilityFDD-v380ext,
    failureCauseWithProtErr          FailureCauseWithProtErr           OPTIONAL
}

SRNC-RelocationInfo-v3a0ext-IEs ::= SEQUENCE {
    cipheringInfoForSRB1-v3a0ext      CipheringInfoPerRB-List-v3a0ext,
    ue-RadioAccessCapability-v3a0ext  UE-RadioAccessCapability-v3a0ext  OPTIONAL,
-- cn-domain identity for IE startValueForCiphering-v3a0ext is specified
-- in subsequent extension (SRNC-RelocationInfo-v3b0ext-IEs)
    startValueForCiphering-v3a0ext    START-Value
}

SRNC-RelocationInfo-v3b0ext-IEs ::= SEQUENCE {
-- cn-domain identity for IE startValueForCiphering-v3a0ext included in previous extension
    cn-DomainIdentity               CN-DomainIdentity,
-- the IE startValueForCiphering-v3b0ext contains the start values for each CN Domain. The
-- value of start indicated by the IE startValueForCiphering-v3a0ext should be set to the
-- same value as the start-Value for the corresponding cn-DomainIdentity in the IE
-- startValueForCiphering-v3b0ext
    startValueForCiphering-v3b0ext    STARTList2                        OPTIONAL
}

SRNC-RelocationInfo-v3c0ext-IEs ::= SEQUENCE {
-- IE rb-IdentityForHOMessage includes the identity of the RB used by the source SRNC
-- to send the message contained in the IE "TargetRNC-ToSourceRNC-Container".
-- Only included if type is "UE involved"
    rb-IdentityForHOMessage          RB-Identity                        OPTIONAL
}

SRNC-RelocationInfo-v3d0ext-IEs ::= SEQUENCE {
-- User equipment IEs
    uESpecificBehaviourInformationlidle  UESpecificBehaviourInformationlidle  OPTIONAL,
    uESpecificBehaviourInformationlinterRAT  UESpecificBehaviourInformationlinterRAT  OPTIONAL
}

SRNC-RelocationInfo-v3g0ext-IEs ::= SEQUENCE {
    ue-RadioAccessCapability-v3g0ext  UE-RadioAccessCapability-v3g0ext  OPTIONAL
}

SRNC-RelocationInfo-v3h0ext-IEs ::= SEQUENCE {
    tpc-CombinationInfoList           TPC-CombinationInfoList           OPTIONAL,
    nonCriticalExtension               SEQUENCE {}                       OPTIONAL
}

SRNC-RelocationInfo-v4d0ext-IEs ::= SEQUENCE {
    tpc-CombinationInfoList           TPC-CombinationInfoList           OPTIONAL
}

```

```

TPC-CombinationInfoList ::= SEQUENCE (SIZE (1..maxRL)) OF
    TPC-Combination-Info

STARTList2 ::=
    SEQUENCE (SIZE (2..maxCNdomains)) OF
        STARTSingle

SRNC-RelocationInfo-v4b0ext-IEs ::= SEQUENCE {
    ue-RadioAccessCapability-v4b0ext    UE-RadioAccessCapability-v4b0ext    OPTIONAL
}

SRNC-RelocationInfo-v590ext-IEs ::= SEQUENCE {
    ue-RadioAccessCapability-v590ext    UE-RadioAccessCapability-v590ext    OPTIONAL,
    ue-RATSpecificCapability-v590ext    InterRAT-UE-RadioAccessCapability-v590ext    OPTIONAL
}

SRNC-RelocationInfo-v5a0ext-IEs ::= SEQUENCE {
    storedCompressedModeInfo            StoredCompressedModeInfo            OPTIONAL
}

SRNC-RelocationInfo-v5b0ext-IEs ::= SEQUENCE {
    interRATCellInfoIndication          InterRATCellInfoIndication          OPTIONAL
}

SRNC-RelocationInfo-v5c0ext-IEs ::= SEQUENCE {
    ue-RadioAccessCapability-v5c0ext    UE-RadioAccessCapability-v5c0ext    OPTIONAL
}

CipheringInfoPerRB-List-v3a0ext ::= SEQUENCE {
    dl-UM-SN                            BIT STRING (SIZE (7))
}

CipheringStatusList ::=
    SEQUENCE (SIZE (1..maxCNdomains)) OF
        CipheringStatusCNdomain

CipheringStatusCNdomain ::=
    SEQUENCE {
        cn-DomainIdentity                CN-DomainIdentity,
        cipheringStatus                  CipheringStatus
    }

CodeChangeStatusList ::= SEQUENCE (SIZE (1..maxRL)) OF
    CodeChangeStatus

CodeChangeStatus ::= SEQUENCE {
    primaryCPICH-Info                    PrimaryCPICH-Info,
    scramblingCodeChange                  ScramblingCodeChange
}

StoredCompressedModeInfo ::= SEQUENCE {
    storedTGP-SequenceList                StoredTGP-SequenceList,
    codeChangeStatusList                  CodeChangeStatusList    OPTIONAL
}

StoredCompressedModeInfo-r8 ::= SEQUENCE {
    storedTGP-SequenceList                StoredTGP-SequenceList-r8,
    codeChangeStatusList                  CodeChangeStatusList    OPTIONAL
}

StoredTGP-SequenceList ::=
    SEQUENCE (SIZE (1..maxTGPS)) OF
        StoredTGP-Sequence

StoredTGP-SequenceList-r8 ::=
    SEQUENCE (SIZE (1..maxTGPS)) OF
        StoredTGP-Sequence-r8

StoredTGP-Sequence ::=
    SEQUENCE {
        tgpsi                             TGPSI,
        current-tgps-Status                CHOICE {
            active                          SEQUENCE {
                tgcfm                       TGCFM
            },
            inactive                        NULL
        },
        tgps-ConfigurationParams           TGPS-ConfigurationParams    OPTIONAL
    }

StoredTGP-Sequence-r8 ::=
    SEQUENCE {
        tgpsi                             TGPSI,
        current-tgps-Status                CHOICE {

```

```

        active                SEQUENCE {
            tgcfm              TGCFM
        },
        inactive              NULL
    },
    tgps-ConfigurationParams  TGPS-ConfigurationParams-r8      OPTIONAL
}

SRNC-RelocationInfo-r4-IEs ::= SEQUENCE {
-- Non-RRC IEs
-- IE rb-IdentityForHOMessage includes the identity of the RB used by the source SRNC
-- to send the message contained in the IE "TargetRNC-ToSourceRNC-Container".
-- Only included if type is "UE involved"
rb-IdentityForHOMessage      RB-Identity              OPTIONAL,
stateOfRRC                  StateOfRRC,
stateOfRRC-Procedure         StateOfRRC-Procedure,
-- Ciphering related information IEs
cipheringStatusList         CipheringStatusList-r4,
latestConfiguredCN-Domain   CN-DomainIdentity,
calculationTimeForCiphering CalculationTimeForCiphering  OPTIONAL,
count-C-List                COUNT-C-List              OPTIONAL,
cipheringInfoPerRB-List     CipheringInfoPerRB-List-r4  OPTIONAL,
-- Integrity protection related information IEs
integrityProtectionStatus    IntegrityProtectionStatus,
-- The target RNC may ignore the IE srb-SpecificIntegrityProtInfo if the
-- IE integrityProtectionStatus has the value "not started".
srb-SpecificIntegrityProtInfo SRB-SpecificIntegrityProtInfoList,
implementationSpecificParams ImplementationSpecificParams  OPTIONAL,
-- User equipment IEs
u-RNTI                      U-RNTI,
c-RNTI                      C-RNTI              OPTIONAL,
ue-RadioAccessCapability     UE-RadioAccessCapability-r4,
ue-RadioAccessCapability-ext UE-RadioAccessCapabBandFDDList  OPTIONAL,
ue-Positioning-LastKnownPos  UE-Positioning-LastKnownPos  OPTIONAL,
uESpecificBehaviourInformationIdle UESpecificBehaviourInformationIdle  OPTIONAL,
uESpecificBehaviourInformationInterRAT UESpecificBehaviourInformationInterRAT  OPTIONAL,
-- Other IEs
ue-RATSpecificCapability     InterRAT-UE-RadioAccessCapabilityList  OPTIONAL,
-- UTRAN mobility IEs
ura-Identity                 URA-Identity              OPTIONAL,
-- Core network IEs
cn-CommonGSM-MAP-NAS-SysInfo NAS-SystemInformationGSM-MAP,
cn-DomainInformationList     CN-DomainInformationListFull  OPTIONAL,
-- Measurement IEs
ongoingMeasRepList          OngoingMeasRepList-r4      OPTIONAL,
-- Radio bearer IEs
predefinedConfigStatusList   PredefinedConfigStatusList,
srb-InformationList          SRB-InformationSetupList,
rab-InformationList          RAB-InformationSetupList-r4  OPTIONAL,
-- Transport channel IEs
ul-CommonTransChInfo        UL-CommonTransChInfo-r4     OPTIONAL,
ul-TransChInfoList          UL-AddReconfTransChInfoList  OPTIONAL,
-- 'dummy', 'dummy1' and 'dummy2' are not used in this version of the specification,
-- they should not be sent and if received they should be ignored.
dummy                       CHOICE {
    fdd                      SEQUENCE {
        dummy1                CPCH-SetID              OPTIONAL,
        dummy2                DRAC-StaticInformationList  OPTIONAL
    },
    tdd                      NULL
}
dl-CommonTransChInfo        DL-CommonTransChInfo-r4     OPTIONAL,
dl-TransChInfoList          DL-AddReconfTransChInfoList-r4  OPTIONAL,
-- Measurement report
measurementReport            MeasurementReport           OPTIONAL,
failureCause                 FailureCauseWithProtErr     OPTIONAL
}

SRNC-RelocationInfo-r5-IEs ::= SEQUENCE {
-- Non-RRC IEs
-- IE rb-IdentityForHOMessage includes the identity of the RB used by the source SRNC
-- to send the message contained in the IE "TargetRNC-ToSourceRNC-Container".
-- Only included if type is "UE involved"
rb-IdentityForHOMessage      RB-Identity              OPTIONAL,
stateOfRRC                  StateOfRRC,
stateOfRRC-Procedure         StateOfRRC-Procedure,
-- Ciphering related information IEs
cipheringStatusList         CipheringStatusList-r4,

```

```

    latestConfiguredCN-Domain          CN-DomainIdentity,
    calculationTimeForCipherng         CalculationTimeForCipherng         OPTIONAL,
    count-C-List                       COUNT-C-List                       OPTIONAL,
    cipherngInfoPerRB-List             CipherngInfoPerRB-List-r4         OPTIONAL,
-- Integrity protection related information IEs
    integrityProtectionStatus          IntegrityProtectionStatus,
    srb-SpecificIntegrityProtInfoList SRB-SpecificIntegrityProtInfoList OPTIONAL,
    implementationSpecificParams       ImplementationSpecificParams       OPTIONAL,
-- User equipment IEs
    u-RNTI                             U-RNTI,
    c-RNTI                             C-RNTI                             OPTIONAL,
    ue-RadioAccessCapability           UE-RadioAccessCapability-r5,
    ue-RadioAccessCapability-ext       UE-RadioAccessCapabBandFDDList   OPTIONAL,
    ue-Positioning-LastKnownPos       UE-Positioning-LastKnownPos       OPTIONAL,
    uESpecificBehaviourInformationIdle UESpecificBehaviourInformationIdle OPTIONAL,
    uESpecificBehaviourInformationInterRAT UESpecificBehaviourInformationInterRAT OPTIONAL,
-- Other IEs
    ue-RATSpecificCapability           InterRAT-UE-RadioAccessCapabilityList-r5 OPTIONAL,
-- UTRAN mobility IEs
    ura-Identity                       URA-Identity                       OPTIONAL,
-- Core network IEs
    cn-CommonGSM-MAP-NAS-SysInfo       NAS-SystemInformationGSM-MAP,
    cn-DomainInformationList           CN-DomainInformationListFull      OPTIONAL,
-- Measurement IEs
    ongoingMeasRepList                 OngoingMeasRepList-r5             OPTIONAL,
-- Radio bearer IEs
    predefinedConfigStatusList         PredefinedConfigStatusList,
    srb-InformationList                SRB-InformationSetupList-r5,
    rab-InformationList                RAB-InformationSetupList-r5       OPTIONAL,
-- Transport channel IEs
    ul-CommonTransChInfo              UL-CommonTransChInfo-r4           OPTIONAL,
    ul-TransChInfoList                UL-AddReconfTransChInfoList      OPTIONAL,
    -- 'dummy', 'dummy1' and 'dummy2' are not used in this version of the specification,
    -- they should not be sent and if received they should be ignored.
    dummy                              CHOICE {
        fdd                             SEQUENCE {
            dummy1                      CPCH-SetID                        OPTIONAL,
            dummy2                      DRAC-StaticInformationList        OPTIONAL,
        },
        tdd                             NULL
    }
    dl-CommonTransChInfo              DL-CommonTransChInfo-r4           OPTIONAL,
    dl-TransChInfoList                DL-AddReconfTransChInfoList-r5   OPTIONAL,
-- PhyCH IEs
    tpc-CombinationInfoList           TPC-CombinationInfoList           OPTIONAL,
-- Measurement report
    measurementReport                  MeasurementReport                  OPTIONAL,
-- Other IEs
    failureCause                       FailureCauseWithProtErr            OPTIONAL
}

SRNC-RelocationInfo-v690ext-IEs ::= SEQUENCE {
-- User equipment IEs
-- IE ueCapabilityContainer is used for the transparent transfer of capability information
-- received from the UE
    ueCapabilityContainer              BIT STRING
                                        (CONTAINING UE-CapabilityContainer-IEs) OPTIONAL,
-- IE ueCapabilityContainer-RSC and IE ueCapabilityContainer-UCI are used for the
-- transparent transfer of capability information received from the UE that was introduced
-- in a release independent manner, i.e., transferred within a VLEC. These UE capabilities
-- are included both in the RRC CONNECTION SETUP COMPLETE and the UE CAPABILITY INFORMATION
-- messages. Only the VLEC of one message needs to be included i.e. the one from these
-- messages that was last received.
-- Case 1: If the last received message was a RRC CONNECTION SETUP COMPLETE (RSC)
    ueCapabilityContainer-RSC          BIT STRING
                                        (CONTAINING RRCConnectionSetupComplete-r3-add-ext-IEs) OPTIONAL,
-- Case 2: If the last received message was a UE CAPABILITY INFORMATION (UCI)
    ueCapabilityContainer-UCI          BIT STRING
                                        (CONTAINING UECapabilityInformation-r3-add-ext-IEs) OPTIONAL,
-- Radio bearer IEs
    rab-InformationSetupList           RAB-InformationSetupList-r6-ext   OPTIONAL,
-- Measurement report
    measuredResultsOnRACHinterFreq     MeasuredResultsOnRACHinterFreq    OPTIONAL,
-- MBMS IEs
    mbms-JoinedInformation             MBMS-JoinedInformation-r6         OPTIONAL,
-- Measurement IEs

```

```

    intraFreqReportingCriteria      IntraFreqReportingCriteria-r6-ext      OPTIONAL
}

SRNC-RelocationInfo-r6-IEs ::=          SEQUENCE {
-- Non-RRC IEs
-- IE rb-IdentityForHOMessage includes the identity of the RB used by the source SRNC
-- to send the message contained in the IE "TargetRNC-ToSourceRNC-Container".
-- Only included if type is "UE involved"
rb-IdentityForHOMessage      RB-Identity      OPTIONAL,
stateOfRRC                  StateOfRRC,
stateOfRRC-Procedure        StateOfRRC-Procedure,
-- Ciphering related information IEs
cipheringStatusList         CipheringStatusList-r4,
latestConfiguredCN-Domain   CN-DomainIdentity,
calculationTimeForCiphering CalculationTimeForCiphering      OPTIONAL,
count-C-List                COUNT-C-List      OPTIONAL,
cipheringInfoPerRB-List     CipheringInfoPerRB-List-r4      OPTIONAL,
-- Integrity protection related information IEs
integrityProtectionStatus   IntegrityProtectionStatus,
srb-SpecificIntegrityProtInfo SRB-SpecificIntegrityProtInfoList OPTIONAL,
implementationSpecificParams ImplementationSpecificParams      OPTIONAL,
-- User equipment IEs
u-RNTI                      U-RNTI,
c-RNTI                      C-RNTI      OPTIONAL,
ue-RadioAccessCapability    UE-RadioAccessCapability-r6,
ue-RadioAccessCapability-ext UE-RadioAccessCapabBandFDDList  OPTIONAL,
ue-Positioning-LastKnownPos UE-Positioning-LastKnownPos      OPTIONAL,
ueSpecificBehaviourInformationIdle
                             UESpecificBehaviourInformationIdle  OPTIONAL,
ueSpecificBehaviourInformationInterRAT
                             UESpecificBehaviourInformationInterRAT  OPTIONAL,
-- IE ueCapabilityContainer is used for the transparent transfer of capability information
-- received from the UE
ueCapabilityContainer        BIT STRING
                             (CONTAINING UE-CapabilityContainer-IEs) OPTIONAL,
-- IE ueCapabilityContainer-RSC and IE ueCapabilityContainer-UCI are used for the
-- transparent transfer of capability information received from the UE that was introduced
-- in a release independent manner, i.e., transferred within a VLEC. These UE capabilities
-- are included both in the RRC CONNECTION SETUP COMPLETE and the UE CAPABILITY INFORMATION
-- messages. Only the VLEC of one message needs to be included i.e. the one from these
-- messages that was last received.
-- Case 1: If the last received message was a RRC CONNECTION SETUP COMPLETE (RSC)
ueCapabilityContainer-RSC    BIT STRING
                             (CONTAINING RRCConnectionSetupComplete-r3-add-ext-IEs) OPTIONAL,
-- Case 2: If the last received message was a UE CAPABILITY INFORMATION (UCI)
ueCapabilityContainer-UCI    BIT STRING
                             (CONTAINING UECapabilityInformation-r3-add-ext-IEs)  OPTIONAL,
-- Other IEs
ue-RATSpecificCapability     InterRAT-UE-RadioAccessCapabilityList-r5  OPTIONAL,
-- UTRAN mobility IEs
ura-Identity                 URA-Identity      OPTIONAL,
-- Core network IEs
cn-CommonGSM-MAP-NAS-SysInfo NAS-SystemInformationGSM-MAP,
cn-DomainInformationList     CN-DomainInformationListFull      OPTIONAL,
-- Measurement IEs
ongoingMeasRepList          OngoingMeasRepList-r6      OPTIONAL,
interRATCellInfoIndication  InterRATCellInfoIndication      OPTIONAL,
-- Radio bearer IEs
predefinedConfigStatusList   PredefinedConfigStatusList,
srb-InformationList          SRB-InformationSetupList-r6,
rab-InformationList          RAB-InformationSetupList-r6      OPTIONAL,
-- Transport channel IEs
ul-CommonTransChInfo        UL-CommonTransChInfo-r4      OPTIONAL,
ul-TransChInfoList          UL-AddReconfTransChInfoList-r6  OPTIONAL,
dl-CommonTransChInfo        DL-CommonTransChInfo-r4      OPTIONAL,
dl-TransChInfoList          DL-AddReconfTransChInfoList-r5  OPTIONAL,
-- PhyCH IEs
tpc-CombinationInfoList      TPC-CombinationInfoList      OPTIONAL,
storedCompressedModeInfo     StoredCompressedModeInfo      OPTIONAL,
-- Measurement report
measurementReport            BIT STRING
                             (CONTAINING MeasurementReport)      OPTIONAL,
-- Other IEs
failureCause                 FailureCauseWithProtErr      OPTIONAL,
-- MBMS IEs
mbms-JoinedInformation       MBMS-JoinedInformation-r6      OPTIONAL
}

```

```

SRNC-RelocationInfo-r6-add-ext-IEs ::= SEQUENCE {
  sRNC-RelocationInfo-v7e0ext      SRNC-RelocationInfo-v7e0ext-IEs,
  v7f0NonCriticalExtensions        SEQUENCE {
    sRNC-RelocationInfo-v7f0ext    SRNC-RelocationInfo-v7f0ext-IEs,
    nonCriticalExtensions          SEQUENCE {} OPTIONAL
  }
  OPTIONAL
}

SRNC-RelocationInfo-v6b0ext-IEs ::= SEQUENCE {
  -- The order of the RABs in IE rab-InformationSetupListExt is the same as
  -- in IE rab-InformationSetupList that is included in this message
  rab-InformationSetupListExt      RAB-InformationSetupList-v6b0ext    OPTIONAL,
  mbmsSelectedServiceInfo         MBMS-SelectedServiceInfo
}

SRNC-RelocationInfo-r7-IEs ::= SEQUENCE {
  -- Non-RRC IEs
  -- IE rb-IdentityForHOMessage includes the identity of the RB used by the source SRNC
  -- to send the message contained in the IE "TargetRNC-ToSourceRNC-Container".
  -- Only included if type is "UE involved"
  rb-IdentityForHOMessage          RB-Identity                        OPTIONAL,
  stateOfRRC                      StateOfRRC,
  stateOfRRC-Procedure            StateOfRRC-Procedure,
  -- Ciphering related information IEs
  cipheringStatusList             CipheringStatusList-r4,
  latestConfiguredCN-Domain       CN-DomainIdentity,
  calculationTimeForCiphering     CalculationTimeForCiphering    OPTIONAL,
  count-C-List                    COUNT-C-List                    OPTIONAL,
  cipheringInfoPerRB-List         CipheringInfoPerRB-List-r4    OPTIONAL,
  -- Integrity protection related information IEs
  integrityProtectionStatus       IntegrityProtectionStatus,
  srb-SpecificIntegrityProtInfo   SRB-SpecificIntegrityProtInfoList OPTIONAL,
  implementationSpecificParams    ImplementationSpecificParams    OPTIONAL,
  -- User equipment IEs
  u-RNTI                          U-RNTI,
  c-RNTI                          C-RNTI                        OPTIONAL,
  -- IE 'UE-RadioAccessCapability-r6' includes the Rel-5 radio access capability extensions
  -- and earlier. Rel-6 and later extensions are included in IE 'UE-CapabilityContainer-IEs'.
  ue-RadioAccessCapability        UE-RadioAccessCapability-r6,
  ue-RadioAccessCapability-ext    UE-RadioAccessCapabBandFDDList OPTIONAL,
  ue-Positioning-LastKnownPos     UE-Positioning-LastKnownPos    OPTIONAL,
  ueSpecificBehaviourInformationlidle
  UEspecificBehaviourInformationlidle    OPTIONAL,
  ueSpecificBehaviourInformationlinterRAT
  UEspecificBehaviourInformationlinterRAT    OPTIONAL,
  -- IE ueCapabilityContainer is used for the transparent transfer of capability information
  -- received from the UE
  ueCapabilityContainer           BIT STRING
  (CONTAINING UE-CapabilityContainer-IEs) OPTIONAL,
  -- IE ueCapabilityContainer-RSC and IE ueCapabilityContainer-UCI are used for the
  -- transparent transfer of capability information received from the UE that was introduced
  -- in a release independent manner, i.e., transferred within a VLEC. These UE capabilities
  -- are included both in the RRC CONNECTION SETUP COMPLETE and the UE CAPABILITY INFORMATION
  -- messages. Only the VLEC of one message needs to be included i.e. the one from these
  -- messages that was last received.
  -- Case 1: If the last received message was a RRC CONNECTION SETUP COMPLETE (RSC)
  ueCapabilityContainer-RSC       BIT STRING
  (CONTAINING RRCConnectionSetupComplete-r3-add-ext-IEs) OPTIONAL,
  -- Case 2: If the last received message was a UE CAPABILITY INFORMATION (UCI)
  ueCapabilityContainer-UCI       BIT STRING
  (CONTAINING UECapabilityInformation-r3-add-ext-IEs)    OPTIONAL,
  -- Other IEs
  ue-RATSpecificCapability        InterRAT-UE-RadioAccessCapabilityList-r5    OPTIONAL,
  -- UTRAN mobility IEs
  ura-Identity                   URA-Identity                        OPTIONAL,
  srns-t-305                     T-305                        OPTIONAL,
  -- Core network IEs
  cn-CommonGSM-MAP-NAS-SysInfo   NAS-SystemInformationGSM-MAP,
  cn-DomainInformationList       CN-DomainInformationListFull    OPTIONAL,
  -- Measurement IEs
  ongoingMeasRepList             OngoingMeasRepList-r7        OPTIONAL,
  interRATCellInfoIndication     InterRATCellInfoIndication    OPTIONAL,
  -- Radio bearer IEs
  predefinedConfigStatusList     PredefinedConfigStatusList,
  srb-InformationList            SRB-InformationSetupList-r7,
  rab-InformationList            RAB-InformationSetupList-r7        OPTIONAL,
  -- Transport channel IEs
  ul-CommonTransChInfo          UL-CommonTransChInfo-r4        OPTIONAL,

```

```

    ul-TransChInfoList          UL-AddReconfTransChInfoList-r7      OPTIONAL,
    dl-CommonTransChInfo        DL-CommonTransChInfo-r4          OPTIONAL,
    dl-TransChInfoList          DL-AddReconfTransChInfoList-r7      OPTIONAL,
-- PhyCH IEs
    tpc-CombinationInfoList      TPC-CombinationInfoList          OPTIONAL,
    storedCompressedModeInfo      StoredCompressedModeInfo          OPTIONAL,
-- Measurement report
    measurementReport            BIT STRING
                                (CONTAINING MeasurementReport)      OPTIONAL,
-- Other IEs
    failureCause                 FailureCauseWithProtErr          OPTIONAL,
-- MBMS IEs
    mbms-JoinedInformation        MBMS-JoinedInformation-r6        OPTIONAL,
    mbmsSelectedServiceInfo       MBMS-SelectedServiceInfo         OPTIONAL
}

SRNC-RelocationInfo-r7-add-ext-IEs ::= SEQUENCE {
    sRNC-RelocationInfo-v7e0ext    SRNC-RelocationInfo-v7e0ext-IEs,
    v7f0NonCriticalExtensions      SEQUENCE {
        sRNC-RelocationInfo-v7f0ext    SRNC-RelocationInfo-v7f0ext-IEs,
        nonCriticalExtensions          SEQUENCE {} OPTIONAL
    } OPTIONAL
}

SRNC-RelocationInfo-v770ext-IEs ::= SEQUENCE {
    thresholdSFN-GPS-TOW-us        ThresholdSFN-GPS-TOW-us          OPTIONAL,
    srns-t-305                     T-305                           OPTIONAL
}

SRNC-RelocationInfo-v7e0ext-IEs ::= SEQUENCE {
-- User equipment IEs
    ue-RadioAccessCapability        UE-RadioAccessCapability-v7e0ext
}

SRNC-RelocationInfo-v7f0ext-IEs ::= SEQUENCE {
-- User equipment IEs
    ue-RadioAccessCapability        UE-RadioAccessCapability-v7f0ext  OPTIONAL
}

SRNC-RelocationInfo-r8-IEs ::= SEQUENCE {
-- Non-RRC IEs
-- IE rb-IdentityForHOMessage includes the identity of the RB used by the source SRNC
-- to send the message contained in the IE "TargetRNC-ToSourceRNC-Container".
-- Only included if type is "UE involved"
    rb-IdentityForHOMessage         RB-Identity                      OPTIONAL,
    stateOfRRC                     StateOfRRC,
    stateOfRRC-Procedure            StateOfRRC-Procedure,
-- Ciphering related information IEs
    cipheringStatusList             CipheringStatusList-r4,
    latestConfiguredCN-Domain       CN-DomainIdentity,
    calculationTimeForCiphering     CalculationTimeForCiphering      OPTIONAL,
    count-C-List                   COUNT-C-List                     OPTIONAL,
    cipheringInfoPerRB-List         CipheringInfoPerRB-List-r4       OPTIONAL,
-- Integrity protection related information IEs
    integrityProtectionStatus        IntegrityProtectionStatus,
    srb-SpecificIntegrityProtInfo    SRB-SpecificIntegrityProtInfoList OPTIONAL,
    implementationSpecificParams     ImplementationSpecificParams     OPTIONAL,
-- User equipment IEs
    u-RNTI                          U-RNTI,
    c-RNTI                          C-RNTI                          OPTIONAL,
-- IE 'UE-RadioAccessCapability-r6' includes the Rel-5 radio access capability extensions
-- and earlier. Rel-6 and later extensions are included in IE 'UE-CapabilityContainer-IEs'.
    ue-RadioAccessCapability         UE-RadioAccessCapability-r6,
    ue-RadioAccessCapability-ext     UE-RadioAccessCapabBandFDDList  OPTIONAL,
    ue-Positioning-LastKnownPos     UE-Positioning-LastKnownPos     OPTIONAL,
    uESpecificBehaviourInformationIdle
                                    uESpecificBehaviourInformationIdle OPTIONAL,
    uESpecificBehaviourInformationInterRAT
                                    uESpecificBehaviourInformationInterRAT OPTIONAL,
-- IE ueCapabilityContainer is used for the transparent transfer of capability information
-- received from the UE
    ueCapabilityContainer            BIT STRING
                                    (CONTAINING UE-CapabilityContainer-IEs) OPTIONAL,
-- IE ueCapabilityContainer-RSC and IE ueCapabilityContainer-UCI are used for the
-- transparent transfer of capability information received from the UE that was introduced
-- in a release independent manner, i.e., transferred within a VLEC. These UE capabilities
-- are included both in the RRC CONNECTION SETUP COMPLETE and the UE CAPABILITY INFORMATION
-- messages. Only the VLEC of one message needs to be included i.e. the one from these

```



```

-- messages that was last received.
-- Case 1: If the last received message was a RRC CONNECTION SETUP COMPLETE (RSC)
ueCapabilityContainer-RSC          BIT STRING
                                   (CONTAINING RRCConnectionSetupComplete-r3-add-ext-IEs)  OPTIONAL,
-- Case 2: If the last received message was a UE CAPABILITY INFORMATION (UCI)
ueCapabilityContainer-UCI          BIT STRING
                                   (CONTAINING UECapabilityInformation-r3-add-ext-IEs)    OPTIONAL,
-- Other IEs
ue-RATSpecificCapability          InterRAT-UE-RadioAccessCapabilityList-r5  OPTIONAL,
-- UTRAN mobility IEs
ura-Identity                      URA-Identity                            OPTIONAL,
srns-t-305                        T-305                            OPTIONAL,
-- Core network IEs
cn-CommonGSM-MAP-NAS-SysInfo     NAS-SystemInformationGSM-MAP,
cn-DomainInformationList         CN-DomainInformationListFull      OPTIONAL,
-- Measurement IEs
ongoingMeasRepList               OngoingMeasRepList-r8           OPTIONAL,
interRATCellInfoIndication       InterRATCellInfoIndication       OPTIONAL,
-- Radio bearer IEs
predefinedConfigStatusList       PredefinedConfigStatusList,
srb-InformationList              SRB-InformationSetupList-r8,
rab-InformationList              RAB-InformationSetupList-r8      OPTIONAL,
-- Transport channel IEs
ul-CommonTransChInfo             UL-CommonTransChInfo-r4         OPTIONAL,
ul-TransChInfoList              UL-AddReconfTransChInfoList-r8  OPTIONAL,
dl-CommonTransChInfo             DL-CommonTransChInfo-r4         OPTIONAL,
dl-TransChInfoList              DL-AddReconfTransChInfoList-r7  OPTIONAL,
-- PhyCH IEs
tpc-CombinationInfoList          TPC-CombinationInfoList         OPTIONAL,
e-RGCH-CombinationInfoList       E-RGCH-CombinationInfoList      OPTIONAL,
storedCompressedModeInfo         StoredCompressedModeInfo-r8     OPTIONAL,
-- Measurement report
measurementReport                 BIT STRING
                                   (CONTAINING MeasurementReport)                  OPTIONAL,
-- Other IEs
failureCause                     FailureCauseWithProtErr          OPTIONAL,
ue-HistoryInformation            UE-HistoryInformation            OPTIONAL,
-- MBMS IEs
mbms-JoinedInformation           MBMS-JoinedInformation-r6       OPTIONAL,
mbms-SelectedServiceInfo        MBMS-SelectedServiceInfo        OPTIONAL,
}

SRNC-RelocationInfo-v820ext-IEs ::= SEQUENCE {
-- Radio bearer IEs
rab-InformationList              RAB-InformationSetupList-v820ext  OPTIONAL
}

SRNC-RelocationInfo-v860ext-IEs ::= SEQUENCE {
-- PhyCH IEs
e-RGCH-CombinationInfoList       E-RGCH-CombinationInfoList      OPTIONAL
}

SRNC-RelocationInfo-v8d0ext-IEs ::= SEQUENCE {
--Radio Bearer IEs
pdcP-ROHC-TargetMode            PDCP-ROHC-TargetMode           OPTIONAL
}

-- IE definitions
CalculationTimeForCiphering ::= SEQUENCE {
cell-Id                          CellIdentity,
sfn                              INTEGER (0..4095)
}

CipheringInfoPerRB ::= SEQUENCE {
dl-HFN                           BIT STRING (SIZE (20..25)),
ul-HFN                           BIT STRING (SIZE (20..25))
}

CipheringInfoPerRB-r4 ::= SEQUENCE {
rb-Identity                      RB-Identity,
dl-HFN                           BIT STRING (SIZE (20..25)),
dl-UM-SN                         BIT STRING (SIZE (7))           OPTIONAL,
ul-HFN                           BIT STRING (SIZE (20..25))
}

-- TABULAR: CipheringInfoPerRB-List, multiplicity value numberOfRadioBearers
-- has been replaced with maxRB.

```

```

CipheringInfoPerRB-List ::= SEQUENCE (SIZE (1..maxRB)) OF
                             CipheringInfoPerRB

CipheringInfoPerRB-List-r4 ::= SEQUENCE (SIZE (1..maxRB)) OF
                                CipheringInfoPerRB-r4

CipheringStatus ::= ENUMERATED {
                        started, notStarted }

CipheringStatusList-r4 ::= SEQUENCE (SIZE (1..maxCNdomains)) OF
                            CipheringStatusCNdomain-r4

CipheringStatusCNdomain-r4 ::= SEQUENCE {
                                cn-DomainIdentity      CN-DomainIdentity,
                                cipheringStatus        CipheringStatus,
                                start-Value           START-Value
                            }

CN-DomainInformation-v390ext ::= SEQUENCE {
                                cn-DRX-CycleLengthCoeff CN-DRX-CycleLengthCoefficient
                            }

CN-DomainInformationList-v390ext ::= SEQUENCE (SIZE (1..maxCNdomains)) OF
                                      CN-DomainInformation-v390ext

CompressedModeMeasCapability-r4 ::= SEQUENCE {
    fdd-Measurements          BOOLEAN,
    -- TABULAR: The IEs tdd-Measurements, gsm-Measurements and multiCarrierMeasurements
    -- are made optional since they are conditional based on another information element.
    -- Their absence corresponds to the case where the condition is not true.
    tdd384-Measurements      BOOLEAN                OPTIONAL,
    tdd128-Measurements      BOOLEAN                OPTIONAL,
    gsm-Measurements         GSM-Measurements       OPTIONAL,
    multiCarrierMeasurements BOOLEAN                OPTIONAL
}

COUNT-C-List ::= SEQUENCE (SIZE (1..maxCNdomains)) OF
                  COUNT-C-List

COUNT-C-List ::= SEQUENCE {
    cn-DomainIdentity      CN-DomainIdentity,
    count-C                BIT STRING (SIZE (32))
}

DL-PhysChCapabilityFDD-r4 ::= SEQUENCE {
    -- The IE "maxNoDPCH-PDSCH-Codes" only gives information on the maximum number of DPCH Codes.
    maxNoDPCH-PDSCH-Codes    INTEGER (1..8),
    maxNoPhysChBitsReceived  MaxNoPhysChBitsReceived,
    supportForSF-512         BOOLEAN,
    -- dummy, dummy2 and dummy3 are not used in this version of the specification
    -- and if received they should be ignored.
    dummy                    BOOLEAN,
    dummy2                   SimultaneousSCCPCH-DPCH-Reception,
    dummy3                   SupportOfDedicatedPilotsForChEstimation    OPTIONAL
}

DL-PhysChCapabilityFDD-r5 ::= SEQUENCE {
    -- The IE "maxNoDPCH-PDSCH-Codes" only gives information on the maximum number of DPCH Codes.
    maxNoDPCH-PDSCH-Codes    INTEGER (1..8),
    maxNoPhysChBitsReceived  MaxNoPhysChBitsReceived,
    supportForSF-512         BOOLEAN,
    -- dummy, dummy2 and dummy3 are not used in this version of the specification
    -- and if received they should be ignored.
    dummy                    BOOLEAN,
    dummy2                   SimultaneousSCCPCH-DPCH-Reception,
    dummy3                   SupportOfDedicatedPilotsForChEstimation    OPTIONAL,
    fdd-hspdsch              CHOICE {
        supported              SEQUENCE {
            hsdSCH-physical-layer-category    HSDSCH-physical-layer-category,
            -- dummy and dummy2 are not used in this version of the specification
            -- and if received they should be ignored.
            dummy                BOOLEAN,
            dummy2               BOOLEAN
        },
        unsupported            NULL
    }
}

```

```

DL-PhysChCapabilityTDD-r5 ::= SEQUENCE {
    maxTS-PerFrame           MaxTS-PerFrame,
    maxPhysChPerFrame       MaxPhysChPerFrame,
    minimumSF                MinimumSF-DL,
    supportOfPDSCH           BOOLEAN,
    maxPhysChPerTS          MaxPhysChPerTS,
    tdd384-hspdsch          CHOICE {
        supported
        unsupported
    }
}

DL-PhysChCapabilityTDD-LCR-r5 ::= SEQUENCE {
    maxTS-PerSubFrame       MaxTS-PerSubFrame-r4,
    maxPhysChPerSubFrame   MaxPhysChPerSubFrame-r4,
    minimumSF               MinimumSF-DL,
    supportOfPDSCH          BOOLEAN,
    maxPhysChPerTS         MaxPhysChPerTS,
    supportOf8PSK           BOOLEAN,
    tdd128-hspdsch         CHOICE {
        supported
        unsupported
    }
}

DL-RFC3095-Context ::= SEQUENCE {
    rfc3095-Context-Identity INTEGER (0..16383),
    dl-mode                  ENUMERATED {u, o, r},
    dl-ref-ir                OCTET STRING ( SIZE (1..3000)),
    dl-ref-time              INTEGER (0..4294967295) OPTIONAL,
    dl-curr-time             INTEGER (0..4294967295) OPTIONAL,
    dl-syn-offset-id        INTEGER (0..65535) OPTIONAL,
    dl-syn-slope-ts         INTEGER (0..4294967295) OPTIONAL,
    dl-dyn-changed          BOOLEAN
}

E-RGCH-Combination-Info ::= SEQUENCE{
    primaryCPICH-Info       PrimaryCPICH-Info,
    rg-CombinationIndex     INTEGER (0..5)
}

E-RGCH-CombinationInfoList ::= SEQUENCE (SIZE (1..maxEDCHRL)) OF
    E-RGCH-Combination-Info

ImplementationSpecificParams ::= BIT STRING (SIZE (1..512))

IntegrityProtectionStatus ::= ENUMERATED {
    started, notStarted }

InterRAT-UE-RadioAccessCapabilityList-r5 ::= SEQUENCE {
    interRAT-UE-RadioAccessCapability InterRAT-UE-RadioAccessCapabilityList,
    geranIu-RadioAccessCapability     GERANIu-RadioAccessCapability OPTIONAL
}

IntraFreqReportingCriteria-r6-ext ::= SEQUENCE {
    -- The content of the v690 non-critical extension should be
    -- considered as an extension of IE IntraFreqEventCriteriaList
    event                EventIj-r6,
    hysteresis           Hysteresis,
    timeToTrigger        TimeToTrigger,
    reportingCellStatus  ReportingCellStatus OPTIONAL
}

-- dummy is not used in this version of the specification, it should
-- not be sent and if received it should be ignored.
MaxHcContextSpace-r5 ::= ENUMERATED {
    dummy, by1024, by2048, by4096, by8192,
    by16384, by32768, by65536, by131072 }

MeasurementCapability-r4 ::= SEQUENCE {
    downlinkCompressedMode CompressedModeMeasCapability-r4,
    uplinkCompressedMode   CompressedModeMeasCapability-r4
}

MeasurementCommandWithType ::= CHOICE {
    setup      MeasurementType,
    modify     NULL,
}

```

```

    release                NULL
  }

MeasurementCommandWithType-r4 ::= CHOICE {
  setup                    MeasurementType-r4,
  modify                   NULL,
  release                  NULL
}

MeasurementCommandWithType-r6 ::= CHOICE {
  setup                    MeasurementType-r6,
  modify                   NULL,
  release                  NULL
}

MeasurementCommandWithType-r7 ::= CHOICE {
  setup                    MeasurementType-r7,
  modify                   NULL,
  release                  NULL
}

MeasurementCommandWithType-r8 ::= CHOICE {
  setup                    MeasurementType-r8,
  modify                   NULL,
  release                  NULL
}

OngoingMeasRep ::= SEQUENCE {
  measurementIdentity      MeasurementIdentity,
  -- TABULAR: The CHOICE Measurement in the tabular description is included
  -- in MeasurementCommandWithType
  measurementCommandWithType MeasurementCommandWithType,
  measurementReportingMode MeasurementReportingMode OPTIONAL,
  additionalMeasurementID-List AdditionalMeasurementID-List OPTIONAL
}

OngoingMeasRep-r4 ::= SEQUENCE {
  measurementIdentity      MeasurementIdentity,
  -- TABULAR: The CHOICE Measurement in the tabular description is included
  -- in MeasurementCommandWithType-r4.
  measurementCommandWithType MeasurementCommandWithType-r4,
  measurementReportingMode MeasurementReportingMode OPTIONAL,
  additionalMeasurementID-List AdditionalMeasurementID-List OPTIONAL
}

OngoingMeasRep-r5 ::= SEQUENCE {
  measurementIdentity      MeasurementIdentity,
  -- TABULAR: The CHOICE Measurement in the tabular description is included
  -- in MeasurementCommandWithType-r4.
  measurementCommandWithType MeasurementCommandWithType-r4,
  measurementReportingMode MeasurementReportingMode OPTIONAL,
  additionalMeasurementID-List AdditionalMeasurementID-List OPTIONAL,
  measurementCommand-v590ext CHOICE {
    -- the choice "intra-frequency" shall be used for the case of intra-frequency measurement,
    -- as well as when intra-frequency events are configured for inter-frequency measurement
    intra-frequency         Intra-FreqEventCriteriaList-v590ext,
    inter-frequency         Inter-FreqEventCriteriaList-v590ext
  } OPTIONAL,
  intraFreqReportingCriteria-1b-r5 IntraFreqReportingCriteria-1b-r5 OPTIONAL,
  intraFreqEvent-1d-r5           IntraFreqEvent-1d-r5 OPTIONAL
}

OngoingMeasRep-r6 ::= SEQUENCE {
  measurementIdentity      MeasurementIdentity,
  measurementCommandWithType MeasurementCommandWithType-r6,
  measurementReportingMode MeasurementReportingMode OPTIONAL,
  additionalMeasurementID-List AdditionalMeasurementID-List OPTIONAL
}

OngoingMeasRep-r7 ::= SEQUENCE {
  measurementIdentity      MeasurementIdentity,
  measurementCommandWithType MeasurementCommandWithType-r7,
  measurementReportingMode MeasurementReportingMode OPTIONAL,
  additionalMeasurementID-List AdditionalMeasurementID-List OPTIONAL
}

OngoingMeasRep-r8 ::= SEQUENCE {
  measurementIdentity      MeasurementIdentity,

```

```

    measurementCommandWithType      MeasurementCommandWithType-r8,
    measurementReportingMode         MeasurementReportingMode
    additionalMeasurementID-List     AdditionalMeasurementID-List      OPTIONAL,
}                                    OPTIONAL

OngoingMeasRepList ::= SEQUENCE (SIZE (1..maxNoOfMeas)) OF
                        OngoingMeasRep

OngoingMeasRepList-r4 ::= SEQUENCE (SIZE (1..maxNoOfMeas)) OF
                          OngoingMeasRep-r4

OngoingMeasRepList-r5 ::= SEQUENCE (SIZE (1..maxNoOfMeas)) OF
                          OngoingMeasRep-r5

OngoingMeasRepList-r6 ::= SEQUENCE (SIZE (1..maxNoOfMeas)) OF
                          OngoingMeasRep-r6

OngoingMeasRepList-r7 ::= SEQUENCE (SIZE (1..maxNoOfMeas)) OF
                          OngoingMeasRep-r7

OngoingMeasRepList-r8 ::= SEQUENCE (SIZE (1..maxNoOfMeas)) OF
                          OngoingMeasRep-r8

PDCP-Capability-r4 ::= SEQUENCE {
    losslessSRNS-RelocationSupport    BOOLEAN,
    supportForRfc2507                  CHOICE {
        notSupported                   NULL,
        supported                       MaxHcContextSpace
    },
    supportForRfc3095                  CHOICE {
        notSupported                   NULL,
        supported                       SEQUENCE {
            maxROHC-ContextSessions    MaxROHC-ContextSessions-r4  DEFAULT s16,
            reverseCompressionDepth     INTEGER (0..65535)         DEFAULT 0
        }
    }
}

PDCP-Capability-r5 ::= SEQUENCE {
    losslessSRNS-RelocationSupport    BOOLEAN,
    supportForRfc2507                  CHOICE {
        notSupported                   NULL,
        supported                       MaxHcContextSpace-r5
    },
    supportForRfc3095                  CHOICE {
        notSupported                   NULL,
        supported                       SEQUENCE {
            maxROHC-ContextSessions    MaxROHC-ContextSessions-r4  DEFAULT s16,
            reverseCompressionDepth     INTEGER (0..65535)         DEFAULT 0,
            supportForRfc3095ContextRelocation  BOOLEAN
        }
    }
}

PDCP-Capability-r6 ::= SEQUENCE {
    losslessSRNS-RelocationSupport    BOOLEAN,
    losslessDLRLC-PDUSizeChange       ENUMERATED { true }      OPTIONAL,
    supportForRfc2507                  CHOICE {
        notSupported                   NULL,
        supported                       MaxHcContextSpace-r5
    },
    supportForRfc3095                  CHOICE {
        notSupported                   NULL,
        supported                       SEQUENCE {
            maxROHC-ContextSessions    MaxROHC-ContextSessions-r4  DEFAULT s16,
            reverseCompressionDepth     INTEGER (0..65535)         DEFAULT 0,
            supportForRfc3095ContextRelocation  BOOLEAN
        }
    }
}

PhysicalChannelCapability-r4 ::= SEQUENCE {
    fddPhysChCapability                SEQUENCE {
        downlinkPhysChCapability       DL-PhysChCapabilityFDD-r4,
        uplinkPhysChCapability         UL-PhysChCapabilityFDD
    }
    tdd384-PhysChCapability            SEQUENCE {
        downlinkPhysChCapability       DL-PhysChCapabilityTDD,

```

```

        uplinkPhysChCapability          UL-PhysChCapabilityTDD
    }                                  OPTIONAL,
    tdd128-PhysChCapability             SEQUENCE {
        downlinkPhysChCapability        DL-PhysChCapabilityTDD-LCR-r4,
        uplinkPhysChCapability          UL-PhysChCapabilityTDD-LCR-r4
    }                                  OPTIONAL
}

PhysicalChannelCapability-r5 ::= SEQUENCE {
    fddPhysChCapability                SEQUENCE {
        downlinkPhysChCapability        DL-PhysChCapabilityFDD-r5,
        uplinkPhysChCapability          UL-PhysChCapabilityFDD
    }                                  OPTIONAL,
    tdd384-PhysChCapability             SEQUENCE {
        downlinkPhysChCapability        DL-PhysChCapabilityTDD-r5,
        uplinkPhysChCapability          UL-PhysChCapabilityTDD
    }                                  OPTIONAL,
    tdd128-PhysChCapability             SEQUENCE {
        downlinkPhysChCapability        DL-PhysChCapabilityTDD-LCR-r5,
        uplinkPhysChCapability          UL-PhysChCapabilityTDD-LCR-r4
    }                                  OPTIONAL
}

RF-Capability-r4 ::= SEQUENCE {
    fddRF-Capability                   SEQUENCE {
        ue-PowerClass                  UE-PowerClassExt,
        txRxFrequencySeparation        TxRxFrequencySeparation
    }                                  OPTIONAL,
    tdd384-RF-Capability                SEQUENCE {
        ue-PowerClass                  UE-PowerClassExt,
        radioFrequencyBandTDDList      RadioFrequencyBandTDDList,
        chipRateCapability              ChipRateCapability
    }                                  OPTIONAL,
    tdd128-RF-Capability                SEQUENCE {
        ue-PowerClass                  UE-PowerClassExt,
        radioFrequencyBandTDDList      RadioFrequencyBandTDDList,
        chipRateCapability              ChipRateCapability
    }                                  OPTIONAL
}

RFC3095-ContextInfo ::= SEQUENCE {
    rb-Identity                         RB-Identity,
    rfc3095-Context-List                RFC3095-Context-List
}

RFC3095-Context-List ::= SEQUENCE (SIZE (1..maxRFC3095-CID)) OF SEQUENCE {
    dl-RFC3095-Context                  DL-RFC3095-Context    OPTIONAL,
    ul-RFC3095-Context                  UL-RFC3095-Context    OPTIONAL
}

RLC-Capability-r5 ::= SEQUENCE {
    totalRLC-AM-BufferSize              TotalRLC-AM-BufferSize-r5,
    maximumRLC-WindowSize               MaximumRLC-WindowSize,
    maximumAM-EntityNumber              MaximumAM-EntityNumberRLC-Cap
}

SRB-SpecificIntegrityProtInfo ::= SEQUENCE {
    ul-RRC-HFN                          BIT STRING (SIZE (28)),
    dl-RRC-HFN                          BIT STRING (SIZE (28)),
    ul-RRC-SequenceNumber               RRC-MessageSequenceNumber,
    dl-RRC-SequenceNumber               RRC-MessageSequenceNumber
}

SRB-SpecificIntegrityProtInfoList ::= SEQUENCE (SIZE (4..maxSRBsetup)) OF
SRB-SpecificIntegrityProtInfo

StateOfRRC ::= ENUMERATED {
    cell-DCH, cell-FACH,
    cell-PCH, ura-PCH }

StateOfRRC-Procedure ::= ENUMERATED {
    awaitNoRRC-Message,
    awaitRB-ReleaseComplete,
    awaitRB-SetupComplete,
    awaitRB-ReconfigurationComplete,
    awaitTransportCH-ReconfigurationComplete,
    awaitPhysicalCH-ReconfigurationComplete,

```

```

        awaitActiveSetUpdateComplete,
        awaitHandoverComplete,
        sendCellUpdateConfirm,
        sendUraUpdateConfirm,
        -- dummy is not used in this version of specification
        -- It should not be sent
        dummy,
        otherStates
    }
}

TotalRLC-AM-BufferSize-r5 ::= ENUMERATED {
    kb10, kb50, kb100, kb150, kb200,
    kb300, kb400, kb500, kb750, kb1000 }

TPC-Combination-Info ::= SEQUENCE {
    primaryCPICH-Info          PrimaryCPICH-Info,
    tpc-CombinationIndex      TPC-CombinationIndex
}

UE-MultiModeRAT-Capability-r5 ::= SEQUENCE {
    multiRAT-CapabilityList    MultiRAT-Capability,
    multiModeCapability        MultiModeCapability,
    supportOfUTRAN-ToGERAN-NACC BOOLEAN
}

UE-Positioning-Capability-r4 ::= SEQUENCE {
    standaloneLocMethodsSupported    BOOLEAN,
    ue-BasedOTDOA-Supported          BOOLEAN,
    networkAssistedGPS-Supported     NetworkAssistedGPS-Supported,
    supportForUE-GPS-TimingOfCellFrames    BOOLEAN,
    supportForIPDL                   BOOLEAN,
    rx-tx-TimeDifferenceType2Capable    BOOLEAN,
    validity-CellPCH-UraPCH           ENUMERATED { true }    OPTIONAL,
    sfn-sfnType2Capability            ENUMERATED { true }    OPTIONAL
}

UE-Positioning-LastKnownPos ::= SEQUENCE {
    sfn                INTEGER (0..4095),
    cell-id            CellIdentity,
    positionEstimate  PositionEstimate
}

UE-RadioAccessCapability-r4 ::= SEQUENCE {
    accessStratumReleaseIndicator    AccessStratumReleaseIndicator,
    pdcp-Capability                  PDCP-Capability-r4,
    rlc-Capability                    RLC-Capability,
    transportChannelCapability        TransportChannelCapability,
    rf-Capability                     RF-Capability-r4,
    physicalChannelCapability         PhysicalChannelCapability-r4,
    ue-MultiModeRAT-Capability        UE-MultiModeRAT-Capability,
    securityCapability                SecurityCapability,
    ue-positioning-Capability          UE-Positioning-Capability-r4,
    measurementCapability              MeasurementCapability-r4    OPTIONAL
}

UE-RadioAccessCapability-r5 ::= SEQUENCE {
    accessStratumReleaseIndicator    AccessStratumReleaseIndicator,
    dl-CapabilityWithSimultaneousHS-DSCHConfig    DL-CapabilityWithSimultaneousHS-DSCHConfig    OPTIONAL,
    pdcp-Capability                  PDCP-Capability-r5,
    rlc-Capability                    RLC-Capability-r5,
    transportChannelCapability        TransportChannelCapability,
    rf-Capability                     RF-Capability-r4,
    physicalChannelCapability         PhysicalChannelCapability-r5,
    ue-MultiModeRAT-Capability        UE-MultiModeRAT-Capability-r5,
    securityCapability                SecurityCapability,
    ue-positioning-Capability          UE-Positioning-Capability-r4,
    measurementCapability              MeasurementCapability-r4    OPTIONAL
}

UE-RadioAccessCapability-r6 ::= SEQUENCE {
    accessStratumReleaseIndicator    AccessStratumReleaseIndicator,
    dl-CapabilityWithSimultaneousHS-DSCHConfig    DL-CapabilityWithSimultaneousHS-DSCHConfig    OPTIONAL,
    pdcp-Capability                  PDCP-Capability-r6,
    rlc-Capability                    RLC-Capability-r5,
    transportChannelCapability        TransportChannelCapability,
    rf-Capability                     RF-Capability-r4,

```

```

physicalChannelCapability      PhysicalChannelCapability-r5,
ue-MultiModeRAT-Capability    UE-MultiModeRAT-Capability-r5,
securityCapability             SecurityCapability,
ue-positioning-Capability      UE-Positioning-Capability-r4,
measurementCapability          MeasurementCapability-r4      OPTIONAL
}

UL-RFC3095-Context ::=
  rfc3095-Context-Identity     INTEGER (0..16383),
  ul-mode                      ENUMERATED {u, o, r},
  ul-ref-ir                    OCTET STRING ( SIZE (1..3000)),
  ul-ref-time                   INTEGER (0..4294967295)      OPTIONAL,
  ul-curr-time                  INTEGER (0..4294967295)      OPTIONAL,
  ul-syn-offset-id             INTEGER (0..65535)             OPTIONAL,
  ul-syn-slope-ts              INTEGER (0..4294967295)      OPTIONAL,
  ul-ref-sn-1                   INTEGER (0..65535)           OPTIONAL
}

END

```

12 Message transfer syntax

Transfer syntax for RRC PDUs is derived from their ASN.1 definitions by use of Packed Encoding Rules, unaligned as specified in X.691 [49], and with adapted final padding. If special encoding is used, it is indicated in the ECN module defined for each ASN.1 module. The use of special encoding is defined in [14].

The following encoding rules apply in addition to what has been specified in X.691 [49]:

- When a bit string value is placed in a bit-field as specified in 15.6 to 15.11 in [11], the leading bit of the bit string value shall be placed in the leading bit of the bit-field, and the trailing bit of the bit string value shall be placed in the trailing bit of the bit-field.

NOTE: The terms "leading bit" and "trailing bit" are defined in ITU-T Rec. X.680 | ISO/IEC 8824-1. When using the "bstring" notation, the leading bit of the bit string value is on the left, and the trailing bit of the bit string value is on the right.

12.1 Structure of encoded RRC messages

An RRC PDU, which is the bit string that is exchanged between peer entities/ across the radio interface, is the concatenation of a basic production, an extension and padding, in that order.

RRC PDUs shall be mapped to and from RLC SDUs upon transmission and reception as follows:

- when delivering an RRC PDU as an RLC SDU to the RLC layer for transmission, the first bit of the RRC PDU shall be represented as the first bit in the RLC SDU and onwards; and
- upon reception of an RLC SDU from the RLC layer, the first bit of the RLC SDU shall represent the first bit of the RRC PDU and onwards.

12.1.1 Basic production

The 'basic production' is obtained by applying UNALIGNED PER to the abstract syntax value (the ASN.1 description) as specified in X.691, except for the 0 to 7 bits added at the end to produce a multiple of 8 bits. The basic production can have any positive number of bits, not necessarily a multiple of 8 bits.

12.1.2 Extension

Emitters compliant with this version of the specification of the protocol shall, unless indicated otherwise on a PDU type basis, set the extension part empty. Emitters compliant with a later version might send non-empty extensions.

12.1.3 Padding

Emitters compliant with this version of the specification of the protocol shall, unless indicated otherwise on a PDU type basis, pad the basic production with the smallest number of bits required to meet the size constraints of the lower layers. Padding bits shall be set to 0.

Receivers compliant with this version of the specification have no need to distinguish the extension and padding parts, and shall, unless indicated otherwise on a PDU type basis, accept RRC PDUs with any bit string in the extension and padding parts.

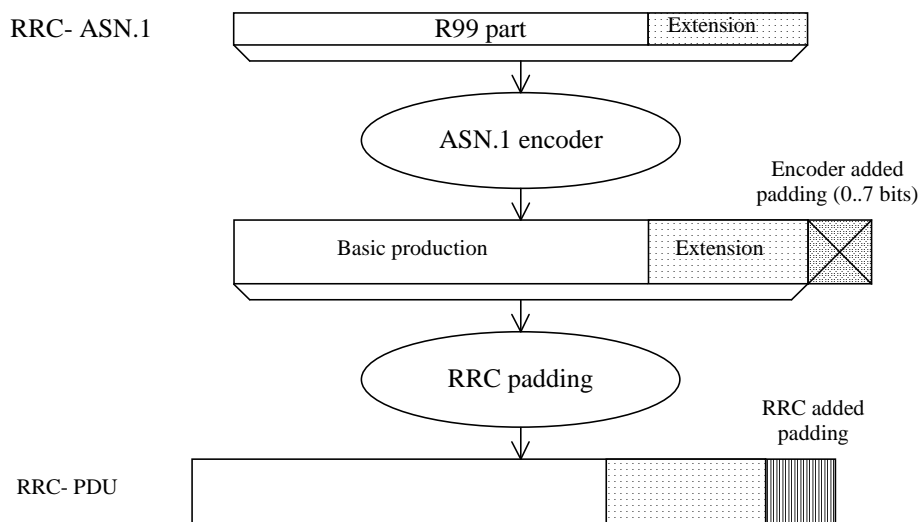

Figure 12.1.3-1: Padding

When using AM or UM mode, RLC requires that the RRC PDU length is a multiple of 8 bits.

When using Tr mode, RLC does neither impose size requirements nor perform padding. This implies that RRC has to take into account the transport format set defined for the transport channel across which the message is to be sent. RRC shall add the lowest number of padding bits required to fit the size specified for the selected transport format. In case of Enhanced Uplink in CELL_FACH state and Idle mode, when using Tr mode, RRC shall add the lowest number of padding bits to ensure octet alignment.

For paging type 1 messages, in case the PCCH is mapped on HS-DSCH, padding needs to apply only to ensure octet alignment.

For SYSTEM INFORMATION CHANGE INDICATION message, in case the BCCH is mapped on HS-DSCH, padding needs to apply only to ensure octet alignment.

For system information blocks, building the PDU involves two steps. The first step is the building of the System Information Blocks, in which step padding is not applied (the rules for extension apply). The second step is the building of the RRC PDUs, involving segmentation and concatenation of System Information Blocks, and then padding as described above for Tr mode if the BCCH carrying the System Information Blocks is mapped on BCH. The procedure is shown by means of an example as described in Figure 12.1.3-2. The example includes two System Information Blocks, SIB_n and SIB_{n+1}, of which only SIB_n includes a protocol extension. The two System Information Blocks used in the example do not require segmentation and are concatenated into one SYSTEM INFORMATION message.

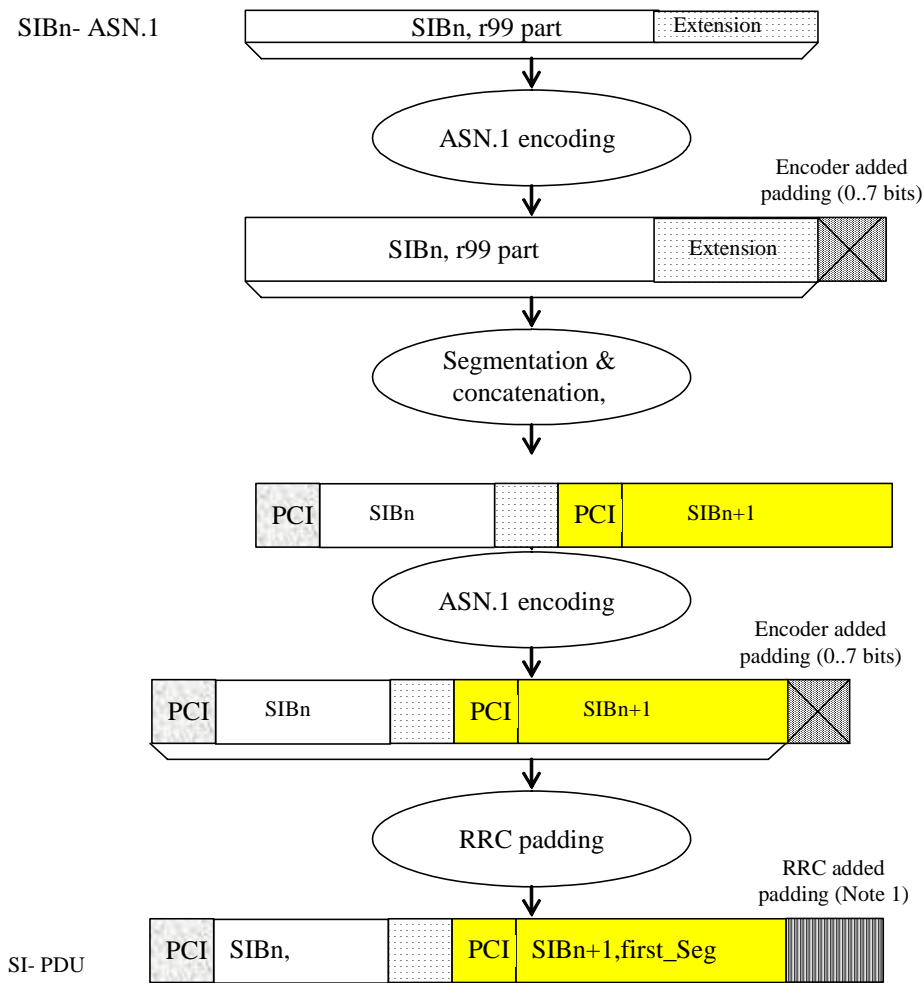

Note 1: RRC padding needs to be added only to octet align BCCH blocks which are mapped onto HS-DSCH

Figure 12.1.3-2: Padding for System Information

PCI: Protocol control information at SYSTEM INFORMATION message level

SI: SYSTEM INFORMATION message

For system information blocks, RRC may also add padding information at the end of IE "SIB data fixed", used both within IE "Last segment" and IE "Complete SIB". The IE "SIB data fixed" has a fixed length i.e. no length denominator used. In case the remaining amount of "SIB data" information is insufficient to fill the IE completely, RRC includes padding bits.

Since no length denominator is included, the receiving RRC cannot remove the padding added by the sender. However, since the padding used is the same as the padding added by the PER encoder to achieve octet alignment, the receiver can handle it.

NOTE 1 The mechanism described above implies that the PDU provided to the ASN.1 decoder may have more than 7 padding bits included. For a complete System Information Block of length 215 bits, 11 padding bits are added by RRC. Since the decoder requires an octet aligned input, 6 additional bits need to be added. In this (worst) case, a total of 17 padding bits is included.

NOTE 2 For the above cases, use of padding bits is possible and more efficient than including a length denominator.

When using the RRC padding described above, the segment has a fixed length, which completely fills the transport block. Therefore, in this case no RRC padding is added within the SYSTEM INFORMATION message. This is illustrated by means of the following figure.

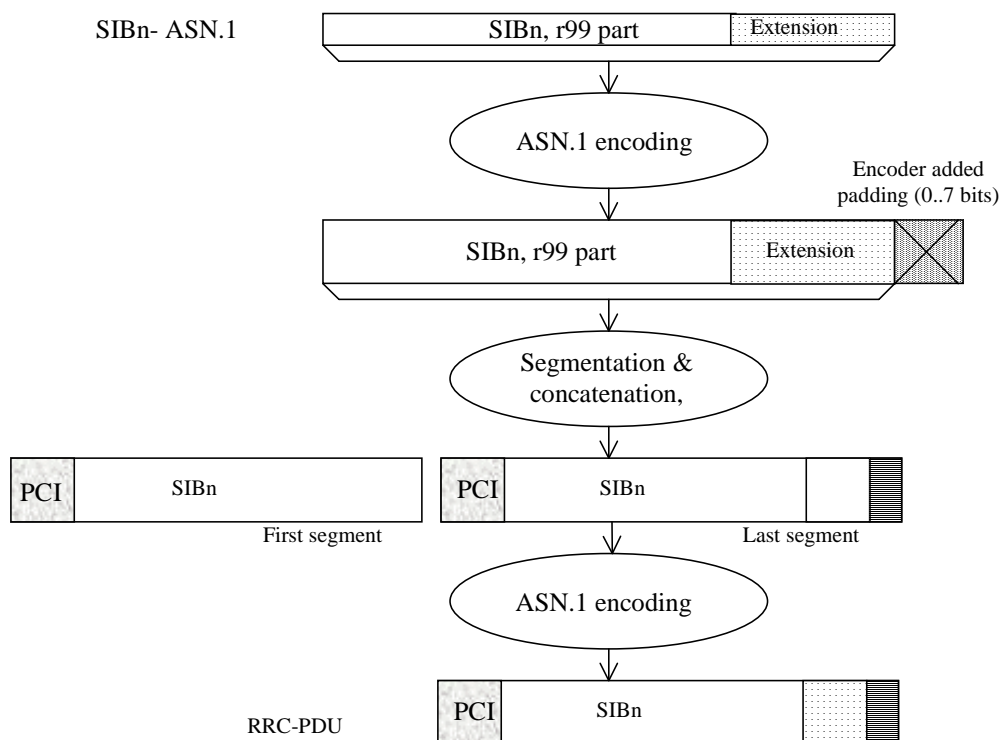

Figure 12.1.3-3: No RRC padding for System Information

12.2 ECN link module for RRC

```

RRC-ECN-Link-Module LINK-DEFINITIONS ::=
BEGIN

IMPORTS
    RRC-encodings          -- Encoding objects for RRC messages
FROM RRC-Encoding-Definitions;

ENCODE Class-definitions
    WITH RRC-encodings
    COMPLETED BY PER-BASIC-UNALIGNED

ENCODE PDU-definitions
    WITH RRC-encodings
    COMPLETED BY PER-BASIC-UNALIGNED

ENCODE InformationElements
    WITH RRC-encodings
    COMPLETED BY PER-BASIC-UNALIGNED

ENCODE Internode-definitions
    WITH RRC-encodings
    COMPLETED BY PER-BASIC-UNALIGNED

END

```

12.3 ECN modules for RRC

The encoding definition module "RRC-Encoding-Definitions" contains definition of the encoding object set "RRC-encodings". The encoding object set contains all the specialized encoding for RRC.

```

RRC-Encoding-Definitions ENCODING-DEFINITIONS ::=

```

```

BEGIN
EXPORTS
    RRC-encodings;

RRC-encodings #ENCODINGS ::= {
    -- Trailing bits
    outer-encoding
}

--*****
--
-- The trailing bits in all RRC messages shall be ignored
-- (including unknown message contents & unknown extensions).
-- This overrides the default PER behaviour which pads the last
-- octet with zero bits.
--
--*****

outer-encoding #OUTER ::= {
    ENCODER-DECODER {
    }
    DECODE AS IF {
        POST-PADDING    encoder-option
    }
}

END

Class-definitions-ECN-Module ENCODING-DEFINITIONS ::=
BEGIN
END

PDU-definitions-ECN-Module ENCODING-DEFINITIONS ::=
BEGIN
END

InformationElements-ECN-Module ENCODING-DEFINITIONS ::=
BEGIN
END

Internode-definitions-ECN-Module ENCODING-DEFINITIONS ::=
BEGIN
END

```

12.4 RRC messages encoded otherwise

NOTE: The messages included in this section are not specified by means of ASN.1.

12.4.1 Messages using tabular encoding specification

The encoding of the message is specified by means of a table listing the information elements known in the message and their order of their appearance in the message.

When a field extends over more than one octet, the order of bit values progressively decreases as the octet number increases. The least significant bit of the field is represented by the lowest numbered bit of the highest numbered octet of the field.

12.4.1.1 TRANSPORT FORMAT COMBINATION CONTROL using transparent DCCH

12.4.1.1.1 TRANSPORT FORMAT COMBINATION CONTROL, 3 bit format

The 3 bit format is as follows:

| 3 | 2 | 1 | Transport Format Combination Set Identity value |
|----------|----------|----------|---|
| 0 | 0 | 0 | 0 |
| 0 | 0 | 1 | 1 |
| 0 | 1 | 0 | 2 |
| | | | |
| 1 | 1 | 1 | 7 |

12.4.1.1.2 Void

12.4.1.1.3 Void

13 Protocol timers, counters, other parameters and default configurations

The information provided in subclauses 13.1 and 13.2 shall be treated as informative. The normative text is specified in the relevant subclauses in clause 8 and clause 8 shall prevail.

13.1 Timers for UE

| Timer | Start | Stop | At expiry |
|-------|---|--|---|
| T300 | Transmission of RRC CONNECTION REQUEST in case of connection establishment for reasons other than MBMS reception | Reception of RRC CONNECTION SETUP | Retransmit RRC CONNECTION REQUEST if V300 =< N300, else go to Idle mode |
| T302 | Transmission of CELL UPDATE/URA UPDATE | Reception of CELL UPDATE CONFIRM/URA UPDATE CONFIRM | Retransmit CELL UPDATE/URA UPDATE if V302 =< N302, else, go to Idle mode |
| T304 | Transmission of UE CAPABILITY INFORMATION | Reception of UE CAPABILITY INFORMATION CONFIRM | Retransmit UE CAPABILITY INFORMATION if V304 =< N304, else initiate a cell update procedure |
| T305 | Entering CELL_FACH or URA_PCH or CELL_PCH state. Reception of CELL UPDATE CONFIRM/URA UPDATE CONFIRM. | Entering another state. | Transmit CELL UPDATE if T307 is not activated and the UE detects "in service area". Otherwise, if T307 is not active, start T307. |
| T307 | When the timer T305 has expired and the UE detects "out of service area". | When the UE detects "in service area". | Transit to idle mode |
| T308 | Transmission of RRC CONNECTION RELEASE COMPLETE | Not stopped | Transmit RRC CONNECTION RELEASE COMPLETE if V308 <=N308, else go to idle mode. |
| T309 | Upon reception of CELL CHANGE ORDER FROM UTRAN message | Successful response to a connection establishment request in the new cell. | Resume the connection to UTRAN |
| T310 | Transmission of PUSCH CAPACITY REQUEST | Reception of PHYSICAL SHARED CHANNEL ALLOCATION | Transmit PUSCH CAPACITY REQUEST if V310 =< N310, else procedure stops. |
| T311 | Reception of PHYSICAL SHARED CHANNEL ALLOCATION message with the CHOICE "PUSCH allocation" set to "PUSCH allocation pending". | Reception of PHYSICAL SHARED CHANNEL ALLOCATION message with CHOICE "PUSCH allocation" set to "PUSCH allocation assignment". | UE may initiate a PUSCH capacity request procedure. |
| T312 | When the UE starts to establish dedicated CH. For 1.28 Mcps TDD, it can also apply for physical shared channel establishment. | When the UE detects N312 "in sync" indication from L1. | The criteria for physical channel establishment failure is fulfilled |
| T313 | When the UE detects consecutive N313 "out of sync" indication from L1. | When the UE detects consecutive N315 "in sync" indication from L1. | The criteria for Radio Link failure is fulfilled. |

| Timer | Start | Stop | At expiry |
|-------|---|--|---|
| T314 | When the criteria for radio link failure are fulfilled.
The timer is started if radio bearer(s) that are associated with T314 exist or if only RRC connection exists only to the CS domain. | When the Cell Update procedure has been completed. | See subclause 8.3.1.13. |
| T315 | When the criteria for radio link failure are fulfilled.
The timer is started only if radio bearer(s) that are associated with T315 exist or if RRC connection exists to PS domain. | When the Cell Update procedure has been completed. | See subclause 8.3.1.14. |
| T316 | When the UE detects "out of service area" in URA_PCH or CELL_PCH state | When the UE detects "in service area". | Initiate cell update procedure if in service area is detected. Otherwise start timer T317, transit to CELL_FACH state and initiate cell update procedure when the UE detects "in service area". |
| T317 | When the T316 expires or when in CELL_FACH state, the UE detects "out of service area". | When the UE detects "in service area". | T317 never expires. |
| T318 | Transmission of RRC CONNECTION REQUEST in case of connection establishment for MBMS reception | Reception of RRC CONNECTION SETUP | Enter idle mode |
| T319 | When entering CELL_PCH or URA_PCH. | When leaving CELL_PCH or URA_PCH state. | The UE activates starts the DRX cycle based on 'DRX cycle length coefficient'. |
| T320 | When receiving the CELL UPDATE CONFIRM message with IE 'Wait time' and IE 'RRC State Indicator' set to the value 'CELL_PCH' or 'URA_PCH'. | When initiating the cell update or URA update procedure, see subclause 8.3.1.2. | See subclause 8.3.1.16. |
| T321 | See subclause 8.5.49. | See subclause 8.5.49. | See subclause 8.5.49. |
| T322 | When received in UTRAN MOBILITY INFORMATION message in the IE 'Dedicated Priority Information' or upon cell (re)selection to UTRA from another RAT with validity time configured for dedicated priorities (in which case the remaining validity time is applied). | When dedicated priorities are cleared, when new dedicated priorities are received, when PLMN selection is performed on request by NAS, or upon cell (re)selection to another RAT (in which case the timer is carried on to the other RAT). | See subclause 8.3.3.7 |
| T323 | When transmitting a SIGNALLING CONNECTION RELEASE INDICATION message including the IE "Signalling Connection Release Indication Cause" | See subclauses 8.2.2.3 and 8.3.1.6. In this version of specification, UE may or may not stop the timer upon release of RRC connection. | See subclause 8.1.14.4 |

| Timer | Start | Stop | At expiry |
|-------|---|---|-------------------------------------|
| T324 | When a measurement report is triggered by intra frequency event 1d and the table 'Target cell preconfigurations' in the variable TARGET_CELL_PRECONFIGURATION includes the cell that triggered the event and an Activation time offset equal to 0 is configured | Upon successful reception of a Target cell HS-SCCH order or after 4 seconds or upon reception of any RRC reconfiguration message or ACTIVE SET UPDATE message | Stop monitoring target cell HS-SCCH |

13.2 Counters for UE

| Counter | Reset | Incremented | When reaching max value |
|---------|--|---|---|
| V300 | When initiating the procedure RRC connection establishment | Upon expiry of T300. | When V300 > N300, the UE enters idle mode. |
| V302 | When initiating the procedure Cell update or URA update | Upon expiry of T302 | When V302 > N302 the UE enters idle mode. |
| V304 | When sending the first UE CAPABILITY INFORMATION message. | Upon expiry of T304 | When V304 > N304 the UE initiates the Cell update procedure |
| V308 | When sending the first RRC CONNECTION RELEASE COMPLETE message in a RRC connection release procedure. | Upon expiry of T308 | When V308 > N308 the UE stops re-transmitting the RRC CONNECTION RELEASE COMPLETE message. |
| V310 | When sending the first PUSCH CAPACITY REQUEST message in a PUSCH capacity request procedure | Upon expiry of T310 | When V310 > N310 the UE stops re-transmitting the PUSCH CAPACITY REQUEST message. |
| V316 | At transmission or reception of PS data or signalling on SRB3 or upwards, or entering RRC Connected mode, or successful SRNS relocation. | Upon sending the SIGNALLING CONNECTION RELEASE INDICATION message, with the IE "Signalling Connection Release Indication Cause" set to "UE Requested PS Data session end" in CELL_PCH state or URA_PCH state and the DRX cycle length in use is equal to or longer than the shorter CN domain specific DRX cycle length for the PS domain and CS domain and V316 < 1. | When V316 >= 1 the UE stops sending any further SIGNALLING CONNECTION RELEASE INDICATION messages, with the IE "Signalling Connection Release Indication Cause" set to "UE Requested PS Data session end" in CELL_PCH state or URA_PCH state for as long as the DRX cycle length in use is equal to or longer than the shorter CN domain specific DRX cycle length for the PS domain and CS domain. |

13.3 UE constants and parameters

| Constant | Usage |
|----------|---|
| N300 | Maximum number of retransmissions of the RRC CONNECTION REQUEST message |
| N302 | Maximum number of retransmissions of the CELL UPDATE / URA UPDATE message |
| N304 | Maximum number of retransmissions of the UE CAPABILITY INFORMATION message |
| N308 | Maximum number of retransmissions of the RRC CONNECTION RELEASE COMPLETE message |
| N310 | Maximum number of retransmission of the PUSCH CAPACITY REQUEST message |
| N312 | Maximum number of "in sync" received from L1. |
| N313 | Maximum number of successive "out of sync" received from L1. |
| N315 | Maximum number of successive "in sync" received from L1 during T313 is activated. |

13.4 UE variables

13.4.ob AM_RLC_ERROR_PENDING_RB234

This variable indicates whether an AM RLC unrecoverable error has been detected during the current cell update procedure on RB 2, 3, or 4.

| Information Element/Group name | Need | Multi | Type and reference | Semantics description |
|--------------------------------|------|-------|--------------------|--|
| AM RLC error pending | MP | | Boolean | TRUE means an unrecoverable error was detected on AM RLC during the current cell update procedure..
Set to FALSE when the cell update procedure is completed. |

13.4.oc AM_RLC_ERROR_PENDING_RB5_AND_UP

This variable indicates whether an AM RLC unrecoverable error has been detected during the current cell update procedure on RB 5 or above.

| Information Element/Group name | Need | Multi | Type and reference | Semantics description |
|--------------------------------|------|-------|--------------------|--|
| AM RLC error pending | MP | | Boolean | TRUE means an unrecoverable error was detected on AM RLC during the current cell update procedure..
Set to FALSE when the cell update procedure is completed. |

13.4.0 CELL_INFO_LIST

This variable contains cell information on intra-frequency, inter-frequency and inter-RAT cells, as received in messages System Information Block Type 11, System Information Block Type 12, and MEASUREMENT CONTROL.

The first position in Intra-frequency cell info list corresponds to Intra-frequency cell id 0, the second to Intra-frequency cell id 1, etc.

The first position in Inter-frequency cell info list corresponds to Inter-frequency cell id 0, the second to Inter-frequency cell id 1, etc.

The first position in Inter-RAT cell info list corresponds to Inter-RAT cell id 0, the second to Inter-RAT cell id 1, etc.

This variable shall be cleared at cell re-selection, when leaving UTRA RRC connected mode, when switched off as well as at selection of a new PLMN.

| Information Element/Group name | Need | Multi | Type and reference | Semantics description | Version |
|--|------|----------------------|--|---|---------|
| Intra-frequency cell info | OP | 1..<maxCel
IMeas> | | | |
| >CHOICE <i>position status</i> | MP | | | | |
| >>Occupied | | | | | |
| >>>Cell info | MP | | Cell info
10.3.7.2 | | |
| >>Vacant | | | | No data | |
| Inter-frequency cell info | OP | 1..<maxCel
IMeas> | | | |
| >CHOICE <i>position status</i> | MP | | | | |
| >>Occupied | | | | | |
| >>>Frequency info | MP | | Frequency
info
10.3.6.36 | | |
| >>>Cell info | MP | | Cell info
10.3.7.2 | | |
| >>Vacant | | | | No data | |
| Adjacent frequency info | OP | | Frequency
info
10.3.6.36 | | REL-8 |
| Inter-RAT cell info list | OP | | | | REL-5 |
| >Inter-RAT cell info | OP | 1..<maxCel
IMeas> | | | |
| >>CHOICE <i>position status</i> | MP | | | | |
| >>>Occupied | | | | | |
| >>>>CHOICE <i>Radio Access
Technology</i> | | | | | |
| >>>>>GSM | | | | | |
| >>>>>>Cell selection and re-
selection info | MP | | Cell
selection
and re-
selection info
for SIB11/12
10.3.2.4 | | |
| >>>>>>BSIC | MP | | BSIC
10.3.8.2 | | |
| >>>>>>BCCH ARFCN | MP | | Integer
(0..1023) | [43] | |
| >>>>>>IS-2000 | | | | | |
| >>>>>>>System specific
measurement info | | | enumerated
(frequency,
timeslot,
colour code,
output
power, PN
offset) | For IS-2000, use fields from
TIA/EIA/IS-2000.5,
subclause 3. 7.3.3.2.27,
<i>Candidate Frequency
Neighbour List Message</i> | |
| >>>Vacant | | | | No data | |
| >CHOICE <i>indication status</i> | MP | | | | REL-5 |
| >>Present | | | | | REL-5 |
| >>>Inter-RAT cell info indication | OP | | Integer (0..3) | | REL-5 |
| >>Not present | | | | No data | REL-5 |

13.4.00 Void

13.4.0a CELL_UPDATE_STARTED

This variable indicates whether a cell update or URA update procedure is in progress.

| Information Element/Group name | Need | Multi | Type and reference | Semantics description |
|--------------------------------|------|-------|--------------------|--|
| Cell update started | MP | | Boolean | TRUE means a cell or URA update procedure is in progress.
Set to FALSE when entering UTRA RRC connected mode.
Set to FALSE when leaving UTRA RRC connected mode. |

13.4.1 CIPHERING_STATUS

This variable contains information about the current status of ciphering in the UE.

| Information Element/Group name | Need | Multi | Type and reference | Semantics description |
|--------------------------------|------|---------------------|----------------------------------|--|
| Status for each CN domain | MP | <1 to maxCNDomains> | | |
| >CN domain identity | MP | | CN domain identity 10.3.1.1 | |
| >Status | MP | | Enumerated(Not started, Started) | Set to "Not started" when entering UTRA RRC connected mode.
Set to "Not started" when leaving UTRA RRC connected mode. |
| Reconfiguration | MP | | Boolean | TRUE means an RRC procedure performing reconfiguration of ciphering is ongoing.
Set to FALSE when entering UTRA RRC connected mode.
Set to FALSE when leaving UTRA RRC connected mode. |

13.4.1a COMMON_E_DCH_TRANSMISSION

This variable indicates whether E-DPDCH and E-DPCCH transmission procedures for FDD or E-RUCCH and E-PUCH transmission procedure for 1.28 Mcps TDD in CELL_FACH state or Idle mode are ongoing. See subclause 8.5.46 for actions related to the setting of this variable.

| Information Element/Group name | Need | Multi | Type and reference | Semantics description | Version |
|--------------------------------|------|-------|--------------------|-----------------------|---------|
| Common E-DCH transmission | MP | | Boolean | See subclause 8.5.46 | REL-8 |

13.4.2 Void

13.4.2a CONFIGURATION_INCOMPLETE

This variable indicates whether a received measurement control message contains invalid an incomplete measurement configuration.

| Information Element/Group name | Need | Multi | Type and reference | Semantics description |
|--------------------------------|------|-------|--------------------|---|
| Configuration incomplete | MP | | Boolean | TRUE: An incomplete configuration has been detected.
Set to FALSE when entering UTRA RRC connected mode.
Set to FALSE when leaving UTRA RRC connected mode. |

13.4.3 C_RNTI

This variable stores the assigned C-RNTI for this UE when in CELL_FACH state. For FDD and 1.28 Mcps TDD, this variable stores the assigned C-RNTI for this UE in CELL_PCH state, if in CELL_PCH state a HS-DSCH transport channel has been allocated.

| Information Element/Group name | Need | Multi | Type and reference | Semantics description |
|--------------------------------|------|-------|--------------------|--|
| C-RNTI | OP | | C-RNTI
10.3.3.8 | Cleared when entering UTRA RRC connected mode when not otherwise stated in the procedure.
Cleared when leaving UTRA RRC connected mode. |

13.4.3a DEFERRED_MEASUREMENT_STATUS

| Information Element/Group name | Need | Multi | Type and reference | Semantics description | Version |
|--------------------------------|------|-------|--------------------|--|---------|
| Deferred measurement status | MP | | Boolean | If TRUE, the UE can transmit RRC messages on RACH and receive RRC messages commanding it to enter CELL_DCH without having read and acted on SIB11, SIB11 bis and 12. | REL-7 |

13.4.3b DTX_DRX_PARAMS

NOTE: For FDD only.

| Information Element/Group name | Need | Multi | Type and reference | Semantics description | Version |
|--------------------------------|------|-------|---|-----------------------|---------|
| UE parameters for DTX-DRX | MD | | DTX-DRX
Information
in 10.3.6.34a | | REL-7 |

13.4.3c DTX_DRX_STATUS

NOTE: For FDD only.

This variable indicates whether discontinuous UL DPCCCH transmission and discontinuous reception of F-DPCCCH and HSPA DL channel procedures are ongoing. See subclause 8.5.34 for actions related to the setting of this variable.

| Information Element/Group name | Need | Multi | Type and reference | Semantics description | Version |
|--------------------------------|------|-------|--------------------|--|---------|
| DTX_DRX_STATUS | MP | | Boolean | TRUE: discontinuous transmission and reception is ongoing.
Set to FALSE when entering UTRA RRC connected mode when not otherwise stated in the procedure.
Set to FALSE when leaving UTRA RRC connected mode. | REL-7 |

13.4.3d DSAC_PARAM

This variable contains Domain Specific Access Restriction Parameters during the connected mode.

| Information Element/Group name | Need | Multi | Type and reference | Semantics description | Version |
|---------------------------------------|------|-------|--|--|---------|
| CS Domain Specific Access Restriction | MP | | Domain Access Restriction
10.3.1.3b | This IE contains CS Domain Specific Access Restriction Parameters
Cleared when leaving UTRA RRC connected mode. | REL-6 |
| PS Domain Specific Access Restriction | MP | | Domain Access Restriction
10.3.1.3b | This IE contains PS Domain Specific Access Restriction Parameters
Cleared when leaving UTRA RRC connected mode. | REL-6 |

13.4.3e DSCH_RNTI

In TDD this variable stores the assigned DSCH-RNTI for this UE when in CELL_DCH state.

| Information Element/Group name | Need | Multi | Type and reference | Semantics description |
|--------------------------------|------|-------|------------------------|--|
| DSCH-RNTI | OP | | DSCH-RNTI
10.3.3.9a | Cleared when entering UTRA RRC connected mode when not otherwise stated in the procedure.
Cleared when leaving UTRA RRC connected mode. |

13.4.4 Void

13.4.4o E_DCH_TRANSMISSION

This variable indicates whether E-DPDCH and E-DPCCH transmission procedures are ongoing. See subclause 8.5.28 for actions related to the setting of this variable.

| Information Element/Group name | Need | Multi | Type and reference | Semantics description | Version |
|--------------------------------|------|-------|--------------------|--|---------|
| E-DCH transmission | MP | | Boolean | TRUE: E-DCH transmission is ongoing.
Set to FALSE when entering UTRA RRC connected mode when not otherwise stated in the procedure.
Set to FALSE when leaving UTRA RRC connected mode. | REL-6 |

13.4.4a E_RNTI

| Information Element/Group name | Need | Multi | Type and reference | Semantics description | Version |
|--------------------------------|------|-------|----------------------|--|---------|
| Primary E-RNTI | OP | | E-RNTI
10.3.3.10a | Cleared when entering UTRA RRC connected mode when not otherwise stated in the procedure.
Cleared when leaving UTRA RRC connected mode. | REL-6 |
| Secondary E-RNTI | OP | | E-RNTI
10.3.3.10a | Cleared when entering UTRA RRC connected mode when not otherwise stated in the procedure.
Cleared when leaving UTRA RRC connected mode. | REL-6 |

13.4.5 ESTABLISHED_RABS

This variable is used to store information about the established radio access bearers and signalling radio bearers in the UE.

| Information Element/Group name | Need | Multi | Type and reference | Semantics description |
|--------------------------------|------|---------------------|--------------------------|---|
| RAB information | OP | 1 to <maxRABsetup> | | For each RAB established.
Cleared when entering UTRA RRC connected mode when not otherwise stated in the procedure.
Cleared when leaving UTRA RRC connected mode. |
| >RAB info | MP | | RAB info
10.3.4.8 | |
| >RB information | MP | 1 to <maxRBper RAB> | | For each RB belonging to the RAB |
| >>RB identity | MP | | RB identity
10.3.4.16 | |
| >>>Subflow | MP | | Integer(0..< | Reference to the RAB subflow |

| Information Element/Group name | Need | Multi | Type and reference | Semantics description |
|-------------------------------------|------|--------------------|------------------------------|---|
| | | | maxSubflow count> | implemented by this RB |
| >>RB started | MD | | Enumerated(stopped, started) | Default value is started |
| Signalling radio bearer information | OP | 1 to <maxSRBsetup> | | In the order of RB0 and upwards.
Cleared when leaving UTRA RRC connected mode. |
| >RB started | MD | | Enumerated(stopped, started) | Default value is started |

13.4.5a ESTABLISHED_SIGNALLING_CONNECTIONS

This variable is used to store information about established signalling connections.

| Information Element/Group name | Need | Multi | Type and reference | Semantics description |
|---------------------------------|------|---------------------|-----------------------------|---|
| Signalling connection list | OP | 1 to <maxCNdomains> | | For each established signalling connection.
Cleared when entering UTRA RRC connected mode when not otherwise stated in the procedure.
Cleared when leaving UTRA RRC connected mode. |
| >Signalling connection identity | MP | | CN domain identity 10.3.1.1 | |

13.4.6 ESTABLISHMENT_CAUSE

This variable is used to store the cause for establishment of a signalling connection received by upper layers, to be used at RRC connection establishment or Initial Direct Transfer.

| Information Element/Group name | Need | Multi | Type and reference | Semantics description |
|--------------------------------|------|-------|-------------------------------|---|
| Establishment cause | OP | | Establishment cause 10.3.3.11 | Cleared when leaving UTRA RRC connected mode. |

13.4.6a EUTRA_FREQUENCY_INFO_LIST

This variable contains cell information on E-UTRA frequencies (possibly with associated blacklists), as received in messages System Information Block Type 19 and MEASUREMENT CONTROL.

| Information Element/Group name | Need | Multi | Type and reference | Semantics description | Version |
|----------------------------------|------|----------------------------|------------------------------------|---|---------|
| Frequency Info List | MP | 1 to <maxNumEUTRAFreqs> | | | REL-8 |
| >EARFCN | MP | | Integer(0 .. 65535) | EARFCN of the downlink carrier frequency [36.101] | REL-8 |
| >Measurement Bandwidth | MD | | Enumerated(6, 15, 25, 50, 75, 100) | Measurement bandwidth information common for all neighbouring cells on the carrier frequency. It is defined by the parameter Transmission Bandwidth Configuration, N _{RB} [36.104]. The values indicate the number of resource blocks over which the UE could measure. Default value is 6. | REL-8 |
| >Blacklisted cells per freq list | OP | 1 to <maxEUTRACellPerFreq> | | | REL-8 |
| >>Physical Cell identity | MP | | Integer (0..503) | A list of blacklisted cells can be signalled per frequency | REL-8 |

13.4.6b ETWS_DUPLICATE_DETECT_PARAM

This variable contains duplicate detection parameter for the ETWS information until the upper layer indicates to clear the variable. The UE should remove entries in this variable when they have been stored for three hours.

| Information Element/Group name | Need | Multi | Type and reference | Semantics description | Version |
|---------------------------------------|------|--------|--------------------|--|---------|
| Duplication detection parameters list | MP | 0 to 2 | | | REL-8 |
| >Message Identifier | MP | | Octet String (2) | IE "Message Identifier" as defined in [77] | REL-8 |
| >Serial Number | MP | | Octet string (2) | IE "Serial Number" as defined in [77] | REL-8 |

13.4.6c ETWS_INFO_IN_PROGRESS

This variable is not used in this version of the specification.

13.4.7 FAILURE_CAUSE

This variable contains the cause for failure of a UE initiated procedure, to be reported in a retransmitted message.

| Information Element/Group name | Need | Multi | Type and reference | Semantics description |
|--------------------------------|------|-------|----------------------------|---|
| Failure cause | OP | | Failure cause
10.3.3.13 | Cleared when entering UTRA RRC connected mode.
Cleared when leaving UTRA RRC connected mode. |

13.4.8 FAILURE_INDICATOR

This variable indicates whether the procedure has failed for a UE initiated procedure.

| Information Element/Group name | Need | Multi | Type and reference | Semantics description |
|--------------------------------|------|-------|--------------------|--|
| Failure indicator | MP | | Boolean | TRUE: Procedure has failed.
Set to FALSE when entering UTRA RRC connected mode.
Set to FALSE when leaving UTRA RRC connected mode. |

13.4.8o H_RNTI

This variable stores the assigned H-RNTI for this UE when in CELL-DCH, CELL_FACH (FDD and 1.28 Mcps TDD only) or CELL_PCH (FDD and 1.28 Mcps TDD only) state, and when an HS-DSCH transport channel has been allocated.

| Information Element/Group name | Need | Multi | Type and reference | Semantics description | Version |
|--------------------------------|------|-------|----------------------|--|---------|
| H-RNTI | OP | | H-RNTI
10.3.3.14a | Cleared when entering UTRA RRC connected mode when not otherwise stated in the procedure.
Cleared when leaving UTRA RRC connected mode. | REL-5 |

13.4.8oo HS_DSCH_RECEPTION

This variable indicates whether HS-SCCH and HS-DSCH reception procedures are ongoing. See subclause 8.5.25 for actions related to the setting of this variable.

| Information Element/Group name | Need | Multi | Type and reference | Semantics description | Version |
|--------------------------------|------|-------|--------------------|---|---------|
| HS-DSCH reception | MP | | Boolean | TRUE: HS-DSCH reception is ongoing.
Set to FALSE when entering UTRA RRC connected mode when not otherwise stated in the procedure.
Set to FALSE when leaving UTRA RRC connected mode. | REL-5 |

13.4.80a HS_DSCH_RECEPTION_CELL_FACH_STATE

This variable indicates whether HS-SCCH and HS-DSCH reception procedures are ongoing in CELL_FACH for BCCH, DCCH and, if configured, DTCH reception. See subclause 8.5.36 for actions related to the setting of this variable.

NOTE: FDD and 1.28 Mcps TDD only.

| Information Element/Group name | Need | Multi | Type and reference | Semantics description | Version |
|--------------------------------------|------|-------|--------------------|---|---------|
| HS-DSCH reception in CELL_FACH state | MP | | Boolean | TRUE: HS-DSCH reception in CELL_FACH is ongoing.
Set to FALSE when entering UTRA RRC connected mode, CELL_PCH, URA_PCH and CELL_DCH.
Set to FALSE when leaving UTRA RRC connected mode, | REL-7 |

13.4.80b HS_DSCH_RECEPTION_OF_CCCH_ENABLED

This variable indicates whether HS-SCCH and HS-DSCH reception procedures are enabled for CCCH and BCCH, and for SRB1 if the UE is in CELL_FACH state. See subclause 8.5.37 for actions related to the setting of this variable.

NOTE: For FDD and 1.28 Mcps TDD only.

| Information Element/Group name | Need | Multi | Type and reference | Semantics description | Version |
|--------------------------------|------|-------|--------------------|--|---------|
| HS-DSCH reception of CCCH | MP | | Boolean | TRUE: HS-DSCH reception for the CCCH is enabled.
Set to FALSE when leaving UTRA RRC connected mode.
Set to FALSE when entering CELL_PCH, URA_PCH and CELL_DCH. | REL-7 |

13.4.8oc HS_DSCH_RECEPTION_GENERAL

This variable indicates whether HS-SCCH and HS-DSCH reception procedures are ongoing in CELL_DCH, CELL_FACH, CELL_PCH, or URA_PCH. See subclause 8.5.37a for actions related to the setting of this variable.

NOTE: FDD and 1.28 Mcps TDD only.

| Information Element/Group name | Need | Multi | Type and reference | Semantics description | Version |
|---------------------------------|------|-------|--------------------|--|---------|
| HS-DSCH reception in all states | MP | | Boolean | TRUE: HS-DSCH reception in CELL_DCH, CELL_FACH, CELL_PCH or URA_PCH is ongoing.
Set to FALSE when entering UTRA RRC connected mode when not otherwise stated in the procedure.
Set to FALSE when leaving UTRA RRC connected mode | REL-7 |

13.4.8od SECONDARY_CELL_HS_DSCH_RECEPTION

This variable indicates whether HS-SCCH and HS-DSCH reception procedures are configured for a secondary serving HS-DSCH cell. See subclause 8.5.51 for actions related to the setting of this variable.

| Information Element/Group name | Need | Multi | Type and reference | Semantics description | Version |
|--------------------------------|------|-------|--------------------|---|---------|
| HS-DSCH reception | MP | | Boolean | TRUE: HS-DSCH reception is configured for a secondary serving HS-DSCH cell.
Set to FALSE when entering UTRA RRC connected mode when not otherwise stated in the procedure.
Set to FALSE when leaving UTRA RRC connected mode. | REL-8 |

13.4.8oe HS_DSCH_DRX_CELL_FACH_STATUS

This variable indicates whether HS-DSCH DRX operation is supported in CELL_FACH. See subclause 8.5.48 for actions related to the setting of this variable.

NOTE: FDD only.

| Information Element/Group name | Need | Multi | Type and reference | Semantics description | Version |
|---------------------------------|------|-------|--------------------|---|---------|
| HS-DSCH DRX in CELL_FACH status | MP | | Boolean | TRUE: HS-DSCH DRX operation in CELL_FACH is supported. Set to FALSE when leaving CELL_FACH or when dedicated H-RNTI is cleared. | REL-8 |

13.4.8of HS_DSCH_RECEPTION_OF_ETWS_ENABLED

This variable is not used in this version of the specification.

13.4.8000 HS_SCCH_LESS_PARAMS

NOTE: For FDD only.

This variable contains the parameters for UE operation in HS-SCCH less mode. The parameters are listed in subclause 10.3.6.36ab.

| Information Element/Group name | Need | Multi | Type and reference | Semantics description | Version |
|--------------------------------|------|-------|---|-----------------------|---------|
| UE parameters for HS-SCCH less | MD | | HS-SCCH less Information in 10.3.6.36ab | | REL-7 |

13.4.80000 HS_SCCH_LESS_STATUS

NOTE: For FDD only.

This variable indicates whether HS-SCCH less HS-DSCH transmission procedures are ongoing. See subclause 8.5.35 for actions related to the setting of this variable.

| Information Element/Group name | Need | Multi | Type and reference | Semantics description | Version |
|--------------------------------|------|-------|--------------------|---|---------|
| HS_SCCH_LESS_STATUS | MP | | Boolean | TRUE: HS-SCCH less HS-DSCH transmission is ongoing. Set to FALSE when entering UTRA RRC connected mode when not otherwise stated in the procedure. Set to FALSE when leaving UTRA RRC connected mode. | REL-7 |

13.4.8a INCOMPATIBLE_SECURITY_RECONFIGURATION

This variable indicates whether an incompatible simultaneous reconfiguration of a security function has been received.

| Information Element/Group name | Need | Multi | Type and reference | Semantics description |
|---------------------------------------|------|-------|--------------------|---|
| Incompatible security reconfiguration | MP | | Boolean | TRUE: An incompatible simultaneous security reconfiguration has been detected.
Set to FALSE when entering UTRA RRC connected mode.
Set to FALSE when leaving UTRA RRC connected mode. |

13.4.8b Void

13.4.8c Void

13.4.8d HSPA_RNTI_STORED_CELL_PCH

This variable indicates whether variables H_RNTI, C_RNTI and E_RNTI are stored in CELL_PCH state.

| Information Element/Group name | Need | Multi | Type and reference | Semantics description | Version |
|--------------------------------|------|-------|--------------------|---|---------|
| HSPA
RNTI_STORED_CELL_PCH | MP | | Boolean | TRUE: variables H_RNTI, C_RNTI and E_RNTI are stored in CELL_PCH state.
Set to FALSE when entering UTRA RRC connected mode when not otherwise stated in the procedure.
Set to FALSE when leaving UTRA RRC connected mode. | REL-8 |

13.4.9 INITIAL_UE_IDENTITY

In this variable the identity used by the UE when establishing an RRC connection is stored.

| Information Element/Group name | Need | Multi | Type and reference | Semantics description |
|--------------------------------|------|-------|----------------------------------|---|
| Initial UE identity | OP | | Initial UE identity
10.3.3.15 | Cleared when leaving UTRA RRC connected mode. |

13.4.9a INTEGRITY_PROTECTION_ACTIVATION_INFO

This variable contains information to be sent to UTRAN about when a new integrity protection configuration shall be activated in the uplink for signalling radio bearers in case of modification of integrity protection.

| Information Element/Group name | Need | Multi | Type and reference | Semantics description |
|---|------|-------|---|---|
| Uplink Integrity protection activation info | OP | | Integrity protection activation info
10.3.3.17 | Cleared when entering UTRA RRC connected mode.
Cleared when leaving UTRA RRC connected mode. |

13.4.10 INTEGRITY_PROTECTION_INFO

This variable contains information about the current status of the integrity protection in the UE.

| Information Element/Group name | Need | Multi | Type and reference | Semantics description |
|---|------|---------------------|-----------------------------------|---|
| Status | MP | | Enumerated(Not started, Started) | Set to "Not started" when entering UTRA RRC connected mode.
Set to "Not started" when leaving UTRA RRC connected mode. |
| Reconfiguration | MP | | Boolean | TRUE means a reconfiguration of integrity protection is ongoing.
Set to FALSE when entering UTRA RRC connected mode.
Set to FALSE when leaving UTRA RRC connected mode. |
| Signalling radio bearer specific integrity protection information | OP | 1 to <maxSRBs etup> | | When integrity protection is started, status information for RB0- RB4 in that order.
Cleared when entering UTRA RRC connected mode.
Cleared when leaving UTRA RRC connected mode. |
| >Uplink RRC HFN | MP | | Bit string (28) | |
| >Downlink RRC HFN | MP | | Bit string (28) | |
| >Uplink RRC Message sequence number | MP | | Integer (0..15) | |
| >Downlink RRC Message sequence number | OP | | Integer (0..15) | |

13.4.10a INTER_RAT_HANDBOVER_INFO_TRANSFERRED

This variable stores information about the inter RAT handover info that has been transferred to another RAT.

| Information Element/Group name | Need | Multi | Type and reference | Semantics description | Version |
|--|------|----------------------------|---|---|---------|
| Predefined configuration status information | OP | | Predefined configuration status information
10.3.4.5a | Cleared upon entering connected mode in another RAT | |
| Predefined configuration status information compressed | OP | | Predefined configuration status information compressed
10.3.4.5b | Cleared upon entering connected mode in another RAT | REL-5 |
| UE security information | OP | | UE security information
10.3.3.4 2b | Cleared upon entering connected mode in another RAT | |
| UE security information2 | OP | | UE security information2
10.3.3.4 2c | Cleared upon entering connected mode in another RAT | REL-6 |
| UE radio access capability | OP | | UE radio access capability
10.3.3.4 2 | Cleared upon entering connected mode in another RAT | |
| UE radio access capability extension | OP | | UE radio access capability extension
10.3.3.4 2a | Cleared upon entering connected mode in another RAT | |
| UE radio access capability compressed | OP | | UE radio access capability compressed
10.3.3.4 2o | | REL-5 |
| UE system specific capability | OP | 1 to <maxSystemCapability> | Inter-RAT UE radio access capability
10.3.8.7 | Cleared upon entering connected mode in another RAT | |
| >Inter-RAT UE radio access capability | MP | | Inter-RAT UE radio | | |

| | | | | | |
|--|--|--|-------------------------------|--|--|
| | | | access capability
10.3.8.7 | | |
|--|--|--|-------------------------------|--|--|

13.4.11 INVALID_CONFIGURATION

This variable indicates whether a received message contained an invalid configuration, by means of invalid values or invalid combinations of information elements.

| Information Element/Group name | Need | Multi | Type and reference | Semantics description |
|--------------------------------|------|-------|--------------------|--|
| Invalid configuration | MP | | Boolean | TRUE: An invalid configuration has been detected.
Set to FALSE when entering UTRA RRC connected mode.
Set to FALSE when leaving UTRA RRC connected mode. |

13.4.11a LATEST_CONFIGURED_CN_DOMAIN

This variable stores the CN-domain that was most recently configured to be used for ciphering and integrity protection.

| Information Element/Group name | Need | Multi | Type and reference | Semantics description |
|--------------------------------|------|-------|--------------------------------|--|
| Latest configured CN domain | OP | | CN domain identity
10.3.1.1 | Cleared when entering UTRA RRC connected mode when not stated otherwise in the procedure.
Cleared when leaving UTRA RRC connected mode. |

13.4.11b LATEST_CONFIGURED_SRB_DELAY_AND_PC_PREAMBLE

This variable stores the SRB delay and PC preamble to be used for establishing the DPCH after failure of hard handover, inter-RAT handover from UTRAN, or cell change order from UTRAN.

| Information Element/Group name | Need | Multi | Type and reference | Semantics description |
|--------------------------------|------|-------|--------------------|---|
| SRB delay | OP | | Integer (0..7) | Cleared when entering UTRA RRC connected mode when not stated otherwise in the procedure. |
| PC preamble | OP | | Integer (0..7) | Cleared when entering UTRA RRC connected mode when not stated otherwise in the procedure. |

13.4.11c MBMS_ACTIVATED_services

This variable stores the MBMS multicast services the UE has joined as well as the MBMS broadcast services the UE is interested to receive. Whenever the list of joined multicast services and/ or interested broadcast services changes, upper layers provide an indication upon which the UE shall update the variable accordingly. In case upper layers de-select an MBMS Selected Services, the UE shall remove the concerned service from the variable. Likewise, when upper layers select an MBMS Selected Services, the UE shall add the concerned service to the variable.

| Information Element/Group name | Need | Multi | Type and reference | Semantics description |
|-----------------------------------|--------------|------------------------|-----------------------------------|--|
| Activated service list | OP | 1 to <maxMBMS-Service> | | |
| >Service Identity | MP | | MBMS Service identity 10.3.9a.8 | |
| >Service type | MP | | Enumerated (Multicast, Broadcast) | |
| >MBMS Selected Services Indicator | CV-Broadcast | | Boolean | TRUE means that the service is currently a MBMS Selected Service |

| Condition | Explanation |
|------------------|---|
| <i>Broadcast</i> | This IE is mandatory present if the IE "Service type" is set to "Broadcast" and not needed otherwise. |

NOTE: An independent instance of the variable MBMS_ACTIVATED_SERVICES is used by UEs supporting reception of MBMS services from cells operating in MBSFN mode and will contain the services available in MBSFN mode only as indicated by higher layers.

13.4.11d MBMS_PREV_FREQUENCY_INFO

This variable stores the frequency information of the cell the UE is camped on, upon moving to the MBMS preferred layer indicated MBMS FLC preferred frequency information.

| Information Element/Group name | Need | Multi | Type and reference | Semantics description | Version |
|--------------------------------|------|-------|---------------------|-----------------------|---------|
| PREV Frequency Information | | | | | |
| CHOICE <i>mode</i> | | | | | |
| >FDD cell | | | | | |
| >>UARFCN downlink (Nd) | MP | | Integer(0 .. 16383) | [21] | |
| >3.84 Mcps TDD cell | | | | | |
| >>UARFCN (Nt) | MP | | Integer(0 .. 16383) | [22] | |
| >1.28 Mcps TDD cell list | | | | | |
| >>UARFCN (Nt) | MP | | Integer(0 .. 16383) | [22] | |

13.4.11e MBMS_PL_Service_Restriction_Info_dedicated

This variable stores the value of the IE "MBMS PL Service Restriction Information" restriction applicable to preferred frequency received in the latest Radio Bearer Control or Cell Update Confirm message.

| Information Element/Group name | Need | Multi | Type and reference | Semantics description | Version |
|--|------|-------|--------------------------|---|---------|
| MBMS_PL_SERVICE_RESTRICTION_INFO_DEDICATED | MP | | Enumerated (TRUE, FALSE) | Set to FALSE when entering UTRA connected mode. | REL-6 |

13.4.12 MEASUREMENT_IDENTITY

This variable stores the measurements configured in the UE. For each configured measurement, the information below shall be stored.

| Information Element/Group name | Need | Multi | Type and reference | Semantics description |
|--------------------------------|------|-------|---|---|
| MEASUREMENT CONTROL | OP | | MEASUREMENT CONTROL 10.2.17, System Information Block type 11 10.2.48.8.12, System Information Block type 12 10.2.48.8.13 | Information as contained in these messages.
Cleared when entering UTRA RRC connected mode when not stated otherwise in the procedure (8.4.1.8-8.4.1.9).
Cleared when leaving UTRA RRC connected mode when not stated otherwise in the procedure (8.4.1.9a). |

13.4.13 Void

13.4.13a MIMO_PARAMS

This variable indicates the values of the parameters for operation in MIMO mode. See subclause 8.5.xx for actions related to the setting of this variable.

| Information Element/Group name | Need | Multi | Type and reference | Semantics description | Version |
|---|------|---------------------|---|--|---------|
| CHOICE mode | MP | | | | REL-8 |
| >FDD | | | | | REL-8 |
| >>MIMO N_cqi_typeA/M_cqi ratio | OP | | Enumerated(1/2, 2/3, 3/4, 4/5, 5/6, 6/7, 7/8, 8/9, 9/10, 1/1) | | |
| >>MIMO pilot configuration | OP | | MIMO pilot configuration 10.3.6.41b | | |
| >>>Precoding weight set restriction | OP | | Enumerated (TRUE) | If present, UE applies precoding weight set restriction. | REL-7 |
| >TDD | | | | | REL-8 |
| >>CHOICE TDD option | MP | | | | REL-8 |
| >>>1.28 Mcps TDD | | | | | REL-8 |
| >>>>MIMO SF Mode for HS-PDSCH dual stream | MP | | Enumerated (SF1, SF1/SF16) | | REL-8 |
| >>>>HS-SICH Reference Signal Info | OP | <1 to maxHSSC CHs > | | The order of the list corresponds to the order of HS-SCCHs in HS-SCCH info | REL-8 |
| >>>>> Reference Signal Midamble configuration | MP | | Integer (2, 4, 6, 8, 10, 12, 14, 16) | Midamble Allocation mode is UE specific midamble allocation | REL-8 |
| >>>>>Reference Signal Midamble Shift | MP | | Integer (0..15) | The allocated midamble shift. | REL-8 |
| >>>>>Reference Signal Timeslot number | MP | | Integer (1..5) | | REL-8 |
| >>>>3.84 Mcps TDD or 7.68 Mcps TDD | | | | (no data) | REL-8 |

13.4.13b MIMO_STATUS

This variable indicates whether the UE is operating in MIMO mode. See subclause 8.5.wv for actions related to the setting of this variable.

| Information Element/Group name | Need | Multi | Type and reference | Semantics description | Version |
|--------------------------------|------|-------|--------------------|--|---------|
| MIMO status | MP | | Boolean | TRUE means the UE is operating in MIMO mode.

Cleared when leaving CELL_DCH state. | |

13.4.14 ORDERED_RECONFIGURATION

This variable stores information about an ongoing Reconfiguration procedure.

| Information Element/Group name | Need | Multi | Type and reference | Semantics description |
|--------------------------------|------|-------|--------------------|--|
| Ordered reconfiguration | MP | | Boolean | TRUE means that a Reconfiguration procedure is ongoing.
Set to FALSE when entering UTRA RRC connected mode.
Set to FALSE when leaving UTRA RRC connected mode. |

13.4.14a PDCP_ROHC_TARGET_MODE

This variable contains the ROHC target mode.

| Information Element/Group name | Need | Multi | Type and reference | Semantics description | Version |
|--------------------------------|------|-------|-----------------------------|---|---------|
| Target Mode | OP | | Enumerated (O-mode, R-mode) | The UE shall only transit to the signalled mode for operation of ROHC as described in [36]. | REL-5 |

13.4.15 PDCP_SN_INFO

This variable contains PDCP receive sequence numbers for one or several radio bearers to be included in a response message to UTRAN.

| Information Element/Group name | Need | Multi | Type and reference | Semantics description |
|--------------------------------|------|----------------------|---------------------------------------|---|
| RB with PDCP information list | OP | 1 to <maxRBall RABs> | | Cleared when entering UTRA RRC connected mode.
Cleared when leaving UTRA RRC connected mode. |
| >RB with PDCP information | MP | | RB with PDCP information
10.3.4.22 | |

13.4.15a PHYSICAL_SHARED_CHANNEL_CONFIGURATION

This variable is used only for TDD to store information about the physical shared channel configuration in the UE.

| Information Element/Group name | Need | Multi | Type and reference | Semantics description |
|--------------------------------|------|------------|------------------------------------|---|
| PUSCH configuration | OP | | | Cleared when entering and leaving UTRA RRC connected mode. |
| >PUSCH info | MP | | PUSCH info 10.3.6.63 | |
| >PUSCH Identity | OP | | Integer(1..hiPUSCHidentities) | |
| >PUSCH power control info | OP | | PUSCH power control info 10.3.6.65 | |
| PDSCH configuration | OP | | | Cleared when entering and leaving UTRA RRC connected mode. |
| >PDSCH Info | MP | | PDSCH Info 10.3.6.44 | |
| >PDSCH Identity | OP | | Integer(1..hiPDSCHidentities) | |
| >PDSCH power control info | OP | | PDSCH power control info 10.3.6.45 | |
| ISCP Timeslot list | OP | 1 to maxTS | | Cleared when entering and leaving UTRA RRC connected mode. |
| >Timeslot number | MP | | Timeslot number 10.3.6.84 | Timeslot numbers, for which the UE shall report the timeslot ISCP in PUSCH CAPACITY REQUEST message |

13.4.15b PPAC_PARAM

This variable contains Paging Permission with Access Control Parameters during the connected mode.

| Information Element/Group name | Need | Multi | Type and reference | Semantics description | Version |
|---|------|-------|--|---|---------|
| Paging Response Restriction Indication | MP | | Enumerated(All, CS, PS, None) | Cleared when leaving UTRA RRC connected mode. | REL-8 |
| Location/Registration Restriction Indicator | MP | | Enumerated(All, CS, PS) | Cleared when leaving UTRA RRC connected mode. | REL-8 |
| Location/Registration | MP | | Location /Registration Parameters 10.3.1.70a | Cleared when leaving UTRA RRC connected mode. | REL-8 |

13.4.15c PRIORITY_INFO_LIST

This variable contains cell information on UTRA and inter-RAT priorities to be applied to neighbour cells stored in CELL_INFO_LIST and EUTRA_FREQUENCY_INFO_LIST, as received in messages System Information Block Type 19 and UTRAN MOBILITY INFORMATION.

The contents of this variable are inherited at inter-RAT cell (re)selection, including the remaining validity time (i.e., T320 in E-UTRAN, T322 in UTRAN, and T3230 in GERAN), if configured.

This variable can be configured in CELL_DCH, CELL_FACH, CELL_PCH, URA_PCH and Idle states. However, it is only used in CELL_FACH, CELL_PCH, URA_PCH and Idle states.

In *Camped on any cell* in [4], the UE implicitly takes actions as described in subclause 8.1.1.6.19 assuming the IE "Priority status" equals "sys_info_priority" using stored System information Block type 19. In *Camped normally* in [4], if the UE assumes it has valid UE specific priorities according to [4], the UE implicitly takes actions as described in subclause 8.6.7.23 without stopping T322 using stored IE "Dedicated Priority Information".

| Information Element/Group name | Need | Multi | Type and reference | Semantics description | Version |
|---------------------------------|------|------------------------|--|---|---------|
| Priority status | MP | | Enumerated (sys_info_priority, dedicated_priority) | | REL-8 |
| UTRA Serving Cell | OP | | | | REL-8 |
| >priority | OP | | Integer (0..<maxPriority-1>) | Absence of this IE indicates that the lowest priority is assigned to the serving frequency (lower than any assigned priority) | REL-8 |
| >S _{prioritysearch1} | MP | | Integer (0..62 by step of 2) | RSCP, dB | REL-8 |
| >S _{prioritysearch2} | MD | | Integer (0..7 by step of 1) | dB, default value is 0 | REL-8 |
| >Thresh _{serving,low} | MP | | Integer (0..62 by step of 2) | RSCP, dB | REL-8 |
| Priority Info List | OP | 1 to <maxNumPrio> | | | REL-8 |
| >priority | OP | | Integer (0..<maxPriority-1>) | Absence of this IE indicates that no priority is assigned to the indicated frequencies | REL-8 |
| >CHOICE Radio Access Technology | MP | | | | REL-8 |
| >>UTRA FDD | | | | | REL-8 |
| >>>Frequency List | | 1 to <maxNumFDD Freqs> | | | |
| >>>>UARFCN | MP | | Integer (0..16383) | | REL-8 |
| >>>>QqualminFDD | MD | | Integer (-24..0) | Ec/N0, [dB]
Default value is -24. | REL-8 |
| >>>>QrxlevminFDD | MD | | Integer (-119..-25 by step of 2) | RSCP, dBm
Default value is -119. | REL-8 |
| >>>>Thresh _{x,high} | OP | | Integer (0..62 by step of 2) | RSCP, dB | REL-8 |
| >>>>Thresh _{x,low} | OP | | Integer (0..62 by step of 2) | RSCP, dB | REL-8 |
| >>UTRA TDD | | | | | REL-8 |
| >>>Frequency List | | 1 to <maxNumTDD Freqs> | | | |
| >>>>UARFCN | MP | | Integer (0..16383) | | REL-8 |
| >>>>QrxlevminTDD | MD | | Integer (-119..-25 by step of 2) | RSCP, dBm
Default value is -119. | REL-8 |
| >>>>Thresh _{x,high} | OP | | Integer (0..62 by step of 2) | RSCP, dB | REL-8 |
| >>>>Thresh _{x,low} | OP | | Integer (0..62 by step of 2) | RSCP, dB | REL-8 |
| >>E-UTRA | | | | | REL-8 |

| | | | | | |
|-------------------------------|----|-------------------------|---|--|-------|
| >>>Frequency List | | 1 to <maxNumEUTRAFreqs> | | | |
| >>>>EARFCN | MP | | Integer(0 .. 65535) | EARFCN of the downlink carrier frequency [36.101] | REL-8 |
| >>>>QrxlevminEUTRA | MD | | Integer (-140..-44 by step of 2) | RSRP, dBm
Default value is -140. | REL-8 |
| >>>>Thresh _{x, high} | OP | | Integer (0..62 by step of 2) | RSRP, dB | REL-8 |
| >>>>Thresh _{x, low} | OP | | Integer (0..62 by step of 2) | RSRP, dB | REL-8 |
| >>GSM | | | | | REL-8 |
| >>>>NCC permitted | MD | | Bit string (8) {NCC 0 to 7} | Bitmap indicating NCC values; reselection of GERAN cells is permitted when the corresponding NCC bit = "1".
Default is '11111111' | |
| >>>Frequency List | MP | 1 to <maxCellMeas> | | | REL-8 |
| >>>>Band indicator | MP | | Enumerated (DCS 1800 band used, PCS 1900 band used) | Indicates how to interpret the BCCH ARFCN | REL-8 |
| >>>>BCCH ARFCN | MP | | Integer (0..1023) | [45] | REL-8 |
| >>>>QrxlevminGSM | MD | | Integer (-115..-56 by step of 2) | GSM RSSI, dBm
Default value is -115. | REL-8 |
| >>>>Thresh _{x, high} | OP | | Integer (0..62 by step of 2) | GSM RSSI, dB | REL-8 |
| >>>>Thresh _{x, low} | OP | | Integer (0..62 by step of 2) | GSM RSSI, dB | REL-8 |
| E-UTRA detection | OP | | Boolean | "TRUE" means that the UE may detect the presence of a E-UTRA cell and report to NAS | REL-8 |

13.4.16 PROTOCOL_ERROR_INDICATOR

This variable indicates whether there exist a protocol error that is to be reported to UTRAN.

| Information Element/Group name | Need | Multi | Type and reference | Semantics description |
|--------------------------------|------|-------|---------------------------------------|---|
| Protocol error indicator | MP | | Protocol error indicator
10.3.3.27 | Set to FALSE when entering UTRA RRC connected mode.
Set to FALSE when leaving UTRA RRC connected mode. |

13.4.17 PROTOCOL_ERROR_INFORMATION

This variable contains diagnostics to be reported to UTRAN for a message that was not completely understood.

| Information Element/Group name | Need | Multi | Type and reference | Semantics description |
|--------------------------------|------|-------|---|---|
| Protocol error information | OP | | Protocol error information
10.3.8.12 | Cleared when entering UTRA RRC connected mode.
Cleared when leaving UTRA RRC connected mode. |

13.4.18 PROTOCOL_ERROR_REJECT

This variable indicates whether there has occurred a severe protocol error causing the ongoing procedure to fail.

| Information Element/Group name | Need | Multi | Type and reference | Semantics description |
|--------------------------------|------|-------|--------------------|--|
| Protocol error reject | MP | | Boolean | TRUE: a severe protocol error has occurred.
Set to FALSE when entering UTRA RRC connected mode.
Set to FALSE when leaving UTRA RRC connected mode. |

13.4.19 RB_TIMER_INDICATOR

This variable contains information to be sent to UTRAN if any of the timers T314 or T315 has expired when the UE sends a cell update with cause RL failure.

| Information Element/Group name | Need | Multi | Type and reference | Semantics description |
|--------------------------------|------|-------|---------------------------------|---|
| RB timer indicator | OP | | RB timer indicator
10.3.3.28 | Cleared when entering UTRA RRC connected mode.
Cleared when leaving UTRA RRC connected mode. |

13.4.20 RB_UPLINK_CIPHERING_ACTIVATION_TIME_INFO

This variable contains information to be sent to UTRAN about when a new ciphering configuration shall be activated in the uplink for radio bearers using RLC-AM or RLC-UM.

| Information Element/Group name | Need | Multi | Type and reference | Semantics description |
|--|------|-------|--------------------------------------|---|
| RB uplink ciphering activation time info | OP | | RB activation time info
10.3.4.13 | Cleared when entering UTRA RRC connected mode.
Cleared when leaving UTRA RRC connected mode. |

13.4.20o RNC_CAPABILITY_CHANGE_SUPPORT

This variable indicates whether the serving RNC supports changes of UE capability in connected mode.

| Information Element/Group name | Need | Multi | Type and reference | Semantics description |
|---|------|-------|--------------------|---|
| RNC support for change of UE capability | MP | | Boolean | Cleared when leaving UTRA RRC connected mode. |

13.4.20oo READY_FOR_COMMON_EDCH

In CELL_FACH state or Idle mode, this variable indicates whether E-DPDCH and E-DPCCH transmission procedures for FDD or E-RUCCH and E-PUCH transmission procedure for 1.28 Mcps TDD can be immediately started by the UE. See subclause 8.5.47 for actions related to the setting of this variable.

| Information Element/Group name | Need | Multi | Type and reference | Semantics description | Version |
|--------------------------------|------|-------|--------------------|-----------------------|---------|
| Ready for common EDCH | MP | | Boolean | See subclause 8.5.47 | REL-8 |

13.4.20a SECURITY_MODIFICATION

This variable contains information on which CN domain is affected by the ongoing security reconfiguration.

| Information Element/Group name | Need | Multi | Type and reference | Semantics description |
|--------------------------------|------|----------------------|---|-----------------------|
| Status for each CN domain | MP | <1 to maxCNDo mains> | | |
| >CN domain identity | MP | | CN domain identity
10.3.1.1 | |
| >Status | MP | | Enumerated(
Affected, Not
Affected) | |

13.4.21 Void

13.4.22 START_THRESHOLD

This variable contains information about the maximum allowed value of the START for a CN domain.

| Information Element/Group name | Need | Multi | Type and reference | Semantics description |
|--------------------------------|------|-------|-------------------------|--|
| THRESHOLD | OP | | Integer
(0..1048576) | 20 bits.
Cleared when entering UTRA RRC connected mode when not stated otherwise in the procedure.
Cleared when leaving UTRA RRC connected mode. |

13.4.23 START_VALUE_TO_TRANSMIT

This variable contains the value of START for new radio bearer(s) to be transmitted in a response message.

| Information Element/Group name | Need | Multi | Type and reference | Semantics description |
|--------------------------------|------|-------|--------------------|---|
| START | OP | | START
10.3.3.38 | Cleared when entering UTRA RRC connected mode.
Cleared when leaving UTRA RRC connected mode. |

13.4.23a TARGET_CELL_PRECONFIGURATION

This variable indicates whether HS-SCCH reception procedures are configured for a target cell for which HS-DSCH serving Cell Change may be initiated by HS-SCCH order sent from target cell. See subclause 8.3.4.3 and 8.5.52 for actions related to the setting of this variable.

NOTE: FDD only.

| Information Element/Group name | Need | Multi | Type and reference | Semantics description | Version |
|---|------|--------------|--|-----------------------|---------|
| Serving Cell Change MAC reset | OP | | Boolean | | REL-8 |
| Serving Cell Change Message Type | OP | | Enumerated (RadioBearerSetup, RadioBearerReconfiguration, TransportChannelReconfiguration, PhysicalChannelReconfiguration) | | REL-8 |
| Serving Cell Change Transaction Id | OP | | Integer (0..3) | | REL-8 |
| Target cell preconfigurations | OP | 1 to <maxRL> | | | REL-8 |
| >Primary scrambling code | MP | | Integer(0..511) | | REL-8 |
| >Target cell preconfiguration information | MP | | Target cell preconfiguration information 10.3.6.79a | | REL-8 |

13.4.24 TFC_SUBSET

This variable contains information about the TFC subset(s) applicable to the UE.

| Information Element/Group name | Need | Multi | Type and reference | Semantics description | Version |
|--------------------------------|------|-------|---|--|---------|
| CHOICE <i>mode</i> | MP | | | | |
| >FDD | | | | | |
| >>Current TFC subset | MP | | Transport Format Combination Subset 10.3.5.22 | Set to "Full transport format set" when entering UTRA RRC connected mode when not stated otherwise in the procedure. | |
| >>Duration | OP | | TFC Control duration 10.3.6.80 | Cleared when entering UTRA RRC connected mode. Cleared when leaving UTRA RRC connected mode. | |
| >>Default TFC subset | OP | | Transport Format Combination Subset 10.3.5.22 | The TFC subset to go back to when any temporary limitation is released. Cleared when entering UTRA RRC connected mode. Cleared when leaving UTRA RRC connected mode. | |

| Information Element/Group name | Need | Multi | Type and reference | Semantics description | Version |
|--------------------------------|------|--------------------|---|---|---------|
| >>TFC subset list | MP | 1 to <maxTF Csub> | | | REL-4 |
| >>>TFC subset | MP | | Transport Format Combination Subset 10.3.5.22 | | REL-4 |
| >TDD | | | | | |
| >>TFCS list | MP | 1 to <maxCCT rCH > | | One TFCS is created when entering UTRA RRC connected mode when not stated otherwise in the procedure. | |
| >>>TFCS identity | MP | | Transport Format Combination Set Identity 10.3.5.21 | "TFCS ID" is set to 1 when entering UTRA RRC connected mode when not stated otherwise in the procedure.
"Shared channel indicator" is set to FALSE when entering UTRA RRC connected mode when not stated otherwise in the procedure. | |
| >>>>Current TFC subset | MP | | Transport Format Combination Subset 10.3.5.22 | Set to "Full transport format set" when entering UTRA RRC connected mode when not stated otherwise in the procedure. | |
| >>>>Duration | OP | | TFC Control duration 10.3.6.80 | Cleared when entering UTRA RRC connected mode. Cleared when leaving UTRA RRC connected mode. | |
| >>>>Default TFC subset | OP | | Transport Format Combination Subset 10.3.5.22 | The TFC subset to go back to when any temporary limitation is released.
Cleared when entering UTRA RRC connected mode. Cleared when leaving UTRA RRC connected mode. | |
| >>TFC subset list | MP | 1 to <maxTF Csub2> | | | REL-4 |
| >>>TFCS identity | MP | | Transport Format Combination Set Identity 10.3.5.21 | | REL-4 |
| >>>>TFC subset | MP | | Transport Format Combination Subset 10.3.5.22 | | REL-4 |

13.4.25 TGPS_IDENTITY

This variable contains the configuration parameters of all the configured compressed mode transmission gap pattern sequences.

| Information Element/Group name | Need | Multi | Type and reference | Semantics description |
|---|-----------|-----------------|----------------------------------|--|
| Transmission gap pattern sequence | OP | 1 to <maxTGP S> | | Cleared when entering UTRA RRC connected mode.
Cleared when leaving UTRA RRC connected mode. |
| >TGPSI | MP | | TGPSI 10.3.6.82 | |
| >TGPS Status Flag | MP | | Enumerated(activate, deactivate) | This flag indicates whether the Transmission Gap Pattern Sequence shall be activated or deactivated. |
| > Current TGPS Status Flag | MP | | Enumerated(active, inactive) | This flag indicates the current status of the Transmission Gap Pattern Sequence, whether it is active or inactive |
| >TGCFN | CV-Active | | Integer (0..255) | Connection Frame Number of the first frame of the first pattern within the Transmission Gap Pattern Sequence. |
| >Transmission gap pattern sequence configuration parameters | MP | | | Information as contained in the IE group "Transmission gap pattern sequence configuration parameters" in IE "DPCH compressed mode info" 10.3.6.33. |

| Condition | Explanation |
|---------------|--|
| <i>Active</i> | This IE is mandatory present when the value of the IE "TGPS Status Flag" is "Activate" and not needed otherwise. |

13.4.26 TGSN_REPORTED

This variable specifies whether an IE "Proposed TGSN" was reported to the UTRAN

| Information Element/Group name | Need | Multi | Type and reference | Semantics description |
|--------------------------------|------|-------|--------------------|---|
| Proposed TGSN reported | MP | | Boolean | Set to FALSE when entering UTRA RRC connected mode.
Set to FALSE when leaving UTRA RRC connected mode. |

13.4.26a TIMERS_AND_CONSTANTS

This variable contains the values for all timers and constants used in connected mode.

| Information Element/Group name | Need | Multi | Type and reference | Semantics description |
|---|------|-------|--|--|
| UE Timers and constants in connected mode | MD | | UE Timers and constants in connected mode
10.3.3.43 | Default value means that for all timers and constants
- for parameters with need MD, the defaults specified in 10.3.3.43 apply and
- for parameters with need OP, the parameters are absent.

All parameters are set to the default value when leaving UTRA RRC connected mode to another RAT. |

13.4.27 TRANSACTIONS

This variable stores the identifications of the ongoing RRC procedure transactions.

| Information Element/Group name | Need | Multi | Type and reference | Semantics description |
|--------------------------------|------|-------------------------|---|---|
| Accepted transactions | OP | 1 to <maxtrans actions> | | Cleared when leaving UTRA RRC connected mode. |
| >Message type | MP | | Message Type | |
| >RRC transaction identifier | MP | | RRC transaction identifier
10.3.3.36 | |
| Rejected transactions | OP | 1 to <maxtrans actions> | | Cleared when leaving UTRA RRC connected mode. |
| >Message type | MP | | Message Type | |
| >RRC transaction identifier | MP | | RRC transaction identifier
10.3.3.36 | |
| Processed transactions | OP | 1 to <maxtrans actions> | | Cleared when leaving UTRA RRC connected. |
| >Message type | MP | | Message Type | |
| >RRC transaction identifier | MP | | RRC transaction identifier
10.3.3.36 | |

13.4.27o Void

13.4.27a TRIGGERED_1A_EVENT

This variable contains information about a 1a event that has been triggered in the UE. There is one such variable per 1a event configured in the UE.

| Information Element/Group name | Need | Multi | Type and reference | Semantics description |
|--------------------------------|------|--------|--------------------|----------------------------|
| Cells triggered | OP | 1 to < | | Cleared when entering UTRA |

| Information Element/Group name | Need | Multi | Type and reference | Semantics description |
|--------------------------------|------|---------------------|------------------------------|---|
| | | maxCellMeas> | | RRC connected mode. Cleared when leaving UTRA RRC connected mode. |
| >primary CPICH | MP | | Primary CPICH info 10.3.6.60 | |
| >sent reports | MP | | Integer(1..Infinity) | Number of reports sent to UTRAN in case of event triggered periodical reporting |
| Cells recently triggered | OP | 1 to < maxCellMeas> | | |
| >primary CPICH | MP | | Primary CPICH info 10.3.6.60 | |
| >sent reports | MP | | Integer(1..Infinity) | Number of reports sent to UTRAN in case of event triggered periodical reporting |
| Periodical reporting running | MP | | Boolean | |

13.4.27b TRIGGERED_1B_EVENT

This variable contains information about a 1b event that has been triggered in the UE. There is one such variable per 1b event configured in the UE.

| Information Element/Group name | Need | Multi | Type and reference | Semantics description | Version |
|--------------------------------|------|---------------------|------------------------------|--|---------|
| Cells triggered | OP | 1 to < maxCellMeas> | | Cleared when entering UTRA RRC connected mode. Cleared when leaving UTRA RRC connected mode. | |
| >primary CPICH | MP | | Primary CPICH info 10.3.6.60 | | |
| >sent reports | MP | | Integer(1..Infinity) | Number of reports sent to UTRAN in case of event triggered periodical reporting | REL-5 |
| Cells recently triggered | OP | 1 to < maxCellMeas> | | | REL-5 |
| >primary CPICH | MP | | Primary CPICH info 10.3.6.60 | | REL-5 |
| >sent reports | MP | | Integer(1..Infinity) | Number of reports sent to UTRAN in case of event triggered periodical reporting. | REL-5 |
| Periodical reporting running | MP | | Boolean | | REL-5 |

13.4.27c TRIGGERED_1C_EVENT

This variable contains information about a 1c event that has been triggered in the UE. There is one such variable per 1c event configured in the UE.

| Information Element/Group name | Need | Multi | Type and reference | Semantics description |
|--------------------------------|------|---------------------|------------------------------|---|
| Cells triggered | OP | 1 to < maxCellMeas> | | Cleared when entering UTRA RRC connected mode.
Cleared when leaving UTRA RRC connected mode. |
| >primary CPICH | MP | | Primary CPICH info 10.3.6.60 | |
| >sent reports | MP | | Integer(1..Infinity) | Number of reports sent to UTRAN in case of event triggered periodical reporting |
| Cells recently triggered | OP | 1 to < maxCellMeas> | | |
| >primary CPICH | MP | | Primary CPICH info 10.3.6.60 | |
| >sent reports | MP | | Integer(1..Infinity) | Number of reports sent to UTRAN in case of event triggered periodical reporting |
| Periodical reporting running | MP | | Boolean | |

13.4.27d BEST_CELL_1D_EVENT

This variable contains information about a 1d event that has been triggered in the UE. There is one such variable per 1d event configured in the UE.

| Information Element/Group name | Need | Multi | Type and reference | Semantics description |
|--------------------------------|------|-------|------------------------------|---|
| Best cell | OP | | Primary CPICH info 10.3.6.60 | Cleared when entering UTRA RRC connected mode.
Cleared when leaving UTRA RRC connected mode. |

13.4.27e TRIGGERED_1E_EVENT

This variable contains information about a 1e event that has been triggered in the UE. There is one such variable per 1e event configured in the UE.

| Information Element/Group name | Need | Multi | Type and reference | Semantics description |
|--------------------------------|------|---------------------|------------------------------|---|
| Cells triggered | OP | 1 to < maxCellMeas> | | Cleared when entering UTRA RRC connected mode.
Cleared when leaving UTRA RRC connected mode. |
| >primary CPICH | MP | | Primary CPICH info 10.3.6.60 | |
| Cells recently triggered | OP | 1 to < maxCellMeas> | | |
| >primary CPICH | MP | | Primary CPICH info 10.3.6.60 | |

13.4.27f TRIGGERED_1F_EVENT

This variable contains information about a 1f event that has been triggered in the UE. There is one such variable per 1f event configured in the UE.

| Information Element/Group name | Need | Multi | Type and reference | Semantics description |
|--------------------------------|------|---------------------|------------------------------|---|
| Cells triggered | OP | 1 to < maxCellMeas> | | Cleared when entering UTRA RRC connected mode.
Cleared when leaving UTRA RRC connected mode. |
| >primary CPICH | MP | | Primary CPICH info 10.3.6.60 | |
| Cells recently triggered | OP | 1 to < maxCellMeas> | | |
| >primary CPICH | MP | | Primary CPICH info 10.3.6.60 | |

13.4.27f1 TRIGGERED_1G_EVENT

This variable contains information about a 1g event that has been triggered in the UE.

| Information Element/Group name | Need | Multi | Type and reference | Semantics description |
|--------------------------------|------|---------------------|------------------------------|-----------------------|
| Cells triggered | OP | 1 to < maxCellMeas> | | |
| >Primary CCPCH info | MP | | Primary CCPCH info 10.3.6.57 | |

13.4.27f2 TRIGGERED_1H_EVENT

This variable contains information about a 1h event that has been triggered in the UE.

| Information Element/Group name | Need | Multi | Type and reference | Semantics description |
|--------------------------------|------|---------------------|------------------------------|-----------------------|
| Cells triggered | OP | 1 to < maxCellMeas> | | |
| >Primary CCPCH info | MP | | Primary CCPCH info 10.3.6.57 | |

13.4.27f3 TRIGGERED_1I_EVENT

This variable contains information about a 1i event that has been triggered in the UE.

| Information Element/Group name | Need | Multi | Type and reference | Semantics description |
|--------------------------------|------|---------------------|------------------------------|-----------------------|
| Cells triggered | OP | 1 to < maxCellMeas> | | |
| >Primary CCPCH info | MP | | Primary CCPCH info 10.3.6.57 | |

13.4.27f4 BEST_FREQUENCY_2A_EVENT

This variable contains information about a 2a event that has been configured in the UE. There is one such variable per 2a event configured in the UE.

| Information Element/Group name | Need | Multi | Type and reference | Semantics description |
|--------------------------------|------|-------|-----------------------------|-----------------------|
| Best frequency | MP | | Frequency info
10.3.6.36 | |

13.4.27f5 TRIGGERED_2B_EVENT

This variable contains information about a 2b event that has been configured in the UE. There is one such variable per 2b event configured in the UE.

| Information Element/Group name | Need | Multi | Type and reference | Semantics description |
|--------------------------------|------|-----------------------------|--------------------|-----------------------|
| Frequency triggered | OP | 1 to <maxCellMeas> | | |
| >Frequency | MP | Frequency info
10.3.6.36 | | |

13.4.27f6 TRIGGERED_2C_EVENT

This variable contains information about a 2c event that has been configured in the UE. There is one such variable per 2c event configured in the UE.

| Information Element/Group name | Need | Multi | Type and reference | Semantics description |
|--------------------------------|------|-----------------------------|--------------------|-----------------------|
| Frequency triggered | OP | 1 to <maxCellMeas> | | |
| >Frequency | MP | Frequency info
10.3.6.36 | | |

13.4.27f7 TRIGGERED_2D_EVENT

This variable contains information about a 2d event that has been configured in the UE. There is one such variable per 2d event configured in the UE.

| Information Element/Group name | Need | Multi | Type and reference | Semantics description |
|--------------------------------|------|-------|--------------------|-----------------------|
| Event triggered | OP | | Boolean | |

13.4.27f8 TRIGGERED_2E_EVENT

This variable contains information about a 2e event that has been configured in the UE. There is one such variable per 2e event configured in the UE.

| Information Element/Group name | Need | Multi | Type and reference | Semantics description |
|--------------------------------|------|-----------------------------|--------------------|-----------------------|
| Frequency triggered | OP | 1 to <maxCellMeas> | | |
| >Frequency | MP | Frequency info
10.3.6.36 | | |

13.4.27f9 TRIGGERED_2F_EVENT

This variable contains information about a 2f event that have been configured in the UE. There is one such variable per 2f event configured in the UE.

| Information Element/Group name | Need | Multi | Type and reference | Semantics description |
|--------------------------------|------|-------|--------------------|-----------------------|
| Event triggered | OP | | Boolean | |

13.4.27f10 TRIGGERED_3A_EVENT

This variable contains information about a 3a event that has been configured in the UE. There is one such variable per event 3a configured in the UE.

| Information Element/Group name | Need | Multi | Type and reference | Semantics description | Version |
|---------------------------------|------|-------------------------------------|------------------------------|---|---------|
| CHOICE <i>system</i> | OP | | | | |
| >GSM | | | | | |
| >>CHOICE <i>BSIC</i> | MP | | | | |
| >>>Verified BSIC | | 0 to <maxCellMeas> | | | |
| >>>>Inter-RAT cell id | MP | | Integer (0..<maxCellMeas>-1) | | |
| >>>Non verified BSIC | | 0 to <maxCellMeas> | | | |
| >>>>BCCH ARFCN | MP | | Integer (0..1023) | | |
| >E-UTRA | | | | | REL-8 |
| >>E-UTRA Carrier Frequency list | MP | 1 to <maxReportedEUTRAFreqs> | | | REL-8 |
| >>>E-UTRA Carrier Frequency | MP | | Integer (0..65535) | EARFCN of the downlink carrier frequency [64] | REL-8 |
| >>>>Cell list | MP | 1 to <maxReportedEUTRACellsPerFreq> | | | REL-8 |
| >>>>>Physical Cell Identity | MP | | Integer (0..503) | | REL-8 |

13.4.27f11 TRIGGERED_3B_EVENT

This variable contains information about a 3b event that has been configured in the UE. There is one such variable per event 3b configured in the UE.

| Information Element/Group name | Need | Multi | Type and reference | Semantics description | Version |
|---------------------------------|------|-------------------------------------|------------------------------|---|---------|
| CHOICE <i>system</i> | OP | | | | |
| >GSM | | | | | |
| >>CHOICE <i>BSIC</i> | MP | | | | |
| >>>Verified BSIC | | 0 to <maxCellMeas> | | | |
| >>>>Inter-RAT cell id | MP | | Integer (0..<maxCellMeas>-1) | | |
| >>>Non verified BSIC | | 0 to <maxCellMeas> | | | |
| >>>>BCCH ARFCN | MP | | Integer (0..1023) | | |
| >E-UTRA | | | | | REL-8 |
| >>E-UTRA Carrier Frequency list | MP | 1 to <maxReportedEUTRAFreqs> | | | REL-8 |
| >>>E-UTRA Carrier Frequency | MP | | Integer (0..65535) | EARFCN of the downlink carrier frequency [64] | REL-8 |
| >>>>Cell list | MP | 1 to <maxReportedEUTRACellsPerFreq> | | | REL-8 |
| >>>>>Physical Cell Identity | MP | | Integer (0..503) | | REL-8 |

13.4.27f12 TRIGGERED_3C_EVENT

This variable contains information about a 3c event that has been configured in the UE. There is one such variable per event 3c configured in the UE.

| Information Element/Group name | Need | Multi | Type and reference | Semantics description | Version |
|---------------------------------|------|-------------------------------------|------------------------------|---|---------|
| CHOICE <i>system</i> | OP | | | | |
| >GSM | | | | | |
| >>CHOICE <i>BSIC</i> | MP | | | | |
| >>>Verified BSIC | | 0 to <maxCellMeas> | | | |
| >>>>Inter-RAT cell id | MP | | Integer (0..<maxCellMeas>-1) | | |
| >>>Non verified BSIC | | 0 to <maxCellMeas> | | | |
| >>>>BCCH ARFCN | MP | | Integer (0..1023) | | |
| >E-UTRA | | | | | REL-8 |
| >>E-UTRA Carrier Frequency list | MP | 1 to <maxReportedEUTRAFreqs> | | | REL-8 |
| >>>E-UTRA Carrier Frequency | MP | | Integer (0..65535) | EARFCN of the downlink carrier frequency [64] | REL-8 |
| >>>>Cell list | MP | 1 to <maxReportedEUTRACellsPerFreq> | | | REL-8 |
| >>>>>Physical Cell Identity | MP | | Integer (0..503) | | REL-8 |

13.4.27f13 BEST_CELL_3D_EVENT

This variable contains information about a 3d event that has been configured in the UE. There is one such variable per event 3d configured in the UE.

| Information Element/Group name | Need | Multi | Type and reference | Semantics description | Version |
|--------------------------------|------|-------|------------------------------|---|---------|
| CHOICE <i>system</i> | | | | | |
| >GSM | | | | | |
| >>CHOICE <i>BSIC</i> | MP | | | | |
| >>>Verified BSIC | | | | | |
| >>>>Inter-RAT cell id | MP | | Integer (0..<maxCellMeas>-1) | | |
| >>>Non verified BSIC | | | | | |
| >>>>BCCH ARFCN | MP | | Integer (0..1023) | | |
| >E-UTRA | | | | | REL-8 |
| >>E-UTRA Carrier Frequency | MP | | Integer (0..65535) | EARFCN of the downlink carrier frequency [64] | REL-8 |
| >>>Physical Cell Identity | MP | | Integer (0..503) | | REL-8 |

13.4.27f14 TRIGGERED_6A_EVENT

This variable contains information about a 6a event that has been configured in the UE. There is one such variable per 6a event configured in the UE.

| Information Element/Group name | Need | Multi | Type and reference | Semantics description |
|--------------------------------|------|-------|--------------------|-----------------------|
| Event triggered | OP | | Boolean | |

13.4.27f15 TRIGGERED_6B_EVENT

This variable contains information about a 6b event that has been configured in the UE. There is one such variable per 6b event configured in the UE.

| Information Element/Group name | Need | Multi | Type and reference | Semantics description |
|--------------------------------|------|-------|--------------------|-----------------------|
| Event triggered | OP | | Boolean | |

13.4.27f16 TRIGGERED_6C_EVENT

This variable contains information about a 6c event that has been configured in the UE. There is one such variable per 6c event configured in the UE.

| Information Element/Group name | Need | Multi | Type and reference | Semantics description |
|--------------------------------|------|-------|--------------------|-----------------------|
| Event triggered | OP | | Boolean | |

13.4.27f17 TRIGGERED_6D_EVENT

This variable contains information about a 6d event that has been configured in the UE. There is one such variable per 6d event configured in the UE.

| Information Element/Group name | Need | Multi | Type and reference | Semantics description |
|--------------------------------|------|-------|--------------------|-----------------------|
| Event triggered | OP | | Boolean | |

13.4.27f18 TRIGGERED_6E_EVENT

This variable contains information about a 6e event that has been configured in the UE. There is one such variable per 6e event configured in the UE.

| Information Element/Group name | Need | Multi | Type and reference | Semantics description |
|--------------------------------|------|-------|--------------------|-----------------------|
| Event triggered | OP | | Boolean | |

13.4.27f19 TRIGGERED_6F_EVENT

This variable contains information about a 6f event that has been configured in the UE. There is one such variable per 6f event configured in the UE.

| Information Element/Group name | Need | Multi | Type and reference | Semantics description | Version |
|--------------------------------|------|-------------|-----------------------------|-----------------------|---------|
| CHOICE mode | | | | | |
| >FDD | | | | | |
| Event triggered_RL | OP | <maxRL
> | Boolean | | |
| >1.28 Mcps TDD | | | | | REL-4 |
| >>T _{ADV} | MP | | TADV info
10.3.7.11
2 | | REL-4 |

13.4.27f20 TRIGGERED_6G_EVENT

This variable contains information about a 6g event that has been configured in the UE. There is one such variable per 6g event configured in the UE.

| Information Element/Group name | Need | Multi | Type and reference | Semantics description |
|--------------------------------|------|---------|--------------------|-----------------------|
| Event triggered_RL | OP | <maxRL> | Boolean | |

13.4.27f21 TRIGGERED_1J_EVENT

This variable contains information about a 1j event that has been triggered in the UE. There is one such variable per 1j event configured in the UE.

| Information Element/Group name | Need | Multi | Type and reference | Semantics description | Version |
|--------------------------------|------|--------------------|------------------------------|---|---------|
| Cells triggered | OP | 1 to <maxCellMeas> | | Cleared when entering UTRA RRC connected mode.
Cleared when leaving UTRA RRC connected mode. | REL-6 |
| >primary CPICH | MP | | Primary CPICH info 10.3.6.60 | | REL-6 |
| >sent reports | MP | | Integer(1..Infinity) | Number of reports sent to UTRAN in case of event triggered periodical reporting | REL-6 |
| Cells recently triggered | OP | 1 to <maxCellMeas> | | | REL-6 |
| >primary CPICH | MP | | Primary CPICH info 10.3.6.60 | | REL-6 |
| >sent reports | MP | | Integer(1..Infinity) | Number of reports sent to UTRAN in case of event triggered periodical reporting | REL-6 |
| Periodical reporting running | MP | | Boolean | | REL-6 |

13.4.27g UE_CAPABILITY_REQUESTED

This variable stores information about the UE capabilities that have been requested by UTRAN but that have not yet been transferred to UTRAN.

| Information Element/Group name | Need | Multi | Type and reference | Semantics description |
|---------------------------------------|------|-------------------------------|---|--|
| UE radio access capability | OP | | UE radio access capability 10.3.3.42 | Cleared when entering UTRA RRC connected mode.
Cleared when leaving UTRA RRC connected mode. |
| UE radio access capability extension | OP | | UE radio access capability extension 10.3.3.42a | Cleared when entering UTRA RRC connected mode.
Cleared when leaving UTRA RRC connected mode. |
| UE system specific capability | OP | 1 to <maxInterSystemMessages> | | |
| >Inter-RAT UE radio access capability | MP | | Inter-RAT UE radio access capability 10.3.8.7 | Includes inter-RAT classmark.
Cleared when entering UTRA RRC connected mode.
Cleared when leaving UTRA RRC connected mode. |

13.4.28 UE_CAPABILITY_TRANSFERRED

This variable stores information about which UE capabilities that have been transferred to UTRAN.

| Information Element/Group name | Need | Multi | Type and reference | Semantics description | Version |
|---------------------------------------|------|----------------------------|---|---|---------|
| UE radio access capability | OP | | UE radio access capability
10.3.3.42 | Cleared when entering UTRA RRC connected mode when not stated otherwise in the procedure.
Cleared when leaving UTRA RRC connected mode. | |
| UE radio access capability extension | OP | | UE radio access capability extension
10.3.3.42a | Cleared when entering UTRA RRC connected mode when not stated otherwise in the procedure.
Cleared when leaving UTRA RRC connected mode. | |
| UE system specific capability | OP | 1 to <maxSystemCapability> | | | |
| >Inter-RAT UE radio access capability | MP | | Inter-RAT UE radio access capability
10.3.8.7 | Includes inter-RAT classmark.
Cleared when entering UTRA RRC connected mode when not stated otherwise in the procedure.
Cleared when leaving UTRA RRC connected mode. | |
| UE radio access capability compressed | OP | | UE radio access capability compressed
10.3.3.42o | | REL-5 |
| Security capability | OP | | Security capability
10.3.3.37 | | REL-5 |

13.4.28a UE_POSITIONING_GPS_DATA

| Information Element/Group name | Need | Multi | Type and reference | Semantics description |
|--|------|-------|--|--|
| GPS Data ciphering info | OP | | UE positioning Ciphering info
10.3.7.86 | |
| GPS Deciphering Keys | OP | | | |
| >Current deciphering key | MP | | Bit string(56) | |
| >Next deciphering key | MP | | Bit string(56) | |
| UE positioning GPS reference time | OP | | UE positioning GPS reference time
10.3.7.96 | |
| UE positioning GPS reference UE position | OP | | Ellipsoid point with altitude and uncertainty ellipsoid
10.3.8.4c | A priori knowledge of UE 3-D position. |
| UE positioning GPS DGPS corrections | OP | | UE positioning GPS DGPS corrections
10.3.7.91 | |

| Information Element/Group name | Need | Multi | Type and reference | Semantics description |
|--|------|-----------------------------|---|-------------------------|
| UE positioning GPS navigation model | OP | 1 to <maxSat> | | |
| >SatID | MP | | Enumerated(0..63) | Satellite ID |
| >GPS Ephemeris and Clock Correction parameters | MP | | UE positioning GPS Ephemeris and Clock Correction parameters 10.3.7.91a | |
| UE positioning GPS ionospheric model | OP | | UE positioning GPS ionospheric model 10.3.7.92 | |
| UE positioning GPS UTC model | OP | | UE positioning GPS UTC model 10.3.7.97 | |
| UE positioning GPS almanac | OP | | | |
| >SatID | MP | 1 to <maxSatAlmanacStorage> | | |
| >>WN _a | MP | | | Same as IE in 10.3.7.89 |
| >>DataID | MP | | | Same as IE in 10.3.7.89 |
| >>e | MP | | | Same as IE in 10.3.7.89 |
| >>t _{oa} | MP | | | Same as IE in 10.3.7.89 |
| >>δI | MP | | | Same as IE in 10.3.7.89 |
| >>OMEGADOT | MP | | | Same as IE in 10.3.7.89 |
| >>SV Health | MP | | | Same as IE in 10.3.7.89 |
| >>A ^{1/2} | MP | | | Same as IE in 10.3.7.89 |
| >>OMEGA ₀ | MP | | | Same as IE in 10.3.7.89 |
| >>M ₀ | MP | | | Same as IE in 10.3.7.89 |
| >>ω | MP | | | Same as IE in 10.3.7.89 |
| >>af ₀ | MP | | | Same as IE in 10.3.7.89 |
| >>af ₁ | MP | | | Same as IE in 10.3.7.89 |
| >SV Global Health | OP | | | Same as IE in 10.3.7.89 |
| UE positioning GPS acquisition assistance | OP | | UE positioning GPS acquisition assistance 10.3.7.88 | |
| UE positioning GPS real-time integrity | OP | | UE positioning GPS real-time integrity 10.3.7.95 | |

13.4.28b UE_POSITIONING_OTDOA_DATA_UE_ASSISTED

| Information Element/Group name | Need | Multi | Type and reference | Semantics description |
|---|------|---------------------|---|-----------------------|
| UE positioning OTDOA reference cell info for UE-assisted | OP | | UE positioning OTDOA reference cell info 10.3.7.108 | |
| UE positioning OTDOA neighbour cell list for UE-assisted | OP | 1 to <maxCellM eas> | | |
| >UE positioning OTDOA neighbour cell info for UE-assisted | MP | | UE positioning OTDOA neighbour cell info 10.3.7.106 | |

13.4.28c UE_POSITIONING_OTDOA_DATA_UE_BASED

| Information Element/Group name | Need | Multi | Type and reference | Semantics description |
|--|------|---------------------|---|-----------------------|
| OTDOA Deciphering Keys | OP | | | |
| >Current deciphering key | MP | | Bit string(56) | |
| >Next deciphering key | MP | | Bit string(56) | |
| OTDOA Data ciphering info | OP | | UE positioning Ciphering info 10.3.7.86 | |
| UE positioning OTDOA reference cell info for UE-based | OP | | UE positioning OTDOA reference cell info for UE-based 10.3.7.108a | |
| UE positioning OTDOA neighbour cell list for UE-based | OP | 1 to <maxCellM eas> | | |
| >UE positioning OTDOA neighbour cell info for UE-based | MP | | UE positioning OTDOA neighbour cell info for UE-based 10.3.7.106 | |

13.4.28d UE_POSITIONING_GANSS_DATA

| Information Element/Group name | Need | Multi | Type and reference | Semantics description | Version |
|---|------------------|-------------------|--|--|---------|
| GANSS Data ciphering info | OP | | UE positioning Ciphering info
10.3.7.86 | | REL-7 |
| GANSS Deciphering Keys | OP | | | | REL-7 |
| >Current deciphering key | MP | | Bit string(56) | | REL-7 |
| >Next deciphering key | MP | | Bit string(56) | | REL-7 |
| UE positioning GANSS reference time | OP | | UE positioning GANSS reference time
10.3.7.96o | | REL-7 |
| UE positioning GANSS reference UE position | OP | | Ellipsoid point with altitude and uncertainty ellipsoid
10.3.8.4c | A priori knowledge of UE 3-D position. | REL-7 |
| UE positioning GANSS additional ionospheric model | OP | | UE positioning GANSS ionospheric model
10.3.7.92b | | REL-8 |
| UE positioning GANSS Earth orientation parameters | OP | | UE positioning GANSS Earth orientation parameters
10.3.7.92c | | REL-8 |
| UE positioning GANSS ionospheric model | OP | | UE positioning GANSS ionospheric model
10.3.7.92a | | REL-7 |
| GANSS Generic DataList | OP | 1 to <maxGANSS> | | | REL-7 |
| >GANSS ID | OP | | Integer (0..7) | Same as IE in 10.3.7.90b | REL-7 |
| >SBAS ID | CV-GANSS-ID-SBAS | | UE positioning GANSS SBAS ID
10.3.7.97e | | REL-8 |
| >GANSS Time Models List | | 1 to <maxGANSS-1> | | | REL-7 |
| >>Positioning GANSS Time Model | OP | | UE positioning GANSS time model
10.3.7.97a | | |
| >UE positioning DGANSS corrections | OP | | UE positioning DGANSS corrections
10.3.7.91b | | REL-7 |
| >UE positioning GANSS | OP | | UE | | REL-7 |

| Information Element/Group name | Need | Multi | Type and reference | Semantics description | Version |
|---|------|-------|---|-----------------------|---------|
| navigation model | | | positioning GANSS navigation model 10.3.7.94a | | |
| >UE positioning GANSS additional navigation models | OP | | UE positioning GANSS additional navigation models 10.3.7.94b | | REL-8 |
| >UE positioning GANSS real-time integrity | OP | | UE positioning GANSS real-time integrity 10.3.7.95a | | REL-7 |
| >UE positioning GANSS data bit assistance | OP | | UE positioning GANSS data bit assistance 10.3.7.97b | | REL-7 |
| >UE positioning GANSS reference measurement information | OP | | UE positioning GANSS reference measurement information 10.3.7.88b | | REL-7 |
| >UE positioning GANSS almanac | OP | | UE positioning GANSS almanac 10.3.7.89a | | REL-7 |
| >UE positioning GANSS UTC model | OP | | UE positioning GANSS UTC model 10.3.7.97c | | REL-7 |
| >UE positioning GANSS additional UTC models | OP | | UE positioning GANSS additional UTC models 10.3.7.97d | | REL-8 |
| >UE positioning GANSS auxiliary information | OP | | UE positioning GANSS auxiliary information 10.3.7.97f | | REL-8 |

| Condition | Explanation |
|---------------|--|
| GANSS-ID-SBAS | The IE is mandatory present if the IE "GANSS ID" is "SBAS" and never stored otherwise. |

13.4.29 UNSUPPORTED_CONFIGURATION

This variable indicates whether a received message contained a configuration that is not supported by the UE.

| Information Element/Group name | Need | Multi | Type and reference | Semantics description |
|--------------------------------|------|-------|--------------------|--|
| Unsupported configuration | MP | | Boolean | TRUE: An unsupported configuration has been detected.
Set to FALSE when entering UTRA RRC connected mode.
Set to FALSE when leaving UTRA RRC connected mode. |

13.4.30 URA_IDENTITY

This variable stores the assigned URA identity for this UE when in URA_PCH state.

| Information Element/Group name | Need | Multi | Type and reference | Semantics description |
|--------------------------------|------|-------|-----------------------|---|
| URA identity | OP | | URA identity 10.3.2.6 | Cleared when entering UTRA RRC connected mode.
Cleared when leaving UTRA RRC connected mode. |

13.4.31 U_RNTI

This variable stores the assigned U-RNTI for this UE.

| Information Element/Group name | Need | Multi | Type and reference | Semantics description |
|--------------------------------|------|-------|--------------------|---|
| U-RNTI | OP | | U-RNTI 10.3.3.47 | Cleared when leaving UTRA RRC connected mode. |

13.4.32 VALUE_TAG

This variable contains information about the value tag for the last received system information block of a given type, for all system information blocks using value tags. The UE shall maintain one instance of this variable for the current selected cell. The UE may store several instances of this variable, one for each cell, to be used if the UE returns to these cells.

All IEs in this variable shall be cleared when switched off. All IEs in this variable except for the IE "SIB 16 value tag list" shall be cleared at selection of a new cell and this cell broadcasts an IE "PLMN Identity" in the MIB which is different from the IE "PLMN Identity" broadcast in the MIB in the previously selected cell. The IE "SIB 16 value tag list" is cleared when NAS informs AS about a new selected PLMN.

| Information Element/Group name | Need | Multi | Type and reference | Semantics description | Version |
|--------------------------------|--------|-------|--------------------------|--|---------|
| MIB value tag | OP | | MIB value tag 10.3.8.9 | Value tag for the master information block | |
| SB 1 value tag | OP | | Cell value tag 10.3.8.4 | Value tag for the scheduling block type 1 | |
| SB 2 value tag | OP | | Cell value tag 10.3.8.4 | Value tag for the scheduling block type 2 | |
| SIB 1 value tag | CV-GSM | | PLMN value tag 10.3.8.10 | Value tag for the system information block type 1
Note: IE "PLMN value tag" is used for SIB1 but the area scope for | |

| Information Element/Group name | Need | Multi | Type and reference | Semantics description | Version |
|--------------------------------|---------|-------|-------------------------|---|---------|
| | | | | SIB 1 is Cell. | |
| SIB 2 value tag | OP | | Cell value tag 10.3.8.4 | Value tag for the system information block type 2 | |
| SIB 3 value tag | OP | | Cell value tag 10.3.8.4 | Value tag for the system information block type 3 | |
| SIB 4 value tag | OP | | Cell value tag 10.3.8.4 | Value tag for the system information block type 4 | |
| SIB 5 value tag | OP | | Cell value tag 10.3.8.4 | Value tag for the system information block type 5 or 5bis | |
| SIB 6 value tag | OP | | Cell value tag 10.3.8.4 | Value tag for the system information block type 6 | |
| CHOICE <i>mode</i> | MP | | | | |
| >FDD | | | | | |
| >TDD | | | | (no data) | |
| SIB 11 value tag | OP | | Cell value tag 10.3.8.4 | Value tag for the system information block type 11 | |
| SIB 11bis value tag | OP | | Cell value tag 10.3.8.4 | Value tag for the system information block type 11bis | REL-6 |
| SIB 12 value tag | OP | | Cell value tag 10.3.8.4 | Value tag for the system information block type 12 | |
| SIB 13 value tag | CV-ANSI | | Cell value tag 10.3.8.4 | Value tag for the system information block type 13 | |
| SIB 13.1 value tag | CV-ANSI | | Cell value tag 10.3.8.4 | Value tag for the system information block type 13.1 | |
| SIB 13.2 value tag | CV-ANSI | | Cell value tag 10.3.8.4 | Value tag for the system information block type 13.2 | |
| SIB 13.3 value tag | CV-ANSI | | Cell value tag 10.3.8.4 | Value tag for the system information block type 13.3 | |
| SIB 13.4 value tag | CV-ANSI | | Cell value tag 10.3.8.4 | Value tag for the system information block type 13.4 | |
| SIB 15 value tag | OP | | Cell value tag 10.3.8.4 | Value tag for the system information block type 15 | |
| SIB 15bis value tag | OP | | Cell value tag 10.3.8.4 | Value tag for the system information block type 15bis | REL-7 |
| SIB 15.1 value tag | OP | | Cell value | Value tag for the | |

| Information Element/Group name | Need | Multi | Type and reference | Semantics description | Version |
|--|------|---------------|--|---|---------|
| | | | tag 10.3.8.4 | system information block type 15.1 | |
| SIB 15.2 value tag list | OP | 1 to <maxSat> | | List of value tags for all stored occurrences of system information block type 15.2 | |
| >SIB 15.2 value tag | MP | | Cell value tag 10.3.8.4 | | |
| >SIB occurrence identity and value tag | MP | | SIB occurrence identity and value tag 10.3.8.20b | | |
| SIB 15.3 value tag list | OP | 1 to <maxSat> | | List of value tags for all stored occurrences of system information block type 15.3 | |
| >SIB 15.3 value tag | MP | | PLMN value tag 10.3.8.10 | Value tag for the system information block type 15.3 | |
| >SIB occurrence identity and value tag | MP | | SIB occurrence identity and value tag 10.3.8.20b | | |
| SIB 15.4 value tag | OP | | Cell value tag 10.3.8.4 | Value tag for the system information block type 15.4 | |

| Information Element/Group name | Need | Multi | Type and reference | Semantics description | Version |
|---|--------------------------|-----------------|--|---|---------|
| SIB 15.5 value tag | OP | | Cell value tag 10.3.8.4 | Value tag for the system information block type 15.5 | |
| GANSS specific SIBs | OP | 1 to <maxGANSS> | | | REL-7 |
| >GANSS ID | MD | | Integer(0..7) | Identifier for GANSS, absence of this IE means Galileo.
For coding description see NOTE 1 in 10.3.7.90b. | REL-7 |
| >SBAS ID | CV-
GANSS-ID
-SBAS | | UE positioning GANSS SBAS ID 10.3.7.97e | | REL-8 |
| >SIB 15.1bis value tag | OP | | Cell value tag 10.3.8.4 | Value tag for the system information block type 15.1bis | REL-7 |
| >SIB 15.2bis value tag list | OP | 1 to <maxSat> | | List of value tags for all stored occurrences of system information block type 15.2bis | REL-7 |
| >>SIB 15.2bis value tag | MP | | Cell value tag 10.3.8.4 | | REL-7 |
| >>SIB occurrence identity and value tag | MP | | SIB occurrence identity and value tag 10.3.8.20b | | REL-7 |
| >SIB 15.2ter value tag list | OP | 1 to <maxSat> | | List of value tags for all stored occurrences of system information block type 15.2ter | REL-8 |
| >>SIB 15.2ter value tag | MP | | Cell value tag 10.3.8.4 | | REL-8 |
| >>SIB occurrence identity and value tag | MP | | SIB occurrence identity and value tag 10.3.8.20b | | REL-8 |
| >SIB 15.3bis value tag list | OP | 1 to <maxSat> | | List of value tags for all stored occurrences of system information block type 15.3bis | REL-7 |
| >>SIB 15.3bis value tag | MP | | PLMN value tag 10.3.8.10 | Value tag for the system information block type 15.3bis | REL-7 |
| >>SIB occurrence identity and value tag | MP | | SIB occurrence identity and value tag 10.3.8.20b | | REL-7 |

| Information Element/Group name | Need | Multi | Type and reference | Semantics description | Version |
|--|------|-------------------------|---|---|---------|
| >SIB 15.6 value tag | OP | | Cell value tag 10.3.8.4 | Value tag for the system information block type 15.6 | REL-7 |
| >SIB 15.7 value tag | OP | | Cell value tag 10.3.8.4 | Value tag for the system information block type 15.7 | REL-7 |
| >SIB 15.8 value tag | OP | | Cell value tag 10.3.8.4 | Value tag for the system information block type 15.8 | REL-7 |
| SIB 16 value tag list | OP | 1 to <maxPred efConfig> | | List of value tags for all stored occurrences of the system information block type 16 | |
| >Predefined configuration identity and value tag | MP | | Predefined configuration identity and value tag 10.3.8.11 | | |
| SIB 18 value tag | OP | | Cell value tag 10.3.8.4 | Value tag for the system information block type 18 | |
| SIB 19 value tag | OP | | Cell value tag 10.3.8.4 | Value tag for the system information block type 19 | REL-8 |
| SIB 20 value tag | OP | | Cell value tag 10.3.8.4 | Value tag for the system information block type 20 | REL-8 |

| Condition | Explanation |
|----------------------|---|
| <i>GSM</i> | This information is optional when the UE is operating in "GSM-MAP mode" and never stored otherwise. |
| <i>ANSI</i> | This information is optional when the UE is operating in "ANSI-41 mode" and never stored otherwise. |
| <i>GANSS-ID-SBAS</i> | The IE is mandatory present if the IE "GANSS ID" is "SBAS" and never stored otherwise. |

13.4.33 CONTROL_CHANNEL_DRX_PARAMS

NOTE: For 1.28 Mcps TDD only.

| Information Element/Group name | Need | Multi | Type and reference | Semantics description | Version |
|---------------------------------------|------|-------|--|-----------------------|---------|
| UE parameters for Control Channel DRX | MP | | Control Channel DRX Information 1.28Mcps TDD in 10.3.6.107 | | REL-8 |

13.4.34 CONTROL_CHANNEL_DRX_STATUS

NOTE: For 1.28 Mcps TDD only.

This variable indicates whether discontinuous reception of Control Channel procedures is enable. See subclause 8.5.53 for actions related to the setting of this variable.

| Information Element/Group name | Need | Multi | Type and reference | Semantics description | Version |
|--------------------------------|------|-------|--------------------|---|---------|
| CONTROL_CHANNEL_DRX_STATUS | MP | | Boolean | TRUE:
control channel discontinuous reception is enable.
Set to FALSE when entering UTRA RRC connected mode when not otherwise stated in the procedure.
Set to FALSE when leaving UTRA RRC connected mode. | REL-8 |

13.4.35 E_DCH_SPS_PARAMS

NOTE: For 1.28 Mcps TDD only.

This variable contains the parameters for E-DCH Semi-persistent Scheduling. The parameters are listed in subclause 10.3.6.111.

| Information Element/Group name | Need | Multi | Type and reference | Semantics description | Version |
|--------------------------------|------|-------|--|-----------------------|---------|
| UE parameters for E-DCH SPS | MP | | E-DCH SPS Information 1.28Mcps TDD in 10.3.6.111 | | REL-8 |

13.4.36 E_DCH_SPS_STATUS

NOTE: For 1.28 Mcps TDD only.

This variable indicates whether E-DCH Semi-persistent Scheduling procedures are ongoing. See subclause 8.5.54 for actions related to the setting of this variable.

| Information Element/Group name | Need | Multi | Type and reference | Semantics description | Version |
|--------------------------------|------|-------|--------------------|---|---------|
| E_DCH_SPS_STATUS | MP | | Boolean | TRUE: E-DCH SPS operation is ongoing.
Set to FALSE when entering UTRA RRC connected mode when not otherwise stated in the procedure.
Set to FALSE when leaving UTRA RRC connected mode. | REL-8 |

13.4.37 HS_DSCH_SPS_PARAMS

NOTE: For 1.28 Mcps only.

This variable contains the parameters for HS-DSCH Semi-persistent Scheduling. The parameters are listed in subclause 10.3.6.112.

| Information Element/Group name | Need | Multi | Type and reference | Semantics description | Version |
|--------------------------------|------|-------|--|-----------------------|---------|
| UE parameters for HS-DSCH SPS | MP | | HS-DSCH SPS Information 1.28Mcps TDD in 10.3.6.112 | | REL-8 |

13.4.38 HS_DSCH_SPS_STATUS

NOTE: For 1.28 Mcps only.

This variable indicates whether HS-DSCH Semi-persistent Scheduling procedures are ongoing. See subclause 8.5.55 for actions related to the setting of this variable.

| Information Element/Group name | Need | Multi | Type and reference | Semantics description | Version |
|--------------------------------|------|-------|--------------------|---|---------|
| HS_DSCH_SPS_STATUS | MP | | Boolean | TRUE: HS-DSCH SPS is ongoing.
Set to FALSE when entering UTRA RRC connected mode when not otherwise stated in the procedure.
Set to FALSE when leaving UTRA RRC connected mode. | REL-8 |

13.5 UE RRC Procedure Performance

This subclause defines the performance requirements related to RRC procedures in the UE. Where the total delay is impacted by processing of variable length on the physical layer (e.g. physical layer synchronisation), references to appropriate specifications are given.

13.5.1 Definitions

The following definitions of N1 and N2 are valid only for this UE RRC Procedure Performance specification.

N1 = upper limit on the time required to execute modifications in UE after the reception of a UTRAN -> UE message has been completed. Where applicable (e.g. the physical layer transmission is impacted), the changes shall be adopted in the beginning of the next TTI starting after N1. N1 is specified as a multiple of 10 ms.

N2 = number of 10 ms radio frames from end of reception of UTRAN -> UE message on UE physical layer before the transmission of the UE -> UTRAN response message must be ready to start on a transport channel with no access delay other than the TTI alignment (e.g. DCH, therefore excluding delays caused by RACH procedure etc). The UE response message transmission from the physical layer shall begin at the latest $(N2*10)+TTI$ ms after completion of the reception of the last TTI carrying the triggering UTRAN -> UE message. When Target State is CELL_DCH, the UE response message transmission from the physical layer may be additionally delayed by the value of IE "SRB delay".

N1 and N2 are independent (e.g. $N2-N1$ is not restricted to being less than or equal to 10ms).

13.5.2 RRC procedure performance values

NOTE: Times indicated in the table do not include cell reselection.

| Procedure title: | UTRAN -> UE | UE -> UTRAN | N1 | N2 | Notes |
|---|--------------------|-------------|----|----|--|
| RRC Connection Management Procedures | | | | | |
| Broadcast of system information | SYSTEM INFORMATION | | | | N2 is not applicable for any system information messages, because there is no response message from the UE. |
| Master Information Block | SYSTEM INFORMATION | | 5 | NA | No system information data shall be lost due to processing of a MIB received with no detectable errors. This means that the UE shall buffer all system information data received after the MIB until the data can be processed according to the information in the MIB, unless the MIB was received erroneously. |
| System Information Block type 1 | SYSTEM INFORMATION | | 10 | NA | |
| System Information Block type 2 | SYSTEM INFORMATION | | 10 | NA | |
| System Information Block type 3 | SYSTEM INFORMATION | | 10 | NA | |
| System Information Block type 4 | SYSTEM INFORMATION | | 10 | NA | |
| System Information Block type 5 or System Information Block type 5bis | SYSTEM INFORMATION | | 10 | NA | |
| System Information Block type 6 | SYSTEM INFORMATION | | 10 | NA | |
| System Information Block type 7 | SYSTEM INFORMATION | | 5 | NA | |
| System Information Block type 11 or System Information Block type 11bis | SYSTEM INFORMATION | | 10 | NA | |
| System Information Block type 12 | SYSTEM INFORMATION | | 10 | NA | |
| System Information Block type 13 | SYSTEM INFORMATION | | 10 | NA | |
| System Information Block type 14 | SYSTEM INFORMATION | | 10 | NA | |

| Procedure title: | UTRAN -> UE | UE -> UTRAN | N1 | N2 | Notes |
|---|-------------------------------|---------------------------------|----|-------|---|
| System Information Block type 15 or 15bis or 15.1 or 15.1bis or 15.2 or 15.2bis or 15.2ter or 15.3 or 15.3bis or 15.4 or 15.5 or 15.6 or 15.7 or 15.8 | SYSTEM INFORMATION | | 10 | NA | |
| System Information Block type 16 | SYSTEM INFORMATION | | 10 | NA | |
| System Information Block type 18 | SYSTEM INFORMATION | | 10 | NA | |
| System Information Block type 19 | SYSTEM INFORMATION | | 10 | NA | |
| System Information Block type 20 | SYSTEM INFORMATION | | 10 | NA | |
| System Information Change Indication | SYSTEM INFORMATION | | 10 | NA | |
| RRC connection establishment
<i>Target state CELL_DCH</i> | RRC CONNECTION SETUP | RRC CONNECTION SETUP COMPLETE | 10 | NA | N1 measures time to the start of tx / rx on DPCH. N2 cannot be specified, because RRC CONNECTION SETUP COMPLETE message is transmitted only after physical layer synchronisation, which also depends on the Node B.

The performance of the physical layer synchronisation procedure is specified in [19] and [20] |
| RRC connection establishment
<i>Target state CELL_FACH</i> | RRC CONNECTION SETUP | RRC CONNECTION SETUP COMPLETE | 10 | 11 | N1 and N2 applicable as defined (N2 can be tested from the initiation of the power ramp on RACH). |
| RRC connection release
<i>From CELL_DCH state</i> | RRC CONNECTION RELEASE | RRC CONNECTION RELEASE COMPLETE | 5 | 8 | N1 sets the requirement for the time from the completion of the last repetition of the RRC CONNECTION RELEASE COMPLETE message to the release of the physical channel.

N2 sets the requirement from the end of successful reception of the RRC CONNECTION RELEASE message to the start of the first transmission of the RRC CONNECTION RELEASE COMPLETE message. |
| RRC connection release
<i>From CELL_FACH state</i> | RRC CONNECTION RELEASE | RRC CONNECTION RELEASE COMPLETE | NA | 11 | N1 represents UE internal configuration that cannot be externally observed. |
| Paging | PAGING TYPE 1 | CELL UPDATE | 10 | 11+ T | T is the repetition period of SIB7 (applicable for FDD) and SIB14 (applicable for TDD) |
| UE capability enquiry | UE CAPABILITY ENQUIRY | UE CAPABILITY INFORMATION | NA | 8 | N1 is not applicable because the UE configuration does not change. |
| Security mode control | SECURITY MODE COMMAND | SECURITY MODE COMPLETE | 5 | 8 | |
| Signalling connection release procedure | SIGNALLING CONNECTION RELEASE | | 5 | NA | N2 is not applicable because there is no response message. |
| Counter check | COUNTER CHECK | COUNTER CHECK RESPONSE | NA | 8 | N1 is not applicable because the UE configuration does not change. |

| Procedure title: | UTRAN -> UE | UE -> UTRAN | N1 | N2 | Notes |
|---|---|---|---------|----|---|
| ETWS Primary Notification with Security | ETWS PRIMARY NOTIFICATION WITH SECURITY | | 10 | NA | N2 is not applicable because there is no response message. |
| Radio Bearer control procedures | | | | | |
| Radio bearer establishment
<i>Target state CELL_DCH</i> | RADIO BEARER SETUP | RADIO BEARER SETUP COMPLETE / FAILURE | 10 | NA | N2 cannot be specified, because the RADIO BEARER SETUP COMPLETE / FAILURE message is transmitted only after physical layer synchronisation, which depends also on Node B. |
| Radio bearer establishment
<i>From state CELL_FACH to state CELL_FACH</i> | RADIO BEARER SETUP | RADIO BEARER SETUP COMPLETE / FAILURE | 10 | 11 | |
| Radio bearer establishment
<i>From CELL_DCH to CELL_FACH</i> | RADIO BEARER SETUP | RADIO BEARER SETUP COMPLETE | NA | NA | N1 and N2 cannot be specified, because UE need to read SIBs on BCH before sending RADIO BEARER SETUP COMPLETE |
| Radio bearer reconfiguration
<i>Target state CELL_DCH</i> | RADIO BEARER RECONFIGURATION | RADIO BEARER RECONFIGURATION COMPLETE / FAILURE | 5 or 10 | NA | N2 cannot be specified, because the RADIO BEARER RECONFIGURATION COMPLETE / FAILURE message is transmitted only after physical layer synchronisation, which depends also on Node B.
NOTE 1 |
| Radio bearer reconfiguration
<i>From Idle Mode and state CELL_FACH to state CELL_DCH</i> | RADIO BEARER RECONFIGURATION | RADIO BEARER RECONFIGURATION COMPLETE / FAILURE | 10 | 11 | This requirement applies when the UE has a common E-DCH resource and is not required to perform any synchronization. |
| Radio bearer reconfiguration
<i>From state CELL_FACH to state CELL_FACH</i> | RADIO BEARER RECONFIGURATION | RADIO BEARER RECONFIGURATION COMPLETE / FAILURE | 10 | 11 | |
| Radio bearer reconfiguration
<i>From state CELL_DCH to state CELL_FACH</i> | RADIO BEARER RECONFIGURATION | RADIO BEARER RECONFIGURATION COMPLETE | NA | NA | N1 and N2 cannot be specified, because UE need to read SIBs on BCH before sending RADIO BEARER RECONFIGURATION COMPLETE |
| Radio bearer release
<i>Target state CELL_DCH</i> | RADIO BEARER RELEASE | RADIO BEARER RELEASE COMPLETE / FAILURE | 10 | 11 | |
| Radio bearer release
<i>From state CELL_FACH to state CELL_FACH</i> | RADIO BEARER RELEASE | RADIO BEARER RELEASE COMPLETE / FAILURE | 10 | 11 | |
| Radio bearer release
<i>From state CELL_DCH to state CELL_FACH</i> | RADIO BEARER RELEASE | RADIO BEARER RELEASE COMPLETE | NA | NA | N1 and N2 cannot be specified, because UE need to read SIBs on BCH before sending RADIO BEARER RECONFIGURATION COMPLETE |

| Procedure title: | UTRAN -> UE | UE -> UTRAN | N1 | N2 | Notes |
|---|--------------------------------------|--|---------|----|--|
| Transport channel reconfiguration
<i>Target state CELL_DCH</i> | TRANSPORT CHANNEL RECONFIGURATION | TRANSPORT CHANNEL RECONFIGURATION COMPLETE / FAILURE | 5 or 10 | NA | N2 cannot be specified, because the TRANSPORT CHANNEL RECONFIGURATION COMPLETE / FAILURE message is transmitted only after physical layer synchronisation, which depends also on Node B.
NOTE 1 |
| Transport channel reconfiguration
<i>From state CELL_FACH to state CELL_FACH</i> | TRANSPORT CHANNEL RECONFIGURATION | TRANSPORT CHANNEL RECONFIGURATION COMPLETE / FAILURE | 10 | 11 | |
| Transport channel reconfiguration
<i>From state CELL_DCH to state CELL_FACH</i> | TRANSPORT CHANNEL RECONFIGURATION | TRANSPORT CHANNEL RECONFIGURATION COMPLETE | NA | NA | N1 and N2 cannot be specified, because UE need to read SIBs on BCH before sending TRANSPORT CHANNEL RECONFIGURATION COMPLETE |
| Transport format combination control
<i>AM or UM RLC mode</i> | TRANSPORT FORMAT COMBINATION CONTROL | TRANSPORT FORMAT COMBINATION CONTROL FAILURE | 5 | 8 | |
| Transport format combination control
<i>Transparent mode</i> | TRANSPORT FORMAT COMBINATION CONTROL | | 5 | NA | N2 is not applicable because no response message is defined. |
| Physical channel reconfiguration
<i>Target state CELL_DCH</i> | PHYSICAL CHANNEL RECONFIGURATION | PHYSICAL CHANNEL RECONFIGURATION COMPLETE / FAILURE | 5 or 8 | NA | N2 cannot be specified, because the PHYSICAL CHANNEL RECONFIGURATION COMPLETE / FAILURE message is transmitted only after physical layer synchronisation, which depends also on Node B.
NOTE 1 |
| Physical channel reconfiguration
<i>From state CELL_FACH to state CELL_FACH</i> | PHYSICAL CHANNEL RECONFIGURATION | PHYSICAL CHANNEL RECONFIGURATION COMPLETE / FAILURE | 8 | 9 | |
| Physical channel reconfiguration
<i>From state CELL_DCH to state CELL_FACH</i> | PHYSICAL CHANNEL RECONFIGURATION | PHYSICAL CHANNEL RECONFIGURATION COMPLETE | NA | NA | N1 and N2 cannot be specified, because UE need to read SIBs on BCH before sending PHYSICAL CHANNEL RECONFIGURATION COMPLETE |
| Physical Shared Channel Allocation [TDD only] | PHYSICAL SHARED CHANNEL ALLOCATION | | 5 | NA | N2 is not applicable because no response message is defined. |
| Uplink Physical Channel Control [TDD only] | UPLINK PHYSICAL CHANNEL CONTROL | | 8 | NA | Requirements for outer loop and timing advance adjustments are defined in [22] and [20]. N2 is not applicable because there is no response message. |
| RRC connection mobility procedures | | | | | |

| Procedure title: | UTRAN -> UE | UE -> UTRAN | N1 | N2 | Notes |
|----------------------------|----------------------------|---|----|----|---|
| Cell update | CELL UPDATE CONFIRM | UTRAN MOBILITY INFORMATION CONFIRM | 5 | 8 | |
| | | PHYSICAL CHANNEL RECONFIGURATION COMPLETE
<i>Target state</i>
<i>CELL_FACH</i> | 8 | 9 | |
| | | PHYSICAL CHANNEL RECONFIGURATION COMPLETE
<i>Target state</i>
<i>CELL_DCH</i> | 8 | NA | N2 cannot be specified, because the PHYSICAL CHANNEL RECONFIGURATION COMPLETE / FAILURE message is transmitted only after physical layer synchronisation, which depends also on Node B. |
| | | TRANSPORT CHANNEL RECONFIGURATION COMPLETE
<i>Target state</i>
<i>CELL_FACH</i> | 10 | 11 | |
| | | TRANSPORT CHANNEL RECONFIGURATION COMPLETE
<i>Target state</i>
<i>CELL_DCH</i> | 10 | NA | N2 cannot be specified, because the PHYSICAL CHANNEL RECONFIGURATION COMPLETE / FAILURE message is transmitted only after physical layer synchronisation, which depends also on Node B. |
| | | RADIO BEARER RECONFIGURATION COMPLETE
<i>Target state</i>
<i>CELL_FACH</i> | 10 | 11 | |
| | | RADIO BEARER RECONFIGURATION COMPLETE
<i>Target state</i>
<i>CELL_DCH</i> | 10 | NA | N2 cannot be specified, because the PHYSICAL CHANNEL RECONFIGURATION COMPLETE / FAILURE message is transmitted only after physical layer synchronisation, which depends also on Node B. |
| | | RADIO BEARER RELEASE COMPLETE
<i>Target state</i>
<i>CELL_DCH</i> | 10 | 11 | |
| URA update | URA UPDATE CONFIRM | UTRAN MOBILITY INFORMATION CONFIRM | 5 | 8 | |
| UTRAN mobility information | UTRAN MOBILITY INFORMATION | UTRAN MOBILITY INFORMATION CONFIRM / FAILURE | 5 | 8 | |

| Procedure title: | UTRAN -> UE | UE -> UTRAN | N1 | N2 | Notes |
|-------------------------------|--|--------------------------------------|----|----|---|
| Active set update | ACTIVE SET UPDATE | ACTIVE SET UPDATE COMPLETE / FAILURE | NA | 5 | The requirements on UE combining and power control performance for both UL and DL are specified by RAN WG4 in [21] and [19].

Also in case of branch addition the COMPLETE / FAILURE message is transmitted without waiting for the new branch to stabilise, therefore N2 is specified. |
| Inter-RAT handover to UTRAN | HANDOVER TO UTRAN COMMAND (other system) | HANDOVER TO UTRAN COMPLETE | NA | NA | The performance of this procedure is specified in 3GPP TS 45.010 in case of handover from GSM and 3GPP TS 36.133 in case of handover from E-UTRA. |
| Inter-RAT handover from UTRAN | HANDOVER FROM UTRAN COMMAND | HANDOVER FROM UTRAN FAILURE | NA | NA | The performance of this procedure is specified in [19] and [20]. |
| Measurement procedures | | | | | |
| Measurement control | MEASUREMENT CONTROL | MEASUREMENT CONTROL FAILURE | 5 | 8 | Response to measurement inquiry depends on physical layer measurement. Response time is defined in [19] and [20]. N1 and N2 only define the processing of the message. |

NOTE 1: The lower value applies when the UE is ordered to do a serving HS-DSCH cell change, changing no other information than contained in the IE "H-RNTI", the IE "Downlink HS-PDSCH information", the IE "Uplink DPCH power control info" and/or the IE "Serving HS-DSCH radio link indicator" (FDD only).

13.6 RB information parameters for signalling radio bearer RB 0

The following Radio Bearer parameter values apply for signalling radio bearer RB0 for TDD and for FDD, if either UE or UTRAN do not support common channel mapping on HS-DSCH:

| Information element/ Group name | Value | Comment |
|---------------------------------|---------|--|
| RLC info | | |
| >Uplink RLC mode | TM | |
| >>Transmission RLC discard | omitted | Neither discard is used, nor will there be a reset |
| >>Segmentation indication | FALSE | |
| >Downlink RLC mode | UM | |
| >>DL UM RLC LI size | 7 | |
| RB mapping info | | Single multiplexing option |
| >Uplink mapping info | | |
| >>UL transport channel | RACH | RACH corresponding with selected PRACH |
| >>RLC size list | N/A | If available the size in the IE 'Additional Dynamic Transport Format Information for CCCH' for the transport channel used.
Else the first TF defined in the Transport Format Set for the transport channel is used. |
| >>MAC logical channel priority | 1 | |
| >Downlink mapping info | | |
| >>DL transport channel | FACH | |

Procedure descriptions in subclause 8.6.4.8 shall not be applied for the IE "RB mapping info" that is used for signalling radio bearer RB0.

13.6a RB information parameters for SHCCH

The following Radio Bearer parameter values apply for SHCCH:

| Information element/ Group name | Value | Comment |
|---------------------------------|---------|---|
| RLC info | | |
| >Uplink RLC mode | TM | |
| >>Transmission RLC discard | omitted | Neither discard is used, nor will there be a reset |
| >>Segmentation indication | FALSE | |
| >Downlink RLC mode | UM | |
| RB mapping info | | |
| >Uplink mapping info | | Option 1 |
| >>UL transport channel | RACH | RACH corresponding with selected PRACH |
| >>RLC size list | N/A | The first TF defined in the Transport Format Set for the transport channel that is used |
| >>MAC logical channel priority | 1 | |
| >Downlink mapping info | | |
| >>DL transport channel | FACH | |
| >Uplink mapping info | | Option 2 |
| >>UL transport channel | USCH | |
| >>UL Transport Channel Identity | 1 | |
| >>MAC logical channel priority | 1 | |
| >>RLC size list | N/A | The first TF defined in the Transport Format Set for the transport channel that is used |
| >Downlink mapping info | | |
| >>DL transport channel | DSCH | |
| >>DL Transport Channel Identity | 1 | |

13.6b RB information parameters for BCCH mapped to FACH

The following Radio Bearer parameter values apply for BCCH mapped to FACH:

| Information element/ Group name | Value | Comment |
|---------------------------------|-------|---------|
| Downlink RLC mode | TM | |
| Segmentation indication | FALSE | |

13.6c RB information parameters for PCCH mapped to PCH

The following Radio Bearer parameter values apply for PCCH mapped to PCH:

| Information element/ Group name | Value | Comment |
|---------------------------------|-------|---------|
| Downlink RLC mode | TM | |
| Segmentation indication | FALSE | |

13.6d Parameters for BCCH mapped to BCH

The transport format parameters for BCH are specified in [34].

13.6e RB information parameters for signalling radio bearer RB 0 mapped on HS-DSCH and RACH

The following Radio Bearer parameter values apply for signalling radio bearer RB0, if UE and UTRAN support common channel mapping on HS-DSCH:

NOTE: FDD only.

| Information element/ Group name | Value | Comment |
|---------------------------------|---------|--|
| RLC info | | |
| >Uplink RLC mode | TM | |
| >>Transmission RLC discard | omitted | Neither discard is used, nor will there be a reset |
| >>Segmentation indication | FALSE | |
| >Downlink RLC mode | UM | |
| >>Length indicator size | 7 | |
| RB mapping info | | Single multiplexing option |
| >Uplink mapping info | | |
| >>UL transport channel | RACH | RACH corresponding with selected PRACH |
| >>RLC size list | N/A | If available the size in the IE 'Additional Dynamic Transport Format Information for CCCH' for the transport channel used.
Else the first TF defined in the Transport Format Set for the transport channel is used. |
| >>MAC logical channel priority | 1 | |
| >Downlink mapping info | | |
| >>DL transport channel | HS-DSCH | |

13.6f RB information parameters for BCCH mapped to HS-DSCH

The following Radio Bearer parameter values apply for BCCH mapped to HS-DSCH:

NOTE: FDD and 1.28 Mcps TDD only.

| Information element/ Group name | Value | Comment |
|---------------------------------|-------|---|
| Downlink RLC mode | TM | |
| Segmentation indication | FALSE | |
| MAC-ehs reordering queue | N/A | No MAC-ehs reordering queue is configured for BCCH reception. |

13.6g RB information parameters for PCCH mapped to HS-DSCH

The following Radio Bearer parameter values apply for PCCH mapped to HS-DSCH:

NOTE: FDD and 1.28 Mcps TDD only.

| Information element/ Group name | Value | Comment |
|---------------------------------|-------|---|
| Downlink RLC mode | TM | |
| Segmentation indication | FALSE | |
| MAC-ehs reordering queue | N/A | No MAC-ehs reordering queue is configured for PCCH reception. |

13.6h RB information parameters for signalling radio bearer RB 0 mapped on HS-DSCH and common E-DCH

The following Radio Bearer parameter values apply for signalling radio bearer RB0, if UE and UTRAN support common channel mapping on HS-DSCH and E-DCH:

NOTE: FDD and 1.28 Mcps TDD only.

| Information element/ Group name | Value | Comment |
|---------------------------------|---------|---|
| RLC info | | |
| >Uplink RLC mode | TM | |
| >>Transmission RLC discard | omitted | Neither discard is used, nor will there be a reset |
| >>Segmentation indication | FALSE | |
| >Downlink RLC mode | UM | |
| >>Length indicator size | 7 | |
| RB mapping info | | Single multiplexing option |
| >Uplink mapping info | | |
| >>UL transport channel | E-DCH | E-DCH corresponding with the Node B allocated common E-DCH resource, i.e. UL DPCCH/E-DPCCH/E-DPDCH. |
| >>RLC size list | N/A | |
| >>MAC logical channel priority | 1 | |
| >Downlink mapping info | | |
| >>DL transport channel | HS-DSCH | |

13.7 Parameter values for default radio configurations

The UE shall support the use of the default radio configurations that are specified in the following.

NOTE 1: These configurations are based on [41] and cover a number of RAB and signalling connection configurations.

In the table that is used to specify the parameter values for these default configurations, the following principles are used:

- Optional IEs that are not used are omitted;
- In case no parameter value is specified in a column, this means the value given the previous (left side) column applies.

NOTE 2: If needed, signalling radio bearer RB4 is established after the completion of handover.

NOTE 3: For each default configuration, the value of FDD, 3.84 Mcps TDD, 7.68 Mcps TDD and 1.28 Mcps TDD parameters are specified. All parameters apply to FDD, 3.84 Mcps TDD, 7.68 Mcps and 1.28 Mcps TDD modes, unless explicitly stated otherwise. It should be noted that in this respect default configurations differ from pre-defined configurations, which only include parameter values for one mode.

NOTE 4: The transport format sizes, indicated in the following table, concern the RLC PDU size, since all configurations concern dedicated channels. The transport block sizes indicated in TS 34.108 are different since these include the size of the MAC header.

NOTE 5: The tabular values included in this subclause, represent the actual IE values as in clause 10, and not the ASN.1 representation of these values.

NOTE 5A: For TDD, default configurations 0, 1, 5, 6, 7 and 22 are incorrect and they should not be used in this version of the specification.

| Configuration | 3.4 kbps signalling | 13.6 kbps signalling | Unused configuration | 12.2 kbps speech + 3.4 kbps signalling |
|--------------------------------|-------------------------|-------------------------|----------------------|--|
| Ref 34.108 | 2 | 3 | | 4 |
| Default configuration identity | 0 | 1 | 2 | 3 |
| RB INFORMATION | | | | |
| rb-Identity | RB1: 1, RB2: 2, RB3: 3 | RB1: 1, RB2: 2, RB3: 3 | | RB1: 1, RB2: 2, RB3: 3, RB5: 5, RB6: 6, RB7: 7 |
| rlc-InfoChoice | Rlc-info | Rlc-info | | Rlc-info |
| >ul-RLC-Mode | RB1: UM
RB2- RB3: AM | RB1: UM
RB2- RB3: AM | | RB1: UM
RB2- RB3: AM
RB5-RB7: TM |

| Configuration | 3.4 kbps signalling | 13.6 kbps signalling | Unused configuration | 12.2 kbps speech + 3.4 kbps signalling |
|-------------------------------|---|---|----------------------|--|
| >>transmissionRLC-DiscardMode | RB1: N/A
RB2- RB3:
NoDiscard | RB1: N/A
RB2- RB3:
NoDiscard | | RB1: N/A
RB2- RB3:
NoDiscard
RB5- RB7: N/A |
| >>>maxDat | RB1: N/A
RB2- RB3: 15 | RB1: N/A
RB2- RB3: 15 | | RB1: N/A
RB2- RB3: 15
RB5- RB7: N/A |
| >>transmissionWindowSize | RB1: N/A
RB2- RB3: 128 for
UEs with more than
10 kbyte "total RLC
AM buffer size" and
32 otherwise | RB1: N/A
RB2- RB3: 128 for
UEs with more than
10 kbyte "total RLC
AM buffer size" and
32 otherwise | | RB1: N/A
RB2- RB3: 128 for
UEs with more than
10 kbyte "total RLC
AM buffer size" and
32 otherwise
RB5- RB7: N/A |
| >>timerRST | RB1: N/A
RB2- RB3: 300 | RB1: N/A
RB2- RB3: 300 | | RB1: N/A
RB2- RB3: 300
RB5- RB7: N/A |
| >>max-RST | RB1: N/A
RB2- RB3: 1 | RB1: N/A
RB2- RB3: 1 | | RB1: N/A
RB2- RB3: 1
RB5- RB7: N/A |
| >>pollingInfo | RB1: N/A
RB2- RB3: as below | RB1: N/A
RB2- RB3: as below | | RB1: N/A
RB2- RB3: as below
RB5- RB7: N/A |
| >>>lastTransmissionPDU-Poll | RB2- RB3: FALSE | RB2- RB3: FALSE | | RB2- RB3: FALSE |
| >>>lastRetransmissionPDU-Poll | RB2- RB3: FALSE | RB2- RB3: FALSE | | RB2- RB3: FALSE |
| >>>timerPollPeriodic | RB2- RB3: 300 | RB2- RB3: 100 | | RB2- RB3: 300 |
| >>segmentationIndication | RB1- RB3: N/A | RB1- RB3: N/A | | RB1- RB3: N/A
RB5- RB7: FALSE |
| >dl-RLC-Mode | RB1: UM
RB2- RB3: AM | RB1: UM
RB2- RB3: AM | | RB1: UM
RB2- RB3: AM
RB5- RB7: TM |
| >>inSequenceDelivery | RB1: N/A
RB2- RB3: TRUE | RB1: N/A
RB2- RB3: TRUE | | RB1: N/A
RB2- RB3: TRUE
RB5- RB7: N/A |
| >>receivingWindowSize | RB1: N/A
RB2- RB3: 128 for
UEs with more than
10 kbyte "total RLC
AM buffer size" and
32 otherwise | RB1: N/A
RB2- RB3: 128 for
UEs with more than
10 kbyte "total RLC
AM buffer size" and
32 otherwise | | RB1: N/A
RB2- RB3: 128 for
UEs with more than
10 kbyte "total RLC
AM buffer size" and
32 otherwise
RB5- RB7: N/A |
| >>dl-RLC-StatusInfo | RB1: N/A
RB2- RB3: as below | RB1: N/A
RB2- RB3: as below | | RB1: N/A
RB2- RB3: as below
RB5- RB7: N/A |
| >>>timerStatusProhibit | RB2- RB3: 100 | RB2- RB3: 100 | | RB2- RB3: 100 |
| >>>missingPDU-Indicator | RB2- RB3: FALSE | RB2- RB3: FALSE | | RB2- RB3: FALSE |
| >>>timerStatusPeriodic | RB2- RB3: 300 | RB2- RB3: 100 | | RB2- RB3: 300 |
| >>segmentationIndication | RB1- RB3: N/A | RB1- RB3: N/A | | RB1- RB3: N/A
RB5- RB7: FALSE |
| rb-MappingInfo | | | | |
| >UL-LogicalChannelMappings | OneLogicalChannel | OneLogicalChannel | | OneLogicalChannel |
| >>ul-TransportChannelType | Dch | Dch | | Dch |
| >>>transportChannelIdentity | RB1- RB3: 1 | RB1- RB3: 1 | | RB1- RB3: 4
RB5: 1, RB6: 2,
RB7: 3 |
| >>logicalChannelIdentity | RB1: 1, RB2: 2,
RB3: 3 | RB1: 1, RB2: 2,
RB3: 3 | | RB1: 1, RB2: 2,
RB3: 3
RB5- RB7: N/A |

| Configuration | 3.4 kbps signalling | 13.6 kbps signalling | Unused configuration | 12.2 kbps speech + 3.4 kbps signalling |
|--------------------------------|---|---|----------------------|--|
| >>rlc-SizeList | RB1- RB3: configured | RB1- RB3: configured | | RB1- RB3: configured
RB5- RB7: N/A |
| >>mac-LogicalChannelPriority | RB1: 1, RB2: 2, RB3: 3 | RB1: 1, RB2: 2, RB3: 3 | | RB1: 1, RB2: 2, RB3: 3
RB5- RB7: 5 |
| >DL-logicalChannelMappingList | | | | |
| >>Mapping option 1 | One mapping option | One mapping option | | One mapping option |
| >>>dl-TransportChannelType | Dch | Dch | | Dch |
| >>>>transportChannelIdentity | RB1- RB3: 1 | RB1- RB3: 1 | | RB1- RB3: 4
RB5: 1, RB6: 2, RB7: 3 |
| >>>>logicalChannelIdentity | RB1: 1, RB2: 2, RB3: 3 | RB1: 1, RB2: 2, RB3: 3 | | RB1: 1, RB2: 2, RB3: 3
RB5- RB7: N/A |
| TrCH INFORMATION PER TrCH | | | | |
| UL-AddReconfTransChInfoList | | | | |
| >Uplink transport channel type | dch | dch | | dch |
| >transportChannelIdentity | TrCH1: 1 | TrCH1: 1 | | TrCH1: 1, TrCH2: 2, TrCH3: 3, TrCH4: 4 |
| >transportFormatSet | DedicatedTransChTFS | DedicatedTransChTFS | | DedicatedTransChTFS |
| >>dynamicTF-information | | | | |
| >>>tf0/ tf0,1 | TrCH1: (0x144, 1x144) | TrCH1: (0x144, 1x144) | | TrCH1: (0x81)
TrCH2: (0x 103, 1x103)
TrCH3: (0x 60, 1x60)
TrCH4: (0x144, 1x144) |
| >>>>rlcSize | BitMode | BitMode | | BitMode |
| >>>>>sizeType | TrCH1: type 2, part1= 2, part2= 0 (144) | TrCH1: type 2, part1= 2, part2= 0 (144) | | TrCH1: type 1: 81
TrCH2: type 1: 103
TrCH3: type 1: 60
TrCH4: 2: type 2, part1= 2, part2= 0 (144) |
| >>>>>numberOfTbSizeList | TrCH1: Zero, one | TrCH1: Zero, one | | TrCH1: Zero
TrCH2-4: Zero, one |
| >>>>>logicalChannelList | All | All | | All |
| >>>>tf 1 | N/A | N/A | | TrCH1: (1x39)
TrCH2- TrCH4: N/A |
| >>>>>numberOfTransportBlocks | | | | TrCH1: One |
| >>>>>rlc-Size | | | | TrCH1: BitMode |
| >>>>>>sizeType | | | | TrCH1: 1: 39 |
| >>>>>>numberOfTbSizeList | | | | TrCH1: One |
| >>>>>>logicalChannelList | | | | TrCH1: all |
| >>>>>tf 2 | N/A | N/A | | TrCH1: (1x81)
TrCH2- TrCH4: N/A |
| >>>>>>numberOfTransportBlocks | | | | TrCH1: One |
| >>>>>>rlc-Size | | | | TrCH1: BitMode |
| >>>>>>>sizeType | | | | TrCH1: type 1: 81 |
| >>>>>>>numberOfTbSizeList | | | | TrCH1: One |
| >>>>>>>logicalChannelList | | | | TrCH1: all |
| >>semistaticTF-Information | | | | |

| Configuration | 3.4 kbps signalling | 13.6 kbps signalling | Unused configuration | 12.2 kbps speech + 3.4 kbps signalling |
|--|---------------------------|---------------------------|----------------------|--|
| >>>tti | TrCH1: 40 | TrCH1: 10 | | TrCH1- TrCH3: 20
TrCH4: 40 |
| >>>channelCodingType | Convolutional | Convolutional | | Convolutional |
| >>>>codingRate | TrCH1: Third | TrCH1: Third | | TrCH1- TrCH2:
Third
TrCH3: Half
TrCH4: Third |
| >>>rateMatchingAttribute | TrCH1: 160 | TrCH1: 160 | | TrCH1: 200
TrCH2: 190
TrCH3: 235
TrCH4: 160 |
| >>>crc-Size | TrCH1: 16 | TrCH1: 16 | | TrCH1: 12
TrCH2- TrCH3: 0
TrCH4: 16 |
| DL-AddReconfTransChInfoList | | | | |
| >Downlink transport channel type | dch | dch | | dch |
| >dl-TransportChannelIdentity (should be as for UL) | TrCH1: 1 | TrCH1: 1 | | TrCH1: 1, TrCH2: 2,
TrCH3: 3, TrCH4: 4 |
| >tfs-SignallingMode | SameAsUL | SameAsUL | | Explicit
<Only tf0 on TrCH1 is different and shown below> |
| >>transportFormatSet | | | | DedicatedTransChTFS |
| >>>dynamicTF-information | | | | |
| >>>>tf0/ tf0,1 | | | | TrCH1: (1x0) |
| >>>>rlcSize | | | | bitMode |
| >>>>>sizeType | | | | TrCH1: type 1: 0 |
| >>>>numberOfTbSizeList | | | | TrCH1: One |
| >>>>logicalChannelList | | | | All |
| >>ULTrCH-Id | TrCH1: 1 | TrCH1: 1 | | TrCH1: 1, TrCH2: 2,
TrCH3: 3, TrCH4: 4 |
| >dch-QualityTarget | | | | |
| >>bler-QualityValue | TrCH1: 5×10^{-2} | TrCH1: 5×10^{-2} | | TrCH1: 7×10^{-3}
TrCH2- TrCH4:
Absent |
| TrCH INFORMATION, COMMON | | | | |
| ul-CommonTransChInfo | | | | |
| >tfs-ID (TDD only) | 1 | 1 | | 1 |
| >sharedChannelIndicator (TDD only) | FALSE | FALSE | | FALSE |
| >tfc-Subset | Absent, not required | Absent, not required | | Absent, not required |
| >ul-TFCS | Normal TFCI signalling | Normal TFCI signalling | | Normal TFCI signalling |
| >>explicitTFCS-ConfigurationMode | Complete | Complete | | Complete |
| >>>ctfcSize | Ctfc2Bit | Ctfc2Bit | | Ctfc6Bit |
| >>>>TFCS representation | Addition | Addition | | Addition |
| >>>>>TFCS list | | | | |
| >>>>>>TFCS 1 | (TF0) | (TF0) | | (TF0, TF0, TF0, TF0) |
| >>>>>>>ctfc | 0 | 0 | | 0 |
| >>>>>>>gainFactorInformation | Computed | Computed | | Computed |
| >>>>>>>>referenceTFCId | 0 | 0 | | 0 |
| >>>>>>>>TFCS 2 | (TF1) | (TF1) | | (TF1, TF0, TF0, TF0) |

| Configuration | 3.4 kbps signalling | 13.6 kbps signalling | Unused configuration | 12.2 kbps speech + 3.4 kbps signalling |
|--------------------------------------|---------------------|----------------------|----------------------|--|
| >>>>>>>ctfc | 1 | 1 | | 1 |
| >>>>>>>gainFactorInformation | Signalled | Signalled | | Computed |
| >>>>>>> β c (FDD only) | 11 | 11 | | N/A |
| >>>>>>> β d | 15 | 15 | | N/A |
| >>>>>>>referenceTFCId | 0 | 0 | | 0 |
| >>>>>>>TFCS 3 | | | | (TF2, TF1, TF1, TF0) |
| >>>>>>>ctfc | | | | 11 |
| >>>>>>>gainFactorInformation | | | | Computed |
| >>>>>>>referenceTFCId | | | | 0 |
| >>>>>>>TFCS 4 | | | | (TF0, TF0, TF0, TF1) |
| >>>>>>>ctfc | | | | 12 |
| >>>>>>>gainFactorInformation | | | | Computed |
| >>>>>>> β c (FDD only) | | | | N/A |
| >>>>>>> β d | | | | N/A |
| >>>>>>>referenceTFCId | | | | 0 |
| >>>>>>>TFCS 5 | | | | (TF1, TF0, TF0, TF1) |
| >>>>>>>ctfc | | | | 13 |
| >>>>>>>gainFactorInformation | | | | Computed |
| >>>>>>>referenceTFCId | | | | 0 |
| >>>>>>>TFCS 6 | | | | (TF2, TF1, TF1, TF1) |
| >>>>>>>ctfc | | | | 23 |
| >>>>>>>gainFactorInformation | | | | Signalled |
| >>>>>>> β c (FDD only) | | | | 11 |
| >>>>>>> β d | | | | 15 |
| >>>>>>>referenceTFCId | | | | 0 |
| dl-CommonTransChInfo | | | | |
| >tfc-SignallingMode | Same as UL | Same as UL | | Same as UL |
| PhyCH INFORMATION FDD | | | | |
| UL-DPCH-InfoPredef | | | | |
| >ul-DPCH-PowerControlInfo | | | | |
| >>powerControlAlgorithm | Algorithm 1 | Algorithm 1 | | Algorithm 1 |
| >>>tpcStepSize | 1 dB | 1 dB | | 1 dB |
| >tfc-Existence | TRUE | TRUE | | TRUE |
| >puncturingLimit | 1 | 1 | | 0.88 |
| DL-CommonInformationPredef | | | | |
| >dl-DPCH-InfoCommon | | | | |
| >>spreadingFactor | 256 | 128 | | 128 |
| >>tfc-Existence | FALSE | FALSE | | FALSE |
| >>pilotBits | 4 | 4 | | 4 |
| >>positionFixed | N/A | N/A | | Fixed |
| PhyCH INFORMATION 3.84/7.68 Mcps TDD | | | | |
| UL-DPCH-InfoPredef | | | | |
| >ul-DPCH-PowerControlInfo | | | | |
| >>dpch-ConstantValue | 0 | 0 | | 0 |
| >commonTimeslotInfo | | | | |

| Configuration | 3.4 kbps signalling | 13.6 kbps signalling | Unused configuration | 12.2 kbps speech + 3.4 kbps signalling |
|---------------------------------|---------------------|----------------------|----------------------|--|
| >>secondInterleavingMode | frameRelated | frameRelated | | frameRelated |
| >>tfc-Coding | 4 | 4 | | 16 |
| >>puncturingLimit | 1 | 0.92 | | 0.88 |
| >>repetitionPeriodAndLength | repetitionPeriod1 | repetitionPeriod1 | | repetitionPeriod1 |
| DL-CommonInformationPredef | | | | |
| >dl-DPCH-InfoCommon | | | | |
| >>commonTimeslotInfo | | | | |
| >>>secondInterleavingMode | frameRelated | frameRelated | | frameRelated |
| >>>tfc-Coding | 4 | 4 | | 16 |
| >>>puncturingLimit | 1 | 0.92 | | 0.92 |
| >>>repetitionPeriodAndLength | repetitionPeriod1 | repetitionPeriod1 | | repetitionPeriod1 |
| PhyCH INFORMATION 1.28 Mcps TDD | | | | |
| UL-DPCH-InfoPredef | | | | |
| >commonTimeslotInfo | | | | |
| >>secondInterleavingMode | frameRelated | frameRelated | | frameRelated |
| >>tfc-Coding | 4 | 4 | | 16 |
| >>puncturingLimit | 1 | 0.64 | | 0.60 |
| >>repetitionPeriodAndLength | repetitionPeriod1 | repetitionPeriod1 | | repetitionPeriod1 |
| DL-CommonInformationPredef | | | | |
| >dl-DPCH-InfoCommon | | | | |
| >>commonTimeslotInfo | | | | |
| >>>secondInterleavingMode | frameRelated | frameRelated | | frameRelated |
| >>>tfc-Coding | 4 | 4 | | 16 |
| >>>puncturingLimit | 1 | 0.64 | | 0.60 |
| >>>repetitionPeriodAndLength | repetitionPeriod1 | repetitionPeriod1 | | repetitionPeriod1 |

| Configuration | 28.8 kbps conv. CS- data + 3.4 kbps signalling | 32 kbps conv. CS- data + 3.4 kbps signalling | 64kbps conv. CS- data + 3.4 kbps signalling | 14.4 kbps streaming CS- data + 3.4 kbps signalling |
|--------------------------------|--|--|---|--|
| Ref 34.108 | 12 | 14 | 13 | 15 |
| Default configuration identity | 4 | 5 | 6 | 7 |
| RB INFORMATION | | | | |
| rb-Identity | RB1: 1, RB2: 2, RB3: 3, RB5: 5 | RB1: 1, RB2: 2, RB3: 3, RB5: 5 | RB1: 1, RB2: 2, RB3: 3, RB5: 5 | RB1: 1, RB2: 2, RB3: 3, RB5: 5 |
| rlc-InfoChoice | Rlc-info | Rlc-info | Rlc-info | Rlc-info |
| >ul-RLC-Mode | RB1: UM
RB2- RB3: AM
RB5: TM | RB1: UM
RB2- RB3: AM
RB5: TM | RB1: UM
RB2- RB3: AM
RB5: TM | RB1: UM
RB2- RB3: AM
RB5: TM |
| >>transmissionRLC-DiscardMode | RB1: N/A
RB2- RB3: NoDiscard
RB5: N/A | RB1: N/A
RB2- RB3: NoDiscard
RB5: N/A | RB1: N/A
RB2- RB3: NoDiscard
RB5: N/A | RB1: N/A
RB2- RB3: NoDiscard
RB5: N/A |
| >>>maxDat | RB1: N/A
RB2- RB3: 15
RB5: N/A | RB1: N/A
RB2- RB3: 15
RB5: N/A | RB1: N/A
RB2- RB3: 15
RB5: N/A | RB1: N/A
RB2- RB3: 15
RB5: N/A |

| Configuration | 28.8 kbps conv. CS-data + 3.4 kbps signalling | 32 kbps conv. CS-data + 3.4 kbps signalling | 64kbps conv. CS-data + 3.4 kbps signalling | 14.4 kbps streaming CS-data + 3.4 kbps signalling |
|-------------------------------|---|---|---|---|
| >>transmissionWindowSize | RB1: N/A
RB2- RB3: 128 for UEs with more than 10 kbyte "total RLC AM buffer size" and 32 otherwise
RB5: N/A | RB1: N/A
RB2- RB3: 128 for UEs with more than 10 kbyte "total RLC AM buffer size" and 32 otherwise
RB5: N/A | RB1: N/A
RB2- RB3: 128 for UEs with more than 10 kbyte "total RLC AM buffer size" and 32 otherwise
RB5: N/A | RB1: N/A
RB2- RB3: 128 for UEs with more than 10 kbyte "total RLC AM buffer size" and 32 otherwise
RB5: N/A |
| >>timerRST | RB1: N/A
RB2- RB3: 300
RB5: N/A | RB1: N/A
RB2- RB3: 300
RB5: N/A | RB1: N/A
RB2- RB3: 300
RB5: N/A | RB1: N/A
RB2- RB3: 300
RB5: N/A |
| >>max-RST | RB1: N/A
RB2- RB3: 1
RB5: N/A | RB1: N/A
RB2- RB3: 1
RB5: N/A | RB1: N/A
RB2- RB3: 1
RB5: N/A | RB1: N/A
RB2- RB3: 1
RB5: N/A |
| >>pollingInfo | RB1: N/A
RB2- RB3: as below
RB5: N/A | RB1: N/A
RB2- RB3: as below
RB5: N/A | RB1: N/A
RB2- RB3: as below
RB5: N/A | RB1: N/A
RB2- RB3: as below
RB5: N/A |
| >>>lastTransmissionPDU-Poll | RB2- RB3: FALSE | RB2- RB3: FALSE | RB2- RB3: FALSE | RB2- RB3: FALSE |
| >>>lastRetransmissionPDU-Poll | RB2- RB3: FALSE | RB2- RB3: FALSE | RB2- RB3: FALSE | RB2- RB3: FALSE |
| >>>timerPollPeriodic | RB2- RB3: 300 | RB2- RB3: 300 | RB2- RB3: 300 | RB2- RB3: 300 |
| >>segmentationIndication | RB1- RB3: N/A
RB5: FALSE | RB1- RB3: N/A
RB5: FALSE | RB1- RB3: N/A
RB5: FALSE | RB1- RB3: N/A
RB5: FALSE |
| >dl-RLC-Mode | RB1: UM
RB2- RB3: AM
RB5: TM | RB1: UM
RB2- RB3: AM
RB5: TM | RB1: UM
RB2- RB3: AM
RB5: TM | RB1: UM
RB2- RB3: AM
RB5: TM |
| >>inSequenceDelivery | RB1: N/A
RB2- RB3: TRUE
RB5: N/A | RB1: N/A
RB2- RB3: TRUE
RB5: N/A | RB1: N/A
RB2- RB3: TRUE
RB5: N/A | RB1: N/A
RB2- RB3: TRUE
RB5: N/A |
| >>receivingWindowSize | RB1: N/A
RB2- RB3: 128 for UEs with more than 10 kbyte "total RLC AM buffer size" and 32 otherwise
RB5: N/A | RB1: N/A
RB2- RB3: 128 for UEs with more than 10 kbyte "total RLC AM buffer size" and 32 otherwise
RB5: N/A | RB1: N/A
RB2- RB3: 128 for UEs with more than 10 kbyte "total RLC AM buffer size" and 32 otherwise
RB5: N/A | RB1: N/A
RB2- RB3: 128 for UEs with more than 10 kbyte "total RLC AM buffer size" and 32 otherwise
RB5: N/A |
| >>dl-RLC-StatusInfo | RB1: N/A
RB2- RB3: as below
RB5: N/A | RB1: N/A
RB2- RB3: as below
RB5: N/A | RB1: N/A
RB2- RB3: as below
RB5: N/A | RB1: N/A
RB2- RB3: as below
RB5: N/A |
| >>>timerStatusProhibit | RB2- RB3: 100 | RB2- RB3: 100 | RB2- RB3: 100 | RB2- RB3: 100 |
| >>>missingPDU-Indicator | RB2- RB3: FALSE | RB2- RB3: FALSE | RB2- RB3: FALSE | RB2- RB3: FALSE |
| >>>timerStatusPeriodic | RB2- RB3: 300 | RB2- RB3: 300 | RB2- RB3: 300 | RB2- RB3: 300 |
| >>segmentationIndication | RB1- RB3: N/A
RB5: FALSE | RB1- RB3: N/A
RB5: FALSE | RB1- RB3: N/A
RB5: FALSE | RB1- RB3: N/A
RB5: FALSE |
| rb-MappingInfo | | | | |
| >UL-LogicalChannelMappings | OneLogicalChannel | OneLogicalChannel | OneLogicalChannel | OneLogicalChannel |
| >>ul-TransportChannelType | Dch | Dch | Dch | Dch |
| >>>transportChannelIdentity | RB1- RB3: 2
RB5: 1 | RB1- RB3: 2
RB5: 1 | RB1- RB3: 2
RB5: 1 | RB1- RB3: 2
RB5: 1 |
| >>logicalChannelIdentity | RB1: 1, RB2: 2,
RB3: 3
RB5: N/A | RB1: 1, RB2: 2,
RB3: 3
RB5: N/A | RB1: 1, RB2: 2,
RB3: 3
RB5: N/A | RB1: 1, RB2: 2,
RB3: 3
RB5: N/A |
| >>rlc-SizeList | RB1- RB3:
configured
RB5: N/A | RB1- RB3:
configured
RB5: N/A | RB1- RB3:
configured
RB5: N/A | RB1- RB3:
configured
RB5: N/A |
| >>mac-LogicalChannelPriority | RB1: 1, RB2: 2,
RB3: 3
RB5: 5 | RB1: 1, RB2: 2,
RB3: 3
RB5: 5 | RB1: 1, RB2: 2,
RB3: 3
RB5: 5 | RB1: 1, RB2: 2,
RB3: 3
RB5: 5 |
| >DL-logicalChannelMappingList | | | | |
| >>Mapping option 1 | One mapping option | One mapping option | One mapping option | One mapping option |

| Configuration | 28.8 kbps conv. CS- data + 3.4 kbps signalling | 32 kbps conv. CS- data + 3.4 kbps signalling | 64kbps conv. CS- data + 3.4 kbps signalling | 14.4 kbps streaming CS- data + 3.4 kbps signalling |
|--|--|---|---|--|
| >>>dl-TransportChannelType | Dch | Dch | Dch | Dch |
| >>>>transportChannelIdentity | RB1- RB3: 2
RB5: 1 | RB1- RB3: 2
RB5: 1 | RB1- RB3: 2
RB5: 1 | RB1- RB3: 2
RB5: 1 |
| >>>logicalChannelIdentity | RB1: 1, RB2: 2,
RB3: 3
RB5: N/A | RB1: 1, RB2: 2,
RB3: 3
RB5: N/A | RB1: 1, RB2: 2,
RB3: 3
RB5: N/A | RB1: 1, RB2: 2,
RB3: 3
RB5: N/A |
| TrCH INFORMATION PER TrCH | | | | |
| UL-AddReconfTransChInfoList | | | | |
| >Uplink transport channel type | dch | dch | dch | dch |
| >transportChannelIdentity | TrCH1: 1, TrCH2: 2 | TrCH1: 1, TrCH2: 2 | TrCH1: 1, TrCH2: 2 | TrCH1: 1, TrCH2: 2 |
| >transportFormatSet | DedicatedTransChTFS | DedicatedTransChTFS | DedicatedTransChTFS | DedicatedTransChTFS |
| >>dynamicTF-information | | | | |
| >>>tf0/ tf0,1 | TrCH1: (0x576, 1x576, 2x576)
TrCH2: (0x144, 1x144) | TrCH1: (0x640, 1x640)
TrCH2: (0x144, 1x144) | TrCH1: (0x640, 2x640)
TrCH2: (0x144, 1x144) | TrCH1: (0x576, 1x576)
TrCH2: (0x144, 1x144) |
| >>>>rlcSize | TrCH1: OctetMode
TrCH2: BitMode | TrCH1: OctetMode
TrCH2: BitMode | TrCH1: OctetMode
TrCH2: BitMode | TrCH1: OctetMode
TrCH2: BitMode |
| >>>>>sizeType | TrCH1: type 2, part1= 9, part2= 2 (576)
TrCH2: type 2, part1= 2, part2= 0 (144) | TrCH1: type 2, part1= 11, part2= 2 (640)
TrCH2: type 2, part1= 2, part2= 0 (144) | TrCH1: type 2, part1= 11, part2= 2 (640)
TrCH2: type 2, part1= 2, part2= 0 (144) | TrCH1: type 2, part1= 9, part2= 2 (576)
TrCH2: type 2, part1= 2, part2= 0 (144) |
| >>>>numberOfTbSizeList | TrCH1: Zero, 1, 2
TrCH2: Zero, one | TrCH1: Zero, one
TrCH2: Zero, one | TrCH1: Zero, 2
TrCH2: Zero, one | TrCH1: Zero, one,
TrCH2: Zero, one |
| >>>>logicalChannelList | All | All | All | All |
| >>semiStaticTF-Information | | | | |
| >>>tti | TrCH1: 40
TrCH2: 40 | TrCH1: 20
TrCH2: 40 | TrCH1: 20
TrCH2: 40 | TrCH1: 40
TrCH2: 40 |
| >>>channelCodingType | TrCH1: Turbo
TrCH2: Convolutional | TrCH1: Turbo
TrCH2: Convolutional | TrCH1: Turbo
TrCH2: Convolutional | TrCH1: Turbo
TrCH2: Convolutional |
| >>>>codingRate | TrCH1: N/A
TrCH2: Third | TrCH1: N/A
TrCH2: Third | TrCH1: N/A
TrCH2: Third | TrCH1: N/A
TrCH2: Third |
| >>>rateMatchingAttribute | TrCH1: 180
TrCH2: 160 | TrCH1: 185
TrCH2: 160 | TrCH1: 170
TrCH2: 160 | TrCH1: 165
TrCH2: 160 |
| >>>crc-Size | TrCH1: 16
TrCH2: 16 | TrCH1: 16
TrCH2: 16 | TrCH1: 16
TrCH2: 16 | TrCH1: 16
TrCH2: 16 |
| DL-AddReconfTransChInfoList | | | | |
| >Downlink transport channel type | dch | dch | dch | dch |
| >dl-TransportChannelIdentity (should be as for UL) | TrCH1: 1, TrCH2: 2 | TrCH1: 1, TrCH2: 2 | TrCH1: 1, TrCH2: 2 | TrCH1: 1, TrCH2: 2 |
| >tfs-SignallingMode | SameAsUL | SameAsUL | SameAsUL | SameAsUL |
| >>transportFormatSet | | | | |
| >>>dynamicTF-information | | | | |
| >>>>tf0/ tf0,1 | | | | |
| >>>>rlcSize | | | | |
| >>>>>sizeType | | | | |
| >>>>numberOfTbSizeList | | | | |
| >>>>logicalChannelList | | | | |

| Configuration | 28.8 kbps conv. CS- data + 3.4 kbps signalling | 32 kbps conv. CS- data + 3.4 kbps signalling | 64kbps conv. CS- data + 3.4 kbps signalling | 14.4 kbps streaming CS- data + 3.4 kbps signalling |
|--|--|--|---|--|
| >>ULTrCH-Id | TrCH1: 1, TrCH2: 2 | TrCH1: 1, TrCH2: 2 | TrCH1: 1, TrCH2: 2 | TrCH1: 1, TrCH2: 2 |
| >dch-QualityTarget | | | | |
| >>bler-QualityValue | TrCH1: 2×10^{-3}
TrCH2: Absent | TrCH1: 2×10^{-3}
TrCH2: Absent | TrCH1: 2×10^{-3}
TrCH2: Absent | TrCH1: 1×10^{-2}
TrCH2: Absent |
| TrCH INFORMATION, COMMON | | | | |
| ul-CommonTransChInfo | | | | |
| >tfc-ID (TDD only) | 1 | 1 | 1 | 1 |
| >sharedChannelIndicator (TDD only) | FALSE | FALSE | FALSE | FALSE |
| >tfc-Subset | Absent, not required | Absent, not required | Absent, not required | Absent, not required |
| >ul-TFCS | Normal TFCI signalling | Normal TFCI signalling | Normal TFCI signalling | Normal TFCI signalling |
| >>explicitTFCS-ConfigurationMode | Complete | Complete | Complete | Complete |
| >>>ctfcSize | Ctfc4Bit | Ctfc2Bit | Ctfc2Bit | Ctfc4Bit |
| >>>>TFCS representation | Addition | Addition | Addition | Addition |
| >>>>>TFCS list | | | | |
| >>>>>>TFCS 1 | (TF0, TF0) | (TF0, TF0) | (TF0, TF0) | (TF0, TF0) |
| >>>>>>>ctfc | 0 | 0 | 0 | 0 |
| >>>>>>>>gainFactorInformation | Computed | Computed | Computed | Computed |
| >>>>>>>>>referenceTFCId | 0 | 0 | 0 | 0 |
| >>>>>>>>>TFCS 2 | (TF1, TF0) | (TF1, TF0) | (TF1, TF0) | (TF1, TF0) |
| >>>>>>>>>>ctfc | 1 | 1 | 1 | 1 |
| >>>>>>>>>>>gainFactorInformation | Computed | Computed | Computed | Computed |
| >>>>>>>>>>>> β_c (FDD only) | N/A | N/A | N/A | N/A |
| >>>>>>>>>>>> β_d | N/A | N/A | N/A | N/A |
| >>>>>>>>>>>>>referenceTFCId | 0 | 0 | 0 | 0 |
| >>>>>>>>>>>>>TFCS 3 | (TF2, TF0) | (TF0, TF1) | (TF0, TF1) | (TF0, TF1) |
| >>>>>>>>>>>>>>ctfc | 2 | 2 | 2 | 2 |
| >>>>>>>>>>>>>>>gainFactorInformation | Computed | Computed | Computed | Computed |
| >>>>>>>>>>>>>>>>referenceTFCId | 0 | 0 | 0 | 0 |
| >>>>>>>>>>>>>>>>>TFCS 4 | (TF0, TF1) | (TF1, TF1) | (TF1, TF1) | (TF1, TF1) |
| >>>>>>>>>>>>>>>>>>ctfc | 3 | 3 | 3 | 3 |
| >>>>>>>>>>>>>>>>>>>gainFactorInformation | Computed | Signalled | Signalled | Signalled |
| >>>>>>>>>>>>>>>>>>>> β_c (FDD only) | N/A | 8 | 8 | 11 |
| >>>>>>>>>>>>>>>>>>>> β_d | N/A | 15 | 15 | 15 |
| >>>>>>>>>>>>>>>>>>>>>referenceTFCId | 0 | 0 | 0 | 0 |
| >>>>>>>>>>>>>>>>>>>>>>TFCS 5 | (TF1, TF1) | N/A | N/A | |
| >>>>>>>>>>>>>>>>>>>>>>>ctfc | 4 | | | |
| >>>>>>>>>>>>>>>>>>>>>>>>gainFactorInformation | Computed | | | |
| >>>>>>>>>>>>>>>>>>>>>>>>>referenceTFCId | 0 | | | |
| >>>>>>>>>>>>>>>>>>>>>>>>>>TFCS 6 | (TF2, TF1) | N/A | N/A | |
| >>>>>>>>>>>>>>>>>>>>>>>>>>>ctfc | 5 | | | |
| >>>>>>>>>>>>>>>>>>>>>>>>>>>>gainFactorInformation | Signalled | | | |
| >>>>>>>>>>>>>>>>>>>>>>>>>>>>> β_c (FDD only) | 8 | | | |
| >>>>>>>>>>>>>>>>>>>>>>>>>>>>> β_d | 15 | | | |
| >>>>>>>>>>>>>>>>>>>>>>>>>>>>>>referenceTFCId | 0 | | | |
| >>>>>>>>>>>>>>>>>>>>>>>>>>>>>>>TFCS 7 | | | | |
| >>>>>>>>>>>>>>>>>>>>>>>>>>>>>>>>ctfc | | | | |
| >>>>>>>>>>>>>>>>>>>>>>>>>>>>>>>>>gainFactorInformation | | | | |
| >>>>>>>>>>>>>>>>>>>>>>>>>>>>>>>>>>referenceTFCId | | | | |

| Configuration | 28.8 kbps conv. CS- data + 3.4 kbps signalling | 32 kbps conv. CS- data + 3.4 kbps signalling | 64kbps conv. CS- data + 3.4 kbps signalling | 14.4 kbps streaming CS- data + 3.4 kbps signalling |
|--------------------------------------|--|--|---|--|
| >>>>>TFCS 8 | | | | |
| >>>>>>ctfc | | | | |
| >>>>>>>gainFactorInformation | | | | |
| >>>>>>>referenceTFCId | | | | |
| >>>>>TFCS 9 | | | | |
| >>>>>>ctfc | | | | |
| >>>>>>>gainFactorInformation | | | | |
| >>>>>>>referenceTFCId | | | | |
| >>>>>TFCS 10 | | | | |
| >>>>>>ctfc | | | | |
| >>>>>>>gainFactorInformation | | | | |
| >>>>>>> β_c (FDD only) | | | | |
| >>>>>>> β_d | | | | |
| >>>>>>>referenceTFCId | | | | |
| dl-CommonTransChInfo | | | | |
| >tfc-SignallingMode | Same as UL | Same as UL | Same as UL | Same as UL |
| PhyCH INFORMATION FDD | | | | |
| UL-DPCH-InfoPredef | | | | |
| >ul-DPCH-PowerControllInfo | | | | |
| >>powerControlAlgorithm | Algorithm 1 | Algorithm 1 | Algorithm 1 | Algorithm 1 |
| >>>tpcStepSize | 1 dB | 1 dB | 1 dB | 1 dB |
| >tfc-Existence | TRUE | TRUE | TRUE | TRUE |
| >puncturingLimit | 0.92 | 0.8 | 0.92 | 1 |
| DL-CommonInformationPredef | | | | |
| >dl-DPCH-InfoCommon | | | | |
| >>spreadingFactor | 64 | 64 | 32 | 128 |
| >>tfc-Existence | TRUE | TRUE | TRUE | TRUE |
| >>pilotBits | 8 | 8 | 8 | 8 |
| >>positionFixed | Flexible | Flexible | Flexible | Flexible |
| PhyCH INFORMATION 3.84/7.68 Mcps TDD | | | | |
| UL-DPCH-InfoPredef | | | | |
| >ul-DPCH-PowerControllInfo | | | | |
| >>dpch-ConstantValue | 0 | 0 | 0 | 0 |
| >commonTimeslotInfo | | | | |
| >>secondInterleavingMode | frameRelated | frameRelated | frameRelated | frameRelated |
| >>tfc-Coding | 16 | 8 | 8 | 8 |
| >>puncturingLimit | 0.44 | 0.8 | 0.56 | 0.8 |
| >>repetitionPeriodAndLength | repetitionPeriod1 | repetitionPeriod1 | repetitionPeriod1 | repetitionPeriod1 |
| DL-CommonInformationPredef | | | | |
| >dl-DPCH-InfoCommon | | | | |
| >>commonTimeslotInfo | | | | |
| >>>secondInterleavingMode | frameRelated | frameRelated | frameRelated | frameRelated |
| >>>tfc-Coding | 16 | 8 | 8 | 8 |
| >>>puncturingLimit | 0.44 | 0.64 | 0.56 | 0.8 |
| >>>repetitionPeriodAndLength | repetitionPeriod1 | repetitionPeriod1 | repetitionPeriod1 | repetitionPeriod1 |

| Configuration | 28.8 kbps conv. CS-data + 3.4 kbps signalling | 32 kbps conv. CS-data + 3.4 kbps signalling | 64kbps conv. CS-data + 3.4 kbps signalling | 14.4 kbps streaming CS-data + 3.4 kbps signalling |
|------------------------------------|--|--|---|--|
| PhyCH INFORMATION
1.28 Mcps TDD | | | | |
| UL-DPCH-InfoPredef | | | | |
| >commonTimeslotInfo | | | | |
| >>secondInterleavingMode | frameRelated | frameRelated | frameRelated | frameRelated |
| >>tfc-Coding | 16 | 8 | 8 | 8 |
| >>puncturingLimit | 0.64 | 0.60 | 0.64 | 1 |
| >>repetitionPeriodAndLength | repetitionPeriod1 | repetitionPeriod1 | repetitionPeriod1 | repetitionPeriod1 |
| DL-CommonInformationPredef | | | | |
| >dl-DPCH-InfoCommon | | | | |
| >>commonTimeslotInfo | | | | |
| >>>secondInterleavingMode | frameRelated | frameRelated | frameRelated | frameRelated |
| >>>tfc-Coding | 16 | 8 | 8 | 8 |
| >>>puncturingLimit | 0.64 | 0.60 | 0.64 | 0.88 |
| >>>repetitionPeriodAndLength | repetitionPeriod1 | repetitionPeriod1 | repetitionPeriod1 | repetitionPeriod1 |

| Configuration | 28.8 kbps streaming CS-data + 3.4 kbps signalling | 57.6 kbps streaming CS-data + 3.4 kbps signalling | 12.2/7.95/5.9/4.75 kbps speech + 3.4 kbps signalling |
|--------------------------------|---|---|--|
| Ref 34.108 | 16 | 17 | 4a |
| Default configuration identity | 8 | 9 | 10 |
| RB INFORMATION | | | |
| rb-Identity | RB1: 1, RB2: 2, RB3: 3, RB5: 5 | RB1: 1, RB2: 2, RB3: 3, RB5: 5 | RB1: 1, RB2: 2, RB3: 3, RB5: 5, RB6: 6, RB7: 7 |
| rlc-InfoChoice | Rlc-info | Rlc-info | Rlc-info |
| >ul-RLC-Mode | RB1: UM
RB2- RB3: AM
RB5: TM | RB1: UM
RB2- RB3: AM
RB5: TM | RB1: UM
RB2- RB3: AM
RB5-RB7: TM |
| >>transmissionRLC-DiscardMode | RB1: N/A
RB2- RB3: NoDiscard
RB5: N/A | RB1: N/A
RB2- RB3: NoDiscard
RB5: N/A | RB1: N/A
RB2- RB3: NoDiscard
RB5- RB7: N/A |
| >>>maxDat | RB1: N/A
RB2- RB3: 15
RB5: N/A | RB1: N/A
RB2- RB3: 15
RB5: N/A | RB1: N/A
RB2- RB3: 15
RB5- RB7: N/A |
| >>transmissionWindowSize | RB1: N/A
RB2- RB3: 128 for UEs with more than 10 kbyte "total RLC AM buffer size" and 32 otherwise
RB5: N/A | RB1: N/A
RB2- RB3: 128 for UEs with more than 10 kbyte "total RLC AM buffer size" and 32 otherwise
RB5: N/A | RB1: N/A
RB2- RB3: 128 for UEs with more than 10 kbyte "total RLC AM buffer size" and 32 otherwise
RB5- RB7: N/A |
| >>timerRST | RB1: N/A
RB2- RB3: 300
RB5: N/A | RB1: N/A
RB2- RB3: 300
RB5: N/A | RB1: N/A
RB2- RB3: 300
RB5- RB7: N/A |
| >>max-RST | RB1: N/A
RB2- RB3: 1
RB5: N/A | RB1: N/A
RB2- RB3: 1
RB5: N/A | RB1: N/A
RB2- RB3: 1
RB5- RB7: N/A |
| >>pollingInfo | RB1: N/A
RB2- RB3: as below
RB5: N/A | RB1: N/A
RB2- RB3: as below
RB5: N/A | RB1: N/A
RB2- RB3: as below
RB5- RB7: N/A |

| Configuration | 28.8 kbps
streaming CS-
data +
3.4 kbps signalling | 57.6 kbps
streaming CS-
data +
3.4 kbps signalling | 12.2/7.95/5.9/4.75
kbps speech +
3.4 kbps signalling |
|-----------------------------------|---|---|--|
| >>>lastTransmissionPDU-Poll | RB2- RB3: FALSE | RB2- RB3: FALSE | RB2- RB3: FALSE |
| >>>lastRetransmissionPDU-Poll | RB2- RB3: FALSE | RB2- RB3: FALSE | RB2- RB3: FALSE |
| >>>timerPollPeriodic | RB2- RB3: 300 | RB2- RB3: 300 | RB2- RB3: 300 |
| >>segmentationIndication | RB1- RB3: N/A
RB5: FALSE | RB1- RB3: N/A
RB5: FALSE | RB1- RB3: N/A
RB5- RB7: FALSE |
| >dl-RLC-Mode | RB1: UM
RB2- RB3: AM
RB5: TM | RB1: UM
RB2- RB3: AM
RB5: TM | RB1: UM
RB2- RB3: AM
RB5- RB7: TM |
| >>inSequenceDelivery | RB1: N/A
RB2- RB3: TRUE
RB5: N/A | RB1: N/A
RB2- RB3: TRUE
RB5: N/A | RB1: N/A
RB2- RB3: TRUE
RB5- RB7: N/A |
| >>receivingWindowSize | RB1: N/A
RB2- RB3: 128 for
UEs with more than
10 kbyte "total RLC
AM buffer size" and
32 otherwise
RB5: N/A | RB1: N/A
RB2- RB3: 128 for
UEs with more than
10 kbyte "total RLC
AM buffer size" and
32 otherwise
RB5: N/A | RB1: N/A
RB2- RB3: 128 for
UEs with more than
10 kbyte "total RLC
AM buffer size" and
32 otherwise
RB5- RB7: N/A |
| >>>dl-RLC-StatusInfo | RB1: N/A
RB2- RB3: as below
RB5: N/A | RB1: N/A
RB2- RB3: as below
RB5: N/A | RB1: N/A
RB2- RB3: as below
RB5- RB7: N/A |
| >>>timerStatusProhibit | RB2- RB3: 100 | RB2- RB3: 100 | RB2- RB3: 100 |
| >>>missingPDU-Indicator | RB2- RB3: FALSE | RB2- RB3: FALSE | RB2- RB3: FALSE |
| >>>timerStatusPeriodic | RB2- RB3: 300 | RB2- RB3: 300 | RB2- RB3: 300 |
| >>segmentationIndication | RB1- RB3: N/A
RB5: FALSE | RB1- RB3: N/A
RB5: FALSE | RB1- RB3: N/A
RB5- RB7: FALSE |
| rb-MappingInfo | | | |
| >UL-
LogicalChannelMappings | OneLogicalChannel | OneLogicalChannel | OneLogicalChannel |
| >>ul-
TransportChannelType | Dch | Dch | Dch |
| >>>transportChannelIdentity | RB1- RB3: 2
RB5: 1 | RB1- RB3: 2
RB5: 1 | RB1- RB3: 4
RB5: 1, RB6: 2,
RB7: 3 |
| >>logicalChannelIdentity | RB1: 1, RB2: 2,
RB3: 3
RB5: N/A | RB1: 1, RB2: 2,
RB3: 3
RB5: N/A | RB1: 1, RB2: 2,
RB3: 3
RB5- RB7: N/A |
| >>rlc-SizeList | RB1- RB3:
configured
RB5: N/A | RB1- RB3:
configured
RB5: N/A | RB1- RB3:
configured
RB5- RB7: N/A |
| >>mac-
LogicalChannelPriority | RB1: 1, RB2: 2,
RB3: 3
RB5: 5 | RB1: 1, RB2: 2,
RB3: 3
RB5: 5 | RB1: 1, RB2: 2,
RB3: 3
RB5- RB7: 5 |
| >DL-
logicalChannelMappingList | | | |
| >>Mapping option 1 | One mapping option | One mapping option | One mapping option |
| >>>dl-
TransportChannelType | Dch | Dch | Dch |
| >>>>transportChannelIdentity | RB1- RB3: 2
RB5: 1 | RB1- RB3: 2
RB5: 1 | RB1- RB3: 4
RB5: 1, RB6: 2,
RB7: 3 |
| >>>>logicalChannelIdentity | RB1: 1, RB2: 2,
RB3: 3
RB5: N/A | RB1: 1, RB2: 2,
RB3: 3
RB5: N/A | RB1: 1, RB2: 2,
RB3: 3
RB5- RB7: N/A |
| TrCH INFORMATION PER
TrCH | | | |
| UL-
AddReconfTransChInfoList | | | |

| Configuration | 28.8 kbps streaming CS-data + 3.4 kbps signalling | 57.6 kbps streaming CS-data + 3.4 kbps signalling | 12.2/7.95/5.9/4.75 kbps speech + 3.4 kbps signalling |
|--------------------------------|--|--|---|
| >Uplink transport channel type | dch | dch | dch |
| >transportChannelIdentity | TrCH1: 1, TrCH2: 2 | TrCH1: 1, TrCH2: 2 | TrCH1: 1, TrCH2: 2, TrCH3: 3, TrCH4: 4 |
| >transportFormatSet | DedicatedTransChTFS | DedicatedTransChTFS | DedicatedTransChTFS |
| >>dynamicTF-information | | | |
| >>>tf0/ tf0,1 | TrCH1: (0x576, 1x576, 2x576)
TrCH2: (0x144, 1x144) | TrCH1: (0x576, 1x576, 2x576, 3x576, 4x576)
TrCH2: (0x144, 1x144) | TrCH1: (0x81)
TrCH2: (0x 103)
TrCH3: (0x 60)
TrCH4: (0x144) |
| >>>>rlcSize | TrCH1: OctetMode
TrCH2:BitMode | TrCH1: OctetMode
TrCH2:BitMode | BitMode |
| >>>>>sizeType | TrCH1: type 2, part1= 9, part2= 2 (576)
TrCH2: type 2, part1= 2, part2= 0 (144) | TrCH1: type 2, part1= 9, part2= 2 (576)
TrCH2: type 2, part1= 2, part2= 0 (144) | TrCH1: type 1: 81
TrCH2: type 1: 103
TrCH3: type 1: 60
TrCH4: type 2, part1= 2, part2= 0 (144) |
| >>>>numberOfTbSizeList | TrCH1: Zero, one, 2
TrCH2: Zero, one | TrCH1: Zero, one, 2, 3, 4
TrCH2: Zero, one | TrCH1-4: Zero |
| >>>>logicalChannelList | All | All | All |
| >>>>tf 1 | | | TrCH1: (1x39)
TrCH2: (1x53)
TrCH3: (1x60)
TrCH4: (1x144) |
| >>>>>numberOfTransportBlocks | | | TrCH1-4: One |
| >>>>>rlc-Size | | | TrCH1-3: BitMode |
| >>>>>>sizeType | | | TrCH1: type 1: 39
TrCH2: type 1: 53
TrCH3: type 1: 60
TrCH4: type 2, part1= 2, part2= 0 (144) |
| >>>>>numberOfTbSizeList | | | TrCH1-4: One |
| >>>>>logicalChannelList | | | TrCH1-4: all |
| >>>>>tf 2 | | | TrCH1: (1x42)
TrCH2: (1x63)
TrCH3- TrCH4: N/A |
| >>>>>>numberOfTransportBlocks | | | TrCH1-2: One |
| >>>>>>rlc-Size | | | TrCH1: BitMode |
| >>>>>>>sizeType | | | TrCH1: type 1: 42
TrCH2: type 1: 63 |
| >>>>>>numberOfTbSizeList | | | TrCH1-2: One |
| >>>>>>logicalChannelList | | | TrCH1: all |
| >>>>>>tf 3 | | | TrCH1: (1x55)
TrCH2: (1x84)
TrCH3- TrCH4: N/A |
| >>>>>>>numberOfTransportBlocks | | | TrCH1-2: One |
| >>>>>>>rlc-Size | | | TrCH1: BitMode |
| >>>>>>>>sizeType | | | TrCH1: type 1: 55
TrCH2: type 1: 84 |
| >>>>>>>numberOfTbSizeList | | | TrCH1-2: One |
| >>>>>>>logicalChannelList | | | TrCH1: all |
| >>>>>>>tf 4 | | | TrCH1: (1x75)
TrCH2: (1x103)
TrCH3- TrCH4: N/A |

| Configuration | 28.8 kbps
streaming CS-
data +
3.4 kbps signalling | 57.6 kbps
streaming CS-
data +
3.4 kbps signalling | 12.2/7.95/5.9/4.75
kbps speech +
3.4 kbps signalling |
|--|---|---|---|
| >>>>numberOfTransportBlocks | | | TrCH1-2: One |
| >>>>rlc-Size | | | TrCH1: BitMode |
| >>>>>sizeType | | | TrCH1: type 1: 75
TrCH2: type 1: 103 |
| >>>>numberOfTbSizeList | | | TrCH1-2: One |
| >>>>logicalChannelList | | | TrCH1: all |
| >>>tf 5 | | | TrCH1: (1x81)
TrCH2- TrCH4: N/A |
| >>>>numberOfTransportBlocks | | | TrCH1: One |
| >>>>rlc-Size | | | TrCH1: BitMode |
| >>>>>sizeType | | | TrCH1: type 1: 81 |
| >>>>numberOfTbSizeList | | | TrCH1: One |
| >>>>logicalChannelList | | | TrCH1: all |
| >>semiStaticTF-Information | | | |
| >>>tti | TrCH1: 40
TrCH2: 40 | TrCH1: 40
TrCH2: 40 | TrCH1- TrCH3: 20
TrCH4: 40 |
| >>>channelCodingType | TrCH1: Turbo
TrCH2:
Convolutional | TrCH1: Turbo
TrCH2:
Convolutional | Convolutional |
| >>>>codingRate | TrCH1: N/A
TrCH2: Third | TrCH1: N/A
TrCH2: Third | TrCH1- TrCH2:
Third
TrCH3: Half
TrCH4: Third |
| >>>rateMatchingAttribute | TrCH1: 155
TrCH2: 160 | TrCH1: 145
TrCH2: 160 | TrCH1: 200
TrCH2: 190
TrCH3: 235
TrCH4: 160 |
| >>>>crc-Size | TrCH1: 16
TrCH2: 16 | TrCH1: 16
TrCH2: 16 | TrCH1: 12
TrCH2- TrCH3: 0
TrCH4: 16 |
| DL-AddReconfTransChInfoList | | | |
| >Downlink transport channel type | dch | dch | dch |
| >dL-TransportChannelIdentity (should be as for UL) | TrCH1: 1, TrCH2: 2 | TrCH1: 1, TrCH2: 2 | TrCH1: 1, TrCH2: 2,
TrCH3: 3, TrCH4: 4 |
| >tfs-SignallingMode | SameAsUL | SameAsUL | Independent
<Only tf0 on TrCH1 is different and shown below> |
| >>transportFormatSet | | | DedicatedTransChTFS |
| >>>>dynamicTF-information | | | |
| >>>>>tf0/ tf0,1 | | | TrCH1: (1x0) |
| >>>>>rlcSize | | | bitMode |
| >>>>>>sizeType | | | TrCH1: type 1: 0 |
| >>>>>numberOfTbSizeList | | | TrCH1: One |
| >>>>>logicalChannelList | | | All |
| >>ULTrCH-Id | TrCH1: 1, TrCH2: 2 | TrCH1: 1, TrCH2: 2 | TrCH1: 1, TrCH2: 2,
TrCH3: 3, TrCH4: 4 |
| >dch-QualityTarget | | | |
| >>bler-QualityValue | TrCH1: 1×10^{-2}
TrCH2: Absent | TrCH1: 1×10^{-2}
TrCH2: Absent | TrCH1: 7×10^{-3}
TrCH2- TrCH4:
Absent |
| TrCH INFORMATION, COMMON | | | |
| ul-CommonTransChInfo | | | |

| Configuration | 28.8 kbps streaming CS-data + 3.4 kbps signalling | 57.6 kbps streaming CS-data + 3.4 kbps signalling | 12.2/7.95/5.9/4.75 kbps speech + 3.4 kbps signalling |
|--|---|---|--|
| >tfc-ID (TDD only) | 1 | 1 | 1 |
| >sharedChannelIndicator (TDD only) | FALSE | FALSE | FALSE |
| >tfc-Subset | Absent, not required | Absent, not required | Absent, not required |
| >ul-TFCS | Normal TFCI signalling | Normal TFCI signalling | Normal TFCI signalling |
| >>explicitTFCS-ConfigurationMode | Complete | Complete | Complete |
| >>>ctfcSize | Ctfc4Bit | Ctfc4Bit | Ctfc8Bit |
| >>>>TFCS representation | Addition | Addition | Addition |
| >>>>>TFCS list | | | |
| >>>>>>TFCS 1 | (TF0, TF0) | (TF0, TF0) | (TF0, TF0, TF0, TF0) |
| >>>>>>>ctfc | 0 | 0 | 0 |
| >>>>>>>>gainFactorInformation | Computed | Computed | Computed |
| >>>>>>>>referenceTFClid | 0 | 0 | 0 |
| >>>>>>>>>TFCS 2 | (TF1, TF0) | (TF1, TF0) | (TF1, TF0, TF0, TF0) |
| >>>>>>>>>>ctfc | 1 | 1 | 1 |
| >>>>>>>>>>>gainFactorInformation | Computed | Computed | Computed |
| >>>>>>>>>>>> β c (FDD only) | N/A | N/A | N/A |
| >>>>>>>>>>>> β d | N/A | N/A | N/A |
| >>>>>>>>>>>>>referenceTFClid | 0 | 0 | 0 |
| >>>>>>>>>>>>>>TFCS 3 | (TF2, TF0) | (TF2, TF0) | (TF2, TF1, TF0, TF0) |
| >>>>>>>>>>>>>>>ctfc | 2 | 2 | 8 |
| >>>>>>>>>>>>>>>>gainFactorInformation | Computed | Computed | Computed |
| >>>>>>>>>>>>>>>>>referenceTFClid | 0 | 0 | 0 |
| >>>>>>>>>>>>>>>>>>TFCS 4 | (TF0, TF1) | (TF3, TF0) | (TF3, TF2, TF0, TF0) |
| >>>>>>>>>>>>>>>>>>>ctfc | 3 | 3 | 15 |
| >>>>>>>>>>>>>>>>>>>>gainFactorInformation | Computed | Computed | Computed |
| >>>>>>>>>>>>>>>>>>>>>> β c (FDD only) | N/A | N/A | N/A |
| >>>>>>>>>>>>>>>>>>>>>> β d | N/A | N/A | N/A |
| >>>>>>>>>>>>>>>>>>>>>>>referenceTFClid | 0 | 0 | 0 |
| >>>>>>>>>>>>>>>>>>>>>>>>TFCS 5 | (TF1, TF1) | (TF4, TF0) | (TF4, TF3, TF0, TF0) |
| >>>>>>>>>>>>>>>>>>>>>>>>>ctfc | 4 | 4 | 22 |
| >>>>>>>>>>>>>>>>>>>>>>>>>>>gainFactorInformation | Computed | Computed | Computed |
| >>>>>>>>>>>>>>>>>>>>>>>>>>>>referenceTFClid | 0 | 0 | 0 |
| >>>>>>>>>>>>>>>>>>>>>>>>>>>>>TFCS 6 | (TF2, TF1) | (TF0, TF1) | (TF5, TF4, TF1, TF0) |
| >>>>>>>>>>>>>>>>>>>>>>>>>>>>>>>ctfc | 5 | 5 | 59 |
| >>>>>>>>>>>>>>>>>>>>>>>>>>>>>>>>gainFactorInformation | Signalled | Computed | Computed |
| >>>>>>>>>>>>>>>>>>>>>>>>>>>>>>>>>> β c (FDD only) | 8 | N/A | N/A |
| >>>>>>>>>>>>>>>>>>>>>>>>>>>>>>>>>>>> β d | 15 | N/A | N/A |
| >>>>>>>>>>>>>>>>>>>>>>>>>>>>>>>>>>>>>>referenceTFClid | 0 | 0 | 0 |
| >>>>>>>>>>>>>>>>>>>>>>>>>>>>>>>>>>>>>>>TFCS 7 | | (TF1, TF1) | (TF0,TF0,TF0,TF1) |
| >>ctfc | | 6 | 60 |
| >>>gainFactorInformation | | Computed | Computed |
| >>referenceTFClid | | 0 | 0 |
| >>>TFCS 8 | | (TF2, TF1) | (TF1,TF0,TF0,TF1) |
| >>ctfc | | 7 | 61 |

| Configuration | 28.8 kbps streaming CS-data + 3.4 kbps signalling | 57.6 kbps streaming CS-data + 3.4 kbps signalling | 12.2/7.95/5.9/4.75 kbps speech + 3.4 kbps signalling |
|--------------------------------------|---|---|--|
| >>>>>>gainFactorInformation | | Computed | Computed |
| >>>>>>referenceTFCIId | | 0 | 0 |
| >>>>>TFCS 9 | | (TF3, TF1) | (TF2,TF1,TF0,TF1) |
| >>>>>>ctfc | | 8 | 68 |
| >>>>>>gainFactorInformation | | Computed | Computed |
| >>>>>>referenceTFCIId | | 0 | 0 |
| >>>>>TFCS 10 | | (TF4, TF1) | (TF3,TF2,TF0,TF1) |
| >>>>>>ctfc | | 9 | 75 |
| >>>>>>gainFactorInformation | | Signalled | Computed |
| >>>>>>>βc (FDD only) | | 8 | N/A |
| >>>>>>>βd | | 15 | N/A |
| >>>>>>>referenceTFCIId | | 0 | 0 |
| >>>>>>TFCS 11 | | | (TF4,TF3,TF0,TF1) |
| >>>>>>>ctfc | | | 82 |
| >>>>>>>gainFactorInformation | | | Computed |
| >>>>>>>referenceTFCIId | | | 0 |
| >>>>>>>TFCS 12 | | | (TF5,TF4,TF1,TF1) |
| >>>>>>>ctfc | | | 119 |
| >>>>>>>gainFactorInformation | | | Signalled |
| >>>>>>>βc (FDD only) | | | 11 |
| >>>>>>>βd | | | 15 |
| >>>>>>>referenceTFCIId | | | 0 |
| dI-CommonTransChInfo | | | |
| >tfcS-SignallingMode | Same as UL | Same as UL | Same as UL |
| PhyCH INFORMATION FDD | | | |
| UL-DPCH-InfoPredef | | | |
| >ul-DPCH-PowerControlInfo | | | |
| >>powerControlAlgorithm | Algorithm 1 | Algorithm 1 | Algorithm 1 |
| >>>tpcStepSize | 1 dB | 1 dB | 1 dB |
| >tfcI-Existence | TRUE | TRUE | TRUE |
| >puncturingLimit | 1 | 1 | 0.88 |
| DL-CommonInformationPredef | | | |
| >dI-DPCH-InfoCommon | | | |
| >>spreadingFactor | 64 | 32 | 128 |
| >>tfcI-Existence | TRUE | TRUE | FALSE |
| >>pilotBits | 8 | 8 | 4 |
| >>positionFixed | Flexible | Flexible | Fixed |
| PhyCH INFORMATION 3.84/7.68 Mcps TDD | | | |
| UL-DPCH-InfoPredef | | | |
| >ul-DPCH-PowerControlInfo | | | |
| >>dpch-ConstantValue | 0 | 0 | 0 |
| >commonTimeslotInfo | | | |
| >>secondInterleavingMode | frameRelated | frameRelated | frameRelated |
| >>tfcI-Coding | 16 | 16 | 16 |
| >>puncturingLimit | 0.44 | 0.48 | 0.88 |
| >>repetitionPeriodAndLength | repetitionPeriod1 | repetitionPeriod1 | repetitionPeriod1 |

| Configuration | 28.8 kbps
streaming CS-
data +
3.4 kbps signalling | 57.6 kbps
streaming CS-
data +
3.4 kbps signalling | 12.2/7.95/5.9/4.75
kbps speech +
3.4 kbps signalling |
|------------------------------------|---|---|--|
| DL-
CommonInformationPredef | | | |
| >dl-DPCH-InfoCommon | | | |
| >>commonTimeslotInfo | | | |
| >>>secondInterleavingMode | frameRelated | frameRelated | frameRelated |
| >>>tfc-Coding | 16 | 16 | 16 |
| >>>puncturingLimit | 0.44 | 0.48 | 0.92 |
| >>>repetitionPeriodAndLength | repetitionPeriod1 | repetitionPeriod1 | repetitionPeriod1 |
| PhyCH INFORMATION
1.28 Mcps TDD | | | |
| UL-DPCH-InfoPredef | | | |
| >commonTimeslotInfo | | | |
| >>secondInterleavingMode | frameRelated | frameRelated | |
| >>tfc-Coding | 16 | 16 | |
| >>puncturingLimit | 0.64 | 0.72 | |
| >>repetitionPeriodAndLength | repetitionPeriod1 | repetitionPeriod1 | |
| DL-
CommonInformationPredef | | | |
| >dl-DPCH-InfoCommon | | | |
| >>commonTimeslotInfo | | | |
| >>>secondInterleavingMode | frameRelated | frameRelated | frameRelated |
| >>>tfc-Coding | 16 | 16 | 16 |
| >>>puncturingLimit | 0.64 | 0.72 | 0.92 |
| >>>repetitionPeriodAndLength | repetitionPeriod1 | repetitionPeriod1 | repetitionPeriod1 |

| Configuration | 10.2/6.7/5.9/4.75 kbps speech + 3.4 kbps signalling + 0.15 kbps SRB#5 | 7.4/6.7/5.9/4.75 kbps speech + 3.4 kbps signalling + 0.15 kbps SRB#5 |
|--------------------------------|--|--|
| Ref 34.108 | 5a | 7a |
| Default configuration identity | 11 | 12 |
| RB INFORMATION | | |
| rb-Identity | RB1: 1, RB2: 2, RB3: 3, RB5: 5, RB6: 6, RB7: 7, RB8: 8 | RB1: 1, RB2: 2, RB3: 3, RB5: 5, RB6: 6, RB7: 7 |
| rlc-InfoChoice | Rlc-info | Rlc-info |
| >ul-RLC-Mode | RB1: UM
RB2- RB3: AM
RB5-RB7: TM | RB1: UM
RB2- RB3: AM
RB5-RB6: TM |
| >>transmissionRLC-DiscardMode | RB1: N/A
RB2- RB3: NoDiscard
RB5- RB7: N/A | RB1: N/A
RB2- RB3: NoDiscard
RB5- RB6: N/A |
| >>>maxDat | RB1: N/A
RB2- RB3: 15
RB5- RB7: N/A | RB1: N/A
RB2- RB3: 15
RB5- RB6: N/A |
| >>transmissionWindowSize | RB1: N/A
RB2- RB3: 128 for UEs with more than 10 kbyte "total RLC AM buffer size" and 32 otherwise
RB5- RB7: N/A | RB1: N/A
RB2- RB3: 128 for UEs with more than 10 kbyte "total RLC AM buffer size" and 32 otherwise
RB5- RB6: N/A |
| >>timerRST | RB1: N/A
RB2- RB3: 300
RB5- RB7: N/A | RB1: N/A
RB2- RB3: 300
RB5- RB6: N/A |
| >>max-RST | RB1: N/A
RB2- RB3: 1
RB5- RB7: N/A | RB1: N/A
RB2- RB3: 1
RB5- RB6: N/A |
| >>pollingInfo | RB1: N/A
RB2- RB3: as below
RB5- RB7: N/A | RB1: N/A
RB2- RB3: as below
RB5- RB6: N/A |
| >>>lastTransmissionPDU-Poll | RB2- RB3: FALSE | RB2- RB3: FALSE |
| >>>lastRetransmissionPDU-Poll | RB2- RB3: FALSE | RB2- RB3: FALSE |
| >>>timerPollPeriodic | RB2- RB3: 300 | RB2- RB3: 300 |
| >>segmentationIndication | RB1- RB3: N/A
RB5- RB7: FALSE | RB1- RB3: N/A
RB5- RB6: FALSE |
| >dl-RLC-Mode | RB1: UM
RB2- RB3: AM
RB5- RB7: TM
RB8: TM | RB1: UM
RB2- RB3: AM
RB5- RB6: TM
RB7: TM |
| >>inSequenceDelivery | RB1: N/A
RB2- RB3: TRUE
RB5- RB8: N/A | RB1: N/A
RB2- RB3: TRUE
RB5- RB7: N/A |
| >>receivingWindowSize | RB1: N/A
RB2- RB3: 128 for UEs with more than 10 kbyte "total RLC AM buffer size" and 32 otherwise
RB5- RB8: N/A | RB1: N/A
RB2- RB3: 128 for UEs with more than 10 kbyte "total RLC AM buffer size" and 32 otherwise
RB5- RB7: N/A |
| >>dl-RLC-StatusInfo | RB1: N/A
RB2- RB3: as below
RB5- RB8: N/A | RB1: N/A
RB2- RB3: as below
RB5- RB7: N/A |
| >>>timerStatusProhibit | RB2- RB3: 100 | RB2- RB3: 100 |
| >>>missingPDU-Indicator | RB2- RB3: FALSE | RB2- RB3: FALSE |
| >>>timerStatusPeriodic | RB2- RB3: 300 | RB2- RB3: 300 |

| | | |
|--------------------------------|---|--|
| >>segmentationIndication | RB1- RB3: N/A
RB5- RB8: FALSE | RB1- RB3: N/A
RB5- RB7: FALSE |
| rb-MappingInfo | | |
| >UL-LogicalChannelMappings | OneLogicalChannel | OneLogicalChannel |
| >>ul-TransportChannelType | Dch | Dch |
| >>>transportChannelIdentity | RB1- RB3: 4
RB5: 1, RB6: 2,
RB7: 3, | RB1- RB3: 3
RB5: 1, RB6: 2 |
| >>logicalChannelIdentity | RB1: 1, RB2: 2,
RB3: 3
RB5- RB7: N/A | RB1: 1, RB2: 2,
RB3: 3
RB5- RB6: N/A |
| >>rlc-SizeList | RB1- RB3:
configured
RB5- RB7: N/A | RB1- RB3:
configured
RB5- RB6: N/A |
| >>mac-LogicalChannelPriority | RB1: 1, RB2: 2,
RB3: 3
RB5- RB7: 5 | RB1: 1, RB2: 2,
RB3: 3
RB5- RB6: 5 |
| >DL-logicalChannelMappingList | | |
| >>Mapping option 1 | One mapping option | One mapping option |
| >>>dl-TransportChannelType | Dch | Dch |
| >>>>transportChannelIdentity | RB1- RB3: 4
RB5: 1, RB6: 2,
RB7: 3, RB8: 5 | RB1- RB3: 3
RB5: 1, RB6: 2,
RB7:4 |
| >>>logicalChannelIdentity | RB1: 1, RB2: 2,
RB3: 3
RB5- RB8: N/A | RB1: 1, RB2: 2,
RB3: 3
RB5- RB7: N/A |
| TrCH INFORMATION PER TrCH | | |
| UL-AddReconfTransChInfoList | | |
| >Uplink transport channel type | dch | dch |
| >transportChannelIdentity | TrCH1: 1, TrCH2: 2,
TrCH3: 3, TrCH4: 4 | TrCH1: 1, TrCH2: 2,
TrCH3: 3 |
| >transportFormatSet | DedicatedTransChTFS | DedicatedTransChTFS |
| >>dynamicTF-information | | |
| >>>tf0/ tf0,1 | TrCH1: (0x65)
TrCH2: (0x 99)
TrCH3: (0x 40,
1x40)
TrCH4: (0x144,
1x144) | TrCH1: (0x61)
TrCH2: (0x 87)
TrCH3: (0x 144,
1x144) |
| >>>>rlcSize | BitMode | BitMode |
| >>>>>sizeType | TrCH1: type 1: 65
TrCH2: type 1: 99
TrCH3: type 1: 40
TrCH4: 2: type 2,
part1= 2, part2= 0
(144) | TrCH1: type 1: 61
TrCH2: type 1: 87
TrCH3: 2: type 2,
part1= 2, part2= 0
(144) |
| >>>>numberOfTbSizeList | TrCH1-2: Zero
TrCH3-4: Zero, one | TrCH1-2: Zero
TrCH3: Zero, one |
| >>>>logicalChannelList | All | All |
| >>>>tf 1 | TrCH1: (1x39)
TrCH2: (1x 53)
TrCH3- TrCH4: N/A | TrCH1: (1x39)
TrCH2: (1x53)
TrCH3: N/A |
| >>>>>numberOfTransportBlocks | TrCH1: One
TrCH2: One | TrCH1: One
TrCH2: One |
| >>>>>rlc-Size | TrCH1-2: BitMode | TrCH1-2: BitMode |
| >>>>>>sizeType | TrCH1: 1: 39
TrCH2: 1: 53 | TrCH1: 1: 39
TrCH1: 1: 53 |
| >>>>>>numberOfTbSizeList | TrCH1-2: One | TrCH1-2: One |

| | | |
|----------------------------------|---|--|
| >>>>logicalChannelList | TrCH1: all | TrCH1: all |
| >>>tf 2 | TrCH1: (1x42)
TrCH2: (1x63)
TrCH3- TrCH4: N/A | TrCH1: (1x42)
TrCH2: (1x63)
TrCH3: N/A |
| >>>>numberOfTransportBlocks | TrCH1: One
TrCh2: One | TrCH1: One
TrCh2: One |
| >>>>rlc-Size | TrCH1: BitMode | TrCH1: BitMode |
| >>>>>sizeType | TrCH1: type 1: 42
TrCH2: type 1: 63 | TrCH1: type 1: 42
TrCH2: type 1: 63 |
| >>>>numberOfTbSizeList | TrCH1: One
TrCH2: One | TrCH1: One
TrCH2: One |
| >>>>logicalChannelList | TrCH1: all
TrCH2: all | TrCH1: all
TrCH2: all |
| >>>tf 3 | TrCH1: (1x55)
TrCH2: (1x76)
TrCH3- TrCH4: N/A | TrCH1: (1x55)
TrCH2: (1x76)
TrCH3: N/A |
| >>>>numberOfTransportBlocks | TrCH1: One
TrCh2: One | TrCH1: One
TrCh2: One |
| >>>>rlc-Size | TrCH1: BitMode | TrCH1: BitMode |
| >>>>>sizeType | TrCH1: type 1: 55
TrCH2: type 1: 76 | TrCH1: type 1: 55
TrCH2: type 1: 76 |
| >>>>numberOfTbSizeList | TrCH1: One
TrCH2: One | TrCH1: One
TrCH2: One |
| >>>>logicalChannelList | TrCH1: all
TrCH2: all | TrCH1: all
TrCH2: all |
| >>>tf 4 | TrCH1: (1x58)
TrCH2: (1x99)
TrCH3- TrCH4: N/A | TrCH1: (1x58)
TrCH2: (1x87)
TrCH3: N/A |
| >>>>numberOfTransportBlocks | TrCH1: One
TrCh2: One | TrCH1: One
TrCh2: One |
| >>>>rlc-Size | TrCH1: BitMode | TrCH1: BitMode |
| >>>>>sizeType | TrCH1: type 1: 58
TrCH2: type 1: 99 | TrCH1: type 1: 58
TrCH2: type 1: 87 |
| >>>>numberOfTbSizeList | TrCH1: One
TrCH2: One | TrCH1: One
TrCH2: One |
| >>>>logicalChannelList | TrCH1: all
TrCH2: all | TrCH1: all
TrCH2: all |
| >>>tf 5 | TrCH1: (1x65)
TrCH2- TrCH4: N/A | TrCH1: (1x61)
TrCH2- TrCH4: N/A |
| >>>>numberOfTransportBlocks | TrCH1: One | TrCH1: One |
| >>>>rlc-Size | TrCH1: BitMode | TrCH1: BitMode |
| >>>>>sizeType | TrCH1: type 1: 65 | TrCH1: type 1: 61 |
| >>>>numberOfTbSizeList | TrCH1: One | TrCH1: One |
| >>>>logicalChannelList | TrCH1: all | TrCH1: all |
| >>semistaticTF-Information | | |
| >>>tti | TrCH1- TrCH3: 20
TrCH4: 40 | TrCH1- TrCH2: 20
TrCH3: 40 |
| >>>channelCodingType | Convolutional | Convolutional |
| >>>>codingRate | TrCH1- TrCH2:
Third
TrCH3: Half
TrCH4: Third | TrCH1- TrCH2:
Third
TrCH3: Third |
| >>>rateMatchingAttribute | TrCH1: 200
TrCH2: 190
TrCH3: 235
TrCH4: 160 | TrCH1: 200
TrCH2: 190
TrCH3: 160 |
| >>>crc-Size | TrCH1: 12
TrCH2- TrCH3: 0
TrCH4: 16 | TrCH1: 12
TrCH2: 0
TrCH3: 16 |
| DL-AddReconfTransChInfoList | | |
| >Downlink transport channel type | dch | dch |

| | | |
|------------------------------------|---|---|
| >dl-TransportChannelIdentity | TrCH1: 1, TrCH2: 2, TrCH3: 3, TrCH4: 4, TrCH5: 5 | TrCH1: 1, TrCH2: 2, TrCH3: 3, TrCH4: 4 |
| >tfs-SignallingMode | Independent
<Only tf0 on TrCH1 and tf0/1 on TrCH5 are different and shown below> | Independent
<Only tf0 on TrCH1 and tf0/1 on TrCH4 are different and shown below> |
| >>transportFormatSet | | |
| >>>dynamicTF-information | | |
| >>>>tf0/ tf0,1 | TrCH1: (1x0)
TrCH5: (0x3, 1x3) | TrCH1: (1x0)
TrCH4: (0x3, 1x3) |
| >>>>rlcSize | BitMode | bitMode |
| >>>>>sizeType | TrCH1: type 1: 0
TrCH5: type 1: 3 | TrCH1: type 1: 0
TrCH4: type 1: 3 |
| >>>>numberOfTbSizeList | TrCH1: One
TrCH5: Zero, one | TrCH1: One
TrCH4: Zero, one |
| >>>>logicalChannelList | All | All |
| >>>semistaticTF-Information | same as UL except for TrCH5 | same as UL except for TrCH4 |
| >>>>tti | TrCH5: 20 | TrCH4: 20 |
| >>>>channelCodingType | Convolutional | Convolutional |
| >>>>>codingRate | TrCH5: Third | TrCH4: Third |
| >>>>rateMatchingAttribute | TrCH5: 200 | TrCH4: 200 |
| >>>>crc-Size | TrCH5: 12 | TrCH4: 12 |
| >>ULTrCH-Id | TrCH1: 1, TrCH2: 2, TrCH3: 3, TrCH4: 4, | TrCH1: 1, TrCH2: 2, TrCH3: 3 |
| >dch-QualityTarget | | |
| >>bler-QualityValue | TrCH1: 7×10^{-3}
TrCH2- TrCH5:
Absent | TrCH1: 7×10^{-3}
TrCH2- TrCH4:
Absent |
| TrCH INFORMATION,
COMMON | | |
| ul-CommonTransChInfo | | |
| >tfc-ID (TDD only) | 1 | 1 |
| >sharedChannelIndicator (TDD only) | FALSE | FALSE |
| > tfc-Subset | Absent, not required | Absent, not required |
| >ul-TFCS | Normal TFCl signalling | Normal TFCl signalling |
| >>explicitTFCS-ConfigurationMode | Complete | Complete |
| >>>ctfcSize | Ctfc8Bit | Ctfc6Bit |
| >>>>TFCS representation | Addition | Addition |
| >>>>>TFC list | | |
| >>>>>>TFC 1 | (TF0, TF0, TF0, TF0) | (TF0, TF0, TF0) |
| >>>>>>>ctfc | 0 | 0 |
| >>>>>>>>gainFactorInformation | Computed | Computed |
| >>>>>>>>referenceTFClId | 0 | 0 |
| >>>>>>>>TFC 2 | (TF1, TF0, TF0, TF0) | (TF1, TF0, TF0) |
| >>>>>>>>ctfc | 1 | 1 |
| >>>>>>>>>gainFactorInformation | Computed | Computed |
| >>>>>>>>>> β_c (FDD only) | N/A | N/A |
| >>>>>>>>>> β_d | N/A | N/A |
| >>>>>>>>>>referenceTFClId | 0 | 0 |
| >>>>>>>>>>TFC 3 | (TF2, TF1, TF0, TF0) | (TF2, TF1, TF0) |
| >>>>>>>>>>>ctfc | 8 | 8 |
| >>>>>>>>>>>>gainFactorInformation | Computed | Computed |
| >>>>>>>>>>>>referenceTFClId | 0 | 0 |

| | | |
|----------------------------------|-------------------------|-----------------|
| >>>>>>TFC 4 | (TF3, TF2, TF0,
TF0) | (TF3, TF2, TF0) |
| >>>>>>>ctfc | 15 | 15 |
| >>>>>>>gainFactorInform
ation | Computed | Computed |
| >>>>>>> β c (FDD only) | | |
| >>>>>>> β d | | |
| >>>>>>>referenceTFCId | 0 | 0 |
| >>>>>>TFC 5 | (TF4, TF3, TF0,
TF0) | (TF4, TF3, TF0) |
| >>>>>>>ctfc | 22 | 22 |
| >>>>>>>gainFactorInform
ation | Computed | Computed |
| >>>>>>>referenceTFCId | 0 | 0 |
| >>>>>>TFC 6 | (TF5, TF4, TF1,
TF0) | (TF5, TF4, TF0) |
| >>>>>>>ctfc | 59 | 29 |
| >>>>>>>gainFactorInform
ation | Computed | Computed |
| >>>>>>> β c (FDD only) | | |
| >>>>>>> β d | | |
| >>>>>>>referenceTFCId | 0 | 0 |
| >>>>>>TFC 7 | (TF0, TF0, TF0,
TF1) | (TF0, TF0, TF1) |
| >>>>>>>ctfc | 60 | 30 |
| >>>>>>>gainFactorInform
ation | Computed | Computed |
| >>>>>>>referenceTFCId | 0 | 0 |
| >>>>>>TFC 8 | (TF1, TF0, TF0,
TF1) | (TF1, TF0, TF1) |
| >>>>>>>ctfc | 61 | 31 |
| >>>>>>>gainFactorInform
ation | computed | computed |
| >>>>>>> β c (FDD only) | | |
| >>>>>>> β d | | |
| >>>>>>>referenceTFCId | 0 | 0 |
| >>>>>>TFC 9 | (TF2, TF1, TF0,
TF1) | (TF2, TF1, TF1) |
| >>>>>>>ctfc | 68 | 38 |
| >>>>>>>gainFactorInform
ation | computed | computed |
| >>>>>>>referenceTFCId | 0 | 0 |
| >>>>>>TFC 10 | (TF3, TF2, TF0,
TF1) | (TF3, TF2, TF1) |
| >>>>>>>ctfc | 75 | 45 |
| >>>>>>>gainFactorInform
ation | computed | computed |
| >>>>>>> β c (FDD only) | | |
| >>>>>>> β d | | |
| >>>>>>>referenceTFCId | 0 | 0 |
| >>>>>>TFC 11 | (TF4, TF3, TF0,
TF1) | (TF4, TF3, TF1) |
| >>>>>>>ctfc | 82 | 52 |
| >>>>>>>gainFactorInform
ation | computed | computed |
| >>>>>>>referenceTFCId | 0 | 0 |
| >>>>>>TFC 12 | (TF5, TF4, TF1,
TF1) | (TF5, TF4, TF1) |
| >>>>>>>ctfc | 119 | 59 |
| >>>>>>>gainFactorInform
ation | signalled | signalled |
| >>>>>>> β c (FDD only) | 11 | 11 |
| >>>>>>> β d | 15 | 15 |

| | | |
|---|---|---|
| >>>>>>referenceTFCId | 0 | 0 |
| > TFC subset list | | |
| >>TFC subset 1 | (speech rate 10.2) | (speech rate 7.4) |
| >>> Allowed transport format combination list | (TFC1, TFC2, TFC3, TFC4, TFC5, TFC7, TFC8, TFC6, TFC9, TFC10, TFC11, TFC12) | (TFC1, TFC2, TFC3, TFC4, TFC5, TFC7, TFC8, TFC6, TFC9, TFC10, TFC11, TFC12) |
| >>TFC subset 2 | (speech rate 6.7) | (speech rate 6.7) |
| >>> Allowed transport format combination list | (TFC1, TFC2, TFC3, TFC4, TFC7, TFC8, TFC5, TFC9, TFC10, TFC11) | (TFC1, TFC2, TFC3, TFC4, TFC7, TFC8, TFC5, TFC9, TFC10, TFC11) |
| >>TFC subset 3 | (speech rate 5.9) | (speech rate 5.9) |
| >>> Allowed transport format combination list | (TFC1, TFC2, TFC3, TFC7, TFC8, TFC4, TFC9, TFC10) | (TFC1, TFC2, TFC3, TFC7, TFC8, TFC4, TFC9, TFC10) |
| >>TFC subset 4 | (speech rate 4.75) | (speech rate 4.75) |
| >>> Allowed transport format combination list | (TFC1, TFC2, TFC7, TFC8, TFC3, TFC9) | (TFC1, TFC2, TFC7, TFC8, TFC3, TFC9) |
| dl-CommonTransChInfo | | |
| >tfc-SignallingMode | Independent | Independent |
| >tfc-ID (TDD only) | 1 | 1 |
| >sharedChannelIndicator (TDD only) | FALSE | FALSE |
| > tfc-Subset | Absent, not required | Absent, not required |
| >dl-TFCS | Normal TFCI signalling | Normal TFCI signalling |
| >>explicitTFCS-ConfigurationMode | Complete | Complete |
| >>>ctfcSize | Ctfc8Bit | Ctfc8Bit |
| >>>>TFCS representation | Addition | Addition |
| >>>>>TFCS list | | |
| >>>>>>TFC 1 | (TF0, TF0, TF0, TF0, TF0) | (TF0, TF0, TF0, TF0) |
| >>>>>>>ctfc | 0 | 0 |
| >>>>>>TFC 2 | (TF1, TF0, TF0, TF0, TF0) | (TF1, TF0, TF0, TF0) |
| >>>>>>>ctfc | 1 | 1 |
| >>>>>>TFC 3 | (TF2, TF1, TF0, TF0, TF0) | (TF2, TF1, TF0, TF0) |
| >>>>>>>ctfc | 8 | 8 |
| >>>>>>TFC 4 | (TF3, TF2, TF0, TF0, TF0) | (TF3, TF2, TF0, TF0) |
| >>>>>>>ctfc | 15 | 15 |
| >>>>>>TFC 5 | (TF4, TF3, TF0, TF0, TF0) | (TF4, TF3, TF0, TF0) |
| >>>>>>>ctfc | 22 | 22 |
| >>>>>>TFC 6 | (TF5, TF4, TF1, TF0, TF0) | (TF5, TF4, TF0, TF0) |
| >>>>>>>ctfc | 59 | 29 |
| >>>>>>TFC 7 | (TF0, TF0, TF0, TF1, TF0) | (TF0, TF0, TF1, TF0) |
| >>>>>>>ctfc | 60 | 30 |
| >>>>>>TFC 8 | (TF1, TF0, TF0, TF1, TF0) | (TF1, TF0, TF1, TF0) |
| >>>>>>>ctfc | 61 | 31 |
| >>>>>>TFC 9 | (TF2, TF1, TF0, TF1, TF0) | (TF2, TF1, TF1, TF0) |
| >>>>>>>ctfc | 68 | 38 |
| >>>>>>TFC 10 | (TF3, TF2, TF0, TF1, TF0) | (TF3, TF2, TF1, TF0) |
| >>>>>>>ctfc | 75 | 45 |

| | | |
|---|------------------------------|-------------------------|
| >>>>>TFC 11 | (TF4, TF3, TF0,
TF1, TF0) | (TF4, TF3, TF1,
TF0) |
| >>>>>>ctfc | 82 | 52 |
| >>>>>TFC 12 | (TF5, TF4, TF1,
TF1, TF0) | (TF5, TF4, TF1,
TF0) |
| >>>>>>ctfc | 119 | 59 |
| >>>>>TFC 13 | (TF0, TF0, TF0,
TF0, TF1) | (TF0, TF0, TF0,
TF1) |
| >>>>>>ctfc | 120 | 60 |
| >>>>>TFC 14 | (TF1, TF0, TF0,
TF0, TF1) | (TF1, TF0, TF0,
TF1) |
| >>>>>>ctfc | 121 | 61 |
| >>>>>TFC 15 | (TF2, TF1, TF0,
TF0, TF1) | (TF2, TF1, TF0,
TF1) |
| >>>>>>ctfc | 128 | 68 |
| >>>>>TFC 16 | (TF3, TF2, TF0,
TF0, TF1) | (TF3, TF2, TF0,
TF1) |
| >>>>>>ctfc | 135 | 75 |
| >>>>>TFC 17 | (TF4, TF3, TF0,
TF0, TF1) | (TF4, TF3, TF0,
TF1) |
| >>>>>>ctfc | 142 | 82 |
| >>>>>TFC 18 | (TF5, TF4, TF1,
TF0, TF1) | (TF5, TF4, TF0,
TF1) |
| >>>>>>ctfc | 179 | 89 |
| >>>>>TFC 19 | (TF0, TF0, TF0,
TF1, TF1) | (TF0, TF0, TF1,
TF1) |
| >>>>>>ctfc | 180 | 90 |
| >>>>>TFC 20 | (TF1, TF0, TF0,
TF1, TF1) | (TF1, TF0, TF1,
TF1) |
| >>>>>>ctfc | 181 | 91 |
| >>>>>TFC 21 | (TF2, TF1, TF0,
TF1, TF1) | (TF2, TF1, TF1,
TF1) |
| >>>>>>ctfc | 188 | 98 |
| >>>>>TFC 22 | (TF3, TF2, TF0,
TF1, TF1) | (TF3, TF2, TF1,
TF1) |
| >>>>>>ctfc | 195 | 105 |
| >>>>>TFC 23 | (TF4, TF3, TF0,
TF1, TF1) | (TF4, TF3, TF1,
TF1) |
| >>>>>>ctfc | 202 | 112 |
| >>>>>TFC 24 | (TF5, TF4, TF1,
TF1, TF1) | (TF5, TF4, TF1,
TF1) |
| >>>>>>ctfc | 239 | 119 |
| PhyCH INFORMATION
FDD | | |
| UL-DPCH-InfoPredef | | |
| >ul-DPCH-
PowerControllInfo | | |
| >>powerControlAlgorithm | Algorithm 1 | Algorithm 1 |
| >>>tpcStepSize | 1 dB | 1 dB |
| >tfc-Existence | TRUE | TRUE |
| >puncturingLimit | 0.88 | 0.88 |
| DL-
CommonInformationPredef | | |
| >dl-DPCH-InfoCommon | | |
| >>spreadingFactor | 128 | 128 |
| >>tfc-Existence | FALSE | FALSE |
| >>pilotBits | 4 | 4 |
| >>positionFixed | Fixed | Fixed |
| | | |
| PhyCH INFORMATION
3.84/7.68 Mcps TDD | | |
| UL-DPCH-InfoPredef | | |
| >ul-DPCH-
PowerControllInfo | | |
| >>dpch-ConstantValue | 0 | 0 |

| | | |
|------------------------------------|-------------------|-------------------|
| >commonTimeslotInfo | | |
| >>secondInterleavingMode | frameRelated | frameRelated |
| >>tfc-Coding | 16 | 16 |
| >>puncturingLimit | 0.60 | 0.60 |
| >>repetitionPeriodAndLength | repetitionPeriod1 | repetitionPeriod1 |
| DL-CommonInformationPredef | | |
| >dl-DPCH-InfoCommon | | |
| >>commonTimeslotInfo | | |
| >>>secondInterleavingMode | frameRelated | frameRelated |
| >>>tfc-Coding | 16 | 16 |
| >>>puncturingLimit | 0.60 | 0.60 |
| >>>repetitionPeriodAndLength | repetitionPeriod1 | repetitionPeriod1 |
| PhyCH INFORMATION
1.28 Mcps TDD | | |
| UL-DPCH-InfoPredef | | |
| >commonTimeslotInfo | | |
| >>secondInterleavingMode | frame Related | frame Related |
| >>tfc-Coding | 16 | 16 |
| >>puncturingLimit | 0.64 | 0.64 |
| >>repetitionPeriodAndLength | repetitionPeriod1 | repetitionPeriod1 |
| DL-CommonInformationPredef | | |
| >dl-DPCH-InfoCommon | | |
| >>commonTimeslotInfo | | |
| >>>secondInterleavingMode | frame Related | frame Related |
| >>>tfc-Coding | 16 | 16 |
| >>>puncturingLimit | 0.64 | 0.64 |
| >>>repetitionPeriodAndLength | repetitionPeriod1 | repetitionPeriod1 |

NOTE : Default configuration identity 11 can not be used with release 4 UEs.

| | |
|-----------------------------------|--|
| Configuration | 12.65/8.85/6.6 kbps
speech +
3.4 kbps signalling
+ 0.15 kbps SRB#5 |
| Ref 34.108 | 62 |
| Default configuration
identity | 13 |
| RB INFORMATION | |
| rb-Identity | RB1: 1, RB2: 2,
RB3: 3, RB5: 5,
RB6: 6, RB7: 7,
RB8: 8 |
| rlc-InfoChoice | Rlc-info |
| >ul-RLC-Mode | RB1: UM
RB2- RB3: AM
RB5-RB7: TM |
| >>transmissionRLC-
DiscardMode | RB1: N/A
RB2- RB3:
NoDiscard
RB5- RB7: N/A |
| >>>maxDat | RB1: N/A
RB2- RB3: 15
RB5- RB7: N/A |
| >>transmissionWindowSiz
e | RB1: N/A
RB2- RB3: 128 for
UEs with more than
10 kbyte "total RLC
AM buffer size" and
32 otherwise
RB5- RB7: N/A |
| >>timerRST | RB1: N/A
RB2- RB3: 300
RB5- RB7: N/A |
| >>max-RST | RB1: N/A
RB2- RB3: 1
RB5- RB7: N/A |
| >>pollingInfo | RB1: N/A
RB2- RB3: as below
RB5- RB7: N/A |
| >>>lastTransmissionPDU-
Poll | RB2- RB3: FALSE |
| >>>lastRetransmissionPD
U-Poll | RB2- RB3: FALSE |
| >>>timerPollPeriodic | RB2- RB3: 300 |
| >>segmentationIndication | RB1- RB3: N/A
RB5- RB7: FALSE |
| >dl-RLC-Mode | RB1: UM
RB2- RB3: AM
RB5- RB7: TM
RB8: TM |
| >>inSequenceDelivery | RB1: N/A
RB2- RB3: TRUE
RB5- RB7: N/A
RB8: N/A |
| >>receivingWindowSize | RB1: N/A
RB2- RB3: 128 for
UEs with more than
10 kbyte "total RLC
AM buffer size" and
32 otherwise
RB5- RB7: N/A
RB8: N/A |
| >>dl-RLC-StatusInfo | RB1: N/A
RB2- RB3: as below
RB5- RB7: N/A
RB8: N/A |

| | |
|--------------------------------|---|
| >>>timerStatusProhibit | RB2- RB3: 100 |
| >>>missingPDU-Indicator | RB2- RB3: FALSE |
| >>>timerStatusPeriodic | RB2- RB3: 300 |
| >>segmentationIndication | RB1- RB3: N/A
RB5- RB7: FALSE
RB8: FALSE |
| rb-MappingInfo | |
| >UL-LogicalChannelMappings | OneLogicalChannel |
| >>ul-TransportChannelType | Dch |
| >>>transportChannelIdentity | RB1- RB3: 4
RB5: 1, RB6: 2,
RB7: 3. |
| >>logicalChannelIdentity | RB1: 1, RB2: 2,
RB3: 3
RB5- RB7: N/A |
| >>rlc-SizeList | RB1- RB3:
configured
RB5- RB7: N/A |
| >>mac-LogicalChannelPriority | RB1: 1, RB2: 2,
RB3: 3
RB5- RB7: 5 |
| >DL-logicalChannelMappingList | |
| >>Mapping option 1 | One mapping option |
| >>>dl-TransportChannelType | Dch |
| >>>>transportChannelIdentity | RB1- RB3: 4
RB5: 1, RB6: 2,
RB7: 3, RB8: 5 |
| >>>logicalChannelIdentity | RB1: 1, RB2: 2,
RB3: 3
RB5- RB7: N/A
RB8: N/A |
| TrCH INFORMATION PER TrCH | |
| UL-AddReconfTransChInfoList | |
| >Uplink transport channel type | dch |
| >transportChannelIdentity | TrCH1: 1, TrCH2: 2,
TrCH3: 3, TrCH4: 4 |
| >transportFormatSet | DedicatedTransChTFS |
| >>dynamicTF-information | |
| >>>tf0/ tf0,1 | TrCH1: (0x72)
TrCH2: (0x 181)
TrCH3: (0x60)
TrCH4: (0x144,
1x144) |
| >>>>rlcSize | BitMode |
| >>>>>sizeType | TrCH1: type 1: 72
TrCH2: type 2:
part1= 6, part2= 5
TrCH3: type1: 60
TrCH4: 2: type 2,
part1= 2, part2= 0
(144) |
| >>>>numberOfTbSizeList | TrCH1-3: Zero
TrCH4: Zero, one |
| >>>>logicalChannelList | All |
| >>>tf 1 | TrCH1: (1x40)
TrCH2: (1x 78)
TrCH3: N/A
TrCH4: N/A |

| | |
|----------------------------------|---|
| >>>>numberOfTransportBlocks | TrCH1: One
TrCH2: One |
| >>>>rlc-Size | TrCH1-2: BitMode |
| >>>>>sizeType | TrCH1: 1: 40
TrCH2: 1: 78 |
| >>>>numberOfTbSizeList | TrCH1-2: One |
| >>>>logicalChannelList | TrCH1: all |
| >>>tf 2 | TrCH1: (1x54)
TrCH2: (1x113)
TrCH3: N/A
TrCH4: N/A |
| >>>>numberOfTransportBlocks | TrCH1: One
TrCh2: One |
| >>>>rlc-Size | TrCH1: BitMode |
| >>>>>sizeType | TrCH1: type 1: 54
TrCH2: type 1: 113 |
| >>>>numberOfTbSizeList | TrCH1: One
TrCH2: One |
| >>>>logicalChannelList | TrCH1: all
TrCH2: all |
| >>>tf 3 | TrCH1: (1x64)
TrCH2: (1x181)
TrCH3: N/A
TrCH4: N/A |
| >>>>numberOfTransportBlocks | TrCH1: One
TrCh2: One |
| >>>>rlc-Size | TrCH1: BitMode |
| >>>>>sizeType | TrCH1: type 1: 64
TrCH2: type 2:
part1=6, part2= 5 |
| >>>>numberOfTbSizeList | TrCH1: One
TrCH2: One |
| >>>>logicalChannelList | TrCH1: all
TrCH2: all |
| >>>tf 4 | TrCH1: (1x72)
TrCH2: N/A
TrCH3: N/A
TrCH4: N/A |
| >>>>numberOfTransportBlocks | TrCH1: One |
| >>>>rlc-Size | TrCH1: BitMode |
| >>>>>sizeType | TrCH1: type 1: 72 |
| >>>>numberOfTbSizeList | TrCH1: One |
| >>>>logicalChannelList | TrCH1: all |
| >>semistaticTF-Information | |
| >>>tti | TrCH1- TrCH3: 20
TrCH4: 40 |
| >>>channelCodingType | Convolutional |
| >>>>codingRate | TrCH1- TrCH3:
Third
TrCH4: Third |
| >>>>rateMatchingAttribute | TrCH1: 200
TrCH2: 190
TrCH3: 256
TrCH4: 170 |
| >>>>crc-Size | TrCH1: 12
TrCH2: 0
TrCH3: 0
TrCH4: 16 |
| DL-AddReconfTransChInfoList | |
| >Downlink transport channel type | dch |
| >dl-TransportChannelIdentity | TrCH1: 1, TrCH2: 2,
TrCH3: 3, TrCH4:
4, TrCH5: 5 |

| | |
|------------------------------------|---|
| >fs-SignallingMode | Independent
<Only tf0 on TrCH1 and tf0/TF1 on TrCH5 are different and shown below> |
| >>transportFormatSet | |
| >>>dynamicTF-information | |
| >>>>tf0/ tf0,1 | TrCH1: (1x0)
TrCH5: (0x3, 1x3) |
| >>>>rlcSize | BitMode |
| >>>>>sizeType | TrCH1: type 1: 0
TrCH5: type 1: 3 |
| >>>>>numberOfTbSizeList | TrCH1: One
TrCH5: Zero, one |
| >>>>>logicalChannelList | All |
| >>>semistaticTF-Information | same as UL except for TrCH5 |
| >>>>tqi | TrCH5: 20 |
| >>>>>channelCodingType | Convolutional |
| >>>>>>codingRate | TrCH5: Third |
| >>>>>>rateMatchingAttribute | TrCH5: 205 |
| >>>>>>crc-Size | TrCH5: 8 |
| >>ULTrCH-Id | TrCH1: 1, TrCH2: 2,
TrCH3: 3, TrCH4: 4, |
| >dch-QualityTarget | |
| >>bler-QualityValue | TrCH1: 7×10^{-3}
TrCH2: Absent
TrCH3: Absent
TrCH4- TrCH5: Absent |
| TrCH INFORMATION,
COMMON | |
| ul-CommonTransChInfo | |
| >tfcs-ID (TDD only) | 1 |
| >sharedChannelIndicator (TDD only) | FALSE |
| > tfc-Subset | Absent, not required |
| >ul-TFCS | Normal TFCI signalling |
| >>explicitTFCS-ConfigurationMode | Complete |
| >>>ctfcSize | Ctfc6Bit |
| >>>>TFCS representation | Addition |
| >>>>>TFC list | |
| >>>>>>TFC 1 | (TF0, TF0, TF0, TF0) |
| >>>>>>>ctfc | 0 |
| >>>>>>>>gainFactorInformation | Computed |
| >>>>>>>>referenceTFCId | 0 |
| >>>>>>TFC 2 | (TF1, TF0, TF0, TF0) |
| >>>>>>>ctfc | 1 |
| >>>>>>>>gainFactorInformation | Computed |
| >>>>>>>>> β_c (FDD only) | N/A |
| >>>>>>>>> β_d | N/A |
| >>>>>>>>>referenceTFCId | 0 |
| >>>>>>TFC 3 | (TF2, TF1, TF0, TF0) |
| >>>>>>>ctfc | 7 |
| >>>>>>>>gainFactorInformation | Computed |
| >>>>>>>>>referenceTFCId | 0 |

| | |
|---|---|
| >>>>>>TFC 4 | (TF3, TF2, TF0, TF0) |
| >>>>>>>ctfc | 13 |
| >>>>>>>gainFactorInformation | Computed |
| >>>>>>> β c (FDD only) | |
| >>>>>>> β d | |
| >>>>>>>referenceTFCId | 0 |
| >>>>>>TFC 5 | (TF4, TF3, TF0, TF0) |
| >>>>>>>ctfc | 19 |
| >>>>>>>gainFactorInformation | Computed |
| >>>>>>>referenceTFCId | 0 |
| >>>>>>TFC 6 | (TF0, TF0, TF0, TF1) |
| >>>>>>>ctfc | 20 |
| >>>>>>>gainFactorInformation | Computed |
| >>>>>>> β c (FDD only) | |
| >>>>>>> β d | |
| >>>>>>>referenceTFCId | 0 |
| >>>>>>TFC 7 | (TF1, TF0, TF0, TF1) |
| >>>>>>>ctfc | 21 |
| >>>>>>>gainFactorInformation | Computed |
| >>>>>>>referenceTFCId | 0 |
| >>>>>>TFC 8 | (TF2, TF1, TF0, TF1) |
| >>>>>>>ctfc | 27 |
| >>>>>>>gainFactorInformation | computed |
| >>>>>>> β c (FDD only) | |
| >>>>>>> β d | |
| >>>>>>>referenceTFCId | 0 |
| >>>>>>TFC 9 | (TF3, TF2, TF0, TF1) |
| >>>>>>>ctfc | 33 |
| >>>>>>>gainFactorInformation | computed |
| >>>>>>>referenceTFCId | 0 |
| >>>>>>TFC 10 | (TF4, TF3, TF0, TF1) |
| >>>>>>>ctfc | 39 |
| >>>>>>>gainFactorInformation | signalled |
| >>>>>>> β c (FDD only) | 11 |
| >>>>>>> β d | 15 |
| >>>>>>>referenceTFCId | 0 |
| > TFC subset list | |
| >>TFC subset 1 | (speech rate 6.6) |
| >>> Allowed transport format combination list | (TFC1, TFC2, TFC3, TFC6, TFC7, TFC8) |
| >>TFC subset 2 | (speech rate 8.85) |
| >>> Allowed transport format combination list | (TFC1, TFC2, TFC3, TFC4, TFC6, TFC7, TFC8, TFC9) |
| >>TFC subset 3 | (speech rate 12.65) |
| >>> Allowed transport format combination list | (TFC1, TFC2, TFC3, TFC4, TFC5, TFC6, TFC7, TFC8, TFC9, TFC10) |

| | |
|------------------------------------|---------------------------|
| dl-CommonTransChInfo | |
| >tfc-SignallingMode | Independent |
| ul-CommonTransChInfo | |
| >tfc-ID (TDD only) | 1 |
| >sharedChannelIndicator (TDD only) | FALSE |
| > tfc-Subset | Absent, not required |
| >dl-TFCS | Normal TFCI signalling |
| >>explicitTFCS-ConfigurationMode | Complete |
| >>>ctfcSize | Ctfc8Bit |
| >>>>TFCS representation | Addition |
| >>>>>TFCS list | |
| >>>>>>TFC 1 | (TF0, TF0, TF0, TF0, TF0) |
| >>>>>>>ctfc | 0 |
| >>>>>>>TFC 2 | (TF1, TF0, TF0, TF0, TF0) |
| >>>>>>>ctfc | 1 |
| >>>>>>>TFC 3 | (TF2, TF1, TF0, TF0, TF0) |
| >>>>>>>ctfc | 7 |
| >>>>>>>TFC 4 | (TF3, TF2, TF0, TF0, TF0) |
| >>>>>>>ctfc | 13 |
| >>>>>>>TFC 5 | (TF4, TF3, TF0, TF0, TF0) |
| >>>>>>>ctfc | 19 |
| >>>>>>>TFC 6 | (TF0, TF0, TF0, TF1, TF0) |
| >>>>>>>ctfc | 20 |
| >>>>>>>TFC 7 | (TF1, TF0, TF0, TF1, TF0) |
| >>>>>>>ctfc | 21 |
| >>>>>>>TFC 8 | (TF2, TF1, TF0, TF1, TF0) |
| >>>>>>>ctfc | 27 |
| >>>>>>>TFC 9 | (TF3, TF2, TF0, TF1, TF0) |
| >>>>>>>ctfc | 33 |
| >>>>>>>TFC 10 | (TF4, TF3, TF0, TF1, TF0) |
| >>>>>>>ctfc | 39 |
| >>>>>>>TFC 11 | (TF0, TF0, TF0, TF0, TF1) |
| >>>>>>>ctfc | 40 |
| >>>>>>>TFC 12 | (TF1, TF0, TF0, TF0, TF1) |
| >>>>>>>ctfc | 41 |
| >>>>>>>TFC 13 | (TF2, TF1, TF0, TF0, TF1) |
| >>>>>>>ctfc | 47 |
| >>>>>>>TFC 14 | (TF3, TF2, TF0, TF0, TF1) |
| >>>>>>>ctfc | 53 |
| >>>>>>>TFC 15 | (TF4, TF3, TF0, TF0, TF1) |
| >>>>>>>ctfc | 59 |
| >>>>>>>TFC 16 | (TF0, TF0, TF0, TF1, TF1) |
| >>>>>>>ctfc | 60 |
| >>>>>>>TFC 17 | (TF1, TF0, TF0, TF1, TF1) |
| >>>>>>>ctfc | 61 |

| | |
|--------------------------------|------------------------------|
| >>>>>TFC 18 | (TF2, TF1, TF0,
TF1, TF1) |
| >>>>>ctfc | 67 |
| >>>>>TFC 19 | (TF3, TF2, TF0,
TF1, TF1) |
| >>>>>ctfc | 73 |
| >>>>>TFC 20 | (TF4, TF3, TF0,
TF1, TF1) |
| >>>>>ctfc | 79 |
| PhyCH INFORMATION
FDD | |
| UL-DPCH-InfoPredef | |
| >ul-DPCH-
PowerControlInfo | |
| >>powerControlAlgorithm | Algorithm 1 |
| >>>tpcStepSize | 1 dB |
| >tfc-Existence | TRUE |
| >puncturingLimit | 0.84 |
| DL-
CommonInformationPredef | |
| >dl-DPCH-InfoCommon | |
| >>spreadingFactor | 128 |
| >>tfc-Existence | FALSE |
| >>pilotBits | 4 |
| >>positionFixed | Fixed |

| Configuration | 12.2/7.4/5.9/4.75
kbps speech + 3.4
kbps signalling
+ 0.15 kbps SRB#5 |
|-----------------------------------|--|
| Ref 34.108 | 4b |
| Default configuration
identity | 14 |
| RB INFORMATION | |
| rb-Identity | RB1: 1, RB2: 2,
RB3: 3, RB5: 5,
RB6: 6, RB7: 7,
RB8: 8 |
| rlc-InfoChoice | Rlc-info |
| >ul-RLC-Mode | RB1: UM
RB2- RB3: AM
RB5-RB7: TM |
| >>transmissionRLC-
DiscardMode | RB1: N/A
RB2- RB3:
NoDiscard
RB5- RB7: N/A |
| >>>maxDat | RB1: N/A
RB2- RB3: 25
RB5- RB7: N/A |
| >>transmissionWindowSiz
e | RB1: N/A
RB2- RB3: 32
RB5- RB7: N/A |
| >>timerRST | RB1: N/A
RB2- RB3: 200
RB5- RB7: N/A |
| >>max-RST | RB1: N/A
RB2- RB3: 1
RB5- RB7: N/A |
| >>pollingInfo | RB1: N/A
RB2- RB3: as below
RB5- RB7: N/A |
| >>>TimerPoll | RB2- RB3: 200 |
| >>>PollPDU | RB2- RB3: n/a |
| >>>PollSDU | RB2- RB3: 1 |

| | |
|--------------------------------|--|
| Configuration | 12.2/7.4/5.9/4.75 kbps speech + 3.4 kbps signalling + 0.15 kbps SRB#5 |
| >>>lastTransmissionPDU-Poll | RB2- RB3: FALSE |
| >>>lastRetransmissionPDU-Poll | RB2- RB3: TRUE |
| >>>PollWindow | RB2- RB3: 99 |
| >>segmentationIndication | RB1- RB3: N/A
RB5- RB7: FALSE |
| >dl-RLC-Mode | RB1: UM
RB2- RB3: AM
RB5- RB7: TM
RB8: TM |
| >>inSequenceDelivery | RB1: N/A
RB2- RB3: TRUE
RB5- RB8: N/A |
| >>receivingWindowSize | RB1: N/A
RB2- RB3: 32
RB5- RB8: N/A |
| >>dl-RLC-StatusInfo | RB1: N/A
RB2- RB3: as below
RB5- RB8: N/A |
| >>>timerStatusProhibit | RB2- RB3: 100 |
| >>>missingPDU-Indicator | RB2- RB3: TRUE |
| >>segmentationIndication | RB1- RB3: N/A
RB5- RB8: FALSE |
| rb-MappingInfo | |
| >UL-LogicalChannelMappings | OneLogicalChannel |
| >>ul-TransportChannelType | Dch |
| >>>transportChannelIdentity | RB1- RB3: 9
RB5: 1, RB6: 2,
RB7: 3. |
| >>logicalChannelIdentity | RB1: 1, RB2: 2,
RB3: 3
RB5- RB7: N/A |
| >>rlc-SizeList | RB1- RB3:
configured
RB5- RB7: N/A |
| >>mac-LogicalChannelPriority | RB1: 1, RB2: 2,
RB3: 3
RB5- RB7: 5 |
| >DL-logicalChannelMappingList | |
| >>Mapping option 1 | One mapping option |
| >>>dl-TransportChannelType | Dch |
| >>>>transportChannelIdentity | RB1- RB3: 9
RB5: 1, RB6: 2,
RB7: 3, RB8: 5 |
| >>>logicalChannelIdentity | RB1: 1, RB2: 2,
RB3: 3
RB5- RB8: N/A |
| TrCH INFORMATION PER TrCH | |
| UL-AddReconfTransChInfoList | |
| >Uplink transport channel type | dch |
| >transportChannelIdentity | TrCH1: 1, TrCH2: 2,
TrCH3: 3, TrCH4: 9 |

| Configuration | 12.2/7.4/5.9/4.75 kbps speech + 3.4 kbps signalling + 0.15 kbps SRB#5 |
|-----------------------------|---|
| >transportFormatSet | DedicatedTransChTFS |
| >>dynamicTF-information | |
| >>>tf0/ tf0,1 | TrCH1: (0x81)
TrCH2: (0x 103)
TrCH3: (0x60)
TrCH4: (0x144, 1x144) |
| >>>>rlcSize | BitMode |
| >>>>>sizeType | TrCH1: type 1: 81
TrCH2: type 1: 103
TrCH3: type1: 60
TrCH4: 2: type 2, part1= 2, part2= 0 (144) |
| >>>>numberOfTbSizeList | TrCH1-3: Zero
TrCH4: Zero, one |
| >>>>logicalChannelList | All |
| >>>>tf 1 | TrCH1: (1x39)
TrCH2: (1x53)
TrCH3: (1x60)
TrCH4: (1x144) |
| >>>>numberOfTransportBlocks | TrCH1-3: One |
| >>>>rlc-Size | TrCH1-3: BitMode |
| >>>>>sizeType | TrCH1: 1: 39
TrCH2: 1: 53
TrCH3: 1: 60 |
| >>>>numberOfTbSizeList | TrCH1-3: One |
| >>>>logicalChannelList | TrCH1-3: all |
| >>>>tf 2 | TrCH1: (1x42)
TrCH2: (1x63)
TrCH3- TrCH4: N/A |
| >>>>numberOfTransportBlocks | TrCH1-2: One |
| >>>>rlc-Size | TrCH1: BitMode |
| >>>>>sizeType | TrCH1: type 1: 42
TrCH2: type 1: 63 |
| >>>>numberOfTbSizeList | TrCH1-2: One |
| >>>>logicalChannelList | TrCH1: all |
| >>>>tf 3 | TrCH1: (1x55)
TrCH2: (1x87)
TrCH3- TrCH4: N/A |
| >>>>numberOfTransportBlocks | TrCH1-2: One |
| >>>>rlc-Size | TrCH1: BitMode |
| >>>>>sizeType | TrCH1: type 1: 55
TrCH2: type 1: 87 |
| >>>>numberOfTbSizeList | TrCH1-2: One |
| >>>>logicalChannelList | TrCH1: all |
| >>>>tf 4 | TrCH1: (1x61)
TrCH2: (1x103)
TrCH3- TrCH4: N/A |
| >>>>numberOfTransportBlocks | TrCH1-2: One |
| >>>>rlc-Size | TrCH1: BitMode |
| >>>>>sizeType | TrCH1: type 1: 61
TrCH2: type 1: 103 |
| >>>>numberOfTbSizeList | TrCH1-2: One |
| >>>>logicalChannelList | TrCH1: all |
| >>>>tf 5 | TrCH1: (1x81)
TrCH2- TrCH4: N/A |

| Configuration | 12.2/7.4/5.9/4.75 kbps speech + 3.4 kbps signalling + 0.15 kbps SRB#5 |
|----------------------------------|---|
| >>>>numberOfTransportBlocks | TrCH1: One |
| >>>>rlc-Size | TrCH1: BitMode |
| >>>>>sizeType | TrCH1: type 1: 81 |
| >>>>numberOfTbSizeList | TrCH1: One |
| >>>>logicalChannelList | TrCH1: all |
| >>semiStaticTF-Information | |
| >>>tti | TrCH1- TrCH3: 20
TrCH4: 40 |
| >>>channelCodingType | Convolutional |
| >>>>codingRate | TrCH1- TrCH2:
Third
TrCH3: Half
TrCH4: Third |
| >>>rateMatchingAttribute | TrCH1: 200
TrCH2: 190
TrCH3: 235
TrCH4: 160 |
| >>>crc-Size | TrCH1: 12
TrCH2- TrCH3: 0
TrCH4: 16 |
| DL-AddReconfTransChInfoList | |
| >Downlink transport channel type | |
| >dl-TransportChannelIdentity | TrCH1: 1, TrCH2: 2,
TrCH3: 3, TrCH4: 9,
TrCH5: 5 |
| >tfs-SignallingMode | Independent
<Only tf0 on TrCH1 and tf0/1 on TrCH5 are different and shown below> |
| >>transportFormatSet | |
| >>>dynamicTF-information | |
| >>>>tf0/ tf0,1 | TrCH1: (1x0)
TrCH5: (0x3, 1x3) |
| >>>>rlcSize | bitMode |
| >>>>>sizeType | TrCH1: type 1: 0
TrCH5: type 1: 3 |
| >>>>numberOfTbSizeList | TrCH1: One
TrCH5: Zero, one |
| >>>>logicalChannelList | all |
| >>>semistaticTF-Information | same as UL except for TrCH5 |
| >>>>tti | TrCH5: 20 |
| >>>>channelCodingType | Convolutional |
| >>>>>codingRate | TrCH5: Third |
| >>>>rateMatchingAttribute | TrCH5: 205 |
| >>>>crc-Size | TrCH5: 8 |
| >>ULTrCH-Id | TrCH1: 1, TrCH2: 2,
TrCH3: 3, TrCH4: 9 |
| >dch-QualityTarget | |
| >>bler-QualityValue | TrCH1: 7×10^{-3}
TrCH2: Absent
TrCH3: Absent
TrCH4- TrCH5: Absent |
| TrCH INFORMATION, COMMON | |

| Configuration | 12.2/7.4/5.9/4.75 kbps speech + 3.4 kbps signalling + 0.15 kbps SRB#5 |
|------------------------------------|---|
| ul-CommonTransChInfo | |
| >tfc-ID (TDD only) | 1 |
| >sharedChannelIndicator (TDD only) | FALSE |
| >tfc-Subset | Absent, not required |
| >ul-TFCS | Normal TFCI signalling |
| >>explicitTFCS-ConfigurationMode | Complete |
| >>>ctfcSize | Ctfc8Bit |
| >>>>TFCS representation | Addition |
| >>>>>TFCS list | |
| >>>>>>TFCS 1 | (TF0, TF0, TF0, TF0) |
| >>>>>>>ctfc | 0 |
| >>>>>>>gainFactorInformation | Computed |
| >>>>>>>referenceTFCId | 0 |
| >>>>>>>TFCS 2 | (TF1, TF0, TF0, TF0) |
| >>>>>>>>ctfc | 1 |
| >>>>>>>>gainFactorInformation | Computed |
| >>>>>>>> β c (FDD only) | N/A |
| >>>>>>>> β d | N/A |
| >>>>>>>>referenceTFCId | 0 |
| >>>>>>>>TFCS 3 | (TF2, TF1, TF0, TF0) |
| >>>>>>>>>ctfc | 8 |
| >>>>>>>>>gainFactorInformation | Computed |
| >>>>>>>>>referenceTFCId | 0 |
| >>>>>>>>>TFCS 4 | (TF3, TF2, TF0, TF0) |
| >>>>>>>>>>ctfc | 15 |
| >>>>>>>>>>gainFactorInformation | Computed |
| >>>>>>>>>> β c (FDD only) | N/A |
| >>>>>>>>>> β d | N/A |
| >>>>>>>>>>referenceTFCId | 0 |
| >>>>>>>>>>TFCS 5 | (TF4, TF3, TF0, TF0) |
| >>>>>>>>>>>ctfc | 22 |
| >>>>>>>>>>>gainFactorInformation | Computed |
| >>>>>>>>>>>referenceTFCId | 0 |
| >>>>>>>>>>>TFCS 6 | (TF5, TF4, TF1, TF0) |
| >>>>>>>>>>>>ctfc | 59 |
| >>>>>>>>>>>>gainFactorInformation | Computed |
| >>>>>>>>>>>> β c (FDD only) | N/A |
| >>>>>>>>>>>> β d | N/A |
| >>>>>>>>>>>>referenceTFCId | 0 |
| >>>>>>>>>>>>TFCS 7 | (TF0, TF0, TF0, TF1) |
| >>>>>>>>>>>>>ctfc | 60 |
| >>>>>>>>>>>>>gainFactorInformation | Computed |
| >>>>>>>>>>>>>referenceTFCId | 0 |
| >>>>>>>>>>>>>TFCS 8 | (TF1, TF0, TF0, TF1) |

| Configuration | 12.2/7.4/5.9/4.75 kbps speech + 3.4 kbps signalling + 0.15 kbps SRB#5 |
|---|---|
| >>>>>>ctfc | 61 |
| >>>>>>gainFactorInformation | Computed |
| >>>>>>referenceTFCId | 0 |
| >>>>>TFCS 9 | (TF2,TF1,TF0,TF1) |
| >>>>>>ctfc | 68 |
| >>>>>>gainFactorInformation | Computed |
| >>>>>>referenceTFCId | 0 |
| >>>>>TFCS 10 | (TF3,TF2,TF0,TF1) |
| >>>>>>ctfc | 75 |
| >>>>>>gainFactorInformation | Computed |
| >>>>>> β c (FDD only) | N/A |
| >>>>>> β d | N/A |
| >>>>>>referenceTFCId | 0 |
| >>>>>TFCS 11 | (TF4,TF3,TF0,TF1) |
| >>>>>>ctfc | 82 |
| >>>>>>gainFactorInformation | Computed |
| >>>>>>referenceTFCId | 0 |
| >>>>>TFCS 12 | (TF5,TF4,TF1,TF1) |
| >>>>>>ctfc | 119 |
| >>>>>>gainFactorInformation | Signalled |
| >>>>>> β c (FDD only) | 11 |
| >>>>>> β d | 15 |
| >>>>>>referenceTFCId | 0 |
| > TFC subset list | |
| >>TFC subset 1 | (speech rate 4.75) |
| >>> Allowed transport format combination list | (TFC1, TFC2, TFC3, TFC7, TFC8, TFC9) |
| >>TFC subset 2 | (speech rate 5.9) |
| >>> Allowed transport format combination list | (TFC1, TFC2, TFC3, TFC4, TFC7, TFC8, TFC9, TFC10) |
| >>TFC subset 3 | (speech rate 7.4) |
| >>> Allowed transport format combination list | (TFC1, TFC2, TFC3, TFC4, TFC5, TFC7, TFC8, TFC9, TFC10, TFC11) |
| >>TFC subset 4 | (speech rate 12.2) |
| >>> Allowed transport format combination list | (TFC1, TFC2, TFC3, TFC4, TFC5, TFC6, TFC7, TFC8, TFC9, TFC10, TFC11, TFC12) |
| dl-CommonTransChInfo | |
| >tfcs-SignallingMode | Independent |
| ul-CommonTransChInfo | |
| >tfcs-ID (TDD only) | 1 |
| >sharedChannelIndicator (TDD only) | FALSE |
| > tfc-Subset | Absent, not required |
| >dl-TFCS | Normal TFCI signalling |
| >>explicitTFCS-ConfigurationMode | Complete |
| >>>ctfcSize | Ctfc8Bit |

| Configuration | 12.2/7.4/5.9/4.75
kbps speech + 3.4
kbps signalling
+ 0.15 kbps SRB#5 |
|-------------------------|--|
| >>>>TFCS representation | Addition |
| >>>>>TFCS list | |
| >>>>>>TFC 1 | (TF0, TF0, TF0,
TF0, TF0) |
| >>>>>>>ctfc | 0 |
| >>>>>>>TFC 2 | (TF1, TF0, TF0,
TF0, TF0) |
| >>>>>>>ctfc | 1 |
| >>>>>>>TFC 3 | (TF2, TF1, TF0,
TF0, TF0) |
| >>>>>>>ctfc | 8 |
| >>>>>>>TFC 4 | (TF3, TF2, TF0,
TF0, TF0) |
| >>>>>>>ctfc | 15 |
| >>>>>>>TFC 5 | (TF4, TF3, TF0,
TF0, TF0) |
| >>>>>>>ctfc | 22 |
| >>>>>>>TFC 6 | (TF5,TF4,TF1,TF0,
TF0) |
| >>>>>>>ctfc | 59 |
| >>>>>>>TFC 7 | (TF0, TF0, TF0,
TF1, TF0) |
| >>>>>>>ctfc | 60 |
| >>>>>>>TFC 8 | (TF1, TF0, TF0,
TF1, TF0) |
| >>>>>>>ctfc | 61 |
| >>>>>>>TFC 9 | (TF2, TF1, TF0,
TF1, TF0) |
| >>>>>>>ctfc | 68 |
| >>>>>>>TFC 10 | (TF3, TF2, TF0,
TF1, TF0) |
| >>>>>>>ctfc | 75 |
| >>>>>>>TFC 11 | (TF4, TF3, TF0,
TF1, TF0) |
| >>>>>>>ctfc | 82 |
| >>>>>>>TFC 12 | (TF5,TF4,TF1,TF1,
TF0) |
| >>>>>>>ctfc | 119 |
| >>>>>>>TFC 13 | (TF0, TF0, TF0,
TF0, TF1) |
| >>>>>>>ctfc | 120 |
| >>>>>>>TFC 14 | (TF1, TF0, TF0,
TF0, TF1) |
| >>>>>>>ctfc | 121 |
| >>>>>>>TFC 15 | (TF2, TF1, TF0,
TF0, TF1) |
| >>>>>>>ctfc | 128 |
| >>>>>>>TFC 16 | (TF3, TF2, TF0,
TF0, TF1) |
| >>>>>>>ctfc | 135 |
| >>>>>>>TFC 17 | (TF4, TF3, TF0,
TF0, TF1) |
| >>>>>>>ctfc | 142 |
| >>>>>>>TFC 18 | (TF5,TF4,TF1,TF0,
TF1) |
| >>>>>>>ctfc | 179 |
| >>>>>>>TFC 19 | (TF0, TF0, TF0,
TF1, TF1) |
| >>>>>>>ctfc | 180 |
| >>>>>>>TFC 20 | (TF1, TF0, TF0,
TF1, TF1) |

| | |
|--------------------------------------|--|
| Configuration | 12.2/7.4/5.9/4.75 kbps speech + 3.4 kbps signalling + 0.15 kbps SRB#5 |
| >>>>>>ctfc | 181 |
| >>>>>>TFC 21 | (TF2, TF1, TF0, TF1, TF1) |
| >>>>>>ctfc | 188 |
| >>>>>>TFC 22 | (TF3, TF2, TF0, TF1, TF1) |
| >>>>>>ctfc | 195 |
| >>>>>>TFC 23 | (TF4, TF3, TF0, TF1, TF1) |
| >>>>>>ctfc | 202 |
| >>>>>>TFC 24 | (TF5,TF4,TF1,TF1, TF1) |
| >>>>>>ctfc | 239 |
| PhyCH INFORMATION FDD | |
| UL-DPCH-InfoPredef | |
| >ul-DPCH-PowerControllInfo | |
| >>powerControlAlgorithm | Algorithm 1 |
| >>>tpcStepSize | 1 dB |
| >tfc-Existence | TRUE |
| >puncturingLimit | 0.84 |
| DL-CommonInformationPredef | |
| >dl-DPCH-InfoCommon | |
| >>spreadingFactor | 128 |
| >>tfc-Existence | FALSE |
| >>pilotBits | 4 |
| >>positionFixed | Fixed |
| PhyCH INFORMATION 3.84/7.68 Mcps TDD | |
| UL-DPCH-InfoPredef | |
| >ul-DPCH-PowerControllInfo | |
| >>dpch-ConstantValue | |
| >commonTimeslotInfo | |
| >>secondInterleavingMode | |
| >>tfc-Coding | |
| >>puncturingLimit | |
| >>repetitionPeriodAndLength | |
| DL-CommonInformationPredef | |
| >dl-DPCH-InfoCommon | |
| >>commonTimeslotInfo | |
| >>>secondInterleavingMode | |
| >>>tfc-Coding | |
| >>>puncturingLimit | |
| >>>repetitionPeriodAndLength | |
| PhyCH INFORMATION 1.28 Mcps TDD | |
| UL-DPCH-InfoPredef | |
| >commonTimeslotInfo | |
| >>secondInterleavingMode | |
| >>tfc-Coding | |

| Configuration | 12.2/7.4/5.9/4.75 kbps speech + 3.4 kbps signalling + 0.15 kbps SRB#5 |
|------------------------------|---|
| >>puncturingLimit | |
| >>repetitionPeriodAndLength | |
| DL-CommonInformationPredef | |
| >dl-DPCH-InfoCommon | |
| >>commonTimeslotInfo | |
| >>>secondInterleavingMode | |
| >>>tfc-Coding | |
| >>>puncturingLimit | |
| >>>repetitionPeriodAndLength | |

| Configuration | 7.95 kbps speech + 3.4 kbps signalling |
|--------------------------------|--|
| Ref 34.108 | 6 |
| Default configuration identity | 15 |
| RB INFORMATION | |
| rb-Identity | RB1: 1, RB2: 2, RB3: 3, RB5: 5, RB6: 6, RB7: 7 |
| rlc-InfoChoice | Rlc-info |
| >ul-RLC-Mode | RB1: UM
RB2- RB3: AM
RB5-RB7: TM |
| >>transmissionRLC-DiscardMode | RB1: N/A
RB2- RB3: NoDiscard
RB5- RB7: N/A |
| >>>maxDat | RB1: N/A
RB2- RB3: 25
RB5- RB7: N/A |
| >>transmissionWindowSize | RB1: N/A
RB2- RB3: 32
RB5- RB7: N/A |
| >>timerRST | RB1: N/A
RB2- RB3: 200
RB5- RB7: N/A |
| >>max-RST | RB1: N/A
RB2- RB3: 1
RB5- RB7: N/A |
| >>pollingInfo | RB1: N/A
RB2- RB3: as below
RB5- RB7: N/A |
| >>>TimerPoll | RB2- RB3: 200 |
| >>>PollPDU | RB2- RB3: n/a |
| >>>PollSDU | RB2- RB3: 1 |
| >>>lastTransmissionPDU-Poll | RB2- RB3: FALSE |
| >>>lastRetransmissionPDU-Poll | RB2- RB3: TRUE |
| >>>PollWindow | RB2- RB3: 99 |
| >>segmentationIndication | RB1- RB3: N/A
RB5- RB7: FALSE |

| Configuration | 7.95 kbps speech
+
3.4 kbps signalling |
|--------------------------------|---|
| >dl-RLC-Mode | RB1: UM
RB2- RB3: AM
RB5- RB7: TM |
| >>inSequenceDelivery | RB1: N/A
RB2- RB3: TRUE
RB5- RB7: N/A |
| >>receivingWindowSize | RB1: N/A
RB2- RB3: 32
RB5- RB7: N/A |
| >>dl-RLC-StatusInfo | RB1: N/A
RB2- RB3: as below
RB5- RB7: N/A |
| >>>timerStatusProhibit | RB2- RB3: 100 |
| >>>missingPDU-Indicator | RB2- RB3: TRUE |
| >>segmentationIndication | RB1- RB3: N/A
RB5- RB7: FALSE |
| rb-MappingInfo | |
| >UL-LogicalChannelMappings | OneLogicalChannel |
| >>ul-TransportChannelType | Dch |
| >>>transportChannelIdentity | RB1- RB3: 9
RB5: 1, RB6: 2,
RB7: 3 |
| >>logicalChannelIdentity | RB1: 1, RB2: 2,
RB3: 3
RB5- RB7: N/A |
| >>rlc-SizeList | RB1- RB3:
configured
RB5- RB7: N/A |
| >>mac-LogicalChannelPriority | RB1: 1, RB2: 2,
RB3: 3
RB5- RB7: 5 |
| >DL-logicalChannelMappingList | |
| >>Mapping option 1 | One mapping option |
| >>>dl-TransportChannelType | Dch |
| >>>>transportChannelIdentity | RB1- RB3: 9
RB5: 1, RB6: 2,
RB7: 3 |
| >>>logicalChannelIdentity | RB1: 1, RB2: 2,
RB3: 3
RB5- RB7: N/A |
| TrCH INFORMATION PER TrCH | |
| UL-AddReconfTransChInfoList | |
| >Uplink transport channel type | dch |
| >transportChannelIdentity | TrCH1: 1, TrCH2: 2,
TrCH3:3, TrCH4: 9 |
| >transportFormatSet | DedicatedTransChTFS |
| >>dynamicTF-information | |
| >>>tf0/ tf0,1 | TrCH1: (0x75)
TrCH2: (0x 84
1x84)
TrCH3: (0x 60)
TrCH4: (0x144,
1x144) |
| >>>>rlcSize | BitMode |

| Configuration | 7.95 kbps speech
+
3.4 kbps signalling |
|--|---|
| >>>>sizeType | TrCH1: type 1: 75
TrCH2: type 1: 84
TrCH3: type 1: 60
TrCH4: 2: type 2,
part1= 2, part2= 0
(144) |
| >>>>numberOfTbSizeList | TrCH1: Zero
TrCH2-4: Zero, one |
| >>>>logicalChannelList | All |
| >>>tf 1 | TrCH1: (1x39)
TrCH2- TrCH4: N/A |
| >>>>numberOfTransportBlocks | TrCH1: One |
| >>>>rlc-Size | TrCH1: BitMode |
| >>>>sizeType | TrCH1: 1: 39 |
| >>>>numberOfTbSizeList | TrCH1: One |
| >>>>logicalChannelList | TrCH1: all |
| >>>tf 2 | TrCH1: (1x75)
TrCH2- TrCH4: N/A |
| >>>>numberOfTransportBlocks | TrCH1: One |
| >>>>rlc-Size | TrCH1: BitMode |
| >>>>sizeType | TrCH1: type 1: 75 |
| >>>>numberOfTbSizeList | TrCH1: One |
| >>>>logicalChannelList | TrCH1: all |
| >>semistaticTF-Information | |
| >>>tti | TrCH1- TrCH3: 20
TrCH4: 40 |
| >>>channelCodingType | Convolutional |
| >>>>codingRate | TrCH1- TrCH2:
Third
TrCH3: Half
TrCH4: Third |
| >>>>rateMatchingAttribute | TrCH1: 200
TrCH2: 190
TrCH3: 235
TrCH4: 160 |
| >>>>crc-Size | TrCH1: 12
TrCH2-TrCH3: 0
TrCH4: 16 |
| DL-AddReconfTransChInfoList | |
| >Downlink transport channel type | Dch |
| >dl-TransportChannelIdentity (should be as for UL) | TrCH1: 1, TrCH2: 2,
TrCH3: 3, TrCH4: 9 |
| >tfs-SignallingMode | Explicit
<Only tf0 on TrCH1
is different and
shown below> |
| >>transportFormatSet | DedicatedTransChTFS |
| >>>dynamicTF-information | |
| >>>>tf0/ tf0,1 | TrCH1: (1x0) |
| >>>>rlcSize | BitMode |
| >>>>sizeType | TrCH1: type 1: 0 |
| >>>>numberOfTbSizeList | TrCH1: One |
| >>>>logicalChannelList | All |
| >>ULTrCH-Id | TrCH1: 1, TrCH2: 2,
TrCH3:3, TrCH4: 9 |
| >dch-QualityTarget | |

| Configuration | 7.95 kbps speech
+
3.4 kbps signalling |
|---------------------------------------|--|
| >>bler-QualityValue | TrCH1: 7x10-3
TrCH2- TrCH4:
Absent |
| TrCH INFORMATION,
COMMON | |
| ul-CommonTransChInfo | |
| >tfc-ID (TDD only) | 1 |
| >sharedChannelIndicator
(TDD only) | FALSE |
| >tfc-Subset | Absent, not required |
| >ul-TFCS | Normal TFCI
signalling |
| >>explicitTFCS-
ConfigurationMode | Complete |
| >>>ctfcSize | Ctfc4Bit |
| >>>>TFCS representation | Addition |
| >>>>>TFCS list | |
| >>>>>>TFCS 1 | (TF0, TF0, TF0,
TF0) |
| >>>>>>>ctfc | 0 |
| >>>>>>>gainFactorInform
ation | Computed |
| >>>>>>>referenceTFCId | 0 |
| >>>>>>TFCS 2 | (TF1, TF0, TF0,
TF0) |
| >>>>>>>ctfc | 1 |
| >>>>>>>gainFactorInform
ation | Computed |
| >>>>>>>>βc (FDD only) | N/A |
| >>>>>>>>βd | N/A |
| >>>>>>>>referenceTFCId | 0 |
| >>>>>>TFCS 3 | (TF2, TF1, TF0,
TF0) |
| >>>>>>>ctfc | 5 |
| >>>>>>>gainFactorInform
ation | Computed |
| >>>>>>>>referenceTFCId | 0 |
| >>>>>>TFCS 4 | (TF0, TF0, TF0,
TF1) |
| >>>>>>>ctfc | 6 |
| >>>>>>>gainFactorInform
ation | Computed |
| >>>>>>>>βc (FDD only) | N/A |
| >>>>>>>>βd | N/A |
| >>>>>>>>referenceTFCId | 0 |
| >>>>>>TFCS 5 | (TF1, TF0, TF0,
TF1) |
| >>>>>>>ctfc | 7 |
| >>>>>>>gainFactorInform
ation | Computed |
| >>>>>>>>referenceTFCId | 0 |
| >>>>>>TFCS 6 | (TF2, TF1, TF0,
TF1) |
| >>>>>>>ctfc | 11 |
| >>>>>>>gainFactorInform
ation | Signalled |
| >>>>>>>>βc (FDD only) | 11 |
| >>>>>>>>βd | 15 |
| >>>>>>>>referenceTFCId | 0 |
| dl-CommonTransChInfo | |

| Configuration | 7.95 kbps speech
+
3.4 kbps signalling |
|---|--|
| >tfcs-SignallingMode | Same as UL |
| PhyCH INFORMATION
FDD | |
| UL-DPCH-InfoPredef | |
| >ul-DPCH-
PowerControlInfo | |
| >>powerControlAlgorithm | Algorithm 1 |
| >>>tpcStepSize | 1 dB |
| >tfci-Existence | TRUE |
| >puncturingLimit | 0.96 |
| DL-
CommonInformationPredef | |
| >dl-DPCH-InfoCommon | |
| >>spreadingFactor | 128 |
| >>tfci-Existence | FALSE |
| >>pilotBits | 4 |
| >>positionFixed | Fixed |
| | |
| PhyCH INFORMATION
3.84/7.68 Mcps TDD | |
| UL-DPCH-InfoPredef | |
| >ul-DPCH-
PowerControlInfo | |
| >>dpch-ConstantValue | 0 |
| >commonTimeslotInfo | |
| >>secondInterleavingMode | frameRelated |
| >>tfci-Coding | 16 |
| >>puncturingLimit | 0.52 |
| >>repetitionPeriodAndLeng
th | repetitionPeriod1 |
| DL-
CommonInformationPredef | |
| >dl-DPCH-InfoCommon | |
| >>commonTimeslotInfo | |
| >>>secondInterleavingMod
e | frameRelated |
| >>>tfci-Coding | 16 |
| >>>puncturingLimit | 0.52 |
| >>>repetitionPeriodAndLe
ngth | repetitionPeriod1 |
| PhyCH INFORMATION
1.28 Mcps TDD | |
| UL-DPCH-InfoPredef | |
| >commonTimeslotInfo | |
| >>secondInterleavingMode | frameRelated |
| >>tfci-Coding | 16 |
| >>puncturingLimit | 0.80 |
| >>repetitionPeriodAndLeng
th | repetitionPeriod1 |
| DL-
CommonInformationPredef | |
| >dl-DPCH-InfoCommon | |
| >>commonTimeslotInfo | |
| >>>secondInterleavingMod
e | frameRelated |
| >>>tfci-Coding | 16 |
| >>>puncturingLimit | 0.80 |
| >>>repetitionPeriodAndLe
ngth | repetitionPeriod1 |

| | |
|-----------------------------------|---|
| Configuration | 12.65/8.85/6.6 kbps
speech +
3.4 kbps signalling
(without SRB#5) |
| Ref 25.993 | 7.1.106 |
| Default configuration
identity | 16 |
| RB INFORMATION | |
| rb-Identity | RB1: 1, RB2: 2,
RB3: 3, RB5: 5,
RB6: 6, RB7: 7, |
| rlc-InfoChoice | Rlc-info |
| >ul-RLC-Mode | RB1: UM
RB2- RB3: AM
RB5-RB7: TM |
| >>transmissionRLC-
DiscardMode | RB1: N/A
RB2- RB3:
NoDiscard
RB5- RB7: N/A |
| >>>maxDat | RB1: N/A
RB2- RB3: 25
RB5- RB7: N/A |
| >>transmissionWindowSiz
e | RB1: N/A
RB2- RB3: 32
RB5- RB7: N/A |
| >>timerRST | RB1: N/A
RB2- RB3: 200
RB5- RB7: N/A |
| >>max-RST | RB1: N/A
RB2- RB3: 1
RB5- RB7: N/A |
| >>pollingInfo | RB1: N/A
RB2- RB3: as below
RB5- RB7: N/A |
| >>>TimerPoll | RB2- RB3: 200 |
| >>>PollPDU | RB2- RB3: n/a |
| >>>PollSDU | RB2- RB3: 1 |
| >>>lastTransmissionPDU-
Poll | RB2- RB3: FALSE |
| >>>lastRetransmissionPD
U-Poll | RB2- RB3: TRUE |
| >>>PollWindow | RB2- RB3: 99 |
| >>segmentationIndication | RB1- RB3: N/A
RB5- RB7: FALSE |
| >dl-RLC-Mode | RB1: UM
RB2- RB3: AM
RB5- RB7: TM |
| >>inSequenceDelivery | RB1: N/A
RB2- RB3: TRUE
RB5- RB7: N/A |
| >>receivingWindowSize | RB1: N/A
RB2- RB3: 32
RB5- RB7: N/A |
| >>dl-RLC-StatusInfo | RB1: N/A
RB2- RB3: as below
RB5- RB7: N/A |
| >>>timerStatusProhibit | RB2- RB3: 100 |
| >>>missingPDU-Indicator | RB2- RB3: TRUE |
| >>segmentationIndication | RB1- RB3: N/A
RB5- RB7: FALSE |
| rb-MappingInfo | |
| >UL-
LogicalChannelMappings | OneLogicalChannel |
| >>ul-
TransportChannelType | Dch |

| | |
|--------------------------------|---|
| >>>transportChannelIdentity | RB1- RB3: 9
RB5: 1, RB6: 2,
RB7: 3. |
| >>logicalChannelIdentity | RB1: 1, RB2: 2,
RB3: 3
RB5- RB7: N/A |
| >>rlc-SizeList | RB1- RB3:
configured
RB5- RB7: N/A |
| >>mac-LogicalChannelPriority | RB1: 1, RB2: 2,
RB3: 3
RB5- RB7: 5 |
| >DL-logicalChannelMappingList | |
| >>Mapping option 1 | One mapping option |
| >>>dl-TransportChannelType | Dch |
| >>>>transportChannelIdentity | RB1- RB3: 9
RB5: 1, RB6: 2,
RB7: 3, |
| >>>logicalChannelIdentity | RB1: 1, RB2: 2,
RB3: 3
RB5- RB7: N/A |
| TrCH INFORMATION PER TrCH | |
| UL-AddReconfTransChInfoList | |
| >Uplink transport channel type | Dch |
| >transportChannelIdentity | TrCH1: 1, TrCH2: 2,
TrCH3: 3, TrCH4: 9 |
| >transportFormatSet | DedicatedTransChTFS |
| >>dynamicTF-information | |
| >>>tf0/ tf0,1 | TrCH1: (0x72)
TrCH2: (0x 181)
TrCH3: (0x60)
TrCH4: (0x144,
1x144) |
| >>>>rlcSize | BitMode |
| >>>>>sizeType | TrCH1: type 1: 72
TrCH2: type 2:
part1= 6, part2= 5
TrCH3: type1: 60
TrCH4: 2: type 2,
part1= 2, part2= 0
(144) |
| >>>>numberOfTbSizeList | TrCH1-3: Zero
TrCH4: Zero, one |
| >>>>logicalChannelList | All |
| >>>tf 1 | TrCH1: (1x40)
TrCH2: (1x 78)
TrCH3: N/A
TrCH4: N/A |
| >>>>numberOfTransportBlocks | TrCH1: One
TrCH2: One |
| >>>>rlc-Size | TrCH1-2: BitMode |
| >>>>>sizeType | TrCH1: 1: 40
TrCH2: 1: 78 |
| >>>>numberOfTbSizeList | TrCH1-2: One |
| >>>>logicalChannelList | TrCH1: all |
| >>>tf 2 | TrCH1: (1x54)
TrCH2: (1x113)
TrCH3: N/A
TrCH4: N/A |

| | |
|----------------------------------|---|
| >>>>numberOfTransportBlocks | TrCH1: One
TrCh2: One |
| >>>>rlc-Size | TrCH1: BitMode |
| >>>>>sizeType | TrCH1: type 1: 54
TrCH2: type 1: 113 |
| >>>>numberOfTbSizeList | TrCH1: One
TrCH2: One |
| >>>>logicalChannelList | TrCH1: all
TrCH2: all |
| >>>tf 3 | TrCH1: (1x64)
TrCH2: (1x181)
TrCH3: N/A
TrCH4: N/A |
| >>>>numberOfTransportBlocks | TrCH1: One
TrCh2: One |
| >>>>rlc-Size | TrCH1: BitMode |
| >>>>>sizeType | TrCH1: type 1: 64
TrCH2: type 2:
part1=6, part2= 5 |
| >>>>numberOfTbSizeList | TrCH1: One
TrCH2: One |
| >>>>logicalChannelList | TrCH1: all
TrCH2: all |
| >>>tf 4 | TrCH1: (1x72)
TrCH2: N/A
TrCH3: N/A
TrCH4: N/A |
| >>>>numberOfTransportBlocks | TrCH1: One |
| >>>>rlc-Size | TrCH1: BitMode |
| >>>>>sizeType | TrCH1: type 1: 72 |
| >>>>numberOfTbSizeList | TrCH1: One |
| >>>>logicalChannelList | TrCH1: all |
| >>semistaticTF-Information | |
| >>>tfti | TrCH1- TrCH3: 20
TrCH4: 40 |
| >>>channelCodingType | Convolutional |
| >>>>codingRate | TrCH1- TrCH3:
Third
TrCH4: Third |
| >>>rateMatchingAttribute | TrCH1: 200
TrCH2: 190
TrCH3: 256
TrCH4: 170 |
| >>>crc-Size | TrCH1: 12
TrCH2: 0
TrCH3: 0
TrCH4: 16 |
| DL-AddReconfTransChInfoList | |
| >Downlink transport channel type | Dch |
| >dl-TransportChannelIdentity | |
| >tfs-SignallingMode | Independent
<Only tf0 on TrCH1 is different and shown below> |
| >>transportFormatSet | |
| >>>dynamicTF-information | |
| >>>>tf0/ tf0,1 | TrCH1: (1x0) |
| >>>>rlcSize | BitMode |
| >>>>>sizeType | TrCH1: type 1: 0 |
| >>>>numberOfTbSizeList | TrCH1: One |
| >>>>logicalChannelList | All |

| | |
|---------------------------------------|--|
| >>>semistaticTF-Information | same as UL |
| >>ULTrCH-Id | TrCH1: 1, TrCH2: 2, TrCH3: 3, TrCH4: 9, |
| >dch-QualityTarget | |
| >>bler-QualityValue | TrCH1: 7×10^{-3}
TrCH2: Absent
TrCH3: Absent
TrCH4: Absent |
| TrCH INFORMATION,
COMMON | |
| ul-CommonTransChInfo | |
| >tfc-ID (TDD only) | 1 |
| >sharedChannelIndicator
(TDD only) | FALSE |
| > tfc-Subset | Absent, not required |
| >ul-TFCS | Normal TFCI
signalling |
| >>explicitTFCS-
ConfigurationMode | Complete |
| >>>ctfcSize | Ctfc6Bit |
| >>>>TFCS representation | Addition |
| >>>>>TFC list | |
| >>>>>>TFC 1 | (TF0, TF0, TF0,
TF0) |
| >>>>>>>ctfc | 0 |
| >>>>>>>gainFactorInform
ation | Computed |
| >>>>>>>referenceTFCId | 0 |
| >>>>>>>TFC 2 | (TF1, TF0, TF0,
TF0) |
| >>>>>>>ctfc | 1 |
| >>>>>>>gainFactorInform
ation | Computed |
| >>>>>>>> β c (FDD only) | N/A |
| >>>>>>>> β d | N/A |
| >>>>>>>>referenceTFCId | 0 |
| >>>>>>>>TFC 3 | (TF2, TF1, TF0,
TF0) |
| >>>>>>>>ctfc | 7 |
| >>>>>>>>gainFactorInform
ation | Computed |
| >>>>>>>>referenceTFCId | 0 |
| >>>>>>>>TFC 4 | (TF3, TF2, TF0,
TF0) |
| >>>>>>>>ctfc | 13 |
| >>>>>>>>gainFactorInform
ation | Computed |
| >>>>>>>>> β c (FDD only) | |
| >>>>>>>>> β d | |
| >>>>>>>>>referenceTFCId | 0 |
| >>>>>>>>>TFC 5 | (TF4, TF3, TF0,
TF0) |
| >>>>>>>>>ctfc | 19 |
| >>>>>>>>>gainFactorInform
ation | Computed |
| >>>>>>>>>referenceTFCId | 0 |
| >>>>>>>>>TFC 6 | (TF0, TF0, TF0,
TF1) |
| >>>>>>>>>ctfc | 20 |
| >>>>>>>>>gainFactorInform
ation | Computed |
| >>>>>>>>>> β c (FDD only) | |
| >>>>>>>>>> β d | |

| | |
|---|---|
| >>>>>>referenceTFCId | 0 |
| >>>>>TFC 7 | (TF1, TF0, TF0, TF1) |
| >>>>>>ctfc | 21 |
| >>>>>>gainFactorInformation | Computed |
| >>>>>>referenceTFCId | 0 |
| >>>>>TFC 8 | (TF2, TF1, TF0, TF1) |
| >>>>>>ctfc | 27 |
| >>>>>>gainFactorInformation | computed |
| >>>>>> β c (FDD only) | |
| >>>>>> β d | |
| >>>>>>referenceTFCId | 0 |
| >>>>>TFC 9 | (TF3, TF2, TF0, TF1) |
| >>>>>>ctfc | 33 |
| >>>>>>gainFactorInformation | computed |
| >>>>>>referenceTFCId | 0 |
| >>>>>TFC 10 | (TF4, TF3, TF0, TF1) |
| >>>>>>ctfc | 39 |
| >>>>>>gainFactorInformation | signalled |
| >>>>>> β c (FDD only) | 11 |
| >>>>>> β d | 15 |
| >>>>>>referenceTFCId | 0 |
| > TFC subset list | |
| >>TFC subset 1 | (speech rate 6.6) |
| >>> Allowed transport format combination list | (TFC1, TFC2, TFC3, TFC6, TFC7, TFC8) |
| >>TFC subset 2 | (speech rate 8.85) |
| >>> Allowed transport format combination list | (TFC1, TFC2, TFC3, TFC4, TFC6, TFC7, TFC8, TFC9) |
| >>TFC subset 3 | (speech rate 12.65) |
| >>> Allowed transport format combination list | (TFC1, TFC2, TFC3, TFC4, TFC5, TFC6, TFC7, TFC8, TFC9, TFC10) |
| dl-CommonTransChInfo | |
| >tfc-SignallingMode | Same as UL |
| ul-CommonTransChInfo | |
| >tfc-ID (TDD only) | 1 |
| >sharedChannelIndicator (TDD only) | FALSE |
| PhyCH INFORMATION FDD | |
| UL-DPCH-InfoPredef | |
| >ul-DPCH-PowerControlInfo | |
| >>powerControlAlgorithm | Algorithm 1 |
| >>>tpcStepSize | 1 dB |
| >tfc-Existence | TRUE |
| >puncturingLimit | 0.84 |
| DL-CommonInformationPredef | |
| >dl-DPCH-InfoCommon | |
| >>spreadingFactor | 128 |
| >>tfc-Existence | FALSE |
| >>pilotBits | 4 |

| | |
|-----------------|-------|
| >>positionFixed | Fixed |
|-----------------|-------|

| Configuration | Signalling on E-DCH on UL depending based on minimum E-DCH UE category + Signalling on HS-DSCH based minimum HS-DSCH UE category |
|------------------------------------|--|
| Ref 25.993 | 7.5.10 |
| Default configuration identity | 17 |
| RB INFORMATION | |
| rb-Identity | RB1: 1, RB2: 2, RB3: 3 |
| rlc-InfoChoice | Rlc-info |
| >ul-RLC-Mode | RB1: UM
RB2- RB3: AM |
| >>transmissionRLC-DiscardMode | RB1: N/A
RB2- RB3: NoDiscard |
| >>>maxDat | RB1: N/A
RB2- RB3: 25 |
| >>transmissionWindowSize | RB1: N/A
RB2- RB3: 128 |
| >>timerRST | RB1: N/A
RB2- RB3: 200 |
| >>max-RST | RB1: N/A
RB2- RB3: 1 |
| >>pollingInfo | RB1: N/A
RB2- RB3: as below |
| >>>TimerPoll | RB2- RB3: 100 |
| >>>PollPDU | RB2- RB3: n/a |
| >>>PollSDU | RB2- RB3: 1 |
| >>>lastTransmissionPDU-Poll | RB2- RB3: FALSE |
| >>>lastRetransmissionPDU-Poll | RB2- RB3: FALSE |
| >>>PollWindow | RB2- RB3: 99 |
| >>segmentationIndication | RB1- RB3: N/A |
| >dl-RLC-Mode | RB1: UM
RB2- RB3: AM |
| >>DL RLC PDU size | RB1-RB3: 144 |
| >>inSequenceDelivery | RB1: N/A
RB2- RB3: TRUE |
| >>receivingWindowSize | RB1: N/A
RB2- RB3: 128 |
| >>dl-RLC-StatusInfo | RB1: N/A
RB2- RB3: as below |
| >>>timerStatusProhibit | RB2- RB3: 100 |
| >>>missingPDU-Indicator | RB2- RB3: TRUE |
| >>segmentationIndication | RB1- RB3: N/A |
| >>dl-UM-RLC-LI-size | 7 |
| Rb-MappingInfo | |
| >UL-LogicalChannelMappings | OneLogicalChannel |
| >>UplinkTransportChannelTypeChoice | |
| >>ul-TransportChannelType | E-DCH |
| >>>logicalChannelIdentity | RB1: 1, RB2: 2, RB3: 3 |
| >>>E-DCH MAC-d flow identity | RB1-RB3:0 |
| >>>DDI | RB1: 1, RB2: 2, RB3: 3 |
| >>>>RLC PDU size | 144 |
| >>mac-LogicalChannelPriority | RB1: 1, RB2: 2, RB3: 3 |

| Configuration | Signalling on E-DCH on UL depending based on minimum E-DCH UE category + Signalling on HS-DSCH based minimum HS-DSCH UE category |
|--|--|
| >DL-logicalChannelMappings | OneLogicalChannel |
| >>Mapping option 1 | One mapping option |
| >>>dl-TransportChannelType | HS-DSCH |
| >>>>Mac-d flow identity | RB1- RB3: 0 |
| >>>>logicalChannelIdentity | RB1: 1, RB2: 2, RB3: 3 |
| TrCH INFORMATION PER TrCH | |
| UL-AddReconfTransChInfoList | |
| >Uplink transport channel type | E-DCH |
| >UL Transport channel identity | |
| > UL-ParametersChoice | |
| >> E-DCH Transmission Time Interval | 10 |
| >> HARQ info for E-DCH | |
| >>> HARQ RV Configuration | Rvtable |
| >> Added or reconfigured E-DCH MAC-d flow | One MAC-d flow |
| >>> E-DCH MAC-d flow identity | 0 |
| >>> E-DCH MAC-d flow power offset | 4 |
| >>> E-DCH MAC-d flow maximum number of retransmissions | 5 |
| >>> E-DCH MAC-d flow multiplexing list | 0 |
| >>> transmission grant typeChoice | |
| >>>> Non-scheduled transmission grant info | Non-scheduled |
| >>>>> Max MAC-e PDU contents size | 162 |
| DL-AddReconfTransChInfoList | |
| >Downlink transport channel type | HS-DSCH |
| >DL-ParametersChoice | |
| >>HARQ Info | |
| >>>Number of Processes | 6 |
| >>>Memory PartitioningChoice | |
| >>>>Implicit | |
| >>Added or reconfigured MAC-d flow | |
| >>> MAC-hs queue to add or reconfigure list | |
| >>>>MAC-hs queue Id | 0 |
| >>>>MAC-d Flow Identity | 0 |
| >>>>T1 | 100 |
| >>>>MAC-hs window size | 12 |
| >>>>MAC-d PDU size info | |
| >>>>>MAC-d PDU size | 148 |
| >>>>>MAC-d PDU size index | 0 |

| Configuration | Signalling on E-DCH on UL depending based on minimum E-DCH UE category + Signalling on HS-DSCH based minimum HS-DSCH UE category |
|--------------------------|--|
| TrCH INFORMATION, COMMON | <i>Null</i> |

| Configuration | 12.2 kbps speech + 13.6 kbps signalling | 12.2/7.95/5.9/4.75 kbps speech + 13.6 kbps signalling |
|--------------------------------|--|---|
| Ref 25.993 | 7.1.131 | 7.1.132 |
| Default configuration identity | 18 | 19 |
| RB INFORMATION | | |
| rb-Identity | RB1: 1, RB2: 2, RB3: 3, RB5: 5, RB6: 6, RB7: 7 | RB1: 1, RB2: 2, RB3: 3, RB5: 5, RB6: 6, RB7: 7 |
| rlc-InfoChoice | Rlc-info | Rlc-info |
| >ul-RLC-Mode | RB1: UM
RB2- RB3: AM
RB5-RB7: TM | RB1: UM
RB2- RB3: AM
RB5-RB7: TM |
| >>transmissionRLC-DiscardMode | RB1: N/A
RB2- RB3: NoDiscard
RB5- RB7: N/A | RB1: N/A
RB2- RB3: NoDiscard
RB5- RB7: N/A |
| >>>maxDat | RB1: N/A
RB2- RB3: 15
RB5- RB7: N/A | RB1: N/A
RB2- RB3: 15
RB5- RB7: N/A |
| >>transmissionWindowSize | RB1: N/A
RB2- RB3: 32
RB5- RB7: N/A | RB1: N/A
RB2- RB3: 32
RB5- RB7: N/A |
| >>timerRST | RB1: N/A
RB2- RB3: 200
RB5- RB7: N/A | RB1: N/A
RB2- RB3: 200
RB5- RB7: N/A |
| >>max-RST | RB1: N/A
RB2- RB3: 1
RB5- RB7: N/A | RB1: N/A
RB2- RB3: 1
RB5- RB7: N/A |
| >>pollingInfo | RB1: N/A
RB2- RB3: as below
RB5- RB7: N/A | RB1: N/A
RB2- RB3: as below
RB5- RB7: N/A |
| >>>TimerPoll | RB2- RB3: 100 | RB2- RB3: 100 |
| >>>PollPDU | RB2- RB3: n/a | RB2- RB3: n/a |
| >>>PollSDU | RB2- RB3: 1 | RB2- RB3: 1 |
| >>>lastTransmissionPDU-Poll | RB2- RB3: FALSE | RB2- RB3: FALSE |
| >>>lastRetransmissionPDU-Poll | RB2- RB3: TRUE | RB2- RB3: TRUE |
| >>>PollWindow | RB2- RB3: 99 | RB2- RB3: 99 |
| >>>timerPollPeriodic | RB2- RB3: n/a | RB2- RB3: n/a |
| >>segmentationIndication | RB1- RB3: N/A
RB5- RB7: FALSE | RB1- RB3: N/A
RB5- RB7: FALSE |
| >dl-RLC-Mode | RB1: UM
RB2- RB3: AM
RB5- RB7: TM | RB1: UM
RB2- RB3: AM
RB5- RB7: TM |
| >>inSequenceDelivery | RB1: N/A
RB2- RB3: TRUE
RB5- RB7: N/A | RB1: N/A
RB2- RB3: TRUE
RB5- RB7: N/A |

| Configuration | 12.2 kbps speech
+
13.6 kbps
signalling | 12.2/7.95/5.9/4.75
kbps speech +
13.6 kbps
signalling |
|-----------------------------------|---|---|
| >>receivingWindowSize | RB1: N/A
RB2- RB3: 32
RB5- RB7: N/A | RB1: N/A
RB2- RB3: 32
RB5- RB7: N/A |
| >>dl-RLC-StatusInfo | RB1: N/A
RB2- RB3: as below
RB5- RB7: N/A | RB1: N/A
RB2- RB3: as below
RB5- RB7: N/A |
| >>>timerStatusProhibit | RB2- RB3: 100 | RB2- RB3: 100 |
| >>>missingPDU-Indicator | RB2- RB3: TRUE | RB2- RB3: TRUE |
| >>>timerStatusPeriodic | RB2- RB3: n/a | RB2- RB3: n/a |
| >>segmentationIndication | RB1- RB3: N/A
RB5- RB7: FALSE | RB1- RB3: N/A
RB5- RB7: FALSE |
| rb-MappingInfo | | |
| >UL-
LogicalChannelMappings | OneLogicalChannel | OneLogicalChannel |
| >>ul-
TransportChannelType | Dch | Dch |
| >>>transportChannelIdentity | RB1- RB3: 9
RB5: 1, RB6: 2,
RB7: 3 | RB1- RB3: 9
RB5: 1, RB6: 2,
RB7: 3 |
| >>logicalChannelIdentity | RB1: 1, RB2: 2,
RB3: 3
RB5- RB7: N/A | RB1: 1, RB2: 2,
RB3: 3
RB5- RB7: N/A |
| >>rlc-SizeList | RB1- RB3:
configured
RB5- RB7: N/A | RB1- RB3:
configured
RB5- RB7: N/A |
| >>mac-
LogicalChannelPriority | RB1: 1, RB2: 2,
RB3: 3
RB5- RB7: 5 | RB1: 1, RB2: 2,
RB3: 3
RB5- RB7: 5 |
| >DL-
logicalChannelMappingList | | |
| >>Mapping option 1 | One mapping option | One mapping option |
| >>>dl-
TransportChannelType | Dch | Dch |
| >>>>transportChannelIdentity | RB1- RB3: 9
RB5: 1, RB6: 2,
RB7: 3 | RB1- RB3: 9
RB5: 1, RB6: 2,
RB7: 3 |
| >>>logicalChannelIdentity | RB1: 1, RB2: 2,
RB3: 3
RB5- RB7: N/A | RB1: 1, RB2: 2,
RB3: 3
RB5- RB7: N/A |
| TrCH INFORMATION PER
TrCH | | |
| UL-
AddReconfTransChInfoList | | |
| >Uplink transport channel
type | dch | dch |
| >transportChannelIdentity | TrCH1: 1, TrCH2: 2,
TrCH3: 3, TrCH4: 9 | TrCH1: 1, TrCH2: 2,
TrCH3: 3, TrCH4: 9 |
| >transportFormatSet | DedicatedTransChT
FS | DedicatedTransChT
FS |
| >>dynamicTF-information | | |
| >>>tf0/ tf0,1 | TrCH1: (0x81)
TrCH2: (0x 103,
1x103)
TrCH3: (0x 60,
1x60)
TrCH4: (0x144,
1x144, 2x144,
3x144, 4x144) | TrCH1: (0x 81)
TrCH2: (0x 103)
TrCH3: (0x 60)
TrCH4: (0x144) |
| >>>>rlcSize | BitMode | BitMode |

| Configuration | 12.2 kbps speech
+
13.6 kbps
signalling | 12.2/7.95/5.9/4.75
kbps speech +
13.6 kbps
signalling |
|-----------------------------|--|--|
| >>>>>sizeType | TrCH1: type 1: 81
TrCH2: type 1: 103
TrCH3: type 1: 60
TrCH4: 2: type 2,
part1= 2, part2= 0
(144) | TrCH1: type 1: 81
TrCH2: type 1: 103
TrCH3: type 1: 60
TrCH4: 2: type 2,
part1= 2, part2= 0
(144) |
| >>>>numberOfTbSizeList | TrCH1: Zero
TrCH2-3: Zero, One
TrCH4: Zero, one,
2, 3, 4 | TrCH1-4: Zero |
| >>>>logicalChannelList | All | All |
| >>>>tf 1 | TrCH1: (1x39)
TrCH2- TrCH4: N/A | TrCH1: (1x39)
TrCH2: (1x53)
TrCH3: (1x60)
TrCH4: (1x144,
2x144, 3x144,
4x144) |
| >>>>numberOfTransportBlocks | TrCH1: One | TrCH1-3: One
TrCH4: One, 2, 3, 4 |
| >>>>rlc-Size | TrCH1: BitMode | TrCH1: BitMode |
| >>>>>sizeType | TrCH1: 1: 39 | TrCH1: 1: 39
TrCH2: 1: 53
TrCH3: 1: 60
TrCH4: 2: type 2,
part1= 2, part2= 0
(144) |
| >>>>numberOfTbSizeList | TrCH1: One | TrCH1: One |
| >>>>logicalChannelList | TrCH1: all | TrCH1: all |
| >>>>tf 2 | TrCH1: (1x81)
TrCH2- TrCH4: N/A | TrCH1: (1x42)
TrCH2: (1x63)
TrCH3- TrCH4: N/A |
| >>>>numberOfTransportBlocks | TrCH1: One | TrCH1-2: One |
| >>>>rlc-Size | TrCH1: BitMode | TrCH1: BitMode |
| >>>>>sizeType | TrCH1: type 1: 81 | TrCH1: type 1: 42
TrCH2: type 1: 63 |
| >>>>numberOfTbSizeList | TrCH1: One | TrCH1: One |
| >>>>logicalChannelList | TrCH1: all | TrCH1: all |
| >>>>tf 3 | | TrCH1: (1x55)
TrCH2: (1x84)
TrCH3- TrCH4: N/A |
| >>>>numberOfTransportBlocks | | TrCH1-2: One |
| >>>>rlc-Size | | TrCH1: BitMode |
| >>>>>sizeType | | TrCH1: type 1: 55
TrCH2: type 1: 84 |
| >>>>numberOfTbSizeList | | TrCH1-2: One |
| >>>>logicalChannelList | | TrCH1: all |
| >>>>tf 4 | | TrCH1: (1x75)
TrCH2: (1x103)
TrCH3- TrCH4: N/A |
| >>>>numberOfTransportBlocks | | TrCH1-2: One |
| >>>>rlc-Size | | TrCH1: BitMode |
| >>>>>sizeType | | TrCH1: type 1: 75
TrCH2: type 1: 103 |
| >>>>numberOfTbSizeList | | TrCH1-2: One |
| >>>>logicalChannelList | | TrCH1: all |
| >>>>tf 5 | | TrCH1: (1x81)
TrCH2- TrCH4: N/A |

| Configuration | 12.2 kbps speech
+
13.6 kbps
signalling | 12.2/7.95/5.9/4.75
kbps speech +
13.6 kbps
signalling |
|---|--|--|
| >>>>numberOfTransportBlocks | | TrCH1: One |
| >>>>rlc-Size | | TrCH1: BitMode |
| >>>>>sizeType | | TrCH1: type 1: 81 |
| >>>>numberOfTbSizeList | | TrCH1: One |
| >>>>logicalChannelList | | TrCH1: all |
| >>semistaticTF-Information | | |
| >>>tti | TrCH1- TrCH3: 20
TrCH4: 40 | TrCH1- TrCH3: 20
TrCH4: 40 |
| >>>channelCodingType | Convolutional | Convolutional |
| >>>>codingRate | TrCH1- TrCH2:
Third
TrCH3: Half
TrCH4: Third | TrCH1- TrCH2:
Third
TrCH3: Half
TrCH4: Third |
| >>>rateMatchingAttribute | TrCH1: 200
TrCH2: 190
TrCH3: 235
TrCH4: 160 | TrCH1: 200
TrCH2: 190
TrCH3: 235
TrCH4: 160 |
| >>>crc-Size | TrCH1: 12
TrCH2- TrCH3: 0
TrCH4: 16 | TrCH1: 12
TrCH2- TrCH3: 0
TrCH4: 16 |
| DL-
AddReconfTransChInfoList | | |
| >Downlink transport
channel type | dch | |
| >dl-
TransportChannelIdentity
(should be as for UL) | TrCH1: 1, TrCH2: 2,
TrCH3: 3, TrCH4: 9 | TrCH1: 1, TrCH2: 2,
TrCH3: 3, TrCH4: 9 |
| >tf0-SignallingMode | Explicit
<Only tf0 on TrCH1
is different and
shown below> | Explicit
<Only tf0 on TrCH1
is different and
shown below> |
| >>transportFormatSet | DedicatedTransChT
FS | DedicatedTransChT
FS |
| >>>dynamicTF-information | | |
| >>>>tf0/ tf0,1 | TrCH1: (1x0) | TrCH1: (1x0) |
| >>>>rlcSize | bitMode | bitMode |
| >>>>>sizeType | TrCH1: type 1: 0 | TrCH1: type 1: 0 |
| >>>>numberOfTbSizeList | TrCH1: One | TrCH1: One |
| >>>>logicalChannelList | All | All |
| >>ULTrCH-Id | TrCH1: 1, TrCH2: 2,
TrCH3: 3, TrCH4: 9 | TrCH1: 1, TrCH2: 2,
TrCH3: 3, TrCH4: 9 |
| >dch-QualityTarget | | |
| >>bler-QualityValue | TrCH1: 7×10^{-3}
TrCH2- TrCH4:
Absent | TrCH1: 7×10^{-3}
TrCH2- TrCH4:
Absent |
| TrCH INFORMATION,
COMMON | | |
| ul-CommonTransChInfo | | |
| >tfcs-ID (TDD only) | 1 | 1 |
| >sharedChannelIndicator
(TDD only) | FALSE | FALSE |
| >tfcs-Subset | Absent, not required | Absent, not required |
| >ul-TFCS | Normal TFCS
signalling | Normal TFCS
signalling |
| >>explicitTFCS-
ConfigurationMode | Complete | Complete |
| >>>ctfcSize | Ctfc6Bit | Ctfc8Bit |
| >>>>TFCS representation | Addition | Addition |
| >>>>>TFCS list | | |

| Configuration | 12.2 kbps speech
+
13.6 kbps
signalling | 12.2/7.95/5.9/4.75
kbps speech +
13.6 kbps
signalling |
|----------------------------------|--|--|
| >>>>>TFC 1 | (TF0, TF0, TF0,
TF0) | (TF0, TF0, TF0,
TF0) |
| >>>>>>ctfc | 0 | 0 |
| >>>>>>>gainFactorInform
ation | Computed | Computed |
| >>>>>>>referenceTFCId | 0 | 0 |
| >>>>>TFC 2 | (TF1, TF0, TF0,
TF0) | (TF1, TF0, TF0,
TF0) |
| >>>>>>ctfc | 1 | 1 |
| >>>>>>>gainFactorInform
ation | Computed | Computed |
| >>>>>>>referenceTFCId | 0 | 0 |
| >>>>>TFC 3 | (TF2, TF1, TF1,
TF0) | (TF2, TF1, TF0,
TF0) |
| >>>>>>ctfc | 11 | 8 |
| >>>>>>>gainFactorInform
ation | Computed | Computed |
| >>>>>>>referenceTFCId | 0 | 0 |
| >>>>>TFC 4 | (TF0, TF0, TF0,
TF1) | (TF3, TF2, TF0,
TF0) |
| >>>>>>ctfc | 12 | 15 |
| >>>>>>>gainFactorInform
ation | Computed | Computed |
| >>>>>>>referenceTFCId | 0 | 0 |
| >>>>>TFC 5 | (TF1, TF0, TF0,
TF1) | (TF4, TF3, TF0,
TF0) |
| >>>>>>ctfc | 13 | 22 |
| >>>>>>>gainFactorInform
ation | Computed | Computed |
| >>>>>>>referenceTFCId | 0 | 0 |
| >>>>>TFC 6 | (TF2, TF1, TF1,
TF1) | (TF5, TF4, TF1,
TF0) |
| >>>>>>ctfc | 23 | 59 |
| >>>>>>>gainFactorInform
ation | Signalled | Computed |
| >>>>>>> β_c (FDD only) | 10 | N/A |
| >>>>>>> β_d | 15 | N/A |
| >>>>>>>referenceTFCId | 0 | 0 |
| >>>>>TFC 7 | (TF0, TF0, TF0,
TF2) | (TF0, TF0, TF0, TF1) |
| >>>>>>ctfc | 24 | 60 |
| >>>>>>>gainFactorInform
ation | Computed | Computed |
| >>>>>>>referenceTFCId | 0 | 0 |
| >>>>>TFC 8 | (TF1, TF0, TF0,
TF2) | (TF1, TF0, TF0, TF1) |
| >>>>>>ctfc | 25 | 61 |
| >>>>>>>gainFactorInform
ation | Computed | Computed |
| >>>>>>>referenceTFCId | 0 | 0 |
| >>>>>TFC 9 | (TF0, TF0, TF0,
TF3) | (TF2, TF1, TF0, TF1) |
| >>>>>>ctfc | 36 | 68 |
| >>>>>>>gainFactorInform
ation | Computed | Computed |
| >>>>>>>referenceTFCId | 0 | 0 |
| >>>>>TFC 10 | (TF1, TF0, TF0,
TF3) | (TF3, TF2, TF0, TF1) |
| >>>>>>ctfc | 37 | 75 |

| Configuration | 12.2 kbps speech + 13.6 kbps signalling | 12.2/7.95/5.9/4.75 kbps speech + 13.6 kbps signalling |
|-----------------------------|---|---|
| >>>>>>gainFactorInformation | Computed | Computed |
| >>>>>>referenceTFCId | 0 | 0 |
| >>>>>>TFC 11 | (TF0, TF0, TF0, TF4) | (TF4, TF3, TF0, TF1) |
| >>>>>>ctfc | 48 | 82 |
| >>>>>>gainFactorInformation | Computed | Computed |
| >>>>>>referenceTFCId | 0 | 0 |
| >>>>>>TFC 12 | | (TF5, TF4, TF1, TF1) |
| >>>>>>ctfc | | 119 |
| >>>>>>gainFactorInformation | | Signalled |
| >>>>>> β_c (FDD only) | | 10 |
| >>>>>> β_d | | 15 |
| >>>>>>referenceTFCId | | 0 |
| >>>>>>TFC 13 | | (TF0, TF0, TF0, TF2) |
| >>>>>>ctfc | | 120 |
| >>>>>>gainFactorInformation | | Computed |
| >>>>>>referenceTFCId | | 0 |
| >>>>>>TFC 14 | | (TF1, TF0, TF0, TF2) |
| >>>>>>ctfc | | 121 |
| >>>>>>gainFactorInformation | | Computed |
| >>>>>>referenceTFCId | | 0 |
| >>>>>>TFC 15 | | (TF0, TF0, TF0, TF3) |
| >>>>>>ctfc | | 180 |
| >>>>>>gainFactorInformation | | Computed |
| >>>>>>referenceTFCId | | 0 |
| >>>>>>TFC 16 | | (TF1, TF0, TF0, TF3) |
| >>>>>>ctfc | | 181 |
| >>>>>>gainFactorInformation | | Computed |
| >>>>>>referenceTFCId | | 0 |
| >>>>>>TFC 17 | | (TF0, TF0, TF0, TF4) |
| >>>>>>ctfc | | 240 |
| >>>>>>gainFactorInformation | | Computed |
| >>>>>>referenceTFCId | | 0 |
| dl-CommonTransChInfo | | |
| >tfc-SignallingMode | Same as UL | Same as UL |
| PhyCH INFORMATION FDD | | |
| UL-DPCH-InfoPredef | | |
| >ul-DPCH-PowerControlInfo | | |
| >>powerControlAlgorithm | Algorithm 1 | Algorithm 1 |
| >>>tpcStepSize | 1 dB | 1 dB |
| >tfc-Existence | TRUE | TRUE |
| >puncturingLimit | 0.84 | 0.84 |
| DL-CommonInformationPredef | | |
| >dl-DPCH-InfoCommon | | |
| >>spreadingFactor | 128 | 128 |
| >>tfc-Existence | TRUE | TRUE |
| >>pilotBits | 4 | 4 |

| Configuration | 12.2 kbps speech
+
13.6 kbps
signalling | 12.2/7.95/5.9/4.75
kbps speech +
13.6 kbps
signalling |
|----------------------|--|--|
| >>positionFixed | Flexible | Flexible |

| Configuration | 64kbps conv. CS-data +
13.6 kbps signalling | 12.65/8.85/6.6 kbps
speech +
13.6 kbps signalling
(without SRB#5) |
|--------------------------------|--|--|
| Ref 25.993 | 7.1.133 | 7.1.134 |
| Default configuration identity | 20 | 21 |
| RB INFORMATION | | |
| Rb-Identity | RB1: 1, RB2: 2, RB3:
3, RB5: 5 | RB1: 1, RB2: 2, RB3:
3, RB5: 5, RB6: 6,
RB7: 7, |
| rlc-InfoChoice | Rlc-info | Rlc-info |
| >ul-RLC-Mode | RB1: UM
RB2- RB3: AM
RB5: TM | RB1: UM
RB2- RB3: AM
RB5-RB7: TM |
| >>transmissionRLC-DiscardMode | RB1: N/A
RB2- RB3: NoDiscard
RB5: N/A | RB1: N/A
RB2- RB3: NoDiscard
RB5- RB7: N/A |
| >>>maxDat | RB1: N/A
RB2- RB3: 25
RB5: N/A | RB1: N/A
RB2- RB3: 25
RB5- RB7: N/A |
| >>transmissionWindowSize | RB1: N/A
RB2- RB3: 32
RB5: N/A | RB1: N/A
RB2- RB3: 32
RB5- RB7: N/A |
| >>timerRST | RB1: N/A
RB2- RB3: 200
RB5: N/A | RB1: N/A
RB2- RB3: 200
RB5- RB7: N/A |
| >>max-RST | RB1: N/A
RB2- RB3: 1
RB5: N/A | RB1: N/A
RB2- RB3: 1
RB5- RB7: N/A |
| >>pollingInfo | RB1: N/A
RB2- RB3: as below
RB5: N/A | RB1: N/A
RB2- RB3: as below
RB5- RB7: N/A |
| >>>TimerPoll | RB2- RB3: 100 | RB2- RB3: 100 |
| >>>PollPDU | RB2- RB3: n/a | RB2- RB3: n/a |
| >>>PollSDU | RB2- RB3: 1 | RB2- RB3: 1 |
| >>>lastTransmissionPDU-Poll | RB2- RB3: FALSE | RB2- RB3: FALSE |
| >>>lastRetransmissionPDU-Poll | RB2- RB3: TRUE | RB2- RB3: TRUE |
| >>>PollWindow | RB2- RB3: 99 | RB2- RB3: 99 |
| >>segmentationIndication | RB1- RB3: N/A
RB5: FALSE | RB1- RB3: N/A
RB5- RB7: FALSE |
| >dl-RLC-Mode | RB1: UM
RB2- RB3: AM
RB5: TM | RB1: UM
RB2- RB3: AM
RB5- RB7: TM |
| >>inSequenceDelivery | RB1: N/A
RB2- RB3: TRUE
RB5: N/A | RB1: N/A
RB2- RB3: TRUE
RB5- RB7: N/A |
| >>receivingWindowSize | RB1: N/A
RB2- RB3: 32
RB5: N/A | RB1: N/A
RB2- RB3: 32
RB5- RB7: N/A |
| >>dl-RLC-StatusInfo | RB1: N/A
RB2- RB3: as below
RB5: N/A | RB1: N/A
RB2- RB3: as below
RB5- RB7: N/A |
| >>>timerStatusProhibit | RB2- RB3: 100 | RB2- RB3: 100 |
| >>>missingPDU-Indicator | RB2- RB3: TRUE | RB2- RB3: TRUE |
| >>segmentationIndication | RB1- RB3: N/A
RB5: FALSE | RB1- RB3: N/A
RB5- RB7: FALSE |
| rb-MappingInfo | | |
| >UL-LogicalChannelMappings | OneLogicalChannel | OneLogicalChannel |
| >>ul-TransportChannelType | Dch | Dch |
| >>>transportChannelIdentity | RB1- RB3: 9
RB5: 1 | RB1- RB3: 9
RB5: 1, RB6: 2, RB7:
3. |
| >>logicalChannelIdentity | RB1: 1, RB2: 2, RB3:
3
RB5: N/A | RB1: 1, RB2: 2, RB3:
3
RB5- RB7: N/A |

| | | |
|--------------------------------|---|---|
| >>rlc-SizeList | RB1- RB3: configured
RB5: N/A | RB1- RB3: configured
RB5- RB7: N/A |
| >>mac-LogicalChannelPriority | RB1: 1, RB2: 2, RB3:
3
RB5: 5 | RB1: 1, RB2: 2, RB3:
3
RB5- RB7: 5 |
| >DL-logicalChannelMappingList | | |
| >>Mapping option 1 | One mapping option | One mapping option |
| >>>dl-TransportChannelType | Dch | Dch |
| >>>>transportChannelIdentity | RB1- RB3: 9
RB5: 1 | RB1- RB3: 9
RB5: 1, RB6: 2, RB7:
3, |
| >>>logicalChannelIdentity | RB1: 1, RB2: 2, RB3:
3
RB5: N/A | RB1: 1, RB2: 2, RB3:
3
RB5- RB7: N/A |
| TrCH INFORMATION PER TrCH | | |
| UL-AddReconfTransChInfoList | | |
| >Uplink transport channel type | dch | Dch |
| >transportChannelIdentity | TrCH1: 1, TrCH2: 9 | TrCH1: 1, TrCH2: 2,
TrCH3: 3, TrCH4: 9 |
| >transportFormatSet | DedicatedTransChTF
S | DedicatedTransChTF
S |
| >>dynamicTF-information | | |
| >>>tf0/ tf0,1,2,3,4 | TrCH1: (0x640,
2x640)
TrCH2: (0x144,
1x144, 2x144, 3x144,
4x144) | TrCH1: (0x72)
TrCH2: (0x 181)
TrCH3: (0x60)
TrCH4: (0x144,
1x144, 2x144, 3x144,
4x144) |
| >>>>rlcSize | TrCH1: OctetMode
TrCH2:BitMode | BitMode |
| >>>>>sizeType | TrCH1: type 2, part1=
11, part2= 2 (640)
TrCH2: type 2, part1=
2, part2= 0 (144) | TrCH1: type 1: 72
TrCH2: type 2: part1=
6, part2= 5
TrCH3: type1: 60
TrCH4: 2: type 2,
part1= 2, part2= 0
(144) |
| >>>>numberOfTbSizeList | TrCH1: Zero, 2
TrCH2: Zero, one, 2,
3, 4 | TrCH1-3: Zero
TrCH4: Zero, one, 2,
3, 4 |
| >>>>logicalChannelList | All | All |
| >>>tf 1 | | TrCH1: (1x40)
TrCH2: (1x 78)
TrCH3: N/A
TrCH4: N/A |
| >>>>numberOfTransportBlocks | | TrCH1: One
TrCH2: One |
| >>>>rlc-Size | | TrCH1-2: BitMode |
| >>>>>sizeType | | TrCH1: 1: 40
TrCH2: 1: 78 |
| >>>>numberOfTbSizeList | | TrCH1-2: One |
| >>>>logicalChannelList | | TrCH1: all |
| >>>tf 2 | | TrCH1: (1x54)
TrCH2: (1x113)
TrCH3: N/A
TrCH4: N/A |
| >>>>numberOfTransportBlocks | | TrCH1: One
TrCh2: One |
| >>>>rlc-Size | | TrCH1: BitMode |
| >>>>>sizeType | | TrCH1: type 1: 54
TrCH2: type 1: 113 |
| >>>>numberOfTbSizeList | | TrCH1: One
TrCH2: One |
| >>>>logicalChannelList | | TrCH1: all
TrCH2: all |

| | | |
|----------------------------------|--|--|
| >>>tf 3 | | TrCH1: (1x64)
TrCH2: (1x181)
TrCH3: N/A
TrCH4: N/A |
| >>>>numberOfTransportBlocks | | TrCH1: One
TrCh2: One |
| >>>>rlc-Size | | TrCH1: BitMode |
| >>>>>sizeType | | TrCH1: type 1: 64
TrCH2: type 2:
part1=6, part2= 5 |
| >>>>numberOfTbSizeList | | TrCH1: One
TrCH2: One |
| >>>>logicalChannelList | | TrCH1: all
TrCH2: all |
| >>>tf 4 | | TrCH1: (1x72)
TrCH2: N/A
TrCH3: N/A
TrCH4: N/A |
| >>>>numberOfTransportBlocks | | TrCH1: One |
| >>>>rlc-Size | | TrCH1: BitMode |
| >>>>>sizeType | | TrCH1: type 1: 72 |
| >>>>numberOfTbSizeList | | TrCH1: One |
| >>>>logicalChannelList | | TrCH1: all |
| >>semistaticTF-Information | | |
| >>>tti | TrCH1: 20
TrCH2: 40 | TrCH1- TrCH3: 20
TrCH4: 40 |
| >>>channelCodingType | TrCH1: Turbo
TrCH2: Convolutional | Convolutional |
| >>>>codingRate | TrCH1: N/A
TrCH2: Third | TrCH1- TrCH3: Third
TrCH4: Third |
| >>>>rateMatchingAttribute | TrCH1: 170

TrCH2: 160 | TrCH1: 200
TrCH2: 190
TrCH3: 256
TrCH4: 170 |
| >>>>crc-Size | TrCH1: 16

TrCH2: 16 | TrCH1: 12
TrCH2: 0
TrCH3: 0
TrCH4: 16 |
| DL-AddReconfTransChInfoList | | |
| >Downlink transport channel type | dch | Dch |
| >dl-TransportChannelIdentity | TrCH1: 1, TrCH2: 9 | |
| >fs-SignallingMode | SameAsUL | Independent
<Only tf0 on TrCH1 is
different and shown
below> |
| >>transportFormatSet | | |
| >>>dynamicTF-information | | |
| >>>>tf0/ tf0,1 | | TrCH1: (1x0) |
| >>>>rlcSize | | BitMode |
| >>>>>sizeType | | TrCH1: type 1: 0 |
| >>>>numberOfTbSizeList | | TrCH1: One |
| >>>>logicalChannelList | | All |
| >>>semistaticTF-Information | | same as UL |
| >>ULTrCH-Id | TrCH1: 1, TrCH2: 9 | TrCH1: 1, TrCH2: 2,
TrCH3: 3, TrCH4: 9, |
| >dch-QualityTarget | | |
| >>bler-QualityValue | TrCH1: 2×10^{-3}
TrCH2: Absent | TrCH1: 7×10^{-3}
TrCH2: Absent
TrCH3: Absent
TrCH4: Absent |
| TrCH INFORMATION, COMMON | | |
| ul-CommonTransChInfo | | |

| | | |
|--------------------------------------|------------------------|------------------------|
| >tfc-ID (TDD only) | 1 | 1 |
| >sharedChannelIndicator (TDD only) | FALSE | FALSE |
| > tfc-Subset | Absent, not required | Absent, not required |
| >ul-TFCS | Normal TFCI signalling | Normal TFCI signalling |
| >>explicitTFCS-ConfigurationMode | Complete | Complete |
| >>>ctfcSize | Ctfc4Bit | Ctfc6Bit |
| >>>>TFCS representation | Addition | Addition |
| >>>>>TFC list | | |
| >>>>>>TFC 1 | (TF0, TF0) | (TF0, TF0, TF0, TF0) |
| >>>>>>>ctfc | 0 | 0 |
| >>>>>>>gainFactorInformation | Computed | Computed |
| >>>>>>>referenceTFCId | 0 | 0 |
| >>>>>>>TFC 2 | (TF1, TF0) | (TF1, TF0, TF0, TF0) |
| >>>>>>>>ctfc | 1 | 1 |
| >>>>>>>>gainFactorInformation | Computed | Computed |
| >>>>>>>>> β c (FDD only) | N/A | N/A |
| >>>>>>>>>> β d | N/A | N/A |
| >>>>>>>>>>referenceTFCId | 0 | 0 |
| >>>>>>>>>>>TFC 3 | (TF0, TF1) | (TF2, TF1, TF0, TF0) |
| >>>>>>>>>>>>ctfc | 2 | 7 |
| >>>>>>>>>>>>gainFactorInformation | Computed | Computed |
| >>>>>>>>>>>>referenceTFCId | 0 | 0 |
| >>>>>>>>>>>>>TFC 4 | (TF1, TF1) | (TF3, TF2, TF0, TF0) |
| >>>>>>>>>>>>>>ctfc | 3 | 13 |
| >>>>>>>>>>>>>>gainFactorInformation | Signalled | Computed |
| >>>>>>>>>>>>>>> β c (FDD only) | 8 | N/A |
| >>>>>>>>>>>>>>>> β d | 15 | N/A |

| | | |
|------------------------------------|-------------|----------------------|
| >>>>>>referenceTFCId | 0 | 0 |
| >>>>>TFC 5 | (TF0, TF2) | (TF4, TF3, TF0, TF0) |
| >>>>>ctfc | 4 | 19 |
| >>>>>gainFactorInformation | Computed | Computed |
| >>>>>>referenceTFCId | 0 | 0 |
| >>>>>TFC 6 | (TF0, TF3) | (TF0, TF0, TF0, TF1) |
| >>>>>ctfc | 6 | 20 |
| >>>>>gainFactorInformation | Computed | Computed |
| >>>>>>referenceTFCId | 0 | 0 |
| >>>>>TFC 7 | (TF0, TF4) | (TF1, TF0, TF0, TF1) |
| >>>>>ctfc | 8 | 21 |
| >>>>>gainFactorInformation | Computed | Computed |
| >>>>>>referenceTFCId | 0 | 0 |
| >>>>>TFC 8 | | (TF2, TF1, TF0, TF1) |
| >>>>>ctfc | | 27 |
| >>>>>gainFactorInformation | | computed |
| >>>>>>referenceTFCId | | 0 |
| >>>>>TFC 9 | | (TF3, TF2, TF0, TF1) |
| >>>>>ctfc | | 33 |
| >>>>>gainFactorInformation | | computed |
| >>>>>>referenceTFCId | | 0 |
| >>>>>TFC 10 | | (TF4, TF3, TF0, TF1) |
| >>>>>ctfc | | 39 |
| >>>>>gainFactorInformation | | signalled |
| >>>>>> β c (FDD only) | | 10 |
| >>>>>> β d | | 15 |
| >>>>>>>referenceTFCId | | 0 |
| >>>>>TFC 11 | | (TF0, TF0, TF0, TF2) |
| >>>>>ctfc | | 40 |
| >>>>>gainFactorInformation | | Computed |
| >>>>>>referenceTFCId | | 0 |
| >>>>>TFC 12 | | (TF1, TF0, TF0, TF2) |
| >>>>>ctfc | | 41 |
| >>>>>gainFactorInformation | | Computed |
| >>>>>>referenceTFCId | | 0 |
| >>>>>TFC 13 | | (TF0, TF0, TF0, TF3) |
| >>>>>ctfc | | 60 |
| >>>>>gainFactorInformation | | Computed |
| >>>>>>referenceTFCId | | 0 |
| >>>>>TFC 14 | | (TF1, TF0, TF0, TF3) |
| >>>>>ctfc | | 61 |
| >>>>>gainFactorInformation | | Computed |
| >>>>>>referenceTFCId | | 0 |
| >>>>>TFC 15 | | (TF0, TF0, TF0, TF4) |
| >>>>>ctfc | | 80 |
| >>>>>gainFactorInformation | | Computed |
| >>>>>>referenceTFCId | | 0 |
| dl-CommonTransChInfo | | |
| >tfc-SignallingMode | Same as UL | Same as UL |
| ul-CommonTransChInfo | | |
| >tfc-ID (TDD only) | | 1 |
| >sharedChannelIndicator (TDD only) | | FALSE |
| > tfc-Subset | | Absent, not required |
| PhyCH INFORMATION FDD | | |
| UL-DPCH-InfoPredef | | |
| >ul-DPCH-PowerControlInfo | | |
| >>powerControlAlgorithm | Algorithm 1 | Algorithm 1 |
| >>>tpcStepSize | 1 dB | 1 dB |
| >tfc-Existence | TRUE | TRUE |
| >puncturingLimit | 0.88 | 0.84 |
| DL-CommonInformationPredef | | |
| >dl-DPCH-InfoCommon | | |
| >>spreadingFactor | 32 | 128 |

| | | |
|---------------------------------|----------|----------|
| >>tfc-Existence | TRUE | TRUE |
| >>pilotBits | 8 | 4 |
| >>positionFixed | Flexible | Flexible |
| PhyCH INFORMATION 3.84 Mcps TDD | | |
| UL-DPCH-InfoPredef | | |
| >ul-DPCH-PowerControllInfo | | |
| >>dpch-ConstantValue | | |
| >commonTimeslotInfo | | |
| >>secondInterleavingMode | | |
| >>tfc-Coding | | |
| >>puncturingLimit | | |
| >>repetitionPeriodAndLength | | |
| DL-CommonInformationPredef | | |
| >dl-DPCH-InfoCommon | | |
| >>commonTimeslotInfo | | |
| >>>secondInterleavingMode | | |
| >>>tfc-Coding | | |
| >>>puncturingLimit | | |
| >>>repetitionPeriodAndLength | | |
| PhyCH INFORMATION 1.28 Mcps TDD | | |
| UL-DPCH-InfoPredef | | |
| >commonTimeslotInfo | | |
| >>secondInterleavingMode | | |
| >>tfc-Coding | | |
| >>puncturingLimit | | |
| >>repetitionPeriodAndLength | | |
| DL-CommonInformationPredef | | |
| >dl-DPCH-InfoCommon | | |
| >>commonTimeslotInfo | | |
| >>>secondInterleavingMode | | |
| >>>tfc-Coding | | |
| >>>puncturingLimit | | |
| >>>repetitionPeriodAndLength | | |

| Configuration | 13.6 kbps signalling |
|--------------------------------|---------------------------------|
| Ref 34.108 | 3 |
| Default configuration identity | 22 |
| RB INFORMATION | |
| rb-Identity | RB1: 1, RB2: 2, RB3: 3 |
| rlc-InfoChoice | Rlc-info |
| >ul-RLC-Mode | RB1: UM
RB2- RB3: AM |
| >>transmissionRLC-DiscardMode | RB1: N/A
RB2- RB3: NoDiscard |
| >>>maxDat | RB1: N/A
RB2- RB3: 25 |
| >>transmissionWindowSize | RB1: N/A
RB2- RB3: 32 |
| >>timerRST | RB1: N/A
RB2- RB3: 200 |
| >>max-RST | RB1: N/A
RB2- RB3: 1 |
| >>pollingInfo | RB1: N/A
RB2- RB3: as below |
| >>>TimerPoll | RB2- RB3: 100 |
| >>>PollPDU | RB2- RB3: n/a |
| >>>PollSDU | RB2- RB3: 1 |

| Configuration | 13.6 kbps signalling |
|--------------------------------|---|
| >>>lastTransmissionPDU-Poll | RB2- RB3: FALSE |
| >>>lastRetransmissionPDU-Poll | RB2- RB3: TRUE |
| >>>PollWindow | RB2- RB3: 99 |
| >>segmentationIndication | RB1- RB3: N/A |
| >dl-RLC-Mode | RB1: UM
RB2- RB3: AM |
| >>inSequenceDelivery | RB1: N/A
RB2- RB3: TRUE |
| >>receivingWindowSize | RB1: N/A
RB2- RB3: 32 |
| >>dl-RLC-StatusInfo | RB1: N/A
RB2- RB3: as below |
| >>>timerStatusProhibit | RB2- RB3: 100 |
| >>>missingPDU-Indicator | RB2- RB3: TRUE |
| >>segmentationIndication | RB1- RB3: N/A |
| rb-MappingInfo | |
| >UL-LogicalChannelMappings | OneLogicalChannel |
| >>ul-TransportChannelType | Dch |
| >>>transportChannelIdentity | RB1- RB3:9 |
| >>logicalChannelIdentity | RB1: 1, RB2: 2,
RB3: 3 |
| >>rlc-SizeList | RB1- RB3:
configured |
| >>mac-LogicalChannelPriority | RB1: 1, RB2: 2,
RB3: 3 |
| >DL-logicalChannelMappingList | |
| >>Mapping option 1 | One mapping option |
| >>>dl-TransportChannelType | Dch |
| >>>>transportChannelIdentity | RB1- RB3: 9 |
| >>>logicalChannelIdentity | RB1: 1, RB2: 2,
RB3: 3 |
| TrCH INFORMATION PER TrCH | |
| UL-AddReconfTransChInfoList | |
| >Uplink transport channel type | Dch |
| >transportChannelIdentity | TrCH1: 9 |
| >transportFormatSet | DedicatedTransChTFS |
| >>dynamicTF-information | |
| >>>tf0/ tf0,1 | TrCH1: (0x144,
1x144) |
| >>>>rlcSize | BitMode |
| >>>>>sizeType | TrCH1: type 2,
part1= 2, part2= 0
(144) |
| >>>>>numberOfTbSizeList | TrCH1: Zero, one |
| >>>>logicalChannelList | All |
| >>>tf 1 | N/A |
| >>>>numberOfTransportBlocks | |
| >>>>rlc-Size | |
| >>>>>sizeType | |
| >>>>>numberOfTbSizeList | |

| Configuration | 13.6 kbps signalling |
|--|---------------------------|
| >>>>logicalChannellist | |
| >>>tf 2 | N/A |
| >>>>numberOfTransportBlocks | |
| >>>>rlc-Size | |
| >>>>>sizeType | |
| >>>>numberOfTbSizeList | |
| >>>>logicalChannellist | |
| >>semistaticTF-Information | |
| >>>tfti | TrCH1: 10 |
| >>>channelCodingType | Convolutional |
| >>>>codingRate | TrCH1: Third |
| >>>>rateMatchingAttribute | TrCH1: 160 |
| >>>>crc-Size | TrCH1: 16 |
| DL-AddReconfTransChInfoList | |
| >Downlink transport channel type | Dch |
| >dl-TransportChannelIdentity (should be as for UL) | TrCH1: 9 |
| >tfs-SignallingMode | SameAsUL |
| >>transportFormatSet | |
| >>>dynamicTF-information | |
| >>>>tf0/ tf0,1 | |
| >>>>rlcSize | |
| >>>>>sizeType | |
| >>>>numberOfTbSizeList | |
| >>>>logicalChannellist | |
| >>ULTrCH-Id | TrCH1: 9 |
| >dch-QualityTarget | |
| >>bler-QualityValue | TrCH1: 1×10^{-2} |
| TrCH INFORMATION, COMMON | |
| ul-CommonTransChInfo | |
| >tfc-ID (TDD only) | 1 |
| >sharedChannelIndicator (TDD only) | FALSE |
| >tfc-Subset | Absent, not required |
| >ul-TFCS | Normal TFCI signalling |
| >>explicitTFCS-ConfigurationMode | Complete |
| >>>ctfcSize | Ctfc2Bit |
| >>>>TFCS representation | Addition |
| >>>>>TFCS list | |
| >>>>>>TFCS 1 | (TF0) |
| >>>>>>>ctfc | 0 |
| >>>>>>>>gainFactorInformation | Computed |
| >>>>>>>>referenceTFCId | 0 |
| >>>>>>>>TFCS 2 | (TF1) |
| >>>>>>>>>ctfc | 1 |
| >>>>>>>>>>gainFactorInformation | Signalled |
| >>>>>>>>>>> β_c (FDD only) | 11 |
| >>>>>>>>>>> β_d | 15 |
| >>>>>>>>>>>>referenceTFCId | 0 |
| dl-CommonTransChInfo | |
| >tfs-SignallingMode | Same as UL |
| PhyCH INFORMATION FDD | |

| Configuration | 13.6 kbps signalling |
|---|----------------------|
| UL-DPCH-InfoPredef | |
| >ul-DPCH-PowerControlInfo | |
| >>powerControlAlgorithm | Algorithm 1 |
| >>>tpcStepSize | 1 dB |
| >tfci-Existence | TRUE |
| >puncturingLimit | 1 |
| DL-CommonInformationPredef | |
| >dl-DPCH-InfoCommon | |
| >>spreadingFactor | 128 |
| >>tfci-Existence | FALSE |
| >>pilotBits | 4 |
| >>positionFixed | N/A |
| | |
| PhyCH INFORMATION
3.84 / 7.68 Mcps TDD | |
| UL-DPCH-InfoPredef | |
| >ul-DPCH-PowerControlInfo | |
| >>dpch-ConstantValue | 0 |
| >commonTimeslotInfo | |
| >>secondInterleavingMode | frameRelated |
| >>tfci-Coding | 4 |
| >>puncturingLimit | 0.92 |
| >>repetitionPeriodAndLength | repetitionPeriod1 |
| DL-CommonInformationPredef | |
| >dl-DPCH-InfoCommon | |
| >>commonTimeslotInfo | |
| >>>secondInterleavingMode | frameRelated |
| >>>tfci-Coding | 4 |
| >>>puncturingLimit | 0.92 |
| >>>repetitionPeriodAndLength | repetitionPeriod1 |
| PhyCH INFORMATION
1.28 Mcps TDD | |
| UL-DPCH-InfoPredef | |
| >commonTimeslotInfo | |
| >>secondInterleavingMode | frameRelated |
| >>tfci-Coding | 4 |
| >>puncturingLimit | 0.64 |
| >>repetitionPeriodAndLength | repetitionPeriod1 |
| DL-CommonInformationPredef | |
| >dl-DPCH-InfoCommon | |
| >>commonTimeslotInfo | |
| >>>secondInterleavingMode | frameRelated |
| >>>tfci-Coding | 4 |
| >>>puncturingLimit | 0.64 |
| >>>repetitionPeriodAndLength | repetitionPeriod1 |

NOTE 6: The difference between default configuration #22 and default configuration #1 (13.6 kbps signalling) resides in the RLC configuration and the DCH quality target.

13.8 Parameter values for default radio configurations in CELL_FACH

This section is not used in this version of the specifications.

14 Specific functions

14.1 Intra-frequency measurements

14.1.1 Intra-frequency measurement quantities

A measurement quantity is used to evaluate whether an intra-frequency event has occurred or not. It can be:

- 1 Downlink E_c/N_0 .
- 2 Downlink path loss.

For FDD:

Pathloss in dB = Primary CPICH Tx power - CPICH RSCP.

For Primary CPICH Tx power the IE "Primary CPICH Tx power" shall be used. The unit is dBm.

CPICH RSCP is the result of the CPICH RSCP measurement. The unit is dBm.

For TDD:

Pathloss in dB = Primary CCPCH TX power - Primary CCPCH RSCP.

For Primary CCPCH TX power the IE "Primary CCPCH TX Power" shall be used. The unit is dBm.

Primary CCPCH RSCP is the result of the Primary CCPCH RSCP measurement. The unit is dBm.

If necessary Pathloss shall be rounded up to the next higher integer.

Results higher than 158 shall be reported as 158.

Results lower than 46 shall be reported as 46.

- 3 Downlink received signal code power (RSCP) after despreading.
- 4 ISCP measured on Timeslot basis.

A description of those values can be found in [7] and [8].

14.1.2 Intra-frequency reporting events for FDD

Within the measurement reporting criteria field in the Measurement Control message the UTRAN notifies the UE which events should trigger a measurement report. The listed events are the toolbox from which the UTRAN can choose the reporting events that are needed for the implemented handover evaluation function, or other radio network functions.

All the specified events are measured with respect to any of the measurement quantities given in subclause 14.1.1. The measurement quantities are measured on the monitored primary common pilot channels (CPICH) of the cell defined in the measurement object.

Special mechanisms for the events are illustrated in subclause 14.1.4 and 14.1.5.

NOTE: The events below are numbered 1A, 1B, 1C,... since all intra-frequency reporting events would be labelled 1X, inter-frequency reporting events would be labelled 2X, and so on for the other measurement types.

When one intra-frequency measurement identity corresponds to multiple intra-frequency events with identical event identities, the UE behaviour is not specified.

14.1.2.1 Reporting event 1A: A Primary CPICH enters the reporting range

When an intra-frequency measurement configuring event 1a is set up, the UE shall:

- 1> create a variable TRIGGERED_1A_EVENT related to that measurement, which shall initially be empty;
- 1> delete this variable when the measurement is released.

When event 1A is configured in the UE, the UE shall:

- 1> if "Measurement quantity" is "pathloss" and Equation 1 below is fulfilled for one or more primary CPICHs, or if "Measurement quantity" is "CPICH E_c/N_0 " or "CPICH RSCP", and Equation 2 below is fulfilled for one or more primary CPICHs, for each of these primary CPICHs:
 - 2> if all required reporting quantities are available for that cell; and
 - 2> if the equations have been fulfilled for a time period indicated by "Time to trigger", and if that primary CPICH is part of cells allowed to trigger the event according to "Triggering condition 2", and if that primary CPICH is not included in the "cells triggered" in the variable TRIGGERED_1A_EVENT:
 - 3> include that primary CPICH in the "cells recently triggered" in the variable TRIGGERED_1A_EVENT.

- 1> if the value of "Reporting deactivations threshold" for this event is greater than or equal to the current number of cells in the active set or equal to 0 and any primary CPICHs are stored in the "cells recently triggered" in the variable TRIGGERED_1A_EVENT:

- 2> if "Reporting interval" for this event is not equal to 0:

- 3> if the IE "Periodical reporting running" in the variable TRIGGERED_1A_EVENT is set to FALSE:

- 4> start a timer with the value of "Reporting interval" for this event and set the IE "Periodical reporting running" in the variable TRIGGERED_1A_EVENT to TRUE;

- 3> set "sent reports" for the primary CPICHs in "cells recently triggered" in the variable TRIGGERED_1A_EVENT to 1.

- 2> send a measurement report with IEs set as below:

- 3> set in "intra-frequency measurement event results": "Intrafrequency event identity" to "1a"; and

- 3> include in "cell measurement event results" all entries of the "cells recently triggered" in the variable TRIGGERED_1A_EVENT in descending order according to the configured measurement quantity taking into account the cell individual offset for each of those cells;

- 3> set the IE "measured results" and the IE "additional measured results" according to subclause 8.4.2, not taking into account the cell individual offset for each cell.

- 2> move all entries from "cells recently triggered" to "cells triggered" in the variable TRIGGERED_1A_EVENT.

- 1> if the timer for the periodical reporting has expired:

- 2> if any primary CPICH is included in the "cells triggered" in the variable TRIGGERED_1A_EVENT:

- 3> if "Reporting interval" for this event is not equal to 0, and if "Amount of reporting" is greater than "sent reports" stored for any of these primary CPICHs, in "cells triggered" in the variable TRIGGERED_1A_EVENT:

- 4> increment the stored counter "sent reports" for all CPICHs in "cell triggered" in variable TRIGGERED_1A_EVENT;

- 4> start a timer with the value of "Reporting interval" for this event;

- 4> send a measurement report with IEs set as below:
 - 5> set in "intra-frequency measurement event results": "Intrafrequency event identity" to "1a"; and
 - 5> include in "cell measurement event results" all entries of the variable TRIGGERED_1A_EVENT with value of IE "sent reports" equal to or smaller than value of "Amount of reporting" in descending order according to the configured measurement quantity taking into account the cell individual offset for each of those cells;
 - 5> set the IE "measured results" and the IE "additional measured results" according to subclause 8.4.2, not taking into account the cell individual offset for each cell.
- 4> if "sent reports" in variable TRIGGERED_1A_EVENT is equal to "Amount of reporting" for all entries:
 - 5> set the IE "Periodical Reporting running" in the variable TRIGGERED_1A_EVENT to FALSE and disable the timer for the periodical reporting.
- 1> if "Measurement quantity" is "pathloss" and Equation 3 below is fulfilled for a primary CPICH, or if "Measurement quantity" is "CPICH Ec/N0" or "CPICH RSCP", and Equation 4 below is fulfilled for a primary CPICH; or
- 1> if a primary CPICH is no longer part of the cells allowed to trigger the event according to the "Triggering condition 2":
 - 2> if that primary CPICH is included in the "cells triggered" or "cells recently triggered" in the variable TRIGGERED_1A_EVENT:
 - 3> remove the entry of that primary CPICH from "cells triggered" or "cells recently triggered" in the variable TRIGGERED_1A_EVENT.
 - 3> if no entry in the variable TRIGGERED_1A_EVENT has a value of "sent reports" smaller than "Amount of reporting"; or
 - 3> if there is no entry in the variable TRIGGERED_1A_EVENT:
 - 4> if the reporting interval timer is running:
 - 5> stop the reporting interval timer;
 - 5> set the IE "Periodical reporting running" in the variable TRIGGERED_1A_EVENT to FALSE.

This event is only applicable to the CELL_DCH state. When the measurement is setup in CELL_DCH or upon transition to CELL_DCH the UE shall:

- 1> if the "Triggering condition 2" includes active set cells:
 - 2> include the primary CPICH of all cells in the current active set into the "cells triggered" in the variable TRIGGERED_1A_EVENT with the counter "sent reports" set to "Amount of reporting".

Equation 1 (Triggering condition for pathloss)

$$10 \cdot \text{Log}M_{New} + CIO_{New} \leq W \cdot 10 \cdot \text{Log} \left(1 / \sum_{i=1}^{N_A} (1/M_i) \right) + (1-W) \cdot 10 \cdot \text{Log}M_{Best} + (R_{1a} - H_{1a} / 2),$$

Equation 2 (Triggering condition for all the other measurement quantities)

$$10 \cdot \text{Log}M_{New} + CIO_{New} \geq W \cdot 10 \cdot \text{Log} \left(\sum_{i=1}^{N_A} M_i \right) + (1-W) \cdot 10 \cdot \text{Log}M_{Best} - (R_{1a} - H_{1a} / 2),$$

Equation 3 (Leaving triggering condition for pathloss)

$$10 \cdot \text{Log}M_{New} + CIO_{New} > W \cdot 10 \cdot \text{Log} \left(1 / \sum_{i=1}^{N_A} (1/M_i) \right) + (1-W) \cdot 10 \cdot \text{Log}M_{Best} + (R_{1a} + H_{1a} / 2),$$

Equation 4 (Leaving triggering condition for all the other measurement quantities)

$$10 \cdot \text{Log} M_{New} + CIO_{New} < W \cdot 10 \cdot \text{Log} \left(\sum_{i=1}^{N_A} M_i \right) + (1-W) \cdot 10 \cdot \text{Log} M_{Best} - (R_{1a} + H_{1a} / 2),$$

The variables in the formula are defined as follows:

M_{New} is the measurement result of the cell entering the reporting range.

CIO_{New} is the individual cell offset for the cell entering the reporting range if an individual cell offset is stored for that cell. Otherwise it is equal to 0.

M_i is a measurement result of a cell not forbidden to affect reporting range in the active set.

N_A is the number of cells not forbidden to affect reporting range in the current active set.

For pathloss

M_{Best} is the measurement result of the cell not forbidden to affect reporting range in the active set with the lowest measurement result, not taking into account any cell individual offset.

for other measurements quantities.

M_{Best} is the measurement result of the cell not forbidden to affect reporting range in the active set with the highest measurement result, not taking into account any cell individual offset.

W is a parameter sent from UTRAN to UE.

R_{1a} is the reporting range constant.

H_{1a} is the hysteresis parameter for the event 1a.

If the measurement results are pathloss or CPICH-Ec/No then M_{New} , M_i and M_{Best} are expressed as ratios.

If the measurement result is CPICH-RSCP then M_{New} , M_i and M_{Best} are expressed in mW.

14.1.2.2 Reporting event 1B: A primary CPICH leaves the reporting range

When an intra-frequency measurement configuring event 1b is set up, the UE shall:

- 1> create a variable TRIGGERED_1B_EVENT related to that measurement, which shall initially be empty;
- 1> delete this variable when the measurement is released.

When event 1B is configured in the UE, the UE shall:

- 1> if "Measurement quantity" is "pathloss" and Equation 1 below is fulfilled for one or more primary CPICHs, or if "Measurement quantity" is "CPICH Ec/No" or "CPICH RSCP", and Equation 2 below is fulfilled for one or more primary CPICHs, for each of these primary CPICHs:
 - 2> if all required reporting quantities are available for that cell, and if the equations have been fulfilled for a time period indicated by "Time to trigger", and if that primary CPICH is part of cells allowed to trigger the event according to "Triggering condition 1", and if that primary CPICH is not included in the "cells triggered" in the variable TRIGGERED_1B_EVENT:
 - 3> include that primary CPICH in the "cells recently triggered" in the variable TRIGGERED_1B_EVENT.
- 1> if any primary CPICHs are stored in the "cells recently triggered" in the variable TRIGGERED_1B_EVENT:
 - 2> if "Periodic reporting info-1b" is present, and "Reporting interval" for this event is not equal to 0:
 - 3> if the IE "Periodical reporting running" in the variable TRIGGERED_1B_EVENT is set to FALSE:
 - 4> start a timer with the value of "Reporting interval" for this event and set the IE "Periodical reporting running" in the variable TRIGGERED_1B_EVENT to TRUE;

- 3> set "sent reports" for the primary CPICHs in "cells recently triggered" in the variable TRIGGERED_1B_EVENT to 1.
- 2> send a measurement report with IEs set as below:
 - 3> set in "intra-frequency measurement event results": "Intrafrequency event identity" to "1b"; and
 - 3> include in "cell measurement event results" all entries of "cells recently triggered" in the variable TRIGGERED_1B_EVENT in ascending order according to the configured measurement quantity taking into account the cell individual offset for each of those cells;
 - 3> set the IE "measured results" and the IE "additional measured results" according to subclause 8.4.2, not taking into account the cell individual offset for each cell.
- 2> move all entries from IE "cells recently triggered" to "cells triggered" in the variable TRIGGERED_1B_EVENT.
- 1> if the timer for the periodical reporting has expired:
 - 2> if any primary CPICH is included in the "cells triggered" in the variable TRIGGERED_1B_EVENT:
 - 3> if "Periodic reporting info-1b" is present:
 - 4> if "Reporting interval" is not equal to 0, and if "Amount of reporting" is greater than "sent reports" stored for any of these primary CPICHs, in "cells triggered" in the variable TRIGGERED_1B_EVENT:
 - 5> increment the stored counter "sent reports" for all CPICHs in "cell triggered" in variable TRIGGERED_1B_EVENT;
 - 5> start a timer with the value of "Reporting interval-1b" for this event;
 - 5> send a measurement report with IEs set as below:
 - 6> set in "intra-frequency measurement event results": "Intrafrequency event identity" to "1b"; and
 - 6> include in "cell measurement event results" all entries of the variable TRIGGERED_1B_EVENT with value of IE "sent reports" equal to or smaller than value of "Amount of reporting" in ascending order according to the configured measurement quantity taking into account the cell individual offset for each of those cells;
 - 6> set the IE "measured results" and the IE "additional measured results" according to subclause 8.4.2, not taking into account the cell individual offset for each cell.
 - 5> if "sent reports" in variable TRIGGERED_1B_EVENT is equal to "Amount of reporting" for all entries:
 - 6> set the IE "Periodical Reporting running" in the variable TRIGGERED_1B_EVENT to FALSE and disable the timer for the periodical reporting.
- 1> if "Measurement quantity" is "pathloss" and Equation 3 below is fulfilled for a primary CPICH, or if "Measurement quantity" is "CPICH Ec/N0" or "CPICH RSCP", and Equation 4 below is fulfilled for a primary CPICH; or
- 1> if a primary CPICH is no longer part of the cells allowed to trigger the event according to the "Triggering condition 1":
 - 2> if that primary CPICH is included in the "cells triggered" in the variable TRIGGERED_1B_EVENT:
 - 3> remove the entry of that primary CPICH from "cells triggered" in the variable TRIGGERED_1B_EVENT;
 - 3> if there is no entry in the variable TRIGGERED_1B_EVENT:
 - 4> if the reporting interval timer is running:
 - 5> stop the reporting interval timer;

5> set the IE "Periodical reporting running" in the variable TRIGGERED_1B_EVENT to FALSE.

Equation 1 (Triggering condition for pathloss)

$$10 \cdot \text{Log}M_{Old} + CIO_{Old} \geq W \cdot 10 \cdot \text{Log} \left(1 / \sum_{i=1}^{N_A} (1 / M_i) \right) + (1 - W) \cdot 10 \cdot \text{Log}M_{Best} + (R_{1b} + H_{1b} / 2),$$

Equation 2 (Triggering condition for all the other measurement quantities)

$$10 \cdot \text{Log}M_{Old} + CIO_{Old} \leq W \cdot 10 \cdot \text{Log} \left(\sum_{i=1}^{N_A} M_i \right) + (1 - W) \cdot 10 \cdot \text{Log}M_{Best} - (R_{1b} + H_{1b} / 2),$$

Equation 3 (Leaving triggering condition for pathloss)

$$10 \cdot \text{Log}M_{Old} + CIO_{Old} < W \cdot 10 \cdot \text{Log} \left(1 / \sum_{i=1}^{N_A} (1 / M_i) \right) + (1 - W) \cdot 10 \cdot \text{Log}M_{Best} + (R_{1b} - H_{1b} / 2),$$

Equation 4 (Leaving triggering condition for all the other measurement quantities)

$$10 \cdot \text{Log}M_{Old} + CIO_{Old} > W \cdot 10 \cdot \text{Log} \left(\sum_{i=1}^{N_A} M_i \right) + (1 - W) \cdot 10 \cdot \text{Log}M_{Best} - (R_{1b} - H_{1b} / 2),$$

The variables in the formula are defined as follows:

M_{Old} is the measurement result of the cell leaving the reporting range.

CIO_{Old} is the individual cell offset for the cell leaving the reporting range if an individual cell offset is stored for that cell. Otherwise it is equal to 0.

M_i is a measurement result of a cell not forbidden to affect reporting range in the active set.

N_A is the number of cells not forbidden to affect reporting range in the current active set.

For pathloss

M_{Best} is the measurement result of the cell not forbidden to affect reporting range in the active set with the lowest measurement result, not taking into account any cell individual offset.

for other measurements quantities.

M_{Best} is the measurement result of the cell not forbidden to affect reporting range in the active set with the highest measurement result, not taking into account any cell individual offset.

W is a parameter sent from UTRAN to UE.

R_{1b} is the reporting range constant.

H_{1b} is the hysteresis parameter for the event 1b.

If the measurement results are pathloss or CPICH-Ec/No then M_{Old} , M_i and M_{Best} are expressed as ratios.

If the measurement result is CPICH-RSCP then M_{Old} , M_i and M_{Best} are expressed in mW.

14.1.2.3 Reporting event 1C: A non-active primary CPICH becomes better than an active primary CPICH

When an intra-frequency measurement configuring event 1c is set up, the UE shall:

1> create a variable TRIGGERED_1C_EVENT related to that measurement, which shall initially be empty;

1> delete this variable when the measurement is released.

When event 1C is configured in the UE, the UE shall:

- 1> if "Measurement quantity" is "pathloss" and Equation 1 below is fulfilled for one or more primary CPICHs, or if "Measurement quantity" is "CPICH Ec/N0" or "CPICH RSCP", and Equation 2 below is fulfilled for one or more primary CPICHs, for each of these primary CPICHs:
 - 2> if all required reporting quantities are available for that cell; and
 - 2> if the equations have been fulfilled for a time period indicated by "Time to trigger", and if the primary CPICH that is better is not included in the active set but the other primary CPICH is any of the primary CPICHs included in the active set, and if that first primary CPICH is not included in the "cells triggered" in the variable TRIGGERED_1C_EVENT:
 - 3> include that primary CPICH in the "cells recently triggered" in the variable TRIGGERED_1C_EVENT.
- 1> if the value of "Replacement activation threshold" for this event is less than or equal to the current number of cells in the active set or equal to 0 and if any primary CPICHs are stored in the "cells recently triggered" in the variable TRIGGERED_1C_EVENT:
 - 2> if "Reporting interval" for this event is not equal to 0:
 - 3> if the IE "Periodical reporting running" in the variable TRIGGERED_1C_EVENT is set to FALSE:
 - 4> start a timer for with the value of "Reporting interval" for this event and set the IE "Periodical reporting running" in the variable TRIGGERED_1C_EVENT to TRUE.
 - 3> set "sent reports" for that primary CPICH in the variable TRIGGERED_1C_EVENT to 1.
 - 2> send a measurement report with IEs set as below:
 - 3> set in "intra-frequency measurement event results": "Intrafrequency event identity" to "1c"; and
 - 3> include in "cell measurement event results" all entries of the "cells recently triggered" in the variable TRIGGERED_1C_EVENT not in the active set as well as the "primary CPICH info" of all the primary CPICHs in the active set for which the measured value is worse (i.e. greater for pathloss and less for the other measurement quantities) than the one of the entry in "cell recently triggered" that has the best measured value taking into account their cell individual offset. The "primary CPICH info" for those cells shall be ordered according to their measured value taking into account their cell individual offset, beginning with the best cell to the worst one;
 - 3> set the IE "measured results" and the IE "additional measured results" according to subclause 8.4.2, not taking into account the cell individual offset for each cell.
 - 2> move all entries from "cells recently triggered" to "cells triggered" in the variable TRIGGERED_1C_EVENT.
- 1> if the timer for the periodical reporting has expired:
 - 2> if any primary CPICH is included in the "cells triggered" in the variable TRIGGERED_1C_EVENT, and not included in the current active set:
 - 3> if "Reporting interval" for this event is not equal to 0, and if "Amount of reporting" is greater than "sent reports" stored for that primary CPICH, in "cells triggered" in the variable TRIGGERED_1C_EVENT:
 - 4> increment the stored counter "sent reports" for all CPICH in "cell triggered" in variable TRIGGERED_1C_EVENT;
 - 4> start a timer with the value of "Reporting interval" for this event;
 - 4> send a measurement report with IEs set as below:
 - 5> set in "intra-frequency measurement event results": "Intrafrequency event identity" to "1c"; and

- 5> include in "cell measurement event results" all entries of the variable TRIGGERED_1C_EVENT with value of IE "sent report" equal to or smaller than value of "Amount of reporting" and that are not part of the active set as well as the "primary CPICH info" of all the primary CPICHs in the active set for which the measured value is worse (i.e. greater for pathloss and less for the other measurement quantities) than the one of the entry in "cell triggered" that has the best measured value, ordering the "primary CPICH info" according to their measured value beginning with the best cell to the worst one, taking into account the cell individual offset for each cell;
- 5> set the IE "measured results" and the IE "additional measured results" according to subclause 8.4.2, not taking into account the cell individual offset for each cell.
- 4> if "sent reports" in variable TRIGGERED_1C_EVENT is equal to "Amount of reporting" for all entries:
 - 5> set the IE "Periodical Reporting running" in the variable TRIGGERED_1C_EVENT to FALSE and disable the timer for the periodical reporting.
- 1> if "Measurement quantity" is "pathloss" and Equation 3 below is fulfilled for a primary CPICH, or if "Measurement quantity" is "CPICH Ec/N0" or "CPICH RSCP", and Equation 4 below is fulfilled for a primary CPICH or;
- 1> if a primary CPICH is added to the active set:
 - 2> if that primary CPICH is included in the "cells triggered" or "cells recently triggered" in the variable TRIGGERED_1C_EVENT:
 - 3> remove the entry of that primary CPICH from "cells triggered" or "cells recently triggered" in the variable TRIGGERED_1C_EVENT.
 - 3> if no entry in the variable TRIGGERED_1C_EVENT has a value of "sent reports" smaller than "Amount of reporting" or
 - 3> if there is no entry in the variable TRIGGERED_1C_EVENT:
 - 4> if the reporting interval timer is running:
 - 5> stop the reporting interval timer;
 - 5> set the IE "Periodical reporting running" in the variable TRIGGERED_1C_EVENT to FALSE.

Equation 1 (Triggering condition for pathloss)

$$10 \log M_{New} + CIO_{New} \leq 10 \log M_{mAS} + CIO_{mAS} - H_{lc} / 2$$

Equation 2 (Triggering condition for all the other measurement quantities)

$$10 \log M_{New} + CIO_{New} \geq 10 \log M_{mAS} + CIO_{mAS} + H_{lc} / 2$$

Equation 3 (Leaving triggering condition for pathloss)

$$10 \log M_{New} + CIO_{New} > 10 \log M_{mAS} + CIO_{mAS} + H_{lc} / 2$$

Equation 4 (Leaving triggering condition for all the other measurement quantities)

$$10 \log M_{New} + CIO_{New} < 10 \log M_{mAS} + CIO_{mAS} - H_{lc} / 2$$

The variables in the formula are defined as follows:

M_{New} is the measurement result of the cell not included in the active set.

CIO_{New} is the individual cell offset for the cell becoming better than the cell in the active set if an individual cell offset is stored for that cell. Otherwise it is equal to 0.

For pathloss:

M_{InAS} is the measurement result of the cell in the active set with the highest measurement result.

For other measurement quantities:

M_{InAS} is the measurement result of the cell in the active set with the lowest measurement result.

CIO_{InAS} is the individual cell offset for the cell in the active set that is becoming worse than the new cell.

H_{Ic} is the hysteresis parameter for the event 1c.

If the measurement results are pathloss or CPICH-Ec/No then M_{New} and M_{InAS} are expressed as ratios.

If the measurement result is CPICH-RSCP then M_{New} and M_{InAS} are expressed in mW.

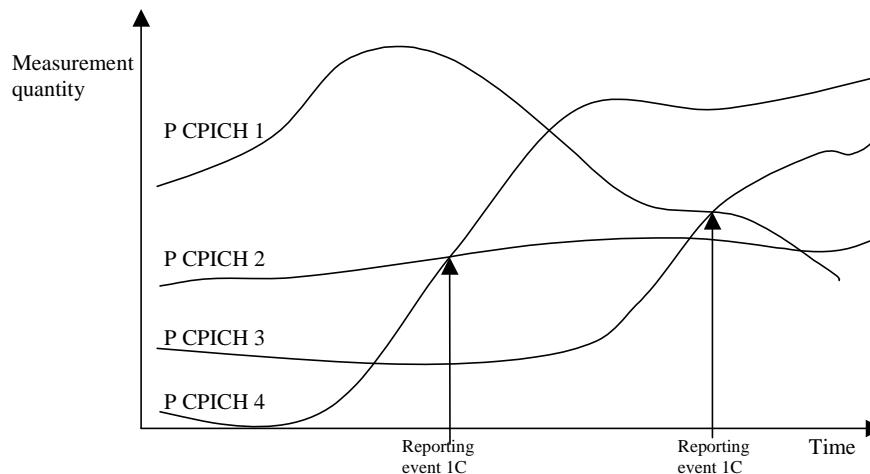

Figure 14.1.2.3-1 [Informative]: A primary CPICH that is not included in the active set becomes better than a primary CPICH that is in the active set

In this figure, the parameters hysteresis and time to trigger, as well as the cell individual offsets for all cells are equal to 0. In this example the cells belonging to primary CPICH 1 and 2 are in the active set, but the cells transmitting primary CPICH 3 and CPICH 4 are not (yet) in the active set.

The first measurement report is sent when primary CPICH 4 becomes better than primary CPICH 2. The "cell measurement event result" of the measurement report contains the information of primary CPICH 4 and CPICH 2.

Assuming that the active set has been updated after the first measurement report (active set is now primary CPICH 1 and primary CPICH 4), the second report is sent when primary CPICH 3 becomes better than primary CPICH 1. The "cell measurement event result" of the second measurement report contains the information of primary CPICH 3 and primary CPICH 1.

14.1.2.4 Reporting event 1D: Change of best cell

When an intra-frequency measurement configuring event 1d is set up, the UE shall:

- 1> create a variable TRIGGERED_1D_EVENT related to that measurement, which shall initially contain the best cell in the active set when the measurement is initiated;
- 1> delete this variable when the measurement is released.
- 1> As soon as the best cell in the active set has been evaluated by the UE (and stored in the TRIGGERED_1D_EVENT variable) and provided that there is more than one cell in the active set, trigger an immediate measurement report with IEs set as below:
 - 2> set in "intra-frequency measurement event results"; "Intrafrequency event identity" to "1d" and "cell measurement event results" to the CPICH info of the primary CPICH stored in the TRIGGERED_1D_EVENT variable;
 - 2> set the IE "measured results" and the IE "additional measured results" according to subclause 8.4.2

When event 1D is configured in the UE, the UE shall:

1> if IE "useCIO" is present and its value is TRUE, take into account the Cell Individual Offset for evaluation of the Equation 1 and 2, otherwise do not take it into account.

1> if "Measurement quantity" is "pathloss" and Equation 1 below is fulfilled for a primary CPICH that is not stored in "Best cell" in variable BEST_CELL_1D_EVENT, or if "Measurement quantity" is "CPICH Ec/No" or "CPICH RSCP", and Equation 2 below is fulfilled for a primary CPICH that is not stored in "Best cell" in variable BEST_CELL_1D_EVENT:

NOTE: If the equations are simultaneously fulfilled for more than one primary CPICH, the UE should report only one event 1D, triggered by the best primary CPICH.

2> if all required reporting quantities are available for that cell, and if the equations have been fulfilled for a time period indicated by "Time to trigger" and if IE "Triggering condition 2" is absent or if it is present and that primary CPICH is part of cells allowed to trigger the event according to "Triggering condition 2":

3> set "best cell" in the variable BEST_CELL_1D_EVENT to that primary CPICH that triggered the event;

3> send a measurement report with IEs set as below:

4> set in "intra-frequency measurement event results"; "Intrafrequency event identity" to "1d" and "cell measurement event results" to the CPICH info of the primary CPICH that triggered the report.

4> set the IE "measured results" and the IE "additional measured results" according to subclause 8.4.2.

This event is only applicable to the CELL_DCH state. Upon transition to CELL_DCH the UE shall:

1> set "best cell" in the variable BEST_CELL_1D_EVENT to the best cell of the primary CPICHs included in the active set.

Equation 1 (Triggering condition for pathloss)

$$10 \log M_{NotBest} + CIO_{NotBest} \leq 10 \log M_{Best} + CIO_{Best} - H_{1d} / 2$$

Equation 2 (Triggering condition for all the other measurement quantities)

$$10 \log M_{NotBest} + CIO_{NotBest} \geq 10 \log M_{Best} + CIO_{Best} + H_{1d} / 2$$

The variables in the formula are defined as follows:

$M_{NotBest}$ is the measurement result of a cell not stored in "best cell" in the variable BEST_CELL_1D_EVENT.

$CIO_{NotBest}$ is the cell individual offset of a cell not stored in "best cell" in the variable BEST_CELL_1D_EVENT.

M_{Best} is the measurement result of the cell stored in "best cell" in variable BEST_CELL_1D_EVENT.

CIO_{Best} is the cell individual offset of a cell stored in "best cell" in the variable BEST_CELL_1D_EVENT.

H_{1d} is the hysteresis parameter for the event 1d.

If the measurement results are pathloss or CPICH-Ec/No then $M_{NotBest}$ and M_{Best} are expressed as ratios.

If the measurement result is CPICH-RSCP then $M_{NotBest}$ and M_{Best} are expressed in mW.

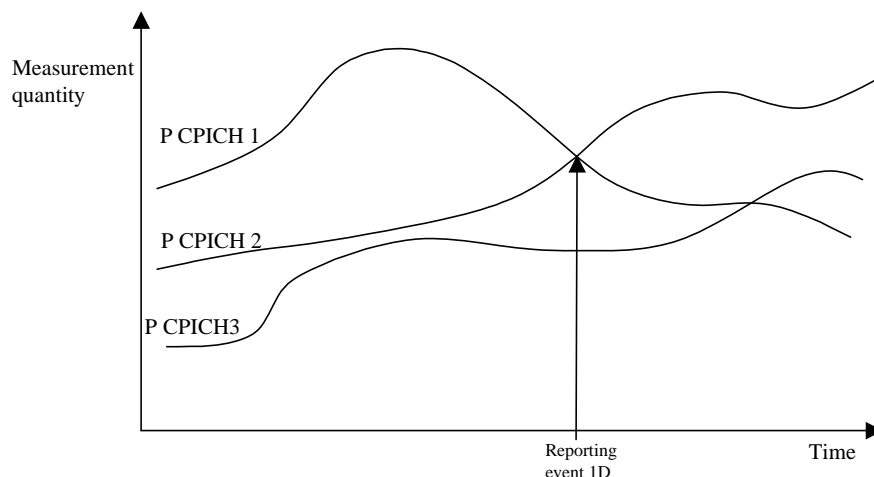

Figure 14.1.2.4-1 [Informative]: A primary CPICH becomes better than the previously best primary CPICH

In this figure, the parameters hysteresis and time to trigger, as well as the cell individual offsets for all cells are equal to 0.

14.1.2.5 Reporting event 1E: A Primary CPICH becomes better than an absolute threshold

When an intra-frequency measurement configuring event 1e is set up, the UE shall:

- 1> create a variable TRIGGERED_1E_EVENT related to that measurement, which shall initially be empty;
- 1> delete this variable when the measurement is released.

When event 1E is configured in the UE, the UE shall:

- 1> if "Measurement quantity" is "pathloss" and Equation 1 below is fulfilled for a primary CPICH, or if "Measurement quantity" is "CPICH E_c/N_0 " or "CPICH RSCP", and Equation 2 below is fulfilled for one or more primary CPICHs, for each of these primary CPICHs:
 - 2> if all required reporting quantities are available for that cell, and if the equations have been fulfilled for a time period indicated by "Time to trigger", and if that primary CPICH is part of cells allowed to trigger the event according to "Triggering condition 2", and that primary CPICH is not included in the "cells triggered" in the variable TRIGGERED_1E_EVENT:
 - 3> include that primary CPICH in the "cells recently triggered" in the variable TRIGGERED_1E_EVENT.
- 1> if any primary CPICHs are stored in the "cells recently triggered" in the variable TRIGGERED_1E_EVENT:
 - 2> send a measurement report with IEs set as below:
 - 3> set in "intra-frequency measurement event results": "Intrafrequency event identity" to "1e"; and
 - 3> include in "cell measurement event results" all entries of the "cells recently triggered" in the variable TRIGGERED_1E_EVENT in descending order according to the configured measurement quantity taking into account the cell individual offset for each of those cells;
 - 3> set the IE "measured results" and the IE "additional measured results" according to subclause 8.4.2, not taking into account the cell individual offset for each cell.
 - 2> move all entries from "cells recently triggered" to "cells triggered" in the variable TRIGGERED_1E_EVENT.
- 1> if "Measurement quantity" is "pathloss" and Equation 3 below is fulfilled for a primary CPICH, or if "Measurement quantity" is "CPICH E_c/N_0 " or "CPICH RSCP", and Equation 4 below is fulfilled for a primary CPICH; or

- 1> if a primary CPICH is no longer part of the cells allowed to trigger the event according to the "Triggering condition 2":
 - 2> if that primary CPICH is included in the "cells triggered" in the variable TRIGGERED_1E_EVENT:
 - 3> remove that primary CPICH and sent reports from "cells triggered" in the variable TRIGGERED_1E_EVENT.

This event is only applicable to the CELL_DCH state. When the measurement is setup in CELL_DCH or upon transition to CELL_DCH the UE shall:

- 1> if the "Triggering condition 2" includes active set cells:
 - 2> include the primary CPICH of all cells in the current active set that fulfil the equations 1 or 2 according to the "Measurement quantity" of event 1e into the "cells triggered" in the variable TRIGGERED_1E_EVENT.

Equation 1 (Triggering condition for pathloss)

$$10 \text{Log}M_{New} + CIO_{New} \leq T_{1e} - H_{1e} / 2,$$

Equation 2 (Triggering condition for all the other measurement quantities)

$$10 \text{Log}M_{New} + CIO_{New} \geq T_{1e} + H_{1e} / 2,$$

Equation 3 (Leaving triggering condition for pathloss)

$$10 \text{Log}M_{New} + CIO_{New} > T_{1e} + H_{1e} / 2,$$

Equation 4 (Leaving triggering condition for all the other measurement quantities)

$$10 \text{Log}M_{New} + CIO_{New} < T_{1e} - H_{1e} / 2,$$

The variables in the formula are defined as follows:

M_{New} is the measurement result of a cell that becomes better than an absolute threshold.

CIO_{New} is the individual cell offset for the cell becoming better than the absolute threshold. Otherwise it is equal to 0.

T_{1e} is an absolute threshold.

H_{1e} is the hysteresis parameter for the event 1e.

If the measurement results are pathloss or CPICH-Ec/No then M_{New} is expressed as ratios.

If the measurement result is CPICH-RSCP then M_{New} is expressed in mW.

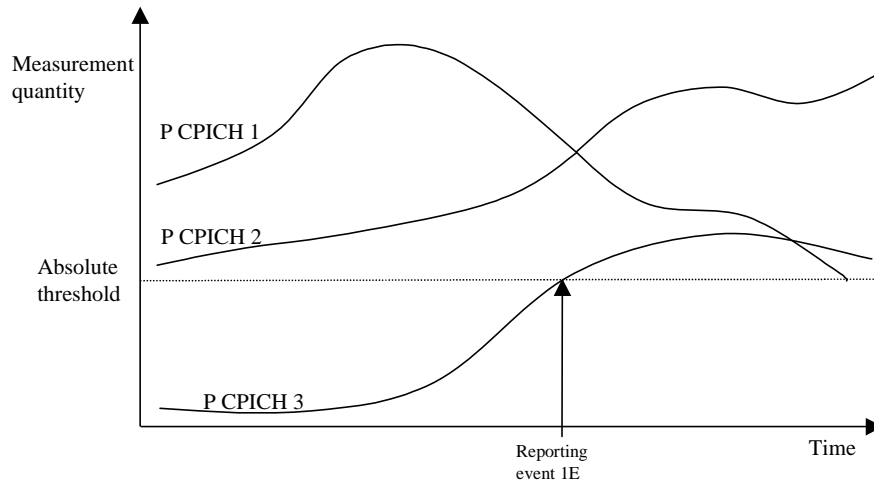

Figure 14.1.2.5-1 [Informative]: Event-triggered report when a Primary CPICH becomes better than an absolute threshold

In this figure, the parameters hysteresis and time to trigger, as well as the cell individual offsets for all cells are equal to 0.

14.1.2.6 Reporting event 1F: A Primary CPICH becomes worse than an absolute threshold

When an intra-frequency measurement configuring event 1F is set up, the UE shall:

- 1> create a variable TRIGGERED_1F_EVENT related to that measurement, which shall initially be empty;
- 1> delete this variable when the measurement is released.

When event 1F is configured in the UE, the UE shall:

- 1> if "Measurement quantity" is "pathloss" and Equation 1 below is fulfilled for one or more primary CPICHs, or if "Measurement quantity" is "CPICH Ec/N0" or "CPICH RSCP", and Equation 2 below is fulfilled for one or more primary CPICHs, for each of these primary CPICHs:
 - 2> if all required reporting quantities are available for that cell, and if the equations have been fulfilled for a time period indicated by "Time to trigger", and if that primary CPICH is part of cells allowed to trigger the event according to "Triggering condition 1", and that primary CPICH is not included in the "cells triggered" in the variable TRIGGERED_1F_EVENT:
 - 3> include that primary CPICH in the "cells recently triggered" in the variable TRIGGERED_1F_EVENT.
- 1> if any primary CPICHs are stored in the "cells recently triggered" in the variable TRIGGERED_1F_EVENT:
 - 2> send a measurement report with IEs set as below:
 - 3> set in "intra-frequency event measurement results": "Intrafrequency event identity" to "1f"; and
 - 3> include in "cell measurement event results" all entries of the "cells recently triggered" in the variable TRIGGERED_1F_EVENT in descending order according to the configured measurement quantity taking into account the cell individual offset for each of those cells;
 - 3> set the IE "measured results" and the IE "additional measured results" according to subclause 8.4.2, not taking into account the cell individual offset for each cell;
 - 2> move all entries from "cells recently triggered" to "cells triggered" in the variable TRIGGERED_1F_EVENT.
- 1> if "Measurement quantity" is "pathloss" and Equation 3 below is fulfilled for a primary CPICH, or if "Measurement quantity" is "CPICH Ec/N0" or "CPICH RSCP", and Equation 4 below is fulfilled for a primary CPICH; or

- 1> if a primary CPICH is no longer part of the cells allowed to trigger the event according to the "Triggering condition 1":
- 2> if that primary CPICH is included in the "cells triggered" in the variable TRIGGERED_1F_EVENT:
- 3> remove that primary CPICH from "cells triggered" in the variable TRIGGERED_1F_EVENT.

Equation 1 (Triggering condition for pathloss)

$$10 \text{Log}M_{Old} + CIO_{Old} \geq T_{I_f} + H_{I_f}/2$$

Equation 2 (Triggering condition for all the other measurement quantities)

$$10 \text{Log}M_{Old} + CIO_{Old} \leq T_{I_f} - H_{I_f}/2$$

Equation 3 (Leaving triggering condition for pathloss)

$$10 \text{Log}M_{Old} + CIO_{Old} < T_{I_f} - H_{I_f}/2$$

Equation 4 (Leaving triggering condition for all the other measurement quantities)

$$10 \text{Log}M_{Old} + CIO_{Old} > T_{I_f} + H_{I_f}/2$$

The variables in the formula are defined as follows:

M_{Old} is the measurement result of a cell that becomes worse than an absolute threshold

CIO_{Old} is the individual cell offset for the cell becoming worse than the absolute threshold. Otherwise it is equal to 0.

T_{I_f} is an absolute threshold

H_{I_f} is the hysteresis parameter for the event 1f.

If the measurement results are pathloss or CPICH-Ec/No then M_{Old} is expressed as ratios.

If the measurement result is CPICH-RSCP then M_{Old} is expressed in mW.

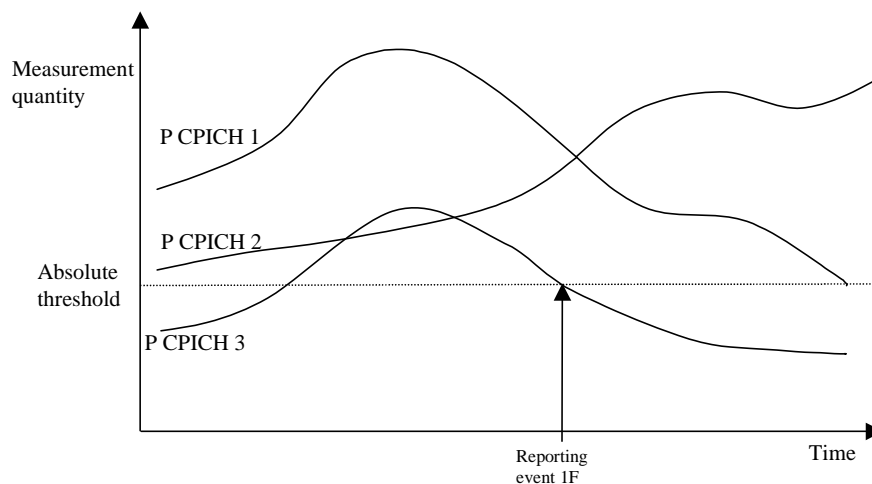

Figure 14.1.2.6-1 [Informative]: Event-triggered report when a Primary CPICH becomes worse than an absolute threshold

In this figure, the parameters hysteresis and time to trigger, as well as the cell individual offsets for all cells are equal to 0.

14.1.2.7 Reporting event 1J: A non-active E-DCH but active DCH primary CPICH becomes better than an active E-DCH primary CPICH

When an intra-frequency measurement configuring event 1j is set up, the UE shall:

- 1> create a variable TRIGGERED_1J_EVENT related to that measurement, which shall initially be empty;
- 1> delete this variable when the measurement is released.

When event 1J is configured in the UE, the UE shall:

- 1> if "Measurement quantity" is "pathloss" and Equation 1 below is fulfilled for one or more primary CPICHs, or if "Measurement quantity" is "CPICH Ec/N0" or "CPICH RSCP", and Equation 2 below is fulfilled for one or more primary CPICHs, for each of these primary CPICHs:
 - 2> if all required reporting quantities are available for that cell; and
 - 2> if the equations have been fulfilled for a time period indicated by "Time to trigger", and if the primary CPICH that is better is not included in the E-DCH active set but included in DCH active set and the other primary CPICH is any of the primary CPICHs included in the E-DCH active set, and if that first primary CPICH is not included in the "cells triggered" in the variable TRIGGERED_1J_EVENT:
 - 3> include that primary CPICH in the "cells recently triggered" in the variable TRIGGERED_1J_EVENT.
- 1> if the value of "Replacement activation threshold" for this event is less than or equal to the current number of cells in the E-DCH active set or equal to 0 and if any primary CPICHs are stored in the "cells recently triggered" in the variable TRIGGERED_1J_EVENT:
 - 2> if "Reporting interval" for this event is not equal to 0:
 - 3> if the IE "Periodical reporting running" in the variable TRIGGERED_1J_EVENT is set to FALSE:
 - 4> start a timer for with the value of "Reporting interval" for this event and set the IE "Periodical reporting running" in the variable TRIGGERED_1J_EVENT to TRUE.
 - 3> set "sent reports" for that primary CPICH in the variable TRIGGERED_1J_EVENT to 1.
 - 2> send a measurement report with IEs set as below:
 - 3> set in "intra-frequency measurement event results": "Intrafrequency event identity" to "1J"; and
 - 3> include in "cell measurement event results" all entries of the "cells recently triggered" in the variable TRIGGERED_1J_EVENT not in the E-DCH active set but included in DCH active set as well as the "primary CPICH info" of all the primary CPICHs in the E-DCH active set for which the measured value is worse (i.e. greater for pathloss and less for the other measurement quantities) than the one of the entry in "cell recently triggered" that has the best measured value taking into account their cell individual offset. The "primary CPICH info" for those cells shall be ordered according to their measured value taking into account their cell individual offset, beginning with the best cell to the worst one;
 - 3> set the IE "measured results" and the IE "additional measured results" according to subclause 8.4.2, not taking into account the cell individual offset for each cell.
 - 2> move all entries from "cells recently triggered" to "cells triggered" in the variable TRIGGERED_1J_EVENT.
- 1> if the timer for the periodical reporting has expired:
 - 2> if any primary CPICH is included in the "cells triggered" in the variable TRIGGERED_1J_EVENT, and not included in the current E-DCH active set but included in DCH active set:
 - 3> if "Reporting interval" for this event is not equal to 0, and if "Amount of reporting" is greater than "sent reports" stored for that primary CPICH, in "cells triggered" in the variable TRIGGERED_1J_EVENT:
 - 4> increment the stored counter "sent reports" for all CPICH in "cell triggered" in variable TRIGGERED_1J_EVENT;
 - 4> start a timer with the value of "Reporting interval" for this event;

- 4> send a measurement report with IEs set as below:
 - 5> set in "intra-frequency measurement event results": "Intrafrequency event identity" to "1J"; and
 - 5> include in "cell measurement event results" all entries of the variable TRIGGERED_1J_EVENT with value of IE "sent reports" equal to or smaller than value of "Amount of reporting" and that are not part of the E-DCH active set but included in DCH active set as well as the "primary CPICH info" of all the primary CPICHs in the E-DCH active set for which the measured value is worse (i.e. greater for pathloss and less for the other measurement quantities) than the one of the entry in "cell triggered" that has the best measured value, ordering the "primary CPICH info" according to their measured value beginning with the best cell to the worst one, taking into account the cell individual offset for each cell;
 - 5> set the IE "measured results" and the IE "additional measured results" according to subclause 8.4.2, not taking into account the cell individual offset for each cell.
- 4> if "sent reports" in variable TRIGGERED_1J_EVENT is equal to "Amount of reporting" for all entries:
 - 5> set the IE "Periodical Reporting running" in the variable TRIGGERED_1J_EVENT to FALSE and disable the timer for the periodical reporting.
- 1> if "Measurement quantity" is "pathloss" and Equation 3 below is fulfilled for a primary CPICH, or if "Measurement quantity" is "CPICH Ec/N0" or "CPICH RSCP", and Equation 4 below is fulfilled for a primary CPICH or;
 - 1> if a primary CPICH is added to the E-DCH active set:
 - 2> if that primary CPICH is included in the "cells triggered" or "cells recently triggered" in the variable TRIGGERED_1J_EVENT:
 - 3> remove the entry of that primary CPICH from "cells triggered" or "cells recently triggered" in the variable TRIGGERED_1J_EVENT.
 - 3> if no entry in the variable TRIGGERED_1J_EVENT has a value of "sent reports" smaller than "Amount of reporting" or
 - 3> if there is no entry in the variable TRIGGERED_1J_EVENT:
 - 4> if the reporting interval timer is running:
 - 5> stop the reporting interval timer;
 - 5> set the IE "Periodical reporting running" in the variable TRIGGERED_1J_EVENT to FALSE.

Equation 1 (Triggering condition for pathloss)

$$10 \log M_{New} + CIQ_{New} \leq 10 \log M_{InAS} + CIQ_{InAS} - H_{1j} / 2$$

Equation 2 (Triggering condition for all the other measurement quantities)

$$10 \log M_{New} + CIQ_{New} \geq 10 \log M_{InAS} + CIQ_{InAS} + H_{1j} / 2$$

Equation 3 (Leaving triggering condition for pathloss)

$$10 \log M_{New} + CIQ_{New} > 10 \log M_{InAS} + CIQ_{InAS} + H_{1j} / 2$$

Equation 4 (Leaving triggering condition for all the other measurement quantities)

$$10 \log M_{New} + CIQ_{New} < 10 \log M_{InAS} + CIQ_{InAS} - H_{1j} / 2$$

The variables in the formula are defined as follows:

M_{New} is the measurement result of the cell not included in the E-DCH active set but included in DCH active set.

CIO_{New} is the individual cell offset for the cell not included in the E-DCH active set but included in DCH active set becoming better than the cell in the E-DCH active set if an individual cell offset is stored for that cell. Otherwise it is equal to 0.

For pathloss:

M_{InAS} is the measurement result of the cell in the E-DCH active set with the highest measurement result.

For other measurement quantities:

M_{InAS} is the measurement result of the cell in the E-DCH active set with the lowest measurement result.

CIO_{InAS} is the individual cell offset for the cell in the E-DCH active set that is becoming worse than the new cell.

H_{IJ} is the hysteresis parameter for the event 1J.

If the measurement results are pathloss or CPICH-Ec/No then M_{New} and M_{inAS} are expressed as ratios.

If the measurement result is CPICH-RSCP then M_{New} and M_{inAS} are expressed in mW.

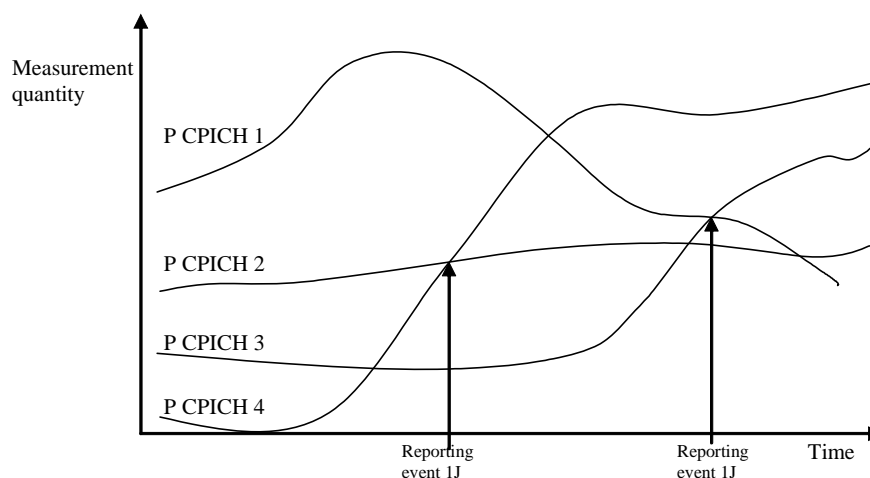

Figure 14.1.2.7-1 [Informative]: A primary CPICH that is not included in the E-DCH active set but included in DCH active set becomes better than a primary CPICH that is in the E-DCH active set

In this figure, the parameters hysteresis and time to trigger, as well as the cell individual offsets for all cells are equal to 0 and replacement activation threshold is equal to 0 or 1 or 2. In this example the cells belonging to primary CPICH 1 and 2 are in the E-DCH active set, but the cells transmitting primary CPICH 3 and CPICH 4 are not (yet) in the E-DCH active set but included in DCH active set.

The first measurement report is sent when primary CPICH 4 becomes better than primary CPICH 2. The "cell measurement event result" of the measurement report contains the information of primary CPICH 4 and CPICH 2.

Assuming that the E-DCH active set has been updated after the first measurement report (E-DCH active set is now primary CPICH 1 and primary CPICH 4), the second report is sent when primary CPICH 3 becomes better than primary CPICH 1. The "cell measurement event result" of the second measurement report contains the information of primary CPICH 3 and primary CPICH 1.

14.1.3 Intra-frequency reporting events for TDD

14.1.3.1 Reporting event 1G: Change of best cell (TDD)

When an intra-frequency measurement configuring event 1g is set up, the UE shall

- 1> create a variable TRIGGERED_1G_EVENT related to that measurement, which shall initially be empty.
- 1> store the P-CCPCH of the serving cell in the variable TRIGGERED_1G_EVENT as the best cell .
- 1> delete this variable when the measurement is released.

When event 1G is configured in the UE, the UE shall:

- 1> if the equation 1 is fulfilled for one or more P-CCPCHs during the time "Time to trigger"
 - 2> if those P-CCPCHs are not included in the "primary CCPCH info" in the variable TRIGGERED_1G_EVENT:
 - 3> include those P-CCPCH in "cells triggered" in the variable TRIGGERED_1G_EVENT;
 - 2> update the prebest cell to the best P-CCPCH and for each cell in the variable TRIGGERED_1G_EVENT:
 - 3> if Equation 2 below is fulfilled for a primary CCPCH:
 - 4> remove the entry of that primary CCPCH from "cells triggered" in the variable TRIGGERED_1G_EVENT;
 - 2> send a measurement report with IEs set as below:
 - 3> set in "intra-frequency measurement event results": "Intrafrequency event identity" to "1g";
 - 3> set the first entry in "cell measurement event results" to the "Cell parameters ID" of the P-CCPCH which was stored in the variable TRIGGERED_1G_EVENT;
 - 3> include all entries in "cells triggered" in variable TRIGGERED_1G_EVENT in "cell measurement event results" in the measurement report in descending order according to:

$$10 \cdot \text{Log}M + O$$

where M is the P-CCPCH RSCP and O the individual offset of a cell;

- 3> set the IE "measured results" and the IE "additional measured results" according to subclause 8.4.2, not taking into account the cell individual offset for each cell.
- 1> if Equation 2 below is fulfilled for a primary CCPCH:
 - 2> if a primary CCPCH is included in the "cells triggered" in the variable TRIGGERED_1G_EVENT:
 - 3> remove the entry of that primary CCPCH from "cells triggered" in the variable TRIGGERED_1G_EVENT;

The UE shall use the equations below for evaluation of reporting event 1g:

Equation 1

$$10 \cdot \text{Log}M_i + O_i - H_{1g} > 10 \cdot \text{Log}M_{\text{previous_best}} + O_{\text{previous_best}}$$

The variables in the formula are defined as follows:

$M_{\text{previous_best}}$ is the current P-CCPCH RSCP of the previous best cell expressed in mW

$O_{\text{previous_best}}$ is the cell individual offset of the previous best cell

M_i is the current P-CCPCH RSCP of the currently evaluated cell i expressed in mW

O_i is the cell individual offset of the currently evaluated cell i

H_{1g} is the hysteresis parameter for the event 1g.

Equation 2

$$10 \cdot \text{Log}M_i + O_i + H_{1g} < 10 \cdot \text{Log}M_{\text{previous_best}} + O_{\text{previous_best}}$$

The variables in the formula are defined as follows:

$M_{\text{previous_best}}$ is the current P-CCPCH RSCP of the previous best cell expressed in mW

$O_{\text{previous_best}}$ is the cell individual offset of the previous best cell

M_i is the current P-CCPCH RSCP of the currently evaluated cell i expressed in mW

O_i is the cell individual offset of the currently evaluated cell i

H_{I_g} is the hysteresis parameter for the event 1g.

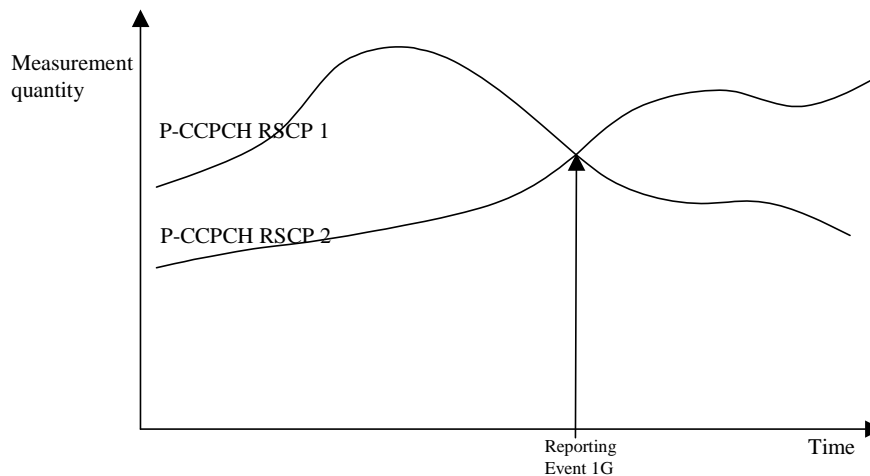

Figure 14.1.3.1-1: A P-CCPCH RSCP becomes better than the previous best P-CCPCH RSCP

14.1.3.2 Reporting event 1H: Timeslot ISCP below a certain threshold (TDD)

When an intra-frequency measurement configuring event 1h is set up, the UE shall:

- 1> create a variable TRIGGERED_1H_EVENT related to that measurement, which shall initially be empty;
- 1> delete this variable when the measurement is released.

When event 1h is configured in the UE, the UE shall:

- 1> if equation 1 is fulfilled for a time period indicated by "Time to trigger" and if that P-CCPCH is not included in the IE "cells triggered" in the variable TRIGGERED_1H_EVENT:
 - 2> include that P-CCPCH in the IE "cells triggered" in the variable TRIGGERED_1H_EVENT;
 - 2> send a measurement report with the IEs set as below:
 - 3> set in "intra-frequency measurement event results": "Intrafrequency event identity" to "1h" and in "cell measurement event results" the "Cell parameters ID" of the P-CCPCH that triggered the report;
 - 3> include in "Cell measured results" the "Timeslot ISCP" of those cells that are included in the variable TRIGGERED_1H_EVENT and "additional measured results" according to subclause 8.4.2, not taking into account the cell individual offset for each cell.
- 1> if Equation 2 below is fulfilled for a primary CCPCH:
 - 2> if a primary CCPCH is included in the "cells triggered" in the variable TRIGGERED_1H_EVENT:
 - 3> remove the entry of that primary CCPCH from "cells triggered" in the variable TRIGGERED_1H_EVENT.

The UE shall use the equations below for evaluation of reporting event 1h:

Equation 1

$$10 \cdot \text{Log}M_i + H_{1h} + O_i < T_{1h},$$

Equation 2

$$10 \cdot \text{Log}M_i - H_{1h} + O_i > T_{1h},$$

The variables in the formula are defined as follows:

M_i is the Timeslot ISCP of the currently evaluated cell i expressed in mW

O_i is the cell individual offset of the currently evaluated cell i

T_{1h} is the Threshold for event 1h

H_{1h} is the hysteresis parameter for the event 1h.

Before any evaluation is done, the Timeslot ISCP expressed in mW is filtered according to subclause 8.6.7.2.

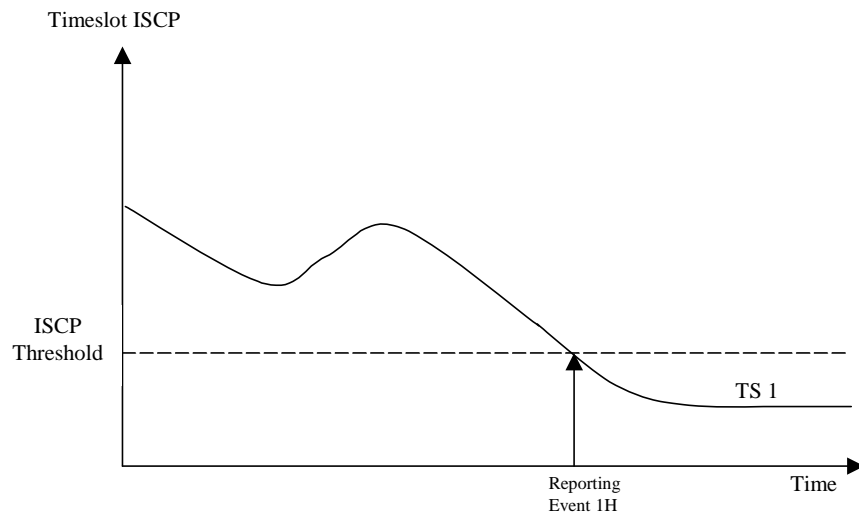

Figure 14.1.3.2-1: An ISCP value of a timeslot drops below an absolute threshold

14.1.3.3 Reporting event 1i: Timeslot ISCP above a certain threshold (TDD)

When an intra-frequency measurement configuring event 1i is set up, the UE shall:

- 1> create a variable TRIGGERED_1I_EVENT related to that measurement, which shall initially be empty;
- 1> delete this variable when the measurement is released.

When event 1i is configured in the UE, the UE shall:

- 1> if equation 1 is fulfilled for a time period indicated by "Time to trigger" and if that P-CCPCH is not included in the IE "cells triggered" in the variable TRIGGERED_1I_EVENT:
 - 2> include that P-CCPCH in the IE "cells triggered" in the variable TRIGGERED_1I_EVENT;
 - 2> send a measurement report with the IEs set as below:
 - 3> set in "intra-frequency measurement event results": "Intrafrequency event identity" to "1i" and in "cell measurement event results" to the "Cell parameters ID" of the P-CCPCH that triggered the report;
 - 3> include in "measured results" the "Timeslot ISCP" of those cells that are included in the variable TRIGGERED_1I_EVENT and "additional measured results" according to 8.4.2, not taking into account the cell individual offset for each cell.
- 1> if Equation 2 below is fulfilled for a primary CCPCH:
 - 2> if a primary CCPCH is included in the "cells triggered" in the variable TRIGGERED_1I_EVENT:
 - 3> remove the entry of that primary CCPCH from "cells triggered" in the variable TRIGGERED_1I_EVENT.

The UE shall use the equation below for evaluation of reporting event 1i:

Equation 1

$$10 \cdot \text{Log}M_i - H_{1i} + O_i > T_{1i},$$

Equation 2

$$10 \cdot \text{Log}M_i - H_{1i} + O_i < T_{1i},$$

The variables in the formula are defined as follows:

M_i is the Timeslot ISCP of the currently evaluated cell i expressed in mW

O_i is the cell individual offset of the currently evaluated cell i

T_{1i} is the Threshold for event 1i

H_{1i} is the hysteresis parameter for the event 1i.

Before any evaluation is done, the Timeslot ISCP expressed in mW is filtered according to subclause 8.6.7.2.

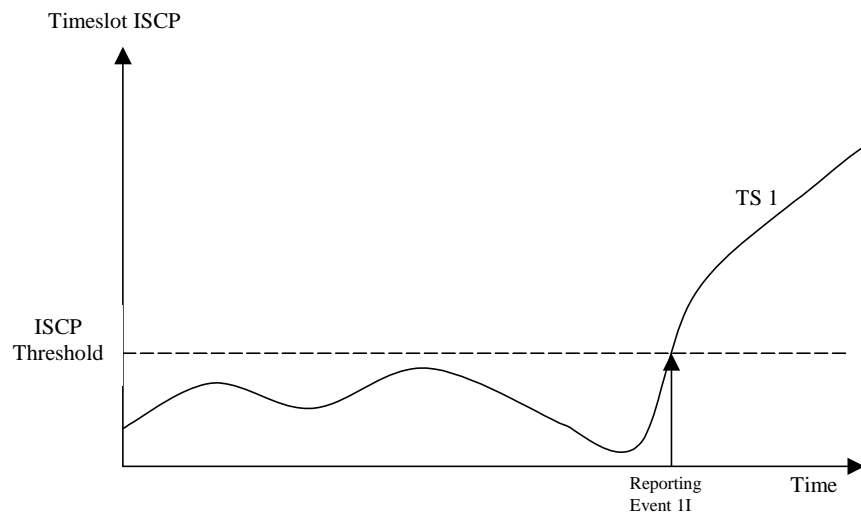

Figure 14.1.3.3-1: An ISCP value of a timeslot exceeds a certain threshold

14.1.4 Event-triggered periodic intra-frequency measurement reports (informative)

14.1.4.1 Cell addition failure (FDD only)

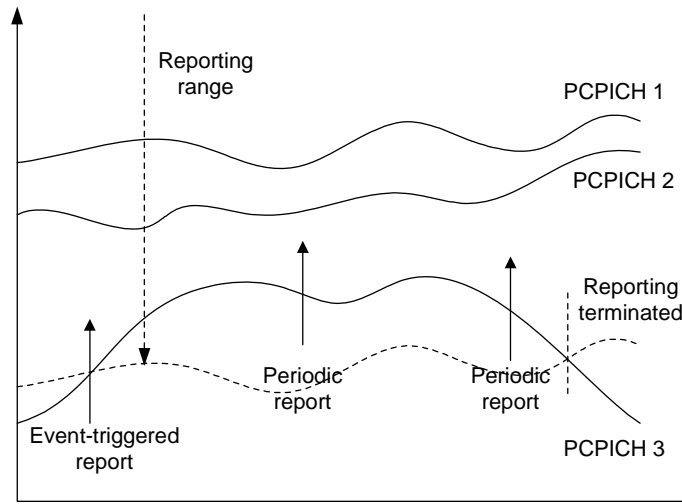

Figure 14.1.4.1-1: Periodic reporting triggered by event 1A

When a cell enters the reporting range and triggers event 1A, the UE shall transmit a MEASUREMENT REPORT to the UTRAN and typically this may result in an update of the active set. However, in some situations the UTRAN may be unable to add a strong cell to the active set typically due to capacity shortage for example.

The UE shall continue reporting after the initial report by reverting to periodical measurement reporting if the reported cell is not added to the active set. This is illustrated in Figure 14.1.4.1-1. During periodic reporting the UE shall transmit MEASUREMENT REPORT messages to the UTRAN at predefined intervals. The reports shall include reporting information of the cells in the current active set and of the monitored cell(s) in the reporting range.

Event-triggered periodic measurement reporting shall be terminated if:

- 1> there are no longer any monitored cell(s) within the reporting range; or
- 1> the UTRAN has added cells to the active set so that it includes the maximum number of cells (defined by the **reporting deactivation threshold** parameter), which are allowed for event 1A to be triggered; or
- 1> the UE has sent the maximum number of MEASUREMENT REPORT messages (defined by the **amount of reporting** parameter).

The reporting period is assigned by the UTRAN (with the **Reporting interval** parameter). If the reporting interval is set to zero event-triggered periodic measurement reporting shall not be applied.

14.1.4.1a Cell removal failure (FDD only)

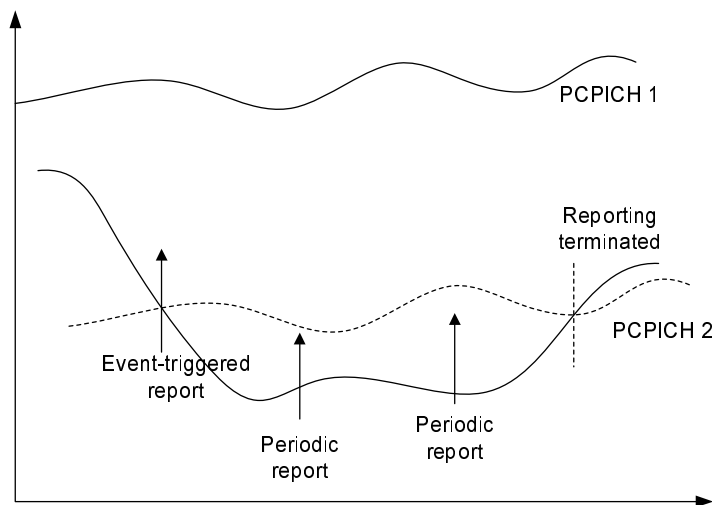

Figure 14.1.4.1a: Periodic reporting triggered by event 1B

When a cell enters the removal range and triggers event 1B, the UE shall transmit a MEASUREMENT REPORT to the UTRAN and typically this may result in the removal of the weakest active cell. If the UTRAN is unable to receive MEASUREMENT REPORT after the maximum retransmission, it is beneficial to receive continuous reports in this case as well.

The UE shall revert to periodical measurement reporting if the UTRAN does not update the active set after the transmission of the measurement report. This is illustrated in Figure 14.1.4.1a. During periodic reporting the UE shall transmit MEASUREMENT REPORT messages to the UTRAN at predefined intervals.

Event-triggered periodic measurement reporting shall be terminated if:

- 1> there are no longer any monitored cell(s) within the removal range; or
- 1> the UTRAN has removed cells from the active set so that there are no longer the minimum amount of active cells for event 1B to be triggered; or
- 1> the UE has sent the maximum number of MEASUREMENT REPORT messages (defined by the "amount of reporting" parameter).

The reporting period is assigned by the UTRAN (with the "Reporting interval" parameter). If the reporting interval is set to zero, event-triggered periodic measurement reporting shall not be applied.

14.1.4.2 Cell replacement failure (FDD only)

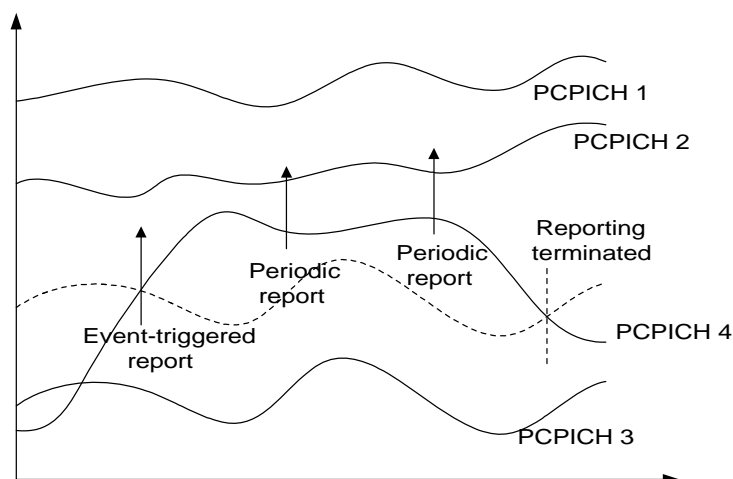

Figure 14.1.4.1-2: Periodic reporting triggered by event 1C

When a cell enters the replacement range and triggers event 1C, the UE shall transmit a MEASUREMENT REPORT to the UTRAN and typically this may result in the replacement of the weakest active cell. If the UTRAN is unable to replace the cell due to for example capacity shortage, it is beneficial to receive continuous reports in this case as well.

The UE shall revert to periodical measurement reporting if the UTRAN does not update the active set after the transmission of the measurement report. This is illustrated in Figure 14.1.4.1-2. During periodic reporting the UE shall transmit MEASUREMENT REPORT messages to the UTRAN at predefined intervals. The reports shall include reporting information of the cells in the current active set and of the monitored cell(s) in the replacement range.

Event-triggered periodic measurement reporting shall be terminated if:

- 1> there are no longer any monitored cell(s) within the replacement range; or
- 1> the UTRAN has removed cells from the active set so that there are no longer the minimum amount of active cells for event 1C to be triggered (as defined by the **replacement activation threshold** parameter); or
- 1> the UE has sent the maximum number of MEASUREMENT REPORT messages (defined by the **amount of reporting** parameter).

The reporting period is assigned by the UTRAN (with the **Reporting interval** parameter). If the reporting interval is set to zero, event-triggered periodic measurement reporting shall not be applied.

14.1.5 Mechanisms available for modifying intra-frequency measurement reporting behaviour (informative)

14.1.5.1 Hysteresis

To limit the amount of event-triggered reports, a hysteresis parameter may be connected with each reporting event given above. The value of the hysteresis is given to the UE in the Reporting criteria field of the Measurement Control message.

In the example in Figure 14.1.5.1-1, the hysteresis ensures that the event 1D (FDD) or IG(TDD) (primary CPICH(FDD)/CCPCH(TDD) 2 becomes the best cell) is not reported until the difference is equal to the hysteresis value. The fact that primary CPICH(FDD)/CCPCH(TDD) 1 becomes best afterwards is not reported at all in the example since the primary CPICH(FDD)/CCPCH(TDD) 1 does not become sufficiently better than the primary CPICH(FDD)/CCPCH(TDD) 2.

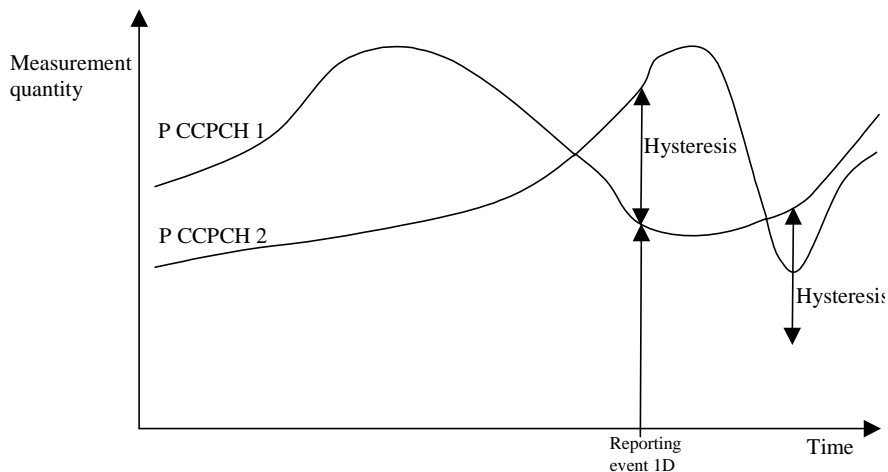

Figure 14.1.5.1-1: Hysteresis limits the amount of measurement reports

14.1.5.2 Time-to-trigger

To limit the measurement signalling load, a time-to-trigger parameter could be connected with each reporting event given above. The value of the time-to-trigger is given to the UE in the Reporting criteria field of the Measurement Control message.

The effect of the time-to-trigger is that the report is triggered only after the conditions for the event have existed for the specified time-to-trigger. In the following FDD example in Figure 14.1.5.2-1, the use of time-to-trigger means that the event (primary CPICH 3 enters the reporting range) is not reported until it has been within the range for the time given by the time-to-trigger parameter.

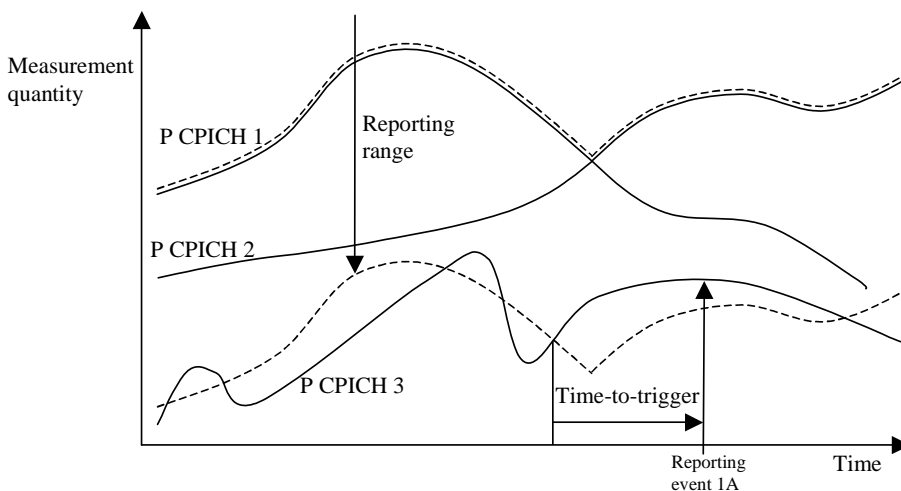

Figure 14.1.5.2-1: Time-to-trigger limits the amount of measurement reports

In the following TDD example in Figure 14.1.5.2-2, the use of time-to-trigger means that the event (Timeslot ISCP upon certain threshold) is not reported until it has been upon the threshold for the time given by the time-to trigger parameter.

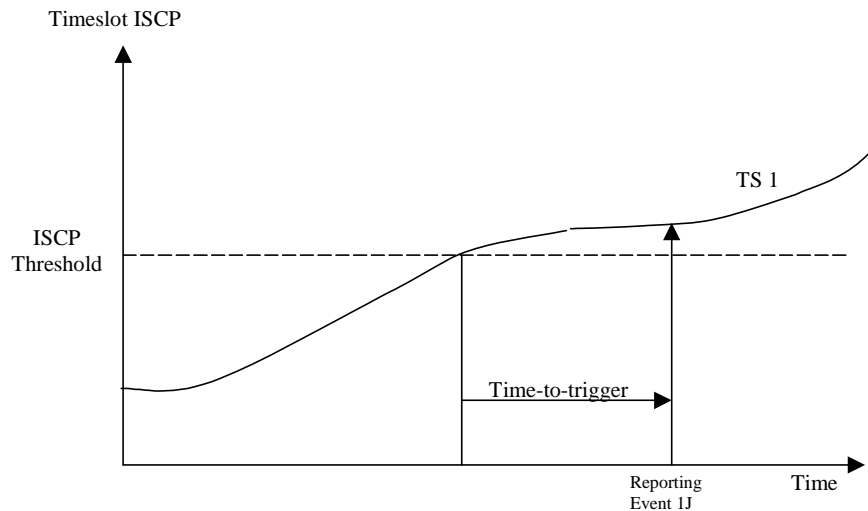

Figure 14.1.5.2-2: Time-to-trigger limits the amount of measurement reports

NOTE: The time-to-trigger could be combined with hysteresis, i.e. a hysteresis value is added to the measurement quantity before evaluating if the time-to-trigger timer should be started.

14.1.5.3 Cell individual offsets

For each cell that is monitored, an offset can be assigned with inband signalling. The offset can be either positive or negative. The offset is added to the measurement quantity before the UE evaluates if an event has occurred. The UE receives the cell individual offsets for each primary CPICH(FDD)/CCPCH(TDD) in the IE "Cell individual offset" included in the IE "Cell info" associated with each measurement object included in the MEASUREMENT CONTROL message.

For the FDD example, in Figure 14.1.5.3-1, since an offset is added to primary CPICH 3, it is the dotted curve that is used to evaluate if an event occurs. Hence, this means that measurement reports from UE to UTRAN are triggered when primary CPICH plus the corresponding offset, i.e. the dotted curve, leaves and enters the reporting range and when it gets better than primary CPICH 1 (if these events have been ordered by UTRAN). This offset mechanism provides the network with an efficient tool to change the reporting of an individual primary CPICH.

By applying a positive offset, as in Figure 14.1.5.3-1, the UE will send measurement reports as if the primary CPICH is offset x dB better than what it really is. This could be useful if the operator knows that a specific cell is interesting to monitor more carefully, even though it is not so good for the moment. In the example in Figure 14.1.5.3-1, the operator might know by experience that in this area primary CPICH 3 can become good very quickly (e.g. due to street corners) and therefore that it is worth reporting more intensively. Depending on the implemented handover evaluation algorithm, this may result in the cell with primary CPICH 3 being included in the active set earlier than would have been the case without the positive offset.

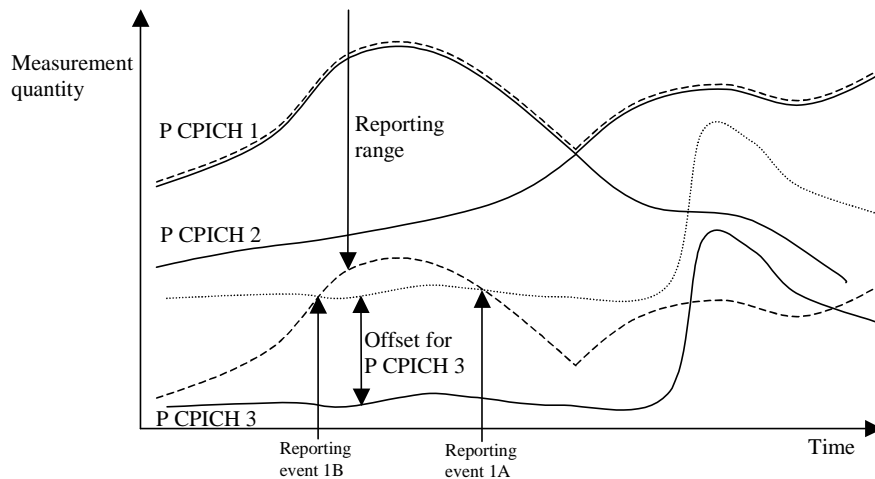

Figure 14.1.5.3-1: A positive offset is applied to primary CPICH 3 before event evaluation in the UE

For the TDD example, in Figure 14.1.5.3-2, an offset is added to primary CCPCH2, it is the dotted curve that is used to evaluate if the primary CCPCH2 becomes better than primary CCPCH1 (ordered by the UTRAN).

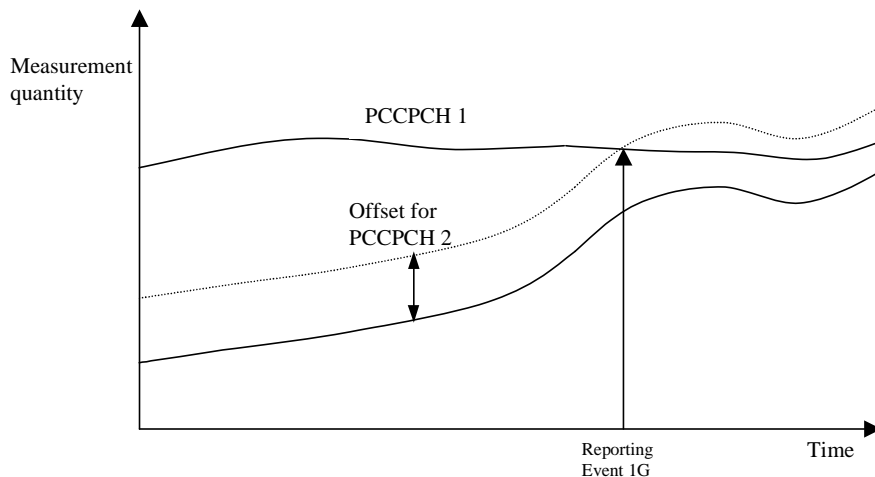

Figure 14.1.5.3-2: A positive offset is applied to primary CCPCH 2

Correspondingly, the operator can choose to apply a negative offset to a primary CCPCH. Then the reporting on that primary CCPCH is limited and the corresponding cell may be, at least temporarily excluded from the active set or as a target cell for handover.

It is important to note that the offset is added before triggering events, i.e. the offset is added by the UE before evaluating if a measurement report should be sent as opposed to offsets that are applied in the network and used for the actual handover evaluation. It should also be noted that the cell individual offset is not used in all measurement reporting events, and that it is not applied to all events in the same way.

14.1.5.4 Forbid a Primary CPICH to affect the reporting range (FDD only)

The reporting range affects the reporting events 1A and 1B presented above. The reporting range is defined as a function of all the Primary CPICHs in the active set (see 14.1.2.1 and 14.1.2.2). If the parameter *W* is set to 0, the reporting range is defined relative to the best Primary CPICH. However, there could be cases where it is good to forbid a specific Primary CPICH to affect the reporting range. For example in Figure 14.1.5.4-1 the network has requested the UE to not let Primary CPICH 3 affect the reporting range. This mechanism could be effective if the operator knows by experience that the quality of Primary CPICH 3 is very unstable in a specific area and therefore should not affect the reporting of the other Primary CPICHs.

The UE shall ignore that a Primary CPICH is forbidden to affect the reporting range if all of the following conditions are fulfilled:

- the Primary CPICH is included in active set; and
- all cells in active set are defined as Primary CPICHs forbidden to affect the reporting range.

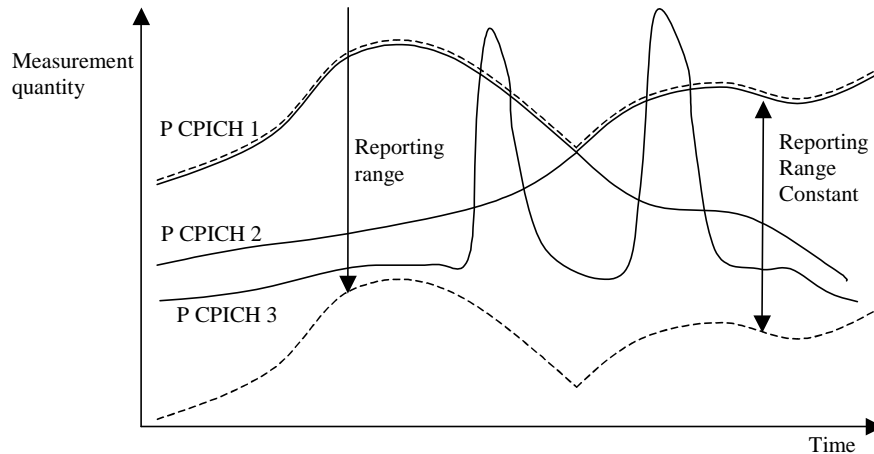

Figure 14.1.5.4-1: Primary CPICH 3 is forbidden to affect the reporting range

14.1.6 Report quantities in intra-frequency measurements

The quantities that the UE shall report to UTRAN when the event is triggered for an intra-frequency measurement are given by the IE "Intra-frequency reporting quantity" stored for this measurement and can be the following:

- 1 SFN-SFN observed time difference
- 2 Cell synchronisation information
- 3 Cell Identity
- 4 Downlink E_c/N_0 (FDD).
- 5 Downlink path loss.

For FDD:

$$\text{Pathloss in dB} = \text{Primary CPICH Tx power} - \text{CPICH RSCP.}$$

- For Primary CPICH Tx power the IE "Primary CPICH Tx power" shall be used. The unit is dBm.
- CPICH RSCP is the result of the CPICH RSCP measurement. The unit is dBm.

For TDD:

$$\text{Pathloss in dB} = \text{Primary CCPCH TX power} - \text{Primary CCPCH RSCP.}$$

- For Primary CCPCH TX power the IE "Primary CCPCH TX Power" shall be used. The unit is dBm.
- Primary CCPCH RSCP is the result of the Primary CCPCH RSCP measurement. The unit is dBm.

If necessary Pathloss shall be rounded up to the next higher integer.

Results higher than 158 shall be reported as 158.

Results lower than 46 shall be reported as 46.

- 6 Downlink received signal code power (RSCP) after despreading (of a primary CPICH for FDD, and of a primary CCPCH for TDD).
- 7 ISCP measured on Timeslot basis. (TDD)

8 Proposed TGSN (TDD)

A description of those values can be found in [7] and [8].

14.2 Inter-frequency measurements

14.2.0a Inter-frequency measurement quantities

The two first measurement quantities listed below are used by the UE to evaluate whether an inter-frequency measurement event has occurred or not, through the computation of a frequency quality estimate. The quantity to use to compute the frequency quality estimate for an inter-frequency measurement is given in the "Inter-frequency measurement quantity" stored for that measurement.

- 1 Downlink Ec/No (FDD)
- 2 Downlink received signal code power (RSCP) after despreading.
- 3 Downlink path loss.

For FDD:

$$\text{Pathloss in dB} = \text{Primary CPICH Tx power} - \text{CPICH RSCP.}$$

- For Primary CPICH Tx power the IE "Primary CPICH Tx power" shall be used. The unit is dBm.
- CPICH RSCP is the result of the CPICH RSCP measurement. The unit is dBm.

For TDD:

$$\text{Pathloss in dB} = \text{Primary CCPCH TX power} - \text{Primary CCPCH RSCP.}$$

- For Primary CCPCH TX power the IE "Primary CCPCH TX Power" shall be used. The unit is dBm.
- Primary CCPCH RSCP is the result of the Primary CCPCH RSCP measurement. The unit is dBm.

A description of those values can be found in [7] and [8].

14.2.0b Frequency quality estimate

14.2.0b.1 FDD cells

The frequency quality estimate used in events 2a, 2b 2c, 2d, 2e and 2f is defined as:

$$Q_{\text{frequency } j} = 10 \cdot \text{Log} M_{\text{frequency } j} = W_j \cdot 10 \cdot \text{Log} \left(\sum_{i=1}^{N_{A_j}} M_{i j} \right) + (1 - W_j) \cdot 10 \cdot \text{Log} M_{\text{Best } j},$$

The variables in the formula are defined as follows ("the virtual active set on frequency j" should be understood as the active set if frequency j is the used frequency. If frequency j is a non-used frequency, the way the virtual active set is initiated and updated is described in subclause 14.11):

$Q_{\text{frequency } j}$ is the estimated quality of the virtual active set on frequency j.

$M_{\text{frequency } j}$ is the estimated quality of the virtual active set on frequency j.

$M_{i j}$ is a measurement result of cell i in the virtual active set on frequency j.

N_{A_j} is the number of cells in the virtual active set on frequency j.

$M_{\text{Best } j}$ is the measurement result of the cell in the virtual active set on frequency j with the highest measurement result.

W_j is a parameter sent from UTRAN to UE and used for frequency j .

If the measurement result is CPICH-Ec/No then $M_{Frequency}$, M_{ij} and M_{Best} are expressed as ratios.

If the measurement result is CPICH-RSCP or PCCPCH-RSCP then $M_{Frequency}$, M_{ij} and M_{Best} are expressed in mW.

14.2.0b.2 TDD cells

$$Q_{i,frequency j} = 10 \cdot \text{Log}M_i + O_{i,j},$$

$Q_{i,frequency j}$ is the estimated quality of cell i on frequency j .

M_i is the measurement result for Primary CCPCH RSCP of cell i on the primary frequency expressed in mW.

O_{ij} is the cell individual offset of the currently evaluated cell i on frequency j . O_{ij} is set by IE "Cell individual offset"

14.2.0c Inter-frequency reporting quantities

The quantities that the UE shall report for each cell to UTRAN when the event is triggered for an inter-frequency measurement is given by the "Inter-frequency reporting quantity" IE stored for this measurement and can be the following, from 1 to 8. The quantity number 9 can be reported for each frequency that triggered the report.

- 1 Cell identity
- 2 SFN-SFN observed time difference
- 3 Cell synchronisation information
- 4 Downlink Ec/No (FDD)
- 5 Downlink path loss.

For FDD:

$$\text{Pathloss in dB} = \text{Primary CPICH Tx power} - \text{CPICH RSCP.}$$

- For Primary CPICH Tx power the IE "Primary CPICH Tx power" shall be used. The unit is dBm.
- CPICH RSCP is the result of the CPICH RSCP measurement. The unit is dBm.

For TDD:

$$\text{Pathloss in dB} = \text{Primary CCPCH TX power} - \text{Primary CCPCH RSCP.}$$

- For Primary CCPCH TX power the IE "Primary CCPCH TX Power" shall be used. The unit is dBm.
- Primary CCPCH RSCP is the result of the Primary CCPCH RSCP measurement. The unit is dBm.

If necessary Pathloss shall be rounded up to the next higher integer.

Results higher than 158 shall be reported as 158.

Results lower than 46 shall be reported as 46.

- 6 Downlink received signal code power (RSCP) after despreading (of a primary CPICH for FDD, and of a primary CCPCH for TDD).
- 7 ISCP measured on Timeslot basis. (TDD)
- 8 Proposed TGSN (TDD)
- 9 UTRA carrier RSSI

A description of those values can be found in [7] and [8].

14.2.1 Inter-frequency reporting events

Within the measurement reporting criteria field in the MEASUREMENT CONTROL message UTRAN notifies the UE which events should trigger the UE to send a MEASUREMENT REPORT message. The listed events are the toolbox from which the UTRAN can choose the reporting events that are needed for the implemented handover evaluation function, or other radio network functions.

All events are evaluated with respect to one of the measurement quantities given in subclause 14.2.0a. The measurement quantities are measured on the monitored primary common pilot channels (CPICH) in FDD mode and the monitored primary common control channels (PCCPCH) in TDD mode of the cell defined in the measurement object. A "non-used frequency" is a frequency that the UE has been ordered to measure upon but is not used for the connection. A "used frequency" is a frequency that the UE has been ordered to measure upon and is also currently used for the connection. An exception to the definition of used and non-used frequency is the frequency of the secondary serving HS-DSCH cell which shall be treated as a non-used frequency for measurement purposes.

The "monitored set on non-used frequency" consists of cells in "cells for measurement" (or all cells in CELL_INFO_LIST if "cells for measurement" is not present) that are not part of the virtual active set on that non-used frequency.

When one inter-frequency measurement identity corresponds to multiple inter-frequency events with identical event identities, the UE behaviour is not specified.

14.2.1.1 Event 2a: Change of best frequency.

When event 2a is configured in the UE within a measurement, the UE shall:

- 1> when the measurement is initiated or resumed:
 - 2> store the used frequency in the variable BEST_FREQUENCY_2A_EVENT.
- 1> if equation 1 below has been fulfilled for a time period indicated by "Time to trigger" for a frequency included for that event and which is not stored in the variable BEST_FREQUENCY_2A_EVENT:
 - 2> send a measurement report with IEs set as below:
 - 3> set in "inter-frequency measurement event results":
 - 4> "inter-frequency event identity" to "2a"; and
 - 4> "Frequency info" to the frequency that triggered the event; and
 - 4> "Non frequency related measurement event results" to the "Primary CPICH info" of the best primary CPICH for FDD cells or "Primary CCPCH info" to the "Cells parameters ID" of the best primary CCPCH for TDD cells on that frequency, not taking into account the cell individual offset.
 - 3> if a non-used frequency triggered the measurement report:
 - 4> include in IE "Inter-frequency measured results list" the measured results for the non-used frequency that triggered the event, not taking into account the cell individual offset.
 - 3> if the used frequency triggered the measurement report:
 - 4> do not include the IE "Inter-frequency measured results list" in the measurement report.
 - 3> set the IE "additional measured results" according to subclause 8.4.2, not taking into account the cell individual offset;
 - 2> update the variable BEST_FREQUENCY_2A_EVENT with that frequency.

Equation 1:

$$Q_{NotBest} \geq Q_{Best} + H_{2a} / 2$$

The variables in the formula are defined as follows:

$Q_{Not\ Best}$ is the quality estimate of a frequency not stored the "best frequency" in the variable BEST_FREQUENCY_2A_EVENT.

Q_{Best} is the quality estimate of the frequency stored in "best frequency" in the variable BEST_FREQUENCY_2A_EVENT.

H_{2a} is the hysteresis parameter for the event 2a in that measurement.

14.2.1.2 Event 2b: The estimated quality of the currently used frequency is below a certain threshold **and** the estimated quality of a non-used frequency is above a certain threshold.

When an inter-frequency measurement configuring event 2b is set up, the UE shall:

- 1> create a variable TRIGGERED_2B_EVENT related to that measurement, which shall initially be empty;
- 1> delete this variable when the measurement is released.

When event 2b is configured in the UE within a measurement, the UE shall:

- 1> if equations 1 and 2 below have been fulfilled for a time period indicated by "Time to Trigger" from the same instant, respectively for one or several non-used frequencies included for that event and for the used frequency:
 - 2> if any of those non-used frequency is not stored in the variable TRIGGERED_2B_EVENT:
 - 3> store the non-used frequencies that triggered the event and that were not previously stored in the variable TRIGGERED_2B_EVENT into that variable;
 - 3> send a measurement report with IEs set as below:
 - 4> set in "inter-frequency measurement event results":
 - 5> "inter-frequency event identity" to "2b"; and
 - 5> for each non-used frequency that triggered the event, beginning with the best frequency:
 - 6> "Frequency info" to that non-used frequency; and
 - 6> "Non frequency related measurement event results" to the "Primary CPICH info" of the best primary CPICH for FDD cells or "Primary CCPCH info" to the "Cell parameters ID" of the best primary CCPCH for TDD cells on that non-used frequency, not taking into account the cell individual offset.
 - 4> include in IE "Inter-frequency measured results list" the measured results for each non-used frequency that triggered the event, not taking into account the cell individual offset;
 - 4> set the IE "additional measured results" according to subclause 8.4.2, not taking into account the cell individual offset.
 - 1> if equation 3 below is fulfilled for a non-used frequency stored in the variable TRIGGERED_2B_EVENT:
 - 2> remove that non-used frequency from the variable TRIGGERED_2B_EVENT.
 - 1> if equation 4 below is fulfilled for the used frequency:
 - 2> clear the variable TRIGGERED_2B_EVENT.

Triggering conditions:

Equation 1:

$$Q_{Non\ used} \geq T_{Non\ used\ 2b} + H_{2b}/2$$

The variables in the formula are defined as follows:

$Q_{Non\ used}$ is the quality estimate of a non-used frequency that becomes better than an absolute threshold.

$T_{Non\ used\ 2b}$ is the absolute threshold that applies for this non-used frequency in that measurement.

H_{2b} is the hysteresis parameter for the event 2b.

Equation 2:

$$Q_{Used} \leq T_{Used\ 2b} - H_{2b}/2$$

The variables in the formula are defined as follows:

Q_{Used} is the quality estimate of the used frequency.

$T_{Used\ 2b}$ is the absolute threshold that applies for the used frequency in that measurement.

H_{2b} is the hysteresis parameter for the event 2b.

Leaving triggered state condition:

Equation 3:

$$Q_{Nonused} < T_{Nonused\ 2b} - H_{2b}/2$$

The variables in the formula are defined as follows:

$Q_{Non\ used}$ is the quality estimate of a non-used frequency that is stored in the variable TRIGGERED_2B_EVENT.

$T_{Non\ used\ 2b}$ is the absolute threshold that applies for this non-used frequency in that measurement.

H_{2b} is the hysteresis parameter for the event 2b.

Equation 4:

$$Q_{Used} > T_{Used\ 2b} + H_{2b}/2$$

The variables in the formula are defined as follows:

Q_{Used} is the quality estimate of the used frequency.

$T_{Used\ 2b}$ is the absolute threshold that applies for the used frequency in that measurement.

H_{2b} is the hysteresis parameter for the event 2b.

14.2.1.3 Event 2c: The estimated quality of a non-used frequency is above a certain threshold

When an inter-frequency measurement configuring event 2c is set up, the UE shall:

- 1> create a variable TRIGGERED_2C_EVENT related to that measurement, which shall initially be empty;
- 1> delete this variable when the measurement is released.

When event 2c is configured in the UE within a measurement, the UE shall:

- 1> if equation 1 below has been fulfilled for one or several non-used frequencies included for that event during the time "Time to trigger":
 - 2> if any of those non-used frequencies is not stored in the variable TRIGGERED_2C_EVENT:
 - 3> store the non-used frequencies that triggered the event and that were not previously stored in the variable TRIGGERED_2C_EVENT into that variable;
 - 3> send a measurement report with IEs set as below:
 - 4> set in "inter-frequency measurement event results":
 - 5> "inter-frequency event identity" to "2c"; and

- 5> for each non-used frequency that triggered the event, beginning with the best frequency:
 - 6> "Frequency info" to that non-used frequency; and
 - 6> "Non frequency related measurement event results" to the "Primary CPICH info" of the best primary CPICH for FDD cells or "Primary CCPCH info" to the "Cell parameters ID" of the best primary CCPCH for TDD cells on that non-used frequency, not taking into account the cell individual offset.
 - 4> include in IE "Inter-frequency measured results list" the measured results for each non-used frequency that triggered the event, not taking into account the cell individual offset;
 - 4> set the IE "additional measured results" according to subclause 8.4.2 not taking into account the cell individual offset.
- 1> if equation 2 below is fulfilled for a non-used frequency stored in the variable TRIGGERED_2C_EVENT:
 - 2> remove that non-used frequency from the variable TRIGGERED_2C_EVENT.

Triggering condition:

Equation 1:

$$Q_{Non\ used} \geq T_{Non\ used\ 2c} + H_{2c}/2$$

The variables in the formula are defined as follows:

$Q_{Non\ used}$ is the quality estimate of a non-used frequency that becomes better than an absolute threshold.

$T_{Non\ used\ 2c}$ is the absolute threshold that applies for this non-used frequency in that measurement.

H_{2c} is the hysteresis parameter for the event 2c.

Leaving triggered state condition:

Equation 2:

$$Q_{Non\ used} < T_{Non\ used\ 2c} - H_{2c}/2$$

The variables in the formula are defined as follows:

$Q_{Non\ used}$ is the quality estimate of a non-used frequency stored in the variable TRIGGERED_2C_EVENT.

$T_{Non\ used\ 2c}$ is the absolute threshold that applies for this non-used frequency in that measurement.

H_{2c} is the hysteresis parameter for the event 2c.

14.2.1.4 Event 2d: The estimated quality of the currently used frequency is below a certain threshold

A UE shall be able to perform this measurement and the corresponding event reporting without requiring compressed mode.

When an inter-frequency measurement configuring event 2d is set up, the UE shall:

- 1> create a variable TRIGGERED_2D_EVENT related to that measurement, which shall initially be set to FALSE;
- 1> delete this variable when the measurement is released.

When event 2d is configured in the UE within a measurement, the UE shall:

- 1> if equation 1 below has been fulfilled for the used frequency during the time "Time to trigger":
 - 2> if the variable TRIGGERED_2D_EVENT is set to FALSE:
 - 3> set the variable TRIGGERED_2D_EVENT to TRUE;

3> send a measurement report with IEs set as below:

4> set in "inter-frequency event results": "inter-frequency event identity" to "2d" and no IE "Inter-frequency cells", not taking into account the cell individual offset;

4> include in IE "Inter-frequency measured results list" the measured results for the used frequency, not taking into account the cell individual offset;

4> set the IE "additional measured results" according to subclause 8.4.2, not taking into account the cell individual offset.

1> if the variable TRIGGERED_2D_EVENT is set to TRUE and if equation 2 is fulfilled for the used frequency:

2> set the variable TRIGGERED_2D_EVENT to FALSE.

Triggering condition:

Equation 1:

$$Q_{Used} \leq T_{Used2d} - H_{2d}/2$$

The variables in the formula are defined as follows:

Q_{Used} is the quality estimate of the used frequency.

T_{Used2d} is the absolute threshold that applies for the used frequency and event 2d.

H_{2d} is the hysteresis parameter for the event 2d.

Leaving triggered state condition:

Equation 2:

$$Q_{Used} > T_{Used2d} + H_{2d}/2$$

The variables in the formula are defined as follows:

Q_{Used} is the quality estimate of the used frequency.

T_{Used2d} is the absolute threshold that applies for the used frequency and event 2d.

H_{2d} is the hysteresis parameter for the event 2d.

14.2.1.5 Event 2e: The estimated quality of a non-used frequency is below a certain threshold

When an inter-frequency measurement configuring event 2e is set up, the UE shall:

1> create a variable TRIGGERED_2E_EVENT related to that measurement, which shall initially be empty;

1> delete this variable when the measurement is released.

When event 2e is configured in the UE within a measurement, the UE shall:

1> if equation 1 below has been fulfilled for one or several non-used frequencies included for that event during the time "Time to trigger":

2> if any of those non-used frequencies is not stored in the variable TRIGGERED_2E_EVENT:

3> store the non-used frequencies that triggered the event and that were not previously stored in the variable TRIGGERED_2E_EVENT into that variable;

3> send a measurement report with IEs set as below:

4> set in "inter-frequency measurement event results":

- 5> "inter-frequency event identity" to "2e"; and
- 5> for each non-used frequency that triggered the event, beginning with the best frequency:
 - 6> "Frequency info" to that non-used frequency; and
 - 6> "Non frequency related measurement event results" to the "Primary CPICH info" of the best primary CPICH for FDD cells or "Primary CCPCH info" to the "Cell parameters ID" of the best primary CCPCH for TDD cells on that non-used frequency, not taking into account the cell individual offset.
- 4> include in the IE "Inter-frequency measured results list" the measured results for each non-used frequency that triggered the event, not taking into account the cell individual offset;
- 4> set the IE "additional measured results" according to subclause 8.4.2, not taking into account the cell individual offset.
- 1> if equation 2 below is fulfilled for a non-used frequency stored in the variable TRIGGERED_2E_EVENT:
 - 2> remove that non-used frequency from the variable TRIGGERED_2E_EVENT.

Triggering condition:

Equation 1:

$$Q_{Nonused} \leq T_{Nonused2e} - H_{2e} / 2$$

The variables in the formula are defined as follows:

$Q_{Non used}$ is the quality estimate of a non-used frequency that becomes worse than an absolute threshold.

$T_{Non used 2e}$ is the absolute threshold that applies for that non-used frequency for that event.

H_{2e} is the hysteresis parameter for the event 2e.

Leaving triggered state condition:

Equation 2:

$$Q_{Nonused} > T_{Nonused2e} + H_{2e} / 2$$

The variables in the formula are defined as follows:

$Q_{Non used}$ is the quality estimate of a non-used frequency stored in the variable TRIGGERED_2E_EVENT.

$T_{Non used 2e}$ is the absolute threshold that applies for that non-used frequency for that event.

H_{2e} is the hysteresis parameter for the event 2e.

14.2.1.6 Event 2 f: The estimated quality of the currently used frequency is above a certain threshold

A UE shall be able to perform this measurement and the corresponding event reporting without requiring compressed mode.

When an inter-frequency measurement configuring event 2f is set up, the UE shall:

- 1> create a variable TRIGGERED_2F_EVENT related to that measurement, which shall initially be set to FALSE;
- 1> delete this variable when the measurement is released.

When event 2f is configured in the UE within a measurement, the UE shall:

- 1> if equation 1 below has been fulfilled for the used frequency during the time "Time to trigger":
 - 2> if the variable TRIGGERED_2F_EVENT is set to FALSE:

3> set the variable TRIGGERED_2F_EVENT to TRUE;

3> send a measurement report with IEs set as below:

4> set in "inter-frequency event results": "inter-frequency event identity" to "2f", and no IE "Inter-frequency cells";

4> include in IE "Inter-frequency measured results list" the measured results for the used frequency, not taking into account the cell individual offset;

4> set the IE "additional measured results" according to subclause 8.4.2, not taking into account the cell individual offset.

1> if the variable TRIGGERED_2F_EVENT is set to TRUE and if equation 2 is fulfilled for the used frequency:

2> set the variable TRIGGERED_2F_EVENT to FALSE.

Triggering condition:

Equation 1:

$$Q_{Used} \geq T_{Used2f} + H_{2f}/2$$

The variables in the formula are defined as follows:

Q_{Used} is the quality estimate of the used frequency.

T_{Used2f} is the absolute threshold that applies for the used frequency and event 2f.

H_{2f} is the hysteresis parameter for the event 2f.

Leaving triggered state condition:

Equation 2:

$$Q_{Used} < T_{Used2f} - H_{2f}/2$$

The variables in the formula are defined as follows:

Q_{Used} is the quality estimate of the used frequency.

T_{Used2f} is the absolute threshold that applies for the used frequency and event 2f.

H_{2f} is the hysteresis parameter for the event 2f.

14.3 Inter-RAT measurements

14.3.0a Inter-RAT measurement quantities

A measurement quantity is used by the UE to evaluate whether an inter-RAT measurement event has occurred or not.

The measurement quantity for UTRAN is used to compute the frequency quality estimate for the active set, as described in the next subclause, and can be:

- 1 Downlink Ec/No.
- 2 Downlink received signal code power (RSCP) after despreading.

The measurement quantity for GSM can be:

- 1 GSM Carrier RSSI

The measurement quantity for E-UTRA can be:

- 1 E-UTRA RSRP

2 E-UTRA RSRQ

A description of those values can be found in [7] and [8].

14.3.0b Frequency quality estimate of the UTRAN frequency

The estimated quality of the active set in UTRAN in event 3a is defined as:

$$Q_{UTRAN} = 10 \cdot \text{Log} M_{UTRAN} = W \cdot 10 \cdot \text{Log} \left(\sum_{i=1}^{N_A} M_i \right) + (1 - W) \cdot 10 \cdot \text{Log} M_{Best},$$

The variables in the formula are defined as follows:

Q_{UTRAN} is the estimated quality of the active set on the currently used UTRAN frequency.

M_{UTRAN} is the estimated quality of the active set on currently used UTRAN frequency expressed in another unit.

M_i is the measurement result of cell i in the active set, according to what is indicated in the IE "Measurement quantity for UTRAN quality estimate".

N_A is the number of cells in the active set.

M_{Best} is the measurement result of the cell in the active set with the highest measurement result.

W is a parameter sent from UTRAN to UE.

If the measurement result is CPICH-Ec/No M_{UTRAN} , M_i and M_{Best} are expressed as ratios.

If the measurement result is CPICH-RSCP or PCCPCH-RSCP, M_{UTRAN} , M_i and M_{Best} are expressed in mW.

14.3.0c Inter-RAT reporting quantities

The quantities that the UE shall report to UTRAN when the event is triggered for an inter-RAT measurement are given by the IE "Inter-RAT reporting quantity" stored for that measurement, and can be the following:

In the case the other RAT is GSM:

- 1 GSM carrier RSSI

In the case the other RAT is E-UTRA:

- 1 Measurement Quantity: In case the measurement quantity is RSRP then only RSRP is reported; in case the measurement quantity is RSRQ then only RSRQ is reported.
- 2 Both: both RSRP and RSRQ are reported.

A description of those values can be found in [7], [8] and [74].

14.3.1 Inter-RAT reporting events

Within the measurement reporting criteria field in the MEASUREMENT CONTROL message the UTRAN notifies the UE which events should trigger the UE to send a MEASUREMENT REPORT message. The listed events are the toolbox from which the UTRAN can choose the reporting events that are needed for the implemented handover evaluation function, or other radio network functions.

All events are measured with respect to one of the measurement quantities given in subclause 14.3.0a, and of the frequency quality estimate given in subclause 14.3.0b. For UTRAN the measurement quantities are measured on the monitored primary common pilot channels (CPICH) in FDD mode and the monitored primary common control channels (PCCPCH) in TDD mode of the cell defined in the measurement object. For other RATs the measurement quantities are system-specific. A "used UTRAN frequency" is a frequency that the UE have been ordered to measure upon and is also currently used for the connection to UTRAN. "Other system" is e.g. GSM or E-UTRA.

In the text below describing the events:

- "The BCCH ARFCN and BSIC combinations considered in that inter-RAT measurement" shall be understood as the BCCH ARFCN and BSIC combinations of the inter-RAT cells pointed at in the IE "Cells for measurement" if it has been received for that inter-RAT measurement, or otherwise of the cells included in the "inter-RAT cell info" part of the variable CELL_INFO LIST.
- "The BCCH ARFCNs considered in that inter-RAT measurement" shall be understood as the BCCH ARFCNs of the inter-RAT cells pointed at in the IE "Cells for measurement" if it has been received for that inter-RAT measurement, or otherwise of the cells included in the "inter-RAT cell info" part of the variable CELL_INFO LIST.
- "The E-UTRA frequencies considered in that inter-RAT measurement" shall be understood as the E-UTRA frequencies whose EARFCNs is included in the the variable EUTRA_FREQUENCY_INFO LIST.

When one inter-RAT measurement identity corresponds to multiple inter-RAT events with identical event identities, the UE behaviour is not specified.

14.3.1.1 Event 3a: The estimated quality of the currently used UTRAN frequency is below a certain threshold **and** the estimated quality of the other system is above a certain threshold.

When an inter-RAT measurement configuring event 3a is set up, the UE shall:

- 1> create a variable TRIGGERED_3A_EVENT related to that measurement, which shall initially be empty;
- 1> delete this variable when the measurement is released.

When event 3a is configured in the UE within a measurement, the UE shall:

- 1> if the other RAT is GSM, and if IE "BSIC verification required" is set to "required":
 - 2> if equations 1 and 2 below have both been fulfilled for a time period indicated by "Time to trigger" from the same instant, respectively for the used UTRAN frequency and for one or several GSM cells that match any of the BCCH ARFCN and BSIC combinations considered in that inter-RAT measurement:
 - 3> if the Inter-RAT cell id of any of those GSM cells is not stored in the variable TRIGGERED_3A_EVENT:
 - 4> store the Inter-RAT cell ids of the GSM cells that triggered the event and that were not previously stored in the variable TRIGGERED_3A_EVENT into that variable.
 - 4> send a measurement report with IEs set as below:
 - 5> in "inter-RAT measurement event result": "inter-RAT event identity" to "3a", "CHOICE BSIC" to "verified BSIC" and "Inter-RAT cell id" to the GSM cells that triggered the event (best one first), taking into account the cell individual offset of the GSM cells;
 - 5> "measured results" and possible "additional measured results" according to subclause 8.6.7.5 and 8.4.2, respectively, not taking into account the cell individual offset.
 - 2> if equation 4 is fulfilled for a GSM cell whose inter-RAT cell id is stored in the variable TRIGGERED_3A_EVENT:
 - 3> remove the inter-RAT cell id of that GSM cell from the variable TRIGGERED_3A_EVENT.
 - 2> if equation 3 is fulfilled for the used frequency in UTRAN:
 - 3> clear the variable TRIGGERED_3A_EVENT.
- 1> if the other RAT is GSM, and if IE "BSIC verification required" is set to "not required":
 - 2> if equations 1 and 2 below have been fulfilled for a time period indicated by "Time to trigger" from the same instant, respectively for the used UTRAN frequency and for one or several BCCH ARFCNs considered in that inter-RAT measurement:
 - 3> if any of those BCCH ARFCNs is not stored into the variable TRIGGERED_3A_EVENT:

- 4> store the BCCH ARFCNs that triggered the event and that were not previously stored in the variable TRIGGERED_3A_EVENT into that variable;
- 4> send a measurement report with IEs set as below:
 - 5> in "inter-RAT measurement event result": "inter-RAT event identity" to "3a", "CHOICE BSIC" to "non verified BSIC" and "BCCH ARFCN" to BCCH ARFCNs that triggered the event (best one first), taking into account the cell individual offset of the GSM cells;
 - 5> "measured results" and possible "additional measured results" according to subclause 8.6.7.5 and 8.4.2, respectively, not taking into account the cell individual offset.
- 2> if equation 4 is fulfilled for a BCCH ARFCN that is stored in the variable TRIGGERED_3A_EVENT:
 - 3> remove that BCCH ARFCN from the variable TRIGGERED_3A_EVENT.
- 2> if equation 3 is fulfilled for the used frequency in UTRAN:
 - 3> clear the variable TRIGGERED_3A_EVENT.
- 1> if the other RAT is E-UTRA:
 - 2> if equations 1 and 2 below have been fulfilled for a time period indicated by "Time to trigger" from the same instant, respectively for the used UTRAN frequency and for one or several E-UTRA cells on any of the frequencies considered in that inter-RAT measurement and that are not included in the blacklist:
 - 3> if any of those E-UTRA cells are not stored into the variable TRIGGERED_3A_EVENT:
 - 4> store the E-UTRA cells that triggered the event and that were not previously stored in the variable TRIGGERED_3A_EVENT into that variable;
 - 4> send a measurement report with IEs set as below:
 - 5> in "E-UTRA event results": "inter-RAT event identity" to "3a", and "E-UTRA carrier frequency" and "Physical cell identity" to the EARFCN and physical cell identity of the cells that triggered the event (best one first);
 - 5> "E-UTRA measured results" according to subclause 8.6.7.5.
 - 2> if equation 4 is fulfilled for a cell that is stored in the variable TRIGGERED_3A_EVENT:
 - 3> remove that cell from the variable TRIGGERED_3A_EVENT.
 - 2> if equation 3 is fulfilled for the used frequency in UTRAN:
 - 3> clear the variable TRIGGERED_3A_EVENT.

Triggering conditions:

Equation 1:

$$Q_{Used} \leq T_{Used} - H_{3a} / 2$$

The variables in the formula are defined as follows:

Q_{Used} is the quality estimate of the used UTRAN frequency.

T_{Used} is the absolute threshold that applies for the used frequency in that measurement.

H_{3a} is the hysteresis parameter for event 3a.

Equation 2:

$$M_{Other RAT} + CIQ_{Other RAT} \geq T_{Other RAT} + H_{3a} / 2$$

The variables in the formula are defined as follows:

$M_{Other\ RAT}$ is the measurement quantity for the cell of the other system.

$CIO_{Other\ RAT}$ is the cell individual offset for the cell of the other system.

$T_{Other\ RAT}$ is the absolute threshold that applies for the other system in that measurement.

H_{3a} is the hysteresis parameter for event 3a.

Leaving triggered state conditions:

Equation 3:

$$Q_{Used} > T_{Used} + H_{3a} / 2$$

The variables in the formula are defined as follows:

Q_{Used} is the quality estimate of the used UTRAN frequency.

T_{Used} is the absolute threshold that applies for the used frequency in that measurement.

H_{3a} is the hysteresis parameter for event 3a.

Equation 4:

$$M_{Other\ RAT} + CIO_{Other\ RAT} < T_{Other\ RAT} - H_{3a} / 2$$

The variables in the formula are defined as follows:

$M_{Other\ RAT}$ is the measurement quantity for the cell of the other system. $M_{Other\ RAT}$ is expressed in dBm.

$CIO_{Other\ RAT}$ is the cell individual offset for the cell of the other system.

$T_{Other\ RAT}$ is the absolute threshold that applies for the other system in that measurement.

H_{3a} is the hysteresis parameter for event 3a.

14.3.1.2 Event 3b: The estimated quality of other system is below a certain threshold

When an inter-RAT measurement configuring event 3b is set up, the UE shall:

- 1> create a variable TRIGGERED_3B_EVENT related to that measurement, which shall initially be empty;
- 1> delete this variable when the measurement is released.

When event 3b is configured in the UE within a measurement, the UE shall:

- 1> if the other RAT is GSM, and if IE "BSIC verification required" is set to "required":
 - 2> if equation 1 below has been fulfilled for a time period indicated by "time to trigger" for one or several GSM cells that match any of the BCCH ARFCN and BSIC combinations considered in that inter-RAT measurement:
 - 3> if the inter-RAT cell id of any of those GSM cell is not stored in the variable TRIGGERED_3B_EVENT:
 - 4> store the inter-RAT cell ids of the GSM cells that triggered the event and that were not previously stored in the variable TRIGGERED_3B_EVENT into that variable;
 - 4> send a measurement report with IEs set as below:
 - 5> set in "inter-RAT measurement event result": "inter-RAT event identity" to "3b", "CHOICE BSIC" to "verified BSIC" and "Inter-RAT cell id" to the GSM cells that triggered the event (worst one first), taking into account the cell individual offset of the GSM cells;
 - 5> set the IE "measured results" and the IE "additional measured results" according to subclause 8.6.7.5 and 8.4.2, respectively, not taking into account the cell individual offset.

- 2> if equation 2 below is fulfilled for a GSM cell whose inter-RAT cell id is stored in the variable TRIGGERED_3B_EVENT:
 - 3> remove the inter-RAT cell id of that GSM cell from the variable TRIGGERED_3B_EVENT.
- 1> if the other RAT is GSM, and if IE "BSIC verification required" is set to "not required":
 - 2> if equation 1 below has been fulfilled for a time period indicated by "time to trigger" for one or several of the BCCH ARFCNs considered in that inter-RAT measurement:
 - 3> if any of those BCCH ARFCN is not stored into the variable TRIGGERED_3B_EVENT:
 - 4> store the BCCH ARFCNs that triggered the event and that were not previously stored in the variable TRIGGERED_3B_EVENT into that variable;
 - 4> send a measurement report with IEs set as below:
 - 5> set in "inter-RAT measurement event result": "inter-RAT event identity" to "3b", "CHOICE BSIC" to "non verified BSIC" and "BCCH ARFCN" to BCCH ARFCNs that triggered the event (worst one first), taking into account the cell individual offset of the GSM cells;
 - 5> set the IE "measured results" and the IE "additional measured results" according to subclause 8.6.7.5 and 8.4.2, respectively, not taking into account the cell individual offset.
 - 2> if equation 2 below is fulfilled for a BCCH ARFCN that is stored in the variable TRIGGERED_3B_EVENT:
 - 3> remove that BCCH ARFCN from the variable TRIGGERED_3B_EVENT.
- 1> if the other RAT is E-UTRA:
 - 2> if equation 1 below has been fulfilled for a time period indicated by "time to trigger" for one or several of the E-UTRA cells on any of the frequencies considered in that inter-RAT measurement and that are not included in the blacklist:
 - 3> if any of those E-UTRA cells is not stored into the variable TRIGGERED_3B_EVENT:
 - 4> store the E-UTRA cells that triggered the event and that were not previously stored in the variable TRIGGERED_3B_EVENT into that variable;
 - 4> send a measurement report with IEs set as below:
 - 5> set in "E-UTRA event results": "inter-RAT event identity" to "3b", and "E-UTRA carrier frequency" and "Physical cell identity" to the EARFCN and physical cell identity of the cells that triggered the event (worst one first);
 - 5> set the IE "E-UTRA measured results" according to subclause 8.6.7.5.
 - 2> if equation 2 below is fulfilled for a cell that is stored in the variable TRIGGERED_3B_EVENT:
 - 3> remove that cell from the variable TRIGGERED_3B_EVENT.

Triggering condition:

Equation 1:

$$M_{Other\ RAT} + CIO_{Other\ RAT} \leq T_{Other\ RAT} - H_{3b} / 2$$

The variables in the formula are defined as follows:

$M_{Other\ RAT}$ is the measurement quantity for the cell of the other system.

$CIO_{Other\ RAT}$ is the cell individual offset for the cell of the other system.

$T_{Other\ RAT}$ is the absolute threshold that applies for the other system in that measurement.

H_{3b} is the hysteresis parameter for event 3b.

Leaving triggered state condition:

Equation 2:

$$M_{Other\ RAT} + CIO_{Other\ RAT} > T_{Other\ RAT} + H_{3b} / 2$$

The variables in the formula are defined as follows:

$M_{Other\ RAT}$ is the measurement quantity for the cell of the other system. $M_{Other\ RAT}$ is expressed in dBm.

$CIO_{Other\ RAT}$ is the cell individual offset for the cell of the other system.

$T_{Other\ RAT}$ is the absolute threshold that applies for the other system in that measurement.

H_{3b} is the hysteresis parameter for event 3b.

14.3.1.3 Event 3c: The estimated quality of other system is above a certain threshold

When an inter-RAT measurement configuring event 3c is set up, the UE shall:

- 1> create a variable TRIGGERED_3C_EVENT related to that measurement, which shall initially be empty;
- 1> delete this variable when the measurement is released.

When event 3c is configured in the UE within a measurement, the UE shall:

- 1> if the other RAT is GSM, and if IE "BSIC verification required" is set to "required":
 - 2> if equation 1 below has been fulfilled for a time period indicated by "time to trigger" for one or several GSM cells that match any of the BCCH ARFCN and BSIC combinations considered in that inter-RAT measurement:
 - 3> if the inter-RAT cell id of any of those GSM cell is not stored in the variable TRIGGERED_3C_EVENT:
 - 4> store the Inter-RAT cell ids of the GSM cells that triggered the event and that were not previously stored in the variable TRIGGERED_3C_EVENT into that variable;
 - 4> send a measurement report with IEs set as below:
 - 5> set in "inter-RAT measurement event result": "inter-RAT event identity" to "3c", "CHOICE BSIC" to "verified BSIC" and "Inter-RAT cell id" to the GSM cells that triggered the event (best one first), taking into account the cell individual offset of the GSM cells;
 - 5> set the IE "measured results" and the IE "additional measured results" according to subclause 8.6.7.5 and 8.4.2, respectively, not taking into account the cell individual offset.
 - 2> if equation 2 below is fulfilled for a GSM cell whose inter-RAT cell id is stored in the variable TRIGGERED_3C_EVENT:
 - 3> remove the inter-RAT cell id of that GSM cell from the variable TRIGGERED_3C_EVENT.
- 1> if the other RAT is GSM, and if IE "BSIC verification required" is set to "not required":
 - 2> if equation 1 below has been fulfilled for a time period indicated by "time to trigger" for one or several of the BCCH ARFCNs considered in that inter-RAT measurement:
 - 3> if any of those BCCH ARFCN is not stored into the variable TRIGGERED_3C_EVENT:
 - 4> store the BCCH ARFCNs that triggered the event and that were not previously stored in the variable TRIGGERED_3C_EVENT into that variable;
 - 4> send a measurement report with IEs set as below:
 - 5> set in "inter-RAT measurement event result": "inter-RAT event identity" to "3c", "CHOICE BSIC" to "non verified BSIC" and "BCCH ARFCN" to BCCH ARFCNs that triggered the event (best one first), taking into account the cell individual offset of the GSM cells;

- 5> set the IE "measured results" and the IE "additional measured results" according to subclause 8.6.7.5 and 8.4.2, respectively, not taking into account the cell individual offset.
- 2> if equation 2 is fulfilled for a BCCH ARFCN that is stored in the variable TRIGGERED_3C_EVENT:
 - 3> remove that BCCH ARFCN from the variable TRIGGERED_3C_EVENT.
- 1> if the other RAT is E-UTRA:
 - 2> if equation 1 below has been fulfilled for a time period indicated by "time to trigger" for one or several E-UTRA cells on any of the frequencies considered in that inter-RAT measurement and that are not included in the blacklist:
 - 3> if any of those E-UTRA cells is not stored into the variable TRIGGERED_3C_EVENT:
 - 4> store the E-UTRA cells that triggered the event and that were not previously stored in the variable TRIGGERED_3C_EVENT into that variable;
 - 4> send a measurement report with IEs set as below:
 - 5> set in "E-UTRA event results": "inter-RAT event identity" to "3c", and "E-UTRA carrier frequency" and "Physical cell identity" to the EARFCN and physical cell identity of the cells that triggered the event (best one first);
 - 5> set the IE "E-UTRA measured results" according to subclause 8.6.7.5.
 - 2> if equation 2 is fulfilled for a cell that is stored in the variable TRIGGERED_3C_EVENT:
 - 3> remove that cell from the variable TRIGGERED_3C_EVENT.

Triggering condition:

Equation 1:

$$M_{Other\ RAT} + CIO_{Other\ RAT} \geq T_{Other\ RAT} + H_{3c} / 2$$

The variables in the formula are defined as follows:

$M_{Other\ RAT}$ is the measurement quantity for the cell of the other system. $M_{Other\ RAT}$ is expressed in dBm.

$CIO_{Other\ RAT}$ is the cell individual offset for the cell of the other system.

$T_{Other\ RAT}$ is the absolute threshold that applies for the other system in that measurement.

H_{3c} is the hysteresis parameter for event 3c.

Leaving triggered state condition:

Equation 2:

$$M_{Other\ RAT} + CIO_{Other\ RAT} < T_{Other\ RAT} - H_{3c} / 2$$

The variables in the formula are defined as follows:

$M_{Other\ RAT}$ is the measurement quantity for the cell of the other system. $M_{Other\ RAT}$ is expressed in dBm.

$CIO_{Other\ RAT}$ is the cell individual offset for the cell of the other system.

$T_{Other\ RAT}$ is the absolute threshold that applies for the other system in that measurement.

H_{3c} is the hysteresis parameter for event 3c.

14.3.1.4 Event 3d: Change of best cell in other system

When an inter-RAT measurement configuring event 3d is set up, the UE shall:

- 1> create a variable BEST_CELL_3D_EVENT related to that measurement;
- 1> delete this variable when the measurement is released.

When event 3d is configured in the UE within a measurement, the UE shall:

- 1> if the other RAT is GSM, and if IE "BSIC verification required" is set to "required":
 - 2> when the measurement is initiated or resumed:
 - 3> store in the variable BEST_CELL_3D_EVENT the Inter-RAT cell id of the GSM cell that has the best measured quantity among the GSM cells that match any of the BCCH ARFCN and BSIC combinations considered in that inter-RAT measurement, not taking into account the cell individual offset of the GSM cells;
 - 3> send a measurement report with IE set as below:
 - 4> set in "inter-RAT measurement event result": "inter-RAT event identity" to "3d", "CHOICE BSIC" to "verified BSIC" and "Inter-RAT cell id" to the GSM cell that is stored in the variable BEST_CELL_3D_EVENT;
 - 4> set the IE "measured results" and the IE "additional measured results" according to subclause 8.6.7.5 and 8.4.2, respectively, not taking into account the cell individual offset.
 - 2> if equation 1 has been fulfilled for a time period indicated by "time to trigger" for a GSM cell that is different from the one stored in BEST_CELL_3D_EVENT and that matches any of the BCCH ARFCN and BSIC combinations considered in that inter-RAT measurement:
 - 3> store the Inter-RAT cell id of that GSM cell in the variable BEST_CELL_3D_EVENT;
 - 3> send a measurement report with IEs set as below:
 - 4> set in "inter-RAT measurement event result": "inter-RAT event identity" to "3d", "CHOICE BSIC" to "verified BSIC" and "Inter-RAT cell id" to the GSM cell is now stored in BEST_CELL_3D_EVENT;
 - 4> set the IE "measured results" and the IE "additional measured results" according to subclause 8.6.7.5 and 8.4.2, respectively, not taking into account the cell individual offset.
- 1> if the other RAT is GSM, and if IE "BSIC verification required" is set to "not required":
 - 2> when the measurement is initiated or resumed:
 - 3> store in the variable BEST_CELL_3D_EVENT the BCCH ARFCN of the GSM cell that has the best measured quantity among the BCCH ARFCNs considered in that inter-RAT measurement;
 - 3> send a measurement report with IE set as below:
 - 4> set in "inter-RAT measurement event result": "inter-RAT event identity" to "3d", "CHOICE BSIC" to "non verified BSIC" and "BCCH ARFCN" to the BCH ARFCN that is stored in the variable BEST_CELL_3D_EVENT;
 - 4> set the IE "measured results" and the IE "additional measured results" according to subclause 8.6.7.5 and 8.4.2, respectively, not taking into account the cell individual offset.
 - 2> if equation 1 below has been fulfilled for a time period indicated by "time to trigger" for one of the BCCH ARFCNs considered in that inter-RAT measurement and different from the one stored in BEST_CELL_3D_EVENT:
 - 3> store the BCCH ARFCN of that GSM cell in the variable BEST_CELL_3D_EVENT;
 - 3> send a measurement report with IEs set as below:
 - 4> set in "inter-RAT measurement event result": "inter-RAT event identity" to "3d", "CHOICE BSIC" to "non verified BSIC" and "BCCH ARFCN" to the BCCH ARFCN that is now stored in the variable BEST_CELL_3D_EVENT;

4> set the IE "measured results" and the IE "additional measured results" according to subclause 8.4.2, not taking into account the cell individual offset.

1> if the other RAT is E-UTRA:

2> when the measurement is initiated or resumed:

3> store in the variable BEST_CELL_3D_EVENT the EARFCN and Physical Cell Identity of the E-UTRA cell that has the best measured quantity among the EARFCNs considered in that inter-RAT measurement;

3> send a measurement report with IE set as below:

4> set in "E-UTRA measurement results": "inter-RAT event identity" to "3d", and "E-UTRA Carrier Frequency" and "Physical Cell Identity" to the EARFCN and the Physical Cell Identity that are stored in the variable BEST_CELL_3D_EVENT;

4> set the IE "E-UTRA measured results" according to subclause 8.6.7.5.

2> if equation 1 below has been fulfilled for a time period indicated by "time to trigger" for a cell on one of the EARFCNs considered in that inter-RAT measurement and different from the cell stored in BEST_CELL_3D_EVENT:

3> store the EARFCN and Physical Cell Identity of that E-UTRA cell in the variable BEST_CELL_3D_EVENT;

3> send a measurement report with IEs set as below:

4> set in "E-UTRA event results": "inter-RAT event identity" to "3d", and "E-UTRA carrier frequency" and "Physical Cell Identity" to the EARFCN and the Physical Cell Identity that are now stored in the variable BEST_CELL_3D_EVENT;

4> set the IE "E-UTRA measured results" according to subclause 8.6.7.5.

Equation 1:

$$M_{New} \geq M_{Best} + H_{3d} / 2$$

The variables in the formula are defined as follows:

M_{New} is the measurement quantity for a cell of the other system that is not stored in the variable BEST_CELL_3D_EVENT.

M_{Best} is the measurement quantity for a cell of the other system that is stored in the variable BEST_CELL_3D_EVENT.

H_{3d} is the hysteresis parameter for event 3d.

14.3.2 GSM measurements in compressed mode

14.3.2.1 GSM RSSI measurements

The UE shall perform GSM RSSI measurements in the gaps of compressed mode pattern sequence specified for GSM RSSI measurement purpose.

14.3.2.2 Initial BSIC identification

The UE shall perform Initial BSIC identification in compressed mode pattern sequence specified for Initial BSIC identification measurement purpose.

The parameter "N identify abort" in the IE "DPCH compressed mode info" indicates the maximum number of patterns that the UE shall use to attempt to decode the unknown BSIC of the GSM cell in the initial BSIC identification procedure.

The BSIC identification procedure is defined in detail in [19].

14.3.2.3 BSIC re-confirmation

The UE shall perform BSIC re-confirmation in compressed mode pattern sequence specified for BSIC re-confirmation measurement purpose.

The parameter "T reconfirm abort" in the IE "DPCH compressed mode info" indicates the maximum time allowed for the re-confirmation of the BSIC of one GSM cell in the BSIC re-confirmation procedure.

The BSIC re-confirmation procedure is defined in detail in [19].

14.3.3 E-UTRA measurements in compressed mode

14.3.3.1 E-UTRA RSRP measurements

The UE shall perform E-UTRA RSRP measurements in the gaps of compressed mode pattern sequence specified for E-UTRA measurement purpose.

14.3.3.2 E-UTRA RSRQ measurements

The UE shall perform E-UTRA RSRQ measurements in the gaps of compressed mode pattern sequence specified for E-UTRA measurement purpose.

14.4 Traffic Volume Measurements

14.4.1 Traffic Volume Measurement Quantity

Traffic volume measurements may be configured by RRC to assist with dynamic radio bearer control. The reported quantities that can be configured are:

- 1 Buffer Occupancy.
- 2 Average of Buffer Occupancy.
- 3 Variance of Buffer Occupancy.

A description of these values can be found in [15].

When a report is triggered, the UE shall provide the requested quantities for the acknowledged and unacknowledged mode RBs mapped onto the transport channels identified.

When the RLC buffer payload, Average of RLC buffer payload or Variance of RLC buffer payload is reported, the measured quantity shall be rounded upwards to the closest higher value possible to report. When the measured quantity is over the highest value possible to report, it shall be set to the highest value.

14.4.2 Traffic Volume reporting triggers

Traffic volume measurement reports can be triggered using two different mechanisms, periodical and event triggered. The reporting criteria are specified in the measurement control message.

All the specified events are evaluated with respect to the Transport Channel Traffic Volume (TCTV). This quantity is equal to the sum of the Buffer Occupancy for all logical channels mapped onto a transport channel. The events on a given transport channel shall be evaluated at least at every TTI (may be more often) as described in [15].

When one traffic volume measurement identity corresponds to multiple traffic volume events with identical event identities for the same transport channel, the UE behaviour is not specified.

When a traffic volume measurement is set up, the UE shall:

- 1> for FDD, if variable READY_FOR_COMMON_EDCH is set to TRUE:

- 2> if one transport channel that is referenced in the IE "Traffic volume measurement object" as "DCH" and IE "measurement validity" is set to "all states except CELL_DCH":
 - 3> the uplink transport channel on which the UE is supposed to report in CELL_FACH state is of type E-DCH.
- 1> for 1.28 Mcps TDD, if one transport channel that is referenced in the IE "Traffic volume measurement object" as "USCH" and the IE "UL target transport channel id" is set to 32 and and IE "measurement validity" is set to "all states" or "all states except CELL_DCH":
 - 2> the uplink transport channel on which the UE is supposed to report is of type E-DCH.
- 1> if the IE "report criteria" is set to "Traffic volume measurement reporting criteria":
 - 2> for each IE "Parameters sent for each transport channel":
 - 3> if the IE "Uplink transport channel type" is not included; or
 - 3> if the IE "Uplink Transport Channel Type" has the value "DCH" or "USCH" and the IE "UL transport channel id" is not included:
 - 4> for each IE "Parameters required for each Event":
 - 5> for each uplink transport channel on which the UE is supposed to report (see below):
 - 6> configure an event trigger defined by the values in the IEs "Measurement Identity", "Traffic volume event identity", "Reporting threshold", "Time to trigger", "Pending time after trigger" and "Tx Interruption after trigger".
 - 3> else:
 - 4> for each IE "Parameters required for each Event":
 - 5> for the uplink transport channel defined by the IEs "Uplink transport channel type" and "UL transport channel id":
 - 6> configure an event trigger defined by the values in the IEs "Measurement Identity", "Traffic volume event identity", "Reporting threshold", "Time to trigger", "Pending time after trigger" and "Tx Interruption after trigger".
- 1> else:
 - 2> if the IE "report criteria" is set to "Periodical reporting criteria":
 - 2> configure periodical triggers with period equal to the value in the IE "Reporting Interval" and with number of transmissions equal to the value in the IE "Amount of reporting" for the measurement identified by the IE "Measurement Identity".

For each transport channel for which an event trigger has been configured, the UE shall:

- 1> for each event configured for this transport channel:
 - 2> if the TCTV is larger than the threshold in IE "Reporting threshold" at TVM setup or modify; or
 - 2> if the TCTV becomes larger than the threshold in IE "Reporting threshold" while the event is configured:
 - 3> if the IE "Traffic volume event identity" has value "4a":
 - 4> if the IE "Time to trigger" is not present; and
 - 4> if the Pending-time-after-trigger timer for this event is not active:
 - 5> if the IE "Pending time after trigger" is included:
 - 6> start the Pending-time-after-trigger timer for this event with the value in this IE.
 - 5> trigger a report for the measurement identified by the IE "Measurement Identity".

- 4> else:
 - 5> start the Time-to-trigger timer for this event with the value in the IE "Time to trigger".
- 3> if the IE "Traffic volume event identity" has value "4b":
 - 4> if the Time-to-trigger timer for this event is active:
 - 5> stop this timer.
- 2> if the TCTV is smaller than the threshold in IE "Reporting threshold" at TVM setup or modify; or
- 2> if the TCTV becomes smaller than the threshold in IE "Reporting threshold" while the event is configured:
 - 3> if the IE "Traffic volume event identity" has value "4a":
 - 4> if the Time-to-trigger timer for this event is active:
 - 5> stop this timer.
 - 3> if the IE "Traffic volume event identity" has value "4b":
 - 4> if the IE "Time to trigger" is not present; and
 - 4> if the Pending-time-after-trigger timer for this event is not active:
 - 5> if the IE "Pending time after trigger" is included:
 - 6> start the Pending-time-after-trigger timer for this event with the value in this IE.
 - 5> trigger a report for the measurement identified by the IE "Measurement Identity".
 - 4> else:
 - 5> start the Time-to-trigger timer for this event with the value in the IE "Time to trigger".

When the Time-to-trigger timer for an event elapses:

- 1> if the Pending-time-after-trigger timer for this event is not active:
 - 2> trigger a report for the measurement identified by the IE "Measurement Identity" corresponding to this event;
- 2> if the IE "Pending time after trigger" is included:
 - 3> start the Pending-time-after-trigger timer for this event with the value in this IE.

When the Pending-time-after-trigger for an event elapses:

- 1> if the IE "Traffic volume event identity" has value "4a":
 - 2> if the TCTV is larger than the threshold in IE "Reporting threshold":
 - 3> if the IE "Time to trigger" is not present:
 - 4> trigger a report for the measurement identified by the IE "Measurement Identity" corresponding to this event;
 - 4> start the Pending-time-after-trigger timer for this event with the value in the IE "Pending time after trigger".
 - 3> else:
 - 4> start the Time-to-trigger timer for this event with the value in the IE "Time to trigger".
- 1> if the IE "Traffic volume event identity" has value "4b":
 - 2> if the TCTV is smaller than the threshold in IE "Reporting threshold":
 - 3> if the IE "Time to trigger" is not present:

- 4> trigger a report for the measurement identified by the IE "Measurement Identity" corresponding to this event;
 - 4> start the Pending-time-after-trigger timer for this event with the value in the IE "Pending time after trigger".
- 3> else:
- 4> start the Time-to-trigger timer for this event with the value in the IE "Time to trigger".

When a periodical trigger elapses, the UE shall:

- 1> trigger a report for the measurement identified by the IE "Measurement Identity";
- 1> if the number of reports triggered by this periodical trigger reaches the value in the IE "Amount of reporting":
 - 2> disable this periodical trigger.

When a report is triggered for a given IE "Measurement Identity", the UE shall:

- 1> consider the variable MEASUREMENT_IDENTITY corresponding to this measurement identity;
- 1> if the report is triggered by an event trigger:
 - 2> include the IE "Event results";
 - 2> if variable READY_FOR_COMMON_EDCH is set to FALSE:
 - 3> set the IE "Uplink transport channel type causing the event" to the type of the transport channel which triggered the report;
 - 3> if the transport channel type is "DCH" or "USCH":
 - 4> include the IE "UL Transport Channel identity" and set it to the identity of the transport channel which triggered the report.
 - 3> else:
 - 4> not include the IE "UL Transport Channel identity".
 - 2> else:
 - 3> for FDD:
 - 4> set the IE "Uplink transport channel type causing the event" to the value "DCH";
 - 4> include the IE "UL Transport Channel identity" and set it to any value.
 - 3> for 1.28 Mcps TDD:
 - 4> include the IE "UL Transport Channel identity" and set it to the identity of the transport channel which triggered the report.
 - 2> set the IE "Traffic volume event identity" to the identity of the event that triggered the report;
 - 2> if the IE "Tx interruption after trigger" for the event that triggered the report is included:
 - 3> if the UE is in CELL_FACH state and
 - 3> if the variable READY_FOR_COMMON_EDCH is set to FALSE:
 - 4> prohibit DTCH transmissions on the RACH;
 - 4> if the Tx interruption timer is not running; or
 - 4> if the Tx interruption timer is running and still has a value larger than the IE "Tx interruption after trigger" for the event, i.e. it was started earlier by another event with a larger value in IE "Tx interruption after trigger":

- 5> start the Tx interruption timer with the value in the IE "Tx interruption after trigger" for this event.
- 4> when it receives from the UTRAN a message causing the transition to CELL_DCH state; or
- 4> when the Tx interruption timer elapses:
 - 5> stop the timer;
 - 5> resume these transmissions.
- 1> if the IE "Traffic volume measurement object" is not included:
 - 2> report on all the uplink transport channels as specified below.
- 1> if the IE "Traffic volume measurement object" is included:
 - 2> report on the uplink transport channels identified in this IE as specified below.
- 1> for each UM or AM RB mapped onto a transport channel on which the UE is expected to report:
 - 2> add an element in the IE "Traffic volume measurement results";
 - 2> set the value of the IE "RB Identity" to the identity of the considered radio bearer;
 - 2> if the RB is mapped onto one logical channel:
 - 3> if the IE "RLC Buffer Payload for each RB" is set to TRUE:
 - 4> include the IE "RLC Buffers Payload" and set it to the Buffer Occupancy value for this logical channel, rounded up to the next allowed value.
 - 3> if the IE "Average of RLC Buffer Payload for each RB" is set to TRUE:
 - 4> include and set the IE "Average of RLC Buffer Payload" to the Buffer Occupancy for this logical channel averaged over the interval specified in the IE "Time Interval to take an average or a variance" (see [15]), rounded up to the next allowed value.
 - 3> if the IE "Variance of RLC Buffer Payload for each RB" is set to TRUE:
 - 4> include and set the IE "Variance of RLC Buffer Payload" to the variance of the Buffer Occupancy for this logical channel computed over the interval specified in the IE "Time Interval to take an average or a variance" (see [15]), rounded up to the next allowed value.
 - 2> if the RB is mapped onto two logical channels:
 - 3> if one logical channel is mapped onto transport channels on which the UE is supposed to report:
 - 4> if the IE "RLC Buffer Payload for each RB" is set to TRUE:
 - 5> include and set the IE "RLC Buffers Payload" to the Buffer Occupancy value for this logical channel, rounded up to the next allowed value.
 - 4> if the IE "Average of RLC Buffer Payload for each RB" is set to TRUE:
 - 5> include and set the IE "Average of RLC Buffer Payload" to the Buffer Occupancy for this logical channel averaged over the interval specified in the IE "Time Interval to take an average or a variance" (see [15]), rounded up to the next allowed value.
 - 4> if the IE "Variance of RLC Buffer Payload for each RB" is set to TRUE:
 - 5> include and set the IE "Variance of RLC Buffer Payload" to the variance of the Buffer Occupancy for this logical channel computed over the interval specified in the IE "Time Interval to take an average or a variance" (see [15]), rounded up to the next allowed value.
 - 3> if both logical channels are mapped onto transport channels on which the UE is supposed to report:
 - 4> if the IE "RLC Buffer Payload for each RB" is set to TRUE:

- 5> include and set the IE "RLC Buffers Payload" to the sum of the Buffer Occupancy values for the two logical channels, rounded up to the next allowed value.
- 4> if the IE "Average of RLC Buffer Payload for each RB" is set to TRUE:
 - 5> include and set the IE "Average of RLC Buffer Payload" to the sum of the Buffer Occupancy for the two logical channels averaged over the interval specified in the IE "Time Interval to take an average or a variance" (see [15]) and rounded up to the next allowed value.
- 4> if the IE "Variance of RLC Buffer Payload for each RB" is set to TRUE:
 - 5> include and set the IE "Variance of RLC Buffer Payload" to the variance of the sum of the Buffer Occupancy for the two logical channels, computed over the interval specified in the IE "Time Interval to take an average or a variance" (see [15]) and rounded up to the next allowed value.

14.4.2.1 Reporting event 4 A: Transport Channel Traffic Volume becomes larger than an absolute threshold

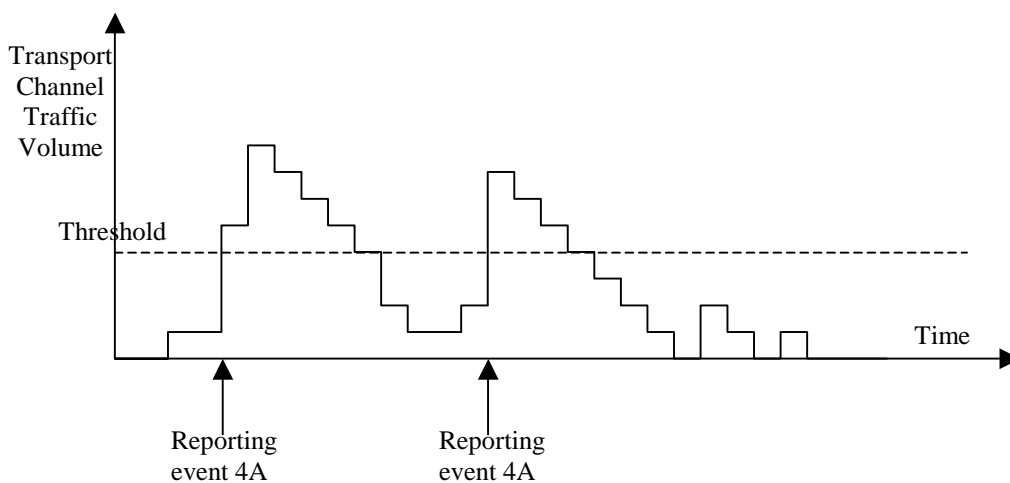

Figure 14.4.2.1-1: Event triggered report when Transport Channel Traffic Volume becomes larger than a certain threshold

If the monitored Transport Channel Traffic Volume (TCTV) [15] is larger than an absolute threshold at TVM setup or modify, or is larger at activation of the monitored transport channel, or becomes larger than an absolute threshold while the event is configured i.e. if $TCTV > \text{Reporting threshold}$, this event could trigger a report. The event could be triggered again only if $TCTV < \text{Reporting threshold}$ and later $TCTV > \text{Reporting threshold}$ is verified again.

14.4.2.2 Reporting event 4 B: Transport Channel Traffic Volume becomes smaller than an absolute threshold

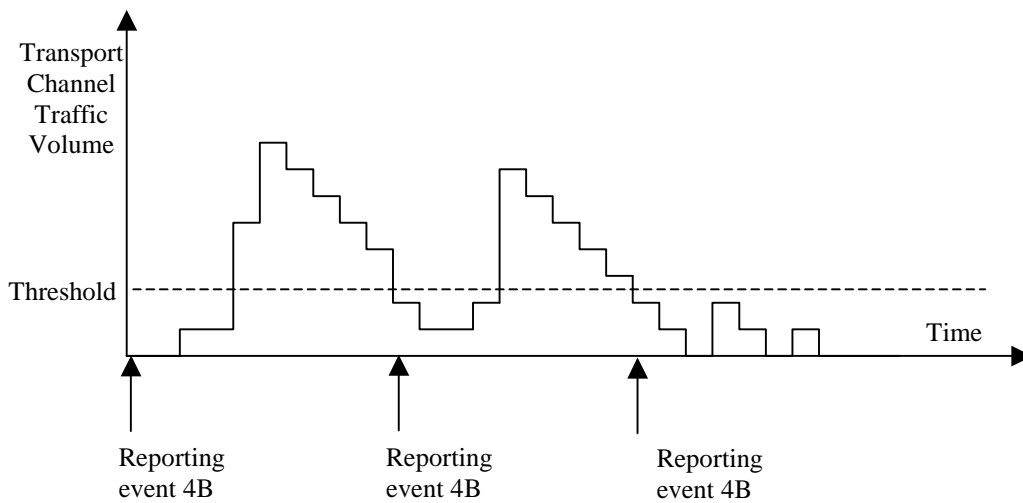

Figure 14.4.2-1-2: Event triggered report when Transport Channel Traffic Volume becomes smaller than certain threshold

If the monitored Transport Channel Traffic Volume (TCTV) [15] is smaller than an absolute threshold at TVM setup or modify, or is smaller at activation of the monitored transport channel, or becomes smaller than an absolute threshold while the event is configured i.e. if $TCTV < \text{Reporting threshold}$, this event could trigger a report. The event could be triggered again only if TCTV becomes bigger than the Reporting threshold and later $TCTV < \text{Reporting threshold}$ is verified again.

14.4.3 Traffic volume reporting mechanisms

Traffic volume measurement triggering could be associated with both a *time-to-trigger* and a *pending time after trigger*. The time-to-trigger is used to get time domain hysteresis, i.e. the condition must be fulfilled during the time-to-trigger time before a report is sent. Pending time after trigger is used to limit consecutive reports when one traffic volume measurement report already has been sent and enables periodic reporting while the TCTV remains above(4a) or below(4b) the threshold. This is described in detail below.

14.4.3.1 Pending time after trigger

This timer is started in the UE when a measurement report has been triggered by a given event. The UE is then forbidden to send new measurement reports triggered by the same event during this time period. Instead the UE waits until the timer has expired. If the Transport Channel Traffic Volume [15] is still above the threshold for event 4a, or below the threshold for event 4b when the timer expires, the UE sends a new measurement report, and the timer is restarted. Otherwise it waits for a new triggering.

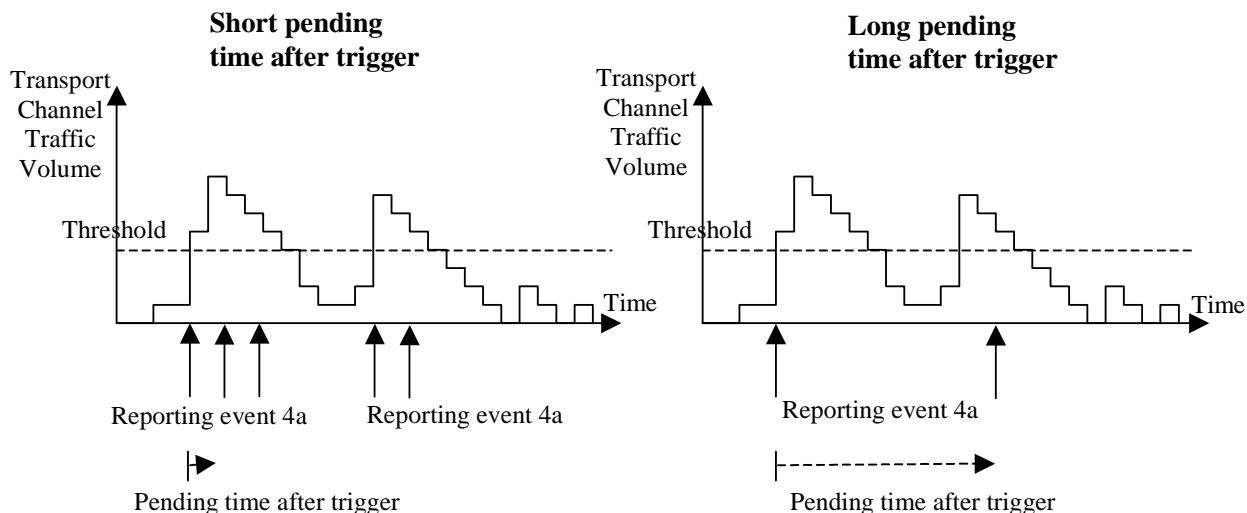

Figure 14.4.3.1-1: Pending time after trigger limits the amount of consecutive measurement reports

Figure 14.4.3.1-1 shows that by increasing the pending time after trigger a triggered second event does not result in a measurement report. The figure assumes absence of the IE "Time to trigger".

14.4.3.2 Time-to-trigger

The timer is started in the UE when the Transport Channel Traffic Volume triggers the event. If the TCTV crosses the threshold before the timer expires, the timer is stopped. If the timer expires then a report is triggered.

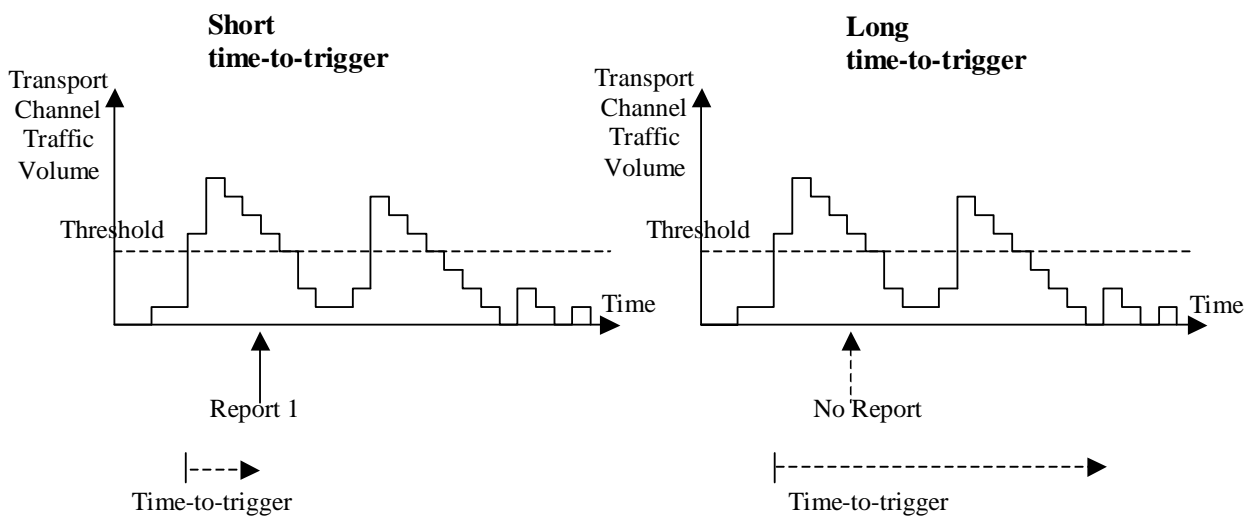

Figure 14.4.3.1-2: Time-to-trigger is used to achieve time hysteresis

Figure 14.4.3.1-2 shows that by increasing the time-to-trigger the report is not triggered.

14.4.4 Interruption of user data transmission

By including the IE "Tx Interruption after trigger", a UE in CELL_FACH state may be instructed by the UTRAN to prohibit transmission of user data on the RACH temporarily after a measurement report has been triggered.

The UE shall only resume transmission of user data, when:

- 1> it receives from the UTRAN a message allocating a dedicated physical channel, leading to the transition to CELL_DCH state; or

1> the time period indicated by the IE "Tx Interruption after trigger" elapses.

The transmission on signalling radio bearers shall not be interrupted.

14.5 Quality Measurements

14.5.1 Quality reporting measurement quantities

For quality measurements, the following measurement quantities are used:

1. Downlink transport channel BLER
2. Timeslot SIR (TDD only)

14.5.2 Quality reporting events

When one measurement identity corresponds to multiple quality events for the same transport channel, the UE behaviour is not specified.

14.5.2.1 Reporting event 5A: A predefined number of bad CRCs is exceeded

When this event is ordered by UTRAN in a measurement control message, the UE shall send a measurement report when the amount of bad CRCs during a predefined sliding window exceeds a predefined number.

The following three parameters are used in the scheme:

- **Total CRC** = the length of the sliding window over which the number of bad CRCs are counted.
- **Bad CRC** = the number of bad CRC that is required within the latest "Total CRC" received CRCs for the event to be triggered.
- **Pending after trigger** = a new event can not be triggered until "Pending after trigger" CRCs have been received,

When a DCH is established, the UE shall begin to count the number of bad CRCs within the last "Total CRC" received CRCs. No event can be triggered until at least "Total CRC" CRCs have been received. For each new received CRC, the UE shall compare the number of bad CRCs within the latest "Total CRC" received CRCs with the parameter "Bad CRC". An event shall be triggered if the number of bad CRCs is equal or larger than "Bad CRC".

At the time when the event is triggered a pending time after trigger timer is started with the length of "Pending after trigger" CRCs. A new event can not be triggered until "Pending after trigger" CRCs have been received. When "Pending after trigger" CRCs have been received the event evaluation start again and a new event can be triggered.

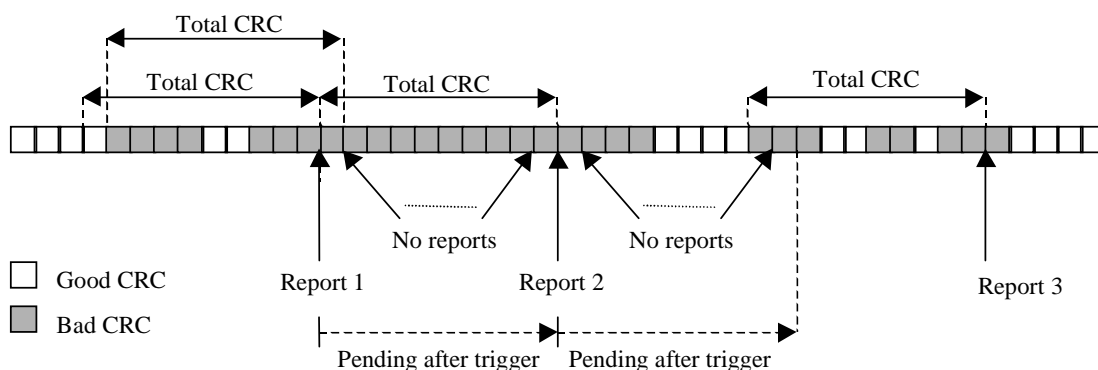

Figure 14.5.2.1-1: Event triggered CRC error reporting

14.6 UE internal measurements

14.6.1 UE internal measurement quantities

For UE internal measurements the following measurement quantities exist:

1. UE transmission (Tx) power, for TDD measured on a timeslot basis.
2. UE received signal strength power (RSSI).
3. UE Rx-Tx time difference (FDD only).
4. T_{ADV} (1.28 Mcps TDD).

14.6.2 UE internal measurement reporting events

In the Measurement reporting criteria field in the Measurement Control messages, the UTRAN notifies the UE of which events should trigger a measurement report. UE internal measurement reporting events that can trigger a report are given below. The reporting events are marked with vertical arrows in the figures below. All events can be combined with time-to-trigger.

NOTE: The reporting events are numbered 6A, 6B, 6C,... where 6 denotes that the event belongs to the type UE internal measurements.

When one measurement identity corresponds to multiple internal events with identical event identities, the UE behaviour is not defined.

14.6.2.1 Reporting event 6A: The UE Tx power becomes larger than an absolute threshold

When a UE internal measurement configuring event 6a is set up, the UE shall:

- 1> create a variable TRIGGERED_6A_EVENT related to that measurement, which shall initially be set to FALSE;
- 1> delete this variable when the measurement is released.

When this event is ordered by UTRAN in a measurement control message, the UE shall:

- 1> if the UE Tx power (for TDD within a single TS) is greater than the value in IE "UE Transmitted Power Tx power threshold" stored for this event in the variable MEASUREMENT_IDENTITY for a time period indicated by the IE "time_to_trigger":
 - 2> if the variable TRIGGERED_6A_EVENT is set to FALSE:
 - 3> set the variable TRIGGERED_6A_EVENT to TRUE;
 - 3> send a measurement report with IEs set as below:
 - 4> set in "UE internal measurement event results": "UE internal event identity" to "6a";
 - 4> set the IE "measured results" and the IE "additional measured results" according to 8.4.2.
 - 1> if the variable TRIGGERED_6A_EVENT is set to TRUE and if the UE Tx power (for TDD within a single TS) is less or equal the value in IE "UE Transmitted Power Tx power threshold" stored for this event in the variable MEASUREMENT_IDENTITY:
 - 2> set the variable TRIGGERED_6A_EVENT to FALSE.

14.6.2.2 Reporting event 6B: The UE Tx power becomes less than an absolute threshold

When a UE internal measurement configuring event 6b is set up, the UE shall:

- 1> create a variable TRIGGERED_6B_EVENT related to that measurement, which shall initially be set to FALSE;
- 1> delete this variable when the measurement is released.

When this event is ordered by UTRAN in a measurement control message, the UE shall:

- 1> if the UE Tx power (for TDD within a single TS) is less than the value in IE "UE Transmitted Power Tx power threshold" stored for this event in the variable MEASUREMENT_IDENTITY for a time period indicated by the IE "time_to_trigger":
 - 2> if the variable TRIGGERED_6B_EVENT is set to FALSE:
 - 3> set the variable TRIGGERED_6B_EVENT to TRUE;
 - 3> send a measurement report with IEs set as below:
 - 4> set in "UE internal measurement event results": "UE internal event identity" to "6b";
 - 4> set the IE "measured results" and the IE "additional measured results" according to 8.4.2.
 - 1> if the variable TRIGGERED_6B_EVENT is set to TRUE and if the UE Tx power (for TDD within a single TS) is greater or equal the value in IE "UE Transmitted Power Tx power threshold" stored for this event in the variable MEASUREMENT_IDENTITY:
 - 2> set the variable TRIGGERED_6B_EVENT to FALSE.

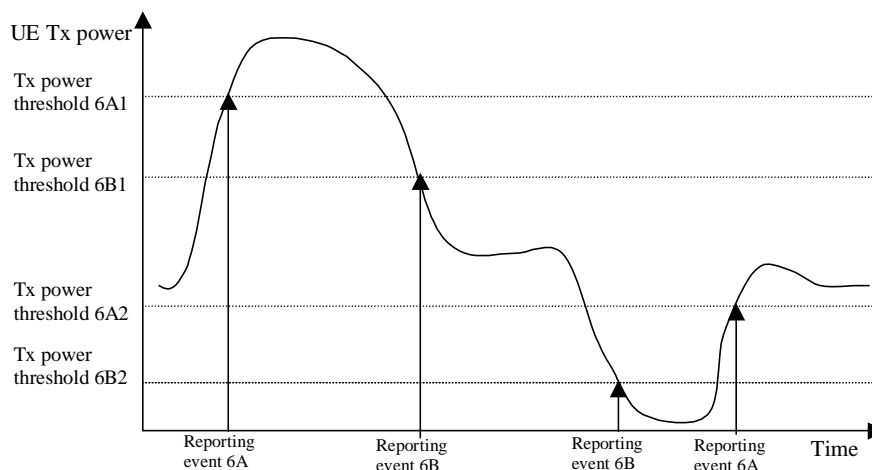

Figure 14.6.2.2-1: Event-triggered measurement reports when the UE Tx power becomes larger or less than absolute thresholds

14.6.2.3 Reporting event 6C: The UE Tx power reaches its minimum value

When a UE internal measurement configuring event 6c is set up, the UE shall:

- 1> create a variable TRIGGERED_6C_EVENT related to that measurement, which shall initially be set to FALSE;
- 1> delete this variable when the measurement is released.

When this event is ordered by UTRAN in a measurement control message, the UE shall:

- 1> if the UE Tx power is equal its minimum value (for TDD its minimum value on a single TS) for a time period indicated by the IE "time_to_trigger":
 - 2> if the variable TRIGGERED_6C_EVENT is set to FALSE:
 - 3> set the variable TRIGGERED_6C_EVENT to TRUE;
 - 3> send a measurement report with IEs set as below:

- 4> set in "UE internal measurement event results": "UE internal event identity" to "6c";
- 4> set the IE "measured results" and the IE "additional measured results" according to 8.4.2.

1> if the variable TRIGGERED_6C_EVENT is set to TRUE and if the UE Tx power is greater than its minimum value:

- 2> set the variable TRIGGERED_6C_EVENT to FALSE.

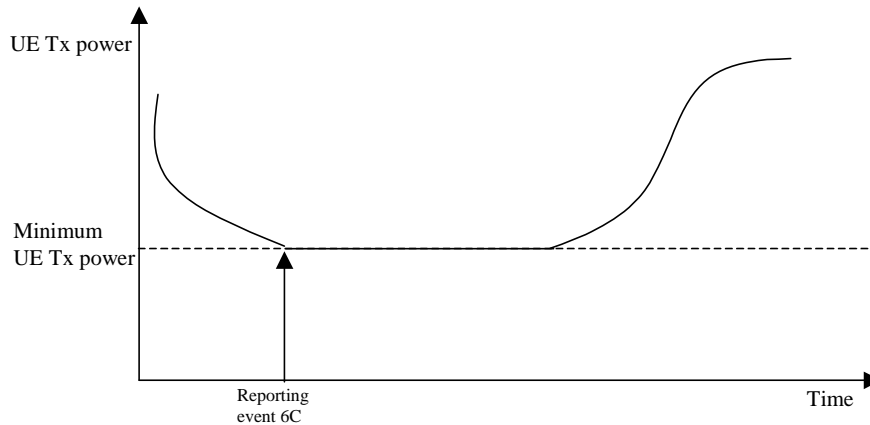

Figure 14.6.2.3-1: Event-triggered measurement report when the UE Tx power reaches its minimum value

14.6.2.4 Reporting event 6D: The UE Tx power reaches its maximum value

When a UE internal measurement configuring event 6d is set up, the UE shall:

- 1> create a variable TRIGGERED_6D_EVENT related to that measurement, which shall initially be set to FALSE;
- 1> delete this variable when the measurement is released.

When this event is ordered by UTRAN in a measurement control message, the UE shall:

- 1> if the UE Tx power equals the maximum power the UE can transmit, i.e. the maximum UE TX power reduced by the power reduction used by the UE (for TDD its maximum value on a single TS) for a time period indicated by the IE "time_to_trigger":
 - 2> if the variable TRIGGERED_6D_EVENT is set to FALSE:
 - 3> set the variable TRIGGERED_6D_EVENT to TRUE;
 - 3> send a measurement report with IEs set as below:
 - 4> set in "UE internal measurement event results": "UE internal event identity" to "6d";
 - 4> set the IE "measured results" and the IE "additional measured results" according to 8.4.2.
- 1> if the variable TRIGGERED_6D_EVENT is set to TRUE and if the UE Tx power is less than the maximum UE TX power:
 - 2> set the variable TRIGGERED_6D_EVENT to FALSE.

NOTE: The maximum UE TX power is defined in subclause 8.6.6.8 and the maximum allowed power reduction is defined in subclause 6.2.2 in [21].

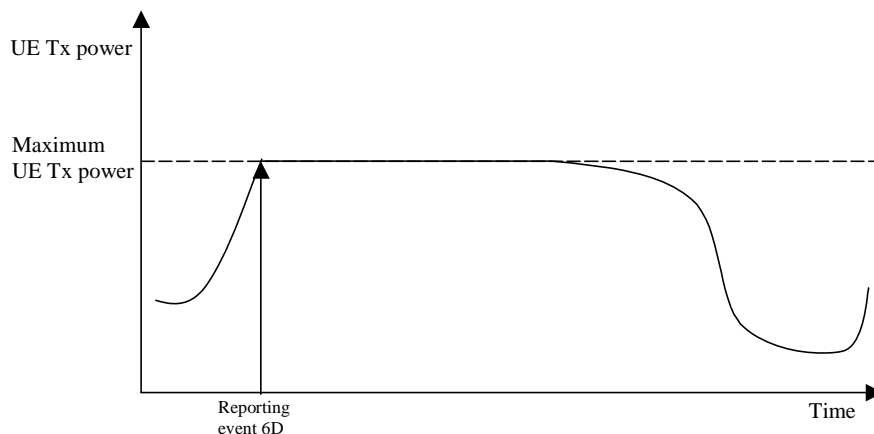

Figure 14.6.2.4-1: Event-triggered report when the UE Tx power reaches its maximum value

14.6.2.5 Reporting event 6E: The UE RSSI reaches the UE's dynamic receiver range

When a UE internal measurement configuring event 6e is set up, the UE shall:

- 1> create a variable TRIGGERED_6E_EVENT related to that measurement, which shall initially be set to FALSE;
- 1> delete this variable when the measurement is released.

When this event is ordered by UTRAN in a measurement control message, the UE shall:

- 1> if the UE RSSI is greater or equal the UE's dynamic receiver range for a time period indicated by the IE "time_to_trigger":
 - 2> if the variable TRIGGERED_6E_EVENT is set to FALSE:
 - 3> set the variable TRIGGERED_6E_EVENT to TRUE;
 - 3> send a measurement report with IEs set as below:
 - 4> set in "UE internal measurement event results": "UE internal event identity" to "6e";
 - 4> set the IE "measured results" and the IE "additional measured results" according to subclause 8.4.2.
 - 1> if the variable TRIGGERED_6E_EVENT is set to TRUE and if the UE RSSI is less than the UE's dynamic receiver range:
 - 2> set the variable TRIGGERED_6E_EVENT to FALSE.

14.6.2.6 Reporting event 6F (FDD): The UE Rx-Tx time difference for a RL included in the active set becomes larger than an absolute threshold

When a UE internal measurement configuring event 6f is set up, the UE shall:

- 1> create a variable TRIGGERED_6F_EVENT related to that measurement, which shall initially be set to FALSE for each RL;
- 1> delete this variable when the measurement is released.

When this event is ordered by UTRAN in a measurement control message, the UE shall:

- 1> if the UE Rx-Tx time difference for a RL included in the active set is greater than the value in the IE "UE Rx-Tx time difference threshold" stored for this event in the variable MEASUREMENT_IDENTITY for a time period indicated by the IE "time_to_trigger":
 - 2> if the variable TRIGGERED_6F_EVENT is set to FALSE for this RL:

- 3> set the variable TRIGGERED_6F_EVENT to TRUE for this RL;
- 3> send a measurement report with IEs set as below:
 - 4> set in "UE internal measurement event results": "UE internal event identity" to "6f";
 - 4> set the IE "measured results" and the IE "additional measured results" according to subclause 8.4.2.
- 1> if the variable TRIGGERED_6F_EVENT is set to TRUE for a RL and if the UE RX-Tx time difference for this RL included in the active set is less than or equal to the value in the IE "UE Rx-Tx time difference threshold" stored for this event in the variable MEASUREMENT_IDENTITY:
 - 2> set the variable TRIGGERED_6F_EVENT to FALSE for this RL.

14.6.2.6a Reporting event 6F (1.28 Mcps TDD): The time difference indicated by T_{ADV} becomes larger than an absolute threshold

When a UE internal measurement configuring event 6f is set up, the UE shall:

- 1> create a variable TRIGGERED_6F_EVENT related to that measurement, which shall initially be set to the currently measured T_{ADV} ;
- 1> delete this variable when the measurement is released.

When this event is ordered by UTRAN in a measurement control message, the UE shall:

- 1> if the absolute value of the difference between the measured T_{ADV} and the T_{ADV} stored in the variable TRIGGERED_6F_EVENT is greater than the predefined threshold configured with the IE "T_{ADV} Threshold" for this event in the variable MEASUREMENT_IDENTITY for a time period indicated by the IE "time_to_trigger":
 - 2> set the variable TRIGGERED_6F_EVENT to the currently measured T_{ADV} ;
 - 2> send a measurement report with IEs set as below:
 - 3> set the IE "T_{ADV}" to the measured value, and the IE "SFN" to the SFN during which the latest measurement was performed, in the IE "T_{ADV} Info";
 - 3> set the IE "measured results" and the IE "additional measured results" according to subclause 8.4.2.

14.6.2.7 Reporting event 6G: The UE Rx-Tx time difference for a RL included in the active set becomes less than an absolute threshold

When a UE internal measurement configuring event 6g is set up, the UE shall:

- 1> create a variable TRIGGERED_6G_EVENT related to that measurement, which shall initially be set to FALSE for each RL;
- 1> delete this variable when the measurement is released.

When this event is ordered by UTRAN in a measurement control message, the UE shall:

- 1> if the UE Rx-Tx time difference for a RL included in the active set is less than the value in IE "UE Rx-Tx time difference threshold" stored for this event in the variable MEASUREMENT_IDENTITY for a time period indicated by the IE "time_to_trigger":
 - 2> if the variable TRIGGERED_6G_EVENT is set to FALSE for this RL:
 - 3> set the variable TRIGGERED_6G_EVENT to TRUE for this RL;
 - 3> send a measurement report with IEs set as below:
 - 4> set in "UE internal measurement event results": "UE internal event identity" to "6g";
 - 4> set the IE "measured results" and the IE "additional measured results" according to subclause 8.4.2.

1> if the variable TRIGGERED_6G_EVENT is set to TRUE for a RL and if the UE RX-Tx time difference for this RL included in the active set is greater or equal the value in IE "UE Rx-Tx time difference threshold" stored for this event in the variable MEASUREMENT_IDENTITY:

2> set the variable TRIGGERED_6G_EVENT to FALSE for this RL.

14.7 UE positioning measurements

14.7.1 UE positioning measurement quantities

The quantity to measure for UE positioning is dependent on the positioning method and the method type requested in the IE "UE positioning reporting quantity".

- 1 SFN-SFN observed time difference type 2, optional.
- 2 Rx-Tx time difference type 2, optional.
- 3 GPS timing of cell frames, optional.

The definition of other GPS measurements is not within the scope of this specification.

14.7.2 Void

14.7.3 UE positioning reporting events

In the IE "UE positioning reporting criteria" in the Measurement Control messages, the UTRAN notifies the UE of which events should trigger a measurement report. UE positioning reporting events that can trigger a report are given below. The content of the measurement report is dependant on the positioning method and method type requested in the IE "UE positioning reporting quantity" of the Measurement Control message and is described in detail in [18].

When one measurement identity corresponds to multiple positioning events with identical event identities, the UE behaviour is not defined.

14.7.3.1 Reporting Event 7a: The UE position changes more than an absolute threshold

This event is used for UE-based methods only.

When this event is ordered by UTRAN in a measurement control message, the UE shall:

- 1> if the UE changes its position compared to the last reported position by more than the threshold defined by the IE "Threshold position change"; or
- 1> if no position has been reported since the event was configured and the UE changes its position compared to the first position estimate obtained after the event was configured by more than the threshold defined by the IE "Threshold position change":
 - 2> send a measurement report as specified in subclause 8.6.7.19.1b;
 - 2> if the value of IE "Amount of Reporting" in variable MEASUREMENT_IDENTITY for this event is greater than zero:
 - 3> decrease IE "Amount of Reporting" in variable MEASUREMENT_IDENTITY for this event by one.
 - 2> if the value of IE "Amount of Reporting" in variable MEASUREMENT_IDENTITY for this event is equal to zero:
 - 3> delete this event from the list of events in variable MEASUREMENT_IDENTITY.
- 1> if the UE is unable to evaluate the event because a position measurement is not available:
 - 2> not send a report.

14.7.3.2 Reporting Event 7b: SFN-SFN measurement changes more than an absolute threshold

When this event is ordered by UTRAN in a measurement control message, the UE shall:

- 1> send a measurement report when the SFN-SFN time difference measurement type 2 of any measured cell changes more than the threshold defined by the IE "Threshold SFN-SFN change"; and
- 1> if UTRAN set IE "Method Type" in "UE positioning reporting quantity" in the MEASUREMENT CONTROL message to "UE-based":
 - 2> act as specified in subclause 8.6.7.19.1b.
- 1> if UTRAN set IE "Method Type" in "UE positioning reporting quantity" in the MEASUREMENT CONTROL message to "UE-assisted":
 - 2> act as specified in subclause 8.6.7.19.1a.
- 1> if UTRAN set IE "Method Type" in "UE positioning reporting quantity" in the MEASUREMENT CONTROL message to "UE-assisted preferred but UE-based allowed" or "UE-based preferred but UE-assisted allowed":
 - 2> the UE may choose to act according to either subclause 8.6.7.19.1a or 8.6.7.19.1b.
- 1> if the value of IE "Amount of Reporting" in variable MEASUREMENT_IDENTITY for this event is greater than zero:
 - 2> decrease IE "Amount of Reporting" in variable MEASUREMENT_IDENTITY for this event by one.
- 1> if the value of IE "Amount of Reporting" in variable MEASUREMENT_IDENTITY for this event is equal to zero:
 - 2> delete this event from the list of events in variable MEASUREMENT_IDENTITY.

14.7.3.3 Reporting Event 7c: GPS time and SFN time have drifted apart more than an absolute threshold

When this event is ordered by UTRAN in a measurement control message, the UE shall:

- 1> send a measurement report when the GPS Time Of Week and the SFN timer have drifted apart more than the threshold defined by the IE "Threshold SFN-GPS TOW"; and
- 1> if UTRAN set IE "Method Type" in "UE positioning reporting quantity" in the MEASUREMENT CONTROL message to "UE based":
 - 2> act as specified in subclause 8.6.7.19.1b.
- 1> if UTRAN set IE "Method Type" in "UE positioning reporting quantity" in the MEASUREMENT CONTROL message to "UE assisted":
 - 2> act as specified in subclause 8.6.7.19.1a.
- 1> if UTRAN set IE "Method Type" in "UE positioning reporting quantity" in the MEASUREMENT CONTROL message to "UE assisted preferred but UE based allowed" or "UE based preferred but UE assisted allowed":
 - 2> act as specified in subclause 8.6.7.19.1a or in subclause 8.6.7.19.1b depending on the method type chosen by the UE.
- 1> if the value of IE "Amount of Reporting" in variable MEASUREMENT_IDENTITY for this event is greater than zero:
 - 2> decrease IE "Amount of Reporting" in variable MEASUREMENT_IDENTITY for this event by one.
- 1> if the value of IE "Amount of Reporting" in variable MEASUREMENT_IDENTITY for this event is equal to zero:
 - 2> delete this event from the list of events in variable MEASUREMENT_IDENTITY.

14.7.3.4 Reporting Event 7d: GANSS time and SFN time have drifted apart more than an absolute threshold

When this event is ordered by UTRAN in a measurement control message, the UE shall:

- 1> send a measurement report when the GANSS Time Of Week and the SFN timer have drifted apart more than the threshold defined by the IE "Threshold SFN-GANSS TOW"; and
- 1> if UTRAN set IE "Method Type" in "UE positioning reporting quantity" in the MEASUREMENT CONTROL message to "UE based":
 - 2> act as specified in subclause 8.6.7.19.1b.
- 1> if UTRAN set IE "Method Type" in "UE positioning reporting quantity" in the MEASUREMENT CONTROL message to "UE assisted":
 - 2> act as specified in subclause 8.6.7.19.1a.
- 1> if UTRAN set IE "Method Type" in "UE positioning reporting quantity" in the MEASUREMENT CONTROL message to "UE assisted preferred but UE based allowed" or "UE based preferred but UE assisted allowed":
 - 2> act as specified in subclause 8.6.7.19.1a or in subclause 8.6.7.19.1b depending on the method type chosen by the UE.
- 1> if the value of IE "Amount of Reporting" in variable MEASUREMENT_IDENTITY for this event is greater than zero:
 - 2> decrease IE "Amount of Reporting" in variable MEASUREMENT_IDENTITY for this event by one.
- 1> if the value of IE "Amount of Reporting" in variable MEASUREMENT_IDENTITY for this event is equal to zero:
 - 2> delete this event from the list of events in variable MEASUREMENT_IDENTITY.

14.8 Void

14.9 Downlink power control

14.9.1 Generalities

This function is implemented in the UE in order to set the SIR target value on each CCTrCH used for the downlink power control. This SIR value shall be adjusted according to an autonomous function in the UE in order to achieve the same measured quality as the quality target set by UTRAN. The quality target is set as the transport channel BLER value for each transport channel as signalled by UTRAN.

When transport channel BLER is used the UE shall run a quality target control loop such that the quality requirement is met for each transport channel, which has been assigned a BLER target.

The UE shall set the SIR target when the physical channel has been set up or reconfigured. It shall not increase the SIR target value before the power control has converged on the current value. The UE may estimate whether the power control has converged on the current value, by comparing the averaged measured SIR to the SIR target value.

NOTE: The power control function for F-DPCH is specified in [29].

14.9.2 Downlink power control in compressed mode

In compressed mode, the target SIR needs to be changed in several frames compared to normal mode. For this purpose, four values DeltaSIR1, DeltaSIRafter1, DeltaSIR2 and DeltaSIRafter2 are signalled by the UTRAN to the UE (see subclause 10.3.6.33).

For each frame, the target SIR offset during compressed mode, compared to normal mode is:

$$\Delta\text{SIR} = \max(\Delta\text{SIR1_compression}, \dots, \Delta\text{SIRn_compression}) + \Delta\text{SIR1_coding} + \Delta\text{SIR2_coding}$$

where n is the number of TTI lengths for all TrChs of the CCTrCh, F_i is the length in number of frames of the i -th TTI and where $\Delta\text{SIR_coding}$ fulfils:

- $\Delta\text{SIR1_coding} = \text{DeltaSIR1}$ if the start of the first transmission gap in the transmission gap pattern is within the current frame.
- $\Delta\text{SIR1_coding} = \text{DeltaSIRafter1}$ if the current frame just follows a frame containing the start of the first transmission gap in the transmission gap pattern.
- $\Delta\text{SIR2_coding} = \text{DeltaSIR2}$ if the start of the second transmission gap in the transmission gap pattern is within the current frame.
- $\Delta\text{SIR2_coding} = \text{DeltaSIRafter2}$ if the current frame just follows a frame containing the start of the second transmission gap in the transmission gap pattern.
- $\Delta\text{SIR1_coding} = 0$ and $\Delta\text{SIR2_coding} = 0$ otherwise.

and $\Delta\text{SIRi_compression}$ is defined by :

- $\Delta\text{SIRi_compression} = 3$ dB for downlink frames compressed by reducing the spreading factor by 2.
- $\Delta\text{SIRi_compression} = 0$ dB in all other cases.

Several compressed mode patterns applying to the same frames should be avoided as much as possible.

In case several compressed mode patterns are used simultaneously, a ΔSIR offset is computed for each compressed mode pattern and the sum of all ΔSIR offsets is applied to the frame.

14.10 Calculated Transport Format Combination

The Calculated Transport Format Combination (CTFC) is a tool for efficient signalling of transport format combinations.

Let I be the number of transport channels that are included in the transport format combination. For DCHs, all configured DCHs are included in the transport format combination. Each transport channel TrCH_i , $i = 1, 2, \dots, I$, has L_i transport formats, i.e. the transport format indicator TFI_i can take L_i values, $\text{TFI}_i \in \{0, 1, 2, \dots, L_i - 1\}$.

Define $P_i = \prod_{j=0}^{i-1} L_j$, where $i = 1, 2, \dots, I$, and $L_0 = 1$.

Let $\text{TFC}(\text{TFI}_1, \text{TFI}_2, \dots, \text{TFI}_I)$ be the transport format combination for which TrCH_1 has transport format TFI_1 , TrCH_2 has transport format TFI_2 , etc. The corresponding $\text{CTFC}(\text{TFI}_1, \text{TFI}_2, \dots, \text{TFI}_I)$ is then computed as:

$$\text{CTFC}(\text{TFI}_1, \text{TFI}_2, \dots, \text{TFI}_I) = \sum_{i=1}^I \text{TFI}_i \cdot P_i.$$

For FACH and PCH transport channels, "TrCH₁" corresponds to the transport channel listed at the first position in IE "FACH/PCH information" in IE "Secondary CCPCCH System Information", "TrCH₂" corresponds to the transport channel listed at the second position in IE "FACH/PCH information" and so on.

For all other transport channels in FDD and for all configured transport channels of the same transport channel type (i.e. DCH, DSCH, USCH) in TDD, "TrCH₁" corresponds to the transport channel having the lowest transport channel identity in the transport format combination mapped to the TFCI field. "TrCH₂" corresponds to the transport channel having the next lowest transport channel identity, and so on.

14.10.1 Default TFCS for MBMS

14.10.1.1 S-CCPCH configuration including a FACH carrying MSCH

In case the S-CCPCH configuration includes a FACH carrying MSCH, the default TFCS is defined according to the following:

Let TrCH 1 be the FACH carrying MSCH, TrCH 2 be the first TrCH carrying MTCH listed in the IE "TrCh information list", TrCH 3 be the second TrCH carrying MTCH listed in the IE "TrCh information list" etc. and let TrCH I be the last TrCH carrying MTCH listed in the IE "TrCh information list".

Each transport channel TrCH_{*i*}, *i* = 1, 2, ..., *I*, has *L_i* transport formats, i.e. the transport format indicator TFI_{*i*} can take *L_i* values.

Each transport format combination set is defined by the transport formats of each transport channel mapped on this S-CCPCH:

TFC = (TFI₁, TFI₂, ..., TFI_{*I*}).

The "MBMS implicit TFCS" contains then the following set of TFCs:

$$\text{TFCS} = \{(0,0,\dots,0), (0,1,\dots,0), \dots, (0,L_2,\dots,0), (0,0,1,\dots,0), \dots, (0,0,L_3,\dots,0), \dots, (0,0,0,\dots,1), \dots, (0,0,0,\dots,L_I), \\ (1,0,\dots,0), (1,1,\dots,0), \dots, (1,L_2,\dots,0), (1,0,1,\dots,0), \dots, (1,0,L_3,\dots,0), \dots, (1,0,0,\dots,1), \dots, (1,0,0,\dots,L_I), \\ (2,0,\dots,0), \dots, (L_1,0,\dots,0)\}$$

14.10.1.2 S-CCPCH configuration not including a FACH carrying MSCH

In case the S-CCPCH configuration does not include a FACH carrying MSCH, the default TFCS is defined according to the following:

Let TrCH 1 be the first TrCH listed in the IE "TrCh information list", TrCH 2 be the second TrCH listed in the IE "TrCh information list" etc. and let TrCH I be the last TrCH listed in the IE "TrCh information list".

Each transport channel TrCH_{*i*}, *i* = 1, 2, ..., *I*, has *L_i* transport formats, i.e. the transport format indicator TFI_{*i*} can take *L_i* values.

Each transport format combination set is defined by the transport formats of each transport channel mapped on this S-CCPCH:

TFC = (TFI₁, TFI₂, ..., TFI_{*I*}).

The "MBMS implicit TFCS" contains then the following set of TFCs:

$$\text{TFCS} = \{(0,\dots,0), (1,\dots,0), \dots, (L_1,\dots,0), (0,1,\dots,0), \dots, (0,L_2,\dots,0), \dots, (0,0,\dots,1), \dots, (0,0,\dots,L_I)\}$$

14.11 UE autonomous update of virtual active set on non-used frequency (FDD only)

In the text that follows:

- a "non-used frequency" is a frequency that the UE has been ordered to measure upon but is not used for the connection. A "used frequency" is a frequency that the UE has been ordered to measure upon and is also currently used for the connection;
- a "non-used frequency (resp. cell) considered in an inter-frequency measurement" shall be understood as a non-used frequency (resp. cell) included in the list of cells pointed at in the IE "cells for measurement" if it was received for that measurement, or otherwise as a non-used frequency (resp. cell) included in the "Inter-frequency cell info" part of the variable CELL_INFO_LIST.

For event-triggered inter frequency measurements it is possible to use intra-frequency measurement reporting events for support of maintenance of an active set associated with a non-used frequency considered in that measurement, a "virtual

active set" and used in the evaluation of the frequency quality estimates. The "initial virtual active set" for a frequency is the virtual active set that is associated to that frequency just after a message was received that sets up or modifies the inter-frequency measurement.

The way the virtual active sets are initiated and updated for the non-used frequencies considered in an inter-frequency measurement is described in the two subclauses below.

The UE shall support a single virtual active set per non-used frequency.

The virtual active set is not initialised and maintained for an inter frequency measurement with periodic reporting. A virtual active set initialised and maintained by another inter-frequency measurement does not affect reporting of the periodic inter-frequency measurement.

14.11.1 Initial virtual active set

If the UE receives a MEASUREMENT CONTROL message that sets up or modifies an inter-frequency measurement and includes the IE "Inter-frequency set update"; or

If at least one cell can be measured on a non-used frequency for which the current virtual active set is empty (see subclause 14.11.2), the UE shall:

- 1> for each non-used frequency F_i considered in the measurement where cells can be measured:
 - 2> if event 1a is configured for the used frequency in an intra-frequency measurement:
 - 3> include in the initial virtual active set the N_i cells that have either the greatest downlink E_c/N_0 or the greatest downlink RSCP after despreading or the lowest pathloss (the measurement quantity to be used is determined by the IE "intra-frequency measurement quantity" of the intra-frequency measurement from which the event 1a configuration is taken), among the cells on frequency F_i considered in that inter-frequency measurement, where:

$$N_i = \min(N_{1a}, N_{Cells\ F_i}) \text{ if } N_{1a} \neq 0 \text{ and } N_i = N_{Cells\ F_i} \text{ otherwise.}$$

where:

N_{1a} is the "Reporting deactivation threshold" included in the intra-frequency measurement for the first event 1a defined in the intra-frequency measurement with the lowest identity at the time the inter-frequency measurement was received with the IE "Inter-frequency set update" present.

$N_{Cells\ F_i}$ is the number of cells on frequency F_i considered in that inter-frequency measurement.

2> else:

$$N_i = N_{Cells\ F_i}$$

where:

$N_{Cells\ F_i}$ is the number of cells on frequency F_i considered in that inter-frequency measurement.

NOTE1: The UE initialises the virtual active set with up to the maximum number of inter-frequency cells supported by the UE as defined in [19].

NOTE2: If the UTRAN configures more than one measurement using events 2A, 2B, 2C or 2E the UE measurement capabilities may be exceeded due to the necessary copying of 1A, 1B, 1C criteria. To avoid this the UTRAN may configure one measurement to apply to multiple frequencies so that the 1A, 1B, and 1C criteria will only be copied once.

NOTE3: After a hard handover (see subclause 8.3.5), if the MEASUREMENT CONTROL message that restarts an inter-frequency measurement using the virtual active set does not include the IE "Inter-frequency set update", the UE behaviour regarding the virtual active set is not specified.

14.11.2 Virtual active set update during an inter-frequency measurement

For an inter-frequency measurement, the UE shall:

- 1> apply the events of type 1a, 1b and 1c that were defined for the used frequency in other stored measurements of type "intra-frequency" at the time the inter-frequency measurement was last received with the IE "Inter-frequency set update" present; and
- 1> update the virtual active set for the non-used frequencies considered in that measurement according to the following rules:
 - 2> if several events of type 1a (resp. 1b,1c) were defined for the used frequency when the inter-frequency measurement was last received with the IE "Inter-frequency set update" present, only the first 1a event (resp. 1b, 1c) that was defined in the measurement with the lowest measurement identity shall apply to the non-used frequencies;
 - 2> all the cells considered in the inter-frequency measurements shall be able to affect the reporting range for event 1a and 1b. (i.e. the IE "Cells forbidden to affect reporting range" possibly stored for the intra-frequency measurements on the used frequency does not apply to the non-used frequencies considered in the inter-frequency measurement);
 - 2> the IEs "amount of reporting" and "reporting interval" that were stored for the intra-frequency measurements on the used frequency shall not be considered if reports of the virtual active set updates are needed.
 - 2> the measurement quantity and filter coefficient to be used is determined by the IE "intra-frequency measurement quantity" of the intra-frequency measurement from which the intra-frequency event configuration is taken.

NOTE: If the measurement quantity and filter coefficients to be used differ for the 1a, 1b, and 1c events applied then the UE behaviour is unspecified.

- 1> if event 1a is applicable to the non-used frequencies considered in the inter-frequency measurement, always only consider monitored cells that are not in the virtual active set for this event, and:
 - 2> when this event is triggered (according to the criteria described in subclause 14.1.2.1) by a cell for a non-used frequency considered in that measurement:
 - 3> if the "Reporting deactivation threshold" is equal to 0, or if the "Reporting deactivation threshold" is different from 0 and the number of cells included in the virtual active set for that frequency is less than or equal to the "Reporting deactivation threshold":
 - 4> add the primary CPICH that enters the reporting range to the "virtual active set".
 - 2> if event 1b is applicable for the non-used frequencies considered in that inter-frequency measurement, always only consider cells in the virtual active set for this event, and when this event is triggered (according to the criteria described in subclause 14.1.2.2) by a cell for a non-used frequency considered in that measurement:
 - 3> if the number of cells included in the virtual active set is greater than 1:
 - 4> remove the primary CPICH that leaves the reporting range from the "virtual active set".
 - 2> if event 1c is applicable for the non-used frequencies considered in that inter-frequency measurement, always only consider monitored cells for this event, and when this event is triggered (according to the criteria described in subclause 14.1.2.3) by a cell for a non-used frequency considered in that measurement:
 - 3> if the "Replacement activation threshold" is equal to 0, or if the "Replacement activation threshold" is different from 0 and the number of cells included in the virtual active set for that frequency is greater than or equal to the "Replacement activation threshold":
 - 4> rank all active and non-active primary CPICHs and take the n best cells to create a new "virtual active set", where n is the number of active primary CPICHs in the "virtual active set".
- 1> if Event 1a is not defined for the used frequency in other stored measurements of type "intra-frequency" at the time the inter-frequency measurement was set up:

- 2> the UE shall continuously update the virtual active set to consist of all cells on frequency F_i considered in that inter-frequency measurement.

NOTE: The UE needs to only update the virtual active set with up to the maximum number of interfrequency cells supported by the UE as defined in [19].

If none of the cells that are considered in the measurement on this frequency were measured, the UE may treat the virtual active set as empty and follow the appropriate initialisation procedure in subclause 14.11.1 when any relevant cell can first be measured.

If a cell is a member of the virtual active set and is removed from the variable CELL_INFO_LIST or removed from the list of cells pointed at by the IE "Cells for measurement" for the inter-frequency measurement then the UE shall remove the cell from the virtual active set.

If an inter-frequency measurement that initialised a virtual active set is released, then any virtual active set associated with this measurement shall also be released.

14.12 Provision and reception of RRC information between network nodes

14.12.0 General

In certain cases, e.g., when performing handover to UTRAN or when performing SRNC relocation, RRC information may need to be transferred between UTRAN nodes, between UTRAN and another RAT, between nodes within another RAT or between the UE and another RAT.

The RRC information exchanged between network nodes or between the UE and another RAT is typically transferred by means of RRC information containers. An RRC information container is a self-contained and extensible RRC information unit that may be used to transfer a number of different RRC messages, one at a time. As stated before, RRC information containers may be used to transfer RRC messages across interfaces other than the Uu interface. The RRC messages that may be included in RRC information containers have similar characteristics as the RRC messages that are transferred across the Uu interface.

The RRC messages that are sent to/ from the UE, e.g., HANDOVER TO UTRAN COMMAND, INTER RAT HANDOVER INFO are covered by (sub)clauses 8, 9, 10, 11.0-11.4 and 12 of this specification. The following subclauses concern RRC messages exchanged between network nodes.

In future versions of this specification, it is possible to extend the RRC messages transferred across interfaces other than Uu. For these RRC messages the same extension mechanism applies as defined for RRC messages transferred across the Uu interface, as is specified in subclause 10.1, i.e., both critical and non-critical extensions may be added.

The transfer syntax for RRC information containers and RRC messages transferred between network nodes is derived from their ASN.1 definitions by use of Packed Encoding Rules, unaligned (X.691). It should be noted that the encoder adds final padding to achieve octet alignment. The resulting octet string is, carried in a container, transferred between the network nodes.

When using a separate RRC information container for each endpoint, the receiving RRC protocol entity is able to interpret the received container; this means that the receiver need not take into account information about the (network interface) message used in transferring the container.

The following encoding rules apply in addition to what has been specified in X.691 [49]:

- 1> When a bit string value is placed in a bit-field as specified in 15.6 to 15.11 in [11], the leading bit of the bit string value shall be placed in the leading bit of the bit-field, and the trailing bit of the bit string value shall be placed in the trailing bit of the bit-field.

NOTE: The terms "leading bit" and "trailing bit" are defined in ITU-T Rec. X.680 | ISO/IEC 8824-1. When using the "bstring" notation, the leading bit of the bit string value is on the left, and the trailing bit of the bit string value is on the right.

14.12.0a General error handling for RRC messages exchanged between network nodes

The error handling for RRC messages that are exchanged between network nodes applies the same principles as defined for other RRC messages.

Although the same principles apply for network nodes receiving unknown, unforeseen and erroneous RRC messages received in RRC information containers, the notification of the error should be done in a different manner, as specified in the following:

The network node receiving an invalid RRC message from another network node should:

- 1> if the received RRC message was unknown, unforeseen or erroneous:
 - 2> prepare an RRC FAILURE INFO message, including the IE "Failure cause" set to "Protocol error" and the IE "Protocol error information" including an IE "Protocol error cause" which should be set as follows:
 - 3> to "ASN.1 violation or encoding error" upon receiving an RRC message for which the encoded message does not result in any valid abstract syntax value;
 - 3> to "Message type non-existent or not implemented" upon receiving an unknown RRC message type;
 - 3> to "Message extension not comprehended" upon receiving an RRC message including an undefined critical message extension;
 - 3> to "Information element value not comprehended" upon receiving an RRC message including an mandatory IE for which no default value is defined and for which either the value is set to spare or for which the encoded IE does not result in a valid transfer syntax. The same applies for conditional IEs, for which the conditions for presence are met, the IE is present but has a value set to spare or for which the encoded IE does not result in a valid transfer syntax;
 - 3> to "Information element missing" upon receiving an RRC information container with an absent conditional IE for which the conditions for presence are met.
 - 1> if there was another failure to perform the operation requested by the received RRC message:
 - 2> prepare an RRC FAILURE INFO message, including the IE "Failure cause" set to a value that reflects the failure cause.
- 1> send the RRC FAILURE INFO message to the network node from which the invalid RRC protocol information was received.

NOTE 1: The appropriate (failure) messages used across the network interfaces may not support the inclusion of a RRC information container. In this case, the information contained in the RRC FAILURE INFO message may need to be transferred otherwise e.g. by mapping to a cause value (e.g. a cause value in the RR-HANDOVER FAILURE message when there is a error associated with the RRC-HANDOVER TO UTRAN COMMAND message).

NOTE 2 In case the RRC procedure used to perform SRNS relocation fails e.g. due to non comprehension, the source RNC may notify the target RNC by including the diagnostics information (IEs "Protocol error" and "Protocol error information") in the "RRC message "SRNS Relocation" Info sent in the RRC information container" used for a subsequent relocation request.

14.12.1 RRC Information to target RNC

The RRC information container "RRC Information to target RNC" may either be sent from source RNC or from another RAT. In case of handover to UTRAN, this information originates from another RAT, while in case of SRNC relocation the RRC information originates from the source RNC. In case of handover to UTRAN, the RRC information transferred may provide UTRAN specific information, as defined in the INTER RAT HANDOVER INFO WITH INTER RAT CAPABILITIES message, that the target RNC needs when preparing the handover command message. In case of SRNC relocation and handover/cell reselection from GERAN *Iu mode*, the RRC information transferred specifies the configuration of RRC and the lower layers it controls, e.g., including the radio bearer and transport channel configuration. It is used by the target RNC to initialise RRC and the lower layer protocols to facilitate SRNC relocation and handover/cell reselection from GERAN *Iu mode* in a manner transparent to the UE.

RFC 3095 CONTEXT INFO is used to transfer the compressor and decompressor context information of the RFC 3095 protocol from source RNC to target RNC.

| Information Element/Group Name | Need | Multi | Type and reference | Semantics description | Version |
|--------------------------------|------|-------|--|---|---------|
| CHOICE <i>case</i> | MP | | | At least one spare choice, Criticality: Reject, is needed | |
| >Handover to UTRAN | | | INTER RAT HANDOVER INFO WITH INTER RAT CAPABILITIES
14.12.4.1 | | |
| >SRNC relocation | | | SRNS RELOCATION INFO
14.12.4.2 | | |
| >RFC 3095 context info | | | RFC 3095 CONTEXT INFO
14.12.4.4 | | REL-5 |

14.12.2 RRC information, target RNC to source RNC

There are 2 possible cases for RNC relocation:

1. The UE is already under control of target RNC; and
2. The SRNC Relocation with Hard Handover (UE still under control of SRNC), but UE is moving to a location controlled by the target RNC (based on measurement information).

In case 1 the relocation is transparent to the UE and there is no "reverse" direction container. The SRNC just assigns the 'serving' function to the target RNC, which then becomes the Serving RNC.

In case 2 the relocation is initiated by SRNC, which also provides the RRC Initialisation Information to the target RNC. Base on this information, the target RNC prepares the Hard Handover Message ("Physical channel reconfiguration" (subclause 8.2.6), "radio bearer establishment" (subclause 8.2.1), "Radio bearer reconfiguration" (subclause 8.2.2), "Radio bearer release" (subclause 8.2.3) or "Transport channel reconfiguration" (subclause 8.2.4).

In case 2 two possibilities are defined in order to transmit the relocation message from the target RNC to the source RNC which can be chosen by the source RNC by including or not including the IE "RB Id for handover message" in the IE "SRNS Relocation Info".

In case the IE "RB Id for handover message" has been received by the target RNC in the IE "SRNS Relocation Info", the target RNC should choose the IE "DL DCCCH message" and include the DL DCCCH message that should be transmitted transparently to the UE by the source RNC. In that case, the target RNC is integrity protecting the message if applicable.

If the target RNC did not receive the IE "RB Id for handover message" in the IE "SRNS Relocation Info" the target RNC should use another choice. In that case, the source RNC should integrity protect the message before transmitting it to the UE if applicable.

The source RNC then transmits the Handover Message to the UE, which then performs the handover.

In the successful case, the UE transmits an XXX COMPLETE message, using the new configuration, to the target RNC.

In case of failure, the UE transmits an XXX FAILURE, using the old configuration, to the source RNC and the RRC context remains unchanged (has to be confirmed and checked with the SRNS relocation procedure).

| Information Element/Group name | Need | Multi | Type and reference | Semantics description |
|--------------------------------|------|-------|--------------------|---|
| CHOICE <i>RRC message</i> | MP | | | At least one spare choice, Criticality: Reject, is needed |

| Information Element/Group name | Need | Multi | Type and reference | Semantics description |
|------------------------------------|------|-------|--|-----------------------|
| >RADIO BEARER SETUP | | | RADIO BEARER SETUP
10.2.31 | |
| >RADIO BEARER RECONFIGURATION | | | RADIO BEARER RECONFIGURATION
10.2.25 | |
| >RADIO BEARER RELEASE | | | RADIO BEARER RELEASE
10.2.28 | |
| >TRANSPORT CHANNEL RECONFIGURATION | | | TRANSPORT CHANNEL RECONFIGURATION
10.2.51 | |
| >PHYSICAL CHANNEL RECONFIGURATION | | | PHYSICAL CHANNEL RECONFIGURATION
10.2.20 | |
| >RRC FAILURE INFO | | | RRC FAILURE INFO
10.2.41
a | |
| >DL DCCH message | | | OCTET STRING | |

14.12.3 Void

14.12.4 RRC messages exchanged between network nodes

14.12.4.0 HANDOVER TO UTRAN COMMAND

This RRC message is sent between network nodes to transfer the actual handover command including the details of the radio configuration to be used upon handover to UTRAN as compiled by the target RNC.

Direction: target RNC →source RAT

The message is exactly the same as the HANDOVER TO UTRAN COMMAND defined in subclause 10.2.16a.

14.12.4.0a INTER RAT HANDOVER INFO

This RRC message is sent between network nodes to transfer information relevant for the target RNC when preparing for handover to UTRAN.

Direction: source RAT node→target RAT node

The message is exactly the same as the INTER RAT HANDOVER INFO defined in subclause 10.2.16d.

14.12.4.1 INTER RAT HANDOVER INFO WITH INTER RAT CAPABILITIES

This RRC message is sent between network nodes when preparing for an inter RAT handover to UTRAN.

The radio access capabilities for the source RAT and target RAT shall always be included; the radio access capabilities for other RATs may be included if available at the source RAT.

Direction: source RAT→target RNC

| Information Element/Group Name | Need | Multi | Type and reference | Semantics description | Version |
|--|------|-------|---|--|---------|
| UE Information elements | | | | | |
| Predefined configuration status information | OP | | Predefined configuration status information
10.3.4.5a | | |
| Predefined configuration status information compressed | OP | | Predefined configuration status information compressed
10.3.4.5b | | REL-5 |
| UE security information | OP | | UE security information
10.3.3.42b | | |
| UE security information2 | OP | | UE security information2
10.3.3.42c | | REL-6 |
| UE Specific Behaviour Information 1 interRAT | OP | | UE Specific Behaviour Information 1 interRAT
10.3.3.52 | This IE shall not be included in this version of the protocol | |
| UE capability container | OP | | | | |
| >UE radio access capability | MP | | UE radio access capability
10.3.3.42 | | |
| >UE radio access capability extension | MP | | UE radio access capability extension
10.3.3.42a | Although this IE is not always required, the need has been set to MP to align with the ASN.1 | |

| Information Element/Group Name | Need | Multi | Type and reference | Semantics description | Version |
|---------------------------------------|------------|----------------------------|--|---|---------|
| UE radio access capability compressed | OP | | UE radio access capability compressed 10.3.3.42o | | REL-5 |
| UE radio access capability comp 2 | OP | | UE radio access capability comp 2 10.3.3.42oa | | REL-6 |
| Other Information elements | | | | | |
| UE system specific capability | OP | 1 to <maxSystemCapability> | | | |
| >Inter-RAT UE radio access capability | MP | | Inter-RAT UE radio access capability 10.3.8.7 | | |
| Failure cause | OP | | Failure cause 10.3.3.13 | Diagnostics information related to an earlier handover to UTRAN request | |
| Protocol error information | CV-ProtErr | | Protocol error information 10.3.8.12 | | |

| Condition | Explanation |
|----------------|---|
| <i>ProtErr</i> | This IE is mandatory present if the IE "Protocol error indicator" is included and has the value TRUE. Otherwise it is not needed. |

NOTE1: To facilitate that network nodes can transparently forward the RRC information received, the INTER RAT HANDOVER INFO WITH INTER RAT CAPABILITIES should include the entire INTER RAT HANDOVER INFO message. The network node, which may not be able to decode the information received, may only append some information to what was received.

NOTE2: The above table does not need to reflect the order of the information elements in the actual encoded message. The order, that is reflected in the ASN.1, should be chosen in a manner that avoids that network nodes need to perform reordering of information elements.

14.12.4.2 SRNS RELOCATION INFO

This RRC message is sent between network nodes when preparing for an SRNS relocation or a handover/cell reselection from GERAN *Iu mode*.

With the presence or absence of the IE "RB identity for Hard Handover message" the source RNC indicates to the target SRNC whether the source RNC expects to receive the choice "DL DCCH message" in the IE "RRC information, target RNC to source RNC" in case the SRNS relocation is of type "UE involved". Furthermore the target RNC uses this information for the calculation of the MAC-I.

Direction: source RNC/RAT→target RNC

| Information Element/Group Name | Need | Multi | Type and reference | Semantics description | Version |
|-----------------------------------|------|-------|-----------------------|--|---------|
| Non RRC IEs | | | | | |
| >RB identity for Handover message | OP | | RB identity 10.3.4.16 | Gives the id of the radio bearer on which the source RNC will transmit the RRC message in the case the relocation is of type "UE involved". In | |

| Information Element/Group Name | Need | Multi | Type and reference | Semantics description | Version |
|--------------------------------------|------|----------------------|---|--|---------|
| | | | | handover from GERAN <i>lu mode</i> this IE is always set to 2. | |
| >State of RRC | MP | | RRC state indicator, 10.3.3.35a | | |
| >State of RRC procedure | MP | | Enumerated (await no RRC message, await RB Release Complete, await RB Setup Complete, await RB Reconfiguration Complete, await Transport CH Reconfiguration Complete, await Physical CH Reconfiguration Complete, await Active Set Update Complete, await Handover Complete, send Cell Update Confirm, send URA Update Confirm, , others) | | |
| Ciphering related information | | | | | |
| >Ciphering status for each CN domain | MP | <1 to maxCNDo mains> | | | |
| >>CN domain identity | MP | | CN domain identity 10.3.1.1 | | |
| >>Ciphering status | MP | | Enumerated(Not started, Started) | | |
| >>START | MP | | START 10.3.3.38 | START value to be used in this CN domain. | |
| >Latest configured CN domain | MP | | CN domain identity 10.3.1.1 | Value contained in the variable of the same name. In case this variable is empty, the source RNC can set any CN domain identity. In that case, the Ciphering status and the Integrity protection status should be Not started and the target RNC should not initialise the variable Latest configured CN domain. | |

| Information Element/Group Name | Need | Multi | Type and reference | Semantics description | Version |
|--|-------------------------|----------------------------|---|---|---------|
| >Calculation time for ciphering related information | CV-
<i>Ciphering</i> | | | Time when the ciphering information of the message were calculated, relative to a cell of the target RNC. In handover and cell reselection from GERAN <i>lu mode</i> this field is not present. | |
| >>Cell Identity | MP | | Cell Identity
10.3.2.2 | Identity of one of the cells under the target RNC and included in the active set of the current call | |
| >>SFN | MP | | Integer(0..4095) | | |
| >COUNT-C list | OP | 1 to
<maxCNdo
mains> | | COUNT-C values for radio bearers using transparent mode RLC | |
| >>CN domain identity | MP | | CN domain
identity
10.3.1.1 | | |
| >>COUNT-C | MP | | Bit string(32) | | |
| >Ciphering info per radio bearer | OP | 1 to
<maxRB> | | For signalling radio bearers this IE is mandatory. | |
| >>RB identity | MP | | RB identity
10.3.4.16 | | |
| >>Downlink HFN | MP | | Bit
string(20..25
) | This IE is either RLC AM HFN (20 bits) or RLC UM HFN (25 bits) | |
| >>Downlink SN | CV- <i>SRB1</i> | | Bit String(7) | VT(US) of RLC UM | |
| >>Uplink HFN | MP | | Bit
string(20..25
) | This IE is either RLC AM HFN (20 bits) or RLC UM HFN (25 bits) | |
| Integrity protection related information | | | | | |
| >Integrity protection status | MP | | Enumerated(
Not started,
Started) | | |
| >Signalling radio bearer specific integrity protection information | CV- <i>IP</i> | 4 to
<maxSRBs
etup> | | | |
| >>Uplink RRC HFN | MP | | Bit string
(28) | For each SRB, in the case activation times for the next IP configuration to be applied on this SRB have already been reached this IE corresponds to the last value used. Else this value corresponds to the value the source would have initialized the HFN to at the activation time, not considering any increment of HFN due to RRC SN roll over. Increment of HFN due to RRC SN roll over is taken care of by target based on value sent by the source. | |
| >>Downlink RRC HFN | MP | | Bit string
(28) | For each SRB, in the case activation times for the next IP configuration to be applied on this SRB have already been reached this IE corresponds to the last value used. Else this value corresponds to the value the source would have initialized the HFN to at the activation time, not considering any increment of HFN due to | |

| Information Element/Group Name | Need | Multi | Type and reference | Semantics description | Version |
|--|------|-------|--|---|---------|
| | | | | RRC SN roll over. Increment of HFN due to RRC SN roll over is taken care of by target based on value sent by the source. In particular, for SRB2, this IE should not take into account the RRC message that will trigger the relocation. NOTE: In order to have the possibility of sending downlink messages after the construction of the IE "SRNS RELOCATION INFO", the source may choose a value ahead of the last value used. | |
| >>Uplink RRC Message sequence number | MP | | Integer (0..15) | For each SRB, this IE corresponds to the last value received or in the case activation time was not reached for a configuration the value equals (activation time - 1). | |
| >>Downlink RRC Message sequence number | MP | | Integer (0..15) | For each SRB, this IE corresponds to the last value used or in the case activation time was not reached for a configuration the value equals (activation time -1). In particular, for SRB2, this IE should not take into account the RRC message that will trigger the relocation. NOTE: In order to have the possibility of sending downlink messages after the construction of the IE "SRNS RELOCATION INFO", the source may choose a value ahead of the last value used for SRB3 and SRB4. | |
| >Implementation specific parameters | OP | | Bit string (1..512) | | |
| RRC IEs | | | | | |
| UE Information elements | | | | | |
| >U-RNTI | MP | | U-RNTI
10.3.3.47 | G-RNTI is placed in this field when performing handover or cell reselection from GERAN <i>lu mode</i> . | |
| >C-RNTI | OP | | C-RNTI
10.3.3.8 | | |
| >UE radio access Capability | MP | | UE radio access capability
10.3.3.42 | | |
| >UE radio access capability extension | OP | | UE radio access capability extension
10.3.3.42a | | |
| >Last known UE position | OP | | | | |
| >>SFN | MP | | Integer (0..4095) | Time when position was estimated | |
| >>Cell ID | MP | | Cell identity;
10.3.2.2 | Indicates the cell, the SFN is valid for. | |
| >>CHOICE <i>Position estimate</i> | MP | | | | |
| >>>Ellipsoid Point | | | Ellipsoid | | |

| Information Element/Group Name | Need | Multi | Type and reference | Semantics description | Version |
|--|------|----------------------------|--|--|---------|
| | | | Point;
10.3.8.4a | | |
| >>>Ellipsoid point with uncertainty circle | | | Ellipsoid point with uncertainty circle
10.3.8.4d | | |
| >>>Ellipsoid point with uncertainty ellipse | | | Ellipsoid point with uncertainty ellipse
10.3.8.4e | | |
| >>>Ellipsoid point with altitude | | | Ellipsoid point with altitude
10.3.8.4b | | |
| >>>Ellipsoid point with altitude and uncertainty ellipsoid | | | Ellipsoid point with altitude and uncertainty ellipsoid
10.3.8.4c | | |
| >UE Specific Behaviour Information 1 idle | OP | | UE Specific Behaviour Information idle 1
10.3.3.51 | This IE should be included if received via the "INTER RAT HANDOVER INFO", the "RRC CONNECTION REQUEST", the IE "SRNS RELOCATION INFO" or the "Inter RAT Handover Info with Inter RAT Capabilities" | |
| >UE Specific Behaviour Information 1 interRAT | OP | | UE Specific Behaviour Information 1 interRAT
10.3.3.52 | This IE should be included if received via the "INTER RAT HANDOVER INFO", the "RRC CONNECTION REQUEST", the IE "SRNS RELOCATION INFO" or the "Inter RAT Handover Info with Inter RAT Capabilities" | |
| Other Information elements | | | | | |
| >UE system specific capability | OP | 1 to <maxSystemCapability> | | | |
| >>Inter-RAT UE radio access capability | MP | | Inter-RAT UE radio access capability
10.3.8.7 | | |
| UTRAN Mobility Information elements | | | | | |
| >URA Identifier | OP | | URA identity
10.3.2.6 | | |
| >T305 | OP | | Integer (5, 10, 30, 60, 120, 360, 720, infinity) | If UE is in CELL_FACH state, this information element shall be included. Value in minutes. Infinity means no update. | REL-7 |
| CN Information Elements | | | | | |
| >CN common GSM-MAP NAS system information | MP | | NAS system information (GSM-MAP)
10.3.1.9 | | |
| >CN domain related information | OP | 1 to <MaxCNdomains> | | CN related information to be provided for each CN domain | |
| >>CN domain identity | MP | | | | |
| >>CN domain specific GSM- | MP | | NAS system | | |

| Information Element/Group Name | Need | Multi | Type and reference | Semantics description | Version |
|---|----------|---------------------|---|--|---------|
| MAP NAS system info | | | information (GSM-MAP) 10.3.1.9 | | |
| >>CN domain specific DRX cycle length coefficient | MP | | CN domain specific DRX cycle length coefficient, 10.3.3.6 | | |
| Measurement Related Information elements | | | | | |
| >For each ongoing measurement reporting | OP | 1 to <MaxNoOf Meas> | | The source RNC should include the measurement IEs for each measurement configured and ongoing in the UE. | |
| >>Measurement Identity | MP | | Measurement identity 10.3.7.48 | | |
| >>Measurement Command | MP | | Measurement command 10.3.7.46 | This IE should have the value Setup. | |
| >>Measurement Type | CV-Setup | | Measurement type 10.3.7.50 | | |
| >>Measurement Reporting Mode | OP | | Measurement reporting mode 10.3.7.49 | | |
| >>Additional Measurements list | OP | | Additional measurements list 10.3.7.1 | | |
| >>CHOICE <i>Measurement</i> | CV-Setup | | | | |
| >>>Intra-frequency | | | | | |
| >>>>Intra-frequency cell info | OP | | Intra-frequency cell info list 10.3.7.33 | | |
| >>>>Intra-frequency measurement quantity | OP | | Intra-frequency measurement quantity 10.3.7.38 | | |
| >>>>Intra-frequency reporting quantity | OP | | Intra-frequency reporting quantity 10.3.7.41 | | |
| >>>>Reporting cell status | OP | | Reporting cell status 10.3.7.61 | | |
| >>>>Measurement validity | OP | | Measurement validity 10.3.7.51 | | |
| >>>>CHOICE <i>report criteria</i> | OP | | | | |
| >>>>>Intra-frequency measurement reporting criteria | | | Intra-frequency measurement reporting criteria 10.3.7.39 | | |
| >>>>>Periodical reporting | | | Periodical reporting criteria 10.3.7.53 | | |

| Information Element/Group Name | Need | Multi | Type and reference | Semantics description | Version |
|---|------|-------|---|-----------------------|---------|
| >>>>No reporting | | | NULL | | |
| >>>Inter-frequency | | | | | |
| >>>>Inter-frequency cell info | OP | | Inter-frequency cell info list
10.3.7.13 | | |
| >>>>Inter-frequency measurement quantity | OP | | Inter-frequency measurement quantity
10.3.7.18 | | |
| >>>>Inter-frequency reporting quantity | OP | | Inter-frequency reporting quantity
10.3.7.21 | | |
| >>>>Reporting cell status | OP | | Reporting cell status
10.3.7.61 | | |
| >>>>Measurement validity | OP | | Measurement validity
10.3.7.51 | | |
| >>>>Inter-frequency set update | OP | | Inter-frequency set update
10.3.7.22 | | |
| >>>>CHOICE <i>report criteria</i> | OP | | | | |
| >>>>>Intra-frequency measurement reporting criteria | | | Intra-frequency measurement reporting criteria
10.3.7.39 | | |
| >>>>>Inter-frequency measurement reporting criteria | | | Inter-frequency measurement reporting criteria
10.3.7.19 | | |
| >>>>>Periodical reporting | | | Periodical reporting criteria
10.3.7.53 | | |
| >>>>>No reporting | | | NULL | | |
| >>>Inter-RAT | | | | | |
| >>>>Inter-RAT cell info | OP | | Inter-RAT cell info list
10.3.7.23 | | |
| >>>>Inter-RAT measurement quantity | OP | | Inter-RAT measurement quantity
10.3.7.29 | | |
| >>>>Inter-RAT reporting quantity | OP | | Inter-RAT reporting quantity
10.3.7.32 | | |
| >>>>Reporting cell status | OP | | Reporting cell status
10.3.7.61 | | |
| >>>>Measurement validity | OP | | Measurement validity
10.3.7.51 | | |

| Information Element/Group Name | Need | Multi | Type and reference | Semantics description | Version |
|--|------|-------|--|-----------------------|---------|
| >>>>E-UTRA frequency list | OP | | E-UTRA frequency list
10.3.7.6b | | REL-8 |
| >>>>CHOICE <i>report criteria</i> | OP | | | | |
| >>>>>Inter-RAT measurement reporting criteria | | | Inter-RAT measurement reporting criteria
10.3.7.30 | | |
| >>>>>>Periodical reporting | | | Periodical reporting criteria
10.3.7.53 | | |
| >>>>>>No reporting | | | NULL | | |
| >>>Traffic Volume | | | | | |
| >>>>Traffic volume measurement Object | OP | | Traffic volume measurement object
10.3.7.70 | | |
| >>>>Traffic volume measurement quantity | OP | | Traffic volume measurement quantity
10.3.7.71 | | |
| >>>>Traffic volume reporting quantity | OP | | Traffic volume reporting quantity
10.3.7.74 | | |
| >>>>Measurement validity | OP | | Measurement validity
10.3.7.51 | | |
| >>>>CHOICE <i>report criteria</i> | OP | | | | |
| >>>>>Traffic volume measurement reporting criteria | | | Traffic volume measurement reporting criteria
10.3.7.72 | | |
| >>>>>>Periodical reporting | | | Periodical reporting criteria
10.3.7.53 | | |
| >>>>>>No reporting | | | NULL | | |
| >>>Quality | | | | | |
| >>>>Quality measurement quantity | OP | | Quality measurement quantity
10.3.7.59 | | |
| >>>>CHOICE <i>report criteria</i> | OP | | | | |
| >>>>>Quality measurement reporting criteria | | | Quality measurement reporting criteria
10.3.7.58 | | |
| >>>>>>Periodical reporting | | | Periodical reporting criteria
10.3.7.53 | | |
| >>>>>>No reporting | | | NULL | | |
| >>>UE internal | | | | | |
| >>>>UE internal measurement quantity | OP | | UE internal measurement | | |

| Information Element/Group Name | Need | Multi | Type and reference | Semantics description | Version |
|---|------|---------------------|---|----------------------------------|---------|
| | | | t quantity
10.3.7.79 | | |
| >>>>UE internal reporting quantity | OP | | UE internal reporting quantity
10.3.7.82 | | |
| >>>>CHOICE <i>report criteria</i> | OP | | | | |
| >>>>>UE internal measurement reporting criteria | | | UE internal measurement reporting criteria
10.3.7.80 | | |
| >>>>>Periodical reporting | | | Periodical reporting criteria
10.3.7.53 | | |
| >>>>>No reporting | | | NULL | | |
| >>>>>UE positioning | | | | | |
| >>>>>LCS reporting quantity | OP | | LCS reporting quantity
10.3.7.111 | | |
| >>>>>CHOICE <i>report criteria</i> | OP | | | | |
| >>>>>>LCS reporting criteria | | | LCS reporting criteria
10.3.7.110 | | |
| >>>>>>Periodical reporting | | | Periodical reporting criteria
10.3.7.53 | | |
| >>>>>>No reporting | | | | | |
| Radio Bearer Information Elements | | | | | |
| >Predefined configuration status information | OP | | Predefined configuration status information
10.3.4.5a | | |
| >Signalling RB information list | MP | 1 to <maxSRBs etup> | | For each signalling radio bearer | |
| >>Signalling RB information | MP | | Signalling RB information to setup
10.3.4.24 | | |
| >RAB information list | OP | 1 to <maxRABs etup> | | Information for each RAB | |
| >>RAB information | MP | | RAB information to setup
10.3.4.10 | | |
| >PDCP ROHC target mode | OP | | PDCP ROHC target mode
10.3.4.2a | | REL-8 |
| Transport Channel Information Elements | | | | | |
| Uplink transport channels | | | | | |
| >UL Transport channel information common for all transport channels | OP | | UL Transport channel information common for | | |

| Information Element/Group Name | Need | Multi | Type and reference | Semantics description | Version |
|---|------|-----------------|--|-----------------------|---------|
| | | | all transport channels
10.3.5.24 | | |
| >UL transport channel information list | OP | 1 to <MaxTrCH > | | | |
| >>UL transport channel information | MP | | Added or reconfigured UL TrCH information
10.3.5.2 | | |
| Downlink transport channels | | | | | |
| >DL Transport channel information common for all transport channels | OP | | DL Transport channel information common for all transport channels
10.3.5.6 | | |
| >DL transport channel information list | OP | 1 to <MaxTrCH > | | | |
| >>DL transport channel information | MP | | Added or reconfigured DL TrCH information
10.3.5.1 | | |

| Information Element/Group Name | Need | Multi | Type and reference | Semantics description | Version |
|--|-----------|-------------------|--|---|---------|
| PhyCH information elements | | | | | |
| >TPC Combination Info list | OP | 1 to <maxRL> | | | |
| >>Primary CPICH info | MP | | Primary CPICH info 10.3.6.60 | | |
| >>TPC combination index | MP | | TPC combination index 10.3.6.85 | | |
| >E-RGCH Combination Info list | OP | 1 to <maxEDC HRL> | | | REL-8 |
| >>Primary CPICH info | MP | | Primary CPICH info 10.3.6.60 | | REL-8 |
| >>RG combination index | MP | | Integer (0..5) | | REL-8 |
| >Transmission gap pattern sequence | OP | 1 to <maxTGP S> | | | REL-5 |
| >>TGPSI | MP | | TGPSI 10.3.6.82 | | REL-5 |
| >> Current TGPS Status Flag | MP | | Enumerated(active, inactive) | This flag indicates the current status of the Transmission Gap Pattern Sequence, whether it is active or inactive | REL-5 |
| >>TGCFN | CV-Active | | Integer (0..255) | Connection Frame Number of the latest past frame of the first pattern within the Transmission Gap Pattern Sequence. | REL-5 |
| >>Transmission gap pattern sequence configuration parameters | OP | | | | REL-5 |
| >>>TGMP | MP | | Enumerated(TDD measurement, FDD measurement, GSM carrier RSSI measurement, GSM Initial BSIC identification, GSM BSIC re-confirmation, Multi-carrier measurement, E-UTRA measurements) | Transmission Gap pattern sequence Measurement Purpose. | REL-5 |
| | | | | | REL-8 |
| >>>TGPRC | MP | | Integer (1..511, Infinity) | The number of remaining transmission gap patterns within the Transmission Gap Pattern Sequence. | REL-5 |
| >>>TGSN | MP | | Integer (0..14) | Transmission Gap Starting Slot Number
The slot number of the first transmission gap slot within the TGCFN. | REL-5 |
| >>>TGL1 | MP | | Integer(1..14) | The length of the first Transmission Gap within the transmission gap pattern | REL-5 |

| Information Element/Group Name | Need | Multi | Type and reference | Semantics description | Version |
|--------------------------------------|------|-------|--|---|---------|
| | | | | expressed in number of slots | |
| >>>TGL2 | MD | | Integer (1..14) | The length of the second Transmission Gap within the transmission gap pattern. If omitted, then TGL2=TGL1. The value of TGL2 shall be ignored if TGD is set to 'undefined' | REL-5 |
| >>>TGD | MP | | Integer(15..269, undefined) | Transmission gap distance indicates the number of slots between starting slots of two consecutive transmission gaps within a transmission gap pattern. If there is only one transmission gap in the transmission gap pattern, this parameter shall be set to undefined. | REL-5 |
| >>>TGPL1 | MP | | Integer (1..144) | The duration of transmission gap pattern 1. | REL-5 |
| >>>RPP | MP | | Enumerated (mode 0, mode 1). | Recovery Period Power control mode during the frame after the transmission gap within the compressed frame. Indicates whether normal PC mode or compressed PC mode is applied | REL-5 |
| >>>ITP | MP | | Enumerated (mode 0, mode 1). | Initial Transmit Power is the uplink power control method to be used to compute the initial transmit power after the compressed mode gap. | REL-5 |
| >>>CHOICE <i>UL/DL mode</i> | MP | | | | REL-5 |
| >>>>DL only | | | | Compressed mode used in DL only | REL-5 |
| >>>>>Downlink compressed mode method | MP | | Enumerated (SF/2, higher layer scheduling) | Method for generating downlink compressed mode gap | REL-5 |
| >>>>>UL only | | | | Compressed mode used in UL only | REL-5 |
| >>>>>Uplink compressed mode method | MP | | Enumerated (SF/2, higher layer scheduling) | Method for generating uplink compressed mode gap | REL-5 |
| >>>>>UL and DL | | | | Compressed mode used in UL and DL | REL-5 |
| >>>>>Downlink compressed mode method | MP | | Enumerated (SF/2, higher layer scheduling) | Method for generating downlink compressed mode gap | REL-5 |
| >>>>>Uplink compressed mode method | MP | | Enumerated (SF/2, higher layer scheduling) | Method for generating uplink compressed mode gap | REL-5 |
| >>>Downlink frame type | MP | | Enumerated (A, B) | | REL-5 |
| >>>DeltaSIR1 | MP | | Real(0..3 by step of 0.1) | Delta in DL SIR target value to be set in the UE during the frame containing the start of the first transmission gap in the transmission gap pattern (without including the effect of the bit-rate increase) | REL-5 |
| >>>DeltaSIRafter1 | MP | | Real(0..3 by | Delta in DL SIR target value to | REL-5 |

| Information Element/Group Name | Need | Multi | Type and reference | Semantics description | Version |
|-----------------------------------|--------------------|--------------|--|---|---------|
| | | | step of 0.1) | be set in the UE one frame after the frame containing the start of the first transmission gap in the transmission gap pattern. | |
| >>>DeltaSIR2 | OP | | Real(0..3 by step of 0.1) | Delta in DL SIR target value to be set in the UE during the frame containing the start of the second transmission gap in the transmission gap pattern (without including the effect of the bit-rate increase)
When omitted, DeltaSIR2 = DeltaSIR1. | REL-5 |
| >>>DeltaSIRafter2 | OP | | Real(0..3 by step of 0.1) | Delta in DL SIR target value to be set in the UE one frame after the frame containing the start of the second transmission gap in the transmission gap pattern.
When omitted, DeltaSIRafter2 = DeltaSIRafter1. | REL-5 |
| >>>N Identify abort | CV-Initial BSIC | | Integer(1..128) | Indicates the maximum number of repeats of patterns that the UE shall use to attempt to decode the unknown BSIC of the GSM cell in the initial BSIC identification procedure | REL-5 |
| >>>T Reconfirm abort | CV-Re-confirm BSIC | | Real(0.5..10.0 by step of 0.5) | Indicates the maximum time allowed for the re-confirmation of the BSIC of one GSM cell in the BSIC re-confirmation procedure. The time is given in steps of 0.5 seconds. | REL-5 |
| >Scrambling Code Change List | CH-SF/2 | 1 to <maxRL> | | | REL-5 |
| >>Primary CPICH info | MP | | Primary CPICH info 10.3.6.60 | | REL-5 |
| >>Scrambling code change | MP | | Enumerated (code change, no code change) | Indicates whether the alternative scrambling code is used for compressed mode method 'SF/2'. | REL-5 |
| Other Information elements | | | | | |
| >Measurement report | OP | | MEASUREMENT REPORT 10.2.19 | The source RNC should include the Measurement report the UE sent that triggered the SRNS relocation. This information could e.g. be used by the target RNC to set initial power when establishing a DCH. | |
| >Failure cause | OP | | Failure cause 10.3.3.13 | Diagnostics information related to an earlier SRNC Relocation request (see NOTE 2 in 14.12.0a) | |
| >Protocol error information | CV-ProtErr | | Protocol error information 10.3.8.12 | | |
| UE history information | OP | | UE history information 10.3.8.23 | | REL-8 |
| MBMS information elements | | | | | |

| Information Element/Group Name | Need | Multi | Type and reference | Semantics description | Version |
|--------------------------------|------|-------|--|---|---------|
| MBMS joined information | OP | | | Included if the UE has joined one or more MBMS services | REL-6 |
| >P-TMSI | OP | | P-TMSI (GSM-MAP) 10.3.1.13 | In case the UE is in PMM-Idle | REL-6 |
| MBMS Selected Service Info | OP | | MBMS Selected Services Info 10.3.9a.7b | | REL-6 |

| Multi Bound | Explanation |
|-------------|---|
| MaxNoOfMeas | Maximum number of active measurements, upper limit 16 |

| Condition | Explanation |
|------------------------|--|
| <i>Setup</i> | The IE is mandatory present when the IE Measurement command has the value "Setup", otherwise the IE is not needed. |
| <i>Ciphering</i> | The IE is mandatory present when the IE Ciphering Status has the value "started" and the ciphering counters need not be reinitialised, otherwise the IE is not needed. |
| <i>IP</i> | The IE is mandatory present when the IE Integrity protection status has the value "started" and the integrity protection counters need not be reinitialised, otherwise the IE is not needed. |
| <i>ProtErr</i> | This IE is mandatory present if the IE "Protocol error indicator" is included and has the value TRUE. Otherwise it is not needed. |
| <i>SRB1</i> | The IE is mandatory present for RB1. Otherwise it is not needed. |
| <i>Active</i> | This IE is mandatory present when the value of the IE "Current TGPS Status Flag" is "Active" and not needed otherwise. |
| <i>Initial BSIC</i> | This IE is mandatory present when the value of the IE "TGMP" is set to "GSM Initial BSIC identification" and not needed otherwise. |
| <i>Re-confirm BSIC</i> | This IE is mandatory present when the value of the IE "TGMP" is set to "GSM BSIC re-confirmation" and not needed otherwise. |
| <i>SF/2</i> | The IE is mandatory present if the IE 'Transmission Gap Pattern Sequence' is included and has the value 'SF/2' as the compressed mode method, and already sent the UE the IE 'Scrambling Code Change' for each RL in the active set. Otherwise the IE is not needed. |

14.12.4.3 Void

14.12.4.4 RFC 3095 CONTEXT INFO

This RRC message is sent between network nodes in SRNS relocation. It is used to transfer the compressor and decompressor context information of the RFC 3095 protocol.

Direction: source RNC →target RNC

| Information Element/Group name | Need | Multi | Type and reference | Semantics description | Version |
|---------------------------------------|------|-----------------------|-------------------------|--|---------|
| RFC 3095 context | MP | 1 to <maxRBall RABs> | | | REL-5 |
| >RB identity | MP | | RB identity 10.3.4.16 | | REL-5 |
| >RFC 3095 context list | MP | 1 to <maxRFC3095-CID> | | | REL-5 |
| >>Downlink RFC 3095 context | OP | | | | REL-5 |
| >>>Downlink RFC 3095 context identity | MP | | Integer (0..16383) | | REL-5 |
| >>>DL_MODE | MP | | Enumerated (u, o, r) | RFC 3095 mode in downlink before SRNS relocation. | REL-5 |
| >>>REF_IR | MP | | Octet string (1..3000) | The RTP IR header (see section 5.7.7 of RFC3095 for detailed format) corresponding to the oldest header in the compressor sliding window. | REL-5 |
| >>>REF_TIME | OP | | Integer (0..4294967295) | Arrival time (at the compressor) of REF_IR in milliseconds. See sections 4.5.4 and 6.5.1 of RFC3095. | REL-5 |
| >>>CURR_TIME | OP | | Integer (0..4294967295) | Current time in milliseconds. See section 6.5.1 of RFC3095. | REL-5 |
| >>>SYN_OFFSET_ID | OP | | Integer (0..65535) | Last synchronized offset of IP-ID. See section 4.5.5 and 6.5.1 of RFC3095 (termed "Offset_I").

It is related to the compression and decompression of IP-ID and is the synchronized offset between the IP-ID value and the SN value (in the same header) during the last SO state before the relocation procedure. | REL-5 |
| >>>SYN_SLOPE_TS | OP | | Integer (0..4294967295) | Last synchronized slope of TS. See sections 5.5.1.2 and 5.7 of RFC3095.

In SO state, $TS(n) = TS(m) + (n-m) * SYN_SLOPE_TS$, where n and m are, the RTP SN of the current and | REL-5 |

| | | | | | |
|-------------------------------------|----|--|-------------------------|---|-------|
| | | | | the reference packet, respectively. The unit of SYN_SLOPE_TS depends on whether TS is scaled before compression or not. | |
| >>>DYN_CHANGED | MP | | Boolean | Information whether dynamic fields other than RTP SN, RTP TS and IP-ID have changed in the headers that are stored in the sliding window. Set to TRUE if changed and FALSE if not changed. | REL-5 |
| >>Uplink RFC 3095 context | OP | | | | REL-5 |
| >>>Uplink RFC 3095 context identity | MP | | Integer (0..16383) | | REL-5 |
| >>>UL_MODE | MP | | Enumerated (u, o, r) | RFC 3095 mode in uplink | REL-5 |
| >>>REF_IR | MP | | Octet string (1..3000) | The RTP IR header (see section 5.7.7 of IETF RFC3095 for detailed format) corresponding to the last correctly decompressed header. | REL-5 |
| >>>REF_TIME | OP | | Integer (0..4294967295) | Arrival time (at the decompressor) of REF_IR in milliseconds. See sections 4.5.4 and 6.5.1 of RFC3095. | REL-5 |
| >>>CURR_TIME | OP | | Integer (0..4294967295) | Current time in milliseconds. See section 6.5.1 of RFC3095. | REL-5 |
| >>>SYN_OFFSET_ID | OP | | Integer (0..65535) | Last synchronized offset of IP-ID. See sections 4.5.5 and 6.5.1 of RFC3095 (termed "Offset_I")

It is related to the compression and decompression of IP-ID and is the synchronized offset between the IP-ID value and the SN value (in the same header) during the last SO state before the relocation | REL-5 |

| | | | | | |
|-----------------|----|--|--------------------------------|--|-------|
| >>>SYN_SLOPE_TS | OP | | Integer
(0..4294967
295) | <p>procedure.</p> <p>Last synchronized slope of TS. See sections 5.5.1.2 and 5.7 of RFC3095.</p> <p>In SO state, $TS(n) = TS(m) + (n-m) * SYN_SLOPE_TS$, where n and m are, the RTP SN of the current and the reference packet, respectively. The unit of SYN_SLOPE_TS depends on whether TS is scaled before compression or not.</p> | REL-5 |
| >>>REF_SN_1 | OP | | Integer
(0..65535) | Corresponds to the RTP Sequence Number of the predecessor of the latest RTP packet. This could be used to perform local repair of context by decompressor in U or O mode (see 'ref - 1' in section 5.3.2.2.5 in IETF RFC3095 for further explanation). | REL-5 |

14.13 Void

14.14 Void

Annex A (informative): USIM parameters

A.1 Introduction

This annex contains recommendations about the RRC parameters to be stored in the USIM.

A.2 Cipherring information

| Information Element/Group name | Need | Multi | Type and reference | Semantics description |
|--|------|----------------------|--------------------|--|
| Cipher key for each CN domain | MP | <1 to maxCNDo mains> | | Cipher key is described in [40]. |
| >CK | MP | | Bit string (128) | |
| Integrity key for each CN domain | MP | <1 to maxCNDo mains> | | Integrity key is described in [40]. |
| >IK | MP | | Bit string (128) | |
| THRESHOLD | MP | | Bit string (20) | |
| START value for each CN domain | MP | <1 to maxCNDo mains> | | START value is described in [40]. |
| >START | MP | | Bit string (20) | |
| KSI, Key set identifier for each CN domain | MP | <1 to maxCNDo mains> | | Key set identifier is described in [40]. |
| >KSI | MP | | Bit string (3) | |

A.3 Frequency information

Neighbour cell list.

| Information Element/Group name | Need | Multi | Type and reference | Semantics description | Version |
|--------------------------------|------|----------------------------|------------------------------|--|---------|
| FDD cell list | OP | <1 to maxFDDFr eqList> | | | |
| >UARFCN downlink (Nd) | MP | | Integer(0 .. 16383) | [21] | |
| >Primary scrambling code | OP | <1 to maxFDDFr eqCellList> | Primary CPICH info 10.3.6.60 | | |
| 3.84 Mcps TDD cell list | OP | <1 to maxTDDFr eqList> | | | |
| >UARFCN (Nt) | MP | | Integer(0 .. 16383) | [22] | |
| >Cell parameters ID | OP | <1 to maxTDDFr eqCellList> | Integer (0..127) | The Cell parameters ID is described in [32]. | |
| 1.28 Mcps TDD cell list | OP | <1 to maxTDDFr eqList> | | | REL-4 |
| >UARFCN (Nt) | MP | | Integer(0 .. | [22] | REL-4 |

| Information Element/Group name | Need | Multi | Type and reference | Semantics description | Version |
|--------------------------------|------|---------------------------|--------------------|--|---------|
| | | | 16383) | | |
| >Cell parameters ID | OP | <1 to maxTDDFreqCellList> | Integer (0..127) | The Cell parameters ID is described in [32]. | REL-4 |
| GSM Neighbour cell list | OP | | | | |
| >GSM neighbour cell info | MP | <1 to maxGSMCellList> | | | |
| >>BSIC | MP | | | | |
| >>BCCH ARFCN | MP | | | | |

A.4 Multiplicity values and type constraint values

| Constant | Explanation | Value |
|------------------------------|--|-------|
| Ciphering information | | |
| maxCNDomains | Maximum number of CN domains | 4 |
| Frequency information | | |
| maxFDDFreqList | Maximum number of FDD carrier frequencies to be stored in USIM | 4 |
| maxTDDFreqList | Maximum number of TDD carrier frequencies to be stored in USIM | 4 |
| maxFDDFreqCellList | Maximum number of neighbouring FDD cells on one carrier to be stored in USIM | 32 |
| maxTDDFreqCellList | Maximum number of neighbouring TDD cells on one carrier to be stored in USIM | 32 |
| maxGSMCellList | Maximum number of GSM cells to be stored in USIM | 32 |

Annex B (informative): Description of RRC state transitions including GSM and E-UTRA

This annex contains Stage 2 description of RRC states and state transitions.

B.1 RRC states and state transitions

After power on, the UE stays in Idle Mode until it transmits a request to establish an RRC Connection. In Idle Mode the connection of the UE is closed on all layers of the access stratum. In Idle Mode the UE is identified by non-access stratum identities such as IMSI, TMSI and P-TMSI. In addition, the UTRAN has no own information about the individual Idle Mode UEs, and it can only address e.g. all UEs in a cell or all UEs monitoring a paging occasion. The UE behaviour within this mode is described in [4].

The UTRA RRC Connected Mode is entered when the RRC Connection is established. The UE is assigned a radio network temporary identity (RNTI) to be used as UE identity on common transport channels.

The RRC states within UTRA RRC Connected Mode reflect the level of UE connection and which transport channels that can be used by the UE.

For inactive stationary data users the UE may fall back to PCH on both the Cell and URA levels. That is, upon the need for paging, the UTRAN checks the current level of connection of the given UE, and decides whether the paging message is sent within the URA, or should it be sent via a specific cell.

B.2 Transition from Idle Mode to UTRA RRC Connected Mode

The transition to the UTRA RRC Connected Mode from the Idle Mode can only be initiated by the UE by transmitting a request for an RRC Connection. The event is triggered either by a paging request from the network or by a request from upper layers in the UE.

When the UE receives a message from the network that confirms the RRC connection establishment, the UE enters the CELL_FACH or CELL_DCH state of UTRA RRC Connected Mode.

In the case of a failure to establish the RRC Connection the UE goes back to Idle Mode. Possible causes are radio link failure, a received reject response from the network or lack of response from the network (timeout).

B.2.1 Transitions for Emergency Calls

Refer to [4] for all states and procedures referred to in this subclause. When UE leaves idle mode from state *Camped on any cell* in order to make an emergency call, moving to state *Connected mode (emergency calls only)*, the UE shall attempt to access the current serving cell. If the access attempt to the serving cell fails the UE shall use the *Cell Reselection* procedure. If no acceptable cell is found, the UE shall use the *Any cell selection*. When returning to idle mode, the UE shall use the procedure *Cell selection when leaving connected mode* in order to find an acceptable cell to camp on, state *Camped on any cell*.

B.3 UTRA RRC Connected Mode States and Transitions

B.3.1 CELL_DCH state

The CELL_DCH state is characterised by

- For TDD: A dedicated physical channel is allocated to the UE in uplink and downlink or a dedicated physical channel is allocated to the UE in the uplink and HS_DSCH_RECEPTION is set to TRUE.

- A dedicated physical channel is allocated to the UE in uplink and downlink.
- For TDD:
 - E_DCH_TRANSMISSION is set to TRUE and HS_DSCH_RECEPTION is set to TRUE.
 - E_DCH_TRANSMISSION is set to TRUE and a dedicated physical channel is allocated to the UE in the downlink.
- The UE is known on cell level according to its current active set.
- Dedicated transport channels, downlink and uplink (TDD) shared transport channels, and a combination of these transport channels can be used by the UE.

The CELL_DCH-state is entered from the Idle Mode through the setup of an RRC connection, or by establishing a dedicated physical channel from the CELL_FACH state.

In TDD a PDSCH may be assigned to the UE in this state, to be used for a DSCH. A PUSCH may also be assigned to the UE in this state, to be used for a USCH. If PDSCH or PUSCH are used for TDD, a FACH transport channel may be assigned to the UE for reception of physical shared channel allocation messages.

B.3.1.1 Transition from CELL_DCH to Idle Mode

Transition to Idle Mode is realised through the release of the RRC connection.

B.3.1.2 Transition from CELL_DCH to CELL_FACH state

Transition to CELL_FACH state occurs when all dedicated channels have been released, which may be

- a) via explicit signalling (e.g. PHYSICAL CHANNEL RECONFIGURATION, RADIO BEARER RECONFIGURATION, RADIO BEARER RELEASE, RADIO BEARER SETUP, TRANSPORT CHANNEL RECONFIGURATION, etc.).

at the end of the time period for which the dedicated channel was allocated (TDD)

B.3.1.3 Transition from CELL_DCH to CELL_PCH state

Transition to CELL_PCH state occurs via explicit signalling (e.g. PHYSICAL CHANNEL RECONFIGURATION, RADIO BEARER RECONFIGURATION, RADIO BEARER RELEASE, RADIO BEARER SETUP, TRANSPORT CHANNEL RECONFIGURATION, etc.).

B.3.1.4 Transition from CELL_DCH to URA_PCH state

Transition to URA_PCH state occurs via explicit signalling (e.g. PHYSICAL CHANNEL RECONFIGURATION, RADIO BEARER RECONFIGURATION, RADIO BEARER RELEASE, RADIO BEARER SETUP, TRANSPORT CHANNEL RECONFIGURATION, etc.).

B.3.1.5 Radio Resource Allocation tasks (CELL_DCH)

For the DCH, several physical channel allocation strategies may be applied. The allocations can be either permanent (needing a DCH release message) or based on time or amount-of-data.

Resource allocation can be done separately for each packet burst with fast signalling on the DCH

For each radio frame the UE and the network indicate the current data rate (in uplink and downlink respectively) using the transport format combination indicator (TFCI). However, in TDD, DCH and DSCH or USCH may be mapped on different CCTrCHs, their TFCI are totally independent. DCH transmission is not modified by the simultaneous existence of DSCH/USCH. If the configured set of combinations (i.e. transport format set for one transport channel) are found to be insufficient to retain the QoS requirements for a transport channel, the network initiates a reconfiguration of the transport format set (TFS) for that transport channel. This reconfiguration can be done during or in between data transmission. Further, the network can reconfigure the physical channel allowing an increase or decrease of the peak data rate.

For the uplink data transmission, the UE reports the observed traffic volume to the network in order for the network to re-evaluate the current allocation of resources. This report contains e.g. the amount of data to be transmitted or the buffer status in the UE.

B.3.1.6 RRC Connection mobility tasks (CELL_DCH)

Depending on the amount and frequency of data macrodiversity (soft handover) may or may not be applied.

The RRC Connection mobility is handled by measurement reporting, soft handover and Timing re-initialised or Timing-maintained hard handover procedures.

B.3.1.7 UE Measurements (CELL_DCH)

The UE performs measurements and transmit measurement reports according to the measurement control information.

The UE uses the connected mode measurement control information received in other states until new measurement control information has been assigned to the UE.

B.3.1.8 Acquisition of system information (CELL_DCH)

FDD UEs with certain capabilities reads system information broadcast on FACH.

TDD UEs reads the BCH to acquire valid system information. For each acquisition, the UE may need different combinations of system information broadcast on BCH. The scheduling on the broadcast channel is done in such way that the UE knows when the requested information can be found.

B.3.2 CELL_FACH state

The CELL_FACH state is characterised by:

- No dedicated physical channel is allocated to the UE.
- The UE continuously monitors in the downlink:
 - In 3.84 Mcps TDD and 7.68 Mcps TDD mode:
 - a FACH.
 - In FDD and 1.28 Mcps TDD mode:
 - a FACH; or
 - an HS-DSCHs and optionally a FACH for MBMS reception.
- The UE is assigned a default common or shared transport channel in the uplink (e.g. RACH or common E-DCH (FDD and 1.28 Mcps TDD only)) that it can use anytime according to the access procedure for that transport channel.
- The position of the UE is known by UTRAN on cell level according to the cell where the UE last made a cell update.
- In TDD mode, one or several USCH or DSCH transport channels may have been established.

B.3.2.1 Transition from CELL_FACH to CELL_DCH state

A transition occurs, when a dedicated physical channel is established via explicit signalling (e.g. PHYSICAL CHANNEL RECONFIGURATION, RADIO BEARER RECONFIGURATION, RADIO BEARER RELEASE, RADIO BEARER SETUP, TRANSPORT CHANNEL RECONFIGURATION, etc.).

B.3.2.2 Transition from CELL_FACH to CELL_PCH state

The transition occurs when UTRAN orders the UE to move to CELL_PCH state, which is done via explicit signalling (e.g. CELL UPDATE CONFIRM, RADIO BEARER RECONFIGURATION, etc.).

B.3.2.3 Transition from CELL_FACH to Idle Mode

Upon release of the RRC connection, the UE moves to the idle mode.

B.3.2.4 Transition from CELL_FACH to URA_PCH State

The transition occurs when UTRAN orders the UE to move to URA_PCH state, which is done via explicit signalling (e.g. URA UPDATE CONFIRM, RADIO BEARER RECONFIGURATION, etc.).

B.3.2.5 Radio Resource Allocation Tasks (CELL_FACH)

For 3.84 Mcps TDD and 7.68 Mcps TDD, in the CELL_FACH state the UE will monitor a FACH.

For FDD in the CELL_FACH state the UE will monitor a FACH, if the UE does not support HS-DSCH reception in CELL_FACH state or IE "HS-DSCH common system information" is not included in the system information. Otherwise the UE will monitor the common HS-DSCH(s), and FACH monitoring is restricted to MBMS reception.

For 1.28 Mcps TDD in the CELL_FACH state the UE will monitor a FACH, if the UE does not support HS-DSCH reception or IE "HS-DSCH common system information" and IE "Common E-DCH system info" are not included in the system information. Otherwise the UE will monitor the common HS-DSCH(s), and FACH monitoring is restricted to MBMS reception.

For 3.84 Mcps TDD and 7.68 Mcps TDD, the UE is enabled to transmit uplink control signals and it may be able to transmit small data packets on the RACH.

For FDD and 1.28 Mcps TDD, the UE is enabled to transmit uplink control signals and it may be able to transmit small data packets on the RACH, if the UE does not support Enhanced Uplink in CELL_FACH state and Idle mode, and if IE "HS-DSCH common system information" and IE "Common E-DCH system info" are not included in the system information. Otherwise the UE is enabled to transmit uplink control signals and it may be able to transmit data packets on common E-DCH.

The network can assign the UE transport channel parameters (e.g. transport format sets) in advance, to be used when a DCH is used. Upon assignment of the physical channel for DCH, the UE moves to CELL_DCH state and uses the pre-assigned TFS for the DCH.

If no UE dedicated physical channel or transport channel configuration has been assigned, the UE uses the common physical channel and transport channel configuration according to the system information.

For the uplink data transmission, the UE reports the observed traffic volume to the network in order for the network to re-evaluate the current allocation of resources. This report contains e.g. the amount of data to be transmitted or the buffer status in the UE.

When there is either user or control data to transmit, a selection procedure determines whether the data should be transmitted on a common transport channel, or if a transition to CELL_DCH should be executed. The selection is dynamic and depends on e.g. traffic parameters (amount of data, packet burst frequency).

In the TDD mode, the UTRAN can assign USCH / DSCH resources to the UE in CELL_FACH state. When USCH / DSCH resources are assigned, the UE will continue to monitor FACHs, depending on the UE capability. The UE may use the USCH / DSCH to transmit signalling messages or user data in the uplink and / or the downlink using USCH and / or DSCH when resources are allocated to cell and UE is assigned use of those USCH / DSCH.

For the uplink data transmission on USCH the UE reports to the network the traffic volume (current size of RLC data buffers). The UTRAN can use these measurement reports to re-evaluate the current allocation of the USCH / DSCH resources.

B.3.2.6 RRC Connection mobility tasks (CELL_FACH)

In this state the location of the UE is known on cell level. A cell update procedure is used to report to the UTRAN, when the UE selects a new cell to observe the common downlink channels of a new cell. Downlink data transmission on the FACH or HS-DSCH (FDD and 1.28 Mcps TDD only) can be started without prior paging.

The UE monitors the broadcast channel and system information on BCCH of its own and neighbour cells and from this the need for the updating of cell location is identified.

The UE performs cell reselection and upon selecting a new UTRA cell, it initiates a cell update procedure. Upon selecting a new cell belonging to another radio access system than UTRA, the UE enters idle mode and makes an access to that system according to its specifications.

B.3.2.7 UE Measurements (CELL_FACH)

The UE performs measurements and transmit measurement reports according to the measurement control information.

By default, the UE uses the measurement control information broadcast within the system information. However, for measurements for which the network also provides measurement control information within a MEASUREMENT CONTROL message, the latter information takes precedence.

B.3.2.8 Transfer and update of system information (CELL_FACH)

The UE reads the BCH to acquire valid system information. For each acquisition, the UE may need different combinations of system information broadcast on BCH. The scheduling on the broadcast channel is done in such way that the UE knows when the requested information can be found.

When the system information is modified, the scheduling information is updated to reflect the changes in system information transmitted on BCH. The new scheduling information is broadcast on FACH and/or on the common HS-DSCH(s) (FDD and 1.28 Mcps TDD only) in order to inform UEs about the changes. If the changes are applicable for the UE, the modified system information is read on BCH.

B.3.3 CELL_PCH state

The CELL_PCH state is characterised by:

- For FDD, if "HS-DSCH paging system information" is not included in System Information or the UE does not support HS-DSCH reception in CELL_PCH and URA_PCH state, and for TDD, no dedicated physical channel is allocated to the UE.

For FDD, if "HS-DSCH paging system information" is included in System Information and the UE does support HS-DSCH reception in CELL_PCH and URA_PCH state, dedicated physical channel may be allocated to the UE.
- For FDD, if "HS-DSCH paging system information" is not included in System Information or the UE does not support HS-DSCH reception in CELL_PCH and URA_PCH state, and for TDD, the UE selects a PCH with the algorithm specified in subclause 8.5.19, and uses DRX for monitoring the selected PCH via an associated PICH.
- For FDD and 1.28 Mcps TDD, if "HS-DSCH paging system information" is included in System Information and the UE supports HS-DSCH reception in CELL_PCH and URA_PCH state, the UE selects a HS-DSCH mapped on the HS-PDSCH with algorithms specified in 8.5.41, 8.5.39 and 8.5.40 for FDD and 8.5.40a for 1.28 Mcps TDD, and uses DRX for monitoring the selected HS-DSCH via an associated PICH.
- No uplink activity is possible.
- The position of the UE is known by UTRAN on cell level according to the cell where the UE last made a cell update in CELL_FACH state.

The DCCH and DTCH logical channels can only be used in this state if HS-DSCH is used and a dedicated H-RNTI is configured and for 1.28 Mcps TDD a dedicated E-RNTI is configured. Otherwise, if the network wants to initiate any activity, it needs to make a paging request on the PCCH logical channel in the known cell to initiate any downlink activity.

B.3.3.1 Transition from CELL_PCH to CELL_FACH state

The UE is transferred to CELL_FACH state:

- a) by paging from UTRAN (PAGING TYPE1 message)
- b) through any uplink access

B.3.3.2 Radio Resource Allocation Tasks (CELL_PCH)

In CELL_PCH state no resources have been granted for data transmission. For this purpose, a transition to another state has to be executed.

The UE may use Discontinuous Reception (DRX) in order to reduce power consumption. When DRX is used the UE needs only to receive at one paging occasion per DRX cycle. The UE may be instructed to use specific DRX cycle lengths by the network. The UE determines its paging occasions in the same way as for Idle Mode, see [4].

B.3.3.3 RRC Connection mobility tasks (CELL_PCH)

In the CELL_PCH state, the UE mobility is performed through cell reselection procedures, which may differ from the one defined in [4].

The UE performs cell reselection and upon selecting a new UTRA cell, it moves to CELL_FACH state and initiates a cell update procedure in the new cell. After the cell update procedure has been performed, the UE changes its state back to CELL_PCH state if neither the UE nor the network has any more data to transmit.

Upon selecting a new cell belonging to another radio access system than UTRA, the UE enters idle mode and make an access to that system according to its specifications.

In case of low UE activity, UTRAN may want to reduce the cell-updating overhead by ordering the UE to move to the URA_PCH State. This transition is made via the CELL_FACH state. UTRAN may apply an inactivity timer, and optionally, a counter, which counts the number of cell updates e.g. UTRAN orders the UE to move to URA_PCH when the number of cell updates has exceeded certain limits (network parameter).

B.3.3.4 UE Measurements (CELL_PCH)

The UE performs measurements and transmit measurement reports according to the measurement control information.

The UE uses the measurement control information according to the system information when no UE dedicated measurement control information has been assigned.

B.3.3.5 Transfer and update of system information (CELL_PCH)

The UE reads the BCH to acquire valid system information. For each acquisition, the UE may need different combinations of system information broadcast on BCH. The scheduling on the broadcast channel is done in such way that the UE knows when the requested information can be found.

B.3.4 URA_PCH State

The URA_PCH state is characterised by:

- No dedicated channel is allocated to the UE.
- For FDD and 1.28 Mcps TDD, if "HS-DSCH paging system information" is not included in System Information or the UE does not support HS-DSCH reception in CELL_PCH and URA_PCH state, and for TDD, the UE selects a PCH with the algorithm specified in subclause 8.5.19, and uses DRX for monitoring the selected PCH via an associated PICH.

- For FDD and 1.28 Mcps TDD, if "HS-DSCH paging system information" is included in System Information and the UE supports HS-DSCH reception in CELL_PCH and URA_PCH state, the UE selects a HS-DSCH mapped on the HS-PDSCH with algorithms specified in 8.5.41, 8.5.39 and 8.5.40 for FDD and 8.5.40a for 1.28 Mcps TDD, and uses DRX for monitoring the selected HS-DSCH via an associated PICH.
- No uplink activity is possible.
- The location of the UE is known on UTRAN Registration area level according to the URA assigned to the UE during the last URA update in CELL_FACH state.

The DCCH logical channel cannot be used in this state. If the network wants to initiate any activity, it needs to make a paging request on the PCCH logical channel within the URA where the location of the UE is known. If the UE needs to transmit anything to the network, it goes to the CELL_FACH state. The transition to URA_PCH State can be controlled with an inactivity timer, and optionally, with a counter that counts the number of cell updates. When the number of cell updates has exceeded certain limits (a network parameter), then the UE changes to the URA_PCH State.

URA updating is initiated by the UE, which, upon the detection of the Registration area, sends the network the Registration area update information on the RACH of the new cell.

B.3.4.1 Transition from URA_PCH State to CELL_FACH State (URA_PCH)

Any activity causes the UE to be transferred to CELL_FACH State.

- a) Uplink access is performed by RACH.
- b) by paging from UTRAN (PAGING TYPE1 message).

NOTE: The release of an RRC connection is possible in the URA_PCH state. UE in URA_PCH is able to go to idle when triggered by paging type 1 message in case "Release indicator" has the value "Release".

B.3.4.2 Radio Resource Allocation Tasks (URA_PCH)

In URA_PCH State no resources have been granted for data transmission. For this purpose, a transition to CELL_FACH State has to be executed.

The UE may use Discontinuous Reception (DRX) in order to reduce power consumption. When DRX is used the UE needs only to receive at one paging occasion per DRX cycle. The UE may be instructed to use specific DRX cycle lengths by the network. The UE determines its paging occasions in the same way as for Idle Mode, see [4].

B.3.4.3 RRC Connection mobility tasks (URA_PCH)

In URA_PCH State the location of a UE is known on UTRAN Registration area level.

In this state, the UE mobility is performed through URA reselection procedures, which may differ from the definitions in [4]. The UE performs cell reselection and upon selecting a new UTRA cell belonging to a URA that does not match the URA used by the UE, the UE moves to CELL_FACH state and initiates a URA update towards the network. After the URA update procedure has been performed, the UE changes its state back to URA_PCH state if neither the UE nor the network has any more data to transmit.

Upon selecting a new cell belonging to another radio access system than UTRA, the UE enters idle mode and makes an access to that system according to its specifications.

B.3.4.4 UE Measurements (URA_PCH)

The UE performs measurements and transmit measurement reports according to the measurement control information.

The UE uses the measurement control information according to the system information when no UE dedicated measurement control information has been assigned.

B.3.4.5 Transfer and update of system information (URA_PCH)

The same mechanisms to transfer and update system information as for state CELL_PCH are applicable for UEs in URA_PCH state.

B.3.5 States and Transitions for Cell Reselection in URA_PCH, CELL_PCH, and CELL_FACH

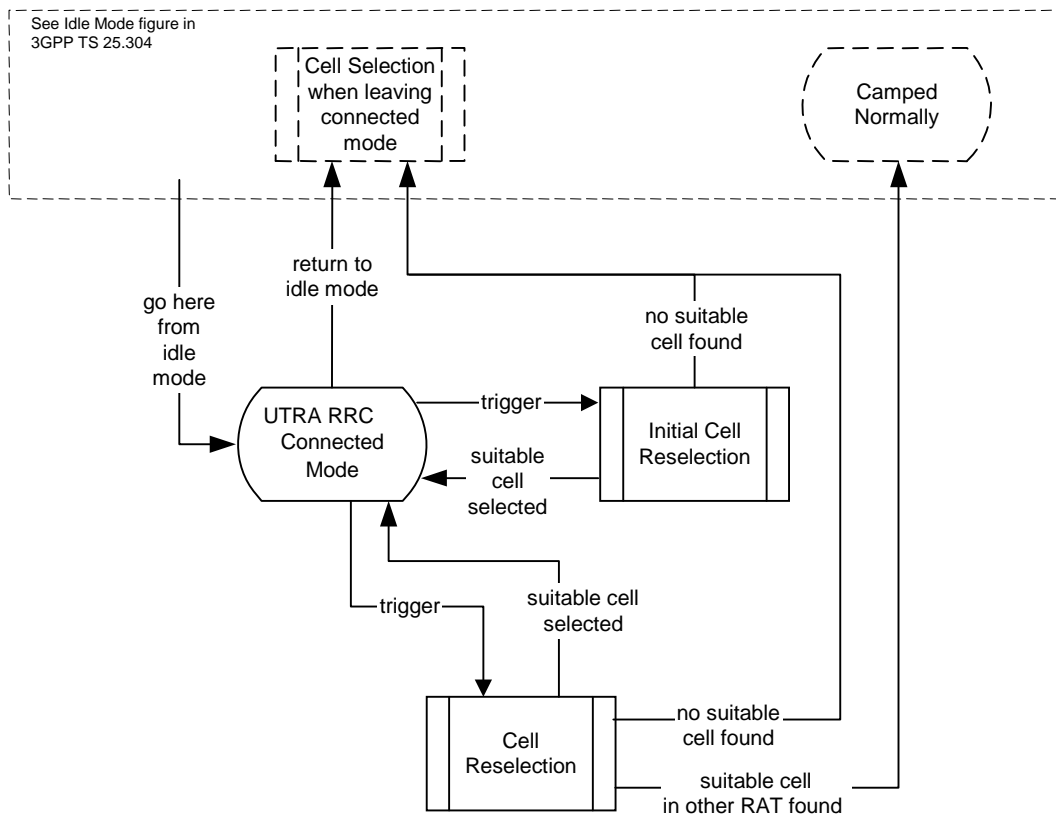

Figure B.3.5-1: UTRA RRC Connected mode cell reselection for URA_PCH, CELL_PCH, and CELL_FACH

In some states the UE performs cell reselection procedures. The UE selects a suitable cell (defined in [4]) and radio access technology based on connected mode radio measurements and cell reselection criteria.

Figure B.3.5-1 shows the states and procedures in the cell reselection process in connected mode.

When a cell reselection is triggered, the UE evaluates the cell reselection criteria based on radio measurements, and if a better cell is found that cell is selected, procedure Cell reselection (see [4]). If the change of cell implies a change of radio access technology, the RRC connection is released, and the UE enters idle mode of the other RAT. If no suitable cell is found in the cell reselection procedure, the UE eventually enters idle mode.

When an Initial cell reselection is triggered, the UE shall use the Initial cell reselection procedure (see [4]) to find a suitable cell. One example where this procedure is triggered is at radio link failure, where the UE may trigger an initial cell reselection in order to request re-establishment of the RRC connection. If the UE is unable to find a suitable cell, the UE eventually enters idle mode.

B.4 Inter-RAT handover with CS domain services

When using CS domain services, UTRAN is using an Inter-Radio access system Handover Procedure and GSM is using a Handover procedure for the transition from UTRA RRC Connected Mode to GSM Connected Mode.

B.5 Inter-RAT handover with PS domain services

When using PS domain services, the UE can initiate cell reselection from a GSM/GPRS cell to a UTRAN cell and then uses the RRC Connection Establishment procedure for the transition to UTRA RRC Connected mode. It is also possible for the BSS to initiate a UTRA Inter-RAT Handover to seamlessly relocate the UE to UTRAN. In this latter case there is no need to return the UE to Idle Mode (GPRS Packet Idle Mode) and the UE immediately moves to RRC connected state in the UTRAN.

In the case that cell reselection is used, when the RRC Connection is established from Idle Mode (GPRS Packet Idle Mode) the RRC CONNECTION REQUEST message contains an indication, that UTRAN needs to continue an already established GPRS UE context from the CN. This indication allows UTRAN to e.g. prioritise the RRC CONNECTION REQUEST from the UE.

It is possible for a E-UTRA eNodeB to initiate a Inter-RAT Handover to UTRAN to seamlessly relocate the UE to the RRC connected state in UTRAN.

In UTRA RRC connected mode UTRAN may use UE or network initiated cell reselection to change from a UTRAN cell to a GSM/GPRS cell. If the cell reselection was successful the UE enters Idle Mode (GPRS Packet Idle Mode). The UE sends a packet channel request from Idle Mode (GPRS Packet Idle mode) to establish a Temporary Block flow and enter GPRS Packet Transfer Mode. In the GPRS Packet Transfer Mode the UE sends a RA Update request message. The RA Update Request message sent from the UE contains an indication that GSM/GPRS need to continue an already established UTRAN UE context from the CN. This means that the RA Update request is always sent for the transition from UTRA RRC Connected Mode to GSM/GPRS regardless if the RA is changed or not.

Alternatively, the UTRAN may use an Inter-System Relocation (PS Handover) to relocate a UTRA RRC connected UE directly to GPRS Packet Transfer Mode in GERAN.

NOTE: The reason for using RA update instead of a new message is to reduce the impact on the existing GSM/GPRS specification.

The UTRAN may use an Inter-RAT Handover to relocate a UTRA RRC connected UE directly to RRC_CONNECTED mode in E-UTRAN.

B.6 Inter-RAT handover with simultaneous PS and CS domain services

B.6.1 Inter-RAT handover UTRAN to GSM / BSS

For a UE in CELL_DCH state using both CS and PS Domain services the Inter-RAT handover procedure is based on measurement reports from the UE but initiated from UTRAN.

The UE performs the Inter-RAT handover from UTRA RRC Connected Mode to GSM Connected Mode first. When the UE has sent handover complete message to GSM / BSS the UE initiates a temporary block flow towards GPRS and sends a RA update request.

If the Inter-RAT handover from UTRA RRC Connected Mode to GSM Connected Mode was successful the handover is considered as successful regardless if the UE was able to establish a temporary block flow or not towards GPRS.

In case of Inter-RAT handover failure the UE has the possibility to go back to UTRA RRC Connected Mode and re-establish the connection in the state it originated from.

B.6.2 Inter-RAT handover GSM / BSS to UTRAN

For a UE in GSM Connected Mode using both CS and PS domain services the Inter-RAT handover procedure is based on measurement reports from the UE but initiated from GSM / BSS.

The UE performs the Inter-RAT handover from GSM Connected Mode to UTRA RRC Connected Mode.

In UTRA RRC Connected Mode both services are established in parallel.

If the Inter-RAT handover from GSM Connected mode to UTRA RRC Connected Mode was successful the handover is considered as successful.

In case of Inter-RAT handover failure the UE has the possibility to go back to GSM Connected Mode and re-establish the connection in the state it originated from.

Annex C (informative): Description for the Compressed Coding of Pre-defined configurations included in the INTER RAT HANDOVER INFO message

This annex contains a description of the compressed coding of the IE "Predefined configuration status information compressed" (see subclause 10.3.4.5b) included in the INTER RAT HANDOVER INFO message.

C.1 Definitions

Pre-defined configuration set with different value tags: This is a set of consecutive positions for which pre-defined configurations are stored with different value tags. The set cannot include positions for which no pre-defined configuration is stored.

Pre-defined configuration list with variable size: This is the variable sized list consisting of the value tags corresponding to the remaining positions after the "Pre-defined configuration sets with different value tags" have been formed. This will also indicate not stored pre-defined configurations, either explicitly or implicitly (i.e. in the case that there are no more stored configurations until the end of the variable sized list). This is highlighted in figures C.2-1 and C.2-2.

C.2 Examples of the methodology

From figure C.2-1 it can be seen that there are two "Pre-defined configuration sets with different value tags".

The start position of Set1 is "1" with a list of 7 pre-defined configurations {1, 2, 3, 4, 5, 6, 7}.

The start position of Set2 is "10" with a list of 6 pre-defined configurations {10, 11, 12, 13, 14, 15}.

The "Pre-defined configurations list with variable size" has a start position of 0, and includes all of the pre-defined configurations not included in the sets {0, 8, 9}. The value tag at position 9 is not stored. This does not need to be explicitly indicated in the coding as "not stored" because there are no stored pre-defined configurations positioned after this in the list.

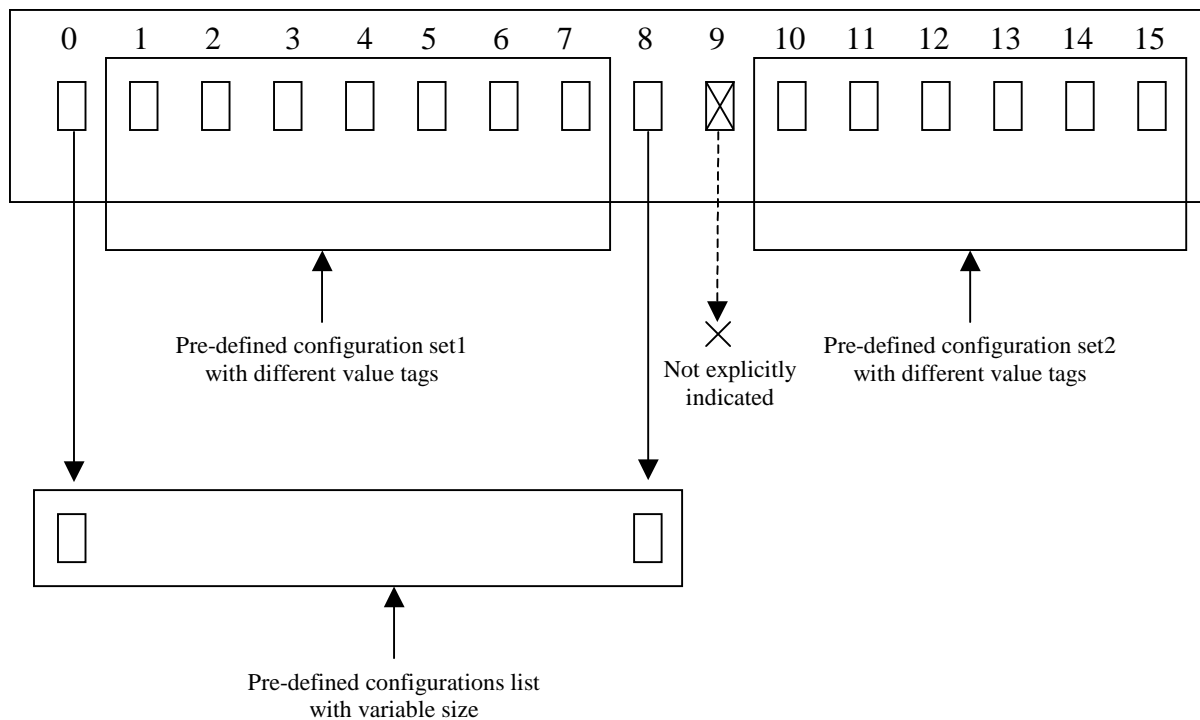

Figure C.2-1: Example scenario where non-stored pre-defined configurations do not need to be explicitly indicated

Figure C.2-2 is similar to Figure C.2-1. However in this case for the "Pre-defined configurations list with variable size", the pre-defined configuration in position 8 is not stored. This needs to be explicitly indicated in the coding as "not stored" because there is a stored pre-defined configuration (position 9) positioned after this in the list.

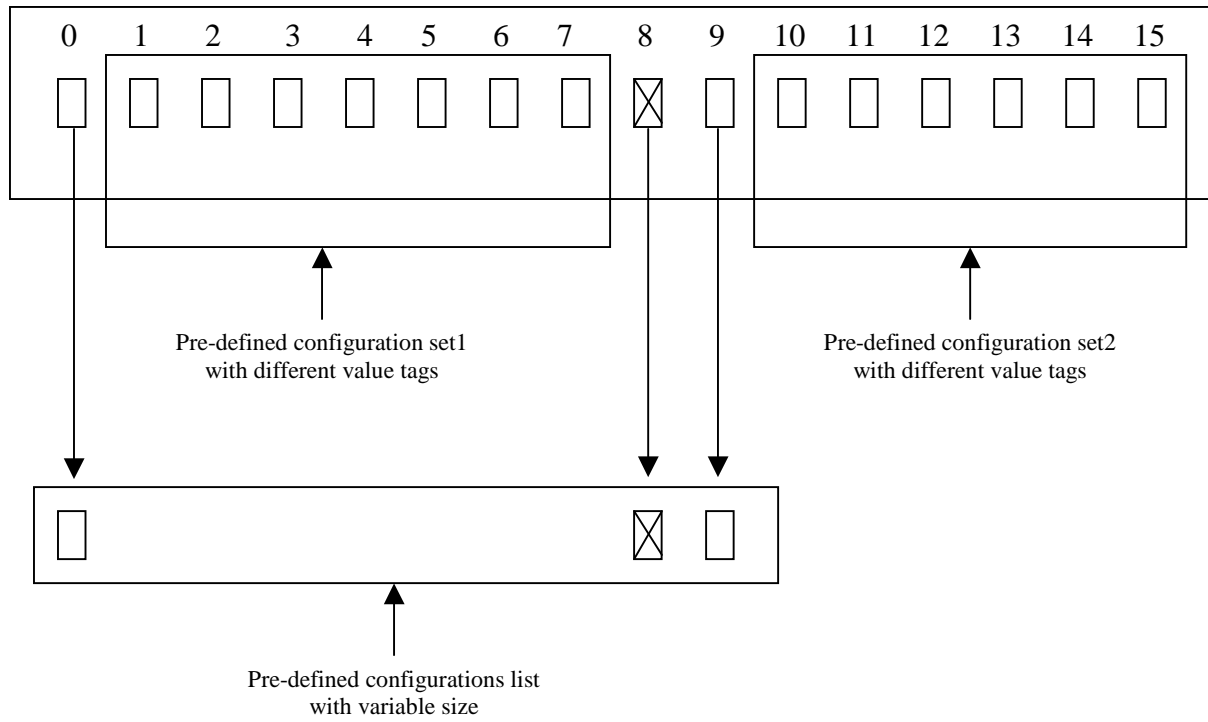

Figure C.2-2: Example scenario where non-stored pre-defined configurations need to be explicitly indicated

Annex D (Normative): Implementation of Domain Specific Access Control (DSAC) in UEs of 3GPP Release 5

UEs of 3GPP Release 5 implementing the domain specific access class control feature but not implementing the network sharing feature shall act on the domain specific access class restriction indicated by the IE "Domain Specific Access Restriction Parameters For PLMN Of MIB" if present, and otherwise apply the access restrictions indicated by the IE "Cell Access Restriction".

Annex E (Normative): EUTRA Feature group indicators

This annex contains the definitions of the bits in EUTRA Feature Group Indicators.

In this release of the specification the UE shall include the optional EUTRA Feature Group Indicators IE in the UE multi-mode/multi RAT capability IE of the RRC message. For a specific indicator, if all functionalities for a feature group listed in Table E.1 have been implemented and tested, the UE shall set the indicator as "true" (as one), else (i.e. if any one of the functionalities in a feature group listed in Table E.1 have not been implemented or tested), the UE shall set the indicator as zero.

The UE shall set all indicators, which do not have a definition in the table E.1, as "false" (as zero).

If the optional EUTRA Feature Group Indicators IE is not included by a UE supporting a future release of the specification, the network may assume the UE supports all features in the feature groups listed in table E.1 and deployed in the network.

Table E.1: Defintions of feature group indicators

| Index of indicator (bit number) | Definition
(description of the supported functionality, if indicator set to "true") | Notes |
|---------------------------------|---|-------|
| 1 (leftmost bit) | - UTRA CELL_PCH to EUTRA RRC_IDLE cell reselection
- UTRA URA_PCH to EUTRA RRC_IDLE cell reselection | |
| 2 | EUTRAN measurements and reporting in connected mode | |
| 3 | - UTRA CELL_FACH absolute priority cell reselection for high priority layers | |
| 4 | - UTRA CELL_FACH absolute priority cell reselection for all layers | |

Clarification for mobility to EUTRAN

For mobility to E-UTRAN, it is assumed that we have 8 main "functions":

- A. Support of measurements and cell reselection procedure in idle mode
- B. Support of measurements and cell reselection procedure in CELL/URA_PCH
- C. Support of RRC release with redirection procedure
- D. Support of RRC reject with redirection procedure
- E. Support of EUTRAN measurements and reporting in connected mode
- F. Support of handover procedure in connected mode
- G. Support of high priority layer measurements and cell reselection procedure in CELL_FACH
- H. Support of all priority layer measurements and cell reselection procedure in CELL_FACH

Of the above, all UEs that indicate support of E-UTRA in UE capability signalling "Support of E-UTRA FDD" or "Support of E-UTRA TDD" support A), C) and D)) EUTRA bands they support.

For B) above, UEs indicate support by the Group 1 indicator bit (if Group 1 is set to "true", it is supported for all EUTRA bands the UE supports).

For E) above, UEs indicate support by the Group 2 indicator bit (if Group 2 is set to "true", it is supported for all EUTRA bands the UE supports). The compressed mode capability for supported E-UTRA frequency bands ("Need for compressed mode") in "Measurement capability extension" is ignored by the network when Group 2 is set to "false".

For F) above, UEs indicate support by the separate UE capability signaling "Support of Inter-RAT PS Handover to E-UTRA FDD/TDD" defined in TS 25.306 (if this bit is set to "true", PS handover is supported for all EUTRA bands the UE supports). This bit can only be set to "true" if the UE has set the Group 2 indicator bit to "true".

For G) above, UEs indicates support by the Group 3 indicator bit (if Group 3 is set to "true", it is supported for all EUTRA bands the UE supports). If the separate UE capability "Support for absolute priority based cell re-selection in UTRAN" is also set to "true", UEs indicate support of high priority layer measurements and cell reselection procedure in CELL_FACH also for UTRA inter-frequency.

For H) above, UEs indicates support by the Group 4 indicator bit (if Group 4 is set to "true", it is supported for all EUTRA bands the UE supports). If the separate UE capability "Support for absolute priority based cell re-selection in UTRAN" is also set to "true", UEs indicate support of high priority layer measurements and cell reselection procedure in CELL_FACH also for UTRA inter-frequency. UEs that indicate support for H also indicate support for G.

Annex F (informative): Change history

| Change history | | | | | | | | |
|----------------|-------|----------|-----|-----|--|-------|-------|--|
| Date | TSG # | TSG Doc. | CR | Rev | Subject/Comment | Old | New | |
| 10/1999 | RP-05 | RP-99524 | - | | Approved at TSG-RAN #5 and placed under Change Control | - | 3.0.0 | |
| 12/1999 | RP-06 | RP-99650 | 001 | | Modification of RRC procedure specifications | 3.0.0 | 3.1.0 | |
| | RP-06 | RP-99654 | 005 | 1 | Introduction of Information Element for Power Control Algorithm | 3.0.0 | 3.1.0 | |
| | RP-06 | RP-99654 | 007 | 1 | RRC parameters for SSdT | 3.0.0 | 3.1.0 | |
| | RP-06 | RP-99656 | 009 | 1 | Inclusion of information elements for integrity protection | 3.0.0 | 3.1.0 | |
| | RP-06 | RP-99656 | 010 | 2 | Security mode control procedure | 3.0.0 | 3.1.0 | |
| | RP-06 | RP-99656 | 011 | 3 | Updates of the system information procedure | 3.0.0 | 3.1.0 | |
| | RP-06 | RP-99656 | 012 | 2 | Inter-frequency measurements and reporting | 3.0.0 | 3.1.0 | |
| | RP-06 | RP-99656 | 013 | 1 | Inter-system measurements and reporting | 3.0.0 | 3.1.0 | |
| | RP-06 | RP-99656 | 014 | 1 | Additional measurements in RRC measurement messages | 3.0.0 | 3.1.0 | |
| | RP-06 | RP-99656 | 015 | 3 | Value range for Measurement Information Elements | 3.0.0 | 3.1.0 | |
| | RP-06 | RP-99656 | 016 | 2 | Message contents for inter system handover to UTRAN | 3.0.0 | 3.1.0 | |
| | RP-06 | RP-99652 | 017 | | Inclusion of ciphering information elements | 3.0.0 | 3.1.0 | |
| | RP-06 | RP-99651 | 018 | | Corrections and editorial changes | 3.0.0 | 3.1.0 | |
| | RP-06 | RP-99654 | 019 | 1 | Algorithm for CTCF Calculation | 3.0.0 | 3.1.0 | |
| | RP-06 | RP-99651 | 025 | | Logical CH for RRC Connection Re-establishment (RRC Connection Re-establishment deleted in RAN_10, RP-000715) | 3.0.0 | 3.1.0 | |
| | RP-06 | RP-99719 | 026 | 1 | Gain Factors | 3.0.0 | 3.1.0 | |
| | RP-06 | RP-99654 | 027 | 1 | Parameters for CELL UPDATE CONFIRM message | 3.0.0 | 3.1.0 | |
| | RP-06 | RP-99651 | 028 | | Cell Update Cause | 3.0.0 | 3.1.0 | |
| | RP-06 | RP-99654 | 029 | 1 | RRC Initialisation Information | 3.0.0 | 3.1.0 | |
| | RP-06 | RP-99656 | 034 | 1 | Open loop power control for PRACH | 3.0.0 | 3.1.0 | |
| | RP-06 | RP-99652 | 038 | | Addition of the UE controlled AMR mode adaptation | 3.0.0 | 3.1.0 | |
| | RP-06 | RP-99651 | 039 | | Information elements for RLC reset | 3.0.0 | 3.1.0 | |
| | RP-06 | RP-99656 | 040 | | Support for DS-41 Initial UE Identity | 3.0.0 | 3.1.0 | |
| | RP-06 | RP-99656 | 042 | 2 | Integration of Cell Broadcast Service (CBS) | 3.0.0 | 3.1.0 | |
| | RP-06 | RP-99654 | 044 | 1 | Gated transmission of DPCCCH | 3.0.0 | 3.1.0 | |
| | RP-06 | RP-99656 | 045 | | Modification to the Transport Format Combination Control message | 3.0.0 | 3.1.0 | |
| | RP-06 | RP-99656 | 046 | | New Information elements and modifications to messages required in order to support configuration and re-configuration of the DSCH in FDD mode | 3.0.0 | 3.1.0 | |
| | RP-06 | RP-99654 | 047 | 1 | Editorial Corrections and Alignments with Layer 1 specifications | 3.0.0 | 3.1.0 | |
| | RP-06 | RP-99654 | 048 | 1 | Information elements for TDD shared channel operation | 3.0.0 | 3.1.0 | |
| | RP-06 | RP-99656 | 049 | | Description of CN dependent IEs in Master Information Block | 3.0.0 | 3.1.0 | |
| | RP-06 | RP-99650 | 050 | | UE capability information elements | 3.0.0 | 3.1.0 | |
| | RP-06 | RP-99656 | 051 | 1 | UTRAN response time to uplink feedback commands of TX diversity control | 3.0.0 | 3.1.0 | |
| | RP-06 | RP-99654 | 052 | | New and corrected CPCH parameters | 3.0.0 | 3.1.0 | |
| | RP-06 | RP-99654 | 053 | 2 | Compressed mode parameters without gating | 3.0.0 | 3.1.0 | |
| | RP-06 | RP-99654 | 054 | | Transport format combination set and transport format combination subset | 3.0.0 | 3.1.0 | |
| | RP-06 | RP-99656 | 055 | 1 | Information elements for cell selection and reselection | 3.0.0 | 3.1.0 | |
| | RP-06 | RP-99654 | 056 | | Corrections and Alignments of the RRC to the L1 for TDD | 3.0.0 | 3.1.0 | |
| | RP-06 | RP-99656 | 057 | 1 | Introduction of a SCCH procedure | 3.0.0 | 3.1.0 | |
| | RP-06 | RP-99656 | 061 | | Support for DS-41 Paging UE Identity | 3.0.0 | 3.1.0 | |
| | RP-06 | RP-99656 | 062 | 2 | Support for cdma2000 Hard Handover | 3.0.0 | 3.1.0 | |
| | RP-06 | RP-99656 | 063 | 1 | Provide necessary signalling to support FDD DSCH | 3.0.0 | 3.1.0 | |
| | RP-06 | RP-99654 | 064 | | RRC procedure interactions | 3.0.0 | 3.1.0 | |
| | RP-06 | RP-99654 | 066 | 1 | Transfer of UE capabilities | 3.0.0 | 3.1.0 | |
| | RP-06 | RP-99654 | 067 | | Selection of initial UE identity | 3.0.0 | 3.1.0 | |
| | RP-06 | RP-99657 | 069 | | UE capability verification in the security mode control procedure | 3.0.0 | 3.1.0 | |
| | RP-06 | RP-99657 | 070 | 1 | DPCH initial power | 3.0.0 | 3.1.0 | |
| | RP-06 | RP-99657 | 071 | | Actions when entering idle mode | 3.0.0 | 3.1.0 | |
| | RP-06 | RP-99657 | 072 | | Specification of inter-frequency and inter-system reporting events for FDD | 3.0.0 | 3.1.0 | |
| | RP-06 | RP-99657 | 073 | 1 | Signalling radio bearers | 3.0.0 | 3.1.0 | |
| | RP-06 | RP-99654 | 074 | | CN information elements | 3.0.0 | 3.1.0 | |
| | RP-06 | RP-99654 | 076 | | UE information elements | 3.0.0 | 3.1.0 | |
| | RP-06 | RP-99657 | 077 | 1 | Radio bearer, transport channel and physical channel information | 3.0.0 | 3.1.0 | |

| Change history | | | | | | | | |
|----------------|-------|-----------|-----|-----|--|-------|-------|--|
| Date | TSG # | TSG Doc. | CR | Rev | Subject/Comment | Old | New | |
| | | | | | elements | | | |
| | RP-06 | RP-99654 | 078 | | Other information elements | 3.0.0 | 3.1.0 | |
| | RP-06 | RP-99657 | 079 | 2 | RRC signalling for PDCP | 3.0.0 | 3.1.0 | |
| | RP-06 | RP-99654 | 080 | | Content of Measurement Control Messages | 3.0.0 | 3.1.0 | |
| | RP-06 | RP-99654 | 081 | | RRC Information Elements to support Block STTD transmission diversity in TDD | 3.0.0 | 3.1.0 | |
| | RP-06 | RP-99657 | 082 | 1 | Signalling connection release | 3.0.0 | 3.1.0 | |
| | RP-06 | RP-99657 | 083 | 1 | Addition of cell access restriction information elements to System Information | 3.0.0 | 3.1.0 | |
| | RP-06 | RP-99655 | 085 | 1 | RRC Connection Establishment parameters | 3.0.0 | 3.1.0 | |
| | RP-06 | RP-99657 | 092 | 1 | Support of UE autonomous update of a active set on a non-used frequency | 3.0.0 | 3.1.0 | |
| | RP-06 | RP-99657 | 095 | 1 | TPC combining for power control | 3.0.0 | 3.1.0 | |
| | RP-06 | RP-99653 | 096 | 1 | Editorial Modification of IEs in RRC messages | 3.0.0 | 3.1.0 | |
| | RP-06 | RP-99655 | 097 | | Selection of SCCPCH | 3.0.0 | 3.1.0 | |
| | RP-06 | RP-99655 | 098 | 1 | RRC Initialisation Information | 3.0.0 | 3.1.0 | |
| | RP-06 | RP-99657 | 100 | 1 | Support of physical channel establishment and failure criteria in the UE | 3.0.0 | 3.1.0 | |
| | RP-06 | RP-99655 | 102 | 1 | RRC Connection Re-establishment (Message deleted in RAN_10, RP-000715) | 3.0.0 | 3.1.0 | |
| | RP-06 | RP-99657 | 106 | 1 | System information on FACH | 3.0.0 | 3.1.0 | |
| | RP-06 | RP-99657 | 108 | 1 | SAPs and Primitives for DS-41 mode | 3.0.0 | 3.1.0 | |
| | RP-06 | RP-99655 | 109 | 1 | TX Diversity Mode for Dedicated Channel | 3.0.0 | 3.1.0 | |
| | RP-06 | RP-99657 | 110 | 1 | RACH message length signalling on System Information | 3.0.0 | 3.1.0 | |
| | RP-06 | RP-99657 | 113 | 1 | Routing of NAS messages in UTRAN | 3.0.0 | 3.1.0 | |
| | RP-06 | RP-99655 | 116 | 3 | TBS Identification in TFS | 3.0.0 | 3.1.0 | |
| | RP-06 | RP-99657 | 117 | 1 | Merging the hard handover and some radio bearer control procedures | 3.0.0 | 3.1.0 | |
| | RP-06 | RP-99653 | 120 | 1 | Selected RRC message transfer syntax | 3.0.0 | 3.1.0 | |
| | RP-06 | RP-99657 | 121 | | Efficient rate command signalling | 3.0.0 | 3.1.0 | |
| 03/2000 | RP-07 | RP-000043 | 122 | | TDD Mode BCH Reception in Cell DCH State | 3.1.0 | 3.2.0 | |
| | RP-07 | RP-000043 | 123 | | Uplink Outer Loop Power Control in TDD Mode | 3.1.0 | 3.2.0 | |
| | RP-07 | RP-000043 | 124 | 1 | TFS TB Size Calculation with Bit Aligned TDD MAC Headers | 3.1.0 | 3.2.0 | |
| | RP-07 | RP-000043 | 125 | | Grouping of DRAC IEs, and detailed definitions of these IEs | 3.1.0 | 3.2.0 | |
| | RP-07 | RP-000043 | 126 | | Correction of specifications for the 'Dynamic Resource Allocation Control of Uplink DCH' Procedure | 3.1.0 | 3.2.0 | |
| | RP-07 | RP-000043 | 131 | 2 | Clarification of PDCP info and PDCP capability IEs | 3.1.0 | 3.2.0 | |
| | RP-07 | RP-000043 | 132 | | Editorial change to "Specification of system information block characteristics" | 3.1.0 | 3.2.0 | |
| | RP-07 | RP-000043 | 133 | | Additions of CBS related Information Elements | 3.1.0 | 3.2.0 | |
| | RP-07 | RP-000043 | 134 | | Signalling for computed gain factors | 3.1.0 | 3.2.0 | |
| | RP-07 | RP-000043 | 137 | 1 | General error handling procedures | 3.1.0 | 3.2.0 | |
| | RP-07 | RP-000043 | 138 | 1 | RRC message extensions | 3.1.0 | 3.2.0 | |
| | RP-07 | RP-000043 | 139 | | Padding of RRC messages using RLC transparent mode | 3.1.0 | 3.2.0 | |
| | RP-07 | RP-000043 | 140 | 2 | UE information elements | 3.1.0 | 3.2.0 | |
| | RP-07 | RP-000043 | 141 | | Other information elements | 3.1.0 | 3.2.0 | |
| | RP-07 | RP-000043 | 142 | 3 | Integrity protection function | 3.1.0 | 3.2.0 | |
| | RP-07 | RP-000043 | 143 | 4 | RAB-RB relations | 3.1.0 | 3.2.0 | |
| | RP-07 | RP-000043 | 144 | 1 | Inter-system handover from UTRAN | 3.1.0 | 3.2.0 | |
| | RP-07 | RP-000043 | 145 | 3 | Handover to UTRAN including procedure for pre-configuration | 3.1.0 | 3.2.0 | |
| | RP-07 | RP-000043 | 146 | 2 | RRC measurement filtering parameters | 3.1.0 | 3.2.0 | |
| | RP-07 | RP-000043 | 147 | | New event "RL out of UE Rx window" | 3.1.0 | 3.2.0 | |
| | RP-07 | RP-000044 | 148 | 1 | Access control on RACH | 3.1.0 | 3.2.0 | |
| | RP-07 | RP-000044 | 149 | 2 | cdma2000 Hard Handover | 3.1.0 | 3.2.0 | |
| | RP-07 | RP-000044 | 150 | 1 | CPCH parameters with corrections | 3.1.0 | 3.2.0 | |
| | RP-07 | RP-000044 | 152 | | U-plane AM RLC reconfiguration by cell update procedure | 3.1.0 | 3.2.0 | |
| | RP-07 | RP-000044 | 154 | 3 | CPCH | 3.1.0 | 3.2.0 | |
| | RP-07 | RP-000044 | 155 | 1 | Information elements for ASC in TDD | 3.1.0 | 3.2.0 | |
| | RP-07 | RP-000044 | 156 | | Addition of timing advance value in handover related messages | 3.1.0 | 3.2.0 | |
| | RP-07 | RP-000044 | 157 | 2 | Physical channel description for TDD | 3.1.0 | 3.2.0 | |

| Change history | | | | | | | |
|----------------|-------|-----------|-----|-----|---|-------|-------|
| Date | TSG # | TSG Doc. | CR | Rev | Subject/Comment | Old | New |
| | RP-07 | RP-000044 | 159 | | Message contents for the intersystem command message to UTRAN operating in TDD mode | 3.1.0 | 3.2.0 |
| | RP-07 | RP-000044 | 160 | | Corrections on use of PUSCH power control info and minor corrections | 3.1.0 | 3.2.0 |
| | RP-07 | RP-000044 | 162 | 2 | UE individual DRX cycles in CELL_PCH and URA_PCH states | 3.1.0 | 3.2.0 |
| | RP-07 | RP-000044 | 163 | | Correction to Transport Format Combination Control procedure | 3.1.0 | 3.2.0 |
| | RP-07 | RP-000044 | 164 | 3 | Downlink outer loop power control | 3.1.0 | 3.2.0 |
| | RP-07 | RP-000044 | 165 | 2 | Redirection of RRC connection setup | 3.1.0 | 3.2.0 |
| | RP-07 | RP-000044 | 166 | 2 | Inter-frequency measurements in CELL_FACH state | 3.1.0 | 3.2.0 |
| | RP-07 | RP-000044 | 167 | | List of found editorial mistakes in the Dec99 version of 25.331 (V3.1.0) | 3.1.0 | 3.2.0 |
| | RP-07 | RP-000044 | 168 | 1 | Transport block size | 3.1.0 | 3.2.0 |
| | RP-07 | RP-000044 | 169 | 1 | Cell Access Restriction | 3.1.0 | 3.2.0 |
| | RP-07 | RP-000044 | 170 | | Editorial modification | 3.1.0 | 3.2.0 |
| | RP-07 | RP-000044 | 171 | | Modification of DPCH info | 3.1.0 | 3.2.0 |
| | RP-07 | RP-000045 | 172 | 1 | Measurement control message | 3.1.0 | 3.2.0 |
| | RP-07 | RP-000045 | 173 | 2 | Reporting cell status | 3.1.0 | 3.2.0 |
| | RP-07 | RP-000045 | 174 | | Additional IE for RB release | 3.1.0 | 3.2.0 |
| | RP-07 | RP-000045 | 175 | | Available SF in PRACH info | 3.1.0 | 3.2.0 |
| | RP-07 | RP-000045 | 176 | | Traffic volume measurement event | 3.1.0 | 3.2.0 |
| | RP-07 | RP-000045 | 177 | | Report of multiple cells on an event result | 3.1.0 | 3.2.0 |
| | RP-07 | RP-000045 | 178 | | Editorial modification on Direct Transfer | 3.1.0 | 3.2.0 |
| | RP-07 | RP-000045 | 179 | | Correction of the Security Mode Control procedure | 3.1.0 | 3.2.0 |
| | RP-07 | RP-000045 | 180 | 1 | Maximum calculated Transport Format Combination | 3.1.0 | 3.2.0 |
| | RP-07 | RP-000045 | 183 | | Additional DPCH IEs to align 25.331 with 25.214 | 3.1.0 | 3.2.0 |
| | RP-07 | RP-000045 | 184 | 1 | RB – DCH mapping | 3.1.0 | 3.2.0 |
| | RP-07 | RP-000045 | 188 | 1 | Modifications related to FDD mode DSCH | 3.1.0 | 3.2.0 |
| | RP-07 | RP-000045 | 189 | 1 | Identification of Shared Channel Physical Configuration in TDD Mode | 3.1.0 | 3.2.0 |
| | RP-07 | RP-000045 | 192 | 1 | Uplink Outer Loop Power Control During Hard Handover | 3.1.0 | 3.2.0 |
| | RP-07 | RP-000045 | 193 | | Support of Multiple CCTrCH's in TDD Mode | 3.1.0 | 3.2.0 |
| | RP-07 | RP-000045 | 194 | 1 | Uplink Physical Channel Control in TDD Mode | 3.1.0 | 3.2.0 |
| | RP-07 | RP-000045 | 201 | 1 | Transfer of initial information from UE to target RNC prior to handover to UTRAN | 3.1.0 | 3.2.0 |
| | RP-07 | RP-000045 | 202 | 1 | CN information elements | 3.1.0 | 3.2.0 |
| | RP-07 | RP-000045 | 203 | | UTRAN mobility information elements | 3.1.0 | 3.2.0 |
| | RP-07 | RP-000045 | 204 | 1 | RB information elements | 3.1.0 | 3.2.0 |
| | RP-07 | RP-000046 | 205 | 1 | Physical channel information elements | 3.1.0 | 3.2.0 |
| | RP-07 | RP-000046 | 206 | 1 | UE capability information elements | 3.1.0 | 3.2.0 |
| | RP-07 | RP-000046 | 207 | | UE variables | 3.1.0 | 3.2.0 |
| | RP-07 | RP-000046 | 208 | 1 | Actions when entering idle mode | 3.1.0 | 3.2.0 |
| | RP-07 | RP-000046 | 209 | | Usage of pilot bits | 3.1.0 | 3.2.0 |
| | RP-07 | RP-000046 | 210 | | System information procedure corrections | 3.1.0 | 3.2.0 |
| | RP-07 | RP-000046 | 212 | | Reconfiguration of ciphering | 3.1.0 | 3.2.0 |
| | RP-07 | RP-000046 | 213 | 1 | Enhancements to RRC connection re-establishment procedure (Message subsequently deleted in RAN !), RP-000715) | 3.1.0 | 3.2.0 |
| | RP-07 | RP-000046 | 215 | | Updates to RRC Initialisation Information transparent container and addition of reverse direction container description | 3.1.0 | 3.2.0 |
| | RP-07 | RP-000046 | 220 | 1 | Changes in RRC messages to support lossless SRNC relocation | 3.1.0 | 3.2.0 |
| | RP-07 | RP-000046 | 229 | 1 | Measurements of unlisted neighbouring cells | 3.1.0 | 3.2.0 |
| | RP-07 | RP-000046 | 234 | 2 | Inclusion of Location Services | 3.1.0 | 3.2.0 |
| | RP-07 | RP-000046 | 236 | 1 | Application of Access Service Classes and relation to Access Classes | 3.1.0 | 3.2.0 |
| | RP-07 | RP-000046 | 252 | 1 | DRX indicator presence and state entering mechanism at the end of a procedure | 3.1.0 | 3.2.0 |
| | RP-07 | RP-000046 | 254 | 1 | Physical shared channel allocation procedure | 3.1.0 | 3.2.0 |
| | RP-07 | RP-000046 | 255 | | Corrections to TDD specific parameters in PICH info | 3.1.0 | 3.2.0 |
| | RP-07 | RP-000046 | 256 | | Editorial modifications | 3.1.0 | 3.2.0 |
| | RP-07 | RP-000046 | 259 | 2 | Introduction of mapping function information in Cell selection and | 3.1.0 | 3.2.0 |
| | RP-07 | RP-000046 | 263 | | Ciphering and integrity HFN | 3.1.0 | 3.2.0 |

| Change history | | | | | | | |
|----------------|-------|-----------|-----|-----|---|-------|-------|
| Date | TSG # | TSG Doc. | CR | Rev | Subject/Comment | Old | New |
| | RP-07 | RP-000046 | 267 | | New SIB for UP | 3.1.0 | 3.2.0 |
| | RP-07 | RP-000047 | 268 | | Removal of synchronization Case 3 | 3.1.0 | 3.2.0 |
| | RP-07 | RP-000047 | 271 | | TX Diversity | 3.1.0 | 3.2.0 |
| | RP-07 | RP-000047 | 272 | | Update of tabular format clause 10 | 3.1.0 | 3.2.0 |
| | RP-07 | RP-000047 | 273 | | ASN.1 description | 3.1.0 | 3.2.0 |
| 06/2000 | RP-08 | RP-000222 | 228 | 5 | Downlink power control in compressed mode | 3.2.0 | 3.3.0 |
| | RP-08 | RP-000222 | 260 | 1 | Clarification on physical channel allocations in TDD | 3.2.0 | 3.3.0 |
| | RP-08 | RP-000222 | 261 | 4 | TDD Measurements and Reporting | 3.2.0 | 3.3.0 |
| | RP-08 | RP-000222 | 262 | 4 | Signalling of IEs related to System Information on FACH | 3.2.0 | 3.3.0 |
| | RP-08 | RP-000222 | 265 | 3 | Transport Format Combination Control | 3.2.0 | 3.3.0 |
| | RP-08 | RP-000222 | 269 | 1 | Signalling of partial failure in radio bearer related procedures | 3.2.0 | 3.3.0 |
| | RP-08 | RP-000222 | 275 | | Clarification on PDCP info | 3.2.0 | 3.3.0 |
| | RP-08 | RP-000222 | 279 | | Editorial modification on Transport Ch capability | 3.2.0 | 3.3.0 |
| | RP-08 | RP-000222 | 280 | | Editorial modification on CN IE | 3.2.0 | 3.3.0 |
| | RP-08 | RP-000222 | 281 | 3 | Editorial modification on Physical CH IE | 3.2.0 | 3.3.0 |
| | RP-08 | RP-000222 | 282 | 1 | Editorial modification on ASN.1 description | 3.2.0 | 3.3.0 |
| | RP-08 | RP-000222 | 283 | 1 | IEs on SIB5/6 | 3.2.0 | 3.3.0 |
| | RP-08 | RP-000222 | 285 | 2 | Re-establishment timer | 3.2.0 | 3.3.0 |
| | RP-08 | RP-000222 | 286 | 1 | CN DRX cycle coefficient | 3.2.0 | 3.3.0 |
| | RP-08 | RP-000222 | 287 | 1 | Cell Access Restriction | 3.2.0 | 3.3.0 |
| | RP-08 | RP-000222 | 288 | 1 | Cell selection and re-selection parameters | 3.2.0 | 3.3.0 |
| | RP-08 | RP-000222 | 289 | 2 | Modification on Measurement IE | 3.2.0 | 3.3.0 |
| | RP-08 | RP-000222 | 291 | 1 | RACH Transmission parameters | 3.2.0 | 3.3.0 |
| | RP-08 | RP-000222 | 292 | 1 | SCCPCH System Info | 3.2.0 | 3.3.0 |
| | RP-08 | RP-000222 | 293 | 1 | Addition of HFN for RRC CONNECTION RE-ESTABLISHMENT COMPLETE | 3.2.0 | 3.3.0 |
| | RP-08 | RP-000223 | 294 | 1 | RLC reconfiguration indicator | 3.2.0 | 3.3.0 |
| | RP-08 | RP-000223 | 296 | 3 | RLC Info | 3.2.0 | 3.3.0 |
| | RP-08 | RP-000223 | 297 | 1 | Usage of Transport CH ID | 3.2.0 | 3.3.0 |
| | RP-08 | RP-000223 | 298 | 2 | Transport format combination set | 3.2.0 | 3.3.0 |
| | RP-08 | RP-000223 | 300 | 1 | Usage of U-RNTI and C-RNTI in DL DCCH message | 3.2.0 | 3.3.0 |
| | RP-08 | RP-000223 | 301 | | Description of Cell Update Procedure | 3.2.0 | 3.3.0 |
| | RP-08 | RP-000223 | 304 | 1 | System information modification procedure | 3.2.0 | 3.3.0 |
| | RP-08 | RP-000223 | 305 | | Functional descriptions of the RRC messages | 3.2.0 | 3.3.0 |
| | RP-08 | RP-000223 | 306 | | Clarification of CTFC calculation | 3.2.0 | 3.3.0 |
| | RP-08 | RP-000223 | 307 | 3 | Compressed mode parameters | 3.2.0 | 3.3.0 |
| | RP-08 | RP-000223 | 309 | 2 | Signalling procedure for periodic local authentication | 3.2.0 | 3.3.0 |
| | RP-08 | RP-000223 | 310 | 5 | Editorial corrections on security | 3.2.0 | 3.3.0 |
| | RP-08 | RP-000223 | 311 | 2 | Security capability | 3.2.0 | 3.3.0 |
| | RP-08 | RP-000223 | 312 | 1 | Corrections on ASN.1 definitions | 3.2.0 | 3.3.0 |
| | RP-08 | RP-000223 | 313 | 2 | DRX cycle lower limit | 3.2.0 | 3.3.0 |
| | RP-08 | RP-000223 | 314 | 1 | Removal of CPICH SIR measurement quantity | 3.2.0 | 3.3.0 |
| | RP-08 | RP-000223 | 315 | 1 | Signalling connection release request | 3.2.0 | 3.3.0 |
| | RP-08 | RP-000223 | 318 | 1 | Change to IMEI coding from BCD to hexadecimal | 3.2.0 | 3.3.0 |
| | RP-08 | RP-000223 | 319 | 1 | Removal of RLC sequence numbers from RRC initialisation information | 3.2.0 | 3.3.0 |
| | RP-08 | RP-000223 | 320 | 3 | Addition of the length of PDCP sequence numbers into PDCP info | 3.2.0 | 3.3.0 |
| | RP-08 | RP-000224 | 323 | 1 | BSIC verification of GSM cells | 3.2.0 | 3.3.0 |
| | RP-08 | RP-000224 | 324 | | Reporting cell status | 3.2.0 | 3.3.0 |
| | RP-08 | RP-000224 | 325 | | RRC measurement filtering parameters | 3.2.0 | 3.3.0 |
| | RP-08 | RP-000224 | 326 | | Cell-reselection parameter signalling | 3.2.0 | 3.3.0 |
| | RP-08 | RP-000224 | 328 | 3 | Multiplicity values | 3.2.0 | 3.3.0 |
| | RP-08 | RP-000224 | 329 | | Quality measurements | 3.2.0 | 3.3.0 |
| | RP-08 | RP-000224 | 330 | 4 | CPCH Status Indication mode correction | 3.2.0 | 3.3.0 |
| | RP-08 | RP-000224 | 331 | 4 | End of CPCH transmission | 3.2.0 | 3.3.0 |
| | RP-08 | RP-000224 | 332 | | Handover to UTRAN procedure | 3.2.0 | 3.3.0 |
| | RP-08 | RP-000224 | 333 | | Harmonization of access service classes in FDD and TDD | 3.2.0 | 3.3.0 |

| Change history | | | | | | | | |
|----------------|-------|-----------|-----|-----|---|-------|-------|--|
| Date | TSG # | TSG Doc. | CR | Rev | Subject/Comment | Old | New | |
| | RP-08 | RP-000224 | 334 | 1 | Correction to usage of primary CCPCH info and primary CPICH info | 3.2.0 | 3.3.0 | |
| | RP-08 | RP-000224 | 335 | | Corrections and clarifications on system information handling | 3.2.0 | 3.3.0 | |
| | RP-08 | RP-000224 | 336 | | Editorial corrections | 3.2.0 | 3.3.0 | |
| | RP-08 | RP-000224 | 337 | 1 | Editorial corrections on uplink timing advance | 3.2.0 | 3.3.0 | |
| | RP-08 | RP-000224 | 339 | | Correction of Transport Format Combination tabular format and ASN.1 | 3.2.0 | 3.3.0 | |
| | RP-08 | RP-000224 | 340 | 1 | UE variables | 3.2.0 | 3.3.0 | |
| | RP-08 | RP-000224 | 342 | 1 | General error handling | 3.2.0 | 3.3.0 | |
| | RP-08 | RP-000224 | 344 | 1 | System Information extensibility in ASN.1 definitions | 3.2.0 | 3.3.0 | |
| | RP-08 | RP-000224 | 345 | | Usage of pilot bits | 3.2.0 | 3.3.0 | |
| | RP-08 | RP-000224 | 346 | 3 | RRC connection release procedure | 3.2.0 | 3.3.0 | |
| | RP-08 | RP-000225 | 347 | 1 | Alignment of Section 10.3 on methodology defined in 25.921 | 3.2.0 | 3.3.0 | |
| | RP-08 | RP-000225 | 348 | | Modifications of cell (re)selection parameters | 3.2.0 | 3.3.0 | |
| | RP-08 | RP-000225 | 350 | 1 | GPS time-of-week represented as seconds and fractions of seconds | 3.2.0 | 3.3.0 | |
| | RP-08 | RP-000225 | 351 | 2 | CPCH corrections | 3.2.0 | 3.3.0 | |
| | RP-08 | RP-000225 | 352 | | PLMN type selection | 3.2.0 | 3.3.0 | |
| | RP-08 | RP-000225 | 353 | 3 | Paging and establishment cause values | 3.2.0 | 3.3.0 | |
| | RP-08 | RP-000225 | 354 | | Common channel configurations | 3.2.0 | 3.3.0 | |
| | RP-08 | RP-000225 | 355 | 2 | Clarification of prioritization of logical channels in UE | 3.2.0 | 3.3.0 | |
| | RP-08 | RP-000225 | 357 | 2 | UE capability corrections | 3.2.0 | 3.3.0 | |
| | RP-08 | RP-000225 | 358 | 2 | Clarification of HFN | 3.2.0 | 3.3.0 | |
| | RP-08 | RP-000225 | 359 | 3 | Clarification of Integrity Protection | 3.2.0 | 3.3.0 | |
| | RP-08 | RP-000225 | 360 | 1 | RRC message size optimization regarding TrCH parameters | 3.2.0 | 3.3.0 | |
| | RP-08 | RP-000225 | 361 | | Protocol extensions in ASN | 3.2.0 | 3.3.0 | |
| | RP-08 | RP-000225 | 362 | 1 | Downloading of pre- defined configurations via SIB 16 | 3.2.0 | 3.3.0 | |
| | RP-08 | RP-000225 | 363 | 1 | Optimization of System Information | 3.2.0 | 3.3.0 | |
| | RP-08 | RP-000225 | 364 | 1 | CPCH gain factor | 3.2.0 | 3.3.0 | |
| | RP-08 | RP-000225 | 368 | 2 | SFN Transmission Rate in TDD Mode | 3.2.0 | 3.3.0 | |
| | RP-08 | RP-000225 | 371 | 1 | Integrity Control | 3.2.0 | 3.3.0 | |
| | RP-08 | RP-000225 | 372 | | Modification to measurement event evaluation | 3.2.0 | 3.3.0 | |
| | RP-08 | RP-000225 | 373 | | System Information related parameters | 3.2.0 | 3.3.0 | |
| | RP-08 | RP-000226 | 375 | 1 | Changes in RB mapping info | 3.2.0 | 3.3.0 | |
| | RP-08 | RP-000226 | 377 | | Editorial corrections to PRACH system information and Cell info | 3.2.0 | 3.3.0 | |
| | RP-08 | RP-000226 | 378 | | Editorial Corrections to 25.331 Procedures and Tabular Format | 3.2.0 | 3.3.0 | |
| | RP-08 | RP-000226 | 379 | 1 | Corrections to figures and procedures for the failure cases | 3.2.0 | 3.3.0 | |
| | RP-08 | RP-000226 | 380 | | Corrections on use of ORDERED_CONFIG | 3.2.0 | 3.3.0 | |
| | RP-08 | RP-000226 | 382 | 1 | Corrections to Transport Channel and RB Reconfiguration procedures | 3.2.0 | 3.3.0 | |
| | RP-08 | RP-000226 | 383 | 1 | Corrections to INITIAL DIRECT TRANSFER and UE CAPABILITY INFORMATION CONFIRM procedures | 3.2.0 | 3.3.0 | |
| | RP-08 | RP-000226 | 384 | | Corrections to Transparent mode signalling info Tabular format and ASN.1 | 3.2.0 | 3.3.0 | |
| | RP-08 | RP-000226 | 385 | | Corrections to Soft Handover messages and procedures | 3.2.0 | 3.3.0 | |
| | RP-08 | RP-000226 | 387 | | Corrections to RRC CONNECTION REJECT procedures | 3.2.0 | 3.3.0 | |
| | RP-08 | RP-000226 | 388 | 1 | Transport format combination in TDD and Transport channel ID | 3.2.0 | 3.3.0 | |
| | RP-08 | RP-000226 | 389 | 1 | Signalling for dynamic TTI in TDD | 3.2.0 | 3.3.0 | |
| | RP-08 | RP-000226 | 390 | 1 | Usage of DCCH for Shared Channel Allocation message | 3.2.0 | 3.3.0 | |
| | RP-08 | RP-000226 | 391 | 1 | Correction to physical channel IEs in TDD | 3.2.0 | 3.3.0 | |
| | RP-08 | RP-000226 | 392 | 1 | TDD preconfiguration for Handover to UTRAN | 3.2.0 | 3.3.0 | |
| | RP-08 | RP-000226 | 393 | | Corrections to measurement control descriptions and messages | 3.2.0 | 3.3.0 | |
| | RP-08 | RP-000226 | 394 | 1 | Corrections on ASN.1 definitions | 3.2.0 | 3.3.0 | |
| | RP-08 | RP-000226 | 395 | | Addition of the Segmentation indication field for transparent mode RLC in the RLC Info | 3.2.0 | 3.3.0 | |
| | RP-08 | RP-000226 | 396 | 1 | Radio Bearer identity for CCCH | 3.2.0 | 3.3.0 | |
| | RP-08 | RP-000226 | 397 | 1 | ASN.1 definitions for RRC information between network nodes | 3.2.0 | 3.3.0 | |
| | RP-08 | RP-000227 | 398 | 1 | NAS Routing | 3.2.0 | 3.3.0 | |
| | RP-08 | RP-000227 | 399 | | DPCCH power control preamble | 3.2.0 | 3.3.0 | |

| Change history | | | | | | | |
|----------------|-------|-----------|-----|-----|---|-------|-------|
| Date | TSG # | TSG Doc. | CR | Rev | Subject/Comment | Old | New |
| | RP-08 | RP-000227 | 400 | 2 | Modifications of Assisted GPS Messages | 3.2.0 | 3.3.0 |
| | RP-08 | RP-000227 | 401 | | Choice of Initial UE Identity | 3.2.0 | 3.3.0 |
| | RP-08 | RP-000227 | 402 | | ANSI-41 information elements | 3.2.0 | 3.3.0 |
| | RP-08 | RP-000227 | 404 | 1 | RLC value ranges | 3.2.0 | 3.3.0 |
| | RP-08 | RP-000227 | 408 | 1 | HFN Reset | 3.2.0 | 3.3.0 |
| | RP-08 | RP-000227 | 409 | 1 | Clarification on ciphering parameters and integrity protection procedure in case of SRNS relocation | 3.2.0 | 3.3.0 |
| | RP-08 | RP-000227 | 410 | 1 | Clarification of compressed mode activation and configuration failure | 3.2.0 | 3.3.0 |
| | RP-08 | RP-000227 | 412 | 1 | Modification of the RLC Size IE | 3.2.0 | 3.3.0 |
| | RP-08 | RP-000227 | 414 | | CPCH DL Power control | 3.2.0 | 3.3.0 |
| | RP-08 | RP-000227 | 415 | 1 | SFN measurements in TDD | 3.2.0 | 3.3.0 |
| 09/2000 | RP-09 | RP-000361 | 356 | 3 | Clarification on multiplicity of PCH and PICH and S-CCPCH selection | 3.3.0 | 3.4.0 |
| | RP-09 | RP-000361 | 403 | 3 | Parameters to be stored in the USIM | 3.3.0 | 3.4.0 |
| | RP-09 | RP-000361 | 413 | 3 | Optimization of Inter-system handover message | 3.3.0 | 3.4.0 |
| | RP-09 | RP-000361 | 416 | 2 | Timing Advance in Handover Procedures | 3.3.0 | 3.4.0 |
| | RP-09 | RP-000361 | 417 | 2 | Synchronization of Timing Advance and Timing Deviation Measurement | 3.3.0 | 3.4.0 |
| | RP-09 | RP-000361 | 418 | | Downlink Physical Channels Per Timeslot | 3.3.0 | 3.4.0 |
| | RP-09 | RP-000361 | 419 | | TDD Mode DCH Reception in Cell DCH State | 3.3.0 | 3.4.0 |
| | RP-09 | RP-000361 | 420 | 2 | Downlink Power Control During DTX in TDD Mode | 3.3.0 | 3.4.0 |
| | RP-09 | RP-000361 | 421 | 1 | Paging Indicator Length Definition | 3.3.0 | 3.4.0 |
| | RP-09 | RP-000361 | 422 | | Updating & alignment of RRC containers & handover to UTRAN information transfer | 3.3.0 | 3.4.0 |
| | RP-09 | RP-000361 | 424 | | Default values for UE timers and counters | 3.3.0 | 3.4.0 |
| | RP-09 | RP-000361 | 425 | 1 | Security mode control | 3.3.0 | 3.4.0 |
| | RP-09 | RP-000361 | 426 | 1 | Corrections and Editorial updates to chapter 8 | 3.3.0 | 3.4.0 |
| | RP-09 | RP-000361 | 427 | | Corrections and editorial updates to chapter 10 | 3.3.0 | 3.4.0 |
| | RP-09 | RP-000361 | 428 | | Transition from CELL_DCH to CELL_PCH and URA_PCH state | 3.3.0 | 3.4.0 |
| | RP-09 | RP-000361 | 430 | | Assisted GPS Messaging and Procedures | 3.3.0 | 3.4.0 |
| | RP-09 | RP-000361 | 431 | 2 | Corrections to Activation Time use | 3.3.0 | 3.4.0 |
| | RP-09 | RP-000361 | 432 | | Editorial Corrections to measurement reporting range | 3.3.0 | 3.4.0 |
| | RP-09 | RP-000361 | 434 | 4 | Default DPCH offset value and DPCH offset | 3.3.0 | 3.4.0 |
| | RP-09 | RP-000361 | 435 | 3 | RLC info | 3.3.0 | 3.4.0 |
| | RP-09 | RP-000362 | 437 | | Clarification of the description of IE semantics in "RB with PDCP information" | 3.3.0 | 3.4.0 |
| | RP-09 | RP-000362 | 438 | 1 | Editorial corrections on security | 3.3.0 | 3.4.0 |
| | RP-09 | RP-000362 | 439 | | Editorial correction to RB mapping info | 3.3.0 | 3.4.0 |
| | RP-09 | RP-000362 | 440 | 1 | Compressed mode configuration failure | 3.3.0 | 3.4.0 |
| | RP-09 | RP-000362 | 441 | | Gain factors for TDD | 3.3.0 | 3.4.0 |
| | RP-09 | RP-000362 | 442 | | Introduction of Default DPCH Offset Value in TDD | 3.3.0 | 3.4.0 |
| | RP-09 | RP-000362 | 444 | 1 | Optimization of handover to UTRAN command | 3.3.0 | 3.4.0 |
| | RP-09 | RP-000362 | 445 | | Editorial corrections | 3.3.0 | 3.4.0 |
| | RP-09 | RP-000362 | 448 | 1 | Mapping of channelisation code | 3.3.0 | 3.4.0 |
| | RP-09 | RP-000362 | 449 | 2 | DL TFCS Limitation | 3.3.0 | 3.4.0 |
| | RP-09 | RP-000362 | 450 | | SIB offset | 3.3.0 | 3.4.0 |
| | RP-09 | RP-000362 | 451 | | RRC CONNECTION RELEASE cause | 3.3.0 | 3.4.0 |
| | RP-09 | RP-000362 | 452 | | Addition of RACH TFCS | 3.3.0 | 3.4.0 |
| | RP-09 | RP-000362 | 453 | 2 | Cell Identity | 3.3.0 | 3.4.0 |
| | RP-09 | RP-000362 | 454 | | Editorial Modifications | 3.3.0 | 3.4.0 |
| | RP-09 | RP-000362 | 455 | 1 | TDD PRACH Power Control for Spreading Factor 8/16 | 3.3.0 | 3.4.0 |
| | RP-09 | RP-000362 | 456 | | TDD CCTrCH Repetition Length Definition | 3.3.0 | 3.4.0 |
| | RP-09 | RP-000362 | 457 | 1 | Reporting threshold of traffic volume measurements | 3.3.0 | 3.4.0 |
| | RP-09 | RP-000362 | 459 | 2 | UP GPS assistance data for SIB | 3.3.0 | 3.4.0 |
| | RP-09 | RP-000362 | 461 | 1 | Support of cell update confirm on CCCH | 3.3.0 | 3.4.0 |
| | RP-09 | RP-000363 | 462 | 1 | Max Window Size in RLC capabilities | 3.3.0 | 3.4.0 |
| | RP-09 | RP-000363 | 463 | 3 | UE handling of CFN | 3.3.0 | 3.4.0 |
| | RP-09 | RP-000363 | 464 | 1 | Correction of padding description in clause 12 | 3.3.0 | 3.4.0 |

| Change history | | | | | | | | |
|----------------|-------|-----------|-----|-----|---|-------|-------|--|
| Date | TSG # | TSG Doc. | CR | Rev | Subject/Comment | Old | New | |
| | RP-09 | RP-000363 | 465 | 1 | Window size in RLC info | 3.3.0 | 3.4.0 | |
| | RP-09 | RP-000363 | 466 | 1 | TFC Control Duration | 3.3.0 | 3.4.0 | |
| | RP-09 | RP-000363 | 467 | | System Information Block Tabular Information | 3.3.0 | 3.4.0 | |
| | RP-09 | RP-000363 | 469 | 1 | Frequency encoding in inter-system handover messages | 3.3.0 | 3.4.0 | |
| | RP-09 | RP-000363 | 470 | | RRC message size optimization regarding TFS parameters | 3.3.0 | 3.4.0 | |
| | RP-09 | RP-000363 | 471 | 2 | RACH selection | 3.3.0 | 3.4.0 | |
| | RP-09 | RP-000363 | 472 | | DRX cycle lower limit | 3.3.0 | 3.4.0 | |
| | RP-09 | RP-000363 | 474 | | Rx window size in RLC info | 3.3.0 | 3.4.0 | |
| | RP-09 | RP-000363 | 476 | 1 | Corrections & optimizations regarding system information blocks of length 215..221 | 3.3.0 | 3.4.0 | |
| | RP-09 | RP-000363 | 477 | 1 | Corrections on 8.1.1 resulting from RRC review at R2#14 | 3.3.0 | 3.4.0 | |
| | RP-09 | RP-000363 | 478 | 1 | Corrections to the RRC connection release procedure | 3.3.0 | 3.4.0 | |
| | RP-09 | RP-000363 | 479 | 1 | New release cause for signalling connection re-establishment | 3.3.0 | 3.4.0 | |
| | RP-09 | RP-000363 | 480 | 1 | Correction to IE midamble shift and burst type | 3.3.0 | 3.4.0 | |
| | RP-09 | RP-000363 | 481 | 1 | Correction in RLC info | 3.3.0 | 3.4.0 | |
| | RP-09 | RP-000363 | 483 | | Description of CTCH occasions | 3.3.0 | 3.4.0 | |
| | RP-09 | RP-000363 | 485 | 1 | TDD CCTrCH UL/DL Pairing for Inner Loop Power Control | 3.3.0 | 3.4.0 | |
| | RP-09 | RP-000363 | 486 | 1 | DCCH and BCCH Signalling of TDD UL OL PC Information | 3.3.0 | 3.4.0 | |
| | RP-09 | RP-000364 | 487 | 1 | Broadcast SIBs for TDD UL OL PC Information | 3.3.0 | 3.4.0 | |
| | RP-09 | RP-000364 | 490 | 1 | CPCH corrections | 3.3.0 | 3.4.0 | |
| | RP-09 | RP-000364 | 492 | 3 | Corrections to Security IEs | 3.3.0 | 3.4.0 | |
| | RP-09 | RP-000364 | 494 | 1 | Corrections to parameters to be stored in the USIM | 3.3.0 | 3.4.0 | |
| | RP-09 | RP-000364 | 496 | | Editorial corrections | 3.3.0 | 3.4.0 | |
| | RP-09 | RP-000364 | 497 | 2 | Physical Shared Channel Allocation procedure | 3.3.0 | 3.4.0 | |
| | RP-09 | RP-000364 | 498 | | Correction to Transport Format Combination Control Message | 3.3.0 | 3.4.0 | |
| | RP-09 | RP-000364 | 499 | 1 | Usage of Cell Parameter ID | 3.3.0 | 3.4.0 | |
| | RP-09 | RP-000364 | 500 | | RB description for SHCCH | 3.3.0 | 3.4.0 | |
| | RP-09 | RP-000364 | 501 | 1 | Use of LI in UM | 3.3.0 | 3.4.0 | |
| | RP-09 | RP-000364 | 502 | 1 | Minor Corrections to RRC Protocol Specification | 3.3.0 | 3.4.0 | |
| | RP-09 | RP-000364 | 503 | 1 | Correction to Cell Update Cause | 3.3.0 | 3.4.0 | |
| | RP-09 | RP-000364 | 504 | | Correction on T307 definition | 3.3.0 | 3.4.0 | |
| | RP-09 | RP-000364 | 505 | | Corrections to relative priorities in RRC Protocol | 3.3.0 | 3.4.0 | |
| | RP-09 | RP-000364 | 506 | | Unification of Reconfiguration Procedures | 3.3.0 | 3.4.0 | |
| | RP-09 | RP-000364 | 507 | 1 | Changes to section 8.2 proposed at Paris RRC Ad Hoc | 3.3.0 | 3.4.0 | |
| | RP-09 | RP-000364 | 508 | | Establishment Cause | 3.3.0 | 3.4.0 | |
| | RP-09 | RP-000364 | 509 | 1 | PRACH partitioning | 3.3.0 | 3.4.0 | |
| | RP-09 | RP-000364 | 510 | | Editorial Correction on Active Set Update | 3.3.0 | 3.4.0 | |
| | RP-09 | RP-000364 | 511 | | Editorial Correction regarding system information | 3.3.0 | 3.4.0 | |
| | RP-09 | RP-000365 | 512 | 1 | Clarification on Reporting Cell Status | 3.3.0 | 3.4.0 | |
| | RP-09 | RP-000365 | 513 | 1 | Editorial corrections on RRC Connection Establishment and Release procedures
NOTE: In subclause 8.1.4.6, the change from "decrease" to "increase" for V308 was decided to be incorrect after discussion on the TSG-RAN WG2 reflector and was not implemented | 3.3.0 | 3.4.0 | |
| | RP-09 | RP-000365 | 514 | | Gated Transmission Control Info | 3.3.0 | 3.4.0 | |
| | RP-09 | RP-000365 | 515 | 1 | Cell selection/reselection parameters for SIB 3/4 | 3.3.0 | 3.4.0 | |
| | RP-09 | RP-000365 | 516 | | Implementation of Ec/N0 parameters and optimization of SIB 11/12 | 3.3.0 | 3.4.0 | |
| | RP-09 | RP-000365 | 517 | | PRACH Info | 3.3.0 | 3.4.0 | |
| | RP-09 | RP-000365 | 518 | 1 | Uplink DPCH power control info | 3.3.0 | 3.4.0 | |
| | RP-09 | RP-000365 | 519 | | AICH power offset value range | 3.3.0 | 3.4.0 | |
| | RP-09 | RP-000365 | 520 | | Direct paging of RRC connected UE in CELL_PCH/URA_PCH
NOTE: This CR was postponed in TSG-RAN #9 and was wrongly included in v3.4.0. This was corrected in v3.4.1 | 3.3.0 | 3.4.0 | |
| | RP-09 | RP-000365 | 521 | | Corrections to Sections 1-7 | 3.3.0 | 3.4.0 | |
| | RP-09 | RP-000365 | 522 | | Error handling for Uplink Physical Channel Control procedure | 3.3.0 | 3.4.0 | |
| | RP-09 | RP-000365 | 523 | | Corrections to downlink outer loop power control in compressed mode | 3.3.0 | 3.4.0 | |
| | RP-09 | RP-000365 | 524 | 1 | Clarification on measurement procedure using compressed mode | 3.3.0 | 3.4.0 | |
| | RP-09 | RP-000365 | 525 | 1 | Updates to cell and URA update procedures based on RRC Ad | 3.3.0 | 3.4.0 | |

| Change history | | | | | | | | |
|----------------|-------|-----------|-----|-----|--|-------|-------|--|
| Date | TSG # | TSG Doc. | CR | Rev | Subject/Comment | Old | New | |
| | | | | | Hoc | | | |
| | RP-09 | RP-000365 | 526 | 1 | Updates to RNTI allocation procedure based on RRC Ad Hoc | 3.3.0 | 3.4.0 | |
| | RP-09 | RP-000365 | 528 | | PRACH constant value | 3.3.0 | 3.4.0 | |
| | RP-09 | RP-000365 | 530 | 1 | Corrections to the paging procedure | 3.3.0 | 3.4.0 | |
| | RP-09 | RP-000365 | 532 | 1 | Moving of text from 25.304 | 3.3.0 | 3.4.0 | |
| | RP-09 | RP-000365 | 533 | 1 | Message extensibility | 3.3.0 | 3.4.0 | |
| | RP-09 | RP-000365 | 534 | 1 | Additions to "State of RRC Procedure" in RRC Initialisation information, source RNC to target RNC | 3.3.0 | 3.4.0 | |
| | RP-09 | RP-000365 | 535 | 1 | Support of codec negotiation | 3.3.0 | 3.4.0 | |
| | - | - | - | | Removal of contents of CR 520 from v3.4.0, because it was postponed at TSG-RAN #9 and by accident included anyway. | 3.4.0 | 3.4.1 | |
| 12/2000 | RP-10 | RP-000570 | 536 | | Downlink outer-loop power control in compressed mode | 3.4.1 | 3.5.0 | |
| | RP-10 | RP-000570 | 537 | 1 | Correction in the use of "U-RNTI Short" | 3.4.1 | 3.5.0 | |
| | RP-10 | RP-000570 | 538 | | Corrections related to UE Timing | 3.4.1 | 3.5.0 | |
| | RP-10 | RP-000570 | 539 | | Corrections to SFN-SFN definition | 3.4.1 | 3.5.0 | |
| | RP-10 | RP-000570 | 541 | 1 | Corrections to definition and use of Activation Time | 3.4.1 | 3.5.0 | |
| | RP-10 | RP-000570 | 542 | | Corrections to logical channel priorities | 3.4.1 | 3.5.0 | |
| | RP-10 | RP-000570 | 543 | 1 | Correction to codec negotiation | 3.4.1 | 3.5.0 | |
| | RP-10 | RP-000570 | 544 | 1 | CFN-SFN observed time difference measurement | 3.4.1 | 3.5.0 | |
| | RP-10 | RP-000570 | 545 | 1 | Correction to timing indication for hard handover | 3.4.1 | 3.5.0 | |
| | RP-10 | RP-000570 | 546 | 1 | UE Radio Access Capability Corrections | 3.4.1 | 3.5.0 | |
| | RP-10 | RP-000570 | 548 | 1 | RRC establishment and paging causes for NAS signalling | 3.4.1 | 3.5.0 | |
| | RP-10 | RP-000570 | 549 | | Corrections to Intra-frequency measurements and Traffic volume measurements | 3.4.1 | 3.5.0 | |
| | RP-10 | RP-000570 | 551 | 1 | PRACH/RACH System information | 3.4.1 | 3.5.0 | |
| | RP-10 | RP-000570 | 553 | 1 | GSM Measurement reporting | 3.4.1 | 3.5.0 | |
| | RP-10 | RP-000570 | 554 | 1 | BLER measurement and quality target | 3.4.1 | 3.5.0 | |
| | RP-10 | RP-000570 | 556 | 1 | Clarification of PDCP sequence number window terminology | 3.4.1 | 3.5.0 | |
| | RP-10 | RP-000570 | 559 | 1 | Clarification on Error Handling | 3.4.1 | 3.5.0 | |
| | RP-10 | RP-000570 | 560 | | Removal of compressed mode measurement purpose "other" | 3.4.1 | 3.5.0 | |
| | RP-10 | RP-000570 | 561 | | Clarification of compressed mode measurement purpose "GSM" | 3.4.1 | 3.5.0 | |
| | RP-10 | RP-000570 | 564 | 2 | Reporting multiple GSM cells | 3.4.1 | 3.5.0 | |
| | RP-10 | RP-000571 | 566 | 1 | Number of RUs that can be removed in Active Set update | 3.4.1 | 3.5.0 | |
| | RP-10 | RP-000571 | 568 | 1 | Clarification on Segment Index | 3.4.1 | 3.5.0 | |
| | RP-10 | RP-000571 | 571 | 3 | RRC procedure performance requirements | 3.4.1 | 3.5.0 | |
| | RP-10 | RP-000571 | 572 | 1 | Correction of newInterSystemCellList and MeasurementControlSysInfo in ASN.1 | 3.4.1 | 3.5.0 | |
| | RP-10 | RP-000571 | 573 | 4 | Removal of Flow Id concept while maintaining lu interface flexibility | 3.4.1 | 3.5.0 | |
| | RP-10 | RP-000571 | 574 | 2 | Ciphering and reset | 3.4.1 | 3.5.0 | |
| | RP-10 | RP-000571 | 575 | 1 | Corrections and clarifications concerning inter-RAT change procedures | 3.4.1 | 3.5.0 | |
| | RP-10 | RP-000571 | 576 | 1 | General Security Clarifications | 3.4.1 | 3.5.0 | |
| | RP-10 | RP-000571 | 577 | | Clarification on RB 0 | 3.4.1 | 3.5.0 | |
| | RP-10 | RP-000571 | 578 | | Clarification on the transition of RRC state | 3.4.1 | 3.5.0 | |
| | RP-10 | RP-000571 | 580 | 1 | UP measurements for RRC information to target RNC | 3.4.1 | 3.5.0 | |
| | RP-10 | RP-000571 | 581 | | Correction on LCS reporting criteria | 3.4.1 | 3.5.0 | |
| | RP-10 | RP-000574 | 583 | 1 | CSICH Corrections | 3.4.1 | 3.5.0 | |
| | RP-10 | RP-000571 | 584 | 1 | Clarification to handling of satellite health issues | 3.4.1 | 3.5.0 | |
| | RP-10 | RP-000571 | 585 | | Clarification on activation time | 3.4.1 | 3.5.0 | |
| | RP-10 | RP-000571 | 586 | | Clarification on activation time for ciphering in TM | 3.4.1 | 3.5.0 | |
| | RP-10 | RP-000571 | 587 | 2 | Measurement procedures and messages | 3.4.1 | 3.5.0 | |
| | RP-10 | RP-000571 | 590 | 1 | Inter-RAT UE radio access capability | 3.4.1 | 3.5.0 | |
| | RP-10 | RP-000571 | 592 | 1 | Clarification on cell update/URA update procedures | 3.4.1 | 3.5.0 | |
| | RP-10 | RP-000571 | 595 | 4 | Protocol States and Process | 3.4.1 | 3.5.0 | |
| | RP-10 | RP-000571 | 596 | 1 | System Information | 3.4.1 | 3.5.0 | |
| | RP-10 | RP-000715 | 597 | 5 | RRC Connection Management Procedures, Generic procedures and actions | 3.4.1 | 3.5.0 | |
| | RP-10 | RP-000572 | 598 | 1 | Paging Procedures | 3.4.1 | 3.5.0 | |

| Change history | | | | | | | | |
|----------------|-------|-----------|-----|-----|--|-------|-------|--|
| Date | TSG # | TSG Doc. | CR | Rev | Subject/Comment | Old | New | |
| | RP-10 | RP-000572 | 599 | | NAS signalling Procedures | 3.4.1 | 3.5.0 | |
| | RP-10 | RP-000572 | 600 | 3 | Radio Bearer Control Procedures | 3.4.1 | 3.5.0 | |
| | RP-10 | RP-000572 | 601 | 1 | Corrections to the Counter Check Procedure | 3.4.1 | 3.5.0 | |
| | RP-10 | RP-000572 | 602 | | Tabular Information and ASN.1 | 3.4.1 | 3.5.0 | |
| | RP-10 | RP-000572 | 604 | 2 | Corrections to Measurement Occasion concept | 3.4.1 | 3.5.0 | |
| | RP-10 | RP-000572 | 606 | | Corrections concerning optimisation of RB information | 3.4.1 | 3.5.0 | |
| | RP-10 | RP-000572 | 608 | 1 | Corrections to security | 3.4.1 | 3.5.0 | |
| | RP-10 | RP-000572 | 609 | 1 | Ciphering activation time for DPCH | 3.4.1 | 3.5.0 | |
| | RP-10 | RP-000572 | 610 | | Confirmation of signalling connection establishment | 3.4.1 | 3.5.0 | |
| | RP-10 | RP-000572 | 611 | 2 | RACH Sub-channel signalling | 3.4.1 | 3.5.0 | |
| | RP-10 | RP-000572 | 613 | 2 | Assistance data delivery for UP | 3.4.1 | 3.5.0 | |
| | RP-10 | RP-000572 | 614 | 1 | Clarification of LCS measurements | 3.4.1 | 3.5.0 | |
| | RP-10 | RP-000572 | 615 | 2 | Configuration of RLC PDU sizes for logical channels | 3.4.1 | 3.5.0 | |
| | RP-10 | RP-000574 | 616 | | PICH power offset for TDD | 3.4.1 | 3.5.0 | |
| | RP-10 | RP-000572 | 617 | | Correction for PDSCH power control for TDD | 3.4.1 | 3.5.0 | |
| | RP-10 | RP-000574 | 618 | | Usage of dynamic spreading factor in uplink | 3.4.1 | 3.5.0 | |
| | RP-10 | RP-000572 | 619 | | Correction of Midamble Shift for Burst Type 3 | 3.4.1 | 3.5.0 | |
| | RP-10 | RP-000572 | 621 | | Correction of text concerning Scheduling of System Information | 3.4.1 | 3.5.0 | |
| | RP-10 | RP-000572 | 622 | 1 | Alignment of GSM'99 BA Range concept and its inclusion in UTRA | 3.4.1 | 3.5.0 | |
| | RP-10 | RP-000572 | 623 | 1 | Clarification of RB mapping info | 3.4.1 | 3.5.0 | |
| | RP-10 | RP-000572 | 624 | 1 | Correction to UE multi-RAT capability | 3.4.1 | 3.5.0 | |
| | RP-10 | RP-000573 | 625 | | Correction to PDCP sequence number exchange during hard handover | 3.4.1 | 3.5.0 | |
| | RP-10 | RP-000573 | 628 | 2 | DCH Quality Target | 3.4.1 | 3.5.0 | |
| | RP-10 | RP-000573 | 629 | 1 | Simultaneous release of RBs and signalling connection | 3.4.1 | 3.5.0 | |
| | RP-10 | RP-000573 | 630 | | Correction on Transport Channel Reconfiguration | 3.4.1 | 3.5.0 | |
| | RP-10 | RP-000573 | 631 | | Limitation of DRX cycle length | 3.4.1 | 3.5.0 | |
| | RP-10 | RP-000574 | 632 | | Signalling of the alpha value in TDD for open loop power control | 3.4.1 | 3.5.0 | |
| | RP-10 | RP-000573 | 633 | | Support for improved compressed mode handling for TDD measurements | 3.4.1 | 3.5.0 | |
| | RP-10 | RP-000573 | 636 | | Usage of secondary CPICH and secondary scrambling code | 3.4.1 | 3.5.0 | |
| | RP-10 | RP-000573 | 639 | | Expiration time of SIB type 7, 14 | 3.4.1 | 3.5.0 | |
| | RP-10 | RP-000573 | 640 | | Correction to integrity protection | 3.4.1 | 3.5.0 | |
| | RP-10 | RP-000684 | 641 | | Downlink Outer Loop Control | 3.4.1 | 3.5.0 | |
| 03/2001 | RP-11 | RP-010029 | 642 | 2 | RL Failure in cell update procedure | 3.5.0 | 3.6.0 | |
| | RP-11 | RP-010029 | 645 | 1 | Clarification on COUNTER CHECK | 3.5.0 | 3.6.0 | |
| | RP-11 | RP-010029 | 646 | 2 | Traffic Volume Measurement corrections | 3.5.0 | 3.6.0 | |
| | RP-11 | RP-010029 | 650 | 2 | Reserved TFICI for the TDD Special Burst | 3.5.0 | 3.6.0 | |
| | RP-11 | RP-010029 | 653 | | Correction to description of RRC state transitions | 3.5.0 | 3.6.0 | |
| | RP-11 | RP-010029 | 657 | | RLC re-establish correction | 3.5.0 | 3.6.0 | |
| | RP-11 | RP-010029 | 658 | 1 | Removal of RLC logical channel mapping indicator | 3.5.0 | 3.6.0 | |
| | RP-11 | RP-010029 | 659 | | New paging and establishment cause "Unknown" | 3.5.0 | 3.6.0 | |
| | RP-11 | RP-010029 | 660 | 1 | Miscellaneous procedure corrections | 3.5.0 | 3.6.0 | |
| | RP-11 | RP-010029 | 661 | | Corrections to compressed mode pattern sequence handling | 3.5.0 | 3.6.0 | |
| | RP-11 | RP-010029 | 662 | | Inter-system change clarifications | 3.5.0 | 3.6.0 | |
| | RP-11 | RP-010029 | 663 | 1 | RLC status transmission in CELL_PCH and URA_PCH | 3.5.0 | 3.6.0 | |
| | RP-11 | RP-010029 | 665 | 1 | Clarification of RB information parameter values for SRB0 | 3.5.0 | 3.6.0 | |
| | RP-11 | RP-010029 | 666 | | Encoding for RRC- container | 3.5.0 | 3.6.0 | |
| | RP-11 | RP-010029 | 667 | 2 | Update of message extension and encoding descriptions | 3.5.0 | 3.6.0 | |
| | RP-11 | RP-010032 | 668 | 4 | Introduction of default pre-defined configurations | 3.5.0 | 3.6.0 | |
| | RP-11 | RP-010029 | 669 | 2 | Security corrections | 3.5.0 | 3.6.0 | |
| | RP-11 | RP-010029 | 670 | | Clarifications on Blind Handover Support | 3.5.0 | 3.6.0 | |
| | RP-11 | RP-010029 | 671 | 1 | Missing descriptions of UE actions | 3.5.0 | 3.6.0 | |
| | RP-11 | RP-010029 | 672 | 2 | Corrections on UE Positioning information | 3.5.0 | 3.6.0 | |
| | RP-11 | RP-010029 | 674 | 1 | Security related corrections to SRNS | 3.5.0 | 3.6.0 | |
| | RP-11 | RP-010032 | 675 | 2 | Downlink power offsets | 3.5.0 | 3.6.0 | |
| | RP-11 | RP-010274 | 676 | 2 | Checking the integrity of UE security capabilities | 3.5.0 | 3.6.0 | |

| Change history | | | | | | | |
|----------------|-------|-----------|-----|-----|--|-------|-------|
| Date | TSG # | TSG Doc. | CR | Rev | Subject/Comment | Old | New |
| | RP-11 | RP-010030 | 678 | 1 | Clarification to Secondary CCPCH info | 3.5.0 | 3.6.0 |
| | RP-11 | RP-010030 | 679 | 1 | Miscellaneous corrections | 3.5.0 | 3.6.0 |
| | RP-11 | RP-010030 | 680 | | Removal of Layer 3 filtering for RACH | 3.5.0 | 3.6.0 |
| | RP-11 | RP-010030 | 681 | 2 | Correction of compressed mode parameters | 3.5.0 | 3.6.0 |
| | RP-11 | RP-010030 | 682 | | Removal of immediate cell evaluation | 3.5.0 | 3.6.0 |
| | RP-11 | RP-010030 | 684 | 2 | Scheduling of SIB 15.2 and SIB 15.3 | 3.5.0 | 3.6.0 |
| | RP-11 | RP-010030 | 685 | 1 | Correction to ECN modules | 3.5.0 | 3.6.0 |
| | RP-11 | RP-010030 | 686 | 1 | Improvement of the description of timing advance for TDD | 3.5.0 | 3.6.0 |
| | RP-11 | RP-010030 | 687 | | Correction on timing advance and allocation for shared channels | 3.5.0 | 3.6.0 |
| | RP-11 | RP-010030 | 688 | 1 | Clarification on SF 1 signalling | 3.5.0 | 3.6.0 |
| | RP-11 | RP-010030 | 689 | 1 | Correction to power control in TDD | 3.5.0 | 3.6.0 |
| | RP-11 | RP-010030 | 690 | | Midamble - Channelisation code association for TDD | 3.5.0 | 3.6.0 |
| | RP-11 | RP-010030 | 691 | | Network requested reporting for physical shared channel allocation | 3.5.0 | 3.6.0 |
| | RP-11 | RP-010030 | 693 | | System Information | 3.5.0 | 3.6.0 |
| | RP-11 | RP-010030 | 694 | 1 | Clarification on Transport Channel Identity | 3.5.0 | 3.6.0 |
| | RP-11 | RP-010030 | 696 | 1 | Editorial Correction | 3.5.0 | 3.6.0 |
| | RP-11 | RP-010030 | 698 | 2 | Correction to add coding of intra domain NAS node selector | 3.5.0 | 3.6.0 |
| | RP-11 | RP-010030 | 700 | 1 | Corrections to system information block characteristics in TDD | 3.5.0 | 3.6.0 |
| | RP-11 | RP-010030 | 701 | 2 | ASN.1 corrections | 3.5.0 | 3.6.0 |
| | RP-11 | RP-010030 | 702 | 2 | Measurement related corrections | 3.5.0 | 3.6.0 |
| | RP-11 | RP-010031 | 703 | 1 | Clarifications on TFC Control procedure | 3.5.0 | 3.6.0 |
| | RP-11 | RP-010031 | 704 | 2 | Association of PLMN ID to neighbour cells | 3.5.0 | 3.6.0 |
| | RP-11 | RP-010031 | 705 | 1 | TFCS Selection Guidelines | 3.5.0 | 3.6.0 |
| | RP-11 | RP-010031 | 710 | | Special Burst Scheduling During DTX in TDD | 3.5.0 | 3.6.0 |
| | RP-11 | RP-010031 | 711 | 1 | Radio Link Failure Criteria in TDD | 3.5.0 | 3.6.0 |
| | RP-11 | RP-010031 | 712 | 1 | Correction & Clarification to TDD RACH Subchannels | 3.5.0 | 3.6.0 |
| | RP-11 | RP-010031 | 713 | 1 | Number of retransmission of RRC CONNECTION REQUEST | 3.5.0 | 3.6.0 |
| | RP-11 | RP-010031 | 714 | | Uplink Frequency Notification | 3.5.0 | 3.6.0 |
| | RP-11 | RP-010031 | 715 | | Clarification of Radio Bearer Mapping for DCH/DSCH Transport Channels | 3.5.0 | 3.6.0 |
| | RP-11 | RP-010031 | 716 | | Correction of mismatches between tabular and ASN.1 | 3.5.0 | 3.6.0 |
| | RP-11 | RP-010031 | 717 | | Correction to discontinuous reception in TDD | 3.5.0 | 3.6.0 |
| | RP-11 | RP-010031 | 718 | | Power control preamble | 3.5.0 | 3.6.0 |
| | RP-11 | RP-010031 | 719 | | Maximum number of AM entity | 3.5.0 | 3.6.0 |
| | RP-11 | RP-010031 | 720 | 1 | Real-time Integrity Broadcast | 3.5.0 | 3.6.0 |
| | RP-11 | RP-010031 | 721 | 3 | Moving Real-time Integrity description to different chapter | 3.5.0 | 3.6.0 |
| | RP-11 | RP-010031 | 723 | 1 | Removal of the payload unit concept | 3.5.0 | 3.6.0 |
| | RP-11 | RP-010031 | 724 | | Security related corrections to SRNS | 3.5.0 | 3.6.0 |
| | RP-11 | RP-010031 | 725 | | Periodic PLMN selection correction | 3.5.0 | 3.6.0 |
| | RP-11 | RP-010042 | 683 | 1 | Modification of "SSDT Information" IE parameters to indicate if SSDT is used in the UL only | 3.6.0 | 4.0.0 |
| | RP-11 | RP-010041 | 692 | 1 | Idle allocation for Node B synchronisation | 3.6.0 | 4.0.0 |
| | RP-11 | RP-010037 | 706 | 1 | Physical channel configuration information elements for 1.28 Mcps TDD | 3.6.0 | 4.0.0 |
| | RP-11 | RP-010037 | 707 | 2 | Changes to Measurement Related Signalling and Introduction of Cell (Re)selection Parameters for 1.28Mcps TDD | 3.6.0 | 4.0.0 |
| | RP-11 | RP-010037 | 708 | 1 | Introduction of RACH Parameters for 1.28 Mcps TDD | 3.6.0 | 4.0.0 |
| | RP-11 | RP-010037 | 709 | | Introduction of UE radio access capability Parameters for 1.28 Mcps TDD | 3.6.0 | 4.0.0 |
| | RP-11 | RP-010040 | 722 | 1 | Introduction of IPDLs for TDD | 3.6.0 | 4.0.0 |
| | RP-11 | RP-010039 | 726 | 1 | ROHC updates to RRC | 3.6.0 | 4.0.0 |
| 06/2001 | RP-12 | RP-010311 | 731 | | Clarification of the IE 'spreading factor' in Uplink DPCH info for FDD mode | 4.0.0 | 4.1.0 |
| | RP-12 | RP-010311 | 733 | | Correction of UE Radio Access Capability depending on UTRAN FDD bands | 4.0.0 | 4.1.0 |
| | RP-12 | RP-010311 | 735 | | Clarification on Security mode control | 4.0.0 | 4.1.0 |
| | RP-12 | RP-010311 | 738 | | Correction of TrCH parameter handling | 4.0.0 | 4.1.0 |
| | RP-12 | RP-010311 | 740 | | TFC Subsets in TDD | 4.0.0 | 4.1.0 |
| | RP-12 | RP-010311 | 746 | | RRC containers | 4.0.0 | 4.1.0 |

| Change history | | | | | | | | |
|----------------|-------|-----------|-----|-----|---|-------|-------|--|
| Date | TSG # | TSG Doc. | CR | Rev | Subject/Comment | Old | New | |
| | RP-12 | RP-010311 | 748 | | Various corrections | 4.0.0 | 4.1.0 | |
| | RP-12 | RP-010311 | 750 | | General error handling for system information | 4.0.0 | 4.1.0 | |
| | RP-12 | RP-010311 | 752 | | Order of elements in strings | 4.0.0 | 4.1.0 | |
| | RP-12 | RP-010311 | 754 | | Configuration consistency checks | 4.0.0 | 4.1.0 | |
| | RP-12 | RP-010312 | 756 | | Compressed mode corrections | 4.0.0 | 4.1.0 | |
| | RP-12 | RP-010312 | 758 | | Correction concerning inter-RAT procedures | 4.0.0 | 4.1.0 | |
| | RP-12 | RP-010312 | 762 | | Measurement corrections | 4.0.0 | 4.1.0 | |
| | RP-12 | RP-010312 | 764 | | RLC Tr Discard | 4.0.0 | 4.1.0 | |
| | RP-12 | RP-010312 | 766 | | Annex B CPCH Correction | 4.0.0 | 4.1.0 | |
| | RP-12 | RP-010312 | 768 | | SIB Correction for CSICH Power Offset | 4.0.0 | 4.1.0 | |
| | RP-12 | RP-010312 | 770 | | Transfer of Last known position in case of SRNS relocation | 4.0.0 | 4.1.0 | |
| | RP-12 | RP-010312 | 772 | | Corrections to UE Positioning measurements | 4.0.0 | 4.1.0 | |
| | RP-12 | RP-010312 | 779 | | GSM measurements in compressed mode | 4.0.0 | 4.1.0 | |
| | RP-12 | RP-010312 | 781 | | Correction of Activation Time in Inter-Rat HO Commands | 4.0.0 | 4.1.0 | |
| | RP-12 | RP-010313 | 785 | | Clarification of FRESH in SRNS relocation | 4.0.0 | 4.1.0 | |
| | RP-12 | RP-010313 | 789 | | Correction to UE timers and constants in idle mode | 4.0.0 | 4.1.0 | |
| | RP-12 | RP-010313 | 793 | | Clarification on multiframe allocation in TDD | 4.0.0 | 4.1.0 | |
| | RP-12 | RP-010313 | 795 | | Predefined parameters for logical channels | 4.0.0 | 4.1.0 | |
| | RP-12 | RP-010313 | 797 | | Pathloss calculation | 4.0.0 | 4.1.0 | |
| | RP-12 | RP-010313 | 799 | | Clarification on periodic measurement reporting | 4.0.0 | 4.1.0 | |
| | RP-12 | RP-010313 | 803 | 1 | Handling of IE PRACH TFCS and Primary CPICH/Primary CCPCH info | 4.0.0 | 4.1.0 | |
| | RP-12 | RP-010313 | 805 | | Correction to FACH measurement occasion in TDD | 4.0.0 | 4.1.0 | |
| | RP-12 | RP-010313 | 807 | | Clarification of L1 synchronization procedures | 4.0.0 | 4.1.0 | |
| | RP-12 | RP-010313 | 809 | | Correction of Activation Time definition | 4.0.0 | 4.1.0 | |
| | RP-12 | RP-010314 | 813 | | Corrections to RRC procedure performance | 4.0.0 | 4.1.0 | |
| | RP-12 | RP-010314 | 815 | | Removal of mapping function | 4.0.0 | 4.1.0 | |
| | RP-12 | RP-010314 | 817 | | Security clarifications | 4.0.0 | 4.1.0 | |
| | RP-12 | RP-010314 | 819 | | Corrections to UE Positioning | 4.0.0 | 4.1.0 | |
| | RP-12 | RP-010314 | 825 | | Definition of DPCH numbering | 4.0.0 | 4.1.0 | |
| | RP-12 | RP-010314 | 827 | | Corrections to System Information Procedure | 4.0.0 | 4.1.0 | |
| | RP-12 | RP-010314 | 829 | | Relation between DOFF and DPCH Frame Offset | 4.0.0 | 4.1.0 | |
| | RP-12 | RP-010314 | 831 | | Procedures for "same as UL" | 4.0.0 | 4.1.0 | |
| | RP-12 | RP-010314 | 837 | | Editorial and minor corrections | 4.0.0 | 4.1.0 | |
| | RP-12 | RP-010314 | 839 | | Editorial Correction | 4.0.0 | 4.1.0 | |
| | RP-12 | RP-010315 | 843 | | Corrections on OTDOA-IPDL specific burst parameter semantic description | 4.0.0 | 4.1.0 | |
| | RP-12 | RP-010315 | 845 | | Error handling for messages sent from another RAT | 4.0.0 | 4.1.0 | |
| | RP-12 | RP-010315 | 849 | | Needed TFC in the TFCS for TDD | 4.0.0 | 4.1.0 | |
| | RP-12 | RP-010315 | 855 | | Clarification of TFCS selection guidelines | 4.0.0 | 4.1.0 | |
| | RP-12 | RP-010315 | 861 | | Clarification of Traffic Volume measurements | 4.0.0 | 4.1.0 | |
| | RP-12 | RP-010315 | 863 | | CFN synchronisation problems at timing re-initialised hard handover | 4.0.0 | 4.1.0 | |
| | RP-12 | RP-010315 | 866 | | Corrections on UP Assistance Message Descriptions | 4.0.0 | 4.1.0 | |
| | RP-12 | RP-010315 | 868 | | Correction on Area Scope of SIB 15.3 | 4.0.0 | 4.1.0 | |
| | RP-12 | RP-010315 | 872 | | Correction to AICH power offset | 4.0.0 | 4.1.0 | |
| | RP-12 | RP-010316 | 875 | | Clarification on IE 'Downlink rate matching restriction information' | 4.0.0 | 4.1.0 | |
| | RP-12 | RP-010316 | 877 | | Corrections on Tabular/ASN.1 | 4.0.0 | 4.1.0 | |
| | RP-12 | RP-010316 | 879 | | Corrections on Tabular and ASN.1 inconsistencies | 4.0.0 | 4.1.0 | |
| | RP-12 | RP-010316 | 881 | | Editorial corrections on Tabular and ASN.1 inconsistencies | 4.0.0 | 4.1.0 | |
| | RP-12 | RP-010316 | 883 | | UE Positioning corrections to ASN.1 and tabular | 4.0.0 | 4.1.0 | |
| | RP-12 | RP-010316 | 885 | | Corrections to resolve inconsistencies between Tabular and ASN.1 | 4.0.0 | 4.1.0 | |
| | RP-12 | RP-010316 | 887 | | UE positioning OTDOA Neighbour Cell Info | 4.0.0 | 4.1.0 | |
| | RP-12 | RP-010316 | 889 | | DRAC corrections | 4.0.0 | 4.1.0 | |
| | RP-12 | RP-010316 | 893 | | ASN.1 Correction of IE TFCS ID | 4.0.0 | 4.1.0 | |
| | RP-12 | RP-010316 | 895 | | Correction of IE IODE range in AGPS Positioning | 4.0.0 | 4.1.0 | |
| | RP-12 | RP-010317 | 897 | | Correction to BurstModeParameters in IPDL | 4.0.0 | 4.1.0 | |

| Change history | | | | | | | | |
|----------------|-------|-----------|------|-----|---|-------|-------|--|
| Date | TSG # | TSG Doc. | CR | Rev | Subject/Comment | Old | New | |
| | RP-12 | RP-010317 | 899 | | Corrections on inconsistencies between Tabular and ASN.1 | 4.0.0 | 4.1.0 | |
| | RP-12 | RP-010317 | 901 | | Naming of message abstract types in ASN.1 | 4.0.0 | 4.1.0 | |
| | RP-12 | RP-010317 | 904 | | Information elements outside the extension container | 4.0.0 | 4.1.0 | |
| | RP-12 | RP-010317 | 906 | | Correction concerning DRX cycle upon inter-RAT change towards UTRAN | 4.0.0 | 4.1.0 | |
| | RP-12 | RP-010323 | 773 | | Corrections to IPDLs for TDD | 4.0.0 | 4.1.0 | |
| | RP-12 | RP-010323 | 850 | 2 | Correction to 1.28Mcps TDD RACH parameters and operation | 4.0.0 | 4.1.0 | |
| | RP-12 | RP-010323 | 851 | | TFCI coding in case of 8PSK | 4.0.0 | 4.1.0 | |
| | RP-12 | RP-010323 | 902 | 1 | Structure and naming of information elements | 4.0.0 | 4.1.0 | |
| 09/2001 | RP-13 | RP-010544 | 0870 | | UL Transport Channel Type Correction | 4.1.0 | 4.2.0 | |
| | RP-13 | RP-010544 | 0908 | | Guidelines concerning conditions, spares, defaults and correction of inconsistencies | 4.1.0 | 4.2.0 | |
| | RP-13 | RP-010544 | 0910 | | Correction to TDD DL DPCH Common Timeslot Info | 4.1.0 | 4.2.0 | |
| | RP-13 | RP-010544 | 0912 | | TDD System Information Update in Cell_DCH | 4.1.0 | 4.2.0 | |
| | RP-13 | RP-010544 | 0914 | | Editorial Corrections | 4.1.0 | 4.2.0 | |
| | RP-13 | RP-010544 | 0916 | | UL DPCH Power Control Info in TDD | 4.1.0 | 4.2.0 | |
| | RP-13 | RP-010544 | 0918 | | CN-originated paging in CELL_PCH and URA_PCH state | 4.1.0 | 4.2.0 | |
| | RP-13 | RP-010544 | 0920 | | Corrections to UE variable handling | 4.1.0 | 4.2.0 | |
| | RP-13 | RP-010544 | 0922 | | Inter-frequency measurements | 4.1.0 | 4.2.0 | |
| | RP-13 | RP-010544 | 0924 | | Inter-RAT measurements | 4.1.0 | 4.2.0 | |
| | RP-13 | RP-010671 | 0926 | 1 | Intra-frequency measurements | 4.1.0 | 4.2.0 | |
| | RP-13 | RP-010545 | 0928 | | Multiplexing configuration corrections | 4.1.0 | 4.2.0 | |
| | RP-13 | RP-010545 | 0930 | | Reception of non-dedicated control channels mapped on FACH in CELL_FACH state | 4.1.0 | 4.2.0 | |
| | RP-13 | RP-010545 | 0932 | | Removal of C-RNTI when entering CELL_DCH | 4.1.0 | 4.2.0 | |
| | RP-13 | RP-010545 | 0935 | | TF and TFC set definition | 4.1.0 | 4.2.0 | |
| | RP-13 | RP-010545 | 0937 | | Correction of remaining ASN.1/Tabular inconsistencies | 4.1.0 | 4.2.0 | |
| | RP-13 | RP-010545 | 0939 | | CPICH Ec/N0 Range | 4.1.0 | 4.2.0 | |
| | RP-13 | RP-010545 | 0941 | | Priorities for IDNNS coding | 4.1.0 | 4.2.0 | |
| | RP-13 | RP-010545 | 0943 | | Dedicated pilots and S-CPICH specification related to UE specific beamforming | 4.1.0 | 4.2.0 | |
| | RP-13 | RP-010545 | 0945 | | Security corrections | 4.1.0 | 4.2.0 | |
| | RP-13 | RP-010546 | 0953 | | Intra-frequency measurement events for TDD corrections | 4.1.0 | 4.2.0 | |
| | RP-13 | RP-010546 | 0955 | | Inconsistencies between ASN.1 and tabular format | 4.1.0 | 4.2.0 | |
| | RP-13 | RP-010546 | 0957 | | TDD PICH corrections and clarifications | 4.1.0 | 4.2.0 | |
| | RP-13 | RP-010546 | 0959 | | Messages on CCCH | 4.1.0 | 4.2.0 | |
| | RP-13 | RP-010546 | 0961 | | Clarification of Parameter Values for Default Radio Configurations | 4.1.0 | 4.2.0 | |
| | RP-13 | RP-010546 | 0963 | | Clarification to usage of default values in "Cell Selection and Reselection for SIB1 1/12Info" | 4.1.0 | 4.2.0 | |
| | RP-13 | RP-010546 | 0965 | | Clarification of handling of System information block 14 | 4.1.0 | 4.2.0 | |
| | RP-13 | RP-010546 | 0967 | | Description of UE behaviour when receiving UE positioning related information | 4.1.0 | 4.2.0 | |
| | RP-13 | RP-010546 | 0982 | | Clarification on periodic measurement reporting | 4.1.0 | 4.2.0 | |
| | RP-13 | RP-010546 | 0984 | | Corrections and clarifications on Measurement procedures description | 4.1.0 | 4.2.0 | |
| | RP-13 | RP-010547 | 0986 | | Lossless Criteria in PDCP Info | 4.1.0 | 4.2.0 | |
| | RP-13 | RP-010547 | 0988 | | Corrections to cell reselection parameter values | 4.1.0 | 4.2.0 | |
| | RP-13 | RP-010547 | 0990 | | Correction to signalling connection release | 4.1.0 | 4.2.0 | |
| | RP-13 | RP-010547 | 0992 | | Corrections to cell update procedures | 4.1.0 | 4.2.0 | |
| | RP-13 | RP-010547 | 0994 | | PDCP configuration and PS domain configuration checks | 4.1.0 | 4.2.0 | |
| | RP-13 | RP-010547 | 0996 | | Correction to handling of RRC transaction identifier for Cell Update, URA Update and RRC connection setup | 4.1.0 | 4.2.0 | |
| | RP-13 | RP-010547 | 0998 | 1 | Correction of UE capabilities regarding Rx-Tx time difference type 2 measurement | 4.1.0 | 4.2.0 | |
| | RP-13 | RP-010547 | 1000 | | Correction to handling of IE 'Downlink info for each radio link' | 4.1.0 | 4.2.0 | |
| | RP-13 | RP-010547 | 1004 | | Redundant IE in Traffic volume measurement system information | 4.1.0 | 4.2.0 | |
| | RP-13 | RP-010547 | 1006 | | Editorial corrections | 4.1.0 | 4.2.0 | |
| | RP-13 | RP-010548 | 1008 | | MAC logical channel priority added to definition of RB0 and SHCCH | 4.1.0 | 4.2.0 | |
| | RP-13 | RP-010548 | 1010 | | Control of primary CCPCH RSCP measurement in PUSCH CAPACITY REQUEST message | 4.1.0 | 4.2.0 | |

| Change history | | | | | | | | |
|----------------|-------|-----------|------|-----|---|-------|-------|--|
| Date | TSG # | TSG Doc. | CR | Rev | Subject/Comment | Old | New | |
| | RP-13 | RP-010548 | 1014 | | Various minor corrections | 4.1.0 | 4.2.0 | |
| | RP-13 | RP-010548 | 1016 | | Range of T312 | 4.1.0 | 4.2.0 | |
| | RP-13 | RP-010548 | 1018 | | Bitstring of channelisationCodeIndices | 4.1.0 | 4.2.0 | |
| | RP-13 | RP-010548 | 1020 | | Transmission of UE CAPABILITY INFORMATION message | 4.1.0 | 4.2.0 | |
| | RP-13 | RP-010548 | 1022 | | Multiple UE capabilities procedures | 4.1.0 | 4.2.0 | |
| | RP-13 | RP-010548 | 1024 | | Corrections to information elements outside the extension container | 4.1.0 | 4.2.0 | |
| | RP-13 | RP-010548 | 1026 | | SFN reporting | 4.1.0 | 4.2.0 | |
| | RP-13 | RP-010548 | 1028 | | TFCl combining indicator | 4.1.0 | 4.2.0 | |
| | RP-13 | RP-010549 | 1030 | | RLC reset on a Signalling Radio Bearer | 4.1.0 | 4.2.0 | |
| | RP-13 | RP-010549 | 1034 | | Quality Indication for UE Positioning Parameters | 4.1.0 | 4.2.0 | |
| | RP-13 | RP-010549 | 1036 | | Editorial Correction for UE Positioning | 4.1.0 | 4.2.0 | |
| | RP-13 | RP-010549 | 1038 | | Clarification on the current status of ciphering | 4.1.0 | 4.2.0 | |
| | RP-13 | RP-010549 | 1048 | | Clarification on HFN initialization at SRB and RB setup | 4.1.0 | 4.2.0 | |
| | RP-13 | RP-010549 | 1050 | | Clarification on Inter-RAT measurement | 4.1.0 | 4.2.0 | |
| | RP-13 | RP-010549 | 1052 | | Clarification on re-assembly of segments | 4.1.0 | 4.2.0 | |
| | RP-13 | RP-010549 | 1062 | | Minor Corrections | 4.1.0 | 4.2.0 | |
| | RP-13 | RP-010549 | 1066 | | Support of dedicated pilots for channel estimation | 4.1.0 | 4.2.0 | |
| | RP-13 | RP-010549 | 1068 | | Correction to SRNS relocation handling | 4.1.0 | 4.2.0 | |
| | RP-13 | RP-010550 | 1076 | | Correction to RLC state variables | 4.1.0 | 4.2.0 | |
| | RP-13 | RP-010550 | 1082 | | Reading of CN information in SIB 1 inRRC Connected Mode | 4.1.0 | 4.2.0 | |
| | RP-13 | RP-010550 | 1086 | | Restricting the maximum amount of preconfigurations in case of equivalent PLMNs | 4.1.0 | 4.2.0 | |
| | RP-13 | RP-010554 | 0933 | | Order of bits in bitstrings | 4.1.0 | 4.2.0 | |
| | RP-13 | RP-010554 | 0946 | | Selection of the RFC3095 CID transmission | 4.1.0 | 4.2.0 | |
| | RP-13 | RP-010554 | 0970 | | Correction of IPDL parameters for TDD enhancements in ASN.1 description | 4.1.0 | 4.2.0 | |
| | RP-13 | RP-010554 | 0971 | 1 | 1.28 Mcps TDD PICH, Midamble and UL timing advance control corrections | 4.1.0 | 4.2.0 | |
| | RP-13 | RP-010554 | 0972 | | Introduction of 1.28 Mcps TDD Mode in clause 13.7 | 4.1.0 | 4.2.0 | |
| | RP-13 | RP-010554 | 0973 | | Tadv in 1.28 Mcps TDD | 4.1.0 | 4.2.0 | |
| | RP-13 | RP-010554 | 0974 | | Correction and clarification to PRACH in 1.28 Mcps TDD | 4.1.0 | 4.2.0 | |
| 10/2001 | - | - | - | | Replacement of incorrect (R'99) version of ASN.1 by correct (Rel-4) version of ASN.1. | 4.2.0 | 4.2.1 | |
| 12/2001 | RP-14 | RP-010763 | 1088 | | Corrections to RRC information containers | 4.2.1 | 4.3.0 | |
| | RP-14 | RP-010763 | 1090 | | Removal of Block SSTD | 4.2.1 | 4.3.0 | |
| | RP-14 | RP-010763 | 1098 | | COUNT-C-SFN frame difference measurement | 4.2.1 | 4.3.0 | |
| | RP-14 | RP-010763 | 1100 | | Trigger for deletion of ciphering and integrity keys | 4.2.1 | 4.3.0 | |
| | RP-14 | RP-010763 | 1102 | | Correction to P_compensation calculation for GSM neighbour cells | 4.2.1 | 4.3.0 | |
| | RP-14 | RP-010763 | 1104 | | Preconfigurations in case of equivalent PLMNs | 4.2.1 | 4.3.0 | |
| | RP-14 | RP-010763 | 1109 | | Handling of DRX cycle and U-RNTI in RRC connection setup and handling of TrCH information | 4.2.1 | 4.3.0 | |
| | RP-14 | RP-010763 | 1111 | | Correction to Information Element names | 4.2.1 | 4.3.0 | |
| | RP-14 | RP-010763 | 1113 | | Correction of Description of IE "SSDT Information" | 4.2.1 | 4.3.0 | |
| | RP-14 | RP-010763 | 1115 | | Clarification on Cell Identity and correction to reference to BAND_INDICATOR | 4.2.1 | 4.3.0 | |
| | RP-14 | RP-010764 | 1117 | | Clarification to Measured Results on RACH and Measurement Events | 4.2.1 | 4.3.0 | |
| | RP-14 | RP-010764 | 1119 | | Inconsistency between ASN.1 and tabular wrt. RPLMN information | 4.2.1 | 4.3.0 | |
| | RP-14 | RP-010764 | 1124 | | General clarification on Establishment of Access Service Classes | 4.2.1 | 4.3.0 | |
| | RP-14 | RP-010764 | 1126 | | Clarification on TX diversity indicator IE and STTD indicator IE | 4.2.1 | 4.3.0 | |
| | RP-14 | RP-010764 | 1132 | | Different diversity modes used in the same active set | 4.2.1 | 4.3.0 | |
| | RP-14 | RP-010764 | 1134 | | Issues regarding signalling connection establishment and RRC connection release | 4.2.1 | 4.3.0 | |
| | RP-14 | RP-010764 | 1136 | | Presence of AC to ASC mapping in SIB5 and SIB6 | 4.2.1 | 4.3.0 | |
| | RP-14 | RP-010764 | 1138 | | RRC establishment cause at inter-RAT cell change order to UTRAN | 4.2.1 | 4.3.0 | |
| | RP-14 | RP-010764 | 1142 | | Start of timers at radio link failure | 4.2.1 | 4.3.0 | |
| | RP-14 | RP-010765 | 1144 | | Handling of the number of FBI bits sent in Uplink DPCH info | 4.2.1 | 4.3.0 | |
| | RP-14 | RP-010765 | 1146 | | Bit string order when using PER | 4.2.1 | 4.3.0 | |

| Change history | | | | | | | | |
|----------------|-------|-----------|------|-----|---|-------|-------|--|
| Date | TSG # | TSG Doc. | CR | Rev | Subject/Comment | Old | New | |
| | RP-14 | RP-010765 | 1148 | | Clarification on DRX cycle length in connected mode | 4.2.1 | 4.3.0 | |
| | RP-14 | RP-010765 | 1152 | | Correction to error condition on downlink information for each radio link | 4.2.1 | 4.3.0 | |
| | RP-14 | RP-010765 | 1154 | | Correction of inconsistencies between tabular and ASN.1 | 4.2.1 | 4.3.0 | |
| | RP-14 | RP-010765 | 1156 | | Measurement related corrections | 4.2.1 | 4.3.0 | |
| | RP-14 | RP-010765 | 1158 | | Inconsistency between hard-coded preconfigurations parameters and procedure text | 4.2.1 | 4.3.0 | |
| | RP-14 | RP-010765 | 1166 | | PLMN search in CELL_PCH/URA_PCH states with 80ms DRX cycle | 4.2.1 | 4.3.0 | |
| | RP-14 | RP-010765 | 1168 | | Correction to CFN calculation for FDD | 4.2.1 | 4.3.0 | |
| | RP-14 | RP-010765 | 1170 | | Correction to radio bearer control | 4.2.1 | 4.3.0 | |
| | RP-14 | RP-010766 | 1172 | | Handling of IE "frequency info" | 4.2.1 | 4.3.0 | |
| | RP-14 | RP-010766 | 1174 | | Correction to Radio Bearer Release | 4.2.1 | 4.3.0 | |
| | RP-14 | RP-010940 | 1178 | 1 | Correction to RACH reporting | 4.2.1 | 4.3.0 | |
| | RP-14 | RP-010766 | 1180 | | Correction to URA/Cell update and other minor corrections | 4.2.1 | 4.3.0 | |
| | RP-14 | RP-010766 | 1182 | | Correction to Active Set Update | 4.2.1 | 4.3.0 | |
| | RP-14 | RP-010766 | 1184 | | Correction of Traffic Volume Measurement Criteria | 4.2.1 | 4.3.0 | |
| | RP-14 | RP-010941 | 1186 | 1 | Correction of UE Positioning | 4.2.1 | 4.3.0 | |
| | RP-14 | RP-010766 | 1203 | | Invalid RRC CONNECTION REJECT | 4.2.1 | 4.3.0 | |
| | RP-14 | RP-010766 | 1214 | | Security baseline for corrections | 4.2.1 | 4.3.0 | |
| | RP-14 | RP-010766 | 1220 | | Pending integrity protection activation time for UL RB0 | 4.2.1 | 4.3.0 | |
| | RP-14 | RP-010767 | 1222 | | Correction of rate matching restriction function | 4.2.1 | 4.3.0 | |
| | RP-14 | RP-010773 | 1096 | | Usage of UM RLC Special Length Indicator | 4.2.1 | 4.3.0 | |
| | RP-14 | RP-010773 | 1120 | | Corrections to REL-4 LCR Tabular Description and ASN1 Code | 4.2.1 | 4.3.0 | |
| | RP-14 | RP-010773 | 1199 | | Correction of FPACH parameter definition for 1.28Mcps TDD | 4.2.1 | 4.3.0 | |
| | RP-14 | RP-010773 | 1200 | | Correction of 1.28Mcps TDD | 4.2.1 | 4.3.0 | |
| | RP-14 | RP-010773 | 1201 | | Correction and Clarification to Open Loop Power Control in 1.28 Mcps TDD | 4.2.1 | 4.3.0 | |
| | RP-14 | RP-010773 | 1206 | | Extensions of IE value ranges in tabular | 4.2.1 | 4.3.0 | |
| 03/2002 | RP-15 | RP-020070 | 1229 | | Constant value range correction for DPCH and PUSCH in TDD mode | 4.3.0 | 4.4.0 | |
| | RP-15 | RP-020070 | 1231 | | Corrections to open loop power control for TDD and RB information parameters for SHCCH | 4.3.0 | 4.4.0 | |
| | RP-15 | RP-020070 | 1233 | | Removal of unnecessary replication of TFCS ID in Physical Shared Channel Allocation message | 4.3.0 | 4.4.0 | |
| | RP-15 | RP-020070 | 1237 | | Correction to TF selection when using UL RLC TM | 4.3.0 | 4.4.0 | |
| | RP-15 | RP-020070 | 1239 | | Correction to the UE behaviour in case of SRNS relocation | 4.3.0 | 4.4.0 | |
| | RP-15 | RP-020070 | 1241 | | Header Compression protocols re-initialisation during SRNS Relocation | 4.3.0 | 4.4.0 | |
| | RP-15 | RP-020070 | 1243 | | Misalignments between tabular and ASN.1 related to UE Positioning, tabular correction | 4.3.0 | 4.4.0 | |
| | RP-15 | RP-020070 | 1245 | | Corrections to comments in ASN.1 | 4.3.0 | 4.4.0 | |
| | RP-15 | RP-020070 | 1247 | | Correction to restarting of T308 | 4.3.0 | 4.4.0 | |
| | RP-15 | RP-020070 | 1249 | | Clarification of the use of T309 during inter-RAT cell reselections | 4.3.0 | 4.4.0 | |
| | RP-15 | RP-020071 | 1251 | | Measurement Corrections | 4.3.0 | 4.4.0 | |
| | RP-15 | RP-020239 | 1253 | 1 | Existence of TFCL bits | 4.3.0 | 4.4.0 | |
| | RP-15 | RP-020071 | 1258 | | Corrections of inconsistency between procedural description, tabular and ASN.1 | 4.3.0 | 4.4.0 | |
| | RP-15 | RP-020071 | 1260 | | Corrections to Expiration Time Factor and Expiration Time formula for SIB 7 and SIB 14 | 4.3.0 | 4.4.0 | |
| | RP-15 | RP-020071 | 1262 | | Corrections to Reporting Cell Status | 4.3.0 | 4.4.0 | |
| | RP-15 | RP-020071 | 1268 | | Correction to inter frequency measurements | 4.3.0 | 4.4.0 | |
| | RP-15 | RP-020071 | 1271 | | Actions at reception of system information block type 1 | 4.3.0 | 4.4.0 | |
| | RP-15 | RP-020071 | 1273 | | Tx diversity and no diversity in the same active set | 4.3.0 | 4.4.0 | |
| | RP-15 | RP-020071 | 1275 | | Correction to cell update | 4.3.0 | 4.4.0 | |
| | RP-15 | RP-020071 | 1277 | | Successful and unsuccessful procedures | 4.3.0 | 4.4.0 | |
| | RP-15 | RP-020072 | 1279 | | Measurement related corrections | 4.3.0 | 4.4.0 | |
| | RP-15 | RP-020072 | 1281 | | Clarifications on Event 1D | 4.3.0 | 4.4.0 | |
| | RP-15 | RP-020205 | 1283 | 1 | Security corrections | 4.3.0 | 4.4.0 | |
| | RP-15 | RP-020072 | 1285 | | Transition from CELL_DCH to CELL_FACH state | 4.3.0 | 4.4.0 | |
| | RP-15 | RP-020072 | 1287 | | Corrections and clarifications of Radio link timing | 4.3.0 | 4.4.0 | |

| Change history | | | | | | | |
|----------------|-------|-----------|------|-----|---|-------|-------|
| Date | TSG # | TSG Doc. | CR | Rev | Subject/Comment | Old | New |
| | RP-15 | RP-020072 | 1289 | | Spare values in ASN.1 | 4.3.0 | 4.4.0 |
| | RP-15 | RP-020072 | 1294 | | Actions on reception of measurement related IEs | 4.3.0 | 4.4.0 |
| | RP-15 | RP-020231 | 1296 | 1 | Removal of channel coding option "no coding" for FDD and 3.84 Mcps TDD | 4.3.0 | 4.4.0 |
| | RP-15 | RP-020072 | 1298 | | Timing Indication when moving to CELL_DCH state | 4.3.0 | 4.4.0 |
| | RP-15 | RP-020072 | 1307 | | Correction to processing RB mapping info | 4.3.0 | 4.4.0 |
| | RP-15 | RP-020072 | 1313 | | RRC Connection Release following network authentication failure | 4.3.0 | 4.4.0 |
| | RP-15 | RP-020072 | 1317 | | Clarification on serving cell in SIB11 | 4.3.0 | 4.4.0 |
| | RP-15 | RP-020073 | 1319 | | Treatment of optional elements in RB control messages | 4.3.0 | 4.4.0 |
| | RP-15 | RP-020073 | 1323 | | Procedure Performance for TDD UL physical Channel Control | 4.3.0 | 4.4.0 |
| | RP-15 | RP-020250 | 1331 | 1 | Clarification to physical channel establishment criteria | 4.3.0 | 4.4.0 |
| | RP-15 | RP-020249 | 1333 | 1 | OTDOA Assistance Data | 4.3.0 | 4.4.0 |
| | RP-15 | RP-020073 | 1337 | | Retransmission of uplink direct transfer at RLC re-establishment and inter-RAT change | 4.3.0 | 4.4.0 |
| | RP-15 | RP-020073 | 1339 | | Correction to IE "UL interference" for UTRA TDD | 4.3.0 | 4.4.0 |
| | RP-15 | RP-020074 | 1343 | | Corrections of UE Positioning requirements | 4.3.0 | 4.4.0 |
| | RP-15 | RP-020074 | 1345 | | Multimode speech in default configurations | 4.3.0 | 4.4.0 |
| | RP-15 | RP-020073 | 1347 | | Correction to UE Id for DSCH | 4.3.0 | 4.4.0 |
| | RP-15 | RP-020073 | 1349 | | Corrections to support combined Cell/URA update and SRNS relocation | 4.3.0 | 4.4.0 |
| | RP-15 | RP-020073 | 1351 | | Number of UTRAN and Inter-RAT frequencies | 4.3.0 | 4.4.0 |
| | RP-15 | RP-020073 | 1353 | | Abortion of signalling connection establishment | 4.3.0 | 4.4.0 |
| | RP-15 | RP-020073 | 1358 | | Modification of GPS timing representation to avoid large integers | 4.3.0 | 4.4.0 |
| | RP-15 | RP-020074 | 1360 | | Additional TFCS selection guidelines | 4.3.0 | 4.4.0 |
| | RP-15 | RP-020074 | 1362 | | Clarification of layer 3 filtering of measurements in the UE | 4.3.0 | 4.4.0 |
| | RP-15 | RP-020210 | 1364 | | Improved readability of procedural text | 4.3.0 | 4.4.0 |
| | RP-15 | RP-020228 | 1366 | | Clarification on ICS version within UE radio access capabilities | 4.3.0 | 4.4.0 |
| | RP-15 | RP-020233 | 1368 | | Clarification of Maximum number of TFC in the TFCS | 4.3.0 | 4.4.0 |
| | RP-15 | RP-020238 | 1370 | | Support of UP measurement reporting in CELL_PCH/URA_PCH | 4.3.0 | 4.4.0 |
| | RP-15 | RP-020082 | 1122 | 2 | Correction to include Cell ID for Cell_DCH state | 4.3.0 | 4.4.0 |
| | RP-15 | RP-020082 | 1187 | 2 | Correction of Transparent mode signalling for UL rate control | 4.3.0 | 4.4.0 |
| | RP-15 | RP-020082 | 1188 | 2 | Introduction of default radio configurations for UMTS_AMR2 with four speech modes | 4.3.0 | 4.4.0 |
| | RP-15 | RP-020082 | 1223 | 1 | Acquisition of PLMN identity of neighbour cells via SIB 18 | 4.3.0 | 4.4.0 |
| | RP-15 | RP-020082 | 1254 | | Various ASN.1 Corrections | 4.3.0 | 4.4.0 |
| | RP-15 | RP-020082 | 1290 | | Handover from UTRAN failure | 4.3.0 | 4.4.0 |
| | RP-15 | RP-020082 | 1335 | | Corrections to indicate that SIB 14 is not used by 1.28 TDD | 4.3.0 | 4.4.0 |
| | RP-15 | RP-020084 | 1129 | 2 | Support of flexible hard split mode | 4.4.0 | 5.0.0 |
| | RP-15 | RP-020090 | 1225 | 1 | Introduction of the parameters of OTDOA with IPDL for 1.28 Mcps TDD | 4.4.0 | 5.0.0 |
| | RP-15 | RP-020085 | 1291 | 1 | Radio link timing | 4.4.0 | 5.0.0 |
| | RP-15 | RP-020094 | 1305 | 2 | Introduction of HSDPA | 4.4.0 | 5.0.0 |
| 06/2002 | RP-16 | RP-020330 | 1373 | | ASN.1 Corrections | 5.0.0 | 5.1.0 |
| | RP-16 | RP-020330 | 1376 | | Clarification of unnecessary MP IEs in RADIO BEARER RECONFIGURATION | 5.0.0 | 5.1.0 |
| | RP-16 | RP-020330 | 1379 | | Correction on SIB type | 5.0.0 | 5.1.0 |
| | RP-16 | RP-020330 | 1382 | | Clarification to the handling of IE "Cells for measurement" received in SIB 11/12 | 5.0.0 | 5.1.0 |
| | RP-16 | RP-020330 | 1385 | 1 | Correction to Cell Update procedure | 5.0.0 | 5.1.0 |
| | RP-16 | RP-020330 | 1388 | | Correction to handling of FACH measurement occasion info in SIB12 | 5.0.0 | 5.1.0 |
| | RP-16 | RP-020331 | 1392 | | Actions when optional IE "Maximum allowed UL TX power" is missing | 5.0.0 | 5.1.0 |
| | RP-16 | RP-020331 | 1395 | | Corrections concerning default configurations | 5.0.0 | 5.1.0 |
| | RP-16 | RP-020331 | 1398 | | Correction concerning when hard handover specific handling applies | 5.0.0 | 5.1.0 |
| | RP-16 | RP-020331 | 1401 | | Handling of variables CELL_INFO_LIST and MEASUREMENT_IDENTITY | 5.0.0 | 5.1.0 |
| | RP-16 | RP-020331 | 1404 | | IE "Cell Synchronisation Information" | 5.0.0 | 5.1.0 |
| | RP-16 | RP-020331 | 1407 | | Corrections to Cell Individual Offset | 5.0.0 | 5.1.0 |
| | RP-16 | RP-020332 | 1410 | | Clarification to Compressed Mode Status Info | 5.0.0 | 5.1.0 |

| Change history | | | | | | | | |
|----------------|-------|-----------|------|-----|---|-------|-------|--|
| Date | TSG # | TSG Doc. | CR | Rev | Subject/Comment | Old | New | |
| | RP-16 | RP-020332 | 1413 | | Clarification of OTDOA quality figure | 5.0.0 | 5.1.0 | |
| | RP-16 | RP-020332 | 1416 | | Correction to Cell Access Restriction for SIB4 | 5.0.0 | 5.1.0 | |
| | RP-16 | RP-020332 | 1419 | | Corrections concerning spare values and comments | 5.0.0 | 5.1.0 | |
| | RP-16 | RP-020332 | 1423 | | Variable for shared channel configurations | 5.0.0 | 5.1.0 | |
| | RP-16 | RP-020332 | 1426 | 1 | Integrity protection on RB0 | 5.0.0 | 5.1.0 | |
| | RP-16 | RP-020333 | 1429 | 1 | Periodic cell update clarifications | 5.0.0 | 5.1.0 | |
| | RP-16 | RP-020333 | 1432 | | Multiple cells triggering event 1D | 5.0.0 | 5.1.0 | |
| | RP-16 | RP-020333 | 1435 | | Disjoint Active Sets in the Active Set Update procedure | 5.0.0 | 5.1.0 | |
| | RP-16 | RP-020333 | 1438 | | Deletion on compressed mode patterns when moving to CELL_FACH state | 5.0.0 | 5.1.0 | |
| | RP-16 | RP-020333 | 1441 | | TDD C-RNTI in Cell DCH | 5.0.0 | 5.1.0 | |
| | RP-16 | RP-020333 | 1444 | 1 | CCTrCH Release in TDD | 5.0.0 | 5.1.0 | |
| | RP-16 | RP-020334 | 1447 | | Layer 3 retransmission of SIGNALLING CONNECTION RELEASE INDICATION | 5.0.0 | 5.1.0 | |
| | RP-16 | RP-020334 | 1450 | | Alignment of tabular and ASN.1 for UTRAN GPS timing of cell frames resolution | 5.0.0 | 5.1.0 | |
| | RP-16 | RP-020334 | 1453 | | Correction to Default Radio Configuration Timers | 5.0.0 | 5.1.0 | |
| | RP-16 | RP-020334 | 1456 | | Clarification to number of L3 filters | 5.0.0 | 5.1.0 | |
| | RP-16 | RP-020334 | 1459 | 1 | Correction to 3G to 2G Inter-RAT handover for multi-domain RABs | 5.0.0 | 5.1.0 | |
| | RP-16 | RP-020334 | 1462 | | DCH quality target | 5.0.0 | 5.1.0 | |
| | RP-16 | RP-020335 | 1465 | | Correction to RB Mapping Info | 5.0.0 | 5.1.0 | |
| | RP-16 | RP-020335 | 1468 | 1 | Ciphering activation for TM bearers | 5.0.0 | 5.1.0 | |
| | RP-16 | RP-020335 | 1471 | | TFCS selection guideline correction | 5.0.0 | 5.1.0 | |
| | RP-16 | RP-020382 | 1480 | 1 | Clarification of Measurement Validity and Valid Measurement Objects | 5.0.0 | 5.1.0 | |
| | RP-16 | RP-020363 | 1483 | | Remaining clarification of Measurement Validity and Valid Measurement Objects | 5.0.0 | 5.1.0 | |
| | RP-16 | RP-020381 | 1486 | 1 | Traffic Volume Measurement clarifications | 5.0.0 | 5.1.0 | |
| | RP-16 | RP-020335 | 1489 | | Correction to handling of IE 'Downlink information for each RL' | 5.0.0 | 5.1.0 | |
| | RP-16 | RP-020336 | 1492 | | Corrections to Security procedure on Missing integrity protection reset on relocation and counter check response actions for asymmetric bearer configurations | 5.0.0 | 5.1.0 | |
| | RP-16 | RP-020336 | 1495 | | Corrections to cell update interactions with security and SRNS Relocation | 5.0.0 | 5.1.0 | |
| | RP-16 | RP-020336 | 1498 | | "Out of service" area definition | 5.0.0 | 5.1.0 | |
| | RP-16 | RP-020339 | 1473 | | RRC connection release procedure in CELL_DCH state | 5.0.0 | 5.1.0 | |
| | RP-16 | RP-020339 | 1475 | | Correction to DL TM DCCH TF size for Default Configurations | 5.0.0 | 5.1.0 | |
| | RP-16 | RP-020339 | 1477 | | Corrections in ASN.1 related to SRNS relocation | 5.0.0 | 5.1.0 | |
| | RP-16 | RP-020341 | 1499 | | HS-DSCH related corrections | 5.0.0 | 5.1.0 | |
| | RP-16 | RP-020341 | 1500 | | Removal of BLER threshold from IE "Measurement Feedback info" | 5.0.0 | 5.1.0 | |
| | RP-16 | RP-020345 | 1501 | | RFC 3095 context relocation | 5.0.0 | 5.1.0 | |
| 09/2002 | RP-17 | RP-020541 | 1504 | 1 | UE behaviour when active set cells are not included in CELL_INFO_LIST | 5.1.0 | 5.2.0 | |
| | RP-17 | RP-020541 | 1507 | 1 | Corrections to handling of IE "Cells for measurement" | 5.1.0 | 5.2.0 | |
| | RP-17 | RP-020541 | 1510 | | Clarification on the use of UE radio access capability extensions within the INTER RAT HANDOVER INFO message | 5.1.0 | 5.2.0 | |
| | RP-17 | RP-020541 | 1513 | | Correction to RRC connection procedure | 5.1.0 | 5.2.0 | |
| | RP-17 | RP-020541 | 1516 | | Correction to the variable TGPS_IDENTITY | 5.1.0 | 5.2.0 | |
| | RP-17 | RP-020541 | 1522 | | Missing IEs in RLC info | 5.1.0 | 5.2.0 | |
| | RP-17 | RP-020542 | 1528 | 1 | Corrections of UE internal measurement reporting events | 5.1.0 | 5.2.0 | |
| | RP-17 | RP-020542 | 1531 | 2 | UE behaviour upon reception of reconfiguration | 5.1.0 | 5.2.0 | |
| | RP-17 | RP-020542 | 1534 | | Application of integrity keys in case of a pending CN domain switch during a SRNS relocation | 5.1.0 | 5.2.0 | |
| | RP-17 | RP-020542 | 1537 | 1 | Clarifications on Quality Measurements | 5.1.0 | 5.2.0 | |
| | RP-17 | RP-020542 | 1540 | | Correction of DPCH constant value in TDD default radio configurations | 5.1.0 | 5.2.0 | |
| | RP-17 | RP-020542 | 1543 | | Handling of UE internal measurement information in broadcast | 5.1.0 | 5.2.0 | |
| | RP-17 | RP-020543 | 1546 | | Observed time difference to GSM reporting indicator | 5.1.0 | 5.2.0 | |
| | RP-17 | RP-020543 | 1551 | | Corrections on Security relative to ciphering of TM bearers and to SRNS relocation | 5.1.0 | 5.2.0 | |
| | RP-17 | RP-020543 | 1554 | | Coding of IE NC mode | 5.1.0 | 5.2.0 | |

| Change history | | | | | | | | |
|----------------|-------|-----------|------|-----|---|-------|-------|--|
| Date | TSG # | TSG Doc. | CR | Rev | Subject/Comment | Old | New | |
| | RP-17 | RP-020543 | 1557 | | Clarification to filtered measurement quantities | 5.1.0 | 5.2.0 | |
| | RP-17 | RP-020543 | 1560 | | Inconsistencies in triggering and reporting for events 1a, 1b,1c, 1e and 1f | 5.1.0 | 5.2.0 | |
| | RP-17 | RP-020543 | 1563 | 1 | Optional and Mandatory fields in Measurement Control | 5.1.0 | 5.2.0 | |
| | RP-17 | RP-020544 | 1566 | | Clarifications to Reporting Cell Status | 5.1.0 | 5.2.0 | |
| | RP-17 | RP-020544 | 1569 | | Clarification to minimum SF | 5.1.0 | 5.2.0 | |
| | RP-17 | RP-020544 | 1572 | | Clarifications to inter-frequency measurements | 5.1.0 | 5.2.0 | |
| | RP-17 | RP-020544 | 1578 | 2 | Ciphering when HO to UMTS of signalling only connection | 5.1.0 | 5.2.0 | |
| | RP-17 | RP-020544 | 1581 | | Inter RAT handover from UTRAN | 5.1.0 | 5.2.0 | |
| | RP-17 | RP-020544 | 1584 | | Correction to Cell Update procedure with cause "Radio link failure" | 5.1.0 | 5.2.0 | |
| | RP-17 | RP-020545 | 1587 | | Correction to the handling of IE "UTRAN DRX cycle length coefficient" in CELL/URA UPDATE procedure | 5.1.0 | 5.2.0 | |
| | RP-17 | RP-020545 | 1590 | | Correction to RLC unrecoverable error occurs in CELL_DCH state | 5.1.0 | 5.2.0 | |
| | RP-17 | RP-020545 | 1593 | | Use of scrambling change when activating CM pattern using SF/2 by MEASUREMENT CONTROL | 5.1.0 | 5.2.0 | |
| | RP-17 | RP-020545 | 1596 | | Actions when optional IE "Maximum allowed UL TX power" is missing | 5.1.0 | 5.2.0 | |
| | RP-17 | RP-020630 | 1599 | 1 | IP_offset correction | 5.1.0 | 5.2.0 | |
| | RP-17 | RP-020545 | 1602 | | Clarification on the IE "Frequency Info" | 5.1.0 | 5.2.0 | |
| | RP-17 | RP-020546 | 1605 | | Correction of RNTI used in PUSCH capacity request and physical shared channel allocation | 5.1.0 | 5.2.0 | |
| | RP-17 | RP-020546 | 1608 | | Correction to allowed logical channel list choice for RACH transport channels | 5.1.0 | 5.2.0 | |
| | RP-17 | RP-020654 | 1611 | 1 | Clarification of SRNS Relocation Info | 5.1.0 | 5.2.0 | |
| | RP-17 | RP-020546 | 1614 | | DCH quality target | 5.1.0 | 5.2.0 | |
| | RP-17 | RP-020546 | 1617 | | Handling of variables CELL_INFO_LIST and MEASUREMENT_IDENTITY(2) | 5.1.0 | 5.2.0 | |
| | RP-17 | RP-020546 | 1620 | 1 | Correction of secondary CCPCH selection and PRACH selection | 5.1.0 | 5.2.0 | |
| | RP-17 | RP-020547 | 1623 | | RRC TVM Corrections | 5.1.0 | 5.2.0 | |
| | RP-17 | RP-020547 | 1626 | | Correction of Transmission Gap Distance semantics description | 5.1.0 | 5.2.0 | |
| | RP-17 | RP-020547 | 1629 | | Corrections to Active Set Update and simultaneous reconfiguration | 5.1.0 | 5.2.0 | |
| | RP-17 | RP-020547 | 1632 | | UE behaviour following RLC size change | 5.1.0 | 5.2.0 | |
| | RP-17 | RP-020547 | 1635 | | RRC SN in uplink | 5.1.0 | 5.2.0 | |
| | RP-17 | RP-020547 | 1638 | | Multiplexing of Tr mode RBs of different CN domains on the same transport channel | 5.1.0 | 5.2.0 | |
| | RP-17 | RP-020548 | 1641 | | Security clarifications | 5.1.0 | 5.2.0 | |
| | RP-17 | RP-020548 | 1644 | | Correction to the actions of "out of service area" and "in service area" | 5.1.0 | 5.2.0 | |
| | RP-17 | RP-020548 | 1647 | | TVM: pending time after trigger and initial conditions | 5.1.0 | 5.2.0 | |
| | RP-17 | RP-020548 | 1650 | 1 | Handling of Downlink information for each RL in reconfiguration messages | 5.1.0 | 5.2.0 | |
| | RP-17 | RP-020548 | 1655 | | Corrections to Cell Update/URA Update Procedure in case of nested cell updates and simultaneous SRNS relocation | 5.1.0 | 5.2.0 | |
| | RP-17 | RP-020548 | 1670 | | Corrections to security | 5.1.0 | 5.2.0 | |
| | RP-17 | RP-020631 | 1673 | 1 | SRNS relocation with integrity | 5.1.0 | 5.2.0 | |
| | RP-17 | RP-020549 | 1676 | | Reception of MEASUREMENT CONTROL in state CELL_FACH | 5.1.0 | 5.2.0 | |
| | RP-17 | RP-020549 | 1679 | | Unsupported configuration | 5.1.0 | 5.2.0 | |
| | RP-17 | RP-020549 | 1682 | | Handover corrections | 5.1.0 | 5.2.0 | |
| | RP-17 | RP-020558 | 1575 | 1 | Correction of SFN-SFN Measurement | 5.1.0 | 5.2.0 | |
| | RP-17 | RP-020559 | 1661 | | Corrections to Synchronisation for 1.28 Mcps TDD | 5.1.0 | 5.2.0 | |
| | RP-17 | RP-020553 | 1657 | | Corrections on Power Control for 1.28 Mcps TDD | 5.1.0 | 5.2.0 | |
| | RP-17 | RP-020553 | 1659 | | Correction to RLC entity re-establishment during SRNS relocation | 5.1.0 | 5.2.0 | |
| | RP-17 | RP-020553 | 1663 | | Reintroduction of IE "SRB delay" in Rel-4 ASN.1 | 5.1.0 | 5.2.0 | |
| | RP-17 | RP-020553 | 1665 | | Corrections to ASN.1 for SRNC relocation container | 5.1.0 | 5.2.0 | |
| | RP-17 | RP-020553 | 1667 | | Unused elements in ASN.1 | 5.1.0 | 5.2.0 | |
| | RP-17 | RP-020557 | 1547 | | Correction on Radio link timing | 5.1.0 | 5.2.0 | |
| | RP-17 | RP-020662 | 1651 | 2 | Physical layer IEs for HSDPA | 5.1.0 | 5.2.0 | |
| | RP-17 | RP-020557 | 1652 | | Transport channel information elements for HSDPA | 5.1.0 | 5.2.0 | |
| | RP-17 | RP-020590 | 1683 | | TX diversity on radio links in the active set | 5.1.0 | 5.2.0 | |

| Change history | | | | | | | |
|----------------|-------|-----------|------|-----|---|-------|-------|
| Date | TSG # | TSG Doc. | CR | Rev | Subject/Comment | Old | New |
| | RP-17 | RP-020557 | 1684 | | Mandatory Support of dedicated pilots for channel estimation | 5.1.0 | 5.2.0 |
| 12/2002 | RP-18 | RP-020721 | 1687 | | Corrections to IEs "Ellipsoid point with Altitude and uncertainty Ellipsoid" and "Ellipsoid point with uncertainty Ellipse" | 5.2.0 | 5.3.0 |
| | RP-18 | RP-020721 | 1690 | 1 | Handling of Ciphering and integrity protection activation times | 5.2.0 | 5.3.0 |
| | RP-18 | RP-020721 | 1693 | | Handling of measurements at state transitions to/from DCH state. | 5.2.0 | 5.3.0 |
| | RP-18 | RP-020721 | 1696 | 2 | Measurement related corrections | 5.2.0 | 5.3.0 |
| | RP-18 | RP-020721 | 1699 | | ASN.1 of the SRNS relocation info | 5.2.0 | 5.3.0 |
| | RP-18 | RP-020721 | 1710 | 1 | Corrections to PRACH selection | 5.2.0 | 5.3.0 |
| | RP-18 | RP-020722 | 1713 | | TDD Downlink Path Loss for interfrequency measurement | 5.2.0 | 5.3.0 |
| | RP-18 | RP-020892 | 1716 | 1 | Correction on coding of GSM Classmark 2 and 3 | 5.2.0 | 5.3.0 |
| | RP-18 | RP-020722 | 1719 | | Correction on Frame Allocation Calculation | 5.2.0 | 5.3.0 |
| | RP-18 | RP-020722 | 1722 | | Inter-frequency measurements | 5.2.0 | 5.3.0 |
| | RP-18 | RP-020722 | 1725 | | Maximum Allowed UL TX Power | 5.2.0 | 5.3.0 |
| | RP-18 | RP-020722 | 1728 | | START values for the initialisation of SRB counters and UTRAN incorrect actions | 5.2.0 | 5.3.0 |
| | RP-18 | RP-020723 | 1731 | | Correction to the RRC transaction table management | 5.2.0 | 5.3.0 |
| | RP-18 | RP-020723 | 1803 | | Use of DCH Quality Target with Blind Transport Format Detection | 5.2.0 | 5.3.0 |
| | RP-18 | RP-020723 | 1742 | | Correction to storing current TFC subset in variable TFC_SUBSET for TDD | 5.2.0 | 5.3.0 |
| | RP-18 | RP-020723 | 1745 | | Security at inter-RAT handover | 5.2.0 | 5.3.0 |
| | RP-18 | RP-020723 | 1748 | | Integrity protection activations times | 5.2.0 | 5.3.0 |
| | RP-18 | RP-020723 | 1751 | | Additional measurements | 5.2.0 | 5.3.0 |
| | RP-18 | RP-020724 | 1754 | | DPCH compressed mode info in Downlink information common for all RLS | 5.2.0 | 5.3.0 |
| | RP-18 | RP-020724 | 1757 | 1 | Handling of RB mapping | 5.2.0 | 5.3.0 |
| | RP-18 | RP-020724 | 1766 | | RLC window size in default configurations | 5.2.0 | 5.3.0 |
| | RP-18 | RP-020724 | 1769 | | Corrections to Activation time | 5.2.0 | 5.3.0 |
| | RP-18 | RP-020724 | 1772 | | Numbering of "ASC Setting" IEs included in "PRACH partitioning" IE | 5.2.0 | 5.3.0 |
| | RP-18 | RP-020724 | 1779 | 2 | Correction on support for compressed mode | 5.2.0 | 5.3.0 |
| | RP-18 | RP-020903 | 1734 | 3 | Introduction of backwards compatible correction mechanism | 5.2.0 | 5.3.0 |
| | RP-18 | RP-020727 | 1776 | | Signalling of the timing adjustment mode for closed loop Tx diversity | 5.2.0 | 5.3.0 |
| | RP-18 | RP-020893 | 1810 | | Handling of hyper frame numbers | 5.2.0 | 5.3.0 |
| | RP-18 | RP-020726 | 1760 | 2 | Early UE Specific Behaviour Information in RRC Connection Request / interRAT info | 5.2.0 | 5.3.0 |
| | RP-18 | RP-020858 | 1701 | | Correction of ASN1 IE "InterFreqCellInfoList-r4" | 5.2.0 | 5.3.0 |
| | RP-18 | RP-020858 | 1703 | | Correction of Special Burst Scheduling for TDD | 5.2.0 | 5.3.0 |
| | RP-18 | RP-020858 | 1705 | | Correction of measurement reporting event 6f for 1.28 Mcps TDD | 5.2.0 | 5.3.0 |
| | RP-18 | RP-020858 | 1781 | | Ciphering during SRNS relocation without reuse of COUNT-C | 5.2.0 | 5.3.0 |
| | RP-18 | RP-020858 | 1783 | | Correction to IE 'Intra Domain NAS Node Selector' | 5.2.0 | 5.3.0 |
| | RP-18 | RP-020858 | 1785 | | Correction to PRACH selection | 5.2.0 | 5.3.0 |
| | RP-18 | RP-020859 | 1787 | | Correction to reporting event 6f for FDD | 5.2.0 | 5.3.0 |
| | RP-18 | RP-020859 | 1802 | | ASN.1 corrections | 5.2.0 | 5.3.0 |
| | RP-18 | RP-020859 | 1805 | | Asymmetric ROHC Configuration | 5.2.0 | 5.3.0 |
| | RP-18 | RP-020859 | 1807 | | Reference Cell for GSM OTD Measurement | 5.2.0 | 5.3.0 |
| | RP-18 | RP-020736 | 1707 | | RRC container for RFC3095 context | 5.2.0 | 5.3.0 |
| | RP-18 | RP-020736 | 1791 | | Correction to IE 'Access stratum release indicator' | 5.2.0 | 5.3.0 |
| | RP-18 | RP-020736 | 1792 | | RLC capability for HSDPA | 5.2.0 | 5.3.0 |
| | RP-18 | RP-020736 | 1794 | | Dedicated pilot bits for HS-DSCH | 5.2.0 | 5.3.0 |
| | RP-18 | RP-020736 | 1795 | | Expansion of CPICH RSCP range | 5.2.0 | 5.3.0 |
| | RP-18 | RP-020736 | 1796 | | L3 Retransmission of event 1b | 5.2.0 | 5.3.0 |
| | RP-18 | RP-020736 | 1797 | | DPC mode change in ACTIVE SET UPDATE message | 5.2.0 | 5.3.0 |
| | RP-18 | RP-020736 | 1798 | | Correction to handling of IE 'Downlink information for each RL' | 5.2.0 | 5.3.0 |
| | RP-18 | RP-020896 | 1793 | 2 | HSDPA parameter value ranges | 5.2.0 | 5.3.0 |
| 03/2003 | RP-19 | RP-030103 | 1813 | | ASN.1 of the SRNS relocation Info | 5.3.0 | 5.4.0 |
| | RP-19 | RP-030103 | 1816 | | Correction to procedural text for Physical Shared Channel Allocation (TDD only) | 5.3.0 | 5.4.0 |
| | RP-19 | RP-030103 | 1819 | 1 | CM and state transition related to measurements, additional measurements, virtual active set and periodic measurements | 5.3.0 | 5.4.0 |

| Change history | | | | | | | |
|----------------|-------|-----------|------|-----|---|-------|-------|
| Date | TSG # | TSG Doc. | CR | Rev | Subject/Comment | Old | New |
| | RP-19 | RP-030103 | 1822 | | Physical channel failure and radio link re-establishment | 5.3.0 | 5.4.0 |
| | RP-19 | RP-030103 | 1825 | | Correction concerning bit numbering convention | 5.3.0 | 5.4.0 |
| | RP-19 | RP-030104 | 1831 | | Additional Measurement reporting list | 5.3.0 | 5.4.0 |
| | RP-19 | RP-030104 | 1834 | 2 | Correction on RRC integrity protection procedure | 5.3.0 | 5.4.0 |
| | RP-19 | RP-030104 | 1837 | | Reporting Cell Status and Event 2A | 5.3.0 | 5.4.0 |
| | RP-19 | RP-030104 | 1840 | | Correction to the handling of variable TGPS_IDENTITY and IE 'Triggering condition 1/2' | 5.3.0 | 5.4.0 |
| | RP-19 | RP-030104 | 1843 | 1 | Hard handover with pending ciphering activation times | 5.3.0 | 5.4.0 |
| | RP-19 | RP-030105 | 1846 | | Correction of default configurations | 5.3.0 | 5.4.0 |
| | RP-19 | RP-030105 | 1849 | | Correction to UE behaviour on entering RRC Connected mode | 5.3.0 | 5.4.0 |
| | RP-19 | RP-030105 | 1855 | | Update of Start values in USIM on inter-RAT transitions and transitions to idle mode | 5.3.0 | 5.4.0 |
| | RP-19 | RP-030082 | 1858 | | Corrections to Channelisation Code TFCI Mapping for TDD | 5.3.0 | 5.4.0 |
| | RP-19 | RP-030111 | 1860 | | Correction of PNBSCH for 1.28Mcps TDD | 5.3.0 | 5.4.0 |
| | RP-19 | RP-030111 | 1862 | | Correction of SFN-SFN observed time difference for 1.28Mcps TDD | 5.3.0 | 5.4.0 |
| | RP-19 | RP-030111 | 1864 | 3 | ASN.1 corrections concerning missing UE capability extensions | 5.3.0 | 5.4.0 |
| | RP-19 | RP-030111 | 1866 | | Extensions for 1.28 Mcps specific elements in system information | 5.3.0 | 5.4.0 |
| | RP-19 | RP-030111 | 1868 | | Corrections to power control parameter signalling for 1.28 Mcps TDD | 5.3.0 | 5.4.0 |
| | RP-19 | RP-030117 | 1872 | | TDD HS-SICH Power Control | 5.3.0 | 5.4.0 |
| | RP-19 | RP-030117 | 1873 | | Usage of separate scrambling code for HSDPA | 5.3.0 | 5.4.0 |
| | RP-19 | RP-030119 | 1874 | | TDD HS-DSCH midamble shift and burst type | 5.3.0 | 5.4.0 |
| | RP-19 | RP-030117 | 1875 | | Corrections to the IE "Added or Reconfigured MAC-d flow" and the associated table in 10.3.10 | 5.3.0 | 5.4.0 |
| | RP-19 | RP-030117 | 1877 | 1 | Network Assisted Cell Change from UTRAN to GERAN | 5.3.0 | 5.4.0 |
| | RP-19 | RP-030117 | 1878 | 1 | Defining more than one DSCH / USCH transport channel in PDSCH and PUSCH system information (TDD only) | 5.3.0 | 5.4.0 |
| | RP-19 | RP-030117 | 1879 | | Introducing the use of pre-defined configurations within UTRA | 5.3.0 | 5.4.0 |
| | RP-19 | RP-030120 | 1880 | | Group release (without security) | 5.3.0 | 5.4.0 |
| | RP-19 | RP-030105 | 1884 | | Correction to Inter-RAT Measurement Report | 5.3.0 | 5.4.0 |
| | RP-19 | RP-030106 | 1887 | | Correction of signalling of transport block size for DSCH | 5.3.0 | 5.4.0 |
| | RP-19 | RP-030106 | 1890 | | PS service continuity when moving between 3G and 2G | 5.3.0 | 5.4.0 |
| | RP-19 | RP-030106 | 1893 | 1 | Multiple activations of the same compressed mode pattern | 5.3.0 | 5.4.0 |
| | RP-19 | RP-030106 | 1896 | | Setting of ciphering activation time for TM bearers | 5.3.0 | 5.4.0 |
| | RP-19 | RP-030117 | 1897 | | Correction of shadow CR implementation | 5.3.0 | 5.4.0 |
| | RP-19 | RP-030111 | 1899 | | Removal of MRRU parameter in PDCP info | 5.3.0 | 5.4.0 |
| | RP-19 | RP-030117 | 1900 | | Measurement event for evaluation of best HS-DSCH cel | 5.3.0 | 5.4.0 |
| | RP-19 | RP-030105 | 1902 | 1 | NAS and Integrity procedure interaction | 5.3.0 | 5.4.0 |
| | RP-19 | RP-030117 | 1903 | | Correction to USBI | 5.3.0 | 5.4.0 |
| | RP-19 | RP-030187 | 1909 | | GPS navigation model update mechanism | 5.3.0 | 5.4.0 |
| | RP-19 | RP-030201 | 1910 | | Layer 3 filtering definition | 5.3.0 | 5.4.0 |
| | RP-20 | RP-030293 | 1913 | | Handling of UP Assistance Data | 5.4.0 | 5.5.0 |
| | RP-20 | RP-030293 | 1916 | 1 | Concerns on Procedures for Cell-ID Positioning Method | 5.4.0 | 5.5.0 |
| | RP-20 | RP-030293 | 1919 | | Inconsistency between Procedural, ASN.1, and Tabular Aspects of UE Positioning Error | 5.4.0 | 5.5.0 |
| | RP-20 | RP-030293 | 1922 | | Removal of FFS (For further Study) and references to other working groups | 5.4.0 | 5.5.0 |
| | RP-20 | RP-030293 | 1926 | | Key handling when entering idle mode and coding of security capabilities | 5.4.0 | 5.5.0 |
| | RP-20 | RP-030293 | 1929 | | Security actions when SIM is present on RRC Connection Request | 5.4.0 | 5.5.0 |
| | RP-20 | RP-030294 | 1932 | | Update of interfrequency measurement cell info list, reading of SIB11/12, inclusion of Measured Results on RACH | 5.4.0 | 5.5.0 |
| | RP-20 | RP-030294 | 1937 | | Additional measurements without measurement validity | 5.4.0 | 5.5.0 |
| | RP-20 | RP-030294 | 1940 | | Handover to UTRAN in macrodiversity | 5.4.0 | 5.5.0 |
| | RP-20 | RP-030294 | 1943 | 1 | TVM Reporting in CELL_PCH state | 5.4.0 | 5.5.0 |
| | RP-20 | RP-030294 | 1946 | 1 | Initialisation of the Virtual Active Set | 5.4.0 | 5.5.0 |
| | RP-20 | RP-030295 | 1949 | | IE 'Tx diversity mode' in ACTIVE SET UPDATE message | 5.4.0 | 5.5.0 |
| | RP-20 | RP-030295 | 1952 | 1 | Correction to transport channel traffic volume measurement events 4a and 4b | 5.4.0 | 5.5.0 |
| | RP-20 | RP-030295 | 1955 | | Maximum Number of GPS Almanac Messages to be Stored in | 5.4.0 | 5.5.0 |

| Change history | | | | | | | | |
|----------------|-------|-----------|------|-----|---|-------|-------|--|
| Date | TSG # | TSG Doc. | CR | Rev | Subject/Comment | Old | New | |
| | | | | | UE_POSITIONING_GPS_DATA | | | |
| | RP-20 | RP-030374 | 1958 | 2 | Stopping of RLC entities at relocation | 5.4.0 | 5.5.0 | |
| | RP-20 | RP-030369 | 1978 | 4 | Ciphering Mode info IE in 2G-3G Handover | 5.4.0 | 5.5.0 | |
| | RP-20 | RP-030295 | 1981 | | START values on 2G-3G handover | 5.4.0 | 5.5.0 | |
| | RP-20 | RP-030298 | 1983 | | ROHC profile signalling | 5.4.0 | 5.5.0 | |
| | RP-20 | RP-030298 | 1959 | 1 | Optimisation of the INTER RAT HANDOVER INFO message | 5.4.0 | 5.5.0 | |
| | RP-20 | RP-030350 | 1987 | 2 | Corrections to security procedures in case of pending security configurations at SRNS Relocation | 5.4.0 | 5.5.0 | |
| | RP-20 | RP-030371 | 1990 | | Setting of T317 to infinity and out of service behaviour | 5.4.0 | 5.5.0 | |
| | RP-20 | RP-030303 | 1960 | | Correction to the IE "HS-DSCH capability class" | 5.4.0 | 5.5.0 | |
| | RP-20 | RP-030303 | 1961 | | Correction of 'RB mapping info' in case HS-DSCH + DCH | 5.4.0 | 5.5.0 | |
| | RP-20 | RP-030303 | 1963 | | Explanation of CV-UE for the IE MidambleShift in the tabular | 5.4.0 | 5.5.0 | |
| 09/2003 | RP-21 | RP-030484 | 1993 | | Handling of key sets at Inter-RAT Handover to UTRAN | 5.5.0 | 5.6.0 | |
| | RP-21 | RP-030484 | 1996 | | Correction to UE Positioning privacy procedures | 5.5.0 | 5.6.0 | |
| | RP-21 | RP-030520 | 2003 | 2 | START calculation in connected mode | 5.5.0 | 5.6.0 | |
| | RP-21 | RP-030506 | 2000 | 1 | Reconfiguration with state transition to an indicated cell on a different frequency | 5.5.0 | 5.6.0 | |
| | RP-21 | RP-030484 | 2006 | | PRACH channelisation code list limitation to align with TS 25.221 | 5.5.0 | 5.6.0 | |
| | RP-21 | RP-030484 | 2009 | | Handling of transport channel information at radio bearer release | 5.5.0 | 5.6.0 | |
| | RP-21 | RP-030485 | 2015 | | Corrections for TDD for the IEs 'Downlink DPCH info common for all radio links' | 5.5.0 | 5.6.0 | |
| | RP-21 | RP-030485 | 2018 | | TFCS selection guidelines for TFC Subset | 5.5.0 | 5.6.0 | |
| | RP-21 | RP-030485 | 2025 | | Value range of UE Rx-Tx time difference type 2 measurement | 5.5.0 | 5.6.0 | |
| | RP-21 | RP-030485 | 2033 | | Activation Time for DSCH | 5.5.0 | 5.6.0 | |
| | RP-21 | RP-030485 | 2044 | | Correction of PDCP Configuration for RFC 2507 | 5.5.0 | 5.6.0 | |
| | RP-21 | RP-030486 | 2048 | | Corrections to event list handling | 5.5.0 | 5.6.0 | |
| | RP-21 | RP-030486 | 2051 | | Corrections to RACH reporting | 5.5.0 | 5.6.0 | |
| | RP-21 | RP-030486 | 2054 | | Corrections to modification of Additional Measurement lists | 5.5.0 | 5.6.0 | |
| | RP-21 | RP-030486 | 2057 | | UE positioning support in the UE | 5.5.0 | 5.6.0 | |
| | RP-21 | RP-030478 | 2064 | | Elimination of EPC mechanism | 5.5.0 | 5.6.0 | |
| | RP-21 | RP-030486 | 2069 | | UE behaviour in transition from CELL_DCH to CELL_FACH/CELL_PCH/URA_PCH and Out of Service is detected | 5.5.0 | 5.6.0 | |
| | RP-21 | RP-030505 | 2072 | 1 | Radio link failure during reconfiguration procedure | 5.5.0 | 5.6.0 | |
| | RP-21 | RP-030491 | 2020 | | Ciphering of TM SRBs | 5.5.0 | 5.6.0 | |
| | RP-21 | RP-030491 | 2022 | 1 | Correction on PDCP Header compression Configuration | 5.5.0 | 5.6.0 | |
| | RP-21 | RP-030491 | 2027 | | Corrections for TDD PUSCH | 5.5.0 | 5.6.0 | |
| | RP-21 | RP-030495 | 1997 | | Correction to UE behaviour on T317 expiry | 5.5.0 | 5.6.0 | |
| | RP-21 | RP-030495 | 2029 | | Correcting value range of MAC-hs buffer ID | 5.5.0 | 5.6.0 | |
| | RP-21 | RP-030495 | 2030 | | Correction of handling of IE "MAC-hs reset indicator" in Added or Reconfigured DL TrCH information | 5.5.0 | 5.6.0 | |
| | RP-21 | RP-030495 | 2035 | 1 | UE capability signalling for UMTS1800 | 5.5.0 | 5.6.0 | |
| | RP-21 | RP-030495 | 2039 | | Handover between UTRAN and GERAN Iu mode | 5.5.0 | 5.6.0 | |
| | RP-21 | RP-030495 | 2040 | | Updated references to the RRC State Indicator IE | 5.5.0 | 5.6.0 | |
| | RP-21 | RP-030495 | 2041 | | Corrections to Event 1D | 5.5.0 | 5.6.0 | |
| | RP-21 | RP-030449 | 2028 | | Reconfiguration of MAC-d flow | 5.5.0 | 5.6.0 | |
| | RP-21 | RP-030462 | 2061 | | HS-SCCH transmit diversity mode | 5.5.0 | 5.6.0 | |
| | RP-21 | RP-030503 | 2066 | | Scrambling code & phase reference combinations for HS-DSCH (solution 2) | 5.5.0 | 5.6.0 | |
| 12/2003 | RP-22 | RP-030617 | 2075 | | Unsuccessful security mode control procedure and Integrity Protection | 5.6.0 | 5.7.0 | |
| | RP-22 | RP-030625 | 2076 | | START value calculation for RLC size change | 5.6.0 | 5.7.0 | |
| | RP-22 | RP-030617 | 2079 | | UE Positioning UE based assisted GPS | 5.6.0 | 5.7.0 | |
| | RP-22 | RP-030617 | 2085 | | Handling of zero-rate TrCHs in TFCS | 5.6.0 | 5.7.0 | |
| | RP-22 | RP-030617 | 2091 | 3 | Measurement control for A-GPS | 5.6.0 | 5.7.0 | |
| | RP-22 | RP-030621 | 2093 | | Corrections to 1.28 Mcps TDD power control: ASN1/Tabular consistency, correction of omissions | 5.6.0 | 5.7.0 | |
| | RP-22 | RP-030621 | 2095 | | UpPCH power control for 1.28Mcps | 5.6.0 | 5.7.0 | |
| | RP-22 | RP-030617 | 2102 | 1 | Interaction between compressed mode pattern activation and message activation time | 5.6.0 | 5.7.0 | |
| | RP-22 | RP-030625 | 2103 | | Initialisation of virtual active set | 5.6.0 | 5.7.0 | |

| Change history | | | | | | | | |
|----------------|-------|-----------|------|-----|--|-------|-------|--|
| Date | TSG # | TSG Doc. | CR | Rev | Subject/Comment | Old | New | |
| | RP-22 | RP-030611 | 2106 | 1 | Correction to Redirection procedure at RRC Connection Setup | 5.6.0 | 5.7.0 | |
| | RP-22 | RP-030610 | 2112 | 2 | SFN associated with GPS timing of cell frame | 5.6.0 | 5.7.0 | |
| | RP-22 | RP-030618 | 2115 | | Correction to Handling SIB1 | 5.6.0 | 5.7.0 | |
| | RP-22 | RP-030618 | 2118 | | Measurement Handling In State Transition for UE Positioning | 5.6.0 | 5.7.0 | |
| | RP-22 | RP-030618 | 2124 | | Corrections to UE positioning reporting for UE assisted and UE based methods | 5.6.0 | 5.7.0 | |
| | RP-22 | RP-030662 | 2127 | 1 | SIB 7 reading | 5.6.0 | 5.7.0 | |
| | RP-22 | RP-030662 | 2130 | | HFN initialisation in case of pending security configurations | 5.6.0 | 5.7.0 | |
| | RP-22 | RP-030621 | 2132 | 1 | General protocol error handling failure for DL CCCH messages due to ASN.1 error | 5.6.0 | 5.7.0 | |
| | RP-22 | RP-030621 | 2136 | | Corrections relating to 1.28 Mcps TDD | 5.6.0 | 5.7.0 | |
| | RP-22 | RP-030621 | 2138 | | Missing CHOICE RLC Info type in the ASN.1 IE "RB-InformationSetup-r4" | 5.6.0 | 5.7.0 | |
| | RP-22 | RP-030625 | 2139 | 1 | RRM in PCH/FACH | 5.6.0 | 5.7.0 | |
| | RP-22 | RP-030625 | 2140 | | Correction of operating band reference | 5.6.0 | 5.7.0 | |
| | RP-22 | RP-030713 | 2141 | 1 | Re-ordering Queue and HARQ Ids | 5.6.0 | 5.7.0 | |
| | RP-22 | RP-030625 | 2142 | | Correction to the procedural description: Reconfiguration of MAC-d flow | 5.6.0 | 5.7.0 | |
| | RP-22 | RP-030625 | 2143 | 1 | Enhancement of RRC transaction identifier for measurement control message | 5.6.0 | 5.7.0 | |
| | RP-22 | RP-030629 | 2144 | | Inclusion of a default configuration identity for AMR-WB | 5.6.0 | 5.7.0 | |
| | RP-22 | RP-030625 | 2145 | | TDD C-RNTI in Cell DCH | 5.6.0 | 5.7.0 | |
| | RP-22 | RP-030662 | 2148 | | Additional Measurements List Modify | 5.6.0 | 5.7.0 | |
| | RP-22 | RP-030625 | 2149 | | IP activation time for RBO | 5.6.0 | 5.7.0 | |
| | RP-22 | RP-030722 | 2152 | 3 | Minimum UE capability class | 5.6.0 | 5.7.0 | |
| | RP-22 | RP-030612 | 2158 | 4 | Measured results on RACH | 5.6.0 | 5.7.0 | |
| | RP-22 | RP-030625 | 2159 | | COUNT-I reverting in case Security Mode Control procedure failure | 5.6.0 | 5.7.0 | |
| | RP-21 | RP-030548 | 2034 | 1 | Maintaining the RRC Connection while Emergency camped on a F-PLMN during OOS (note: it was decided that this CR would not be implemented until the Rel-6 would be created) | 5.5.0 | 6.0.0 | |
| | RP-22 | RP-030630 | 2133 | | Introduction of UMTS800 | 5.7.0 | 6.0.0 | |
| | RP-22 | RP-030721 | 2134 | 1 | AS capability indication | 5.7.0 | 6.0.0 | |
| | RP-22 | RP-030630 | 2160 | | Introduction of new bands | 5.7.0 | 6.0.0 | |
| | | Editorial | | | Repair of corrupted figures | 6.0.0 | 6.0.1 | |
| 03/2004 | RP-23 | RP-040095 | 2168 | 2 | Response on SRNS Relocation with Cell Update | 6.0.1 | 6.1.0 | |
| | RP-23 | RP-040095 | 2172 | | TPC Combination Index in SRNC relocation | 6.0.1 | 6.1.0 | |
| | RP-23 | RP-040107 | 2176 | 1 | Correction to "Current TGPS Status Flag" | 6.0.1 | 6.1.0 | |
| | RP-23 | RP-040095 | 2180 | 1 | Invalidation of START value in USIM/UE. | 6.0.1 | 6.1.0 | |
| | RP-23 | RP-040095 | 2184 | 1 | Uplink Integrity protection handling in case of N302 increment | 6.0.1 | 6.1.0 | |
| | RP-23 | RP-040095 | 2188 | 1 | Amount of reporting for UE-based and UE assisted A-GPS | 6.0.1 | 6.1.0 | |
| | RP-23 | RP-040101 | 2191 | 1 | Ensuring decoding possibility related to Introduction of new bands | 6.0.1 | 6.1.0 | |
| | RP-23 | RP-040101 | 2197 | 2 | Clarification to multimode indication | 6.0.1 | 6.1.0 | |
| | RP-23 | RP-040101 | 2200 | | Correction for 1.28 Mcps TDD Power Control | 6.0.1 | 6.1.0 | |
| | RP-23 | RP-040101 | 2203 | | Missing "pdcp-SN-info" in ASN.1 IE "RB-InformationReconfig-r4" | 6.0.1 | 6.1.0 | |
| | RP-23 | RP-040107 | 2207 | | Correction to HS-SCCH info | 6.0.1 | 6.1.0 | |
| | RP-23 | RP-040107 | 2209 | | Correction to HS-SCCH info | 6.0.1 | 6.1.0 | |
| | RP-23 | RP-040107 | 2213 | | Correction to activation time for HS-DSCH reconfiguration in TDD | 6.0.1 | 6.1.0 | |
| | RP-23 | RP-040131 | 2217 | 3 | Connected mode handling IE 'CN domain system information' in SIB1 | 6.0.1 | 6.1.0 | |
| | RP-23 | RP-040096 | 2221 | | Correction to event 6D | 6.0.1 | 6.1.0 | |
| | RP-23 | RP-040096 | 2225 | 1 | Correction to UE positioning reporting for GPS standalone operation mode | 6.0.1 | 6.1.0 | |
| | RP-23 | RP-040092 | 2229 | | Frequency band alignment with 25.101 | 6.0.1 | 6.1.0 | |
| | RP-23 | RP-040096 | 2235 | | UTRAN setting of the activation time for TM bearers in Ciphering Mode info IE | 6.0.1 | 6.1.0 | |
| | RP-23 | RP-040096 | 2239 | | Corrections to "Entered parameter" | 6.0.1 | 6.1.0 | |
| | RP-23 | RP-040097 | 2243 | | Corrections to TFC Subset Functionality | 6.0.1 | 6.1.0 | |
| | RP-23 | RP-040097 | 2247 | 1 | Waiting for RLC-ACK on UMI | 6.0.1 | 6.1.0 | |
| | RP-23 | RP-040105 | 2249 | | Invalid Simultaneous Reconfiguration Criteria | 6.0.1 | 6.1.0 | |

| Change history | | | | | | | |
|----------------|-------|-----------|------|-----|---|-------|-------|
| Date | TSG # | TSG Doc. | CR | Rev | Subject/Comment | Old | New |
| | RP-23 | RP-040101 | 2252 | 1 | General correction and alignment of the ASN.1 and tabular | 6.0.1 | 6.1.0 |
| | RP-23 | RP-040121 | 2253 | 1 | Introduction of UMTS1700/2100 (Band IV) | 6.0.1 | 6.1.0 |
| | RP-23 | RP-040091 | 2254 | | Introduction of UMTS850 (Band V) | 6.0.1 | 6.1.0 |
| | RP-23 | RP-040101 | 2257 | | Introduction of VLEC in every message branch | 6.0.1 | 6.1.0 |
| | RP-23 | RP-040107 | 2259 | | Simultaneous Reception of S-CCPCH and HS-DSCH | 6.0.1 | 6.1.0 |
| | RP-23 | RP-040107 | 2261 | | Cell reselection between UTRAN and GERAN lu mode | 6.0.1 | 6.1.0 |
| | RP-23 | RP-040108 | 2263 | | HSDPA related corrections on buffer flushing on state transitions, RAT transitions, error cases, MAC-hs reconfiguration and readiness to receive HS-PDSCH | 6.0.1 | 6.1.0 |
| | RP-23 | RP-040106 | 2265 | 2 | Signalling of MAC-hs Reset | 6.0.1 | 6.1.0 |
| | RP-23 | RP-040131 | 2267 | 2 | Modification of Inter-frequency CELL_INFO_LIST | 6.0.1 | 6.1.0 |
| | RP-23 | RP-040131 | 2269 | 1 | [VAS] 1B-1C conflicts when 1A is not configured | 6.0.1 | 6.1.0 |
| | RP-23 | RP-040131 | 2271 | 1 | Handling of wait time in RRC connection reject | 6.0.1 | 6.1.0 |
| | RP-23 | RP-040108 | 2274 | | Misalignments between R'99 and Rel-5 procedures | 6.0.1 | 6.1.0 |
| | RP-23 | RP-040097 | 2281 | | Issues related to Inter-RAT and Inter-frequency handovers | 6.0.1 | 6.1.0 |
| | RP-23 | RP-040097 | 2285 | 1 | Corrections to reconfiguration scenarios and ciphering of TM RBs | 6.0.1 | 6.1.0 |
| | RP-23 | RP-040110 | 2286 | 4 | Addition of "cell selection indication" for cell selection at release of RRC connection and RRC connection reject with re-direction | 6.0.1 | 6.1.0 |
| | RP-23 | RP-040129 | 2288 | | HSDPA capability for multimode FDD-TDD terminals | 6.0.1 | 6.1.0 |
| | RP-23 | RP-040095 | 2168 | 2 | Response on SRNS Relocation with Cell Update | 6.0.1 | 6.1.0 |
| 06/2004 | RP-24 | RP-040203 | 2292 | | Empty non-critical extensions | 6.1.0 | 6.2.0 |
| | RP-24 | RP-040211 | 2294 | 1 | Missing 'v3g0' extension in the UE CAPABILITY INFORMATION | 6.1.0 | 6.2.0 |
| | RP-24 | RP-040203 | 2303 | | Correction on System Information in TDD | 6.1.0 | 6.2.0 |
| | RP-24 | RP-040236 | 2305 | | Corrections to Cell Change Order from UTRAN procedure | 6.1.0 | 6.2.0 |
| | RP-24 | RP-040206 | 2308 | | Correction on SFN-SFN time difference misalignment in 1.28 Mcps TDD | 6.1.0 | 6.2.0 |
| | RP-24 | RP-040207 | 2311 | | ASN.1 correction leftovers | 6.1.0 | 6.2.0 |
| | RP-24 | RP-040210 | 2313 | | Closing the REL-5 extensions in the ASN.1 | 6.1.0 | 6.2.0 |
| | RP-24 | RP-040207 | 2316 | | Incorrect presence of UE-RadioAccessCapability extension in RRC CONNECTION SETUP COMPLETE | 6.1.0 | 6.2.0 |
| | RP-24 | RP-040210 | 2318 | | Unnecessary MAC-d flow identity in the IE 'DL-TrCH-Type-r5' | 6.1.0 | 6.2.0 |
| | RP-24 | RP-040211 | 2320 | 1 | UE capability enquiry for GERAN lu mode | 6.1.0 | 6.2.0 |
| | RP-24 | RP-040207 | 2323 | | Clean up of SRNS Relocation Info REL-4 version | 6.1.0 | 6.2.0 |
| | RP-24 | RP-040210 | 2325 | | Tabular correction for RADIO BEARER RELEASE message | 6.1.0 | 6.2.0 |
| | RP-24 | RP-040210 | 2327 | | Misalignments between R'99 and Rel-5 procedures | 6.1.0 | 6.2.0 |
| | RP-24 | RP-040210 | 2329 | | Erroneous setting of Re-establish Indicator in case of SRNS relocation | 6.1.0 | 6.2.0 |
| | RP-24 | RP-040207 | 2332 | | Correction to IE 'Cell Info' | 6.1.0 | 6.2.0 |
| | RP-24 | RP-040210 | 2334 | | Correction Concerning UE Positioning Measurement | 6.1.0 | 6.2.0 |
| | RP-24 | RP-040236 | 2336 | | Pending compressed mode reconfigurations | 6.1.0 | 6.2.0 |
| | | RP-040236 | 2338 | | Active compressed mode patterns with same measurement purpose | 6.1.0 | 6.2.0 |
| | RP-24 | RP-040211 | 2340 | | Correction to Information Elements for UE Rx-Tx time difference | 6.1.0 | 6.2.0 |
| | RP-24 | RP-040210 | 2342 | | Naming correction in the HS-DSCH IE Measurement Feedback Information | 6.1.0 | 6.2.0 |
| | RP-24 | RP-040206 | 2345 | | Clarification about open loop power control in 1.28Mcps TDD | 6.1.0 | 6.2.0 |
| | RP-24 | RP-040206 | 2348 | | Clarification about measurement control system information in TDD mode | 6.1.0 | 6.2.0 |
| | RP-24 | RP-040211 | 2350 | | Correction to timing-maintained hard handover regarding the UL transmission timing | 6.1.0 | 6.2.0 |
| | RP-24 | RP-040236 | 2354 | 2 | Selection of suitable cell | 6.1.0 | 6.2.0 |
| | RP-24 | RP-040236 | 2356 | | Check of the PLMN identity in the MIB when selecting a new cell | 6.1.0 | 6.2.0 |
| | RP-24 | RP-040211 | 2358 | | Compressed INTER RAT HANDOVER INFO message modifications/corrections | 6.1.0 | 6.2.0 |
| | RP-24 | RP-040215 | 2359 | | The ASN.1 definition of IE 'SysInfoType5bis' | 6.1.0 | 6.2.0 |
| | RP-24 | RP-040224 | 2361 | | RLC size handling and RLC re-establishment | 6.1.0 | 6.2.0 |
| | RP-24 | RP-040212 | 2363 | | Restrict operation of the virtual active set | 6.1.0 | 6.2.0 |
| | RP-24 | RP-040213 | 2365 | | Usage of different RB mapping info | 6.1.0 | 6.2.0 |
| | RP-24 | RP-040256 | 2367 | 1 | Clarification on UE procedure in case of HHO failure | 6.1.0 | 6.2.0 |
| 09/2004 | RP-25 | RP-040327 | 2373 | | TDD misalignment between tabular and ASN.1 definitions of UL Transport channel information common for all transport channels | 6.2.0 | 6.3.0 |

| Change history | | | | | | | | |
|----------------|-------|-----------|------|-----|--|-------|-------|--|
| Date | TSG # | TSG Doc. | CR | Rev | Subject/Comment | Old | New | |
| | | | | | and special burst scheduling | | | |
| | RP-25 | RP-040327 | 2377 | | Definition of parameters for UE-assisted A-GPS | 6.2.0 | 6.3.0 | |
| | RP-25 | RP-040339 | 2378 | 2 | Addition of UMTS850 (Band V) in the tabular | 6.2.0 | 6.3.0 | |
| | RP-25 | RP-040360 | 2381 | | Default Configurations for multiple AMR Rate Configurations | 6.2.0 | 6.3.0 | |
| | RP-25 | RP-040319 | 2384 | | Correction on PRACH selection in 1.28Mcps TDD | 6.2.0 | 6.3.0 | |
| | RP-25 | RP-040334 | 2386 | | Inconsistency in UE action for HFN initialisation | 6.2.0 | 6.3.0 | |
| | RP-25 | RP-040334 | 2388 | | Usage of different RB mapping info for TDD | 6.2.0 | 6.3.0 | |
| | RP-25 | RP-040334 | 2390 | | TDD HS-DSCH Corrections | 6.2.0 | 6.3.0 | |
| | RP-25 | RP-040334 | 2392 | | Alignment of Tabular Definition with ASN.1 for HS-SCCH Info | 6.2.0 | 6.3.0 | |
| | RP-25 | RP-040348 | 2394 | 1 | Correction to HS-DSCH reception conditions | 6.2.0 | 6.3.0 | |
| | RP-25 | RP-040334 | 2396 | | Correction to RB mapping check | 6.2.0 | 6.3.0 | |
| | RP-25 | RP-040334 | 2398 | | Position Timestamp for A-GPS | 6.2.0 | 6.3.0 | |
| | RP-25 | RP-040334 | 2400 | | Pending compressed mode reconfigurations | 6.2.0 | 6.3.0 | |
| | RP-25 | RP-040335 | 2402 | | Predefined configurations for the RRC connection request | 6.2.0 | 6.3.0 | |
| | RP-25 | RP-040335 | 2404 | | Cell update during reconfiguration from CELL_FACH to CELL_PCH | 6.2.0 | 6.3.0 | |
| | RP-25 | RP-040335 | 2406 | | UE actions for Delta_ACK/NACK and repetition factor | 6.2.0 | 6.3.0 | |
| | RP-25 | RP-040335 | 2408 | | Calculation of UL transmit power for HS-SICH (TDD) | 6.2.0 | 6.3.0 | |
| | RP-25 | RP-040335 | 2410 | | Handling of Timer T302 Expiry | 6.2.0 | 6.3.0 | |
| | RP-25 | RP-040335 | 2412 | | Correct naming for HS-DSCH with DCH multiplexing option | 6.2.0 | 6.3.0 | |
| | RP-25 | RP-040335 | 2414 | | Compressed Pre-defined configurations description in new Annex C | 6.2.0 | 6.3.0 | |
| | RP-25 | RP-040335 | 2416 | | Integration between integrity protection and the sending of downlink messages during SRNS relocation | 6.2.0 | 6.3.0 | |
| | RP-25 | RP-040328 | 2418 | | Corrections to restrictions of operation of the virtual active set | 6.2.0 | 6.3.0 | |
| | RP-25 | RP-040336 | 2420 | | UE actions for received new keys | 6.2.0 | 6.3.0 | |
| | RP-25 | RP-040336 | 2422 | 1 | Scrambling Code Change | 6.2.0 | 6.3.0 | |
| | RP-25 | RP-040328 | 2428 | | Clarifications to VAS functionality | 6.2.0 | 6.3.0 | |
| | RP-25 | RP-040336 | 2430 | | UE security capability in INTER_RAT handover | 6.2.0 | 6.3.0 | |
| | RP-25 | RP-040336 | 2432 | | Correction to the Radio Link Failure behaviour | 6.2.0 | 6.3.0 | |
| 12/2004 | RP-26 | RP-040481 | 2434 | | Correction to measured results on RACH | 6.3.0 | 6.4.0 | |
| | RP-26 | RP-040481 | 2436 | | T305 handling upon a state transition | 6.3.0 | 6.4.0 | |
| | RP-26 | RP-040481 | 2438 | | Handling of pending AM RLC unrecoverable errors signalled by cell update | 6.3.0 | 6.4.0 | |
| | RP-26 | RP-040476 | 2442 | | Correction to maximum length of CTCH period | 6.3.0 | 6.4.0 | |
| | RP-26 | RP-040481 | 2444 | | TPC step size in default configurations | 6.3.0 | 6.4.0 | |
| | RP-26 | RP-040474 | 2448 | | References to ITU-T Recommendations on ASN.1 | 6.3.0 | 6.4.0 | |
| | RP-26 | RP-040477 | 2451 | | ASN.1 clarification on Measurement Report for 1.28 Mcps TDD | 6.3.0 | 6.4.0 | |
| | RP-26 | RP-040481 | 2453 | | Correction to HS-DSCH reception conditions | 6.3.0 | 6.4.0 | |
| | RP-26 | RP-040481 | 2455 | 1 | MAC-hs Reset procedure | 6.3.0 | 6.4.0 | |
| | RP-26 | RP-040526 | 2457 | 2 | Cell selection and reselection parameters | 6.3.0 | 6.4.0 | |
| | RP-26 | RP-040482 | 2459 | 1 | Clarification the PDCP capability- Max HC context space | 6.3.0 | 6.4.0 | |
| | RP-26 | RP-040482 | 2461 | | Corrections to IE 'WAIT TIME' = 0 | 6.3.0 | 6.4.0 | |
| | RP-26 | RP-040482 | 2463 | 1 | RRC transaction identifier in the MEASUREMENT CONTROL message | 6.3.0 | 6.4.0 | |
| | RP-26 | RP-040482 | 2465 | | Correction to intra-frequency measurement handling in SIB11 | 6.3.0 | 6.4.0 | |
| | RP-26 | RP-040477 | 2468 | 1 | Missing OTDOA TDD related v4b0 extension in MEASUREMENT CONTROL | 6.3.0 | 6.4.0 | |
| | RP-26 | RP-040482 | 2470 | 2 | Clarification of Radio Bearer Downlink Ciphering Activation Time Info | 6.3.0 | 6.4.0 | |
| | RP-26 | RP-040520 | 2472 | 2 | TFC Subset Variable Usage and Application of Transport Format Combination Subset | 6.3.0 | 6.4.0 | |
| | RP-26 | RP-040505 | 2474 | | Use of preconfiguration in the RADIO BEARER RECONFIGURATION message | 6.3.0 | 6.4.0 | |
| | RP-26 | RP-040505 | 2476 | | UTRAN setting of ciphering activation time for SRB2 | 6.3.0 | 6.4.0 | |
| | RP-26 | RP-040505 | 2478 | | Correction to ASN.1 IE 'srb-SpecificIntegrityProtInfo' | 6.3.0 | 6.4.0 | |
| | RP-26 | RP-040522 | 2480 | 2 | Criteria for initiating cell update on receiving 'Frequency info' IE in CELL UPDATE CONFIRM message | 6.3.0 | 6.4.0 | |
| | RP-26 | RP-040505 | 2482 | | Traffic volume measurements in PCH states | 6.3.0 | 6.4.0 | |
| | RP-26 | RP-040505 | 2484 | | Failure cause indication on Cell Update | 6.3.0 | 6.4.0 | |

| Change history | | | | | | | |
|----------------|-------|-----------|------|-----|---|-------|-------|
| Date | TSG # | TSG Doc. | CR | Rev | Subject/Comment | Old | New |
| | RP-26 | RP-040495 | 2487 | 1 | Network Sharing and multiple PLMN identities | 6.3.0 | 6.4.0 |
| | RP-26 | RP-040505 | 2493 | | Inter-RAT measurement control information used | 6.3.0 | 6.4.0 |
| | RP-26 | RP-040491 | 2494 | | ASN.1 update for the introduction of MBMS | 6.3.0 | 6.4.0 |
| | RP-26 | RP-040491 | 2495 | 1 | Introduction of MBMS | 6.3.0 | 6.4.0 |
| | RP-26 | RP-040543 | 2496 | 2 | Preamble and Postamble to reduce HS-DPCCH transmit power | 6.3.0 | 6.4.0 |
| | RP-26 | RP-040507 | 2497 | | Introduction of E-DCH | 6.3.0 | 6.4.0 |
| 03/2005 | RP-27 | RP-050038 | 2491 | 2 | Removal of TGPL2 | 6.4.0 | 6.5.0 |
| | RP-27 | RP-050069 | 2499 | | Minor HSDPA related corrections | 6.4.0 | 6.5.0 |
| | RP-27 | RP-050169 | 2501 | | Integrity protection related information in the SRNS relocation info | 6.4.0 | 6.5.0 |
| | RP-27 | RP-050069 | 2503 | | Number of timeslots that can be used for HS-PDSCH resource for 3.84 Mcps TDD | 6.4.0 | 6.5.0 |
| | RP-27 | RP-050089 | 2504 | | HS-DSCH operation without a DL DPCH for 3.84 Mcps TDD | 6.4.0 | 6.5.0 |
| | RP-27 | RP-050114 | 2506 | | Removal of unnecessary cell updates on receiving 'Frequency info' IE in CELL UPDATE CONFIRM message | 6.4.0 | 6.5.0 |
| | RP-27 | RP-050069 | 2508 | | ASN.1 clarification on Cell and Channel Identity info for 1.28 Mcps TDD | 6.4.0 | 6.5.0 |
| | RP-27 | RP-050070 | 2510 | | Handling of TM SRB's at radio link failure | 6.4.0 | 6.5.0 |
| | RP-27 | RP-050070 | 2513 | | Removal of the UARFCN uplink (Nu) in the informative Annex A.3 | 6.4.0 | 6.5.0 |
| | RP-27 | RP-050070 | 2515 | 1 | Correction on PRACH selection | 6.4.0 | 6.5.0 |
| | RP-27 | RP-050067 | 2517 | 3 | Lossless DL RLC PDU size change | 6.4.0 | 6.5.0 |
| | RP-27 | RP-050069 | 2519 | | Clarification of GERAN (P)SI message coding in NACC | 6.4.0 | 6.5.0 |
| | RP-27 | RP-050070 | 2521 | | Unsupported RLC mode reconfigurations | 6.4.0 | 6.5.0 |
| | RP-27 | RP-050070 | 2523 | | Correction to Inter RAT cell info indication | 6.4.0 | 6.5.0 |
| | RP-27 | RP-050086 | 2524 | | Correction to network sharing functionality | 6.4.0 | 6.5.0 |
| | RP-27 | RP-050086 | 2525 | | Network sharing corrections | 6.4.0 | 6.5.0 |
| | RP-27 | RP-050110 | 2526 | 1 | CN domain specific Access Class Barring | 6.4.0 | 6.5.0 |
| | RP-27 | RP-050081 | 2527 | | Corrections to "selected PLMN" in access stratum | 6.4.0 | 6.5.0 |
| | RP-27 | RP-050074 | 2528 | | Introduction of F-DPCH | 6.4.0 | 6.5.0 |
| | RP-27 | RP-050084 | 2529 | | Minor E-DCH related corrections | 6.4.0 | 6.5.0 |
| | RP-27 | RP-050079 | 2530 | 2 | Miscellaneous MBMS corrections | 6.4.0 | 6.5.0 |
| | RP-27 | RP-050087 | 2532 | | Additional Frequency Bands | 6.4.0 | 6.5.0 |
| | RP-27 | RP-050084 | 2534 | | Introduction of E-DCH in the ASN.1 | 6.4.0 | 6.5.0 |
| | RP-27 | RP-050097 | 2535 | | Improvements to uplink closed loop power control for 1.28 Mcps TDD | 6.4.0 | 6.5.0 |
| | RP-27 | RP-050079 | 2536 | 1 | MBMS Corrections to 25.331 ASN.1 | 6.4.0 | 6.5.0 |
| | RP-27 | RP-050128 | 2538 | 1 | Correction to cell selection and reselection parameters to enable enhanced cell reselection | 6.4.0 | 6.5.0 |
| 06/2005 | RP-28 | RP-050253 | 2539 | 3 | Faster L1 DCH synchronization | 6.5.0 | 6.6.0 |
| | RP-28 | RP-050339 | 2540 | 3 | Timing maintained hard handover | 6.5.0 | 6.6.0 |
| | RP-28 | RP-050320 | 2541 | 1 | Removal of unnecessary Start values | 6.5.0 | 6.6.0 |
| | RP-28 | RP-050329 | 2542 | | Merged CR alignment w.r.t. network sharing functionality | 6.5.0 | 6.6.0 |
| | RP-28 | RP-050302 | 2545 | | Timing Reinitialized Handover & Radio Link Timing Adjustmen | 6.5.0 | 6.6.0 |
| | RP-28 | RP-050302 | 2547 | | Addition of omitted IE 'report criteria' in MEASUREMENT CONTROL message 'modify' command | 6.5.0 | 6.6.0 |
| | RP-28 | RP-050316 | 2548 | 2 | Miscellaneous MBMS corrections (set II) | 6.5.0 | 6.6.0 |
| | RP-28 | RP-050316 | 2549 | 1 | Correction to MBMS notification procedure | 6.5.0 | 6.6.0 |
| | RP-28 | RP-050316 | 2550 | 1 | FACH Measurement Occasion when UE receives MBMS | 6.5.0 | 6.6.0 |
| | RP-28 | RP-050316 | 2551 | | Frequency layer dispersion | 6.5.0 | 6.6.0 |
| | RP-28 | RP-050303 | 2553 | 2 | Signalling of target mode for ROHC operation | 6.5.0 | 6.6.0 |
| | RP-28 | RP-050320 | 2554 | 2 | Introduction of inter-frequency RACH measurement reporting | 6.5.0 | 6.6.0 |
| | RP-28 | RP-050324 | 2555 | | Closed-Loop Power Control Improvements for 1.28 Mcps TDD – ASN1 Corrections | 6.5.0 | 6.6.0 |
| | RP-28 | RP-050322 | 2556 | | Release 6 HS-DSCH operation without a DL DPCH for 3.84 Mcps TDD – Setting of Dhs-sync | 6.5.0 | 6.6.0 |
| | RP-28 | RP-050320 | 2557 | 1 | Correction to the Amount of Reporting | 6.5.0 | 6.6.0 |
| | RP-28 | RP-050320 | 2558 | | Measurement report message definition when Inter-RAT cell info indication is used | 6.5.0 | 6.6.0 |
| | RP-28 | RP-050320 | 2559 | | Direct transition to DCH | 6.5.0 | 6.6.0 |

| Change history | | | | | | | | |
|----------------|-------|-----------|------|-----|--|-------|-------|--|
| Date | TSG # | TSG Doc. | CR | Rev | Subject/Comment | Old | New | |
| | RP-28 | RP-050316 | 2560 | 1 | Addition of the number of MBMS Neighbour Cell PTM Information messages to the MBMS Modified Services Information message | 6.5.0 | 6.6.0 | |
| | RP-28 | RP-050316 | 2561 | 1 | Addition of MBMS counting for UEs in Cell_PCH and Cell_FACH states and addition of UE requested p-t-p bearer establishment | 6.5.0 | 6.6.0 | |
| | RP-28 | RP-050320 | 2562 | | Introduction of IE 'RB information to reconfigure' in RB SETUP, RB RELEASE messages | 6.5.0 | 6.6.0 | |
| | RP-28 | RP-050320 | 2564 | | Including HS-DSCH serving cell change in ASU | 6.5.0 | 6.6.0 | |
| | RP-28 | RP-050320 | 2566 | 1 | Detection of Activation CFN wraparound in the UE during HS-DSCH cell change | 6.5.0 | 6.6.0 | |
| | RP-28 | RP-050304 | 2568 | | Correction to handling of keys at inter-RAT handover | 6.5.0 | 6.6.0 | |
| | RP-28 | RP-050302 | 2572 | | CTFC calculation for DCH | 6.5.0 | 6.6.0 | |
| | RP-28 | RP-050302 | 2574 | | Default RB identity in IE 'Signalling RB information to setup' | 6.5.0 | 6.6.0 | |
| | RP-28 | RP-050302 | 2576 | | Default configuration 13 | 6.5.0 | 6.6.0 | |
| | RP-28 | RP-050320 | 2577 | | UE L3 requirements for HS-DSCH mobility | 6.5.0 | 6.6.0 | |
| | RP-28 | RP-050374 | 2579 | 3 | Support for out-of-sequence PDUs in RLC-UM | 6.5.0 | 6.6.0 | |
| | RP-28 | RP-050305 | 2581 | | Feature Clean Up: Removal of 80 ms TTI for DCH for all other cases but when the UE supports SF512 | 6.5.0 | 6.6.0 | |
| | RP-28 | RP-050306 | 2583 | | Feature Clean Up: Removal of observed time difference to GSM cell | 6.5.0 | 6.6.0 | |
| | RP-28 | RP-050307 | 2585 | | Feature Clean Up: Removal of SSDT | 6.5.0 | 6.6.0 | |
| | RP-28 | RP-050308 | 2586 | | Feature Clean-up: Removal of DSCH (FDD) | 6.5.0 | 6.6.0 | |
| | RP-28 | RP-050309 | 2589 | | Feature Clean Up: Removal of CPCH | 6.5.0 | 6.6.0 | |
| | RP-28 | RP-050310 | 2591 | | Feature Clean Up: Removal of dedicated pilot as sole phase reference | 6.5.0 | 6.6.0 | |
| | RP-28 | RP-050311 | 2593 | | Feature Clean Up: Removal of DRAC | 6.5.0 | 6.6.0 | |
| | RP-28 | RP-050312 | 2595 | | Feature Clean Up: Removal of TX diversity closed loop mode 2 | 6.5.0 | 6.6.0 | |
| | RP-28 | RP-050313 | 2597 | | Feature Clean Up: Removal of Compressed mode by puncturing | 6.5.0 | 6.6.0 | |
| | RP-28 | RP-050327 | 2598 | 2 | Alignment of EUDCH RRC Stage-3 to Stage-2 status, including handling of 2 E-RNTIs | 6.5.0 | 6.6.0 | |
| | RP-28 | RP-050336 | 2599 | | Radio link failure in F-DPCH | 6.5.0 | 6.6.0 | |
| | RP-28 | RP-050323 | 2600 | 1 | Setting up F-DPCH and E-DCH in RRC connection setup | 6.5.0 | 6.6.0 | |
| | RP-28 | RP-050316 | 2601 | 1 | Validity of PtM configurations | 6.5.0 | 6.6.0 | |
| | RP-28 | RP-050392 | 2602 | 1 | CCCH message enhancements | 6.5.0 | 6.6.0 | |
| | RP-28 | RP-050320 | 2604 | | Quality measurement corrections | 6.5.0 | 6.6.0 | |
| | RP-28 | RP-050328 | 2605 | | Clean-up of R6 ASN.1 leftovers | 6.5.0 | 6.6.0 | |
| | RP-28 | RP-050346 | 2607 | 2 | UE behaviour for DCH SIR target setting for Downlink power control | 6.5.0 | 6.6.0 | |
| | RP-28 | RP-050317 | 2608 | | RLC LI Optimization for VoIP | 6.5.0 | 6.6.0 | |
| | RP-28 | RP-050316 | 2609 | 2 | Introduction of an S-CCPCH power offset difference in order to improve cell selection for soft and selective combining | 6.5.0 | 6.6.0 | |
| | RP-28 | RP-050320 | 2610 | | Erroneous implementation of CR#2501 in RRC specification v6.5.0. | 6.5.0 | 6.6.0 | |
| | RP-28 | RP-050329 | 2611 | | Correction to network sharing | 6.5.0 | 6.6.0 | |
| | RP-28 | RP-050316 | 2613 | | MBMS asn1 issues | 6.5.0 | 6.6.0 | |
| | RP-28 | RP-050316 | 2614 | | SCCPCH timing offset information for FDD MBMS soft combining | 6.5.0 | 6.6.0 | |
| | RP-28 | RP-050316 | 2615 | | MBMS corrections on signalling optimization | 6.5.0 | 6.6.0 | |
| 09/2005 | RP-29 | RP-050486 | 2616 | | Support of Domain Specific Access control in Rel-5 Ues | 6.6.0 | 6.7.0 | |
| | RP-29 | RP-050465 | 2619 | | ASN1 update for InterRATReportingQuantity | 6.6.0 | 6.7.0 | |
| | RP-29 | RP-050465 | 2621 | 1 | IE 'RB information to reconfigure' for RADIO BEARER RECONFIGURATION message | 6.6.0 | 6.7.0 | |
| | RP-29 | RP-050465 | 2623 | | Size of TFC Subset List for Transport Format Combination Control | 6.6.0 | 6.7.0 | |
| | RP-29 | RP-050465 | 2626 | | RB mapping rules | 6.6.0 | 6.7.0 | |
| | RP-29 | RP-050587 | 2628 | 3 | Rules for triggering hard handover | 6.6.0 | 6.7.0 | |
| | RP-29 | RP-050465 | 2630 | | RSCP value range extension | 6.6.0 | 6.7.0 | |
| | RP-29 | RP-050465 | 2632 | | H-RNTI validity | 6.6.0 | 6.7.0 | |
| | RP-29 | RP-050482 | 2633 | | Removal RLC-SDU alignment capability | 6.6.0 | 6.7.0 | |
| | RP-29 | RP-050458 | 2635 | | Feature Clean Up: Removal of DRAC | 6.6.0 | 6.7.0 | |
| | RP-29 | RP-050458 | 2637 | | DRAC & Dedicated pilots removal leftovers (asn1) | 6.6.0 | 6.7.0 | |
| | RP-29 | RP-050458 | 2639 | | DRAC & CPCH removal leftovers (sib8,9,10) | 6.6.0 | 6.7.0 | |

| Change history | | | | | | | |
|----------------|-------|-----------|------|-----|--|-------|-------|
| Date | TSG # | TSG Doc. | CR | Rev | Subject/Comment | Old | New |
| | RP-29 | RP-050458 | 2641 | 1 | Feature remove (Tabular/asn1 alignment) | 6.6.0 | 6.7.0 |
| | RP-29 | RP-050482 | 2642 | | Correction to UE L3 requirements for HS-DSCH mobility | 6.6.0 | 6.7.0 |
| | RP-29 | RP-050482 | 2643 | | Rate Control Correction | 6.6.0 | 6.7.0 |
| | RP-29 | RP-050482 | 2644 | | Introduction of container to facilitate transparent transfer of UE capabilities | 6.6.0 | 6.7.0 |
| | RP-29 | RP-050482 | 2645 | | Minor ASN.1 correction for TDD IEs Beacon PL Est and DHS-Sync | 6.6.0 | 6.7.0 |
| | RP-29 | RP-050482 | 2646 | | Addition of ongoing reconfiguration indicator in cell update | 6.6.0 | 6.7.0 |
| | RP-29 | RP-050482 | 2648 | | Faster L1 DCH synchronization | 6.6.0 | 6.7.0 |
| | RP-29 | RP-050482 | 2649 | | Direct transition to DCH | 6.6.0 | 6.7.0 |
| | RP-29 | RP-050482 | 2650 | | PSI messages in CELL CHANGE ORDER FROM UTRAN | 6.6.0 | 6.7.0 |
| | RP-29 | RP-050482 | 2651 | | SRNS relocation info | 6.6.0 | 6.7.0 |
| | RP-29 | RP-050482 | 2652 | | Correction to UE-assisted OTDOA support | 6.6.0 | 6.7.0 |
| | RP-29 | RP-050482 | 2653 | | Correction to undefined UE behaviour in case of Cell-ID positioning with method type UE-based | 6.6.0 | 6.7.0 |
| | RP-29 | RP-050482 | 2654 | | Receiving "Frequency info" IE in CELL UPDATE CONFIRM message | 6.6.0 | 6.7.0 |
| | RP-29 | RP-050483 | 2655 | | Re-entry in service in CELL_PCH before T316 expiry | 6.6.0 | 6.7.0 |
| | RP-29 | RP-050483 | 2656 | | ASN.1 alignment to Rel-5 of InterRATCellInfoIndication | 6.6.0 | 6.7.0 |
| | RP-29 | RP-050483 | 2657 | | Addition of Inter-frequency measurements reporting on RACH reporting in the ASN.1 of RRC CONNECTION REQUEST and CELL UPDATE messages | 6.6.0 | 6.7.0 |
| | RP-29 | RP-050483 | 2658 | | Correction to the Amount of Reporting | 6.6.0 | 6.7.0 |
| | RP-29 | RP-050483 | 2659 | | Minor correction of HS-DSCH/ E-DCH capability indication | 6.6.0 | 6.7.0 |
| | RP-29 | RP-050476 | 2660 | | Modification of TPC command error rate granularity and range | 6.6.0 | 6.7.0 |
| | RP-29 | RP-050473 | 2661 | 1 | Introduction of PS handover between UTRAN and GERAN | 6.6.0 | 6.7.0 |
| | RP-29 | RP-050483 | 2662 | | Including HS-DPCCH power offset and HARQ preamble mode in active set update | 6.6.0 | 6.7.0 |
| | RP-29 | RP-050468 | 2663 | | Minor MBMS corrections (set IV) | 6.6.0 | 6.7.0 |
| | RP-29 | RP-050468 | 2664 | | Clarification on MBMS modified services information IE | 6.6.0 | 6.7.0 |
| | RP-29 | RP-050468 | 2665 | | MBMS correction for recounting | 6.6.0 | 6.7.0 |
| | RP-29 | RP-050468 | 2666 | 1 | MBMS asn1 issues | 6.6.0 | 6.7.0 |
| | RP-29 | RP-050471 | 2667 | | E-DCH corrections and additions | 6.6.0 | 6.7.0 |
| | RP-29 | RP-050471 | 2668 | | E-DCH corrections | 6.6.0 | 6.7.0 |
| | RP-29 | RP-050472 | 2669 | 4 | E-DCH additions to active set update | 6.6.0 | 6.7.0 |
| | RP-29 | RP-050471 | 2670 | 1 | UE capabilities for E-DCH in 25.331 | 6.6.0 | 6.7.0 |
| | RP-29 | RP-050468 | 2671 | | Conditional suspension of CELL_FACH measurements to enable reception of MCCH | 6.6.0 | 6.7.0 |
| | RP-29 | RP-050468 | 2672 | | MBMS message order on MCCH | 6.6.0 | 6.7.0 |
| | RP-29 | RP-050468 | 2673 | | MSCH configuration information in case of soft combining Timing Offset | 6.6.0 | 6.7.0 |
| | RP-29 | RP-050469 | 2674 | 1 | Removal of fixed position for S-CCPCHs carrying MBMS channels | 6.6.0 | 6.7.0 |
| | RP-29 | RP-050467 | 2675 | | Introduction of Band VII | 6.6.0 | 6.7.0 |
| | RP-29 | RP-050483 | 2676 | | Introducing pre- configuration upon radio bearer establishment | 6.6.0 | 6.7.0 |
| | RP-29 | RP-050484 | 2677 | 1 | Introduction of the device type indication in UE capability | 6.6.0 | 6.7.0 |
| | RP-29 | RP-050471 | 2680 | | E-DCH TTI Reconfiguration | 6.6.0 | 6.7.0 |
| | RP-29 | RP-050483 | 2681 | | Maximum number of reference ETFCI's | 6.6.0 | 6.7.0 |
| | RP-29 | RP-050561 | 2682 | | F-DPCH power control | 6.6.0 | 6.7.0 |
| 12/2005 | RP-30 | RP-050801 | 2617 | 2 | Introduction of UMTS1700 | 6.7.0 | 6.8.0 |
| | RP-30 | RP-050787 | 2683 | 4 | Introduction of the HSDPA and E-DCH Capable Cell Indicator | 6.7.0 | 6.8.0 |
| | RP-30 | RP-050785 | 2685 | 1 | PRACH for CCCH in SIB 6 | 6.7.0 | 6.8.0 |
| | RP-30 | RP-050796 | 2686 | 1 | Tx/Rx frequency separation capability (FDD) | 6.7.0 | 6.8.0 |
| | RP-30 | RP-050827 | 2687 | 1 | E-DCH mobility corrections and multi-step handling for E-RGCH | 6.7.0 | 6.8.0 |
| | RP-30 | RP-050797 | 2688 | 1 | L1 synchronisation at HHO | 6.7.0 | 6.8.0 |
| | RP-30 | RP-050786 | 2690 | | Correction to UE positioning measurements in CELL_PCH/URA_PCH state | 6.7.0 | 6.8.0 |
| | RP-30 | RP-050785 | 2692 | | Clarification of Delta in Inter/Intra-frequency measurement reporting criteria | 6.7.0 | 6.8.0 |
| | RP-30 | RP-050785 | 2694 | | Clarification of the usage of "Ack-Nack Power Offset" in HSDPA for TDD | 6.7.0 | 6.8.0 |

| Change history | | | | | | | | |
|----------------|-------|-----------|------|-----|---|-------|-------|--|
| Date | TSG # | TSG Doc. | CR | Rev | Subject/Comment | Old | New | |
| | RP-30 | RP-050785 | 2696 | | Modification of WB-AMR default configuration | 6.7.0 | 6.8.0 | |
| | RP-30 | RP-050785 | 2698 | | Serving E-DCH radio link indication | 6.7.0 | 6.8.0 | |
| | RP-30 | RP-050800 | 2699 | | Introduction of UMTS 900 (Band VIII) | 6.7.0 | 6.8.0 | |
| | RP-30 | RP-050788 | 2700 | | MCCH configuration information | 6.7.0 | 6.8.0 | |
| | RP-30 | RP-050788 | 2701 | | Correction of default TFCS for MBMS | 6.7.0 | 6.8.0 | |
| | RP-30 | RP-050797 | 2702 | | Unidirectional RLC reconfiguration | 6.7.0 | 6.8.0 | |
| | RP-30 | RP-050793 | 2703 | 1 | Misalignments for E-DCH | 6.7.0 | 6.8.0 | |
| | RP-30 | RP-050793 | 2704 | | Update for E-DCH Serving Grant IE value range | 6.7.0 | 6.8.0 | |
| | RP-30 | RP-050793 | 2705 | | Clarification on MAC-d flow multiplexing list | 6.7.0 | 6.8.0 | |
| | RP-30 | RP-050793 | 2706 | | Addition of E-DCH power offsets to active set update | 6.7.0 | 6.8.0 | |
| | RP-30 | RP-050793 | 2707 | | E-RNTI validity | 6.7.0 | 6.8.0 | |
| | RP-30 | RP-050793 | 2708 | | Clarification of bit strings for EUL | 6.7.0 | 6.8.0 | |
| | RP-30 | RP-050793 | 2709 | 1 | Modification of SI periodicity | 6.7.0 | 6.8.0 | |
| | RP-30 | RP-050793 | 2710 | | E-DCH PO signalling | 6.7.0 | 6.8.0 | |
| | RP-30 | RP-050793 | 2711 | 1 | MAC es/e reset indicator | 6.7.0 | 6.8.0 | |
| | RP-30 | RP-050788 | 2714 | 1 | MBMS corrections on default TFCS, service identity and PL Service Information | 6.7.0 | 6.8.0 | |
| | RP-30 | RP-050831 | 2717 | 1 | Corrections of inconsistencies in Rel-6 RRC messages (ASN.1 review) | 6.7.0 | 6.8.0 | |
| | RP-30 | RP-050861 | 2718 | 1 | Introduction of Support of Handover to GAN | 6.7.0 | 6.8.0 | |
| 03/2006 | RP-31 | RP-060087 | 2716 | 5 | E-DCH Measurement Event 1J | 6.8.0 | 6.9.0 | |
| | RP-31 | RP-060083 | 2720 | - | Default configuration 11 for multirate AMR with SRB5 | 6.8.0 | 6.9.0 | |
| | RP-31 | RP-060081 | 2722 | 1 | Addition of synchronization parameters in RRC for HS-SICH in 1.28Mcps TDD | 6.8.0 | 6.9.0 | |
| | RP-31 | RP-060091 | 2723 | - | Integrity Protection check for NAS messages | 6.8.0 | 6.9.0 | |
| | RP-31 | RP-060087 | 2724 | - | E-DCH radio link addition using ASU of RL already in DCH active set | 6.8.0 | 6.9.0 | |
| | RP-31 | RP-060087 | 2725 | - | Addition of SF128 and SF256 in E-DCH maximum channelisation codes | 6.8.0 | 6.9.0 | |
| | RP-31 | RP-060087 | 2726 | 2 | RRC signaling efficiency changes for E-DCH | 6.8.0 | 6.9.0 | |
| | RP-31 | RP-060087 | 2727 | - | E-DCH HARQ Info signalling | 6.8.0 | 6.9.0 | |
| | RP-31 | RP-060087 | 2728 | - | Secondary Scrambling Code in F-DPCH RL information | 6.8.0 | 6.9.0 | |
| | RP-31 | RP-060087 | 2729 | - | Correction to E-DCH IEs | 6.8.0 | 6.9.0 | |
| | RP-31 | RP-060087 | 2730 | - | Non-scheduled grant | 6.8.0 | 6.9.0 | |
| | RP-31 | RP-060087 | 2731 | - | IE handling for E-DCH | 6.8.0 | 6.9.0 | |
| | RP-31 | RP-060087 | 2732 | - | E-RNTI handling in Active Set Update procedure | 6.8.0 | 6.9.0 | |
| | RP-31 | RP-060087 | 2733 | - | Editorial correction on 'E-DCH information' | 6.8.0 | 6.9.0 | |
| | RP-31 | RP-060120 | 2734 | 1 | Corrections of inconsistencies in Rel-6 RRC messages (ASN.1 review) | 6.8.0 | 6.9.0 | |
| | RP-31 | RP-060091 | 2735 | - | Correction to Modifying Integrity Protection Configuration for TM SRB | 6.8.0 | 6.9.0 | |
| | RP-31 | RP-060091 | 2736 | - | Correction to Security Mode Control Procedure | 6.8.0 | 6.9.0 | |
| | RP-31 | RP-060091 | 2737 | - | Resolving problems from CR implementation | 6.8.0 | 6.9.0 | |
| | RP-31 | RP-060093 | 2738 | - | Removal of GPRS encryption algorithm info | 6.8.0 | 6.9.0 | |
| | RP-31 | RP-060092 | 2739 | 1 | Default configurations for Multi-mode AMR | 6.8.0 | 6.9.0 | |
| | RP-31 | RP-060091 | 2740 | - | Periodic URA Update in OOS | 6.8.0 | 6.9.0 | |
| | RP-31 | RP-060091 | 2741 | - | Correction in IE UE positioning capability | 6.8.0 | 6.9.0 | |
| | RP-31 | RP-060091 | 2742 | - | F-DPCH, HSDPA and E-DCH in HANDOVER TO UTRAN COMMAND (Rel-6 ASN.1 review issue 013) | 6.8.0 | 6.9.0 | |
| | RP-31 | RP-060091 | 2743 | - | Representation of IE "latestConfiguredCN-Domain" in the r3 branch of SRNS Relocation Info | 6.8.0 | 6.9.0 | |
| | RP-31 | RP-060083 | 2746 | 1 | 7.95kbps NB AMR Default Configuration removal | 6.8.0 | 6.9.0 | |
| | RP-31 | RP-060091 | 2747 | - | Periodic BMC Schedule Message | 6.8.0 | 6.9.0 | |
| | RP-31 | RP-060092 | 2748 | 1 | Introduction of additional Default configuration identities | 6.8.0 | 6.9.0 | |
| | RP-31 | RP-060095 | 2749 | 1 | PS default configurations | 6.8.0 | 6.9.0 | |
| | RP-31 | RP-060091 | 2751 | - | Configuration of DL TFCS as 'Same as UL' | 6.8.0 | 6.9.0 | |
| | RP-31 | RP-060091 | 2752 | - | NAS synchronization indicator in RB setup | 6.8.0 | 6.9.0 | |
| | RP-31 | RP-060088 | 2753 | - | General error handling in case of ASN.1 violation and for MBMS channels | 6.8.0 | 6.9.0 | |
| | RP-31 | RP-060091 | 2754 | - | Clarification of UE action upon receiving the IE RB information to | 6.8.0 | 6.9.0 | |

| Change history | | | | | | | | |
|----------------|-------|-----------|------|-----|---|-------|-------|--|
| Date | TSG # | TSG Doc. | CR | Rev | Subject/Comment | Old | New | |
| | | | | | change list | | | |
| | RP-31 | RP-060091 | 2755 | - | Removal of unnecessary checking for HS-DSCH and E-DCH configuration | 6.8.0 | 6.9.0 | |
| | RP-31 | RP-060091 | 2756 | - | Introduction of WB-AMR default configuration without SRB#5 | 6.8.0 | 6.9.0 | |
| | RP-31 | RP-060091 | 2757 | - | Initial DPCH frame offset for F-DPCH | 6.8.0 | 6.9.0 | |
| | RP-31 | RP-060086 | 2760 | 1 | Support for different E-DCH and HS-DSCH serving cells | 6.8.0 | 6.9.0 | |
| | RP-31 | RP-060088 | 2761 | - | Correction to S-CCPCH power offset for MBMS | 6.8.0 | 6.9.0 | |
| | RP-31 | RP-060093 | 2764 | - | Inter-RAT PS Handover capability | 6.8.0 | 6.9.0 | |
| | RP-31 | RP-060095 | 2765 | - | Indication of HSPA capability and conversation call type for CS | 6.8.0 | 6.9.0 | |
| | RP-31 | RP-060097 | 2713 | 3 | Enabling the Providing of Velocity | 6.9.0 | 7.0.0 | |
| | RP-31 | RP-060096 | 2758 | | Release 7 HS-DSCH operation without a DL DPCH for 1.28 Mcps TDD – synchronisation and power control of UL DPCH via PLCCCH | 6.9.0 | 7.0.0 | |
| | RP-31 | RP-060098 | 2759 | | 7.68 Mcps TDD Option (Release 7) | 6.9.0 | 7.0.0 | |
| | RP-31 | RP-060099 | 2762 | | Introduction of REL-7 access stratum release indicator | 6.9.0 | 7.0.0 | |
| 06/2006 | RP-32 | RP-060374 | 2769 | 1 | RoHC Segmentation, padding and Packet_sizes_allowed parameter removal | 7.0.0 | 7.1.0 | |
| | RP-32 | RP-060360 | 2772 | 1 | Corrections of procedures dealing with 'Serving HS-DSCH radio link indicator' and 'Serving E-DCH radio link indicator' | 7.0.0 | 7.1.0 | |
| | RP-32 | RP-060361 | 2774 | 1 | MAC-HS handling for "return in case of failure" | 7.0.0 | 7.1.0 | |
| | RP-32 | RP-060383 | 2776 | 1 | 'RB' terminology in security procedures | 7.0.0 | 7.1.0 | |
| | RP-32 | RP-060368 | 2778 | - | Clarification on IE 'MBMS re-acquire MCCH' | 7.0.0 | 7.1.0 | |
| | RP-32 | RP-060368 | 2780 | - | Clarification on MCCH Acquisition Initiation | 7.0.0 | 7.1.0 | |
| | RP-32 | RP-060368 | 2782 | - | Clarification of encoding of TB size for FDD common transport channels | 7.0.0 | 7.1.0 | |
| | RP-32 | RP-060368 | 2784 | - | HCS parameters for MBMS cell reselection | 7.0.0 | 7.1.0 | |
| | RP-32 | RP-060354 | 2786 | - | Clarification on MAC-e/es reset | 7.0.0 | 7.1.0 | |
| | RP-32 | RP-060361 | 2788 | - | Modification to the 'BLER target' configuration method in RRC spec for 3.84Mcps TDD | 7.0.0 | 7.1.0 | |
| | RP-32 | RP-060361 | 2790 | - | Add some IEs regarding HS-SICH power control parameter updating in UPLINK PHYSICAL CHANNEL CONTROL message in 1.28Mcps TDD mode | 7.0.0 | 7.1.0 | |
| | RP-32 | RP-060364 | 2792 | - | Corrections on Inter-RAT cell info indication | 7.0.0 | 7.1.0 | |
| | RP-32 | RP-060364 | 2794 | - | Clarifications regarding virtual active set | 7.0.0 | 7.1.0 | |
| | RP-32 | RP-060358 | 2796 | - | PS Handover Capability | 7.0.0 | 7.1.0 | |
| | RP-32 | RP-060364 | 2798 | - | Handling of System Information Block type 5bis. | 7.0.0 | 7.1.0 | |
| | RP-32 | RP-060364 | 2800 | - | Introducing container for Measurement Report informaton within SRNS relocation | 7.0.0 | 7.1.0 | |
| | RP-32 | RP-060364 | 2802 | - | Removal of GSM OTD reference cell | 7.0.0 | 7.1.0 | |
| | RP-32 | RP-060364 | 2804 | - | Error handling of 'dummy' IEs introduced in ASN.1 by recent feature removal | 7.0.0 | 7.1.0 | |
| | RP-32 | RP-060365 | 2806 | - | START value in Cell Update | 7.0.0 | 7.1.0 | |
| | RP-32 | RP-060365 | 2808 | - | Default configurations 10 and 13 | 7.0.0 | 7.1.0 | |
| | RP-32 | RP-060365 | 2810 | - | Inter-frequency measurement reporting on RACH | 7.0.0 | 7.1.0 | |
| | RP-32 | RP-060365 | 2812 | - | Radio bearer mapping for SRBs | 7.0.0 | 7.1.0 | |
| | RP-32 | RP-060365 | 2814 | - | Correction to RLC default configuration | 7.0.0 | 7.1.0 | |
| | RP-32 | RP-060366 | 2816 | - | New standalone SRB default configuration | 7.0.0 | 7.1.0 | |
| | RP-32 | RP-060366 | 2818 | - | Introduction of default configurations with "flexible TFCS" | 7.0.0 | 7.1.0 | |
| | RP-32 | RP-060366 | 2820 | - | Small IE corrections: "RB information to change list", "Access Class Barred" | 7.0.0 | 7.1.0 | |
| | RP-32 | RP-060366 | 2822 | - | Correction to IE Default Configuration Identity | 7.0.0 | 7.1.0 | |
| | RP-32 | RP-060366 | 2824 | - | Correction to TFC subset for default configurations 11&12 | 7.0.0 | 7.1.0 | |
| | RP-32 | RP-060366 | 2826 | - | HSDPA/E-DCH info in INTER RAT HANDOVER INFO WITH INTER RAT CAPABILITIES | 7.0.0 | 7.1.0 | |
| | RP-32 | RP-060373 | 2827 | 1 | Adding CS Call Type to Cell Update Message | 7.0.0 | 7.1.0 | |
| | RP-32 | RP-060359 | 2829 | - | Correct indication of Rel-7 tabular entries | 7.0.0 | 7.1.0 | |
| | RP-32 | RP-060359 | 2830 | - | Corrections to REL-7 ASN.1 | 7.0.0 | 7.1.0 | |
| | RP-32 | RP-060362 | 2831 | - | Measurement control ASN.1 error | 7.0.0 | 7.1.0 | |
| | RP-32 | RP-060368 | 2833 | - | Clarification on MBMS Radio Bearer Release | 7.0.0 | 7.1.0 | |
| | RP-32 | RP-060354 | 2835 | - | Correction on E-DCH DL Scrambling Code | 7.0.0 | 7.1.0 | |
| | RP-32 | RP-060366 | 2837 | - | Reinstatement of missing IE "Periodical reporting information-1b" in ASN.1 | 7.0.0 | 7.1.0 | |
| | RP-32 | RP-060366 | 2839 | - | SRB2 suspension | 7.0.0 | 7.1.0 | |

| Change history | | | | | | | |
|----------------|-------|-----------|------|-----|---|-------|-------|
| Date | TSG # | TSG Doc. | CR | Rev | Subject/Comment | Old | New |
| | RP-32 | RP-060369 | 2842 | - | Release 7 Timing Advance (3.84 Mcps and 7.68 Mcps TDD) | 7.0.0 | 7.1.0 |
| | RP-32 | RP-060369 | 2843 | - | Introduction of REL-7 access stratum release indicator | 7.0.0 | 7.1.0 |
| | RP-32 | RP-060369 | 2844 | - | Positioning velocity ASN.1 | 7.0.0 | 7.1.0 |
| | RP-32 | RP-060386 | 2845 | 1 | Correction of positioning confidence reporting inconsistencies | 7.0.0 | 7.1.0 |
| 09/2006 | RP-33 | RP-060573 | 2848 | - | Removal of CID indication in PDCP PID | 7.1.0 | 7.2.0 |
| | RP-33 | RP-060574 | 2852 | - | Correction to the tabulars for Serving Grant value | 7.1.0 | 7.2.0 |
| | RP-33 | RP-060575 | 2854 | - | Range of the encoding of E-DCH physical layer category and HS-DSCH physical layer category | 7.1.0 | 7.2.0 |
| | RP-33 | RP-060574 | 2856 | - | 3-index step 2-index step clarifications | 7.1.0 | 7.2.0 |
| | RP-33 | RP-060597 | 2858 | 2 | Introduction of SIB 11bis | 7.1.0 | 7.2.0 |
| | RP-33 | RP-060581 | 2859 | - | Power class for UMTS2600 (VII) internal / 900 (VIII) | 7.1.0 | 7.2.0 |
| | RP-33 | RP-060576 | 2861 | - | Corrections to MBMS Downlink Timeslots and Codes for TDD | 7.1.0 | 7.2.0 |
| | RP-33 | RP-060576 | 2865 | - | Clarification on MBMS notification for UEs in CELL_DCH state | 7.1.0 | 7.2.0 |
| | RP-33 | RP-060576 | 2867 | - | Clarification on MBMS p-t-m activation time IE | 7.1.0 | 7.2.0 |
| | RP-33 | RP-060576 | 2869 | - | Access probability factor | 7.1.0 | 7.2.0 |
| | RP-33 | RP-060575 | 2871 | - | Modification to the HS-SCCH set configuration method in RRC spec for 1.28Mcps TDD | 7.1.0 | 7.2.0 |
| | RP-33 | RP-060575 | 2873 | - | Correction to tabular for IE 'Delay restriction Flag' | 7.1.0 | 7.2.0 |
| | RP-33 | RP-060575 | 2877 | - | Correction on 3G-2G Handover | 7.1.0 | 7.2.0 |
| | RP-33 | RP-060575 | 2879 | - | Pending security configuration for SRB2 | 7.1.0 | 7.2.0 |
| | RP-33 | RP-060593 | 2881 | - | UE radio access capability for Single-band UE | 7.1.0 | 7.2.0 |
| | RP-33 | RP-060593 | 2883 | - | Inter-RAT handover to UTRAN (HSPA) | 7.1.0 | 7.2.0 |
| | RP-33 | RP-060593 | 2885 | - | Tabular & reference corrections | 7.1.0 | 7.2.0 |
| | RP-33 | RP-060593 | 2887 | - | F-DPCH Tx Diversity | 7.1.0 | 7.2.0 |
| | RP-33 | RP-060593 | 2889 | 1 | Expiration of RRC timer T314/T315 associated to CS/PS RABs | 7.1.0 | 7.2.0 |
| | RP-33 | RP-060583 | 2892 | - | Clarification on Exceeding Variance in Traffic Volume Measurement | 7.1.0 | 7.2.0 |
| | RP-33 | RP-060573 | 2897 | 1 | Use of CM_PATTERN_ACTIVATION_ABORTED | 7.1.0 | 7.2.0 |
| | RP-33 | RP-060573 | 2900 | 1 | Corrections of procedures dealing with Hard Handover | 7.1.0 | 7.2.0 |
| | RP-33 | RP-060585 | 2901 | - | Correction to spreading factors used for 7.68 Mcps TDD PRACH | 7.1.0 | 7.2.0 |
| | RP-33 | RP-060583 | 2902 | - | Corrections to ASN.1 (3.84 Mcps and 7.68 Mcps TDD) | 7.1.0 | 7.2.0 |
| | RP-33 | RP-060586 | 2903 | - | Introduction of 3.84 Mcps and 7.68 Mcps TDD E-DCH | 7.1.0 | 7.2.0 |
| | RP-33 | RP-060582 | 2904 | - | Support of 2570 – 2620 MHz band for TDD | 7.1.0 | 7.2.0 |
| | RP-33 | RP-060593 | 2907 | - | ASN1 correction on Inter-frequency RACH measurement reporting, backward compatible solution | 7.1.0 | 7.2.0 |
| | RP-33 | RP-060584 | 2908 | - | CS Call type indication in CELL_FACH | 7.1.0 | 7.2.0 |
| | RP-33 | RP-060584 | 2910 | 1 | UE behaviour in RRC Connection Re-establishment scenarios | 7.1.0 | 7.2.0 |
| | RP-33 | RP-060624 | 2911 | 2 | Enhancing MBMS support for Mobile TV | 7.1.0 | 7.2.0 |
| | RP-33 | RP-060574 | 2913 | - | E-DCH gain factor computation | 7.1.0 | 7.2.0 |
| | RP-33 | RP-060593 | 2915 | - | Correction to default configuration #22 | 7.1.0 | 7.2.0 |
| | RP-33 | RP-060622 | 2917 | - | Correction to coding of PLCCCH for 1.28Mcps TDD | 7.1.0 | 7.2.0 |
| | RP-33 | RP-060578 | 2919 | - | MAC-hs reset | 7.1.0 | 7.2.0 |
| 12/2006 | RP-34 | RP-060722 | 2916 | 2 | UE based OTDOA positioning in WCDMA cells with extended range | 7.2.0 | 7.3.0 |
| | RP-34 | RP-060717 | 2922 | 1 | Correction on acceptable configurations for compression entities | 7.2.0 | 7.3.0 |
| | RP-34 | RP-060715 | 2923 | - | Introduction of Band X (Extended UMTS 1.7/2.1 GHz) in 25.331 | 7.2.0 | 7.3.0 |
| | RP-34 | RP-060716 | 2925 | - | Grant and MAC-e/es headers for E-DCH and References | 7.2.0 | 7.3.0 |
| | RP-34 | RP-060804 | 2927 | 2 | Correction to E-DCH reconfiguration | 7.2.0 | 7.3.0 |
| | RP-34 | RP-060718 | 2931 | - | Removal of MSCH configuration information from S-CCPCH system information | 7.2.0 | 7.3.0 |
| | RP-34 | RP-060718 | 2933 | - | Correction relating to the formation of a list of services | 7.2.0 | 7.3.0 |
| | RP-34 | RP-060718 | 2935 | - | Indentation error in handling MBMS establishment cause values | 7.2.0 | 7.3.0 |
| | RP-34 | RP-060718 | 2936 | - | MSCH configuration information | 7.2.0 | 7.3.0 |
| | RP-34 | RP-060719 | 2938 | - | Tabular/ASN.1 mismatch for IE "UE radio access capability comp 2" | 7.2.0 | 7.3.0 |
| | RP-34 | RP-060716 | 2940 | - | Correction to Radio Bearer Mapping for UE in CELL_DCH state | 7.2.0 | 7.3.0 |
| | RP-34 | RP-060726 | 2941 | 1 | State transition diagram from URA_PCH/Cell_PCH to idle | 7.2.0 | 7.3.0 |
| | RP-34 | RP-060719 | 2943 | - | Usage of Band Indicator in Inter-RAT cell info list | 7.2.0 | 7.3.0 |
| | RP-34 | RP-060716 | 2945 | - | Correction for support of HS-DSCH in RRC Connection Setup | 7.2.0 | 7.3.0 |
| | RP-34 | RP-060720 | 2947 | - | Corrections related to 3.84 and 7.68 Mcps TDD E-DCH and the support of TDD at 2.6 GHz | 7.2.0 | 7.3.0 |
| | RP-34 | RP-060712 | 2948 | 1 | Introduction of the UE speed information at the CELL_DCH transition | 7.2.0 | 7.3.0 |

| Change history | | | | | | | |
|----------------|-------|-----------|------|-----|--|-------|-------|
| Date | TSG # | TSG Doc. | CR | Rev | Subject/Comment | Old | New |
| | RP-34 | RP-060713 | 2949 | 2 | Introduction of the new security algorithms UEA2 and UIA2. | 7.2.0 | 7.3.0 |
| | RP-34 | RP-060718 | 2951 | - | RAB ID for mobile TV | 7.2.0 | 7.3.0 |
| | RP-34 | RP-060718 | 2953 | - | MBMS PL Service Restriction Information and preferred frequency layer | 7.2.0 | 7.3.0 |
| | RP-34 | RP-060724 | 2954 | 2 | Introduction of inter-RAT DTM Handover | 7.2.0 | 7.3.0 |
| | RP-34 | RP-060718 | 2956 | - | MBMS short transmission ID and Mobile TV | 7.2.0 | 7.3.0 |
| 03/2007 | RP-35 | RP-070159 | 2957 | 2 | Deferred SIB11/12 reading and acting | 7.3.0 | 7.4.0 |
| | RP-35 | RP-070159 | 2958 | - | UE Positioning Fine Time Assistance for GPS | 7.3.0 | 7.4.0 |
| | RP-35 | RP-070159 | 2959 | - | Correction of "Threshold SFN-GPS TOW" | 7.3.0 | 7.4.0 |
| | RP-35 | RP-070159 | 2960 | 1 | Correction to standalone UE positioning | 7.3.0 | 7.4.0 |
| | RP-35 | RP-070159 | 2961 | - | Clarification on introduction of the new security algorithms | 7.3.0 | 7.4.0 |
| | RP-35 | RP-070159 | 2962 | - | Change to area scope of SIB1 value tag | 7.3.0 | 7.4.0 |
| | RP-35 | RP-070159 | 2963 | - | Correction of the tabular description of the IE Downlink information for each radio link Post | 7.3.0 | 7.4.0 |
| | RP-35 | RP-070159 | 2964 | - | Removal of redundant ASN1 element DL-CCTrChTPCList | 7.3.0 | 7.4.0 |
| | RP-35 | RP-070151 | 2966 | - | Correction of MBMS MODIFICATION REQUEST | 7.3.0 | 7.4.0 |
| | RP-35 | RP-070151 | 2968 | - | Wording of MBMS PL Service Restriction Information and preferred frequency layer | 7.3.0 | 7.4.0 |
| | RP-35 | RP-070151 | 2970 | - | maxMBMS-Services definition | 7.3.0 | 7.4.0 |
| | RP-35 | RP-070151 | 2972 | 1 | MBMS selected services indication | 7.3.0 | 7.4.0 |
| | RP-35 | RP-070151 | 2973 | 1 | Correction of RAB release procedure for Mobile TV | 7.3.0 | 7.4.0 |
| | RP-35 | RP-070153 | 2975 | - | Tabular Alignment for Uplink DPCH Info | 7.3.0 | 7.4.0 |
| | RP-35 | RP-070151 | 2977 | 1 | Update the IE 'RAB information to reconfigure' for Mobile TV | 7.3.0 | 7.4.0 |
| | RP-35 | RP-070154 | 2979 | - | Absence of MS Classmark 2 and 3 in IE "Inter-RAT UE radio access capability" | 7.3.0 | 7.4.0 |
| | RP-35 | RP-070153 | 2981 | - | Handling of TFCS with no DCH configured | 7.3.0 | 7.4.0 |
| | RP-35 | RP-070163 | 2983 | 1 | Introducing 64QAM downlink support | 7.3.0 | 7.4.0 |
| | RP-35 | RP-070157 | 2984 | - | Introduction of 1.28 Mcps TDD E-DCH | 7.3.0 | 7.4.0 |
| | RP-35 | RP-070161 | 2985 | 1 | Introducing MIMO in RRC specification | 7.3.0 | 7.4.0 |
| | RP-35 | RP-070172 | 2986 | - | Alignment of Tabular with ASN.1 | 7.3.0 | 7.4.0 |
| | RP-35 | RP-070160 | 2987 | - | Corrections to Tabular for 3.84 and 7.68 McpsTDD E-DCH | 7.3.0 | 7.4.0 |
| | RP-35 | RP-070151 | 2989 | 1 | MICH reception for services scheduled with MSCH | 7.3.0 | 7.4.0 |
| | RP-35 | RP-070158 | 2990 | - | Introduction of DTX-DRX and HS-SCCH less in RRC | 7.3.0 | 7.4.0 |
| 06/2007 | RP-36 | RP-070402 | 2982 | 6 | Introducing 16QAM uplink support | 7.4.0 | 7.5.0 |
| | RP-36 | RP-070407 | 2992 | | Use of Integrity protection algorithm UIA/2: removal of a 'shall' in a note | 7.4.0 | 7.5.0 |
| | RP-36 | RP-070407 | 2993 | | RRC Cellid encoding alignment on RANAP | 7.4.0 | 7.5.0 |
| | RP-36 | RP-070407 | 2994 | | Signalling connection release at T314/315 expiry | 7.4.0 | 7.5.0 |
| | RP-36 | RP-070408 | 2995 | | Cell Update Confirm with RLC re-establish indicator | 7.4.0 | 7.5.0 |
| | RP-36 | RP-070408 | 2996 | | Correction of STTD Indicator for F-DPCH Tx Diversity | 7.4.0 | 7.5.0 |
| | RP-36 | RP-070395 | 2997 | | Introduction of GAN PS handover | 7.4.0 | 7.5.0 |
| | RP-36 | RP-070408 | 2998 | | Feature Clean Up leftover: Removal of DRAC leftover | 7.4.0 | 7.5.0 |
| | RP-36 | RP-070408 | 2999 | | Initialisation of CFN calculation for CELL_FACH | 7.4.0 | 7.5.0 |
| | RP-36 | RP-070408 | 3000 | | PLMN selection ping-pong control | 7.4.0 | 7.5.0 |
| | RP-36 | RP-070408 | 3001 | | Optimization of switching between MBMS broadcast TV channels transmitted on ptp bearers (MBMS for Mobile TV) | 7.4.0 | 7.5.0 |
| | RP-36 | RP-070408 | 3002 | | Alignment of tabular to ASN.1 for SIB11/SIB12 and event 1J | 7.4.0 | 7.5.0 |
| | RP-36 | RP-070403 | 3003 | 2 | Introduction of HS-DSCH reception in CELL_FACH, URA_PCH and CELL_PCH | 7.4.0 | 7.5.0 |
| | RP-36 | RP-070408 | 3004 | 1 | Introduction two DRX schemes in URA_PCH and CELL_PCH | 7.4.0 | 7.5.0 |
| | RP-36 | RP-070416 | 3008 | | Maintenance of PMM connection for MBMS PTP reception | 7.4.0 | 7.5.0 |
| | RP-36 | RP-070401 | 3010 | | Content of MSI message when sent on DCCH | 7.4.0 | 7.5.0 |
| | RP-36 | RP-070401 | 3012 | | Relative ordering of MBMS Selected Services when indicated to the network | 7.4.0 | 7.5.0 |
| | RP-36 | RP-070416 | 3013 | | Background scan during MBMS PTM reception | 7.4.0 | 7.5.0 |
| | RP-36 | RP-070401 | 3015 | | Default MBMS activation time and 'MBMS all unmodified p-t-m services' | 7.4.0 | 7.5.0 |
| | RP-36 | RP-070401 | 3017 | | Problem with the IE 'MBMS service identity' included in the IE 'RAB info' | 7.4.0 | 7.5.0 |
| | RP-36 | RP-070406 | 3019 | | Correction of SRB delay | 7.4.0 | 7.5.0 |
| | RP-36 | RP-070406 | 3021 | | Incorrect reference to 25.993 for default configuration 17 | 7.4.0 | 7.5.0 |
| | RP-36 | RP-070416 | 3022 | | Removal of redundant IE 'MBMS-PreferredFreqRequest-r6' | 7.4.0 | 7.5.0 |
| | RP-36 | RP-070406 | 3024 | | Correction to CTFC for default configuration 12 | 7.4.0 | 7.5.0 |

| Change history | | | | | | | |
|----------------|-------|-----------|------|-----|--|-------|-------|
| Date | TSG # | TSG Doc. | CR | Rev | Subject/Comment | Old | New |
| | RP-36 | RP-070404 | 3025 | 1 | Introduction of Improved L2 support for high data rates | 7.4.0 | 7.5.0 |
| | RP-36 | RP-070400 | 3026 | | MBMS TDD and FDD Physical Layer Improvements | 7.4.0 | 7.5.0 |
| | RP-36 | RP-070408 | 3027 | | Introduction of Wait time to Cell Update Confirm | 7.4.0 | 7.5.0 |
| | RP-36 | RP-070415 | 3028 | | Removing the limitation of SRNC identity size | 7.4.0 | 7.5.0 |
| | RP-36 | RP-070408 | 3029 | | Using special value of HE field to indicate end of an SDU for RLC AM | 7.4.0 | 7.5.0 |
| | RP-36 | RP-070408 | 3030 | 1 | T305 timer in RRC container at SRNS relocation | 7.4.0 | 7.5.0 |
| | RP-36 | RP-070408 | 3031 | | Support for signalling of F-DPCH slot formats | 7.4.0 | 7.5.0 |
| | RP-36 | RP-070398 | 3032 | 1 | A-GNSS in UTRAN (RRC) | 7.4.0 | 7.5.0 |
| | RP-36 | RP-070397 | 3034 | | Addition of E-DCH Scheduling Information Power Offset in TDD mode | 7.4.0 | 7.5.0 |
| | RP-36 | RP-070397 | 3035 | 1 | Corrections to tabular for non-scheduled transmission for LCR TDD | 7.4.0 | 7.5.0 |
| | RP-36 | RP-070397 | 3036 | | Introduction of PRACH configuration in messages triggering E-DCH serving cell change in LCR TDD mode | 7.4.0 | 7.5.0 |
| | RP-36 | RP-070417 | 3037 | | Correction to definition of maxNumE-AGCH for TDD | 7.4.0 | 7.5.0 |
| | RP-36 | RP-070394 | 3038 | | Correction to definition of Power Resource Related Information (TDD only) | 7.4.0 | 7.5.0 |
| | RP-36 | RP-070401 | 3039 | | MBMS Scheduling Information | 7.4.0 | 7.5.0 |
| | RP-36 | RP-070401 | 3040 | | MBMS Notification | 7.4.0 | 7.5.0 |
| | RP-36 | RP-070401 | 3041 | | Minor correction on text | 7.4.0 | 7.5.0 |
| | RP-36 | RP-070504 | 3043 | 2 | Indication for F-DPCH support status | 7.4.0 | 7.5.0 |
| 09/2007 | RP-37 | RP-070623 | 3047 | 1 | Correction to E-DCH STTD operation | 7.5.0 | 7.6.0 |
| | RP-37 | RP-070625 | 3048 | 1 | Requirement on MICH reading | 7.5.0 | 7.6.0 |
| | RP-37 | RP-070624 | 3050 | | START values in cell update before security is enabled | 7.5.0 | 7.6.0 |
| | RP-37 | RP-070671 | 3053 | 1 | Clarification on Enhanced CELL_FACH State | 7.5.0 | 7.6.0 |
| | RP-37 | RP-070671 | 3054 | | Correction of UTRAN MOBILITY INFORMATION extension | 7.5.0 | 7.6.0 |
| | RP-37 | RP-070626 | 3055 | 1 | Lossless reconfiguration between fixed and flexible RLC PDU size | 7.5.0 | 7.6.0 |
| | RP-37 | RP-070630 | 3056 | | Restriction on the number of MIMO processes | 7.5.0 | 7.6.0 |
| | RP-37 | RP-070670 | 3057 | | Correction on 16 QAM Category | 7.5.0 | 7.6.0 |
| | RP-37 | RP-070632 | 3058 | 1 | Correction to MBSFN TDM | 7.5.0 | 7.6.0 |
| | RP-37 | RP-070631 | 3059 | | Corrections to Tabular (alignment with ASN.1) | 7.5.0 | 7.6.0 |
| | RP-37 | RP-070631 | 3060 | | CR implementation issues 25.331 v7.4.0 (2007-03) | 7.5.0 | 7.6.0 |
| | RP-37 | RP-070636 | 3061 | | Incomplete exception description in UE-based OTDOA | 7.5.0 | 7.6.0 |
| | RP-37 | RP-070636 | 3062 | | Correction of inconsistency in 25.331 related to UE-sending of capabilities | 7.5.0 | 7.6.0 |
| | RP-37 | RP-070625 | 3064 | 1 | MBMS Counting completion in RRC | 7.5.0 | 7.6.0 |
| | RP-37 | RP-070625 | 3066 | 1 | MBMS ptp service change | 7.5.0 | 7.6.0 |
| | RP-37 | RP-070623 | 3068 | 1 | Clarification on logical channel multiplexing | 7.5.0 | 7.6.0 |
| | RP-37 | RP-070625 | 3072 | | Integrity Protection and MBMS: Correction to Procedural Text (alignment with ASN.1) | 7.5.0 | 7.6.0 |
| | RP-37 | RP-070625 | 3074 | | MBMS services naming | 7.5.0 | 7.6.0 |
| | RP-37 | RP-070671 | 3077 | | Removal of RRC padding on BCCH and PCCH carried on HS-DSCH | 7.5.0 | 7.6.0 |
| | RP-37 | RP-070671 | 3078 | | Periodic MAC-ehs reset | 7.5.0 | 7.6.0 |
| | RP-37 | RP-070671 | 3079 | | Correction to UE behavior to disable HS-DSCH operation when HS-DSCH reception is unavailable | 7.5.0 | 7.6.0 |
| | RP-37 | RP-070671 | 3080 | | Cell reselection issues during RRC connection establishment procedure | 7.5.0 | 7.6.0 |
| | RP-37 | RP-070671 | 3081 | | Additional cases of MAC-ehs reset for UEs operating in Enhanced CELL_FACH | 7.5.0 | 7.6.0 |
| | RP-37 | RP-070634 | 3082 | 2 | UE Capabilities for Rel-7, with 'improved L2' optional | 7.5.0 | 7.6.0 |
| | RP-37 | RP-070627 | 3083 | | Correction to CPC UL DTX for addition of a new cell in the active set. | 7.5.0 | 7.6.0 |
| | RP-37 | RP-070627 | 3084 | 1 | Handling of DPCH Slot Format 4 | 7.5.0 | 7.6.0 |
| | RP-37 | RP-070627 | 3085 | | Correction to the related IEs of DTX-DRX operation in RRC | 7.5.0 | 7.6.0 |
| | RP-37 | RP-070627 | 3086 | 1 | Restriction of HS-SCCH less operation and MIMO | 7.5.0 | 7.6.0 |
| | RP-37 | RP-070627 | 3087 | 1 | HS-SCCH less virtual IR buffer size | 7.5.0 | 7.6.0 |
| | RP-37 | RP-070629 | 3088 | | Timing Advance Corrections for 3.84/7.68 Mcps TDD E-DCH | 7.5.0 | 7.6.0 |
| | RP-37 | RP-070631 | 3089 | | 3.84/7.68 Mcps TDD EDCH Sending Scheduling Information Periodically | 7.5.0 | 7.6.0 |
| | RP-37 | RP-070670 | 3090 | | Correction on 64QAM and MIMO UE capability in RRC | 7.5.0 | 7.6.0 |
| | RP-37 | RP-070670 | 3092 | 1 | Starting and stopping operation in 16QAM mode | 7.5.0 | 7.6.0 |

| Change history | | | | | | | |
|----------------|-------|-----------|------|-----|---|-------|-------|
| Date | TSG # | TSG Doc. | CR | Rev | Subject/Comment | Old | New |
| | RP-37 | RP-070623 | 3093 | | The range of E-TFCL_ed,switch | 7.5.0 | 7.6.0 |
| | RP-37 | RP-070650 | 3094 | | Introduction of multi-frequency operation for LCR TDD | 7.5.0 | 7.6.0 |
| | RP-37 | RP-070624 | 3096 | | F-DPCH TPC error rate target | 7.5.0 | 7.6.0 |
| | RP-37 | RP-070624 | 3098 | | Correction to CTFC for default configuration 14 | 7.5.0 | 7.6.0 |
| | RP-37 | RP-070624 | 3100 | | Correction to default configuration 16 | 7.5.0 | 7.6.0 |
| | RP-37 | RP-070624 | 3102 | | Security correction on PS handover to UTRAN | 7.5.0 | 7.6.0 |
| | RP-37 | RP-070626 | 3103 | | IE Common RB mapping info | 7.5.0 | 7.6.0 |
| | RP-37 | RP-070626 | 3104 | | Common-MAC-ehs-ReorderingQueues | 7.5.0 | 7.6.0 |
| | RP-37 | RP-070627 | 3105 | 2 | Correction to CPC Parameters | 7.5.0 | 7.6.0 |
| | RP-37 | RP-070632 | 3107 | | Change Request for 25.331 ASN.1 for MBMS TDD and FDD Physical Layer Improvements | 7.5.0 | 7.6.0 |
| | RP-37 | RP-070628 | 3108 | | Update of GANSS elements improving GANSS ambiguity resolution | 7.5.0 | 7.6.0 |
| | RP-37 | RP-070636 | 3109 | | Corrections to DRX schemes in URA_PCH and CELL_PCH | 7.5.0 | 7.6.0 |
| | RP-37 | RP-070636 | 3112 | | Clarification on reconfiguration of T305 | 7.5.0 | 7.6.0 |
| | RP-37 | RP-070628 | 3113 | | Introduction of SIB type extension for SIB type 15.8 | 7.5.0 | 7.6.0 |
| | RP-37 | RP-070636 | 3114 | | Correction for configuration of RFC2507 header compression | 7.5.0 | 7.6.0 |
| | RP-37 | RP-070636 | 3115 | | Correction for CS call type | 7.5.0 | 7.6.0 |
| | RP-37 | RP-070636 | 3116 | | Add the frequency info to identify the neighbour cells when report the OTDOA measurement results | 7.5.0 | 7.6.0 |
| | RP-37 | RP-070624 | 3120 | | Corrections in the default radio configurations 11/12/13 | 7.5.0 | 7.6.0 |
| | RP-37 | RP-070624 | 3122 | | Miscellaneous corrections in the default radio configurations | 7.5.0 | 7.6.0 |
| | RP-37 | RP-070764 | 3123 | 1 | For the creation of RRC Rel-8 | 7.5.0 | 8.0.0 |
| | RP-37 | RP-070633 | 3069 | | Introduction of Band XI | 7.5.0 | 8.0.0 |
| 12/2007 | RP-38 | RP-071011 | 3126 | 2 | UE setting for the 'Extension indicator' in the frequency band IEs | 8.0.0 | 8.1.0 |
| | RP-38 | RP-070898 | 3133 | | Correction to Measurement Report Initiation Procedure with UEs in CELL_PCH | 8.0.0 | 8.1.0 |
| | RP-38 | RP-070899 | 3135 | | START value and reconfiguration from fixed to flexible | 8.0.0 | 8.1.0 |
| | RP-38 | RP-070900 | 3137 | | UE DTX capability in RRC Connection Request | 8.0.0 | 8.1.0 |
| | RP-38 | RP-070903 | 3141 | 1 | Introduction of an additional UE category for 1.28Mcps TDD E-DCH | 8.0.0 | 8.1.0 |
| | RP-38 | RP-070905 | 3143 | | UE Waiting during Cell Update Procedure | 8.0.0 | 8.1.0 |
| | RP-38 | RP-070905 | 3145 | 1 | Correction for radio bearer mapping for FDD | 8.0.0 | 8.1.0 |
| | RP-38 | RP-070903 | 3147 | | Add E-RUCCH SYNC-UL info for handover procedure for LCR TDD | 8.0.0 | 8.1.0 |
| | RP-38 | RP-070895 | 3151 | | Correction on MMSI reception on DCCH | 8.0.0 | 8.1.0 |
| | RP-38 | RP-070894 | 3154 | 2 | RADIO BEARER SETUP using default configurations | 8.0.0 | 8.1.0 |
| | RP-38 | RP-070895 | 3157 | | Correction of integrity protection and checking of MBMS MODIFIED SERVICES INFORMATION message on DCCH | 8.0.0 | 8.1.0 |
| | RP-38 | RP-070892 | 3162 | | Use of default configuration 12 | 8.0.0 | 8.1.0 |
| | RP-38 | RP-070903 | 3164 | | A Correction about SNPL for 1.28 Mcps TDD | 8.0.0 | 8.1.0 |
| | RP-38 | RP-070903 | 3166 | | Support of SRB transmission on HSPA for 1.28Mcps TDD | 8.0.0 | 8.1.0 |
| | RP-38 | RP-070902 | 3169 | | More improvement on Dedicated frequency for 1.28 Mcps TDD MBMS | 8.0.0 | 8.1.0 |
| | RP-38 | RP-070903 | 3171 | | Clarification of gain factor Beta-e in LCR TDD EUL | 8.0.0 | 8.1.0 |
| | RP-38 | RP-070898 | 3173 | 2 | Iur backward compatibility problem | 8.0.0 | 8.1.0 |
| | RP-38 | RP-070898 | 3175 | | BCCH reception on HS-DSCH for CELL_PCH UE | 8.0.0 | 8.1.0 |
| | RP-38 | RP-070898 | 3177 | | Cell_PCH UE behaviour upon reception of activation time in reconfiguration message | 8.0.0 | 8.1.0 |
| | RP-38 | RP-070899 | 3179 | | CQI Table usage | 8.0.0 | 8.1.0 |
| | RP-38 | RP-070938 | 3181 | | Scheduled Grant setting in DTX Cycle 2 during CPC operation | 8.0.0 | 8.1.0 |
| | RP-38 | RP-070894 | 3184 | | Wrong UL Puncturing Limits for default configurations #15, #18, #19, #20 and #21 | 8.0.0 | 8.1.0 |
| | RP-38 | RP-070906 | 3186 | 1 | Change of UE capability during an RRC connection | 8.0.0 | 8.1.0 |
| | RP-38 | RP-070901 | 3188 | | Correction to HS-SCCH numbering assumption for 64QAM encoding | 8.0.0 | 8.1.0 |
| | RP-38 | RP-070905 | 3190 | | Clarification that 'Default DPCH offset value' is required for FACH->DCH reconfiguration | 8.0.0 | 8.1.0 |
| | RP-38 | RP-070895 | 3192 | | Error in Rel-7 shadow CR concerning MBMS preferred frequency information | 8.0.0 | 8.1.0 |
| | RP-38 | RP-070905 | 3196 | | Correction to Control Information transmission with two logical channels | 8.0.0 | 8.1.0 |
| | RP-38 | RP-070905 | 3198 | | Some editorial corrections on Multi-carriers for LCR TDD | 8.0.0 | 8.1.0 |
| | RP-38 | RP-070895 | 3201 | | Procedure text concerning MBMS offsets and tabular/ASN.1 | 8.0.0 | 8.1.0 |

| Change history | | | | | | | | |
|----------------|-------|-----------|------|-----|---|-------|-------|--|
| Date | TSG # | TSG Doc. | CR | Rev | Subject/Comment | Old | New | |
| | | | | | description are not aligned | | | |
| | RP-38 | RP-070905 | 3203 | 1 | MBMS Common Physical Channels limitation | 8.0.0 | 8.1.0 | |
| | RP-38 | RP-070895 | 3206 | 1 | Correction on MBMS Frequency Layer Dispersion (FLD) | 8.0.0 | 8.1.0 | |
| | RP-38 | RP-070897 | 3208 | 1 | Replacement of the almanac Sat Mask by SV ID | 8.0.0 | 8.1.0 | |
| | RP-38 | RP-070911 | 3210 | | Clarification on E-DPDCH power extrapolation/interpolation | 8.0.0 | 8.1.0 | |
| | RP-38 | RP-070895 | 3212 | | BCCH / MCCH consistency for MBMS reception | 8.0.0 | 8.1.0 | |
| | RP-38 | RP-070910 | 3214 | | Introduction of CS voice over HSPA | 8.0.0 | 8.1.0 | |
| | RP-38 | RP-070907 | 3215 | | Introduction of HS-DSCH category for combined MIMO and DL64QAM | 8.0.0 | 8.1.0 | |
| | RP-38 | RP-070905 | 3217 | | Disable reselection to the original RAT when UE receives RRC CONNECTION REJECT | 8.0.0 | 8.1.0 | |
| | RP-38 | RP-070904 | 3219 | | Corrections due to the ASN.1 R7 review (main CR) | 8.0.0 | 8.1.0 | |
| | RP-38 | RP-070904 | 3221 | | Signalling of Rel-7 UE capabilities (ASN.1 R7 review) | 8.0.0 | 8.1.0 | |
| | RP-38 | RP-070912 | 3223 | | Augmentation of GANSS Signal ID field | 8.0.0 | 8.1.0 | |
| | RP-38 | RP-070905 | 3225 | | Delta T2TP Parameter | 8.0.0 | 8.1.0 | |
| 03/2008 | RP-39 | RP-080178 | 3231 | - | Clarification on MAX_CID | 8.1.0 | 8.2.0 | |
| | RP-39 | RP-080189 | 3233 | - | FACH measurement occasion Calculation | 8.1.0 | 8.2.0 | |
| | RP-39 | RP-080189 | 3235 | - | Clarification on 'Default DPCH offset value' | 8.1.0 | 8.2.0 | |
| | RP-39 | RP-080189 | 3237 | - | Synchronised modification of system information blocks | 8.1.0 | 8.2.0 | |
| | RP-39 | RP-080189 | 3239 | - | Clarification on 'Measured Results on RACH' in enhanced CELL_FACH | 8.1.0 | 8.2.0 | |
| | RP-39 | RP-080186 | 3241 | - | Correction to conditions for setting MIMO_STATUS variable | 8.1.0 | 8.2.0 | |
| | RP-39 | RP-080188 | 3243 | - | Correction to HS-SCCH numbering assumption for 64QAM encoding | 8.1.0 | 8.2.0 | |
| | RP-39 | RP-080181 | 3245 | - | Use of cell selection and reselection info in the case that a cell is providing MBSFN only service | 8.1.0 | 8.2.0 | |
| | RP-39 | RP-080191 | 3247 | - | Corrections due to the RRC Rel-7 ASN.1 review | 8.1.0 | 8.2.0 | |
| | RP-39 | RP-080177 | 3250 | - | L2-combining in MBMS CURRENT CELL P-T-M RB INFORMATION message | 8.1.0 | 8.2.0 | |
| | RP-39 | RP-080189 | 3253 | - | Traffic volum measurement for CELL_PCH UE | 8.1.0 | 8.2.0 | |
| | RP-39 | RP-080190 | 3255 | - | Support of octet aligned HS-DSCH transport block sizes for non-64QAM | 8.1.0 | 8.2.0 | |
| | RP-39 | RP-080186 | 3257 | 1 | Correction to MIMO with the message PHYSICAL CHANNEL RECONFIGURATION | 8.1.0 | 8.2.0 | |
| | RP-39 | RP-080182 | 3259 | - | Supporting multi-frequency for 1.28 Mcps TDD MBMS | 8.1.0 | 8.2.0 | |
| | RP-39 | RP-080185 | 3261 | - | Modification of variable E_DCH_TRANSMISSION setting | 8.1.0 | 8.2.0 | |
| | RP-39 | RP-080185 | 3263 | - | Correction and Clarification of non-scheduled E-PUCH allocation for LCR TDD | 8.1.0 | 8.2.0 | |
| | RP-39 | RP-080185 | 3265 | - | Modifications on the values of T-RUCCH timer for LCR TDD | 8.1.0 | 8.2.0 | |
| | RP-39 | RP-080184 | 3267 | - | Persistence scaling values for 3.84/7.68 Mcps TDD E-DCH | 8.1.0 | 8.2.0 | |
| | RP-39 | RP-080178 | 3270 | - | Correction to default configuration 17 | 8.1.0 | 8.2.0 | |
| | RP-39 | RP-080203 | 3271 | - | Signaling of default configuration 17 in HANDOVER TO UTRAN COMMAND message | 8.1.0 | 8.2.0 | |
| | RP-39 | RP-080200 | 3272 | - | Introduction of UMTS 700 MHz (Bands XII – XIV) in 25.331 | 8.1.0 | 8.2.0 | |
| | RP-39 | RP-080201 | 3273 | 1 | CS-HSPA UL AMR Rate and maximum jitter time | 8.1.0 | 8.2.0 | |
| | RP-39 | RP-080201 | 3274 | 2 | Proposal for RRC based rate control | 8.1.0 | 8.2.0 | |
| | RP-39 | RP-080202 | 3275 | - | Introducing Improved L2 for uplink | 8.1.0 | 8.2.0 | |
| | RP-39 | RP-080204 | 3276 | - | Introduction of PPAC | 8.1.0 | 8.2.0 | |
| 05/2008 | RP-40 | RP-080390 | 3282 | 1 | Interpretation of the "Neighbouring cell identity" in MBMS NEIGHBOURING CELL PTM RB INFO | 8.2.0 | 8.3.0 | |
| | RP-40 | RP-080390 | 3285 | - | Clarification on MBMS dispersion | 8.2.0 | 8.3.0 | |
| | RP-40 | RP-080403 | 3287 | - | Minor ASN.1 corrections due errors detected during v780 implementation | 8.2.0 | 8.3.0 | |
| | RP-40 | RP-080414 | 3288 | 2 | Configurable values for the minimum and maximum RLC PDU size | 8.2.0 | 8.3.0 | |
| | RP-40 | RP-080417 | 3289 | - | Introduction of 64QAM in RRC for LCR TDD | 8.2.0 | 8.3.0 | |
| | RP-40 | RP-080396 | 3291 | - | Correction on the attribute of Treset in system information | 8.2.0 | 8.3.0 | |
| | RP-40 | RP-080396 | 3293 | - | Editorial correction to reconfigure MAC-ehs reordering queue | 8.2.0 | 8.3.0 | |
| | RP-40 | RP-080403 | 3295 | - | Editorial correction to variable description of CELL_INFO_LIST | 8.2.0 | 8.3.0 | |
| | RP-40 | RP-080393 | 3298 | - | Correction to the calculation of DPCH frame offset for F-DPCH on timing re-initialised hard handover | 8.2.0 | 8.3.0 | |
| | RP-40 | RP-080403 | 3300 | - | Handling of TRANSPORT FORMAT COMBINATION CONTROL | 8.2.0 | 8.3.0 | |
| | RP-40 | RP-080404 | 3302 | - | Completion of the mechanism for Scheduling Information transmission on MAC-e PDU alone for 1.28 Mcps TDD in EUL | 8.2.0 | 8.3.0 | |
| | RP-40 | RP-080443 | 3304 | 1 | Counter and timers for Scheduling Information Reporting of LCR | 8.2.0 | 8.3.0 | |

| Change history | | | | | | | | |
|----------------|-------|-----------|------|-----|--|-------|-------|--|
| Date | TSG # | TSG Doc. | CR | Rev | Subject/Comment | Old | New | |
| | | | | | TDD | | | |
| | RP-40 | RP-080398 | 3306 | - | Clarification of the definition of PRRI for TDD | 8.2.0 | 8.3.0 | |
| | RP-40 | RP-080400 | 3308 | 1 | Correction and Clarification of E-RUCCH Info for LCR TDD | 8.2.0 | 8.3.0 | |
| | RP-40 | RP-080395 | 3312 | - | Re-establishment condition for RLC reconfiguration to fixed from flexible PDU size | 8.2.0 | 8.3.0 | |
| | RP-40 | RP-080418 | 3313 | - | Early Implementation of PPAC | 8.2.0 | 8.3.0 | |
| | RP-40 | RP-080402 | 3315 | - | MBSFN Corrections | 8.2.0 | 8.3.0 | |
| | RP-40 | RP-080405 | 3316 | 1 | RAB reconfiguration for CS HSPA | 8.2.0 | 8.3.0 | |
| | RP-40 | RP-080419 | 3317 | - | Various corrections due to editorial problems detected during CR implementation after RAN-39 | 8.2.0 | 8.3.0 | |
| | RP-40 | RP-080419 | 3319 | - | Correction of missing Rel-7 VLEC in the Radio Bearer Reconfiguration message and other non-editorial corrections due to problems discovered during CR implementation | 8.2.0 | 8.3.0 | |
| | RP-40 | RP-080396 | 3321 | - | RRC connection release for Cell_PCH | 8.2.0 | 8.3.0 | |
| | RP-40 | RP-080384 | 3322 | - | Introduce a new band E for LCR TDD | 8.2.0 | 8.3.0 | |
| | RP-40 | RP-080396 | 3324 | - | Correction of CELL_PCH in Reconfiguration Procedure | 8.2.0 | 8.3.0 | |
| | RP-40 | RP-080401 | 3329 | - | Extended power control gap for E-PUCH in LCR TDD | 8.2.0 | 8.3.0 | |
| | RP-40 | RP-080300 | 3332 | - | GANSS corrections | 8.2.0 | 8.3.0 | |
| | RP-40 | RP-080442 | 3340 | - | Correction to note on reference E-TFCI configuration | 8.2.0 | 8.3.0 | |
| | RP-40 | RP-080394 | 3342 | - | Correction to relation between DTX-DRX timing and DTX-DRX configuration | 8.2.0 | 8.3.0 | |
| | RP-40 | RP-080400 | 3344 | 1 | Clarification on Number of E-UCCH for LCR TDD | 8.2.0 | 8.3.0 | |
| | RP-40 | RP-080400 | 3346 | 1 | Presence clarification of E-HICH Information per radio link for TDD | 8.2.0 | 8.3.0 | |
| | RP-40 | RP-080400 | 3348 | - | Correction on the non-scheduled E-PUCH configuration | 8.2.0 | 8.3.0 | |
| | RP-40 | RP-080403 | 3349 | - | Correction of missing Rel-7 VLEC in the Radio Bearer Reconfiguration message | 8.2.0 | 8.3.0 | |
| | RP-40 | RP-080403 | 3350 | - | Various ASN.1 corrections | 8.2.0 | 8.3.0 | |
| | RP-40 | RP-080394 | 3352 | - | Correction to signaling of Uplink DPCCH slot format information | 8.2.0 | 8.3.0 | |
| | RP-40 | RP-080403 | 3353 | - | Uncorrect way to delete MAC-ehs re-ordering queue | 8.2.0 | 8.3.0 | |
| | RP-40 | RP-080442 | 3355 | 1 | Indication for E-DPCCH Power Boosting support status | 8.2.0 | 8.3.0 | |
| | RP-40 | RP-080440 | 3356 | - | HS-SCCH orders for HS-SCCH-less operation | 8.2.0 | 8.3.0 | |
| 08/2008 | - | - | - | - | Fix Word problem | 8.3.0 | 8.3.1 | |
| 09/2008 | RP-41 | RP-080681 | 3358 | - | Correct the description of UE behaviour during HS-DSCH Reception in CELL_PCH and URA_PCH | 8.3.1 | 8.4.0 | |
| | RP-41 | RP-080679 | 3360 | 1 | Correction on the non-scheduled E-PUCH configuration for 1.28Mcps TDD | 8.3.1 | 8.4.0 | |
| | RP-41 | RP-080680 | 3362 | 2 | MBSFN Corrections | 8.3.1 | 8.4.0 | |
| | RP-41 | RP-080686 | 3363 | 3 | RRC procedures for configuring Improved layer 2 for UL | 8.3.1 | 8.4.0 | |
| | RP-41 | RP-080681 | 3365 | - | Deletion of Duplicate Definition of CELL_FACH HS-DSCH Variables | 8.3.1 | 8.4.0 | |
| | RP-41 | RP-080684 | 3367 | - | Modification of GANSS timing representation to avoid large integers | 8.3.1 | 8.4.0 | |
| | RP-41 | RP-080701 | 3373 | - | Reading Traffic Volume Measurement System Information in SIB11 | 8.3.1 | 8.4.0 | |
| | RP-41 | RP-080678 | 3376 | 4 | Clarification of the UE behavior on DSAC | 8.3.1 | 8.4.0 | |
| | RP-41 | RP-080701 | 3382 | - | Correction to signalling of multiple PLMNs in SIB18 | 8.3.1 | 8.4.0 | |
| | RP-41 | RP-080685 | 3386 | 2 | Reconfiguration of inactive RABs to DCH | 8.3.1 | 8.4.0 | |
| | RP-41 | RP-080696 | 3387 | 3 | Introduction of Enhanced Uplink in CELL_FACH in 25.331 | 8.3.1 | 8.4.0 | |
| | RP-41 | RP-080682 | 3389 | - | Correction to MIMO parameters | 8.3.1 | 8.4.0 | |
| | RP-41 | RP-080679 | 3391 | - | Persistence value (Pi) completion for E-RUCCH in LCR TDD | 8.3.1 | 8.4.0 | |
| | RP-41 | RP-080679 | 3395 | - | Introduce E-DCH Traffic volume measurement for LCR TDD | 8.3.1 | 8.4.0 | |
| | RP-41 | RP-080685 | 3397 | - | Introduce QrxlevminOffset in 25.331 for TDD | 8.3.1 | 8.4.0 | |
| | RP-41 | RP-080679 | 3400 | 1 | Correction of E-RUCCH configuration for LCR TDD EUL | 8.3.1 | 8.4.0 | |
| | RP-41 | RP-080687 | 3401 | 2 | Ciphering procedures for CS over HSPA | 8.3.1 | 8.4.0 | |
| | RP-41 | RP-080694 | 3403 | 1 | Introduction of absolute priorities reselection | 8.3.1 | 8.4.0 | |
| | RP-41 | RP-080694 | 3404 | 1 | UE Capabilities and redirection (UTRA-LTE) | 8.3.1 | 8.4.0 | |
| | RP-41 | RP-080697 | 3405 | 2 | Introduction of CELL_FACH DRX | 8.3.1 | 8.4.0 | |
| 12/2008 | RP-42 | RP-081022 | 3414 | - | HARQ feedback with Enhanced Uplink in Cell_FACH state | 8.4.0 | 8.5.0 | |
| | RP-42 | RP-081013 | 3415 | - | Clarification for LI size decision for UM RLC uplink | 8.4.0 | 8.5.0 | |
| | RP-42 | RP-081014 | 3416 | - | Correction to measurement behaviour for CELL_FACH UE | 8.4.0 | 8.5.0 | |
| | RP-42 | RP-080999 | 3419 | - | Typo in IE 'Domain Specific Access Restriction' | 8.4.0 | 8.5.0 | |
| | RP-42 | RP-081005 | 3421 | - | Misplaced IEs in RADIO BEARER RECONFIGURATION | 8.4.0 | 8.5.0 | |
| | RP-42 | RP-081022 | 3422 | 1 | Replacement of E-AICH in 25.331 | 8.4.0 | 8.5.0 | |

| Change history | | | | | | | | |
|----------------|-------|-----------|------|-----|--|-------|-------|--|
| Date | TSG # | TSG Doc. | CR | Rev | Subject/Comment | Old | New | |
| | RP-42 | RP-081004 | 3424 | 1 | Resetting the periodic cell update timer T305 after autonomous state transition to CELL_FACH in Enhanced CELL_FACH | 8.4.0 | 8.5.0 | |
| | RP-42 | RP-081022 | 3425 | 2 | Resetting the periodic cell update timer T305 after autonomous state transition to CELL_FACH in Enhanced Uplink in CELL_FACH state | 8.4.0 | 8.5.0 | |
| | RP-42 | RP-081022 | 3426 | 1 | Clarification of common E-DCH resource usage in 25.331 | 8.4.0 | 8.5.0 | |
| | RP-42 | RP-081022 | 3427 | 1 | Corrections for Enhanced Uplink in CELL_FACH in 25.331 | 8.4.0 | 8.5.0 | |
| | RP-42 | RP-081014 | 3428 | 1 | Smaller value ranges for DRX burst length | 8.4.0 | 8.5.0 | |
| | RP-42 | RP-081003 | 3430 | 1 | Clarification to the scope of Uplink DPCCCH slot format 4 feature | 8.4.0 | 8.5.0 | |
| | RP-42 | RP-081007 | 3432 | - | Introduce Intra-SecondaryFrequency Indicator for LCR TDD | 8.4.0 | 8.5.0 | |
| | RP-42 | RP-081030 | 3433 | - | Clarification of non-used frequency definition for secondary frequency in DC-HSDPA | 8.4.0 | 8.5.0 | |
| | RP-42 | RP-081004 | 3435 | 2 | correct the description of UE behaviour during HS-DSCH Reception in CELL_PCH | 8.4.0 | 8.5.0 | |
| | RP-42 | RP-081014 | 3436 | - | Some corrections for Enhanced UE DRX | 8.4.0 | 8.5.0 | |
| | RP-42 | RP-081003 | 3438 | - | Modification of the conditions for disabling HS-SCCH less operation | 8.4.0 | 8.5.0 | |
| | RP-42 | RP-081029 | 3439 | - | Support for additional navigation satellite systems in RRC | 8.4.0 | 8.5.0 | |
| | RP-42 | RP-081022 | 3445 | 1 | SIB7 reading time with Enhanced Uplink for CELL_FACH state in 25.331 | 8.4.0 | 8.5.0 | |
| | RP-42 | RP-081033 | 3446 | - | Introduction of new default configurations | 8.4.0 | 8.5.0 | |
| | RP-42 | RP-081022 | 3447 | - | Clarification of HS-DPCCH usage for Enhanced Uplink in CELL_FACH | 8.4.0 | 8.5.0 | |
| | RP-42 | RP-081033 | 3448 | - | Inclusion of UE historical information in SRNC RELOCATION INFO | 8.4.0 | 8.5.0 | |
| | RP-42 | RP-081033 | 3453 | - | Size constraints on UE band capabilities | 8.4.0 | 8.5.0 | |
| | RP-42 | RP-081102 | 3458 | 3 | Introduction of UE Measurement Capability on frequency adjacent to intra-frequency | 8.4.0 | 8.5.0 | |
| | RP-42 | RP-081015 | 3460 | 1 | Prevention of excessive OOS due to failure of Squal criterion | 8.4.0 | 8.5.0 | |
| | RP-42 | RP-081033 | 3462 | 2 | Improved EUL power control at UE power limitation | 8.4.0 | 8.5.0 | |
| | RP-42 | RP-080857 | 3463 | - | Introduction of ETWS PRIMARY NOTIFICATION WITH SECURITY message | 8.4.0 | 8.5.0 | |
| | RP-42 | RP-081000 | 3466 | 1 | MBMS frequency selection | 8.4.0 | 8.5.0 | |
| | RP-42 | RP-081003 | 3468 | - | Correction to DRX and CQI reporting | 8.4.0 | 8.5.0 | |
| | RP-42 | RP-081030 | 3469 | 1 | Introduction of Dual Cell HSDPA operation | 8.4.0 | 8.5.0 | |
| | RP-42 | RP-081028 | 3470 | 2 | Introduction of HS-DSCH cell change enhancements | 8.4.0 | 8.5.0 | |
| | RP-42 | RP-081033 | 3471 | 3 | Introduction of optional features in Release 8 | 8.4.0 | 8.5.0 | |
| | RP-42 | RP-081015 | 3473 | - | Detection of E-UTRA cell in idle mode | 8.4.0 | 8.5.0 | |
| | RP-42 | RP-081033 | 3476 | - | Add the max number of the extended bands for TDD | 8.4.0 | 8.5.0 | |
| | RP-42 | RP-081003 | 3478 | - | Clarification to the use of 'F-DPCH slot format' IE | 8.4.0 | 8.5.0 | |
| | RP-42 | RP-081015 | 3480 | 1 | Corrections to absolute priority reselection and redirection to EUTRA procedures and parameters | 8.4.0 | 8.5.0 | |
| | RP-42 | RP-081015 | 3481 | 1 | PS handover to/from E-UTRAN | 8.4.0 | 8.5.0 | |
| | RP-42 | RP-081015 | 3482 | 1 | Measurement and measurement reporting of E-UTRAN cells | 8.4.0 | 8.5.0 | |
| | RP-42 | RP-081033 | 3483 | 2 | Fast Dormancy for UMTS | 8.4.0 | 8.5.0 | |
| | RP-42 | RP-081005 | 3484 | - | Corrections related to the cell update wait timer T320 | 8.4.0 | 8.5.0 | |
| | RP-42 | RP-081012 | 3485 | - | Correction of the small typo | 8.4.0 | 8.5.0 | |
| | RP-42 | RP-081012 | 3486 | - | RLF handling during CS over HSPA reconfiguration | 8.4.0 | 8.5.0 | |
| | RP-42 | RP-081015 | 3487 | - | UE behaviour of NAS message transmission when inter-RAT change | 8.4.0 | 8.5.0 | |
| | RP-42 | RP-081005 | 3489 | - | Correction to IDT procedure | 8.4.0 | 8.5.0 | |
| | RP-42 | RP-081006 | 3492 | - | Clarification for 16QAM UL E-AGCH table mapping | 8.4.0 | 8.5.0 | |
| | RP-42 | RP-081025 | 3494 | 2 | Introduction of enhanced CELL_FACH, CELL_PCH and URA_PCH for 1.28Mcps TDD | 8.4.0 | 8.5.0 | |
| | RP-42 | RP-080998 | 3499 | - | Correction of measurement event 11 | 8.4.0 | 8.5.0 | |
| | RP-42 | RP-081007 | 3501 | - | Clarification of Persistence Value (Pi) for E-RUCCH in LCR TDD | 8.4.0 | 8.5.0 | |
| | RP-42 | RP-081024 | 3505 | - | Introduction of additional UE categories for 1.28Mcps TDD 64QAM DL | 8.4.0 | 8.5.0 | |
| | RP-42 | RP-081005 | 3509 | - | Correction to 'DL RLC PDU size' explicit configuration to prevent security issue | 8.4.0 | 8.5.0 | |
| | RP-42 | RP-081003 | 3511 | - | Clarification to the use of 'DTX-DRX timing information' for hard handover | 8.4.0 | 8.5.0 | |
| | RP-42 | RP-081030 | 3512 | 1 | Clarification of current frequency in DC-HSDPA | 8.4.0 | 8.5.0 | |
| | RP-42 | RP-081005 | 3514 | 1 | Correction of measurement event 1H | 8.4.0 | 8.5.0 | |

| Change history | | | | | | | |
|----------------|-------|-----------|------|-----|---|-------|-------|
| Date | TSG # | TSG Doc. | CR | Rev | Subject/Comment | Old | New |
| | RP-42 | RP-081014 | 3515 | 1 | Add indication of enhanced DRX capability into CELL UPDATE | 8.4.0 | 8.5.0 |
| | RP-42 | RP-081030 | 3516 | - | Indication of Dual Cell capability in RRC Connection Request and Cell Update | 8.4.0 | 8.5.0 |
| | RP-42 | RP-081005 | 3518 | - | Support of Enhanced F-DPCH in RRC CONNECTION REQUEST | 8.4.0 | 8.5.0 |
| | RP-42 | RP-081031 | 3520 | 1 | CR on CSG Support in 25.331 | 8.4.0 | 8.5.0 |
| | RP-42 | RP-081128 | 3521 | 2 | Support for 3.84 Mcps MBSFN IMB operation | 8.4.0 | 8.5.0 |
| 03/2009 | RP-43 | RP-090144 | 3532 | 2 | Support for 3.84 Mcps MBSFN IMB operation | 8.5.0 | 8.6.0 |
| | RP-43 | RP-090115 | 3535 | 1 | UMTS frequency information in IE 'Rplmn information' | 8.5.0 | 8.6.0 |
| | RP-43 | RP-090115 | 3538 | - | CN system information after PS HO | 8.5.0 | 8.6.0 |
| | RP-43 | RP-090119 | 3540 | - | Correction to the UE behaviour when entering URA_PCH state | 8.5.0 | 8.6.0 |
| | RP-43 | RP-090117 | 3542 | 1 | Condition to set the 'Security capability indication' flag | 8.5.0 | 8.6.0 |
| | RP-43 | RP-090117 | 3544 | 2 | Ciphering for intra-UTRAN Radio Bearer Setup - Rel 7 | 8.5.0 | 8.6.0 |
| | RP-43 | RP-090139 | 3545 | - | T321 Timer Start Time Clarification | 8.5.0 | 8.6.0 |
| | RP-43 | RP-090136 | 3546 | 1 | Clarification of ACK/NACK reporting for Enhanced Uplink in CELL_FACH | 8.5.0 | 8.6.0 |
| | RP-43 | RP-090149 | 3547 | 1 | Introduction of MIMO for 1.28Mcps TDD | 8.5.0 | 8.6.0 |
| | RP-43 | RP-090141 | 3548 | 2 | Correction to GANSS additional assistance data request | 8.5.0 | 8.6.0 |
| | RP-43 | RP-090140 | 3549 | - | CS-HSPA information in RAB information to reconfigure | 8.5.0 | 8.6.0 |
| | RP-43 | RP-090136 | 3550 | - | Addition of E-RNTI and H-RNTI in URA UPDATE CONFIRM message | 8.5.0 | 8.6.0 |
| | RP-43 | RP-090135 | 3551 | 1 | CSG corrections | 8.5.0 | 8.6.0 |
| | RP-43 | RP-090147 | 3552 | 3 | Introduction of Continuous Connectivity for packet data users for 1.28Mcps TDD | 8.5.0 | 8.6.0 |
| | RP-43 | RP-090142 | 3553 | 1 | Corrections to Enhanced Serving Cell Change | 8.5.0 | 8.6.0 |
| | RP-43 | RP-090139 | 3554 | 3 | Corrections for Enhanced UE DRX | 8.5.0 | 8.6.0 |
| | RP-43 | RP-090151 | 3555 | 1 | General default configuration for CELL_FACH | 8.5.0 | 8.6.0 |
| | RP-43 | RP-090132 | 3556 | - | Corrections to detection of E-UTRA cell | 8.5.0 | 8.6.0 |
| | RP-43 | RP-090144 | 3558 | - | Correction on MBSFN frequency list IE in 3.84Mcps TDD MBSFN IMB | 8.5.0 | 8.6.0 |
| | RP-43 | RP-090150 | 3559 | - | Correction to activation/deactivation of secondary cell reception | 8.5.0 | 8.6.0 |
| | RP-43 | RP-090132 | 3561 | - | Missing reference to E-UTRAN DL-DCCH-Message at Inter-RAT Handover | 8.5.0 | 8.6.0 |
| | RP-43 | RP-090139 | 3562 | - | Corrections for enhanced UE DRX | 8.5.0 | 8.6.0 |
| | RP-43 | RP-090132 | 3563 | 1 | Clearing of START and Pre-defined configurations at Inter-RAT Handover UTRAN to E-UTRAN | 8.5.0 | 8.6.0 |
| | RP-43 | RP-090148 | 3565 | - | Introduction of SR-VCC operations | 8.5.0 | 8.6.0 |
| | RP-43 | RP-090136 | 3566 | 1 | Removal of redundant Cell Update procedure | 8.5.0 | 8.6.0 |
| | RP-43 | RP-090142 | 3567 | - | Processed transactions initialisation upon SRB re-establishment | 8.5.0 | 8.6.0 |
| | RP-43 | RP-090118 | 3569 | - | Clarification of scope of signaled transport block sizes for HS-SCCH less operation | 8.5.0 | 8.6.0 |
| | RP-43 | RP-090132 | 3573 | 1 | Support E-UTRAN Inter-RAT measurement by UTRA TDD UE | 8.5.0 | 8.6.0 |
| | RP-43 | RP-090117 | 3575 | - | 25.331 Rel 8 CR UE restrictions on E-TFCI | 8.5.0 | 8.6.0 |
| | RP-43 | RP-090151 | 3577 | 2 | Corrections related to UTRA R8 ASN.1 issues | 8.5.0 | 8.6.0 |
| | RP-43 | RP-090115 | 3580 | - | Correction to handling of CELL_INFO_LIST when 'Inter-frequency cell info list' is received in System Information Block Type 11bis | 8.5.0 | 8.6.0 |
| | RP-43 | RP-090115 | 3583 | 1 | Corrections for PS handover to UTRAN | 8.5.0 | 8.6.0 |
| | RP-43 | RP-090121 | 3585 | 1 | Correction to RRC handling of AG and SG tables when 16QAM UL is configured | 8.5.0 | 8.6.0 |
| | RP-43 | RP-090118 | 3587 | 1 | Correction to handling of DTX-DRX information | 8.5.0 | 8.6.0 |
| | RP-43 | RP-090132 | 3592 | - | Corrections to UTRA to EUTRA mobility | 8.5.0 | 8.6.0 |
| | RP-43 | RP-090132 | 3593 | - | Correction to serving cell dedicated priority handling when no priority is available | 8.5.0 | 8.6.0 |
| | RP-43 | RP-090133 | 3594 | - | EUTRA Feature Group Support Indicators in UTRA | 8.5.0 | 8.6.0 |
| | RP-43 | RP-090364 | 3595 | 4 | Revised RAN2 REL-8 CRs for LTE on Feature Group Indicators | 8.5.0 | 8.6.0 |
| | RP-43 | RP-090135 | 3596 | 2 | Correction to CSG PSC signalling | 8.5.0 | 8.6.0 |
| | RP-43 | RP-090151 | 3601 | - | Addition of E-RGCH Combination Info in SRNS RELOCATION INFO(R8) | 8.5.0 | 8.6.0 |
| | RP-43 | RP-090150 | 3603 | - | Corrections to Dual Cell HSDPA operation | 8.5.0 | 8.6.0 |
| | RP-43 | RP-090142 | 3605 | - | Corrections to HS-DSCH cell change enhancements(R8MIMO) | 8.5.0 | 8.6.0 |
| | RP-43 | RP-090142 | 3607 | - | Some corrections to Serving Cell Change enhancements | 8.5.0 | 8.6.0 |
| | RP-43 | RP-090132 | 3608 | - | Corrections to absolute priority reselection | 8.5.0 | 8.6.0 |
| | RP-43 | RP-090139 | 3609 | - | Clarification of enhanced UE DRX operation | 8.5.0 | 8.6.0 |
| | RP-43 | RP-090132 | 3610 | - | Inheriting of dedicated priorities at inter-RAT reselection | 8.5.0 | 8.6.0 |

| Change history | | | | | | | |
|----------------|-------|-----------|------|-----|---|-------|-------|
| Date | TSG # | TSG Doc. | CR | Rev | Subject/Comment | Old | New |
| | RP-43 | RP-090137 | 3613 | 1 | Corrections to enhanced CELL_FACH in 1.28Mcps TDD | 8.5.0 | 8.6.0 |
| | RP-43 | RP-090122 | 3614 | 1 | Clarification of 64QAM TB Table applicability | 8.5.0 | 8.6.0 |
| | RP-43 | RP-090151 | 3615 | - | Correction of Uplink DPCH power control info IE | 8.5.0 | 8.6.0 |
| | RP-43 | RP-090146 | 3617 | - | Introduction of UMTS Band f in 25.331 | 8.5.0 | 8.6.0 |
| | RP-43 | RP-090136 | 3618 | - | Correction on F-DPCH slot format for E-DCH in CELL_FACH | 8.5.0 | 8.6.0 |
| | RP-43 | RP-090326 | 3619 | 1 | Addition of CSG capability indication | 8.5.0 | 8.6.0 |
| | RP-43 | RP-090145 | 3620 | - | Correction for UTRA ETWS duplicate detection | 8.5.0 | 8.6.0 |
| | RP-43 | RP-090117 | 3622 | - | Adding the MBMS PTM RB release cause in the MCCH message when releasing the MBMS service for 1.28Mcps TDD | 8.5.0 | 8.6.0 |
| | RP-43 | RP-090326 | 3624 | - | Addition of CSG capability indication in Initial Direct Transfer | 8.5.0 | 8.6.0 |
| 06/2009 | RP-44 | RP-090498 | 3629 | 1 | Removal of description of CPCH feature | 8.6.0 | 8.7.0 |
| | RP-44 | RP-090505 | 3631 | 1 | Error in UE capability update procedure | 8.6.0 | 8.7.0 |
| | RP-44 | RP-090505 | 3633 | 1 | Correction on deferredMeasurementControlReading | 8.6.0 | 8.7.0 |
| | RP-44 | RP-090500 | 3635 | - | Clarification for setting the HS_SCCH_LESS_STATUS variable | 8.6.0 | 8.7.0 |
| | RP-44 | RP-090506 | 3636 | - | Removal of FFS in reference to GERAN timer T3230 | 8.6.0 | 8.7.0 |
| | RP-44 | RP-090517 | 3637 | 1 | Addition of semantics description for support of CSG | 8.6.0 | 8.7.0 |
| | RP-44 | RP-090506 | 3638 | 1 | Clarification of setting measurement capability TDD in INTER RAT HANDOVER INFOR message | 8.6.0 | 8.7.0 |
| | RP-44 | RP-090519 | 3639 | - | Correction to enhanced Serving Cell Change procedure | 8.6.0 | 8.7.0 |
| | RP-44 | RP-090519 | 3640 | - | Correction of the 'else' clause in Target cell HS-SCCH reception | 8.6.0 | 8.7.0 |
| | RP-44 | RP-090519 | 3641 | - | SIB7 and enhanced UE DRX operation | 8.6.0 | 8.7.0 |
| | RP-44 | RP-090519 | 3642 | 2 | Correction to statement of SPS operation for 1.28Mcps TDD | 8.6.0 | 8.7.0 |
| | RP-44 | RP-090506 | 3643 | 1 | Preserving dedicated priorities in camped on any cell state | 8.6.0 | 8.7.0 |
| | RP-44 | RP-090505 | 3645 | - | Correction on UE Mobility State Indicator | 8.6.0 | 8.7.0 |
| | RP-44 | RP-090500 | 3647 | - | Correction to CPC activation/deactivation | 8.6.0 | 8.7.0 |
| | RP-44 | RP-090519 | 3648 | - | Procedure requirements for ETWS primary notification with security | 8.6.0 | 8.7.0 |
| | RP-44 | RP-090519 | 3649 | - | Handling of dual cell HS-SCCH orders at serving cell change | 8.6.0 | 8.7.0 |
| | RP-44 | RP-090519 | 3650 | - | Corrections to common E-DCH operation | 8.6.0 | 8.7.0 |
| | RP-44 | RP-090607 | 3656 | 4 | Specification of CPC restored state upon physical layer failure | 8.6.0 | 8.7.0 |
| | RP-44 | RP-090501 | 3658 | 2 | Correction to non-scheduled transmission for 1.28 Mcps TDD | 8.6.0 | 8.7.0 |
| | RP-44 | RP-090503 | 3660 | - | Clarification of CQI reporting for 1.28Mcps TDD | 8.6.0 | 8.7.0 |
| | RP-44 | RP-090503 | 3662 | - | Correction to Improved L2 support for high data rates for TDD | 8.6.0 | 8.7.0 |
| | RP-44 | RP-090518 | 3663 | - | Missing CS over HSPA operation in SR-VCC | 8.6.0 | 8.7.0 |
| | RP-44 | RP-090519 | 3664 | - | Correction on CPICH Secondary CCPCH power offset in 3.84 Mcps TDD MBSFN IMB | 8.6.0 | 8.7.0 |
| | RP-44 | RP-090502 | 3665 | 1 | Correction on p-t-m bearer release in 3.84 Mcps TDD MBSFN IMB | 8.6.0 | 8.7.0 |
| | RP-44 | RP-090517 | 3667 | 1 | Addition of CSG cell reservation signalling | 8.6.0 | 8.7.0 |
| | RP-44 | RP-090499 | 3671 | - | Clarification to the support of 2 different layer 3 filters per measurement type | 8.6.0 | 8.7.0 |
| | RP-44 | RP-090505 | 3673 | 1 | Clarification to handling of IE 'Use special value of HE field' | 8.6.0 | 8.7.0 |
| | RP-44 | RP-090500 | 3675 | - | Removal of slot format 3 from IE 'Uplink DPCH slot format information'in 'DTX-DRX information' | 8.6.0 | 8.7.0 |
| | RP-44 | RP-090519 | 3676 | 1 | Correction to TargetCellPreconfigInfo asn1 | 8.6.0 | 8.7.0 |
| | RP-44 | RP-090506 | 3680 | - | Correction for E-UTRA measurement and reporting quantity CR for 25.331 | 8.6.0 | 8.7.0 |
| | RP-44 | RP-090506 | 3681 | - | Corrections to absolute priority reselection | 8.6.0 | 8.7.0 |
| | RP-44 | RP-090504 | 3683 | - | Correction to Enhanced CELL_FACH Capability | 8.6.0 | 8.7.0 |
| | RP-44 | RP-090519 | 3684 | - | Configuration of EAI power offset | 8.6.0 | 8.7.0 |
| | RP-44 | RP-090519 | 3688 | - | Correction to RRC transaction identifier handling | 8.6.0 | 8.7.0 |
| | RP-44 | RP-090500 | 3690 | 1 | Corrections to CPC when E-DCH TTI is reconfigured (Rel8) | 8.6.0 | 8.7.0 |
| | RP-44 | RP-090505 | 3692 | - | Call Type Inclusion condition | 8.6.0 | 8.7.0 |
| | RP-44 | RP-090506 | 3694 | 2 | Transfer of INTER RAT HANDOVER INFO upon handover from UTRAN | 8.6.0 | 8.7.0 |
| | RP-44 | RP-090519 | 3695 | - | Clarification of SIB7 reading for enhanced uplink in CELL_FACH state | 8.6.0 | 8.7.0 |
| 09/2009 | RP-45 | RP-090906 | 3700 | 1 | Correction for the value range of threshold other system in case E-UTRA measurement Alt1 | 8.7.0 | 8.8.0 |
| | RP-45 | RP-090906 | 3701 | - | Inconsistency between ASN.1 and Tabular format of E-UTRA target info | 8.7.0 | 8.8.0 |
| | RP-45 | RP-090906 | 3702 | 3 | Clarification on signalling connection initialisation upon HO to UTRAN | 8.7.0 | 8.8.0 |
| | RP-45 | RP-090901 | 3704 | - | Missing RRC messages in RRC procedure performance values | 8.7.0 | 8.8.0 |

| Change history | | | | | | | | |
|----------------|-------|-----------|------|-----|--|-------|-------|--|
| Date | TSG # | TSG Doc. | CR | Rev | Subject/Comment | Old | New | |
| | | | | | section | | | |
| | RP-45 | RP-090912 | 3705 | - | Corrections to handling of secondary cell HS-DSCH information in DC-HSDPA | 8.7.0 | 8.8.0 | |
| | RP-45 | RP-090905 | 3708 | - | Correction to HS-SCCH less operation (Rel-8) | 8.7.0 | 8.8.0 | |
| | RP-45 | RP-090914 | 3709 | 1 | Correction to the reception of a Target cell HS-SCCH order | 8.7.0 | 8.8.0 | |
| | RP-45 | RP-090911 | 3710 | - | Corrections related to CSG | 8.7.0 | 8.8.0 | |
| | RP-45 | RP-090916 | 3713 | - | Actions upon CS over HSPA is configured in 'RB information to setup' IE | 8.7.0 | 8.8.0 | |
| | RP-45 | RP-090916 | 3715 | - | Validation of PDCP configuration in case of CS voice over HSPA | 8.7.0 | 8.8.0 | |
| | RP-45 | RP-090908 | 3717 | 1 | E-DCH TTI restriction for 16QAM | 8.7.0 | 8.8.0 | |
| | RP-45 | RP-090917 | 3718 | - | Clarification that a configuration with simultaneous RB mapping options for mac-is/i and mac-es/e is invalid | 8.7.0 | 8.8.0 | |
| | RP-45 | RP-090912 | 3719 | - | Dual Cell HSDPA: clarification of setting of variable SECONDARY_CELL_HS_DSCH_RECEPTION | 8.7.0 | 8.8.0 | |
| | RP-45 | RP-090913 | 3722 | - | Inconsistency with ASN.1 for TVM for Enhanced UL for CELL_FACH | 8.7.0 | 8.8.0 | |
| | RP-45 | RP-090902 | 3728 | 1 | Making features 'Using special value of HE field to indicate end of an SDU for RLC AM' optional, octet aligned HS-DSCH transport block table optional for non-64QAM UEs and 'Removing the constraint that the same HS-SCCH should be used in contiguous TTIs' optional | 8.7.0 | 8.8.0 | |
| | RP-45 | RP-090912 | 3735 | 1 | Clarification of H-ARQ Info for DC-HSDPA | 8.7.0 | 8.8.0 | |
| | RP-45 | RP-090912 | 3736 | - | Correction in the use of H-RNTI for the secondary cell of Dual Cell HSDPA operation | 8.7.0 | 8.8.0 | |
| | RP-45 | RP-090916 | 3738 | - | Correction to response message of Cell Update Confirm message in case of Voice Type Transition i.e. 'CS over HSPA' to 'CS over DCH' or vice-versa | 8.7.0 | 8.8.0 | |
| | RP-45 | RP-090909 | 3742 | - | Clarification for UE behaviour on RLC unrecoverable error when UE has not received L2 Ack for a Reconfig Complete msg | 8.7.0 | 8.8.0 | |
| | RP-45 | RP-090910 | 3743 | 1 | Clarification on common E-DCH MAC flow configuration in enhanced CELL_FACH for 1.28 Mcps TDD | 8.7.0 | 8.8.0 | |
| | RP-45 | RP-090910 | 3745 | 1 | Correction to periodical cell update for 1.28 Mcps TDD | 8.7.0 | 8.8.0 | |
| | RP-45 | RP-090910 | 3747 | 1 | Clarification on UE category of enhanced CELL_FACH for 1.28Mcps TDD | 8.7.0 | 8.8.0 | |
| | RP-45 | RP-090901 | 3749 | - | Clarification of multi-frequency info for 1.28Mcps TDD | 8.7.0 | 8.8.0 | |
| | RP-45 | RP-090915 | 3750 | - | Security threat with duplicate detection for ETWS | 8.7.0 | 8.8.0 | |
| | RP-45 | RP-090904 | 3754 | - | Correction to the description of MIMO parameters | 8.7.0 | 8.8.0 | |
| | RP-45 | RP-090917 | 3755 | - | Ambiguity on the RLC PDU type of SRB | 8.7.0 | 8.8.0 | |
| | RP-45 | RP-090902 | 3759 | - | Making features 'F-DPCH' and 'Introduction of Wait time to Cell Update Confirm' optional | 8.7.0 | 8.8.0 | |
| | RP-45 | RP-090907 | 3760 | - | 25.331 Features to be made optional in release 8: E-DPCCH power boosting | 8.7.0 | 8.8.0 | |
| | RP-45 | RP-090918 | 3761 | - | Correction regarding SRVCC | 8.7.0 | 8.8.0 | |
| | RP-45 | RP-090906 | 3762 | 1 | Clarification on key mapping and storing after successful handover from EUTRAN | 8.7.0 | 8.8.0 | |
| | RP-45 | RP-090899 | 3764 | 2 | Making features "Two DRX schemes in URA_PCH and CELL_PCH" and "E-DPDCH power interpolation formula" optional | 8.7.0 | 8.8.0 | |
| | RP-45 | RP-090917 | 3765 | - | Clarification that DDI is not used with mac-i/is configuration | 8.7.0 | 8.8.0 | |
| | RP-45 | RP-090916 | 3769 | - | CS voice over HSPA UE capability in RRC CONNECTION REQUEST | 8.7.0 | 8.8.0 | |
| | RP-45 | RP-090920 | 3776 | - | Corrections to the CONTROL_CHANNEL_DRX_STATUS of 1.28Mcps TDD | 8.7.0 | 8.8.0 | |
| | RP-45 | RP-090903 | 3778 | - | Clarification on the Power Resource Related Information of 1.28Mcps TDD | 8.7.0 | 8.8.0 | |
| | RP-45 | RP-090903 | 3780 | - | Clarification on the configuration of T-SI-NST for 1.28Mcps TDD | 8.7.0 | 8.8.0 | |
| | RP-45 | RP-090910 | 3781 | - | Clarification on fach measurement occasion for 1.28Mcps TDD | 8.7.0 | 8.8.0 | |
| | RP-45 | RP-090917 | 3785 | - | Clarification on Scheduling Information transmission | 8.7.0 | 8.8.0 | |
| | RP-45 | RP-090920 | 3788 | - | Clarification on the number of RxTx Pattern of SPS operation for 1.28Mcps TDD | 8.7.0 | 8.8.0 | |
| | RP-45 | RP-090909 | 3792 | 1 | 25.331 on Addition of LCR TDD R8 extend capability info in Inter-RAT Handover info | 8.7.0 | 8.8.0 | |
| | RP-45 | RP-090909 | 3800 | - | Missing RRC messages in RRC procedure performance values section | 8.7.0 | 8.8.0 | |
| | RP-45 | RP-090900 | 3803 | - | Clarification on Inter-frequency RACH reporting quantity for TDD | 8.7.0 | 8.8.0 | |
| | RP-45 | RP-090900 | 3807 | - | E-AGCH channel and E_RNTI variable corrections | 8.7.0 | 8.8.0 | |
| | RP-45 | RP-090874 | 3810 | 4 | Making features "Absolute priority reselection to GERAN", | 8.7.0 | 8.8.0 | |

| Change history | | | | | | | |
|----------------|-------|-----------|------|-----|--|-------|-------|
| Date | TSG # | TSG Doc. | CR | Rev | Subject/Comment | Old | New |
| | | | | | "Absolute priority reselection to UTRA inter-frequency" and "Improved EUL power control" optional | | |
| | RP-45 | RP-090901 | 3813 | - | Enhancing the Category Handling in UMTS | 8.7.0 | 8.8.0 |
| | RP-45 | RP-090902 | 3814 | - | Making the bit of feature "UEA2/UIA2" reformulated | 8.7.0 | 8.8.0 |
| | RP-45 | RP-090900 | 3816 | - | RLC Size - SizeInfoType2 correction | 8.7.0 | 8.8.0 |
| 12/2009 | RP-46 | RP-091307 | 3819 | - | Adding missing reference for HS_SCCH_LESS_STATUS variable | 8.8.0 | 8.9.0 |
| | RP-46 | RP-091306 | 3823 | - | Clarification on deferred measurement control reading | 8.8.0 | 8.9.0 |
| | RP-46 | RP-091321 | 3825 | 1 | Clarification for initial SPS Tx pattern parameter for 1.28Mcps TDD | 8.8.0 | 8.9.0 |
| | RP-46 | RP-091327 | 3830 | 2 | Clarification of common E-DCH mac-d flow for CCCH transmission | 8.8.0 | 8.9.0 |
| | RP-46 | RP-091310 | 3833 | 1 | Clarification of Power Offset for Scheduling Info for 1.28Mcps TDD (change 1) | 8.8.0 | 8.9.0 |
| | RP-46 | RP-091310 | 3835 | 1 | Clarification of Power Offset for Scheduling Info for 1.28Mcps TDD (change 2) | 8.8.0 | 8.9.0 |
| | RP-46 | RP-091325 | 3840 | - | Clarification on the configuration of TX diversity mode on DPCH in DC-HSDPA | 8.8.0 | 8.9.0 |
| | RP-46 | RP-091325 | 3842 | - | Clarification to the number of HARQ processes in DC-HSDPA | 8.8.0 | 8.9.0 |
| | RP-46 | RP-091318 | 3843 | - | Correction of nesting levels greater 15 in ASN.1 IE definitions | 8.8.0 | 8.9.0 |
| | RP-46 | RP-091324 | 3845 | 1 | Correction of number of NI per frame for 3.84 Mcps TDD MBSFN IMB | 8.8.0 | 8.9.0 |
| | RP-46 | RP-091314 | 3847 | 1 | Correction of the UE behaviour after RRC connection Reject with redirection to EUTRA | 8.8.0 | 8.9.0 |
| | RP-46 | RP-091377 | 3849 | 2 | One correction to ASN1 of enhanced CELL_FACH state for LCR TDD | 8.8.0 | 8.9.0 |
| | RP-46 | RP-091312 | 3855 | 1 | MAC-es/e reset when 16QAM operation starts or stops(REL-8) | 8.8.0 | 8.9.0 |
| | RP-46 | RP-091315 | 3857 | - | Making features 'Absolute priority reselection to GERAN', 'Absolute priority reselection to UTRA inter-frequency' optional (Option1) | 8.8.0 | 8.9.0 |
| | RP-46 | RP-091321 | 3861 | - | Correction on Control Channel DRX description in CELL_DCH state for 1.28Mcps TDD | 8.8.0 | 8.9.0 |
| | RP-46 | RP-091321 | 3863 | - | Clarification of the actions related to HS_DSCH_RECEPTION variable for 1.28Mcps TDD | 8.8.0 | 8.9.0 |
| | RP-46 | RP-091306 | 3867 | - | Corrections to the Frequency quality estimate in 1.28Mcps TDD | 8.8.0 | 8.9.0 |
| | RP-46 | RP-091317 | 3871 | - | Inconsistency between tabular and ASN.1 for Adjacent Frequency measurements without compressed mode | 8.8.0 | 8.9.0 |
| | RP-46 | RP-091305 | 3878 | 1 | UE behaviour upon a removal of the serving HS-DSCH/E-DCH radio link | 8.8.0 | 8.9.0 |
| | RP-46 | RP-091305 | 3882 | - | Maximum Power Reduction (MPR) and event 6D reporting | 8.8.0 | 8.9.0 |
| | RP-46 | RP-091308 | 3885 | 1 | RRC Signaling of S-CPICH power offset for MIMO UEs | 8.8.0 | 8.9.0 |
| | RP-46 | RP-091325 | 3889 | - | Clarification of the definition of the multicell support | 8.8.0 | 8.9.0 |
| | RP-46 | RP-091317 | 3893 | - | Clarification on the UE state after fast dormancy request | 8.8.0 | 8.9.0 |
| | RP-46 | RP-091327 | 3897 | - | Clarification on the transmission of MAC-c PDUs (R8) | 8.8.0 | 8.9.0 |
| | RP-46 | RP-091325 | 3903 | - | HARQ memory partitioning configuration for DC-HSDPA | 8.8.0 | 8.9.0 |
| | RP-46 | RP-091306 | 3919 | 2 | Modification of inter RAT handover info for 1.28 Mcps TDD | 8.8.0 | 8.9.0 |
| | RP-46 | RP-091322 | 3921 | - | Correction to MEASUREMENT CONTROL reception in enhanced CELL_FACH for 1.28 Mcps TDD | 8.8.0 | 8.9.0 |
| | RP-46 | RP-091322 | 3923 | - | Clarification of PICH selection scheme for 1.28 Mcps TDD | 8.8.0 | 8.9.0 |
| | RP-46 | RP-091321 | 3927 | - | Correction to CPC operation for 1.28 Mcps TDD | 8.8.0 | 8.9.0 |
| | RP-46 | RP-091258 | 3929 | 1 | Synchronization detection window configuration in CPC for 1.28 Mcps TDD | 8.8.0 | 8.9.0 |
| | RP-46 | RP-091320 | 3936 | 1 | UE support for E-UTRAN measurements and reporting in connected mode | 8.8.0 | 8.9.0 |
| | RP-46 | RP-091308 | 3946 | 1 | Optional support of Tx diversity on DL control channels for MIMO capable UEs | 8.8.0 | 8.9.0 |
| | RP-46 | RP-091325 | 3947 | - | Searching on the adjacent cell without the need for compressed mode - Rel 8 | 8.8.0 | 8.9.0 |
| | RP-46 | RP-091259 | 3955 | 1 | Carrier-specific STTD configuration for DC-HSDPA | 8.8.0 | 8.9.0 |
| | RP-46 | RP-091314 | 3959 | 1 | Correction to UE behaviour after handover to UTRAN from EUTRAN or GERAN | 8.8.0 | 8.9.0 |
| | RP-46 | RP-091329 | 3965 | - | Clarification that a configuration with RB mapping options for flexible RLC PDU size and mac-es/e is invalid | 8.8.0 | 8.9.0 |
| | RP-46 | RP-091328 | 3967 | 2 | UM RLC ciphering error detection and recovery | 8.8.0 | 8.9.0 |
| | RP-46 | RP-091328 | 3969 | - | CS voice over HSPA SDU discard timer configuration | 8.8.0 | 8.9.0 |
| | RP-46 | RP-091325 | 3972 | 1 | Correction to the implicit HARQ memory partitioning procedure for DC-HSDPA | 8.8.0 | 8.9.0 |
| | RP-46 | RP-091322 | 3975 | - | Supporting CCCH transmission on secondary frequency for | 8.8.0 | 8.9.0 |

| Change history | | | | | | | |
|----------------|-------|-----------|------|-----|---|--------|--------|
| Date | TSG # | TSG Doc. | CR | Rev | Subject/Comment | Old | New |
| | | | | | 1.28Mcps TDD | | |
| | RP-46 | RP-091317 | 3982 | - | Update UE variable VALUE_TAG to include SIB types 19 and 20 | 8.8.0 | 8.9.0 |
| | RP-46 | RP-091306 | 3985 | 1 | Correction to the reference in section 14.9.2 | 8.8.0 | 8.9.0 |
| | RP-46 | RP-091317 | 4000 | - | Standard Time Information Transmission in 1.28Mcps TDD System | 8.8.0 | 8.9.0 |
| | RP-46 | RP-091375 | 4006 | - | Common E-DCH MAC-d flow List ASN.1 definition correction | 8.8.0 | 8.9.0 |
| 03/2010 | RP-47 | RP-100199 | 4009 | 1 | Indication of MIMO codebook restriction | 8.9.0 | 8.10.0 |
| | RP-47 | RP-100284 | 4012 | - | Traffic volume measurement in CELL_PCH state | 8.9.0 | 8.10.0 |
| | RP-47 | RP-100294 | 4014 | 1 | Clarification of T323 configuration | 8.9.0 | 8.10.0 |
| | RP-47 | RP-100287 | 4016 | - | Clarification to the frequency selection operation for E-FACH of 1.28Mcps TDD | 8.9.0 | 8.10.0 |
| | RP-47 | RP-100294 | 4029 | - | UE behaviour upon RLC re-establishment or inter-RAT change before successful delivery of SCRI for fast dormancy | 8.9.0 | 8.10.0 |
| | RP-47 | RP-100285 | 4038 | 1 | Correction on measurement to E-UTRA(R8) | 8.9.0 | 8.10.0 |
| | RP-47 | RP-100287 | 4051 | - | Addition of 'Cell Selection and Re-selection Info' in measurement control | 8.9.0 | 8.10.0 |
| | RP-47 | RP-100287 | 4053 | - | Addition of HS-SCCH TPC step size for enhanced CELL_FACH for 1.28 Mcps TDD | 8.9.0 | 8.10.0 |
| | RP-47 | RP-100287 | 4055 | - | Clarification on E-RUCCH info in enhanced CELL_FACH | 8.9.0 | 8.10.0 |
| | RP-47 | RP-100289 | 4060 | - | Corrections to CPC when no DPCH is configured for 1.28 Mcps TDD | 8.9.0 | 8.10.0 |
| | RP-47 | RP-100294 | 4063 | 1 | ASN.1 issue with SIGNALLING CONNECTION RELEASE INDICATION | 8.9.0 | 8.10.0 |
| | RP-47 | RP-100294 | 4067 | - | Intra Domain NAS Node Selector Derivation | 8.9.0 | 8.10.0 |
| | RP-47 | RP-100284 | 4072 | 1 | Corrections to HS-DSCH reception in CELL-PCH and CELL-FACH | 8.9.0 | 8.10.0 |
| | RP-47 | RP-100283 | 4078 | 1 | Corrections to the Delta Primary CCPCH RSCP for 1.28Mcps TDD | 8.9.0 | 8.10.0 |
| | RP-47 | RP-100289 | 4080 | - | Clarification to the capabilities of SPS and control channel DRX in CELL_UPDATE for 1.28Mcps TDD | 8.9.0 | 8.10.0 |
| | RP-47 | RP-100288 | 4082 | 1 | Correction of RNTIs handling for Enhanced Uplink in CELL_FACH | 8.9.0 | 8.10.0 |
| | RP-47 | RP-100294 | 4087 | 2 | UE Fast Dormancy upon SRNS relocation | 8.9.0 | 8.10.0 |
| | RP-47 | RP-100294 | 4096 | - | Correction on simultaneous deletion and addition of Transport Channels in a single reconfiguration message | 8.9.0 | 8.10.0 |
| | RP-47 | RP-100294 | 4100 | 1 | Modification to Fast Dormancy in PCH States | 8.9.0 | 8.10.0 |
| | RP-47 | RP-100285 | 4102 | - | Correction to the value range of RSRQ | 8.9.0 | 8.10.0 |
| | RP-47 | RP-100293 | 4104 | 1 | Clarification for PPAC after Inter-RAT Redirection | 8.9.0 | 8.10.0 |
| | RP-47 | RP-100285 | 4108 | - | Clarification of the IE UE Security Information2 | 8.9.0 | 8.10.0 |
| 06/2010 | RP-48 | RP-100541 | 4121 | - | Clarification for Enhanced serving cell change on removal of a RL. | 8.10.0 | 8.11.0 |
| | RP-48 | RP-100537 | 4123 | 1 | Clarification of DL MAC header type setting when MAC-i is configured | 8.10.0 | 8.11.0 |
| | RP-48 | RP-100537 | 4125 | - | Clarification of Tx interruption after trigger handling for Enhanced Uplink in CELL_FACH state and Idle mode | 8.10.0 | 8.11.0 |
| | RP-48 | RP-100538 | 4127 | - | Clarification on CSG indicator (Release 8) | 8.10.0 | 8.11.0 |
| | RP-48 | RP-100538 | 4128 | - | Correct the inconsistency between tabular and ASN.1 for 'Support of CSG' in 'UE radio access capability' | 8.10.0 | 8.11.0 |
| | RP-48 | RP-100539 | 4130 | - | Correction to the E-RUCCH transmission on the secondary frequency during RRC state transition for 1.28 Mcps TDD | 8.10.0 | 8.11.0 |
| | RP-48 | RP-100532 | 4133 | 1 | Handling of RRC Unrecoverable Error in Enhanced CELL_FACH | 8.10.0 | 8.11.0 |
| | RP-48 | RP-100539 | 4140 | - | Addition of UpPCH position info in enhanced CELL_FACH | 8.10.0 | 8.11.0 |
| | RP-48 | RP-100544 | 4142 | - | Clarification on SRVCC | 8.10.0 | 8.11.0 |
| | RP-48 | RP-100539 | 4143 | 2 | Clarification on the usage of Treset for 1.28 Mcps TDD | 8.10.0 | 8.11.0 |
| | RP-48 | RP-100544 | 4145 | - | Addition of UE capability in INTER RAT HANDOVER INFO for LCR TDD | 8.10.0 | 8.11.0 |
| | RP-48 | RP-100534 | 4148 | - | Clarification on UE radio access capability in ASN1 for LCR TDD | 8.10.0 | 8.11.0 |
| | RP-48 | RP-100532 | 4160 | - | Clarification on the HS-DSCH reception in enhanced CELL_FACH state | 8.10.0 | 8.11.0 |
| | RP-48 | RP-100545 | 4175 | - | Enhanced serving cell Change allowing the re-addition of a RL in order to update target cell preconfiguration information | 8.10.0 | 8.11.0 |
| | RP-48 | RP-100543 | 4182 | - | Clarification of active set for secondary serving HS-DSCH cell | 8.10.0 | 8.11.0 |
| | RP-48 | RP-100532 | 4188 | - | Clarification on the traffic volume measurement in CELL_PCH state | 8.10.0 | 8.11.0 |
| 09/2010 | RP-49 | RP-100844 | 4192 | - | Incorrect inconsistency check on MAC-ehs reordering queue | 8.11.0 | 8.12.0 |
| | RP-49 | RP-100850 | 4198 | - | Correction to VAS updating | 8.11.0 | 8.12.0 |
| | RP-49 | RP-100842 | 4215 | - | Correction to RRC Signaling of S-CPICH power offset for MIMO UEs | 8.11.0 | 8.12.0 |

| Change history | | | | | | | | |
|----------------|-------|-----------|------|-----|--|--------|--------|--|
| Date | TSG # | TSG Doc. | CR | Rev | Subject/Comment | Old | New | |
| | RP-49 | RP-100842 | 4216 | - | Correction to missing ASN.1 for MIMO parameters | 8.11.0 | 8.12.0 | |
| | RP-49 | RP-100850 | 4219 | - | Correction to deferred SIB11 reading | 8.11.0 | 8.12.0 | |
| | RP-49 | RP-100841 | 4238 | 1 | Flexible RLC only applies to user RB, not SRB | 8.11.0 | 8.12.0 | |
| | RP-49 | RP-100883 | 4243 | 1 | LI size for CCCH(SRB#0) in enhanced CELL_FACH operation | 8.11.0 | 8.12.0 | |
| | RP-49 | RP-100844 | 4269 | - | Correction to default radio configuration #20 | 8.11.0 | 8.12.0 | |
| | RP-49 | RP-100844 | 4273 | - | Clarifications to the intra-frequency measurement event for 1.28Mcps TDD | 8.11.0 | 8.12.0 | |
| | RP-49 | RP-100846 | 4287 | 1 | Explicit HARQ Memory partitioning for dual cell operation | 8.11.0 | 8.12.0 | |
| | RP-49 | RP-100850 | 4293 | - | Correction to default configuration #23 | 8.11.0 | 8.12.0 | |
| | RP-49 | RP-100842 | 4299 | - | Clarification of when to clear IE Precoding weight set restriction" from MIMO_PARAMS" | 8.11.0 | 8.12.0 | |
| | RP-49 | RP-100848 | 4309 | - | Security procedures for intra-UTRAN SR-VCC | 8.11.0 | 8.12.0 | |
| | RP-49 | RP-100846 | 4323 | 2 | Correction of the DC-HSDPA procedures | 8.11.0 | 8.12.0 | |
| 12/2010 | RP-50 | RP-101205 | 4329 | - | Addition of ROHC target mode in SRNS relocation message | 8.12.0 | 8.13.0 | |
| | RP-50 | RP-101201 | 4332 | - | Clarification of the operation of RRC for 3.84 Mcps TDD IMB MBSFN | 8.12.0 | 8.13.0 | |
| | RP-50 | RP-101200 | 4335 | - | Correction on actions related to HSPA_RNTI_STORED_CELL_PCH | 8.12.0 | 8.13.0 | |
| | RP-50 | RP-101200 | 4340 | - | Correction on READY_FOR_COMMON_EDCH definition | 8.12.0 | 8.13.0 | |
| | RP-50 | RP-101198 | 4346 | - | CR on T324 timer usage | 8.12.0 | 8.13.0 | |
| | RP-50 | RP-101199 | 4349 | - | Power offset for Scheduling Info in MAC-i | 8.12.0 | 8.13.0 | |
| | RP-50 | RP-101203 | 4355 | - | UE behaviour when PPAC and DSAC parameters not present in SIB3 | 8.12.0 | 8.13.0 | |
| | RP-50 | RP-101204 | 4358 | - | Corrections to ETWS primary notification with security procedure | 8.12.0 | 8.13.0 | |
| | RP-50 | RP-101205 | 4367 | 1 | Correction related to inter-RAT and inter-frequency measurements on a frequency other than the used frequency | 8.12.0 | 8.13.0 | |
| | RP-50 | RP-101200 | 4384 | 3 | SIB5 changes for E-DCH in CELL_FACH and Idle Mode | 8.12.0 | 8.13.0 | |
| | RP-50 | RP-101200 | 4395 | - | RRC procedure performance requirements for Enhanced Uplink in CELL_FACH | 8.12.0 | 8.13.0 | |
| | RP-50 | RP-101200 | 4404 | - | Correction of HSPA_RNTI_STORED_CELL_PCH handling | 8.12.0 | 8.13.0 | |
| | RP-50 | RP-101198 | 4409 | 1 | Clarifications for deletion of target cell preconfiguration RL by ASU | 8.12.0 | 8.13.0 | |
| | RP-50 | RP-101200 | 4432 | 2 | Further corrections on actions related to HSPA_RNTI_STORED_CELL_PCH | 8.12.0 | 8.13.0 | |
| 03/2011 | RP-51 | RP-110267 | 4435 | - | Change in the radio bearer mapping due to a system info message | 8.13.0 | 8.14.0 | |
| | RP-51 | RP-110268 | 4439 | - | Clarification on UE behavior after transition to enhanced CELL_FACH for LCR TDD | 8.13.0 | 8.14.0 | |
| | RP-51 | RP-110267 | 4442 | - | Correction of RB mapping option selection for HSPA_RNTI_STORED_CELL_PCH | 8.13.0 | 8.14.0 | |
| | RP-51 | RP-110268 | 4447 | - | Correction on Scheduling Info parameters for LCR TDD | 8.13.0 | 8.14.0 | |
| | RP-51 | RP-110266 | 4451 | - | Inconsistency between ASN.1 and tabular format for Active Set Update message | 8.13.0 | 8.14.0 | |
| | RP-51 | RP-110264 | 4455 | - | PCI Weight set restriction logic | 8.13.0 | 8.14.0 | |
| | RP-51 | RP-110264 | 4463 | - | Use of New H-RNTI in UMI message in CELL_DCH state | 8.13.0 | 8.14.0 | |
| | RP-51 | RP-110268 | 4467 | - | Handling of variables PPAC_PARAM" and "DSAC_PARAM" | 8.13.0 | 8.14.0 | |
| | RP-51 | RP-110264 | 4474 | 1 | Reconfiguration messages and HS-SSCH orders interaction for DTX/DRX | 8.13.0 | 8.14.0 | |
| | RP-51 | RP-110266 | 4493 | - | Clarification of invalid configuration for enhanced serving HS-DSCH cell change | 8.13.0 | 8.14.0 | |
| | RP-51 | RP-110268 | 4524 | - | Clarification to the intra and inter frequency measurement in E-FACH for 1.28Mcps | 8.13.0 | 8.14.0 | |
| | RP-51 | RP-110266 | 4540 | - | Correction of target cell preconfiguration info handling upon reconfiguration | 8.13.0 | 8.14.0 | |
| | RP-51 | RP-110268 | 4556 | - | Negative values in a 'mod' function | 8.13.0 | 8.14.0 | |
| | RP-51 | RP-110266 | 4569 | 1 | Correction related to handling of DTX, DRX HS-SCCH orders upon enhanced serving cell change | 8.13.0 | 8.14.0 | |
| 06/2011 | RP-52 | RP-110829 | 4580 | 1 | Correction for SR-VCC Parameter Setting | 8.14.0 | 8.15.0 | |
| | RP-52 | RP-110829 | 4590 | - | Correction to the HS-SCCH system info for 1.28Mcps TDD | 8.14.0 | 8.15.0 | |
| | RP-52 | RP-110829 | 4593 | - | Corrections to T321 and enhanced UE DRX operation upon transition to CELL_FACH state | 8.14.0 | 8.15.0 | |
| | RP-52 | RP-110829 | 4596 | - | Fast Dormancy correction for releasing radio bearers | 8.14.0 | 8.15.0 | |
| | RP-52 | RP-110829 | 4599 | 1 | Further clarification on UE behavior during state transition from CELL_PCH/URA_PCH to CELL_FACH | 8.14.0 | 8.15.0 | |
| | RP-52 | RP-110826 | 4604 | - | Handling of START value due to an RLC reestablishment when DL RLC PDU size is reconfigured from fixed to flexible with 15-bit LI | 8.14.0 | 8.15.0 | |

| Change history | | | | | | | |
|----------------|-------|-----------|------|-----|---|--------|--------|
| Date | TSG # | TSG Doc. | CR | Rev | Subject/Comment | Old | New |
| | RP-52 | RP-110826 | 4624 | - | Clarification to the number of HARQ processes in HSDPA when switching between MIMO and non-MIMO | 8.14.0 | 8.15.0 |
| | RP-52 | RP-110829 | 4630 | - | Reconfiguration messages and HS-SSCH orders interaction for DC-HSDPA | 8.14.0 | 8.15.0 |
| | RP-52 | RP-110825 | 4640 | - | Corrections to the selection of RB multiplexing option | 8.14.0 | 8.15.0 |
| | RP-52 | RP-110829 | 4647 | 1 | Correction of actions related to TARGET_CELL_RECONFIGURATION variable | 8.14.0 | 8.15.0 |
| | RP-52 | RP-110829 | 4650 | 1 | Clearance of the stored frequency info for measure without CM | 8.14.0 | 8.15.0 |
| | RP-52 | RP-110829 | 4655 | 1 | Correction to SIB5 5bis and SIB6 handle for Enhanced Uplink | 8.14.0 | 8.15.0 |
| | RP-52 | RP-110828 | 4659 | 1 | Corrections to detection of E-UTRA cell | 8.14.0 | 8.15.0 |
| | RP-52 | RP-110827 | 4664 | 2 | Informative note of UE behaviour when change of the value of Use special value of HE field without downlink RLC entity re-establishment | 8.14.0 | 8.15.0 |
| | RP-52 | RP-110829 | 4672 | 1 | Correction to the physical channel failure in CELL UPDATE CONFIRM for 1.28Mcps TDD | 8.14.0 | 8.15.0 |
| 09/2011 | RP-53 | RP-111274 | 4729 | 2 | Clarification on Uplink DPCH power control info for Common E-DCH | 8.15.0 | 8.16.0 |
| | RP-53 | RP-111276 | 4765 | - | Disabling default configuration 17,23 in Handover To UTRAN Command | 8.15.0 | 8.16.0 |
| | RP-53 | RP-111274 | 4773 | - | Use of New E-RNTI in UMI message | 8.15.0 | 8.16.0 |
| | RP-53 | RP-111274 | 4780 | 2 | PPAC corrections | 8.15.0 | 8.16.0 |
| | RP-53 | RP-111274 | 4783 | 1 | Correction to the SPS resource configuration for 1.28Mcps TDD | 8.15.0 | 8.16.0 |
| | RP-53 | RP-111277 | 4800 | - | UE Fast dormancy upon RRC Connection Release | 8.15.0 | 8.16.0 |
| 12/2011 | RP-54 | RP-111708 | 4806 | - | Correction on the measurement configuration validation for SFN reading | 8.16.0 | 8.17.0 |
| | RP-54 | RP-111706 | 4810 | - | Corrections of PS keys handling upon PS ISHO | 8.16.0 | 8.17.0 |
| | RP-54 | RP-111701 | 4820 | - | Correction to Default Radio Configurations for TDD: invalidation of identities 0, 1, 5, 6, 7, 22 | 8.16.0 | 8.17.0 |
| | RP-54 | RP-111703 | 4862 | 2 | Clarification to the handling of HS-DSCH TB size table | 8.16.0 | 8.17.0 |
| | RP-54 | RP-111704 | 4871 | 1 | Correction of BCCH mapping on HS-DSCH | 8.16.0 | 8.17.0 |
| 03/2012 | RP-55 | RP-120320 | 4918 | 2 | Clarification on stored HARQ info when HS-DSCH reception is not supported | 8.17.0 | 8.18.0 |
| | RP-55 | RP-120320 | 4932 | - | Clarifications of the UE behaviours when initiating a cell update procedure | 8.17.0 | 8.18.0 |
| | RP-55 | RP-120322 | 4950 | - | Disabling of default radio configurations in CELL_FACH in Rel-8 | 8.17.0 | 8.18.0 |
| 06/2012 | RP-56 | RP-120803 | 4956 | - | Reconfiguration messages and HS-SCCH orders interaction for HS-SCCH less | 8.18.0 | 8.19.0 |
| | RP-56 | RP-120806 | 4964 | - | Corrections regarding the UE behaviour on evaluating the variable HSPA_RNTI_STORED_CELL_PCH | 8.18.0 | 8.19.0 |
| | RP-56 | RP-120806 | 4968 | - | Clarifications of the UE behaviours when initiating a cell update procedure for 1.28Mcps TDD | 8.18.0 | 8.19.0 |
| | RP-56 | RP-120806 | 4972 | - | Corrections on DSAC and PPAC | 8.18.0 | 8.19.0 |
| 09/2012 | RP-57 | RP-121357 | 5117 | - | Invalidation of default configuration #23 | 8.19.0 | 8.20.0 |
| | RP-57 | RP-121368 | 5184 | - | Introduction of absolute priority based measurements and reselection in CELL_FACH State in 25.331 | 8.19.0 | 8.20.0 |
| 12/2012 | RP-58 | RP-121925 | 5187 | - | Clarification to the handling of IE Different Tx diversity mode configuration from serving HS-DSCH cell | 8.20.0 | 8.21.0 |
| | RP-58 | RP-121925 | 5191 | - | Corrections to intra-UTRAN SR-VCC handover procedure | 8.20.0 | 8.21.0 |
| | RP-58 | RP-121923 | 5236 | - | Corrections to Cell Update when UE experiences failure | 8.20.0 | 8.21.0 |
| | RP-58 | RP-121925 | 5256 | - | Correction on the deactivation of the secondary cell reception | 8.20.0 | 8.21.0 |
| 03/2013 | RP-59 | RP-130229 | 5293 | - | CR to 25.331 on PRACH preamble control parameters for Enhanced Uplink (R8) | 8.21.0 | 8.22.0 |
| | RP-59 | RP-130229 | 5297 | 1 | Clarification to RRC padding for CCCH transmission in case of EUL FACH | 8.21.0 | 8.22.0 |
| | RP-59 | RP-130229 | 5320 | - | Correction of UE behavior when variable E_RNTI is not set in CELL_PCH | 8.21.0 | 8.22.0 |
| | RP-59 | RP-130228 | 5340 | - | Invalidation of ETWS with security feature | 8.21.0 | 8.22.0 |
| | RP-59 | RP-130229 | 5352 | - | Clarification on available signature ordering in common E-DCH | 8.21.0 | 8.22.0 |
| 06/2013 | RP-60 | RP-130802 | 5381 | - | LI size and Flexible RLC PDUs in uplink | 8.22.0 | 8.23.0 |
| | RP-60 | RP-130802 | 5427 | 1 | Clarification for the support of DC-HSDPA | 8.22.0 | 8.23.0 |

NOTE: CR3785 "Clarification on Scheduling Information transmission" for TS 25.331 v8.7.0 of RP-090917 which was approved by RAN #45 could not be implemented as it is actually a CR to 25.321 v8.6.0.

History

| Document history | | |
|-------------------------|---------------|-------------|
| V8.0.0 | January 2008 | Publication |
| V8.1.0 | January 2008 | Publication |
| V8.2.0 | May 2008 | Publication |
| V8.3.0 | July 2008 | Publication |
| V8.3.1 | October 2008 | Publication |
| V8.4.0 | October 2008 | Publication |
| V8.5.0 | February 2009 | Publication |
| V8.6.0 | April 2009 | Publication |
| V8.7.0 | July 2009 | Publication |
| V8.8.0 | October 2009 | Publication |
| V8.9.0 | February 2010 | Publication |
| V8.10.0 | May 2010 | Publication |
| V8.11.0 | July 2010 | Publication |
| V8.12.0 | October 2010 | Publication |
| V8.13.0 | March 2011 | Publication |
| V8.14.0 | May 2011 | Publication |
| V8.15.0 | July 2011 | Publication |
| V8.16.0 | November 2011 | Publication |
| V8.17.0 | January 2012 | Publication |
| V8.18.0 | April 2012 | Publication |
| V8.19.0 | July 2012 | Publication |
| V8.20.0 | November 2012 | Publication |
| V8.21.0 | February 2013 | Publication |
| V8.22.0 | April 2013 | Publication |
| V8.23.0 | July 2013 | Publication |