

ETSI TS 125 346 V14.0.0 (2017-04)



**Universal Mobile Telecommunications System (UMTS);
Introduction of the Multimedia Broadcast/Multicast
Service (MBMS) in the Radio Access Network (RAN);
Stage 2
(3GPP TS 25.346 version 14.0.0 Release 14)**



Reference

RTS/TSGR-0225346ve00

Keywords

UMTS

ETSI

650 Route des Lucioles
F-06921 Sophia Antipolis Cedex - FRANCE

Tel.: +33 4 92 94 42 00 Fax: +33 4 93 65 47 16

Siret N° 348 623 562 00017 - NAF 742 C
Association à but non lucratif enregistrée à la
Sous-Préfecture de Grasse (06) N° 7803/88

Important notice

The present document can be downloaded from:
<http://www.etsi.org/standards-search>

The present document may be made available in electronic versions and/or in print. The content of any electronic and/or print versions of the present document shall not be modified without the prior written authorization of ETSI. In case of any existing or perceived difference in contents between such versions and/or in print, the only prevailing document is the print of the Portable Document Format (PDF) version kept on a specific network drive within ETSI Secretariat.

Users of the present document should be aware that the document may be subject to revision or change of status. Information on the current status of this and other ETSI documents is available at
<https://portal.etsi.org/TB/ETSIDeliverableStatus.aspx>

If you find errors in the present document, please send your comment to one of the following services:
<https://portal.etsi.org/People/CommitteeSupportStaff.aspx>

Copyright Notification

No part may be reproduced or utilized in any form or by any means, electronic or mechanical, including photocopying and microfilm except as authorized by written permission of ETSI.

The content of the PDF version shall not be modified without the written authorization of ETSI.
The copyright and the foregoing restriction extend to reproduction in all media.

© European Telecommunications Standards Institute 2017.
All rights reserved.

DECT™, **PLUGTESTS™**, **UMTS™** and the ETSI logo are Trade Marks of ETSI registered for the benefit of its Members.
3GPP™ and **LTE™** are Trade Marks of ETSI registered for the benefit of its Members and of the 3GPP Organizational Partners.
GSM® and the GSM logo are Trade Marks registered and owned by the GSM Association.

Intellectual Property Rights

IPRs essential or potentially essential to the present document may have been declared to ETSI. The information pertaining to these essential IPRs, if any, is publicly available for **ETSI members and non-members**, and can be found in ETSI SR 000 314: "*Intellectual Property Rights (IPRs); Essential, or potentially Essential, IPRs notified to ETSI in respect of ETSI standards*", which is available from the ETSI Secretariat. Latest updates are available on the ETSI Web server (<https://ipr.etsi.org>).

Pursuant to the ETSI IPR Policy, no investigation, including IPR searches, has been carried out by ETSI. No guarantee can be given as to the existence of other IPRs not referenced in ETSI SR 000 314 (or the updates on the ETSI Web server) which are, or may be, or may become, essential to the present document.

Foreword

This Technical Specification (TS) has been produced by ETSI 3rd Generation Partnership Project (3GPP).

The present document may refer to technical specifications or reports using their 3GPP identities, UMTS identities or GSM identities. These should be interpreted as being references to the corresponding ETSI deliverables.

The cross reference between GSM, UMTS, 3GPP and ETSI identities can be found under <http://webapp.etsi.org/key/queryform.asp>.

Modal verbs terminology

In the present document "**shall**", "**shall not**", "**should**", "**should not**", "**may**", "**need not**", "**will**", "**will not**", "**can**" and "**cannot**" are to be interpreted as described in clause 3.2 of the [ETSI Drafting Rules](#) (Verbal forms for the expression of provisions).

"**must**" and "**must not**" are **NOT** allowed in ETSI deliverables except when used in direct citation.

Contents

Intellectual Property Rights	2
Foreword.....	2
Modal verbs terminology.....	2
Foreword.....	6
1 Scope	7
2 References	7
3 Definitions, symbols and abbreviations	7
3.1 Definitions	7
3.2 Symbols.....	9
3.3 Abbreviations	9
4 Background and introduction	10
5 MBMS UTRAN and protocol architecture	10
5.1 MBMS UTRAN architecture principles.....	10
5.1.1 MBMS Service Context in CRNC.....	10
5.1.2 MBMS Session start and MBMS Session Stop	11
5.1.3 MBMS Iu bearer	11
5.1.4 MBMS Iub bearer	12
5.1.5 Mapping of MBMS Iu bearer to p-t-p and p-t-m connections	12
5.1.6 UE Linking/De-linking	12
5.1.7 RNC Registration.....	14
5.1.8 RNC De-Registration.....	14
5.1.9 CN De-Registration	14
5.1.10 URA Linking/De-linking	14
5.1.11 IP Multicast Distribution	15
5.2 MBMS Uu Principles	15
5.2.1 MBMS Service States in UE.....	15
5.2.2 One PDCP and RLC entity shared among multiple cells within one RNS	16
5.2.3 MCCH Information Scheduling.....	16
5.2.4 MBMS Notification	17
5.2.5 MBMS Counting	18
5.2.6 MBMS Radio Bearer Release in the UE.....	19
5.2.7 MBMS Session Repetition.....	20
5.2.8 MBMS Service Prioritisation.....	20
5.3 Protocol structure	21
5.3.1 MBMS User Plane Protocol Stack Architecture.....	21
5.3.2 MBMS Control Plane Protocol Stack Architecture	22
5.4 MAC architecture	23
5.4.1 UTRAN MAC Architecture to support MBMS.....	23
5.4.2 MAC-c/sh/m architecture: UTRAN side	23
5.4.3 MAC-c/sh/m architecture: UE side.....	24
6 MBMS Channel Structure	25
6.1 Point-to-Point Transmission.....	25
6.2 Point-to-multipoint Transmission.....	25
6.2.1 Logical Channels	25
6.2.1.1 MBMS point-to-multipoint Control Channel (MCCH).....	25
6.2.1.2 MBMS point-to-multipoint Traffic Channel (MTCH).....	25
6.2.1.3 MBMS point-to-multipoint Scheduling Channel (MSCH)	25
6.2.2 Transport Channel	26
6.2.3 Physical Channel	26
6.2.4 Mapping between channels.....	26
6.2.5 Data Flows through Layer 2	27
6.2.5.1 Data flow for MCCH mapped to FACH	27

6.2.5.2	Data flow for MTCH mapped to FACH	27
6.2.5.3	Data flow for MSCH mapped to FACH.....	27
6.3.	MBMS Notification Indicator Channel	27
7	MBMS Reception and UE Capability	27
7.1	Selective and Soft Combining for MBMS P-T-M transmission.....	27
7.1.bis	Simulcast Combining (TDD only).....	28
7.1.ter	Chip Combining (1.28Mcps TDD).....	29
7.1A	MBMS over a Single Frequency Network (MBSFN)	30
7.1A.1	3.84 / 7.68 MCPS TDD MBMS over a Single Frequency Network (MBSFN).....	31
7.1A.2	FDD MBMS over a Single Frequency Network (MBSFN).....	32
7.1A.3	1.28 MCPS TDD MBMS over a Single Frequency Network (MBSFN).....	32
7.1A.4	3.84 Mcps TDD IMB MBMS over a Single Frequency Network (MBSFN).....	33
7.1B	MBMS in case of inter-RNC synchronization.....	34
7.1B.1	Control Plane aspects.....	34
7.1B.1.1	MBMS Parameter Configurations.....	34
7.1B.1.2	MBMS Counting and mode switch coordination.....	34
7.1B.1.3	Control Plane Coordination at MBMS Session Start	35
7.1B.1.3.1	Coordination of neighbor cell configuration	35
7.1B.1.4	MCCH synchronization in an MBSFN cluster.....	36
7.1B.2	User Plane aspects	36
7.1B.2.1	Timing requirements	36
7.1B.2.2	MBMS User Data flow synchronization.....	36
7.1B.2.3	User Plane recovery in case of Multiple Packets Loss.....	37
7.2	UE Capability.....	38
7.3	MBMS Reception.....	39
7.3.1	MBMS Reception in RRC Idle Mode.....	39
7.3.2	MBMS Reception in RRC Connected Mode: URA_PCH state	39
7.3.3	MBMS Reception in RRC Connected Mode: CELL_PCH state.....	40
7.3.4	MBMS Reception in RRC Connected Mode: CELL_FACH state	40
7.3.5	MBMS Reception in RRC Connected Mode: CELL_DCH state	40
8	UTRAN Signalling Flows for MBMS	41
8.1	MBMS High Level Signalling Scenarios	41
8.1.1	Session start	41
8.1.2	Joining (during a session)	43
8.1.3	Recounting.....	44
8.1.4	Session stop	45
8.2	MBMS RNC Signalling Flows.....	45
8.2.1	MBMS Session Start procedure.....	45
8.2.2	MBMS Session Update procedure.....	46
8.2.3	MBMS Session Stop procedure	46
8.2.4	RNC Registration procedure.....	47
8.2.5	RNC De-Registration procedure.....	47
8.2.6	CN De-Registration procedure	47
8.2.7	MBMS Channel Type Switching over Uu.....	48
8.2.8	MBMS UE Linking	48
8.2.9	MBMS UE De-Linking	49
8.2.10	MBMS Service Id Request	49
8.2.11	MBMS Attach/Detach over Iur.....	50
8.2.12	MBMS Channel Type Reconfiguration over Iur	50
8.2.13	Information Exchange over Iur.....	51
8.2.14	MBMS RAB Establishment Indication.....	52
8.2.15	MBMS RAB Release.....	52
8.2.16	MBMS Session Start procedure in case of IP Multicast transport.....	53
8.2.17	MBSFN MCCH Information	54
8.3	MBMS Uu Signalling Flows	54
8.3.1	Broadcast of MBMS System Information	54
8.3.2	MBMS Service Information	55
8.3.3	MBMS Radio Bearer Information	55
8.3.4	MBMS Access Information	56
8.3.5	MBMS Neighbouring Cell Information.....	56

8.3.6	MBMS Joined Indication.....	57
8.3.7	MTCH Scheduling Information.....	57
8.3.8	MBMS Change Information	58
8.3.9	MBMS P-T-P Modification Request	58
8.3.10	MBMS Counting Response	59
8.3.11	MBMS Selected Services Information	59
9	Security for MBMS.....	59
10	Mobility Procedures for MBMS.....	60
10.1	Use of Periodical Transmission of MBMS Critical Information.....	60
10.2	UE Actions for Mobility.....	60
10.2.1	RRC idle mode	60
10.2.2	URA_PCH State	61
10.2.3	CELL_PCH.....	61
10.2.4	CELL_FACH.....	62
10.2.5	CELL_DCH State	62
11	Resource Management for MBMS.....	63
11.1	MBMS Access Control Procedure	63
11.2	Frequency layer Convergence	64
11.3	Frequency layer Dispersion.....	64
Annex A (informative): MBMS Phases in UTRAN.....		65
A1	Security for MBMS.....	65
A2	MBMS Phase 2.....	65
A3	MBMS Phase 3.....	66
A4	MBMS Phases and Status Parameters.....	66
Annex B (informative): MBMS Control Information.....		67
Annex C (informative): Change history		69
History		72

Foreword

This Technical Report has been produced by the 3rd Generation Partnership Project (3GPP).

The contents of the present document are subject to continuing work within the TSG and may change following formal TSG approval. Should the TSG modify the contents of the present document, it will be re-released by the TSG with an identifying change of release date and an increase in version number as follows:

Version x.y.z

where:

- x the first digit:
 - 1 presented to TSG for information;
 - 2 presented to TSG for approval;
 - 3 or greater indicates TSG approved document under change control.
- y the second digit is incremented for all changes of substance, i.e. technical enhancements, corrections, updates, etc.
- z the third digit is incremented when editorial only changes have been incorporated in the document.

1 Scope

The present document is a technical specification of the overall support of Multimedia Broadcast Multicast Service in UTRA.

2 References

The following documents contain provisions which, through reference in this text, constitute provisions of the present document.

- References are either specific (identified by date of publication, edition number, version number, etc.) or non-specific.
- For a specific reference, subsequent revisions do not apply.
- For a non-specific reference, the latest version applies.

[1] 3GPP TR 21.905: " Vocabulary for 3GPP Specifications ".

[2] 3GPP TS 22.146: "Multimedia Broadcast/Multicast Service; Stage 1".

[3] 3GPP TS 22.246: "MBMS User Services; Stage 1".

[4] 3GPP TS 23.246: "Multimedia Broadcast Multicast Service; Architecture and Functional Description".

[5] 3GPP TR 25.992: "Multimedia Broadcast Multicast Service (MBMS); UTRAN/GERAN Requirements".

[6] 3GPP TS 23.236: "Intra-domain connection of Radio Access Network (RAN) nodes to multiple Core Network (CN) nodes".

[7] 3GPP TS 33.246: "3G Security; Security of Multimedia Broadcast/Multicast Service (MBMS)".

[8] 3GPP TS 25.301: "Radio Interface Protocol Architecture".

[9] 3GPP TS 25.211: "Physical channels and mapping of transport channels onto physical channels (FDD)".

[10] 3GPP TS 25.221: "Physical channels and mapping of transport channels onto physical channels (TDD) ".

[11] 3GPP TS 25.304: "User Equipment (UE) procedures in idle mode and procedures for cell reselection in connected mode".

[12] 3GPP TS 25.306: "UE Radio Access capabilities".

[13] 3GPP TS 25.331: "Radio Resource Control (RRC); Protocol Specification".

[14] 3GPP TS 25.446: "MBMS Synchronisation Protocol (SYNC)".

[15] 3GPP TS 23.007: "Restoration procedures".

3 Definitions, symbols and abbreviations

3.1 Definitions

For the purposes of the present document, the following terms and definitions apply.

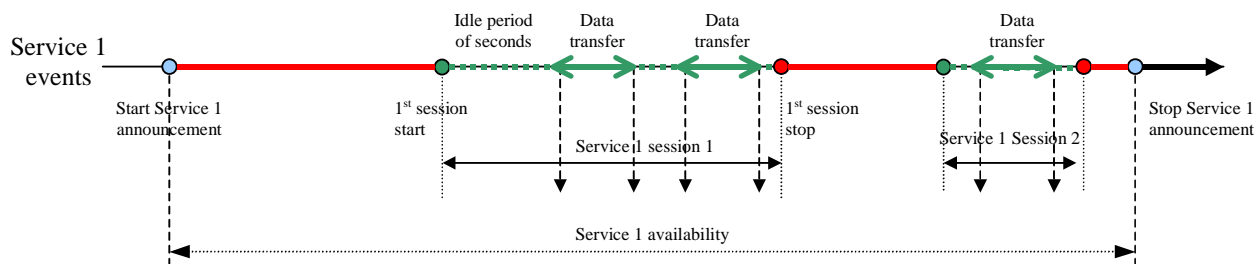

Figure 3.1: MBMS Timeline, based on [4].

MBMS session start is the point at which the BM-SC is ready to send data.

MBMS notification informs the UEs about forthcoming and about ongoing MBMS data transfer.

MBMS Cell Group is a group of multiple cells belonging to one RNS and sharing one PDCP and RLC entity to utilize p-t-m transmission of the MBMS Service

MBMS session stop is the point at which the BM-SC determines that there will be no more data to send for some period of time.

Data transfer is the phase when MBMS data are transferred to the UEs.

MBMS service availability is the phase between start of service announcement and the end of the last session or stop of service announcement.

MBMS Iu data bearer denotes the data bearer established between SGSN and RNC to transport MBMS data

MBMS radio bearer denotes the data bearer established between RNC and UE(s) to transport MBMS data

MBMS RAB denotes both, the MBMS Iu data bearer and the MBMS radio bearer

MBMS Service Context contains the necessary information for the UTRAN to control the MBMS Service in UTRAN.

MBMS Activated Services: a set of services made up of those in MBMS multicast mode that the UE has joined as well as those in MBMS broadcast mode that the UE is interested in receiving.

MBMS Selected Services: a subset of the MBMS activated services in MBMS Broadcast mode for which the UE applies RRC procedures to inform UTRAN that the service has been selected (by upper layers).

MBMS Iu signalling connection denotes the signalling connection established between the RNC and the CN node to serve one MBMS Service Context.

MBMS Service Announcement: Mechanism to allow users to be informed about the MBMS services available [4]

Pool area: see definition in ref.[6]

MBMS Multicast Service Activation: see description in ref.[4]

Critical Information: MBMS Neighbouring Cell Information, MBMS Radio Bearer Information and MBMS Service Information sent on MCCH.

Non-critical information: MBMS Access Information sent on MCCH.

MBMS Service Area: The area in which a specific MBMS session is made available. Each transmission and retransmission of an MBMS session of an MBMS Bearer Service may be made available to a different MBMS Service Area. The MBMS Service Area is described by a list of MBMS Service Area IDs, where each MBMS Service Area ID represents a group of cells. The definition of an MBMS Service Area ID is independent of an MBMS session, and of an MBMS Bearer Service. [4]

L1-combining schedule: Indicates when the soft combining is applicable between the specific S-CCPCH of the cell and the specific S-CCPCH of the neighbouring cell.

MBMS Single Frequency Network: A simulcast transmission technique realised by transmission of identical waveforms at the same time via a group of cells covering a geographic area.

MBSFN mode: In order to achieve higher spectral efficiency synchronized cells operate in MBSFN mode which implies that they transmit exactly the same content over an area that is seen as one MBSFN cell by the UE.

MBSFN cluster: Set of cells operating in MBSFN mode providing only MBMS service in PtM mode and seen as one cell by a UE.

MBMS service transmission schedule: Indicates when the specific MBMS service is expected to be transmitted in the cell in specific S-CCPCH. The information is transmitted on MSCH

S-CCPCH: In case of TDD, the S-CCPCH refers to the CCTrCH carrying FACH. In case of 3.84 Mcps TDD MBSFN IMB, the S-CCPCH refers either to S-CCPCH frame type 1 or S-CCPCH frame type 2, or both S-CCPCH frame type 1 and S-CCPCH frame type 2.

UE Link denotes the stored information in the RNC on MBMS services joined by the UE in the state other than URA_PCH in the course of the UE Linking procedure.

URA Link denotes the stored information in the RNC on MBMS services joined by a UE in URA_PCH state in the course of the URA Linking procedure.

MBMS Master RNC: role an RNC can take with respect to one or more specific MBSFN cluster(s). MRNC may be used for Inter-RNC MBSFN operation whenever dynamic synchronization of radio resources used for MBMS services is centrally controlled. There is only one MBMS Master RNC for any MBSFN cluster, which may control one or more MBSFN cluster(s). The MRNC has the overall control of the logical resources of the RNSs that are used for MBSFN operation within the MBSFN cluster(s).

Synchronisation Sequence: Each SYNC PDU contains a time stamp which indicates the start time of the synchronisation sequence. Each synchronisation sequence has the same duration which is configured in the BM-SC and the RNCs operating in inter-RNC synchronisation mode.

Synchronisation Period: The synchronisation period provides the time reference for the indication of the start time of each synchronisation sequence. The time stamp which is provided in each SYNC PDU is a relative value which refers to the start time of the synchronisation period. The duration of the synchronisation period is configurable.

3.2 Symbols

(void)

3.3 Abbreviations

For the purposes of the present document, the abbreviations given in 3GPP TS 21.905 [1] and the following apply:

CELL_DCH	
CELL_FACH	
FFS	For Further Study
FLC	Frequency Layer Convergence
IMB	Integrated Mobile Broadcast
LCI	Layer Convergence Information
MBMS	Multimedia Broadcast Multicast Service
MBSFN	MBMS over a Single Frequency Network
MBMS service ID	Multimedia Broadcast Multicast Service Identity
MBMS Session ID	Multimedia Broadcast Multicast Service session identity
MCCH	MBMS point-to-multipoint Control Channel
MICH	MBMS notification Indicator Channel
MRNC	MBMS Mater RNC
MSCH	MBMS point-to-multipoint Scheduling Channel
MTCH	MBMS point-to-multipoint Traffic Channel
NI	Notification Indicator
PL	Preferred Layer
p-t-p	Point-to-Point

p-t-m	Point-to-Multipoint
PF	Probability Factor

4 Background and introduction

The Introduction of the Multimedia Broadcast Multicast Service in UTRA describes techniques for optimised transmission of MBMS bearer service in UTRA such as point-to-multipoint transmission, selective combining and transmission mode selection between point-to-multipoint and point-to-point bearer.

The Stage 1 MBMS service requirements are defined in [2] and MBMS Stage 1 user services are defined in [3]. UTRAN (and GERAN) requirements are covered in TR 25.992 [5]. The overall architecture, functional description and the reference architecture of MBMS are covered in TS 23.246 [3].

5 MBMS UTRAN and protocol architecture

5.1 MBMS UTRAN architecture principles

5.1.1 MBMS Service Context in CRNC

Each RNC-which is controlling one or several cells within an MBMS Service area maintains an MBMS Service Context for each MBMS service.

- 1 Each CRNC MBMS Service Context is associated with an MBMS service ID, i.e. TMGI.
- 2 The CRNC MBMS Service Context contains a list of PMM connected mode UEs which are present in one or several cells of the CRNC and which have activated the MBMS service and/or a list of URAs in which there is at least one URA_PCH UE which has activated the MBMS service. The list includes at least the U-RNTI of the UEs in the state other than URA_PCH and/or URA-IDs.

NOTE: The MBMS Service Context in the CRNC contains no information about RRC Idle mode UEs.

- 3 The MBMS Service Context is created in the CRNC either
 - if the SGSN informs the RNC that a UE has activated the MBMS Service in a cell controlled by the CRNC by the UE Linking procedure. In this case, the CRNC is the SRNC of the UE,
 - or if the RNC is notified of an MBMS Session Start,
 - or if the RNC serves as a Drift RNC for a PMM-CONNECTED UE and receives for this UE a UE Link from the SRNC containing the MBMS Service Id of the concerned MBMS Service,
 - or if the RNC receives a URA Link containing the MBMS Service Id of the concerned MBMS Service.
- 4 Each RNC which is informed by the SGSN that a UE has activated one (or several) MBMS Service(s) by the UE Linking procedure maintains an MBMS Service Context for each indicated MBMS service, irrespectively of the MBMS Service Area.
- 5 The MBMS Service Context is released by the CRNC either
 - if the MBMS Service Context does not contain any UE/URA information after a UE/URA Unlinking procedure from a SGSN and there is no active MBMS Session for the concerned MBMS Service,
 - or if the MBMS Service Context does not contain any UE Link/URA Link at the time of a Session Stop
 - or if the RNC receives a CN De-Registration for MBMS Service
- 6 Associated functionalities:
 - 6.1 Bearer type selection for MBMS transmissions based on information in the CRNC MBMS Service Context. The decision process requires inter-working with Radio Resource Management and with the UE's SRNC in the case of p-t-p bearers.
 - 6.2 MBMS RB control for p-t-m bearers in each cell, based on information in the CRNC MBMS Service Context.

- 6.3 Update of the MBMS Service Context when a PMM-CONNECTED UE, which has activated an MBMS Service, has entered a cell. Update of the MBMS Service Context via Iur is performed by UE Linking.
- 6.4 Update of the MBMS Service Context when a PMM-CONNECTED UE, which has activated an MBMS Service, has left a cell. Update of the MBMS Service Context via Iur is performed by UE Un-Linking.

NOTE: For further details of UE linking via the Iur interface see chapter 5.1.6.

5.1.2 MBMS Session start and MBMS Session Stop

At MBMS Session Start and MBMS Session Stop the RNC receives a respective request from the CN. The MBMS Session Start Request shall contain the MBMS Service Id, MBMS Bearer Service Type and MBMS Session Attributes (MBMS Service Area Information, QoS parameters, ...). The MBMS Session Start Request triggers the RNC to notify UEs, which have activated the MBMS Service of the MBMS Session Start. The MBMS Session Stop Request may trigger the RNC to notify UEs, which have activated the MBMS Service of the MBMS Session Stop.

The MBMS Session Start and Session Stop procedures provide the setup and release of the MBMS RAB in the following way:

The MBMS Session Start Request shall contain all information necessary to setup an MBMS RAB. When the RNC receives an MBMS Session Start Request, it typically executes MBMS Iu data bearer set up and shall inform the sending CN node, of the outcome in the MBMS Session Start response message.

Upon reception of MBMS Session Start Request, if the MBMS Service Context is not yet present in the RNC, the RNC shall store the MBMS Service Id. Further the RNC shall memorise the MBMS Bearer Service Type, MBMS Counting Information, MBMS Counting Information and MBMS Session Attributes (MBMS Service Area Information, QoS parameters, ...) as part of the MBMS Service Context.

The RNC may choose not to execute the MBMS Iu data bearer setup, for a particular MBMS service, when:

1. The RNC does not control any cell contained within the MBMS Service Area, or
2. The RNC controls at least one cell contained within the MBMS Service Area and a list of PMM-Idle Mode UEs is included in MBMS Session Start but no RA's contained within the list are under the control of the RNC

The RNC may not execute the MBMS Iu data bearer setup for a given Iu interface in case of Iu-flex. In those cases the CN node shall be informed accordingly.

In case of Iu-flex, the RNC might receive more than one MBMS Session Start Request for an MBMS Service and shall not set up more than one MBMS Iu bearer for a certain MBMS Service towards a pool area.

When the RNC receives an MBMS Session Stop Request it shall release the associated MBMS RAB resources.

The MBMS Session Start and Session Stop procedures serve to establish and release the MBMS Iu signalling connection.

5.1.3 MBMS Iu bearer

For each MBMS service, data is transferred via an MBMS RAB between the SGSN and the UE. For each MBMS service, data is transferred via one MBMS Iu bearer between SGSN and the RNC in the whole MBMS Service area. Signalling messages specific for an MBMS Service are transferred via one dedicated MBMS Iu signalling connection between the RNC and the SGSN.

- 1 One MBMS Iu bearer is established per MBMS service at MBMS Session Start.
- 2 Regarding Iu-flex the RNC shall not set up more than one MBMS Iu bearer.
- 3 Because of the dedicated channels and Iur mobility, there is a need to send MBMS data to an RNC which is not necessarily part of the MBMS Service area.
- 4 The MBMS Iu bearer on Iu is established per MBMS service and not per UE individually.
- 5 Each PMM-CONNECTED mode UE with an activated MBMS service has its UE context bind to the MBMS Iu bearer.
- 6 There could be several MBMS RBs linked to one MBMS Iu bearer (i.e. one MBMS Iu bearer on Iu maybe mapped to multiple DTCH and/or p-t-m traffic channels over the radio -interface).

5.1.4 MBMS Iub bearer

The existing FACH transport channel mechanism over Iub is to be used in case of p-t-m MBMS transmission.

5.1.5 Mapping of MBMS Iu bearer to p-t-p and p-t-m connections

The service specific MBMS RAB on Iu may be mapped to p-t-m bearers in order to provide MBMS data via common channels.

- 1 The MBMS control function in the CRNC may decide to establish a p-t-m connection, if the number of counted MBMS users in a cell exceeds a certain operator-defined threshold or if the MBMS Counting Information indicates that MBMS Counting procedures are not applicable.
- 2 The MBMS control function in the CRNC may decide to establish a p-t-m connection depending on the congestion scenario expected for a specific cell (e.g. in hotspot areas where no bearer type switching is needed). and/or the MBMS service characteristics (e.g. session duration time) on a per cell basis.
- 3 The MBMS control function in the CRNC may, through a configurable parameter enable/disable bearer type switching and the associated procedures on a per cell basis.
- 4 The MBMS control function in the CRNC establishes an MBMS RB by sending service specific signalling messages (e.g. MBMS RB Setup message) to all the UEs in the cell listening MBMS point-to-multipoint control channel (MCCH). UEs with activated service(s) may then execute the RB set-up.
- 5 MBMS data is transferred on an MBMS point-to-multipoint traffic channel (MTCH) to all the UEs which have executed the RB setup.
- 6 The MBMS control function in the CRNC releases the MBMS RB (e.g. MBMS RB Release) when the data transfer has been finished or it has been interrupted by the CRNC.
- 7 p-t-p transmission of MBMS data should use the DTCH as defined for other dedicated services.
- 8 p-t-m transmission of MBMS data applies to all RRC states and modes.

5.1.6 UE Linking/De-linking

UE Linking denotes the process where a UE, which has joined one or several MBMS services, is linked to one or several MBMS service context in the RNC.

MBMS UE linking procedure in the SRNC is performed in following cases.

1. When the UE, which has joined an MBMS service, is moved to PMM-CONNECTED and sets up a PS RAB This may happen at any point in time during the whole MBMS service availability (i.e. before, during and between MBMS sessions).
2. When the UE joins an MBMS service and is in PMM-CONNECTED due to an existing PS RAB. This may happen at any point in time during the whole MBMS service availability (i.e. before, during and between MBMS sessions).
3. When the UE is moved to PMM-CONNECTED only for MBMS purpose, e.g. to respond to counting/recounting indication or respond to p-t-p bearer indication from RNC. This may happen at any point in time during MBMS sessions.
4. When the UE is moved to PMM-CONNECTED and the UE provides MBMS Selected Services Information to the RNC.

Keeping UEs in PMM-CONNECTED only for MBMS between sessions is implementation specific. The UE linking in the SRNC for services delivered over MBMS Multicast mode is performed via UE dedicated Iu procedures. An entry for the UE is added to the related MBMS service context(s) in the SRNC. If an MBMS service context doesn't exist yet it needs to be created.

In cases where a UE is present in a cell under the control of a drift RNC, the UE Linking is performed via Iur in the following way.

1. When the UE, which has activated one or several MBMS services, is in CELL_DCH state and starts to consume radio resources from one or several cells controlled by the DRNC, MBMS UE Linking in the DRNC

is performed via UE dedicated Iur procedures. After that the DRNC shall update the MBMS Service context on the request of every radio link setup/release from the SRNC.

2. When the UE, which has activated one or several MBMS services, is in CELL_FACH state and starts to consume radio resources from one cell controlled by the DRNC, MBMS UE Linking in the DRNC is performed via UE dedicated Iur procedures. After that the DRNC shall update the MBMS Service context in the DRNC at every intra-DRNC cell change without the need to receive UE Link from the SRNC.
3. If the UE is in CELL_DCH and CELL_FACH state and there is no dedicated RNL signalling activity ongoing for this UE and UE Linking is performed in the SRNC for an MBMS Service, MBMS UE Linking in the DRNC is performed via the MBMS Attach procedure.
4. If the UE is in CELL_PCH and moves to a cell within the DRNC area for the first time, the MBMS UE Linking in the DRNC is performed. The cell the UE moved to is indicated to the DRNC. After that at every intra-DRNC cell change the DRNC shall update the MBMS Service context in the DRNC without the need to receive UE Link from the SRNC.
5. If the UE is in CELL_PCH and there is no mobility related signalling activity ongoing for this UE and UE Linking is performed in the SRNC for an MBMS Service, MBMS UE Linking in the DRNC is performed via the MBMS Attach procedure.
6. If the UE is in RRC connected mode and UE Linking is performed in the SRNC for an MBMS Service and a session of this MBMS Service is ongoing UE Linking in the DRNC needs to be performed immediately.

At MBMS UE linking in the DRNC the MBMS service context in the DRNC needs to be updated. If an MBMS service context does not exist yet then it shall be created and if needed, DRNC can acquire the APN and IP Multicast Address from the SRNC for the specific service via Information Exchange procedure.

UE De-linking denotes the process where a UE, which has joined MBMS service(s), is removed from one or several MBMS service contexts in the RNC.

MBMS UE De-linking procedure in the SRNC is performed in following cases.

1. When the UE has left the MBMS service and is in PMM-CONNECTED due to an existing PS RAB. This may happen at any point in time during the whole MBMS service availability (i.e. before, during and between MBMS sessions).
2. When the UE sends new MBMS Selected Services Information to the RNC omitting an MBMS service which is identified on the MCCH.
3. When CN decides to de-link a certain PMM-CONNECTED mode UE due to e.g. error cases.

MBMS UE De-linking in the SRNC for services in MBMS Multicast mode is performed via UE dedicated Iu procedure. The entry for the UE is removed from the concerned MBMS service context(s) in the SRNC.

MBMS UE De-linking procedure in the DRNC is performed via Iur in the following way:

1. If the UE is in CELL_DCH or CELL_FACH state and stops consuming the radio resources from one or several cells controlled by the DRNC, MBMS UE is De-linked from the MBMS Service Context in the DRNC via UE dedicated Iur procedure.
2. If the UE is in CELL_DCH or CELL_FACH state and there is no dedicated RNL signalling activity ongoing for this UE and UE De-linking is performed in the SRNC for an MBMS Service, MBMS UE De-linking in the DRNC is performed via the MBMS Detach procedure.
3. If the UE is in CELL_PCH and leaves for a cell out of the DRNC area the UE is delinked from the MBMS Service context in the DRNC via the MBMS Detach procedure. The cell the UE moved out of is indicated to the DRNC.
4. If the UE is in RRC connected mode and UE De-linking is performed in the SRNC for an MBMS Service and a session of this MBMS Service is ongoing UE De-linking in the DRNC needs to be performed immediately.

5.1.7 RNC Registration

RNC Registration for a certain MBMS Service denotes the process where the CN becomes aware of an RNC hosting UEs, which have activated that MBMS Service.

Due to UE mobility, a RNC with no MBMS Service Context, can be informed that a PMM-CONNECTED UE, which has entered the cell, has activated an MBMS Service by means of the MBMS UE Linking procedure via the Iur interface. Then the RNC informs the CN that it would like to receive MBMS Session Start Request messages when applicable for the concerned MBMS Service by sending MBMS Registration Request message.

It results in the set-up of a corresponding MBMS distribution tree, but it does not result in the establishment of Iu user plane, which will be established by the MBMS Session Start procedure.

1. Implicit Registration

- RNC Registration for Serving RNCs is performed implicitly, i.e. due to UE linking and MBMS Multicast Service Activation. No explicit registration procedure needs to be performed.

2. Explicit Registration

- RNC Registration for Drift RNCs is performed explicitly if an RNC becomes a Drift RNC for a UE, which has activated an MBMS service and has no MBMS Service Context for that MBMS Service.
- RNC Registration for Drift RNCs is performed explicitly if an RNC is no longer the SRNC of any connected UE which has activated an MBMS service, but hosts at least a UE which consumes radio resources of the RNC via Iur. This shall happen only before sessions or between sessions.
- The DRNC will perform a registration towards its default CN node only.

5.1.8 RNC De-Registration

RNC De-Registration for a certain MBMS Service denotes the process where the CN becomes aware that an RNC registered at a CN node does not host any more PMM-CONNECTED UEs which have activated that MBMS Service.

• Implicit RNC De-Registration

- RNC De-Registration for Serving RNCs is performed implicitly, i.e. due to UE Unlinking and MBMS Multicast Service Deactivation. No explicit de-registration procedure needs to be performed.

• Explicit RNC De-Registration

- RNC De-Registration for Drift RNCs is performed explicitly if a RNC is not acting as a Serving RNC and has ceased to act as a Drift RNC for UEs which have activated an MBMS service, it will perform a de-registration towards the CN node it was registered to.
- The timing of RNC De-Registration is implementation specific.

NOTE: When the Drift RNC performs the explicit De-registration, the Implicit registration may still remain and in that case Iu data bearer should not be removed.

5.1.9 CN De-Registration

CN De-Registration denotes the process where the CN informs the RNC that a certain MBMS service is no longer available. CN De-Registration should result in releasing of all associated MBMS Service Contexts and resources.

The CN De-Registration procedure serves to release the MBMS Iu signalling connection.

5.1.10 URA Linking/De-linking

URA Linking denotes the process where a URA, which contains one or more cells in which at least one URA_PCH UE has joined the MBMS service or has passed MBMS Selected Service Information about the MBMS service, is linked to an MBMS service context in the RNC. An entry for the URA is added to the MBMS service context in the RNC.

If the UE in URA_PCH state, which has activated one or several MBMS Services, is present within a URA containing one or more cells that are controlled by one or more drift RNCs, the URA Linking is performed in the following way.

1. If the UE is in URA_PCH, having activated one or more MBMS services, is the first UE for the particular MBMS service to move to a URA which contains one or more cells that are controlled by one or more DRNCs, the URA is linked to the MBMS Service context in each applicable DRNC. The URA the UE moved to will be indicated.
2. As long as the SRNC serves UEs in URA_PCH in URAs containing cells controlled by one or more DRNCs, the SRNC shall keep the other RNCs informed about every URA in which UEs having activated certain MBMS services have to be notified. This is done when the first UE enters the URA, by indicating to the other RNCs a list of URAs and the corresponding MBMS Services via MBMS Attach procedure.

NOTE: Bullet points 1 and 2 above may be merged in a future version of this document.

At MBMS URA linking in the RNC the MBMS service context in the RNC needs to be updated. If an MBMS service context does not exist yet then it shall be created and acquire the APN and IP Multicast Address from the SRNC for the specific service via Information Exchange procedure.

URA De-linking denotes the process where a URA is removed from one or several MBMS service contexts in the RNC.

1. If the UE is in URA_PCH and, for the particular MBMS service, is the last UE to leave a URA which contains one or more cells controlled by one or more DRNCs the URA is de-linked from the MBMS Service context in each applicable DRNC via the MBMS Detach procedure.

5.1.11 IP Multicast Distribution

To improve the transport efficiency the IP Multicast may be used for the MBMS payload distribution in the backbone network between the GGSN and the RNCs, bypassing the SGSN.

The GGSN allocates during the session start the Transport Layer Address used for the IP-multicast and the DL TEID used for the Iu Transport association. The RNCs will receive these parameters from SGSN in the Session Start message as part of the MBMS session attributes.

The RNC may accept or reject the proposed IP Multicast distribution in the MBMS Session Start Response to the SGSN. If accepted the RNC shall report the channel (IP Multicast and Source address) to the backbone in order to join the bearer service multicast distribution. If one or more downstream RNC nodes doesn't accept IP Multicast distribution, the SGSN will establish an MBMS RAB which the IP multicast distribution is not applied, to related RNCs.

The MBMS payload is forwarded by the GGSN towards the IP Multicast address. The RNCs joined to that IP Multicast address will receive the user data packets (SYNC PDU) together with the synchronisation-related information in header part of SYNC PDU. The information in header part of SYNC PDU is delivered to allow the softcombining and MBSFN transmission across the RNCs. The details of inter-RNC synchronization are described in section 7.1B.

In case the header compression is used in MBMS PtM mode for an MBMS stream the compression is done in BM-SC. The usage of header compression is configured in advance in the BM-SC and the RNC is receiving the information during the MBMS Session start as part of the session attributes. In case header compression is configured, the MBMS user data packets forwarded from BM-SC to RNCs via GGSN will contain in addition to the synchronisation-related information and PDCP protocol information, the full IP header of the payload and the payload with compressed header. The RNC using MBMS PtP mode in a cell may process the UE dedicated RoHC for the full IP header of the payload and replace the compressed header of PtM mode with it.

5.2 MBMS Uu Principles

5.2.1 MBMS Service States in UE

The MBMS bearer service has following service states in the UE:

1. Not active, UE has not joined any MBMS multicast service or not activated the broadcast mode of the MBMS
2. Not active, UE has joined at least one MBMS multicast service and/or activated the broadcast mode of the MBMS, but MBMS SYSTEM INFORMATION is not broadcasted on BCCH.

3. Active, UE has joined at least one MBMS multicast service and/or activated the broadcast mode of the MBMS, but any of the services that UE has joined (interested in broadcast mode) is not being transmitted. UE monitors MICH to find modifications in the MCCH as defined in 5.1.6
4. Active; at least one MBMS service appearing in the list of MBMS Activated Services, is received on p-t-m
 - UE is receiving MBMS transmission on MTCH
 - UE is using DRX based on scheduling information informing that coming MTCH transmission is not in the interest of the UE.
5. Active; at least one MBMS service is received on p-t-p
6. Active; at least one MBMS service is received on p-t-p and at least one MBMS service is received on p-t-m. (only valid if UE has capability to support this combination)

When MBMS transmission is started in cell the UE moves from state 3 to either state 4 or state 5 (6), depending on p-t-p transmission mode and after MBMS transmission ends in the cell, the UE moves from state 4 or state 5 (6) to state 3.

5.2.2 One PDCP and RLC entity shared among multiple cells within one RNS

For each MBMS service, a group of multiple cells belonging to one RNS shares one PDCP entity and RLC entity over p-t-m transmission. The group of multiple cells is called 'MBMS Cell Group'.

1. There are one or more MBMS Cell Groups per RNS. The MBMS Cell Groups are managed by the CRNC.
2. There are one or more cells pertaining to the same RNS for one MBMS Cell Group.
3. The MBMS Cell Group identity is used to uniquely identify a group of multiple cells, which for each MBMS service share the same PDCP entity and RLC entity within an RNS.

In case the MBMS combining methods are used across multiple RNSs for an MBMS service, the RNSs belong to the same IP Multicast group used for the MBMS user data distribution from the GGSN to CRNCs. One common PDCP entity for header compression is used for MBMS P-t-M transmission among the RNSs being part of the IP Multicast group.

The RLC entity for p-t-m transmission is shared by a group of multiple cells belonging to one RNS. The RLC entities, within the RNSs shall be synchronized to each other in way that they, process the user data in the same manner with the help of information delivered by the SYNC-protocol to RNS.

5.2.3 MCCH Information Scheduling

The MCCH information will be transmitted based on a fixed schedule. This schedule will identify the TTI containing the beginning of the MCCH information. The transmission of this information may take a variable number of TTIs and the UTRAN should transmit MCCH information in consecutive TTIs. The UE will keep receiving the S-CCPCH until:

- It receives all of the MCCH information, or
- It receives a TTI that does not include any MCCH data, or
- The information contents indicate that further reception is not required (e.g. no modification to the desired service information).

Based on this behaviour, the UTRAN may repeat the MCCH information following a scheduled transmission in order to improve reliability. The MCCH schedule will be common for all services.

The entire MCCH information will be transmitted periodically based on a "repetition period". The "modification period" will be defined as an integer multiple of the repetition period. The MBMS ACCESS INFORMATION may be transmitted periodically based on an "access info period". This period will be an integer divider of the "repetition period".

MCCH information is split into critical and non-critical information. The critical information is made up of the MBMS NEIGHBOURING CELL INFORMATION, MBMS SERVICE INFORMATION and MBMS RADIO BEARER INFORMATION. The non-critical information corresponds to the MBMS ACCESS INFORMATION. Changes to critical information will only be applied at the first MCCH transmission of a modification period and in the beginning of each modification period UTRAN transmits the MBMS CHANGE INFORMATION including MBMS services ids whose MCCH information is modified at that modification period. MBMS CHANGE INFORMATION is repeated at least once in each repetition period of that modification period. Changes to non-critical information could take place at any time.

The Figure 5.2.3 below illustrates the schedule with which the MBMS SERVICE INFORMATION and RADIO BEARER INFORMATION would be transmitted. Different colours indicate potentially different MCCH content.

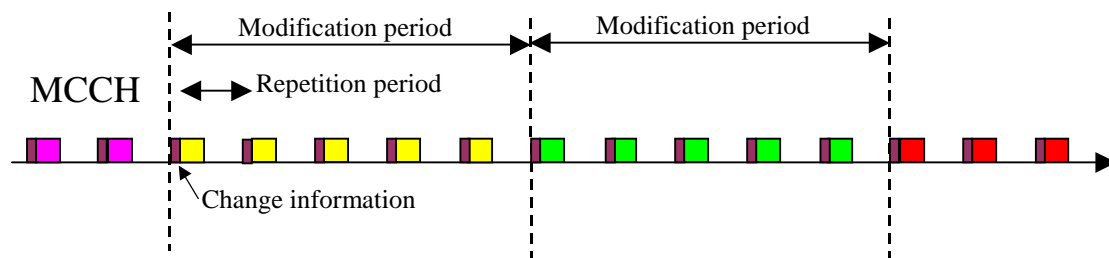

Figure 5.2.3: MCCH Information Schedule

5.2.4 MBMS Notification

The MBMS notification mechanism is used to inform UEs of an upcoming change in critical MCCH information. Notifications are based on service groups. The mapping between service IDs and service groups is specified in [11].

The MBMS notification indicators will be sent on an MBMS specific PICH, called the MICH. A single MICH frame will be able to carry indications for every service-group.

Critical MCCH information can only be changed at the beginning of a modification period as described in Section 5.2.3. The MBMS notification indicator corresponding to the service group of every affected service shall be set continuously during the entire modification period preceding the first change in MCCH information related to a given service. Subsequent changes in the MCCH information in the next modification period related to the same service can be signalled on the MCCH.

UEs which are not receiving any MBMS service on MTCH or p-t-p channel are free to read the MBMS notification at any time; however the modification interval shall be long enough so that UEs are able to reliably detect it even if they only receive the MICH during their regular Release '99 paging occasions.

Upon detecting the MBMS notification indication for a service group, UEs with an activated service service corresponding to this group shall start reading the MCCH at the beginning of the next modification period. The UE shall read at least MBMS CHANGE INFORMATION.

The Figure 5.2.4 below illustrates the timing relation between the setting of the MICH and the first MCCH critical information change. The green colour for the MICH indicates when the NI is set for the service. For the MCCH, different colours indicate MCCH content related to the notification of different services.

UEs, which are receiving MBMS service(s) on MTCH in idle mode or URA_PCH, CELL_PCH, or CELL_FACH state shall read the MCCH at the beginning of the each modification period to receive the MBMS CHANGE INFORMATION, which will indicate MBMS service Ids and optionally MBMS Session ID whose MCCH information is modified at that modification period. If MBMS service Id and optionally MBMS Session ID, which UE has activated, is indicated in MBMS CHANGE INFORMATION the UE shall read the rest of the MCCH information.

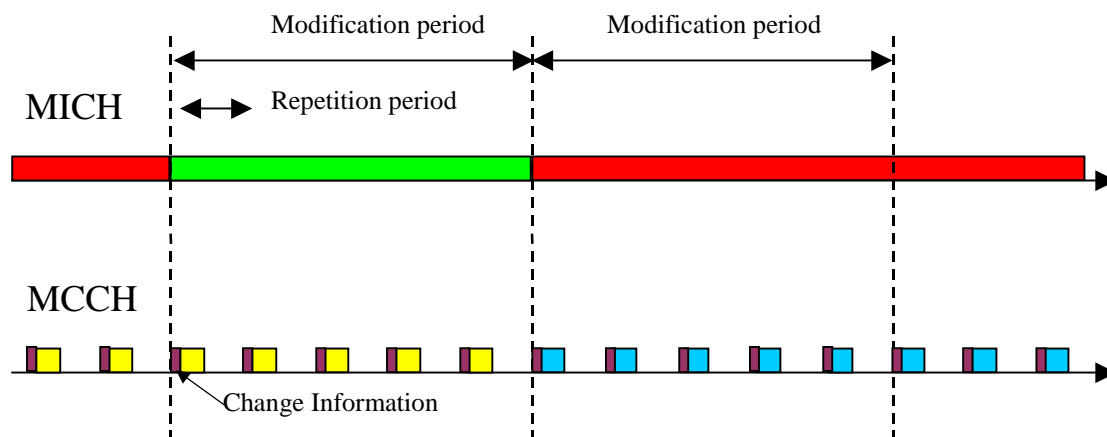

Figure 5.2.4: Illustration of MICH timing relative to Modification period

5.2.5 MBMS Counting

MBMS Counting is used to determine the optimum transmission mechanism for a given service.

1. The need for counting is indicated in the notification, and achieved by requesting UEs, belonging to the same MBMS service group, to respond to counting by sending MBMS COUNTING RESPONSE signalling flow to CRNC.
 - a. For UEs in idle mode the counting response refers to the RRC connection establishment procedure.
 - b. For UEs in URA_PCH, or CELL_PCH state the counting response refers to cell update procedure
 - c. For UEs in CELL_FACH state the counting response refers to signalling on CCCH or DCCH.
2. The exact number of UEs that need to respond to counting is an RRM issue.
3. Since it is desirable in a specific cell, to avoid bringing a large number of UEs for counting purposes to RRC connected mode at the same time (RACH load, etc), RRM may control the load due to the RRC connection establishment requests, by setting an access "probability factor". For UEs in PMM connected mode the UTRAN may set different "probability factor" than for UEs in idle mode.
4. Following counting, the number of subscribers that need to be maintained in RRC connected mode or for which the RNC releases their connection, is also an RRM issue. In Broadcast Mode, the RNC may also decide to reject the RRC connection establishment and indicate during this reject that counting has been completed.
5. For a given MBMS service, the counting indication in the notification may be switched on and off, on per-cell basis.
6. The RNC may use notification to indicate counting during an ongoing MBMS session (term used is re-counting).
7. The RNC receives via Iu from CN information (MBMS service ID) about UEs who are in RRC Connected mode, and have joined the MBMS service. This information may be used for counting purposes.

The MBMS counting function includes a mechanism by which the UTRAN can prompt UEs with a given activated service to become RRC connected. This procedure is only applicable for UEs in idle mode and relies on the MBMS ACCESS INFORMATION transmitted on the MCCH. The probability factor indicates the probability with which UEs need to attempt an RRC connection procedure.

In order to trigger counting for a given service, the UTRAN may use the regular MBMS notification mechanism outlined in section 5.2.4 to force UEs with that service activated to read the MCCH information.

Once a UE detects that the counting procedure is on-going for the specific service it wants to receive, it will attempt to respond to the counting based on the probability factor included in the MCCH. If the response to counting is for a service identified in the list of MBMS Selected Services, the UE should provide the MBMS Service ID in the response.

Also, the UE will keep receiving the MBMS ACCESS INFORMATION at every access info period until the UE successfully responds to the counting or counting is no longer required. Whenever it receives new MBMS ACCESS INFORMATION the UE will update its probability factor with the new value.

The Figure 5.2.5 below illustrates this mechanism. The green colour for the MICH indicates when the NI is set for the service. The green colour for the MBMS ACCESS INFORMATION indicates that the counting procedure is on-going and that UEs need to establish an RRC connection based on the included probability factor (PF). For the critical MCCH info, different colours indicate potentially different content.

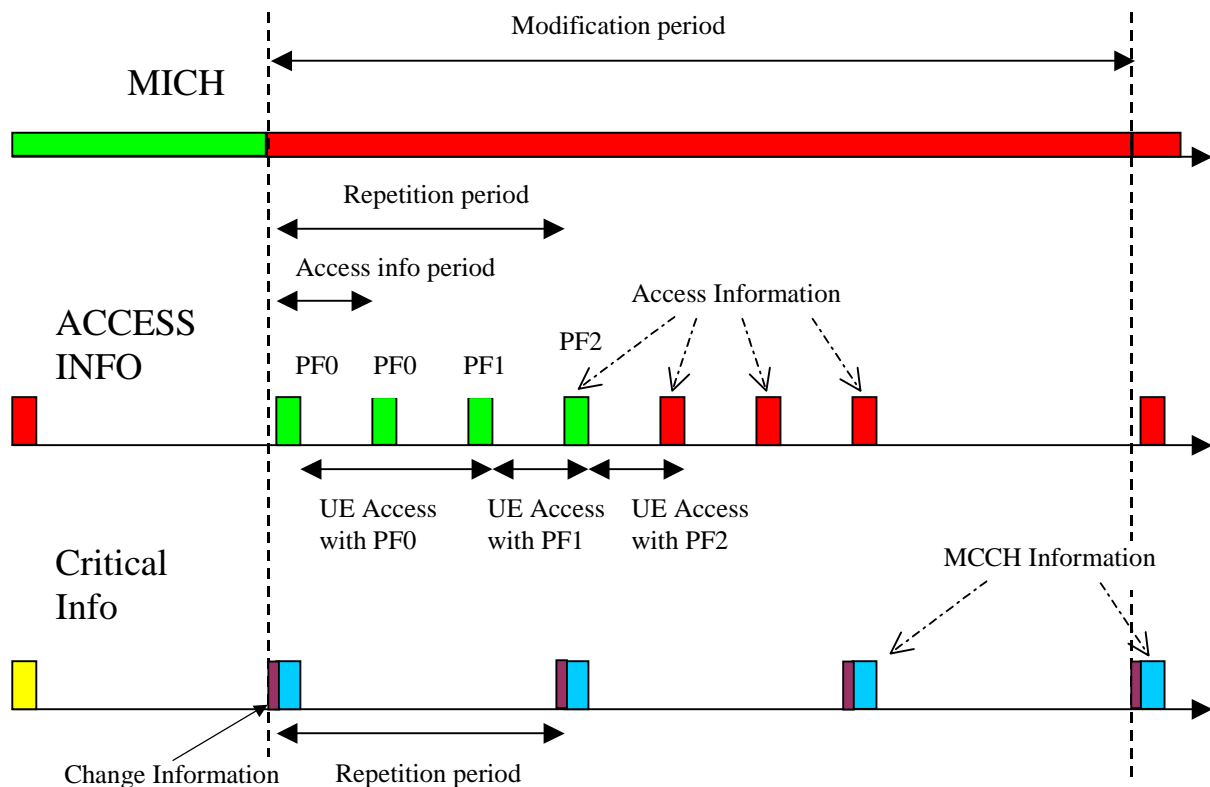

Figure 5.2.5: Illustration of Access Info period during MBMS counting

For every UE brought to RRC connected state for the purpose of counting, UTRAN will initiate the PMM Connection establishment procedure and will obtain from CN the set of MBMS services these users have joined.

Counting for on-going services (re-counting) will rely on the same scheduling of the MCCH information.

5.2.6 MBMS Radio Bearer Release in the UE

The UE releases the MBMS RB by using one of the following mechanisms:

- Explicit MBMS RB Release
- Implicit MBMS RB Release

The Explicit MBMS RB Release mechanism allows UTRAN to explicitly indicate to MBMS UEs that an MBMS Radio Bearer should be released. For p-t-m transmissions the Explicit MBMS RB Release indication is contained within the MBMS SERVICE INFORMATION signalling flow. For p-t-p transmission the release of MBMS radio bearers is completed in the same way as for a non-MBMS radio bearer. If the Explicit MBMS RB Release indication is received, the UE releases the MBMS RB.

The Implicit MBMS RB Release mechanism applies only to p-t-m transmission and enables a UE to release the MBMS Radio Bearer without receiving the Explicit MBMS RB Release. The UE identifies Implicit MBMS RB release if it detects that the RB is not present in the MBMS SERVICE INFORMATION signalling flow.

5.2.7 MBMS Session Repetition

In the case that the BM-SC repeats MBMS sessions (send multiple time identical content), the MBMS service Id and MBMS session Id is used to identify specific MBMS service and session. The validity of the session Id is handled on the MBMS application layer between the BM-SC and the UE. If UTRAN receives the MBMS session ID in session start, the UTRAN should:

- include MBMS session Id in critical and non critical information send on MCCH
Note: The non-critical information may contain index referring to critical information, avoiding repetition of MBMS service and session Id in non-critical information.

If the UE has already received correctly the data of the MBMS session, which is being indicated on MCCH, the UE may:

- ignore FLC by not applying the Layer Convergence Information
- ignore counting procedure in Idle, URA_PCH, CELL_PCH, and CELL_FACH state
- ignore p-t-m MBMS RB setup signalled on MCCH
- ignore p-t-p MBMS RB indication signalled on MCCH
- reject the p-t-p RB setup for MBMS service, signalled on DCCH

In the case that UTRAN receives reject from the UE to the p-t-p RB setup for MBMS service on DCCH, the UTRAN should not try to re-establish p-t-p RB setup for that MBMS service and session.

In the case that the UE has accepted the p-t-p RB for repeated MBMS session the UE shall receive the complete session.

5.2.8 MBMS Service Prioritisation

The CN may assign the Allocation and Retention Priority for the MBMS bearer service. The Allocation and Retention Priority allows for prioritisation between MBMS bearer services and between MBMS bearer services and non MBMS bearer services in the UTRAN.

The UE may assign internally different priorities for different MBMS services to prioritise MBMS and non MBMS service reception. In case that UE has no capability to receive simultaneously, the dedicated non MBMS service and the MBMS service and the MBMS service has priority over the non MBMS service the UE may:

- initialise signalling with CN on NAS layer to stop reception of dedicated non MBMS service

If the UE has no capacity on receiving all MBMS services, which it has activated and which are transmitted simultaneously on p-t-m RBs, the UE may

- stop autonomously ongoing reception of lower priority MBMS service
- act on MCCH message assigned to the highest priority MBMS service
- start autonomously the reception p-t-m RB of the highest priority MBMS service

If the reception p-t-p RB of the lower priority MBMS service is blocking the reception of p-t-m RB of the higher priority MBMS service the UE may:

If p-t-p RB is being established

- reject the setup of p-t-p MBMS RB

If the UTRAN receives reject message UTRAN should not try to re-establish p-t-p RB setup for that MBMS service and session.

If p-t-p RB is already existing

- request the release of p-t-p MBMS RB from the UTRAN or only indicate frequency of higher priority MBMS service

If the UTRAN receives release request message UTRAN may release the p-t-p MBMS RB.

5.3 Protocol structure

5.3.1 MBMS User Plane Protocol Stack Architecture

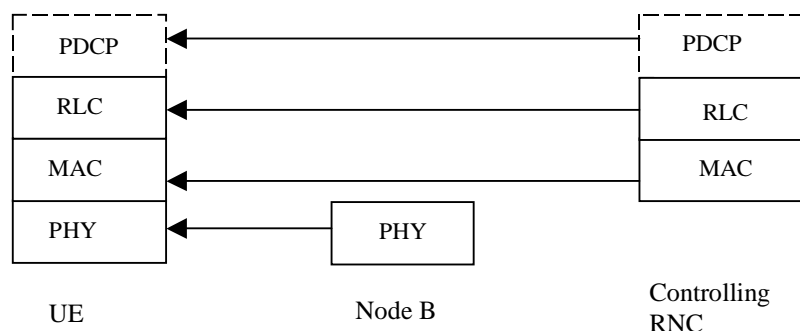

Figure 5.3.1-1: Protocol Stack for MTCH

Figure 5.3.1-1 illustrates the protocol termination for MTCH in MBMS, which is used in p-t-m transmission.

If configured by CRNC the PDCP sub-layer performs header compression/decompression for the MBMS traffic.

The PDCP sub-layer may operate with the RFC 3095 header compression protocol. In that case, header compression should be performed under RFC 3095 U-mode.

In the UTRAN, for p-t-m transmission, there is one PDCP entity for each MBMS service for each MBMS Cell Group that provides the service (an MBMS Cell Group may contain one or more than one cell).

In the UTRAN, for p-t-m transmission, there is one RLC entity for each MBMS service in each cell or cell group in case of utilization of selective combining or maximum ratio combining in TDD, and one MAC entity for each cell.

In the UE side, there is one PDCP and RLC entity for each MBMS service in each UE. In each UE there is one MAC entity per received cell when UE is performing the selective combining between these cells.

In case of p-t-p transmission, DTCH is used for MBMS transmission and the protocol termination for DTCH mapped on DCH and RACH/FACH are presented in [8].

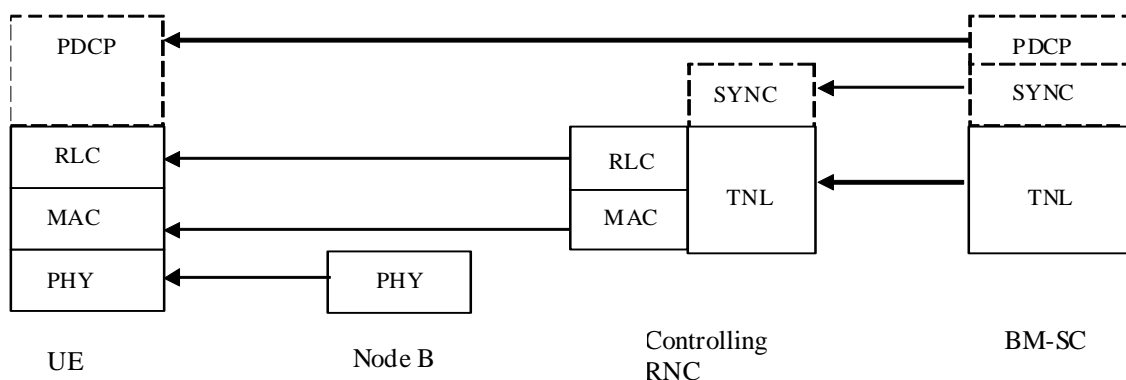

Figure 5.3.1-2: Protocol Stack for MTCH (P-T-M) in case of IP multicast distribution

Figure 5.3.1-2 illustrates the protocol termination for MTCH in MBMS, which is used in p-t-m transmission in case of IP Multicast distribution.

Based on the configuration in BM-SC the PDCP sub-layer may perform header compression/decompression for the MBMS traffic.

The PDCP sub-layer may operate with the RFC 3095 header compression protocol. In that case, header compression should be performed under RFC 3095 U-mode.

In the UTRAN, for p-t-m transmission, there is one PDCP entity for each MBMS service for each MBMS IP Multicast Group that provides the service (an MBMS IP Multicast Group may contain one or more than one RNC, see section 5.2.2).

For p-t-m transmission there is one RLC entity for each MBMS service in each cell or in a group of multiple cells belonging to one RNS. The RLC entities, in the RNSs synchronized to each other, shall process the user data similar manner with the help of information delivered by the SYNC-protocol to RNS. There is one MAC entity for each cell.

In the UE side, there is one PDCP and RLC entity for each MBMS service in each UE. In each UE there is one MAC entity per received cell when UE is performing the selective combining between these cells.

In case of p-t-p transmission, DTCH is used for MBMS transmission and the protocol termination for DTCH mapped on DCH and RACH/FACH are presented in [8].

5.3.2 MBMS Control Plane Protocol Stack Architecture

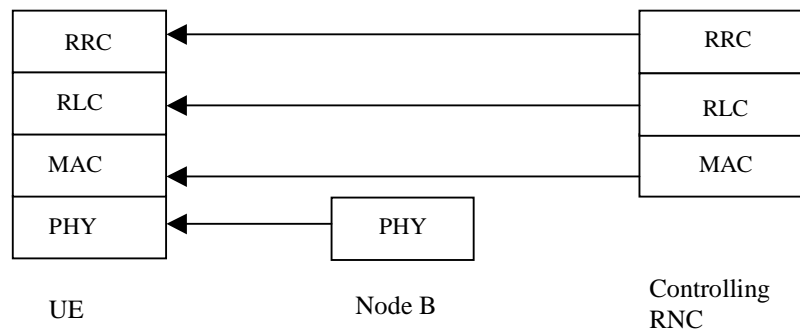

Figure 5.3.2-1: Protocol Stack for MCCH and MSCH

Figure 5.3.2-1 illustrates the protocol termination for MCCH and MSCH in MBMS, which are MBMS p-t-m control channels.

MBMS functionalities are included in MAC and RRC.

In case of p-t-p transmission, DCCH is used for MBMS and the protocol termination for DCCH mapped on DCH and FACH are presented in [8].

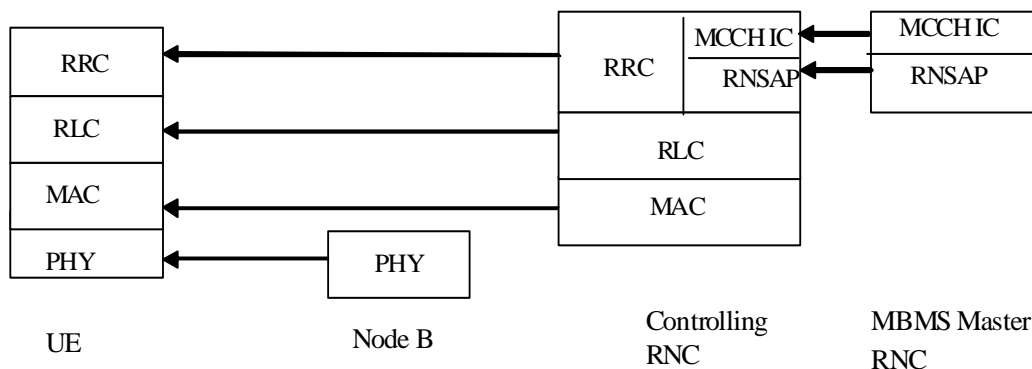

Figure 5.3.2-2: Protocol Stack for MCCH

In case MRNC is used, figure 5.3.2-2 illustrates the protocol termination for MCCH in MBMS, which is MBMS p-t-m control channel.

MBSFN MCCH Information Control function is split between MRNC and CRNC. The MRNC controls the logical resources of the RNSs that are used for MBSFN operation within the MBSFN cluster(s). The MRNC informs the CRNC of the MCCH configuration (using transfer of MCCH Information Control messages) and schedule information to be used (included in RNSAP). The CRNC performs the MCCH configuration and sends the MCCH information accordingly.

5.4 MAC architecture

5.4.1 UTRAN MAC Architecture to support MBMS

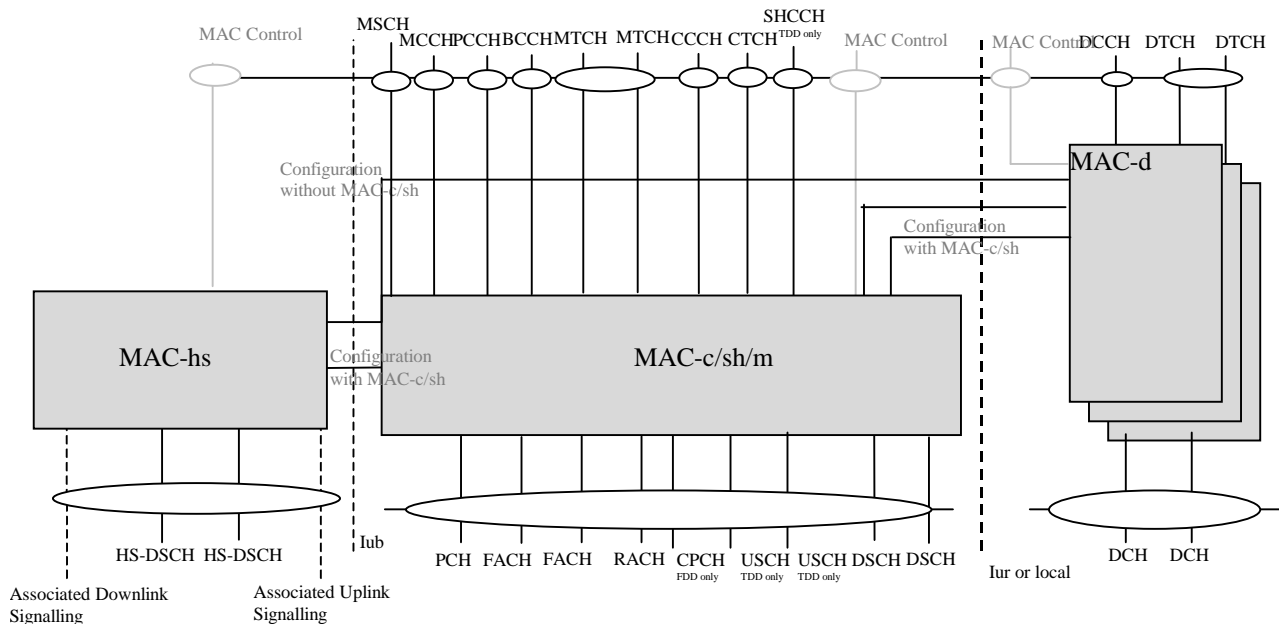

Figure 5.4.1: UTRAN MAC architecture

To support MBMS user and control plane transmission, a multicast functionality is added in the MAC c/sh, entitled "MAC m", to take care of scheduling of MBMS related transport channels as presented in Figure 5.4.1. In addition, three logical channels are considered for p-t-m transmission of MBMS: MCCH, MSCH and MTCH. These logical channels are mapped on FACH. In case of p-t-p transmission DTCH and DCCH are used.

5.4.2 MAC-c/sh/m architecture: UTRAN side

Figure 5.4.2 illustrates the MAC-m additions to the MAC-c/sh architecture in the UTRAN side, needed to transmit MBMS data over a common transport channel (FACH).

MAC-c/sh/m is located in the controlling RNC. The following functionalities are covered:

- **Scheduling / Buffering / Priority Handling:** This function manages common transport resources between MBMS and non-MBMS data flow(s) according to their priority and delay requirements set by higher layers.
- **TCTF MUX:** This function handles insertion of the TCTF field in the MAC header and also the respective mapping between logical channels (i.e. MTCH and MCCH) and transport channels. The TCTF field indicates which type of logical channel (i.e. MTCH and MCCH) is used.
- **Addition of MBMS-ID:** For p-t-m type of logical channels, the MBMS-ID field in the MAC header is used to distinguish between MBMS services.
- **TFC selection:** Transport format combination selection is done for a common transport channel (FACH) mapped to MTCH, MSCH and MCCH. In the case of MBMS soft combining (excluding TrCH combining in TDD), the combinable S-CCPCHs shall have the same TFC during the TTIs in which L1 combining is used.

There is one MAC-c/sh/m entity in the UTRAN for each cell.

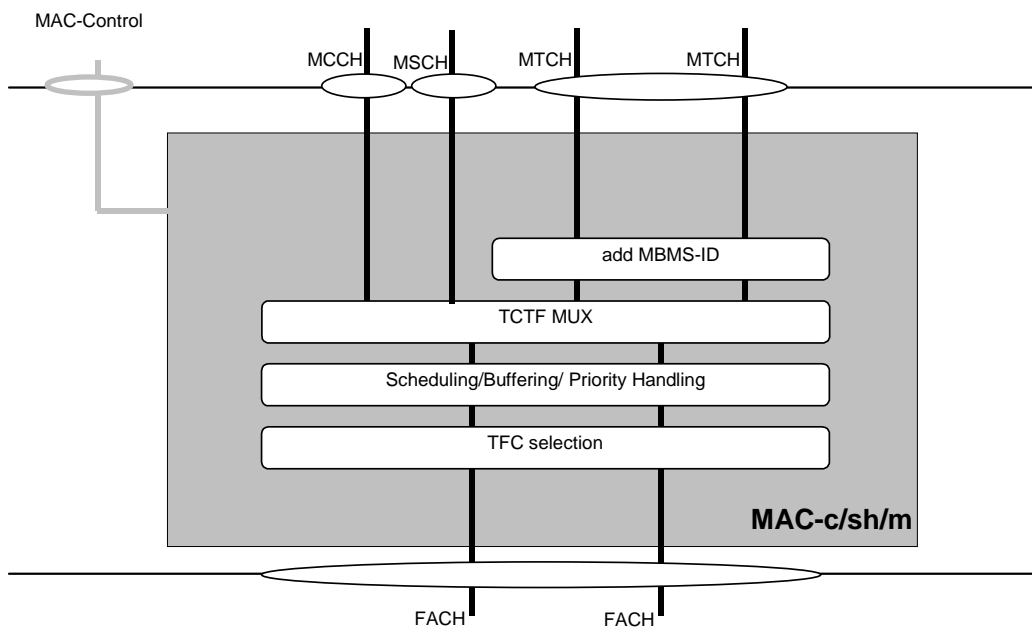

Figure 5.4.2: UTRAN side MAC-m architecture additions to MAC-c/sh

5.4.3 MAC-c/sh/m architecture: UE side

Figure 5.4.3 illustrates the MAC-m additions to the MAC-c/sh architecture in the UE side, needed to receive MBMS data over a transport channel (FACH).

The following functionalities are covered:

- TCTF DEMUX: This function handles detection and deletion of the TCTF field in the MAC header, and also the respective mapping between logical channels (i.e. MTCH and MCCH) and transport channels. The TCTF field indicates which type of logical channel (i.e. MTCH and MCCH) is used.
- Reading of MBMS-ID: The MBMS-ID identifies data to a specific MBMS service.

There is one MAC-m entity in the UE or in case of selective combining one MAC-m entity for each selectively combined cell in the UE.

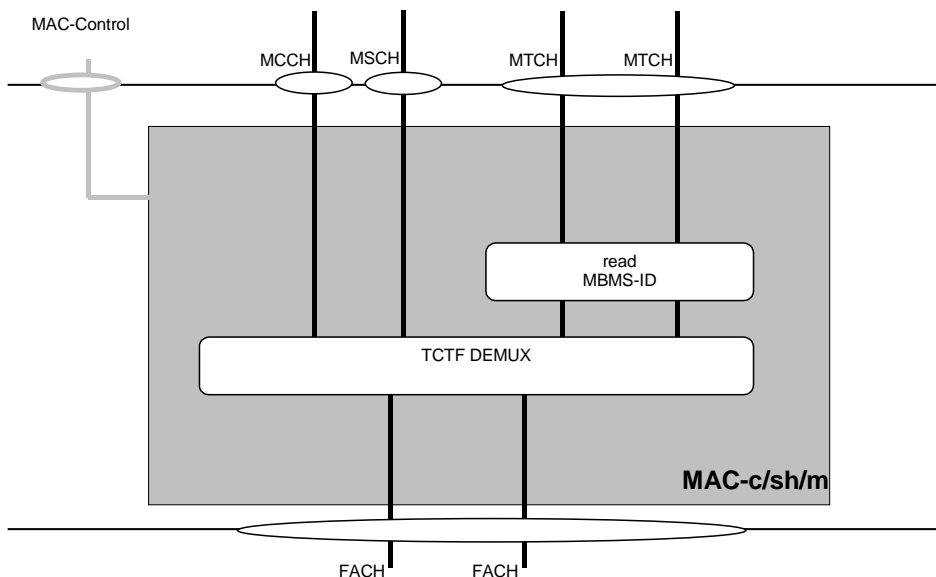

Figure 5.4.3: UE side MAC-m additions to MAC-c/sh

6 MBMS Channel Structure

There exists two transmission modes to provide the MBMS service:

- Point-to-point transmission (p-t-p)
- Point-to-multipoint transmission (p-t-m)

6.1 Point-to-Point Transmission

Point-to-point transmission is used to transfer MBMS specific control/user plane information as well as dedicated control/user plane information between the network and one UE in RRC Connected Mode. It is used only for the multicast mode of MBMS and for services identified in the list of MBMS Selected Services.

For a UE in CELL_FACH and Cell_DCH, DCCH or DTCH is used, allowing all existing mappings to transport channels.

A detailed description of channels used for point-to-point transmission is given in [8].

6.2 Point-to-multipoint Transmission

Point-to-multipoint transmission is used to transfer MBMS specific control/user plane information between the network and several UEs in RRC Connected or Idle Mode. It is used for broadcast or multicast mode of MBMS.

6.2.1 Logical Channels

6.2.1.1 MBMS point-to-multipoint Control Channel (MCCH)

This logical channel is used for a p-t-m downlink transmission of control plane information between network and UEs in RRC Connected or Idle Mode. The control plane information on MCCH is MBMS specific and is sent to UEs in a cell with an activated (joined) MBMS service. MCCH can be sent in S-CCPCH carrying the DCCH of the UEs in CELL_FACH state, or in standalone S-CCPCH, or in same S-CCPCH with MTCH. For 3.84 Mcps TDD MBSFN IMB, MCCH is sent in a standalone S-CCPCH frame type 1 only.

The MCCH is always mapped to one specific FACH in the S-CCPCH as indicated on the BCCH. If MCCH is the only logical channel mapped in to the FACH, the absence of the TCTF field is explicitly signalled otherwise the TCTF field is used in MAC header to identify MCCH logical channel type. In case of soft combining, the MCCH is mapped to a different S-CCPCH (CCTrCH in TDD) than MTCH.

Reception of paging has priority over reception of MCCH for Idle mode and URA/CELL_PCH UEs.

6.2.1.2 MBMS point-to-multipoint Traffic Channel (MTCH)

This logical channel is used for a p-t-m downlink transmission of user plane information between network and UEs in RRC Connected or Idle Mode. The user plane information on MTCH is MBMS Service specific and is sent to UEs in a cell with an activated MBMS service.

The MTCH is always mapped to one specific FACH in the S-CCPCH, or in the S-CCPCH frame type 2 in case of 3.84 Mcps TDD MBSFN IMB, as indicated on the MCCH. The TCTF field is always used in MAC header to identify MTCH logical channel type.

6.2.1.3 MBMS point-to-multipoint Scheduling Channel (MSCH)

This logical channel is used for a p-t-m downlink transmission of MBMS service transmission schedule between network and UEs in RRC Connected or Idle Mode. The control plane information on MSCH is MBMS service and S-CCPCH specific and is sent to UEs in a cell receiving MTCH. One MSCH is sent in each S-CCPCH carrying the MTCH.

The MSCH is always mapped to one specific FACH in the S-CCPCH as indicated on the MCCH. Due to different error requirements the MSCH is mapped to a different FACH than MTCH. If MSCH is the only logical channel mapped in to the FACH, the absence of the TCTF field is explicitly signalled otherwise the TCTF field is used in MAC header to identify MSCH logical channel type.

6.2.2 Transport Channel

FACH is used as a transport channel for MTCH, MSCH and MCCH.

6.2.3 Physical Channel

SCCPCH is used as a physical channel for FACH carrying MTCH or MCCH or MSCH.

6.2.4 Mapping between channels

Only in downlink, the following connections between logical channels and transport channels exist:

- MCCH can be mapped to FACH
- MTCH can be mapped to FACH
- MSCH can be mapped to FACH

The mappings as seen from the UE and UTRAN sides are shown in Figure 6.2.4-1 and Figure 6.2.4-2 respectively.

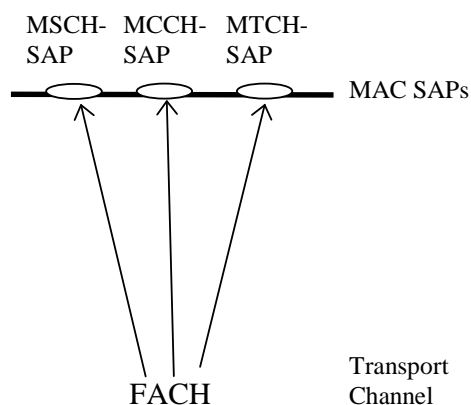

Figure 6.2.4-1: Logical channels mapped onto transport channel, seen from the UE side

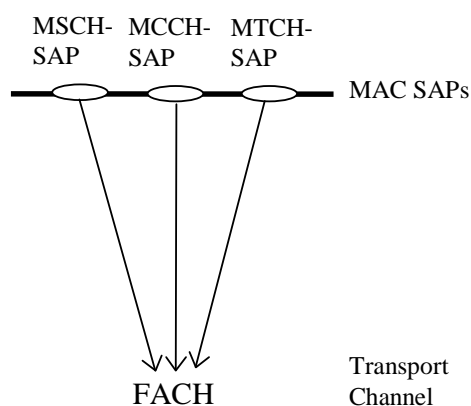

Figure 6.2.4-2: Logical channels mapped onto transport channel, seen from the UTRAN side

6.2.5 Data Flows through Layer 2

6.2.5.1 Data flow for MCCH mapped to FACH

For MCCH, the RLC mode to be employed is UM-RLC, with required enhancements to support out of sequence SDU delivery. A MAC header is used for logical channel type identification.

6.2.5.2 Data flow for MTCH mapped to FACH

For MTCH, the RLC mode to be employed is UM-RLC, with required enhancements to support selective combining. Quick repeat may be used in RLC-UM. A MAC header is used for logical channel type identification and MBMS service identification. For MBMS in case of inter-RNC MBSFN and soft combining, MAC PDUs to be transmitted in one TTI shall be ordered according to MBMS-ID when multiple MTCHs are multiplexed onto one FACH.

6.2.5.3 Data flow for MSCH mapped to FACH

For MSCH, the RLC mode to be employed is UM-RLC. A MAC header is used for logical channel type identification.

6.3. MBMS Notification Indicator Channel

MBMS notification utilizes a new MBMS specific PICH called the MBMS Notification Indicator Channel (MICH) in each cell. Its coding is defined in [9] (FDD) and [10] (TDD).

7 MBMS Reception and UE Capability

7.1 Selective and Soft Combining for MBMS P-T-M transmission

The selective combining for MBMS p-t-m transmission is supported by RLC PDU numbering. Therefore, the selective combining in the UE is possible from cells providing similar MBMS RB bit rate, provided that the de-synchronization between MBMS p-t-m transmission streams does not exceed the RLC re-ordering capability of the UE. Thus, there exist one RLC entity in the UE side.

To support selective combining it is decided to:

- Introduce re-ordering as a configurable feature of RLC-UM, within the RLC specification.
- Use the same mechanism as what is specified for MAC-hs (single T1 timer).

For selective combining there exist one RLC entity per MBMS service utilizing p-t-m transmission in the cell group of the CRNC. All cells in the cell group are under the same CRNC, i.e. Iur support is not considered.

For soft combining to be possible, the relative delay between the radio links to be combined, when they are received by the UE, must be no more than $(1 \text{ TTI}) + (1 \text{ slot})$.

The UE capability requirements to support selective and soft combining are defined in chapter 7.2. In case de-synchronization occurs between MBMS transmissions in neighbouring cells belonging to an MBMS cell group the CRNC may perform re-synchronization actions enabling UEs to perform the selective combining between these cells.

For TDD, selection combining and soft combining can be used when Node-Bs are synchronised. For FDD soft combining can be used when Node-Bs are synchronized inside UE's soft combining reception window, and the data fields of the soft combined S-CCPCHs are identical during soft combining moments.

When selective or soft combining is available between cells the UTRAN should send MBMS NEIGHBOURING CELL INFORMATION containing the MTCH configuration of the neighbouring cells, available for selective or soft combining. When partial soft combining is applied the MBMS NEIGHBOURING CELL INFORMATION contains the L1-combining schedule, which indicates the time moments when the UE may soft combine the S-CCPCH transmitted in neighbouring cells with the S-CCPCH transmitted in the serving cell. With MBMS NEIGHBOURING CELL

INFORMATION the UE is able to receive MTCH transmission from neighbouring cell without reception of the MCCH of that cell.

The UE determines the neighbouring cell suitable for selective or soft combining based on threshold (e.g. measured CPICH E_c/N_0) and the presence of MBMS NEIGHBOURING CELL INFORMATION of that neighbour cell.

The possibility of performing selective or soft combining should be signalled to the UE.

7.1.bis Simulcast Combining (TDD only)

In contrast to FDD, downlink macro diversity has not been a characteristic of TDD during release '99/4/5. As such TDD receivers are not typically designed to facilitate the simultaneous reception of multiple radio links and the incorporation of such a requirement for MBMS in TDD would have non-trivial impacts on the receiver design.

Much of the receiver complexity increase associated with the combining of multiple radio links in the UE can however be avoided in TDD by combining macro-diversity with timeslot re-use. This also allows for the throughput gains from timeslot re-use to be combined with further gains from macro diversity.

In such a scheme, the transmissions of the same information from the multiple participating cells are arranged such that they arrive at the UE on substantially different timeslots, thereby removing the requirement at the UE to detect multiple cells in the same timeslot.

As such, cells are partitioned into transmission "groups" or "sets". Each transmission set is allocated a timeslot (or set of timeslots) for MBMS transmission. The assigned slots are typically exclusively used by that MBMS set; sets do not transmit when another set is active. The UE attempts to receive information from each set and to combine them either at the physical layer or RLC layer in order to enhance reception reliability.

Figure 7.1.bis shows such a scheme applied to a tri-sectored deployment model. 3 timeslots (t_1 , t_2 and t_3) are allocated to each sector for the purposes of MBMS transmission. Each sector is assigned to a particular "MBMS transmission set", set 1, 2 or 3.

An MBMS data unit or transport block is encoded over several radio frames (eg: 80ms TTI). The physical channel bits that result are effectively transmitted three times; once by MBMS set 1 in timeslot t_1 , once by MBMS set 2 in timeslot t_2 , and once by MBMS set 3 in timeslot t_3 .

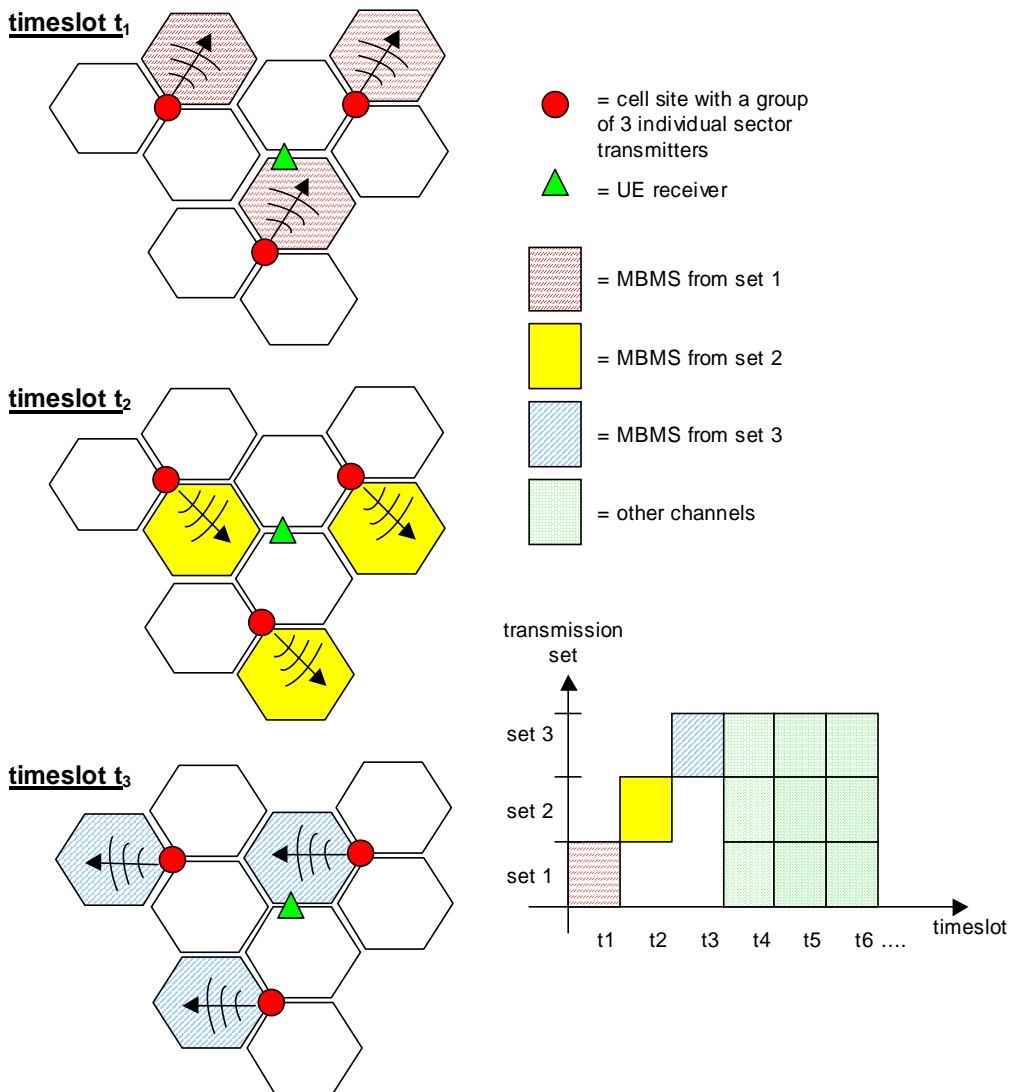

Figure 7.1.bis: Example of non-time-coincident macro diversity transmission

A given UE may be configured to listen to the separate transmissions of the MBMS physical channels (one from each set) which, over the course of the TTI, correspond to the MBMS transport block(s). The signals from each MBMS set are largely non-time-coincident and do not require the use of an extensively modified receiver architecture –a receiver architecture resembling that of a normal "single-radio-link" TDD receiver may be used.

The received transport blocks may be provided to the RLC layer for selective combining, or soft information may be buffered and combined across MBMS sets during the course of the TTI via physical layer soft combining .

The UTRAN shall signal to the UE on the MCCH which services may be soft combined (and in which cells). The cell group for soft combining may be different than the cell group for selective combining. The UE may assume that transmissions of a given service that may soft combined take place in the same frame.

7.1.ter Chip Combining (1.28Mcps TDD)

Chip Combining is a technique that bears some relation to Space Code Transmit Diversity (SCTD) in existing releases except that the combining is performed between cells with different scrambling codes instead of between transmit antennas of the same cell with the same scrambling code.

Chip Combining has been proposed as another form of combining method for p-t-m transmissions for 1.28Mcps TDD mode. All involved cells still keep their own configuration of scrambling code (i.e. different cells participating in the p-t-m transmission have different scrambling codes on the MBMS timeslots). As for SFN transmission, in Chip Combining mode, all Node Bs involved are closely time synchronized, which is an inherent characteristic of TDD systems.

The UE interested in one p-t-m MBMS service gets the active configuration, such as the midamble codes and the scrambling codes used in the current cell and in the involved neighbouring cells from BCCH and/or MCCH. The UE must monitor the signal strengths of the involved cells and must select a number of cells to combine. In an active p-t-m timeslot, the UE performs channel estimation of each cell to be combined and gets the system matrixes of each involved cell respectively, and then, one compound system matrix can be formed by combining the system matrix of these involved cells. After that, the UE uses joint detection algorithm to recover the MBMS data with the compound system matrix.

Chip Combining brings no change and requirement to network equipment. However, in order to approach the performance offered by SFN, a relatively large number of cells must be detected and efficiently combined by the UE. Alternatively, chip combining could be used for small service areas (only a small number of cells participate in a simulcast transmission). In this case the number of cells which must be combined by the UE can be reduced and the performance loss compared to SFN is then lowered.

A UE should have a minimum capability to detect and combine a certain number of cells so that performance of the MBMS p-t-m (and hence coverage of the MBMS service) can be guaranteed. The complexity of the UE and the performance of the chip combining method would have some bearing on the choice of this minimum number of cells that must be combined by the UE.

7.1A MBMS over a Single Frequency Network (MBSFN)

Another form of combining is possible for p-t-m transmissions and is realised via utilisation of the same scrambling code at a given moment in time by a group of cells covering a geographic area and is applicable for FDD and for TDD. This form of combining is referred to as MBMS over a Single Frequency Network (MBSFN). Signals from multiple cells may be combined by the UE in the same manner as used for multipath signal components from a single cell.

The UE reception of MBMS services provided in MBSFN mode shall not affect the UE behaviour on the unicast carrier. Especially the UE mobility on the unicast carrier is not affected by the reception of MBMS services provided on a cell operating in MBSFN mode and can imply that the reception of the MBMS service on the cell operating in MBSFN mode is impossible due to the limited support of combination of frequency bands for MBMS SFN reception and unicast reception.

MBSFN requires all Node Bs involved in the simulcast transmission to be closely time synchronised and exactly the same content is delivered to each of the involved Node Bs. All involved Node Bs are assumed to share the same CRNC (the MBSFN area is limited to the area controlled by a single RNC).

For TDD, some or all timeslots may utilise an MBSFN mode of transmission. Such timeslots are configured by the RNC to use the same scrambling codes across participating Node-Bs. Any non-MBSFN timeslots continue to use the scrambling codes associated with the cell ID. The timeslots that are operating in the MBSFN mode form together with the synchronized neighbouring cells transmitting the exactly same data the over the MBSFN cluster.

For FDD, Node-Bs participating in an MBSFN transmission do so on all slots of the radio frame. Thus, MBSFN transmission occupies an entire carrier in the case of FDD, whereas for TDD, part or all of the carrier may be used for MBSFN.

In addition, MBSFN Integrated Mobile Broadcast (3.84 Mcps TDD MBSFN IMB) is defined. In this configuration, the downlink physical channels for the MBSFN option are mapped on a 3.84 Mcps TDD carrier frequency [10]. RF channel spacing according to the 3.84 Mcps TDD option is used. The entire carrier is used downlink for the 3.84 Mcps TDD MBSFN IMB transmission. For the Node B, the transmitter RF requirements defined for the 3.84 Mcps TDD carriers apply. For the UE, the receiver RF requirements defined for the 3.84 Mcps TDD carriers apply. A primary synchronisation code shall be used, which is orthogonal to the primary synchronisation code used in normal 3.84 Mcps TDD configurations. Unless specified otherwise, the RRC and the MAC protocols are operated according to the FDD requirements applicable for MBSFN.

It shall be possible for UEs supporting MBSFN to receive MBMS via carriers operating in FDD or TDD MBSFN mode and to also obtain unicast and MBMS (those not provided via MBSFN) by another carrier.

Allied to MBSFN is the use of higher order modulation techniques (16QAM) for S-CCPCH and in the case of 3.84/7.68 Mcps TDD only the use of a new burst type to support longer delay spread. In case of 3.84 Mcps TDD MBSFN IMB, there are two types of S-CCPCHs: S-CCPCH frame type1 and S-CCPCH frame type2. S-CCPCH frame type 1 consists of 15 slots per radio frame and uses a channelisation code of spreading factor 256. FACH carrying MCCH is mapped onto S-CCPCH type 1. S-CCPCH frame type 2 uses channelisation codes of spreading factor 16 and consists of 5 sub-

frames per radio frame; each sub-frame consisting of 3 slots. S-CCPCH frame type 2 is used to support short duty cycles on MTCH. The FACH carrying MTCH may be mapped onto one or more codes of spreading factor 16.

Reception of MBMS services over a network operating in MBSFN mode implies that the UE is registered to a PLMN in order to perform higher layer procedures such as subscription to MBMS broadcast services. The means by which a UE obtains details of services provided, subscribes to those services it is interested in and obtains any ciphering keys necessary to decrypt services and/or means by which the services are delivered (MBSFN mode, frequency band used etc.), is considered to be outside the scope of 3GPP specifications. However, it is envisaged that the UE may obtain service details via a point-to-point connection via the carrier that is used to provide unicast services.

The UE selects a MBSFN cluster to receive MBMS service that is part of one of the registered PLMN or part of the equivalent PLMN list. (Note: Network sharing is supported on carriers operating in MBSFN mode using the possibility to broadcast multiple PLMNs in the MIB just as it supported on carriers supporting unicast services)

For the MBSFN cluster in 1.28 Mcps TDD mode, the UE that needs receive MBMS services delivered in an MBSFN cluster may first get synchronized to the non MBSFN cell that the MBSFN cluster is associated with and then search the MBSFN cluster with the information indicated in the system information of the non MBSFN cell. From the UE's perspective, the registered PLMN of the MBSFN cluster should be the same as the PLMN that is registered by the UE from the associated unicast carrier.

A MBSFN cluster provides only MBMS service in PtM mode. Counting and PtP establishment procedures are not supported for a cell operating in MBSFN mode.

For FDD, 3.84 Mcps TDD IMB and 3.84/7.68 Mcps TDD, the selection between MBSFN clusters is performed similarly to the way that cell selection is performed for cells that are not operating in MBSFN mode. The UE shall meet the minimum performance requirements specified for the reception of a MBMS cluster. The UE may consider a minimum receive power of the CPICH (FDD and 3.84 Mcps TDD IMB) or P-CCPCH (3.84/7.68 Mcps TDD) in order to determine when to receive MBMS service broadcast in MBSFN mode. However apart from background search procedures for receiving other MBSFN clusters the UE is not required to perform inter-frequency measurements for other MBSFN clusters. Hierarchical cell structure, rules for fast moving UEs and inter-frequency and inter RAT measurements are not applicable for the cell operating in MBSFN mode. The intra frequency measurements for the reselection between MBSFN clusters are not specified.

In a MBSFN cluster only MIB, system information blocks 3, 5/5bis and 11 may be broadcast. The content of other system information blocks is ignored by the UE.

A MBSFN cluster on one frequency might indicate the existence and the services provided by other MBSFN clusters on different frequencies. The MBSFN cluster on one frequency may also indicate other MBSFN frequencies that have to be selected in order for the UE to be aware of available services that are not provided via the currently selected MBSFN cluster and for which the availability can not be indicated on the current MBSFN cluster. The choice of the MBSFN frequency based on this information is UE implementation specific. Because inter frequency measurements for MBSFN frequencies are not applicable the choice of the MBSFN frequency done by the UE may be completely service dependant. For FDD, 3.84 Mcps TDD IMB and 3.84/7.68 Mcps TDD the UE only has to discover one MBMS cluster on another frequency that fulfils the selection criteria. Other frequencies on which MBMS service is broadcast in MBSFN mode is indicated on the MBSFN frequency.

A cluster operating in MBSFN mode does not provide paging information because the MBSFN cluster will not be considered as a suitable cell by the UE.

The cells in a MBSFN cluster belong to different MBMS service areas compared to the cells of a carrier providing unicast service. This allows the RNC to know which services are intended for the transmission on the cells of a MBSFN cluster. The same MBMS bearer service is not provided on a MBSFN cluster and the unicast cells.

The minimum MBMS service area must be equal to one MBSFN cluster. A MBMS bearer service must be transmitted in a complete MBSFN cluster.

7.1A.1 3.84 / 7.68 MCPS TDD MBMS over a Single Frequency Network (MBSFN)

A TDD UE operating on a carrier not dedicated to MBSFN shall follow MBMS procedures specified with respect to the RRC states (see Section 10). For TDD carriers not dedicated to MBSFN, MBMS services may be delivered via MBSFN and/or non-MBSFN means. In the case that any non-MBSFN transmissions are used to deliver MBMS services, the MCCH should not be transmitted via MBSFN means.

The reception of MBMS on a cell operating in MBSFN mode is independent to the UE behaviour for the reception of service on the frequency that the UE is camping on for obtaining unicast or MBMS service. For the reception of MBMS service on a TDD cell dedicated to MBSFN operation the UE is conceptually an independent component which receives MBMS service on a TDD cell dedicated to MBSFN.

The TDD component of a UE for receiving MBMS service on a TDD carrier dedicated to downlink MBSFN shall:

- receive services provided via MBSFN independently of RRC state transitions for any non-MBSFN component of the UE
- obtain details concerning the MCCH provided via the BCCH of the cell providing MBSFN and listen to that MCCH for details of MBMS services provided p-t-m on the TDD DL-only carrier
- search for a suitable TDD MBSFN cluster providing the MBMS services that it is interested in:
 - o is only required to support BCH and FACH transport channels and physical channels P-CCPCH, S-CCPCH, SCH on the TDD carrier
 - o may optionally support MICH on the TDD carrier
 - o shall expect to receive S-CCPCH configuration information via System Information Block 5 (the UE shall expect to receive System Information blocks 3, 5 and 11 only in addition to the Master Information Block) via the BCH on the TDD carrier.

7.1A.2 FDD MBMS over a Single Frequency Network (MBSFN)

A FDD UE operating on a carrier not dedicated to MBSFN shall follow MBMS procedures specified with respect to the RRC states (see Section 10).

The reception of MBMS on a cell operating in MBSFN mode is independent to the UE behaviour for the reception of service on the frequency that the UE is camping on for obtaining unicast or MBMS service. For the reception of MBMS service on a FDD cell dedicated to MBSFN operation the UE is conceptually an independent component which receives MBMS service on a FDD cell dedicated to MBSFN.

The FDD component of a UE operating in a receive-only mode on a FDD carrier operating in MBSFN mode shall:

- receive services provided via MBSFN independently of RRC state transitions for any non-MBSFN component of the UE
- obtain details concerning the MCCH provided via the BCCH of the cell providing MBSFN and listen to that MCCH for details of MBMS services provided p-t-m on the FDD DL-only carrier
- search for a suitable FDD MBSFN cluster:
 - o is only required to support BCH and FACH transport channels and physical channels P-CCPCH, S-CCPCH and SCH on the FDD carrier
 - o may optionally support MICH on the FDD carrier
 - o shall expect to receive S-CCPCH configuration information via System Information Block 5 (the UE shall expect to receive System Information blocks 3, 5 and 11 only in addition to the Master Information Block) via the BCH on the FDD carrier.

7.1A.3 1.28 MCPS TDD MBMS over a Single Frequency Network (MBSFN)

A TDD UE operating on a carrier not dedicated to MBSFN shall follow MBMS procedures specified with respect to the RRC states (see Section 10). For TDD carriers not dedicated to MBSFN, MBMS services may be delivered via MBSFN and/or non-MBSFN means. In the case that any non-MBSFN transmissions are used to deliver MBMS services, the MCCH should not be transmitted via MBSFN means.

The reception of MBMS on a cell operating in MBSFN mode is independent to the UE behaviour for the reception of service on the frequency that the UE is camping on for obtaining unicast or MBMS service. For the reception of MBMS service on a TDD cell dedicated to MBSFN operation the UE is conceptually an independent component which receives MBMS service on a TDD cell dedicated to MBSFN.

The TDD component of a UE for receiving MBMS service on a TDD carrier dedicated to downlink MBSFN shall:

- receive services provided via MBSFN independently of RRC state transitions for any non-MBSFN component of the UE
- obtain details concerning the MCCH provided via the BCCH of the cell providing MBSFN and listen to that MCCH for details of MBMS services provided p-t-m on the TDD DL-only carrier
- search for a suitable TDD MBSFN cluster providing the MBMS services that it is interested in:
 - o is only required to support BCH and FACH transport channels and physical channels P-CCPCH, S-CCPCH on the TDD carrier
 - o may optionally support MICH on the TDD carrier
 - o shall expect to receive S-CCPCH configuration information via System Information Block 5 (the UE shall expect to receive System Information blocks 3, 5 and 11 only in addition to the Master Information Block) via the BCH on the TDD carrier.

NOTE: For 1.28 Mcps TDD, if a cell is operating in MBSFN mode, system information and MCCH messages are transmitted through the Special Timeslot [10].

7.1A.4 3.84 Mcps TDD IMB MBMS over a Single Frequency Network (MBSFN)

A 3.84 Mcps TDD MBSFN IMB capable UE operating on an FDD or 3.84/7.68 Mcps TDD carrier not dedicated to MBSFN shall follow MBMS procedures specified with respect to the RRC states (see Section 10).

The reception of MBMS on a cell operating in MBSFN mode is independent to the UE behaviour for the reception of service on the frequency that the UE is camping on for obtaining unicast or MBMS service. For the reception of MBMS service on a cell dedicated to 3.84 Mcps TDD MBSFN IMB operation, the UE is conceptually an independent component which receives MBMS service on a cell dedicated to 3.84 Mcps TDD MBSFN IMB.

The 3.84 Mcps TDD MBSFN IMB component of a UE receiving MBMS service on a 3.84 Mcps TDD carrier dedicated to 3.84 Mcps TDD MBSFN IMB shall:

- receive services provided via MBSFN independently of RRC state transitions for any non-MBSFN component of the UE;
- obtain details concerning the MCCH provided via the BCCH of the cell providing 3.84 Mcps TDD MBSFN IMB and listen to that MCCH for details of MBMS services provided p-t-m on the 3.84 Mcps TDD carrier dedicated to 3.84 Mcps TDD MBSFN IMB;
- search for a suitable MBSFN cluster providing the MBMS services the UE has activated:
 - o is only required to support BCH and FACH transport channels and physical channels P-CCPCH, S-CCPCH frame type 1, S-CCPCH frame type 2 and SCH on the 3.84 Mcps TDD carrier dedicated to 3.84 Mcps TDD MBSFN IMB;
 - o may optionally support MICH on the 3.84 Mcps TDD carrier dedicated to 3.84 Mcps TDD MBSFN IMB;
 - o shall expect to receive S-CCPCH frame type 1 configuration information via System Information Block 5 (the UE shall expect to receive System Information blocks 3, 5 and 11 only in addition to the Master Information Block) via the BCH on the 3.84 Mcps TDD carrier dedicated to 3.84 Mcps TDD MBSFN IMB.

7.1B MBMS in case of inter-RNC synchronization

7.1B.1 Control Plane aspects

7.1B.1.1 MBMS Parameter Configurations

The common parameters in MBMS P-t-M RB configurations shall be configured in each RNC semi-static manner via O&M.

The parameters, transmitted in RRC: MBMS Common P-T-M RB Information and to be configured, are:

- RB Information list
 - RB identity
 - PDCP info
 - RLC info
- TrCh information for each TrCH
 - Transport channel identity
 - TFS
- TrCh information for each CCTrCh
 - CCTrCH identity
 - TFCS

In case of soft combining the Secondary CCPCH configurations shall be aligned between the neighboring cells.

In case of MBSFN:

If MBMS services are controlled statically, the parameters to be configured for MBSFN:

- PhyCh information
 - PhyCh identity
 - Secondary CCPCH info MBMS

.In the case the used parameter value in a cell may depend on the received RAB QoS and/or MBMS service area ID and/or TMGI value, the mapping information should be configured via O&M. Such mapping information should be available in RNCs before the MBMS session setup.

If MRNC is used, the parameters shall be configured by MRNC, and the MRNC shall inform CRNC of the configuration and mapping information of MBMS service to RB information at session start.

In addition to parameters used for air interface, the pool of DL TEIDs used for the MBMS transmission on Iu carried by IP-multicast distribution shall be configured in all RNCs by O&M. The stored DL TEIDs used in IP multicast distribution shall not be used by the RNC for any other transmission.

7.1B.1.2 MBMS Counting and mode switch coordination

The RNC shall generate the MBMS Counting procedure towards UEs as in case of intra-RNC selective/soft combining (see section 5.2.5).

If the RNS controlled by a RNC is smaller than the possible selective / soft combining area, the status of the cells in surrounding RNC that are part of the selective/soft combining area should be known before deciding on the own transmission mode. Therefore the RNC shall exchange the transmission mode and counting information with the neighbouring RNCs, which are controlling cells part of the same selective/soft combining area as the cells controlled by

the current RNC. Also the neighbour cells indicated for selective/soft combining in MBMS NEIGHBOURING CELL P-T-M RB INFORMATION message have to be coordinated between RNCs.

The RNSAP function, *Information Exchange* is used for counting and mode switch coordination.

The RNC may request for the counting results and transmission mode information in cells controlled by a neighbour RNC by sending the INFORMATION EXCHANGE INITIATION REQUEST message to the relevant neighbouring RNCs.

For counting the INFORMATION EXCHANGE INITIATION REQUEST message will contain the information about the cells controlled by the sending RNC, for which the sending RNC have requested counting. The RNC receiving the INFORMATION EXCHANGE INITIATION REQUEST message shall first identify if any of the cells received in the message is announced as a neighbour cell for the MBMS service in the cells controlled by the receiving RNC (own cells). Thereafter the receiving RNC shall perform counting in these own cells and inform sending RNC about the result over Iur in the INFORMATION EXCHANGE INITIATION RESPONSE message.

For MBMS transmission mode change the INFORMATION EXCHANGE INITIATION REQUEST message will contain information about the cells controlled by the sending RNC ("initiating cell list") and the TMGIs for which the MBMS transmission mode are requested to be reported when the transmission mode is changed. The MBMS transmission mode shall be reported for cells under control of the RNC receiving the INFORMATION EXCHANGE INITIATION REQUEST message. The MBMS transmission mode for the TMGIs in the INFORMATION EXCHANGE INITIATION REQUEST message shall be reported for the cells that have a configured neighbour relation to the cells in the "initiating cell list".

The RNC initiating the Information Exchange Initiation procedure shall use the received MBMS transmission mode information of the neighbour cells under control of another RNC to update MBMS NEIGHBOURING CELL P_T_M RB INFORMATION message content of its own cells.

7.1B.1.3 Control Plane Coordination at MBMS Session Start

7.1B.1.3.1 Coordination of neighbor cell configuration

The RNC shall at MBMS session start in its own cells, being part of the targeted MBMS service area, activate the RNSAP Information Exchange Initiation procedure to all neighboring RNCs, which are controlling cells allowed to be used for selective/soft combining with the relevant own cells of the RNC. The response, INFORMATION EXCHANGE INITIATION RESPONSE and INFORMATION REPORT messages shall contain the copy of the RRC containers, which were sent out on MCCH announcing the active MBMS session and for each MBMS session that is started a list of cell identities in which the MBMS session (identified with TMGI) was setup.

The receiving RNC shall identify based on the received information the valid neighbor cells for soft/selective combining in the RNC, which is the sender of the message for the new MBMS session, and retrieve the S-CCPCH configuration in those neighboring cells. Finally the MBMS COMMON P-T-M RB INFORMATION shall be updated with the received S-CCPCH configuration information and the neighboring cells are announced in MBMS NEIGHBOURING CELL P-T-M RB INFORMATION.

As part of the "Valid neighbor cell identification" the RNC shall verify that the configuration of the cells of the sending RNC is aligned and possible for soft combining, e.g. that the MBMS logical channel id is aligned for all MBMS sessions. The RNC shall not accept the cell as neighbor cell if not aligned. The consequence of a mismatch is that the soft/selective combining gain is lost for this MBMS session, but as this abnormal condition only occurs rarely it is regarded as acceptable.

Coordination of MBMS configurations after RNC restarts

In case of restart the RNC may loose all the MBMS configurations of its cells as well the neighbor cell MBMS information and any other MBMS related parameters.

The RNC will recover from that situation by getting the MBMS configurations updated in a three phase approach:

1. via O&M the MBMS service configurations for its cells. In addition to the MBMS service area configurations there are other parameters which can be configured semi-static manner via O&M system like indicated above.
2. As part of the general restart procedure the SGSN will send the Session Starts for all ongoing MBMS sessions to the RNC. RNC will respond to the MBMS Session Start messages normal manner in line with the MBMS service area configurations of its cells.

3. After the RNC has become aware of the active MBMS sessions it will identify the relevant neighboring RNCs which should be contacted to retrieve the necessary parameters for the neighbor cell configuration.

7.1B.1.4 MCCH synchronization in an MBSFN cluster

To synchronize MCCH dynamically, the logical entity "MBMS Master RNC" may be introduced to control the resources of the RNSs within the MBSFN cluster(s). There's only one MBMS Master RNC for any MBSFN cluster. The other RNC can be seen as the CRNC.

If MRNC is used, the RNSAP procedure "MBSFN MCCH Information" is used to transfer information between MRNC and CRNC to synchronize the MCCH.

7.1B.2 User Plane aspects

7.1B.2.1 Timing requirements

The soft combining and MBSFN mode across RNCs will require similar timing requirements between the cells controlled by different RNCs as what is required for cells part of same RNC in Rel-6 and Rel-7. The summary of the timing requirements is presented in the table below.

Table 7.1B.2.1-1 The table summarizes the timing requirements for WCDMA MBMS

Functionality	Release	Timing requirement
MBMS 40 ms TTI	3GPP Release 6	40.667 ms
MBMS 80 ms TTI	3GPP Release 6	80.667 ms
MBMS with single frequency network support (MBSFN)	3GPP Release 7/8	12.8 microseconds

There are several ways to synchronize the network elements to a common reference time: which meet Rel6/MBSFN timing requirements.

- 3GPP synchronization in UTRAN,
- Network Time Protocol (NTP),
- Relying on IP multicast distribution,
- Global positioning system (GPS),
- IEEE1588.

All the listed synchronisation methods may be used but the provided accuracy could be dependent on the synchronisation deployment solution

7.1B.2.2 MBMS User Data flow synchronization

The synchronized radio interface transmission from the cells controlled by different RNCs require a SYNC-protocol support over the Iu-interface between the BM-SC and the RNCs.

As part of the SYNC-protocol procedure the BM-SC shall include to the SYNC PDU packets a time stamp which tells the timing based on which the RNC sends MBMS data over air interface. This time stamp is based on a common time reference available at the BM-SC and the RNCs and represents a relative time value which refers to the start time of the synchronisation period.

MBMS user data shall be time-stamped based on separable synchronization sequences which are tied to multiples of the TTI length. Synchronization sequence is transmitted continuously, even if there is no MBMS user data in the synchronization sequence. Each synchronization sequence for each service is denoted by a single timestamp value working in such a manner that an increase of the timestamp value by one synchronisation sequence length shall be interpreted as an implicit start-of-a-new-synchronization-sequence-indicator, so that the RNC becomes aware that a new sequence is starting. For additional robustness, the timestamp shall be replicated to all packets that shall be submitted over the air interface within one or multiple TTIs.

When adding the Time Stamp the BM-SC should take into account following factors: arrival time of data, the Maximum Transmission Delay from BM-SC to the farthest RNC, the length of the synchronization sequence used for time stamping and other extra delay (e.g. processing delay in RNC and NodeB). The parameters 'Max Tx Delay', 'synchronization sequence length' and 'Other Extra Delay' are set via O&M in BM-SC.

The BM-SC does not know the absolute time point at which a TTI starts, but the sequence length for the time stamp is set by O&M like the delay parameters. The BM-SC will use the delay parameters to define the transmission time point of that user data packet and for the following user data packets the sequence length for the time stamp: following user data packets arriving within e.g. 40ms will receive the same time stamp value as the first data packet, if the sequence length is set to be 40 ms.

The RNC shall schedule the received data packets in the TTIs following the time point indicated by the timestamp.

NOTE: From the timestamp the RNC can interpret the TTI from which the transmission of the first user data packet with that time stamp value shall start. Whether there will be data packets to be transmitted in the following TTIs will depend on the used synchronization sequence length vs. the TTI length and on the user data flow.

In case MRNC is used and TDM multiplexing is used over air interface, scheduling transmission time interval is defined as a time interval of the minimal common multiple of synchronization sequence length and TDM period (CFN period shall be divided by TDM period) in the MRNC. The MRNC shall inform the scheduling transmission time interval to the RNCs over Iur together with MCCH message. The RNC shall schedule received data packets in the scheduling transmission time interval following the time point indicated by the timestamp. If multiple synchronization sequences are to be transmitted consecutively in one scheduling transmission time interval, these synchronization sequences shall be processed as if they are a single synchronization sequence.

In case MRNC is not used and TDM is used over air interface, the synchronization sequence length should be configured to be multiples of the TDM Period (CFN period shall be a multiple of the TDM period).

The elementary procedures related to the SYNC-protocol are defined in [14].

In addition to the Time Stamp parameter the BM-SC shall provide together with each MBMS User data packet the '*Packet Counter*' and '*Elapsed Octet Counter*' information. Based on these parameters the RNC is able to notice if any data packets were lost during transmission via IP Multicast and to know the size of the lost payload, in case of a single packet is lost. Additionally the RNC is able to reorder the PDUs before passing them to RLC processing, if needed.

At the end of each synchronization sequence the BM-SC shall send to the RNCs at least one user data frame, which contains counter information including '*Total Number Of Packet Counter*' and '*Total Number Of Octet*' without MBMS payload. This *Total Counter* frame is implicitly marking the end-of-sync.seq.. The *Total Counter* frame without payload may be repeated in order to improve the reliability of the delivery to the RNCs.

If neither Total Counter frame nor data Frame is received by a RNC for a synchronization sequence, the RNC shall regard the whole synchronization sequence data frame as lost.

7.1B.2.3 User Plane recovery in case of Multiple Packets Loss

In case multiple contiguous SYNC PDUs are lost in the RNC, the division of payload between the lost packets is not necessarily known by the RNC. This may lead to an incorrect RLC SN value usage in the RNC, when handling the first data packet received from BM-SC after the multiple packet loss. The RNC is able to notice the loss of multiple user data packets based on the '*Packet Counter*' information delivered by the SYNC-protocol together with the user data packets. In such a situation the radio interface transmission should be avoided until the RNC is able to resynchronize its transport block creation with the neighbouring RNCs or the radio interface transmission may be avoided for exact TTI(s) impacted by the lost SYNC PDUs using the help of the length information of the lost SYNC PDU provided by SYNC protocol.

In case of soft combining and MBSFN mode the RNC resynchronization is supported by the RLC SN reset at the start of each synchronization sequence in all RNCs part of the IP Multicast distribution. The RNCs are able to notice the start of the synchronization sequence from the new time stamp value and the packet counter information received from BM-SC.

In case MRNC is used and TDM multiplexing is used over air interface, the RNC re-synchronization is supported by the RLC SN reset at the start of each scheduling transmission time interval signalled from MRNC in all RNCs part of the IP Multicast distribution.

In case of selective combining the RNC shall request from the neighbouring RNCs, which are used for selective combining for that particular MBMS stream, the correct RLC SN value to be used for the first RLC PDU of the next synchronization sequence.

7.2 UE Capability

The UE MBMS capability is not sent to UTRAN and is subject to UE implementation, including the relation between MBMS capability and actual RRC state which is also a UE implementation. A consequence is that a UE may be counted although its actual capability does not allow to receive MBMS transmissions e.g. because of its current RRC state.

The standard will describe a minimum UE capability requirement in order to allow operators to configure MBMS channels that can be common to all UEs supporting the given service.

There are some UE capability requirements that are common to all eventual service categories:

The minimum UE capability for MBMS capable UE, is one primary CCPCH plus all the configurations below. The UE is not required to support these configurations simultaneously.

1. One PICH and one MICH
2. One S-CCPCH and one MICH
3. One S-CCPCH (dedicated FACH and possibly the FACH, which may carry MCCH) and two S-CCPCH with 80ms TTI for MTCH reception
4. One S-CCPCH (dedicated FACH and possibly the FACH, which may carry MCCH) and three S-CCPCH with 40ms TTI for MTCH reception
5. One PICH and two S-CCPCH with 80ms TTI for MTCH reception
6. One PICH and three S-CCPCH with 40ms TTI for MTCH reception

The requirement one reflects the case when the UE is in Idle mode, or URA_PCH, CELL_PCH state and MBMS reception is not ongoing and requirement five and six are for the case that MBMS reception is ongoing in Idle mode, or URA_PCH, CELL_PCH state.

The requirement two reflects the case when the UE is in CELL_FACH state and MBMS is reception not ongoing and requirement three and four are for the case when MBMS reception is ongoing respectively.

The requirement for the number of simultaneous S-CCPCHs for MTCH reception includes those S-CCPCHs for which combining is performed.

When MBMS ptm reception is ongoing, the UE is required to periodically monitor the MCCH, which may be mapped onto a different S-CCPCH from MTCH, and a different S-CCPCH than the R'99 FACH when the UE is in CELL_FACH state. However this does not increase the requirement for the number of S-CCPCHs to be simultaneously received by the UE.

The ability of the UE to receive DPCH/HS-PDSCH simultaneously with S-CCPCH carrying MTCH/MCCH is subject to UE capability.

The minimum MBMS bit rate that all MBMS capable UEs shall support is to be defined [12].

For FDD, the UE shall support selective combining and soft combining on cells not indicating that they provide MBMS service in MBSFN mode.

For FDD and 3.84 Mcps TDD IMB, the UE is not required to support selective combining and soft combining on cells indicating that they provide MBMS service in MBSFN mode.

For a TDD UE supporting both transmit and receive functions, selective and soft combining shall be supported. For a 3.84 / 7.68 Mcps TDD UE supporting both transmit and receive functions, MBSFN operation shall also be supported. For a UE supporting 3.84 / 7.68 Mcps TDD MBSFN receive only, support for selective combining and soft combining is not required.

The standard may restrict further the UE implementation options by defining certain capability combinations.

If the UE is supporting MBMS ptm reception in CELL_DCH state, it shall have capability to acquire MCCH configuration from BCCH after handover procedure, and after that receive MCCH and MTCH.

7.3 MBMS Reception

The following descriptions add MBMS specific processes to be considered for each RRC State/Mode.

The BCCH contains information regarding the MCCH, while the latter contains information on the MTCH.

In the sub-sections below, how and when the UE reads the MCCH is not described as periodic MCCH transmission is described in section 5.2.3.

The reception of multiple MBMS services simultaneously is subject to UE capability; selection principles between MBMS services are defined in section 5.2.8. The specific actions related to MBMS session repetition are specified in section 5.2.7.

7.3.1 MBMS Reception in RRC Idle Mode

In idle mode, the UE shall:

- if the UE supports MBMS and
- if the UE has activated an MBMS service and there is an ongoing session for this service in the cell where the UE is situated, i.e. MTCH and MCCH are available
 - act on RRC messages received on MCCH and:
 - if the MBMS service requires the establishment of an RRC Connection due to counting response or due to the utilisation of p-t-p transfer mode for the MBMS service:
 - inform upper layers that the MBMS Service requires the establishment of an RRC Connection.
 - if the MBMS service does not require the establishment of an RRC Connection :
 - listen to the common transport channel on which the MTCH is mapped.
 - if the UE determines that a neighbouring cell is suitable for selective or soft combining and the UE has valid MBMS NEIGHBOURING CELL INFORMATION of that cell:
 - performs selective or soft combining of MTCH between the selected cell and the neighbouring cell.

7.3.2 MBMS Reception in RRC Connected Mode: URA_PCH state

In URA_PCH, the UE shall:

- if the UE supports MBMS and
- if the UE has activated an MBMS service and there is an ongoing session for this service in the URA where the UE is situated, i.e. MTCH and MCCH are available
 - act on RRC messages received on MCCH,
 - if on the MCCH it is indicated that the MBMS service in the cell requires a counting response or is due to the utilisation of p-t-p transfer mode for the MBMS service:
 - initiate a cell update procedure, for sending MBMS COUNTING RESPONSE, or MBMS P-T-P MODIFICATION REQUEST signalling flow. The cause to be used in the cell update procedure is defined in [13].
 - for each MBMS service that the UE has activated and where transmission on a MTCH is indicated in the MCCH, listen to the common transport channel on which the MTCH is mapped,
 - if the UE determines that a neighbouring cell is suitable for selective or soft combining and the UE has valid MBMS NEIGHBOURING CELL INFORMATION of that cell

- performs selective or soft combining of MTCH between the selected cell and the neighbouring cell.

7.3.3 MBMS Reception in RRC Connected Mode: CELL_PCH state

In CELL_PCH, the UE shall:

- if the UE supports MBMS and
- if the UE has activated an MBMS service and there is an ongoing session for this service in the cell where the UE is situated, i.e. MTCH and MCCH are available
 - act on RRC messages received on MCCH
 - if on the MCCH it is indicated that the MBMS service in the cell requires counting response or is due to the utilisation of p-t-p transfer mode for the MBMS service:
 - initiate a cell update procedure for sending MBMS COUNTING RESPONSE, or MBMS P-T-P MODIFICATION REQUEST signalling flow. The cause to be used in the cell update procedure is defined in [13].
 - listen to the common transport channel on which the MTCH is mapped,
 - if the UE determines that a neighbouring cell is suitable for selective or soft combining and the UE has valid MBMS NEIGHBOURING CELL INFORMATION of that cell
 - performs selective or soft combining of MTCH between the selected cell and the neighbouring cell.

7.3.4 MBMS Reception in RRC Connected Mode: CELL_FACH state

In CELL_FACH, the UE shall:

- if the UE supports MBMS and
- if the UE has activated an MBMS service and there is an ongoing session for this service in the cell where the UE is situated, i.e. MTCH and MCCH are available
 - act on RRC messages received on MCCH
 - if on the MCCH it is indicated that the MBMS service in the cell requires a counting response or is due to the utilisation of p-t-p transfer mode for MBMS service:
 - initiate a counting response for sending MBMS COUNTING RESPONSE, or MBMS P-T-P MODIFICATION REQUEST signalling flow.
 - listen to the common transport channel on which the MTCH is mapped
 - if the UE determines that a neighbouring cell is suitable for selective or soft combining and the UE has valid MBMS NEIGHBOURING CELL INFORMATION of that cell
 - performs selective or soft combining of MTCH between the selected cell and the neighbouring cell.

NOTE: For UEs in CELL_FACH, UTRAN may decide to send MBMS data over DTCH.

7.3.5 MBMS Reception in RRC Connected Mode: CELL_DCH state

In CELL_DCH, the UE shall,

- if the UE supports MBMS and
- if the UE has activated an MBMS service and there is an ongoing session for this service in the cell where the UE is situated, i.e. MTCH and MCCH are available and
- if the UE has the capabilities:
 - act on RRC messages received on MCCH

- listen to the common transport channel on which the MTCH is mapped.
- if the UE determines that a neighbouring cell is suitable for selective or soft combining and the UE has valid MBMS NEIGHBOURING CELL INFORMATION of that cell and UE has capability
 - performs selective or soft combining of MTCH between the selected cell and the neighbouring cell.

NOTE: For UEs in CELL_DCH, UTRAN may decide to send MBMS data over DTCH

8 UTRAN Signalling Flows for MBMS

8.1 MBMS High Level Signalling Scenarios

8.1.1 Session start

Upon receiving a session start indication from CN, UTRAN initiates the session start sequence to allocate radio resources to UEs for receiving the MBMS content. As part of this sequence, UTRAN may apply the counting procedure (counting the number of idle mode, URA_PCH, CELL_PCH and CELL_FACH state UEs) to decide whether to use the p-t-m or p-t-p transfer mode. For MBMS Broadcast mode, the applicability of the counting procedure for a service is indicated by the CN.

The Figure 8.1.1 shows an example of a possible session start sequence.

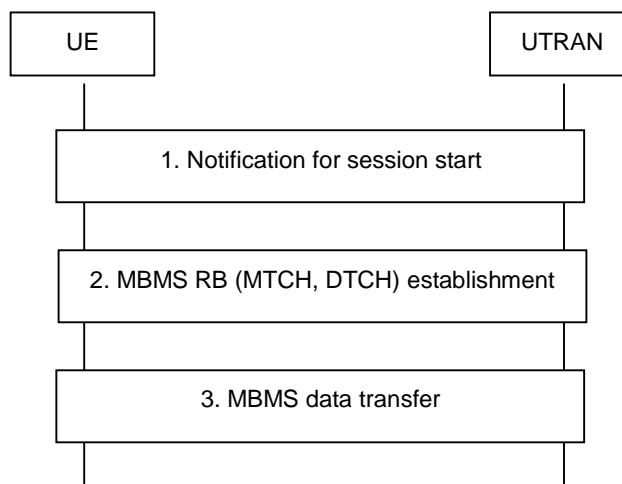

Figure 8.1.1: Session start

In general, the session start sequence involves the following steps:

- In case UTRAN applies counting to determine the most optimal transfer mode the following steps are performed:
 - UTRAN sets the correct MBMS Notification Indicator (NI) and sends the MBMS CHANGE INFORMATION and the MBMS ACCESS INFORMATION including service ID, the session ID if received from the CN, and access probability on MCCH.
 - Upon DRX wakeup, UEs in idle mode as well as UEs in CELL_PCH, URA_PCH and CELL_FACH not receiving an MBMS service provided in p-t-m transfer mode evaluate the MBMS NI and if set, read the MBMS CHANGE INFORMATION from MCCH at beginning of the modification period. UEs in idle mode as well as UEs in CELL_PCH, URA_PCH and CELL_FACH receiving an MBMS service provided in p-t-m transfer mode read the MBMS CHANGE INFORMATION directly. If service Id of activated MBMS service and session ID that the UE has not received is indicated in MBMS CHANGE INFORMATION UEs continue reading the rest of MCCH information. Upon receiving the MBMS ACCESS INFORMATION including access probability, UEs in idle mode or URA_PCH, CELL_PCH, and CELL_FACH state for which the probability check passes, initiate counting response. UTRAN counts

the UEs with an activated MBMS service by combining the UE linking from CN and received counting responses from UEs.

- In the case that no UE is counted as present in the cell then UTRAN may decide not to provide any RB for the service in the cell.
- In case a pre- defined threshold is reached, UTRAN applies the p-t-m RB establishment procedure specified below. Otherwise, UTRAN may repeat the MBMS ACCESS INFORMATION a number of times, using different probability values. If the threshold is not reached, UTRAN applies the p-t-p RB establishment procedure
- In case UTRAN selects the p-t-m RB establishment procedure:
 - UTRAN configures MTCH and updates MCCH (MBMS SERVICE INFORMATION and MBMS RADIO BEARER INFORMATION) by including the service ID, the session ID if received from the CN, and p-t-m RB information for the concerned MBMS service
 - In case p-t-m RB establishment is not preceded by counting, UTRAN sets the correct MBMS Notification Indicator (NI) and sends MBMS CHANGE INFORMATION.
 - UTRAN sends the MBMS dedicated notification message including the service ID and cause= session start on DCCH to inform UEs in CELL_DCH that are not receiving an MBMS service provided using p-t-m transfer mode
 - In case p-t-m RB establishment is preceded by counting, UEs read MCCH at the pre- defined time(s) to acquire the MBMS SERVICE INFORMATION and MBMS RADIO BEARER INFORMATION
 - In case p-t-m RB establishment is not preceded by counting, Upon DRX wakeup, UEs not receiving MTCH evaluate the MBMS NI and if set, read MCCH at beginning of modification period to acquire MBMS CHANGE INFORMATION. UEs in idle mode as well as UEs in CELL_PCH, URA_PCH and CELL_FACH receiving an MBMS service provided in p-t-m transfer mode read the MBMS CHANGE INFORMATION directly. If service Id of activated MBMS service and session ID that the UE has not received is indicated in MBMS CHANGE INFORMATION UEs continue reading the rest of MCCH information to acquire the MBMS SERVICE INFORMATION and MBMS RADIO BEARER INFORMATION
 - UEs that are incapable of receiving the MTCH for the session that is started in parallel to the existing activity notify the user. This enables the user to choose between the ongoing activity and the new MBMS service
 - Upon receiving MBMS dedicated notification with cause= session start, UEs in CELL_DCH that are incapable of receiving the MCCH and the corresponding MTCH in parallel to the existing activity notify the user. This enables the user to choose between the ongoing activity and the new MBMS service. If the user decides to receive the new MBMS service, the UE shall read MCCH to acquire the MBMS SERVICE INFORMATION and MBMS RADIO BEARER INFORMATION.
 - Upon receiving the MBMS SERVICE INFORMATION and the MBMS RB INFORMATION including the p-t-m RB information for the concerned MBMS service, the UE starts receiving the p-t-m radio bearers
- In case UTRAN selects the p-t-p RB establishment procedure:
 - UTRAN indicates on MCCH in MBMS CHANGE INFORMATION that MBMS service is provided via p-t-p
 - After receiving MBMS CHANGE INFORMATION UEs with an activated MBMS service, after possible service prioritisation, request MBMS p-t-p RB establishment by sending MBMS P-T-P MODIFICATION REQUEST signalling flow.
 - Furthermore, UTRAN establishes the p-t-p RB by means of appropriate RRC procedures e.g. the RB setup procedure
 - UEs establish the p-t-p radio bearers by means of the RRC procedure selected by UTRAN eg. the RB setup procedure

- UTRAN updates MCCH (MBMS SERVICE INFO) to inform UEs joining or entering the cell at a later point in time.

8.1.2 Joining (during a session)

In case the user wants to join an MBMS service (before or during a session), the UE initiates NAS procedures (e.g. MBMS service activation).

If no session is ongoing upon completion of the joining procedure, the joining procedure is transparent to the AS.

In case a session using p-t-m transfer mode is ongoing upon completion of the joining procedure, the UE may initiate reception of the p-t-m radio bearers. In case the ongoing session applies p-t-p transfer mode, UTRAN may establish the p-t-p radio bearers. UTRAN would do this upon receiving a UE linking indication from CN, which normally follows the joining. As a result of the UE linking, UTRAN may decide to change the transfer mode from p-t-p to p-t-m. This change of transfer mode is out of the scope of this sequence (to be covered by a separate sequence).

The Figure 8.1.2 shows an example of a possible joining sequence.

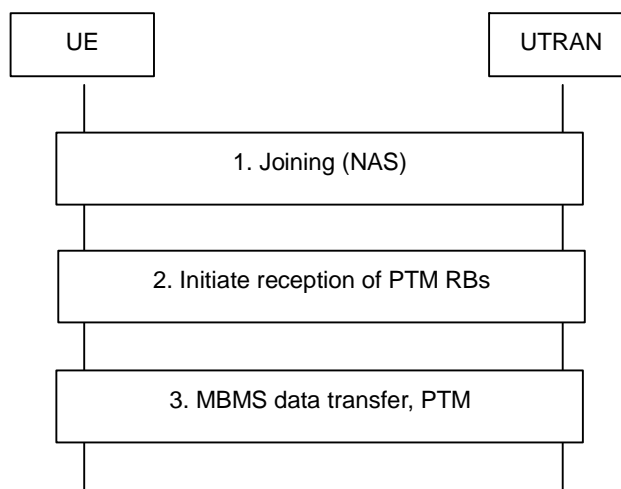

Figure 8.1.2: Joining with continuation of p-t-m

In general, the joining sequence involves the following steps:

- UEs in idle mode first perform RRC connection establishment, while UEs in CELL_PCH and URA_PCH first perform cell update
- UEs initiate the joining procedure (NAS)
- In case UTRAN continues to use the p-t-m transfer mode:
 - UTRAN sends the MBMS dedicated notification message on DCCH including the service ID and cause=session ongoing to inform UEs in CELL_DCH
 - Upon receiving MBMS dedicated notification with cause=session ongoing, UEs in CELL_DCH that are incapable of receiving the MCCH and the corresponding MTCH in parallel to the existing activity notify the upper layer. This enables the user to choose between the ongoing activity and the new MBMS service. If the user chooses to receive the new MBMS service or if the UE in Cell_DCH is capable of receiving MCCH and MTCH in parallel to the existing activity, the UE shall read MCCH to acquire the MBMS SERVICE INFORMATION and MBMS RADIO BEARER INFORMATION from MCCH.
 - Upon acquiring the MBMS SERVICE INFORMATION and the MBMS RADIO BEARER INFORMATION including the p-t-m RB information for the concerned MBMS service, the UE starts receiving the p-t-m radio bearers
- In case UTRAN continues using the p-t-p transfer mode:
 - UTRAN establishes the p-t-p RB by means of appropriate RRC procedures eg. the RB setup procedure

- UEs establish the p-t-p radio bearers by means of the RRC procedure selected by UTRAN eg. the RB setup procedure.

8.1.3 Recounting

During a p-t-m MBMS session, UTRAN may perform re-counting to verify if p-t-m is still the optimal transfer mode. The purpose of the re-counting procedure is to count the number of idle mode, URA_PCH, CELL_PCH, and CELL_FACH state UEs that have joined a specific service. As a result of this procedure, UTRAN may decide to change the transfer mode from p-t-m to p-t-p. This change of transfer mode is outside the scope of this sequence (to be covered by a separate sequence).

The Figure 8.1.3 shows an example of a possible recounting sequence.

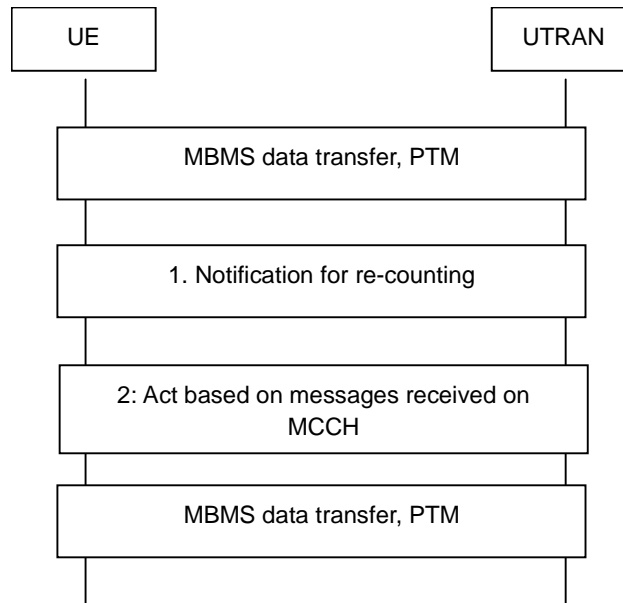

Figure 8.1.3: Recounting with continuation of p-t-m

In case UTRAN applies re-counting to determine the most optimal transfer mode, the following steps are performed:

- UTRAN sends the MBMS CHANGE INFORMATION and the MBMS ACCESS INFORMATION including service ID, and access probability on MCCH
- UEs in idle mode as well as UEs in CELL_PCH, URA_PCH and CELL_FACH receiving an MBMS service provided in p-t-m transfer mode read the MBMS CHANGE INFORMATION at the beginning of each modification period. If service Id of activated MBMS service is indicated in MBMS CHANGE INFORMATION UEs continue reading the rest of MCCH information.
- Upon receiving the MBMS ACCESS INFORMATION including access probability, UEs in idle mode or URA_PCH, CELL_PCH and CELL_FACH state for which the probability check passes, initiate counting response.
- UTRAN counts the UEs with an activated MBMS service by combining the UE linking from CN and received counting responses from UEs.
- In the case that no UE is counted as present in the cell then UTRAN may decide not to provide any RB for the service in the cell.
- In case a pre-defined threshold is reached, UTRAN continues using the p-t-m transfer mode. Otherwise, UTRAN may repeat the MBMS ACCESS INFORMATION a number of times, using different probability values. If the threshold is not reached, UTRAN switches transfer mode from p-t-m to p-t-p
- In case UTRAN continues using the p-t-m transfer mode, it may return UEs that responded to counting back to idle mode by releasing the RRC connection.

8.1.4 Session stop

UTRAN may apply the session stop procedure to inform UEs that the end of MTCH transmission concerns the end of a session rather than just an idle period. The purpose of the procedure is to reduce the UE power consumption.

The Figure 8.1.4 shows an example of a possible session stop sequence.

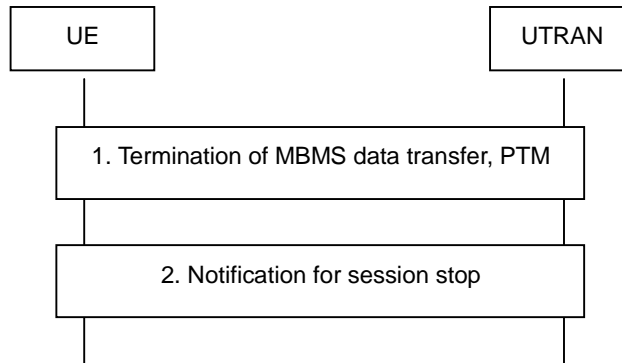

Figure 8.1.4: Session stop

In case UTRAN provides the service p-t-m, the session stop sequence involves the following steps:

- UTRAN updates the MBMS CHANGE INFORMATION, MBMS SERVICE INFORMATION and the MBMS RADIO BEARER INFORMATION including the service ID and the explicit radio bearer release indicator. UTRAN updates MCCH (MBMS SERVICE INFORMATION) to inform UEs joining or entering the cell in a later point of time.
- UEs in idle mode as well as UEs in CELL_PCH, URA_PCH and CELL_FACH receiving an MBMS service provided in p-t-m transfer mode read the MBMS CHANGE INFORMATION at the beginning of the each modification period. If service Id of activated MBMS service is indicated in MBMS CHANGE INFORMATION UEs continue reading the rest of MCCH information.
- Upon receiving this information the UE stops receiving the MTCH

In case UTRAN provides the service p-t-p, the session stop sequence involves the following steps:

- UTRAN releases the p-t-p radio bearers and updates MCCH (MBMS SERVICE INFO) to inform UEs joining or entering the cell at a later point in time.

8.2 MBMS RNC Signalling Flows

8.2.1 MBMS Session Start procedure

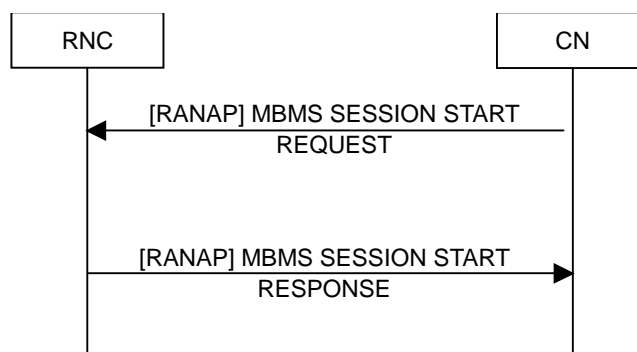

Figure 8.2.1: MBMS Session Start procedure. Successful operation.

The MBMS Session Start procedure is initiated by the CN when an MBMS Session is started. The MBMS SESSION START REQUEST is sent to each RNC that is connected to the CN (in case of Iu-flex the RNC may receive more than one MBMS SESSION START REQUEST message).

The MBMS SESSION START REQUEST contains the MBMS Service Id, and optionally the MBMS Session ID, MBMS Bearer Service Type and the MBMS Session Attributes (MBMS Service Area Information, QoS parameters...) It may also include a list of RAs which lists each RA that contains at least one PMM-IDLE UE that has activated the service.

MBMS Session Start procedure also provides the MBMS Iu Data Bearer Establishment functionality. In case of Iu-flex the RNC shall not establish more than one MBMS Iu bearer for a certain service towards a pool area and shall inform the respective CN nodes accordingly.

MBMS Session Start procedure may also be initiated by the CN to restore the MBMS service following an RNC failure or an Iu path failure as specified in TS 23.007 [15].

The MBMS Session Start procedure in case of IP Multicast is described in section 8.2.16.

8.2.2 MBMS Session Update procedure

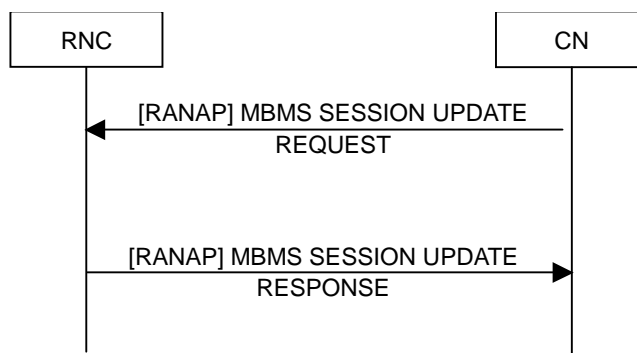

Figure 8.2.2: MBMS Session Update procedure. Successful operation.

The MBMS Session Update procedure is initiated by the CN when an MBMS Session is ongoing and SGSN notices that there is a need to update the list of RAs. The MBMS SESSION UPDATE REQUEST contains the MBMS Service Id, and e.g. List of RAs with PMM Idle UEs..

8.2.3 MBMS Session Stop procedure

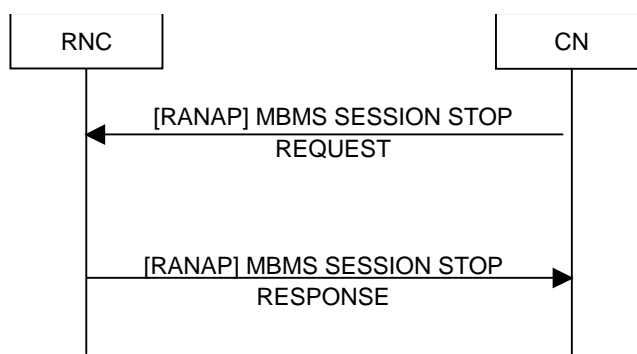

Figure 8.2.3: MBMS Session Stop procedure.

This signalling flow depicts the MBMS Session Stop procedure.

This procedure is initiated by the CN to the RNCs with an ongoing MBMS session, when no more data will be sent for that MBMS service for some period of time.

The MBMS Session Stop procedure also provides the MBMS Iu Data Bearer Release functionality.

8.2.4 RNC Registration procedure

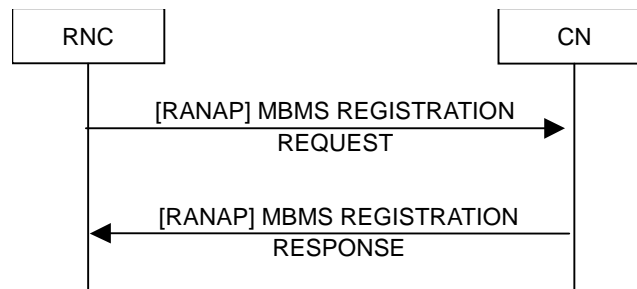

Figure 8.2.4: MBMS Registration procedure.

This signalling flow depicts the MBMS Registration procedure.

This procedure is initiated by the RNC in the case that the RNC is not SRNC for any UE that has joined the MBMS Service, but this RNC is DRNC for PMM-CONNECTED UEs that have joined the MBMS Service and there is no MBMS Service Context for the MBMS Service in this RNC.

This procedure shall be initiated by the DRNC, as soon as a UE link is received over the Iur and there exists no MBMS Service Context for the MBMS service for which the UE link is received.

8.2.5 RNC De-Registration procedure

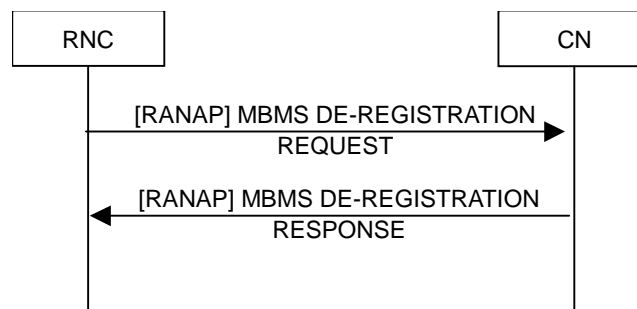

Figure 8.2.5: RNC MBMS De-Registration procedure.

This signalling flow depicts the RNC De-Registration procedure. This procedure is initiated by the RNC towards the CN node it was registered to in case the RNC is not acting as a Serving RNC for any UE that has activated the MBMS Service and has ceased to act as a Drift RNC for UEs which has activated an MBMS service.

8.2.6 CN De-Registration procedure

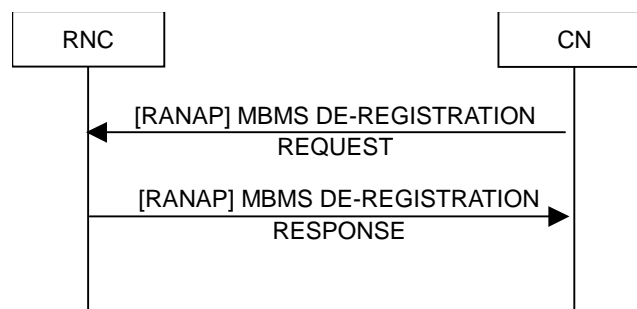

Figure 8.2.6: CN MBMS De-Registration procedure.

This signalling flow depicts the CN De-Registration procedure.

This procedure is initiated by the CN in order to inform the RNC that a certain MBMS Service is no longer available.

8.2.7 MBMS Channel Type Switching over Uu

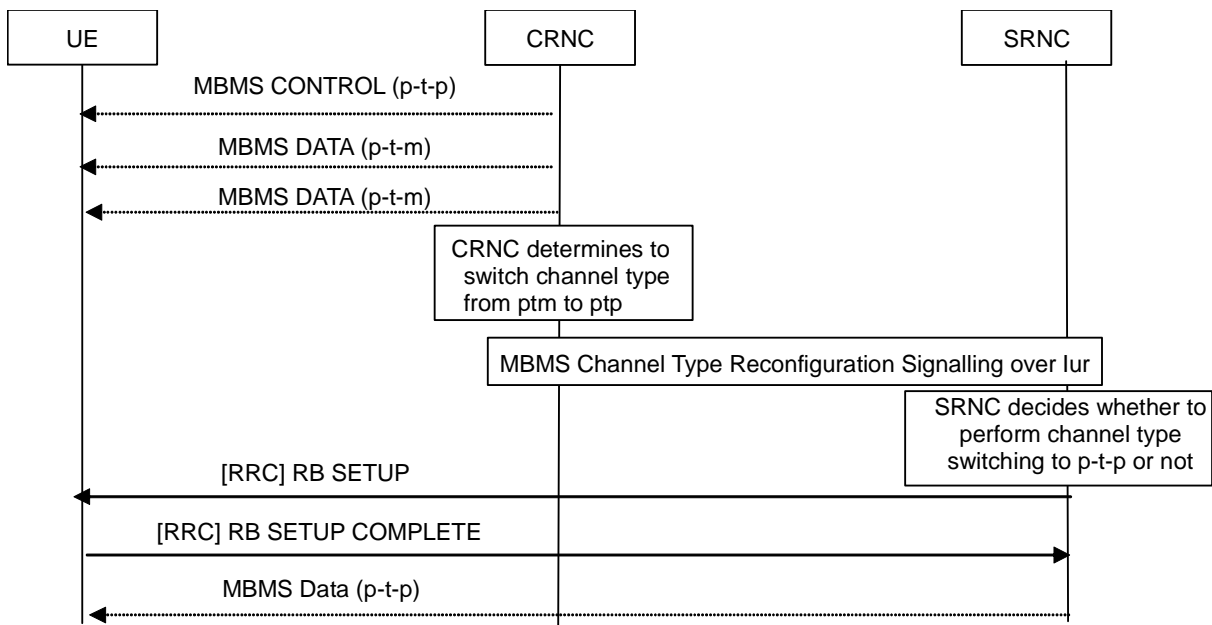

Figure 8.2.7: Channel type switching signalling flow from p-t-m to p-t-p.

The CRNC is responsible for the decision regarding having p-t-m transmission or no p-t-m transmission in a cell for a specific MBMS service. The CRNC informs all the SRNCs having UEs in that cell about its decision. The SRNC is the RNC controlling the RRC connection and RBs to a specific UE. In the example shown, the CRNC decided to no longer use p-t-m, then the SRNC decided to perform channel type switching to deliver the MBMS service over DTCH mapped on a dedicated channel. The RB SETUP message contains the MBMS Service Id. It is FFS whether the SRNC always follows the CRNC's request or not.

NOTE: the channel type switching in this case includes a change of both transport and logical channels.

8.2.8 MBMS UE Linking

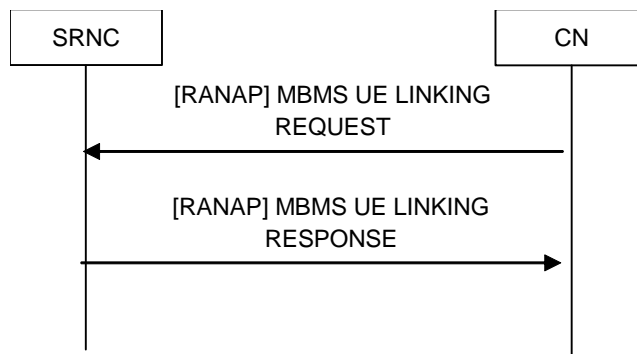

Figure 8.2.8: MBMS UE linking signalling flow

This signalling flow is only applicable for handling UEs in PMM-CONNECTED mode with activated MBMS Services.

The signalling flow is used to link a specific UE to one or several MBMS service contexts in the SRNC. The MBMS UE LINKING REQUEST message contains the whole list of MBMS Service Ids and MBMS PTP RAB IDs (e.g. mapped from NSAPIs) activated by the UE. If there has not been an MBMS service context related to an MBMS Service Id then SRNC creates an MBMS service context as a result of this procedure.

8.2.9 MBMS UE De-Linking

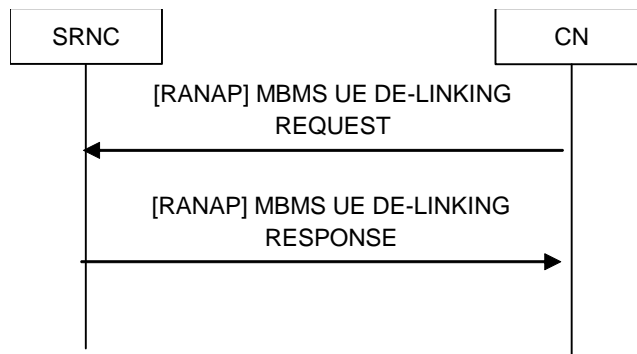

Figure 8.2.9: MBMS UE De-linking signalling flow

This signalling flow is only applicable for handling UEs in PMM-CONNECTED mode with activated MBMS Services.

The signalling flow is used to remove a specific UE from one or several MBMS service context in the SRNC. The MBMS UE DE-LINKING REQUEST message contains the list of MBMS Service Ids de-activated by the UE.

8.2.10 MBMS Service Id Request

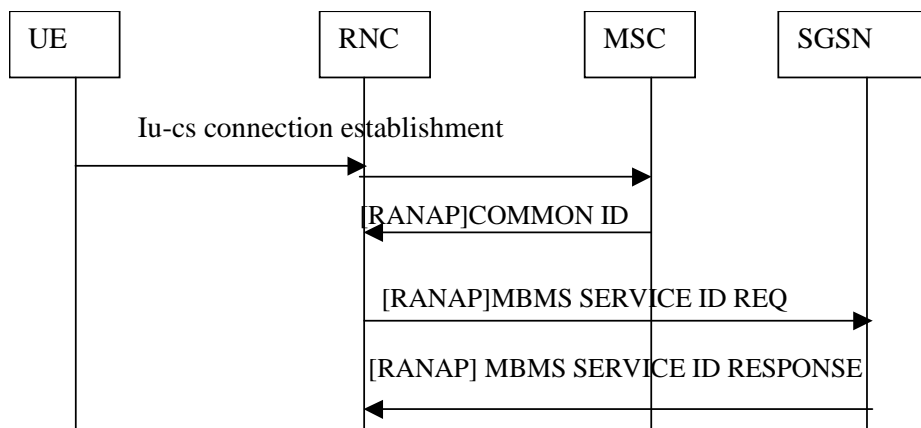

Figure 8.2.10: MBMS Service Id list over Iu signalling flow

This signalling flow is applicable for handling MBMS to UEs in RRC-Connected, PMM-IDLE state. The list of MBMS services the user has joined is sent over Iu.

The purpose of this signalling flow is to perform UE linking for a RRC connected, PMM idle user. The UE provides an indication that the user has joined at least one MBMS service and the PS Domain specific IDNNS (the message that would carry this information is FFS) whenever an Iu-cs connection is established and the UE is PMM idle (that is there is no Iu-ps connection), The RNC requests the MBMS services the UE has joined from the SGSN (or the SGSN the UE is attached to in case of Iu-flex) using a connectionless procedure. The MBMS SERVICE ID REQ contains the IMSI of the UE. The SGSN response contains the full list of MBMS services the user has joined.

The MBMS service list is then stored in the RNC. The list is deleted when the UE moves to RRC idle and the RRC context is removed in the RNC.

8.2.11 MBMS Attach/Detach over Iur

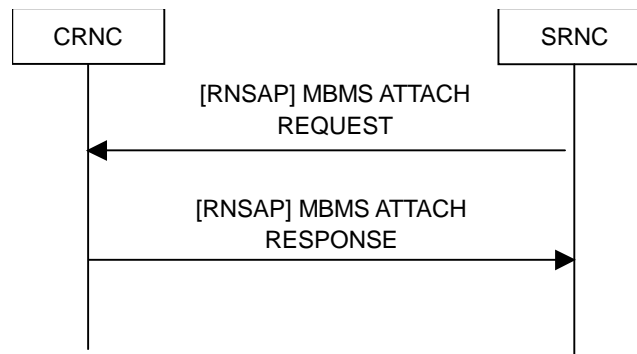

Figure 8.2.11-1: MBMS attach request signalling flow: Successful Operation.

This signalling flow is only applicable for handling UEs in RRC connected mode with activated MBMS Services.

The purpose of this signalling flow is

- to either allow the CRNC to add one or several new UEs to the total number of UEs in a given cell using one or several MBMS services. The MBMS ATTACH REQUEST then contains the Cell Id of the new cell (may contain the URA Id of the new URA for UEs in URA_PCH state), the whole list of affected MBMS Service Ids and a UTRAN specific UE Identification if necessary.
- or to allow the SRNC to inform the DRNC in which URA notifications for MBMS Services have to be sent. The MBMS ATTACH REQUEST then contains a list of URAs and the corresponding MBMS Services.

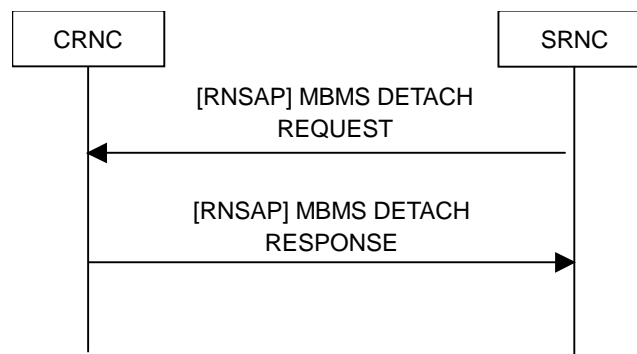

Figure 8.2.11-2: MBMS detach request signalling flow: Successful Operation.

This signalling flow is only applicable for handling UEs in RRC connected mode with activated MBMS Services.

The purpose of this signalling flow is

- to either allow the CRNC to decrease the total number of UEs receiving one or several MBMS service in a given cell. The MBMS DETACH REQUEST contains the Cell Id of the old cell (may contain the URA Id of the old URA for UEs in URA_PCH state), the whole list of affected MBMS Service Ids and a UTRAN specific UE Identification if necessary.
- or to allow the SRNC to inform the DRNC in which URA there is not anymore a need to send notifications for MBMS Services due to the presence of UEs in URA_PCH. The MBMS DETACH REQUEST then contains a list of URAs and the corresponding MBMS Services

8.2.12 MBMS Channel Type Reconfiguration over Iur

These signalling flows need further study.

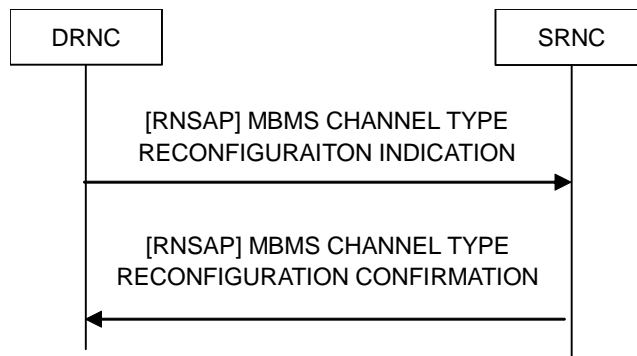

Figure 8.2.12: Channel Type Reconfiguration signalling flow: Successful Operation.

This signalling flow is only applicable for handling MBMS UEs in RRC connected mode.

The purpose of this signalling flow is that the CRNC informs the selected channel type to the SRNCs used in a cell under the CRNC. The MBMS CHANNEL TYPE RECONFIGURATION INDICATION contains a list of U-RNTI, Channel type and MBMS Service Id corresponding to the UEs connected to the SRNC.

8.2.13 Information Exchange over Iur

These signalling flows is used by the DRNC to acquire the MBMS related information for MBMS service identified by TMGI and is used between the RNCs, which are controlling cells neighbouring to each other for selective/soft combining in case of inter-RNC synchronization.

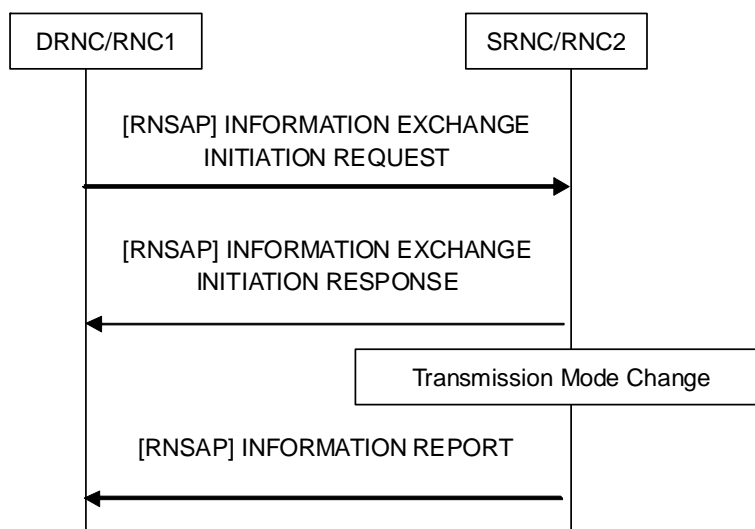

Figure 8.2.13: Information Exchange Initiation signalling flow: Successful Operation.

The purpose of this signalling flow is that the DRNC request the APN and IP multicast address for an MBMS service. The INFORMATION EXCHANGE INITIATION REQUEST includes the TMGI for which the APN and IP multicast address are requested. In the INFORMATION EXCHANGE INITIATION RESPONSE message, the corresponding APN and IP multicast address are included.

If the Information Exchange procedure is started and the transmission mode is changed, this shall be reported by the INFORMATION REPORT message.

And the additional purpose of this signalling flow used in case of inter-RNC synchronization is

- to request the external neighbouring RNC(s) to provide the counting results in cells the neighbouring RNC controls
- to request the external neighbouring RNC(s) to inform about the transmission mode change in cells the neighbouring RNC controls for a MBMS session

- to request the external neighbouring RNC(s) to provide the MBMS PTM RB configuration used in cells the neighbouring RNC controls
- to request the external neighbouring RNC(s) to provide the RLC Sequence Number.

8.2.14 MBMS RAB Establishment Indication

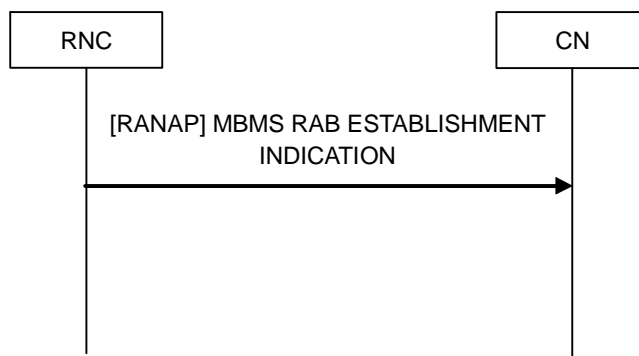

Figure 8.2.14: MBMS RAB Establishment Indication procedure

This signalling flow is used by the RNC to indicate to the CN the establishment of the MBMS RAB corresponding to the MBMS Iu signalling connection.

When the RNC decides not to establish an MBMS Iu bearer, for a particular MBMS service, during MBMS Session Start procedure, for example the RNC does not control any contained in MBMS Service Area Information and the RNC does not belong to any of the RA in a list of RAs which lists each RA that contains at least one PMM-IDLE UE but later when a UE linking (via Iu or Iur) is performed or as a result (p-t-p decision) of channel type reconfiguration in another RNC, the RNC establishes the Iu bearer and uses this procedure to inform the CN that an Iu bearer has been established.

If Iu-Flex is active, the selection of the CN node is implementation dependant.

The MBMS RAB ESTABLISHMENT INDICATION message contains the *Transport Layer Address* IE and the *Iu Transport Association* IE.

8.2.15 MBMS RAB Release

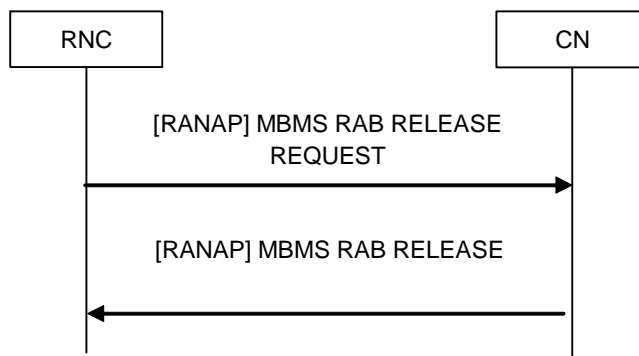

Figure 8.2.15: MBMS RAB Release Request procedure.

This signalling flow is used by the RNC to indicate to the CN to request the release of an MBMS RAB.

At reception of the MBMS RAB RELEASE REQUEST message the CN should initiate the release of all MBMS resources related to the Iu connection without releasing the Iu signalling connection.

The RNC shall at reception of MBMS RAB RELEASE initiate the release of the related MBMS RAB resources.

The MBMS RAB release may be initiated e.g. for the following reasons (unexhausted):

- There are lack of radio resource in UTRAN and RNC decided to pre-empt an MBMS RAB for a on-going MBMS session based on Allocation/Retention Priority
- When there are no UEs with a given activated MBMS service consuming radio resources in cells under the RNC or the RNC is controlling UEs in cells under another RNC;
- In case of channel type switching from ptp to ptm in cells under control of another RNC in its role of DRNC;
- There are no cells under the RNC which are part of the RA List Of Idle UEs if received.

8.2.16 MBMS Session Start procedure in case of IP Multicast transport

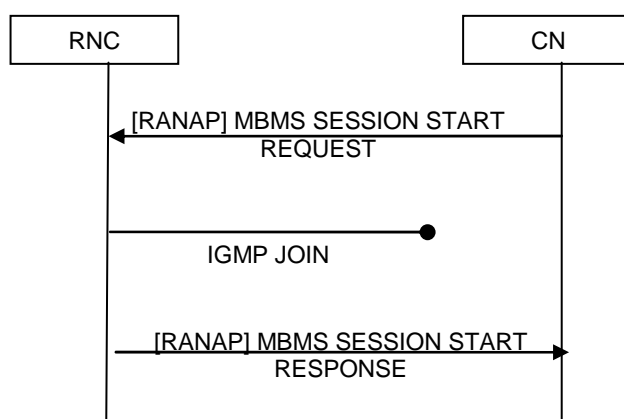

Figure 8.2.16-1: MBMS Session Start procedure. Successful operation.

The MBMS Session Start procedure is initiated by the CN when an MBMS Session is started. The MBMS SESSION START REQUEST is sent to each RNC that is connected to the CN (in case of Iu-flex the RNC may receive more than one MBMS SESSION START REQUEST message).

The MBMS SESSION START REQUEST contains the MBMS Service Id, and optionally the MBMS Session ID, MBMS Bearer Service Type, the MBMS Session Attributes (MBMS Service Area Information, QoS parameters, ...) and Transport Layer Address used for the IP-multicast and Iu Transport Association (DL TEID) IE. In addition in case PDCP is used for the MBMS service the PDCP information is included. It may also include a list of RAs which lists each RA that contains at least one PMM-IDLE UE that has activated the service.

The RNC stores the session attributes in the MBMS Service Context, sets the state attribute of its MBMS Service Context to 'Active' and joins the IP Multicast group, which is used for the User data delivery of this MBMS session between the GGSN and RNCs in case radio resource is available. In case of successful joining the indicated IP Multicast group the RNC replies to the CN nodes from which it has received the MBMS Session Start Request message that the IP Multicast Bearer setup was successful and establishes the radio resource for the transfer of MBMS data to the interested UEs.

8.2.17 MBSFN MCCH Information

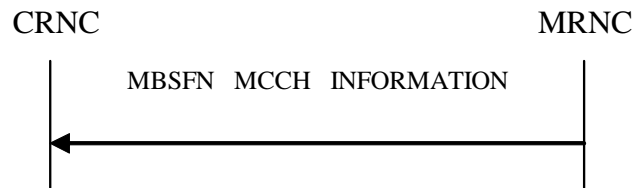

Figure 8.2.17-1: MBSFN MCCH Information procedure, Successful Operation

The signalling flow shall be used only if MRNC is used for MBSFN operation.

The MBSFN MCCH INFORMATION message contains the MCCH messages list sent on the MRNC and the MCCH configuration information of the MRNC.

The signalling flow is used by the MRNC to inform the CRNC of the MCCH configuration and scheduling information used in MRNC upon receipt of MBMS SESSION START message from CN.

The CRNC shall prepare the setup of the requested MBMS sessions upon receipt of MBMS SESSION START message from CN, then instead of preparing RRC messages and physical configuration, wait for the MBSFN MCCH INFORMATION message that is sent from MRNC.

Upon receipt of the MBSFN MCCH INFORMATION message, if the *MCCH Configuration* IE exists, the CRNC shall setup or reconfigure the MCCH of all cells in the MBSFN cluster with the configuration contained in this IE, and update the System Information of these cells.

The CRNC shall decode the *L3 Information* IE contained in the *MCCH Message List* IE and apply the RLC/MAC/PHY configuration specified by relative MCCH Message to setup the RB information of MTCH, and then send the *L3 Information* IE on the MCCH in the receiving sequence at the beginning of the first MCCH modification period following the CFN carried in the message.

8.3 MBMS Uu Signalling Flows

8.3.1 Broadcast of MBMS System Information

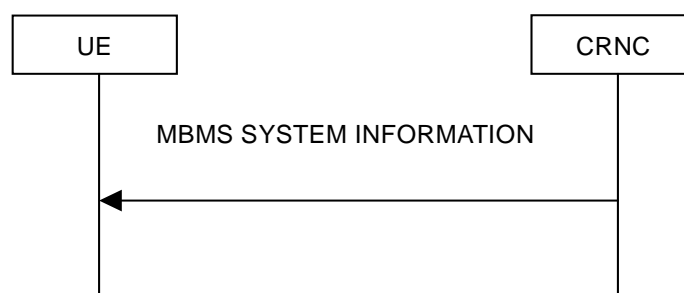

Figure 8.3.1: Broadcast of MBMS system information.

This signalling flow is applicable for handling MBMS to UEs in PMM IDLE and PMM-CONNECTED mode.

The purpose of the signalling flow is for UTRAN to broadcast MBMS system information to UEs using the BCCH. The MBMS SYSTEM INFORMATION shall be repeatedly transmitted after its first transmission. Upon receiving the first MBMS SYSTEM INFORMATION, the UE shall establish the radio bearer carrying an MCCH.

The MBMS SYSTEM INFORMATION includes:

- MCCH schedule information (access info, repetition and modification periods)

- Configuration of a radio bearer carrying an MCCH

More information may be included in the MBMS SYSTEM INFORMATION.

8.3.2 MBMS Service Information

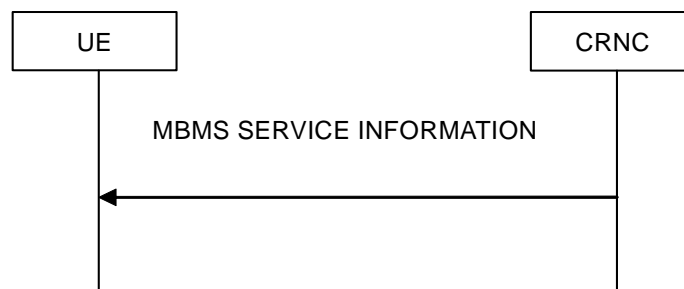

Figure 8.3.2: MBMS service information signalling flow

This signalling flow is applicable for handling MBMS to UEs in PMM IDLE and PMM-CONNECTED mode.

The purpose of the signalling flow is for RNC to inform UEs of all of MBMS services available in one cell. The MBMS SERVICE INFORMATION shall be transmitted periodically on MCCH to provide an indication of the status of the MBMS service in the cell and to support mobility.

The MBMS SERVICE INFORMATION contains MBMS service ids, optionally the MBMS Session ID, and an indication of the service status in the cell i.e. whether it is provided by p-t-m or p-t-p bearers or whether explicit release is indicated. The MBMS service ids indicate the MBMS services which are being served in the cell or the MBMS services which can be served if the UE requests it. P-t-m indication indicates that the MBMS service is on p-t-m in the cell, thus it informs the UE of the need of reception of the MBMS RADIO BEARER INFORMATION.

8.3.3 MBMS Radio Bearer Information



Figure 8.3.3: MBMS radio bearer information signalling flow

This signalling flow is applicable for handling MBMS to UEs in IDLE and PMM-CONNECTED mode.

The purpose of the signalling flow is for the RNC to inform UE(s) regarding the MTCH radio bearer information. MBMS RADIO BEARER INFORMATION is only available for p-t-m transmission. MBMS RADIO BEARER INFORMATION shall be transmitted periodically on MCCH to support mobility in the MBMS service.

MBMS RADIO BEARER INFORMATION includes MBMS Service Id, radio bearer, transport channel and physical channel information per MBMS service.

8.3.4 MBMS Access Information

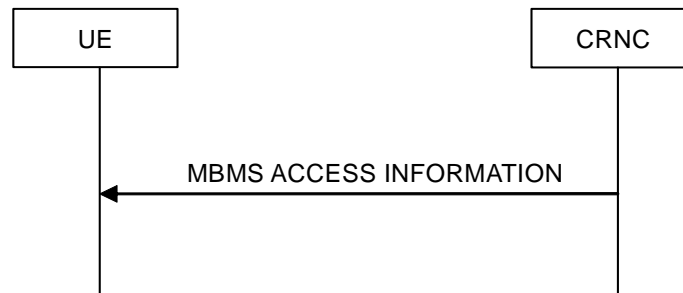

Figure 8.3.4: MBMS Access Information signalling flow

This signalling flow is applicable for handling MBMS UEs in IDLE mode or URA_PCH, CELL_PCH, CELL_FACH state.

The purpose of the signalling flow is for the RNC to inform UE(s) with particular activated MBMS service of the potential need to make an MBMS Counting Response i.e. establish an RRC connection or make a cell update. The MBMS ACCESS INFORMATION is transmitted during counting and re-counting on MCCH. The MBMS ACCESS INFORMATION includes, for each service for which counting is required, the MBMS service identifier, probability factors for idle and connected modes and an indication of the connected mode states to which the signalling flow applies.

8.3.5 MBMS Neighbouring Cell Information



Figure 8.3.5: MBMS Neighbouring Cell Information signalling flow

This signalling flow is applicable for handling MBMS to UEs in PMM IDLE and CONNECTED mode.

The purpose of the MBMS NEIGHBOURING CELL INFORMATION signalling flow is for the UTRAN to inform to UEs of the MTCH configuration of the neighbouring cells which are available for selective combining. In case of partial soft combining, the MBMS NEIGHBOURING CELL INFORMATION contains the L1-combining schedule, which indicates when the soft combining is applicable between the specific S-CCPCH of the cell and the specific S-CCPCH of the neighbouring cell. With MBMS NEIGHBOURING CELL INFORMATION the UE is able to receive MTCH transmission from neighbouring cell without reception of the MCCH of that cell. The MBMS NEIGHBOURING CELL INFORMATION shall be repeatedly transmitted on MCCH when selective or soft combining is utilized in the MBMS p-t-m transmission in the given cell group.

8.3.6 MBMS Joined Indication

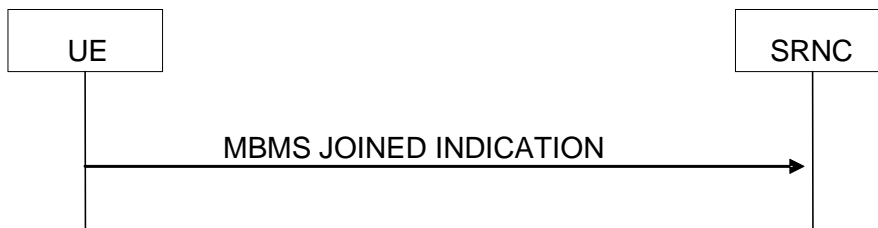

Figure 8.3.6: MBMS joined indication signalling flow

This signalling flow is applicable for handling MBMS to UEs in RRC-Connected, PMM-IDLE state. The MBMS JOINED INDICATION is sent over the DCCH.

The signalling flow is initiated by the UE after entering RRC-Connected, PMM-IDLE state. The purpose of the signalling flow is to enable the UE to inform the SRNC that the user has joined at least one MBMS service. The SRNC requests the MBMS services the UE has joined from the SGSN as defined in subclause 8.2.10.

In SRNC relocation this information is transmitted from source RNC to target RNC.

NOTE: If SRNC has valid linking information the complete service list of activated services is also transmitted from source RNC to target RNC in SRNC relocation.

8.3.7 MTCH Scheduling Information



Figure 8.3.7: MTCH scheduling information.

This signalling flow is applicable for handling MBMS to UEs in PMM IDLE and CONNECTED mode.

The purpose of the signalling flow is to enable UEs to perform discontinuous reception of MTCH. The UE may discontinuously receive MTCH based on scheduling information indicated by the MTCH SCHEDULING INFORMATION. This signalling is transmitted on MSCH mapped on SCCPCH carrying MTCH. The MTCH SCHEDULING INFORMATION is signalled on each MSCH repetition period. The MSCH repetition period and the offset from the cell timing are indicated on MCCH. In case of soft combining, the MSCH repetition period is same for all soft combinable S-CCPCH. The scheduling information allows to cover different periods for different MBMS services.

The MTCH SCHEDULING INFORMATION includes for each service:

- MBMS service Id (the actual coding is defined in stage-3).
- Beginning and duration of MBMS data transmission (one contiguous block or more is defined in Stage-3).
- Duration can be infinite (no DTX). This option could be signalled in the MCCH (Stage-3 definition).
- Indication of no MBMS data transmission for either this period or several consecutive periods (a period is expressed in MSCH repetition period).

8.3.8 MBMS Change Information

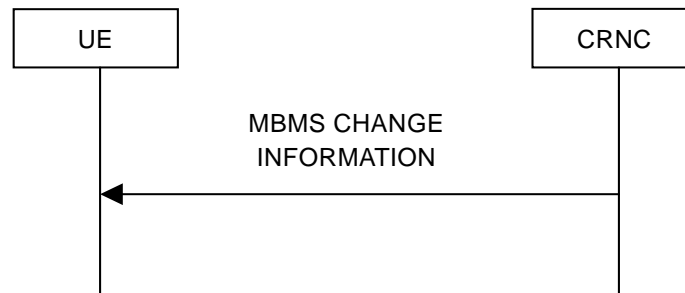

Figure 8.3.8: MBMS change information.

This signalling flow is applicable for handling MBMS to UEs in PMM IDLE and CONNECTED mode. UTRAN should transmit this signalling flow in beginning of each modification period on MCCH and repeat it at least in every repetition period of that modification period. UE shall read this information flow when detecting that MICH bits set for a service that UE has activated, or periodically at the begin of each modification period when receiving MTCH.

The purpose of the signalling flow is to indicate MBMS services whose MCCH information is changed in that modification period. The content of MBMS CHANGE INFORMATION shall be minimized, so that the MCCH reading time for the UEs, activated MBMS service whose MCCH information is not modified on that modification period, is minimized.

The MBMS CHANGE INFORMATION includes:

- The MBMS service Ids for which MCCH information is modified on that modification period.

8.3.9 MBMS P-T-P Modification Request



Figure 8.3.9: MBMS P-T-P Modification Request.

This signalling flow is applicable for handling UEs with an activated service that requires MBMS p-t-p RB in PMM IDLE and CONNECTED mode. In idle mode, URA_PCH and CELL_PCH states the UE may transmit this signalling flow to request the setup of a p-t-p MBMS RB after receiving the indication on MCCH that p-t-p transfer mode is utilised or, in CELL_DCH state, to request the release of the p-t-p MBMS RB due to higher priority MBMS service, or to indicate the frequency used for transmitting the higher priority service as specified in subclause 5.2.8. This signalling flow is transmitted on DCCH or on CCCH dependent upon UE state.

UEs in idle mode are required to perform RRC connection establishment for sending this information flow. UEs that are in URA_PCH or CELL_PCH state are required to make a cell update and UEs that are in CELL_DCH state transmit an MBMS MODIFICATION REQUEST message.

When UTRAN receives this message from the UE, the UTRAN may setup or release the p-t-p MBMS RB by normal RB release procedure or, in the case of a preferred frequency being indicated, it may perform inter-frequency HHO.

The MBMS P-T-P Modification Request message includes the identity of the MBMS service when the service appears in the list of MBMS Selected Services.

8.3.10 MBMS Counting Response

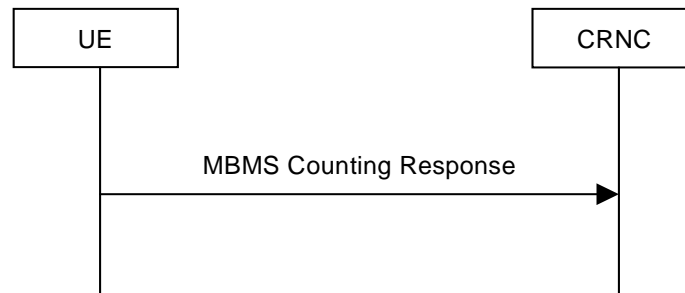

Figure 8.3.10: MBMS Counting Response.

This signalling flow is applicable for UEs passing the probability check in counting procedure in idle mode or URA_PCH, CELL_PCH or CELL_FACH state. For the UE in idle mode this signalling flow refers to the complete RRC connection establishment procedure. For UEs in URA_PCH, CELL_PCH and CELL_FACH state this signalling flow refers to cell update procedure.

The MBMS Counting Response message includes the identity of the MBMS service when the service appears in the list of MBMS Selected Services.

8.3.11 MBMS Selected Services Information

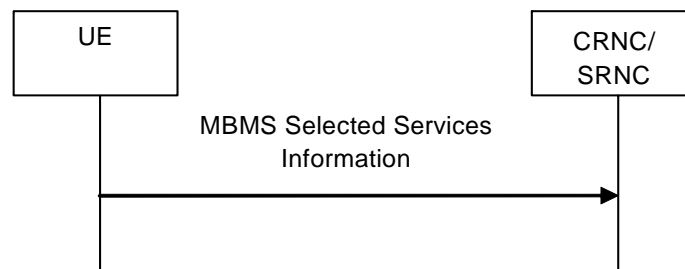

Figure 8.3.11: MBMS Selected Services Information.

This signalling flow is applicable for UEs entering CELL_DCH state. The purpose of the signalling flow is to enable the UE to inform the SRNC that the user requires the reception of MBMS Selected Services. When the SRNC is not the CRNC of the UE, this signalling flow may interact with the URA linking/de-linking described in subclause 5.1.10.

This signalling flow is also applicable for UEs in CELL_DCH states, when the list of MBMS Selected Services has been modified.

This signalling flow is also applicable for UEs in CELL_PCH, URA_PCH and CELL_FACH states when the list of MBMS Selected Services has been modified by the upper layers and the MBMS Service appears in the MCCH of the cell and the RNC has indicated in the MBMS GENERAL INFORMATION message that it should be notified of a change to this list. If an MBMS Service is contained in the list of MBMS Selected Services but is currently not available in the cell, when the service appears on the MCCH the UE does not perform this signalling flow.

The purpose of the signalling flow is to enable the UE to inform the CRNC that the list of MBMS Selected Services in the UE has been modified.

9 Security for MBMS

Ciphering for MBMS multicast data is done between the BM-SC and the UE as defined in [7]. Therefore, for MBMS p-t-m data transmissions no radio interface ciphering is applied.

In case of p-t-p MBMS data transmissions, if the security is activated for the UE the ciphering is also applied for p-t-p MBMS data RB as for any other RB of the UE.

10 Mobility Procedures for MBMS

One of the requirements in [5] is: "Data loss during cell change should be minimal". Therefore, when the UE receiving an MBMS session in idle mode or connected mode (not including CELL_DCH) re-selects between cells, it should be possible to provide service continuity to this UE.

The following mechanism has been identified to minimise the data loss on cell change.

10.1 Use of Periodical Transmission of MBMS Critical Information

In this mechanism, the cell periodically transmits an MBMS critical information, informing all MBMS services currently configured for p-t-m transmission or p-t-p transmission. If MBMS service is configured for p-t-m transmission, the periodical transmission of MBMS critical information may also contain the Radio Bearer information corresponding to each MBMS service and Neighbouring cell information.

If the cell is configured for p-t-p transmission, then the UE would perform a normal RRC connection establishment.

10.2 UE Actions for Mobility

The UE mobility between intra frequency cells is not affected by the MBMS reception. The mobility between different frequency layers is affected by the Frequency Layer Convergence process as defined in 11.2, if used by the network.

In CELL_FACH and in CELL_DCH state the RRC operation has priority over MBMS reception, thus UE performs the inter frequency and inter RAT measurements as configured by the SRNC. UTRAN should utilize different periodicities between MCCH transmissions and CELL_FACH state measurement occasion, such that CELL_FACH state measurements and MCCH transmissions are not constantly overlapping for some UE.

In Idle mode and in CELL_PCH, URA_PCH states the measurements are performed as configured by the network based on the Release 5. The MBMS specific measurement occasions to S-CCPCH for UEs in idle mode and in CELL_PCH, URA_PCH states are not introduced and measurements have priority over MBMS reception. The usage of channel protection (channel coding) to recover some of the lost transport blocks is possible.

UEs may have DRx occasions for specific MBMS service when UE can stop decoding S-CCPCH and perform measurements. DRx occasion are based on scheduling information.

R'99 standards have some means to reduce need for number of measurements, which can be utilized for MBMS.

When the UE reselects the cell due to the mobility or returns to on service from out of service, the UE shall acquire the MCCH information if the activated MBMS service is available in the selected cell for the reception of the service. The service is available when the session has been already started and the service is being served on p-t-p/p-t-m in the cell, or the service can be served in the cell if the UE requests it.

If the MBMS service is available in the cell, the UE will perform an action for the service reception in the cell. For example, if the service is on p-t-p, the idle mode UE will initiate RRC connection establishment procedure. Otherwise, the UE does not need to perform such an action in the cell. The UE, which moves to the new cell, will operate according to the RRC state/mode as follows.

Whenever the UE moves between p-t-m cells while continuing to receive a service, UE shall receive MCCH information in a new cell, which includes an MBMS cell group identity. If a UE moves between cells belong to the same MBMS cell group based on the MCCH information, the UE does not need to re-establish RLC entity and re-initialise PDCP entity for the service received on MTCH. If a UE moves between cells belong to different MBMS cell groups based on the MCCH information, the UE shall re-establish RLC entity and re-initialise PDCP entity for the service received on MTCH.

10.2.1 RRC idle mode

Idle mode UE shall:

- if BCCH contains information regarding the MCCH in the new cell:
 - listen to the MCCH and receive the MBMS SERVICE INFORMATION;

- if the MBMS SERVICE INFORMATION contains the activated MBMS service-id:
 - if MBMS SERVICE INFORMATION indicates that the service is on p-t-m:
 - receive the MBMS RADIO BEARER INFORMATION and listen to the MTCH;
 - else:
 - initiate RRC connection establishment procedure and request the setup of MBMS p-t-p RB;
- if the UE receive the MBMS RADIO BEARER INFORMATION before the MBMS SERVICE INFORMATION and;
 - if MBMS RADIO BEARER INFORMATION contains the activated MBMS service id:
 - listen to the MTCH without the need of receiving the MBMS SERVICE INFORMATION.

10.2.2 URA_PCH State

URA_PCH state UE shall:

- perform URA update procedure if needed;
- if BCCH contains information regarding the MCCH in the new cell:
 - listen to the MCCH and receive the MBMS SERVICE INFORMATION;
- if MBMS SERVICE INFORMATION contains the activated MBMS service id:
 - if MBMS SERVICE INFORMATION indicates that the service is on p-t-m:
 - receive the MBMS RADIO BEARER INFORMATION and listen to the MTCH;
 - else:
 - initiate cell update procedure and request to setup the MBMS p-t-p RB;
- if the UE receive the MBMS RADIO BEARER INFORMATION before MBMS SERVICE INFORMATION message and;
 - if MBMS RADIO BEARER INFORMATION contains the activated MBMS service id:
 - listen to the MTCH without the need of receiving the MBMS SERVICE INFORMATION.

10.2.3 CELL_PCH

CELL_PCH state UE shall:

- perform cell update procedure;
- if BCCH contains information regarding the MCCH in the new cell:
 - listen to the MCCH and receive the MBMS SERVICE INFORMATION;
- if MBMS SERVICE INFORMATION contains the activated MBMS service id and:
 - if MBMS SERVICE INFORMATION indicates that the service is on p-t-m:
 - receive the MBMS RADIO BEARER INFORMATION message and listen to the MTCH.
 - else:
 - initiate the cell update procedure and request to setup the MBMS p-t-p RB.
- if the UE receive the MBMS RADIO BEARER INFORMATION before the MBMS SERVICE INFORMATION and;

- if MBMS RADIO BEARER INFORMATION contains the activated MBMS service id:
 - listen to the MTCH without the need of receiving the MBMS SERVICE INFORMATION.

10.2.4 CELL_FACH

CELL_FACH state UE shall:

- perform cell update procedure
- if BCCH contains information regarding the MCCH in the new cell:
 - listen to the MCCH and receive the MBMS SERVICE INFORMATION;
- if MBMS SERVICE INFORMATION contains the activated MBMS service id and;
 - if MBMS SERVICE INFORMATION indicates that the service is on p-t-m:
 - receive the MBMS RADIO BEARER INFORMATION and listen to the MTCH;
 - else:
 - initiate request to setup the MBMS p-t-p RB;
 - if the UE receive the MBMS RADIO BEARER INFORMATION before the MBMS SERVICE INFORMATION and;
 - if MBMS RADIO BEARER INFORMATION contains the activated MBMS service id:
 - listen to the MTCH without the need of receiving the MBMS SERVICE INFORMATION.

10.2.5 CELL_DCH State

CELL_DCH state UE shall:

- act on the RRC message received on DCCH in handover.
- if the UE has the capability to support MBMS in CELL_DCH:
 - if BCCH contains information regarding the MCCH in the new cell:
 - listen to the MCCH and receive the MBMS SERVICE INFORMATION;
 - if MBMS SERVICE INFORMATION contains the activated MBMS service id and;
 - if MBMS SERVICE INFORMATION indicates that the service is on p-t-m:
 - receive the MBMS RADIO BEARER INFORMATION and listen to the MTCH.
 - if the UE receive the MBMS RADIO BEARER INFORMATION before the MBMS SERVICE INFORMATION and;
 - if MBMS RADIO BEARER INFORMATION contains the activated MBMS service id:
 - listen to the MTCH without the need of receiving the MBMS SERVICE INFORMATION.

11 Resource Management for MBMS

11.1 MBMS Access Control Procedure

MCCH messages initiating counting or recounting cause multiple responses from UEs within a cell. This may result in RACH congestion if number of UEs is high in a cell. To avoid this, CRNC may perform MBMS access control procedure during counting or recounting procedure. MBMS access control procedure is described in Figure 11.1.

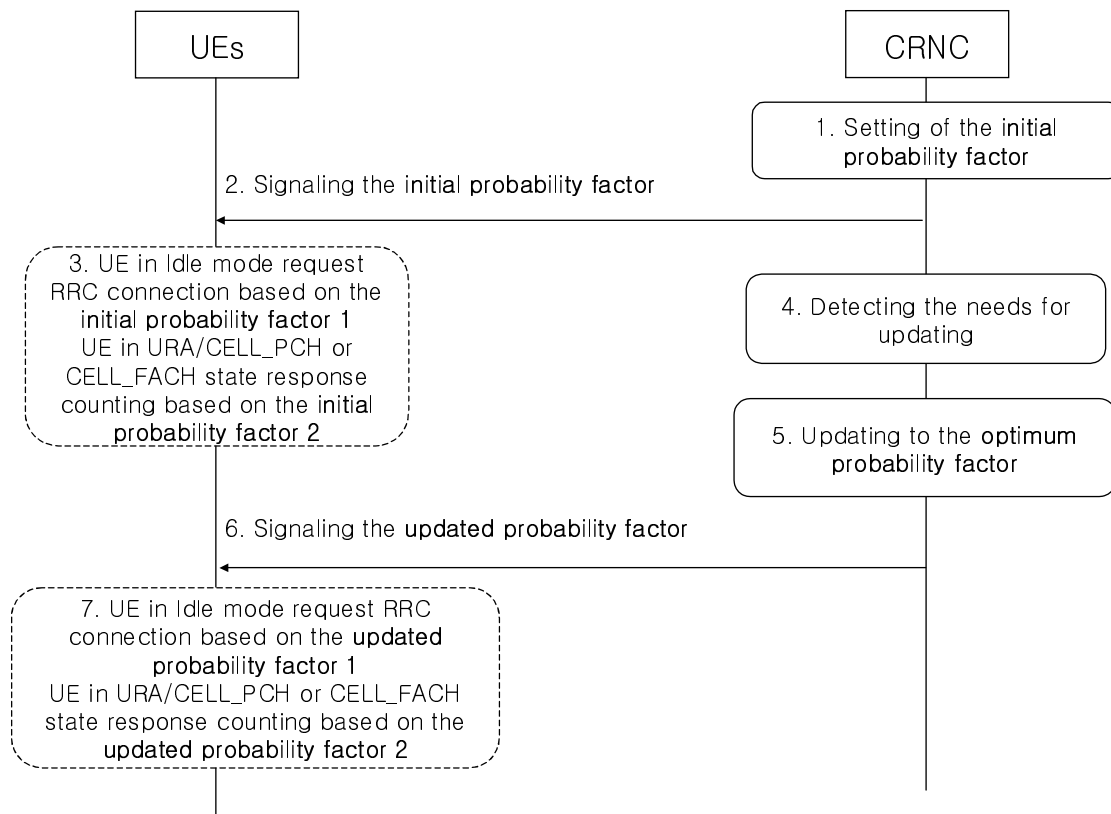

Figure 11.1: MBMS Access Control Procedure

1. CRNC calculates an initial probability factor for an MBMS service when a MCCH message causing counting or recounting is about to be sent. CRNC can use different probability factor for UEs in Idle mode and for different UEs in URA_PCH, CELL_PCH and CELL_FACH.
2. CRNC includes the probability factor into the MCCH message and sends it to UEs. This can be done in MBMS Group Notification.
3. UEs in idle mode or in URA_PCH, CELL_PCH and CELL_FACH state passing the probability check performs counting response UEs keep listening to MCCH to get updated probability factor until they have successfully responded to counting or counting is no longer required.
4. CRNC detects the probability factor needs to be updated. Detecting mechanism is not to be standardized.
5. CRNC recalculates the probability factor. The way of calculating new probability factor is not to be standardized.
6. CRNC includes the updated probability factor into the MCCH message and sends it to UEs.

7. UEs in idle mode or in URA_PCH, CELL_PCH or CELL_FACH state that pass the probability check, by using updated probability factor, perform counting response.

CRNC and UEs that are still trying to perform the counting response repeat step 3 ~ step 7 until e.g. counting or recounting procedure ends.

11.2 Frequency layer Convergence

Frequency Layer Convergence (FLC) denotes the process where the UTRAN requests UEs to preferentially re-select to the frequency layer on which the MBMS service is intended to be transmitted. This layer preference could be done by an additional MBMS session related Layer Convergence Information (LCI) such as offset and target frequency. The FLC is supported by specifications for both networks utilizing HCS and for networks not utilizing HCS.

The preferred layer (PL) is indicated per MBMS service and the LCI (offset) is the same for all MBMS services on a given preferred layer. UTRAN can consist of multiple preferred layers and the PL for given services is decided by RRM. Thus the PL for an MBMS service might be different in different parts of the service area. Network co-ordination between RNCs may be added for the Rel-7. The CN may also request the RNC (e.g. using “no-FLC-flag” value) not to apply any frequency layer convergence mechanisms for the MBMS service (e.g. emergency service). In case no PL info is specified for the MBMS service, the UE may assume that the MBMS service is available on all frequencies.

The LCI can be signalled to UEs by the CRNC after the session start is received over Iu interface until reception of the session stop. The UEs shall take LCI into account whenever it is signalled on the MCCH in Idle mode and URA_PCH, CELL_PCH and in CELL_FACH states. The FLC is not applicable in CELL_DCH state, as it is only effecting UEs cell re-selection procedure.

The UE shall ignore Sintersearch parameter only for the potential preferred layers when LCI is signalled and on preferred layer the UE shall apply the Sintersearch parameter. In case of UE is in CELL_FACH state without measurement occasions, the UE may not be able to measure cells on preferred layers.

In the case that the UE has joined multiple services and they have different frequencies as preferred layer, the UE should apply the FLC applicable for the highest priority MBMS service, which it has activated and has a PL. The priority setting of different MBMS services is decided by NAS.

Based on RRM decision, a given MBMS service can be provided on non-preferred layer by p-t-p or p-t-m transfer mode.

The details of the mechanism are defined in state 3.

11.3 Frequency layer Dispersion

Frequency Layer Dispersion (FLD) denotes the process where the UTRAN redistributes UEs across the frequencies. UTRAN can use FLD per MBMS session.

For FDD, the FLD is applicable in Idle mode, URA_PCH, CELL_PCH and CELL_FACH states.

For TDD, the FLD is applicable in Idle mode, URA_PCH and CELL_PCH states.

When FLC is applied, the UE stores the frequency where it was camped previously. Upon session stop or service deactivation, the UE attempts to return to that frequency.

If the UE does not find a suitable cell on the target frequency, the UE attempts to select a cell on a randomly chosen frequency.

Dispersion applies when the MBMS session on the MBMS preferred frequency ends, or when the MBMS service on the MBMS preferred frequency is deactivated by the UE. Dispersion does not apply in the case where the UE decides to receive another service for which FLC is applied.

The details of the mechanism are defined in the stage 3.

Annex A (informative): MBMS Phases in UTRAN

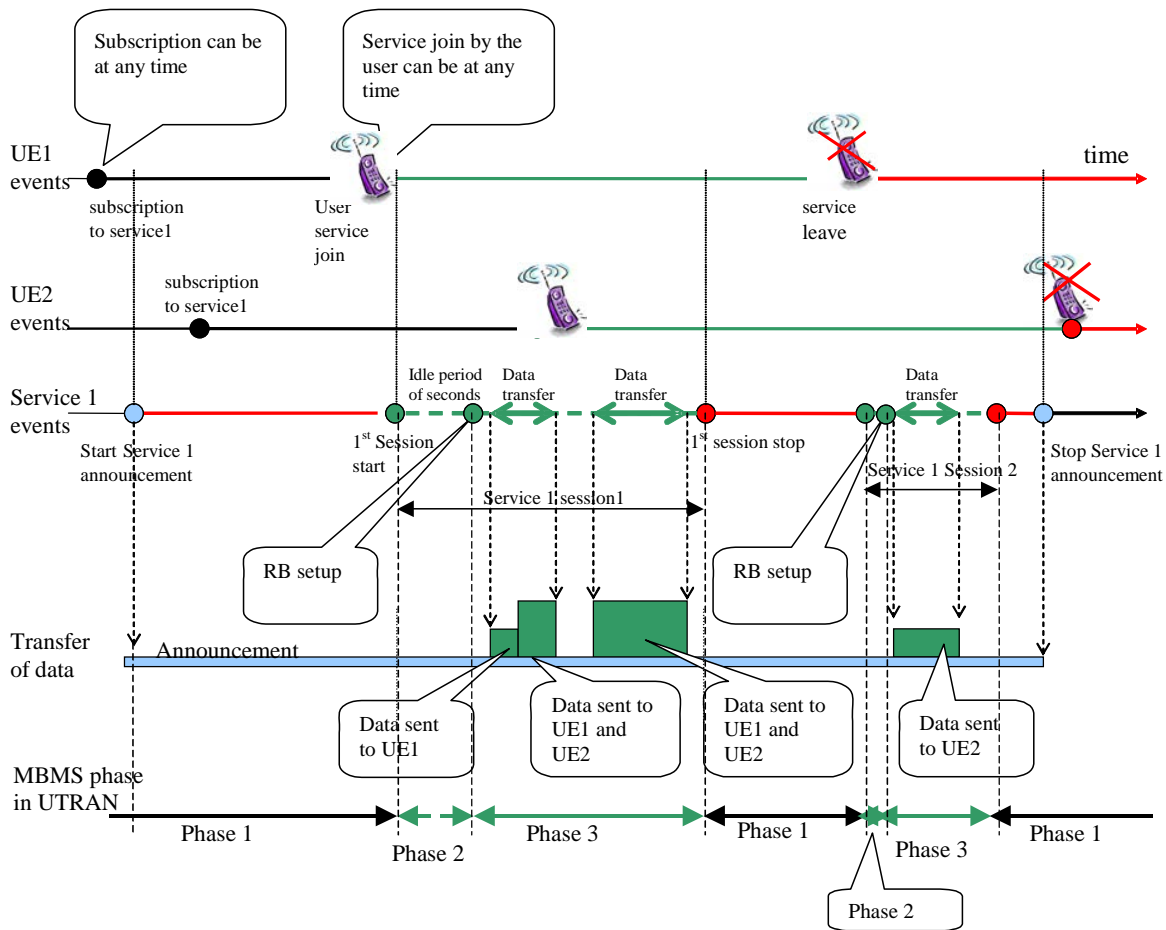

Figure A: Timeline of MBMS Service

The UTRAN MBMS behavior is divided into 3 phases. Figure A illustrates the timeline of an MBMS service with regards to these phases.

A1 Security for MBMS

A cell stays in phase 1, if there is no ongoing session for the MBMS service, or if it does not belong to the MBMS service area of the service.

A UE that has joined an MBMS service may regularly try to receive MBMS notification in a cell [FFS]. At this phase the UE does not request service delivery to UTRAN.

A2 MBMS Phase 2

This phase starts when UTRAN receives the MBMS "session start" from CN, and ends when UTRAN initially sets up MBMS radio bearer for the session, or decides not to set up the MBMS radio bearer in a cell.

In this phase, UTRAN transmits notification to UEs about the incoming service and could perform counting procedure to decide the type of MBMS radio bearer. UTRAN decides whether to set up p-t-m, p-t-p radio bearer or no radio

bearer, based on the number of UEs that expected to receive the service in the cell. A UE that has at least one activated MBMS service acts on an RRC message in MCCH.

A3 MBMS Phase 3

This phase starts after initial MBMS radio bearer setup and ends when UTRAN receives the MBMS "session stop" from CN.

In this phase, UTRAN transmits the data for the MBMS service received from CN using, if any, the established radio bearer. If there is no set-up radio bearer, UTRAN waits for service delivery request from UE. Recounting and radio bearer reconfiguration may be performed during this phase.

UTRAN behaviour in this phase can be divided into three states: no transmission, p-t-p transmission, and p-t-m transmission. Each cell belonging to the same MBMS service area may be in any of three states. With the variation of the number of UEs, the state of a cell may change between the three states. UTRAN may broadcast the state of each cell.

- 1) **No Transmission:** In this state of a cell, there is no established radio bearer because there is no UE who wants to receive the service. An MBMS-joined (or MBMS-interested in broadcast mode) UE in idle mode that moves into the cell of this state requests service delivery to UTRAN.
- 2) **P-t-p Transmission:** In this state of a cell, p-t-p radio bearer is established. A UE that has joined (or interested in broadcast mode) an MBMS service may receive MBMS data over p-t-p radio bearer if there is MBMS data to receive.
- 3) **P-t-m Transmission:** In this state of a cell, p-t-m radio bearer is established. A UE that has joined (or interested in broadcast mode) an MBMS service may receive MBMS data over p-t-m radio bearer if there is MBMS data to receive.

A4 MBMS Phases and Status Parameters

Table 1 lists the MBMS parameters that need to be broadcast in each MBMS phase. The list is [FFS]

Table 1: MBMS Status Parameters

	Phase 1	Phase 2	Phase 3	Description
Service ID	X	O	O	Identity of the Service
Transmission State	X	X	O (NONE/p-t-p/p-t-m)	State of the cell for MBMS transmission
Counting	X	O (On/Off)	O (On/Off)	Whether counting procedure is going on.

- 1) **Service ID:** This parameters indicates is the identity of the service concerned.
- 2) **Transmission state:** This parameter indicates to UE(s) the state of the concerned cell while it is in phase 3. According to this parameter, UE entering the cell starts re-configuration of the radio bearer, or requests service delivery to UTRAN. Specifically, if this parameter is set to "p-t-m", UE receives service over p-t-m radio bearer and if set to "p-t-p", UE receives service over p-t-p radio bearer. If it is set to NONE, UE has to request UTRAN to deliver the service.
- 3) **Counting:** The counting parameter informs UEs whether counting is required (and is going on) or not. If this parameter is set to "ON", UE should perform RRC connection procedure.

Annex B (informative): MBMS Control Information

Tables 2 and 3 describe MBMS control information in the downlink and uplink.

Table 2: Mapping of MBMS Control Parameters in DL

Information Element	Description
MICH – Transmitted continuously – Can be modified at a modification period boundary	
MBMS Notification Indicators	Indicates when new information is to be transmitted on MCCH in the next modification period.
BCCH - Transmitted periodically	
MCCH System Information	Includes: <ul style="list-style-type: none"> - Configuration of the radio bearer carrying MCCH, - MCCH schedule information (access info, repetition and modification periods).
MCCH – Non Critical Information – Transmitted at access info events – Can be modified at any transmission	
MBMS Access Information	Contains parameters that control, for the purposes of counting, whether UEs should establish an RRC connection (idle mode) or make a cell update (URA_PCH state). It may include for each service for which counting is in progress: <ul style="list-style-type: none"> - MBMS service identity, - Probability factor (Idle mode), - Probability factor (URA_PCH), Additional parameters may be identified in stage 3.
MCCH – Critical Information – Transmitted at repetition period Events – Can be modified at a modification period boundary	
MBMS Change Information	Identifies MBMS services for which parameters are modified in this modification period. It may include for each service listed: <ul style="list-style-type: none"> - MBMS service identity, - MBMS session identity. Additional parameters may be identified in stage 3. In stage 3, MBMS Change Information is contained in the MBMS MODIFIED SERVICES INFORMATION message.
MBMS Service Information	Identifies MBMS services that are available in the cell. It may include for each service listed: <ul style="list-style-type: none"> - MBMS service identity, - MBMS session identity, - Indication that a p-t-m bearer is established for the service in the cell, - RB release indication, - Preferred frequency layer information. Additional parameters may be identified in stage 3. In stage 3, MBMS Services Information for a service is contained in either the MBMS MODIFIED SERVICES INFORMATION or the MBMS UNMODIFIED SERVICES INFORMATION messages depending upon the change status of the service.
MBMS Radio Bearer Information	Contains, for one or more MBMS services information describing the radio bearer and the p-t-m bearer that is used within the serving cell. It may include for each service listed: <ul style="list-style-type: none"> - MBMS service identity, - MBMS cell group identity, - Physical channel information, - Transport channel information, - Radio Bearer information. Additional parameters may be identified in stage 3.

MBMS Neighbouring Cell Information	<p>Contains, for one or more MBMS services transmitted in neighbour cells that can be used for soft or selective combining, information describing the p-t-m bearer to which it is mapped in the neighbour cell. It may include for each service listed:</p> <ul style="list-style-type: none"> - MBMS service identity, - Cell identification information, - Physical channel information, - Transport channel information, - Radio Bearer information, - L1 scheduling information, - Soft/ selective combining information. <p>Additional parameters may be identified in stage 3.</p>
MSCH – Transmitted periodically	
MTCH Scheduling Information	<p>Contains information that enables UEs to perform discontinuous reception of MTCH. It may include for each of one or more services:</p> <ul style="list-style-type: none"> - MBMS service identity, - The start time and duration of a period of data transmission, - Indication that there is no data transmission for one or more MSCH repetition periods.

Table 3: Mapping of MBMS Control Parameters in UL

Information Element	Description
DCCH - Service Related Control Information	
MBMS Joined Indication	Indicates that a PMM IDLE state UE in RRC connected mode has joined at least one MBMS service
MBMS P-T-P Modification Request	UEs in CELL_DCH state may transmit this signalling flow to request the release of a p-t-p MBMS RB for a higher priority MBMS service.

Annex C (informative): Change history

Change history							
Date	TSG #	TSG Doc.	CR	Rev	Cat	Subject/Comment	New version
8/02	RAN2 #31	R2-021846					0.0.1
9/02	RAN2 #32	R2-020590				Skeleton Endorsed with some changes in sections from RAN2#31	1.0.0
11/02	RAN2 #33	R2-022927				No MBMS Discussions	
1/03	RAN2/3 MBMS AdHoc	R2-030006				R2-022644 and R2-022699	1.1.0
2/03	RAN2 #34	R2-030122				Inclusion of R2-030010, R2-030050, figure from R2-030015, mechanism 1 from R2-030062, + editorial changes + principles in section 5.1.3	1.4.0
4/03	RAN2 #35	R2-030707				Inclusion of R2-030010 + section 5.1.4 based on agreed bullet points from RAN2#34 + correction of version numbering + addition of "change history" section.	1.5.0
5/03	RAN2/3AdHoc	R2-030882				-R2-030907 "Functional Description on MAC-c/sh/m". -R2-030902 on the "MBMS Control Plane Protocol Stack". -R2-030910 on MBMS UTRAN Phases in Annex A. -R3-030584: only inclusion of sections: 7.1.3 and 7.1.4. In 7.1.3 there is one additional comment regarding the addition of "PMM" whenever CONNECTED mode" is mentioned. -R3-030614: Addition of chapter 5.1.x -R3-030615: changes in section 5.1.2. -R3-030615: proposed section 5.1 was reworded.	1.6.0
5/03	RAN2 #36					- Inclusion of contribution R2-03930, sections: 7.2.1.1 and 7.2.1.2 from decisions from RAN2/3 MBMS adhoc. - Use of term "MBMS service context" instead of "MBMS context" throughout the document. - Correction of spelling mistake in figure 1: "Protocol Stack for MCTCH" should be: "Protocol Stack for MTCH". - Revision of Appendix A "MBMS Phase 1": Part of the second paragraph has been deleted due to concerns from RAN3. - During the RAN2 MBMS AdHoc it was decided that MCCH and MTCH are to be mapped on FACH. This decision is captured at the bottom of 5.3.1 by adding the sentence "Both logical channels are mapped on FACH". FACH is also mentioned in several places in 5.3.2 (MAC Architecture) as an example (e.g. FACH). The "e.g." has now been deleted.	1.6.1
06/03	TSG RAN #20					The version 2.0.0 identical to version 1.6.1 was presented in TSG RAN plenary meeting for information and approval. The TS was not approved so drafting work will continue in WG2/3 based on version 2.0.0. The changes in version 2.1.0 compared to 2.0.0 are in Section 5.1.4 Counting where point 8 "The possibility for the RNC to receive the service Id in RRC connection request is [FFS]..." is removed. This reflects to the decision made in RAN2/3AdHoc 05/03 but was missing from earlier versions, and pointed out by RAN WG2 chairman in reflector and in TSG RAN #20.	2.1.0
09/03	RAN2 #37 RAN3 #37	R2-031713 R3-031174 R3-031223				Editorial corrections based on R2-031713 included. New chapter "7. MBMS reception UE Capability" created and agreed UE capability text inserted to the new chapter "7.1. UE Capability". Modifications based on R3-031174 to the definitions Sections 5.1.1, 5.1.5 and 5.1.6 enhanced and sections 5.1.7, 5.1.8 and 5.1.9 created, and signalling flows updated in section 7.1. based on R3-031223 Following Editorial enhancements proposed by editor: Chapter 5.3.1.1 and 5.3.1.2 moved to under chapter 6.1. Logical channels and chapter "5.4 MBMS Reception in RRC States/Modes" moved under chapter 7. in new chapter "7.2 MBMS reception "	2.2.0
10/03	RAN2 #38	R2-032116 R2-032074 R2-032121				Chapter 5.2.1 MBMS User Plane Protocol Stack Architecture enhanced accordingly. Chapter 9 Security for MBMS enhanced accordingly	2.3.0

Change history							
Date	TSG #	TSG Doc.	CR	Rev	Cat	Subject/Comment	New version
	RAN3 #38	R2-032277 R2-032087 R2-032275 R2-032081 R2-032281 R3-031421				Chapter 8.2.2 MBMS service availability enhanced, (message changed to information). Chapter 9.2. UE Actions for Mobility created and 9.2.4 text depending UE capability inserted Chapters 8.2.4. MBMS Joined Services Indication and 8.2.5 MBMS PMM-Connected State Required Indication created Chapters 6.1. re-formatted, Section 6.2.1-6.2.5 created The MBMS access control procedure inserted in chapter 11.1 Broadcast of MBMS System Information signalling flow added. Tables inserted to an informative annex to identify MBMS control information and describe their mapping on transport channels MBMS Time line and MBMS Service announcement definitions included in Section 3.1 Chapter 5.1.1 One Context per MBMS Service in CRNC and 5.1.8 RNC deregistration updated accordingly Editorial harmonization of terms: MCCH and MTCH used constantly. (NCCH and CTCH removed) In Uu signalling messages CRNC introduced to keep messages send/received in SRNC and CRNC inline.	
11/03	RAN2 #39	R2-032350 R2-032398 R2-032667 R2-032666 R2-032497				The Signalling flow MBMS service availability changed to MBMS service information in 8.2.2. Appropriate changes done in 10.2. In the Chapter 7.1. included that MBMS UE must capability to receive two SCCPCH MBMS notification principles chapter created as 5.1.5 and PICH bits used for MBMS notification defined in 6.2.3 physical channels chapters. The number of different protocol entities clarified in chapter 5.2.1. The shared PDCP entity principle created in 5.1.4. Protocol layerre-establishments due to mobility defined in 10.2. UEs measurements are clarified based in working assumption in Section 10.2. Editorial enhancements to chapter names in chapters 5.1.1, 5.1.2 and 5.1.3	2.4.0
01/04	RAN2 #40 RAN3 #40	R2-04086 Meeting report R2-040027 R2-040070 R3-040061 R3-040075 R3-040076				A chapter 11.2 Frequency layer Convergence introduced based on revised text from R2-04086 Text inserted based on conclusion on selective combining, multiplexing and measurement occasions Editorial clarifications. Constant usage of MBMS Service Area as defined in [4] Session stop included High level signalling scenarios inserted Modification to chapter 5.1.8 Modification to RNC registration procedure Additional modifications to 5.1.8	2.5.0
02/04	RAN2 #41 RAN3 #41	Meeting minutes R2-040572 R2-040690 R2-040711 R3-040577 R3-040576 R3-040314 R3-040393 R3-040575 R3-040458 R3-040516 R3-040545 Meeting minutes				Selective combining, simulcast for TDD, Neighbouring cell info, included MCCH scheduling, MBMS notification and counting enhanced. MBMS access MTCH Scheduling information signalling flow included MBMS high level signalling scenarios updated Editorial clean up, separation of UTRAN architecture principles and MBMS Uu principles chapter created Functionality to filtering of MBMS notifications and Session update signalling flow included MBMS Service Id Request to handle UEs in RRC connected PMM idle state. The Signalling flow MBMS Joined Indication modified and MBMS PMM connected stated required removed. FFS removed from RNC De-Registration and CN De-Registration Clarifications to MBMS lu bearer and MBMS Session Start and Session Stop and CN De-Registration UE linking over lur modified according agreements Clarification to creation of MBMS Service context after receiving the first UE linking Editorial clean up to RAN3 specific sections. The lub bearer mechanisms defined. Editorial enhancements based on comments after email review on RAN1/2/3 reflectors.	2.6.0
03/2004	RAN# 23	RP-040079				Upgrade towards Change Control (Release 6) and ETSI MCC clean-up.	6.0.0
06/2004	RP-24	RP-040216	001			Updates based on the MBMS ad-hoc, Budapest, 20-22 April 2004	6.1.0
	RP-24	RP-040216	002			Updates to TS25.346 from the RAN3#42 meeting in Montreal, Canada, 10-14 May 2004	6.1.0

Change history							
Date	TSG #	TSG Doc.	CR	Rev	Cat	Subject/Comment	New version
09/2004	RP-25	RP-040340	003			Introduction of MBMS Change Information and Removal of usage of the secondary notification indicators	6.2.0
	RP-25	RP-040340	004			Clarifications to Frequency Layer Convergence and UE behaviour at return on Service	6.2.0
	RP-25	RP-040340	005			lur Linking for URA_PCH UEs and MBMS Session Start Request corrections for TS25.346 from RAN3#43	6.2.0
12/2004	RP-26	RP-040492	006	1		Actions due to MBMS session repetition and MBMS service prioritisation	6.3.0
	RP-26	RP-040492	007	1		Introduction of MSCH and soft combining and other general corrections	6.3.0
	RP-26	RP-040492	008			Corrections to UE Linking, Session Start and addition of URA Linking and Information Exchange procedure	6.3.0
	RP-26	RP-040492	009			Update of Annex B	6.3.0
03/2005	RP-27	RP-050080	010			Introduction of MBMS Frequency dispersion	6.4.0
	RP-27	RP-050080	011			Correction on MBMS multiplexing and soft combining in TDD	6.4.0
	RP-27	RP-050080	012			Clarification to UE capabilities to consider MCCH reception and selective/soft combining requirements	6.4.0
	RP-27	RP-050080	013			Extending the counting procedure for UEs in CELL_PCH/FACH state and introducing UE initialised p-t-p setup request	6.4.0
	RP-27	RP-050080	015			Introduction of new procedure in MBMS stage 2 spec	6.4.0
06/2005	RP-28	RP-050314	0016			FLD scenario clarifications	6.5.0
	RP-28	RP-050314	0018			Handling the validity of the MBMS session Id	6.5.0
09/2005	RP-29	RP-050468	0019			Change of scope for the MBMS Access Information and MBMS P-T-P Modification Request signalling flows plus editorial corrections	6.6.0
12/2005	RP-30	RP-050788	0020			Correction to MBMS Cell Group	6.7.0
03/2006	RP-31	-	-			Upgrade to Release 7 - no technical change	7.0.0
06/2006	RP-32	RP-060368	0022			Clarification of conditions for soft combining	7.1.0
09/2006	RP-33	RP-060624	0024	1		Enhancing MBMS support for Mobile TV	7.2.0
03/2007	RP-35	RP-070151	0026	1		Modification of the MBMS Service Area definition	7.3.0
06/2007	RP-36	RP-070400	0027	4		MBMS TDD and FDD Physical Layer Improvements	7.4.0
	RP-36	RP-070401	0029			MSCH transmission - alignment to stage 3	7.4.0
09/2007	RP-37	RP-070625	0032			MBMS Counting completion (stage 2)	7.5.0
	RP-37	RP-070625	0034			MBMS services naming	7.5.0
	RP-37	RP-070632	0036			Editorial Corrections concerning non MBSFN dedicated TDD carriers	7.5.0
12/2007	RP-38	RP-070902	0037			More improvement on Dedicated Carrier for 1.28Mcps TDD MBMS	7.6.0
	RP-38	-	-			Upgrade to the Release 8 - no technical change	8.0.0
03/2008	RP-39	RP-080177	0040	-		Correction on Frequency Layer Dispersion (FLD) in MBMS stage 2	8.1.0
	RP-39	RP-080180	0042	1		Clarification of FLC flag in MBMS stage 2	8.1.0
12/2008	RP-42	RP-081023	0045	-		Introduction of MBMS Improved Solution	8.2.0
	RP-42	RP-081129	0046	2		Support for 3.84 Mcps MBSFN IMB operation	8.2.0
03/2009	RP-43	RP-090143	0047	-		Correction of MBMS improvements	8.3.0
	RP-43	RP-090264	0048	-		Correction on MBMS Improved Solution	8.3.0
12/2009	RP-46	RP-091326	0049	-		Correction for the Synchronisation Sequence	8.4.0
12/2009	RP-46	-	-	-		Upgrade to the Release 9 - no technical change	9.0.0
03/2010	RP-47	RP-100305	0051	-		Clarification on Total counter frame	9.1.0
	RP-47	RP-100305	0052	-		Calculation of time stamp value	9.1.0
	RP-47	RP-100291	0053	-		Update for SYNC Description	9.1.0
03/2011	RP-51	-	-	-		Upgrade to the Release 10 - no technical change	10.0.0
09/2012	RP-57	-	-	-		Upgrade to the Release 11 - no technical change	11.0.0
03/2014	RP-63	RP-140363	0054	-		Introduction of MBMS Restoration	12.0.0
12/2015	RP-70	-	-	-		Upgrade to the Release 13 - no technical change	13.0.0
03/2017	RP-75	-	-	-		Upgrade to Release 14 - no technical change	14.0.0

History

Document history		
V14.0.0	April 2017	Publication