

# ETSI TS 125 346 V6.1.0 (2004-06)

---

*Technical Specification*

**Universal Mobile Telecommunications System (UMTS);  
Introduction of Multimedia Broadcast/Multicast  
Service (MBMS) in the Radio Access Network (RAN);  
Stage 2  
(3GPP TS 25.346 version 6.1.0 Release 6)**

---



---

Reference

RTS/TSGR-0225346v610

---

Keywords

UMTS

**ETSI**

650 Route des Lucioles  
F-06921 Sophia Antipolis Cedex - FRANCE

Tel.: +33 4 92 94 42 00 Fax: +33 4 93 65 47 16

Siret N° 348 623 562 00017 - NAF 742 C  
Association à but non lucratif enregistrée à la  
Sous-Préfecture de Grasse (06) N° 7803/88

---

**Important notice**

Individual copies of the present document can be downloaded from:

<http://www.etsi.org>

The present document may be made available in more than one electronic version or in print. In any case of existing or perceived difference in contents between such versions, the reference version is the Portable Document Format (PDF). In case of dispute, the reference shall be the printing on ETSI printers of the PDF version kept on a specific network drive within ETSI Secretariat.

Users of the present document should be aware that the document may be subject to revision or change of status. Information on the current status of this and other ETSI documents is available at

<http://portal.etsi.org/tb/status/status.asp>

If you find errors in the present document, send your comment to:

[editor@etsi.org](mailto:editor@etsi.org)

---

**Copyright Notification**

No part may be reproduced except as authorized by written permission.  
The copyright and the foregoing restriction extend to reproduction in all media.

© European Telecommunications Standards Institute 2004.  
All rights reserved.

**DECT**<sup>TM</sup>, **PLUGTESTS**<sup>TM</sup> and **UMTS**<sup>TM</sup> are Trade Marks of ETSI registered for the benefit of its Members.  
**TIPHON**<sup>TM</sup> and the **TIPHON logo** are Trade Marks currently being registered by ETSI for the benefit of its Members.  
**3GPP**<sup>TM</sup> is a Trade Mark of ETSI registered for the benefit of its Members and of the 3GPP Organizational Partners.

---

## Intellectual Property Rights

IPRs essential or potentially essential to the present document may have been declared to ETSI. The information pertaining to these essential IPRs, if any, is publicly available for **ETSI members and non-members**, and can be found in ETSI SR 000 314: "*Intellectual Property Rights (IPRs); Essential, or potentially Essential, IPRs notified to ETSI in respect of ETSI standards*", which is available from the ETSI Secretariat. Latest updates are available on the ETSI Web server (<http://webapp.etsi.org/IPR/home.asp>).

Pursuant to the ETSI IPR Policy, no investigation, including IPR searches, has been carried out by ETSI. No guarantee can be given as to the existence of other IPRs not referenced in ETSI SR 000 314 (or the updates on the ETSI Web server) which are, or may be, or may become, essential to the present document.

---

## Foreword

This Technical Specification (TS) has been produced by ETSI 3rd Generation Partnership Project (3GPP).

The present document may refer to technical specifications or reports using their 3GPP identities, UMTS identities or GSM identities. These should be interpreted as being references to the corresponding ETSI deliverables.

The cross reference between GSM, UMTS, 3GPP and ETSI identities can be found under <http://webapp.etsi.org/key/queryform.asp>.

# Contents

|  |    |
|--|----|
| Intellectual Property Rights .....   | 2  |
| Foreword.....  | 2  |
| Foreword.....  | 5  |
| 1 Scope .....  | 6  |
| 2 References .....   | 6  |
| 3 Definitions, symbols and abbreviations .....                                 | 6  |
| 3.1 Definitions .....  | 6  |
| 3.2 Symbols.....   | 7  |
| 3.3 Abbreviations .....  | 7  |
| 4 Background and introduction .....  | 8  |
| 5 MBMS UTRAN and protocol architecture .....                                   | 8  |
| 5.1 MBMS UTRAN architecture principles.....                                    | 8  |
| 5.1.1 MBMS Service Context in CRNC .....                                       | 8  |
| 5.1.2 MBMS Session start and MBMS Session Stop .....                           | 9  |
| 5.1.3 MBMS Iu bearer .....   | 9  |
| 5.1.4 MBMS Iub bearer .....  | 9  |
| 5.1.5 Mapping of MBMS Iu bearer to p-t-p and p-t-m connections .....           | 9  |
| 5.1.6 UE Linking .....   | 10 |
| 5.1.7 RNC Registration.....  | 11 |
| 5.1.8 RNC De-Registration.....   | 11 |
| 5.1.9 CN De-Registration .....   | 12 |
| 5.2 MBMS Uu Principles .....   | 12 |
| 5.2.1 MBMS Service States in UE.....   | 12 |
| 5.2.2 One PDCP and RLC entity shared among multiple cells within one RNS ..... | 12 |
| 5.2.3 MCCH Information Scheduling.....   | 13 |
| 5.2.4 MBMS Notification .....  | 13 |
| 5.2.5 MBMS Counting .....  | 14 |
| 5.2.6 MBMS Radio Bearer Release in the UE.....                                 | 15 |
| 5.3 Protocol structure .....   | 16 |
| 5.3.1 MBMS User Plane Protocol Stack Architecture .....                        | 16 |
| 5.3.2 MBMS Control Plane Protocol Stack Architecture .....                     | 17 |
| 5.4 MAC architecture .....   | 17 |
| 5.4.1 UTRAN MAC Architecture to support MBMS.....                              | 17 |
| 5.4.2 MAC-c/sh/m architecture: UTRAN side .....                                | 17 |
| 5.4.3 MAC-c/sh/m architecture: UE side.....                                    | 18 |
| 6 MBMS Channel Structure .....   | 19 |
| 6.1 Point-to-Point Transmission.....   | 19 |
| 6.2 Point-to-multipoint Transmission.....                                      | 19 |
| 6.2.1 Logical Channels .....   | 19 |
| 6.2.1.1 MBMS point-to-multipoint Control Channel (MCCH).....                   | 19 |
| 6.2.1.2 MBMS point-to-multipoint Traffic Channel (MTCH).....                   | 20 |
| 6.2.2 Transport Channel .....  | 20 |
| 6.2.3 Physical Channel .....   | 20 |
| 6.2.4 Mapping between channels.....  | 20 |
| 6.2.5 Data Flows through Layer 2 .....   | 21 |
| 6.2.5.1 Data flow for MCCH mapped to FACH .....                                | 21 |
| 6.2.5.2 Data flow for MTCH mapped to FACH .....                                | 21 |
| 6.3 MBMS Notification Indicator Channel .....                                  | 21 |
| 7 MBMS Reception and UE Capability .....                                       | 21 |
| 7.1 Selective Combining for MBMS P-T-M transmission.....                       | 21 |
| 7.1.bis Simulcast Combining (TDD only).....                                    | 21 |
| 7.2 UE Capability .....  | 23 |
| 7.3 MBMS Reception.....  | 23 |

|                               |   |           |
|-------------------------------|---|-----------|
| 7.3.1                         | MBMS Reception in RRC Idle Mode.....                        | 24        |
| 7.3.2                         | MBMS Reception in RRC Connected Mode: URA_PCH state .....   | 24        |
| 7.3.3                         | MBMS Reception in RRC Connected Mode: CELL_PCH state.....   | 24        |
| 7.3.4                         | MBMS Reception in RRC Connected Mode: CELL_FACH state ..... | 25        |
| 7.3.5                         | MBMS Reception in RRC Connected Mode: CELL_DCH state .....  | 25        |
| 8                             | UTRAN Signalling Flows for MBMS .....                       | 25        |
| 8.1                           | MBMS High Level Signalling Scenarios .....                  | 25        |
| 8.1.1                         | Session start .....   | 26        |
| 8.1.2                         | Joining (during a session) .....                            | 27        |
| 8.1.3                         | Recounting.....   | 28        |
| 8.1.4                         | Session stop .....  | 30        |
| 8.2                           | MBMS RNC Signalling Flows.....                              | 30        |
| 8.2.1                         | MBMS Session Start procedure.....                           | 30        |
| 8.2.2                         | MBMS Session Update procedure.....                          | 31        |
| 8.2.3                         | MBMS Session Stop procedure .....                           | 31        |
| 8.2.4                         | RNC Registration procedure.....                             | 32        |
| 8.2.5                         | RNC De-Registration procedure.....                          | 32        |
| 8.2.6                         | CN De-Registration procedure .....                          | 32        |
| 8.2.7                         | MBMS Channel Type Switching over Uu.....                    | 33        |
| 8.2.8                         | MBMS UE Linking .....                                       | 33        |
| 8.2.9                         | MBMS UE De-Linking .....                                    | 34        |
| 8.2.10                        | MBMS Service Id Request .....                               | 34        |
| 8.2.11                        | MBMS Attach/Detach over Iur.....                            | 35        |
| 8.2.12                        | MBMS Channel Type Reconfiguration over Iur .....            | 35        |
| 8.3                           | MBMS Uu Signalling Flows.....                               | 36        |
| 8.3.1                         | Broadcast of MBMS System Information .....                  | 36        |
| 8.3.2                         | MBMS Service Information .....                              | 37        |
| 8.3.3                         | MBMS Radio Bearer Information .....                         | 37        |
| 8.3.4                         | MBMS Access Information .....                               | 38        |
| 8.3.5                         | MBMS Neighbouring Cell Information.....                     | 38        |
| 8.3.6                         | MBMS Joined Indication.....                                 | 38        |
| 8.3.7                         | MTCH Scheduling Information .....                           | 39        |
| 9                             | Security for MBMS .....                                     | 39        |
| 10                            | Mobility Procedures for MBMS.....                           | 39        |
| 10.1                          | Use of Periodical MBMS Channel Type Notification.....       | 39        |
| 10.2                          | UE Actions for Mobility.....                                | 40        |
| 10.2.1                        | RRC idle mode .....   | 40        |
| 10.2.2                        | URA_PCH State .....   | 41        |
| 10.2.3                        | CELL_PCH.....   | 41        |
| 10.2.4                        | CELL_FACH.....  | 42        |
| 10.2.5                        | CELL_DCH State .....  | 42        |
| 11                            | Resource Management for MBMS.....                           | 42        |
| 11.1                          | MBMS Access Control Procedure .....                         | 42        |
| 11.2                          | Frequency layer Convergence .....                           | 43        |
| <b>Annex A (informative):</b> | <b>MBMS Phases in UTRAN .....</b>                           | <b>45</b> |
| A1                            | Security for MBMS .....                                     | 45        |
| A2                            | MBMS Phase 2.....   | 45        |
| A3                            | MBMS Phase 3.....   | 46        |
| A4                            | MBMS Phases and Status Parameters.....                      | 46        |
| <b>Annex B (informative):</b> | <b>MBMS Control Information.....</b>                        | <b>47</b> |
| <b>Annex C (informative):</b> | <b>Change history .....</b>                                 | <b>49</b> |
| History .....                 |   | 52        |

---

# Foreword

This Technical Report has been produced by the 3<sup>rd</sup> Generation Partnership Project (3GPP).

The contents of the present document are subject to continuing work within the TSG and may change following formal TSG approval. Should the TSG modify the contents of the present document, it will be re-released by the TSG with an identifying change of release date and an increase in version number as follows:

Version x.y.z

where:

- x the first digit:
  - 1 presented to TSG for information;
  - 2 presented to TSG for approval;
  - 3 or greater indicates TSG approved document under change control.
- y the second digit is incremented for all changes of substance, i.e. technical enhancements, corrections, updates, etc.
- z the third digit is incremented when editorial only changes have been incorporated in the document.

# 1 Scope

The present document is a technical specification of the overall support of Multimedia Broadcast Multicast Service in UTRA.

# 2 References

The following documents contain provisions which, through reference in this text, constitute provisions of the present document.

- References are either specific (identified by date of publication, edition number, version number, etc.) or non-specific.
- For a specific reference, subsequent revisions do not apply.
- For a non-specific reference, the latest version applies.

[1] 3GPP TR 21.905: " Vocabulary for 3GPP Specifications ".

[2] 3GPP TS 22.146: "Multimedia Broadcast/Multicast Service; Stage 1".

[3] 3GPP TS 22.246: "MBMS User Services; Stage 1".

[4] 3GPP TS 23.246: "Multimedia Broadcast Multicast Service; Architecture and Functional Description".

[5] 3GPP TR 25.992: "Multimedia Broadcast Multicast Service (MBMS); UTRAN/GERAN Requirements".

[6] 3GPP TS 23.236: "Intra-domain connection of Radio Access Network (RAN) nodes to multiple Core Network (CN) nodes".

[7] 3GPP TS 33.246: "3G Security; Security of Multimedia Broadcast/Multicast Service (MBMS)".

[8] 3GPP TS 25.301: "Radio Interface Protocol Architecture".

# 3 Definitions, symbols and abbreviations

## 3.1 Definitions

For the purposes of the present document, the following terms and definitions apply.

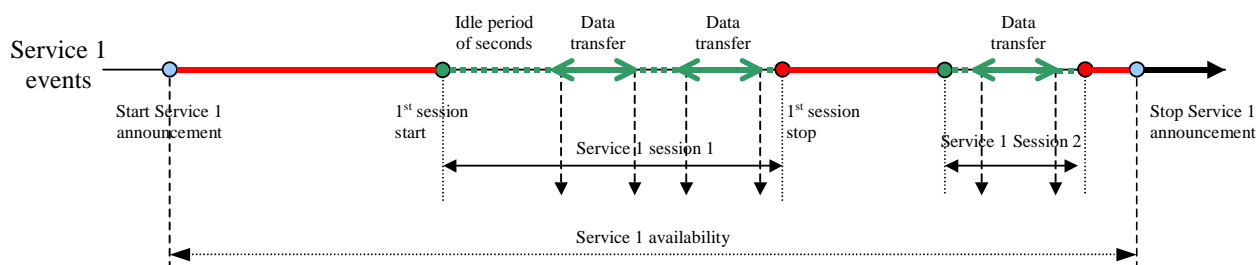

Figure 1: MBMS Timeline, based on [4].

**MBMS session start** is the point at which the BM-SC is ready to send data.

**MBMS notification** informs the UEs about forthcoming and about ongoing MBMS data transfer.

**MBMS Cell Group** is a group of multiple cells belonging to one RNS and sharing one PDCP and RLC entity to utilize p-t-m transmission of the MBMS Service

**MBMS session stop** is the point at which the BM-SC determines that there will be no more data to send for some period of time.

**Data transfer** is the phase when MBMS data are transferred to the UEs.

**MBMS service availability** is the phase between start of service announcement and the end of the last session or stop of service announcement.

**MBMS Iu data bearer** denotes the data bearer established between SGSN and RNC to transport MBMS data

**MBMS radio bearer** denotes the data bearer established between RNC and UE(s) to transport MBMS data

**MBMS RAB** denotes both, the MBMS Iu data bearer and the MBMS radio bearer

**MBMS Service Context** contains the necessary information for the UTRAN to control the MBMS Service in UTRAN.

**MBMS Iu signalling connection** denotes the signalling connection established between the RNC and the CN node to serve one MBMS Service Context.

**MBMS Service Announcement:** Mechanism to allow users to be informed about the MBMS services available [4]

**Pool area:** see definition in ref.[6]

**MBMS Multicast Service Activation:** see description in ref.[4]

**Critical Information:** MBMS Neighbouring Cell Information, MBMS Radio Bearer Information and MBMS Service Information sent on MCCH.

**Non-critical information:** MBMS Access Information sent on MCCH.

**MBMS Service Area:** The area in which a specific MBMS Bearer Service is available. It is defined individually per MBMS Bearer Service. [4]

## 3.2 Symbols

(void)

## 3.3 Abbreviations

For the purposes of the present document, the abbreviations given in 3GPP TS 21.905 [1] and the following apply:

|                 |   |
|-----------------|---|
| CELL_DCH        |   |
| CELL_FACH       |   |
| CG-Id           | Cell Group Identifier                                   |
| CRNC-Id         | CRNC Identifier   |
| FFS             | For Further Study                                       |
| MBMS            | Multimedia Broadcast Multicast Service                  |
| MBMS service ID | Multimedia Broadcast Multicast Service service Identity |
| MBMS CG-Id      | MBMS Cell Group Identifier                              |
| MBMS UCG-Id     | MBMS UTRAN Cell Group Identifier                        |
| MCCH            | MBMS point-to-multipoint Control Channel                |
| MICH            | MBMS notification Indicator Channel                     |
| MTCH            | MBMS point-to-multipoint Traffic Channel                |
| NI              | Notification Indicator                                  |
| p-t-p           | Point-to-Point  |
| p-t-m           | Point-to-Multipoint                                     |
| PF              | Probability Factor                                      |
| SNI             | Secondary Notification Indicator                        |



---

## 4 Background and introduction

The Introduction of the Multimedia Broadcast Multicast Service in UTRA describes techniques for optimised transmission of MBMS bearer service in UTRA such as point-to-multipoint transmission, selective combining and transmission mode selection between point-to-multipoint and point-to-point bearer.

The Stage 1 MBMS service requirements are defined in [2] and MBMS Stage 1 user services are defined in [3]. UTRAN (and GERAN) requirements are covered in TR 25.992 [5]. The overall architecture, functional description and the reference architecture of MBMS are covered in TS 23.246 [3].

---

## 5 MBMS UTRAN and protocol architecture

### 5.1 MBMS UTRAN architecture principles

#### 5.1.1 MBMS Service Context in CRNC

Each RNC-which is controlling one or several cells within an MBMS Service area maintains an MBMS Service Context for each MBMS service.

- 1 Each CRNC MBMS Service Context is associated with an MBMS service ID.
- 2 The CRNC MBMS Service Context contains a list of PMM connected mode UEs which are present in one or several cells of the CRNC and which have activated an MBMS service. The list includes at least the U-RNTI of the UEs.

NOTE: The MBMS Service Context in the CRNC contains no information about RRC Idle mode UEs.

- 3 The MBMS Service Context is created in the CRNC either
  - if the SGSN informs the RNC that a UE has activated the MBMS Service in a cell controlled by the CRNC by the UE Linking procedure. In this case, the CRNC is the SRNC of the UE,
  - or if the RNC is notified of an MBMS Session Start,
  - or if the RNC serves as a Drift RNC for a PMM-CONNECTED UE and receives for this UE a UE Link from the SRNC containing the MBMS Service Id of the concerned MBMS Service.
- 4 Each RNC which is informed by the SGSN that a UE has activated one (or several) MBMS Service(s) by the UE Linking procedure maintains an MBMS Context for each indicated MBMS service, irrespectively of the MBMS Service Area.
- 5 The MBMS Service Context is released by the CRNC either
  - if the MBMS Service Context does not contain any UE information after a UE Unlinking procedure from a SGSN and there is no active MBMS Session for the concerned MBMS Service,
  - or if the MBMS Service Context does not contain any UE Link at the time of a Session Stop
  - or if the RNC receives a CN De-Registration for MBMS Service
- 6 Associated functionalities:
  - 6.1 Bearer type selection for MBMS transmissions based on information in the CRNC MBMS Service Context. The decision process requires inter-working with Radio Resource Management and with the UE's SRNC in the case of p-t-p bearers.
  - 6.2 MBMS RB control for p-t-m bearers in each cell, based on information in the CRNC MBMS Service Context.
  - 6.3 Update of the MBMS Service Context when a PMM-CONNECTED UE, which has activated an MBMS Service, has entered a cell. Update of the MBMS Service Context via Iur is performed by UE Linking.

- 6.4 Update of the MBMS Service Context when a PMM-CONNECTED UE, which has activated an MBMS Service, has left a cell. Update of the MBMS Service Context via Iur is performed by UE Un-Linking.

Note: For further details of UE linking via the Iur interface see chapter 5.1.5.

### 5.1.2 MBMS Session start and MBMS Session Stop

At MBMS Session Start and MBMS Session Stop the RNC receives a respective request from the CN. The MBMS Session Start Request shall contain the MBMS Service Id and MBMS Session Attributes (MBMS Service Area Information, QoS parameters, ...). The MBMS Session Start Request triggers the RNC to notify UEs, which have activated the MBMS Service of the MBMS Session Start. The MBMS Session Stop Request may trigger the RNC to notify UEs, which have activated the MBMS Service of the MBMS Session Stop.

The MBMS Session Start and Session Stop procedures provide the setup and release of the MBMS RAB in the following way:

The MBMS Session Start Request shall contain all information necessary to setup an MBMS RAB. When the RNC receives an MBMS Session Start Request, it typically executes MBMS Iu data bearer set up and shall inform the sending CN node, of the outcome in the MBMS Session Start response message

The RNC may not execute the MBMS Iu data bearer setup for a given Iu interface in case of Iu-flex. In those cases the CN node shall be informed accordingly.

In case of Iu-flex, the RNC might receive more than one MBMS Session Start Request for an MBMS Service and shall not set up more than one MBMS Iu bearer for a certain MBMS Service towards a pool area.

When the RNC receives an MBMS Session Stop Request it shall release the associated MBMS RAB resources.

The MBMS Session Start and Session Stop procedures serve to establish and release the MBMS Iu signalling connection.

### 5.1.3 MBMS Iu bearer

For each MBMS service, data is transferred via an MBMS RAB between the SGSN and the UE. For each MBMS service, data is transferred via one MBMS Iu bearer between SGSN and the RNC in the whole MBMS Service area. Signalling messages specific for an MBMS Service are transferred via one dedicated MBMS Iu signalling connection between the RNC and the SGSN.

- 1 One MBMS Iu bearer is established per MBMS service at MBMS Session Start.
- 2 Regarding Iu-flex the RNC shall not set up more than one MBMS Iu bearer.
- 3 Because of the dedicated channels and Iur mobility, there is a need to send MBMS data to an RNC which is not necessarily part of the MBMS Service area.
- 4 The MBMS Iu bearer on Iu is established per MBMS service and not per UE individually.
- 5 Each PMM-CONNECTED mode UE with an activated MBMS service has its UE context bind to the MBMS Iu bearer.
- 6 There could be several MBMS RBs linked to one MBMS Iu bearer (i.e. one MBMS Iu bearer on Iu maybe mapped to multiple DTCH and/or or p-t-m traffic channels over the radio -interface).

### 5.1.4 MBMS Iub bearer

The existing FACH transport channel mechanism over Iub is to be used in case of p-t-m MBMS transmission.

### 5.1.5 Mapping of MBMS Iu bearer to p-t-p and p-t-m connections

The service specific MBMS RAB on Iu may be mapped to p-t-m bearers in order to provide MBMS data via common channels.

- 1 The MBMS control function in the CRNC may decide to establish a p-t-m connection, if the number of counted MBMS users in a cell exceeds a certain operator-defined threshold.

- 2 The MBMS control function in the CRNC may decide to establish a p-t-m connection depending on the congestion scenario expected for a specific cell (e.g. in hotspot areas where no bearer type switching is needed).
- 3 The MBMS control function in the CRNC may, through a configurable parameter enable/disable bearer type switching and the associated procedures on a per cell basis.
- 4 The MBMS control function in the CRNC establishes an MBMS RB by sending service specific signalling messages (e.g. MBMS RB Setup message) to all the UEs in the cell listening MBMS point-to-multipoint control channel (MCCH). UEs with activated service(s) may then execute the RB set-up.
- 5 MBMS data is transferred on a MBMS point-to-multipoint traffic channel (MTCH) to all the UEs which have executed the RB setup.
- 6 The MBMS control function in the CRNC releases the MBMS RB (e.g. MBMS RB Release) when the data transfer has been finished or it has been interrupted by the CRNC.
- 7 p-t-p transmission of MBMS data should use the DTCH as defined for other dedicated services.
- 8 p-t-m transmission of MBMS data applies to all RRC states and modes.

### 5.1.6 UE Linking

UE Linking denotes the process where a UE, which has joined the MBMS service, is linked to an MBMS service context in the RNC.

MBMS UE linking procedure in the SRNC is performed in following cases.

1. When the UE, which has joined the MBMS service, is moved to PMM-CONNECTED and sets up a PS RAB. This may happen at any point in time during the whole MBMS service availability (i.e. before, during and between MBMS sessions).
2. When the UE joins the MBMS service and is in PMM-CONNECTED due to an existing PS RAB. This may happen at any point in time during the whole MBMS service availability (i.e. before, during and between MBMS sessions).
3. When the UE is moved to PMM-CONNECTED only for MBMS purpose, e.g. to respond to counting/recounting indication or respond to p-t-p bearer indication from RNC. This may happen at any point in time during MBMS sessions.

Keeping UEs in PMM-CONNECTED only for MBMS between sessions is implementation specific. The UE linking in the SRNC is performed via UE dedicated Iu procedures. An entry for the UE is added to the MBMS service context in the SRNC. If the MBMS service context doesn't exist yet it needs to be created.

In case the UE consumes radio resources from a drift RNC, the UE Linking is performed via Iur in the following way.

1. When the UE, which has activated one or several MBMS services, is in CELL\_DCH or CELL\_FACH state and starts to consume radio resources from one or several cells controlled by the DRNC, MBMS UE Linking in the DRNC is performed via UE dedicated Iur procedures.
2. If the UE is in CELL\_DCH and CELL\_FACH state and there is no dedicated RNL signalling activity ongoing for this UE and UE Linking is performed in the SRNC for an MBMS Service, MBMS UE Linking in the DRNC is performed via the MBMS Attach procedure.
3. If the UE is in CELL\_PCH and moves to a cell controlled by the DRNC, the MBMS UE Linking in the DRNC is performed. The cell the UE moved to is indicated to the DRNC. After that the MBMS Service context in the DRNC needs to be updated at every intra-DRNC cell change.
- 4a. If the UE is in URA\_PCH and moves to a URA which contain cell(s) that are controlled by the DRNC the UE is linked to the MBMS Service context in the DRNC. The URA the UE moved to will be indicated. The MBMS Service context in the DRNC needs to be updated at every intra-DRNC URA change.
- 4b. As long as the SRNC serves UEs in URA\_PCH in URAs containing cells controlled by another RNC, the SRNC shall keep this other RNC informed about every URA in which UEs having activated certain MBMS services have to be notified. This is done by indicating to the other RNC a list of URAs and the corresponding MBMS Services.

NOTE1: Whether the SRNC shall link all UEs in URA\_PCH to the MBMS Service context in the DRNC for counting on URA basis is FFS.

NOTE2: Bullet points 4a and 4b above may be merged in a future version of this document.

5. If the UE is in CELL\_PCH or URA\_PCH and there is no mobility related signalling activity ongoing for this UE and UE Linking is performed in the SRNC for an MBMS Service, MBMS UE Linking in the DRNC is performed via the MBMS Attach procedure.
6. If the UE is in CELL\_PCH and leaves a cell controlled by the DRNC the UE is unlinked from the MBMS Service context in the DRNC via the MBMS Detach procedure.
7. If the UE is in URA\_PCH and leaves a URA containing cell(s) controlled by the DRNC the UE is unlinked from the MBMS Service context in the DRNC via the MBMS Detach procedure.
8. If the UE is in RRC connected mode and UE Linking is performed in the SRNC for an MBMS Service and a session of this MBMS Service is ongoing UE Linking in the DRNC needs to be performed immediately.

At MBMS UE linking in the DRNC the MBMS service context in the DRNC needs to be updated. If an MBMS service context does not exist yet then it shall be created.

### 5.1.7 RNC Registration

RNC Registration for a certain MBMS Service denotes the process where the CN becomes aware of an RNC hosting UEs, which have activated that MBMS Service.

Due to UE mobility, a RNC with no MBMS Service Context, can be informed that a PMM-CONNECTED UE, which has entered the cell, has activated an MBMS Service by means of the MBMS UE Linking procedure via the Iur interface. Then the RNC informs the CN that it would like to receive MBMS Session Start Request messages when applicable for the concerned MBMS Service by sending MBMS Registration Request message.

It results in the set-up of a corresponding MBMS distribution tree, but it does not result in the establishment of Iu user plane, which will be established by the MBMS Session Start procedure.

1. Implicit Registration
  - RNC Registration for Serving RNCs is performed implicitly, i.e. due to UE linking and MBMS Multicast Service Activation. No explicit registration procedure needs to be performed.
2. Explicit Registration
  - RNC Registration for Drift RNCs is performed explicitly if an RNC becomes a Drift RNC for a UE, which has activated an MBMS service and has no MBMS Service Context for that MBMS Service.
  - RNC Registration for Drift RNCs is performed explicitly if an RNC is no longer the SRNC of any connected UE which has activated an MBMS service, but hosts at least a UE which consumes radio resources of the RNC via Iur. This shall happen only before sessions or between sessions.
  - The DRNC will perform a registration towards its default CN node only.

### 5.1.8 RNC De-Registration

RNC De-Registration for a certain MBMS Service denotes the process where the CN becomes aware that an RNC registered at a CN node does not host any more PMM-CONNECTED UEs which have activated that MBMS Service.

1. Implicit RNC De-Registration
  - RNC De-Registration for Serving RNCs is performed implicitly, i.e. due to UE Unlinking and MBMS Multicast Service Deactivation. No explicit de-registration procedure needs to be performed.
2. Explicit RNC De-Registration
  - RNC De-Registration for Drift RNCs is performed explicitly if a RNC is not acting as a Serving RNC and has ceased to act as a Drift RNC for UEs which have activated an MBMS service, it will perform a de-registration towards the CN node it was registered to.
  - The timing of RNC De-Registration is implementation specific.

NOTE: When the Drift RNC performs the explicit De-registration, the Implicit registration may still remain and in that case Iu data bearer should not be removed.

## 5.1.9 CN De-Registration

CN De-Registration denotes the process where the CN informs the RNC that a certain MBMS service is no longer available. CN De-Registration should result in releasing of all associated MBMS Service Contexts and resources.

The CN De-Registration procedure serves to release the MBMS Iu signalling connection.

## 5.2 MBMS Uu Principles

### 5.2.1 MBMS Service States in UE

The MBMS bearer service has following service states in the UE:

1. Not active, UE has not joined any MBMS multicast service or not activated the broadcast mode of the MBMS
2. Not active, UE has joined at least one MBMS multicast service and/or activated the broadcast mode of the MBMS, but MBMS SYSTEM INFORMATION is not broadcasted on BCCH.
3. Active, UE has joined at least one MBMS multicast service and/or activated the broadcast mode of the MBMS, but any of the services that UE has joined (interested in broadcast mode) is not being transmitted. UE monitors MICH to find modifications in the MCCH as defined in 5.1.6
4. Active; at least one MBMS multicast service which the UE has joined (interested in broadcast mode) is transmitted on p-t-m
  - UE is receiving MBMS transmission on MTCH
  - UE is using DRX based on scheduling information informing that coming MTCH transmission is not in the interest of the UE.
5. Active; at least one MBMS multicast service which UE has joined is transmitted on p-t-p
6. Active; at least one MBMS multicast service which UE has joined is transmitted on p-t-p and at least one MBMS multicast service which UE has joined (interested in broadcast mode) is transmitted on p-t-m. (only valid if UE has capability to support this combination)

When MBMS transmission is started in cell the UE moves from state 3 to either state 4 or state 5 (6), depending on p-t-p transmission mode and after MBMS transmission ends in the cell, the UE moves from state 4 or state 5 (6) to state 3.

### 5.2.2 One PDCP and RLC entity shared among multiple cells within one RNS

For each MBMS service, a group of multiple cells belonging to one RNS shares one PDCP entity and RLC entity over p-t-m transmission. The group of multiple cells is called 'MBMS Cell Group'.

1. There are one or more MBMS Cell Groups per MBMS service per RNS. The MBMS Cell Groups are managed by the CRNC.
2. There are one or more cells pertaining to the same RNS for one MBMS Cell Group.
3. For each MBMS service, the MBMS Cell Group Identifier (MBMS CG-Id) is used to uniquely identify a group of multiple cells sharing the same PDCP entity and RLC entity within an RNS.
4. For each MBMS service, the MBMS CG-Id together with the identifier of the controlling RNC (CRNC-Id) constitutes the MBMS UTRAN Cell Group Identifier (MBMS UCG-Id).
5. Each cell sends the MBMS UCG-Id to UEs for each MBMS service. The MBMS UCG-Id is used to uniquely identify an MBMS Cell Group in the UTRAN and UE.

### 5.2.3 MCCH Information Scheduling

The MCCH information will be transmitted based on a fixed schedule. This schedule will identify the TTI containing the beginning of the MCCH information. The transmission of this information may take a variable number of TTIs and the UE will keep receiving the S-CCPCH until:

- It receives all of the MCCH information, or
- It receives a TTI that does not include any MCCH data, or
- The information contents indicate that further reception is not required (e.g. no modification to the desired service information).

Based on this behaviour, the UTRAN may repeat the MCCH information following a scheduled transmission in order to improve reliability. The MCCH schedule will be common for all services.

The entire MCCH information will be transmitted periodically based on a "repetition period". The "modification period" will be defined as an integer multiple of the repetition period. The MBMS ACCESS INFORMATION may be transmitted periodically based on an "access info period". This period will be an integer divider of the "repetition period".

MCCH information is split into critical and non-critical information. The critical information is made up of the MBMS NEIGHBOURING CELL INFORMATION, MBMS SERVICE INFORMATION and MBMS RADIO BEARER INFORMATION. The non-critical information corresponds to the MBMS ACCESS INFORMATION. Changes to critical information will only be applied at the first MCCH transmission of a modification period. Changes to non-critical information could take place at any time.

The Figure 2 below illustrates the schedule with which the MBMS SERVICE INFORMATION and RADIO BEARER INFORMATION would be transmitted. Different colours indicate potentially different MCCH content.

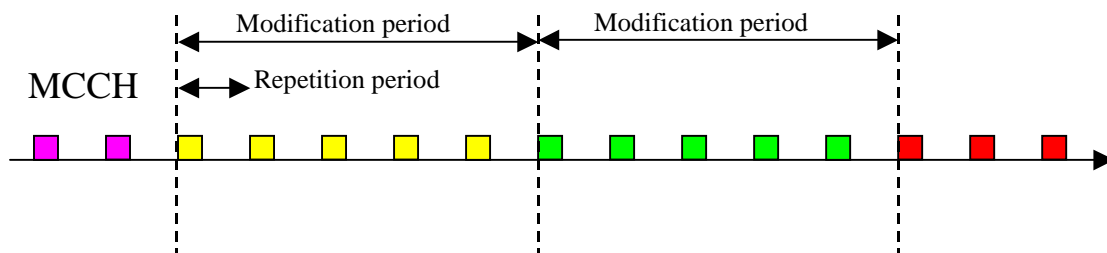

Figure 2: MCCH Information Schedule

### 5.2.4 MBMS Notification

NOTE: This section describes only the case that the MBMS notification indicators are sent on MICH.

An MBMS notification may also be sent on the S-CCPCH carrying the MTCH or even on the S-CCPCH carrying the MCCH. Thus UTRAN may use in-band notification instead of the MICH to notify users receiving MTCH. [FFS based on decision on SNI].

The MBMS notification mechanism is used to inform UEs of an upcoming change in critical MCCH information. Notifications are based on service groups. The mapping between service IDs and service groups will be based on a hashing mechanism. The exact details of this mechanism will be defined in the Stage 3 specifications.

The MBMS notification indicators will be sent on an MBMS specific PICH, called the MICH. A single MICH frame will be able to carry indications for every service-group.

Critical MCCH information can only be changed at the beginning of a modification period as described in Section 5.2.3. The MBMS notification indicator corresponding to the service group of every affected service shall be set continuously during the entire modification period preceding the first change in MCCH information related to a given service. Subsequent changes in the MCCH information in the next modification period related to the same service can be signalled on the MCCH.

UEs are free to read the MBMS notification at any time; however the modification interval shall be long enough so that UEs are able to reliably detect it even if they only receive the MICH during their regular Release 99 paging occasions. The need to limit particularly long DRX cycles (e.g. 5 sec) due to MBMS reception is defined in Stage 3.

Upon detecting the MBMS notification indication for a service group, UEs interested in a service corresponding to this group shall start reading the MCCH at the beginning of the next modification period.

The Figure 3 below illustrates the timing relation between the setting of the MICH and the first MCCH critical information change. The green colour for the MICH indicates when the NI is set for the service. For the MCCH, different colours indicate MCCH content related to the notification of different services.

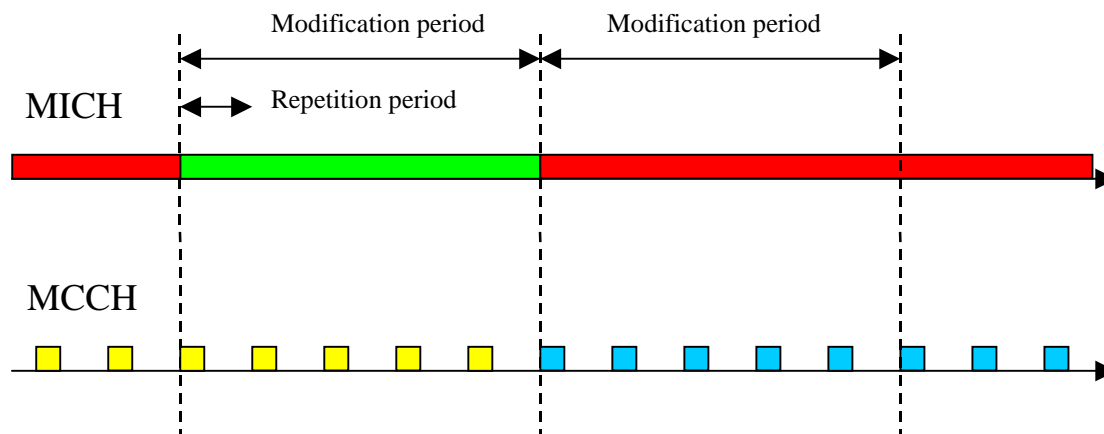

Figure 3: Illustration of MICH timing relative to Modification period

### 5.2.5 MBMS Counting

MBMS Counting is used to determine the optimum transmission mechanism for a given service.

1. The need for counting is indicated in the notification, and achieved by requesting UEs, belonging to the same MBMS service group, to establish an RRC connection.
2. The exact number of UEs that need to be brought to RRC connected mode is an RRM issue.
3. Since it is desirable in a specific cell, to avoid bringing a large number of UEs for counting purposes to RRC connected mode at the same time (RACH load, etc), RRM may control the load due to the RRC connection establishment requests, by setting an access "probability factor".
4. Following counting, the number of subscribers that need to be maintained in RRC connected mode or for which the RNC releases their connection, is also an RRM issue.
5. For a given MBMS service, the counting indication in the notification may be switched on and off, on per-cell basis.
6. The RNC may use notification to indicate counting during an ongoing MBMS session (term used is re-counting).
7. The RNC receives via Iu from CN information (MBMS service ID) about UEs who are in RRC Connected mode, and have joined the MBMS service. This information may be used for counting purposes.

The MBMS counting function includes a mechanism by which the UTRAN can prompt users interested in a given service to become RRC connected. This procedure is only applicable for UEs in idle mode and relies on the MBMS ACCESS INFORMATION transmitted on the MCCH. The probability factor indicates the probability with which UEs need to attempt an RRC connection procedure.

In order to trigger counting for a given service, the UTRAN may use the regular MBMS notification mechanism outlined in section 5.2.4 to force UEs interested in the service to read the MCCH information.

Once a UE detects that the counting procedure is on-going for the specific service it wants to receive, it will attempt to set up an RRC connection based on the probability factor included in the MCCH. [The details of this mechanism will be defined in the Stage 3 specifications].

A UE in URA\_PCH state which is notified on the MCCH shall initiate a cell update procedure with a specific cause based upon the information provided in the MBMS ACCESS INFORMATION.

Also, the UE will keep receiving the MBMS ACCESS INFORMATION at every access info period until UE becomes RRC connected or counting is no longer required. Whenever it receives new MBMS ACCESS INFORMATION the UE will update its probability factor with the new value.

The Figure 4 below illustrates this mechanism. The green colour for the MICH indicates when the NI is set for the service. The green colour for the MBMS ACCESS INFORMATION indicates that the counting procedure is on-going and that UEs need to establish an RRC connection based on the included probability factor (PF). For the critical MCCH info, different colours indicate potentially different content.

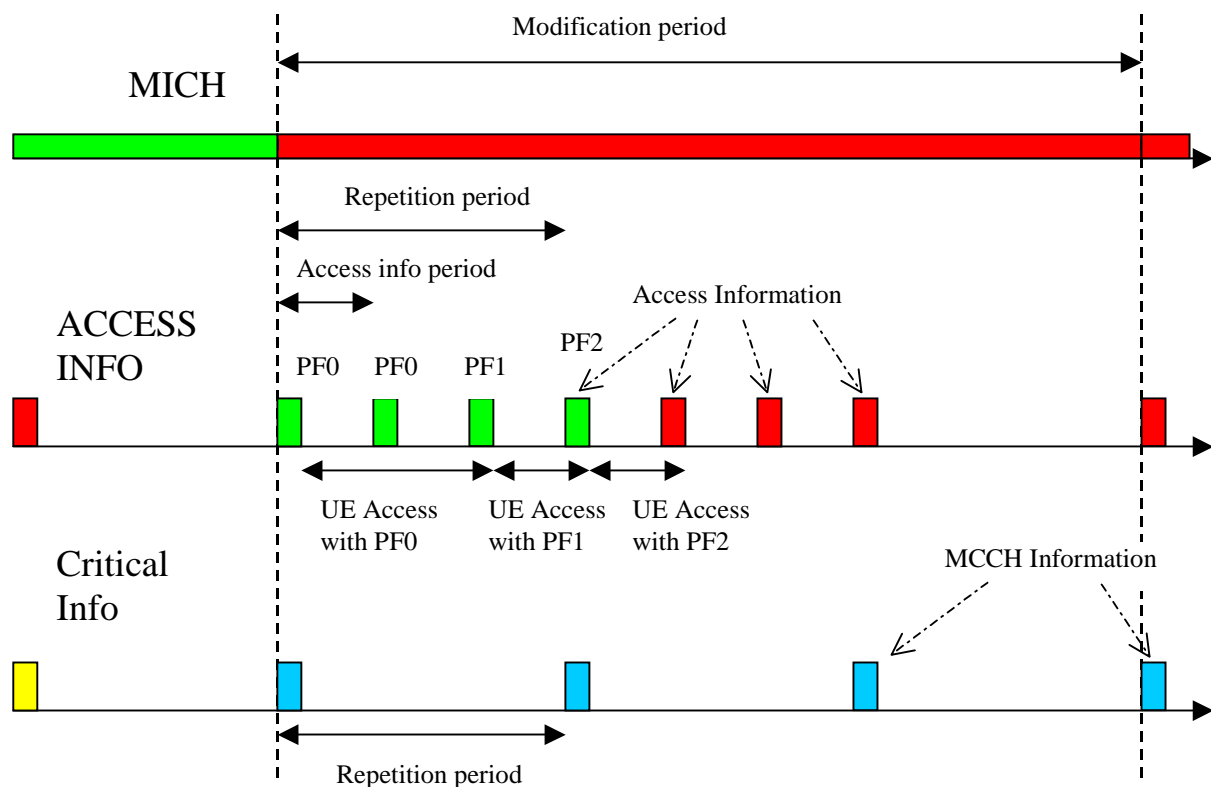

**Figure 4: Illustration of Access Info period during MBMS counting**

For every UE brought to RRC connected state for the purpose of counting, UTRAN will initiate the PMM Connection establishment procedure and will obtain from CN the set of MBMS services these users have joined.

Counting for on-going services (re-counting) will rely on the same scheduling of the MCCH information. The only difference is that UTRAN may use in-band notification instead of the MICH to notify users [FFS based on decision on SNI].

### 5.2.6 MBMS Radio Bearer Release in the UE

The UE releases the MBMS RB by using one of the following mechanisms:

- Explicit MBMS RB Release
- Implicit MBMS RB Release

The Explicit MBMS RB Release mechanism allows UTRAN to explicitly indicate to MBMS UEs that an MBMS Radio Bearer should be released. The Explicit MBMS RB Release indication is included in a new MBMS RADIO BEARER RELEASE information, the existing MBMS SERVICE INFORMATION, MBMS RADIO BEARER INFORMATION



or the existing RADIO BEARER RELEASE message. If the Explicit MBMS RB Release indication is received, the UE releases the MBMS RB.

The Implicit MBMS RB Release mechanism allows is only used for p-t-m transmission and a UE to release the MBMS Radio Bearer without receiving the MBMS RB release message given from UTRAN as follows:

A UE uses a timer to implicit release of the MBMS RB. The timer value is given from UTRAN.

## 5.3 Protocol structure

### 5.3.1 MBMS User Plane Protocol Stack Architecture

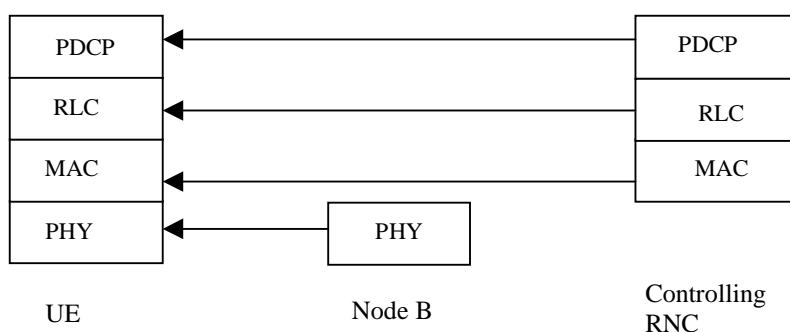

**Figure 5: Protocol Stack for MTCH**

Figure 5 illustrates the protocol termination for MTCH in MBMS, which is used in p-t-m transmission.

PDCP sub-layer performs header compression/decompression for the MBMS traffic.

PDCP sub-layer may operate with RFC 3095 header compression protocol. In that case, header compression should be performed under RFC 3095 U-mode.

In the UTRAN side, there is one PDCP entity per cell supporting MBMS or MBMS Cell Group for each MBMS service in each RNS. The shared PDCP entity in the UTRAN duplicates all PDCP PDUs to every RLC entity for every cell belonging to one MBMS Cell Group.

In the UTRAN, there is one RLC entity for each MBMS service in each cell or cell group in case of utilization of selective combining or maximum ratio combining in TDD, and one MAC entity for each cell.

In the UE side, there is one PDCP and RLC entity for each MBMS service in each UE. In each UE there is one MAC entity per received cell when UE is performing the selective combining between these cells.

In case of p-t-p transmission, DTCH is used for MBMS transmission and the protocol termination for DTCH mapped on DCH and RACH/FACH are presented in [8].

### 5.3.2 MBMS Control Plane Protocol Stack Architecture

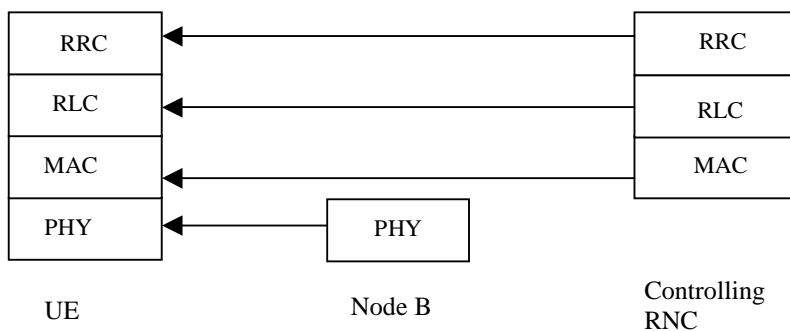

Figure 6: Protocol Stack for MCCH

Figure 6 illustrates the protocol termination for MCCH in MBMS, which is p-t-m control channel.

MBMS functionalities are included in MAC and RRC.

In case of p-t-p transmission, DCCH is used for MBMS and the protocol termination for DCCH mapped on DCH and FACH are presented in [8].

## 5.4 MAC architecture

### 5.4.1 UTRAN MAC Architecture to support MBMS

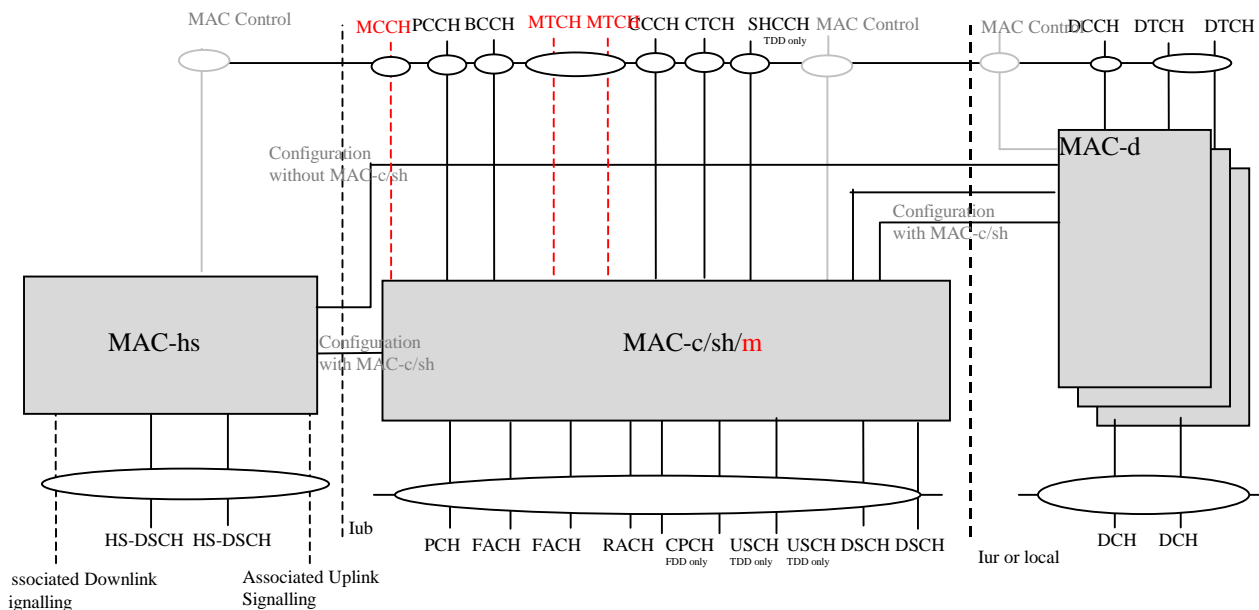

Figure 7: UTRAN MAC architecture

To support MBMS user and control plane transmission, a multicast functionality is added in the MAC c/sh, entitled "MAC m", to take care of scheduling of MBMS related transport channels as presented in Figure 7. In addition, two logical channels are considered for p-t-m transmission of MBMS: MCCH and MTCH. Both logical channels are mapped on FACH. In case of p-t-p transmission DTCH and DCCH are used.

### 5.4.2 MAC-c/sh/m architecture: UTRAN side

Figure 4 illustrates the MAC-m additions to the MAC-c/sh architecture in the UTRAN side, needed to transmit MBMS data over a common transport channel (FACH).

MAC-c/sh/m is located in the controlling RNC. The following functionalities are covered:

- Scheduling / Buffering / Priority Handling: This function manages common transport resources between MBMS and non-MBMS data flow(s) according to their priority.
- TCTF MUX: This function handles insertion of the TCTF field in the MAC header and also the respective mapping between logical channels (i.e. MTCH and MCCH) and transport channels. The TCTF field indicates which type of logical channel (i.e. MTCH and MCCH) is used.
- Addition of MBMS-ID: For p-t-m type of logical channels, the MBMS-ID field in the MAC header is used to distinguish between MBMS services.
- TFC selection: Transport format combination selection is done for a common transport channel (FACH) mapped to MTCH and MCCH.

There is one MAC-c/sh/m entity in the UTRAN for each cell.

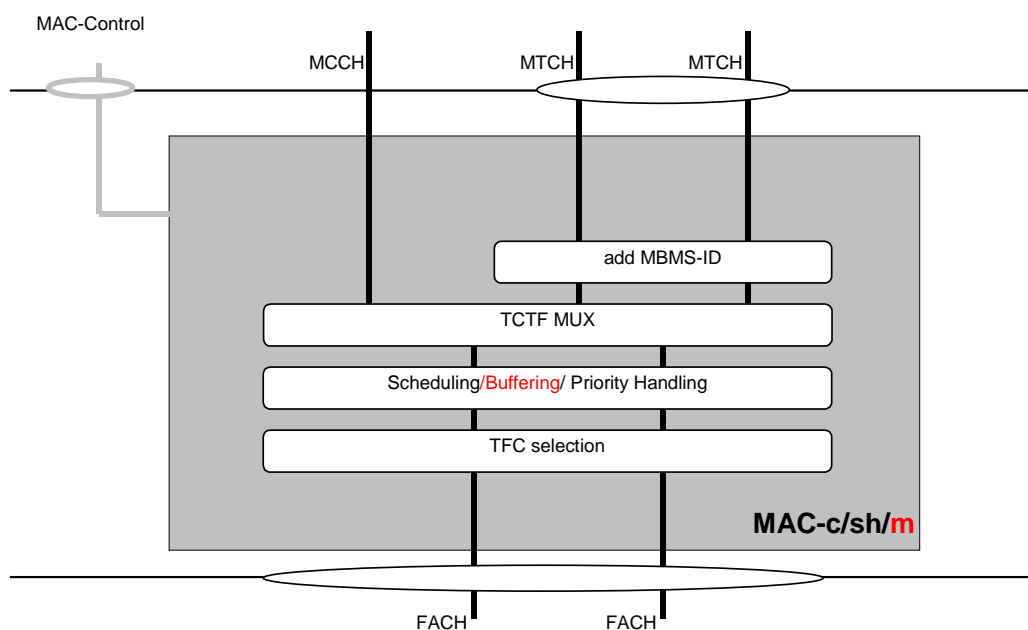

**Figure 8: UTRAN side MAC-m architecture additions to MAC-c/sh**

### 5.4.3 MAC-c/sh/m architecture: UE side

Figure 5 illustrates the MAC-m additions to the MAC-c/sh architecture in the UE side, needed to receive MBMS data over a transport channel (FACH).

The following functionalities are covered:

- TCTF DEMUX: This function handles detection and deletion of the TCTF field in the MAC header, and also the respective mapping between logical channels (i.e. MTCH and MCCH) and transport channels. The TCTF field indicates which type of logical channel (i.e. MTCH and MCCH) is used.
- Reading of MBMS-ID: The MBMS-ID identifies data to a specific MBMS service.

There are one or several (in case of selective combining) MAC-m entities in each UE.

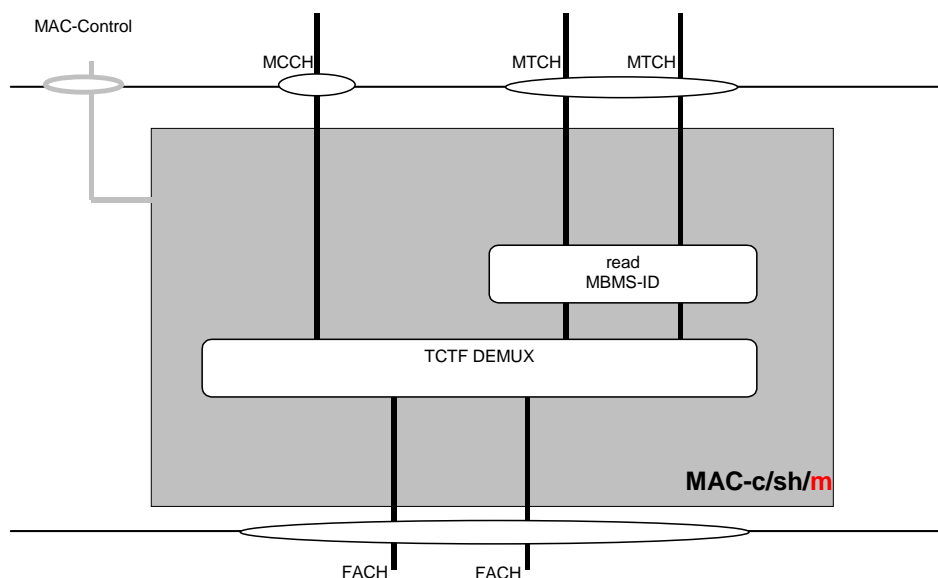

Figure 9: UE side MAC-m additions to MAC-c/sh

## 6 MBMS Channel Structure

There exists two transmission modes to provide the MBMS service:

- Point-to-point transmission (p-t-p)
- Point-to-multipoint transmission (p-t-m)

### 6.1 Point-to-Point Transmission

Point-to-point transmission is used to transfer MBMS specific control/user plane information as well as dedicated control/user plane information between the network and one UE in RRC Connected Mode. It is used only for the multicast mode of MBMS.

For a UE in CELL\_FACH and Cell\_DCH, DCCH or DTCH is used, allowing all existing mappings to transport channels.

A detailed description of channels used for point-to-point transmission is given in [8].

### 6.2 Point-to-multipoint Transmission

Point-to-multipoint transmission is used to transfer MBMS specific control/user plane information between the network and several UEs in RRC Connected or Idle Mode. It is used for broadcast or multicast mode of MBMS.

#### 6.2.1 Logical Channels

##### 6.2.1.1 MBMS point-to-multipoint Control Channel (MCCH)

This logical channel is used for a p-t-m downlink transmission of control plane information between network and UEs in RRC Connected or Idle Mode. The control plane information on MCCH is MBMS specific and is sent to UEs in a cell with an activated (joined) MBMS service. MCCH can be sent in S-CCPCH carrying the DCCH of the UEs in CELL\_FACH state, or in standalone S-CCPCH, or in same S-CCPCH with MTCH. Short indication is always given to UE to when to read MCCH. UTRAN may use in-band notification instead of the MICH to notify users receiving MTCH. [FFS based on decision on SNI].

Reception of paging has priority over reception of MCCH for Idle mode and URA/CELL\_PCH UEs.

### 6.2.1.2 MBMS point-to-multipoint Traffic Channel (MTCH)

This logical channel is used for a p-t-m downlink transmission of user plane information between network and UEs in RRC Connected or Idle Mode. The user plane information on MTCH is MBMS Service specific and is sent to UEs in a cell with an activated MBMS service.

### 6.2.2 Transport Channel

FACH is used as a transport channel for MTCH and MCCH.

### 6.2.3 Physical Channel

SCCPCH is used as a physical channel for FACH carrying MTCH or MCCH.

### 6.2.4 Mapping between channels

Only in downlink, the following connections between logical channels and transport channels exist:

- MCCH can be mapped to FACH
- MTCH can be mapped to FACH

The mappings as seen from the UE and UTRAN sides are shown in Figure 10 and Figure 11 respectively.

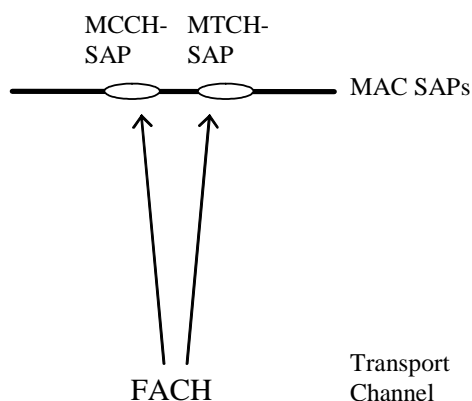

Figure 10: Logical channels mapped onto transport channel, seen from the UE side

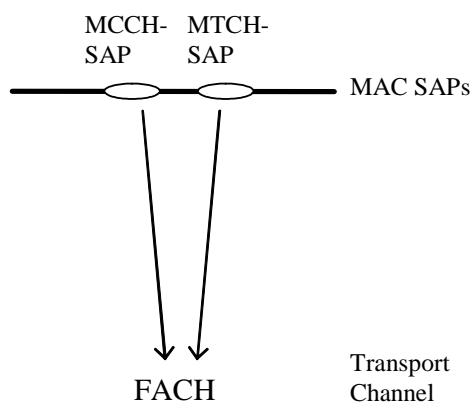

Figure 11: Logical channels mapped onto transport channel, seen from the UTRAN side

## 6.2.5 Data Flows through Layer 2

### 6.2.5.1 Data flow for MCCH mapped to FACH

For MCCH, the RLC mode to be employed is UM-RLC, with required enhancements to support out of sequence SDU delivery. A MAC header is used for logical channel type identification.

### 6.2.5.2 Data flow for MTCH mapped to FACH

For MTCH, the RLC mode to be employed is UM-RLC, with required enhancements to support selective combining. Quick repeat may be used in RLC-UM. A MAC header is used for logical channel type identification and MBMS service identification.

## 6.3. MBMS Notification Indicator Channel

MBMS notification utilizes a new MBMS specific PICH called MBMS Notification Indicator Channel (MICH) in cell. The exact coding is defined in Stage-3 physical layer specifications.

---

# 7 MBMS Reception and UE Capability

## 7.1 Selective Combining for MBMS P-T-M transmission

The selective combining for MBMS p-t-m transmission is supported by RLC PDU numbering. Therefore, the selective combining in the UE is possible from cells providing similar MBMS RB bit rate, provided that the de-synchronization between MBMS p-t-m transmission streams does not exceed the RLC re-ordering capability of the UE. Thus, there exist one RLC entity in the UE side.

To support selective combining it is decided to:

- Introduce re-ordering as a configurable feature of RLC-UM, within the RLC specification.
- Use the same mechanism as what is specified for MAC-hs (single T1 timer).

For selective combining there exist one RLC entity per MBMS service utilizing p-t-m transmission in the cell group of the CRNC. All cells in the cell group are under the same CRNC, i.e. Iur support is not considered.

The UE capability requirements to support selective combining are defined in chapter 7.2. In case de-synchronization occurs between MBMS transmissions in neighbouring cells belonging to an MBMS cell group the CRNC may perform re-synchronization actions enabling UEs to perform the selective combining between these cells.

For TDD, selection combining and the maximum ratio combining can be used when Node-Bs are synchronized

When selective combining is available between cells the UTRAN should send MBMS NEIGHBOURING CELL INFORMATION containing the MTCH configuration of the neighbouring cells, available for selective combining. With MBMS NEIGHBOURING CELL INFORMATION the UE is able to receive MTCH transmission from neighbouring cell without reception of the MCCH of that cell.

The UE determines the neighbouring cell suitable for selective combining based on threshold (e.g. measured CPICH  $E_c/N_0$ ) and the presence of MBMS NEIGHBOURING CELL INFORMATION of that neighbour cell.

The possibility of performing selective combining should be signalled to the UE.

### 7.1.bis Simulcast Combining (TDD only)

In contrast to FDD, downlink macro diversity has not been a characteristic of TDD during release '99/4/5. As such TDD receivers are not typically designed to facilitate the simultaneous reception of multiple radio links and the incorporation of such a requirement for MBMS in TDD would have non-trivial impacts on the receiver design.

Much of the receiver complexity increase associated with the combining of multiple radio links in the UE can however be avoided in TDD by combining macro-diversity with timeslot re-use. This also allows for the throughput gains from timeslot re-use to be combined with further gains from macro diversity.

In such a scheme, the transmissions of the same information from the multiple participating cells are arranged such that they arrive at the UE on substantially different timeslots, thereby removing the requirement at the UE to detect multiple cells in the same timeslot.

As such, cells are partitioned into transmission "groups" or "sets". Each transmission set is allocated a timeslot (or set of timeslots) for MBMS transmission. The assigned slots are typically exclusively used by that MBMS set; sets do not transmit when another set is active. The UE attempts to receive information from each set and to combine them either at the physical layer or RLC layer in order to enhance reception reliability.

Figure 12 shows such a scheme applied to a tri-sectored deployment model. 3 timeslots ( $t_1$ ,  $t_2$  and  $t_3$ ) are allocated to each sector for the purposes of MBMS transmission. Each sector is assigned to a particular "MBMS transmission set", set 1, 2 or 3.

An MBMS data unit or transport block is encoded over several radio frames (eg: 80ms TTI). The physical channel bits that result are effectively transmitted three times; once by MBMS set 1 in timeslot  $t_1$ , once by MBMS set 2 in timeslot  $t_2$ , and once by MBMS set 3 in timeslot  $t_3$ .

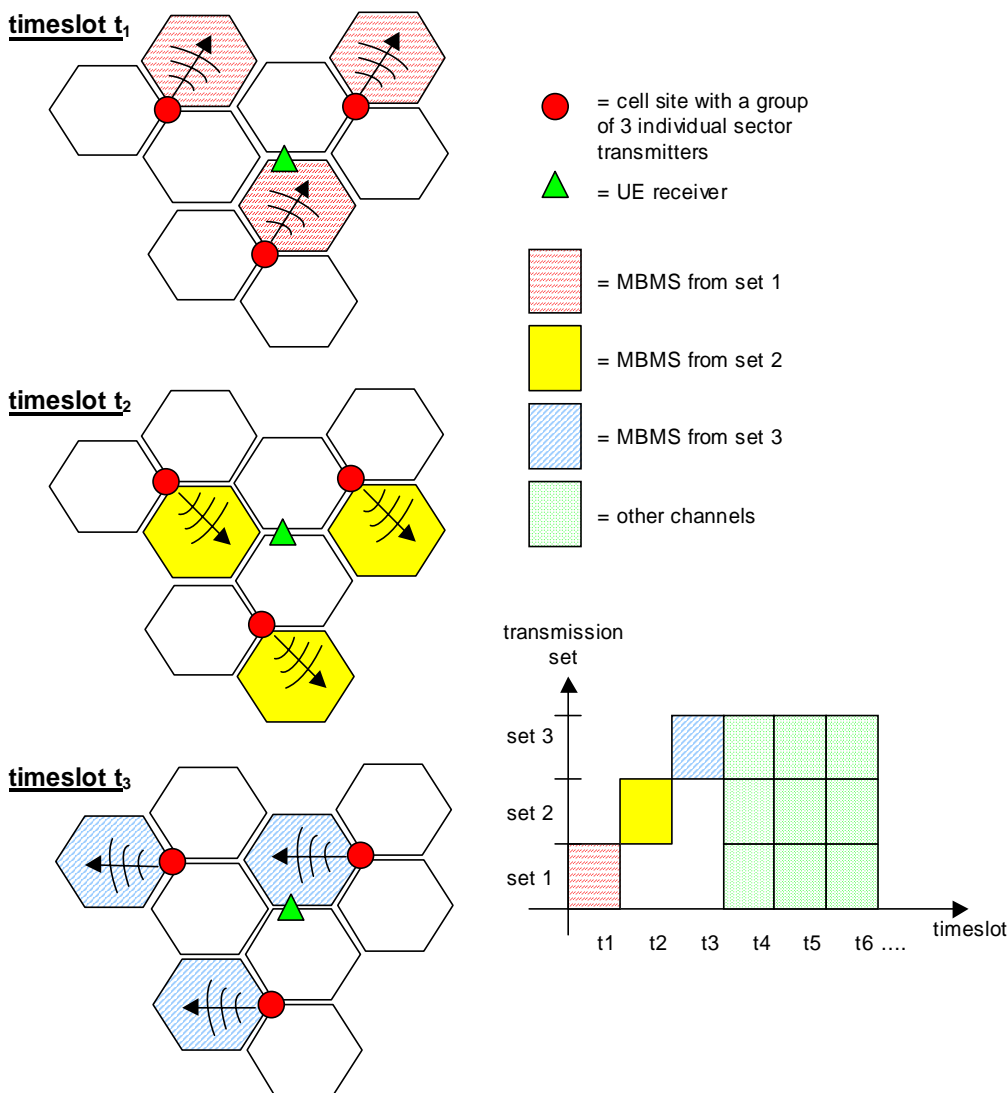

**Figure 12: Example of non-time-coincident macro diversity transmission**

A given UE may be configured to listen to the separate transmissions of the MBMS physical channels (one from each set) which, over the course of the TTI, correspond to the MBMS transport block(s). The signals from each MBMS set

are largely non-time-coincident and do not require the use of an extensively modified receiver architecture – a receiver architecture resembling that of a normal "single-radio-link" TDD receiver may be used.

The received transport blocks may be provided to the RLC layer for selective combining, or soft information may be buffered and combined across MBMS sets during the course of the TTI via physical layer maximum ratio combining .

The UTRAN shall signal to the UE on the MCCH which services may be maximum ratio combined (and in which cells). The cell group for maximum ratio combining may be different than the cell group for selective combining. The UE may assume that transmissions of a given service that may be maximum ratio combined take place in the same frame.

## 7.2 UE Capability

The UE MBMS capability is not sent to UTRAN and is subject to UE implementation, including the relation between MBMS capability and actual RRC state which is also a UE implementation. A consequence is that a UE may be counted although its actual capability does not allow to receive MBMS transmissions e.g. because of its current RRC state. Further optimizations to avoid counting of useless UEs may be included in Stage 3.

The standard will describe a minimum UE capability requirement in order to allow operators to configure MBMS channels that can be common to all UEs supporting the given service.

There are some UE capability requirements that are common to all eventual service categories:

The minimum UE capability for MBMS capable UE, is one primary CCPCH plus all the configurations below. The UE is not required to support these configurations simultaneously.

1. One PICH and one MICH
2. One S-CCPCH and one MICH
3. One S-CCPCH (dedicated FACH and possibly the FACH, which may carry MCCH) and two S-CCPCH with 80ms TTI for MTCH reception
4. One S-CCPCH (dedicated FACH and possibly the FACH, which may carry MCCH) and three S-CCPCH with 40ms TTI for MTCH reception
5. One PICH and two S-CCPCH with 80ms TTI for MTCH reception
6. One PICH and three S-CCPCH with 40ms TTI for MTCH reception

The requirement one reflects the case when the UE is in Idle mode, or URA\_PCH, CELL\_PCH state and MBMS reception is not ongoing and requirement five and six are for the case that MBMS reception is ongoing in Idle mode, or URA\_PCH, CELL\_PCH state.

The requirement two reflects the case when the UE is in CELL\_FACH state and MBMS is reception not ongoing and requirement three and four are for the case when MBMS reception is ongoing respectively.

The ability of the UE to receive DPCH/HS-PDSCH simultaneously with S-CCPCH carrying MTCH/MCCH is subject to UE capability.

The minimum MBMS bit rate that all MBMS capable UEs shall support is to be defined in Stage 3.

For FDD, the UE shall support selective combining and may support soft combining (signalling support will be needed). For TDD, the UE shall support both selective and maximum ratio combining.

The standard may restrict further the UE implementation options by defining certain capability combinations.

## 7.3 MBMS Reception

The following descriptions add MBMS specific processes to be considered for each RRC State/Mode.

The BCCH contains information regarding the MCCH, while the latter contains information on the MTCH.



In the sub-sections below, how and when the UE reads the MCCH is not described as periodic MCCH transmission is described in 5.2.3. .

NOTE: reception of multiple MBMS services simultaneously is subject to UE capability; selection between these when needed is [FFS].

### 7.3.1 MBMS Reception in RRC Idle Mode

In idle mode, the UE shall:

- if the UE supports MBMS and
- if the UE has activated an MBMS service and there is an ongoing session for this service in the cell where the UE is situated, i.e. MTCH and MCCH are available
  - act on RRC messages received on MCCH and:
    - if the MBMS service requires the establishment of an RRC Connection
      - inform upper layers that the MBMS Service requires the establishment of an RRC Connection,
    - if the MBMS service does not require the establishment of an RRC Connection :
      - listen to the common transport channel on which the MTCH is mapped.
  - if the UE determines that a neighbouring cell is suitable for selective combining and the UE has valid MBMS NEIGHBOURING CELL INFORMATION of that cell:
    - performs selective combining of MTCH between the selected cell and the neighbouring cell.

### 7.3.2 MBMS Reception in RRC Connected Mode: URA\_PCH state

In URA\_PCH, the UE shall:

- if the UE supports MBMS and
- if the UE has activated an MBMS service and there is an ongoing session for this service in the URA where the UE is situated, i.e. MTCH and MCCH are available
  - act on RRC messages received on MCCH,
    - if on the MCCH is indicated that the MBMS service in the cell requires a cell update:
      - initiate a cell update procedure. The cause to be used in the cell update procedure is defined in Stage 3.
  - for each MBMS service that the UE has activated and where transmission on a MTCH is indicated in the MCCH, listen to the common transport channel on which the MTCH is mapped,
  - if the UE determines that a neighbouring cell is suitable for selective combining the UE has valid MBMS NEIGHBOURING CELL INFORMATION of that cell
    - performs selective combining of MTCH between the selected cell and the neighbouring cell.

### 7.3.3 MBMS Reception in RRC Connected Mode: CELL\_PCH state

In CELL\_PCH, the UE shall:

- if the UE supports MBMS and
- if the UE has activated an MBMS service and there is an ongoing session for this service in the cell where the UE is situated, i.e. MTCH and MCCH are available
  - act on RRC messages received on MCCH

- listen to the common transport channel on which the MTCH is mapped,
- if the UE determines that a neighbouring cell is suitable for selective combining the UE has valid MBMS NEIGHBOURING CELL INFORMATION of that cell
  - performs selective combining of MTCH between the selected cell and the neighbouring cell.

### 7.3.4 MBMS Reception in RRC Connected Mode: CELL\_FACH state

In CELL\_FACH, the UE shall:

- if the UE supports MBMS and
- if the UE has activated an MBMS service and there is an ongoing session for this service in the cell where the UE is situated, i.e. MTCH and MCCH are available
  - act on RRC messages received on MCCH
  - listen to the common transport channel on which the MTCH is mapped
  - if the UE determines that a neighbouring cell is suitable for selective combining the UE has valid MBMS NEIGHBOURING CELL INFORMATION of that cell
    - performs selective combining of MTCH between the selected cell and the neighbouring cell.

NOTE: For UEs in CELL\_FACH, UTRAN may decide to send MBMS data over DTCH.

### 7.3.5 MBMS Reception in RRC Connected Mode: CELL\_DCH state

In CELL\_DCH, the UE shall,

- if the UE supports MBMS and
- if the UE has activated an MBMS service and there is an ongoing session for this service in the cell where the UE is situated, i.e. MTCH and MCCH are available and
- if the UE has the capabilities:
  - act on RRC messages received on MCCH
  - listen to the common transport channel on which the MTCH is mapped.
  - if the UE determines that a neighbouring cell is suitable for selective combining the UE has valid MBMS NEIGHBOURING CELL INFORMATION of that cell and UE has capability
    - performs selective combining of MTCH between the selected cell and the neighbouring cell.

NOTE: For UEs in CELL\_DCH, UTRAN may decide to send MBMS data over DTCH

---

## 8 UTRAN Signalling Flows for MBMS

### 8.1 MBMS High Level Signalling Scenarios

*This subclause includes descriptions for a number of aspects for which the solution has not been agreed. This relates at least to the following open issues that are not agreed:*

- *Use of notification indicators for cases other than session start [This open issue is marked also in Chapters 5.2.4 MBMS Notification and 5.2.5 MBMS Counting]*

- *The use of the Secondary Notification Indicator (SNI), including its contents and its mapping [This open issue relates to previous one and is marked also in Chapters 5.2.4 MBMS Notification and 5.2.5 MBMS Counting]*

*Even when not explicitly marked as FFS, the descriptions included in this subclause relating to the issues listed above should be considered as just one possible approach.*

### 8.1.1 Session start

Upon receiving a session start indication from CN, UTRAN initiates the session start sequence to allocate radio resources to UEs for receiving the MBMS content. As part of this sequence, UTRAN may apply the counting procedure (counting the number of idle mode UEs) to decide whether to use the p-t-m or p-t-p transfer mode.

The Figure 13 shows an example of a possible session start sequence.

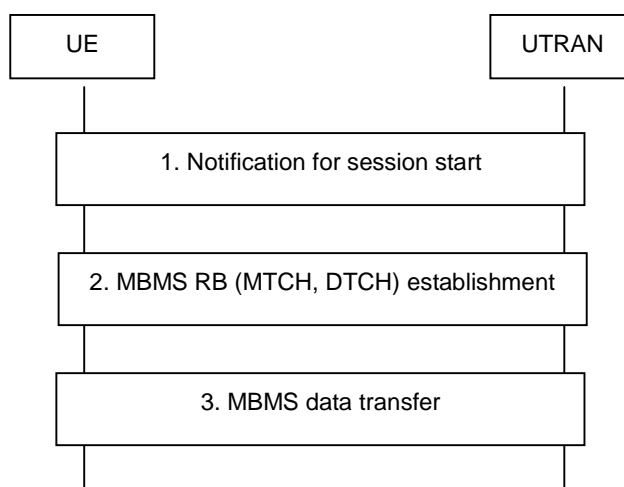

**Figure 13: Session start**

In general, the session start sequence involves the following steps:

- In case UTRAN applies counting to determine the most optimal transfer mode, it may first apply conventional paging to move UEs in URA\_PCH to CELL\_PCH state. Next, the following steps are performed:
  - UTRAN sets the correct MBMS Notification Indicator (NI) and sends the MBMS ACCESS INFORMATION including service ID, and access probability on MCCH.
  - Upon DRX wakeup, UEs in idle mode as well as UEs in CELL\_PCH, URA\_PCH and CELL\_FACH not receiving an MBMS service provided in p-t-m transfer mode evaluate the MBMS NI and if set, read MCCH at the pre- defined time(s). Upon receiving the MBMS ACCESS INFORMATION including access probability, UEs in idle mode for which the probability check passes, initiate RRC connection establishment to move to PMM CONNECTED. RRC Connected mode UEs ignore the MBMS ACCESS INFORMATION. UTRAN counts the UEs interested in the MBMS service using UE linking from CN
  - In case a pre- defined threshold is reached, UTRAN applies the p-t-m RB establishment procedure specified below. Otherwise, UTRAN may repeat the MBMS ACCESS INFORMATION a number of times, using different probability values. If the threshold is not reached, UTRAN applies the p-t-p RB establishment procedure

**NOTE:** The NIs are evaluated by UEs in CELL\_PCH, URA\_PCH and CELL\_FACH that are not receiving an MBMS service that is provided using p-t-m transfer mode. In this section these UEs are referred to as 'NI-detecting connected mode UEs'. The UEs in CELL\_PCH, URA\_PCH, CELL\_FACH and CELL\_DCH that are receiving an MBMS service that is provided using p-t-m transfer mode receive the Secondary Notification Indicator (SNI) instead. The latter UEs are referred to as 'SNI detecting connected mode UEs'.

- In case UTRAN selects the p-t-m RB establishment procedure:

- UTRAN configures MTCH and updates MCCH (MBMS SERVICE INFORMATION and MBMS RADIO BEARER INFORMATION) by including the service ID and p-t-m RB information for the concerned MBMS service
- In case p-t-m RB establishment is not preceded by counting, UTRAN sets the correct MBMS Notification Indicator (NI). Regardless of counting, UTRAN also provides the Secondary Notification Indicator.
- UTRAN sends the MBMS dedicated notification message including the service ID and cause= session start on DCCH to inform UEs in CELL\_DCH that are not receiving an MBMS service provided using p-t-m transfer mode
- In case p-t-m RB establishment is preceded by counting, UEs in idle mode as well as NI- detecting connected mode UEs read MCCH at the pre- defined time(s) to acquire the MBMS SERVICE INFORMATION and MBMS RADIO BEARER INFORMATION
- In case p-t-m RB establishment is not preceded by counting, Upon DRX wakeup, UEs in idle mode as well as NI- detecting connected mode UEs evaluate the MBMS NI and if set, read MCCH at the pre- defined time(s) to acquire the MBMS SERVICE INFORMATION and MBMS RADIO BEARER INFORMATION
- Upon detecting the MBMS SNI, SNI- detecting connected mode UEs read MCCH at the pre- defined time(s) to acquire the MBMS SERVICE INFORMATION and MBMS RADIO BEARER INFORMATION. UEs that are incapable of receiving the MTCH for the session that is started in parallel to the existing activity notify the user. This enables the user to choose between the ongoing activity and the new MBMS service
- Upon receiving MBMS dedicated notification with cause= session start, UEs in CELL\_DCH that are incapable of receiving the MCCH and the corresponding MTCH in parallel to the existing activity notify the user. This enables the user to choose between the ongoing activity and the new MBMS service. If the user decides to receive the new MBMS service, the UE shall read MCCH at the pre- defined time(s) to acquire the MBMS SERVICE INFORMATION and MBMS RADIO BEARER INFORMATION.
- Upon receiving the MBMS SERVICE INFORMATION and the MBMS RB INFORMATION including the p-t-m RB information for the concerned MBMS service, the UE starts receiving the p-t-m radio bearers
- In case UTRAN selects the p-t-p RB establishment procedure:
  - UTRAN applies conventional paging to trigger UEs in CELL\_PCH to perform cell update. Furthermore, UTRAN establishes the p-t-p RB by means of appropriate RRC procedures eg. the RB setup procedure
  - UEs establish the p-t-p radio bearers by means of the RRC procedure selected by UTRAN eg. the RB setup procedure
  - UTRAN updates MCCH (MBMS SERVICE INFO) to inform UEs joining or entering the cell at a later point in time.

### 8.1.2 Joining (during a session)

In case the user wants to join an MBMS service (before or during a session), the UE initiates NAS procedures (e.g. MBMS service activation).

If no session is ongoing upon completion of the joining procedure, the joining procedure is transparent to the AS.

In case a session using p-t-m transfer mode is ongoing upon completion of the joining procedure, the UE may initiate reception of the p-t-m radio bearers. In case the ongoing session applies p-t-p transfer mode, UTRAN may establish the p-t-p radio bearers. UTRAN would do this upon receiving a UE linking indication from CN, which normally follows the joining. As a result of the UE linking, UTRAN may decide to change the transfer mode from p-t-p to p-t-m. This change of transfer mode is out of the scope of this sequence (to be covered by a separate sequence).

The Figure 14 shows an example of a possible joining sequence.

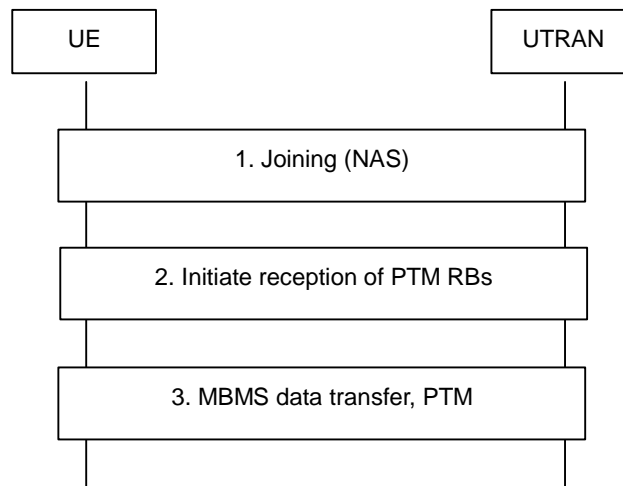

**Figure 14: Joining with continuation of p-t-m**

In general, the joining sequence involves the following steps:

- UEs in idle mode first perform RRC connection establishment, while UEs in CELL\_PCH and URA\_PCH first perform cell update
- UEs initiate the joining procedure (NAS)
- In case UTRAN continues to use the p-t-m transfer mode:
  - UTRAN sends the MBMS dedicated notification message on DCCH including the service ID and cause= session ongoing to inform UEs in CELL\_DCH
  - Upon receiving MBMS dedicated notification with cause= session ongoing, UEs in CELL\_DCH that are incapable of receiving the MCCH and the corresponding MTCH in parallel to the existing activity notify the upper layer. This enables the user to choose between the ongoing activity and the new MBMS service. If the user chooses to receive the new MBMS service or if the UE in Cell\_DCH is capable of receiving MCCH and MTCH in parallel to the existing activity, the UE shall read MCCH at the pre- defined time(s) to acquire the MBMS SERVICE INFORMATION and MBMS RADIO BEARER INFORMATION from MCCH.
  - Upon acquiring the MBMS SERVICE INFORMATION and the MBMS RADIO BEARER INFORMATION including the p-t-m RB information for the concerned MBMS service, the UE starts receiving the p-t-m radio bearers
- In case UTRAN continues using the p-t-p transfer mode:
  - UTRAN establishes the p-t-p RB by means of appropriate RRC procedures eg. the RB setup procedure
  - UEs establish the p-t-p radio bearers by means of the RRC procedure selected by UTRAN eg. the RB setup procedure.

### 8.1.3 Recounting

During a p-t-m MBMS session, UTRAN may perform re- counting to verify if p-t-m is still the optimal transfer mode. The purpose of the re- counting procedure is to count the number of idle mode UEs that have joined a specific service. As a result of this procedure, UTRAN may decide to change the transfer mode from p-t-m to p-t-p. This change of transfer mode is outside the scope of this sequence (to be covered by a separate sequence).

The Figure 15 shows an example of a possible recounting sequence.

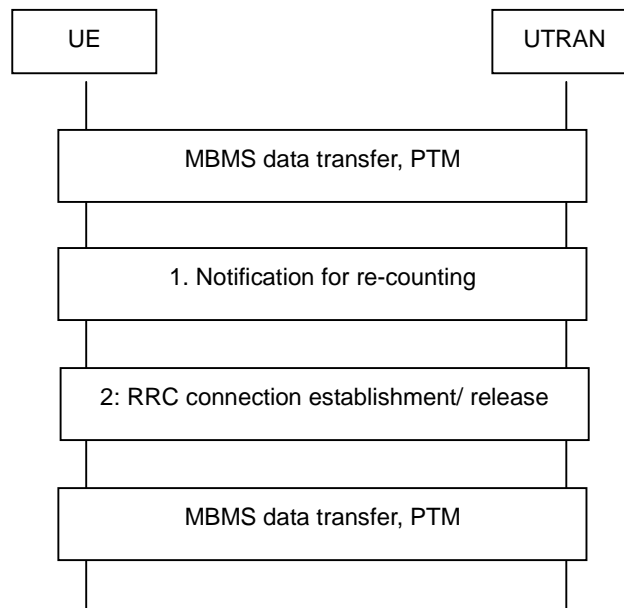

**Figure 15: Recounting with continuation of p-t-m**

In case UTRAN applies re-counting to determine the most optimal transfer mode, the following steps are performed:

- UTRAN sets the correct MBMS NI and sends the MBMS ACCESS INFORMATION including service ID, and access probability on MCCH
- Upon DRX wakeup, UEs in idle mode as well as NI-detecting connected mode UEs evaluate the MBMS NI and if set, read MCCH at the pre-defined time(s). Upon receiving the MBMS ACCESS INFORMATION including access probability, UEs in idle mode for which the probability check passes, initiate RRC connection establishment. Connected mode UEs ignore the MBMS ACCESS INFORMATION.
- UTRAN counts the UEs interested in the MBMS service using UE linking from CN
- In case a pre-defined threshold is reached, UTRAN continues using the p-t-m transfer mode. Otherwise, UTRAN may repeat the MBMS ACCESS INFORMATION a number of times, using different probability values. If the threshold is not reached, UTRAN switches transfer mode from p-t-m to p-t-p
- In case UTRAN continues using the p-t-m transfer mode, it may return UEs that responded to counting back to idle mode by releasing the RRC connection.

### 8.1.4 Session stop

UTRAN may apply the session stop procedure to inform UEs that the end of MTCH transmission concerns the end of a session rather than just an idle period. The purpose of the procedure is to reduce the UE power consumption.

The Figure 16 shows an example of a possible session stop sequence.

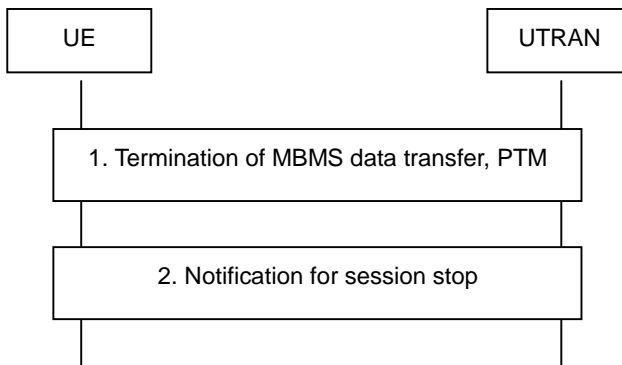

**Figure 16: Session stop**

In case UTRAN provides the service p-t-m, the session stop sequence involves the following steps:

- UTRAN sets the correct MBMS NI and provides the SNI
- Upon DRX wakeup, UEs in idle mode as well as NI detecting connected mode UEs evaluate the MBMS NI and if set, read MCCH at the pre- defined time(s) to acquire the required MCCH information. Upon receiving this information the UE stops receiving the MTCH
- Upon detecting the MBMS SNI, SNI- detecting connected mode UEs read MCCH at the pre- defined time(s) to acquire the required MCCH information. Upon receiving this information the UE stops receiving the MTCH

In case UTRAN provides the service p-t-p, the session stop sequence involves the following steps:

- UTRAN releases the p-t-p radio bearers and updates MCCH (MBMS SERVICE INFO) to inform UEs joining or entering the cell at a later point in time.

## 8.2 MBMS RNC Signalling Flows

### 8.2.1 MBMS Session Start procedure

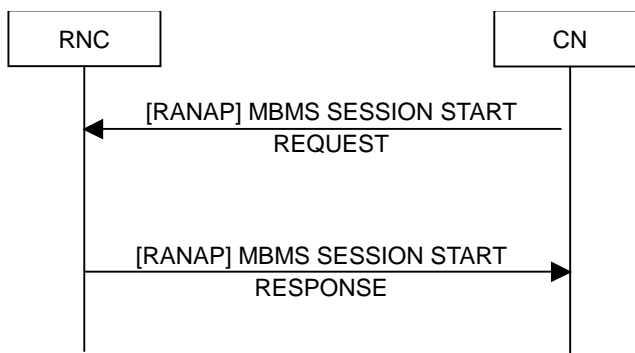

**Figure 17: MBMS Session Start procedure. Successful operation.**

The MBMS Session Start procedure is initiated by the CN when an MBMS Session is started. The MBMS SESSION START REQUEST is typically sent by a CN node to RNCs hosting at least one UE that has joined the MBMS Service (in case of Iu-flex the RNC may receive more than one MBMS SESSION START REQUEST message).

The MBMS SESSION START REQUEST contains the MBMS Service Id, the MBMS Session Attributes (MBMS Service Area Information, QoS parameters...) It may also include a list of RAs which lists each RA that contains at least one PMM-IDLE UE that has activated the service. The MBMS Service Area Information could include MBMS Service Areas where UEs have to be tracked (counted), and/or a MBMS Service Areas where this is not required.

MBMS Session Start procedure also provides the MBMS Iu Data Bearer Establishment functionality. If the RNC cannot provide resources at all the RNC shall inform the CN accordingly. In case of Iu-flex the RNC shall not establish more than one MBMS Iu bearer for a certain service towards a pool area and shall inform the respective CN nodes accordingly.

## 8.2.2 MBMS Session Update procedure

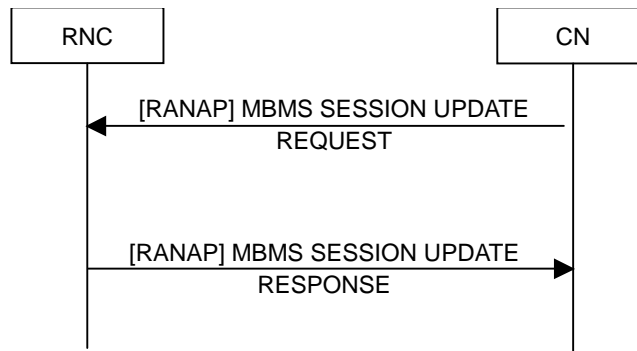

**Figure 18: MBMS Session Update procedure. Successful operation.**

The MBMS Session Update procedure is initiated by the CN when an MBMS Session is ongoing and SGSN notices that there is a need to update the list of RAs. The MBMS SESSION UPDATE REQUEST contains the MBMS Service Id, List of RAs with PMM Idle UEs,...).

## 8.2.3 MBMS Session Stop procedure

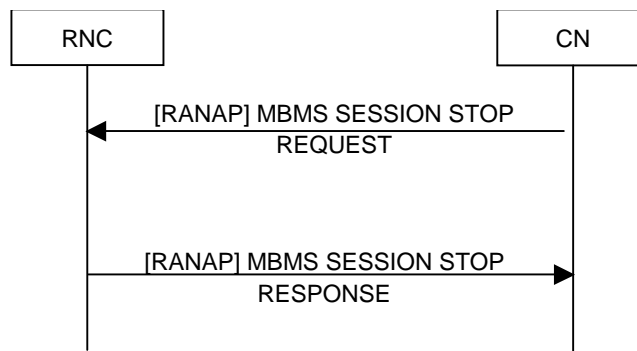

**Figure 19: MBMS Session Stop procedure.**

This signalling flow depicts the MBMS Session Stop procedure.

This procedure is initiated by the CN to the RNCs with an ongoing MBMS session, when no more data will be sent for that MBMS service for some period of time.

The MBMS Session Stop procedure also provides the MBMS Iu Data Bearer Release functionality.



## 8.2.4 RNC Registration procedure

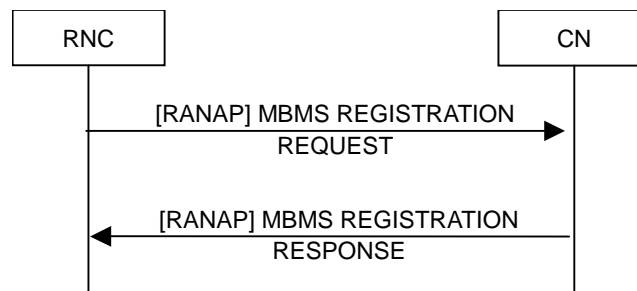

**Figure 20: MBMS Registration procedure.**

This signalling flow depicts the MBMS Registration procedure.

This procedure is initiated by the RNC in the case that the RNC is not SRNC for any UE that has joined the MBMS Service, but this RNC is DRNC for PMM-CONNECTED UEs that have joined the MBMS Service and there is no MBMS Service Context for the MBMS Service in this RNC.

This procedure shall be initiated by the DRNC, as soon as a UE link is received over the Iur and there exists no MBMS Service Context for the MBMS service for which the UE link is received.

## 8.2.5 RNC De-Registration procedure

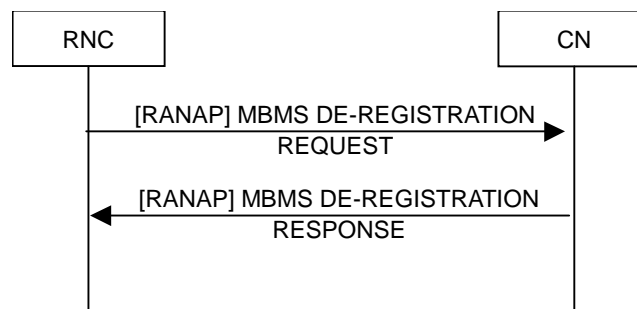

**Figure 21: RNC MBMS De-Registration procedure.**

This signalling flow depicts the RNC De-Registration procedure. This procedure is initiated by the RNC towards the CN node it was registered to in case the RNC is not acting as a Serving RNC for any UE that has activated the MBMS Service and has ceased to act as a Drift RNC for UEs which has activated an MBMS service.

## 8.2.6 CN De-Registration procedure

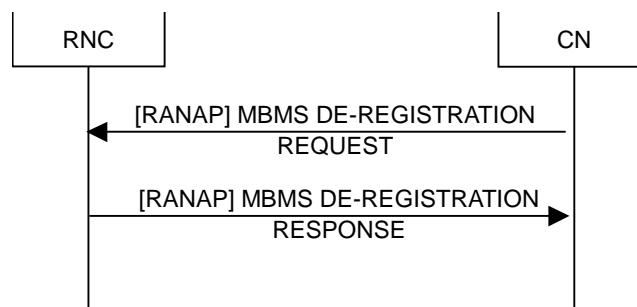
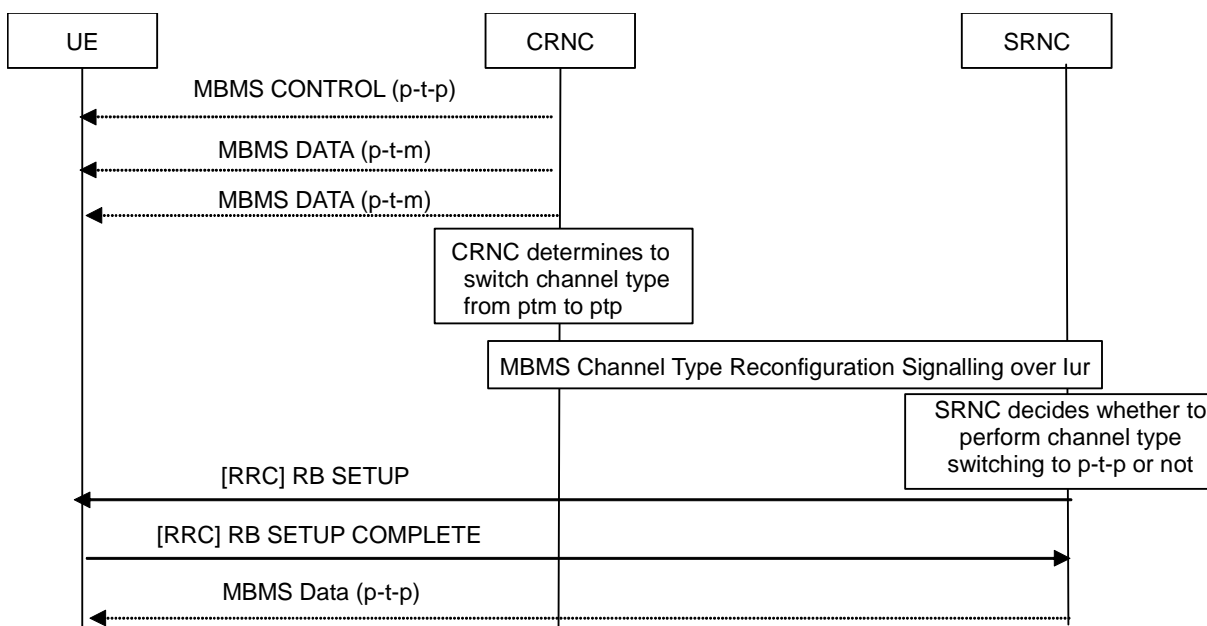

**Figure 22: CN MBMS De-Registration procedure.**

This signalling flow depicts the CN De-Registration procedure.

This procedure is initiated by the CN in order to inform the RNC that a certain MBMS Service is no longer available.

### 8.2.7 MBMS Channel Type Switching over Uu

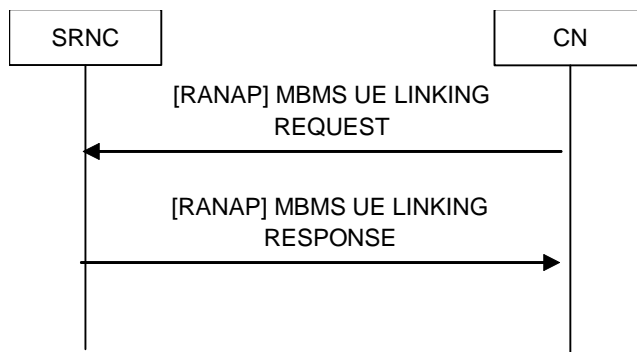

**Figure 23: Channel type switching signalling flow from p-t-m to p-t-p.**

The CRNC is responsible for the decision regarding having p-t-m transmission or no p-t-m transmission in a cell for a specific MBMS service. The CRNC informs all the SRNCs having UEs in that cell about its decision. The SRNC is the RNC controlling the RRC connection and RBs to a specific UE. In the example shown, the CRNC decided to no longer use p-t-m, then the SRNC decided to perform channel type switching to deliver the MBMS service over DTCH mapped on a dedicated channel. The RB SETUP message contains the MBMS Service Id. It is FFS whether the SRNC always follows the CRNC's request or not.

NOTE: the channel type switching in this case includes a change of both transport and logical channels.

### 8.2.8 MBMS UE Linking

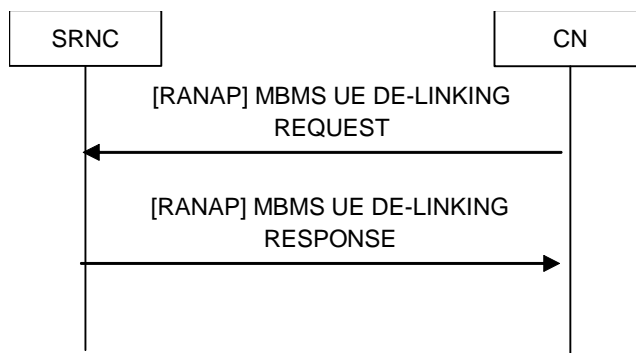

**Figure 24: MBMS UE linking signalling flow**

This signalling flow is only applicable for handling UEs in PMM-CONNECTED mode with activated MBMS Services.

The signalling flow is used to link a specific UE to one or several MBMS service contexts in the SRNC. The MBMS UE LINKING REQUEST message contains the whole list of MBMS Service Ids activated by the UE. If there has not been a MBMS service context related to an MBMS Service Id then SRNC creates a MBMS service context as a result of this procedure.

### 8.2.9 MBMS UE De-Linking

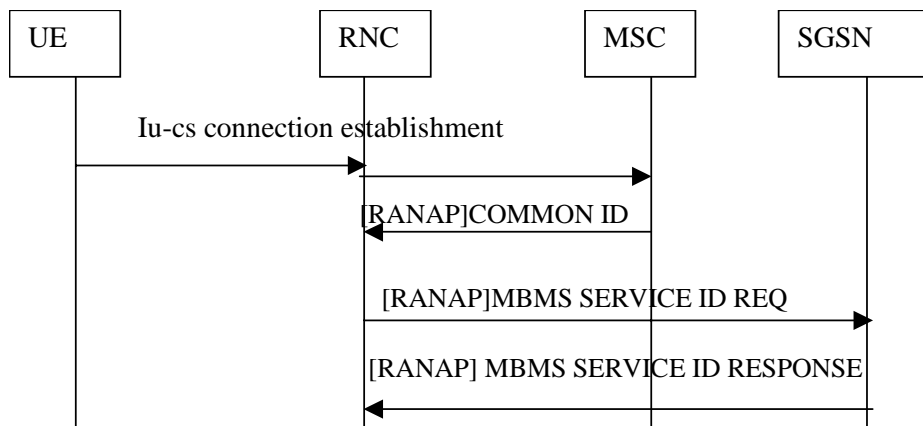

**Figure 25: MBMS UE De-linking signalling flow**

This signalling flow is only applicable for handling UEs in PMM-CONNECTED mode with activated MBMS Services.

The signalling flow is used to remove a specific UE from one or several MBMS service context in the SRNC. The MBMS UE DE-LINKING REQUEST message contains the list of MBMS Service Ids de-activated by the UE.

### 8.2.10 MBMS Service Id Request



**Figure 26: MBMS Service Id list over Iu signalling flow**

This signalling flow is applicable for handling MBMS to UEs in RRC-Connected, PMM-IDLE state. The list of MBMS services the user has joined is sent over Iu.

The purpose of this signalling flow is to perform UE linking for a RRC connected, PMM idle user. The UE provides an indication that the user has joined at least one MBMS service and the PS Domain specific IDNNS (the message that would carry this information is FFS) whenever an Iu-cs connection is established and the UE is PMM idle (that is there is no Iu-ps connection), The RNC requests the MBMS services the UE has joined from the SGSN (or the SGSN the UE is attached to in case of Iu-flex) using a connectionless procedure. The MBMS SERVICE ID REQ contains the IMSI of the UE. The SGSN response contains the full list of MBMS services the user has joined.

The MBMS service list is then stored in the RNC. The list is deleted when the UE moves to RRC idle and the RRC context is removed in the RNC.

## 8.2.11 MBMS Attach/Detach over Iur

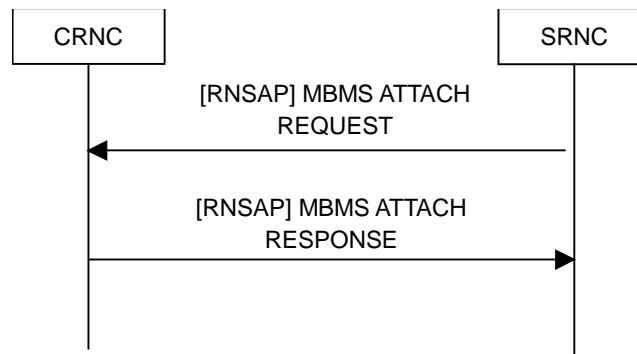
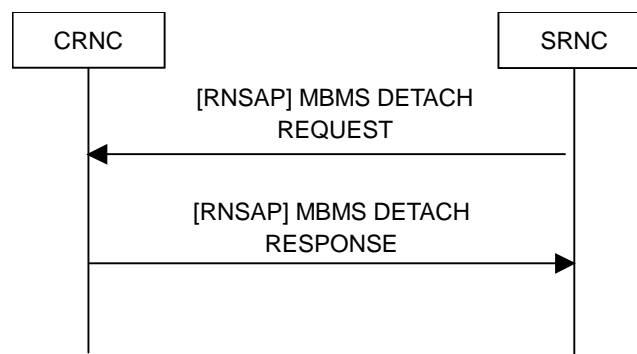

**Figure 27: MBMS attach request signalling flow: Successful Operation.**

This signalling flow is only applicable for handling UEs in RRC connected mode with activated MBMS Services.

The purpose of this signalling flow is

- to either allow the CRNC to add one or several new UEs to the total number of UEs in a given cell using one or several MBMS services. The MBMS ATTACH REQUEST then contains the Cell Id of the new cell (may contain the URA Id of the new URA for UEs in URA\_PCH state), the whole list of affected MBMS Service Ids and a UTRAN specific UE Identification if necessary.
- or to allow the SRNC to inform the DRNC in which URA notifications for MBMS Services have to be sent. The MBMS ATTACH REQUEST then contains a list of URAs and the corresponding MBMS Services.



**Figure 28: MBMS detach request signalling flow: Successful Operation.**

This signalling flow is only applicable for handling UEs in RRC connected mode with activated MBMS Services.

The purpose of this signalling flow is

- to either allow the CRNC to decrease the total number of UEs receiving one or several MBMS service in a given cell. The MBMS DETACH REQUEST contains the Cell Id of the old cell (may contain the URA Id of the old URA for UEs in URA\_PCH state), the whole list of affected MBMS Service Ids and a UTRAN specific UE Identification if necessary.
- or to allow the SRNC to inform the DRNC in which URA there is not anymore a need to send notifications for MBMS Services due to the presence of UEs in URA\_PCH. The MBMS DETACH REQUEST then contains a list of URAs and the corresponding MBMS Services

## 8.2.12 MBMS Channel Type Reconfiguration over Iur

These signalling flows need further study.

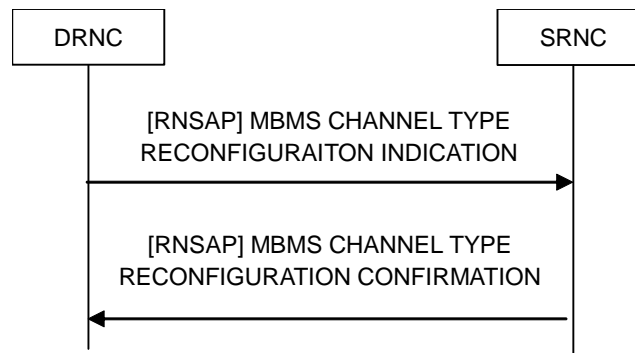

**Figure 29: Channel Type Reconfiguration signalling flow: Successful Operation.**

This signalling flow is only applicable for handling MBMS UEs in RRC connected mode.

The purpose of this signalling flow is that the CRNC informs the selected channel type to the SRNCs used in a cell under the CRNC. The MBMS CHANNEL TYPE RECONFIGURATION INDICATION contains a list of U-RNTI, Channel type and MBMS Service Id corresponding to the UEs connected to the SRNC. It is FFS whether the MBMS CHANNEL TYPE RECONFIGURATION INDICATION is initiated when the indicated MBMS Services are delivered in p-t-m in CRNC in the session start.

## 8.3 MBMS Uu Signalling Flows

### 8.3.1 Broadcast of MBMS System Information

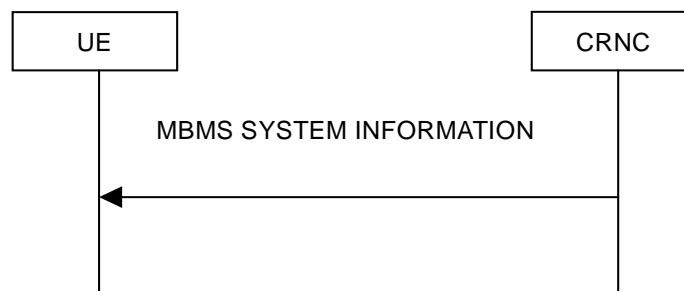

**Figure 30: Broadcast of MBMS system information.**

This signalling flow is applicable for handling MBMS to UEs in PMM IDLE and PMM-CONNECTED mode.

The purpose of the signalling flow is for UTRAN to broadcast MBMS system information to UEs using the BCCH. The MBMS SYSTEM INFORMATION shall be repeatedly transmitted after its first transmission. Upon receiving the first MBMS SYSTEM INFORMATION, the UE shall establish the radio bearer carrying an MCCH.

The MBMS SYSTEM INFORMATION includes:

- MCCH schedule information (access info, repetition and modification periods)
- Configuration of a radio bearer carrying an MCCH

More information may be included in the MBMS SYSTEM INFORMATION.

### 8.3.2 MBMS Service Information



**Figure 31: MBMS service information signalling flow**

This signalling flow is applicable for handling MBMS to UEs in PMM IDLE and PMM-CONNECTED mode.

The purpose of the signalling flow is for RNC to inform UEs of all of MBMS services available in one cell. The MBMS SERVICE INFORMATION shall be transmitted periodically to support mobility in the MBMS service.

The MBMS SERVICE INFORMATION contains MBMS service ids and p-t-m indication. The MBMS service ids indicate the MBMS services which are being served in the cell or the MBMS services which can be served if the UE requests it. P-t-m indication indicates that the MBMS service is on p-t-m in the cell, thus it informs the UE of the need of reception of the MBMS RADIO BEARER INFORMATION. More information may be included in the MBMS SERVICE INFORMATION.

### 8.3.3 MBMS Radio Bearer Information

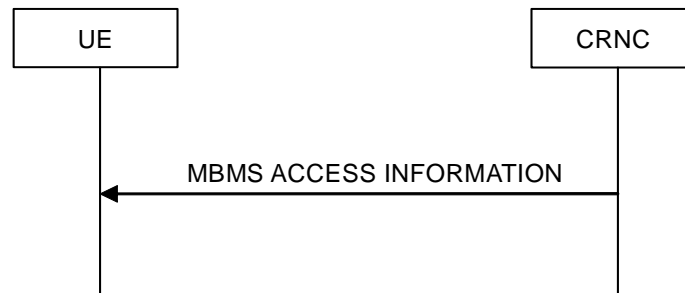

**Figure 32: MBMS radio bearer information signalling flow**

This signalling flow is applicable for handling MBMS to UEs in IDLE and PMM-CONNECTED mode.

The purpose of the signalling flow is for the RNC to inform UE(s) regarding the MTCH radio bearer information. MBMS RADIO BEARER INFORMATION is only available for p-t-m transmission. MBMS RADIO BEARER INFORMATION includes MBMS Service Id, MBMS UTRAN Cell Group Identifier, logical channel, transport channel and physical channel information per MBMS service. An MBMS UTRAN Cell Group Identifier is used to indicate to UEs which MBMS Cell Group the cell pertains to. More information may be included in MBMS RADIO BEARER INFORMATION.

### 8.3.4 MBMS Access Information

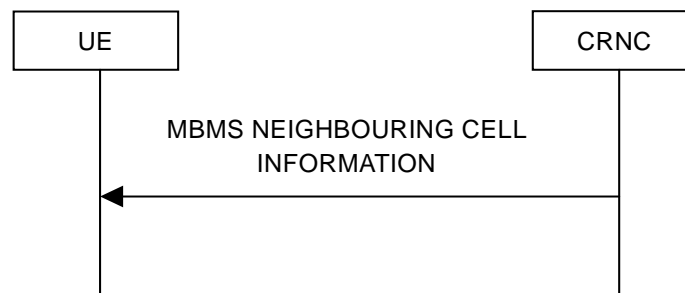

**Figure 33: MBMS Access Information signalling flow**

This signalling flow is applicable for handling MBMS UEs in IDLE mode.

The purpose of the signalling flow is for the RNC to inform UE(s) interested in a particular service of the potential need to establish an RRC connection. The MBMS ACCESS INFORMATION includes MBMS service id for each service for which counting is required and the associated access "probability factor". More information may be included in MBMS ACCESS INFORMATION.

### 8.3.5 MBMS Neighbouring Cell Information



**Figure 34: MBMS Neighbouring Cell Information signalling flow**

This signalling flow is applicable for handling MBMS to UEs in PMM IDLE and CONNECTED mode.

The purpose of the MBMS NEIGHBOURING CELL INFORMATION signalling flow is for the UTRAN to inform to UEs of the MTCH configuration of the neighbouring cells which are available for selective combining. With MBMS NEIGHBOURING CELL INFORMATION the UE is able to receive MTCH transmission from neighbouring cell without reception of the MCCH of that cell. The MBMS NEIGHBOURING CELL INFORMATION shall be repeatedly transmitted on MCCH when selective combining is utilized in the MBMS p-t-m transmission in the given cell group.

The usage of MBMS NEIGHBOURING CELL INFORMATION in normal cell reselection case is FFS.

### 8.3.6 MBMS Joined Indication

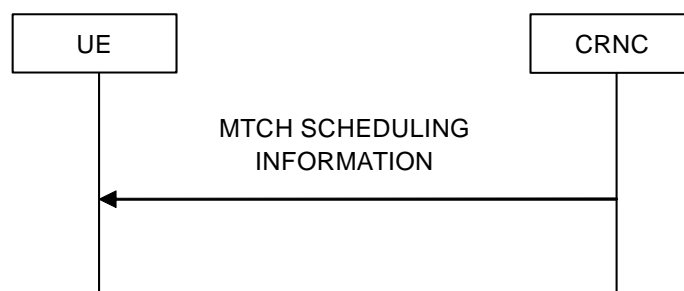

**Figure 35: MBMS joined indication signalling flow**

This signalling flow is applicable for handling MBMS to UEs in RRC-Connected, PMM-IDLE state. The MBMS JOINED INDICATION is sent over the DCCH.

The signalling flow is initiated by the UE after entering RRC-Connected, PMM-IDLE state. The purpose of the signalling flow is to enable the UE to inform the SRNC that the user has joined at least one MBMS service. The SRNC requests the MBMS services the UE has joined from the SGSN as defined in 8.2.10.

### 8.3.7 MTCH Scheduling Information



**Figure 36: MTCH scheduling information.**

This signalling flow is applicable for handling MBMS to UEs in PMM IDLE and CONNECTED mode.

1. The purpose of the signalling flow is to enable UEs to perform discontinuous reception of MTCH. The UE may discontinuously receive MTCH based on scheduling information indicated by the MTCH SCHEDULING INFORMATION. This signalling is transmitted on SCCPCH carrying MTCH. The MTCH SCHEDULING INFORMATION is signalled at predetermined intervals. The scheduling information allows to cover different periods for different MBMS services.

The MTCH SCHEDULING INFORMATION includes:

- The beginning and duration for possible MBMS service transmissions on this SCCPCH.

---

## 9 Security for MBMS

Ciphering for MBMS multicast data is done between the BM-SC and the UE as defined in [7]. Therefore, for MBMS p-t-m data transmissions no radio interface ciphering is applied.

In case of p-t-p MBMS data transmissions, if the security is activated for the UE the ciphering is also applied for p-t-p MBMS data RB as for any other RB of the UE.

---

## 10 Mobility Procedures for MBMS

One of the requirements in [5] is: "Data loss during cell change should be minimal". Therefore, when the UE receiving an MBMS session in idle mode or connected mode (not including CELL\_DCH) re-selects between cells, it should be possible to provide service continuity to this UE.

The following mechanism has been identified to minimise the data loss on cell change. Additional mechanisms allowing to send the MBMS bearer type notification when new mobiles arrive or leave a cell are [FFS].

### 10.1 Use of Periodical MBMS Channel Type Notification

In this mechanism, the cell periodically transmits an MBMS Channel Type Notification from the UTRAN, informing all MBMS subscribers if it is currently configured for p-t-m transmission or p-t-p transmission. If it is configured for p-t-m transmission, the channel may also contain the Radio Bearer parameters corresponding to the TMGI of each service. Thus no UE signalling would be required towards the UTRAN.



[However, if it is necessary for the UE to instead initiate reception of the RB parameters, such a mechanism similar to the Cell Update procedure may be more suitable.]

If the cell is configured for p-t-p transmission, then the UE would perform a normal RRC connection establishment.

Additionally, the UE in a cell receiving MBMS p-t-m, could be periodically checking the MBMS Channel Type Notification in neighbour MBMS cells to acquire information about whether p-t-m or p-t-p transmission is required if it accesses that cell.

## 10.2 UE Actions for Mobility

The UE mobility between intra frequency cells is not affected by the MBMS reception. The mobility between different frequency layers is affected by the Frequency Layer Convergence process as defined in 11.2, if used by the network.

In CELL\_FACH and in CELL\_DCH state the RRC operation has priority over MBMS reception, thus UE performs the inter frequency and inter RAT measurements as configured by the SRNC. UTRAN should utilize different periodicities between MCCH transmissions and CELL\_FACH state measurement occasion, such that CELL\_FACH state measurements and MCCH transmissions are not constantly overlapping for some UE.

In Idle mode and in CELL\_PCH, URA\_PCH states the measurements are performed as configured by the network based on the Release 5. The MBMS specific measurement occasions to S-CCPCH for UEs in idle mode and in CELL\_PCH, URA\_PCH states are not introduced and measurements have priority over MBMS reception. The usage of channel protection (channel coding) to recover some of the lost transport blocks is to be checked with RAN1.

UEs may have DRx occasions for specific MBMS service when UE can stop decoding S-CCPCH and perform measurements. DRx occasion are based on scheduling information. UE may also have possibility to skip the complete MCCH transmission based on e.g. "value tag".

R99 standards have some means to reduce need for number of measurements, which can be utilized for MBMS.

When the UE reselects the cell due to the mobility, the UE should check if the interested MBMS service is available in the new cell for the reception of the service. The service is available when the session has been already started and the service is being served on p-t-p/p-t-m in the cell, or the service can be served in the cell if the UE requests it.

If the MBMS service is available in the cell, the UE will perform an action for the service reception in the cell. For example, if the service is on p-t-p, the idle mode UE will initiate RRC connection establishment procedure. Otherwise, the UE does not need to perform such an action in the cell. The UE, which moves to the new cell, will operate according to the RRC state/mode as follows.

Whenever the UE moves between p-t-m cells, UE shall receive an MBMS UCG-Id, which is included in the MBMS RADIO BEARER INFORMATION. If the MBMS UCG-Id received in a new cell is the same as the MBMS UCG-Id received in an old cell, then the UE receives MTCH without re-establishment of its PDCP as the new cell is processed by the same PDCP entity as the old cell. If the MBMS UCG-Ids differs between old on new cell, the UE re-establishes its PDCP entity according to the RADIO BEARER INFORMATION. In case that RLC entity is shared in CRNC between old and new cell, the UE receives MTCH without re-establishment of its RLC. If old and new cell does not share RLC entity in CRNC the UE shall re-establish its RLC. UE shall re-establish MAC and physical layer protocol entities upon cell change.

### 10.2.1 RRC idle mode

Idle mode UE shall:

- if BCCH contains information regarding the MCCH in the new cell:
  - listen to the MCCH and receive the MBMS SERVICE INFORMATION;
- if the MBMS SERVICE INFORMATION contains the interested MBMS service-id:
  - if MBMS SERVICE INFORMATION indicates that the service is on p-t-m:
    - receive the MBMS RADIO BEARER INFORMATION and listen to the MTCH;
  - else:

- initiate RRC connection establishment procedure;
- if the UE receive the MBMS RADIO BEARER INFORMATION before the MBMS SERVICE INFORMATION and;
- if MBMS RADIO BEARER INFORMATION contains the interested MBMS service id:
  - listen to the MTCH without the need of receiving the MBMS SERVICE INFORMATION.

## 10.2.2 URA\_PCH State

URA\_PCH state UE shall:

- perform URA update procedure if needed;
- if BCCH contains information regarding the MCCH in the new cell:
  - listen to the MCCH and receive the MBMS SERVICE INFORMATION;
- if MBMS SERVICE INFORMATION contains the interested MBMS service id:
  - if MBMS SERVICE INFORMATION indicates that the service is on p-t-m:
    - receive the MBMS RADIO BEARER INFORMATION and listen to the MTCH;
  - else:
    - initiate cell update procedure
- if the UE receive the MBMS RADIO BEARER INFORMATION before MBMS SERVICE INFORMATION message and;
- if MBMS RADIO BEARER INFORMATION contains the interested MBMS service id:
  - listen to the MTCH without the need of receiving the MBMS SERVICE INFORMATION.

## 10.2.3 CELL\_PCH

CELL\_PCH state UE shall:

- perform cell update procedure;
- if cell update confirm message contains MBMS radio bearer information:
  - listen to the MBMS radio bearer;
- else:
  - if BCCH contains information regarding the MCCH in the new cell:
    - listen to the MCCH and receive the MBMS SERVICE INFORMATION;
  - if MBMS SERVICE INFORMATION contains the interested MBMS service id and;
    - if MBMS SERVICE INFORMATION indicates that the service is on p-t-m:
      - receive the MBMS RADIO BEARER INFORMATION message and listen to the MTCH
  - if the UE receive the MBMS RADIO BEARER INFORMATION before the MBMS SERVICE INFORMATION and;
  - if MBMS RADIO BEARER INFORMATION contains the interested MBMS service id:
    - listen to the MTCH without the need of receiving the MBMS SERVICE INFORMATION.

## 10.2.4 CELL\_FACH

CELL\_FACH state UE shall, depending on UE capability:

- perform cell update procedure
- if cell update confirm message contains MBMS radio bearer information:
  - listen to the MBMS radio bearer;
- else:
  - if BCCH contains information regarding the MCCH in the new cell:
    - listen to the MCCH and receive the MBMS SERVICE INFORMATION;
    - if MBMS SERVICE INFORMATION contains the interested MBMS service id and;
      - if MBMS SERVICE INFORMATION indicates that the service is on p-t-m:
        - receive the MBMS RADIO BEARER INFORMATION and listen to the MTCH;
    - if the UE receive the MBMS RADIO BEARER INFORMATION before the MBMS SERVICE INFORMATION and;
    - if MBMS RADIO BEARER INFORMATION contains the interested MBMS service id:
      - listen to the MTCH without the need of receiving the MBMS SERVICE INFORMATION.

## 10.2.5 CELL\_DCH State

CELL\_DCH state UE shall:

- act on the RRC message received on DCCH in handover.

---

# 11 Resource Management for MBMS

## 11.1 MBMS Access Control Procedure

MCCH messages initiating counting or recounting cause multiple responses from UEs within a cell. This may result in RACH congestion if number of UEs is high in a cell. To avoid this, CRNC may perform MBMS access control procedure during counting or recounting procedure. MBMS access control procedure is described in Figure 37.

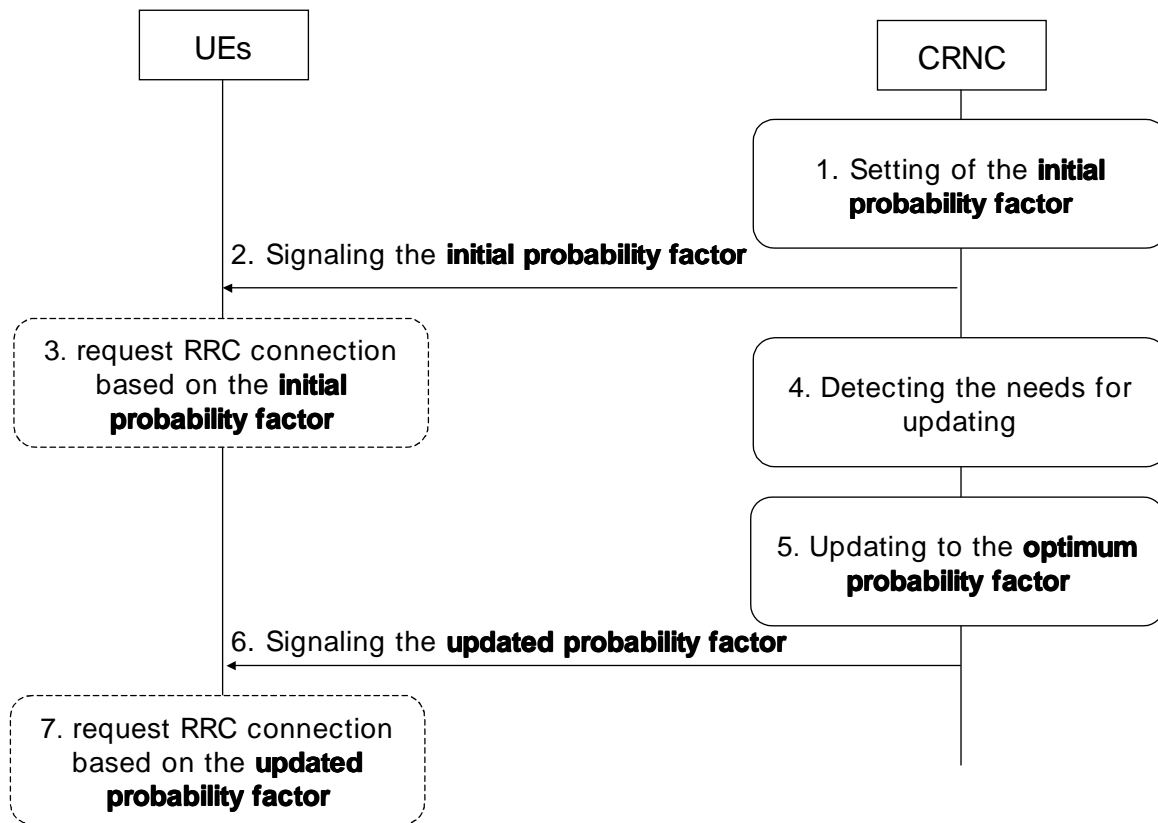

**Figure 37: MBMS Access Control Procedure**

1. CRNC calculates an initial probability factor for a MBMS service when a MCCH message causing counting or recounting is about to be sent.
2. CRNC includes the probability factor into the MCCH message and sends it to UEs. This can be done in MBMS Group Notification.
3. UEs perform RRC connection request procedure using the probability factor received in step 2. UEs keep listening to MCCH to get updated probability factor until they succeed to establish RRC connection.
4. CRNC detects the probability factor needs to be updated. Detecting mechanism is not to be standardized.
5. CRNC recalculates the probability factor. The way of calculating new probability factor is not to be standardized.
6. CRNC includes the updated probability factor into the MCCH message and sends it to UEs.
7. UEs perform RRC connection request procedure using the new probability factor. UEs keep listening to MCCH to get updated probability factor until they succeed to establish RRC connection.

CRNC and UEs who are still trying to perform the RRC connection request procedure repeat step 3 ~ step 7 until e.g. counting or recounting procedure ends.

## 11.2 Frequency layer Convergence

Frequency Layer Convergence denotes the process where the UTRAN requests UEs to preferentially re-select to the frequency layer on which the MBMS service is intended to be transmitted. This layer preference could be done by an

additional MBMS session related Layer Convergence Information (LCI) such as offset and target frequency. These kinds of information could be given to UEs at session start and during the whole session, and will be applied during the entire session. More than one offset may be required to support multiple frequencies, but it is assumed that the same LCI information will apply to all the services on the same frequencies.

The details of the mechanism are defined in state 3.

# Annex A (informative): MBMS Phases in UTRAN

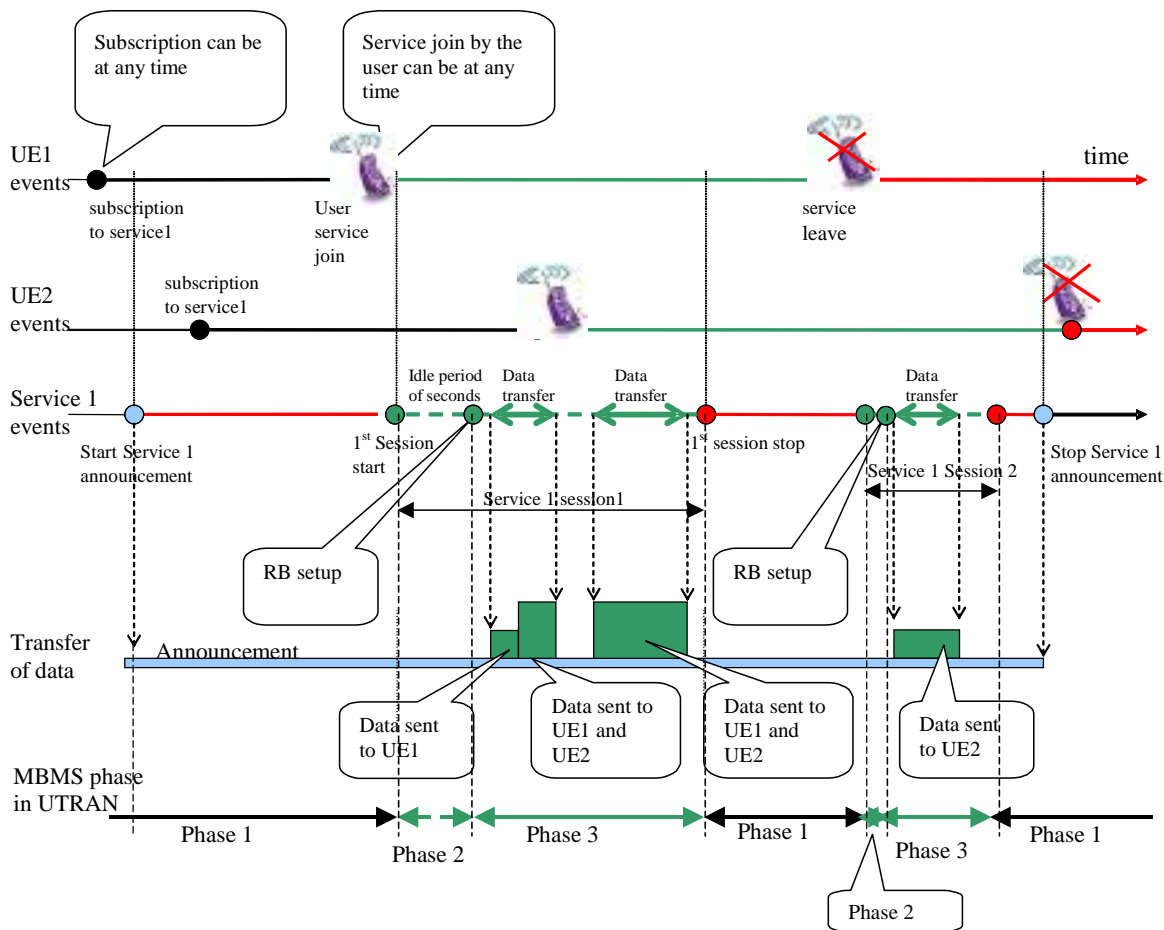

**Figure 38: Timeline of MBMS Service**

The UTRAN MBMS behavior is divided into 3 phases. Figure 14 illustrates the timeline of an MBMS service with regards to these phases.

## A1 Security for MBMS

A cell stays in phase 1, if there is no ongoing session for the MBMS service, or if it does not belong to the MBMS service area of the service.

A UE that has joined an MBMS service may regularly try to receive MBMS notification in a cell [FFS]. At this phase the UE does not request service delivery to UTRAN.

## A2 MBMS Phase 2

This phase starts when UTRAN receives the MBMS "session start" from CN, and ends when UTRAN initially sets up MBMS radio bearer for the session, or decides not to set up the MBMS radio bearer in a cell.

In this phase, UTRAN transmits notification to UEs about the incoming service and could perform counting procedure to decide the type of MBMS radio bearer. UTRAN decides whether to set up p-t-m, p-t-p radio bearer or no radio bearer, based on the number of UEs that expected to receive the service in the cell. A UE that has joined a MBMS service acts on a RRC message in MCCH.

---

## A3 MBMS Phase 3

This phase starts after initial MBMS radio bearer setup and ends when UTRAN receives the MBMS "session stop" from CN.

In this phase, UTRAN transmits the data for the MBMS service received from CN using, if any, the established radio bearer. If there is no set-up radio bearer, UTRAN waits for service delivery request from UE. Recounting and radio bearer reconfiguration may be performed during this phase.

UTRAN behavior in this phase can be divided into three states: no transmission, p-t-p transmission, and p-t-m transmission. Each cell belonging to the same MBMS service area may be in any of three states. With the variation of the number of UEs, the state of a cell may change between the three states. UTRAN may broadcast the state of each cell.

- 1) **No Transmission:** In this state of a cell, there is no established radio bearer because there is no UE who wants to receive the service. An MBMS-joined UE in idle mode that moves into the cell of this state requests service delivery to UTRAN.
- 2) **P-t-p Transmission:** In this state of a cell, p-t-p radio bearer is established. A UE that has joined a MBMS service may receive MBMS data over p-t-p radio bearer if there is MBMS data to receive.
- 3) **P-t-m Transmission:** In this state of a cell, p-t-m radio bearer is established. A UE that has joined a MBMS service may receive MBMS data over p-t-m radio bearer if there is MBMS data to receive.

---

## A4 MBMS Phases and Status Parameters

Table 1 lists the MBMS parameters that need to be broadcast in each MBMS phase. The list is [FFS]

**Table 1: MBMS Status Parameters**

|                    | Phase 1 | Phase 2    | Phase 3              | Description                             |
|--------------------|---------|------------|----------------------|---|
| Service ID         | X       | O          | O                    | Identity of the Service                 |
| Transmission State | X       | X          | O (NONE/p-t-p/p-t-m) | State of the cell for MBMS transmission |
| Counting           | X       | O (On/Off) | O (On/Off)           | Whether counting procedure is going on. |

- 1) **Service ID:** This parameter indicates the identity of the service concerned.
- 2) **Transmission state:** This parameter indicates to UE(s) the state of the concerned cell while it is in phase 3. According to this parameter, UE entering the cell starts re-configuration of the radio bearer, or requests service delivery to UTRAN. Specifically, if this parameter is set to "p-t-m", UE receives service over p-t-m radio bearer and if set to "p-t-p", UE receives service over p-t-p radio bearer. If it is set to NONE, UE has to request UTRAN to deliver the service.
- 3) **Counting:** The counting parameter informs UEs whether counting is required (and is going on) or not. If this parameter is set to "ON", UE should perform RRC connection procedure.

## Annex B (informative): MBMS Control Information

Table 2 and 3 identifies MBMS control information and describes their mapping on BCCH, MCCH and DCCH.

**Table 2: Mapping of MBMS Control Parameters in DL**

| Information Element                                    | Description  | DCCH | BCCH | MCCH |
|--|--|------|------|------|
| <b>MBMS Signalling Radio Bearer Information (MCCH)</b> |  |      |      |      |
| MBMS SRB Info<br>- MCCH Indicator                      | Information to configure the MBMS signalling radio bearer mapped on S-CCPCH/FACH, this information includes the identification of a FACH transport channel carrying the MCCH.          |      | X    |      |
| <b>MBMS Radio Bearer Information (MTCH)</b>            |  |      |      |      |
| MBMS RB Info   | Information to configure a p-t-m radio bearer mapped on S-CCPCH/FACH for transmission of an MBMS service.  |      |      | X    |
| <b>Service related Control Information</b>             |  |      |      |      |
| MBMS Service ID(s)                                     | Identifies all MBMS services that are potentially available in one cell (service area indication).<br><br>Identifies also the MBMS service related to a specific signalling procedure. |      |      | X    |
| p-t-m Indicator  | Indicates that a p-t-m bearer type is established in one cell in order to transmit data for a particular MBMS service and the UE is required read the MBMS RB Info on MCCH.            |      |      | X    |
| RRC Connection Establishment Indicator                 | Indicates to idle mode UEs that transition to RRC connected mode is required for counting.   |      |      | X    |
| Required MBMS RB configuration                         | Indicates to the UE that an MBMS service is transmitted using a certain RB configuration in order to achieve a specific QoS.   |      |      | X    |
| RACH Access Probability Factor                         | Controls RACH access in order to avoid RACH overload if transition to RRC connected mode is required.  |      |      | X    |
|  |  |      |      |      |



**Table 3: Mapping of MBMS Control Parameters in UL**

| <b>Information Element</b>                 | <b>Description</b>  | <b><i>DCCH</i></b> |
|--|---|--------------------|
| <b>Service related Control Information</b> |   |                    |
| MBMS Joined flag                           | Indicates that a PMM IDLE state UE in RRC connected mode has joined at least one MBMS service | X                  |

## Annex C (informative): Change history

| Change history |                         |                                     |    |     |   |       |       |
|----------------|-------------------------|-------------------------------------|----|-----|---|-------|-------|
| Date           | TSG #                   | TSG Doc.                            | CR | Rev | Subject/Comment   | Old   | New   |
| 8/02           | RAN2#31                 | R2-021846                           |    |     |   |       | 0.0.1 |
| 9/02           | RAN2#32                 | R2-020590                           |    |     | Skeleton Endorsed with some changes in sections from RAN2#31  | 0.0.1 | 1.0.0 |
| 11/02          | RAN2#33                 | R2-022927                           |    |     | No MBMS Discussions   |       |       |
| 1/03           | RAN2/3<br>MBMS<br>AdHoc | R2-030006                           |    |     | R2-022644 and R2-022699   | 1.0.0 | 1.1.0 |
| 2/03           | RAN2#34                 | R2-030122                           |    |     | Inclusion of R2-030010, R2-030050, figure from R2-030015, mechanism 1 from R2-030062, + editorial changes + principles in section 5.1.3   | 1.1.0 | 1.4.0 |
| 4/03           | RAN2#35                 | R2-030707                           |    |     | Inclusion of R2-030010 + section 5.1.4 based on agreed bullet points from RAN2#34 + correction of version numbering + addition of "change history" section.   | 1.4.0 | 1.5.0 |
| 5/03           | RAN2/3A<br>dHoc         | R2-030882                           |    |     | -R2-030907 "Functional Description on MAC-c/sh/m".<br>-R2-030902 on the "MBMS Control Plane Protocol Stack".<br>-R2-030910 on MBMS UTRAN Phases in Annex A.<br>-R3-030584: only inclusion of sections: 7.1.3 and 7.1.4. In 7.1.3 there is one additional comment regarding the addition of "PMM" wherever CONNECTED mode" is mentioned.<br>-R3-030614: Addition of chapter 5.1.x<br>-R3-030615: changes in section 5.1.2.<br>-R3-030615: proposed section 5.1 was reworded.   | 1.5.0 | 1.6.0 |
| 5/03           | RAN2#36                 |                                     |    |     | - Inclusion of contribution R2-03930, sections: 7.2.1.1 and 7.2.1.2 from decisions from RAN2/3 MBMS adhoc.<br>- Use of term "MBMS service context" instead of "MBMS context" throughout the document.<br>- Correction of spelling mistake in figure 1: "Protocol Stack for MCTCH" should be: "Protocol Stack for MTCH".<br>- Revision of Appendix A "MBMS Phase 1": Part of the second paragraph has been deleted due to concerns from RAN3.<br>- During the RAN2 MBMS AdHoc it was decided that MCCH and MTCH are to be mapped on FACH. This decision is captured at the bottom of 5.3.1 by adding the sentence "Both logical channels are mapped on FACH". FACH is also mentioned in several places in 5.3.2 (MAC Architecture) as an example (e.g. FACH). The "e.g." has now been deleted. | 1.6.0 | 1.6.1 |
| 06/03          | TSG RAN<br>#20          |                                     |    |     | The version 2.0.0 identical to version 1.6.1 was presented in TSG RAN plenary meeting for information and approval. The TS was not approved so drafting work will continue in WG2/3 based on version 2.0.0.<br>The changes in version 2.1.0 compared to 2.0.0 are in Section 5.1.4 Counting where point 8 " <i>The possibility for the RNC to receive the service Id in RRC connection request is [FFS]...</i> " is removed. This reflects to the decision made in RAN2/3AdHoc 05/03 but was missing from earlier versions, and pointed out by RAN WG2 chairman in reflector and in TSG RAN #20.  | 2.0.0 | 2.1.0 |
| 09/03          | RAN2#37<br>RAN3#37      | R2-031713<br>R3-031174<br>R3-031223 |    |     | Editorial corrections based on R2-031713 included.<br>New chapter "7. MBMS reception UE Capability" created and agreed UE capability text inserted to the new chapter "7.1. UE Capability".<br>Modifications based on R3-031174 to the definitions Sections 5.1.1, 5.1.5 and 5.1.6 enhanced and sections 5.1.7, 5.1.8 and 5.1.9 created, and signalling flows updated in section 7.1. based on R3-031223<br><br>Following Editorial enhancements proposed by editor: Chapter 5.3.1.1 and 5.3.1.2 moved to under chapter 6.1. Logical channels   | 2.1.0 | 2.2.0 |

| Change history |         |  |    |     |  |       |       |
|----------------|---------|--|----|-----|--|-------|-------|
| Date           | TSG #   | TSG Doc.   | CR | Rev | Subject/Comment  | Old   | New   |
|                |         |  |    |     | and chapter "5.4 MBMS Reception in RRC States/Modes" moved under chapter 7. in new chapter "7.2 MBMS reception "   |       |       |
| 10/03          | RAN2#38 | R2-032116<br>R2-032074<br>R2-032121<br><br>R2-032277<br><br>R2-032087<br>R2-032275<br>R2-032081<br>R2-032281 |    |     | Chapter 5.2.1 MBMS User Plane Protocol Stack Architecture enhanced accordingly.<br>Chapter 9 Security for MBMS enhanced accordingly<br>Chapter 8.2.2 MBMS service availability enhanced, (message changed to information). Chapter 9.2. UE Actions for Mobility created and 9.2.4 text depending UE capability inserted<br>Chapters 8.2.4. MBMS Joined Services Indication and 8.2.5 MBMS PMM-Connected State Required Indication created<br>Chapters 6.1. re-formatted, Section 6.2.1-6.2.5 created<br>The MBMS access control procedure inserted in chapter 11.1<br>Broadcast of MBMS System Information signalling flow added.<br>Tables inserted to an informative annex to identify MBMS control information and describe their mapping on transport channels | 2.2.0 | 2.3.0 |
|                | RAN3#38 | R3-031421  |    |     | MBMS Time line and MBMS Service announcement definitions included in Section 3.1 Chapter 5.1.1 One Context per MBMS Service in CRNC and 5.1.8 RNC deregistration updated accordingly<br>Editorial harmonization of terms: MCCH and MTCH used constantly. (NCCH and CTCH removed)<br>In Uu signalling messages CRNC introduced to keep messages send/received in SRNC and CRNC inline.  |       |       |
| 11/03          | RAN2#39 | R2-032350<br>R2-032398<br>R2-032667<br><br>R2-032666<br><br>R2-032497  |    |     | The Signalling flow MBMS service availability changed to MBMS service information in 8.2.2. Appropriate changes done in 10.2.<br>In the Chapter 7.1. included that MBMS UE must capability to receive two SCCPCH<br>MBMS notification principles chapter created as 5.1.5 and PICH bits used for MBMS notification defined in 6.2.3 physical channels chapters.<br>The number of different protocol entities clarified in chapter 5.2.1.<br>The shared PDCP entity principle created in 5.1.4. Protocol layer-establishments due to mobility defined in 10.2.<br>UEs measurements are clarified based in working assumption in Section 10.2.<br>Editorial enhancements to chapter names in chapters 5.1.1, 5.1.2 and 5.1.3   | 2.3.0 | 2.4.0 |
| 01/04          | RAN2#40 | R2-04086<br><br>Meeting report<br><br>R2-040027<br>R2-040070   |    |     | A chapter 11.2 Frequency layer Convergence introduced based on revised text from R2-04086<br>Text inserted based on conclusion on selective combining, multiplexing and measurement occasions<br>Editorial clarifications. Constant usage of MBMS Service Area as defined in [4]<br>Session stop included<br>High level signalling scenarios inserted  | 2.4.0 | 2.5.0 |
|                | RAN3#40 | R3-040061<br>R3-040075<br>R3-040076  |    |     | Modification to chapter 5.1.8<br>Modification to RNC registration procedure<br>Additional modifications to 5.1.8   |       |       |

| Change history |         |   |     |     |   |       |       |
|----------------|---------|---|-----|-----|---|-------|-------|
| Date           | TSG #   | TSG Doc.  | CR  | Rev | Subject/Comment   | Old   | New   |
| 02/04          | RAN2#41 | Meeting minutes<br>R2-040572<br><br>R2-040690<br>R2-040711  |     |     | Selective combining, simulcast for TDD, Neighbouring cell info, included<br>MCCH scheduling, MBMS notification and counting enhanced.<br>MBMS access<br>MTCH Scheduling information signalling flow included<br>MBMS high level signalling scenarios updated<br>Editorial clean up, separation of UTRAN architecture principles and MBMS Uu principles chapter created  | 2.5.0 | 2.6.0 |
|                | RAN3#41 | R3-040577<br>R3-040576<br><br>R3-040314<br>R3-040393<br><br>R3-040575<br>R3-040458<br>R3-040516<br><br>R3-040545<br>Meeting minutes |     |     | Functionality to filtering of MBMS notifications and Session update signalling flow included<br>MBMS Service Id Request to handle UEs in RRC connected PMM idle state. The Signalling flow MBMS Joined Indication modified and MBMS PMM connected stated required removed.<br>FFS removed from RNC De-Registration and CN De-Registration<br>Clarifications to MBMS lu bearer and MBMS Session Start and Session Stop and CN De-Registration<br>UE linking over lur modified according agreements<br><br>Clarification to creation of MBMS Service context after receiving the first UE linking<br>Editorial clean up to RAN3 specific sections.<br>The lub bearer mechanisms defined.<br><br>Editorial enhancements based on comments after email review on RAN1/2/3 reflectors. |       |       |
| 03/2004        | RAN#23  | RP-040079   |     |     | Upgrade towards Change Control (Release 6) and ETSI MCC clean-up.   | 2.6.0 | 6.0.0 |
| 06/2004        | RP-24   | RP-040216   | 001 |     | Updates based on the MBMS ad-hoc, Budapest, 20-22 April 2004  | 6.0.0 | 6.1.0 |
|                | RP-24   | RP-040216   | 002 |     | Updates to TS25.346 from the RAN3#42 meeting in Montreal, Canada, 10-14 May 2004  | 6.0.0 | 6.1.0 |

---

# History

| <b>Document history</b> |            |             |
|-------------------------|------------|-------------|
| V6.0.0                  | March 2004 | Publication |
| V6.1.0                  | June 2004  | Publication |
|                         |            |             |
|                         |            |             |
|                         |            |             |