

# ETSI TS 125 346 V6.9.1 (2006-09)

---

*Technical Specification*

**Universal Mobile Telecommunications System (UMTS);  
Introduction of the Multimedia Broadcast/Multicast  
Service (MBMS) in the Radio Access Network (RAN);  
Stage 2  
(3GPP TS 25.346 version 6.9.1 Release 6)**

---



---

**Reference**

RTS/TSGR-0225346v691

---

**Keywords**

UMTS

**ETSI**

---

650 Route des Lucioles  
F-06921 Sophia Antipolis Cedex - FRANCE

Tel.: +33 4 92 94 42 00 Fax: +33 4 93 65 47 16

Siret N° 348 623 562 00017 - NAF 742 C  
Association à but non lucratif enregistrée à la  
Sous-Préfecture de Grasse (06) N° 7803/88

---

**Important notice**

Individual copies of the present document can be downloaded from:

<http://www.etsi.org>

The present document may be made available in more than one electronic version or in print. In any case of existing or perceived difference in contents between such versions, the reference version is the Portable Document Format (PDF). In case of dispute, the reference shall be the printing on ETSI printers of the PDF version kept on a specific network drive within ETSI Secretariat.

Users of the present document should be aware that the document may be subject to revision or change of status. Information on the current status of this and other ETSI documents is available at

<http://portal.etsi.org/tb/status/status.asp>

If you find errors in the present document, please send your comment to one of the following services:

[http://portal.etsi.org/chaicor/ETSI\\_support.asp](http://portal.etsi.org/chaicor/ETSI_support.asp)

---

**Copyright Notification**

No part may be reproduced except as authorized by written permission.  
The copyright and the foregoing restriction extend to reproduction in all media.

© European Telecommunications Standards Institute 2006.  
All rights reserved.

**DECT**<sup>TM</sup>, **PLUGTESTS**<sup>TM</sup> and **UMTS**<sup>TM</sup> are Trade Marks of ETSI registered for the benefit of its Members.  
**TIPHON**<sup>TM</sup> and the **TIPHON logo** are Trade Marks currently being registered by ETSI for the benefit of its Members.  
**3GPP**<sup>TM</sup> is a Trade Mark of ETSI registered for the benefit of its Members and of the 3GPP Organizational Partners.

---

## Intellectual Property Rights

IPRs essential or potentially essential to the present document may have been declared to ETSI. The information pertaining to these essential IPRs, if any, is publicly available for **ETSI members and non-members**, and can be found in ETSI SR 000 314: "*Intellectual Property Rights (IPRs); Essential, or potentially Essential, IPRs notified to ETSI in respect of ETSI standards*", which is available from the ETSI Secretariat. Latest updates are available on the ETSI Web server (<http://webapp.etsi.org/IPR/home.asp>).

Pursuant to the ETSI IPR Policy, no investigation, including IPR searches, has been carried out by ETSI. No guarantee can be given as to the existence of other IPRs not referenced in ETSI SR 000 314 (or the updates on the ETSI Web server) which are, or may be, or may become, essential to the present document.

---

## Foreword

This Technical Specification (TS) has been produced by ETSI 3rd Generation Partnership Project (3GPP).

The present document may refer to technical specifications or reports using their 3GPP identities, UMTS identities or GSM identities. These should be interpreted as being references to the corresponding ETSI deliverables.

The cross reference between GSM, UMTS, 3GPP and ETSI identities can be found under <http://webapp.etsi.org/key/queryform.asp>.

# Contents

Intellectual Property Rights .....	2
Foreword.....	2
Foreword.....	6
1 Scope .....	7
2 References .....	7
3 Definitions, symbols and abbreviations .....	7
3.1 Definitions .....	7
3.2 Symbols.....	9
3.3 Abbreviations .....	9
4 Background and introduction .....	9
5 MBMS UTRAN and protocol architecture .....	9
5.1 MBMS UTRAN architecture principles.....	9
5.1.1 MBMS Service Context in CRNC.....	9
5.1.2 MBMS Session start and MBMS Session Stop .....	10
5.1.3 MBMS Iu bearer .....	11
5.1.4 MBMS Iub bearer.....	11
5.1.5 Mapping of MBMS Iu bearer to p-t-p and p-t-m connections .....	11
5.1.6 UE Linking/De-linking .....	12
5.1.7 RNC Registration.....	13
5.1.8 RNC De-Registration.....	14
5.1.9 CN De-Registration .....	14
5.1.10 URA Linking/De-linking.....	14
5.2 MBMS Uu Principles .....	15
5.2.1 MBMS Service States in UE.....	15
5.2.2 One PDCP and RLC entity shared among multiple cells within one RNS .....	15
5.2.3 MCCH Information Scheduling.....	15
5.2.4 MBMS Notification .....	16
5.2.5 MBMS Counting .....	17
5.2.6 MBMS Radio Bearer Release in the UE.....	18
5.2.7 MBMS Session Repetition.....	19
5.2.8 MBMS Service Prioritisation.....	19
5.3 Protocol structure .....	20
5.3.1 MBMS User Plane Protocol Stack Architecture.....	20
5.3.2 MBMS Control Plane Protocol Stack Architecture .....	20
5.4 MAC architecture .....	21
5.4.1 UTRAN MAC Architecture to support MBMS.....	21
5.4.2 MAC-c/sh/m architecture: UTRAN side .....	21
5.4.3 MAC-c/sh/m architecture: UE side.....	22
6 MBMS Channel Structure .....	23
6.1 Point-to-Point Transmission.....	23
6.2 Point-to-multipoint Transmission.....	23
6.2.1 Logical Channels .....	23
6.2.1.1 MBMS point-to-multipoint Control Channel (MCCH).....	23
6.2.1.2 MBMS point-to-multipoint Traffic Channel (MTCH).....	23
6.2.1.3 MBMS point-to-multipoint Scheduling Channel (MSCH) .....	23
6.2.2 Transport Channel .....	24
6.2.3 Physical Channel .....	24
6.2.4 Mapping between channels.....	24
6.2.5 Data Flows through Layer 2 .....	25
6.2.5.1 Data flow for MCCH mapped to FACH .....	25
6.2.5.2 Data flow for MTCH mapped to FACH .....	25
6.2.5.3 Data flow for MSCH mapped to FACH.....	25

6.3.	MBMS Notification Indicator Channel .....	25
7	MBMS Reception and UE Capability .....	25
7.1	Selective and Soft Combining for MBMS P-T-M transmission.....	25
7.1.bis	Simulcast Combining (TDD only).....	26
7.2	UE Capability.....	27
7.3	MBMS Reception.....	28
7.3.1	MBMS Reception in RRC Idle Mode.....	28
7.3.2	MBMS Reception in RRC Connected Mode: URA_PCH state .....	29
7.3.3	MBMS Reception in RRC Connected Mode: CELL_PCH state .....	29
7.3.4	MBMS Reception in RRC Connected Mode: CELL_FACH state .....	30
7.3.5	MBMS Reception in RRC Connected Mode: CELL_DCH state .....	30
8	UTRAN Signalling Flows for MBMS .....	30
8.1	MBMS High Level Signalling Scenarios .....	30
8.1.1	Session start .....	30
8.1.2	Joining (during a session) .....	32
8.1.3	Recounting.....	33
8.1.4	Session stop .....	35
8.2	MBMS RNC Signalling Flows.....	35
8.2.1	MBMS Session Start procedure.....	35
8.2.2	MBMS Session Update procedure.....	36
8.2.3	MBMS Session Stop procedure .....	36
8.2.4	RNC Registration procedure.....	37
8.2.5	RNC De-Registration procedure.....	37
8.2.6	CN De-Registration procedure .....	37
8.2.7	MBMS Channel Type Switching over Uu.....	38
8.2.8	MBMS UE Linking .....	38
8.2.9	MBMS UE De-Linking .....	39
8.2.10	MBMS Service Id Request .....	39
8.2.11	MBMS Attach/Detach over Iur.....	40
8.2.12	MBMS Channel Type Reconfiguration over Iur .....	40
8.2.13	Information Exchange over Iur.....	41
8.2.14	MBMS RAB Establishment Indication.....	41
8.2.15	MBMS RAB Release.....	42
8.3	MBMS Uu Signalling Flows .....	43
8.3.1	Broadcast of MBMS System Information .....	43
8.3.2	MBMS Service Information .....	43
8.3.3	MBMS Radio Bearer Information .....	44
8.3.4	MBMS Access Information .....	44
8.3.5	MBMS Neighbouring Cell Information.....	45
8.3.6	MBMS Joined Indication.....	45
8.3.7	MTCH Scheduling Information.....	46
8.3.8	MBMS Change Information .....	46
8.3.9	MBMS P-T-P Modification Request .....	47
8.3.10	MBMS Counting Response .....	47
8.3.11	MBMS Selected Services Information .....	48
9	Security for MBMS .....	48
10	Mobility Procedures for MBMS.....	48
10.1	Use of Periodical Transmission of MBMS Critical Information.....	48
10.2	UE Actions for Mobility.....	49
10.2.1	RRC idle mode .....	49
10.2.2	URA_PCH State .....	50
10.2.3	CELL_PCH.....	50
10.2.4	CELL_FACH.....	50
10.2.5	CELL_DCH State .....	51
11	Resource Management for MBMS.....	51
11.1	MBMS Access Control Procedure .....	51
11.2	Frequency layer Convergence .....	53
11.3	Frequency layer Dispersion.....	53

<b>Annex A (informative):</b>	<b>MBMS Phases in UTRAN</b> .....	<b>54</b>
A1	Security for MBMS .....	54
A2	MBMS Phase 2.....	54
A3	MBMS Phase 3.....	55
A4	MBMS Phases and Status Parameters.....	55
<b>Annex B (informative):</b>	<b>MBMS Control Information</b> .....	<b>56</b>
<b>Annex C (informative):</b>	<b>Change history</b> .....	<b>58</b>
History .....		61

---

# Foreword

This Technical Report has been produced by the 3<sup>rd</sup> Generation Partnership Project (3GPP).

The contents of the present document are subject to continuing work within the TSG and may change following formal TSG approval. Should the TSG modify the contents of the present document, it will be re-released by the TSG with an identifying change of release date and an increase in version number as follows:

Version x.y.z

where:

- x the first digit:
  - 1 presented to TSG for information;
  - 2 presented to TSG for approval;
  - 3 or greater indicates TSG approved document under change control.
- y the second digit is incremented for all changes of substance, i.e. technical enhancements, corrections, updates, etc.
- z the third digit is incremented when editorial only changes have been incorporated in the document.

---

# 1 Scope

The present document is a technical specification of the overall support of Multimedia Broadcast Multicast Service in UTRA.

---

## 2 References

The following documents contain provisions which, through reference in this text, constitute provisions of the present document.

- References are either specific (identified by date of publication, edition number, version number, etc.) or non-specific.
- For a specific reference, subsequent revisions do not apply.
- For a non-specific reference, the latest version applies.

[1] 3GPP TR 21.905: " Vocabulary for 3GPP Specifications ".

[2] 3GPP TS 22.146: "Multimedia Broadcast/Multicast Service; Stage 1".

[3] 3GPP TS 22.246: "MBMS User Services; Stage 1".

[4] 3GPP TS 23.246: "Multimedia Broadcast Multicast Service; Architecture and Functional Description".

[5] 3GPP TR 25.992: "Multimedia Broadcast Multicast Service (MBMS); UTRAN/GERAN Requirements".

[6] 3GPP TS 23.236: "Intra-domain connection of Radio Access Network (RAN) nodes to multiple Core Network (CN) nodes".

[7] 3GPP TS 33.246: "3G Security; Security of Multimedia Broadcast/Multicast Service (MBMS)".

[8] 3GPP TS 25.301: "Radio Interface Protocol Architecture".

[9] 3GPP TS 25.211: "Physical channels and mapping of transport channels onto physical channels (FDD)".

[10] 3GPP TS 25.221: "Physical channels and mapping of transport channels onto physical channels (TDD) ".

[11] 3GPP TS 25.304: "User Equipment (UE) procedures in idle mode and procedures for cell reselection in connected mode".

[12] 3GPP TS 25.306: "UE Radio Access capabilities".

[13] 3GPP TS 25.331: "Radio Resource Control (RRC); Protocol Specification".

---

## 3 Definitions, symbols and abbreviations

### 3.1 Definitions

For the purposes of the present document, the following terms and definitions apply.



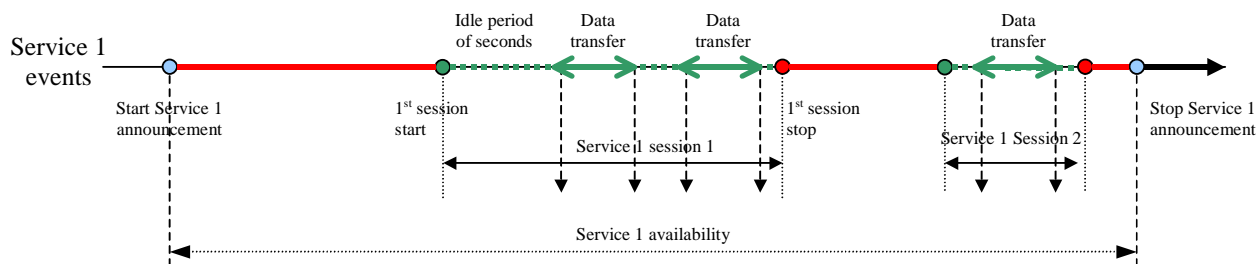

Figure 3.1: MBMS Timeline, based on [4].

**MBMS session start** is the point at which the BM-SC is ready to send data.

**MBMS notification** informs the UEs about forthcoming and about ongoing MBMS data transfer.

**MBMS Cell Group** is a group of multiple cells belonging to one RNS and sharing one PDCP and RLC entity to utilize p-t-m transmission of the MBMS Service

**MBMS session stop** is the point at which the BM-SC determines that there will be no more data to send for some period of time.

**Data transfer** is the phase when MBMS data are transferred to the UEs.

**MBMS service availability** is the phase between start of service announcement and the end of the last session or stop of service announcement.

**MBMS Iu data bearer** denotes the data bearer established between SGSN and RNC to transport MBMS data

**MBMS radio bearer** denotes the data bearer established between RNC and UE(s) to transport MBMS data

**MBMS RAB** denotes both, the MBMS Iu data bearer and the MBMS radio bearer

**MBMS Service Context** contains the necessary information for the UTRAN to control the MBMS Service in UTRAN.

**MBMS Activated Services:** a set of services made up of those in MBMS multicast mode that the UE has joined as well as those in MBMS broadcast mode that the UE is interested in receiving.

**MBMS Selected Services:** a subset of the MBMS activated services in MBMS Broadcast mode for which the UE applies RRC procedures to inform UTRAN that the service has been selected (by upper layers).

**MBMS Iu signalling connection** denotes the signalling connection established between the RNC and the CN node to serve one MBMS Service Context.

**MBMS Service Announcement:** Mechanism to allow users to be informed about the MBMS services available [4]

**Pool area:** see definition in ref.[6]

**MBMS Multicast Service Activation:** see description in ref.[4]

**Critical Information:** MBMS Neighbouring Cell Information, MBMS Radio Bearer Information and MBMS Service Information sent on MCCH.

**Non-critical information:** MBMS Access Information sent on MCCH.

**MBMS Service Area:** The area in which a specific MBMS Bearer Service is available. It is defined individually per MBMS Bearer Service. [4]

**L1-combining schedule:** Indicates when the soft combining is applicable between the specific S-CCPCH of the cell and the specific S-CCPCH of the neighbouring cell.

**MBMS service transmission schedule:** Indicates when the specific MBMS service is expected to be transmitted in the cell in specific S-CCPCH. The information is transmitted on MSCH

**S-CCPCH:** In case of TDD, the S-CCPCH refers to the CCTrCH carrying FACH

**UE Link** denotes the stored information in the RNC on MBMS services joined by the UE in the state other than URA\_PCH in the course of the UE Linking procedure.

**URA Link** denotes the stored information in the RNC on MBMS services joined by a UE in URA\_PCH state in the course of the URA Linking procedure.

## 3.2 Symbols

(void)

## 3.3 Abbreviations

For the purposes of the present document, the abbreviations given in 3GPP TS 21.905 [1] and the following apply:

CELL_DCH	
CELL_FACH	
FFS	For Further Study
FLC	Frequency Layer Convergence
LCI	Layer Convergence Information
MBMS	Multimedia Broadcast Multicast Service
MBMS service ID	Multimedia Broadcast Multicast Service service Identity
MBMS Session ID	Multimedia Broadcast Multicast Service session identity
MCCH	MBMS point-to-multipoint Control Channel
MICH	MBMS notification Indicator Channel
MSCH	MBMS point-to-multipoint Scheduling Channel
MTCH	MBMS point-to-multipoint Traffic Channel
NI	Notification Indicator
PL	Preferred Layer
p-t-p	Point-to-Point
p-t-m	Point-to-Multipoint
PF	Probability Factor

---

## 4 Background and introduction

The Introduction of the Multimedia Broadcast Multicast Service in UTRA describes techniques for optimised transmission of MBMS bearer service in UTRA such as point-to-multipoint transmission, selective combining and transmission mode selection between point-to-multipoint and point-to-point bearer.

The Stage 1 MBMS service requirements are defined in [2] and MBMS Stage 1 user services are defined in [3]. UTRAN (and GERAN) requirements are covered in TR 25.992 [5]. The overall architecture, functional description and the reference architecture of MBMS are covered in TS 23.246 [3].

---

## 5 MBMS UTRAN and protocol architecture

### 5.1 MBMS UTRAN architecture principles

#### 5.1.1 MBMS Service Context in CRNC

Each RNC-which is controlling one or several cells within an MBMS Service area maintains an MBMS Service Context for each MBMS service.

- 1 Each CRNC MBMS Service Context is associated with an MBMS service ID, i.e. TMGI.
- 2 The CRNC MBMS Service Context contains a list of PMM connected mode UEs which are present in one or several cells of the CRNC and which have activated the MBMS service and/or a list of URAs in which there is

at least one URA\_PCH UE which has activated the MBMS service. The list includes at least the U-RNTI of the UEs in the state other than URA\_PCH and/or URA-IDs.

NOTE: The MBMS Service Context in the CRNC contains no information about RRC Idle mode UEs.

- 3 The MBMS Service Context is created in the CRNC either
  - if the SGSN informs the RNC that a UE has activated the MBMS Service in a cell controlled by the CRNC by the UE Linking procedure. In this case, the CRNC is the SRNC of the UE,
  - or if the RNC is notified of an MBMS Session Start,
  - or if the RNC serves as a Drift RNC for a PMM-CONNECTED UE and receives for this UE a UE Link from the SRNC containing the MBMS Service Id of the concerned MBMS Service,
  - or if the RNC receives a URA Link containing the MBMS Service Id of the concerned MBMS Service.
- 4 Each RNC which is informed by the SGSN that a UE has activated one (or several) MBMS Service(s) by the UE Linking procedure maintains an MBMS Service Context for each indicated MBMS service, irrespectively of the MBMS Service Area.
- 5 The MBMS Service Context is released by the CRNC either
  - if the MBMS Service Context does not contain any UE/URA information after a UE/URA Unlinking procedure from a SGSN and there is no active MBMS Session for the concerned MBMS Service,
  - or if the MBMS Service Context does not contain any UE Link/URA Link at the time of a Session Stop
  - or if the RNC receives a CN De-Registration for MBMS Service
- 6 Associated functionalities:
  - 6.1 Bearer type selection for MBMS transmissions based on information in the CRNC MBMS Service Context. The decision process requires inter-working with Radio Resource Management and with the UE's SRNC in the case of p-t-p bearers.
  - 6.2 MBMS RB control for p-t-m bearers in each cell, based on information in the CRNC MBMS Service Context.
  - 6.3 Update of the MBMS Service Context when a PMM-CONNECTED UE, which has activated an MBMS Service, has entered a cell. Update of the MBMS Service Context via Iur is performed by UE Linking.
  - 6.4 Update of the MBMS Service Context when a PMM-CONNECTED UE, which has activated an MBMS Service, has left a cell. Update of the MBMS Service Context via Iur is performed by UE Unlinking.

NOTE: For further details of UE linking via the Iur interface see chapter 5.1.6.

## 5.1.2 MBMS Session start and MBMS Session Stop

At MBMS Session Start and MBMS Session Stop the RNC receives a respective request from the CN. The MBMS Session Start Request shall contain the MBMS Service Id, MBMS Bearer Service Type and MBMS Session Attributes (MBMS Service Area Information, QoS parameters, ...). The MBMS Session Start Request triggers the RNC to notify UEs, which have activated the MBMS Service of the MBMS Session Start. The MBMS Session Stop Request may trigger the RNC to notify UEs, which have activated the MBMS Service of the MBMS Session Stop.

The MBMS Session Start and Session Stop procedures provide the setup and release of the MBMS RAB in the following way:

The MBMS Session Start Request shall contain all information necessary to setup an MBMS RAB. When the RNC receives an MBMS Session Start Request, it typically executes MBMS Iu data bearer set up and shall inform the sending CN node, of the outcome in the MBMS Session Start response message.

Upon reception of MBMS Session Start Request, if the MBMS Service Context is not yet present in the RNC, the RNC shall store the MBMS Service Id. Further the RNC shall memorise the MBMS Bearer Service Type, MBMS Counting Information and MBMS Session Attributes (MBMS Service Area Information, QoS parameters, ...) as part of the MBMS Service Context.

The RNC may choose not to execute the MBMS Iu data bearer setup, for a particular MBMS service, when:

1. The RNC does not control any cell contained within the MBMS Service Area, or
2. The RNC controls at least one cell contained within the MBMS Service Area and a list of PMM-Idle Mode UEs is included in MBMS Session Start but no RA"s contained within the list are under the control of the RNC

The RNC may not execute the MBMS Iu data bearer setup for a given Iu interface in case of Iu-flex. In those cases the CN node shall be informed accordingly.

In case of Iu-flex, the RNC might receive more than one MBMS Session Start Request for an MBMS Service and shall not set up more than one MBMS Iu bearer for a certain MBMS Service towards a pool area.

When the RNC receives an MBMS Session Stop Request it shall release the associated MBMS RAB resources.

The MBMS Session Start and Session Stop procedures serve to establish and release the MBMS Iu signalling connection.

### 5.1.3 MBMS Iu bearer

For each MBMS service, data is transferred via an MBMS RAB between the SGSN and the UE. For each MBMS service, data is transferred via one MBMS Iu bearer between SGSN and the RNC in the whole MBMS Service area. Signalling messages specific for an MBMS Service are transferred via one dedicated MBMS Iu signalling connection between the RNC and the SGSN.

- 1 One MBMS Iu bearer is established per MBMS service at MBMS Session Start.
- 2 Regarding Iu-flex the RNC shall not set up more than one MBMS Iu bearer.
- 3 Because of the dedicated channels and Iur mobility, there is a need to send MBMS data to an RNC which is not necessarily part of the MBMS Service area.
- 4 The MBMS Iu bearer on Iu is established per MBMS service and not per UE individually.
- 5 Each PMM-CONNECTED mode UE with an activated MBMS service has its UE context bind to the MBMS Iu bearer.
- 6 There could be several MBMS RBs linked to one MBMS Iu bearer (i.e. one MBMS Iu bearer on Iu maybe mapped to multiple DTCH and/or p-t-m traffic channels over the radio -interface).

### 5.1.4 MBMS Iub bearer

The existing FACH transport channel mechanism over Iub is to be used in case of p-t-m MBMS transmission.

### 5.1.5 Mapping of MBMS Iu bearer to p-t-p and p-t-m connections

The service specific MBMS RAB on Iu may be mapped to p-t-m bearers in order to provide MBMS data via common channels.

- 1 The MBMS control function in the CRNC may decide to establish a p-t-m connection, if the number of counted MBMS users in a cell exceeds a certain operator-defined threshold or if the MBMS Counting Information indicates that MBMS Counting procedures are not applicable.
- 2 The MBMS control function in the CRNC may decide to establish a p-t-m connection depending on the congestion scenario expected for a specific cell (e.g. in hotspot areas where no bearer type switching is needed). and/or the MBMS service characteristics (e.g. session duration time) on a per cell basis.
- 3 The MBMS control function in the CRNC may, through a configurable parameter enable/disable bearer type switching and the associated procedures on a per cell basis.
- 4 The MBMS control function in the CRNC establishes an MBMS RB by sending service specific signalling messages (e.g. MBMS RB Setup message) to all the UEs in the cell listening MBMS point-to-multipoint control channel (MCCH). UEs with activated service(s) may then execute the RB set-up.
- 5 MBMS data is transferred on an MBMS point-to-multipoint traffic channel (MTCH) to all the UEs which have executed the RB setup.
- 6 The MBMS control function in the CRNC releases the MBMS RB (e.g. MBMS RB Release) when the data transfer has been finished or it has been interrupted by the CRNC.

- 7 p-t-p transmission of MBMS data should use the DTCH as defined for other dedicated services.
- 8 p-t-m transmission of MBMS data applies to all RRC states and modes.

### 5.1.6 UE Linking/De-linking

UE Linking denotes the process where a UE, which has joined one or several MBMS services, is linked to one or several MBMS service context in the RNC.

MBMS UE linking procedure in the SRNC is performed in following cases.

1. When the UE, which has joined an MBMS service, is moved to PMM-CONNECTED and sets up a PS RAB This may happen at any point in time during the whole MBMS service availability (i.e. before, during and between MBMS sessions).
2. When the UE joins an MBMS service and is in PMM-CONNECTED due to an existing PS RAB. This may happen at any point in time during the whole MBMS service availability (i.e. before, during and between MBMS sessions).
3. When the UE is moved to PMM-CONNECTED only for MBMS purpose, e.g. to respond to counting/recounting indication or respond to p-t-p bearer indication from RNC. This may happen at any point in time during MBMS sessions.
4. When the UE is moved to PMM-CONNECTED and the UE provides MBMS Selected Services Information to the RNC.

Keeping UEs in PMM-CONNECTED only for MBMS between sessions is implementation specific. The UE linking in the SRNC for services delivered over MBMS Multicast mode is performed via UE dedicated Iu procedures. An entry for the UE is added to the related MBMS service context(s) in the SRNC. If an MBMS service context does not exist yet it needs to be created.

In cases where a UE is present in a cell under the control of a drift RNC, the UE Linking is performed via Iur in the following way.

1. When the UE, which has activated one or several MBMS services, is in CELL\_DCH state and starts to consume radio resources from one or several cells controlled by the DRNC, MBMS UE Linking in the DRNC is performed via UE dedicated Iur procedures. After that the DRNC shall update the MBMS Service context on the request of every radio link setup/release from the SRNC.
2. When the UE, which has activated one or several MBMS services, is in CELL\_FACH state and starts to consume radio resources from one cell controlled by the DRNC, MBMS UE Linking in the DRNC is performed via UE dedicated Iur procedures. After that the DRNC shall update the MBMS Service context in the DRNC at every intra-DRNC cell change without the need to receive UE Link from the SRNC.
3. If the UE is in CELL\_DCH and CELL\_FACH state and there is no dedicated RNL signalling activity ongoing for this UE and UE Linking is performed in the SRNC for an MBMS Service, MBMS UE Linking in the DRNC is performed via the MBMS Attach procedure.
4. If the UE is in CELL\_PCH and moves to a cell within the DRNC area for the first time, the MBMS UE Linking in the DRNC is performed. The cell the UE moved to is indicated to the DRNC. After that at every intra-DRNC cell change the DRNC shall update the MBMS Service context in the DRNC without the need to receive UE Link from the SRNC.
5. If the UE is in CELL\_PCH and there is no mobility related signalling activity ongoing for this UE and UE Linking is performed in the SRNC for an MBMS Service, MBMS UE Linking in the DRNC is performed via the MBMS Attach procedure.
6. If the UE is in RRC connected mode and UE Linking is performed in the SRNC for an MBMS Service and a session of this MBMS Service is ongoing UE Linking in the DRNC needs to be performed immediately.

At MBMS UE linking in the DRNC the MBMS service context in the DRNC needs to be updated. If an MBMS service context does not exist yet then it shall be created and if needed, DRNC can acquire the APN and IP Multicast Address from the SRNC for the specific service via Information Exchange procedure.

UE De-linking denotes the process where a UE, which has joined MBMS service(s), is removed from one or several MBMS service contexts in the RNC.

MBMS UE De-linking procedure in the SRNC is performed in following cases.

1. When the UE has left the MBMS service and is in PMM-CONNECTED due to an existing PS RAB. This may happen at any point in time during the whole MBMS service availability (i.e. before, during and between MBMS sessions).
2. When the UE sends new MBMS Selected Services Information to the RNC omitting an MBMS service which is identified on the MCCH.
3. When CN decides to de-link a certain PMM-CONNECTED mode UE due to e.g. error cases.

MBMS UE De-linking in the SRNC for services in MBMS Multicast mode is performed via UE dedicated Iu procedure. The entry for the UE is removed from the concerned MBMS service context(s) in the SRNC.

MBMS UE De-linking procedure in the DRNC is performed via Iur in the following way:

1. If the UE is in CELL\_DCH or CELL\_FACH state and stops consuming the radio resources from one or several cells controlled by the DRNC, MBMS UE is De-linked from the MBMS Service Context in the DRNC via UE dedicated Iur procedure.
2. If the UE is in CELL\_DCH or CELL\_FACH state and there is no dedicated RNL signalling activity ongoing for this UE and UE De-linking is performed in the SRNC for an MBMS Service, MBMS UE De-linking in the DRNC is performed via the MBMS Detach procedure.
3. If the UE is in CELL\_PCH and leaves for a cell out of the DRNC area the UE is delinked from the MBMS Service context in the DRNC via the MBMS Detach procedure. The cell the UE moved out of is indicated to the DRNC.
4. If the UE is in RRC connected mode and UE De-linking is performed in the SRNC for an MBMS Service and a session of this MBMS Service is ongoing UE De-linking in the DRNC needs to be performed immediately.

## 5.1.7 RNC Registration

RNC Registration for a certain MBMS Service denotes the process where the CN becomes aware of an RNC hosting UEs, which have activated that MBMS Service.

Due to UE mobility, a RNC with no MBMS Service Context, can be informed that a PMM-CONNECTED UE, which has entered the cell, has activated an MBMS Service by means of the MBMS UE Linking procedure via the Iur interface. Then the RNC informs the CN that it would like to receive MBMS Session Start Request messages when applicable for the concerned MBMS Service by sending MBMS Registration Request message.

It results in the set-up of a corresponding MBMS distribution tree, but it does not result in the establishment of Iu user plane, which will be established by the MBMS Session Start procedure.

1. Implicit Registration
  - RNC Registration for Serving RNCs is performed implicitly, i.e. due to UE linking and MBMS Multicast Service Activation. No explicit registration procedure needs to be performed.
2. Explicit Registration
  - RNC Registration for Drift RNCs is performed explicitly if an RNC becomes a Drift RNC for a UE, which has activated an MBMS service and has no MBMS Service Context for that MBMS Service.
  - RNC Registration for Drift RNCs is performed explicitly if an RNC is no longer the SRNC of any connected UE which has activated an MBMS service, but hosts at least a UE which consumes radio resources of the RNC via Iur. This shall happen only before sessions or between sessions.
  - The DRNC will perform a registration towards its default CN node only.

## 5.1.8 RNC De-Registration

RNC De-Registration for a certain MBMS Service denotes the process where the CN becomes aware that an RNC registered at a CN node does not host any more PMM-CONNECTED UEs which have activated that MBMS Service.

- Implicit RNC De-Registration
  - RNC De-Registration for Serving RNCs is performed implicitly, i.e. due to UE Unlinking and MBMS Multicast Service Deactivation. No explicit de-registration procedure needs to be performed.
- Explicit RNC De-Registration
  - RNC De-Registration for Drift RNCs is performed explicitly if a RNC is not acting as a Serving RNC and has ceased to act as a Drift RNC for UEs which have activated an MBMS service, it will perform a de-registration towards the CN node it was registered to.
  - The timing of RNC De-Registration is implementation specific.

NOTE: When the Drift RNC performs the explicit De-registration, the Implicit registration may still remain and in that case Iu data bearer should not be removed.

## 5.1.9 CN De-Registration

CN De-Registration denotes the process where the CN informs the RNC that a certain MBMS service is no longer available. CN De-Registration should result in releasing of all associated MBMS Service Contexts and resources.

The CN De-Registration procedure serves to release the MBMS Iu signalling connection.

## 5.1.10 URA Linking/De-linking

URA Linking denotes the process where a URA, which contains one or more cells in which at least one URA\_PCH UE has joined the MBMS service or has passed MBMS Selected Service Information about the MBMS service, is linked to an MBMS service context in the RNC. An entry for the URA is added to the MBMS service context in the RNC.

If the UE in URA\_PCH state, which has activated one or several MBMS Services, is present within a URA containing one or more cells that are controlled by one or more drift RNCs, the URA Linking is performed in the following way.

1. If the UE is in URA\_PCH, having activated one or more MBMS services, is the first UE for the particular MBMS service to move to a URA which contains one or more cells that are controlled by one or more DRNCs, the URA is linked to the MBMS Service context in each applicable DRNC. The URA the UE moved to will be indicated.
2. As long as the SRNC serves UEs in URA\_PCH in URAs containing cells controlled by one or more DRNCs, the SRNC shall keep the other RNCs informed about every URA in which UEs having activated certain MBMS services have to be notified. This is done when the first UE enters the URA, by indicating to the other RNCs a list of URAs and the corresponding MBMS Services via MBMS Attach procedure.

NOTE: Bullet points 1 and 2 above may be merged in a future version of this document.

At MBMS URA linking in the RNC the MBMS service context in the RNC needs to be updated. If an MBMS service context does not exist yet then it shall be created and acquire the APN and IP Multicast Address from the SRNC for the specific service via Information Exchange procedure.

URA De-linking denotes the process where a URA is removed from one or several MBMS service contexts in the RNC.

1. If the UE is in URA\_PCH and, for the particular MBMS service, is the last UE to leave a URA which contains one or more cells controlled by one or more DRNCs the URA is de-linked from the MBMS Service context in each applicable DRNC via the MBMS Detach procedure.

## 5.2 MBMS Uu Principles

### 5.2.1 MBMS Service States in UE

The MBMS bearer service has following service states in the UE:

1. Not active, UE has not joined any MBMS multicast service or not activated the broadcast mode of the MBMS
2. Not active, UE has joined at least one MBMS multicast service and/or activated the broadcast mode of the MBMS, but MBMS SYSTEM INFORMATION is not broadcasted on BCCH.
3. Active, UE has joined at least one MBMS multicast service and/or activated the broadcast mode of the MBMS, but any of the services that UE has joined (interested in broadcast mode) is not being transmitted. UE monitors MICH to find modifications in the MCCH as defined in 5.1.6
4. Active; at least one MBMS service appearing in the list of MBMS Activated Services, is received on p-t-m
  - UE is receiving MBMS transmission on MTCH
  - UE is using DRX based on scheduling information informing that coming MTCH transmission is not in the interest of the UE.
5. Active; at least one MBMS service received on p-t-p
6. Active; at least one MBMS service is received on p-t-p and at least one MBMS service is received on p-t-m. (only valid if UE has capability to support this combination)

When MBMS transmission is started in cell the UE moves from state 3 to either state 4 or state 5 (6), depending on p-t-p transmission mode and after MBMS transmission ends in the cell, the UE moves from state 4 or state 5 (6) to state 3.

### 5.2.2 One PDCP and RLC entity shared among multiple cells within one RNS

For each MBMS service, a group of multiple cells belonging to one RNS shares one PDCP entity and RLC entity over p-t-m transmission. The group of multiple cells is called 'MBMS Cell Group'.

1. There are one or more MBMS Cell Groups per RNS. The MBMS Cell Groups are managed by the CRNC.
2. There are one or more cells pertaining to the same RNS for one MBMS Cell Group.
3. The MBMS Cell Group identity is used to uniquely identify a group of multiple cells, which for each MBMS service share the same PDCP entity and RLC entity within an RNS.

### 5.2.3 MCCH Information Scheduling

The MCCH information will be transmitted based on a fixed schedule. This schedule will identify the TTI containing the beginning of the MCCH information. The transmission of this information may take a variable number of TTIs and the UTRAN should transmit MCCH information in consecutive TTIs. The UE will keep receiving the S-CCPCH until:

- It receives all of the MCCH information, or
- It receives a TTI that does not include any MCCH data, or
- The information contents indicate that further reception is not required (e.g. no modification to the desired service information).

Based on this behaviour, the UTRAN may repeat the MCCH information following a scheduled transmission in order to improve reliability. The MCCH schedule will be common for all services.

The entire MCCH information will be transmitted periodically based on a "repetition period". The "modification period" will be defined as an integer multiple of the repetition period. The MBMS ACCESS INFORMATION may be



transmitted periodically based on an "access info period". This period will be an integer divider of the "repetition period".

MCCH information is split into critical and non-critical information. The critical information is made up of the MBMS NEIGHBOURING CELL INFORMATION, MBMS SERVICE INFORMATION and MBMS RADIO BEARER INFORMATION. The non-critical information corresponds to the MBMS ACCESS INFORMATION. Changes to critical information will only be applied at the first MCCH transmission of a modification period and in the beginning of each modification period UTRAN transmits the MBMS CHANGE INFORMATION including MBMS services ids whose MCCH information is modified at that modification period. MBMS CHANGE INFORMATION is repeated at least once in each repetition period of that modification period. Changes to non-critical information could take place at any time.

The Figure 1 below illustrates the schedule with which the MBMS SERVICE INFORMATION and RADIO BEARER INFORMATION would be transmitted. Different colours indicate potentially different MCCH content.

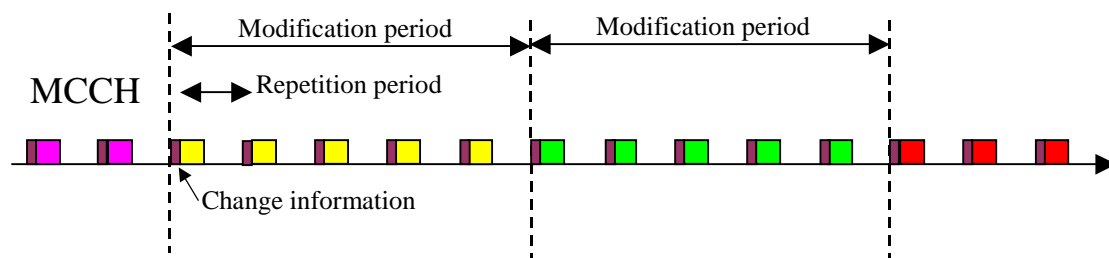

**Figure 5.2.3: MCCH Information Schedule**

## 5.2.4 MBMS Notification

The MBMS notification mechanism is used to inform UEs of an upcoming change in critical MCCH information. Notifications are based on service groups. The mapping between service IDs and service groups is specified in [11].

The MBMS notification indicators will be sent on an MBMS specific PICH, called the MICH. A single MICH frame will be able to carry indications for every service-group.

Critical MCCH information can only be changed at the beginning of a modification period as described in Section 5.2.3. The MBMS notification indicator corresponding to the service group of every affected service shall be set continuously during the entire modification period preceding the first change in MCCH information related to a given service. Subsequent changes in the MCCH information in the next modification period related to the same service can be signalled on the MCCH.

UEs which are not receiving any MBMS service on MTCH or p-t-p channel are free to read the MBMS notification at any time; however the modification interval shall be long enough so that UEs are able to reliably detect it even if they only receive the MICH during their regular Release '99 paging occasions.

Upon detecting the MBMS notification indication for a service group, UEs interested in a service corresponding to this group shall start reading the MCCH at the beginning of the next modification period. The UE shall read at least MBMS CHANGE INFORMATION.

The Figure 2 below illustrates the timing relation between the setting of the MICH and the first MCCH critical information change. The green colour for the MICH indicates when the NI is set for the service. For the MCCH, different colours indicate MCCH content related to the notification of different services.

UEs, which are receiving MBMS service(s) on MTCH in idle mode or URA\_PCH, CELL\_PCH, or CELL\_FACH state shall read the MCCH at the beginning of the each modification period to receive the MBMS CHANGE INFORMATION, which will indicate MBMS service Ids and optionally MBMS Session ID whose MCCH information is modified at that modification period. If MBMS service Id and optionally MBMS Session ID, which UE has activated, is indicated in MBMS CHANGE INFORMATION the UE shall read the rest of the MCCH information.

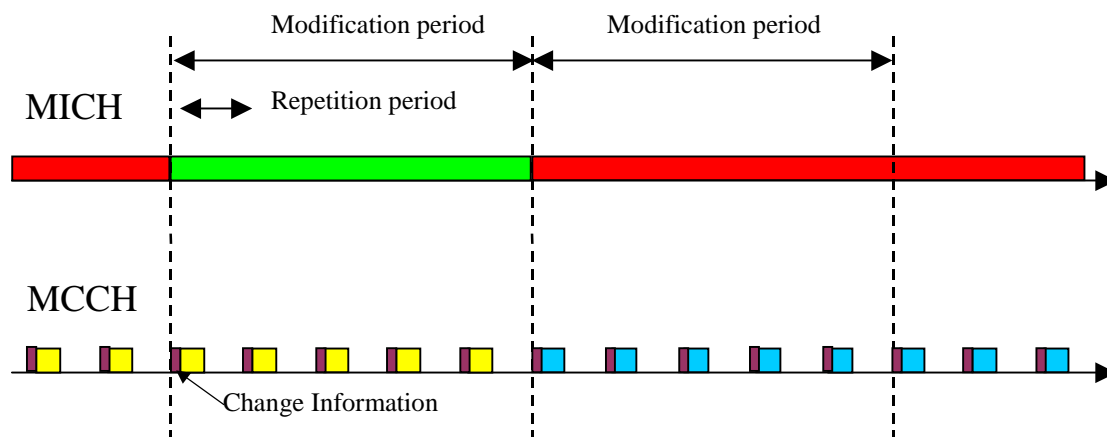

Figure 5.2.4: Illustration of MICH timing relative to Modification period

## 5.2.5 MBMS Counting

MBMS Counting is used to determine the optimum transmission mechanism for a given service.

1. The need for counting is indicated in the notification, and achieved by requesting UEs, belonging to the same MBMS service group, to respond to counting by sending MBMS COUNTING RESPONSE signalling flow to CRNC.
  - a. For UEs in idle mode the counting response refers to the RRC connection establishment procedure.
  - b. For UEs in URA\_PCH, or CELL\_PCH state the counting response refers to cell update procedure
  - c. For UEs in CELL\_FACH state the counting response refers to signalling on CCCH or DCCH.
2. The exact number of UEs that need to respond to counting is an RRM issue.
3. Since it is desirable in a specific cell, to avoid bringing a large number of UEs for counting purposes to RRC connected mode at the same time (RACH load, etc), RRM may control the load due to the RRC connection establishment requests, by setting an access "probability factor". For UEs in PMM connected mode the UTRAN may set different "probability factor" than for UEs in idle mode.
4. Following counting, the number of subscribers that need to be maintained in RRC connected mode or for which the RNC releases their connection, is also an RRM issue.
5. For a given MBMS service, the counting indication in the notification may be switched on and off, on per-cell basis.
6. The RNC may use notification to indicate counting during an ongoing MBMS session (term used is re-counting).
7. The RNC receives via Iu from CN information (MBMS service ID) about UEs who are in RRC Connected mode, and have joined the MBMS service. This information may be used for counting purposes.

The MBMS counting function includes a mechanism by which the UTRAN can prompt users interested in a given service to become RRC connected. This procedure is only applicable for UEs in idle mode and relies on the MBMS ACCESS INFORMATION transmitted on the MCCH. The probability factor indicates the probability with which UEs need to attempt an RRC connection procedure.

In order to trigger counting for a given service, the UTRAN may use the regular MBMS notification mechanism outlined in section 5.2.4 to force UEs interested in the service to read the MCCH information.

Once a UE detects that the counting procedure is on-going for the specific service it wants to receive, it will attempt to respond to the counting based on the probability factor included in the MCCH. If the response to counting is for a service identified in the list of MBMS Selected Services, the UE should provide the MBMS Service ID in the response.

Also, the UE will keep receiving the MBMS ACCESS INFORMATION at every access info period until the UE successfully responds to the counting or counting is no longer required. Whenever it receives new MBMS ACCESS INFORMATION the UE will update its probability factor with the new value.

The Figure 3 below illustrates this mechanism. The green colour for the MICH indicates when the NI is set for the service. The green colour for the MBMS ACCESS INFORMATION indicates that the counting procedure is on-going and that UEs need to establish an RRC connection based on the included probability factor (PF). For the critical MCCH info, different colours indicate potentially different content.

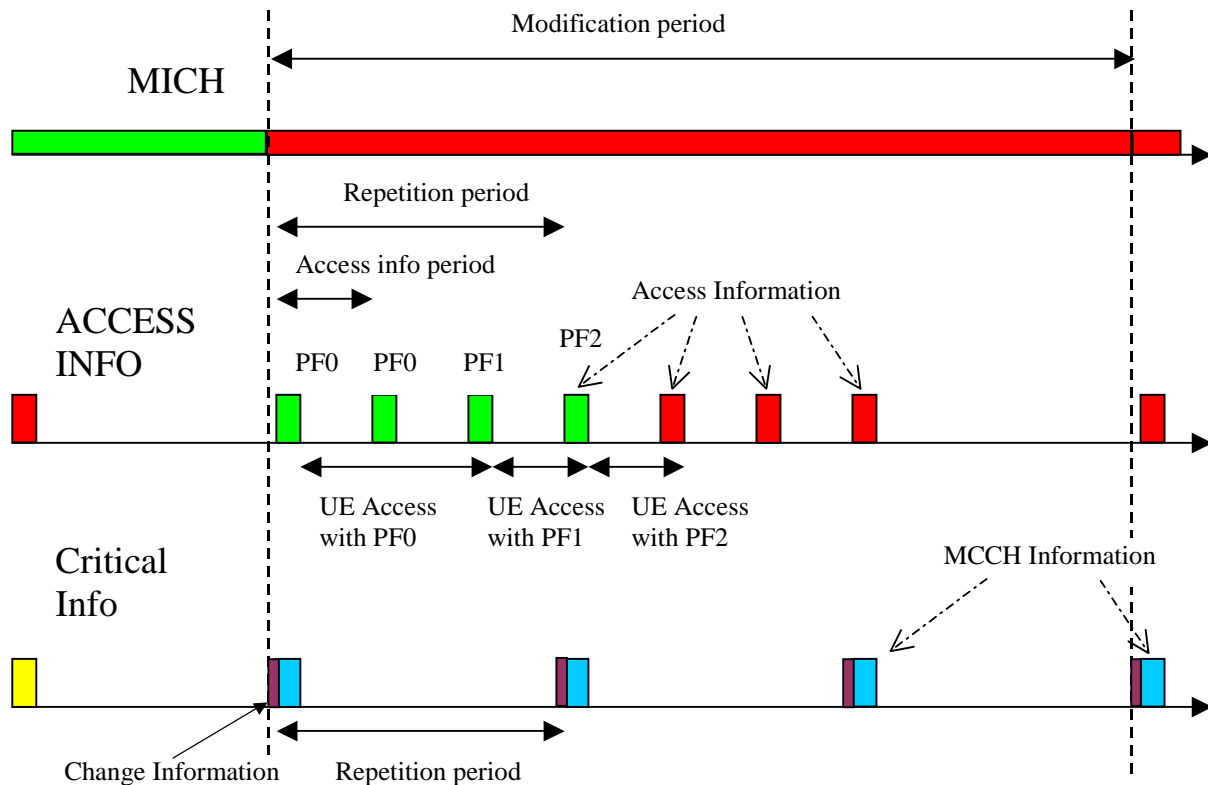

**Figure 5.2.5: Illustration of Access Info period during MBMS counting**

For every UE brought to RRC connected state for the purpose of counting, UTRAN will initiate the PMM Connection establishment procedure and will obtain from CN the set of MBMS services these users have joined.

Counting for on-going services (re-counting) will rely on the same scheduling of the MCCH information.

## 5.2.6 MBMS Radio Bearer Release in the UE

The UE releases the MBMS RB by using one of the following mechanisms:

- Explicit MBMS RB Release
- Implicit MBMS RB Release

The Explicit MBMS RB Release mechanism allows UTRAN to explicitly indicate to MBMS UEs that an MBMS Radio Bearer should be released. For p-t-m transmissions the Explicit MBMS RB Release indication is contained within the MBMS SERVICE INFORMATION signalling flow. For p-t-p transmission the release of MBMS radio bearers is completed in the same way as for a non-MBMS radio bearer. If the Explicit MBMS RB Release indication is received, the UE releases the MBMS RB.

The Implicit MBMS RB Release mechanism applies only to p-t-m transmission and enables a UE to release the MBMS Radio Bearer without receiving the Explicit MBMS RB Release. The UE identifies Implicit MBMS RB release if it detects that the RB is not present in the MBMS SERVICE INFORMATION signalling flow.

## 5.2.7 MBMS Session Repetition

In the case that the BM-SC repeats MBMS sessions (send multiple time identical content), the MBMS service Id and MBMS session Id is used to identify specific MBMS service and session. The validity of the session Id is handled on the MBMS application layer between the BM-SC and the UE. If UTRAN receives the MBMS session ID in session start, the UTRAN should:

- include MBMS session Id in critical and non critical information send on MCCH  
Note: The non-critical information may contain index referring to critical information, avoiding repetition of MBMS service and session Id in non-critical information.

If the UE has already received correctly the data of the MBMS session, which is being indicated on MCCH, the UE may:

- ignore FLC by not applying the Layer Convergence Information
- ignore counting procedure in Idle, URA\_PCH, CELL\_PCH, and CELL\_FACH state
- ignore p-t-m MBMS RB setup signalled on MCCH
- ignore p-t-p MBMS RB indication signalled on MCCH
- reject the p-t-p RB setup for MBMS service, signalled on DCCH

In the case that UTRAN receives reject from the UE to the p-t-p RB setup for MBMS service on DCCH, the UTRAN should not try to re-establish p-t-p RB setup for that MBMS service and session.

In the case that the UE has accepted the p-t-p RB for repeated MBMS session the UE shall receive the complete session.

## 5.2.8 MBMS Service Prioritisation

The CN may assign the Allocation and Retention Priority for the MBMS bearer service. The Allocation and Retention Priority allows for prioritisation between MBMS bearer services and between MBMS bearer services and non MBMS bearer services in the UTRAN.

The UE may assign internally different priorities for different MBMS services to prioritise MBMS and non MBMS service reception. In case that UE has no capability to receive simultaneously, the dedicated non MBMS service and the MBMS service and the MBMS service has priority over the non MBMS service the UE may:

- initialise signalling with CN on NAS layer to stop reception of dedicated non MBMS service

If the UE has no capacity on receiving all MBMS services, which it has activated and which are transmitted simultaneously on p-t-m RBs, the UE may

- stop autonomously ongoing reception of lower priority MBMS service
- act on MCCH message assigned to the highest priority MBMS service
- start autonomously the reception p-t-m RB of the highest priority MBMS service

If the reception p-t-p RB of the lower priority MBMS service is blocking the reception of p-t-m RB of the higher priority MBMS service the UE may:

If p-t-p RB is being established

- reject the setup of p-t-p MBMS RB

If the UTRAN receives reject message UTRAN should not try to re-establish p-t-p RB setup for that MBMS service and session.

If p-t-p RB is already existing

- request the release of p-t-p MBMS RB from the UTRAN or only indicate frequency of higher priority MBMS service

If the UTRAN receives release request message UTRAN may release the p-t-p MBMS RB.

### 5.3 Protocol structure

#### 5.3.1 MBMS User Plane Protocol Stack Architecture

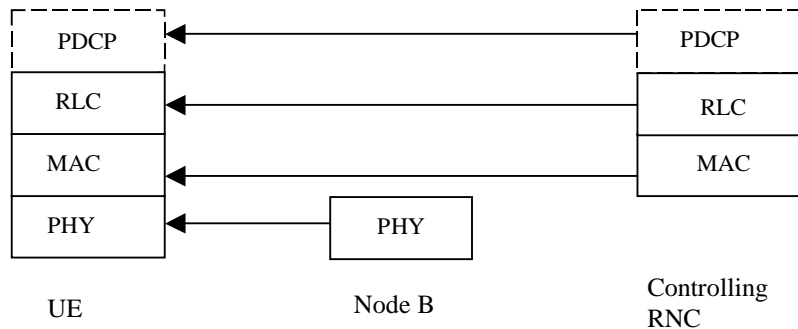

**Figure 5.3.1: Protocol Stack for MTCH**

Figure 5.3.1 illustrates the protocol termination for MTCH in MBMS, which is used in p-t-m transmission.

If configured by CRNC the PDCP sub-layer performs header compression/decompression for the MBMS traffic.

The PDCP sub-layer may operate with the RFC 3095 header compression protocol. In that case, header compression should be performed under RFC 3095 U-mode.

In the UTRAN, for p-t-m transmission, there is one PDCP entity for each MBMS service for each MBMS Cell Group that provides the service (an MBMS Cell Group may contain one or more than one cell).

In the UTRAN, for p-t-m transmission, there is one RLC entity for each MBMS service in each cell or cell group in case of utilization of selective combining or maximum ratio combining in TDD, and one MAC entity for each cell.

In the UE side, there is one PDCP and RLC entity for each MBMS service in each UE. In each UE there is one MAC entity per received cell when UE is performing the selective combining between these cells.

In case of p-t-p transmission, DTCH is used for MBMS transmission and the protocol termination for DTCH mapped on DCH and RACH/FACH are presented in [8].

#### 5.3.2 MBMS Control Plane Protocol Stack Architecture

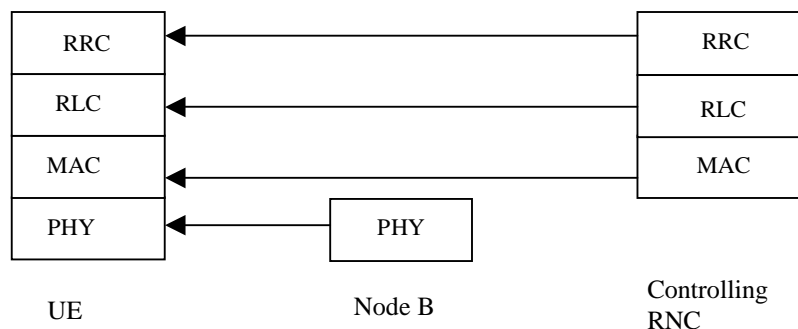

**Figure 5.3.2: Protocol Stack for MCCH and MSCH**

Figure 5.3.2 illustrates the protocol termination for MCCH and MSCH in MBMS, which are MBMS p-t-m control channels.

MBMS functionalities are included in MAC and RRC.

In case of p-t-p transmission, DCCH is used for MBMS and the protocol termination for DCCH mapped on DCH and FACH are presented in [8].

## 5.4 MAC architecture

### 5.4.1 UTRAN MAC Architecture to support MBMS

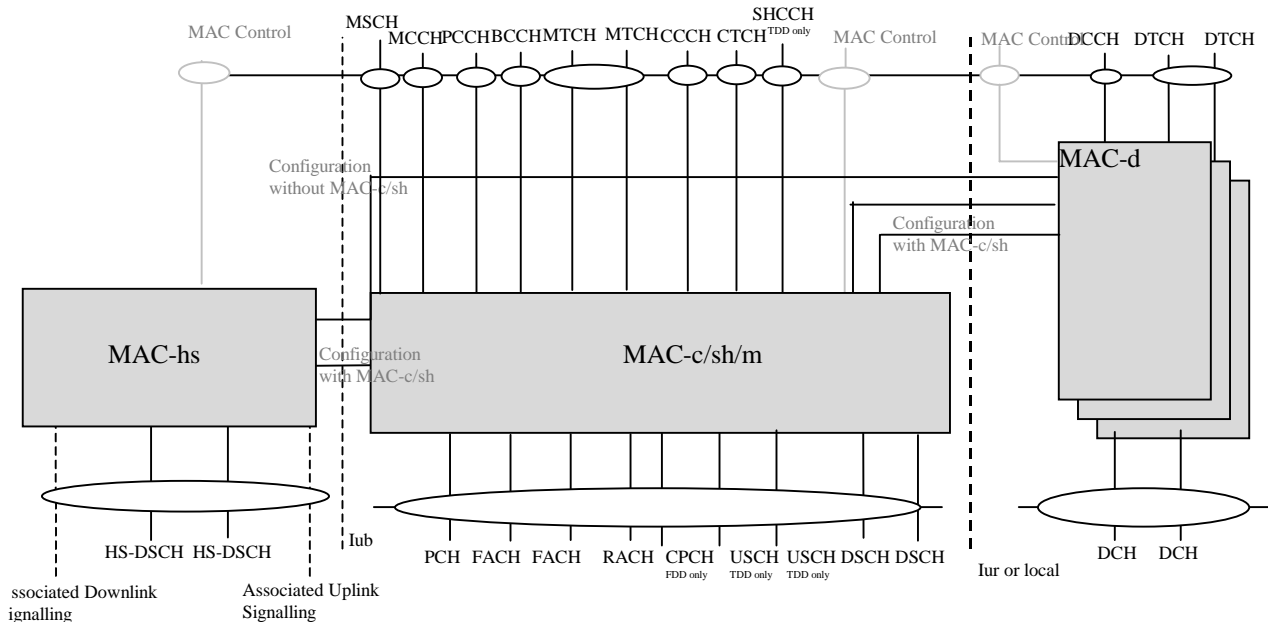

**Figure 5.4.1: UTRAN MAC architecture**

To support MBMS user and control plane transmission, a multicast functionality is added in the MAC c/sh, entitled "MAC m", to take care of scheduling of MBMS related transport channels as presented in Figure 5.4.1. In addition, three logical channels are considered for p-t-m transmission of MBMS: MCCH, MSCH and MTCH. These logical channels are mapped on FACH. In case of p-t-p transmission DTCH and DCCH are used.

### 5.4.2 MAC-c/sh/m architecture: UTRAN side

Figure 4 illustrates the MAC-m additions to the MAC-c/sh architecture in the UTRAN side, needed to transmit MBMS data over a common transport channel (FACH).

MAC-c/sh/m is located in the controlling RNC. The following functionalities are covered:

- **Scheduling / Buffering / Priority Handling:** This function manages common transport resources between MBMS and non-MBMS data flow(s) according to their priority and delay requirements set by higher layers.
- **TCTF MUX:** This function handles insertion of the TCTF field in the MAC header and also the respective mapping between logical channels (i.e. MTCH and MCCH) and transport channels. The TCTF field indicates which type of logical channel (i.e. MTCH and MCCH) is used.
- **Addition of MBMS-ID:** For p-t-m type of logical channels, the MBMS-ID field in the MAC header is used to distinguish between MBMS services.
- **TFC selection:** Transport format combination selection is done for a common transport channel (FACH) mapped to MTCH, MSCH and MCCH. In the case of MBMS soft combining (excluding TrCH combining in TDD), the combinable S-CCPCHs shall have the same TFC during the TTIs in which L1 combining is used.

There is one MAC-c/sh/m entity in the UTRAN for each cell.

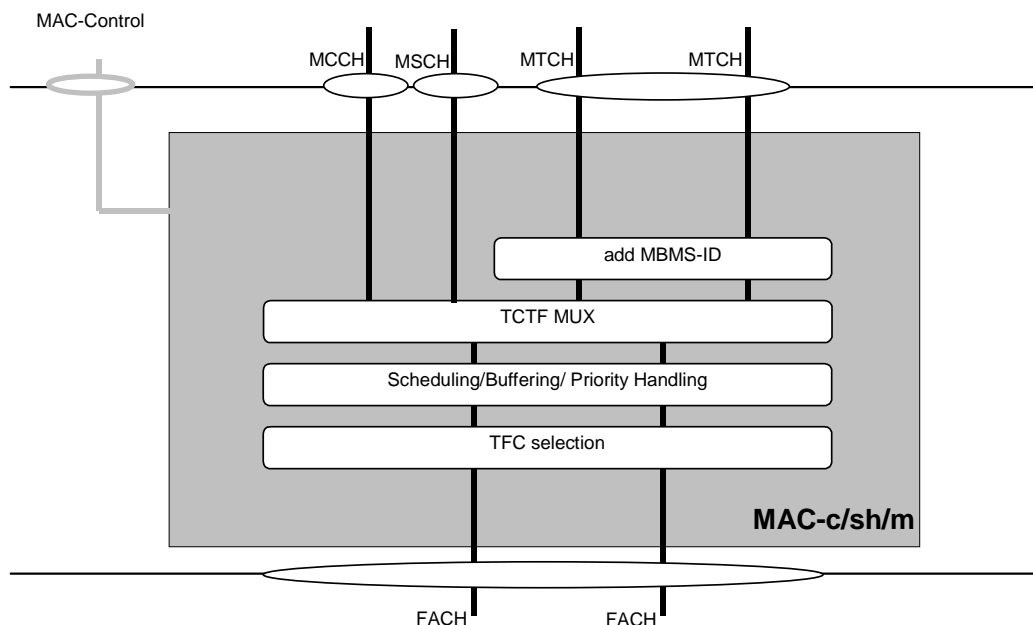

Figure 5.4.2: UTRAN side MAC-m architecture additions to MAC-c/sh

### 5.4.3 MAC-c/sh/m architecture: UE side

Figure 5 illustrates the MAC-m additions to the MAC-c/sh architecture in the UE side, needed to receive MBMS data over a transport channel (FACH).

The following functionalities are covered:

- TCTF DEMUX: This function handles detection and deletion of the TCTF field in the MAC header, and also the respective mapping between logical channels (i.e. MTCH and MCCH) and transport channels. The TCTF field indicates which type of logical channel (i.e. MTCH and MCCH) is used.
- Reading of MBMS-ID: The MBMS-ID identifies data to a specific MBMS service.

There is one MAC-m entity in the UE or in case of selective combining one MAC-m entity for each selectively combined cell in the UE.

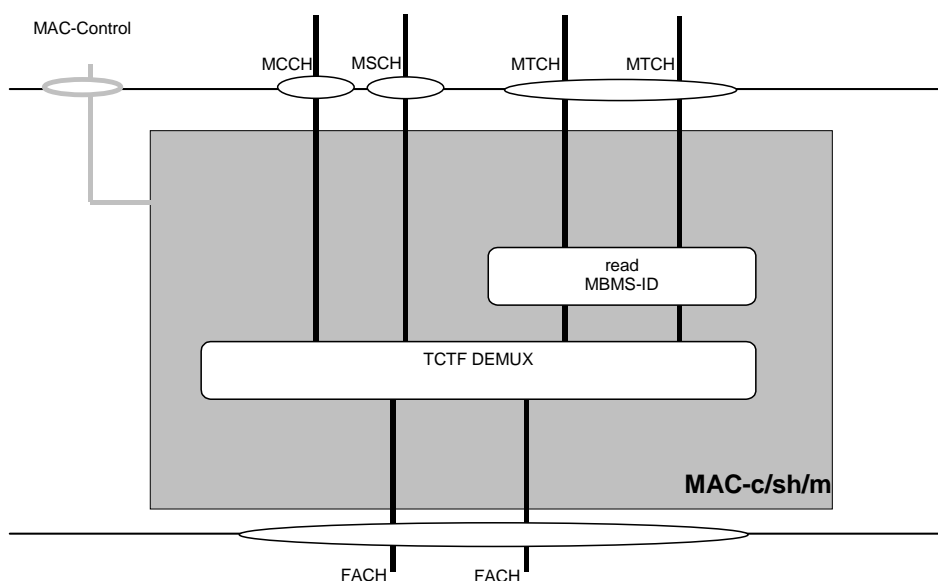

Figure 5.4.3: UE side MAC-m additions to MAC-c/sh

## 6 MBMS Channel Structure

There exists two transmission modes to provide the MBMS service:

- Point-to-point transmission (p-t-p)
- Point-to-multipoint transmission (p-t-m)

### 6.1 Point-to-Point Transmission

Point-to-point transmission is used to transfer MBMS specific control/user plane information as well as dedicated control/user plane information between the network and one UE in RRC Connected Mode. It is used only for the multicast mode of MBMS and for services identified in the list of MBMS Selected Services.

For a UE in CELL\_FACH and Cell\_DCH, DCCH or DTCH is used, allowing all existing mappings to transport channels.

A detailed description of channels used for point-to-point transmission is given in [8].

### 6.2 Point-to-multipoint Transmission

Point-to-multipoint transmission is used to transfer MBMS specific control/user plane information between the network and several UEs in RRC Connected or Idle Mode. It is used for broadcast or multicast mode of MBMS.

#### 6.2.1 Logical Channels

##### 6.2.1.1 MBMS point-to-multipoint Control Channel (MCCH)

This logical channel is used for a p-t-m downlink transmission of control plane information between network and UEs in RRC Connected or Idle Mode. The control plane information on MCCH is MBMS specific and is sent to UEs in a cell with an activated (joined) MBMS service. MCCH can be sent in S-CCPCH carrying the DCCH of the UEs in CELL\_FACH state, or in standalone S-CCPCH, or in same S-CCPCH with MTCH.

The MCCH is always mapped to one specific FACH in the S-CCPCH as indicated on the BCCH. If MCCH is the only logical channel mapped in to the FACH, the absence of the TCTF field is explicitly signalled otherwise the TCTF field is used in MAC header to identify MCCH logical channel type. In case of soft combining, the MCCH is mapped to a different S-CCPCH (CCTrCH in TDD) than MTCH.

Reception of paging has priority over reception of MCCH for Idle mode and URA/CELL\_PCH UEs.

##### 6.2.1.2 MBMS point-to-multipoint Traffic Channel (MTCH)

This logical channel is used for a p-t-m downlink transmission of user plane information between network and UEs in RRC Connected or Idle Mode. The user plane information on MTCH is MBMS Service specific and is sent to UEs in a cell with an activated MBMS service.

The MTCH is always mapped to one specific FACH in the S-CCPCH as indicated on the MCCH. The TCTF field is always used in MAC header to identify MTCH logical channel type.

##### 6.2.1.3 MBMS point-to-multipoint Scheduling Channel (MSCH)

This logical channel is used for a p-t-m downlink transmission of MBMS service transmission schedule between network and UEs in RRC Connected or Idle Mode. The control plane information on MSCH is MBMS service and S-CCPCH specific and is sent to UEs in a cell receiving MTCH. One MSCH is sent in each S-CCPCH carrying the MTCH.

The MSCH is always mapped to one specific FACH in the S-CCPCH as indicated on the MCCH. Due to different error requirements the MSCH is mapped to a different FACH than MTCH. If MSCH is the only logical channel mapped in to



the FACH, the absence of the TCTF field is explicitly signalled otherwise the TCTF field is used in MAC header to identify MSCH logical channel type.

## 6.2.2 Transport Channel

FACH is used as a transport channel for MTCH, MSCH and MCCH.

## 6.2.3 Physical Channel

SCCPCH is used as a physical channel for FACH carrying MTCH or MCCH or MSCH.

## 6.2.4 Mapping between channels

Only in downlink, the following connections between logical channels and transport channels exist:

- MCCH can be mapped to FACH
- MTCH can be mapped to FACH
- MSCH can be mapped to FACH

The mappings as seen from the UE and UTRAN sides are shown in Figure 6.2.4-1 and Figure 6.2.4-2 respectively.

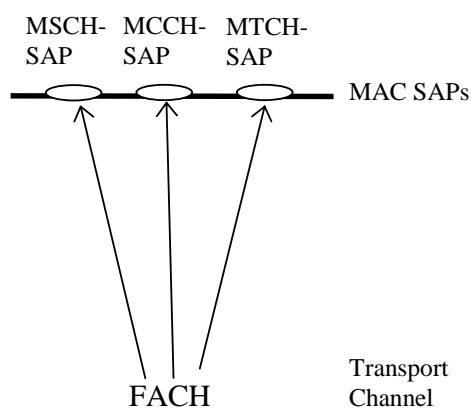

**Figure 6.2.4-1: Logical channels mapped onto transport channel, seen from the UE side**

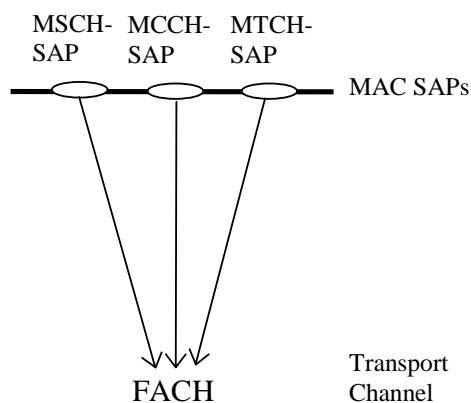

**Figure 6.2.4-2: Logical channels mapped onto transport channel, seen from the UTRAN side**

## 6.2.5 Data Flows through Layer 2

### 6.2.5.1 Data flow for MCCH mapped to FACH

For MCCH, the RLC mode to be employed is UM-RLC, with required enhancements to support out of sequence SDU delivery. A MAC header is used for logical channel type identification.

### 6.2.5.2 Data flow for MTCH mapped to FACH

For MTCH, the RLC mode to be employed is UM-RLC, with required enhancements to support selective combining. Quick repeat may be used in RLC-UM. A MAC header is used for logical channel type identification and MBMS service identification.

### 6.2.5.3 Data flow for MSCH mapped to FACH

For MSCH, the RLC mode to be employed is UM-RLC. A MAC header is used for logical channel type identification.

## 6.3. MBMS Notification Indicator Channel

MBMS notification utilizes a new MBMS specific PICH called the MBMS Notification Indicator Channel (MICH) in each cell. Its coding is defined in [9] (FDD) and [10] (TDD).

---

# 7 MBMS Reception and UE Capability

## 7.1 Selective and Soft Combining for MBMS P-T-M transmission

The selective combining for MBMS p-t-m transmission is supported by RLC PDU numbering. Therefore, the selective combining in the UE is possible from cells providing similar MBMS RB bit rate, provided that the de-synchronization between MBMS p-t-m transmission streams does not exceed the RLC re-ordering capability of the UE. Thus, there exist one RLC entity in the UE side.

To support selective combining it is decided to:

- Introduce re-ordering as a configurable feature of RLC-UM, within the RLC specification.
- Use the same mechanism as what is specified for MAC-hs (single T1 timer).

For selective combining there exist one RLC entity per MBMS service utilizing p-t-m transmission in the cell group of the CRNC. All cells in the cell group are under the same CRNC, i.e. Iur support is not considered.

For soft combining to be possible, the relative delay between the radio links to be combined, when they are received by the UE, must be no more than  $(1 \text{ TTI}) + (1 \text{ slot})$ .

The UE capability requirements to support selective and soft combining are defined in chapter 7.2. In case de-synchronization occurs between MBMS transmissions in neighbouring cells belonging to an MBMS cell group the CRNC may perform re-synchronization actions enabling UEs to perform the selective combining between these cells.

For TDD, selective combining and soft combining can be used when Node-Bs are synchronised. For FDD soft combining can be used when Node-Bs are synchronized inside UE's soft combining reception window, and the data fields of the soft combined S-CCPCHs are identical during soft combining moments.

When selective or soft combining is available between cells the UTRAN should send MBMS NEIGHBOURING CELL INFORMATION containing the MTCH configuration of the neighbouring cells, available for selective or soft combining. When partial soft combining is applied the MBMS NEIGHBOURING CELL INFORMATION contains the L1-combining schedule, which indicates the time moments when the UE may soft combine the S-CCPCH transmitted in neighbouring cells with the S-CCPCH transmitted in the serving cell. With MBMS NEIGHBOURING CELL

INFORMATION the UE is able to receive MTCH transmission from neighbouring cell without reception of the MCCH of that cell.

The UE determines the neighbouring cell suitable for selective or soft combining based on threshold (e.g. measured CPICH  $E_c/N_0$ ) and the presence of MBMS NEIGHBOURING CELL INFORMATION of that neighbour cell.

The possibility of performing selective or soft combining should be signalled to the UE.

## 7.1.bis Simulcast Combining (TDD only)

In contrast to FDD, downlink macro diversity has not been a characteristic of TDD during release '99/4/5. As such TDD receivers are not typically designed to facilitate the simultaneous reception of multiple radio links and the incorporation of such a requirement for MBMS in TDD would have non-trivial impacts on the receiver design.

Much of the receiver complexity increase associated with the combining of multiple radio links in the UE can however be avoided in TDD by combining macro-diversity with timeslot re-use. This also allows for the throughput gains from timeslot re-use to be combined with further gains from macro diversity.

In such a scheme, the transmissions of the same information from the multiple participating cells are arranged such that they arrive at the UE on substantially different timeslots, thereby removing the requirement at the UE to detect multiple cells in the same timeslot.

As such, cells are partitioned into transmission "groups" or "sets". Each transmission set is allocated a timeslot (or set of timeslots) for MBMS transmission. The assigned slots are typically exclusively used by that MBMS set; sets do not transmit when another set is active. The UE attempts to receive information from each set and to combine them either at the physical layer or RLC layer in order to enhance reception reliability.

Figure 7.1.bis shows such a scheme applied to a tri-sectored deployment model. 3 timeslots ( $t_1$ ,  $t_2$  and  $t_3$ ) are allocated to each sector for the purposes of MBMS transmission. Each sector is assigned to a particular "MBMS transmission set", set 1, 2 or 3.

An MBMS data unit or transport block is encoded over several radio frames (eg: 80ms TTI). The physical channel bits that result are effectively transmitted three times; once by MBMS set 1 in timeslot  $t_1$ , once by MBMS set 2 in timeslot  $t_2$ , and once by MBMS set 3 in timeslot  $t_3$ .

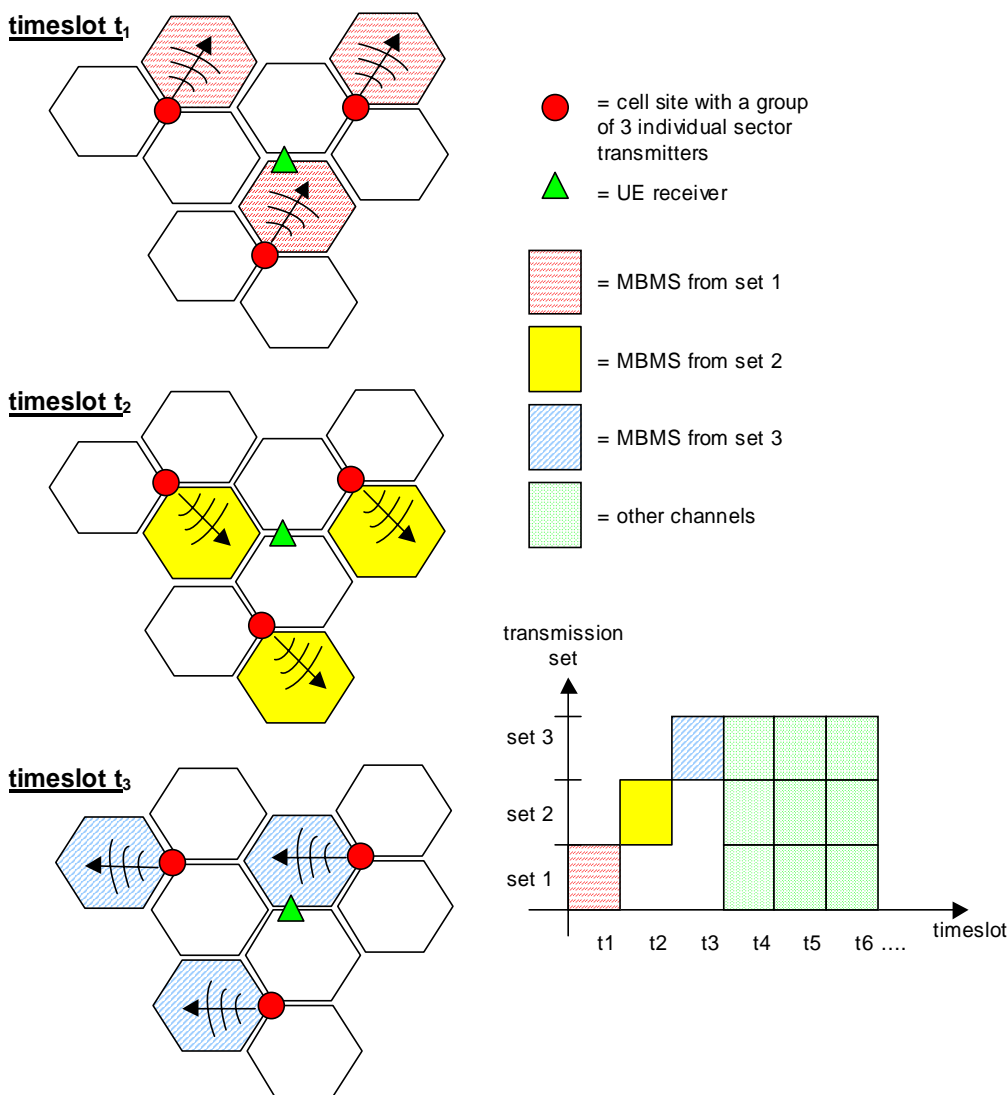

**Figure 7.1.bis: Example of non-time-coincident macro diversity transmission**

A given UE may be configured to listen to the separate transmissions of the MBMS physical channels (one from each set) which, over the course of the TTI, correspond to the MBMS transport block(s). The signals from each MBMS set are largely non-time-coincident and do not require the use of an extensively modified receiver architecture –a receiver architecture resembling that of a normal "single-radio-link" TDD receiver may be used.

The received transport blocks may be provided to the RLC layer for selective combining, or soft information may be buffered and combined across MBMS sets during the course of the TTI via physical layer soft combining .

The UTRAN shall signal to the UE on the MCCH which services may be soft combined (and in which cells). The cell group for soft combining may be different than the cell group for selective combining. The UE may assume that transmissions of a given service that may soft combined take place in the same frame.

## 7.2 UE Capability

The UE MBMS capability is not sent to UTRAN and is subject to UE implementation, including the relation between MBMS capability and actual RRC state which is also a UE implementation. A consequence is that a UE may be counted although its actual capability does not allow to receive MBMS transmissions e.g. because of its current RRC state.

The standard will describe a minimum UE capability requirement in order to allow operators to configure MBMS channels that can be common to all UEs supporting the given service.

There are some UE capability requirements that are common to all eventual service categories:

The minimum UE capability for MBMS capable UE, is one primary CCPCH plus all the configurations below. The UE is not required to support these configurations simultaneously.

1. One PICH and one MICH
2. One S-CCPCH and one MICH
3. One S-CCPCH (dedicated FACH and possibly the FACH, which may carry MCCH) and two S-CCPCH with 80ms TTI for MTCH reception
4. One S-CCPCH (dedicated FACH and possibly the FACH, which may carry MCCH) and three S-CCPCH with 40ms TTI for MTCH reception
5. One PICH and two S-CCPCH with 80ms TTI for MTCH reception
6. One PICH and three S-CCPCH with 40ms TTI for MTCH reception

The requirement one reflects the case when the UE is in Idle mode, or URA\_PCH, CELL\_PCH state and MBMS reception is not ongoing and requirement five and six are for the case that MBMS reception is ongoing in Idle mode, or URA\_PCH, CELL\_PCH state.

The requirement two reflects the case when the UE is in CELL\_FACH state and MBMS is reception not ongoing and requirement three and four are for the case when MBMS reception is ongoing respectively.

The requirement for the number of simultaneous S-CCPCHs for MTCH reception includes those S-CCPCHs for which combining is performed.

When MBMS ptm reception is ongoing, the UE is required to periodically monitor the MCCH, which may be mapped onto a different S-CCPCH from MTCH, and a different S-CCPCH than the R<sup>99</sup> FACH when the UE is in CELL\_FACH state. However this does not increase the requirement for the number of S-CCPCHs to be simultaneously received by the UE.

The ability of the UE to receive DPCH/HS-PDSCH simultaneously with S-CCPCH carrying MTCH/MCCH is subject to UE capability.

The minimum MBMS bit rate that all MBMS capable UEs shall support is to be defined [12].

For FDD, the UE shall support selective combining and soft combining. For TDD, the UE shall support selective and soft combining.

The standard may restrict further the UE implementation options by defining certain capability combinations.

If the UE is supporting MBMS ptm reception in CELL\_DCH state, it shall have capability to acquire MCCH configuration from BCCH after handover procedure, and after that receive MCCH and MTCH.

## 7.3 MBMS Reception

The following descriptions add MBMS specific processes to be considered for each RRC State/Mode.

The BCCH contains information regarding the MCCH, while the latter contains information on the MTCH.

In the sub-sections below, how and when the UE reads the MCCH is not described as periodic MCCH transmission is described in section 5.2.3.

The reception of multiple MBMS services simultaneously is subject to UE capability; selection principles between MBMS services are defined in section 5.2.8. The specific actions related to MBMS session repetition are specified in section 5.2.7.

### 7.3.1 MBMS Reception in RRC Idle Mode

In idle mode, the UE shall:

- if the UE supports MBMS and

- if the UE has activated an MBMS service and there is an ongoing session for this service in the cell where the UE is situated, i.e. MTCH and MCCH are available
  - act on RRC messages received on MCCH and:
    - if the MBMS service requires the establishment of an RRC Connection due to counting response or due to the utilisation of p-t-p transfer mode for the MBMS service:
      - inform upper layers that the MBMS Service requires the establishment of an RRC Connection.
    - if the MBMS service does not require the establishment of an RRC Connection :
      - listen to the common transport channel on which the MTCH is mapped.
    - if the UE determines that a neighbouring cell is suitable for selective or soft combining and the UE has valid MBMS NEIGHBOURING CELL INFORMATION of that cell:
      - performs selective or soft combining of MTCH between the selected cell and the neighbouring cell.

### 7.3.2 MBMS Reception in RRC Connected Mode: URA\_PCH state

In URA\_PCH, the UE shall:

- if the UE supports MBMS and
- if the UE has activated an MBMS service and there is an ongoing session for this service in the URA where the UE is situated, i.e. MTCH and MCCH are available
  - act on RRC messages received on MCCH,
    - if on the MCCH it is indicated that the MBMS service in the cell requires a counting response or is due to the utilisation of p-t-p transfer mode for the MBMS service:
      - initiate a cell update procedure, for sending MBMS COUNTING RESPONSE, or MBMS P-T-P MODIFICATION REQUEST signalling flow. The cause to be used in the cell update procedure is defined in [13].
  - for each MBMS service that the UE has activated and where transmission on a MTCH is indicated in the MCCH, listen to the common transport channel on which the MTCH is mapped,
  - if the UE determines that a neighbouring cell is suitable for selective or soft combining and the UE has valid MBMS NEIGHBOURING CELL INFORMATION of that cell
    - performs selective or soft combining of MTCH between the selected cell and the neighbouring cell.

### 7.3.3 MBMS Reception in RRC Connected Mode: CELL\_PCH state

In CELL\_PCH, the UE shall:

- if the UE supports MBMS and
- if the UE has activated an MBMS service and there is an ongoing session for this service in the cell where the UE is situated, i.e. MTCH and MCCH are available
  - act on RRC messages received on MCCH
    - if on the MCCH it is indicated that the MBMS service in the cell requires counting response or is due to the utilisation of p-t-p transfer mode for the MBMS service:
      - initiate a cell update procedure for sending MBMS COUNTING RESPONSE, or MBMS P-T-P MODIFICATION REQUEST signalling flow. The cause to be used in the cell update procedure is defined in [13].
  - listen to the common transport channel on which the MTCH is mapped,

- if the UE determines that a neighbouring cell is suitable for selective or soft combining and the UE has valid MBMS NEIGHBOURING CELL INFORMATION of that cell
  - performs selective or soft combining of MTCH between the selected cell and the neighbouring cell.

### 7.3.4 MBMS Reception in RRC Connected Mode: CELL\_FACH state

In CELL\_FACH, the UE shall:

- if the UE supports MBMS and
  - if the UE has activated an MBMS service and there is an ongoing session for this service in the cell where the UE is situated, i.e. MTCH and MCCH are available
    - act on RRC messages received on MCCH
      - if on the MCCH it is indicated that the MBMS service in the cell requires a counting response or is due to the utilisation of p-t-p transfer mode for MBMS service:
        - initiate a counting response for sending MBMS COUNTING RESPONSE, or MBMS P-T-P MODIFICATION REQUEST signalling flow.
    - listen to the common transport channel on which the MTCH is mapped
    - if the UE determines that a neighbouring cell is suitable for selective or soft combining and the UE has valid MBMS NEIGHBOURING CELL INFORMATION of that cell
      - performs selective or soft combining of MTCH between the selected cell and the neighbouring cell.

NOTE: For UEs in CELL\_FACH, UTRAN may decide to send MBMS data over DTCH.

### 7.3.5 MBMS Reception in RRC Connected Mode: CELL\_DCH state

In CELL\_DCH, the UE shall,

- if the UE supports MBMS and
  - if the UE has activated an MBMS service and there is an ongoing session for this service in the cell where the UE is situated, i.e. MTCH and MCCH are available and
    - if the UE has the capabilities:
      - act on RRC messages received on MCCH
      - listen to the common transport channel on which the MTCH is mapped.
      - if the UE determines that a neighbouring cell is suitable for selective or soft combining and the UE has valid MBMS NEIGHBOURING CELL INFORMATION of that cell and UE has capability
        - performs selective or soft combining of MTCH between the selected cell and the neighbouring cell.

NOTE: For UEs in CELL\_DCH, UTRAN may decide to send MBMS data over DTCH

---

## 8 UTRAN Signalling Flows for MBMS

### 8.1 MBMS High Level Signalling Scenarios

#### 8.1.1 Session start

Upon receiving a session start indication from CN, UTRAN initiates the session start sequence to allocate radio resources to UEs for receiving the MBMS content. As part of this sequence, UTRAN may apply the counting procedure

(counting the number of idle mode, URA\_PCH, CELL\_PCH and CELL\_FACH state UEs) to decide whether to use the p-t-m or p-t-p transfer mode. For MBMS Broadcast mode, the applicability of the counting procedure for a service is indicated by the CN.

The Figure 8.1.1 shows an example of a possible session start sequence.

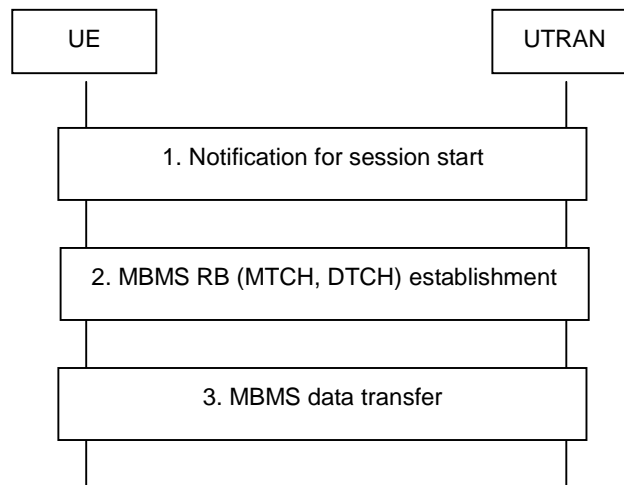

**Figure 8.1.1: Session start**

In general, the session start sequence involves the following steps:

- In case UTRAN applies counting to determine the most optimal transfer mode the following steps are performed:
  - UTRAN sets the correct MBMS Notification Indicator (NI) and sends the MBMS CHANGE INFORMATION and the MBMS ACCESS INFORMATION including service ID, the session ID if received from the CN, and access probability on MCCH.
  - Upon DRX wakeup, UEs in idle mode as well as UEs in CELL\_PCH, URA\_PCH and CELL\_FACH not receiving an MBMS service provided in p-t-m transfer mode evaluate the MBMS NI and if set, read the MBMS CHANGE INFORMATION from MCCH at beginning of the modification period. UEs in idle mode as well as UEs in CELL\_PCH, URA\_PCH and CELL\_FACH receiving an MBMS service provided in p-t-m transfer mode read the MBMS CHANGE INFORMATION directly. If service Id of activated MBMS service and session ID that the UE has not received is indicated in MBMS CHANGE INFORMATION UEs continue reading the rest of MCCH information. Upon receiving the MBMS ACCESS INFORMATION including access probability, UEs in idle mode or URA\_PCH, CELL\_PCH, and CELL\_FACH state for which the probability check passes, initiate counting response. UTRAN counts the UEs interested in the MBMS service combining the UE linking from CN and received counting responses from UEs.
  - In the case that no UE is counted as present in the cell then UTRAN may decide not to provide any RB for the service in the cell.
  - In case a pre- defined threshold is reached, UTRAN applies the p-t-m RB establishment procedure specified below. Otherwise, UTRAN may repeat the MBMS ACCESS INFORMATION a number of times, using different probability values. If the threshold is not reached, UTRAN applies the p-t-p RB establishment procedure
- In case UTRAN selects the p-t-m RB establishment procedure:
  - UTRAN configures MTCH and updates MCCH (MBMS SERVICE INFORMATION and MBMS RADIO BEARER INFORMATION) by including the service ID, the session ID if received from the CN, and p-t-m RB information for the concerned MBMS service
  - In case p-t-m RB establishment is not preceded by counting, UTRAN sets the correct MBMS Notification Indicator (NI) and sends MBMS CHANGE INFORMATION.



- UTRAN sends the MBMS dedicated notification message including the service ID and cause= session start on DCCCH to inform UEs in CELL\_DCH that are not receiving an MBMS service provided using p-t-m transfer mode
- In case p-t-m RB establishment is preceded by counting, UEs read MCCH at the pre- defined time(s) to acquire the MBMS SERVICE INFORMATION and MBMS RADIO BEARER INFORMATION
- In case p-t-m RB establishment is not preceded by counting, Upon DRX wakeup, UEs not receiving MTCH evaluate the MBMS NI and if set, read MCCH at beginning of modification period to acquire MBMS CHANGE INFORMATION. UEs in idle mode as well as UEs in CELL\_PCH, URA\_PCH and CELL\_FACH receiving an MBMS service provided in p-t-m transfer mode read the MBMS CHANGE INFORMATION directly. If service Id of activated MBMS service and session ID that the UE has not received is indicated in MBMS CHANGE INFORMATION UEs continue reading the rest of MCCH information to acquire the MBMS SERVICE INFORMATION and MBMS RADIO BEARER INFORMATION
- UEs that are incapable of receiving the MTCH for the session that is started in parallel to the existing activity notify the user. This enables the user to choose between the ongoing activity and the new MBMS service
- Upon receiving MBMS dedicated notification with cause= session start, UEs in CELL\_DCH that are incapable of receiving the MCCH and the corresponding MTCH in parallel to the existing activity notify the user. This enables the user to choose between the ongoing activity and the new MBMS service. If the user decides to receive the new MBMS service, the UE shall read MCCH to acquire the MBMS SERVICE INFORMATION and MBMS RADIO BEARER INFORMATION.
- Upon receiving the MBMS SERVICE INFORMATION and the MBMS RB INFORMATION including the p-t-m RB information for the concerned MBMS service, the UE starts receiving the p-t-m radio bearers
- In case UTRAN selects the p-t-p RB establishment procedure:
  - UTRAN indicates on MCCH in MBMS CHANGE INFORMATION that MBMS service is provided via p-t-p
  - After receiving MBMS CHANGE INFORMATION UEs interested to receive MBMS service, after possible service prioritisation, request MBMS p-t-p RB establishment by sending MBMS P-T-P MODIFICATION REQUEST signalling flow.
  - Furthermore, UTRAN establishes the p-t-p RB by means of appropriate RRC procedures e.g. the RB setup procedure
  - UEs establish the p-t-p radio bearers by means of the RRC procedure selected by UTRAN eg. the RB setup procedure
  - UTRAN updates MCCH (MBMS SERVICE INFO) to inform UEs joining or entering the cell at a later point in time.

### 8.1.2 Joining (during a session)

In case the user wants to join an MBMS service (before or during a session), the UE initiates NAS procedures (e.g. MBMS service activation).

If no session is ongoing upon completion of the joining procedure, the joining procedure is transparent to the AS.

In case a session using p-t-m transfer mode is ongoing upon completion of the joining procedure, the UE may initiate reception of the p-t-m radio bearers. In case the ongoing session applies p-t-p transfer mode, UTRAN may establish the p-t-p radio bearers. UTRAN would do this upon receiving a UE linking indication from CN, which normally follows the joining. As a result of the UE linking, UTRAN may decide to change the transfer mode from p-t-p to p-t-m. This change of transfer mode is out of the scope of this sequence (to be covered by a separate sequence).

The Figure 8.1.2 shows an example of a possible joining sequence.

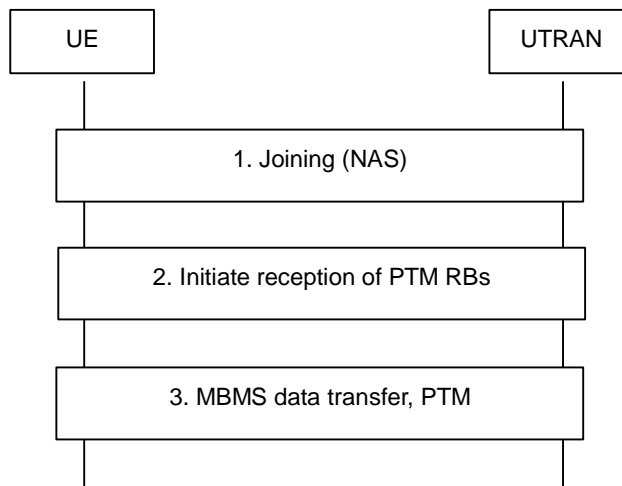

**Figure 8.1.2: Joining with continuation of p-t-m**

In general, the joining sequence involves the following steps:

- UEs in idle mode first perform RRC connection establishment, while UEs in CELL\_PCH and URA\_PCH first perform cell update
- UEs initiate the joining procedure (NAS)
- In case UTRAN continues to use the p-t-m transfer mode:
  - UTRAN sends the MBMS dedicated notification message on DCCH including the service ID and cause= session ongoing to inform UEs in CELL\_DCH
  - Upon receiving MBMS dedicated notification with cause= session ongoing, UEs in CELL\_DCH that are incapable of receiving the MCCH and the corresponding MTCH in parallel to the existing activity notify the upper layer. This enables the user to choose between the ongoing activity and the new MBMS service. If the user chooses to receive the new MBMS service or if the UE in Cell\_DCH is capable of receiving MCCH and MTCH in parallel to the existing activity, the UE shall read MCCH to acquire the MBMS SERVICE INFORMATION and MBMS RADIO BEARER INFORMATION from MCCH.
  - Upon acquiring the MBMS SERVICE INFORMATION and the MBMS RADIO BEARER INFORMATION including the p-t-m RB information for the concerned MBMS service, the UE starts receiving the p-t-m radio bearers
- In case UTRAN continues using the p-t-p transfer mode:
  - UTRAN establishes the p-t-p RB by means of appropriate RRC procedures eg. the RB setup procedure
  - UEs establish the p-t-p radio bearers by means of the RRC procedure selected by UTRAN eg. the RB setup procedure.

### 8.1.3 Recounting

During a p-t-m MBMS session, UTRAN may perform re-counting to verify if p-t-m is still the optimal transfer mode. The purpose of the re-counting procedure is to count the number of idle mode, URA\_PCH, CELL\_PCH, and CELL\_FACH state UEs that have joined a specific service. As a result of this procedure, UTRAN may decide to change the transfer mode from p-t-m to p-t-p. This change of transfer mode is outside the scope of this sequence (to be covered by a separate sequence).

The Figure 8.1.3 shows an example of a possible recounting sequence.

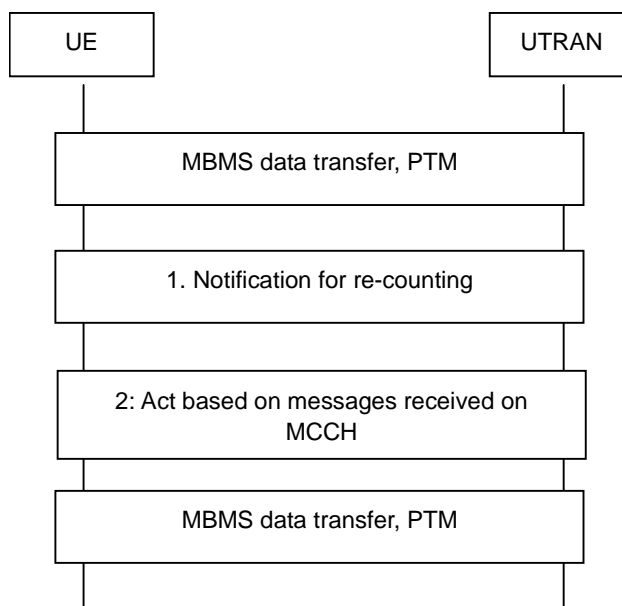

**Figure 8.1.3: Recounting with continuation of p-t-m**

In case UTRAN applies re-counting to determine the most optimal transfer mode, the following steps are performed:

- UTRAN sends the MBMS CHANGE INFORMATION and the MBMS ACCESS INFORMATION including service ID, and access probability on MCCH
- UEs in idle mode as well as UEs in CELL\_PCH, URA\_PCH and CELL\_FACH receiving an MBMS service provided in p-t-m transfer mode read the MBMS CHANGE INFORMATION at the beginning of each modification period. If service Id of activated MBMS service is indicated in MBMS CHANGE INFORMATION UEs continue reading the rest of MCCH information.
- Upon receiving the MBMS ACCESS INFORMATION including access probability, UEs in idle mode or URA\_PCH, CELL\_PCH and CELL\_FACH state for which the probability check passes, initiate counting response.
- UTRAN counts the UEs interested in the MBMS service combining the UE linking from CN and received counting responses from UEs.
- In the case that no UE is counted as present in the cell then UTRAN may decide not to provide any RB for the service in the cell.
- In case a pre-defined threshold is reached, UTRAN continues using the p-t-m transfer mode. Otherwise, UTRAN may repeat the MBMS ACCESS INFORMATION a number of times, using different probability values. If the threshold is not reached, UTRAN switches transfer mode from p-t-m to p-t-p
- In case UTRAN continues using the p-t-m transfer mode, it may return UEs that responded to counting back to idle mode by releasing the RRC connection.

### 8.1.4 Session stop

UTRAN may apply the session stop procedure to inform UEs that the end of MTCH transmission concerns the end of a session rather than just an idle period. The purpose of the procedure is to reduce the UE power consumption.

The Figure 8.1.4 shows an example of a possible session stop sequence.

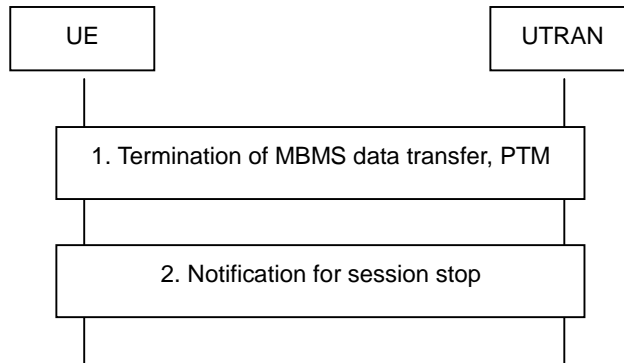

**Figure 8.1.4: Session stop**

In case UTRAN provides the service p-t-m, the session stop sequence involves the following steps:

- UTRAN updates the MBMS CHANGE INFORMATION, MBMS SERVICE INFORMATION and the MBMS RADIO BEARER INFORMATION including the service ID and the explicit radio bearer release indicator. UTRAN updates MCCH (MBMS SERVICE INFORMATION) to inform UEs joining or entering the cell in a later point of time.
- UEs in idle mode as well as UEs in CELL\_PCH, URA\_PCH and CELL\_FACH receiving an MBMS service provided in p-t-m transfer mode read the MBMS CHANGE INFORMATION at the beginning of the each modification period. If service Id of activated MBMS service is indicated in MBMS CHANGE INFORMATION UEs continue reading the rest of MCCH information.
- Upon receiving this information the UE stops receiving the MTCH

In case UTRAN provides the service p-t-p, the session stop sequence involves the following steps:

- UTRAN releases the p-t-p radio bearers and updates MCCH (MBMS SERVICE INFO) to inform UEs joining or entering the cell at a later point in time.

## 8.2 MBMS RNC Signalling Flows

### 8.2.1 MBMS Session Start procedure

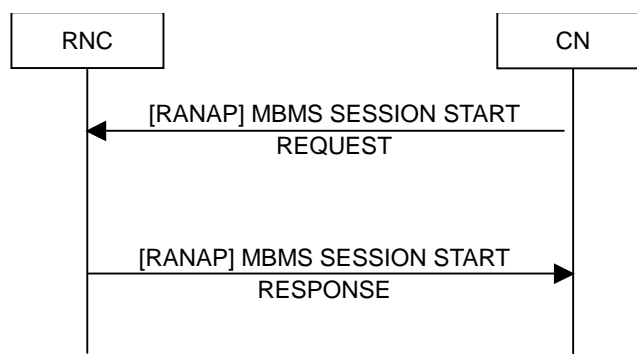

**Figure 8.2.1: MBMS Session Start procedure. Successful operation.**

The MBMS Session Start procedure is initiated by the CN when an MBMS Session is started. The MBMS SESSION START REQUEST is sent to each RNC that is connected to the CN (in case of Iu-flex the RNC may receive more than one MBMS SESSION START REQUEST message).

The MBMS SESSION START REQUEST contains the MBMS Service Id, and optionally the MBMS Session ID, MBMS Bearer Service Type and the MBMS Session Attributes (MBMS Service Area Information, QoS parameters...) It may also include a list of RAs which lists each RA that contains at least one PMM-IDLE UE that has activated the service.

MBMS Session Start procedure also provides the MBMS Iu Data Bearer Establishment functionality. In case of Iu-flex the RNC shall not establish more than one MBMS Iu bearer for a certain service towards a pool area and shall inform the respective CN nodes accordingly.

### 8.2.2 MBMS Session Update procedure

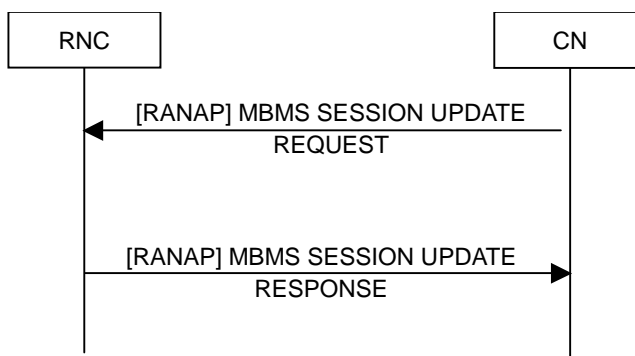

**Figure 8.2.2: MBMS Session Update procedure. Successful operation.**

The MBMS Session Update procedure is initiated by the CN when an MBMS Session is ongoing and SGSN notices that there is a need to update the list of RAs. The MBMS SESSION UPDATE REQUEST contains the MBMS Service Id, and e.g. List of RAs with PMM Idle UEs..

### 8.2.3 MBMS Session Stop procedure

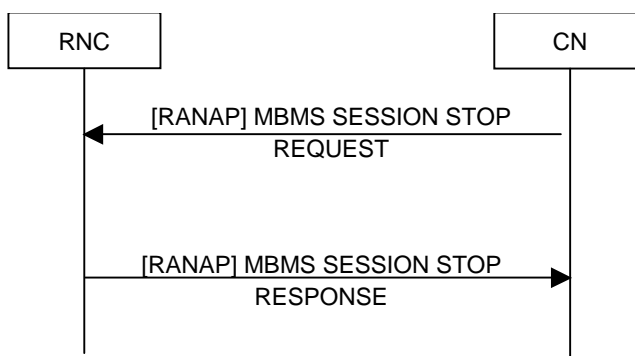

**Figure 8.2.3: MBMS Session Stop procedure.**

This signalling flow depicts the MBMS Session Stop procedure.

This procedure is initiated by the CN to the RNCs with an ongoing MBMS session, when no more data will be sent for that MBMS service for some period of time.

The MBMS Session Stop procedure also provides the MBMS Iu Data Bearer Release functionality.

## 8.2.4 RNC Registration procedure

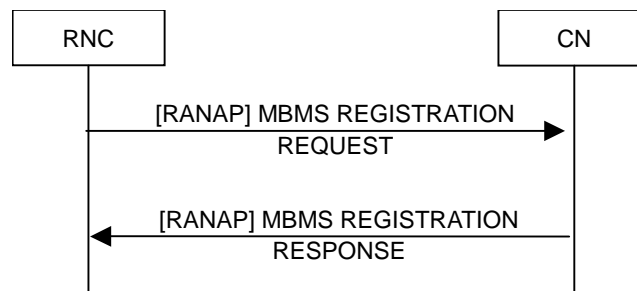

**Figure 8.2.4: MBMS Registration procedure.**

This signalling flow depicts the MBMS Registration procedure.

This procedure is initiated by the RNC in the case that the RNC is not SRNC for any UE that has joined the MBMS Service, but this RNC is DRNC for PMM-CONNECTED UEs that have joined the MBMS Service and there is no MBMS Service Context for the MBMS Service in this RNC.

This procedure shall be initiated by the DRNC, as soon as a UE link is received over the Iur and there exists no MBMS Service Context for the MBMS service for which the UE link is received.

## 8.2.5 RNC De-Registration procedure

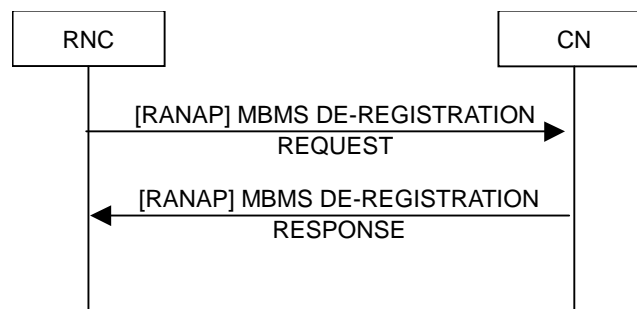

**Figure 8.2.5: RNC MBMS De-Registration procedure.**

This signalling flow depicts the RNC De-Registration procedure. This procedure is initiated by the RNC towards the CN node it was registered to in case the RNC is not acting as a Serving RNC for any UE that has activated the MBMS Service and has ceased to act as a Drift RNC for UEs which has activated an MBMS service.

## 8.2.6 CN De-Registration procedure

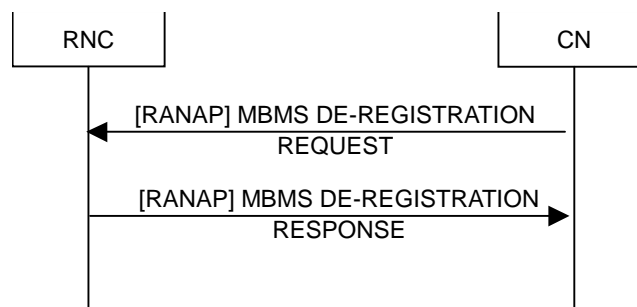
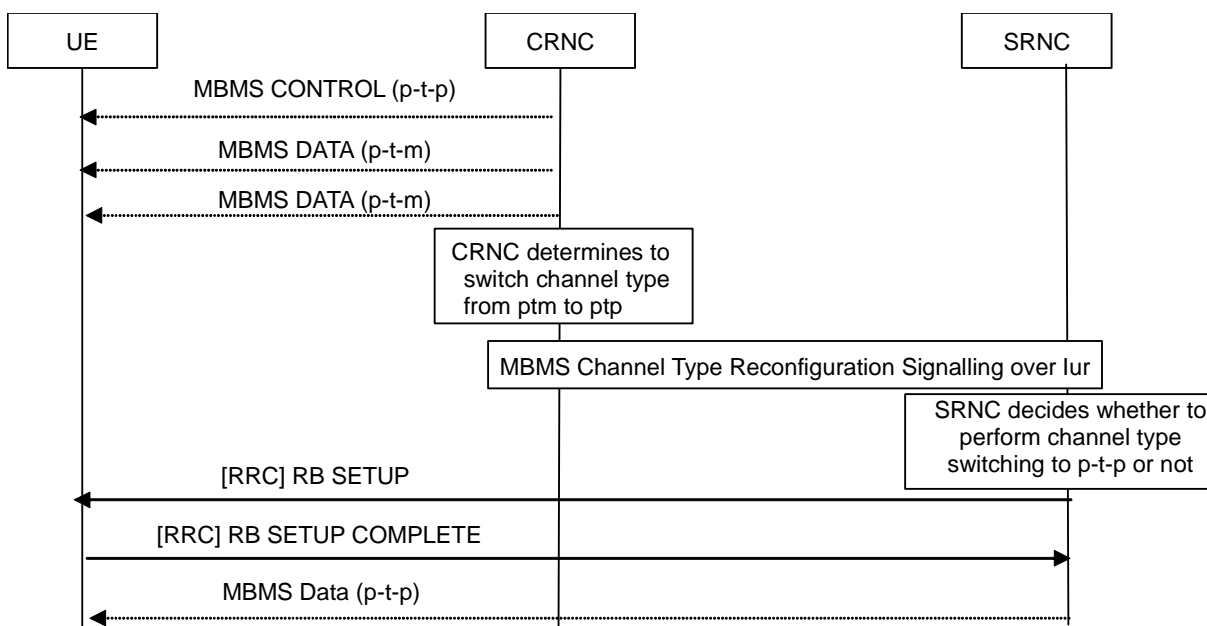

**Figure 8.2.6: CN MBMS De-Registration procedure.**

This signalling flow depicts the CN De-Registration procedure.

This procedure is initiated by the CN in order to inform the RNC that a certain MBMS Service is no longer available.

### 8.2.7 MBMS Channel Type Switching over Uu

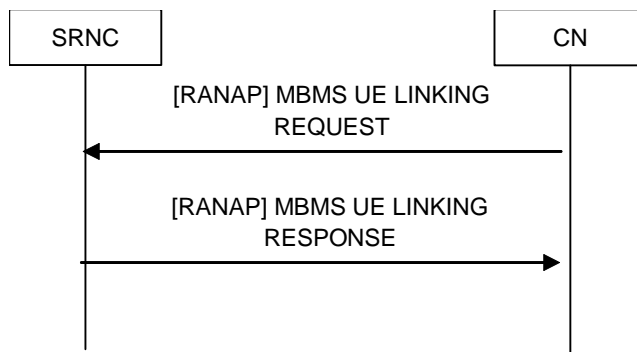

**Figure 8.2.7: Channel type switching signalling flow from p-t-m to p-t-p.**

The CRNC is responsible for the decision regarding having p-t-m transmission or no p-t-m transmission in a cell for a specific MBMS service. The CRNC informs all the SRNCs having UEs in that cell about its decision. The SRNC is the RNC controlling the RRC connection and RBs to a specific UE. In the example shown, the CRNC decided to no longer use p-t-m, then the SRNC decided to perform channel type switching to deliver the MBMS service over DTCH mapped on a dedicated channel. The RB SETUP message contains the MBMS Service Id. It is FFS whether the SRNC always follows the CRNC's request or not.

NOTE: the channel type switching in this case includes a change of both transport and logical channels.

### 8.2.8 MBMS UE Linking

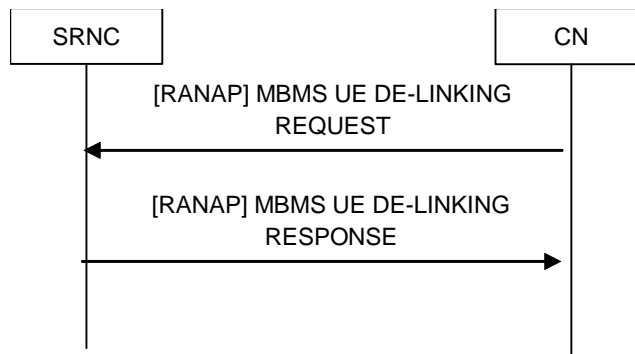

**Figure 8.2.8: MBMS UE linking signalling flow**

This signalling flow is only applicable for handling UEs in PMM-CONNECTED mode with activated MBMS Services.

The signalling flow is used to link a specific UE to one or several MBMS service contexts in the SRNC. The MBMS UE LINKING REQUEST message contains the whole list of MBMS Service Ids and MBMS PTP RAB IDs (e.g. mapped from NSAPIs) activated by the UE. If there has not been an MBMS service context related to an MBMS Service Id then SRNC creates an MBMS service context as a result of this procedure.

### 8.2.9 MBMS UE De-Linking

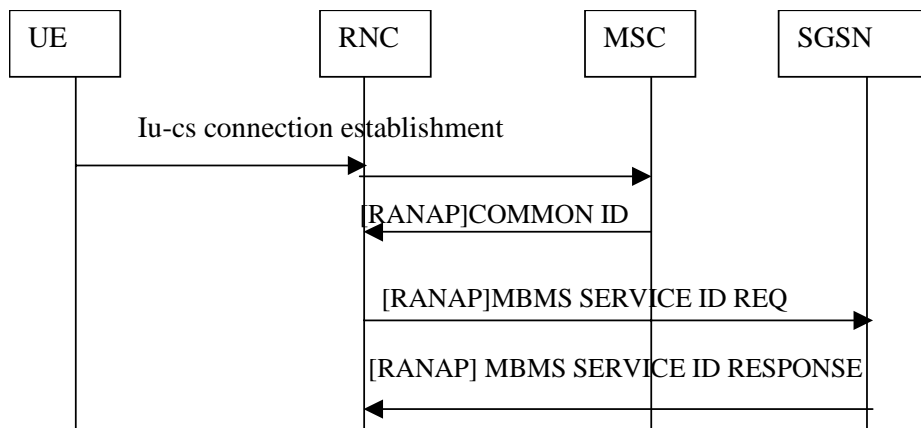

**Figure 8.2.9: MBMS UE De-linking signalling flow**

This signalling flow is only applicable for handling UEs in PMM-CONNECTED mode with activated MBMS Services.

The signalling flow is used to remove a specific UE from one or several MBMS service context in the SRNC. The MBMS UE DE-LINKING REQUEST message contains the list of MBMS Service Ids de-activated by the UE.

### 8.2.10 MBMS Service Id Request



**Figure 8.2.10: MBMS Service Id list over Iu signalling flow**

This signalling flow is applicable for handling MBMS to UEs in RRC-Connected, PMM-IDLE state. The list of MBMS services the user has joined is sent over Iu.

The purpose of this signalling flow is to perform UE linking for a RRC connected, PMM idle user. The UE provides an indication that the user has joined at least one MBMS service and the PS Domain specific IDNNS (the message that would carry this information is FFS) whenever an Iu-cs connection is established and the UE is PMM idle (that is there is no Iu-ps connection), The RNC requests the MBMS services the UE has joined from the SGSN (or the SGSN the UE is attached to in case of Iu-flex) using a connectionless procedure. The MBMS SERVICE ID REQ contains the IMSI of the UE. The SGSN response contains the full list of MBMS services the user has joined.

The MBMS service list is then stored in the RNC. The list is deleted when the UE moves to RRC idle and the RRC context is removed in the RNC.



## 8.2.11 MBMS Attach/Detach over Iur

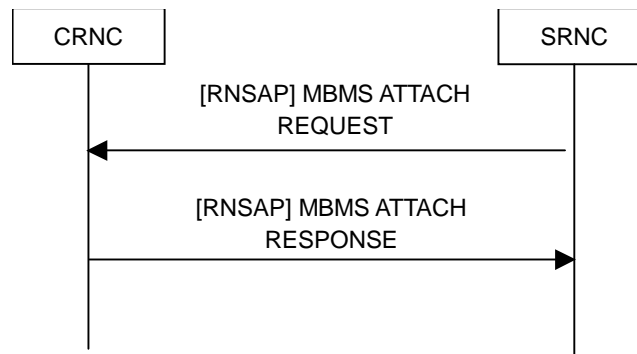
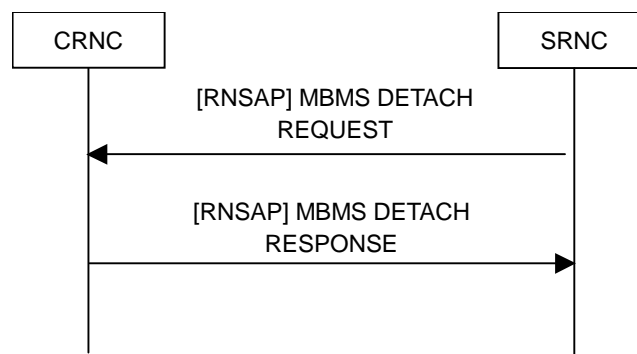

**Figure 8.2.11-1: MBMS attach request signalling flow: Successful Operation.**

This signalling flow is only applicable for handling UEs in RRC connected mode with activated MBMS Services.

The purpose of this signalling flow is

- to either allow the CRNC to add one or several new UEs to the total number of UEs in a given cell using one or several MBMS services. The MBMS ATTACH REQUEST then contains the Cell Id of the new cell (may contain the URA Id of the new URA for UEs in URA\_PCH state), the whole list of affected MBMS Service Ids and a UTRAN specific UE Identification if necessary.
- or to allow the SRNC to inform the DRNC in which URA notifications for MBMS Services have to be sent. The MBMS ATTACH REQUEST then contains a list of URAs and the corresponding MBMS Services.



**Figure 8.2.11-2: MBMS detach request signalling flow: Successful Operation.**

This signalling flow is only applicable for handling UEs in RRC connected mode with activated MBMS Services.

The purpose of this signalling flow is

- to either allow the CRNC to decrease the total number of UEs receiving one or several MBMS service in a given cell. The MBMS DETACH REQUEST contains the Cell Id of the old cell (may contain the URA Id of the old URA for UEs in URA\_PCH state), the whole list of affected MBMS Service Ids and a UTRAN specific UE Identification if necessary.
- or to allow the SRNC to inform the DRNC in which URA there is not anymore a need to send notifications for MBMS Services due to the presence of UEs in URA\_PCH. The MBMS DETACH REQUEST then contains a list of URAs and the corresponding MBMS Services

## 8.2.12 MBMS Channel Type Reconfiguration over Iur

These signalling flows need further study.

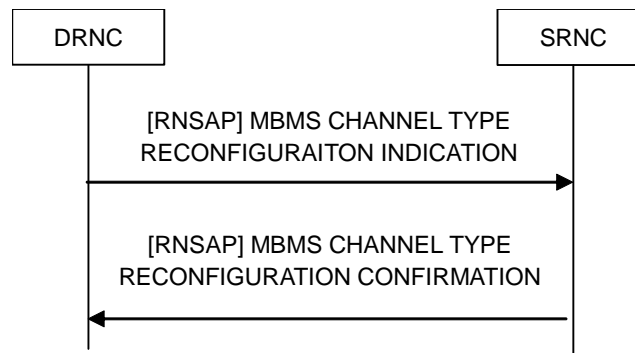

**Figure 8.2.12: Channel Type Reconfiguration signalling flow: Successful Operation.**

This signalling flow is only applicable for handling MBMS UEs in RRC connected mode.

The purpose of this signalling flow is that the CRNC informs the selected channel type to the SRNCs used in a cell under the CRNC. The MBMS CHANNEL TYPE RECONFIGURATION INDICATION contains a list of U-RNTI, Channel type and MBMS Service Id corresponding to the UEs connected to the SRNC.

### 8.2.13 Information Exchange over Iur

These signalling flows is used by the DRNC to acquire the MBMS related information for MBMS service identified by TMGI.

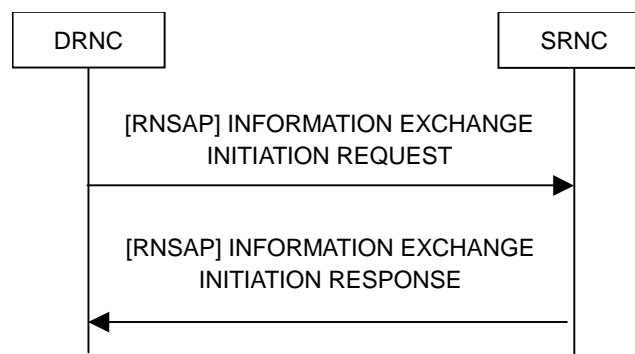

**Figure 8.2.13: Information Exchange Initiation signalling flow: Successful Operation.**

The purpose of this signalling flow is that the DRNC request the APN and IP multicast address for an MBMS service. The INFORMATION EXCHANGE INITIATION REQUEST includes the TMGI for which the APN and IP multicast address are requested. In the INFORMATION EXCHANGE INITIATION RESPONSE message, the corresponding APN and IP multicast address are included.

### 8.2.14 MBMS RAB Establishment Indication

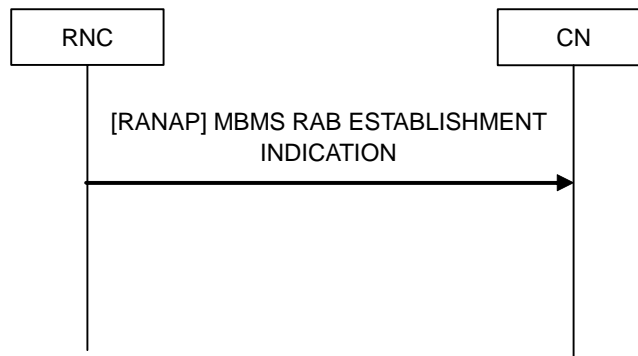

**Figure 8.2.14: MBMS RAB Establishment Indication procedure**

This signalling flow is used by the RNC to indicate to the CN the establishment of the MBMS RAB corresponding to the MBMS Iu signalling connection.

When the RNC decides not to establish an MBMS Iu bearer, for a particular MBMS service, during MBMS Session Start procedure, for example the RNC does not control any contained in MBMS Service Area Information and the RNC does not belong to any of the RA in a list of RAs which lists each RA that contains at least one PMM-IDLE UE but later when a UE linking (via Iu or Iur) is performed or as a result (p-t-p decision) of channel type reconfiguration in another RNC, the RNC establishes the Iu bearer and uses this procedure to inform the CN that an Iu bearer has been established.

If Iu-Flex is active, the selection of the CN node is implementation dependant.

The MBMS RAB ESTABLISHMENT INDICATION message contains the *Transport Layer Address* IE and the *Iu Transport Association* IE.

## 8.2.15 MBMS RAB Release

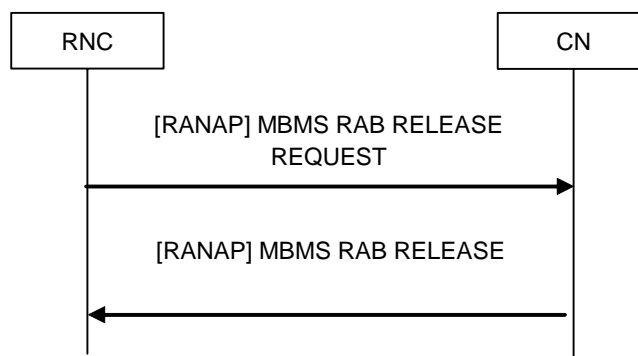

**Figure 8.2.15: MBMS RAB Release Request procedure.**

This signalling flow is used by the RNC to indicate to the CN to request the release of an MBMS RAB.

At reception of the MBMS RAB RELEASE REQUEST message the CN should initiate the release of all MBMS resources related to the Iu connection without releasing the Iu signalling connection.

The RNC shall at reception of MBMS RAB RELEASE initiate the release of the related MBMS RAB resources.

The MBMS RAB release may be initiated e.g. for the following reasons (unexhausted):

- There are lack of radio resource in UTRAN and RNC decided to pre-empt an MBMS RAB for a on-going MBMS session based on Allocation/Retention Priority

- When there are no UEs interested in MBMS consuming radio resources in cells under the RNC or the RNC is controlling UEs in cells under another RNC;
- In case of channel type switching from ptp to ptm in cells under control of another RNC in its role of DRNC;
- There are no cells under the RNC which are part of the RA List Of Idle UEs if received.

## 8.3 MBMS Uu Signalling Flows

### 8.3.1 Broadcast of MBMS System Information

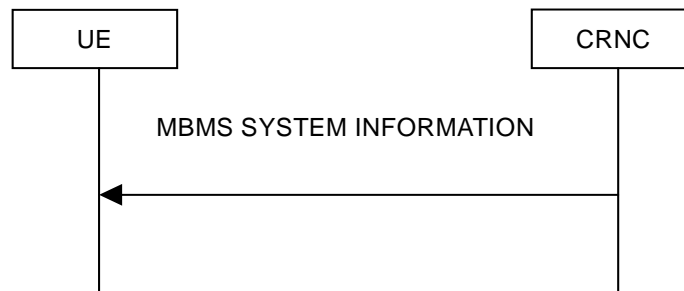

**Figure 8.3.1: Broadcast of MBMS system information.**

This signalling flow is applicable for handling MBMS to UEs in PMM IDLE and PMM-CONNECTED mode.

The purpose of the signalling flow is for UTRAN to broadcast MBMS system information to UEs using the BCCH. The MBMS SYSTEM INFORMATION shall be repeatedly transmitted after its first transmission. Upon receiving the first MBMS SYSTEM INFORMATION, the UE shall establish the radio bearer carrying an MCCH.

The MBMS SYSTEM INFORMATION includes:

- MCCH schedule information (access info, repetition and modification periods)
- Configuration of a radio bearer carrying an MCCH

More information may be included in the MBMS SYSTEM INFORMATION.

### 8.3.2 MBMS Service Information

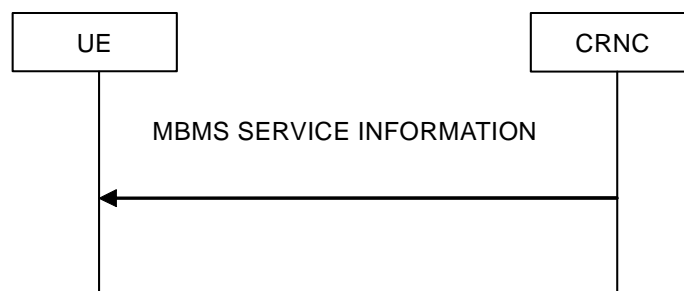

**Figure 8.3.2: MBMS service information signalling flow**

This signalling flow is applicable for handling MBMS to UEs in PMM IDLE and PMM-CONNECTED mode.

The purpose of the signalling flow is for RNC to inform UEs of all of MBMS services available in one cell. The MBMS SERVICE INFORMATION shall be transmitted periodically on MCCH to provide an indication of the status of the MBMS service in the cell and to support mobility.

The MBMS SERVICE INFORMATION contains MBMS service ids, optionally the MBMS Session ID, and an indication of the service status in the cell i.e. whether it is provided by p-t-m or p-t-p bearers or whether explicit release is indicated. The MBMS service ids indicate the MBMS services which are being served in the cell or the MBMS

services which can be served if the UE requests it. P-t-m indication indicates that the MBMS service is on p-t-m in the cell, thus it informs the UE of the need of reception of the MBMS RADIO BEARER INFORMATION.

### 8.3.3 MBMS Radio Bearer Information

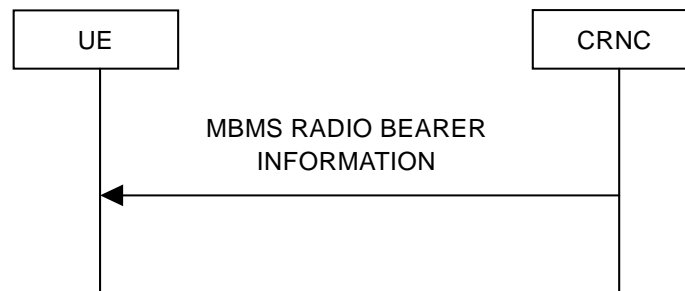

**Figure 8.3.3: MBMS radio bearer information signalling flow**

This signalling flow is applicable for handling MBMS to UEs in IDLE and PMM-CONNECTED mode.

The purpose of the signalling flow is for the RNC to inform UE(s) regarding the MTCH radio bearer information. MBMS RADIO BEARER INFORMATION is only available for p-t-m transmission. MBMS RADIO BEARER INFORMATION shall be transmitted periodically on MCCH to support mobility in the MBMS service.

MBMS RADIO BEARER INFORMATION includes MBMS Service Id, radio bearer, transport channel and physical channel information per MBMS service.

### 8.3.4 MBMS Access Information

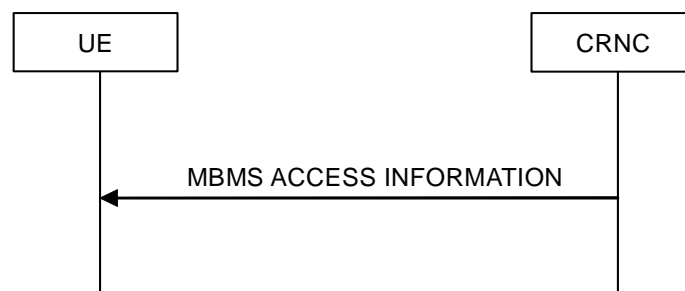
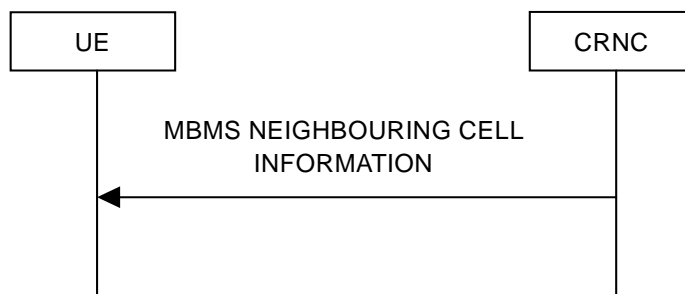

**Figure 8.3.4: MBMS Access Information signalling flow**

This signalling flow is applicable for handling MBMS UEs in IDLE mode or URA\_PCH, CELL\_PCH, CELL\_FACH state.

The purpose of the signalling flow is for the RNC to inform UE(s) interested in a particular service of the potential need to make an MBMS Counting Response i.e. establish an RRC connection or make a cell update. The MBMS ACCESS INFORMATION is transmitted during counting and re-counting on MCCH. The MBMS ACCESS INFORMATION includes, for each service for which counting is required, the MBMS service identifier, probability factors for idle and connected modes and an indication of the connected mode states to which the signalling flow applies.

### 8.3.5 MBMS Neighbouring Cell Information



**Figure 8.3.5: MBMS Neighbouring Cell Information signalling flow**

This signalling flow is applicable for handling MBMS to UEs in PMM IDLE and CONNECTED mode.

The purpose of the MBMS NEIGHBOURING CELL INFORMATION signalling flow is for the UTRAN to inform to UEs of the MTCH configuration of the neighbouring cells which are available for selective combining. In case of partial soft combining, the MBMS NEIGHBOURING CELL INFORMATION contains the L1-combining schedule, which indicates when the soft combining is applicable between the specific S-CCPCH of the cell and the specific S-CCPCH of the neighbouring cell. With MBMS NEIGHBOURING CELL INFORMATION the UE is able to receive MTCH transmission from neighbouring cell without reception of the MCCH of that cell. The MBMS NEIGHBOURING CELL INFORMATION shall be repeatedly transmitted on MCCH when selective or soft combining is utilized in the MBMS p-t-m transmission in the given cell group.

### 8.3.6 MBMS Joined Indication



**Figure 8.3.6: MBMS joined indication signalling flow**

This signalling flow is applicable for handling MBMS to UEs in RRC-Connected, PMM-IDLE state. The MBMS JOINED INDICATION is sent over the DCCH.

The signalling flow is initiated by the UE after entering RRC-Connected, PMM-IDLE state. The purpose of the signalling flow is to enable the UE to inform the SRNC that the user has joined at least one MBMS service. The SRNC requests the MBMS services the UE has joined from the SGSN as defined in subclause 8.2.10.

In SRNC relocation this information is transmitted from source RNC to target RNC.

**NOTE:** If SRNC has valid linking information the complete service list of activated services is also transmitted from source RNC to target RNC in SRNC relocation.

### 8.3.7 MTCH Scheduling Information



**Figure 8.3.7: MTCH scheduling information.**

This signalling flow is applicable for handling MBMS to UEs in PMM IDLE and CONNECTED mode.

The purpose of the signalling flow is to enable UEs to perform discontinuous reception of MTCH. The UE may discontinuously receive MTCH based on scheduling information indicated by the MTCH SCHEDULING INFORMATION. This signalling is transmitted on MSCH mapped on SCCPCH carrying MTCH. The MTCH SCHEDULING INFORMATION is signalled on each MSCH repetition period. The MSCH repetition period and the offset from the MCCH modification period are indicated on MCCH. In case of soft combining, the MSCH repetition period is same for all soft combinable S-CCPCH. The scheduling information allows to cover different periods for different MBMS services.

The MTCH SCHEDULING INFORMATION includes for each service:

- MBMS service Id (the actual coding is defined in stage-3).
- Beginning and duration of MBMS data transmission (one contiguous block or more is defined in Stage-3).
- Duration can be infinite (no DTX). This option could be signalled in the MCCH (Stage-3 definition).
- Indication of no MBMS data transmission for either this period or several consecutive periods (a period is expressed in MSCH repetition period).

### 8.3.8 MBMS Change Information

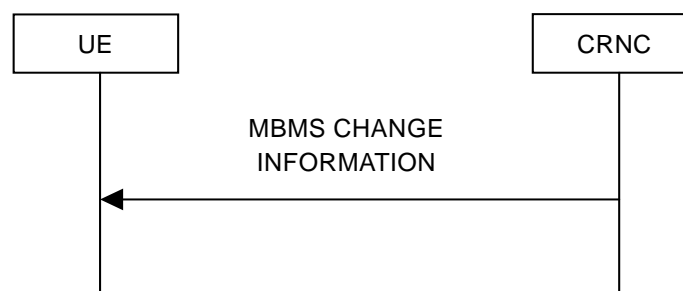

**Figure 8.3.8: MBMS change information.**

This signalling flow is applicable for handling MBMS to UEs in PMM IDLE and CONNECTED mode. UTRAN should transmit this signalling flow in beginning of each modification period on MCCH and repeat it at least in every repetition period of that modification period. UE shall read this information flow when detecting that MICH bits set for a service that UE has activated, or periodically at the begin of each modification period when receiving MTCH.

The purpose of the signalling flow is to indicate MBMS services whose MCCH information is changed in that modification period. The content of MBMS CHANGE INFORMATION shall be minimized, so that the MCCH reading time for the UEs, activated MBMS service whose MCCH information is not modified on that modification period, is minimized.

The MBMS CHANGE INFORMATION includes:

- The MBMS service Ids for which MCCH information is modified on that modification period.

### 8.3.9 MBMS P-T-P Modification Request

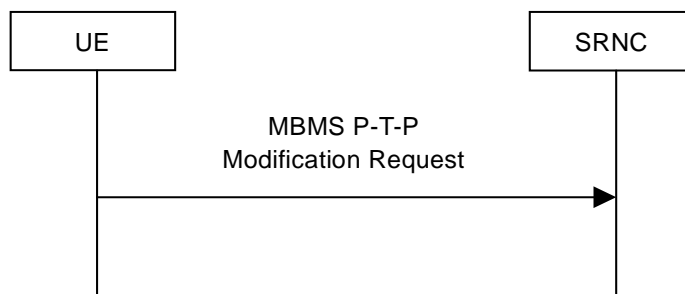

**Figure 8.3.9: MBMS P-T-P Modification Request.**

This signalling flow is applicable for handling UEs that are interested to receive MBMS p-t-p RB in PMM IDLE and CONNECTED mode. In idle mode, URA\_PCH and CELL\_PCH states the UE may transmit this signalling flow to request the setup of a p-t-p MBMS RB after receiving the indication on MCCH that p-t-p transfer mode is utilised or, in CELL\_DCH state, to request the release of the p-t-p MBMS RB due to higher priority MBMS service, or to indicate the frequency used for transmitting the higher priority service as specified in subclause 5.2.8. This signalling flow is transmitted on DCCH or on CCCH dependent upon UE state.

UEs in idle mode are required to perform RRC connection establishment for sending this information flow. UEs that are in URA\_PCH or CELL\_PCH state are required to make a cell update and UEs that are in CELL\_DCH state transmit an MBMS MODIFICATION REQUEST message.

When UTRAN receives this message from the UE, the UTRAN may setup or release the p-t-p MBMS RB by normal RB release procedure or, in the case of a preferred frequency being indicated, it may perform inter-frequency HHO.

The MBMS P-T-P Modification Request message includes the identity of the MBMS service when the service appears in the list of MBMS Selected Services.

### 8.3.10 MBMS Counting Response

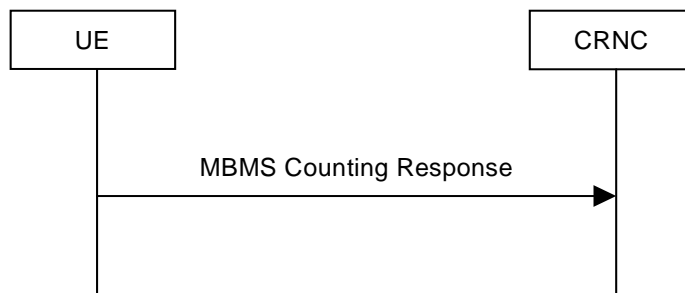

**Figure 8.3.10: MBMS Counting Response.**

This signalling flow is applicable for UEs passing the probability check in counting procedure in idle mode or URA\_PCH, CELL\_PCH or CELL\_FACH state. For the UE in idle mode this signalling flow refers to the complete RRC connection establishment procedure. For UEs in URA\_PCH, CELL\_PCH and CELL\_FACH state this signalling flow refers to cell update procedure.

The MBMS Counting Response message includes the identity of the MBMS service when the service appears in the list of MBMS Selected Services.



### 8.3.11 MBMS Selected Services Information

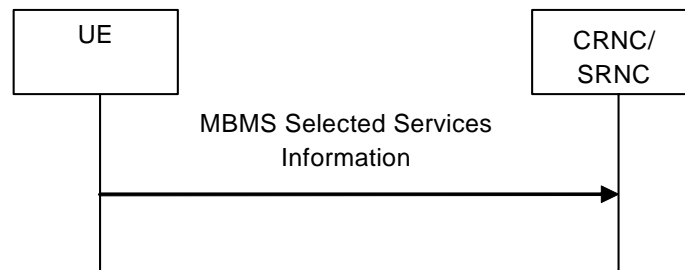

This signalling flow is applicable for UEs entering CELL\_DCH state. The purpose of the signalling flow is to enable the UE to inform the SRNC that the user requires the reception of MBMS Selected Services. When the SRNC is not the CRNC of the UE, this signalling flow may interact with the URA linking/de-linking described in sub-clause 5.1.10.

This signalling flow is also applicable for UEs in CELL\_DCH states, when the list of MBMS Selected Services has been modified.

This signalling flow is also applicable for UEs in CELL\_PCH, URA\_PCH and CELL\_FACH states when the list of MBMS Selected Services has been modified by the upper layers and the MBMS Service appears in the MCCH of the cell and the RNC has indicated in the MBMS GENERAL INFORMATION message that it should be notified of a change to this list. If an MBMS Service is contained in the list of MBMS Selected Services but is currently not available in the cell, when the service appears on the MCCH the UE does not perform this signalling flow.

The purpose of the signalling flow is to enable the UE to inform the CRNC that the list of MBMS Selected Services in the UE has been modified.

---

## 9 Security for MBMS

Ciphering for MBMS multicast data is done between the BM-SC and the UE as defined in [7]. Therefore, for MBMS p-t-m data transmissions no radio interface ciphering is applied.

In case of p-t-p MBMS data transmissions, if the security is activated for the UE the ciphering is also applied for p-t-p MBMS data RB as for any other RB of the UE.

---

## 10 Mobility Procedures for MBMS

One of the requirements in [5] is: "Data loss during cell change should be minimal". Therefore, when the UE receiving an MBMS session in idle mode or connected mode (not including CELL\_DCH) re-selects between cells, it should be possible to provide service continuity to this UE.

The following mechanism has been identified to minimise the data loss on cell change.

### 10.1 Use of Periodical Transmission of MBMS Critical Information

In this mechanism, the cell periodically transmits an MBMS critical information, informing all MBMS services currently configured for p-t-m transmission or p-t-p transmission. If MBMS service is configured for p-t-m transmission, the periodical transmission of MBMS critical information may also contain the Radio Bearer information corresponding to each MBMS service and Neighbouring cell information.

If the cell is configured for p-t-p transmission, then the UE would perform a normal RRC connection establishment.

## 10.2 UE Actions for Mobility

The UE mobility between intra frequency cells is not affected by the MBMS reception. The mobility between different frequency layers is affected by the Frequency Layer Convergence process as defined in 11.2, if used by the network.

In CELL\_FACH and in CELL\_DCH state the RRC operation has priority over MBMS reception, thus UE performs the inter frequency and inter RAT measurements as configured by the SRNC. UTRAN should utilize different periodicities between MCCH transmissions and CELL\_FACH state measurement occasion, such that CELL\_FACH state measurements and MCCH transmissions are not constantly overlapping for some UE.

In Idle mode and in CELL\_PCH, URA\_PCH states the measurements are performed as configured by the network based on the Release 5. The MBMS specific measurement occasions to S-CCPCH for UEs in idle mode and in CELL\_PCH, URA\_PCH states are not introduced and measurements have priority over MBMS reception. The usage of channel protection (channel coding) to recover some of the lost transport blocks is possible.

UEs may have DRx occasions for specific MBMS service when UE can stop decoding S-CCPCH and perform measurements. DRx occasion are based on scheduling information.

R'99 standards have some means to reduce need for number of measurements, which can be utilized for MBMS.

When the UE reselects the cell due to the mobility or returns to on service from out of service, the UE shall acquire the MCCH information if the interested MBMS service is available in the selected cell for the reception of the service. The service is available when the session has been already started and the service is being served on p-t-p/p-t-m in the cell, or the service can be served in the cell if the UE requests it.

If the MBMS service is available in the cell, the UE will perform an action for the service reception in the cell. For example, if the service is on p-t-p, the idle mode UE will initiate RRC connection establishment procedure. Otherwise, the UE does not need to perform such an action in the cell. The UE, which moves to the new cell, will operate according to the RRC state/mode as follows.

Whenever the UE moves between p-t-m cells while continuing to receive a service, UE shall receive MCCH information in a new cell, which includes an MBMS cell group identity. If a UE moves between cells belong to the same MBMS cell group based on the MCCH information, the UE does not need to re-establish RLC entity and re-initialise PDCP entity for the service received on MTCH. If a UE moves between cells belong to different MBMS cell groups based on the MCCH information, the UE shall re-establish RLC entity and re-initialise PDCP entity for the service received on MTCH.

### 10.2.1 RRC idle mode

Idle mode UE shall:

- if BCCH contains information regarding the MCCH in the new cell:
  - listen to the MCCH and receive the MBMS SERVICE INFORMATION;
  - if the MBMS SERVICE INFORMATION contains the interested MBMS service-id:
    - if MBMS SERVICE INFORMATION indicates that the service is on p-t-m:
      - receive the MBMS RADIO BEARER INFORMATION and listen to the MTCH;
    - else:
      - initiate RRC connection establishment procedure and request the setup of MBMS p-t-p RB;
  - if the UE receive the MBMS RADIO BEARER INFORMATION before the MBMS SERVICE INFORMATION and;
    - if MBMS RADIO BEARER INFORMATION contains the interested MBMS service id:
      - listen to the MTCH without the need of receiving the MBMS SERVICE INFORMATION.

## 10.2.2 URA\_PCH State

URA\_PCH state UE shall:

- perform URA update procedure if needed;
- if BCCH contains information regarding the MCCH in the new cell:
  - listen to the MCCH and receive the MBMS SERVICE INFORMATION;
- if MBMS SERVICE INFORMATION contains the interested MBMS service id:
  - if MBMS SERVICE INFORMATION indicates that the service is on p-t-m:
    - receive the MBMS RADIO BEARER INFORMATION and listen to the MTCH;
  - else:
    - initiate cell update procedure and request to setup the MBMS p-t-p RB;
- if the UE receive the MBMS RADIO BEARER INFORMATION before MBMS SERVICE INFORMATION message and;
  - if MBMS RADIO BEARER INFORMATION contains the interested MBMS service id:
    - listen to the MTCH without the need of receiving the MBMS SERVICE INFORMATION.

## 10.2.3 CELL\_PCH

CELL\_PCH state UE shall:

- perform cell update procedure;
- if BCCH contains information regarding the MCCH in the new cell:
  - listen to the MCCH and receive the MBMS SERVICE INFORMATION;
- if MBMS SERVICE INFORMATION contains the interested MBMS service id and:
  - if MBMS SERVICE INFORMATION indicates that the service is on p-t-m:
    - receive the MBMS RADIO BEARER INFORMATION message and listen to the MTCH.
  - else:
    - initiate the cell update procedure and request to setup the MBMS p-t-p RB.
- if the UE receive the MBMS RADIO BEARER INFORMATION before the MBMS SERVICE INFORMATION and;
  - if MBMS RADIO BEARER INFORMATION contains the interested MBMS service id:
    - listen to the MTCH without the need of receiving the MBMS SERVICE INFORMATION.

## 10.2.4 CELL\_FACH

CELL\_FACH state UE shall:

- perform cell update procedure
- if BCCH contains information regarding the MCCH in the new cell:
  - listen to the MCCH and receive the MBMS SERVICE INFORMATION;
- if MBMS SERVICE INFORMATION contains the interested MBMS service id and;
  - if MBMS SERVICE INFORMATION indicates that the service is on p-t-m:

- receive the MBMS RADIO BEARER INFORMATION and listen to the MTCH;
- else:
  - initiate request to setup the MBMS p-t-p RB;
- if the UE receive the MBMS RADIO BEARER INFORMATION before the MBMS SERVICE INFORMATION and;
  - if MBMS RADIO BEARER INFORMATION contains the interested MBMS service id:
    - listen to the MTCH without the need of receiving the MBMS SERVICE INFORMATION.

## 10.2.5 CELL\_DCH State

CELL\_DCH state UE shall:

- act on the RRC message received on DCCH in handover.
- if the UE has the capability to support MBMS in CELL\_DCH:
  - if BCCH contains information regarding the MCCH in the new cell:
    - listen to the MCCH and receive the MBMS SERVICE INFORMATION;
    - if MBMS SERVICE INFORMATION contains the interested MBMS service id and;
      - if MBMS SERVICE INFORMATION indicates that the service is on p-t-m:
        - receive the MBMS RADIO BEARER INFORMATION and listen to the MTCH.
  - if the UE receive the MBMS RADIO BEARER INFORMATION before the MBMS SERVICE INFORMATION and;
    - if MBMS RADIO BEARER INFORMATION contains the interested MBMS service id:
      - listen to the MTCH without the need of receiving the MBMS SERVICE INFORMATION.

---

# 11 Resource Management for MBMS

## 11.1 MBMS Access Control Procedure

MCCH messages initiating counting or recounting cause multiple responses from UEs within a cell. This may result in RACH congestion if number of UEs is high in a cell. To avoid this, CRNC may perform MBMS access control procedure during counting or recounting procedure. MBMS access control procedure is described in Figure 11.1.

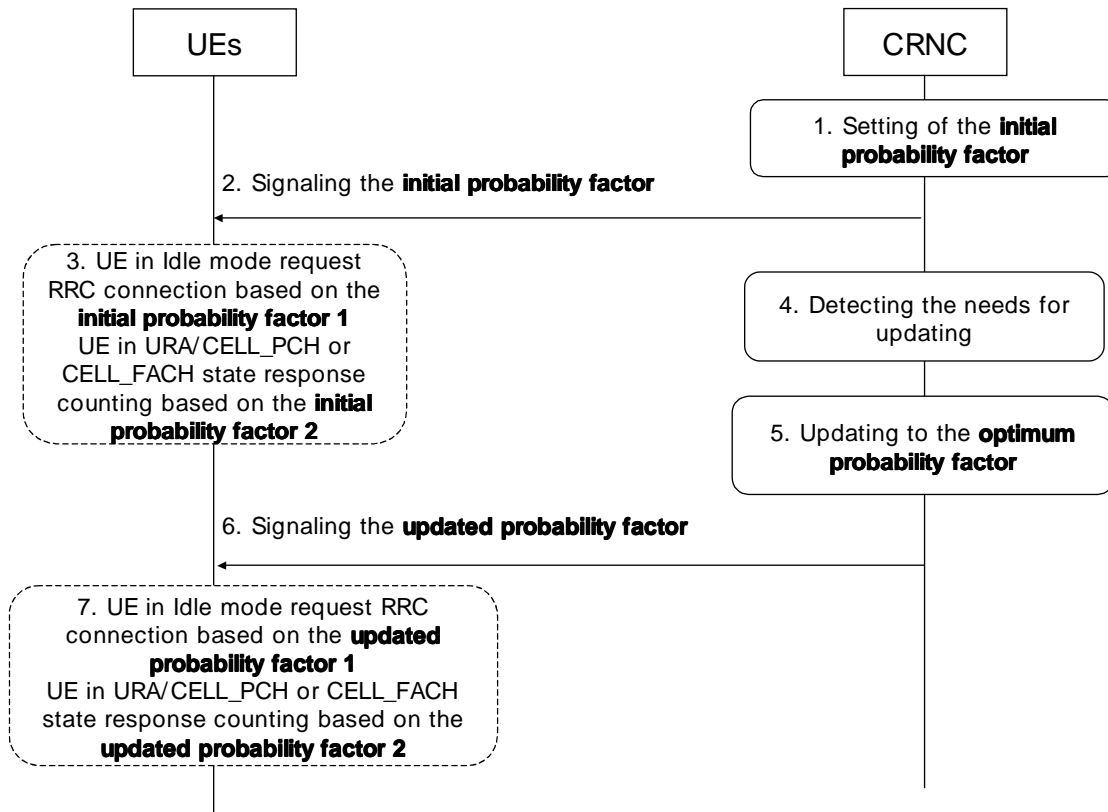

**Figure 11.1: MBMS Access Control Procedure**

1. CRNC calculates an initial probability factor for an MBMS service when a MCCH message causing counting or recounting is about to be sent. CRNC can use different probability factor for UEs in Idle mode and for different UEs in URA\_PCH, CELL\_PCH and CELL\_FACH.
2. CRNC includes the probability factor into the MCCH message and sends it to UEs. This can be done in MBMS Group Notification.
3. UEs in idle mode or in URA\_PCH, CELL\_PCH and CELL\_FACH state passing the probability check performs counting response UEs keep listening to MCCH to get updated probability factor until they have successfully responded to counting or counting is no longer required.
4. CRNC detects the probability factor needs to be updated. Detecting mechanism is not to be standardized.
5. CRNC recalculates the probability factor. The way of calculating new probability factor is not to be standardized.
6. CRNC includes the updated probability factor into the MCCH message and sends it to UEs.
7. UEs in idle mode or in URA\_PCH, CELL\_PCH or CELL\_FACH state that pass the probability check, by using updated probability factor, perform counting response.

CRNC and UEs that are still trying to perform the counting response repeat step 3 ~ step 7 until e.g. counting or recounting procedure ends.

## 11.2 Frequency layer Convergence

Frequency Layer Convergence denotes the process where the UTRAN requests UEs to preferentially re-select to the frequency layer on which the MBMS service is intended to be transmitted. This layer preference could be done by an additional MBMS session related Layer Convergence Information (LCI) such as offset and target frequency. The FLC is supported by specifications for both networks utilizing HCS and for networks not utilizing HCS.

The preferred layer (PL) is indicated per MBMS service and the LCI (offset) is the same for all MBMS services on a given preferred layer. UTRAN can consist of multiple preferred layers and the PL for given services is decided by RRM. Thus the PL for an MBMS service might be different in different parts of the service area. Network co-ordination between RNCs may be added for the Rel-7.

The LCI can be signalled to UEs by the CRNC after the session start is received over Iu interface until reception of the session stop. The UEs shall take LCI into account whenever it is signalled on the MCCH in Idle mode and URA\_PCH, CELL\_PCH and in CELL\_FACH states. The FLC is not applicable in CELL\_DCH state, as it is only effecting UEs cell re-selection procedure.

The UE shall ignore Sintersearch parameter only for the potential preferred layers when LCI is signalled and on preferred layer the UE shall apply the Sintersearch parameter. In case of UE is in CELL\_FACH state without measurement occasions, the UE may not be able to measure cells on preferred layers.

In the case that the UE has joined multiple services and they have different frequencies as preferred layer, the UE should apply the FLC applicable for the highest priority MBMS service, which it has activated and has a PL. The priority setting of different MBMS services is decided by NAS.

Based on RRM decision, a given MBMS service can be provided on non-preferred layer by p-t-p or p-t-m transfer mode.

The details of the mechanism are defined in state 3.

## 11.3 Frequency layer Dispersion

Frequency Layer Dispersion (FLD) denotes the process where the UTRAN redistributes UEs across the frequencies. UTRAN can use FLD per MBMS session.

The request to perform dispersion can be signalled to UEs by the CRNC after the session stop is received over Iu interface. The UEs shall take into account this request whenever it is signalled on the MCCH.

For FDD, the FLD is applicable in Idle mode, URA\_PCH, CELL\_PCH and CELL\_FACH states.

For TDD, the FLD is applicable in Idle mode, URA\_PCH and CELL\_PCH states.

When FLC is applied, the UE stores the frequency where it was camped previously. Upon session stop, the UE attempts to return to that frequency.

If the UE does not find a suitable cell on the target frequency, the UE attempts to select a cell on a randomly chosen frequency.

Dispersion does not apply in the case where the UE decides to receive another service for which FLC is applied.

The details of the mechanism are defined in the stage 3.

## Annex A (informative): MBMS Phases in UTRAN

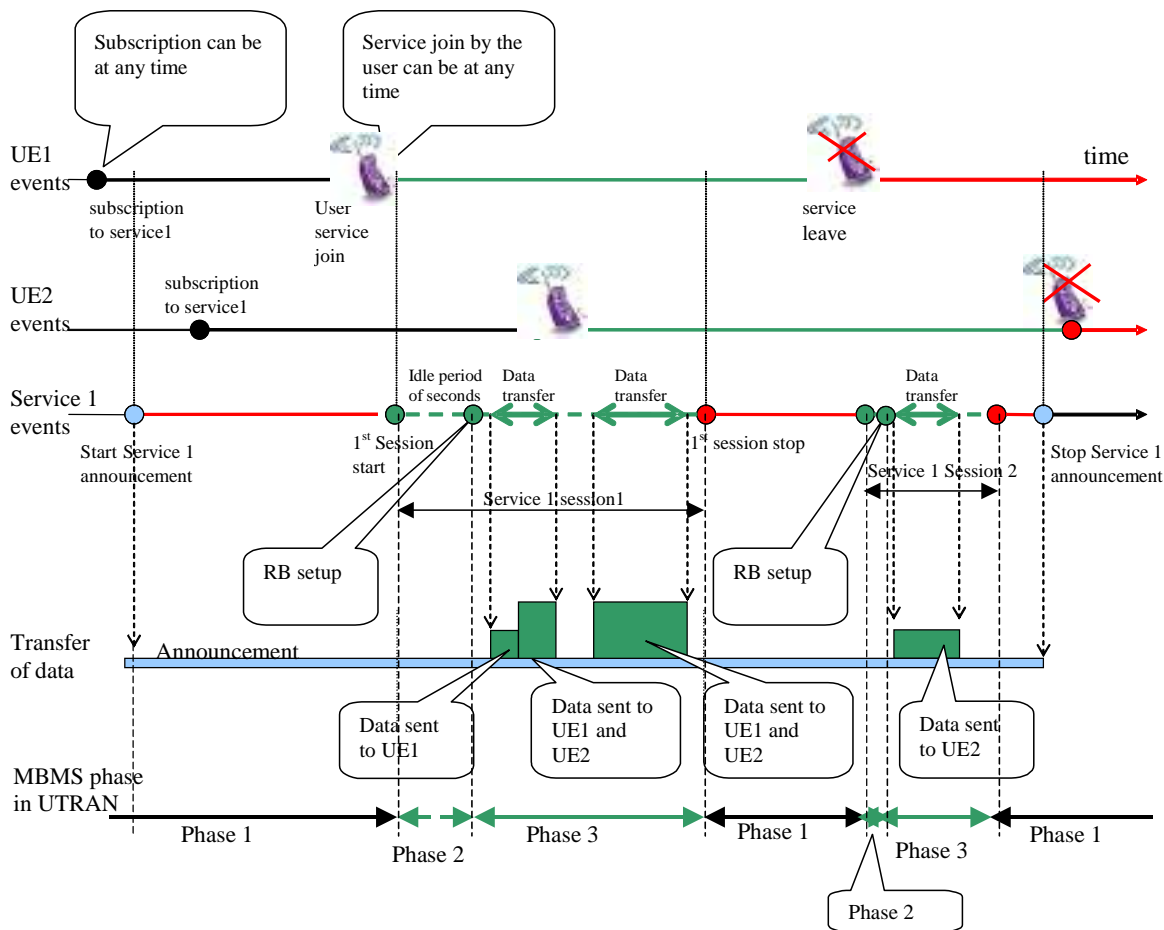

**Figure A: Timeline of MBMS Service**

The UTRAN MBMS behavior is divided into 3 phases. Figure 14 illustrates the timeline of an MBMS service with regards to these phases.

### A1 Security for MBMS

A cell stays in phase 1, if there is no ongoing session for the MBMS service, or if it does not belong to the MBMS service area of the service.

A UE that has joined an MBMS service may regularly try to receive MBMS notification in a cell [FFS]. At this phase the UE does not request service delivery to UTRAN.

### A2 MBMS Phase 2

This phase starts when UTRAN receives the MBMS "session start" from CN, and ends when UTRAN initially sets up MBMS radio bearer for the session, or decides not to set up the MBMS radio bearer in a cell.

In this phase, UTRAN transmits notification to UEs about the incoming service and could perform counting procedure to decide the type of MBMS radio bearer. UTRAN decides whether to set up p-t-m, p-t-p radio bearer or no radio bearer, based on the number of UEs that expected to receive the service in the cell. A UE that has at least one activated MBMS service acts on an RRC message in MCCH.

## A3 MBMS Phase 3

This phase starts after initial MBMS radio bearer setup and ends when UTRAN receives the MBMS "session stop" from CN.

In this phase, UTRAN transmits the data for the MBMS service received from CN using, if any, the established radio bearer. If there is no set-up radio bearer, UTRAN waits for service delivery request from UE. Recounting and radio bearer reconfiguration may be performed during this phase.

UTRAN behaviour in this phase can be divided into three states: no transmission, p-t-p transmission, and p-t-m transmission. Each cell belonging to the same MBMS service area may be in any of three states. With the variation of the number of UEs, the state of a cell may change between the three states. UTRAN may broadcast the state of each cell.

- 1) **No Transmission:** In this state of a cell, there is no established radio bearer because there is no UE who wants to receive the service. An MBMS-joined (or MBMS-interested in broadcast mode) UE in idle mode that moves into the cell of this state requests service delivery to UTRAN.
- 2) **P-t-p Transmission:** In this state of a cell, p-t-p radio bearer is established. A UE that has joined (or interested in broadcast mode) an MBMS service may receive MBMS data over p-t-p radio bearer if there is MBMS data to receive.
- 3) **P-t-m Transmission:** In this state of a cell, p-t-m radio bearer is established. A UE that has joined (or interested in broadcast mode) an MBMS service may receive MBMS data over p-t-m radio bearer if there is MBMS data to receive.

## A4 MBMS Phases and Status Parameters

Table 1 lists the MBMS parameters that need to be broadcast in each MBMS phase. The list is [FFS]

**Table 1: MBMS Status Parameters**

	Phase 1	Phase 2	Phase 3	Description
Service ID	X	O	O	Identity of the Service
Transmission State	X	X	O (NONE/p-t-p/p-t-m)	State of the cell for MBMS transmission
Counting	X	O (On/Off)	O (On/Off)	Whether counting procedure is going on.

- 1) **Service ID:** This parameter indicates the identity of the service concerned.
- 2) **Transmission state:** This parameter indicates to UE(s) the state of the concerned cell while it is in phase 3. According to this parameter, UE entering the cell starts re-configuration of the radio bearer, or requests service delivery to UTRAN. Specifically, if this parameter is set to "p-t-m", UE receives service over p-t-m radio bearer and if set to "p-t-p", UE receives service over p-t-p radio bearer. If it is set to NONE, UE has to request UTRAN to deliver the service.
- 3) **Counting:** The counting parameter informs UEs whether counting is required (and is going on) or not. If this parameter is set to "ON", UE should perform RRC connection procedure.



## Annex B (informative): MBMS Control Information

Tables 2 and 3 describe MBMS control information in the downlink and uplink.

**Table 2: Mapping of MBMS Control Parameters in DL**

Information Element	Description
<b>MICH – Transmitted continuously – Can be modified at a modification period boundary</b>	
MBMS Notification Indicators	Indicates when new information is to be transmitted on MCCH in the next modification period.
<b>BCCH - Transmitted periodically</b>	
MCCH System Information	Includes: <ul style="list-style-type: none"> <li>- Configuration of the radio bearer carrying MCCH,</li> <li>- MCCH schedule information (access info, repetition and modification periods).</li> </ul>
<b>MCCH – Non Critical Information – Transmitted at access info events – Can be modified at any transmission</b>	
MBMS Access Information	Contains parameters that control, for the purposes of counting, whether UEs should establish an RRC connection (idle mode) or make a cell update (URA_PCH state). It may include for each service for which counting is in progress: <ul style="list-style-type: none"> <li>- MBMS service identity,</li> <li>- Probability factor (Idle mode),</li> <li>- Probability factor (URA_PCH),</li> </ul> Additional parameters may be identified in stage 3.
<b>MCCH – Critical Information – Transmitted at repetition period Events – Can be modified at a modification period boundary</b>	
MBMS Change Information	Identifies MBMS services for which parameters are modified in this modification period. It may include for each service listed: <ul style="list-style-type: none"> <li>- MBMS service identity,</li> <li>- MBMS session identity.</li> </ul> Additional parameters may be identified in stage 3. In stage 3, MBMS Change Information is contained in the MBMS MODIFIED SERVICES INFORMATION message.
MBMS Service Information	Identifies MBMS services that are available in the cell. It may include for each service listed: <ul style="list-style-type: none"> <li>- MBMS service identity,</li> <li>- MBMS session identity,</li> <li>- Indication that a p-t-m bearer is established for the service in the cell,</li> <li>- RB release indication,</li> <li>- Preferred frequency layer information.</li> </ul> Additional parameters may be identified in stage 3. In stage 3, MBMS Services Information for a service is contained in either the MBMS MODIFIED SERVICES INFORMATION or the MBMS UNMODIFIED SERVICES INFORMATION messages depending upon the change status of the service.
MBMS Radio Bearer Information	Contains, for one or more MBMS services information describing the radio bearer and the p-t-m bearer that is used within the serving cell. It may include for each service listed: <ul style="list-style-type: none"> <li>- MBMS service identity,</li> <li>- MBMS cell group identity,</li> <li>- Physical channel information,</li> <li>- Transport channel information,</li> <li>- Radio Bearer information.</li> </ul> Additional parameters may be identified in stage 3.

MBMS Neighbouring Cell Information	<p>Contains, for one or more MBMS services transmitted in neighbour cells that can be used for soft or selective combining, information describing the p-t-m bearer to which it is mapped in the neighbour cell. It may include for each service listed:</p> <ul style="list-style-type: none"> <li>- MBMS service identity,</li> <li>- Cell identification information,</li> <li>- Physical channel information,</li> <li>- Transport channel information,</li> <li>- Radio Bearer information,</li> <li>- L1 scheduling information,</li> <li>- Soft/ selective combining information.</li> </ul> <p>Additional parameters may be identified in stage 3.</p>
<b>MSCH – Transmitted periodically</b>	
MTCH Scheduling Information	<p>Contains information that enables UEs to perform discontinuous reception of MTCH. It may include for each of one or more services:</p> <ul style="list-style-type: none"> <li>- MBMS service identity,</li> <li>- The start time and duration of a period of data transmission,</li> <li>- Indication that there is no data transmission for one or more MSCH repetition periods.</li> </ul>

**Table 3: Mapping of MBMS Control Parameters in UL**

Information Element	Description
<b>DCCH - Service Related Control Information</b>	
MBMS Joined Indication	Indicates that a PMM IDLE state UE in RRC connected mode has joined at least one MBMS service
MBMS P-T-P Modification Request	UEs in CELL_DCH state may transmit this signalling flow to request the release of a p-t-p MBMS RB for a higher priority MBMS service.

## Annex C (informative): Change history

Change history							
Date	TSG #	TSG Doc.	CR	Rev	Subject/Comment	Old	New
8/02	RAN2#31	R2-021846					0.0.1
9/02	RAN2#32	R2-020590			Skeleton Endorsed with some changes in sections from RAN2#31	0.0.1	1.0.0
11/02	RAN2#33	R2-022927			No MBMS Discussions		
1/03	RAN2/3 MBMS AdHoc	R2-030006			R2-022644 and R2-022699	1.0.0	1.1.0
2/03	RAN2#34	R2-030122			Inclusion of R2-030010, R2-030050, figure from R2-030015, mechanism 1 from R2-030062, + editorial changes + principles in section 5.1.3	1.1.0	1.4.0
4/03	RAN2#35	R2-030707			Inclusion of R2-030010 + section 5.1.4 based on agreed bullet points from RAN2#34 + correction of version numbering + addition of "change history" section.	1.4.0	1.5.0
5/03	RAN2/3AdHoc	R2-030882			-R2-030907 "Functional Description on MAC-c/sh/m". -R2-030902 on the "MBMS Control Plane Protocol Stack". -R2-030910 on MBMS UTRAN Phases in Annex A. -R3-030584: only inclusion of sections: 7.1.3 and 7.1.4. In 7.1.3 there is one additional comment regarding the addition of "PMM" wherever CONNECTED mode" is mentioned. -R3-030614: Addition of chapter 5.1.x -R3-030615: changes in section 5.1.2. -R3-030615: proposed section 5.1 was reworded.	1.5.0	1.6.0
5/03	RAN2#36				- Inclusion of contribution R2-03930, sections: 7.2.1.1 and 7.2.1.2 from decisions from RAN2/3 MBMS adhoc. - Use of term "MBMS service context" instead of "MBMS context" throughout the document. - Correction of spelling mistake in figure 1: "Protocol Stack for MCTCH" should be: "Protocol Stack for MTCH". - Revision of Appendix A "MBMS Phase 1": Part of the second paragraph has been deleted due to concerns from RAN3. - During the RAN2 MBMS AdHoc it was decided that MCCH and MTCH are to be mapped on FACH. This decision is captured at the bottom of 5.3.1 by adding the sentence "Both logical channels are mapped on FACH". FACH is also mentioned in several places in 5.3.2 (MAC Architecture) as an example (e.g. FACH). The "e.g." has now been deleted.	1.6.0	1.6.1
06/03	TSG RAN #20				The version 2.0.0 identical to version 1.6.1 was presented in TSG RAN plenary meeting for information and approval. The TS was not approved so drafting work will continue in WG2/3 based on version 2.0.0. The changes in version 2.1.0 compared to 2.0.0 are in Section 5.1.4 Counting where point 8 "The possibility for the RNC to receive the service Id in RRC connection request is [FFS]..." is removed. This reflects to the decision made in RAN2/3AdHoc 05/03 but was missing from earlier versions, and pointed out by RAN WG2 chairman in reflector and in TSG RAN #20.	2.0.0	2.1.0
09/03	RAN2#37 RAN3#37	R2-031713 R3-031174 R3-031223			Editorial corrections based on R2-031713 included. New chapter "7. MBMS reception UE Capability" created and agreed UE capability text inserted to the new chapter "7.1. UE Capability". Modifications based on R3-031174 to the definitions Sections 5.1.1, 5.1.5 and 5.1.6 enhanced and sections 5.1.7, 5.1.8 and 5.1.9 created, and signalling flows updated in section 7.1. based	2.1.0	2.2.0

Change history							
Date	TSG #	TSG Doc.	CR	Rev	Subject/Comment	Old	New
					on R3-031223		
					Following Editorial enhancements proposed by editor: Chapter 5.3.1.1 and 5.3.1.2 moved to under chapter 6.1. Logical channels and chapter "5.4 MBMS Reception in RRC States/Modes" moved under chapter 7. in new chapter "7.2 MBMS reception "		
10/03	RAN2# 38	R2-032116 R2-032074 R2-032121 R2-032277 R2-032087 R2-032275 R2-032081 R2-032281			Chapter 5.2.1 MBMS User Plane Protocol Stack Architecture enhanced accordingly. Chapter 9 Security for MBMS enhanced accordingly Chapter 8.2.2 MBMS service availability enhanced, (message changed to information). Chapter 9.2. UE Actions for Mobility created and 9.2.4 text depending UE capability inserted Chapters 8.2.4. MBMS Joined Services Indication and 8.2.5 MBMS PMM-Connected State Required Indication created Chapters 6.1. re-formatted, Section 6.2.1-6.2.5 created The MBMS access control procedure inserted in chapter 11.1 Broadcast of MBMS System Information signalling flow added. Tables inserted to an informative annex to identify MBMS control information and describe their mapping on transport channels	2.2.0	2.3.0
	RAN3# 38	R3-031421			MBMS Time line and MBMS Service announcement definitions included in Section 3.1 Chapter 5.1.1 One Context per MBMS Service in CRNC and 5.1.8 RNC deregistration updated accordingly Editorial harmonization of terms: MCCH and MTCH used constantly. (NCCH and CTCH removed) In Uu signalling messages CRNC introduced to keep messages send/received in SRNC and CRNC inline.		
11/03	RAN2# 39	R2-032350 R2-032398 R2-032667 R2-032666 R2-032497			The Signalling flow MBMS service availability changed to MBMS service information in 8.2.2. Appropriate changes done in 10.2. In the Chapter 7.1. included that MBMS UE must capability to receive two SCCPCH MBMS notification principles chapter created as 5.1.5 and PICH bits used for MBMS notification defined in 6.2.3 physical channels chapters. The number of different protocol entities clarified in chapter 5.2.1. The shared PDCP entity principle created in 5.1.4. Protocol layer establishments due to mobility defined in 10.2. UEs measurements are clarified based in working assumption in Section 10.2. Editorial enhancements to chapter names in chapters 5.1.1, 5.1.2 and 5.1.3	2.3.0	2.4.0
01/04	RAN2# 40	R2-04086 Meeting report R2-040027 R2-040070			A chapter 11.2 Frequency layer Convergence introduced based on revised text from R2-04086 Text inserted based on conclusion on selective combining, multiplexing and measurement occasions Editorial clarifications. Constant usage of MBMS Service Area as defined in [4] Session stop included High level signalling scenarios inserted	2.4.0	2.5.0
	RAN3# 40	R3-040061 R3-040075 R3-040076			Modification to chapter 5.1.8 Modification to RNC registration procedure Additional modifications to 5.1.8		
02/04	RAN2# 41	Meeting minutes R2-040572 R2-040690 R2-040711			Selective combining, simulcast for TDD, Neighbouring cell info, included MCCH scheduling, MBMS notification and counting enhanced. MBMS access MTCH Scheduling information signalling flow included MBMS high level signalling scenarios updated Editorial clean up, separation of UTRAN architecture principles and MBMS Uu principles chapter created	2.5.0	2.6.0
	RAN3# 41	R3-040577 R3-040576 R3-040314 R3-040393 R3-040575 R3-040458 R3-040516			Functionality to filtering of MBMS notifications and Session update signalling flow included MBMS Service Id Request to handle UEs in RRC connected PMM idle state. The Signalling flow MBMS Joined Indication modified and MBMS PMM connected stated required removed. FFS removed from RNC De-Registration and CN De-Registration Clarifications to MBMS lu bearer and MBMS Session Start and Session Stop and CN De-Registration UE linking over lur modified according agreements Clarification to creation of MBMS Service context after receiving the		

Change history							
Date	TSG #	TSG Doc.	CR	Rev	Subject/Comment	Old	New
		R3-040545 Meeting minutes			first UE linking Editorial clean up to RAN3 specific sections. The lub bearer mechanisms defined.  Editorial enhancements based on comments after email review on RAN1/2/3 reflectors.		
03/2004	RAN#23	RP-040079			Upgrade towards Change Control (Release 6) and ETSI MCC clean-up.	2.6.0	6.0.0
06/2004	RP-24	RP-040216	001		Updates based on the MBMS ad-hoc, Budapest, 20-22 April 2004	6.0.0	6.1.0
	RP-24	RP-040216	002		Updates to TS25.346 from the RAN3#42 meeting in Montreal, Canada, 10-14 May 2004	6.0.0	6.1.0
09/2004	RP-25	RP-040340	003		Introduction of MBMS Change Information and Removal of usage of the secondary notification indicators	6.1.0	6.2.0
	RP-25	RP-040340	004		Clarifications to Frequency Layer Convergence and UE behaviour at return on Service	6.1.0	6.2.0
	RP-25	RP-040340	005		lur Linking for URA_PCH UEs and MBMS Session Start Request corrections for TS25.346 from RAN3#43	6.1.0	6.2.0
12/2004	RP-26	RP-040492	006	1	Actions due to MBMS session repetition and MBMS service prioritisation	6.2.0	6.3.0
	RP-26	RP-040492	007	1	Introduction of MSCH and soft combining and other general corrections	6.2.0	6.3.0
	RP-26	RP-040492	008		Corrections to UE Linking, Session Start and addition of URA Linking and Information Exchange procedure	6.2.0	6.3.0
	RP-26	RP-040492	009		Update of Annex B	6.2.0	6.3.0
03/2005	RP-27	RP-050080	010		Introduction of MBMS Frequency dispersion	6.3.0	6.4.0
	RP-27	RP-050080	011		Correction on MBMS multiplexing and soft combining in TDD	6.3.0	6.4.0
	RP-27	RP-050080	012		Clarification to UE capabilities to consider MCCH reception and selective/soft combining requirements	6.3.0	6.4.0
	RP-27	RP-050080	013		Extending the counting procedure for UEs in CELL_PCH/FACH state and introducing UE initialised p-t-p setup request	6.3.0	6.4.0
	RP-27	RP-050080	015		Introduction of new procedure in MBMS stage 2 spec	6.3.0	6.4.0
06/2005	RP-28	RP-050314	0016		FLD scenario clarifications	6.4.0	6.5.0
	RP-28	RP-050314	0018		Handling the validity of the MBMS session Id	6.4.0	6.5.0
09/2005	RP-29	RP-050468	0019		Change of scope for the MBMS Access Information and MBMS P-T-P Modification Request signalling flows plus editorial corrections	6.5.0	6.6.0
12/2005	RP-30	RP-050788	0020		Correction to MBMS Cell Group	6.6.0	6.7.0
06/2006	RP-32	RP-060368	0021		Clarification of conditions for soft combining	6.7.0	6.8.0
09/2006	RP-33	RP-060624	0023	1	Enhancing MBMS support for Mobile TV	6.8.0	6.9.0
	-	-	-	-	Correction on date on coversheet - no technical change	6.9.0	6.9.1

---

## History

<b>Document history</b>		
V6.0.0	May 2004	Publication
V6.1.0	June 2004	Publication
V6.2.0	September 2004	Publication
V6.3.0	December 2004	Publication
V6.4.0	March 2005	Publication
V6.5.0	June 2005	Publication
V6.6.0	September 2005	Publication
V6.7.0	December 2005	Publication
V6.8.0	June 2006	Publication
V6.9.0	September 2006	Publication (Withdrawn)
V6.9.1	September 2006	Publication