

ETSI TS 125 413 V11.2.0 (2013-01)



Technical Specification

**Universal Mobile Telecommunications System (UMTS);
UTRAN Iu interface Radio Access Network
Application Part (RANAP) signalling
(3GPP TS 25.413 version 11.2.0 Release 11)**



Reference

RTS/TSGR-0325413vb20

Keywords

UMTS

ETSI

650 Route des Lucioles
F-06921 Sophia Antipolis Cedex - FRANCE

Tel.: +33 4 92 94 42 00 Fax: +33 4 93 65 47 16

Siret N° 348 623 562 00017 - NAF 742 C
Association à but non lucratif enregistrée à la
Sous-Préfecture de Grasse (06) N° 7803/88

Important notice

Individual copies of the present document can be downloaded from:

<http://www.etsi.org>

The present document may be made available in more than one electronic version or in print. In any case of existing or perceived difference in contents between such versions, the reference version is the Portable Document Format (PDF). In case of dispute, the reference shall be the printing on ETSI printers of the PDF version kept on a specific network drive within ETSI Secretariat.

Users of the present document should be aware that the document may be subject to revision or change of status. Information on the current status of this and other ETSI documents is available at

<http://portal.etsi.org/tb/status/status.asp>

If you find errors in the present document, please send your comment to one of the following services:

http://portal.etsi.org/chaicor/ETSI_support.asp

Copyright Notification

No part may be reproduced except as authorized by written permission.
The copyright and the foregoing restriction extend to reproduction in all media.

© European Telecommunications Standards Institute 2013.
All rights reserved.

DECT™, **PLUGTESTS™**, **UMTS™** and the ETSI logo are Trade Marks of ETSI registered for the benefit of its Members.
3GPP™ and **LTE™** are Trade Marks of ETSI registered for the benefit of its Members and
of the 3GPP Organizational Partners.
GSM® and the GSM logo are Trade Marks registered and owned by the GSM Association.

Intellectual Property Rights

IPRs essential or potentially essential to the present document may have been declared to ETSI. The information pertaining to these essential IPRs, if any, is publicly available for **ETSI members and non-members**, and can be found in ETSI SR 000 314: *"Intellectual Property Rights (IPRs); Essential, or potentially Essential, IPRs notified to ETSI in respect of ETSI standards"*, which is available from the ETSI Secretariat. Latest updates are available on the ETSI Web server (<http://ipr.etsi.org>).

Pursuant to the ETSI IPR Policy, no investigation, including IPR searches, has been carried out by ETSI. No guarantee can be given as to the existence of other IPRs not referenced in ETSI SR 000 314 (or the updates on the ETSI Web server) which are, or may be, or may become, essential to the present document.

Foreword

This Technical Specification (TS) has been produced by ETSI 3rd Generation Partnership Project (3GPP).

The present document may refer to technical specifications or reports using their 3GPP identities, UMTS identities or GSM identities. These should be interpreted as being references to the corresponding ETSI deliverables.

The cross reference between GSM, UMTS, 3GPP and ETSI identities can be found under <http://webapp.etsi.org/key/queryform.asp>.

Contents

Intellectual Property Rights	2
Foreword.....	2
Foreword.....	13
1 Scope	14
2 References	14
3 Definitions, symbols and abbreviations	16
3.1 Definitions	16
3.2 Symbols.....	19
3.3 Abbreviations	19
4 General	21
4.1 Procedure Specification Principles.....	21
4.2 Forwards and Backwards Compatibility	21
4.3 Specification Notations	21
5 RANAP Services.....	22
6 Services Expected from Signalling Transport.....	22
7 Functions of RANAP	22
8 RANAP Procedures.....	24
8.1 Elementary Procedures.....	24
8.2 RAB Assignment.....	25
8.2.1 General.....	25
8.2.2 Successful Operation	26
8.2.2.1 Successful Operation for GERAN Iu-mode.....	33
8.2.3 Unsuccessful Operation	33
8.2.4 Abnormal Conditions.....	33
8.3 RAB Release Request	34
8.3.1 General.....	34
8.3.2 Successful Operation	34
8.3.3 Abnormal Conditions.....	35
8.4 Iu Release Request	35
8.4.1 General.....	35
8.4.2 Successful Operation	35
8.4.3 Abnormal Conditions.....	35
8.5 Iu Release	35
8.5.1 General.....	35
8.5.2 Successful Operation	36
8.5.3 Abnormal Conditions.....	37
8.6 Relocation Preparation	37
8.6.1 General.....	37
8.6.2 Successful Operation	37
8.6.2.1 Successful Operation for GERAN Iu-mode.....	41
8.6.3 Unsuccessful Operation	41
8.6.4 Abnormal Conditions.....	42
8.6.5 Co-ordination of Two Iu Signalling Connections	42
8.7 Relocation Resource Allocation	43
8.7.1 General.....	43
8.7.2 Successful Operation	43
8.7.2.1 Successful Operation for GERAN Iu-mode.....	48
8.7.3 Unsuccessful Operation	49
8.7.3.1 Unsuccessful Operation for GERAN Iu-mode.....	50
8.7.4 Abnormal Conditions.....	50
8.7.5 Co-ordination of Two Iu Signalling Connections	50

8.21.2	Successful Operation	67
8.21.3	Unsuccessful Operation	67
8.21.4	Abnormal Conditions.....	67
8.22	Initial UE Message	68
8.22.1	General.....	68
8.22.2	Successful Operation	68
8.22.2.1	Successful Operation for GERAN Iu-mode.....	69
8.23	Direct Transfer	69
8.23.1	General.....	69
8.23.2	Successful Operation	69
8.23.2.1	CN Originated Direct Transfer.....	69
8.23.2.2	UTRAN Originated Direct Transfer	70
8.23.3	Abnormal Conditions.....	71
8.24	Void.....	71
8.25	Overload Control.....	71
8.25.1	General.....	71
8.25.2	Philosophy	72
8.25.3	Successful Operation	72
8.25.3.1	Overload at the CN.....	72
8.25.3.2	Overload at the UTRAN	72
8.25.4	Abnormal Conditions.....	72
8.26	Reset.....	73
8.26.1	General.....	73
8.26.2	Successful Operation	73
8.26.2.1	Reset Procedure Initiated from the CN	73
8.26.2.2	Reset Procedure Initiated from the UTRAN	74
8.26.3	Abnormal Conditions.....	74
8.26.3.1	Abnormal Condition at the CN	74
8.26.3.2	Abnormal Condition at the UTRAN	74
8.26.3.3	Crossing of Reset Messages.....	74
8.27	Error Indication	75
8.27.1	General.....	75
8.27.2	Successful Operation	75
8.27.3	Abnormal Conditions.....	75
8.28	CN Deactivate Trace	76
8.28.1	General.....	76
8.28.2	Successful Operation	76
8.28.2.1	Successful Operation for GERAN Iu mode	76
8.28.3	Abnormal Conditions.....	76
8.29	Reset Resource	76
8.29.1	General.....	76
8.29.1.1	Reset Resource procedure initiated from the RNC	76
8.29.1.2	Reset Resource procedure initiated from the CN.....	76
8.29.2	Successful Operation	77
8.29.2.1	Reset Resource procedure initiated from the RNC	77
8.29.2.2	Reset Resource procedure initiated from the CN.....	77
8.30	RAB Modification Request	78
8.30.1	General.....	78
8.30.2	Successful Operation	78
8.30.3	Abnormal Conditions.....	79
8.31	Location Related Data	79
8.31.1	General.....	79
8.31.2	Successful Operation	79
8.31.2.1	Successful Operation for GERAN Iu mode	79
8.31.3	Unsuccessful Operation	80
8.31.4	Abnormal Conditions.....	80
8.31.4.1	Abnormal Conditions for GERAN Iu mode.....	80
8.32	Information Transfer	80
8.32.1	General.....	80
8.32.2	Successful Operation	81
8.32.3	Unsuccessful Operation	82
8.32.4	Abnormal Conditions.....	82

9.1.49	LOCATION RELATED DATA FAILURE	133
9.1.50	INFORMATION TRANSFER INDICATION.....	133
9.1.51	INFORMATION TRANSFER CONFIRMATION.....	133
9.1.52	INFORMATION TRANSFER FAILURE	134
9.1.53	UE SPECIFIC INFORMATION INDICATION.....	134
9.1.54	DIRECT INFORMATION TRANSFER.....	135
9.1.55	UPLINK INFORMATION EXCHANGE REQUEST	135
9.1.56	UPLINK INFORMATION EXCHANGE RESPONSE.....	136
9.1.57	UPLINK INFORMATION EXCHANGE FAILURE	136
9.1.58	MBMS SESSION START.....	137
9.1.59	MBMS SESSION START RESPONSE.....	138
9.1.60	MBMS SESSION START FAILURE.....	139
9.1.61	MBMS SESSION UPDATE	139
9.1.62	MBMS SESSION UPDATE RESPONSE.....	139
9.1.63	MBMS SESSION UPDATE FAILURE.....	140
9.1.64	MBMS SESSION STOP	140
9.1.65	MBMS SESSION STOP RESPONSE.....	140
9.1.66	MBMS UE LINKING REQUEST.....	141
9.1.67	MBMS UE LINKING RESPONSE.....	141
9.1.68	MBMS REGISTRATION REQUEST	142
9.1.69	MBMS REGISTRATION RESPONSE.....	142
9.1.70	MBMS REGISTRATION FAILURE.....	143
9.1.71	MBMS CN DE-REGISTRATION REQUEST	143
9.1.72	MBMS CN DE-REGISTRATION RESPONSE	143
9.1.73	MBMS RAB ESTABLISHMENT INDICATION	144
9.1.74	MBMS RAB RELEASE REQUEST	144
9.1.75	MBMS RAB RELEASE.....	145
9.1.76	MBMS RAB RELEASE FAILURE.....	145
9.1.77	ENHANCED RELOCATION COMPLETE REQUEST	145
9.1.78	ENHANCED RELOCATION COMPLETE RESPONSE	147
9.1.79	ENHANCED RELOCATION COMPLETE FAILURE	148
9.1.80	ENHANCED RELOCATION COMPLETE CONFIRM	149
9.1.81	RANAP ENHANCED RELOCATION INFORMATION REQUEST	149
9.1.82	RANAP ENHANCED RELOCATION INFORMATION RESPONSE.....	151
9.1.83	SRVCC CS KEYS REQUEST	152
9.1.84	SRVCC CS KEYS RESPONSE	152
9.1.85	UE RADIO CAPABILITY MATCH REQUEST.....	153
9.1.86	UE RADIO CAPABILITY MATCH RESPONSE.....	153
9.2	Information Element Definitions.....	153
9.2.0	General.....	153
9.2.1	Radio Network Layer Related IEs	153
9.2.1.1	Message Type	153
9.2.1.2	RAB ID	155
9.2.1.3	RAB Parameters.....	155
9.2.1.4	Cause.....	167
9.2.1.5	CN Domain Indicator.....	175
9.2.1.6	Trace Type	175
9.2.1.7	Trigger ID	175
9.2.1.8	Trace Reference	175
9.2.1.9	UE Identity.....	176
9.2.1.10	OMC ID	176
9.2.1.11	Integrity Protection Information.....	177
9.2.1.12	Encryption Information.....	177
9.2.1.13	Chosen Integrity Protection Algorithm.....	177
9.2.1.14	Chosen Encryption Algorithm	177
9.2.1.15	Categorisation Parameters.....	178
9.2.1.16	Request Type.....	178
9.2.1.17	Data Volume Reporting Indication	178
9.2.1.18	User Plane Mode	178
9.2.1.19	UP Mode Versions	179
9.2.1.20	Chosen UP Version.....	179
9.2.1.21	Paging Area ID.....	179

10.3	Abstract Syntax Error.....	398
10.3.1	General.....	398
10.3.2	Criticality Information	398
10.3.3	Presence Information	399
10.3.4	Not comprehended IE/IE group.....	399
10.3.4.1	Procedure Code	399
10.3.4.1A	Type of Message	399
10.3.4.2	IEs other than the Procedure Code and Type of Message.....	399
10.3.5	Missing IE or IE group	401
10.3.6	IEs or IE groups received in wrong order or with too many occurrences or erroneously present	402
10.4	Logical Error	402
10.5	Exceptions	403
11	Special Procedures for RNC to RNC Communication.....	403
11.1	General	403
11.2	RANAP Relocation Information	403
11.2.1	General.....	403
11.2.2	Operation	403
11.3	RANAP Enhanced Relocation Information	404
11.3.1	General.....	404
11.3.2	Operation	404
	Annex A (informative): RANAP guidelines	409
A.1	Rules for building RANAP messages	409
A.1.1	Rules for RANAP messages that shall contain the CN Domain Indicator IE.....	409
A.2	Guidelines for Usage of the Criticality Diagnostics IE	409
A.2.1	EXAMPLE MESSAGE Layout.....	409
A.2.2	Example on a Received EXAMPLE MESSAGE	410
A.2.3	Content of Criticality Diagnostics	411
A.2.3.1	Example 1	411
A.2.3.2	Example 2	412
A.2.3.3	Example 3	413
A.2.3.4	Example 4	414
A.2.3.5	Example 5	415
A.2.4	ASN.1 of EXAMPLE MESSAGE.....	416
	Annex B (informative): RANAP Transparent containers content.....	419
	Annex C (informative): Processing of Transparent Containers at the SGSN.....	420
	Annex D (informative): Change History	421
	History	429

Foreword

This Technical Specification (TS) has been produced by the 3rd Generation Partnership Project (3GPP).

The contents of the present document are subject to continuing work within the TSG and may change following formal TSG approval. Should the TSG modify the contents of the present document, it will be re-released by the TSG with an identifying change of release date and an increase in version number as follows:

Version x.y.z

where:

- x the first digit:
 - 1 presented to TSG for information;
 - 2 presented to TSG for approval;
 - 3 or greater indicates TSG approved document under change control.
- y the second digit is incremented for all changes of substance, i.e. technical enhancements, corrections, updates, etc.
- z the third digit is incremented when editorial only changes have been incorporated in the document.

1 Scope

The present document specifies the radio network layer signalling protocol called Radio Access Network Application Part (RANAP) for the Iu interface. RANAP supports the functions of Iu interface by signalling procedures defined in this document. RANAP is developed in accordance to the general principles stated in TR 23.930 [1], TS 25.410 [2] and TS 25.401 [3].

2 References

The following documents contain provisions which, through reference in this text, constitute provisions of the present document.

- References are either specific (identified by date of publication, edition number, version number, etc.) or non-specific.
- For a specific reference, subsequent revisions do not apply.
- For a non-specific reference, the latest version applies. In the case of a reference to a 3GPP document (including a GSM document), a non-specific reference implicitly refers to the latest version of that document *in the same Release as the present document*.

- [1] 3GPP TR 23.930 (version.4.0.0, 2001-04): "Iu Principles".
- [2] 3GPP TS 25.410: "UTRAN Iu Interface: General Aspects and Principles".
- [3] 3GPP TS 25.401: "UTRAN Overall Description".
- [4] 3GPP TR 25.931: "UTRAN Functions, Examples on Signalling Procedures".
- [5] 3GPP TS 25.412: "UTRAN Iu interface signalling transport".
- [6] 3GPP TS 25.415: "UTRAN Iu interface user plane protocols".
- [7] 3GPP TS 23.107: "Quality of Service (QoS) concept and architecture".
- [8] 3GPP TS 24.008: "Mobile radio interface layer 3 specification; Core network protocols; Stage 3".
- [9] 3GPP TS 25.414: "UTRAN Iu interface data transport and transport signalling".
- [10] 3GPP TS 25.331: "Radio Resource Control (RRC) protocol specification".
- [11] 3GPP TS 48.008: "Mobile Switching Centre – Base Station System (MSC - BSS) interface; Layer 3 specification".
- [12] Void
- [13] ITU-T Recommendation X.691 (07/2002): "Information technology - ASN.1 encoding rules: Specification of Packed Encoding Rules (PER)".
- [14] ITU-T Recommendation X.680 (07/2002): "Information technology - Abstract Syntax Notation One (ASN.1): Specification of basic notation".
- [15] ITU-T Recommendation X.681 (07/2002): "Information technology - Abstract Syntax Notation One (ASN.1): Information object specification".
- [16] 3GPP TS 23.110: "UMTS Access Stratum, Services and Functions".
- [17] 3GPP TS 25.323: "Packet Data Convergence Protocol (PDCP) specification".
- [18] 3GPP TR 25.921 (version.7.0.0): "Guidelines and principles for protocol description and error handling".
- [19] 3GPP TS 23.003: "Numbering, addressing and identification".

- [20] 3GPP TS 23.032: "Universal Geographical Area Description (GAD)".
- [21] 3GPP TS 23.060: "General Packet Radio Service (GPRS); Service description; Stage 2".
- [22] 3GPP TS 24.080: "Mobile radio Layer 3 supplementary services specification; Formats and coding".
- [23] 3GPP TS 29.108: "Application of the Radio Access Network Application Part (RANAP) on the E-interface".
- [24] 3GPP TS 29.002: "Mobile Application Part (MAP) specification".
- [25] GSM TS 12.20: "Base Station System (BSS) management information".
- [26] 3GPP TS 23.236: "Intra-domain connection of Radio Access Network (RAN) nodes to multiple Core Network (CN) nodes".
- [27] 3GPP TS 43.051: "3rd Generation Partnership Project; Technical Specification Group GSM/EDGE Radio Access Network; Overall description - Stage 2".
- [28] Void.
- [29] 3GPP TS 43.059: "Functional stage 2 description of Location Services (LCS) in GERAN".
- [30] 3GPP TS 22.071: "Location Services (LCS); Service description - Stage 1".
- [31] 3GPP TR 25.994 (version.5.0.0): "Measures employed by the UMTS Radio Access Network (UTRAN) to overcome early User Equipment (UE) implementation faults".
- [32] 3GPP TR 25.995 (version.5.0.0): "Measures employed by the UMTS Radio Access Network (UTRAN) to cater for legacy User Equipment (UE) which conforms to superseded versions of the RAN interface specification".
- [33] 3GPP TS 23.195 (version.5.4.0): "Provision of UE Specific Behaviour Information to Network Entities".
- [34] 3GPP TS 49.031: "Location Services (LCS) – Base Station System Application Part LCS Extension – (BSSAP-LE)".
- [35] 3GPP TR 21.905: "Vocabulary for 3GPP Specifications".
- [36] 3GPP TS 48.018: "General Packet Radio Service (GPRS); BSS GPRS Protocol (BSSGP)".
- [37] 3GPP TS 32.421: "Subscriber and equipment trace: Trace concepts and requirements".
- [38] 3GPP TS 32.422: "Subscriber and equipment trace: Trace control and Configuration Management".
- [39] 3GPP TS 23.251: "Network sharing - Architecture and functional description".
- [40] 3GPP TS 22.146: "Multimedia Broadcast/Multicast Service; Stage 1".
- [41] 3GPP TS 23.246: "Multimedia Broadcast Multicast Service; Architecture and Functional Description".
- [42] 3GPP TS 25.346: "Introduction of the Multimedia Broadcast Multicast Service (MBMS) in the Radio Access Network (RAN); Stage 2".
- [43] 3GPP TS 23.172: "Technical realization of Circuit Switched (CS) multimedia service UDI/RDI fallback and service modification; Stage 2".
- [44] 3GPP TS 29.061 "Interworking between the Public Land Mobile Network (PLMN) supporting packet based services and Packet Data Networks (PDN)".
- [45] 3GPP TS 44.018: "Mobile radio interface layer 3 specification; Radio Resource Control Protocol".

- [46] 3GPP TS 44.060: "General Packet Radio Service (GPRS); Mobile Station (MS) - Base Station System (BSS) interface; Radio Link Control/Medium Access Control (RLC/MAC) protocol".
- [47] 3GPP TS 43.055: "3rd Generation Partnership Project; Technical Specification Group GSM/EDGE Radio Access Network; Dual Transfer Mode (DTM) - Stage 2".
- [48] 3GPP TS 23.401: "General Packet Radio Service (GPRS) enhancements for Evolved Universal Terrestrial Radio Access Network (E-UTRAN) access".
- [49] 3GPP TS 36.413: "Evolved Universal Terrestrial Radio Access Network (E-UTRAN); S1 Application Protocol (S1AP)".
- [50] 3GPP TS 25.104: "Base Station (BS) radio transmission and reception(FDD)".
- [51] 3GPP TS 25.446: "MBMS Synchronisation Protocol(SYNC)".
- [52] 3GPP TS 36.300: "Evolved Universal Terrestrial Radio Access (E-UTRA), Evolved Universal Terrestrial Radio Access Network (E-UTRAN); Overall description; stage 2".
- [53] 3GPP TS 23.007: "Restoration procedures"
- [54] 3GPP TS 23.216: "Single Radio Voice Call Continuity (SRVCC); Stage 2"
- [55] 3GPP TS 25.467: "UTRAN architecture for 3G Home Node B (HNB) - Stage 2"
- [56] 3GPP TS 22.220: "Service requirements for Home NodeBs and Home eNodeBs".
- [57] 3GPP TS 29.060: "General Packet Radio Service (GPRS); GPRS Tunnelling Protocol (GTP) across the Gn and Gp Interface".
- [58] 3GPP TS 36.101: "Evolved Universal Terrestrial Radio Access (E-UTRA); User Equipment (UE) radio transmission and reception".
- [59] 3GPP TS 29.281: "General Packet Radio Service (GPRS); Tunnelling Protocol User Plane (GTPv1-U)".
- [60] 3GPP TS 33.102: "3G Security; Security architecture".
- [61] 3GPP TS 32.240: "Charging management; Charging architecture and principles".
- [62] 3GPP TS 52.008: "Telecommunication management; GSM subscriber and equipment trace".
- [63] 3GPP TS 33.401: "3GPP System Architecture Evolution (SAE); Security architecture".
- [64] 3GPP TS 37.320: "Universal Terrestrial Radio Access (UTRA) and Evolved Universal Terrestrial Radio Access (E-UTRA); Radio measurement collection for Minimization of Drive Tests (MDT); Overall description; Stage 2".
- [65] 3GPP TS 23.139: "3GPP system – fixed broadband access network interworking".

3 Definitions, symbols and abbreviations

3.1 Definitions

For the purposes of the present document, the following terms and definitions below apply. Terms and definitions not defined below can be found in TR 21.905 [35].

Cell Load-Based Inter-System Handover: This mechanism, which is contained within a UTRAN RNC, consists of three primary functions:

1. The RNC has the capability to generate and send Cell Load Information towards the target/source system.
2. The RNC has the capability to receive Cell Load Information from the target/source system, and is able to interpret this information.

Signalling Based Activation: as defined in TS 32.421 [37].

Source RNC: source RNC is the RNC belonging to source RNS

Source RNS: role, with respect to a specific connection between UTRAN and CN, that RNS takes when it decides to initiate a relocation of SRNS

System Information in GERAN: as defined in TS 44.018 [45].

Target RNC: target RNC is the RNC belonging to target RNS

Target RNS: role an RNS gets with respect to a specific connection between UTRAN and CN when it is being a subject of a relocation of SRNS which is being made towards that RNS

UE Specific Behaviour Information – Iu: as defined in TS 23.195 [33].

3.2 Symbols

Void.

3.3 Abbreviations

Applicable abbreviations can be found in TR 21.905 [35]. For the purposes of the present document, the following abbreviations apply:

AAL2	ATM Adaptation Layer type 2
ALCAP	Access Link Control Application Part
APN	Access Point Name
AS	Access Stratum
ASN.1	Abstract Syntax Notation One
ATM	Asynchronous Transfer Mode
BBF	Broadband Forum
BSC	Base Station Controller
CC	Call Control
CN	Core Network
CRNC	Controlling RNC
CS	Circuit Switched
CSG	Closed Subscriber Group
DCH	Dedicated Channel
DL	Downlink
DRNC	Drift RNC
DRNS	Drift RNS
DSCH	Downlink Shared Channel
eNB	E-UTRA NodeB
EP	Elementary Procedure
E-UTRA	Evolved UTRA
E-UTRAN	Evolved UTRAN
GANSS	Galileo and Additional Navigation Satellite Systems
GERAN	GSM/EDGE Radio Access Network
GPRS	General Packet Radio System
GSM	Global System for Mobile communications
GTP	GPRS Tunnelling Protocol
GWCN	GateWay Core Network
HNB	Home Node B
IE	Information Element
IMEI	International Mobile Equipment Identity
IMSI	International Mobile Subscriber Identity
IPv4	Internet Protocol (version 4)
IPv6	Internet Protocol (version 6)
IRAT	Inter-RAT
L-GW	Local GateWay

LIPA	Local IP Access
MBMS	Multimedia Broadcast Multicast Service
MDT	Minimization of Drive Tests
MM	Mobility Management
MOCN	Multi Operator Core Network
MSC	Mobile services Switching Center
MSISDN	MS International PSTN/ISDN Number
NACC	Network Assisted Cell Change
NAS	Non Access Stratum
NNSF	NAS Node Selection Function
NRT	Non-Real Time
N-PDU	Network – Protocol Data Unit
OSP:IHOSS	Octet Stream Protocol: Internet-Hosted Octet Stream Service
P-TMSI	Packet TMSI
PDCP	Packet Data Convergence Protocol
PDP	Packet Data Protocol
PDU	Protocol Data Unit
PLMN	Public Land Mobile Network
PPP	Point-to-Point Protocol
PS	Packet Switched
PSI	Packet System Information
PTP	Point To Point
PUESBINE	Provision of UE Specific Behaviour Information to Network Entities
QoS	Quality of Service
RAB	Radio Access Bearer
RANAP	Radio Access Network Application Part
RAT	Radio Access Technology
RIM	RAN Information Management
RNC	Radio Network Controller
RNS	Radio Network Subsystem
RRC	Radio Resource Control
rSRVCC	reverse Single Radio Voice Call Continuity
RT	Real Time
SAI	Service Area Identifier
SAP	Service Access Point
SDU	Service Data Unit
SGSN	Serving GPRS Support Node
SI	System Information in GERAN
SIPTO	Selected IP Traffic Offload
SNA	Shared Network Area
SNAC	Shared Network Area Code
SRNC	Serving RNC
SRNS	Serving RNS
SRVCC	Single Radio Voice Call Continuity
TEID	Tunnel Endpoint Identifier
TMGI	Temporary Mobile Group Identity
TMSI	Temporary Mobile Subscriber Identity
UE	User Equipment
UEA	UMTS Encryption Algorithm
UESBI-Iu	UE Specific Behaviour Information - Iu
UIA	UMTS Integrity Algorithm
UL	Uplink
UMTS	Universal Mobile Telecommunications System
USCH	Uplink Shared Channel
UTRA	UMTS Terrestrial Radio Access
UTRAN	UMTS Terrestrial Radio Access Network

4 General

4.1 Procedure Specification Principles

The principle for specifying the procedure logic is to specify the functional behaviour of the RNC exactly and completely. The CN functional behaviour is left unspecified. The EPs Relocation Preparation, Reset, Reset Resource and Overload Control are exceptions from this principle.

The following specification principles have been applied for the procedure text in clause 8:

- The procedure text discriminates between:

- 1) Functionality which "shall" be executed

The procedure text indicates that the receiving node "shall" perform a certain function Y under a certain condition. If the receiving node supports procedure X but cannot perform functionality Y requested in the REQUEST message of a Class 1 or Class 3 EP, the receiving node shall respond with the message used to report unsuccessful outcome for this procedure, containing an appropriate cause value.

- 2) Functionality which "shall, if supported" be executed

The procedure text indicates that the receiving node "shall, if supported," perform a certain function Y under a certain condition. If the receiving node supports procedure X, but does not support functionality Y, the receiving node shall proceed with the execution of the EP, possibly informing the requesting node about the not supported functionality.

- Any required inclusion of an optional IE in a response message is explicitly indicated in the procedure text. If the procedure text does not explicitly indicate that an optional IE shall be included in a response message, the optional IE shall not be included. For requirements on including *Criticality Diagnostics* IE, see section 10. For examples on how to use the *Criticality Diagnostics* IE, see Annex A.2.

4.2 Forwards and Backwards Compatibility

The forwards and backwards compatibility of the protocol is assured by mechanism where all current and future messages, and IEs or groups of related IEs, include ID and criticality fields that are coded in a standard format that will not be changed in the future. These parts can always be decoded regardless of the standard version.

4.3 Specification Notations

For the purposes of the present document, the following notations apply:

Procedure	When referring to an elementary procedure in the specification the Procedure Name is written with the first letters in each word in upper case characters followed by the word "procedure", e.g. RAB Assignment procedure.
Message	When referring to a message in the specification the MESSAGE NAME is written with all letters in upper case characters followed by the word "message", e.g. RAB ASSIGNMENT REQUEST message.
IE	When referring to an information element (IE) in the specification the <i>Information Element Name</i> is written with the first letters in each word in upper case characters and all letters in Italic font followed by the abbreviation "IE", e.g. <i>User Plane Mode IE</i> .
Value of an IE	When referring to the value of an information element (IE) in the specification the "Value" is written as it is specified in subclause 9.2 enclosed by quotation marks, e.g. "Abstract Syntax Error (Reject)" or "Geographical Coordinates".

5 RANAP Services

RANAP provides the signalling service between UTRAN or GERAN (in Iu mode) and CN that is required to fulfil the RANAP functions described in clause 7. RANAP services are divided into four groups. The first three are based on Service Access Points (SAP) defined in TS 23.110 [16]:

1. General control services: They are related to the whole Iu interface instance between RNC and logical CN domain, and are accessed in CN through the General Control SAP. They utilise connectionless signalling transport provided by the Iu signalling bearer.
2. Notification services: They are related to specified UEs or all UEs in specified area, and are accessed in CN through the Notification SAP. They utilise connectionless signalling transport provided by the Iu signalling bearer.
3. Dedicated control services: They are related to one UE, and are accessed in CN through the Dedicated Control SAP. RANAP functions that provide these services are associated with Iu signalling connection that is maintained for the UE in question. The Iu signalling connection is realised with connection oriented signalling transport provided by the Iu signalling bearer.
4. MBMS control services: They are related to one MBMS Bearer Service. RANAP functions that provide these services are associated with one or several Iu signalling connection that is maintained for the MBMS Bearer Service in question during the MBMS Session. The Iu signalling connection is realised with connection oriented signalling transport provided by the Iu signalling bearer.

6 Services Expected from Signalling Transport

Signalling transport (See TS 25.412 [5]) shall provide two different service modes for the RANAP.

1. Connection oriented data transfer service. This service is supported by a signalling connection between RNC and CN domain. It shall be possible to dynamically establish and release signalling connections based on the need. Each active UE shall have its own signalling connection. Each MBMS Bearer Service during a given MBMS Session shall have one or several signalling connections. The signalling connection shall provide in sequence delivery of RANAP messages. RANAP shall be notified if the signalling connection breaks.
2. Connectionless data transfer service. RANAP shall be notified in case a RANAP message did not reach the intended peer RANAP entity.

7 Functions of RANAP

RANAP protocol has the following functions:

- Relocating serving RNC. This function enables to change the serving RNC functionality as well as the related Iu resources (RAB(s) and Signalling connection) from one RNC to another.
- Overall RAB management. This function is responsible for setting up, modifying and releasing RABs.
- Queuing the setup of RAB. The purpose of this function is to allow placing some requested RABs into a queue, and indicate the peer entity about the queuing.
- Requesting RAB release. While the overall RAB management is a function of the CN, the RNC has the capability to request the release of RAB.
- Release of all Iu connection resources. This function is used to explicitly release all resources related to one Iu connection.
- Requesting the release of all Iu connection resources. While the Iu release is managed from the CN, the RNC has the capability to request the release of all Iu connection resources from the corresponding Iu connection.
- SRNS context forwarding function. This function is responsible for transferring SRNS context from the RNC to the CN for intersystem change in case of packet forwarding.

- Controlling overload in the Iu interface. This function allows adjusting the load in the control plane of the Iu interface.
- Resetting the Iu. This function is used for resetting an Iu interface.
- Sending the UE Common ID (permanent NAS UE identity) to the RNC. This function makes the RNC aware of the UE's Common ID.
- Paging the user. This function provides the CN for capability to page the UE.
- Controlling the tracing of the subscriber or user equipment activity. This function allows setting the trace mode for a given subscriber or user equipment. This function also allows the deactivation of a previously established trace.
- MDT function. This function is to enable the transfer of MDT measurements collected by the UE.
- Transport of NAS information between UE and CN (see TS 24.008 [8]). This function has two sub-classes:
 1. Transport of the initial NAS signalling message from the UE to CN. This function transfers transparently the NAS information. As a consequence also the Iu signalling connection is set up.
 2. Transport of NAS signalling messages between UE and CN, This function transfers transparently the NAS signalling messages on the existing Iu signalling connection. It also includes a specific service to handle signalling messages differently.
- Controlling the security mode in the UTRAN. This function is used to send the security keys (ciphering and integrity protection) to the UTRAN, and setting the operation mode for security functions.
- Controlling location reporting. This function allows the CN to operate the mode in which the UTRAN reports the location of the UE.
- Location reporting. This function is used for transferring the actual location information from RNC to the CN.
- Data volume reporting function. This function is responsible for reporting unsuccessfully transmitted DL data volume over UTRAN for specific RABs.
- Reporting general error situations. This function allows reporting of general error situations, for which function specific error messages have not been defined.
- Location related data. This function allows the CN to either retrieve from the RNC deciphering keys (to be forwarded to the UE) for the broadcast assistance data, or request the RNC to deliver dedicated assistance data to the UE.
- Information Transfer. This function allows the CN to transfer information to the RNC.
- Uplink Information Exchange. This function allows the RNC to transfer or request information to the CN. For instance the RNC has the capability to request MBMS specific information to the CN e.g. the Multicast Service lists for a given UE or the IP Multicast Address and APN for one or several MBMS Bearer Services.
- MBMS RANAP overall function. This function allows the following different sub-functions:
 - MBMS RAB management. This function is responsible for setting up, updating and releasing the MBMS RAB as well as the MBMS Iu signalling connection corresponding to one MBMS Session. The MBMS RAB is defined for the CN PS domain only.
 - MBMS CN (PS domain) de-registration. This function makes the RNC aware that a given Multicast Service is no longer available.
 - MBMS UE linking/de-linking. This function makes the RNC aware that a given UE, with existing Iu-ps signalling connection, has joined/left some Multicast Service(s).
 - Requesting MBMS Service registration/de-registration. While the overall MBMS CN de-registration is a function of the CN (PS domain), the RNC has the capability to register/de-register to a specific Multicast Service.

These functions are implemented by one or several RANAP elementary procedures described in the following clause.

8 RANAP Procedures

8.1 Elementary Procedures

In the following tables, all EPs are divided into Class 1, Class 2 and Class 3 EPs (see subclause 3.1 for explanation of the different classes):

Table 1: Class 1

Elementary Procedure	Initiating Message	Successful Outcome	Unsuccessful Outcome
		Response message	Response message
Iu Release	IU RELEASE COMMAND	IU RELEASE COMPLETE	
Relocation Preparation	RELOCATION REQUIRED	RELOCATION COMMAND	RELOCATION PREPARATION FAILURE
Relocation Resource Allocation	RELOCATION REQUEST	RELOCATION REQUEST ACKNOWLEDGE	RELOCATION FAILURE
Relocation Cancel	RELOCATION CANCEL	RELOCATION CANCEL ACKNOWLEDGE	
SRNS Context Transfer	SRNS CONTEXT REQUEST	SRNS CONTEXT RESPONSE	
Security Mode Control	SECURITY MODE COMMAND	SECURITY MODE COMPLETE	SECURITY MODE REJECT
Data Volume Report	DATA VOLUME REPORT REQUEST	DATA VOLUME REPORT	
Reset	RESET	RESET ACKNOWLEDGE	
Reset Resource	RESET RESOURCE	RESET RESOURCE ACKNOWLEDGE	
Location related Data	LOCATION RELATED DATA REQUEST	LOCATION RELATED DATA RESPONSE	LOCATION RELATED DATA FAILURE
Information Transfer	INFORMATION TRANSFER INDICATION	INFORMATION TRANSFER CONFIRMATION	INFORMATION TRANSFER FAILURE
Uplink Information Exchange	UPLINK INFORMATION EXCHANGE REQUEST	UPLINK INFORMATION EXCHANGE RESPONSE	UPLINK INFORMATION EXCHANGE FAILURE
MBMS Session Start	MBMS SESSION START	MBMS SESSION START RESPONSE	MBMS SESSION START FAILURE
MBMS Session Update	MBMS SESSION UPDATE	MBMS SESSION UPDATE RESPONSE	MBMS SESSION UPDATE FAILURE
MBMS Session Stop	MBMS SESSION STOP REQUEST	MBMS SESSION STOP RESPONSE	
MBMS UE Linking	MBMS UE LINKING REQUEST	MBMS UE LINKING RESPONSE	
MBMS Registration	MBMS REGISTRATION REQUEST	MBMS REGISTRATION RESPONSE	MBMS REGISTRATION FAILURE
MBMS CN De-Registration	MBMS CN DE-REGISTRATION REQUEST	MBMS CN DE-REGISTRATION RESPONSE	
MBMS RAB Release	MBMS RAB RELEASE REQUEST	MBMS RAB RELEASE	MBMS RAB RELEASE FAILURE
Enhanced Relocation Complete	ENHANCED RELOCATION COMPLETE REQUEST	ENHANCED RELOCATION COMPLETE RESPONSE	ENHANCED RELOCATION COMPLETE FAILURE
SRVCC Preparation	SRVCC CS KEYS REQUEST	SRVCC CS KEYS RESPONSE	
UE Radio Capability Match	UE RADIO CAPABILITY MATCH REQUEST	UE RADIO CAPABILITY MATCH RESPONSE	

Table 2: Class 2

Elementary Procedure	Message
RAB Modification Request	RAB MODIFY REQUEST
RAB Release Request	RAB RELEASE REQUEST
Iu Release Request	IU RELEASE REQUEST
Relocation Detect	RELOCATION DETECT
Relocation Complete	RELOCATION COMPLETE
SRNS Data Forwarding Initiation	SRNS DATA FORWARD COMMAND
SRNS Context Forwarding from Source RNC to CN	FORWARD SRNS CONTEXT
SRNS Context Forwarding to Target RNC from CN	FORWARD SRNS CONTEXT
Paging	PAGING
Common ID	COMMON ID
CN Invoke Trace	CN INVOKE TRACE
CN Deactivate Trace	CN DEACTIVATE TRACE
Location Reporting Control	LOCATION REPORTING CONTROL
Location Report	LOCATION REPORT
Initial UE Message	INITIAL UE MESSAGE
Direct Transfer	DIRECT TRANSFER
Overload Control	OVERLOAD
Error Indication	ERROR INDICATION
UE Specific Information	UE SPECIFIC INFORMATION INDICATION
Direct Information Transfer	DIRECT INFORMATION TRANSFER
MBMS RAB Establishment Indication	MBMS RAB ESTABLISHMENT INDICATION
Enhanced Relocation Complete Confirm	ENHANCED RELOCATION COMPLETE CONFIRM

Table 3: Class 3

Elementary Procedure	Initiating Message	Response Message
RAB Assignment	RAB ASSIGNMENT REQUEST	RAB ASSIGNMENT RESPONSE x N (N>=1)

The following applies concerning interference between Elementary Procedures:

- The Reset procedure takes precedence over all other EPs.
- The Reset Resource procedure takes precedence over all other EPs except the Reset procedure.
- The Iu Release procedure takes precedence over all other EPs except the Reset procedure and the Reset Resource procedure.

8.2 RAB Assignment

8.2.1 General

The purpose of the RAB Assignment procedure is to establish new RABs and/or to enable modifications and/or releases of already established RABs for a given UE. The procedure uses connection oriented signalling.

8.2.2 Successful Operation

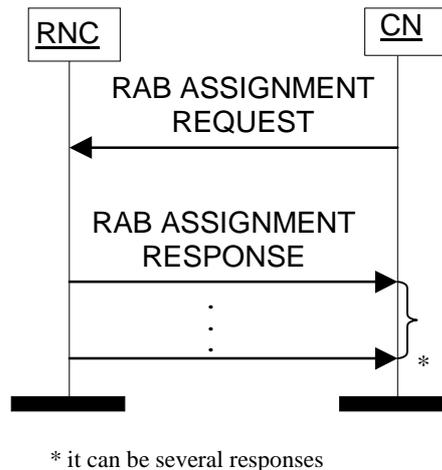

Figure 1: RAB Assignment procedure. Successful operation.

The CN initiates the procedure by sending a RAB ASSIGNMENT REQUEST message. When sending the RAB ASSIGNMENT REQUEST message, the CN shall start the $T_{RABAssgt}$ timer.

The CN may request the UTRAN to:

- establish,
- modify,
- release

one or several RABs with one RAB ASSIGNMENT REQUEST message.

The CN shall include in the RAB ASSIGNMENT REQUEST message at least one request to either establish/modify or release a RAB.

The message shall contain the information required by the UTRAN to build the new RAB configuration, such as:

- list of RABs to establish or modify with their bearer characteristics;
- list of RABs to release;
- UE Aggregate Maximum Bit Rate (if available).

For each RAB requested to be established, the message shall contain:

- RAB ID;
- NAS Synchronisation Indicator (only when available);
- RAB parameters (including e.g. Allocation/Retention Priority);
- User Plane Information (i.e. required User Plane Mode and required UP Mode Versions);
- Transport Layer Information;
- PDP Type Information (only for PS) or PDP Type Information extension (only for PS);
- Data Volume Reporting Indication (only for PS);
- DL GTP-PDU sequence number (only when GTP-PDU sequence number is available in cases of intersystem change from GPRS to UMTS or when establishing a RAB for an existing PDP context or in some further cases described in TS 23.060 [21]);

- UL GTP-PDU sequence number (only when GTP-PDU sequence number is available in cases of intersystem change from GPRS to UMTS or when establishing a RAB for an existing PDP context or in some further cases described in TS 23.060 [21]);
- DL N-PDU sequence number (only when N-PDU sequence number is available in case of intersystem change from GPRS to UMTS or in some further cases described in TS 23.060 [21]);
- UL N-PDU sequence number (only when N-PDU sequence number is available in case of intersystem change from GPRS to UMTS or in some further cases described in TS 23.060 [21]).

The RAB ASSIGNMENT REQUEST message shall, if supported, include the *Correlation ID* IE for each RAB established towards a L-GW collocated with the RNC.

For each RAB requested to be modified, the message may contain:

- RAB ID (mandatory);
- NAS Synchronisation Indicator;
- RAB parameters;
- Transport Layer Information;
- User Plane Information.

If the *UE Aggregate Maximum Bit Rate* IE is present in the RAB ASSIGNMENT REQUEST message, the UTRAN shall, if supported, store the received UE Aggregate Maximum Bit Rate parameters to control the aggregate data rate of non-GBR traffic for this UE.

The *Transport Layer Information* IE may be present at a RAB modification except in the case when the only other present IE, besides the *RAB ID* IE, is the *NAS Synchronisation Indicator* IE.

At a RAB modification that does not include transfer of the *NAS Synchronisation Indicator* IE, the *RAB Parameters* IE shall be present in the RAB ASSIGNMENT REQUEST message only when any previously set value for this IE is requested to be modified.

At a RAB modification, the *User Plane Information* IE shall be present in the RAB ASSIGNMENT REQUEST message only when any previously set value for this IE is requested to be modified.

For a RAB setup, the *SDU Format Information Parameter* IE in the *RAB Parameters* IE shall be present only if the *User Plane Mode* IE is set to "support mode for pre-defined SDU sizes" and the *Traffic Class* IE is set to either "Conversational" or "Streaming".

For a RAB setup or modification, when the maximum bit rate (respectively the guaranteed bit rate when applicable) to be signalled for the RAB exceeds the maximum value of the *Maximum Bit Rate* IE (respectively *Guaranteed Bit Rate* IE), either the *Extended Maximum Bit Rate* IE (respectively *Extended Guaranteed Bit Rate* IE) shall be included together with the *Maximum Bit Rate* IE (respectively *Guaranteed Bit Rate* IE) set to its maximum value or the *Supported Maximum Bit Rate* IE (respectively *Supported Guaranteed Bit Rate* IE) shall be used.

For a RAB setup or modification, if the *Extended Maximum Bit Rate* IE (respectively *Extended Guaranteed Bit Rate* IE) is present, the RNC shall consider it and ignore the *Maximum Bit Rate* IE (respectively *Guaranteed Bit Rate* IE).

For a RAB if *Extended Maximum Bit Rate* IE (respectively *Extended Guaranteed Bit Rate* IE when applicable) is signalled in one direction RNC shall use the *Extended Maximum Bit Rate* IE (respectively *Extended Guaranteed Bit Rate* IE) also for the other direction for this RAB. If the *Supported Maximum Bit Rate* IE (respectively *Supported Guaranteed Bit Rate* IE) is present, it shall be used in both directions.

For a RAB setup or modification, if the *Supported Maximum Bit Rate* IE (respectively *Supported Guaranteed Bit Rate* IE) is present, the RNC shall consider it and ignore the *Maximum Bit Rate* IE (respectively *Guaranteed Bit Rate* IE).

For a RAB setup, the *RAB Parameters* IE may contain the *Signalling Indication* IE. The *Signalling Indication* IE shall not be present if the *Traffic Class* IE is not set to "Interactive" or if the *CN Domain Indicator* IE is not set to "PS domain".

If the *RAB Parameters* IE is present for a RAB modification, the *SDU Format Information Parameter* IE in the *RAB Parameters* IE shall be present only if the *Traffic Class* IE is set to either "Conversational" or "Streaming" and if

The RAB ID shall uniquely identify the RAB for the specific CN domain and for the particular UE, which makes the RAB ID unique over the Iu connection on which the RAB ASSIGNMENT REQUEST message is received. When a RAB ID already in use over that particular Iu instance is used, the procedure is considered as modification of that RAB.

The RNC shall pass the contents of the *RAB ID* IE to the radio interface protocol for each RAB requested to be established or modified.

The RNC shall establish or modify the resources according to the values of the *Allocation/Retention Priority* IE (priority level, pre-emption indicators, queuing) and the resource situation as follows:

- The RNC shall consider the priority level of the requested RAB, when deciding on the resource allocation.
- If the requested RAB is allowed for queuing and the resource situation requires so, the RNC may place the RAB in the establishment queue.
- The priority levels and the pre-emption indicators may (singularly or in combination) be used to determine whether the RAB assignment has to be performed unconditionally and immediately. If the requested RAB is marked as "may trigger pre-emption" and the resource situation requires so, the RNC may trigger the pre-emption procedure which may then cause the forced release of a lower priority RAB which is marked as "pre-emptable". Whilst the process and the extent of the pre-emption procedure is operator-dependent, the pre-emption indicators, if given in the RAB ASSIGNMENT REQUEST message, shall be treated as follows:
 1. The values of the last received *Pre-emption Vulnerability* IE and *Priority Level* IE shall prevail.
 2. If the *Pre-emption Capability* IE is set to "may trigger pre-emption", then this allocation request may trigger the pre-emption procedure.
 3. If the *Pre-emption Capability* IE is set to "shall not trigger pre-emption", then this allocation request shall not trigger the pre-emption procedure.
 4. If the *Pre-emption Vulnerability* IE is set to "pre-emptable", then this connection shall be included in the pre-emption process.
 5. If the *Pre-emption Vulnerability* IE is set to "not pre-emptable", then this connection shall not be included in the pre-emption process.
 6. If the *Priority Level* IE is set to "no priority" the given values for the *Pre-emption Capability* IE and *Pre-emption Vulnerability* IE shall not be considered. Instead the values "shall not trigger pre-emption" and "not pre-emptable" shall prevail.
- If the *Allocation/Retention Priority* IE is not given in the RAB ASSIGNMENT REQUEST message, the allocation request shall not trigger the pre-emption process and the connection may be pre-empted and considered to have the value "lowest" as priority level. Moreover, queuing shall not be allowed.
- The UTRAN pre-emption process shall keep the following rules:
 1. UTRAN shall only pre-empt RABs with lower priority, in ascending order of priority.
 2. The pre-emption may be done for RABs belonging to the same UE or to other UEs.

If the *NAS Synchronisation Indicator* IE is contained in the RAB ASSIGNMENT REQUEST message, the RNC shall pass it to the radio interface protocol for transfer to the UE.

If the RAB ASSIGNMENT REQUEST message includes the *PDP Type Information* IE or *PDP Type Information* extension IE, the UTRAN may use it to configure any compression algorithms.

If included, the *Service Handover* IE tells if the requested RAB

- should be handed over to GSM, i.e. from a NAS point of view, the requested RAB should be handed over to GSM as soon as possible although the final decision whether to perform a handover to GSM is still made in the UTRAN.
- should not be handed over to GSM, i.e. from a NAS point of view, the requested RAB should remain in UMTS as long as possible although the final decision whether to perform a handover to GSM is still made in the UTRAN.

- shall not be handed over to GSM, i.e. the requested RAB shall never be handed over to GSM. This means that the UTRAN shall not initiate handover to GSM for the UE unless the RABs with this indication have first been released with the normal release procedures.

The value of the *Service Handover* IE is valid throughout the lifetime of the RAB or until changed by a RAB modification.

The *Service Handover* IE shall only influence decisions made regarding UTRAN-initiated inter-system handovers.

If the *Service Handover* IE is not included during RAB Setup and all subsequent RAB Modifications, the decision whether to perform an inter-system handover to GSM is only an internal UTRAN matter.

If included, the *E-UTRAN Service Handover* IE tells if the requested RAB is allowed to be handed over to E-UTRAN.

If the E-UTRAN service handover function is supported,

- The RNC shall not trigger handover or redirection to E-UTRAN for a UE with a signaling connection only;
- The RNC shall not trigger handover or redirection to E-UTRAN for a UE if all established RABs have *E-UTRAN Service Handover* IE set to Handover to E-UTRAN shall not be performed.

The value of the *E-UTRAN Service Handover* IE is valid throughout the lifetime of the RAB or until changed by a RAB modification.

If the *E-UTRAN Service Handover* IE is not included during RAB Setup and all subsequent RAB Modifications, the decision whether to perform an inter-system mobility to E-UTRAN, e.g., handover or redirection, is only an internal UTRAN matter.

The UTRAN shall report to the CN, in the first RAB ASSIGNMENT RESPONSE message, the result for all the requested RABs, such as:

- List of RABs successfully established or modified.
- List of RABs released.
- List of RABs queued.
- List of RABs failed to establish or modify.
- List of RABs failed to release.

The same RAB ID shall only be present once in the whole RAB ASSIGNMENT RESPONSE message.

For each RAB successfully established towards the PS domain or towards the CS domain when an ALCAP is not used, the RNC shall include the *Transport Layer Address* IE and the *Iu Transport Association* IE in the RAB ASSIGNMENT RESPONSE message.

For each RAB successfully released towards the PS domain, for which data volume reporting had been requested when the RAB was established, the RNC shall include the *DL Data Volumes* IE in the RAB ASSIGNMENT RESPONSE message. The *DL Data Volumes* IE shall contain in the *Unsuccessfully Transmitted DL Data Volume* IE the total amount of unsuccessfully transmitted DL data for the RAB since its establishment and may contain the *Data Volume Reference* IE.

For each RAB successfully released towards the PS domain, the RNC shall include in the RAB ASSIGNMENT RESPONSE message the *DL GTP-PDU Sequence Number* IE and the *UL GTP-PDU Sequence Number* IE, if available and if the release was initiated by the UTRAN.

The RNC shall report in the RAB ASSIGNMENT RESPONSE message at least one RAB:

- setup/modified or
- released or
- queued or
- failed to setup/modify or

When the request to establish or modify one or several RABs is put in a queue, the UTRAN shall start the timer T_{QUEUING} . This timer specifies the maximum time for queuing of the request for establishment or modification. The same timer T_{QUEUING} supervises all RABs of the request being queued.

For each RAB that is queued the following outcomes are possible:

- successfully established or modified;
- failed to establish or modify;
- failed due to expiry of the timer T_{QUEUING} .

For RABs indicated as queued in the first RAB ASSIGNMENT RESPONSE message, the UTRAN shall report the outcome of the queuing for every RAB individually or for several RABs in subsequent RAB ASSIGNMENT RESPONSE message(s). This is left to implementation. The UTRAN shall stop T_{QUEUING} when all RABs have been either successfully established or modified or failed to establish or modify. The RAB Assignment procedure is then terminated both in the CN and the UTRAN when all RABs have been responded to.

When the CN receives the response that one or several RABs are queued, it shall expect the UTRAN to provide the outcome of the queuing function for each RAB before expiry of the T_{RABASSGT} timer. In case the timer T_{RABASSGT} expires, the CN shall consider the RAB Assignment procedure terminated and the RABs not reported shall be considered as failed.

In case the timer T_{QUEUING} expires, the RAB Assignment procedure terminates in the UTRAN for all queued RABs, and the UTRAN shall respond for all of them in one RAB ASSIGNMENT RESPONSE message. The RAB Assignment procedure shall also be terminated in the CN.

In case a request to modify or release a RAB contains the RAB ID of a RAB being queued, the RAB shall be taken out of the queue and treated according to the second request. The first request shall be responded to as a RAB failed to setup or modify with the cause value "Request superseded".

If the UTRAN failed to modify a RAB, it shall keep the RAB as it was configured prior to the modification request.

When UTRAN reports unsuccessful establishment/modification of a RAB, the cause value should be precise enough to enable the core network to know the reason for unsuccessful establishment/modification. Typical cause values are: "Requested Traffic Class not Available", "Invalid RAB Parameters Value", "Requested Maximum Bit Rate not Available", "Requested Maximum Bit Rate for DL not Available", "Requested Maximum Bit Rate for UL not Available", "Requested Guaranteed Bit Rate not Available", "Requested Guaranteed Bit Rate for DL not Available", "Requested Guaranteed Bit Rate for UL not Available", "Requested Transfer Delay not Achievable", "Invalid RAB Parameters Combination", "Condition Violation for SDU Parameters", "Condition Violation for Traffic Handling Priority", "Condition Violation for Guaranteed Bit Rate", "User Plane Versions not Supported", "Iu UP Failure", "Iu Transport Connection Failed to Establish", " T_{QUEUING} Expiry".

If the RAB ID of a RAB requested to be released is unknown in the RNC, this shall be reported as a RAB failed to release with the cause value "Invalid RAB ID".

The RNC may indicate an impending directed retry attempt to GSM by sending a RAB ASSIGNMENT RESPONSE message with a RAB ID included in the list of RABs failed to setup and a cause value of "Directed Retry".

The RNC shall be prepared to receive a RAB ASSIGNMENT REQUEST message containing a *RABs To Be Released* IE at any time and shall always reply to it. If there is an ongoing RAB Assignment procedure for a RAB indicated within the *RABs To Be Released* IE, the RNC shall discard the preceding RAB Assignment procedure for that specific RAB, release any related resources and report the released RAB within the RAB ASSIGNMENT RESPONSE message.

After sending a RAB ASSIGNMENT RESPONSE message containing RAB ID within the *RABs Released* IE, the RNC shall be prepared to receive a new establishment request for a RAB identified by the same RAB ID.

In case SIPTO at Iu-PS functionality is supported by the UTRAN, the following applies in addition for the successful operation of the RAB Assignment procedure:

- If the *MSISDN* IE is present in the RAB ASSIGNMENT REQUEST message, then the UTRAN may offload the RAB(s) where the *Offload RAB Parameters* IE is present in the *RABs To Be Setup Or Modified Item IEs* IE. The *Access Point Name* IE and the *Charging Characteristics* IE within the *Offload RAB Parameters* IE and the *MSISDN* IE may only be used for the SIPTO at Iu-PS function and according to the description in TS 23.060 [21].

8.2.2.1 Successful Operation for GERAN Iu-mode

For GERAN Iu-mode the following shall apply in addition for the successful operation of the RAB Assignment procedure:

- In case of GERAN Iu-mode, for a RAB requested to be setup or modified from the CS domain, the RAB ASSIGNMENT REQUEST message may contain the *GERAN BSC Container* IE in order to provide GERAN-specific information to GERAN (see TS 43.051 [27]).
- In case of GERAN Iu-mode (only for CS), if the BSC cannot provide an appropriate RAB corresponding to the content of the *GERAN BSC Container* IE (if received), the BSC shall report unsuccessful RAB establishment/modification indicating the cause value "GERAN Iu-mode Failure" and the *GERAN Classmark* IE in the *GERAN Iu mode specific RABs Failed To Setup Or Modify List* IE within the RAB ASSIGNMENT RESPONSE message.

8.2.3 Unsuccessful Operation

The unsuccessful operation for this Class 3 Elementary procedure is described under the Successful Operation chapter.

8.2.4 Abnormal Conditions

For a RAB requested to be modified, if only the *RAB ID* IE, the *NAS Synchronisation Indicator* IE and the *Transport Layer Information* IE are included in the *First Setup or Modify Item* IE, the RAB shall not be modified, and the corresponding *RAB ID* IE and *Cause* IE shall be included in the "RABs Failed To Setup Or Modify List" in the RAB ASSIGNMENT RESPONSE message.

If, for a RAB requested to be setup towards the PS domain, any of the following IEs:

- *PDP Type Information*.
- *PDP Type Information extension*.
- *Data Volume Reporting Indication*.

is not present, the RNC shall continue with the procedure.

Interactions with Relocation Preparation/Enhanced Relocation procedure:

If the relocation or enhanced relocation becomes necessary during the RAB Assignment procedure, the RNC may interrupt the ongoing RAB Assignment procedure and initiate the Relocation Preparation or Enhanced Relocation procedure as follows:

1. The RNC shall terminate the RAB Assignment procedure indicating unsuccessful RAB configuration modification:
 - for all queued RABs;
 - for RABs not already established or modified, and
 - for RABs not already released;with the cause "Relocation triggered".
2. The RNC shall terminate the RAB Assignment procedure indicating successful RAB configuration modification:
 - for RABs already established or modified but not yet reported to the CN, and
 - for RABs already released but not yet reported to the CN.
3. The RNC shall report the outcome of the procedure in one RAB ASSIGNMENT RESPONSE message.
4. The RNC shall either invoke relocation by sending a RELOCATION REQUIRED message to the active CN node(s) or enhanced relocation by sending the *Iur ENHANCED RELOCATION REQUEST* message to the target RAN node.

5. The CN shall terminate the RAB Assignment procedure at reception of the RAB ASSIGNMENT RESPONSE message.

Directed retry from UMTS to GSM (CS domain only):

In the case where the RNC has no RAB configuration for a particular UE in the CS domain, and the RNC receives a RAB ASSIGNMENT REQUEST message for that UE requesting the establishment of one RAB only, a directed retry to perform inter-system handover to GSM may be initiated. In this case the RNC may interrupt the ongoing RAB Assignment procedure and initiate the Relocation Preparation procedure as follows:

1. The RNC shall terminate the RAB Assignment procedure indicating unsuccessful RAB configuration modification of that RAB with the cause "Directed retry".
2. The RNC shall report the outcome of the procedure in one RAB ASSIGNMENT RESPONSE message.
3. The RNC shall invoke relocation by sending a RELOCATION REQUIRED message to the active CN node, with the cause "Directed Retry".
4. The CN shall terminate the RAB Assignment procedure at reception of the RAB ASSIGNMENT RESPONSE message.

For a RAB setup or modification, if the *Supported Maximum Bit Rate IE* (respectively *Supported Guaranteed Bit Rate IE*) is present in the *RAB Parameters IE*, the RNC shall ignore the corresponding bitrate and/or extended bitrate definition in this IE.

For a RAB setup or modification, if the *Supported Alternative Maximum Bit Rate IE* (respectively *Supported Alternative Guaranteed Bit Rate IE*) is present in the *Alternative RAB Parameter Values IE*, the RNC shall ignore the corresponding alternative bitrate and/or extended alternative bitrate definitions in this IE.

8.3 RAB Release Request

8.3.1 General

The purpose of the RAB Release Request procedure is to enable the UTRAN to request the release of one or several radio access bearers. The procedure uses connection oriented signalling.

8.3.2 Successful Operation

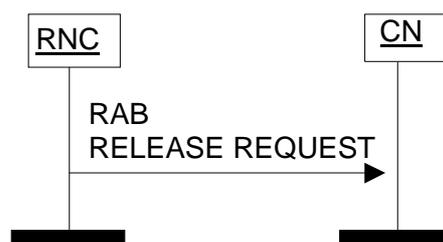

Figure 2: RAB Release Request procedure. Successful operation.

The RNC initiates the procedure by generating a RAB RELEASE REQUEST message towards the CN. The *RABs To Be Released IE* shall indicate the list of RABs requested to release and the *Cause IE* associated to each RAB shall indicate the reason for the release, e.g. "RAB pre-empted", "Release due to UTRAN Generated Reason", "Radio Connection With UE Lost".

The RNC shall indicate the *Cause IE* set to "GTP Resources Unavailable" for the reasons specified in TS 23.007 [53].

Upon reception of the RAB RELEASE REQUEST message, the CN should normally initiate the appropriate release procedure for the RABs identified in the RAB RELEASE REQUEST message as defined below. It is up to the CN to decide how to react to the request.

Interaction with Iu Release Command:

If no RABs will remain according to the RAB RELEASE REQUEST message, the CN should initiate the Iu Release procedure if it does not want to keep the Iu signalling connection. The cause value to use is "No Remaining RAB".

Interaction with RAB Assignment (release RAB):

If the CN decides to release some or all indicated RABs, the CN should invoke the RAB Assignment procedure (release RAB) to this effect.

8.3.3 Abnormal Conditions

Not applicable.

8.4 Iu Release Request

8.4.1 General

The purpose of the Iu Release Request procedure is to enable the UTRAN to request the CN to release the Iu connection for a particular UE due to some UTRAN generated reason (e.g. "O&M Intervention", "Unspecified Failure", "User Inactivity", "Repeated Integrity Checking Failure", "Release due to UE generated signalling connection release", "Radio Connection With UE Lost", "Access Restricted Due to Shared Networks"). The procedure uses connection oriented signalling.

8.4.2 Successful Operation



Figure 3: Iu Release Request procedure. Successful operation.

The RNS controlling the Iu connection(s) of that particular UE initiates the procedure by generating an IU RELEASE REQUEST message towards the affected CN domain(s). The procedure may be initiated for instance when the contact with a particular UE is lost or due to user inactivity.

The IU RELEASE REQUEST message shall indicate the appropriate cause value for the requested Iu connection release. It is up to the CN to decide how to react to the request.

Interactions with Iu Release procedure:

The Iu Release procedure should be initiated upon reception of an IU RELEASE REQUEST message when the cause is different than "User Inactivity". When the cause is set to "User Inactivity", it is optional to initiate the Iu Release procedure.

8.4.3 Abnormal Conditions

Not applicable.

8.5 Iu Release

8.5.1 General

The purpose of the Iu Release procedure is to enable the CN to release an Iu connection for a particular UE and all UTRAN resources related only to that Iu connection. The procedure uses connection oriented signalling.

The Iu Release procedure can be initiated for at least the following reasons:

- Completion of transaction between the UE and the CN.
- UTRAN-generated reasons, e.g. reception of an IU RELEASE REQUEST message.
- Completion of successful relocation of SRNS.
- Cancellation of relocation after successful completion of a Relocation Resource Allocation procedure.
- Detection of two Iu connections in the same domain toward one UE.

The Iu release procedure should also be initiated when there is a period of Iu signalling inactivity with no existing RAB.

8.5.2 Successful Operation

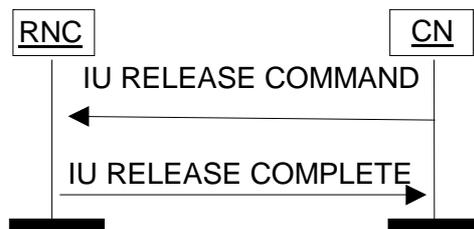

Figure 4: Iu Release procedure. Successful operation.

The CN initiates the procedure by sending an IU RELEASE COMMAND message to the UTRAN.

After the IU RELEASE COMMAND message has been sent, the CN shall not send further RANAP connection-oriented messages on this particular connection.

The IU RELEASE COMMAND message shall include a *Cause* IE indicating the reason for the release (e.g. "Successful Relocation", "Normal Release", "Release due to UTRAN Generated Reason", "Relocation Cancelled", "No Remaining RAB").

When the RNC receives the IU RELEASE COMMAND message:

1. Clearing of the related UTRAN resources is initiated. However, the UTRAN shall not clear resources related to other Iu signalling connections the UE might have. The Iu transport bearers for RABs subject to data forwarding and other UTRAN resources used for the GTP-PDU forwarding process, are released by the RNC only when the timer $T_{DATAfwd}$ expires.
2. The RNC returns any assigned Iu user plane resources to idle i.e. neither uplink user data nor downlink user data can be transferred over the Iu interface anymore. Then the RNC sends an IU RELEASE COMPLETE message to the CN. (The RNC does not need to wait for the release of UTRAN radio resources or for the transport network layer signalling to be completed before returning the IU RELEASE COMPLETE message.) When an IU RELEASE COMPLETE message is sent, the procedure is terminated in the UTRAN.

If the IU RELEASE COMMAND message included the *End Of CSFB* IE, the RNC may use the indication to determine which of the existing mechanisms that should be used to move the UE to E UTRAN.

If the IU RELEASE COMMAND message includes the *Out Of UTRAN* IE, the RNC may use the indication to determine whether to explicitly release the RRC connection.

In case the UE has been linked to Multicast Service(s) in UTRAN and the RNC receives the IU RELEASE COMMAND message from PS domain or from CS domain when no Iu signalling connection exists towards the other domain the RNC shall perform UE de-linking as described in TS 25.346 [42].

The IU RELEASE COMPLETE message shall include within the *RABs Data Volume Report List* IE for each RAB towards the PS domain successfully addressed and for which data volume reporting was requested during RAB establishment, the total amount of unsuccessfully transmitted DL data for the RAB since its establishment.

If the release was initiated by the UTRAN, for each RAB towards the PS domain for which the *DL GTP-PDU Sequence Number* IE and/or the *UL GTP-PDU Sequence Number* IE are (is) available, the RNC shall include the available

sequence number(s) in the *RABs Released Item IE* (within the *RAB Released List IE*) in the IU RELEASE COMPLETE message.

The *RAB Release Item IE* shall not be present if there is no sequence number to be reported for that RAB.

Reception of an IU RELEASE COMPLETE message terminates the procedure in the CN.

Interaction with Trace:

In case of simultaneous Iu signalling connections for both CS and PS domains, if a trace session was activated by both domains, the successful release of one of the connections should not close this trace session. If the trace session was activated by only one domain and the Iu connection for this domain is successfully released, this trace session shall be stopped in UTRAN.

8.5.3 Abnormal Conditions

If the Iu Release procedure is not initiated towards the source RNC from the CN before the expiry of timer $T_{RELOCoverall}$, the source RNC should initiate the Iu Release Request procedure towards the CN with a cause value "T_{RELOCoverall} expiry".

8.6 Relocation Preparation

8.6.1 General

The purpose of the Relocation Preparation procedure is to prepare relocation of SRNS either with involving the UE or without involving the UE. The relocation procedure shall be co-ordinated over all Iu signalling connections existing for the UE in order to allow Relocation co-ordination in the target RNC. The procedure uses connection oriented signalling.

The source RNC shall not initiate the Relocation Preparation procedure for an Iu signalling connection if a Prepared Relocation exists in the RNC for that Iu signalling connection or if a Relocation Preparation procedure is ongoing for that Iu signalling connection or in the case of a MOCN configuration if the Rerouting Function is ongoing.

8.6.2 Successful Operation

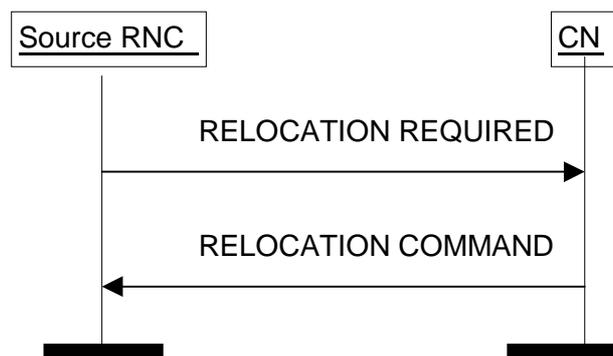

Figure 5: Relocation Preparation procedure. Successful operation.

The source RNC initiates the procedure by sending a RELOCATION REQUIRED message. The source RNC shall decide whether to initiate an intra-system Relocation or an inter-system handover.

The source RNC shall indicate the appropriate cause value for the Relocation in the *Cause IE*. Typical cause values are "Time critical Relocation", "Resource optimisation relocation", "Relocation desirable for radio reasons", "Directed Retry", "Reduce Load in Serving Cell", "Access Restricted Due to Shared Networks", "No Iu CS UP relocation".

The source RNC shall determine whether the relocation of SRNS shall be executed with or without involvement of the UE. The source RNC shall set accordingly the *Relocation Type IE* to "UE involved in relocation of SRNS" or "UE not involved in relocation of SRNS".

In case of intra-system Relocation, the source RNC:

- shall indicate in the *Source ID IE* the RNC-ID of the source RNC and in the *Target ID IE* the RNC-ID of the target RNC only including the RAC if the message is sent towards the PS domain;
- shall in case SRVCC is performed include the *SRVCC HO Indication IE* in the RELOCATION REQUIRED message. The value of *SRVCC HO Indication IE* shall be set by the source RNC. In case the source RNC decides to involve at the target side only CS domain, the *SRVCC HO Indication IE* shall be set to "CS only", to "PS and CS" in case CS and PS domain at the target side shall be involved;

NOTE: The *Number of Iu Instances IE* within the *Source RNC to Target RNC Transparent Container IE* shall be set according to the *SRVCC HO Indication IE*.

- shall include in the RELOCATION REQUIRED message the *Source to Target Transparent Container IE*. This container shall be encoded according to the *Source RNC to Target RNC Transparent Container IE* definition. The *Source RNC to Target RNC Transparent Container IE* shall include:
 - the *Relocation Type IE* and the *Number of Iu Instances IE* containing the number of Iu signalling connections existing for the UE.
 - the *Integrity Protection Key IE* from the last received domain on which the Security Mode Control procedure has been successfully performed, and the associated *Chosen Integrity Protection Algorithm IE* that has been selected for this domain.
 - the *Ciphering Key IE* for the signalling data from the last received domain on which the Security Mode Control procedure has been successfully performed if the ciphering has been started, together with the associated *Chosen Encryption Algorithm IE* that has been selected for this domain. If the ciphering has not been started, the RNC may include the *Ciphering Key IE* and the *Chosen Encryption Algorithm IE* if they are available.
 - for each domain where the Security Mode Control procedure has been successfully performed in the source RNC, the *Chosen Encryption Algorithm IE* of CS (PS respectively) user data corresponding to the ciphering alternative that has been selected for this domain. If the Security Mode Control procedure had not been successful or performed for one domain or had proposed no ciphering alternative, the *Chosen Encryption Algorithm IE* for the user data of this domain shall not be included. When both the CS and the PS user data *Chosen Encryption Algorithm IE*s are provided, they shall be the same.
 - the *RRC Container IE*. If the *Relocation Type IE* is set to "UE not involved in relocation of SRNS" and the UE is using DCH(s), DSCH(s), USCH(s), HS-DSCH and/or E-DCH, the *Source RNC to Target RNC Transparent Container IE* shall:
 - for each RAB include the RAB ID, the *CN Domain Indicator IE* and the mapping between each RAB subflow and transport channel identifier(s) over Iur, i.e. if the RAB is carried on a DCH(s), the DCH ID(s) shall be included, and when it is carried on DSCH(s), USCH(s), HS-DSCH and/or E-DCH, the DSCH ID(s), USCH ID(s), HS-DSCH MAC-d Flow ID and/or E-DCH MAC-d Flow ID respectively shall be included.
 - only in the case the active SRBs in SRNC are not all mapped onto the same DCH, include the *SRB TrCH Mapping IE* containing for each SRB the SRB ID and the associated transport channel identifier over Iur, i.e. if the SRB is carried on a DCH, the DCH ID shall be included, and when it is carried on DSCH, USCH, HS-DSCH and/or E-DCH, the DSCH ID, USCH ID, HS-DSCH MAC-d Flow ID and/or E-DCH MAC-d Flow ID respectively shall be included.
 - the *d-RNTI IE*, if the *Relocation Type IE* is set to "UE not involved in relocation of SRNS".
 - the *Target Cell ID IE*, if the *Relocation Type IE* is set to "UE involved in relocation of SRNS".
 - in the *PS RAB To Be Replaced IE* the RAB ID of the voice RAB which is relocated from the PS to the CS CN domain, in case SRVCC is performed.
 - the *d-RNTI for No IuCS UP IE*, if the source RNC doesn't have an Iu-CS user plane connection, the *Relocation Type IE* is set to "UE involved in relocation of SRNS" and the reason for the relocation is the source RNC cannot support CS service. The *Cause IE* shall be set as "No Iu CS UP relocation" in the RELOCATION REQUIRED message.
 - the *MBMS Linking Information IE*, if available, in case the UE has been linked to at least one Multicast Service.

- the *UE History Information* IE and the source RNC shall add the stored information to the *Last Visited Cell List* IE, in case the source RNC is configured to collect UE history information.
- the Subscriber Profile ID for RAT/Frequency priority IE if available in the source RNC.
- the *Management Based MDT Allowed* IE only or the *Management Based MDT Allowed* IE and the *Management Based MDT PLMN List* IE, if this has been provided to the RNC and the serving PLMN of the relocation target is included in the *Management Based MDT PLMN List*.
- may in case a Trace Recording Session is active in the Source RNC due to a Signalling Based Activation (see ref TS 32.421 [37]), include the *Trace Recording Session Information* IE containing information identifying the Trace Record being generated in the *Source RNC to Target RNC Transparent Container* IE.

In case of inter-system handover to GSM CS domain, the RNC:

- the source RNC shall indicate in the *Source ID* IE the Service Area Identifier and in the *Target ID* IE the cell global identity of the cell in the target system;
- shall include the *MS Classmark 2* and *MS Classmark 3* IEs received from the UE in the RELOCATION REQUIRED message to the CN;
- shall include the *Old BSS to New BSS Information* IE within the RELOCATION REQUIRED message only if the information is available. This information shall include, if available, the current traffic load in the source cell, i.e. prior to the inter-system handover attempt. This information shall also include the source cell identifier the included traffic load values correspond to. In the case the UE is using, prior to the inter-system handover attempt, radio resources of more than one cell, it is implementation specific for which cell the source RNC should report the current traffic load and the cell identifier.
- shall in case SRVCC is performed include the *SRVCC HO Indication* IE in the RELOCATION REQUIRED message. The value of *SRVCC HO Indication* IE shall be set to "CS only" by the source RNC;

In case of inter-system handover to GSM PS domain, the RNC:

- shall indicate in the *Source ID* IE the Service Area Identifier, in the *Target ID* IE the cell global identity of the cell in the target system and shall also indicate routing area code for the relevant cell in the target system;
- shall include the *Source BSS to Target BSS Transparent Container* IE within the RELOCATION REQUIRED message to the CN. It may indicate in this container whether it requests to receive the SI/PSI container from the external inter-system handover target in the RELOCATION COMMAND message.

In case of inter-system handover towards the GSM CS domain and GSM PS domain in parallel, the source RNC:

- shall include in the *Target ID* IE the same cell global identity of the cell in the target system for CS domain and PS domain and set the appropriate information about the nature of the CS/PS inter-system handover (see ref TS 43.055 [47]) in the *Old BSS to New BSS Information* IE and *Source BSS to Target BSS Transparent Container* IE accordingly.
- shall in case SRVCC is performed include the *SRVCC HO Indication* IE in the RELOCATION REQUIRED message. The value of *SRVCC HO Indication* IE shall be set to "PS and CS" by the source RNC;

In case of inter-system handover to E-UTRAN (as specified in TS 23.401 [48]), the RNC:

- shall indicate in the *Source ID* IE the RNC-ID of the source RNC and in the *Target ID* IE either the eNB-ID or the Corresponding RNC-ID of the target eNodeB in the target system (see subclause 9.2.1.25);
- shall include the *Source to Target Transparent Container* IE within the RELOCATION REQUIRED message. The information in the container shall be encoded according to the *Source eNB to Target eNB Transparent Container* IE definition as specified in TS 36.413 [49].
- shall, in case rSRVCC is performed, include the *rSRVCC HO Indication* IE in the RELOCATION REQUIRED message. The value of *rSRVCC HO Indication* IE shall be set to "PS only" by the source RNC.

When the source RNC sends the RELOCATION REQUIRED message, it shall start the timer $T_{\text{RELOCprep}}$.

When the preparation including resource allocation in the target system is ready and the CN has decided to continue the relocation of SRNS, the CN shall send a RELOCATION COMMAND message to the source RNC and the CN shall start the timer $T_{RELOC\ complete}$.

If the *CSG Id IE* and no *Cell Access Mode IE* are received in the RELOCATION REQUIRED message, the CN shall perform the access control according to the CSG Subscription Data of that UE and if the access control is successful, or if one of the RABs has some particular ARP values (see TS 23.060 [21]), it shall continue the relocation and propagate the target *CSG Id IE* to the target side. If the access control is unsuccessful but at least one of the RABs has some particular ARP values (see TS 23.060 [21]) the CN shall also provide the *CSG Membership Status IE* set to "non-member" to the target side.

If the *CSG Id IE* and the *Cell Access Mode IE* set to "hybrid" are received in the RELOCATION REQUIRED message, the CN shall provide the *CSG Membership Status IE* of the UE and the target *CSG Id* to the target side.

If the *Target To Source Transparent Container IE* or the *L3 information IE* or the *Target BSS to Source BSS Transparent Container IE* is received by the CN from the relocation target, it shall be included in the RELOCATION COMMAND message.

The RELOCATION COMMAND message may also contain the *Inter-System Information Transparent Container IE*.

In case of SRVCC operation, when the target system is GERAN the RELOCATION COMMAND message shall contain the *SRVCC Information IE*.

In case of rSRVCC operation, the RELOCATION COMMAND message shall contain the *rSRVCC Information IE*.

If the *Target BSS to Source BSS Transparent Container IE* is received in the RELOCATION COMMAND message, only the value part of the UE related containers received shall be sent to the UE.

For each RAB successfully established in the target system and originating from the PS domain, the RELOCATION COMMAND message shall contain at least one pair of Iu transport address and Iu transport association to be used for the forwarding of the DL N-PDU duplicates towards the relocation target. If more than one pair of Iu transport address and Iu transport association is included, the source RNC shall select one of the pairs to be used for the forwarding of the DL N-PDU duplicates towards the relocation target. Upon reception of the RELOCATION COMMAND message from the PS domain, the source RNC shall start the timer $T_{DATA\ fwd}$.

The Relocation Preparation procedure is terminated in the CN by transmission of the RELOCATION COMMAND message.

If the target system (including target CN) does not support all existing RABs, the RELOCATION COMMAND message shall contain a list of RABs indicating all the RABs that are not supported by the target system. This list may include information on RABs from the PS domain not existing in the source RNC which shall be ignored by the source RNC. This list is contained in the *RABs to Be Released IE*. The source RNC shall use this list to avoid transferring associated contexts where applicable and may use this list e.g. to decide if to cancel the relocation or not. The resources associated with not supported RABs shall not be released until the relocation is completed. This is in order to make a return to the old configuration possible in case of a failed or cancelled relocation.

Upon reception of the RELOCATION COMMAND message the source RNC shall stop the timer $T_{RELOC\ prep}$, start the timer $T_{RELOC\ overall}$ and terminate the Relocation Preparation procedure. The source RNC is then defined to have a Prepared Relocation for that Iu signalling connection.

When the Relocation Preparation procedure is successfully terminated and when the source RNC is ready, the source RNC should trigger the execution of relocation of SRNS.

Interactions with the SRVCC Preparation procedure:

In case of SRVCC operation, the *Source RNC to Target RNC Transparent Container IE* shall include the *Integrity Protection Key IE*, the *Ciphering Key IE* for the signalling data and the SRVCC Information as received during the SRVCC Preparation procedure.

Interactions with the rSRVCC Preparation procedure:

In case of rSRVCC operation, the RNC shall only initiate the Relocation Preparation procedure on the Iu-CS signalling connections existing for the UE.

Interactions with other procedures:

If, after a RELOCATION REQUIRED message is sent and before the Relocation Preparation procedure is terminated, the source RNC receives a RANAP message initiating another connection oriented RANAP class 1 or class 3 procedure (except IU RELEASE COMMAND message, which shall be handled normally) via the same Iu signalling connection, the source RNC shall either:

1. cancel the Relocation Preparation procedure i.e. execute the Relocation Cancel procedure with an appropriate value for the *Cause IE*, e.g. "Interaction with other procedure", and after successful completion of the Relocation Cancel procedure, the source RNC shall continue the initiated RANAP procedure;

or

2. terminate the initiated RANAP procedure without any changes in UTRAN by sending the appropriate response message with the cause value "Relocation Triggered" to the CN. The source RNC shall then continue the relocation of SRNS.

If during the Relocation Preparation procedure the source RNC receives a DIRECT TRANSFER message it shall be handled normally up to the anticipated limit according to section 14.12.4.2 TS 25.331 [10].

If during the Relocation Preparation procedure the source RNC receives connection oriented RANAP class 2 messages (with the exception of DIRECT TRANSFER message) it shall decide to either execute the procedure immediately or suspend it. In case the relocation is cancelled, the RNC shall resume any suspended procedures (if any).

After the Relocation Preparation procedure is successfully terminated, all RANAP messages (except IU RELEASE COMMAND message, which shall be handled normally) received via the same Iu signalling bearer shall be ignored by the source RNC.

8.6.2.1 Successful Operation for GERAN Iu-mode

The relocation between UTRAN and GERAN Iu-mode shall be considered in the Relocation Preparation procedure as intra-system relocation from RANAP point of view.

For GERAN Iu-mode and to support Relocation towards a GERAN BSC in Iu mode the following shall apply in addition for the successful operation of the Relocation Preparation procedure:

- In case of a Relocation to GERAN Iu-mode (only for CS), the RNC shall include, if available, the *GERAN Classmark IE* within the RELOCATION REQUIRED message in those cases where the transmission of the *GERAN Classmark IE* is required, as defined in TS 43.051 [27].

8.6.3 Unsuccessful Operation

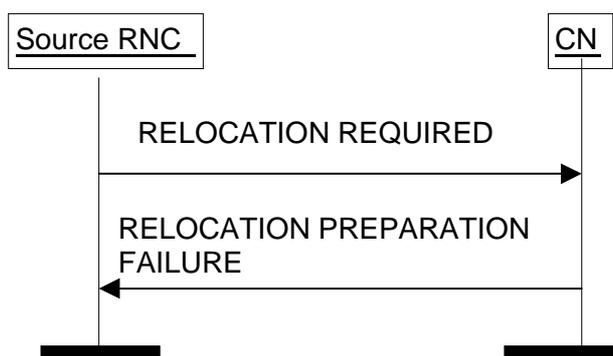

Figure 6: Relocation Preparation procedure. Unsuccessful operation.

If the CN or target system is not able to even partially accept the relocation of SRNS, or a failure occurs during the Relocation Preparation procedure in the CN, or the CN decides not to continue the relocation of SRNS, the CN shall send a RELOCATION PREPARATION FAILURE message to the source RNC.

The RELOCATION PREPARATION FAILURE message shall contain the appropriate value for the *Cause IE*, e.g. "T_{RELOCalloc} expiry", "Relocation Failure in Target CN/RNC or Target System", "Relocation not supported in Target RNC or Target System", "Relocation Target not allowed", "No Radio Resources Available in Target Cell" or "Traffic Load In The Target Cell Higher Than In The Source Cell".

Transmission of the RELOCATION PREPARATION FAILURE message terminates the procedure in the CN.
Reception of the RELOCATION PREPARATION FAILURE message terminates the procedure in UTRAN.

When the Relocation Preparation procedure is unsuccessfully terminated, the existing Iu signalling connection can be used normally.

If the Relocation Preparation procedure is unsuccessfully terminated, the CN shall release the possibly existing Iu signalling connection for the same UE and related to the same relocation of SRNS towards the target RNC by initiating the Iu Release procedure towards the target RNC with an appropriate value for the *Cause* IE, e.g. "Relocation Cancelled".

The RELOCATION PREPARATION FAILURE message may contain the *Inter-System Information Transparent Container* IE.

If the *CSG Id* IE and no *Cell Access Mode* IE are received in the RELOCATION REQUIRED message and the access control is unsuccessful and if none of the RABs has some particular ARP values (see TS 23.060 [21]), the CN shall send the RELOCATION PREPARATION FAILURE message with an appropriate cause value to the source RNC. Upon reception, the source RNC may decide to prevent relocation for that UE towards CSG cells with corresponding CSG Id.

Interactions with Relocation Cancel procedure:

If there is no response from the CN to the RELOCATION REQUIRED message before timer $T_{\text{RELOCprep}}$ expires in the source RNC, the source RNC shall cancel the Relocation Preparation procedure by initiating the Relocation Cancel procedure with the appropriate value for the *Cause* IE, e.g. " $T_{\text{RELOCprep}}$ expiry".

8.6.4 Abnormal Conditions

If the target RNC indicated in the RELOCATION REQUIRED message is not known to the CN:

1. The CN shall reject the relocation of SRNS by sending a RELOCATION PREPARATION FAILURE message to the source RNC with *Cause* IE set to "Unknown target RNC".
2. The CN shall continue to use the existing Iu connection towards the source RNC.

NOTE: In case two CN domains are involved in the SRNS Relocation Preparation procedure and the Source RNC receives the *Target RNC to Source RNC Transparent Container* IE via two CN domains, it may check whether the content of the two *Target RNC to Source RNC Transparent Container* IE is the same. In case the Source RNC receives two different *Target RNC to Source RNC Transparent Container* IEs, the RNC behaviour is left implementation-specific.

NOTE: In case two CN domains are involved in the SRNS Relocation Preparation procedure due to the inter-system handover towards the GSM CS domain and GSM PS domain in parallel and the Source RNC receives the *L3 Information* IE from CS domain and the *Target BSS to Source BSS Transparent Container* IE from PS domain, it may check whether the content of the *L3 Information* IE and the content of the *Target BSS to Source BSS Transparent Container* IE is the same. In case the Source RNC receives two IEs with different contents, the RNC behaviour is left implementation-specific.

8.6.5 Co-ordination of Two Iu Signalling Connections

If the RNC decides to initiate the Relocation Preparation procedure for a UTRAN to UTRAN relocation, the RNC shall initiate simultaneously a Relocation Preparation procedure on all Iu signalling connections existing for the UE. The source RNC shall also include the same *Source RNC to Target RNC Transparent Container* IE, *Relocation Type* IE, *Source ID* IE and *Cause* IE in the RELOCATION REQUIRED message towards the two domains.

For intersystem handover to GSM, the Relocation Preparation procedure shall be initiated either only towards the circuit-switched CN or only towards the packet-switched CN, if the inter-system handover towards the GSM CS domain and GSM PS domain in parallel is not supported. Otherwise the Relocation Preparation procedure shall be simultaneously initiated towards both the circuit-switched CN and the packet-switched CN.

The source RNC shall not trigger the execution of relocation of SRNS unless it has received a RELOCATION COMMAND message from all Iu signalling connections for which the Relocation Preparation procedure has been

initiated, except for the case where the relocation is to a target CSG cell where the UE is a non-member of the target CSG, and where there is at least one of the RABs that has a particular ARP value (see TS 23.060 [21]).

If the source RNC receives a RELOCATION PREPARATION FAILURE message from the CN, the RNC shall initiate the Relocation Cancel procedure on the other Iu signalling connection for the UE if the other Iu signalling connection exists and if the Relocation Preparation procedure is still ongoing or the procedure has terminated successfully in that Iu signalling connection, except for the case where the relocation is to a target CSG cell where the UE is a non-member of the target CSG, and where there is at least one of the RABs that has a particular ARP value (see TS 23.060 [21]) in the other domain.

8.7 Relocation Resource Allocation

8.7.1 General

The purpose of the Relocation Resource Allocation procedure is to allocate resources from a target RNS for a relocation of SRNS. The procedure shall be co-ordinated over all Iu signalling connections existing for the UE. The procedure uses connection oriented signalling.

NOTE: In case of SRVCC operation, the procedure shall be co-ordinated in the domains which the source RNC decides to involve in the SRVCC operation.

8.7.2 Successful Operation

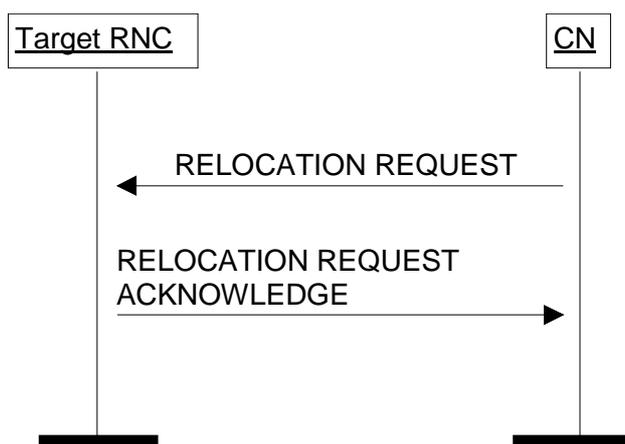

Figure 7: Relocation Resource Allocation procedure. Successful operation.

The CN initiates the procedure by generating a RELOCATION REQUEST message. In a UTRAN to UTRAN relocation, the message shall contain the information (if any) required by the UTRAN to build at least the same set of RABs as existing for the UE before the relocation, except the relocation due to SRVCC operation. The CN may indicate that RAB QoS negotiation is allowed for certain RAB parameters and in some cases also which alternative values to be used in the negotiation.

The RELOCATION REQUEST message may also include an alternative RAB configuration for a RAB specified in the *Alternative RAB configuration* IE in the *Alternative RAB Parameter Values* IE. If *Alternative RAB configuration* IE for a RAB is included in the RELOCATION REQUEST message, the target RNC is allowed after the successful relocation to request the CN to trigger the execution of this alternative RAB configuration. No negotiation is allowed during the Relocation Resource Allocation procedure between the requested RAB configuration and this alternative RAB configuration.

When the CN transmits the RELOCATION REQUEST message, it shall start the timer $T_{\text{RELOCalloc}}$.

When a RELOCATION REQUEST message is sent from a CN node towards an RNC for which the sending CN node is not the default CN node, the *Global CN-ID* IE shall be included.

Upon reception of the RELOCATION REQUEST message, the target RNC shall initiate allocation of requested resources.

The RELOCATION REQUEST message shall contain the following IEs:

- *Permanent NAS UE Identity IE* (if available);
- *Cause IE*;
- *CN Domain Indicator IE*;
- *Source RNC To Target RNC Transparent Container IE*;
- *Iu Signalling Connection Identifier IE*;
- *Integrity Protection Information IE* (if available);
- *SNA Access Information IE* (if available);
- *UESBI-Iu IE* (if available);
- *Selected PLMN identity IE* if in MOCN or GWCN configuration;
- *CN MBMS Linking Information IE* (if available);
- *UE Aggregate Maximum Bit Rate IE* (if available);
- *Anchor PLMN Identity IE* (if available).

For each RAB requested to relocate (or to be created e.g. in the case of inter-system handover), the message shall contain the following IEs:

- *RAB-ID IE*;
- *NAS Synchronisation Indicator IE* (if the relevant NAS information is provided by the CN);
- *RAB parameters IE*;
- *User Plane Information IE*;
- *Transport Layer Address IE*;
- *Iu Transport Association IE*;
- *Data Volume Reporting Indication IE* (only for PS);
- *PDP Type Information IE* (only for PS).

The RELOCATION REQUEST message may include the following IE:

- *Encryption Information IE* (shall not be included if the *Integrity Protection Information IE* is not included);
- *CSG Membership Status IE* (shall be included in cases of relocation of CSG capable UEs to hybrid cells);
- *PDP Type Information extension IE* (may be included if *PDP Type Information IE* is included).

For each RAB requested to relocate the message may include the following IEs:

- *Service Handover IE*;
- *Alternative RAB Parameter Values IE*;
- *E-UTRAN Service Handover IE*.

The following information elements received in RELOCATION REQUEST message require the same special actions in the RNC as specified for the same IEs in the RAB Assignment procedure:

- *RAB-ID IE*;
- *User plane Information IE* (i.e. required User Plane Mode and required User Plane Versions);
- *Priority level IE*, *Pre-emption Capability IE* and *Pre-emption Vulnerability IE*;

- In case of intra-system relocation, when an *Integrity Protection Key* IE is provided within the *Source RNC to Target RNC Transparent Container* IE, the target RNC shall select one integrity algorithm to start integrity and shall in this case make use of this key whatever the selected algorithm. The integrity protection key that is contained within the *Integrity Protection Information* IE of the RELOCATION REQUEST message shall never be considered.
- In case of intra-system relocation, when a *Trace Recording Session Information* IE is provided within the *Source RNC to Target RNC Transparent Container* IE, the Target RNC should store that information to include it in a potential future Trace Record for that UE.
- If the *Subscriber Profile ID for RAT/Frequency priority* IE is contained in the *Source RNC to Target RNC Transparent Container* IE, the target RNC shall store the received Subscriber Profile ID for RAT/Frequency priority and use it as defined in TS 36.300 [52].
- If the *CSFB Information* IE is contained in the *Source RNC to Target RNC Transparent Container* IE, the target RNC may apply special treatment.
- The RELOCATION REQUEST message may contain the *Cell Load Group Information* IE in the *Source RNC to Target RNC Transparent Container* IE.
- If the *Management Based MDT Allowed* IE only or the *Management Based MDT Allowed* IE and the *Management Based MDT PLMN List* IE, is contained in the *Source RNC to Target RNC Transparent Container* IE, the target RNC shall use it, if supported, to allow subsequent selection of the UE for management based MDT as defined in TS 32.422 [38].

In case of inter-system relocation, the integrity protection and ciphering information to be considered shall be the ones received in the *Integrity Protection Information* IE and *Encryption Information* IE of the RELOCATION REQUEST message.

The *Global CN-ID* IE contains the identity of the CN node that sent the RELOCATION REQUEST message, and it shall, if included, be stored together with the Iu signalling connection identifier. If the *Global CN-ID* IE is not included, the RELOCATION REQUEST message shall be considered as coming from the default CN node for the indicated CN domain.

The following additional actions shall be executed in the target RNC during the Relocation Resource Allocation procedure:

If included in the RELOCATION REQUEST ACKNOWLEDGE message, the *Target to Source Transparent Container* IE shall be encoded as the *Target RNC to Source RNC Transparent Container* IE.

If the *Relocation Type* IE is set to "UE involved in relocation of SRNS":

- except the relocation due to SRVCC operation, the target RNC should not accept a requested RAB if the RAB did not exist in the source RNC before the relocation. In case of SRVCC operation, the target RNC may accept CS RAB even if it did not exist in the source RNC before the relocation.
- The target RNC may accept a requested RAB only if the RAB can be supported by the target RNC.
- Other RABs shall be rejected by the target RNC in the RELOCATION REQUEST ACKNOWLEDGE message with an appropriate value in the *Cause* IE, e.g. "Unable to Establish During Relocation".
- The target RNC shall include information adapted to the resulting RAB configuration in the target to source RNC transparent container to be included in the RELOCATION REQUEST ACKNOWLEDGE message sent to the CN. If the target RNC supports triggering of the Relocation Detect procedure via the Iur interface, the RNC shall assign a d-RNTI for the context of the relocation and include it in the container. If two CNs are involved in the relocation of SRNS, the target RNC may, however, decide to send the container to only one CN.
- If any alternative RAB parameter values have been used when allocating the resources, these RAB parameter values shall be included in the RELOCATION REQUEST ACKNOWLEDGE message within the *Assigned RAB Parameter Values* IE.
- If *d-RNTI for No IuCS UP* IE is contained in the RELOCATION REQUEST message, the target RNC shall use this information to configure the resource for the UE over Iur during the relocation.

If the *Relocation Type* IE is set to "UE not involved in relocation of SRNS":

If the *SNA Access Information IE* is contained in the RELOCATION REQUEST message, the target RNC shall store this information and use it to determine whether the UE has access to radio resources in the UTRAN. The target RNC shall consider that the UE is authorised to access only the PLMNs identified by the *PLMN identity IE* in the *SNA Access Information IE*. If the *Authorised SNAs IE* is included for a given PLMN (identified by the *PLMN identity IE*), then the target RNC shall consider that the access to radio resources for the concerned UE is restricted to the LAs contained in the SNAs identified by the *SNAC IEs*.

If the *SNA Access Information IE* is not contained in the RELOCATION REQUEST message, the target RNC shall consider that no access restriction applies to the UE in the UTRAN.

Transmission and reception of a RELOCATION REQUEST ACKNOWLEDGE message terminate the procedure in the UTRAN and in the CN respectively.

Before reporting the successful outcome of the Relocation Resource allocation procedure, the RNC shall have executed the initialisation of the user plane mode as requested by the CN in the *User Plane Mode IE*. If the RNC can not initialise the requested user plane mode for any of the user plane mode versions in the *UP Mode Versions IE* according to the rules for initialisation of the respective user plane mode versions, as described in TS 25.415 [6], the RAB Relocation shall fail with the cause value "RNC unable to establish all RFCs".

If the *Selected PLMN identity IE* is contained in the RELOCATION REQUEST message, the target RNC shall use this information to send it to the UE.

If the *UE Aggregate Maximum Bit Rate IE* is included in the RELOCATION REQUEST message, the UTRAN shall, if supported, store the received UE Aggregate Maximum Bit Rate parameters to control the aggregate data rate of non-GBR traffic for this UE.

In case SIPTO at Iu-PS functionality is supported by the UTRAN, the following applies in addition for the successful operation of the Relocation Resource Allocation procedure:

- If the *MSISDN IE* is present in the RELOCATION REQUEST message, then the UTRAN may offload the RAB(s) where the *Offload RAB Parameters IE* is present in the *RABs To Be Setup Item IEs IE*. The *Access Point Name IE* and the *Charging Characteristics IE* within the *Offload RAB Parameters IE* and the *MSISDN IE* may only be used for the SIPTO at Iu-PS function and according to the description in TS 23.060 [21].

Interactions with Uplink Information Exchange procedure:

In case of UTRAN to UTRAN CS only relocation, if the RELOCATION REQUEST message includes the *MBMS Linking Information IE* in the *Source RNC To Target RNC Transparent Container IE*, the RNC shall, if supported, initiate the Uplink Information Exchange procedure to retrieve the Multicast Service list for the UE, create relevant MBMS Service Context, store this information and perform the relevant UE linking as defined in TS 25.346 [42].

8.7.2.1 Successful Operation for GERAN Iu-mode

The relocation between UTRAN and GERAN Iu-mode shall be considered in the Relocation Resource Allocation procedure as intra-system relocation from RANAP point of view.

For GERAN Iu-mode and to support Relocation towards a GERAN BSC in Iu mode the following shall apply in addition for the successful operation of the Relocation Resource Allocation procedure:

- In case of GERAN Iu-mode, for RAB requested to be relocated from the the CS domain, the RELOCATION REQUEST message may contain the *GERAN BSC Container IE* in order to provide GERAN specific information to the target BSC (see TS 43.051 [27]).

8.7.3 Unsuccessful Operation

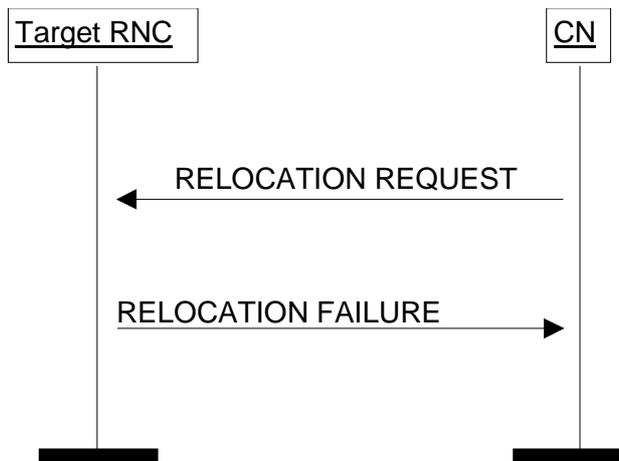

Figure 8: Relocation Resource Allocation procedure: Unsuccessful operation.

If the target RNC can not even partially accept the relocation of SRNS or a failure occurs during the Relocation Resource Allocation procedure in the target RNC, the target RNC shall send a RELOCATION FAILURE message to the CN. The RELOCATION FAILURE message shall contain the *Cause* IE with an appropriate value.

If the target RNC cannot support any of the integrity protection (ciphering respectively) alternatives provided in the *Integrity Protection Information IE* or *Encryption Information IE*, it shall return a RELOCATION FAILURE message with the cause "Requested Ciphering and/or Integrity Protection algorithms not supported".

If the target RNC cannot support the relocation due to PUESBINE feature, it shall return a RELOCATION FAILURE message with the cause "Incoming Relocation Not Supported Due To PUESBINE Feature".

If the target RNC does not receive the *CSG Membership Status IE* but does receive the *CSG Id IE* in the RELOCATION REQUEST message and the *CSG Id IE* is not valid, it shall send the RELOCATION FAILURE message to the CN with an appropriate cause value.

If the *CSG ID IE* is not received in the RELOCATION REQUEST message and the access control for the relocation to a CSG cell is unsuccessful and if none of the RABs has some particular ARP values (see TS 23.060 [21]), the target RNC shall return a RELOCATION FAILURE message with an appropriate cause value, e.g. "Relocation Target not allowed".

Transmission and reception of a RELOCATION FAILURE message terminate the procedure in the UTRAN and in the CN respectively.

When the CN receives a RELOCATION FAILURE message from the target RNC, it shall stop timer $T_{RELOCalloc}$ and shall assume possibly allocated resources within the target RNC completely released.

In case of inter-system handover, and if the target RNC supports cell load-based inter-system handover, then

- the *NewBSS to Old BSS Information IE* may be included in the RELOCATION FAILURE message. This information shall include, if available, the current traffic load in the target cell.
- the RELOCATION FAILURE message shall contain the *Cause IE* with an appropriate value, e.g. "No Radio Resources Available in Target Cell" or "Traffic Load In The Target Cell Higher Than In The Source Cell".
- If the *Cause IE* received in the RELOCATION REQUEST message contains the value "Reduce Load in Serving Cell" and the load in the target cell is greater than in the source cell then, if the target cell is not in a congested or blocked state, the RNC shall return a RELOCATION FAILURE message which may include the cause "Traffic Load In The Target Cell Higher Than In The Source Cell".
- When the RNC returns a RELOCATION FAILURE message with the cause "Traffic Load In The Target Cell Higher Than In The Source Cell", it shall also include the *NewBSS to Old BSS Information IE*. This information shall include the current traffic load in the target cell.

8.7.3.1 Unsuccessful Operation for GERAN Iu-mode

For GERAN Iu-mode and to support Relocation towards a GERAN BSC in Iu mode the following shall apply in addition for the unsuccessful operation of the Relocation Resource Allocation procedure:

- In case a Relocation to GERAN Iu-mode fails (only for CS), because the Target BSC cannot provide an appropriate RAB corresponding to the content of the *GERAN BSC Container* IE (if received), the Target BSC shall report the unsuccessful Relocation Resource Allocation by indicating the cause value "GERAN Iu-mode Failure" within the RELOCATION FAILURE message and shall include the *GERAN Classmark* IE.

8.7.4 Abnormal Conditions

If after reception of the RELOCATION REQUEST message, the target RNC receives another RELOCATION REQUEST message on the same Iu connection, then the target RNC shall discard the latter message and the original Relocation Resource Allocation procedure shall continue normally.

If the target RNC receives a *Source RNC to Target RNC Transparent Container* IE containing *Chosen Integrity Protection (Encryption respectively) Algorithm* IE without *Integrity Protection (Ciphering respectively) Key* IE, it shall return a RELOCATION FAILURE message with the cause "Conflict with already existing Integrity protection and/or Ciphering information".

Interactions with Iu Release procedure:

If the CN decides to not continue the Relocation Resource Allocation procedure (e.g. due to $T_{\text{RELOCalloc}}$ expiry) before the Relocation Resource Allocation procedure is completed, the CN shall stop timer $T_{\text{RELOCalloc}}$ (if timer $T_{\text{RELOCalloc}}$ has not already expired) and the CN shall, if the Iu signalling connection has been established or later becomes established, initiate the Iu Release procedure towards the target RNC with an appropriate value for the *Cause* IE, e.g. "Relocation Cancelled".

- NOTE: In case two CN domains are involved in the Relocation Resource Allocation procedure, the target RNC may check whether the content of the two *Source RNC to Target RNC Transparent Container* IEs or the two *SNA Access Information* IEs is the same. In case the target RNC receives two different *Source RNC to Target RNC Transparent Container* IEs or two different *SNA Access Information* IEs, the RNC behaviour is left implementation specific.

8.7.5 Co-ordination of Two Iu Signalling Connections

Co-ordination of two Iu signalling connections during Relocation Resource Allocation procedure shall be executed by the target RNC when the *Number of Iu Instances* IE received in the *Source RNC to Target RNC Transparent Container* IE in the RELOCATION REQUEST message indicates that two CN domains are involved in relocation of SRNS.

When both the CS and PS user data *Chosen Encryption Algorithm* IE are received within the *Source RNC to Target RNC Transparent Container* IE and if these two received *Chosen Encryption Algorithm* IE are not the same, the target RNC shall fail the Relocation Resource Allocation procedure by sending back a RELOCATION FAILURE message.

The integrity protection (ciphering respectively) alternatives provided in the *Integrity Protection Information* IE (*Encryption Information* IE respectively) of the RELOCATION REQUEST messages received from both CN domains shall have at least one common alternative, otherwise the Relocation Resource Allocation shall be failed by sending back a RELOCATION FAILURE message.

If two CN domains are involved, the following actions shall be taken by the target RNC:

- The target RNC shall utilise the *Permanent NAS UE Identity* IE, received explicitly from each CN domain within the RELOCATION REQUEST messages, to co-ordinate both Iu signalling connections.
- The target RNC shall generate and send RELOCATION REQUEST ACKNOWLEDGE messages only after all expected RELOCATION REQUEST messages are received and analysed, except for the case where the relocation is to a target CSG cell where the UE is a non-member of the target CSG, and where there is at least one of the RABs that has a particular ARP value (see TS 23.060 [21]).
- If the relocation is to a target CSG cell where the UE is a non-member of the target CSG, and where there is at least one of the RABs that has a particular ARP value (see TS 23.060 [21]) in one domain, the target RNC shall accept those RABs with a particular ARP value (see TS 23.060 [21]) and fail the other RABs, and send

RELOCATION REQUEST ACKNOWLEDGE messages without waiting for the RELOCATION REQUEST message in the other domain.

- If the target RNC decides to send the *Target RNC to Source RNC Transparent Container IE* via the two CN domains, the target RNC shall ensure that the same *Target RNC to Source RNC Transparent Container IE* is included in RELOCATION REQUEST ACKNOWLEDGE messages transmitted via the two CN domains and related to the same relocation of SRNS.

If the target RNC receives the *UESBI-Iu* IE on the Iu-CS but not on the Iu-PS interface (or vice versa), the RNC shall, if supported, use the *UESBI-Iu* IE for both domains.

8.8 Relocation Detect

8.8.1 General

The purpose of the Relocation Detect procedure is to indicate to the CN the detection by the RNC of an SRNS relocation execution. The procedure shall be co-ordinated over all Iu signalling connections existing for the UE. The procedure uses connection-oriented signalling.

8.8.2 Successful Operation

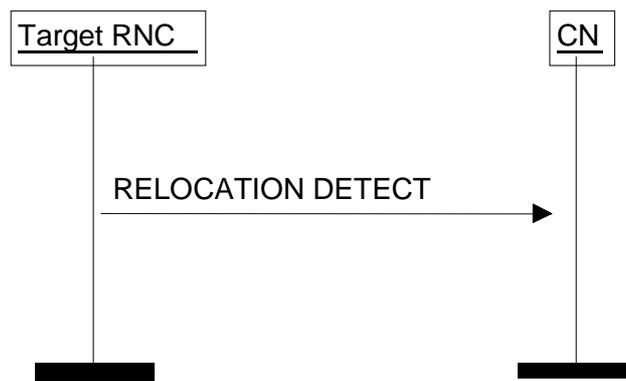

Figure 9: Relocation Detect procedure: Successful operation.

The target RNC shall send a RELOCATION DETECT message to the CN when a relocation execution trigger is received.

If the type of relocation of SRNS is "UE involved in relocation of SRNS", the relocation execution trigger may be received either from the Uu interface or as an implementation option from the Iur interface. If the type of relocation of SRNS is "UE not involved in relocation of SRNS", the relocation execution trigger is received from the Iur interface.

When the RELOCATION DETECT message is sent, the target RNC shall start SRNC operation.

Upon reception of the RELOCATION DETECT message, the CN may switch the user plane from the source RNC to the target RNC.

8.8.3 Abnormal Conditions

Interactions with Relocation Complete procedure:

If the RELOCATION COMPLETE message is received by the CN before the reception of the RELOCATION DETECT message, the CN shall handle the RELOCATION COMPLETE message normally.

8.8.4 Co-ordination of Two Iu Signalling Connections

When the Relocation Detect procedure is to be initiated by the target RNC, the target RNC shall initiate the Relocation Detect procedure on all Iu signalling connections existing for the UE between the target RNC and the CN.

8.9 Relocation Complete

8.9.1 General

The purpose of the Relocation Complete procedure is to indicate to the CN the completion by the target RNC of the relocation of SRNS. The procedure shall be co-ordinated over all Iu signalling connections existing for the UE. The procedure uses connection-oriented signalling.

8.9.2 Successful Operation



Figure 10: Relocation Complete procedure. Successful operation.

When the new SRNC-ID and serving RNC Radio Network Temporary Identity are successfully exchanged with the UE by the radio protocols, the target RNC shall initiate the Relocation Complete procedure by sending a RELOCATION COMPLETE message to the CN. Upon reception of the RELOCATION COMPLETE message, the CN should stop the $T_{RELOCcomplete}$ timer.

If the *Higher bitrates than 16 Mbps flag* IE is included in the RELOCATION COMPLETE message then the CN shall, if supported, use the IE as described in TS 23.060 [21].

If the *Tunnel Information for BBF* IE is received in the RELOCATION COMPLETE message, the CN shall, if supported, use the IE as described in TS 23.139 [65].

8.9.3 Abnormal Conditions

If the timer $T_{RELOCcomplete}$ expires:

- The CN should initiate release of Iu connections towards the source and the target RNC by initiating the Iu Release procedure with an appropriate value for the *Cause* IE, e.g. " $T_{RELOCcomplete}$ expiry".

Interactions with the Relocation Detect procedure:

If the RELOCATION DETECT message is not received by the CN before reception of the RELOCATION COMPLETE message, the CN shall handle the RELOCATION COMPLETE message normally.

8.9.4 Co-ordination of Two Iu Signalling Connections

When the Relocation Complete procedure is to be initiated by the target RNC, the target RNC shall initiate the Relocation Complete procedure on all Iu signalling connections existing for the UE between the target RNC and the CN.

8.10 Relocation Cancel

8.10.1 General

The purpose of the Relocation Cancel procedure is to enable a source RNC to cancel an ongoing relocation of SRNS. The Relocation Cancel procedure may be initiated by the source RNC during and after the Relocation Preparation procedure if either of the following conditions is fulfilled:

1. The source RNC has not yet initiated the execution of relocation of SRNS, neither via the Iur interface nor via the Uu interface.

2. After having initiated the execution of relocation of SRNS, the UE has returned to the source RNC by transmitting an RRC message which indicates that the UE considers the source RNC as its serving RNC.

The procedure shall be co-ordinated in all Iu signalling connections for which the Relocation Preparation procedure has been initiated. The procedure uses connection oriented signalling.

8.10.2 Successful Operation

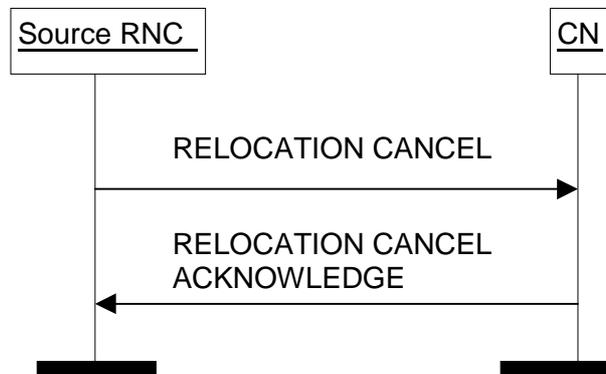

Figure 11: Relocation Cancel procedure. Successful operation.

The RNC initiates the procedure by sending a RELOCATION CANCEL message to the CN. This message shall indicate the reason for cancelling the relocation of SRNS by the appropriate value of the *Cause* IE. Upon reception of a RELOCATION CANCEL message, the CN shall send a RELOCATION CANCEL ACKNOWLEDGE message to the source RNC.

Transmission and reception of a RELOCATION CANCEL ACKNOWLEDGE message terminate the procedure in the CN and in the source RNC respectively. After this, the source RNC does not have a prepared relocation for that Iu signalling connection.

Interactions with Relocation Preparation procedure:

Upon reception of a RELOCATION CANCEL message from the source RNC, the CN shall locally terminate the possibly ongoing Relocation Preparation procedure towards that RNC and abandon the relocation of SRNS.

If the source RNC receives a RELOCATION COMMAND message from the CN after the Relocation Cancel procedure is initiated, the source RNC shall ignore the received RELOCATION COMMAND message.

If the source RNC receives a RELOCATION PREPARATION FAILURE message from the CN after the Relocation Cancel procedure is initiated, then the source RNC shall terminate the ongoing Relocation Cancel procedure.

8.10.3 Unsuccessful Operation

Not applicable.

8.10.4 Abnormal Conditions

Not applicable.

8.10.5 Co-ordination of Two Iu Signalling Connections

If the Relocation Cancel procedure is to be initiated due to other reasons than reception of a RELOCATION PREPARATION FAILURE message, the Relocation Cancel procedure shall be initiated on all Iu signalling connections existing for the UE in which the Relocation Preparation procedure has not terminated unsuccessfully.

8.11 SRNS Context Transfer

8.11.1 General

The purpose of the SRNS Context Transfer procedure is to trigger the transfer of SRNS contexts from the source RNC to the CN (PS domain) in case of intersystem change or in some further cases described in TS 23.060 [21]. The procedure uses connection oriented signalling.

8.11.2 Successful Operation

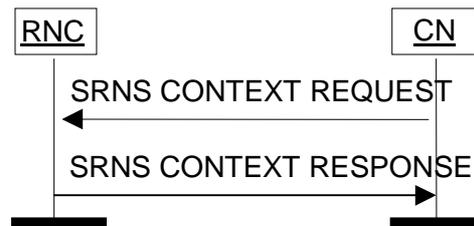

Figure 12: SRNS Context Transfer procedure. Successful operation.

The CN initiates the procedure by sending an SRNS CONTEXT REQUEST message to the source RNC. The SRNS CONTEXT REQUEST message shall include the list of RABs whose contexts should be transferred, and may include the *RAT Type IE*, when available to indicate the RAT from which the context request originates.

The source RNC shall respond to the CN with an SRNS CONTEXT RESPONSE message containing all the referenced RABs, including both successful and unsuccessful RABs transfers. For each RAB whose transfer is successful, the following context information elements shall be included:

- *RAB ID IE*;
- always when available, the sequence number for the next downlink GTP-PDU to be sent to the UE, i.e. the *DL GTP-PDU Sequence Number IE*;
- always when available, the sequence number for the next uplink GTP-PDU to be tunnelled to the GGSN, i.e. the *UL GTP-PDU Sequence Number IE*;
- always when available, the radio interface sequence number (PDCP) TS 25.323 [17] of the next downlink N-PDU (PDCP SDU) that would have been sent to the UE by a source system, i.e. the *DL N-PDU Sequence Number IE*;
- always when available, the radio interface sequence number (PDCP) TS 25.323 [17] of the next uplink N-PDU (PDCP SDU) that would have been expected from the UE by a source system, i.e. the *UL N-PDU Sequence Number IE*.

Transmission and reception of the SRNS CONTEXT RESPONSE message terminate the procedure in the UTRAN and in the CN respectively.

8.11.3 Unsuccessful Operation

For each RAB for which the UTRAN is not able to transfer the RAB context, e.g. if the RAB ID is unknown to the RNC, the RAB ID is included in the SRNS CONTEXT RESPONSE message together with a *Cause IE*, e.g. "Invalid RAB ID".

8.11.4 Abnormal Conditions

Not applicable.

8.12 SRNS Data Forwarding Initiation

8.12.1 General

The purpose of the SRNS Data Forwarding procedure is to trigger the transfer of N-PDUs from the RNC to the CN (PS domain) in case of intersystem change or in some further cases described in TS 23.060 [21]. The procedure uses connection oriented signalling.

8.12.2 Successful Operation



Figure 13: SRNS Data Forwarding Initiation procedure. Successful operation.

The CN initiates the procedure by sending an SRNS DATA FORWARD COMMAND message to the UTRAN. The SRNS DATA FORWARD COMMAND message includes the list of RABs towards the PS domain whose data should be forwarded, and the necessary information for establishing a GTP tunnel to be used for data forwarding. For each indicated RAB, the list shall include the *RAB ID* IE, the *Transport Layer Address* IE and the *Iu Transport Association* IE.

Upon reception of the SRNS DATA FORWARD COMMAND message the RNC starts the timer $T_{DATAfwd}$.

8.12.3 Abnormal Conditions

Not applicable.

8.13 SRNS Context Forwarding from Source RNC to CN

8.13.1 General

The purpose of this procedure is to transfer SRNS contexts from the source RNC to the CN (PS domain) in case of handover via the CN. The procedure uses connection oriented signalling. SRNS contexts are sent for each concerned RAB among those that are supported by the target system, and for which at least either GTP-PDU or PDCP sequence numbering is available. The SRNS contexts contain the sequence numbers of the next GTP-PDUs to be transmitted in the uplink and downlink directions, if available, and the next PDCP sequence numbers that would have been used to send and receive data from the UE, if available. The Source RNC PDCP context info shall be sent if available.

8.13.2 Successful Operation

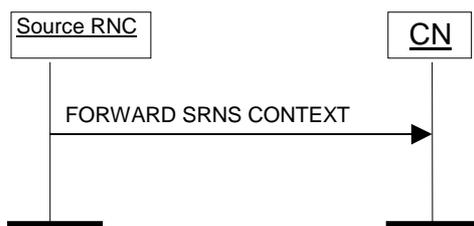

Figure 14: SRNS Context forwarding from source RNC to CN. Successful operation.

The source RNC initialises the procedure by sending a FORWARD SRNS CONTEXT message to the CN. The FORWARD SRNS CONTEXT message contains the RAB Context information for each referenced RAB. For each RAB the following information shall be included:

- *RAB ID IE*;
- always when available, the sequence number for the next downlink GTP-PDU to be sent to the UE, i.e. the *DL GTP-PDU Sequence Number IE*;
- always when available, the sequence number for the next uplink GTP-PDU to be tunnelled to the GGSN, i.e. the *UL GTP-PDU Sequence Number IE*;
- always when available, the radio interface sequence number (PDCP) TS 25.323 [17] of the next uplink N-PDU (PDCP SDU) that would have been expected from the UE by a source system i.e. the *UL N-PDU Sequence Number IE*;
- always when available, the radio interface sequence number (PDCP) TS 25.323 [17] of the next downlink N-PDU (PDCP SDU) that would have been sent to the UE by a source system i.e. the *DL N-PDU Sequence Number IE*.

8.13.3 Abnormal Conditions

Not applicable.

8.14 SRNS Context Forwarding to Target RNC from CN

8.14.1 General

The purpose of this procedure is to transfer SRNS contexts from the CN (PS domain) to the target RNC in case of handover via the CN. The procedure uses connection oriented signalling. SRNS contexts are sent for each referenced RAB, for which at least either GTP-PDU or PDCP sequence numbering is available. The SRNS contexts contain the sequence numbers of the next GTP-PDUs to be transmitted in the uplink and downlink directions, if available, and the next PDCP sequence numbers that would have been used to send and receive data from the UE, if available. The source RNC PDCP context info shall be sent if available.

8.14.2 Successful Operation

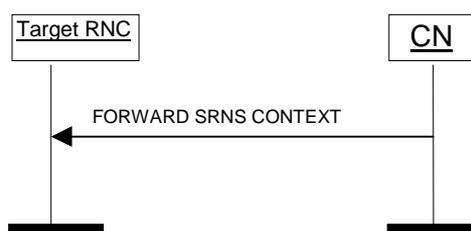

Figure 15: SRNS Context forwarding to target RNC from CN. Successful operation.

The CN initialises the procedure by sending FORWARD SRNS CONTEXT message to the target RNC. The FORWARD SRNS CONTEXT message contains the RAB Context information for each referenced RAB. For each RAB the following information shall be included:

- *RAB ID IE*;
- always when available, the sequence number for the next downlink GTP-PDU to be sent to the UE, i.e. the *DL GTP-PDU Sequence Number IE*;
- always when available, the sequence number for the next uplink GTP-PDU to be tunnelled to the GGSN, i.e. the *UL GTP-PDU Sequence Number IE*;

- always when available, the radio interface sequence number (PDCP) TS 25.323 [17] of the next uplink N-PDU (PDCP SDU) that would have been expected from the UE by a source system i.e. the *UL N-PDU Sequence Number IE*;
- always when available, the radio interface sequence number (PDCP) TS 25.323 [17] of the next downlink N-PDU (PDCP SDU) that would have been sent to the UE by a source system i.e. the *DL N-PDU Sequence Number IE*.

8.14.3 Abnormal Conditions

Not applicable.

8.15 Paging

8.15.1 General

The purpose of the Paging procedure is to enable the CN to request the UTRAN to contact that UE. The procedure uses connectionless signalling.

8.15.2 Successful Operation

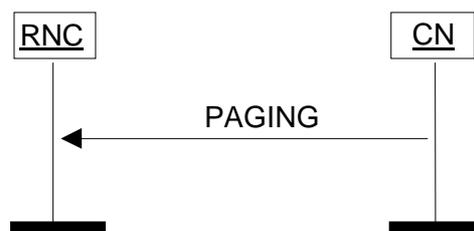

Figure 16: Paging procedure. Successful operation.

The CN initiates the procedure by sending a PAGING message. The PAGING message shall contain the following IEs:

- *CN Domain Indicator*
- *Permanent NAS UE Identity*
- *DRX Cycle Length Coefficient* (if available)

The PAGING message may contain following IEs:

- *Temporary UE Identity*
- *Paging Area*
- *Paging Cause*
- *Non Searching Indication*
- *Global CN-ID*
- *CSG Id List*

The *CN Domain Indicator* IE shall be used by the RNC to identify from which CN domain the paging request originates.

The *Permanent NAS UE Identity* IE (i.e. IMSI) shall be used by the UTRAN paging co-ordination function to check if a signalling connection towards the other CN domain already exists for this UE. In that case, the radio interface paging message shall be sent via that connection instead of using the paging broadcast channel.

The *Temporary UE Identity* IE (e.g. TMSI) is the temporary identity of the user (allocated by that CN Domain) which can be used in a radio interface paging message. If the *Temporary UE Identity* IE is not included in the PAGING message, the RNC shall use the *Permanent NAS UE Identity* instead – if no signalling connection exists.

If NNSF is active, and the *Temporary UE Identity* IE is not included in the PAGING message, the PAGING message shall include the *Global CN-ID* IE and, in case this PAGING message is originated from the CS domain, the RNC may start the T_{NNSF} timer and store the *Permanent NAS UE Identity* IE along with the related *Global CN-ID* IE until the T_{NNSF} timer has expired.

The *Paging Area* IE shall be used by the RNC to identify the area in which the radio interface paging message shall be broadcast in case no signalling connection, as described above, already exists for the UE. If the *Paging Area* IE is not included in the PAGING message, the whole RNC area shall be used as Paging Area – if no signalling connection exists for that UE.

The *Paging Cause* IE shall indicate to the RNC the reason for sending the PAGING message. The paging cause is transferred transparently to the UE.

The *Non Searching Indication* IE shall, if present, be used by the RNC to decide whether the UTRAN paging co-ordination function needs to be activated or not. In the absence of this IE, UTRAN paging co-ordination shall be performed.

The *DRX Cycle Length Coefficient* IE may be included in the PAGING message, and if present, the UTRAN shall, when applicable, use it for calculating the paging occasions for the UE.

A list of CSG IDs may be included in the PAGING message. If included, the UTRAN may use the list of CSG IDs to avoid paging the UE at CSG cells whose CSG ID does not appear in the list.

It should be noted that each PAGING message on the Iu interface relates to only one UE and therefore the RNC has to pack the pages into the relevant radio interface paging message.

The core network is responsible for the paging repetition over the Iu interface.

8.15.3 Abnormal Conditions

Not applicable.

8.16 Common ID

8.16.1 General

The purpose of the Common ID procedure is to inform the RNC about the permanent NAS UE Identity (i.e. IMSI) of a user. This is used by the RNC e.g. to create a reference between the permanent NAS UE identity of the user and the RRC connection of that user for UTRAN paging co-ordination. The procedure may also be used to provide the *SNA Access Information* IE to the RNC or to provide the *Management Based MDT Allowed* IE to the RNC or to provide the *Management Based MDT PLMN List* IE to the RNC.

The procedure uses connection oriented signalling.

8.16.2 Successful Operation

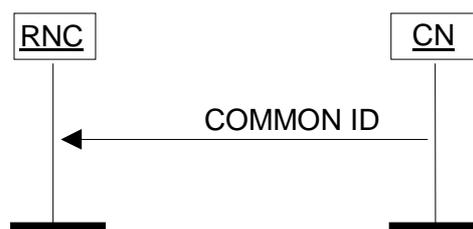

Figure 17: Common ID procedure. Successful operation.

After having established an Iu signalling connection, and if the Permanent NAS UE identity (i.e. IMSI) is available, the CN shall send to the RNC a COMMON ID message containing the *Permanent NAS UE Identity* IE and optionally the *SNA Access Information* IE. The COMMON ID message may also include the *UESBI-Iu* IE. The RNC shall associate the permanent identity to the RRC Connection of that user and shall save it for the duration of the RRC connection.

The RNC shall, if supported, use the *UESBI-Iu* IE when received in the COMMON ID message.

If the *CSG Membership Status* IE is included in the COMMON ID message the RAN shall, if supported, take the following actions:

- If the cell that serves the UE is a Hybrid cell, the RNC shall store the value contained in the *CSG Membership Status* IE and replace any previously stored membership status value by this new one. The RNC may use such information to perform differentiated treatment for member and non-member UEs.
- If the cell that serves the UE is a CSG cell, and the *CSG Membership Status* IE is set to 'non-member', the RNC should initiate actions to ensure that the UE is no longer served by the CSG cell as defined in TS 25.467 [55].

If the *SNA Access Information* IE is contained in the COMMON ID message, the RNC shall store this information and use it to determine whether the UE has access to radio resources in the UTRAN. The RNC shall consider that the UE is authorised to access only the PLMNs identified by the *PLMN identity* IEs in the *SNA Access Information* IE. If the *Authorised SNAs* IE is included for a given PLMN (identified by the *PLMN identity* IE), then the RNC shall consider that the access to radio resources for the concerned UE is restricted to the LAs contained in the SNAs identified by the *SNAC* IEs.

In case of GWCN configuration for a network sharing non-supporting UE, the COMMON ID message shall include, if available, the *Selected PLMN identity* IE. If received, the RNC shall store this information.

In case SRVCC functionality is supported by the UE and CN, the CN shall include *SRVCC Operation Possible* IE in COMMON ID message.

If the *Management Based MDT Allowed* IE is included in the the COMMON ID message, the RNC shall use it, if supported, together with information in the *Management Based MDT PLMN List* IE, if available, to allow subsequent selection of the UE for management based MDT as defined in TS 32.422 [38].

Upon receipt of the COMMON ID message the RNC shall

- store the Subscriber Profile ID for RAT/Frequency priority IE and use it as defined in TS 36.300 [52].

8.16.3 Abnormal Conditions

Not applicable.

8.17 CN Invoke Trace

8.17.1 General

When used for signalling based activation, the purpose of the CN Invoke Trace procedure is to inform the RNC that it should begin a trace session with the parameters indicated by the CN and related to the UE, the Iu connection is used for.

When used for management based activation, the purpose of the CN Invoke Trace procedure is to provide the RNC with the equipment identity of the UE for which the RNC should begin a trace recording session.

The procedure uses connection oriented signalling.

8.17.2 Successful Operation



Figure 18: CN Invoke Trace procedure. Successful operation.

The CN Invoke Trace procedure is invoked by the CN by sending a CN INVOKE TRACE message to the RNC as defined in TS 32.422 [38].

The CN INVOKE TRACE message shall include the following IEs:

- The *Trace Reference* IE, which uniquely identifies the trace session it refers to.
- The *UE Identity* IE, which indicates the UE to which this trace session pertains.
- The *Trace Propagation Parameters* IE, only in case of a signalling based activation.

If present, the *Trace Propagation Parameters* IE shall include the following IEs:

- The *Trace Recording Session Reference* IE, which is allocated by the CN.
- The *Trace Depth* IE, which defines how detailed information should be recorded for this trace session in the RNC.

The *Trace Propagation Parameters* IE may also include the *List Of Interfaces To Trace* IE, which defines which interfaces should be traced in the RNC. If the *List Of Interfaces To Trace* IE is not included, the RNC should trace all the following interfaces, if available: Iu-CS, Iu-PS, Uu, Iur and Iub.

Upon receiving the CN INVOKE TRACE message, which includes the *Trace Propagation Parameters* IE, the RNC should begin a trace recording session according to the parameters indicated in the CN INVOKE TRACE message. If the RNC does not support the requested value "Minimum" or "Medium" of the *Trace Depth* IE, the RNC should begin a trace recording session with maximum trace depth.

Upon receiving the CN INVOKE TRACE message, which does not include the *Trace Propagation Parameters* IE, the RNC should begin a trace recording session according to the parameters configured in the RNC for the indicated equipment identity in the CN INVOKE TRACE message.

The RNC may not start a trace recording session if there are insufficient resources available within the RNC.

The *Trace Reference* IE, *UE identity* IE and, if the *Trace Propagation Parameters* IE is present, the *Trace Recording Session Reference* IE are used to tag the trace record to allow simpler construction of the total record by the entity which combines trace records.

If the *MDT Configuration* IE is included in the CN INVOKE TRACE message and includes the *MDT Activation* IE set to 'Immediate MDT and Trace' then the RNC shall, if supported, initiate the requested trace function and MDT function as described in TS 32.422 [38].

If the *MDT Configuration* IE is included in the CN INVOKE TRACE message and includes the *MDT Activation* IE set to 'Immediate MDT Only' or 'Logged MDT only', then the RNC shall, if supported, initiate the requested MDT function as described in TS 32.422 [38] and shall ignore the *List of Interfaces to Trace* IE and the *Trace Depth* IE.

If *Trace Collection Entity IP Address* IE is included and if the *MDT Configuration* IE is also included then the RNC shall, if supported, store the Trace Collection Entity IP address and use it when transferring Trace records, otherwise if *MDT Configuration* IE is not included, the RNC may use the Trace Collection Entity IP address when transferring trace records.

If the *MDT Configuration* IE is included in the CN INVOKE TRACE message and includes the *Signalling based MDT PLMN List* IE, then the RNC may use it to propagate the trace function as described in TS 37.320 [64].

Interaction with Relocation and Enhanced Relocation:

In case of signalling based activation, the order to perform tracing is lost in UTRAN at successful Relocation of SRNS. If the tracing shall continue also after the relocation has been performed, the CN Invoke Trace procedure shall thus be re-initiated from the CN towards the future SRNC after the Relocation Resource Allocation or the Enhanced Relocation procedure has been executed successfully.

8.17.2.1 Successful Operation for GERAN lu mode

The CN INVOKE TRACE message shall include the *Trace Type* IE to indicate the events and parameters to be recorded.

The message shall include a *Trace Reference* IE which is allocated by the entity which triggered the trace.

The message may include the *OMC ID* IE, which if present, indicates the OMC to which the record is destined.

The message may include the *UE Identity* IE, which if present, indicates the UE to which this record pertains to.

The message may include the *Trigger ID* IE, which if present, indicates the entity which triggered the trace.

The *Trace Reference* and *Trigger ID* IEs are used to tag the trace record to allow simpler construction of the total record by the entity which combines trace records.

8.17.3 Abnormal Conditions

If the *MDT Configuration* IE is included in the CN INVOKE TRACE message and the *Trace Collection Entity IP Address* IE is not included, the RNC shall ignore the MDT Configuration.

8.17.3.1 Abnormal Conditions for GERAN lu mode

Not applicable.

8.18 Security Mode Control

8.18.1 General

The purpose of the Security Mode Control procedure is to pass ciphering and integrity mode information to the UTRAN. The UTRAN uses this information to select and load the encryption device for user and signalling data with the appropriate parameters, and also to store the appropriate parameters for the integrity algorithm. The procedure uses connection oriented signalling.

8.18.2 Successful Operation

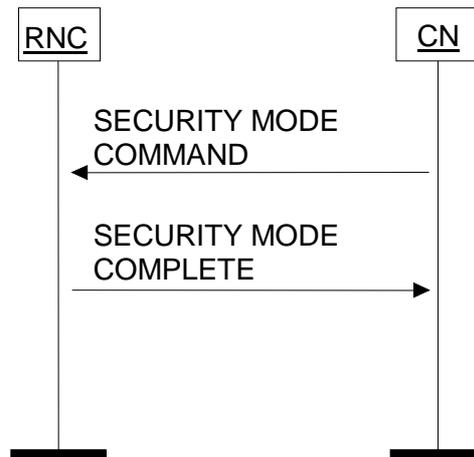

Figure 19: Security Mode Control procedure. Successful operation.

The CN initiates the procedure by sending a SECURITY MODE COMMAND message. The message may contain the *Encryption Information IE* and shall contain the *Integrity Protection Information IE*, specifying, in preferred order with the most preferred first in the list, which ciphering, if any, and integrity protection algorithms may be used by the UTRAN.

The *Permitted Encryption Algorithms IE* within the *Encryption Information IE* may contain "no encryption" within an element of its list in order to allow the RNC not to cipher the respective connection. This can be done either by not starting ciphering or by using the UEA0 algorithm. In the absence of the *Encryption Information group IE* in SECURITY MODE COMMAND message, the RNC shall not start ciphering.

Upon reception of the SECURITY MODE COMMAND message, the UTRAN shall internally select appropriate algorithms, taking into account the UE/UTRAN capabilities. If a signalling connection already exists towards the other core network domain and integrity has been started, the same ciphering and integrity alternatives as being used for that core network domain shall be selected. If a signalling connection already exists towards the other core network domain and the Security Mode Control procedure is ongoing on that core network domain, the same ciphering and integrity alternative shall be selected for the two domains. This means in particular for encryption that if "no encryption" or no *Encryption Information IE* has been received from the first core network domain and integrity has been started but ciphering has not been started, ciphering shall also not be started for the second core network domain. The UTRAN shall then trigger the execution of the corresponding radio interface procedure and, if applicable, start/restart the encryption device and also start/modify the integrity protection.

The CN may send a SECURITY MODE COMMAND message towards the RNC also when integrity protection and possibly ciphering has already been started for an existing signalling connection towards that core network domain. This may be used to activate new integrity protection and ciphering keys. The included integrity protection and ciphering information shall then support (at least) the integrity protection alternative and the ciphering alternative presently being used and the *Key Status IE* shall have the value "New".

When the execution of the radio interface procedure is successfully finished, the UTRAN shall return a SECURITY MODE COMPLETE message to the CN. This message shall include the *Chosen Integrity Protection Algorithm IE* and may include the *Chosen Encryption Algorithm IE*.

The *Chosen Encryption Algorithm IE* shall be included in the SECURITY MODE COMPLETE message if, and only if the *Encryption Information IE* was included in the SECURITY MODE COMMAND message.

The set of permitted algorithms specified in the SECURITY MODE COMMAND message shall remain applicable for subsequent RAB Assignments and Intra-UTRAN Relocations.

In case of a UE with Radio Access Bearers towards both core networks, the user data towards CS shall always be ciphered with the ciphering key received from CS and the user data towards PS with the ciphering key received from PS. The signalling data shall always be ciphered with the last received ciphering key and integrity protected with the last received integrity protection key from any of the two CNs.

8.18.3 Unsuccessful Operation

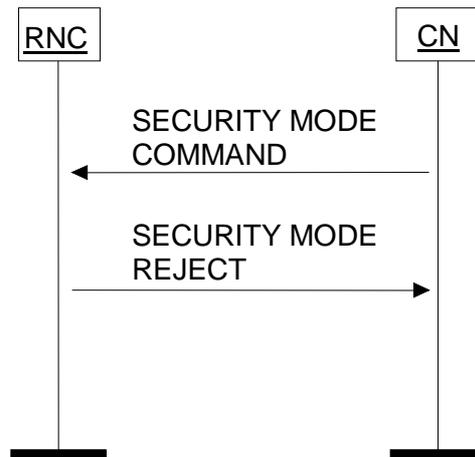

Figure 20: Security Mode Control procedure. Unsuccessful operation.

If the UTRAN or the UE is unable to support the ciphering and/or integrity protection algorithms specified in the SECURITY MODE COMMAND message, then the UTRAN shall return to the CN a SECURITY MODE REJECT message with cause value "Requested Ciphering and/or Integrity Protection Algorithms not Supported". If the radio interface Security Mode Control procedure fails, a SECURITY MODE REJECT message shall be sent to the CN with cause value "Failure in the Radio Interface Procedure".

8.18.4 Abnormal Conditions

If, when establishing a signalling connection towards a second core network domain, the integrity has already been started by the first domain and the integrity protection and ciphering information specified in the SECURITY MODE COMMAND message does not support the integrity protection alternative and the ciphering alternative presently being used, a SECURITY MODE REJECT message shall be sent to the second core network domain with cause value "Conflict with already existing Integrity protection and/or Ciphering information".

If, upon reception of a SECURITY MODE COMMAND message from a core network domain with an already existing signalling connection from that core network domain and for which integrity protection and possibly ciphering have already been started, the *Key Status* IE has the value "Old", a SECURITY MODE REJECT message shall be returned with cause value "Conflict with already existing Integrity protection and/or Ciphering information".

If, upon reception of a SECURITY MODE COMMAND message from a core network domain with an already existing signalling connection and for which integrity protection and possibly ciphering have already been started, the included integrity protection and ciphering information does not support the integrity protection alternative and the ciphering alternative presently being used, a SECURITY MODE REJECT message shall be returned with cause value "Conflict with already existing Integrity protection and/or Ciphering information".

8.19 Location Reporting Control

8.19.1 General

The purpose of the Location Reporting Control procedure is to allow the CN to request information on the location and optionally velocity of a given UE. The procedure uses connection oriented signalling.

8.19.2 Successful Operation



Figure 21: Location Reporting Control procedure. Successful operation.

The CN initiates the procedure by sending a LOCATION REPORTING CONTROL message.

The *Request Type* IE shall indicate to the serving RNC whether:

- to report directly;
- to stop a direct report;
- to report periodically;
- to stop periodic reporting;
- to report upon change of Service area, or
- to stop reporting at change of Service Area.

If reporting upon change of Service Area is requested, the Serving RNC shall report whenever the UE moves between Service Areas. For this procedure, only Service Areas that are defined for the PS and CS domains shall be considered.

The *Request Type* IE shall also indicate what type of location information the serving RNC shall report. The location information is either of the following types:

- Service Area Identifier, or
- Geographical area, including geographical coordinates with or without requested accuracy. If the *Vertical Accuracy Code* IE is included, the *Accuracy Code* IE in the *Request Type* IE shall be present. The *Accuracy Code* IE shall be understood as the horizontal accuracy code.

A request for a direct report or for periodic reporting can be done in parallel with having an active request to report upon change of Service Area for the same UE. The request to report upon change of Service Area shall not be affected by this.

Any of the *Vertical Accuracy Code* IE, *Response Time* IE, *Positioning Priority* IE, *Client Type* IE or *Periodic Location Info* IE shall be included according to the following rules:

- Vertical Accuracy Code shall be included, if available, in connection with Geographical Area,
- Response time shall be included, if available, in connection with request for start of direct reporting of Geographical Area,
- Client type shall be included in connection with request for start of direct reporting of Geographical Area and, if available, in request for direct reporting of SAI or periodic reporting,
- Positioning Priority shall be included, if available, in connection with request for start of direct reporting or in connection with request for start of reporting upon change of Service Area,
- Periodic Location Info shall be included in connection with a request for start of periodic reporting of Geographical Area.

When no *Positioning Priority* IE is included, the RNC shall consider the request as if "Normal Priority" value had been received.

When no *Response Time* IE is included, the RNC shall consider the request as if "Delay Tolerant" value had been received.

Interaction with Relocation and Enhanced Relocation:

The order to perform location reporting at change of Service Area is lost in UTRAN at successful Relocation of SRNS. If the location reporting at change of Service Area shall continue also after the relocation has been performed, the Location Reporting Control procedure shall thus be re-initiated from the CN towards the future SRNC after the Relocation Resource Allocation procedure or the Enhanced Relocation procedure has been executed successfully.

8.19.3 Abnormal Conditions

Not applicable.

8.20 Location Report

8.20.1 General

The purpose of the Location Report procedure is to provide the UE's location and optionally velocity information to the CN. The procedure uses connection oriented signalling.

8.20.2 Successful Operation

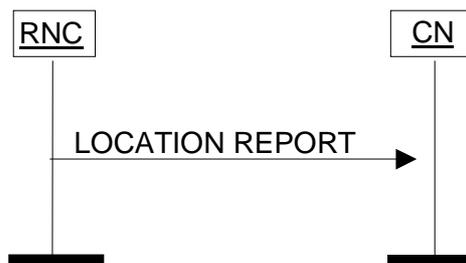

Figure 22: Location Report procedure. Successful operation.

The serving RNC initiates the procedure by generating a LOCATION REPORT message. The LOCATION REPORT message may be used as a response to a LOCATION REPORTING CONTROL message. Also, when a user enters or leaves a classified zone set by O&M, e.g. a zone where a disaster has occurred, a LOCATION REPORT message including the Service Area of the UE in the *Area Identity* IE shall be sent to the CN. The *Cause* IE shall indicate the appropriate cause value to the CN, e.g. "User Restriction Start Indication" and "User Restriction End Indication". The CN shall react to the LOCATION REPORT message with CN vendor specific actions.

For this procedure, only Service Areas that are defined for the PS and CS domains shall be considered.

In case reporting at change of Service Area is requested by the CN, then the RNC shall issue a LOCATION REPORT message:

- whenever the information given in the previous LOCATION REPORT message or INITIAL UE MESSAGE message is not anymore valid.
- upon receipt of the first LOCATION REPORTING CONTROL message following a Relocation Resource Allocation procedure, with the *Event* IE included in the *Request Type* IE set to "Change of Service Area", as soon as SAI becomes available in the new SRNC and the relocation procedure has been successfully completed.

In case a Service Area is reported, the RNC shall include in the *Area Identity* IE of the LOCATION REPORT message a Service Area that includes at least one of the cells from which the UE is consuming radio resources.

In case the LOCATION REPORT message is sent as an answer to a request for a direct report, for periodic reporting or for reports at a change of Service Area, the *Request Type* IE from the LOCATION REPORTING CONTROL message shall be included.

If the LOCATION REPORT message is sent as an answer to a request for a direct report of Service Area and the current Service Area can not be determined by the RNC, then the *Area Identity* IE shall be omitted and a cause value shall be included to indicate that the request could not be fulfilled, e.g. "Requested Information Not Available" or "Location Reporting Congestion". The RNC may also include the *Last Known Service Area* IE.

If the RNC can not deliver the location information as requested by the CN, due to either the non-support of the requested event or the non-support of the requested report area, or if the RNC is currently not able to reach the UE, the RNC shall indicate the UE location to be "Undetermined" by omitting the *Area Identity* IE. A cause value shall instead be added to indicate the reason for the undetermined location, e.g. "Requested Request Type not supported", "Location Reporting Congestion" or "No Resource Available".

In case of periodic reporting is requested by the CN, the RNC shall issue the first LOCATION REPORT message one reporting interval as indicated in the *Reporting Interval* IE contained in the LOCATION REPORTING CONTROL message after reception of the LOCATION REPORTING CONTROL message and continue to send LOCATION REPORT messages one reporting interval after the previous LOCATION REPORT message until the desired amount of reports as given in the *Reporting Amount* IE has been attained, or until the periodic reporting is canceled by the CN or aborted by the RNC. When no location estimate is available at the RNC when the reporting criteria are fulfilled (e.g., due to failure of a position method itself), the RNC shall indicate the UE location to be "Undetermined" by omitting the *Area Identity* IE. A cause value shall instead be added to indicate the reason for the undetermined location, e.g. "Periodic Location Information not Available".

If the Location Report procedure was triggered by a LOCATION REPORTING CONTROL message, which included a request to report a geographical area with a specific accuracy, the LOCATION REPORT message shall include:

- the *Geographical Area* IE within the *Area Identity* IE containing either a point with indicated uncertainty or a polygon or an other type, which fulfils the requested accuracy, and
- the *Accuracy Fulfilment Indicator* IE with the value "requested accuracy fulfilled".

If the Location Report procedure was triggered by a LOCATION REPORTING CONTROL message, which included a request to report with a geographical area and whenever one of the geographic area shapes *Ellipsoid point with uncertainty Ellipse* IE, *Ellipsoid point with altitude and uncertainty Ellipsoid* IE or *Ellipsoid Arc* IE is reported, the *Confidence* IE shall indicate the probability that the UE is located within the uncertainty region of the shape. The value of the *Confidence* IE shall be in the interval of "1" to "100".

If any of the requested accuracy cannot be fulfilled, the LOCATION REPORT message shall include:

- the *Geographical Area* IE within the *Area Identity* IE containing either a point with indicated uncertainty or a polygon or an other type, with the best possible accuracy, and
- the *Accuracy Fulfilment Indicator* IE with the value "requested accuracy not fulfilled".

If the *Confidence* IE received from the UE has value "0", the RNC shall consider the requested accuracy as not fulfilled and if the received position is reported or forwarded then the confidence and uncertainty shape shall not be included (i.e. either the *Point* IE or the *Ellipsoid point with altitude* IE shall be used).

If, on the other hand, no specific accuracy level was requested in the LOCATION REPORTING CONTROL message, the LOCATION REPORT message shall include the *Geographical Area* IE within the *Area Identity* IE, the reported *Geographical Area* IE may include an accuracy.

The LOCATION REPORT message shall also include, if available, the *Position Data* IE containing the positioning method (or list of positioning methods) used successfully to obtain the location estimate, together with the usage information.

If the Location Report procedure was triggered by a LOCATION REPORTING CONTROL message which included a request to report with a geographical area and in which the *Include Velocity* IE was set to "requested", the LOCATION REPORT message shall include a *Velocity Estimate* IE, if available and if the handling of velocity is supported by the RNC.

If the Location Report procedure was triggered by a LOCATION REPORTING CONTROL message, which included a request to report with a geographical area and in which the *Client Type* IE was not included, the RNC shall answer with the *Point* IE, or the *Point With Uncertainty* IE or the *Polygon* IE within the *Geographical Area* IE of the LOCATION REPORT message.

8.20.3 Abnormal Conditions

Not applicable.

8.21 Data Volume Report

8.21.1 General

The Data Volume Report procedure is used by CN to request the unsuccessfully transmitted DL data volume for specific RABs. This procedure only applies to the PS domain. The procedure uses connection oriented signalling.

NOTE: In line with TS32.240 [61], this procedure is not used and the RNC should ignore a DATA VOLUME REPORT REQUEST message if received.

8.21.2 Successful Operation

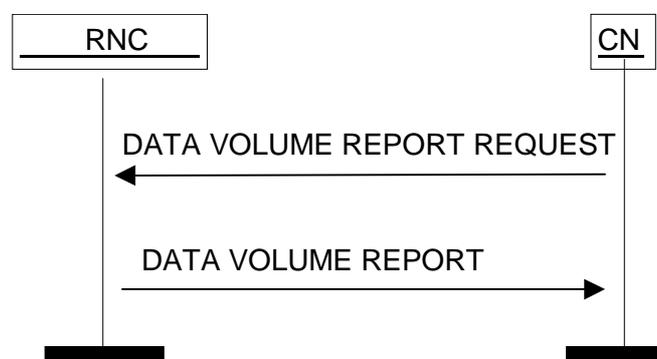

Figure 23: Data Volume Report procedure. Successful operation.

The procedure is initiated by CN by sending DATA VOLUME REPORT REQUEST message to UTRAN. This message shall contain the list of RAB ID IEs to identify the RABs for which the unsuccessfully transmitted DL data volume shall be reported.

At reception of a DATA VOLUME REPORT REQUEST message, the UTRAN shall produce a DATA VOLUME REPORT message. For each RAB successfully addressed within the RAB Data Volume Report List IE of the DATA VOLUME REPORT REQUEST message, the DATA VOLUME REPORT message shall include in the Unsuccessfully Transmitted DL Data Volume IE the amount of unsuccessfully transmitted DL data since the last data volume reported to the CN for the RAB and with the same data volume reference, if present. The message may also contain the Data Volume Reference IE.

The message may contain for each RAB successfully addressed a maximum of two RAB Data Volume Report Item IEs within the RAB Data Volume Report List IE for the case when there is a need to report two different data volumes since the last data volume indication to the CN. The UTRAN shall also reset the data volume counter for the reported RABs. The UTRAN shall send the DATA VOLUME REPORT message to the CN. Transmission and reception of the DATA VOLUME REPORT message terminate the procedure in the UTRAN and in the CN respectively.

The Data Volume Reference IE, if included, indicates the time when the data volume is counted.

8.21.3 Unsuccessful Operation

The RAB ID IE for each RAB for which UTRAN is not able to transfer a data volume report is included in the DATA VOLUME REPORT message together with a Cause IE, e.g. "Invalid RAB ID".

8.21.4 Abnormal Conditions

Not applicable.

8.22 Initial UE Message

8.22.1 General

The purpose of the Initial UE Message procedure is to establish an Iu signalling connection between a CN domain and the RNC and to transfer the initial NAS-PDU to the CN node as determined by the NAS Node Selection Function - if this function is active, or otherwise to the default CN node- or by the Rerouting Function (see TS 25.410 [2]) in case of MOCN configuration. The procedure uses connection oriented signalling.

8.22.2 Successful Operation

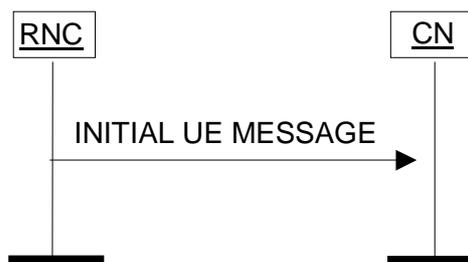

Figure 24: Initial UE Message procedure. Successful operation.

When the RNC has received from radio interface a NAS message (see TS 24.008 [8]) to be forwarded to a CN domain to which no Iu signalling connection for the UE exists, the RNC shall initiate the Initial UE Message procedure and send the INITIAL UE MESSAGE message to the CN. If NNSF is active, the selection of the CN node is made according to TS 23.236 [26].

In addition to the received NAS-PDU, the RNC shall add the following information to the INITIAL UE MESSAGE message:

- CN domain indicator, indicating the CN domain towards which this message is sent.
- For CS domain, the LAI which is the last LAI indicated to the UE by the UTRAN via the current RRC connection, or if the UTRAN has not yet indicated any LAI to the UE via the current RRC connection, then the LAI of the cell via which the current RRC connection was established.
- For PS domain, the LAI+RAC which are the last LAI+RAC indicated to the UE by UTRAN via the current RRC connection, or if the UTRAN has not yet indicated any LAI+RAC to the UE via the current RRC connection, then the LAI+RAC of the cell via which the current RRC connection was established.
- Service Area corresponding to at least one of the cells from which the UE is consuming radio resources.
- Iu signalling connection identifier.
- Global RNC identifier.
- Selected PLMN Identity, if received from radio interface by a network sharing supporting UE in shared networks.
- Redirect Attempt Flag, in MOCN configuration for a network sharing non supporting UE in order to indicate that the CN should respond with a Redirection Indication IE or a Redirection Completed IE.

The *Iu Signalling Connection Identifier* IE contains an Iu signalling connection identifier which is allocated by the RNC. The value for the *Iu Signalling Connection Identifier* IE shall be allocated so as to uniquely identify an Iu signalling connection for the RNC. The CN should store and remember this identifier for the duration of the Iu connection.

Whereas several processing entities within the CN (e.g. charging, interception, etc.) may make use of the location information given in the *SAI* IE and the *LAI* (and *RAC* for PS domain) IE, the mobility management within the CN shall rely on the information given within the *LAI* IE (respectively *LAI* and *RAC* IEs for PS domain) only.

If the establishment of the Iu signalling connection towards the CN is performed due to an RRC connection establishment originating from a CSG cell and if the UE is CSG capable, the *CSG Id* IE shall be included in the INITIAL UE MESSAGE message.

If the establishment of the Iu signalling connection towards the CN is performed due to an RRC connection establishment originating from a Hybrid cell and if the UE is CSG capable, the *CSG Id* IE and *Cell Access Mode* IE shall be included in the INITIAL UE MESSAGE message.

If the RNC has a co-located L-GW, it shall include the *L-GW Transport Layer Address* IE in the INITIAL UE MESSAGE message.

If the *Higher bitrates than 16 Mbps flag* IE is included in the INITIAL UE MESSAGE message then the CN shall, if supported, use the IE as described in TS 23.060 [21].

If the *Tunnel Information for BBF* IE is received in the INITIAL UE MESSAGE message, the CN shall, if supported, use the IE as described in TS 23.139 [65].

Interaction with Direct Transfer procedure

In MOCN configuration, if the RNC receives the *Redirection Indication* IE in the DIRECT TRANSFER message from a CN node which is not the last attempted, it shall initiate the Initial UE Message procedure towards another CN operator when possible (or possibly to the same CN in case when CS/PS coordination is required), with the following additional information in the INITIAL UE MESSAGE message:

- *NAS Sequence Number* IE, if received from previously attempted CN operator;
- *Permanent NAS UE Identity* IE, if received from one of previously attempted CN operators.

8.22.2.1 Successful Operation for GERAN Iu-mode

For GERAN Iu-mode, the following shall apply in addition for the successful operation of the Initial UE Message procedure:

- In case of establishment of a signalling connection towards the CS domain in GERAN Iu-mode, the INITIAL UE MESSAGE message shall contain the *GERAN Classmark* IE in order to provide the CN with GERAN-specific information (see TS 43.051 [27]).

8.23 Direct Transfer

8.23.1 General

The purpose of the Direct Transfer procedure is to carry UE – CN signalling messages over the Iu Interface. The UE - CN signalling messages are not interpreted by the UTRAN, and their content (e.g. MM or CC message) is outside the scope of this specification (see TS 24.008 [8]). The UE – CN signalling messages are transported as a parameter in the DIRECT TRANSFER messages. The procedure uses connection oriented signalling.

8.23.2 Successful Operation

8.23.2.1 CN Originated Direct Transfer



Figure 25: Direct Transfer, CN originated. Successful operation.

If a UE - CN signalling message has to be sent from the CN to the UE, the CN shall send a DIRECT TRANSFER message to the RNC including the UE - CN signalling message as a *NAS-PDU* IE.

If the DIRECT TRANSFER message is sent in the downlink direction, it shall include the *SAPI* IE and shall not include the *LAI + RAC* IE and the *SAI* IE. The use of the *SAPI* IE included in the DIRECT TRANSFER message enables the UTRAN to provide specific service for the transport of the included NAS message.

Upon receipt of the DIRECT TRANSFER message the RNC shall

- store the Subscriber Profile ID for RAT/Frequency priority IE and use it as defined in TS 36.300 [52].

In case of rerouting in MOCN configuration:

If the CN can serve the network sharing non-supporting UE, the *NAS-PDU* IE - i.e. the accept NAS message - and the *Redirection completed* IE shall be included in the DIRECT TRANSFER message for the downlink direction.

If the CN cannot serve the network sharing non-supporting UE, the *NAS-PDU* IE - i.e. the reject NAS message - and a *Redirection Indication* IE shall be included in the DIRECT TRANSFER message for the downlink direction.

If the CN can serve the network sharing non-supporting UE, but CS/PS coordination is required, the *NAS-PDU* IE - i.e. the reject NAS message - and a *Redirection Indication* IE shall be included in the DIRECT TRANSFER message for the downlink direction.

The *Redirection Indication* IE shall contain:

- The *initial NAS-PDU* IE received from the UE;
- The *Reject Cause Value* IE;
- The *NAS Sequence Number* IE, if available for CS;
- The Permanent NAS UE Identity IE, if available.

Upon reception of the downlink DIRECT TRANSFER message including the *Redirection Indication* IE, the RNC shall store as part of the Rerouting Function the associated *Reject Cause Value* IE and *NAS-PDU* IE related to this CN. In case the *Reject Cause Value* IE is set to "CS/PS coordination required", then the RNC shall perform CS/PS coordination based on the received *Permanent NAS UE Identity* IE. In this case the *Reject Cause Value* IE and the associated *NAS-PDU* IE shall not be stored.

In case all attempted CN operators have replied with the *Redirection Indication* IE, the RNC shall select the most appropriate NAS-PDU among the *NAS-PDU* IEs received from the attempted CN nodes based on the stored information as part of the Rerouting function and send it back to the UE.

Upon reception of the downlink DIRECT TRANSFER message including the *Redirection Completed* IE, the RNC shall send back the included NAS-PDU IE to the UE and terminate the Rerouting Function.

8.23.2.2 UTRAN Originated Direct Transfer



Figure 26: Direct Transfer, RNC originated. Successful operation.

If a UE - CN signalling message has to be sent from the RNC to the CN without interpretation, the RNC shall send a DIRECT TRANSFER message to the CN including the UE - CN signalling message as a *NAS-PDU* IE.

If the DIRECT TRANSFER message shall be sent to the PS domain, the RNC shall also add the *LAI* and the *RAC* IEs, which were the last *LAI + RAC* indicated to the UE by the UTRAN via the current RRC connection, or if the UTRAN had not yet indicated any *LAI + RAC* to the UE via the current RRC connection, then the *LAI + RAC* of the cell via

which the current RRC connection was established. If the DIRECT TRANSFER message is sent to the PS domain, the RNC shall also add a Service Area corresponding to at least one of the cells from which the UE is consuming radio resources. If the DIRECT TRANSFER message is sent in uplink direction, the RNC shall not include the *SAPI* IE.

If the RNC has a co-located L-GW, it shall include the *L-GW Transport Layer Address* IE in the DIRECT TRANSFER message.

8.23.3 Abnormal Conditions

If the DIRECT TRANSFER message is sent by the RNC to the PS domain, and any of the *LAI* IE, *RAC* IE or *SAI* IE is missing, the CN shall continue with the Direct Transfer procedure, ignoring the missing IE.

If the DIRECT TRANSFER message is sent by the CN to the RNC without the *SAPI* IE, the RNC shall continue with the Direct Transfer procedure.

8.24 Void

8.25 Overload Control

8.25.1 General

This procedure is defined to give some degree of signalling flow control. At the UTRAN side, "Processor Overload" and "Overload in the Capability to Send Signalling Messages to the UE" are catered for, and at the CN side, "Processor Overload" is catered for. The procedure uses connectionless signalling.

The philosophy used is to stem the traffic at source with known effect on the service. The algorithm used is:

At the CN side:

- If T_{igOC} is not running and an OVERLOAD message or "Signalling Point Congested" information is received, the traffic should be reduced by one step. It is also possible, optionally, to indicate the number of steps to reduce the traffic within the *Number of Steps* IE. At the same time, timers T_{igOC} and T_{inTC} should be started.
- During T_{igOC} all received OVERLOAD messages or "Signalling Point Congested" information should be ignored.
- This step by step reduction of traffic should be continued until maximum reduction is obtained by arriving at the last step.
- If T_{inTC} expires, the traffic should be increased by one step and T_{inTC} should be re-started unless the number of steps by which the traffic is reduced is back to zero.

At the UTRAN side:

- If T_{igOR} is not running and an OVERLOAD message not including the *Priority Class Indicator* IE or "Signalling Point Congested" information is received, all the traffic should be reduced by one step. It is also possible, optionally, to indicate the number of steps to reduce the traffic within the *Number of Steps* IE. At the same time, timers T_{igOR} and T_{inTR} should be started.
- If T_{igOR} is not running and an OVERLOAD message including the *Priority Class Indicator* IE is received and a procedure for reduction of all traffic is not being processed, then signalling traffic for the indicated priority class should be reduced by one step. It is also possible, optionally, to indicate the number of steps to reduce the traffic within the *Number of Steps* IE. At the same time, timers T_{igOR} and T_{inTR} should be started.
- During T_{igOR} all received OVERLOAD messages or "Signalling Point Congested" information should be ignored.
- This step-by-step reduction of traffic should be continued until maximum reduction is obtained by arriving at the last step.

- If T_{inTR} expires, the traffic should be increased by one step and T_{inTR} should be re-started unless the number of steps by which the traffic is reduced is back to zero.

The number of steps and the method for reducing the load are implementation-specific.

There may be other traffic control mechanisms from O&M activities occurring simultaneously.

8.25.2 Philosophy

Void.

8.25.3 Successful Operation

8.25.3.1 Overload at the CN



Figure 27: Overload at the CN. Successful operation.

The CN should indicate to the RNC that it is in a congested state by sending an OVERLOAD message. The *CN Domain Indicator* IE may be included, if the CN can determine the domain suffering from the signalling traffic overload. A specific CN node shall send this message only towards those RNCs from which it can receive the INITIAL UE MESSAGE message.

Reception of the message by the UTRAN should cause reduction of signalling traffic towards the CN. If the *CN Domain Indicator* IE is included in the OVERLOAD message, and the *Global CN-ID* IE is not, the RNC should apply signalling traffic reduction mechanisms towards the indicated domain. If the *Priority Class Indicator* IE is included then the RNC should take the appropriate action to reduce the traffic for the priority class indicated in the IE.

If the NNSF is active, the CN shall include the *Global CN-ID* IE within the OVERLOAD message, and the RNC should apply signalling traffic reduction mechanisms towards the indicated CN node only.

8.25.3.2 Overload at the UTRAN



Figure 28: Overload at the UTRAN. Successful operation.

If the UTRAN is not capable of sending signalling messages to UEs due to overloaded resources, the UTRAN should send an OVERLOAD message to the CN. The RNC shall include the *Global RNC-ID* IE in this message. The message shall be sent only towards those CN nodes towards which the RNC can send the INITIAL UE MESSAGE message. If the *Priority Class Indicator* IE is included it shall be ignored.

8.25.4 Abnormal Conditions

Not applicable.

8.26 Reset

8.26.1 General

The purpose of the Reset procedure is to initialise the UTRAN in the event of a failure in the CN or vice versa. The procedure uses connectionless signalling.

8.26.2 Successful Operation

8.26.2.1 Reset Procedure Initiated from the CN

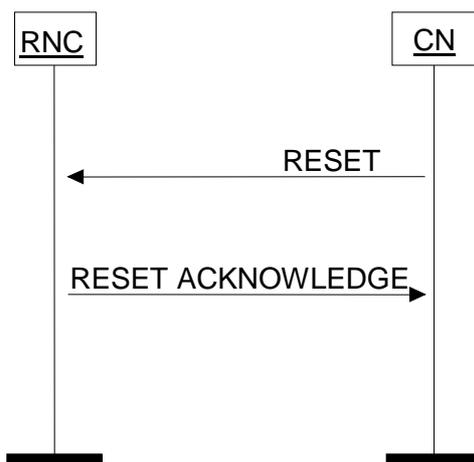

Figure 29: Reset procedure initiated from the CN. Successful operation.

In the event of a failure at the CN, which has resulted in the loss of transaction reference information, a RESET message shall be sent to the RNC. When a CN node sends this message towards an RNC for which it is not the default CN node, the *Global CN-ID* IE shall be included. This message is used by the UTRAN to release affected Radio Access Bearers and to erase all affected references for the specific CN node that sent the RESET message, i.e. the CN node indicated by the *Global CN-ID* IE or, if this IE is not included, the default CN node for the indicated CN domain.

After a guard period of T_{RatC} seconds a RESET ACKNOWLEDGE message shall be returned to the CN, indicating that all references at the UTRAN have been cleared. The RNC does not need to wait for the release of UTRAN radio resources or for the transport network layer signalling to be completed before returning the RESET ACKNOWLEDGE message.

The RNC shall include the *Global RNC-ID* IE in the RESET ACKNOWLEDGE message. The *Global RNC-ID* IE shall not be included in the RESET message.

Interactions with other procedures:

In case of interactions with other procedures, the Reset procedure shall always override all other procedures.

8.26.2.2 Reset Procedure Initiated from the UTRAN

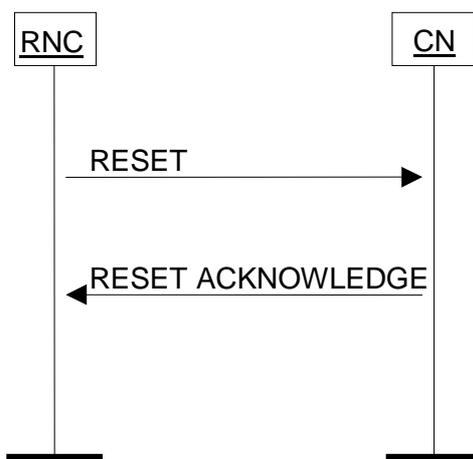

Figure 30: Reset procedure initiated from the UTRAN. Successful operation.

In the event of a failure at the UTRAN which has resulted in the loss of transaction reference information, a RESET message shall be sent to all CN nodes towards which the RNC has Iu signalling connections established. This message is used by the CN to release affected Radio Access Bearers and to erase all affected references for the sending RNC.

The RNC shall include the *Global RNC-ID* IE in the RESET message.

After a guard period of T_{RafR} seconds a RESET ACKNOWLEDGE message shall be returned to the UTRAN indicating that all references have been cleared.

When a RESET ACKNOWLEDGE message is sent from a CN node towards an RNC for which the sending CN node is not the default CN node, the *Global CN-ID* IE shall be included.

Interactions with other procedures:

In case of interactions with other procedures, the Reset procedure shall always override all other procedures.

8.26.3 Abnormal Conditions

8.26.3.1 Abnormal Condition at the CN

If the CN sends a RESET message to the RNC and receives no RESET ACKNOWLEDGE message within a period T_{RafR} then it shall repeat the entire Reset procedure. The sending of the RESET message shall be repeated a maximum of "n" times where n is an operator matter. After the n-th unsuccessful repetition the procedure shall be stopped and e.g. the maintenance system be informed.

8.26.3.2 Abnormal Condition at the UTRAN

If the RNC sends a RESET message to the CN and receives no RESET ACKNOWLEDGE message within a period T_{RafC} then it shall repeat the entire Reset procedure. The sending of the RESET message shall be repeated a maximum of "n" times where n is an operator matter. After the n-th unsuccessful repetition the procedure shall be stopped and e.g. the maintenance system be informed.

8.26.3.3 Crossing of Reset Messages

When an entity that has sent a RESET message and is waiting for a RESET ACKNOWLEDGE message, instead receives a RESET message from the peer entity, it shall stop timer T_{RafC} or T_{RafR} and send a RESET ACKNOWLEDGE message to the peer entity.

8.27 Error Indication

8.27.1 General

The Error Indication procedure is initiated by a node to report detected errors in one incoming message, provided they cannot be reported by an appropriate failure message.

If the error situation arises due to reception of a message utilising dedicated signalling, then the Error Indication procedure uses connection oriented signalling. Otherwise the procedure uses connectionless signalling.

8.27.2 Successful Operation



Figure 31: Error Indication procedure, CN originated. Successful operation.



Figure 32: Error Indication procedure, RNC originated. Successful operation.

When the conditions defined in clause 10 are fulfilled, the Error Indication procedure is initiated by an ERROR INDICATION message sent from the receiving node.

The ERROR INDICATION message shall contain at least either the *Cause* IE or the *Criticality Diagnostics* IE.

Examples for possible cause values for protocol error indications are:

- "Transfer Syntax Error"
- "Semantic Error"
- "Message not compatible with receiver state".

If the ERROR INDICATION message is sent connectionless, the *CN Domain Indicator* IE shall be present.

If the ERROR INDICATION message is sent connectionless towards the CN, the *Global RNC-ID* IE shall be present.

When an ERROR INDICATION message is sent connectionless from a CN node towards an RNC for which the sending CN node is not the default CN node, the *Global CN-ID* IE shall be included.

8.27.3 Abnormal Conditions

Not applicable.

8.28 CN Deactivate Trace

8.28.1 General

The purpose of the CN Deactivate Trace procedure is to inform the RNC to stop the trace session, initiated by a signalling based activation, for the indicated trace reference and related to the UE the Iu connection is used for. The procedure uses connection oriented signalling.

8.28.2 Successful Operation



Figure 33: CN Deactivate Trace procedure. Successful operation.

The CN invokes the CN Deactivate Trace procedure by sending a CN DEACTIVATE TRACE message to the UTRAN as defined in TS 32.422 [38].

The CN DEACTIVATE TRACE message shall contain the *Trace Reference* IE. The RNC shall stop the trace session for the indicated trace reference in the *Trace Reference* IE. In case of simultaneous CS/PS connections, the trace session for the indicated trace reference shall be closed upon reception of the CN DEACTIVATE TRACE message from any of the CN domain, whether it was the one which initiated trace session activation or not.

8.28.2.1 Successful Operation for GERAN Iu mode

The CN DEACTIVATE TRACE message shall contain the *Trace Reference* IE and may contain the *Trigger ID* IE. The *Trace Reference* IE and, if present, the *Trigger ID* IE are used to indicate which trace shall be stopped.

8.28.3 Abnormal Conditions

Void

8.29 Reset Resource

8.29.1 General

The purpose of the Reset Resource procedure is to initialise part of the UTRAN in the event of an abnormal failure in the CN or vice versa (e.g. Signalling Transport processor reset). The procedure uses connectionless signalling.

8.29.1.1 Reset Resource procedure initiated from the RNC

Void

8.29.1.2 Reset Resource procedure initiated from the CN

Void.

8.29.2 Successful Operation

8.29.2.1 Reset Resource procedure initiated from the RNC

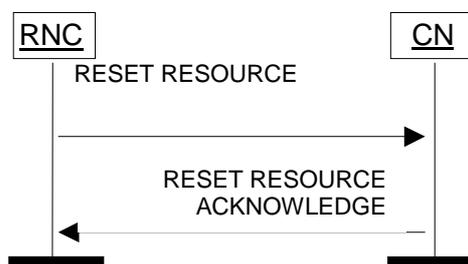

Figure 34: RNC initiated Reset Resource procedure. Successful operation.

The RNC initiates the procedure by sending a RESET RESOURCE message to the CN.

The RESET RESOURCE message shall include the *CN Domain Indicator* IE, the *Global RNC-ID* IE, the *Cause* IE with the appropriate cause value (e.g. "Signalling Transport Resource Failure") and a list containing *Iu Signalling Connection Identifier* IEs.

On reception of this message the CN shall release locally the resources and references (i.e. resources and Iu signalling connection identifiers) associated to the Iu signalling connection identifiers indicated in the received message. The CN shall always return the RESET RESOURCE ACKNOWLEDGE message to the RNC when all Iu-related resources and references have been released and shall include the *CN Domain Indicator* IE and a list of *Iu Signalling Connection Identifier* IEs. The list of *Iu Signalling Connection Identifier* IEs within the RESET RESOURCE ACKNOWLEDGE message shall be in the same order as received in the RESET RESOURCE message. Unknown signalling connection identifiers shall be reported as released.

When a RESET RESOURCE ACKNOWLEDGE message is sent from a CN node towards an RNC for which the sending CN node is not the default CN node, the *Global CN-ID* IE shall be included.

Both the CN and the RNC shall provide means to prevent the immediate re-assignment of released Iu signalling connection identifiers to minimise the risk that the Reset Resource procedure releases the same Iu signalling connection identifiers re-assigned to new Iu connections.

8.29.2.2 Reset Resource procedure initiated from the CN

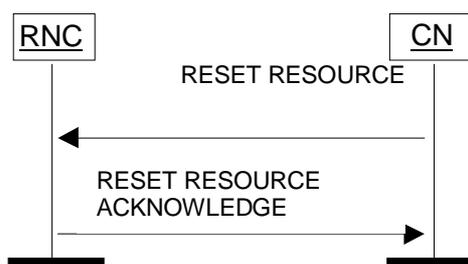

Figure 35: CN initiated Reset Resource procedure. Successful operation.

The CN initiates the procedure by sending a RESET RESOURCE message to the RNC.

The RESET RESOURCE message shall include the *CN Domain Indicator* IE, the *Cause* IE with the appropriate cause value (e.g. "Signalling Transport Resource Failure") and a list containing *Iu Signalling Connection Identifier* IEs.

When a RESET RESOURCE message is sent from a CN node towards an RNC for which the sending CN node is not the default CN node, the *Global CN-ID* IE shall be included.

On reception of this message the RNC shall release locally the resources and references (i.e. radio resources and Iu signalling connection identifiers) associated to the specific CN node and Iu signalling connection identifiers indicated in the received message. The *Global RNC-ID* IE shall not be included in the RESET RESOURCE message. If no *Global CN-ID* IE is included in the RESET RESOURCE message to indicate the sending CN node, the default CN node for the

indicated CN domain shall be considered as sender. The RNC shall always return the RESET RESOURCE ACKNOWLEDGE message to the CN when all Iu-related resources and references have been released and shall include the *CN Domain Indicator* IE, a list of *Iu Signalling Connection Identifier* IEs and the *Global RNC-ID* IE. The list of *Iu Signalling Connection Identifier* IEs within the RESET RESOURCE ACKNOWLEDGE message shall be in the same order as received in the RESET RESOURCE message. Unknown signalling connection identifiers shall be reported as released.

Both the RNC and the CN shall provide means to prevent the immediate re-assignment of released Iu signalling connection identifiers to minimise the risk that the Reset Resource procedure releases the same Iu signalling connection identifiers re-assigned to new Iu connections.

8.30 RAB Modification Request

8.30.1 General

The purpose of the RAB Modification Request procedure is to allow the RNC to initiate renegotiation of RABs for a given UE after RAB establishment. The procedure uses connection oriented signalling.

8.30.2 Successful Operation

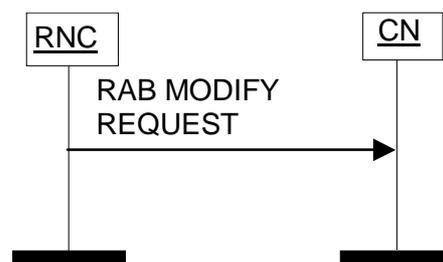

Figure 36: RAB Modification procedure.

The RNC initiates the procedure by generating a RAB MODIFY REQUEST message towards the CN and shall include a list of *RABs To Be Modified* IEs. For each RAB requested to be modified the *RABs To Be Modified Item* IE of the RAB MODIFY REQUEST message shall include the *RAB ID* IE, and the corresponding *Requested RAB Parameter Values* IE. The *Requested RAB Parameter Values* IE shall either list those RAB parameters the RNC would like modified and the associated new RAB parameter values it is requesting or shall indicate that the execution of the alternative RAB configuration is requested. For any given RAB, the RNC shall be able to propose modifications to any negotiable RAB parameters.

If the requested maximum bit rate (respectively the requested guaranteed bit rate when applicable) exceeds the maximum value of the *Requested Maximum Bit Rate* IE (respectively *Requested Guaranteed Bit Rate* IE), either the *Extended Requested Maximum Bit Rate* IE (respectively *Extended Requested Guaranteed Bit Rate* IE) shall be used or the *Supported Requested Maximum Bit Rate* IE (respectively *Supported Requested Guaranteed Bit Rate* IE) shall be used.

For a RAB if *Extended Requested Maximum Bit Rate* IE (respectively *Extended Requested Guaranteed Bit Rate* IE when applicable) is signalled in one direction RNC shall signal the *Extended Requested Maximum Bit Rate* IE (respectively *Extended Requested Guaranteed Bit Rate* IE) also in the other direction for this RAB. If *Supported Requested Maximum Bit Rate* IE (respectively *Supported Requested Guaranteed Bit Rate* IE) is used it shall be used in both directions.

If supported the RNC may include the *Supported Requested Maximum Bit Rate* IE (respectively *Supported Requested Guaranteed Bit Rate* IE) in *Requested RAB Parameter Values* IE to define the RAB parameters the RNC would like modified and the associated new RAB parameter values.

If the RNC is allowed to request an alternative RAB Configuration, the RNC may request the CN to trigger the execution of this alternative RAB configuration by including the *Alternative RAB Configuration Request* IE in the RAB MODIFY REQUEST message.

Upon reception of the RAB MODIFY REQUEST message, it is up to the CN to decide how to react to the request.

8.30.3 Abnormal Conditions

Not applicable.

8.31 Location Related Data

8.31.1 General

The purpose of the Location Related Data procedure is to provide the means to handle additional location-related requests over the Iu interface: it allows the CN to either retrieve from the RNC deciphering keys (to be forwarded to the UE) for the broadcast assistance data, or request the RNC to deliver dedicated assistance data to the UE. The procedure uses connection oriented signalling.

8.31.2 Successful Operation

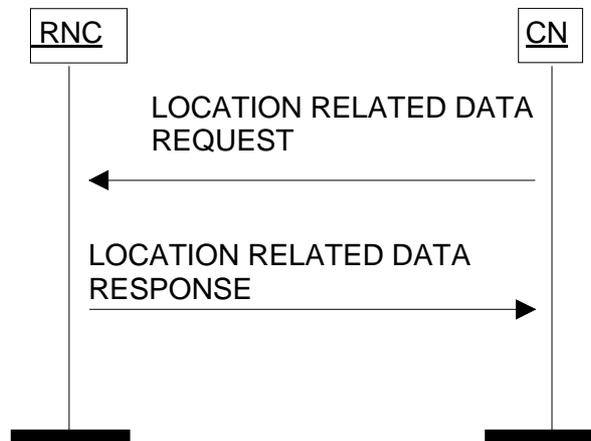

Figure 37: Location Related Data procedure. Successful operation.

The CN initiates the procedure by generating a LOCATION RELATED DATA REQUEST message to the RNC.

Upon reception of the LOCATION RELATED DATA REQUEST message, the RNC shall initiate the requested function indicated in the *Location Related Data Request Type IE*.

The *Location Related Data Request Type IE* indicates to the RNC whether:

- to start dedicated assistance data delivery to the UE, or
- to send deciphering keys for broadcast assistance data to the CN.

If the LOCATION RELATED DATA REQUEST message included a request for dedicated assistance data delivery to the UE, and if the dedicated assistance data was successfully delivered to the UE, the RNC shall respond to the CN with a LOCATION RELATED DATA RESPONSE message containing no data.

If the LOCATION RELATED DATA REQUEST message included a request for deciphering keys of broadcast assistance data, the RNC shall respond to the CN with a LOCATION RELATED DATA RESPONSE message containing the *Broadcast Assistance Data Deciphering Keys IE*.

8.31.2.1 Successful Operation for GERAN Iu mode

Upon reception of the LOCATION RELATED DATA REQUEST message, the BSS shall initiate the requested function indicated in the *Location Related Data Request Type IE* or the *Location Related Data Request Type Specific To GERAN Iu Mode IE*.

In the sole case of a request for GERAN Iu mode specific positioning method, E-OTD, defined in TS 43.059 [29], the LOCATION RELATED DATA REQUEST message shall include the *Location Related Data Request Type Specific To GERAN Iu Mode* IE and not the *Location Related Data Request Type* IE.

The *Location Related Data Request Type* IE or the *Location Related Data Request Type Specific To GERAN Iu Mode* IE shall indicate to the BSS whether:

- to start dedicated assistance data delivery to the UE, or
- to send deciphering keys for broadcast assistance data to the CN.

8.31.3 Unsuccessful Operation

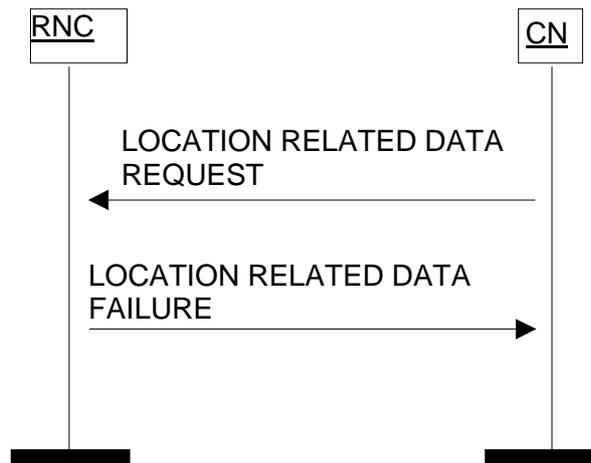

Figure 38: Location Related Data procedure. Unsuccessful operation.

If the RNC was not able to successfully deliver the requested dedicated assistance data to the UE, or if the RNC is not able to provide the requested deciphering keys, the RNC shall send a LOCATION RELATED DATA FAILURE message including the *Cause* IE to the CN. The *Cause* IE shall indicate the appropriate cause value to the CN, e.g. "Dedicated Assistance data Not Available" or "Deciphering Keys Not Available".

8.31.4 Abnormal Conditions

8.31.4.1 Abnormal Conditions for GERAN Iu mode

If the *Location Related Data Request Type* IE and *Location Related Data Request Type Specific To GERAN Iu Mode* IE are both included in the LOCATION RELATED DATA REQUEST message, the BSS shall reject the procedure by sending a LOCATION RELATED DATA FAILURE message.

If the *Location Related Data Request Type* IE is set to the value "Deciphering Keys for UE Based OTDOA" or "Dedicated Assistance Data for UE Based OTDOA", the BSS shall reject the procedure by sending a LOCATION RELATED DATA FAILURE message.

8.32 Information Transfer

8.32.1 General

The purpose of the Information Transfer procedure is to transfer information from the CN to the RNC.

This procedure uses connectionless signalling.

8.32.2 Successful Operation

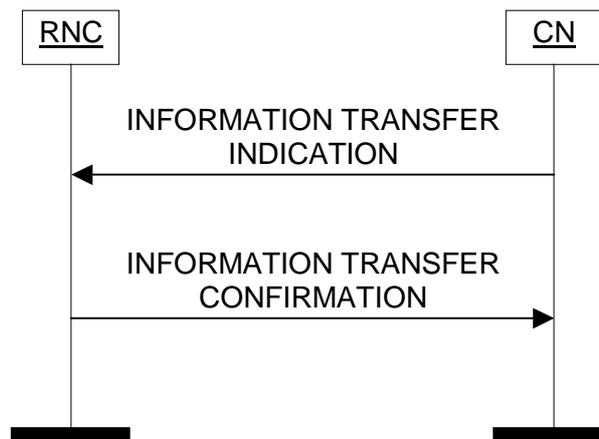

Figure 39: Information Transfer procedure. Successful operation.

The CN initiates the procedure by sending an INFORMATION TRANSFER INDICATION message to the RNC.

NOTE: The CN should initiate the Information Transfer procedure, if information is available, at least after the CN or the RNC has performed the Reset procedure or whenever the respective information has changed in the CN.

Upon reception of the INFORMATION TRANSFER INDICATION message, the RNC shall store the received information and use it according to its purpose.

The INFORMATION TRANSFER INDICATION message shall contain the following IEs:

- *Information Transfer ID*
- *Provided Data*
- *CN Domain Indicator*.

When a CN node sends this message towards an RNC for which it is not the default CN node, the *Global CN-ID* IE shall be included.

If the RNC is able to process the information contained in the *Provided Data* IE, it shall respond with the INFORMATION TRANSFER CONFIRMATION message provided with the same *Information Transfer ID* IE as the one received in the INFORMATION TRANSFER INDICATION message.

The RNC shall include the *Global RNC-ID* IE and the *CN Domain Indicator* IE in the INFORMATION TRANSFER CONFIRMATION message.

If the *Provided Data* IE contains the *Shared Network Information* IE, the RNC shall replace existing Shared Network Information provided in a previous Information Transfer procedure by the newly provided Shared Network Information.

8.32.3 Unsuccessful Operation

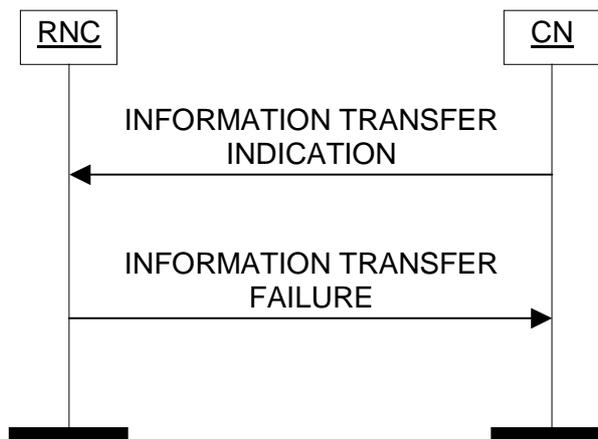

Figure 40: Information Transfer procedure. Unsuccessful operation.

If the RNC is not able to process the information contained in the *Provided Data* IE the RNC shall regard the Information Transfer procedure as failed and send the INFORMATION TRANSFER FAILURE message to the CN. The message shall include the same value of the *Information Transfer ID* IE as received in the INFORMATION TRANSFER INDICATION message and set the *Cause* IE to an appropriate value.

The RNC shall include the *Global RNC-ID* IE and the *CN Domain Indicator* IE in the INFORMATION TRANSFER FAILURE message.

8.32.4 Abnormal Conditions

None.

8.33 UE Specific Information

8.33.1 General

The purpose of the UE Specific Information procedure is to transfer from the CN to the RNC data related to a particular UE and a particular communication.

The procedure uses connection oriented signalling.

8.33.2 Successful Operation



Figure 41: UE Specific Information procedure. Successful operation.

The UE SPECIFIC INFORMATION INDICATION message may include the *UESBI-Iu* IE.

The RNC shall, if supported, use the *UESBI-Iu* IE when received in the UE SPECIFIC INFORMATION INDICATION message.

8.34 Direct Information Transfer

8.34.1 General

The purpose of the Direct Information Transfer procedure is to transfer some information from the RNC to the CN or vice versa in unacknowledged mode.

This procedure uses connectionless signalling.

8.34.2 Successful Operation

8.34.2.1 Direct Information Transfer initiated from the RNC

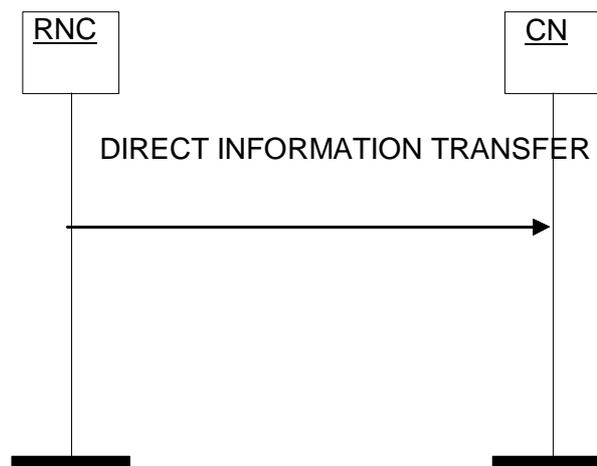

Figure 42: Information Request procedure. Successful operation.

The procedure is initiated with a DIRECT INFORMATION TRANSFER message sent from the RNC to the CN.

The DIRECT INFORMATION TRANSFER message shall include the following IEs:

- Inter-system Information Transfer Type,
- Global RNC-ID,
- CN Domain Indicator,

The *Inter-system Information Transfer Type* IE indicates the nature of the transferred information.

When the transferred information is of RIM nature, the *RIM Information* IE within the *RIM Transfer* IE shall contain a BSSGP RIM PDU. The final RAN destination node where the RIM information needs to be routed by the CN shall be indicated in the *RIM Routing Address* IE within the *RIM Transfer* IE and shall include either the identity of a GSM cell to identify a target BSS, or the identity of a Tracking Area and an eNB to identify the target eNB.

8.34.2.1.1 Successful Operation for GERAN Iu mode

In the case of a Direct Information Transfer procedure initiated from GERAN Iu mode BSC, the final RAN destination node where the RIM information needs to be routed by the CN shall be indicated in the *RIM Routing Address* IE within the *RIM Transfer* IE and may include the identity of either a GSM cell to identify a target BSS or the *Target RNC-ID* IE including the *RAC* IE to identify a target RNC.

8.34.2.2 Direct Information Transfer initiated from the CN

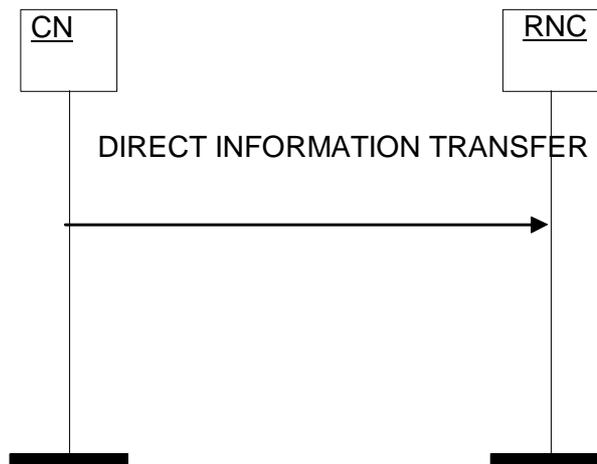

Figure 43: Information Request procedure. Successful operation.

The procedure is initiated with a DIRECT INFORMATION TRANSFER message sent from the CN to the RNC.

The DIRECT INFORMATION TRANSFER message shall include the following IEs:

- Inter-system Information Transfer Type,
- CN Domain Indicator,

The DIRECT INFORMATION TRANSFER message may include the following IEs:

- Global CN-ID.

The *Global CN-ID* IE shall be included only when the CN node sending the message is not the default CN node of the RNC.

The *Inter-system Information Transfer Type* IE indicates the nature of the transferred information.

When the transferred information is of RIM nature, the *RIM Information* IE within the *RIM Transfer* IE shall contain a BSSGP RIM PDU. The *RIM Routing Address* IE shall not be present since the RNC is the final destination node.

8.34.3 Abnormal Conditions

Not applicable.

8.35 Uplink Information Exchange

8.35.1 General

The purpose of the Uplink Information Exchange procedure is to transfer or request some information to the CN.

This procedure uses connectionless signalling.

8.35.2 Successful Operation

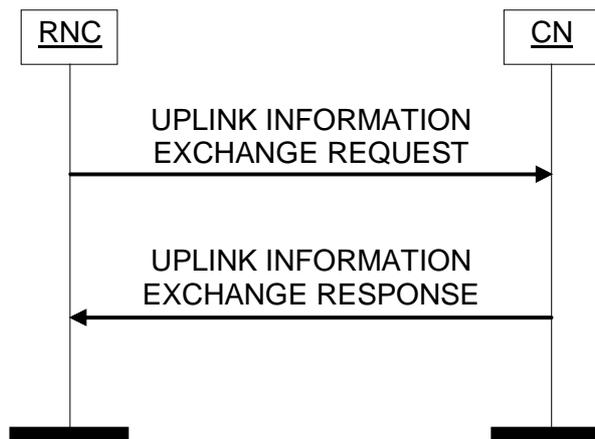

Figure 44: Uplink Information Exchange procedure. Successful operation.

The procedure is initiated with an UPLINK INFORMATION EXCHANGE REQUEST message sent from the RNC to the CN.

The UPLINK INFORMATION EXCHANGE REQUEST message shall contain the following IEs:

- Information Exchange ID
- Information Exchange Type
- CN Domain Indicator
- Global RNC-ID

The *Information Exchange Type* IE indicates whether the RNC asks the CN to either transfer or request specific information. If the *Information Exchange Type* IE is set to the value "transfer", the RNC shall also include in the UPLINK INFORMATION EXCHANGE REQUEST message the *Information Transfer Type* IE which indicates the nature of the information transferred.

If the *Information Exchange Type* IE is set to the value "request", the RNC shall also include in the UPLINK INFORMATION EXCHANGE REQUEST message the *Information Request Type* IE which indicates the nature of the information requested.

When the transferred information in the *Information Transfer Type* IE relates to a Trace Session in the RNC, the *Trace Activation Indicator* IE indicates whether the Trace Session identified by the *Trace Reference* IE is activated or deactivated in the RNC. In case the Trace Session is activated, the *Equipments To Be Traced* IE gives the Equipment Identity of the UEs that the RNC has to trace. If the *Trace Recording Session Reference* IE and the *IMSI* IE are included in the message, the CN shall take the information into account for anonymization of MDT data (TS 32.422 [10]).

When the requested information in the *Information Request Type* IE relates to the Multicast Service list for a given UE identified by its Permanent NAS UE Identity in the *Information Request Type* IE, this requested information, i.e. the list of Multicast Services the UE has joined, shall be included in the *Information Requested* IE in the UPLINK INFORMATION EXCHANGE RESPONSE message.

When the requested information in the *Information Request Type* IE relates to the IP Multicast Address and APN for one or several MBMS bearer service identified by their respective TMGIs in the *Information Request Type* IE, this requested information, i.e. IP Multicast Address and APN, shall be included in the *Information Requested* IE in the UPLINK INFORMATION EXCHANGE RESPONSE message.

If the CN node is capable of processing the request or the transfer, the RNC shall be informed by the UPLINK INFORMATION EXCHANGE RESPONSE message. The UPLINK INFORMATION EXCHANGE RESPONSE message shall contain the *Information Exchange ID* IE and the *CN Domain Indicator* IE. If the RNC has not sent the UPLINK INFORMATION EXCHANGE REQUEST message to the default CN node, the UPLINK INFORMATION EXCHANGE RESPONSE message shall also include the *Global CN-ID* IE.

Upon reception of the UPLINK INFORMATION EXCHANGE RESPONSE message including the IP Multicast Address and APN list in the *Information Requested* IE, the RNC shall store this information in the relevant MBMS Service Contexts.

Upon reception of the UPLINK INFORMATION EXCHANGE RESPONSE message including the Multicast Service list in the *Information Requested* IE, the RNC shall perform, for each TMGI received, the corresponding UE linking as described in TS 25.346 [42].

8.35.3 Unsuccessful Operation

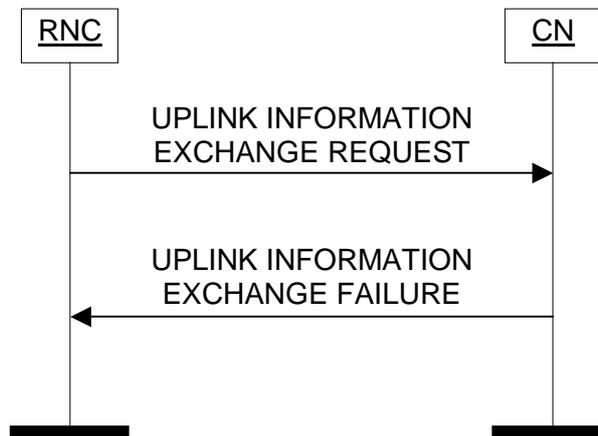

Figure 45: Uplink Information Exchange procedure. Unsuccessful operation.

If the CN node is not capable of correctly processing the request or the transfer, the RNC shall be informed by the UPLINK INFORMATION EXCHANGE FAILURE message. The UPLINK INFORMATION EXCHANGE FAILURE message shall contain the *Information Exchange ID* IE and the *CN Domain Indicator* IE. If the RNC has not sent the UPLINK INFORMATION EXCHANGE REQUEST message to the default CN node, the UPLINK INFORMATION EXCHANGE FAILURE message shall include the *Global CN-ID* IE.

The UPLINK INFORMATION EXCHANGE FAILURE message shall inform the RNC about the reason for unsuccessful operation with an appropriate cause value e.g. "MBMS - No Multicast Service For This UE", "MBMS - Unknown UE ID".

8.35.4 Abnormal Conditions

Not Applicable.

8.36 MBMS Session Start

8.36.1 General

The purpose of the MBMS Session Start procedure is to request the UTRAN to notify UEs about an upcoming MBMS Session of a given MBMS Bearer Service and to establish a MBMS RAB and MBMS Iu signalling connection for this MBMS Session. The MBMS Session Start procedure is triggered by the CN (PS domain).

The procedure uses connection oriented signalling.

8.36.2 Successful Operation

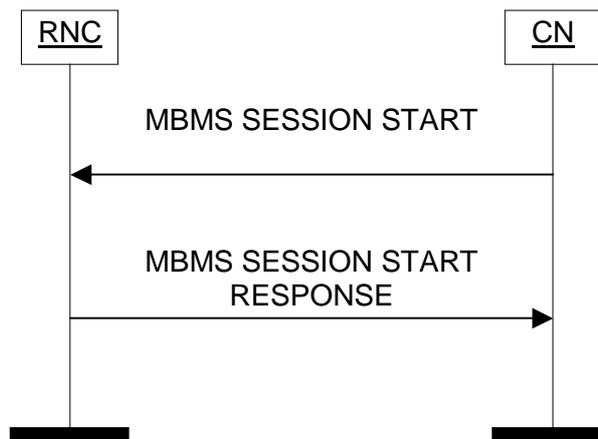

Figure 46: MBMS Session Start procedure. Successful operation.

The CN initiates the procedure by sending a MBMS SESSION START message.

The MBMS SESSION START message shall contain:

- TMGI;
- MBMS Bearer Service Type;
- MBMS Session Identity, if available;
- Iu Signalling Connection Identifier IE;
- RAB parameters (including e.g. Allocation/Retention Priority);
- PDP Type Information, if available;
- PDP Type Information extension, if available;
- MBMS Session Duration;
- MBMS Service Area;
- Frequency Layer Convergence Flag, if available;
- RA List of Idle Mode UEs, if available;
- Global CN-ID IE, only when the MBMS SESSION START message is sent from a CN node towards an RNC for which the sending CN node is not the default CN node;
- MBMS Session Repetition Number, if available;
- Time to MBMS Data Transfer;
- MBMS Counting Information, if available.

Upon reception of the MBMS SESSION START message, the RNC shall store the *Iu Signalling Connection Identifier* IE for the duration of the MBMS Iu signalling connection. The *Iu Signalling Connection Identifier* IE contains an Iu signalling connection identifier which is allocated by the CN. The value for the *Iu Signalling Connection Identifier* IE shall be allocated so as to uniquely identify an Iu signalling connection for the involved CN node.

The *Global CN-ID* IE contains the identity of the CN node that sent the MBMS SESSION START message, and it shall, if included, be stored together with the Iu signalling connection identifier. If the *Global CN-ID* IE is not included, the MBMS SESSION START message shall be considered as coming from the default CN node.

Upon reception of the MBMS SESSION START message, the RNC shall store, if not already, and remember the *TMGI* IE, the *RAB parameters* IE and the other attributes of the session as part of the MBMS Service Context. The *TMGI* IE contains the TMGI identifier which uniquely identifies the MBMS Bearer Service.

If the *MBMS Bearer Service Type* IE is set to "Multicast", upon reception of the MBMS SESSION START message, the RNC shall initiate allocation of requested resources for the MBMS RAB at a proper point in time if at least one of the following two conditions is fulfilled:

- the RNC controls at least one cell contained in the indicated MBMS Service Area and, if the *RA List of Idle Mode UEs* IE is included in MBMS SESSION START message, at least one RNC's RA is contained in this list, or if *Empty/Full RA List of Idle Mode UEs* IE included in MBMS SESSION START message is set to "fulllist",
- the RNC serves UEs consuming radio resources from cells contained in the indicated MBMS Service Area.

If no mapping is configured for a certain MBMS Service Area Identity in the *MBMS Service Area* IE in the RNC it shall simply ignore it

The RNC may optimise the point in time when the resource allocation is initiated based on the *Time to MBMS Data Transfer* IE.

In case the *RA List of Idle Mode UEs* IE is included in MBMS SESSION START message but none of above conditions is fulfilled, the RNC may decide to wait for either an update of the RA List of Idle Mode UEs or a UE linking to finally establish the MBMS RAB. If the RNC decides so, it shall report it immediately to the CN in the MBMS SESSION START RESPONSE message with the cause value "Successful MBMS Session Start - No Data Bearer Necessary" and maintain an Iu signalling connection.

If the *Empty/Full RA List of Idle Mode UEs* IE included in MBMS SESSION START message is set to "fulllist", the RNC shall initiate the MBMS Notification over the Uu interface in all the cells under its control which belong to the indicated MBMS service area.

If the *MBMS Bearer Service Type* IE is set to "Broadcast", the *MBMS Counting Information* IE shall be included in the MBMS SESSION START message. If the *MBMS Counting Information* IE is set to "counting", the RNC may apply MBMS counting.

If the *MBMS Bearer Service Type* IE is set to "Broadcast" upon reception of the MBMS SESSION START message, the RNC shall initiate allocation of requested resources for the MBMS RAB at a proper point in time if it controls at least one cell contained in the indicated MBMS Service Area.

If the *MBMS Bearer Service Type* IE is set to "Multicast" the *MBMS Counting Information* IE shall be ignored.

The allocation of requested resources shall be made according to the values of the *Allocation/Retention Priority* IE (priority level, pre-emption indicators) and the resource situation as follows:

- The RNC shall consider the priority level of the requested MBMS RAB, when deciding on the resource allocation.
- The *Queuing Allowed* IE shall be ignored for MBMS RAB.
- The priority levels and the pre-emption indicators may (singularly or in combination) be used to determine whether the MBMS RAB establishment has to be performed unconditionally and immediately. If the requested MBMS RAB is marked as "may trigger pre-emption" and the resource situation requires so, the RNC may trigger the pre-emption procedure which may then cause the forced release of a lower priority RAB which is marked as "pre-emptable". Whilst the process and the extent of the pre-emption procedure is operator-dependent, the pre-emption indicators, if given in the MBMS SESSION START message, shall be treated as follows:
 1. If the *Pre-emption Capability* IE is set to "may trigger pre-emption", then this allocation request may trigger the pre-emption procedure. UTRAN shall only pre-empt RABs (other MBMS RABs or UE specific RABs) with lower priority, in ascending order of priority.
 2. If the *Pre-emption Capability* IE is set to "shall not trigger pre-emption", then this allocation request shall not trigger the pre-emption procedure.
 3. If the *Pre-emption Vulnerability* IE is set to "pre-emptable", then this connection shall be included in the pre-emption process.

4. If the *Pre-emption Vulnerability IE* is set to "not pre-emptable", then this connection shall not be included in the pre-emption process.
 5. If the *Priority Level IE* is set to "no priority" the given values for the *Pre-emption Capability IE* and *Pre-emption Vulnerability IE* shall not be considered. Instead the values "shall not trigger pre-emption" and "not pre-emptable" shall prevail.
- If the *Allocation/Retention Priority IE* is not given in the MBMS SESSION START message, the allocation request shall not trigger the pre-emption process and the connection may be pre-empted and considered to have the value "lowest" as priority level. Moreover, queuing shall not be allowed.

The UTRAN shall use the *PDP Type Information IE* or *PDP Type Information extension IE* to configure any compression algorithms.

The MBMS SESSION START message may contain the *MBMS Synchronisation Information IE*, consisting of the

- *MBMS HC Indicator IE*;
- *IP Multicast Address IE*;
- *GTP DL TEID IE*;
- *IP Source Address IE*, if available.

In case of successful MBMS RAB establishment, if the *MBMS Synchronisation Information IE* was not received within the MBMS SESSION START message, the RNC shall include the *Transport Layer Address IE* and the *Iu Transport Association IE* in the MBMS SESSION START RESPONSE message. The RNC may answer successfully even though the MBMS resources have not been established in all relevant cells.

If NNSF is active, the RNC may receive from several CN nodes for a certain MBMS Bearer Service the MBMS SESSION START message. In this case, if the RNC decides to establish the requested MBMS RAB, it shall only establish one MBMS Iu bearer and shall inform the selected CN node accordingly i.e. with MBMS SESSION START RESPONSE message including the *Transport Layer Address IE* and the *Iu Transport Association IE*.

If the *MBMS Synchronisation Information IE* was received within the MBMS SESSION START message, even if the RNC received related information more than once due to NNSF, if supported, it shall not include the *Transport Layer Address IE* and the *Iu Transport Association IE* in the MBMS SESSION START RESPONSE message and shall join the indicated IP Multicast group only once for the indicated MBMS Service Id. In case of successful joining the indicated IP Multicast group, the RNC shall inform all the CN nodes from which it has received a MBMS SESSION START message for that MBMS service with the *Cause IE* set to "Successful MBMS Session Start – IP Multicast Bearer established". If the *IP Source Address IE* is contained in the *MBMS Synchronisation Information IE*, the RNC shall use this information for joining the IP Multicast group.

If the RNC receives from several CN nodes for a certain MBMS Bearer Service the MBMS SESSION START message and all the MBMS SESSION START messages include the *RA List of Idle Mode UEs IE*, the RNC shall, if supported, maintain an MBMS Iu signalling connection towards all the CN nodes and inform them accordingly i.e. with MBMS SESSION START RESPONSE message and cause value "Successful MBMS Session Start - No Data Bearer Necessary" to all the CN nodes except the one, if any, towards which the RNC confirmed the successful MBMS RAB establishment.

The *MBMS Session Repetition Number IE* may be included in the MBMS SESSION START message in case the *MBMS Session Identity IE* is included in the same message. The *MBMS Session Repetition Number IE* may be used by RNC to recognise retransmissions of a particular session of a MBMS Bearer Service with identical contents. This IE may be used for counting purpose.

When the *Frequency Layer Convergence Flag IE* is set to "no-FLC-flag", the RNC is being requested to not apply any frequency layer convergence mechanism. The service shall then be delivered to all cells of all the MBMS Service Area Identities indicated in the *MBMS Service Area IE*.

Transmission and reception of a MBMS SESSION START RESPONSE message terminate the procedure in the UTRAN and in the CN respectively.

8.36.3 Unsuccessful Operation

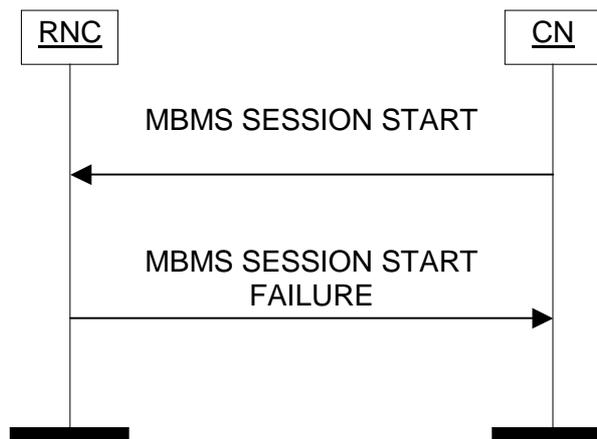

Figure 47: MBMS Session Start procedure. Unsuccessful operation.

If the RNC is not capable of correctly processing the request (e.g. the MBMS resources could not be established at all in any cell), the CN shall be informed by the MBMS SESSION START FAILURE message.

If the *MBMS Bearer Service Type* IE is set to "Broadcast" upon reception of the MBMS SESSION START message and the RNC doesn't have any cell contained in the indicated MBMS Service Area, it shall report it immediately to the CN in the MBMS SESSION START FAILURE message with the cause value "MBMS - No cell in MBMS Service Area".

If NNSF is active and the RNC received from several CN nodes for a certain MBMS Bearer Service the MBMS SESSION START message, but not all of the MBMS SESSION START messages include the *RA List of Idle Mode UEs* IE, the RNC shall inform the respective CN nodes accordingly i.e. with MBMS SESSION START FAILURE message and cause value "MBMS - Superseded Due To NNSF" to all the CN nodes except the one towards which the RNC confirmed the successful MBMS RAB establishment with MBMS SESSION START RESPONSE message.

When UTRAN reports failure of the MBMS Session Start procedure, the cause value should be precise enough to enable the core network to know the reason for the failure. Typical cause values are: "MBMS - Superseded Due To NNSF", "Requested Traffic Class not Available", "Invalid RAB Parameters Value", "Requested Maximum Bit Rate not Available", "Requested Guaranteed Bit Rate not Available", "Requested Transfer Delay not Achievable", "Invalid RAB Parameters Combination", "Condition Violation for Guaranteed Bit Rate", "Iu Transport Connection Failed to Establish", "No Resource Available".

Transmission and reception of a MBMS SESSION START FAILURE message terminate the procedure in the UTRAN and in the CN respectively.

8.36.4 Abnormal Conditions

If, for a MBMS RAB requested to be set up, the *PDP Type Information* IE and/or *PDP Type Information extension* IE is not present, the RNC shall continue with the procedure.

If an MBMS SESSION START message from a given CN Node provides a *TMGI* IE that is used for an already established and running MBMS Session provided by the same CN Node, and the indicated *MBMS Service Area* IE refers to an MBMS Service Area that is partially or completely overlapping with the MBMS Service Area of the already established and running MBMS Session, then the RNC shall return an MBMS SESSION START FAILURE message with the cause value "TMGI in Use and overlapping MBMS Service Area".

If an MBMS SESSION START message from a given CN Node provides a *TMGI* IE that is used for an already established and running MBMS Session provided by another CN Node, and the indicated *MBMS Service Area* IE refers to a different MBMS Service Area that is partially overlapping with the MBMS Service Area of the already established and running MBMS Session, then the RNC shall return an MBMS SESSION START FAILURE message with the cause value "TMGI in Use and overlapping MBMS Service Area".

8.37 MBMS Session Update

8.37.1 General

The purpose of the MBMS Session Update procedure is to inform the RNC during a MBMS Session whenever the RA List of Idle Mode UEs changes compared to one previously sent. The MBMS Session Update procedure is triggered by the CN (PS domain).

The procedure uses connection oriented signalling.

8.37.2 Successful Operation

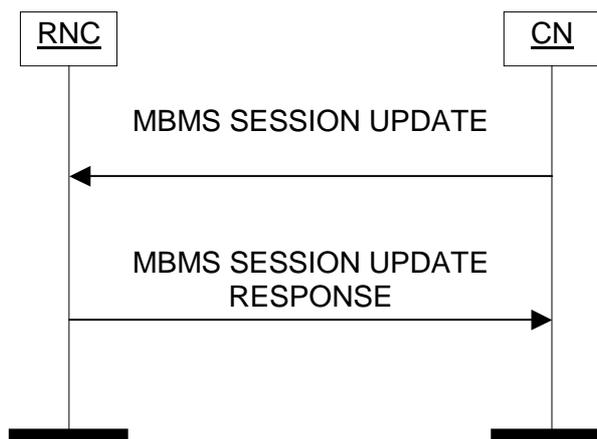

Figure 48: MBMS Session Update procedure. Successful operation.

The CN initiates the procedure by sending a MBMS SESSION UPDATE message.

The MBMS SESSION UPDATE message shall contain the *Delta RA List of Idle Mode UEs* IE and the *Session Update ID* IE.

Upon reception of the MBMS SESSION UPDATE message, if a MBMS RAB has already been established, the RNC shall initiate allocation of additional MBMS radio resources for this MBMS RAB if the RNC controls at least one cell that is part of both the MBMS Service Area and one of the RNC's RAs indicated in the *New RA List of Idle Mode UEs* IE, if this IE is included in the *Delta RA List of Idle Mode UEs* IE group. The RNC may release the existing MBMS radio resources for the cells part of the RNC's RAs indicated in the *RA List with No Idle Mode UEs Any More* IE, if this IE is included in the *Delta RA List of Idle Mode UEs* IE group.

Upon reception of the MBMS SESSION UPDATE message, if no MBMS RAB has yet been established, the RNC shall establish the MBMS RAB if the RNC controls at least one cell that is part of both the MBMS Service Area and one of the RNC's RAs indicated in the *New RA List of Idle Mode UEs* IE, if this IE is included in the *Delta RA List of Idle Mode UEs* IE group. If the previous condition is not fulfilled, the RNC may decide to wait for either another update of the RA List of Idle Mode UEs or a UE linking to finally establish the MBMS RAB.

In case of successful MBMS RAB establishment, the RNC shall include the *Transport Layer Address* IE and the *Iu Transport Association* IE in the MBMS SESSION UPDATE RESPONSE message.

When the update of the RA List of Idle Mode UEs is successfully executed, the UTRAN shall report it to the CN in the MBMS SESSION UPDATE RESPONSE message, which shall include the same *Session Update ID* IE as received in the MBMS SESSION UPDATE message. The RNC may answer successfully even though MBMS resources have not been established in all relevant cells.

Transmission and reception of a MBMS SESSION UPDATE RESPONSE message terminate the procedure in the UTRAN and in the CN respectively.

8.37.3 Unsuccessful Operation

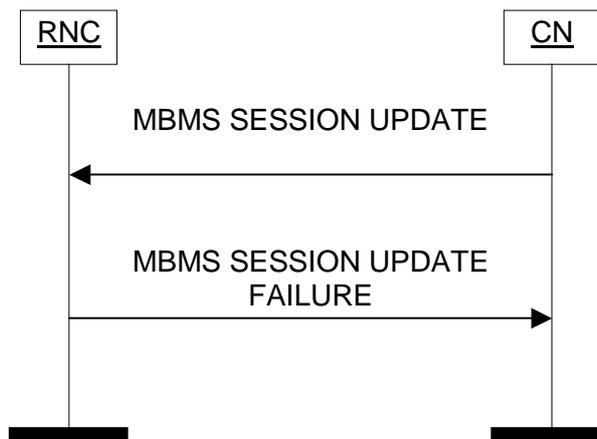

Figure 49: MBMS Session Update procedure. Unsuccessful operation.

If the RNC is not capable of correctly processing the request (e.g. additional MBMS resources could not be established at all in any cell), the CN shall be informed by the MBMS SESSION UPDATE FAILURE message, which shall include the same *Session Update ID* IE as received in the MBMS SESSION UPDATE message.

Transmission and reception of a MBMS SESSION UPDATE FAILURE message terminate the procedure in the UTRAN and in the CN respectively.

8.37.4 Abnormal Conditions

Not applicable.

8.38 MBMS Session Stop

8.38.1 General

The purpose of the MBMS Session Stop procedure is to request the UTRAN to notify UEs about the end of a given MBMS Session and to release the corresponding MBMS RAB and MBMS Iu signalling connection for this MBMS Session. The MBMS RAB Session Stop procedure may also be used as the last MBMS session stop to make the RNC aware that a certain Multicast Service is no longer available. The MBMS Session Stop procedure is triggered by the CN (PS domain).

The procedure uses connection oriented signalling.

8.38.2 Successful Operation

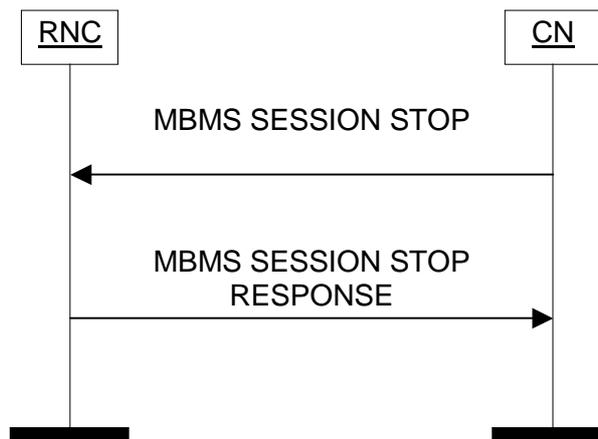

Figure 50: MBMS Session Stop procedure. Successful operation.

The CN initiates the procedure by sending a MBMS SESSION STOP message.

Upon reception of the MBMS SESSION STOP message, the RNC shall release all allocated resources for the MBMS RAB, including the MBMS Iu signalling connection used for this MBMS RAB.

The MBMS SESSION STOP message shall include the *MBMS CN De-Registration IE*. If the *MBMS CN De-Registration IE* is set to the value "deregister", the RNC shall also remove all associated MBMS Service Context(s) and release all allocated MBMS resources for the MBMS Bearer Service.

The RNC does not need to wait for the release of all UTRAN radio resources before returning the MBMS SESSION STOP RESPONSE message.

In case of successful release of the MBMS Iu signalling connection, after the MBMS SESSION STOP RESPONSE message has been sent, the CN shall not send further RANAP connection-oriented messages on this particular connection.

Transmission and reception of a MBMS SESSION STOP RESPONSE message terminate the procedure in the UTRAN and in the CN respectively.

8.38.3 Abnormal Conditions

Not applicable.

8.39 MBMS UE Linking

8.39.1 General

The purpose of the MBMS UE Linking procedure is to make the RNC aware that a given UE, with existing Iu-ps signalling connection, joined and/or left one or several Multicast Services.

The procedure uses connection oriented signalling.

8.39.2 Successful Operation

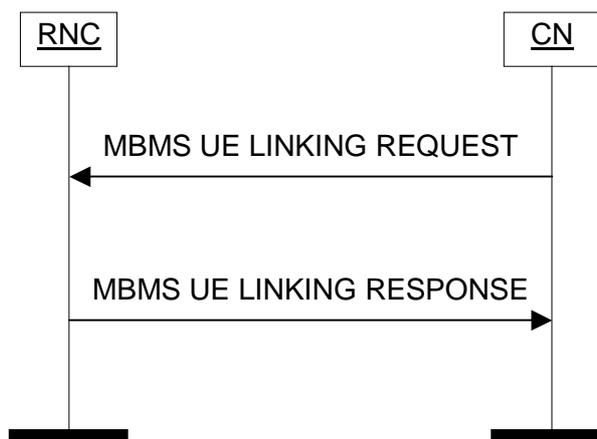

Figure 51: MBMS UE Linking procedure. Successful operation.

The CN initiates the procedure by sending a MBMS UE LINKING REQUEST message.

The MBMS UE LINKING REQUEST message shall contain the following IEs:

- a list of one or several TMGIs, each identifying the MBMS Bearer Service that the UE joined or left and which has not yet been linked or unlinked respectively in the UTRAN;
- for each of the MBMS Bearer Services that the UE joined;
- the PTP RAB ID.

Upon reception of the MBMS UE LINKING REQUEST message, for each TMGI received identifying the MBMS Bearer Service that the UE joined and which has not yet been linked in the UTRAN, the RNC shall perform the corresponding UE linking as described in TS 25.346 [42].

Upon reception of the MBMS UE LINKING REQUEST message, for each TMGI received identifying the MBMS Bearer Service that the UE left and which has not yet been de-linked in the UTRAN, the RNC shall perform the corresponding UE de-linking as described in TS 25.346 [42].

After handling all received TMGI(s), the RNC shall only report to the CN in the MBMS UE LINKING RESPONSE message the unsuccessful linking(s)/de-linking(s) with an appropriate cause value e.g. "MBMS - UE Linking Already Done", "MBMS - UE De-Linking Failure - No Existing UE Linking".

Transmission and reception of a MBMS UE LINKING RESPONSE message terminate the procedure in the UTRAN and in the CN respectively.

8.39.3 Unsuccessful Operation

The unsuccessful operation for this Class 1 Elementary procedure is described under the Successful Operation chapter.

8.39.4 Abnormal Conditions

Upon reception of the MBMS UE LINKING REQUEST message, if for a given TMGI received identifying the MBMS Bearer Service that the UE joined, the linking has already been done in the UTRAN, the RNC shall consider this linking as unsuccessful but shall proceed with the other ones.

Upon reception of the MBMS UE LINKING REQUEST message, if a given TMGI received identifying the MBMS Bearer Service that the UE left, cannot be found in the UE context, the RNC shall consider this de-linking as unsuccessful but shall proceed with the other ones.

8.40 MBMS Registration

8.40.1 General

The purpose of the MBMS Registration procedure is to request the CN (PS domain) to register or de-register the RNC for a certain Multicast Service.

The procedure uses connectionless signalling, unless the procedure is used to request CN to de-register the RNC for a Multicast Service which has an existing Iu signalling connection towards the RNC i.e. during a MBMS Session. In this last case, the procedure uses connection oriented signalling.

8.40.2 Successful Operation

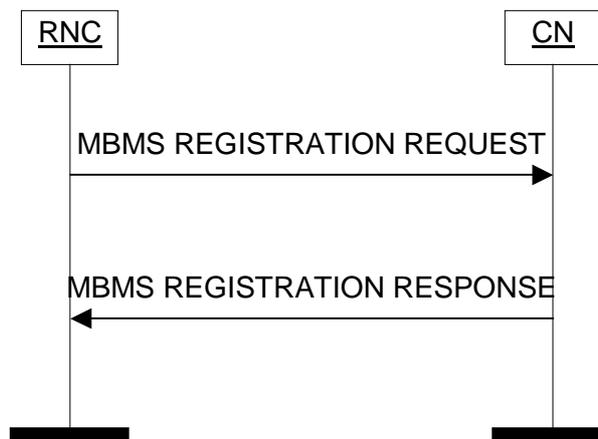

Figure 52: MBMS Registration procedure. Successful operation.

The RNC initiates the procedure by sending a MBMS REGISTRATION REQUEST message.

The MBMS REGISTRATION REQUEST message shall contain the following IEs:

- MBMS Registration Request type;
- TMGI;
- The associated IP Multicast Address and the APN corresponding to the MBMS Bearer Service identified by the TMGI, only in the case the *MBMS Registration Request type* IE is set to "register";
- Global RNC-ID, if connectionless signalling.

If the CN node is capable of processing the request, the RNC shall be informed by the MBMS REGISTRATION RESPONSE message.

In case of connectionless signalling the MBMS REGISTRATION RESPONSE message shall contain the same TMGI as received in the MBMS REGISTRATION REQUEST message.

If the RNC has not sent the MBMS REGISTRATION REQUEST message with the *MBMS Registration Request Type* IE set to "register", to the default CN node, the MBMS REGISTRATION RESPONSE message shall also include the *Global CN-ID* IE.

Upon reception of the MBMS REGISTRATION RESPONSE message as a response to a connectionless MBMS REGISTRATION REQUEST message with the *MBMS Registration Request Type* IE set to "deregister", the RNC shall remove all associated MBMS resources and context(s) corresponding to the MBMS Bearer Service identified by the TMGI included in the MBMS REGISTRATION REQUEST message.

Upon reception of the MBMS REGISTRATION RESPONSE message as a response to a connection oriented MBMS REGISTRATION REQUEST message with the *MBMS Registration Request Type* IE set to "deregister", the RNC shall release the MBMS Iu signalling connection and the RAB, if any, identified by the TMGI included in the MBMS REGISTRATION REQUEST message.

Transmission and reception of a MBMS REGISTRATION RESPONSE message terminate the procedure in the CN and in the UTRAN respectively.

8.40.3 Unsuccessful Operation

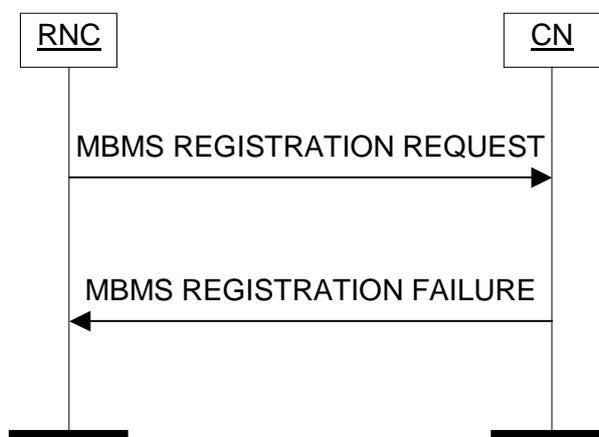

Figure 53: MBMS Registration procedure. Unsuccessful operation.

If the CN node is not capable of correctly processing the request, the RNC shall be informed by the MBMS REGISTRATION FAILURE message.

In case of connectionless signalling, the MBMS REGISTRATION FAILURE message shall contain the same TMGI as received in the MBMS REGISTRATION REQUEST message.

The MBMS REGISTRATION FAILURE message shall inform the RNC about the reason for unsuccessful operation thanks to appropriate cause value e.g. "TMGI Unknown", "IP Multicast Address And APN Not Valid", "MBMS De-Registration Rejected Due To Implicit Registration", "MBMS - Request Superseded", "MBMS De-Registration During Session Not Allowed".

In case of connectionless signalling, if the RNC has not sent the MBMS REGISTRATION REQUEST message with the *MBMS Registration Request Type* IE set to "register", to the default CN node, the MBMS REGISTRATION FAILURE message shall also include the *Global CN-ID* IE.

Transmission and reception of a MBMS REGISTRATION FAILURE message terminate the procedure in the CN and in the UTRAN respectively.

8.40.4 Abnormal Conditions

Not applicable.

8.41 MBMS CN De-Registration

8.41.1 General

The purpose of the MBMS CN De-Registration procedure is to make the RNC aware that a certain Multicast Service is no longer available. The MBMS CN De-Registration procedure is triggered by the CN (PS domain).

The procedure uses connectionless signalling.

8.41.2 Successful Operation

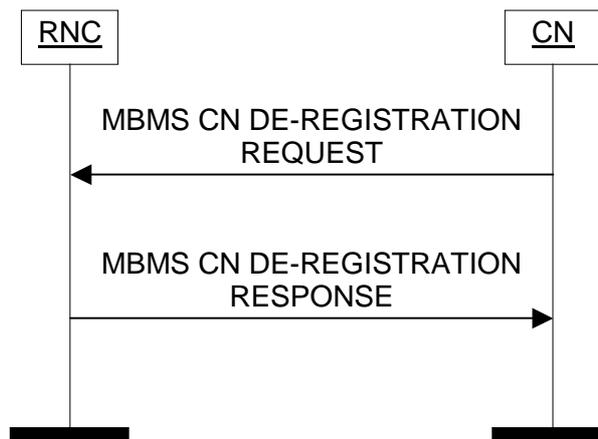

Figure 54: MBMS CN De-Registration procedure. Successful operation.

The CN initiates the procedure by sending a MBMS CN DE-REGISTRATION REQUEST message.

The MBMS CN DE-REGISTRATION REQUEST message shall contain the following IEs:

- TMGI;
- Global CN-ID IE, only when the MBMS CN DE-REGISTRATION REQUEST message is sent from a CN node towards an RNC for which the sending CN node is not the default CN node.

If the *Global CN-ID* IE is not included, the MBMS CN DE-REGISTRATION REQUEST message shall be considered as coming from the default CN node.

Upon reception of the MBMS CN DE-REGISTRATION REQUEST message, the RNC shall remove all associated MBMS context(s) and resources corresponding to the MBMS Bearer Service identified by the indicated TMGI and shall report it to the CN by sending the MBMS CN DE-REGISTRATION RESPONSE message.

Upon reception of the MBMS CN DE-REGISTRATION REQUEST message, if no existing MBMS Bearer Service can be identified by the indicated TMGI in the RNC, it shall consider this MBMS CN De-Registration procedure unsuccessful and shall report it to the CN by sending the MBMS CN DE-REGISTRATION RESPONSE message with the appropriate cause value e.g. "TMGI unknown".

The MBMS CN DE-REGISTRATION RESPONSE message shall contain the *Global RNC-ID* IE and the same TMGI as received in the MBMS CN DE-REGISTRATION REQUEST message.

Transmission and reception of a MBMS CN DE-REGISTRATION RESPONSE message terminate the procedure in the UTRAN and in the CN respectively.

8.41.3 Unsuccessful Operation

The unsuccessful operation for this Class 1 Elementary procedure is described under the Successful Operation chapter.

8.41.4 Abnormal Conditions

If NNSF is active, the RNC may receive from several CN nodes for a certain MBMS Bearer Service the MBMS CN DE-REGISTRATION REQUEST message. In this case the RNC will only proceed with the first MBMS CN DE-REGISTRATION REQUEST message received and will inform the respective CN nodes accordingly i.e. with MBMS CN DE-REGISTRATION RESPONSE message and cause value "TMGI unknown" to all the CN nodes except the one towards which the RNC confirmed the successful the MBMS CN De-Registration procedure with MBMS CN DE-REGISTRATION RESPONSE message including no cause value.

8.42 MBMS RAB Establishment Indication

8.42.1 General

The purpose of the MBMS RAB Establishment Indication procedure is to inform the CN (PS domain) of the establishment of the MBMS RAB corresponding to the MBMS Iu signalling connection used for this procedure.

The procedure uses connection oriented signalling.

8.42.2 Successful Operation

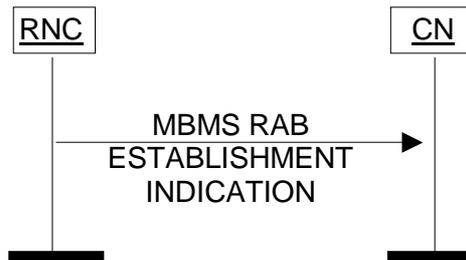

Figure 55: MBMS RAB Establishment Indication procedure. Successful operation.

When the RNC has not yet established the MBMS RAB for a particular Multicast Service and is informed that a given UE joined this particular Multicast Service, the RNC shall initiate the MBMS RAB Establishment Indication procedure and send the MBMS RAB ESTABLISHMENT INDICATION message to the CN. If NNSF is active, the selection of the CN node is implementation dependant.

The MBMS RAB ESTABLISHMENT INDICATION message shall include the *Transport Layer Address* IE and the *Iu Transport Association* IE.

8.42.3 Abnormal Conditions

Not applicable.

8.43 MBMS RAB Release

8.43.1 General

The purpose of the MBMS RAB Release procedure is to enable the UTRAN to request the release of an MBMS RAB. The MBMS RAB is defined for the PS domain only.

The procedure uses connection oriented signalling.

8.43.2 Successful Operation

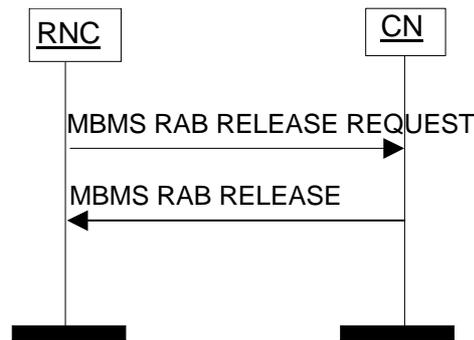

Figure 56: MBMS RAB Release procedure. Successful operation.

The RNC initiates the procedure by generating a MBMS RAB RELEASE REQUEST message towards the CN. The MBMS RAB RELEASE REQUEST message is sent on the Iu connection related to the MBMS RAB to be released. The included cause value indicates the reason for the release, e.g. "RAB pre-empted", "Release due to UTRAN Generated Reason", "MBMS - No Data Bearer Necessary".

The CN should according to the MBMS RAB RELEASE REQUEST message initiate the release of all MBMS resources related to the Iu connection.

For MBMS Multicast service the Iu signalling connection should not be released.

The RNC may at reception of MBMS RAB RELEASE initiate release of the related MBMS bearer resources.

MBMS Broadcast service, interaction with MBMS Session Stop:

For MBMS Broadcast service the CN may initiate the appropriate release procedure for the MBMS Session related to the Iu signalling connection and invoke the MBMS Session Stop procedure.

8.43.3 Unsuccessful Operation

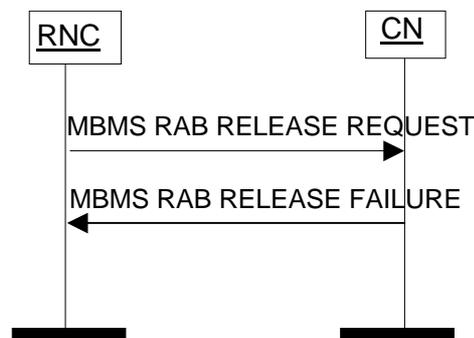

Figure 57: MBMS RAB RELEASE procedure. Unsuccessful operation.

If the CN node is not capable of correctly processing the request, the RNC shall be informed by the MBMS RAB RELEASE FAILURE message.

The MBMS RAB RELEASE FAILURE message shall inform the RNC about the reason for the unsuccessful operation with an appropriate cause value.

8.43.4 Abnormal Conditions

Not applicable.

8.44 Enhanced Relocation Complete

8.44.1 General

The purpose of the Enhanced Relocation Complete procedure is to inform the CN that the resources have been allocated by the target RNC. The target RNC provides necessary information to the CN to switch the user plane to the target RNC.

The procedure uses connection oriented signalling.

8.44.2 Successful Operation

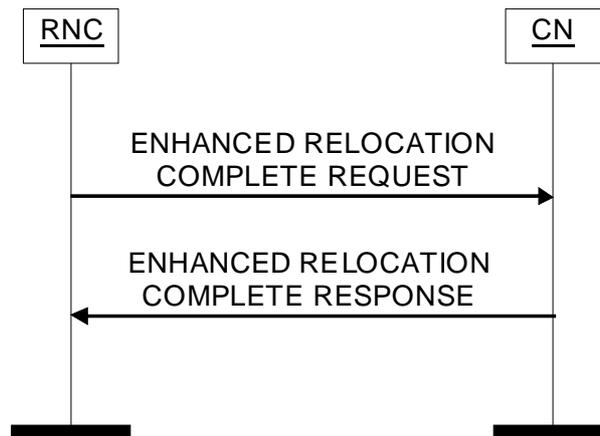

Figure 58: Enhanced Relocation Complete procedure. Successful operation.

The RNC initiates the procedure by sending the ENHANCED RELOCATION COMPLETE REQUEST message to the CN.

If the *RABs Setup List* IE in the ENHANCED RELOCATION COMPLETE REQUEST message does not include all RABs previously established for the UE, the CN shall consider the non included RABs as implicitly released by the RNC.

For each RAB the resource allocation was successful towards the PS domain or towards the CS domain when an ALCAP is not used, the RNC shall include the *Transport Layer Address* IE and the *Iu Transport Association* IE in the *RABs Setup List* IE in the ENHANCED RELOCATION COMPLETE REQUEST message. If any alternative RAB parameter values have been used when allocating the resources, these RAB parameter values shall be included in the ENHANCED RELOCATION COMPLETE REQUEST message within the *Assigned RAB Parameter Values* IE.

NOTE: If ALCAP is not used, the RNC shall include the same kind of TNL information (i.e. IPv4 or IPv6) as received from the source RNC in the RANAP ENHANCED RELOCATION INFORMATION REQUEST message.

The target RNC shall include the *Chosen Integrity Protection Algorithm* IE (*Chosen Encryption Algorithm* IE respectively) within the ENHANCED RELOCATION COMPLETE REQUEST message, if, and only if the *Integrity Protection Key* IE (*Ciphering Key* IE respectively) was included within the *Source RNC To Target RNC Transparent Container* IE of the RANAP ENHANCED RELOCATION INFORMATION message.

If the *Higher bitrates than 16 Mbps flag* IE is included in the ENHANCED RELOCATION COMPLETE REQUEST message then the CN shall, if supported, use the IE as described in TS 23.060 [21].

If the *CSG Id* IE and the *Cell Access Mode* IE set to "hybrid" are received in the ENHANCED RELOCATION COMPLETE REQUEST message, the CN shall provide the *CSG Membership Status* IE of the UE to the target side.

After all necessary updates including the DL transport layer information have been successfully completed in the CN, the CN shall send the ENHANCED RELOCATION COMPLETE RESPONSE message to the RNC.

In case the CN failed to setup for at least one of the RABs included the *RABs Setup List* IE in the ENHANCED RELOCATION COMPLETE REQUEST message, the CN shall include the RABs it failed to setup in the *RABs To Be*

Released List IE in the ENHANCED RELOCATION COMPLETE RESPONSE message. In this case, the RNC shall release the resource for the RABs and the RNC shall regard the RABs indicated in the *RABs To Be Released List* IE as being fully released.

The ENHANCED RELOCATION COMPLETE RESPONSE message shall contain the *User Plane Information* IE.

The ENHANCED RELOCATION COMPLETE RESPONSE message shall contain the *Transport Layer Address* IE and the *Binding ID* IE for each RAB towards the CS domain when an ALCAP is used.

In case the CN decides to change the uplink transport layer information when an ALCAP is not used it may include the *Transport Layer Address* IE and the *Binding ID* IE within the *RABs Setup List* IE in the ENHANCED RELOCATION COMPLETE RESPONSE message.

The ENHANCED RELOCATION COMPLETE RESPONSE message may contain the *RAB Parameters* IE for each RAB towards the CS domain in RAB Setup List.

If the *RAB Parameters* IE is included in the ENHANCED RELOCATION COMPLETE RESPONSE the RNC shall

- replace the previously provided RAB Parameter for the RAB. The RNC shall use the received RAB Parameter for the RAB.

If the *RAB Parameters* IE is not contained in the ENHANCED RELOCATION COMPLETE RESPONSE message, the RNC shall use the previously provided RAB parameters.

The ENHANCED RELOCATION COMPLETE RESPONSE message may contain the *UE Aggregate Maximum Bit Rate* IE to control the aggregate data rate of non-GBR traffic for this UE.

If the *UE Aggregate Maximum Bit Rate* IE is contained in the ENHANCED RELOCATION COMPLETE RESPONSE message, the RNC shall, if supported,

- replace the previously provided UE Aggregate Maximum Bit Rate Parameter for this UE. The RNC shall use the received UE Aggregate Maximum Bit Rate Parameter for this UE.

If the *UE Aggregate Maximum Bit Rate* IE is not contained in the ENHANCED RELOCATION COMPLETE RESPONSE message, the RNC shall, if supported, use the previously provided UE Aggregate Maximum Bit Rate Parameter.

In case SIPTO at Iu-PS functionality is supported by the UTRAN, the following applies in addition for the successful operation of Enhanced Relocation Complete procedure:

- If the *MSISDN* IE is present in the ENHANCED RELOCATION COMPLETE RESPONSE message, then the UTRAN may offload the RAB(s) where the *Offload RAB Parameters* IE is present in the *RABs Setup Item IEs* IE. The *Access Point Name* IE and the *Charging Characteristics* IE within the *Offload RAB Parameters* IE and the *MSISDN* IE may only be used for the SIPTO at Iu-PS function and according to the description in TS 23.060 [21].

If the *CSG Membership Status* IE is included in the ENHANCED RELOCATION COMPLETE RESPONSE message the RAN shall, if supported, take the following:

- If the cell that serves the UE is a Hybrid cell, the RNC shall store the value contained in the *CSG Membership Status* IE and replace any previously stored membership status value by this new one. The RNC may use such information to perform differentiated treatment for member and non-member UEs.

If the *Tunnel Information for BBF* IE is received in the DIRECT TRANSFER message, the CN shall, if supported, use the IE as described in TS 23.139 [65].

8.44.3 Unsuccessful Operation

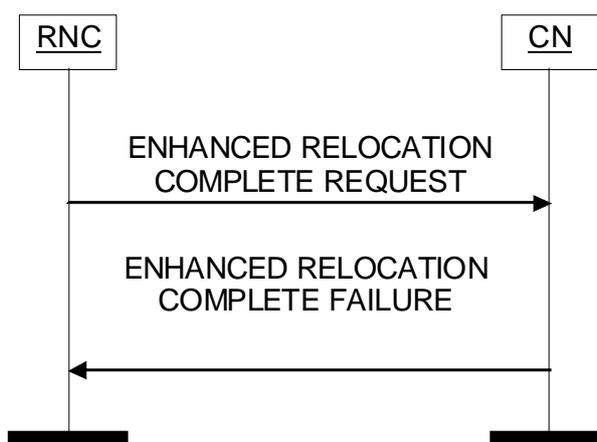

Figure 59: Enhanced Relocation Complete procedure. Unsuccessful operation.

If a failure occurs in the CN during the execution of the relocation procedure, the CN shall send the ENHANCED RELOCATION COMPLETE FAILURE message to the RNC with an appropriate cause value. The RNC shall assume the Iu resources between the old source RNC and the CN node being released by the respective CN node.

8.45 Enhanced Relocation Complete Confirm

8.45.1 General

The purpose of the Enhanced Relocation Complete Confirm procedure is to indicate the CN (applicable towards the CS domain only) to switch the bearers towards the target RNC. The procedure uses connection-oriented signalling.

8.45.2 Successful Operation



Figure 60: Enhanced Relocation Complete Confirm procedure. Successful operation.

The RNC shall initialise the Enhanced Relocation Complete Confirm procedure by sending the ENHANCED RELOCATION COMPLETE CONFIRM message. If the RNC is not able to successfully initialise RABs for which an Iu user plane initialisation is necessary, it shall provide respective information within the *RABs Failed To Initialise List* IE with an appropriate cause value.

8.46 SRVCC Preparation

8.46.1 General

The purpose of the SRVCC Preparation procedure is the reception of the security parameters from the PS CN domain needed for successful SRVCC operation as described in TS 23.216 [54].

The procedure uses connection oriented signalling.

8.46.2 Successful Operation

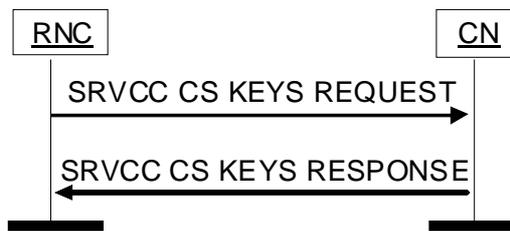

Figure 61: SRVCC Preparation procedure. Successful operation.

The RNC shall determine if the SRVCC operation as described in TS 23.216 [54] is required. In such case the RNC shall initiate the SRVCC Preparation procedure by sending an SRVCC CS KEYS REQUEST message to the source SGSN.

The SGSN shall respond to the RNC with SRVCC CS KEYS RESPONSE message containing the *Integrity Protection Key* IE, the *Encryption Key* IE and the *SRVCC Information* IE.

8.46.3 Abnormal Conditions

Not applicable.

8.47 UE Radio Capability Match

8.47.1 General

The purpose of the UE Radio Capability Match procedure is to enable the SGSN to request for an indication on whether the UE capabilities match the network configuration for voice continuity. The procedure uses connection oriented signalling.

8.47.2 Successful Operation

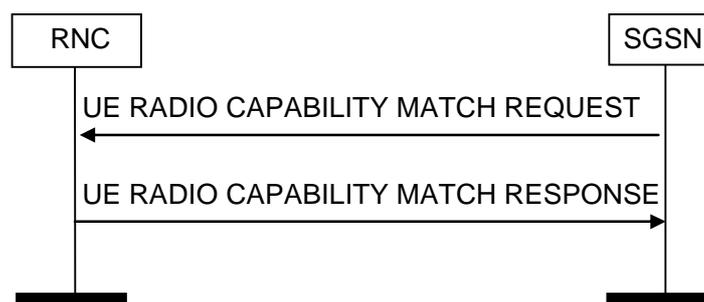

Figure 62: UE Radio Capability Match procedure: Successful operation.

The SGSN initiates the procedure by sending a UE RADIO CAPABILITY MATCH REQUEST message to the RNC. The RNC shall, if supported, respond with a UE RADIO CAPABILITY MATCH RESPONSE message.

8.47.3 Unsuccessful Operation

Not applicable.

8.47.4 Abnormal Conditions

Not applicable.

9 Elements for RANAP Communication

9.1 Message Functional Definition and Content

9.1.1 General

Subclause 9.1 presents the contents of RANAP messages in tabular format. The corresponding ASN.1 definition is presented in subclause 9.3. In case there is contradiction between the tabular format in subclause 9.1 and the ASN.1 definition, the ASN.1 shall take precedence, except for the definition of conditions for the presence of conditional IEs, where the tabular format shall take precedence.

NOTE: The messages have been defined in accordance to the guidelines specified in TR 25.921 [18].

9.1.2 Message Contents

9.1.2.1 Presence

All information elements in the message descriptions below are marked mandatory, optional or conditional according to table 4.

Table 4: Meaning of abbreviations used in RANAP messages

Abbreviation	Meaning
M	IEs marked as Mandatory (M) shall always be included in the message.
O	IEs marked as Optional (O) may or may not be included in the message.
C	IEs marked as Conditional (C) shall be included in a message only if the condition is satisfied. Otherwise the IE shall not be included.

9.1.2.2 Criticality

Each Information Element or Group of Information Elements may have criticality information applied to it. Following cases are possible:

Table 5: Meaning of content within "Criticality" column

Abbreviation	Meaning
–	No criticality information is applied explicitly.
YES	Criticality information is applied. This is usable only for non-repeatable IEs
GLOBAL	The IE and all its repetitions together have one common criticality information. This is usable only for repeatable IEs.
EACH	Each repetition of the IE has its own criticality information. It is not allowed to assign different criticality values to the repetitions. This is usable only for repeatable IEs.

9.1.2.3 Range

The Range column indicates the allowed number of copies of repetitive IEs/IE groups.

9.1.2.4 Assigned Criticality

This column provides the actual criticality information as defined in subclause 10.3.2, if applicable.

9.1.3 RAB ASSIGNMENT REQUEST

This message is sent by the CN to request the establishment, modification or release of one or more RABs for the same UE.

Direction: CN→RNC.

Signalling bearer mode: Connection oriented.

IE/Group Name	Presence	Range	IE type and reference	Semantics description	Criticality	Assigned Criticality
Message Type	M		9.2.1.1		YES	reject
RABs To Be Setup Or Modified List	O				YES	ignore
>RABs To Be Setup Or Modified Item IEs		1 to <maxnoofRABs>				
>>First Setup Or Modify Item	M			Grouping reason: same criticality.	EACH	reject
>>>RAB ID	M		9.2.1.2	The same RAB ID must only be present in one group.	-	
>>>NAS Synchronisation Indicator	O		9.2.3.18		-	
>>>RAB Parameters	O		9.2.1.3	Includes all necessary parameters for RABs (both for MSC and SGSN) including QoS.	-	
>>>User Plane Information	O				-	
>>>>User Plane Mode	M		9.2.1.18		-	
>>>>UP Mode Versions	M		9.2.1.19		-	
>>>Transport Layer Information	O				-	
>>>>Transport Layer Address	M		9.2.2.1		-	
>>>>lu Transport Association	M		9.2.2.2		-	
>>>Service Handover	O		9.2.1.41		-	
>>>E-UTRAN Service Handover	O		9.2.1.90		YES	ignore
>>>Correlation ID	O		9.2.2.5		-	
>>Second Setup Or Modify Item	M			Grouping reason: same criticality.	EACH	ignore
>>>PDP Type Information	O		9.2.1.40		-	
>>>Data Volume Reporting Indication	O		9.2.1.17		-	
>>>DL GTP-PDU Sequence Number	O		9.2.2.3		-	
>>>UL GTP-PDU Sequence Number	O		9.2.2.4		-	
>>>DL N-PDU Sequence Number	O		9.2.1.33		-	
>>>UL N-PDU Sequence Number	O		9.2.1.34		-	
>>>Alternative RAB Parameter Values	O		9.2.1.43		YES	ignore
>>>GERAN BSC Container	O		9.2.1.58		YES	ignore

>>>PDP Type Information extension	O		9.2.1.40a	The <i>PDP Type Information extension</i> IE can only be included if <i>PDP Type Information</i> IE is not present.	YES	ignore
>>>Offload RAB parameters	O		9.2.1.94	Applicable only for SIPTO at lu-PS.	YES	ignore
RABs To Be Released List	O				YES	ignore
>RABs To Be Released Item IEs		1 to <maxnoofRABs>			EACH	ignore
>>RAB ID	M		9.2.1.2	The same RAB ID must only be present in one group.	-	
>>Cause	M		9.2.1.4		-	
UE Aggregate Maximum Bit Rate	O		9.2.1.91		YES	ignore
MSISDN	O		9.2.1.95	Applicable only for SIPTO at lu-PS.	YES	ignore

Range bound	Explanation
maxnoofRABs	Maximum no. of RABs for one UE. Value is 256.

9.1.4 RAB ASSIGNMENT RESPONSE

This message is sent by the RNC to report the outcome of the request from the RAB ASSIGNMENT REQUEST message.

Direction: RNC → CN.

Signalling bearer mode: Connection oriented.

IE/Group Name	Presence	Range	IE type and reference	Semantics description	Criticality	Assigned Criticality
Message Type	M		9.2.1.1		YES	reject
RABs Setup Or Modified List	O				YES	ignore
>RABs Setup Or Modified Item IEs		1 to <maxnoofRABs>			EACH	ignore
>>RAB ID	M		9.2.1.2	The same RAB ID must only be present in one group.	-	
>>Transport Layer Address	O		9.2.2.1		-	
>>lu Transport Association	O		9.2.2.2		-	
>>DL Data Volumes	O				-	
>>>Data Volume List		1 to <maxnoofVol>			-	
>>>>Unsuccessfully Transmitted DL Data Volume	M		9.2.3.12		-	
>>>>Data Volume Reference	O		9.2.3.13		-	
>>Assigned RAB Parameter Values	O		9.2.1.44		YES	ignore
RABs Released List	O				YES	ignore
>RABs Released Item IEs		1 to <maxnoofRABs>			EACH	ignore
>>RAB ID	M		9.2.1.2	The same RAB ID must only be present in one group.	-	
>>DL Data Volumes	O				-	
>>>Data Volume List		1 to <maxnoofVol>			-	
>>>>Unsuccessfully Transmitted DL Data Volume	M		9.2.3.12		-	
>>>>Data Volume Reference	O		9.2.3.13		-	
>>DL GTP-PDU Sequence Number	O		9.2.2.3		-	
>>UL GTP-PDU Sequence Number	O		9.2.2.4		-	
RABs Queued List	O				YES	ignore
>RABs Queued Item IEs		1 to <maxnoofRABs>			EACH	ignore
>>RAB ID	M		9.2.1.2	The same RAB ID must only be present in one group.	-	
RABs Failed To Setup Or Modify List	O				YES	ignore
>RABs Failed To Setup Or Modify Item IEs		1 to <maxnoofRABs>			EACH	ignore
>>RAB ID	M		9.2.1.2	The same RAB ID must only be present in one group.	-	
>>Cause	M		9.2.1.4		-	
RABs Failed To Release List	O				YES	ignore
>RABs Failed To		1 to			EACH	ignore

Release Item IEs		<maxnoofRABs>				
>>RAB ID	M		9.2.1.2	The same RAB ID must only be present in one group.	-	
>>Cause	M		9.2.1.4.		-	
Criticality Diagnostics	O		9.2.1.35		YES	ignore
GERAN lu mode specific RABs Failed To Setup Or Modify List	O			This applies only in GERAN lu mode case.	YES	ignore
>GERAN lu mode specific RABs Failed To Setup Or Modify Item IEs		1 to <maxnoofRABs>			EACH	ignore
>>RAB ID	M		9.2.1.2	The same RAB ID must only be present in one group.	-	
>>Cause	M		9.2.1.4		-	
>>GERAN Classmark	O		9.2.1.57		-	

Range bound	Explanation
maxnoofRABs	Maximum no. of RABs for one UE. Value is 256.
maxnoofVol	Maximum no. of reported data volume for one RAB. Value is 2.

9.1.5 RAB RELEASE REQUEST

This message is sent by the RNC to request the CN to release one or more RABs for the same UE.

Direction: RNC → CN.

Signalling bearer mode: Connection oriented.

IE/Group Name	Presence	Range	IE type and reference	Semantics description	Criticality	Assigned Criticality
Message Type	M		9.2.1.1		YES	ignore
RABs To Be Released List	M				YES	ignore
>RABs To Be Released Item IEs		1 to <maxnoofRABs>			EACH	ignore
>>RAB ID	M		9.2.1.2		-	
>>Cause	M		9.2.1.4		-	

Range bound	Explanation
maxnoofRABs	Maximum no. of RABs for one UE. Value is 256.

9.1.6 IU RELEASE REQUEST

This message is sent by the RNC to request the CN to release the Iu connection.

Direction: RNC → CN.

Signalling bearer mode: Connection oriented.

IE/Group Name	Presence	Range	IE type and reference	Semantics description	Criticality	Assigned Criticality
Message Type	M		9.2.1.1		YES	ignore
Cause	M		9.2.1.4		YES	ignore

9.1.7 IU RELEASE COMMAND

This message is sent by the CN to order the RNC to release all resources related to the Iu connection.

Direction: CN → RNC.

Signalling bearer mode: Connection oriented.

IE/Group Name	Presence	Range	IE type and reference	Semantics description	Criticality	Assigned Criticality
Message Type	M		9.2.1.1		YES	reject
Cause	M		9.2.1.4		YES	ignore
End Of CSFB	O		9.2.1.111		YES	ignore
Out Of UTRAN	O		9.2.1.112		YES	ignore

9.1.8 IU RELEASE COMPLETE

This message is sent by the RNC as a response to the IU RELEASE COMMAND message.

Direction: RNC → CN.

Signalling bearer mode: Connection oriented.

IE/Group Name	Presence	Range	IE type and reference	Semantics description	Criticality	Assigned Criticality
Message Type	M		9.2.1.1		YES	reject
RABs Data Volume Report List	O				YES	ignore
>RABs Data Volume Report Item IEs		1 to <maxnoofRABs>			EACH	ignore
>>RAB ID	M		9.2.1.2		-	
>>>RAB Data Volume Report List	O				-	
>>>>RAB Data Volume Report Item IEs		1 to <maxnoofVol>			-	
>>>>>Unsuccessfully Transmitted DL Data Volume	M		9.2.3.12		-	
>>>>>Data Volume Reference	O		9.2.3.13		-	
RABs Released List	O				YES	ignore
>RABs Released Item IEs		1 to <maxnoofRABs>			EACH	ignore
>>RAB ID	M		9.2.1.2		-	
>>>DL GTP-PDU Sequence Number	O		9.2.2.3		-	
>>>>UL GTP-PDU Sequence Number	O		9.2.2.4		-	
Criticality Diagnostics	O		9.2.1.35		YES	ignore

Range bound	Explanation
maxnoofRABs	Maximum no. of RABs for one UE. Value is 256.
maxnoofVol	Maximum no. of reported data volume for one RAB. Value is 2.

9.1.9 RELOCATION REQUIRED

This message is sent by the source RNC to inform the CN that a relocation is to be performed.

Direction: RNC → CN.

Signalling bearer mode: Connection oriented.

IE/Group Name	Presence	Range	IE type and reference	Semantics description	Criticality	Assigned Criticality
Message Type	M		9.2.1.1		YES	reject
Relocation Type	M		9.2.1.23		YES	reject
Cause	M		9.2.1.4		YES	ignore
Source ID	M		9.2.1.24		YES	ignore
Target ID	M		9.2.1.25		YES	reject
MS Classmark 2	C – ifGSMCStar get		9.2.1.26		YES	reject
MS Classmark 3	C – ifGSMCStar get		9.2.1.27		YES	ignore
Source To Target Transparent Container	C – ifUMTStarge t or ifEUTRA靶 et		9.2.1.30A		YES	reject
Old BSS To New BSS Information	O		9.2.1.29	Can optionally be used if GSM target but not used for UMTS target.	YES	ignore
GERAN Classmark	O		9.2.1.57		YES	ignore
Source BSS To Target BSS Transparent Container	O		9.2.1.79	Shall be included if, and only if, GSM PS domain is target.	YES	ignore
SRVCC HO Indication	O		9.2.1.88		YES	reject
CSG id	O		9.2.1.85		YES	reject
Cell Access Mode	O		9.2.1.93		YES	reject
rSRVCC HO Indication	O		9.2.1.114		YES	reject

Condition	Explanation
ifGSMCStararget	This IE shall be present if the <i>Target ID</i> IE contains a <i>CGI</i> IE and Source BSS To Target BSS Transparent Container is not included.
ifUMTStarget	This IE shall be present if the <i>Target ID</i> IE contains a <i>Target RNC-ID</i> IE.
ifEUTRA靶et	This IE shall be present if the <i>Target ID</i> IE contains a <i>Target eNB-ID</i> IE or if the <i>Target ID</i> IE contains a <i>Target RNC-ID</i> IE containing a Corresponding RNC-ID.

9.1.10 RELOCATION REQUEST

This message is sent by the CN to request the target RNC to allocate necessary resources for a relocation.

Direction: CN → RNC.

Signalling bearer mode: Connection oriented.

IE/Group Name	Presence	Range	IE type and reference	Semantics description	Criticality	Assigned Criticality
Message Type	M		9.2.1.1		YES	reject
Permanent NAS UE Identity	O		9.2.3.1		YES	ignore
Cause	M		9.2.1.4		YES	ignore
CN Domain Indicator	M		9.2.1.5		YES	reject
Source To Target Transparent Container	M		9.2.1.30a	Encoded as the <i>Source RNC To Target RNC Transparent Container</i> IE defined in subclause 9.2.1.28.	YES	reject
RABs To Be Setup List	O				YES	reject
>RABs To Be Setup Item IEs		1 to <maxnoofRABs>			EACH	reject
>>RAB ID	M		9.2.1.2		-	
>>NAS Synchronisation Indicator	O		9.2.3.18		-	
>>RAB Parameters	M		9.2.1.3		-	
>>Data Volume ReportingIndication	C – ifPS		9.2.1.17		-	
>>PDP Type Information	C – ifPS		9.2.1.40		-	
>>User Plane Information	M				-	
>>>User Plane Mode	M		9.2.1.18		-	
>>>UP Mode Versions	M		9.2.1.19		-	
>>Transport Layer Address	M		9.2.2.1		-	
>>lu Transport Association	M		9.2.2.2		-	
>>Service Handover	O		9.2.1.41		-	
>>Alternative RAB Parameter Values	O		9.2.1.43		YES	ignore
>>GERAN BSC Container	O		9.2.1.58		YES	ignore
>>E-UTRAN Service Handover	O		9.2.1.90		YES	ignore
>>PDP Type Information extension	O		9.2.1.40a	The <i>PDP Type Information extension</i> IE can only be included if <i>PDP Type Information</i> IE is present.	YES	ignore
>>Offload RAB parameters	O		9.2.1.94	Applicable only for SIPTO at lu-PS	YES	ignore
Integrity Protection Information	O		9.2.1.11	Integrity Protection Information includes key and permitted algorithms.	YES	ignore

Encryption Information	O		9.2.1.12	Encryption Information includes key and permitted algorithms.	YES	ignore
Iu Signalling Connection Identifier	M		9.2.1.38		YES	ignore
Global CN-ID	O		9.2.1.46		YES	reject
SNA Access Information	O		9.2.3.24		YES	ignore
UESBI-Iu	O		9.2.1.59		YES	ignore
Selected PLMN Identity	O		9.2.3.33		YES	ignore
CN MBMS Linking Information	O				YES	ignore
>Joined MBMS Bearer Service IEs		1 to <maxnoofMulticastServicesPerUE>			EACH	ignore
>>TMGI	M		9.2.3.37	The same TMGI must only be present in one group.	-	-
>>PTP RAB ID	M		9.2.1.75		-	-
UE Aggregate Maximum Bit Rate	O		9.2.1.91		YES	ignore
CSG id	O		9.2.1.85		YES	reject
CSG Membership Status	O		9.2.1.92		YES	ignore
MSISDN	O		9.2.1.95	Applicable only for SIPTO at Iu-PS.	YES	ignore
Anchor PLMN Identity	O		9.2.3.33	Indicates the PS core network operator in case of SRVCC (see TS 23.251 [39])	YES	Ignore

Condition	Explanation
IfPS	This IE shall be present if the <i>CN domain indicator</i> IE is set to "PS domain".

Range bound	Explanation
maxnoofRABs	Maximum no. of RABs for one UE. Value is 256.
maxnoofMulticastServicesPerUE	Maximum no. of Multicast Services that a UE can join and leave respectively. Value is 128.

9.1.11 RELOCATION REQUEST ACKNOWLEDGE

This message is sent by the target RNC to inform the CN about the result of the resource allocation for the requested relocation.

Direction: RNC → CN.

Signalling bearer mode: Connection oriented.

IE/Group Name	Presence	Range	IE type and reference	Semantics description	Criticality	Assigned Criticality
Message Type	M		9.2.1.1		YES	reject
Target To Source Transparent Container	O		9.2.1.30b	Encoded as the <i>Target RNC To Source RNC Transparent Container</i> IE defined in subclause 9.2.1.30.	YES	ignore
RABs Setup List	O				YES	ignore
>RABs Setup Item IEs		1 to <maxnoofRABs>			EACH	reject
>>RAB ID	M		9.2.1.2		-	
>>Transport Layer Address	O		9.2.2.1	IPv6 or IPv4 address if no other TLA included. IPv4 address if other TLA included.	-	
>>lu Transport Association	O		9.2.2.2	Related to TLA above.	-	
>>Assigned RAB Parameter Values	O		9.2.1.44		YES	ignore
>>Transport Layer Address	O		9.2.2.1	IPv6 address if included.	YES	ignore
>>lu Transport Association	O		9.2.2.2	Related to TLA above.	YES	ignore
RABs Failed To Setup List	O				YES	ignore
>RABs Failed To Setup Item IEs		1 to <maxnoofRABs>			EACH	ignore
>>RAB ID	M		9.2.1.2		-	
>>Cause	M		9.2.1.4		-	
Chosen Integrity Protection Algorithm	O		9.2.1.13	Indicates the Integrity Protection algorithm that will be used by the target RNC.	YES	ignore
Chosen Encryption Algorithm	O		9.2.1.14	Indicates the Encryption algorithm that will be used by the target RNC.	YES	ignore
Criticality Diagnostics	O		9.2.1.35		YES	ignore
New BSS To Old BSS Information	O		9.2.1.47	Defined in TS 48.008 [11].	YES	ignore
CSG Id	O		9.2.1.85		YES	ignore

Range bound	Explanation
maxnoofRABs	Maximum no. of RABs for one UE. Value is 256.

9.1.12 RELOCATION COMMAND

This message is sent by the CN to the source RNC to inform that resources for the relocation are allocated in the target RNC (in case of intra-system relocation) or in the target system (in case of inter-system relocation).

Direction: CN → RNC.

Signalling bearer mode: Connection oriented.

IE/Group Name	Presence	Range	IE type and reference	Semantics description	Criticality	Assigned Criticality
Message Type	M		9.2.1.1		YES	reject
Target To Source Transparent Container	O		9.2.1.30B		YES	reject
L3 Information	O		9.2.1.31		YES	ignore
RABs To Be Released List	O				YES	ignore
>RABs To Be Released Item IEs		1 to <maxnoofRABs>			EACH	ignore
>>RAB ID	M		9.2.1.2		-	
RABs Subject To Data Forwarding List	O				YES	ignore
>RABs Subject To Data Forwarding Item IEs		1 to <maxnoofRABs>			EACH	ignore
>>RAB ID	M		9.2.1.2		-	
>>Transport Layer Address	M		9.2.2.1	IPv6 or IPv4 address if no other TLA included. IPv4 address if other TLA included.	-	
>>lu Transport Association	M		9.2.2.2	Related to TLA above.	-	
>>Transport Layer Address	O		9.2.2.1	IPv6 address if included.	YES	ignore
>>lu Transport Association	O		9.2.2.2	Related to TLA above.	YES	ignore
Criticality Diagnostics	O		9.2.1.35		YES	ignore
Inter-System Information Transparent Container	O		9.2.1.48		YES	ignore
Target BSS to Source BSS Transparent Container	O		9.2.1.80		YES	ignore
SRVCC Information	O		9.2.1.89		YES	reject
rSRVCC Information	O		9.2.1.115		YES	reject

Range bound	Explanation
maxnoofRABs	Maximum no. of RABs for one UE. Value is 256.

9.1.13 RELOCATION DETECT

This message is sent by the target RNC to inform the CN that the relocation execution trigger has been received.

Direction: RNC → CN.

Signalling bearer mode: Connection oriented.

IE/Group Name	Presence	Range	IE type and reference	Semantics description	Criticality	Assigned Criticality
Message Type	M		9.2.1.1		YES	ignore

9.1.14 RELOCATION COMPLETE

This message is sent by the target RNC to inform the CN that the relocation is completed.

Direction: RNC → CN.

Signalling bearer mode: Connection oriented.

IE/Group Name	Presence	Range	IE type and reference	Semantics description	Criticality	Assigned Criticality
Message Type	M		9.2.1.1		YES	ignore
Higher bitrates than 16 Mbps flag	O		9.2.3.54	May only be included towards the PS domain.	YES	ignore
Tunnel Information for BBF	O		Tunnel Information 9.2.2.6	Indicating HNB's Local IP Address assigned by the broadband access provider, UDP port Number.	YES	ignore

9.1.15 RELOCATION PREPARATION FAILURE

This message is sent by the CN to the source RNC if the relocation preparation failed.

Direction: CN → RNC.

Signalling bearer mode: Connection oriented.

IE/Group Name	Presence	Range	IE type and reference	Semantics description	Criticality	Assigned Criticality
Message Type	M		9.2.1.1		YES	reject
Cause	M		9.2.1.4		YES	ignore
Criticality Diagnostics	O		9.2.1.35		YES	ignore
Inter-System Information Transparent Container	O		9.2.1.48		YES	ignore

9.1.16 RELOCATION FAILURE

This message is sent by the target RNC to inform the CN that the requested resource allocation failed.

Direction: RNC → CN.

Signalling bearer mode: Connection oriented.

IE/Group Name	Presence	Range	IE type and reference	Semantics description	Criticality	Assigned Criticality
Message Type	M		9.2.1.1		YES	reject
Cause	M		9.2.1.4		YES	ignore
Criticality Diagnostics	O		9.2.1.35		YES	ignore
New BSS to Old BSS Information	O		9.2.1.47	Defined in TS 48.008 [11].	YES	ignore
GERAN Classmark	O		9.2.1.57		YES	ignore

9.1.17 RELOCATION CANCEL

This message is sent by the source RNC to the CN to cancel an ongoing relocation.

Direction: RNC → CN.

Signalling bearer mode: Connection oriented.

IE/Group Name	Presence	Range	IE type and reference	Semantics description	Criticality	Assigned Criticality
Message Type	M		9.2.1.1		YES	reject
Cause	M		9.2.1.4		YES	ignore

9.1.18 RELOCATION CANCEL ACKNOWLEDGE

This message is sent by the CN to the source RNC when the relocation has been cancelled.

Direction: CN → RNC.

Signalling bearer mode: Connection oriented.

IE/Group Name	Presence	Range	IE type and reference	Semantics description	Criticality	Assigned Criticality
Message Type	M		9.2.1.1		YES	reject
Criticality Diagnostics	O		9.2.1.35		YES	ignore

9.1.19 SRNS CONTEXT REQUEST

This message is sent by the CN to the source RNC to indicate the PS RABs for which context transfer shall be performed.

Direction: CN → RNC.

Signalling bearer mode: Connection oriented.

IE/Group Name	Presence	Range	IE type and reference	Semantics description	Criticality	Assigned Criticality
Message Type	M		9.2.1.1		YES	reject
RABs Subject To Data Forwarding List	M				YES	ignore
>RABs Subject To Data Forwarding Item IEs		1 to <maxnoofRABs>			EACH	reject
>>RAB ID	M		9.2.1.2		-	
RAT Type	O		9.2.3.52		YES	ignore

Range bound	Explanation
maxnoofRABs	Maximum no. of RABs for one UE. Value is 256.

9.1.20 SRNS CONTEXT RESPONSE

This message is sent by the source RNC as a response to SRNS CONTEXT REQUEST message.

Direction: RNC → CN.

Signalling bearer mode: Connection oriented.

IE/Group Name	Presence	Range	IE type and reference	Semantics description	Criticality	Assigned Criticality
Message Type	M		9.2.1.1		YES	reject
RABs Contexts List	O				YES	ignore
>RABs Contexts Item IEs		1 to <maxnoofRABs>			EACH	ignore
>>RAB ID	M		9.2.1.2		-	
>>DL GTP-PDU Sequence Number	O		9.2.2.3		-	
>>UL GTP-PDU Sequence Number	O		9.2.2.4		-	
>>DL N-PDU Sequence Number	O		9.2.1.33		-	
>>UL N-PDU Sequence Number	O		9.2.1.34		-	
RABs Contexts Failed To Transfer List	O				YES	ignore
>RABs Contexts Failed To Transfer Item IEs		1 to <maxnoofRABs>			EACH	ignore
>>RAB ID	M		9.2.1.2		-	
>>Cause	M		9.2.1.4		-	
Criticality Diagnostics	O		9.2.1.35		YES	ignore

Range bound	Explanation
maxnoofRABs	Maximum no. of RABs for one UE. Value is 256.

9.1.21 SRNS DATA FORWARD COMMAND

This message is sent by the CN to the RNC to trigger the transfer of N-PDUs from the RNC to the CN in intersystem change or in some further cases described in TS 23.060 [21].

Direction: CN → RNC.

Signalling bearer mode: Connection oriented.

IE/Group Name	Presence	Range	IE type and reference	Semantics description	Criticality	Assigned Criticality
Message Type	M		9.2.1.1		YES	ignore
RABs Subject To Data Forwarding List	O				YES	ignore
>RABs Subject To Data Forwarding Item IEs		1 to <maxnoofRABs>			EACH	ignore
>>RAB ID	M		9.2.1.2		-	
>>Transport Layer Address	M		9.2.2.1		-	
>>Iu Transport Association	M		9.2.2.2		-	

Range bound	Explanation
maxnoofRABs	Maximum no. of RABs for one UE. Value is 256.

9.1.22 FORWARD SRNS CONTEXT

This message is sent either by the source RNC to the CN or by the CN to the target RNC to transfer the SRNS Context.

Direction: CN → RNC and RNC → CN.

Signalling bearer mode: Connection oriented.

IE/Group Name	Presence	Range	IE type and reference	Semantics description	Criticality	Assigned Criticality
Message Type	M		9.2.1.1		YES	ignore
RAB Contexts List	M				YES	ignore
>RAB Contexts Item IEs		1 to <maxnoofRABs>			EACH	ignore
>>RAB ID	M		9.2.1.2		-	
>>DL GTP-PDU Sequence Number	O		9.2.2.3		-	
>>UL GTP-PDU Sequence Number	O		9.2.2.4		-	
>>DL N-PDU Sequence Number	O		9.2.1.33		-	
>>UL N-PDU Sequence Number	O		9.2.1.34		-	
Source RNC PDCP context info	O		9.2.1.54		YES	ignore

Range bound	Explanation
maxnoofRABs	Maximum no. of RABs for one UE. Value is 256.

9.1.23 PAGING

This message is sent by the CN to request the UTRAN to page a specific UE.

Direction: CN → RNC.

Signalling bearer mode: Connectionless.

IE/Group Name	Presence	Range	IE type and reference	Semantics description	Criticality	Assigned Criticality
Message Type	M		9.2.1.1		YES	ignore
CN Domain Indicator	M		9.2.1.5		YES	ignore
Permanent NAS UE Identity	M		9.2.3.1		YES	ignore
Temporary UE Identity	O		9.2.3.2		YES	ignore
Paging Area ID	O		9.2.1.21		YES	ignore
Paging Cause	O		9.2.3.3		YES	ignore
Non Searching Indication	O		9.2.1.22		YES	ignore
DRX Cycle Length Coefficient	O		9.2.1.37		YES	ignore
Global CN-ID	O		9.2.1.46		YES	ignore
CSG Id List		0 to < maxnoofCSGId >			YES	ignore
>CSG Id	M		9.2.1.85			

Range bound	Explanation
maxnoofCSGIds	Maximum no. of CSG Ids within the CSG Id List. Value is 256.

9.1.24 COMMON ID

This message is sent by the CN to inform the RNC about the permanent NAS UE identity for a user. It may include additional information.

Direction: CN → RNC.

Signalling bearer mode: Connection oriented.

IE/Group Name	Presence	Range	IE type and reference	Semantics description	Criticality	Assigned Criticality
Message Type	M		9.2.1.1		YES	ignore
Permanent NAS UE Identity	M		9.2.3.1		YES	ignore
SNA Access Information	O		9.2.3.24		YES	ignore
UESBI-Iu	O		9.2.1.59		YES	ignore
Selected PLMN Identity	O		9.2.3.33		YES	ignore
Subscriber Profile ID for RAT/Frequency priority	O		9.2.1.86		YES	ignore
SRVCC operation possible	O		9.2.1.87		YES	ignore
CSG Membership Status	O		9.2.1.92		YES	ignore
Management Based MDT Allowed	O		9.2.1.110		YES	ignore
Management Based MDT PLMN List	O		MDT PLMN List 9.2.1.116		YES	ignore

9.1.25 CN INVOKE TRACE

This message is sent by the CN to request the RNC to start a trace recording session.

Direction: CN → RNC.

Signalling bearer mode: Connection oriented.

IE/Group Name	Presence	Range	IE type and reference	Semantics description	Criticality	Assigned Criticality
Message Type	M		9.2.1.1		YES	ignore
Trace Type	O		9.2.1.6	Mandatory for GERAN Iu Mode. Not applicable to UTRAN.	YES	ignore
Trace Reference	M		9.2.1.8		YES	ignore
Trigger ID	O		9.2.1.7	Mandatory for GERAN Iu Mode. Not applicable to UTRAN.	YES	ignore
UE Identity	O		9.2.1.9	Mandatory for UTRAN. Optional for GERAN Iu Mode.	YES	ignore
OMC ID	O		9.2.1.10	Mandatory for GERAN Iu Mode. Not applicable to UTRAN.	YES	ignore
Trace Propagation Parameters	O		9.2.1.68	Optional for UTRAN. Not applicable to GERAN Iu Mode.	YES	ignore
MDT Configuration	O		9.2.1.97		YES	ignore
Trace Collection Entity IP Address	O		9.2.2.1		YES	ignore

9.1.26 SECURITY MODE COMMAND

This message is sent by the CN to trigger the integrity and ciphering functions over the radio interface.

Direction: CN → RNC.

Signalling bearer mode: Connection oriented.

IE/Group Name	Presence	Range	IE type and reference	Semantics description	Criticality	Assigned Criticality
Message Type	M		9.2.1.1		YES	reject
Integrity Protection Information	M		9.2.1.11	Integrity information includes key and permitted algorithms.	YES	reject
Encryption Information	O		9.2.1.12	Encryption information includes key and permitted algorithms.	YES	ignore
Key Status	M		9.2.1.36		YES	reject

9.1.27 SECURITY MODE COMPLETE

This message is sent by the RNC as a successful response to a SECURITY MODE COMMAND message.

Direction: RNC → CN.

Signalling bearer mode: Connection oriented.

IE/Group Name	Presence	Range	IE type and reference	Semantics description	Criticality	Assigned Criticality
Message Type	M		9.2.1.1		YES	reject
Chosen Integrity Protection Algorithm	M		9.2.1.13		YES	reject
Chosen Encryption Algorithm	O		9.2.1.14		YES	ignore
Criticality Diagnostics	O		9.2.1.35		YES	ignore

9.1.28 SECURITY MODE REJECT

This message is sent by the RNC as an unsuccessful response to a SECURITY MODE COMMAND message.

Direction: RNC → CN.

Signalling bearer mode: Connection oriented.

IE/Group Name	Presence	Range	IE type and reference	Semantics description	Criticality	Assigned Criticality
Message Type	M		9.2.1.1		YES	reject
Cause	M		9.2.1.4		YES	ignore
Criticality Diagnostics	O		9.2.1.35		YES	ignore

9.1.29 LOCATION REPORTING CONTROL

This message is sent by the CN to initiate, modify or stop location reporting from the RNC to the CN.

Direction: CN → RNC.

Signalling bearer mode: Connection oriented.

IE/Group Name	Presence	Range	IE type and reference	Semantics description	Criticality	Assigned Criticality
Message Type	M		9.2.1.1		YES	ignore
Request Type	M		9.2.1.16		YES	ignore
Vertical Accuracy Code	O		9.2.1.46a		YES	ignore
Response Time	O		9.2.1.46b		YES	ignore
Positioning Priority	O		9.2.1.46c		YES	ignore
Client Type	O		9.2.1.46d		YES	ignore
Include Velocity	O		9.2.1.81		YES	ignore
Periodic Location Info	O		9.2.1.82		YES	ignore

9.1.30 LOCATION REPORT

This message is sent by the RNC to the CN with information about the UE location.

Direction: RNC → CN.

Signalling bearer mode: Connection oriented.

IE/Group Name	Presence	Range	IE type and reference	Semantics description	Criticality	Assigned Criticality
Message Type	M		9.2.1.1		YES	ignore
Area Identity	O		9.2.3.10		YES	ignore
Cause	O		9.2.1.4		YES	ignore
Request Type	O		9.2.1.16		YES	ignore
Last Known Service Area	O		9.2.3.22		YES	ignore
Position Data	O		9.2.3.27	Optional for UTRAN only.	YES	ignore
Position Data Specific To GERAN Iu Mode	O		9.2.3.28	Coded as the value part of the <i>Positioning Data</i> IE defined in TS 49.031 [34]. Optional for GERAN Iu mode only. Not applicable for UTRAN.	YES	ignore
Accuracy Fulfilment Indicator	O		9.2.3.29		YES	ignore
Velocity Estimate	O		9.2.3.51		YES	ignore

9.1.31 DATA VOLUME REPORT REQUEST

This message is sent by the CN to request unsuccessfully transmitted data volumes for specific RABs.

Direction: CN → RNC.

Signalling bearer mode: Connection oriented.

IE/Group Name	Presence	Range	IE type and reference	Semantics description	Criticality	Assigned Criticality
Message Type	M		9.2.1.1		YES	reject
RABs Data Volume Report List	M				YES	ignore
>RABs Data Volume Report Item IEs		1 to <maxnoofRABs>			EACH	reject
>>RAB ID	M		9.2.1.2		-	

Range bound	Explanation
maxnoofRABs	Maximum no. of RABs for one UE. Value is 256.

9.1.32 DATA VOLUME REPORT

This message is sent by the RNC and informs the CN about unsuccessfully transmitted data volumes for requested RABs.

Direction: RNC → CN.

Signalling bearer mode: Connection oriented.

IE/Group Name	Presence	Range	IE type and reference	Semantics description	Criticality	Assigned Criticality
Message Type	M		9.2.1.1		YES	reject
RABs Data Volume Report List	O				YES	ignore
>RABs Data Volume Report Item IEs		1 to <maxnoofRABs>			EACH	ignore
>>RAB ID	M		9.2.1.2		-	
>>RAB Data Volume Report List	O				-	
>>>RAB Data Volume Report Item IEs		1 to <maxnoofVol>			-	
>>>>Unsuccessfully Transmitted DL Data Volume	M		9.2.3.12		-	
>>>>Data Volume Reference	O		9.2.3.13		-	
RABs Failed To Report List	O				YES	ignore
>RABs Failed To Report Item IEs		1 to <maxnoofRABs>			EACH	ignore
>>RAB ID	M		9.2.1.2		-	
>>Cause	M		9.2.1.4		-	
Criticality Diagnostics	O		9.2.1.35		YES	ignore

Range bound	Explanation
maxnoofRABs	Maximum no. of RABs for one UE. Value is 256.
maxnoofVol	Maximum no. of reported data volume for one RAB. Value is 2.

9.1.33 INITIAL UE MESSAGE

This message is sent by the RNC to transfer the radio interface initial layer 3 message to the CN.

Direction: RNC → CN.

Signalling bearer mode: Connection oriented.

IE/Group Name	Presence	Range	IE type and reference	Semantics description	Criticality	Assigned Criticality
Message Type	M		9.2.1.1		YES	ignore
CN Domain Indicator	M		9.2.1.5		YES	ignore
LAI	M		9.2.3.6		YES	ignore
RAC	C - ifPS		9.2.3.7		YES	ignore
SAI	M		9.2.3.9		YES	ignore
NAS-PDU	M		9.2.3.5		YES	ignore
Iu Signalling Connection Identifier	M		9.2.1.38		YES	ignore
Global RNC-ID	M		9.2.1.39	If the Extended <i>RNC-ID</i> IE is included in the message, the <i>RNC-ID</i> IE in the <i>Global RNC-ID</i> IE shall be ignored.	YES	ignore
GERAN Classmark	O		9.2.1.57		YES	ignore
Selected PLMN Identity	O		9.2.3.33		YES	ignore
NAS Sequence Number	O		9.2.3.34		YES	ignore
Permanent NAS UE Identity	O		9.2.3.1		YES	ignore
Redirect Attempt Flag	O		9.2.3.50		YES	ignore
Extended RNC-ID	O		9.2.1.39a	The <i>Extended RNC-ID</i> IE shall be used if the RNC identity has a value larger than 4095.	YES	reject
CSG Id	O		9.2.1.85		YES	reject
Cell Access Mode	O		9.2.1.93		YES	reject
L-GW Transport Layer Address	O		Transport Layer Address 9.2.2.1	Indicating the Transport Layer address of the L-GW if the L-GW is co-located with the RNC.	YES	ignore
Higher bitrates than 16 Mbps flag	O		9.2.3.54	May only be included towards the PS domain.	YES	ignore
Tunnel Information for BBF	O		Tunnel Information 9.2.2.6	Indicating HNB's Local IP Address assigned by the broadband access provider, UDP port Number.	YES	ignore

Condition	Explanation
ifPS	This IE shall be present if the <i>CN Domain Indicator</i> IE is set to "PS domain".

9.1.34 DIRECT TRANSFER

This message is sent by both the CN and the RNC and is used for carrying NAS information over the Iu interface.

Direction: RNC → CN and CN → RNC.

Signalling bearer mode: Connection oriented.

IE/Group Name	Presence	Range	IE type and reference	Semantics description	Criticality	Assigned Criticality
Message Type	M		9.2.1.1		YES	ignore
NAS-PDU	M		9.2.3.5		YES	ignore
LAI	O		9.2.3.6		YES	ignore
RAC	O		9.2.3.7		YES	ignore
SAI	O		9.2.3.9		YES	ignore
SAPI	O		9.2.3.8		YES	ignore
Redirection Indication	O		9.2.3.36		YES	ignore
Redirection Completed	O		9.2.3.35		YES	ignore
Subscriber Profile ID for RAT/Frequency priority	O		9.2.1.86		YES	ignore
L-GW Transport Layer Address	O		Transport Layer Address 9.2.2.1	Indicating the Transport Layer address of the L-GW if the L-GW is co-located with RNC. It can only be transmitted from the RNC to the CN.	YES	ignore

9.1.35 CN INFORMATION BROADCAST REQUEST

Void.

9.1.36 CN INFORMATION BROADCAST CONFIRM

Void.

9.1.37 CN INFORMATION BROADCAST REJECT

Void.

9.1.38 OVERLOAD

This message is sent by either the CN or the RNC to indicate that the control plane of the node is overloaded.

Direction: RNC → CN and CN → RNC.

Signalling bearer mode: Connectionless.

IE/Group Name	Presence	Range	IE type and reference	Semantics description	Criticality	Assigned Criticality
Message Type	M		9.2.1.1		YES	ignore
Number Of Steps	O		9.2.1.32		YES	ignore
Global RNC-ID	O		9.2.1.39	If the <i>Extended RNC-ID</i> IE is included in the message, the <i>RNC-ID</i> IE in the <i>Global RNC-ID</i> IE shall be ignored.	YES	ignore
CN Domain Indicator	O		9.2.1.5		YES	ignore
Global CN-ID	O		9.2.1.46		YES	ignore
Extended RNC-ID	O		9.2.1.39a	The <i>Extended RNC-ID</i> IE shall be used if the RNC identity has a value larger than 4095.	YES	reject
Priority Class Indicator	O		9.2.1.109		YES	ignore

9.1.39 RESET

This message is sent by both the CN and the RNC and is used to request that the other node be reset.

Direction: RNC → CN and CN → RNC.

Signalling bearer mode: Connectionless.

IE/Group Name	Presence	Range	IE type and reference	Semantics description	Criticality	Assigned Criticality
Message Type	M		9.2.1.1		YES	reject
Cause	M		9.2.1.4		YES	ignore
CN Domain Indicator	M		9.2.1.5		YES	reject
Global RNC-ID	O		9.2.1.39	If the <i>Extended RNC-ID</i> IE is included in the message, the <i>RNC-ID</i> IE in the <i>Global RNC-ID</i> IE shall be ignored.	YES	ignore
Global CN-ID	O		9.2.1.46		YES	ignore
Extended RNC-ID	O		9.2.1.39a	The <i>Extended RNC-ID</i> IE shall be used if the RNC identity has a value larger than 4095.	YES	reject

9.1.40 RESET ACKNOWLEDGE

This message is sent by both the CN and the RNC as a response to a RESET message.

Direction: RNC → CN and CN → RNC.

Signalling bearer mode: Connectionless.

IE/Group Name	Presence	Range	IE type and reference	Semantics description	Criticality	Assigned Criticality
Message Type	M		9.2.1.1		YES	reject
CN Domain Indicator	M		9.2.1.5		YES	reject
Criticality Diagnostics	O		9.2.1.35		YES	ignore
Global RNC-ID	O		9.2.1.39	If the <i>Extended RNC-ID</i> IE is included in the message, the <i>RNC-ID</i> IE in the <i>Global RNC-ID</i> IE shall be ignored.	YES	ignore
Global CN-ID	O		9.2.1.46		YES	ignore
Extended RNC-ID	O		9.2.1.39a	The <i>Extended RNC-ID</i> IE shall be used if the RNC identity has a value larger than 4095.	YES	reject

9.1.41 ERROR INDICATION

This message is sent by both the CN and the RNC and is used to indicate that some error has been detected in the node.

Direction: RNC → CN and CN → RNC.

Signalling bearer mode: Connection oriented or connectionless.

IE/Group Name	Presence	Range	IE type and reference	Semantics description	Criticality	Assigned Criticality
Message Type	M		9.2.1.1		YES	ignore
Cause	O		9.2.1.4		YES	ignore
Criticality Diagnostics	O		9.2.1.35		YES	ignore
CN Domain Indicator	O		9.2.1.5		YES	ignore
Global RNC-ID	O		9.2.1.39	If the <i>Extended RNC-ID</i> IE is included in the message, the <i>RNC-ID</i> IE in the <i>Global RNC-ID</i> IE shall be ignored.	YES	ignore
Global CN-ID	O		9.2.1.46		YES	ignore
Extended RNC-ID	O		9.2.1.39a	The <i>Extended RNC-ID</i> IE shall be used if the RNC identity has a value larger than 4095.	YES	reject

9.1.42 CN DEACTIVATE TRACE

This message is sent by the CN to request the RNC to stop a trace session for the indicated trace reference.

Direction: CN → RNC.

Signalling bearer mode: Connection Oriented.

IE/Group Name	Presence	Range	IE type and reference	Semantics description	Criticality	Assigned Criticality
Message Type	M		9.2.1.1		YES	ignore
Trace Reference	M		9.2.1.8		YES	ignore
Trigger ID	O		9.2.1.7	Optional for GERAN Iu Mode. Not applicable to UTRAN.	YES	ignore

9.1.43 RANAP RELOCATION INFORMATION

This message is part of a special RANAP Relocation Information procedure, and is sent between RNCs during Relocation.

Direction: RNC - RNC.

Signalling bearer mode: Not applicable.

IE/Group Name	Presence	Range	IE type and reference	Semantics description	Criticality	Assigned Criticality
Message Type	M		9.2.1.1		YES	ignore
Direct Transfer Information List	O				YES	ignore
>Direct Transfer Information Item IEs		1 to <maxnoofDT>		Information received in one or more DIRECT TRANSFER messages and that needs to be transferred to target RNC for further transmission to the UE.	EACH	ignore
>>NAS-PDU	M		9.2.3.5		-	
>>SAPI	M		9.2.3.8		-	
>>CN Domain Indicator	M		9.2.1.5		-	
RAB Contexts List	O				YES	ignore
>RAB Contexts Item IEs		1 to <maxnoofRABs >			EACH	ignore
>>RAB ID	M		9.2.1.2		-	
>>DL GTP-PDU Sequence Number	O		9.2.2.3		-	
>>UL GTP-PDU Sequence Number	O		9.2.2.4		-	
>>DL N-PDU Sequence Number	O		9.2.1.33		-	
>>UL N-PDU Sequence Number	O		9.2.1.34		-	
Source RNC PDCP context info	O		9.2.1.54		YES	ignore
RNSAP Relocation parameters	O		9.2.1.101	Applicable only to RNSAP relocation.	YES	reject

Range bound	Explanation
maxnoofDT	Maximum no. of DT information. Value is 15.
maxnoofRABs	Maximum no. of RABs for one UE. Value is 256.

9.1.44 RESET RESOURCE

This message is sent by either the CN or the RNC. The sending entity informs the receiving entity that it requests the receiving entity to release resources and references associated to the Iu signalling connection identifiers of the message.

Direction: RNC → CN and CN → RNC.

Signalling bearer mode: Connectionless.

IE/Group Name	Presence	Range	IE type and reference	Semantics description	Criticality	Assigned Criticality
Message Type	M		9.2.1.1		YES	reject
CN Domain Indicator	M		9.2.1.5		YES	reject
Cause	M		9.2.1.4		YES	ignore
Reset Resource List	M				YES	ignore
>Reset Resource Item IEs		1 to <maxnoofIuSigConIds>			EACH	reject
>>Iu Signalling Connection Identifier	M		9.2.1.38		-	
Global RNC-ID	O		9.2.1.39	If the <i>Extended RNC-ID</i> IE is included in the message, the <i>RNC-ID</i> IE in the <i>Global RNC-ID</i> IE shall be ignored.	YES	ignore
Global CN-ID	O		9.2.1.46		YES	ignore
Extended RNC-ID	O		9.2.1.39a	The <i>Extended RNC-ID</i> IE shall be used if the RNC identity has a value larger than 4095.	YES	reject

Range bound	Explanation
maxnoofIuSigConIds	Maximum no. of Iu signalling connection identifiers. Value is 250.

The maximum number of Iu signalling connection identifiers contained in the RESET RESOURCE message shall not exceed the range bound specified for the maxnoofIuSigConIds (max. no. of Iu signalling connection identifiers) as indicated in the table above.

9.1.45 RESET RESOURCE ACKNOWLEDGE

This message is sent by either the CN or the RNC to inform the RNC or the CN that the RESET RESOURCE message has been received.

Direction: RNC → CN and CN → RNC.

Signalling bearer mode: Connectionless.

IE/Group Name	Presence	Range	IE type and reference	Semantics description	Criticality	Assigned Criticality
Message Type	M		9.2.1.1		YES	reject
CN Domain Indicator	M		9.2.1.5		YES	reject
Reset Resource List	M				YES	ignore
>Reset Resource Item IEs		1 to <maxnoofluSigConIds>		This list shall be in the same order as the list received in the RESET RESOURCE message.	EACH	reject
>>lu Signalling Connection Identifier	M		9.2.1.38		-	
Global RNC-ID	O		9.2.1.39	If the <i>Extended RNC-ID</i> IE is included in the message, the <i>RNC-ID</i> IE in the <i>Global RNC-ID</i> IE shall be ignored.	YES	ignore
Criticality Diagnostics	O		9.2.1.35		YES	ignore
Global CN-ID	O		9.2.1.46		YES	ignore
Extended RNC-ID	O		9.2.1.39a	The <i>Extended RNC-ID</i> IE shall be used if the RNC identity has a value larger than 4095.	YES	reject

Range bound	Explanation
maxnoofluSigConIds	Maximum no. of lu signalling connection identifiers. Value is 250.

9.1.46 RAB MODIFY REQUEST

This message is sent by the RNC to the CN to request modification of one or more RABs for the same UE.

Direction: RNC → CN.

Signalling bearer mode: Connection oriented.

IE/Group Name	Presence	Range	IE type and reference	Semantics description	Criticality	Assigned Criticality
Message Type	M		9.2.1.1		YES	ignore
RABs To Be Modified List	M				YES	ignore
>RABs To Be Modified Item IEs		1 to <maxnoofRABs>			EACH	ignore
>>RAB ID	M		9.2.1.2	Uniquely identifies the RAB for a specific CN domain, for a particular UE.	-	
>>Requested RAB Parameter Values	M		9.2.1.45	Includes RAB parameters for which different values than what was originally negotiated are being requested.	-	

Range bound	Explanation
maxnoofRABs	Maximum no. of RABs for one UE. Value is 256.

9.1.47 LOCATION RELATED DATA REQUEST

This message is sent by the CN either to initiate delivery of dedicated assistance data from the RNC to the UE, or to retrieve deciphering keys for the broadcast assistance data.

Direction: CN → RNC.

Signalling bearer mode: Connection oriented.

IE/Group Name	Presence	Range	IE type and reference	Semantics description	Criticality	Assigned Criticality
Message Type	M		9.2.1.1		YES	reject
Location Related Data Request Type	O		9.2.3.19	Mandatory for UTRAN. Optional for GERAN Iu Mode.	YES	reject
Location Related Data Request Type Specific To GERAN Iu Mode	O		9.2.3.26	Optional for GERAN Iu Mode only. Not applicable for UTRAN.	YES	reject
Requested GANSS Assistance Data	C – ifDedAssGANSS		9.2.3.53		YES	reject

Condition	Explanation
ifDedAssGANSS	This IE shall be present if the <i>Requested Location Related Data Type</i> IE is set to "Dedicated Assistance Data for Assisted GANSS" or "Dedicated Assistance Data for Assisted GPS and GANSS".

9.1.48 LOCATION RELATED DATA RESPONSE

This message is sent by the RNC as a successful response to a LOCATION RELATED DATA REQUEST message.

Direction: RNC → CN.

Signalling bearer mode: Connection oriented.

IE/Group Name	Presence	Range	IE type and reference	Semantics description	Criticality	Assigned Criticality
Message Type	M		9.2.1.1		YES	reject
Broadcast Assistance Data Deciphering Keys	O		9.2.3.20	Deciphering keys for UE based OTDOA or Assisted GPS.	YES	ignore
Criticality Diagnostics	O		9.2.1.35		YES	ignore
Broadcast GANSS Assistance Data Deciphering Keys	O		9.2.3.20	Deciphering keys for Assisted GANSS.	YES	ignore

9.1.49 LOCATION RELATED DATA FAILURE

This message is sent by the RNC to report an unsuccessful response to a LOCATION RELATED DATA REQUEST message.

Direction: RNC → CN.

Signalling bearer mode: Connection oriented.

IE/Group Name	Presence	Range	IE type and reference	Semantics description	Criticality	Assigned Criticality
Message Type	M		9.2.1.1		YES	reject
Cause	M		9.2.1.4		YES	ignore
Criticality Diagnostics	O		9.2.1.35		YES	ignore

9.1.50 INFORMATION TRANSFER INDICATION

This message is sent by the CN to transfer information to an RNC.

Direction: CN → RNC.

Signalling bearer mode: Connectionless.

IE/Group Name	Presence	Range	IE type and reference	Semantics description	Criticality	Assigned Criticality
Message Type	M		9.2.1.1		YES	reject
Information Transfer ID	M		9.2.1.55		YES	reject
Provided Data	M		9.2.1.56		YES	reject
CN Domain Indicator	M		9.2.1.5		YES	reject
Global CN-ID	O		9.2.1.46		YES	ignore

9.1.51 INFORMATION TRANSFER CONFIRMATION

This message is sent by the RNC as a successful response to an INFORMATION TRANSFER INDICATION message.

Direction: RNC → CN.

Signalling bearer mode: Connectionless.

IE/Group Name	Presence	Range	IE type and reference	Semantics description	Criticality	Assigned Criticality
Message Type	M		9.2.1.1		YES	reject
Information Transfer ID	M		9.2.1.55		YES	ignore
CN Domain Indicator	M		9.2.1.5		YES	ignore
Criticality Diagnostics	O		9.2.1.35		YES	ignore
Global RNC-ID	M		9.2.1.39	If the <i>Extended RNC-ID</i> IE is included in the message, the <i>RNC-ID</i> IE in the <i>Global RNC-ID</i> IE shall be ignored.	YES	ignore
Extended RNC-ID	O		9.2.1.39a	The <i>Extended RNC-ID</i> IE shall be used if the RNC identity has a value larger than 4095.	YES	reject

9.1.52 INFORMATION TRANSFER FAILURE

This message is sent by the RNC as an unsuccessful response to an INFORMATION TRANSFER INDICATION message.

Direction: RNC → CN.

Signalling bearer mode: Connectionless.

IE/Group Name	Presence	Range	IE type and reference	Semantics description	Criticality	Assigned Criticality
Message Type	M		9.2.1.1		YES	reject
Information Transfer ID	M		9.2.1.55		YES	ignore
CN Domain Indicator	M		9.2.1.5		YES	ignore
Cause	M		9.2.1.4		YES	ignore
Criticality Diagnostics	O		9.2.1.35		YES	ignore
Global RNC-ID	M		9.2.1.39	If the <i>Extended RNC-ID</i> IE is included in the message, the <i>RNC-ID</i> IE in the <i>Global RNC-ID</i> IE shall be ignored.	YES	ignore
Extended RNC-ID	O		9.2.1.39a	The <i>Extended RNC-ID</i> IE shall be used if the RNC identity has a value larger than 4095.	YES	reject

9.1.53 UE SPECIFIC INFORMATION INDICATION

This message is sent by the CN to inform the RNC about information related to this connection.

Direction: CN → RNC.

Signalling bearer mode: Connection oriented.

IE/Group Name	Presence	Range	IE type and reference	Semantics description	Criticality	Assigned Criticality
Message Type	M		9.2.1.1		YES	ignore
UESBI-Iu	O		9.2.1.59		YES	ignore

9.1.54 DIRECT INFORMATION TRANSFER

This message is sent by both the RNC and the CN in order to transfer specific information.

Direction: RNC → CN and CN → RNC.

Signalling bearer mode: Connectionless.

IE/Group Name	Presence	Range	IE type and reference	Semantics description	Criticality	Assigned Criticality
Message Type	M		9.2.1.1		YES	ignore
Inter-system Information Transfer Type	O		9.2.1.62		YES	ignore
CN Domain Indicator	M		9.2.1.5		YES	ignore
Global RNC-ID	O		9.2.1.39	If the <i>Extended RNC-ID</i> IE is included in the message, the <i>RNC-ID</i> IE in the <i>Global RNC-ID</i> IE shall be ignored.	YES	ignore
Global CN-ID	O		9.2.1.46		YES	ignore
Extended RNC-ID	O		9.2.1.39a	The <i>Extended RNC-ID</i> IE shall be used if the RNC identity has a value larger than 4095.	YES	reject

9.1.55 UPLINK INFORMATION EXCHANGE REQUEST

This message is sent by the RNC to the CN in order to transfer or request specific information. The nature of the exchange i.e. transfer or request of specific information is indicated within the *Information Exchange Type* IE. The nature of the information to be transferred is indicated within the *Information Transfer Type* IE. The nature of the information requested is indicated within the *Information Request Type* IE.

Direction: RNC → CN.

Signalling bearer mode: Connectionless.

IE/Group Name	Presence	Range	IE type and reference	Semantics description	Criticality	Assigned Criticality
Message Type	M		9.2.1.1		YES	reject
Information Exchange ID	M		9.2.1.71		YES	reject
Information Exchange Type	M		9.2.1.72		YES	reject
Information Transfer Type	C – iftransfer		9.2.1.63		YES	reject
Information Request Type	C – ifrequest		9.2.1.73		YES	reject
CN Domain Indicator	M		9.2.1.5		YES	reject
Global RNC-ID	M		9.2.1.39	If the <i>Extended RNC-ID</i> IE is included in the message, the <i>RNC-ID</i> IE in the <i>Global RNC-ID</i> IE shall be ignored.	YES	reject
Extended RNC-ID	O		9.2.1.39a	The <i>Extended RNC-ID</i> IE shall be used if the RNC identity has a value larger than 4095.	YES	reject

Condition	Explanation
iftransfer	This IE shall be present if the <i>Information Exchange Type</i> IE is set to "transfer".
ifrequest	This IE shall be present if the <i>Information Exchange Type</i> IE is set to "request".

9.1.56 UPLINK INFORMATION EXCHANGE RESPONSE

This message is sent by the CN to the RNC as a successful response to the UPLINK INFORMATION EXCHANGE REQUEST message.

Direction: CN → RNC.

Signalling bearer mode: Connectionless.

IE/Group Name	Presence	Range	IE type and reference	Semantics description	Criticality	Assigned Criticality
Message Type	M		9.2.1.1		YES	reject
Information Exchange ID	M		9.2.1.71		YES	ignore
Information Requested	O		9.2.1.74		YES	ignore
CN Domain Indicator	M		9.2.1.5		YES	ignore
Global CN-ID	O		9.2.1.46		YES	ignore
Criticality Diagnostics	O		9.2.1.35		YES	ignore

9.1.57 UPLINK INFORMATION EXCHANGE FAILURE

This message is sent by the CN to the RNC as an unsuccessful response to the UPLINK INFORMATION EXCHANGE REQUEST message.

Direction: CN → RNC.

Signalling bearer mode: Connectionless.

IE/Group Name	Presence	Range	IE type and reference	Semantics description	Criticality	Assigned Criticality
Message Type	M		9.2.1.1		YES	reject
Information Exchange ID	M		9.2.1.71		YES	ignore
CN Domain Indicator	M		9.2.1.5		YES	ignore
Global CN-ID	O		9.2.1.46		YES	ignore
Cause	M		9.2.1.4		YES	ignore
Criticality Diagnostics	O		9.2.1.35		YES	ignore

9.1.58 MBMS SESSION START

This message is sent by the CN to establish a MBMS Iu signalling connection and if needed a MBMS RAB.

Direction: CN → RNC.

Signalling bearer mode: Connection oriented.

IE/Group Name	Presence	Range	IE type and reference	Semantics description	Criticality	Assigned Criticality
Message Type	M		9.2.1.1		YES	reject
TMGI	M		9.2.3.37		YES	reject
MBMS Session Identity	O		9.2.3.38		YES	ignore
MBMS Bearer Service Type	M		9.2.3.39		YES	reject
Iu Signalling Connection Identifier	M		9.2.1.38		YES	reject
RAB parameters	M		9.2.1.3		YES	reject
PDP Type Information	O		9.2.1.40		YES	ignore
MBMS Session Duration	M		9.2.3.40		YES	reject
MBMS Service Area	M		9.2.3.41		YES	reject
Frequency Layer Convergence Flag	O		9.2.1.76		YES	ignore
RA List of Idle Mode UEs	O		9.2.3.42		YES	ignore
Global CN-ID IE	O		9.2.1.46		YES	reject
MBMS Session Repetition Number	O		9.2.3.48		YES	ignore
Time to MBMS Data Transfer	M		9.2.3.49		YES	reject
MBMS Counting Information	O		9.2.3.39a		YES	ignore
MBMS Synchronisation Information	O				YES	ignore
>MBMS HC Indicator	M		9.2.1.84		-	
>IP Multicast Address	M		OCTET STRING (4..16)		-	
>GTP DL TEID	M		OCTET STRING (4)	For details and range, see TS 29.281 [59].	-	
>IP Source Address	O		OCTET STRING (4..16)		YES	reject
PDP Type Information extension	O		9.2.1.40 a	The <i>PDP Type Information extension</i> IE can only be included if <i>PDP Type Information</i> IE is not present.	YES	Ignore

9.1.59 MBMS SESSION START RESPONSE

This message is sent by the RNC to report the successful outcome of the request from the MBMS SESSION START message.

Direction: RNC → CN.

Signalling bearer mode: Connection oriented.

IE/Group Name	Presence	Range	IE type and reference	Semantics description	Criticality	Assigned Criticality
Message Type	M		9.2.1.1		YES	reject
Transport Layer Information	O				YES	ignore
>Transport Layer Address	M		9.2.2.1		YES	ignore
>lu Transport Association	M		9.2.2.2		YES	ignore
Cause	O		9.2.1.4		YES	ignore
Criticality Diagnostics	O		9.2.1.35		YES	ignore

9.1.60 MBMS SESSION START FAILURE

This message is sent by the RNC to report the unsuccessful outcome of the request from the MBMS SESSION START message.

Direction: RNC → CN.

Signalling bearer mode: Connection oriented.

IE/Group Name	Presence	Range	IE type and reference	Semantics description	Criticality	Assigned Criticality
Message Type	M		9.2.1.1		YES	reject
Cause	M		9.2.1.4		YES	ignore
Criticality Diagnostics	O		9.2.1.35		YES	ignore

9.1.61 MBMS SESSION UPDATE

This message is sent by the CN to inform the RNC whenever the RA List of Idle Mode UEs changes compared to one previously sent.

Direction: CN → RNC.

Signalling bearer mode: Connection oriented.

IE/Group Name	Presence	Range	IE type and reference	Semantics description	Criticality	Assigned Criticality
Message Type	M		9.2.1.1		YES	reject
Session Update ID	M		9.2.1.77		YES	reject
Delta RA List of Idle Mode UEs	M		9.2.3.43		YES	reject

9.1.62 MBMS SESSION UPDATE RESPONSE

This message is sent by the RNC to report the successful outcome of the request from the MBMS SESSION UPDATE message.

Direction: RNC → CN.

Signalling bearer mode: Connection oriented.

IE/Group Name	Presence	Range	IE type and reference	Semantics description	Criticality	Assigned Criticality
Message Type	M		9.2.1.1		YES	reject
Session Update ID	M		9.2.1.77		YES	ignore
Transport Layer Information	O				YES	ignore
>Transport Layer Address	M		9.2.2.1		YES	ignore
>lu Transport Association	M		9.2.2.2		YES	ignore
Cause	O		9.2.1.4		YES	ignore
Criticality Diagnostics	O		9.2.1.35		YES	ignore

9.1.63 MBMS SESSION UPDATE FAILURE

This message is sent by the RNC to report the unsuccessful outcome of the request from the MBMS SESSION UPDATE message.

Direction: RNC → CN.

Signalling bearer mode: Connection oriented.

IE/Group Name	Presence	Range	IE type and reference	Semantics description	Criticality	Assigned Criticality
Message Type	M		9.2.1.1		YES	reject
Session Update ID	M		9.2.1.77		YES	ignore
Cause	M		9.2.1.4		YES	ignore
Criticality Diagnostics	O		9.2.1.35		YES	ignore

9.1.64 MBMS SESSION STOP

This message is sent by the CN to release a MBMS Iu signalling connection and its associated MBMS RAB.

Direction: CN → RNC.

Signalling bearer mode: Connection oriented.

IE/Group Name	Presence	Range	IE type and reference	Semantics description	Criticality	Assigned Criticality
Message Type	M		9.2.1.1		YES	reject
MBMS CN De-Registration	M		9.2.3.44		YES	reject

9.1.65 MBMS SESSION STOP RESPONSE

This message is sent by the RNC to report the outcome of the request from the MBMS SESSION STOP message.

Direction: RNC → CN.

Signalling bearer mode: Connection oriented.

IE/Group Name	Presence	Range	IE type and reference	Semantics description	Criticality	Assigned Criticality
Message Type	M		9.2.1.1		YES	reject
Cause	O		9.2.1.4		YES	ignore
Criticality Diagnostics	O		9.2.1.35		YES	ignore

9.1.66 MBMS UE LINKING REQUEST

This message is sent by the CN to make the RNC aware that a given UE, with existing Iu-ps signalling connection, joined/left one or several Multicast Services.

Direction: CN → RNC.

Signalling bearer mode: Connection oriented.

IE/Group Name	Presence	Range	IE type and reference	Semantics description	Criticality	Assigned Criticality
Message Type	M		9.2.1.1		YES	reject
Joined MBMS Bearer Services List	O				YES	reject
>Joined MBMS Bearer Service IEs		1 to <maxnoofMulticas tServicesPerUE>			EACH	reject
>>TMGI	M		9.2.3.37	The same TMGI must only be present in one group.	-	-
>>PTP RAB ID	M		9.2.1.75		-	-
Left MBMS Bearer Services List	O				YES	reject
>Left MBMS Bearer Service IEs		1 to <maxnoofMulticas tServicesPerUE>			EACH	reject
>>TMGI	M		9.2.3.37	The same TMGI must only be present in one group.	-	-

Range bound	Explanation
maxnoofMulticastServicesPerUE	Maximum no. of Multicast Services that a UE can join and leave respectively. Value is 128.

9.1.67 MBMS UE LINKING RESPONSE

This message is sent by the RNC to report the outcome of the request from the MBMS UE LINKING REQUEST message.

Direction: RNC → CN.

Signalling bearer mode: Connection oriented.

IE/Group Name	Presence	Range	IE type and reference	Semantics description	Criticality	Assigned Criticality
Message Type	M		9.2.1.1		YES	reject
Unsuccessful Linking List	O				YES	ignore
>Unsuccessful Linking IEs		1 to <maxnoofMulticas tServicesPerUE>			EACH	ignore
>>TMGI	M		9.2.3.37	The same TMGI must only be present in one group.	-	-
>>Cause	M		9.2.1.4		-	-
Criticality Diagnostics	O		9.2.1.35		YES	ignore

Range bound	Explanation
maxnoofMulticastServicesPerUE	Maximum no. of Multicast Services that a UE can join and leave respectively. Value is 128.

9.1.68 MBMS REGISTRATION REQUEST

This message is sent by the RNC to request the CN to register or de-register the RNC for a certain Multicast Service.

Direction: RNC → CN.

Signalling bearer mode: Connectionless or connection oriented.

IE/Group Name	Presence	Range	IE type and reference	Semantics description	Criticality	Assigned Criticality
Message Type	M		9.2.1.1		YES	reject
MBMS Registration Request Type	M		9.2.3.45		YES	reject
TMGI	M		9.2.3.37		YES	reject
IP Multicast Address	C- ifRegister		OCTET STRING		YES	reject
APN	C- ifRegister		OCTET STRING		YES	reject
Global RNC-ID	O		9.2.1.39	If the <i>Extended RNC-ID</i> IE is included in the message, the <i>RNC-ID</i> IE in the <i>Global RNC-ID</i> IE shall be ignored.	YES	reject
Extended RNC-ID	O		9.2.1.39a	The <i>Extended RNC-ID</i> IE shall be used if the RNC identity has a value larger than 4095.	YES	reject

Condition	Explanation
IfRegister	This IE shall be present if the <i>MBMS Registration Request Type</i> IE is set to "register".

9.1.69 MBMS REGISTRATION RESPONSE

This message is sent by the CN to the RNC as a successful response to the MBMS REGISTRATION REQUEST message.

Direction: CN → RNC.

Signalling bearer mode: Connectionless or connection oriented.

IE/Group Name	Presence	Range	IE type and reference	Semantics description	Criticality	Assigned Criticality
Message Type	M		9.2.1.1		YES	reject
TMGI	O		9.2.3.37		YES	ignore
Global CN-ID	O		9.2.1.46		YES	ignore
Criticality Diagnostics	O		9.2.1.35		YES	ignore

9.1.70 MBMS REGISTRATION FAILURE

This message is sent by the CN to the RNC as an unsuccessful response to the MBMS REGISTRATION REQUEST message.

Direction: CN → RNC.

Signalling bearer mode: Connectionless or connection oriented.

IE/Group Name	Presence	Range	IE type and reference	Semantics description	Criticality	Assigned Criticality
Message Type	M		9.2.1.1		YES	reject
TMGI	O		9.2.3.37		YES	ignore
Global CN-ID	O		9.2.1.46		YES	ignore
Cause	M		9.2.1.4		YES	ignore
Criticality Diagnostics	O		9.2.1.35		YES	ignore

9.1.71 MBMS CN DE-REGISTRATION REQUEST

This message is sent by the CN to make the RNC aware that a certain Multicast Service is no longer available.

Direction: CN → RNC.

Signalling bearer mode: Connectionless.

IE/Group Name	Presence	Range	IE type and reference	Semantics description	Criticality	Assigned Criticality
Message Type	M		9.2.1.1		YES	reject
TMGI	M		9.2.3.37		YES	reject
Global CN-ID	O		9.2.1.46		YES	reject

9.1.72 MBMS CN DE-REGISTRATION RESPONSE

This message is sent by the RNC to the CN as a response to the MBMS CN DE-REGISTRATION REQUEST message.

Direction: RNC → CN.

Signalling bearer mode: Connectionless.

IE/Group Name	Presence	Range	IE type and reference	Semantics description	Criticality	Assigned Criticality
Message Type	M		9.2.1.1		YES	reject
TMGI	M		9.2.3.37		YES	ignore
Global RNC-ID	M		9.2.1.39	If the <i>Extended RNC-ID</i> IE is included in the message, the <i>RNC-ID</i> IE in the <i>Global RNC-ID</i> IE shall be ignored.	YES	ignore
Cause	O		9.2.1.4		YES	ignore
Criticality Diagnostics	O		9.2.1.35		YES	ignore
Extended RNC-ID	O		9.2.1.39a	The <i>Extended RNC-ID</i> IE shall be used if the RNC identity has a value larger than 4095.	YES	reject

9.1.73 MBMS RAB ESTABLISHMENT INDICATION

This message is sent by the RNC to the CN to inform the CN of the establishment of the MBMS RAB corresponding to the MBMS Iu signalling connection used by this message.

Direction: RNC → CN.

Signalling bearer mode: Connection oriented.

IE/Group Name	Presence	Range	IE type and reference	Semantics description	Criticality	Assigned Criticality
Message Type	M		9.2.1.1		YES	ignore
Transport Layer Information	M				YES	ignore
>Transport Layer Address	M		9.2.2.1		YES	ignore
>Iu Transport Association	M		9.2.2.2		YES	ignore

9.1.74 MBMS RAB RELEASE REQUEST

This message is sent by the RNC to request the CN to release the MBMS RAB.

Direction: RNC → CN.

Signalling bearer mode: Connection oriented.

IE/Group Name	Presence	Range	IE type and reference	Semantics description	Criticality	Assigned Criticality
Message Type	M		9.2.1.1		YES	reject
Cause	M		9.2.1.4		YES	ignore

9.1.75 MBMS RAB RELEASE

This message is sent by the CN to order the RNC to release all MBMS resources related to the Iu connection.

Direction: CN → RNC.

Signalling bearer mode: Connection oriented.

IE/Group Name	Presence	Range	IE type and reference	Semantics description	Criticality	Assigned Criticality
Message Type	M		9.2.1.1		YES	reject
Cause	M		9.2.1.4		YES	ignore
Criticality Diagnostics	O		9.2.1.35		YES	ignore

9.1.76 MBMS RAB RELEASE FAILURE

This message is sent by the CN to the RNC as an unsuccessful response to the MBMS RAB RELEASE REQUEST message.

Direction: CN → RNC.

Signalling bearer mode: Connection oriented.

IE/Group Name	Presence	Range	IE type and reference	Semantics description	Criticality	Assigned Criticality
Message Type	M		9.2.1.1		YES	reject
Cause	M		9.2.1.4		YES	ignore
Criticality Diagnostics	O		9.2.1.35		YES	ignore

9.1.77 ENHANCED RELOCATION COMPLETE REQUEST

This message is sent by the RNC to inform the CN that an enhanced relocation is completed.

Direction: RNC → CN

Signalling bearer mode: Connection oriented.

IE/Group Name	Presence	Range	IE type and reference	Semantics description	Criticality	Assigned Criticality
Message Type	M		9.2.1.1		YES	reject
Old Iu Signalling Connection Identifier	M		Iu Signalling Connection Identifier 9.2.1.38		YES	reject
Iu Signalling Connection Identifier	M		9.2.1.38		YES	reject
Relocation Source RNC-ID	M		Global RNC-ID 9.2.1.39	If the <i>Relocation Source Extended RNC-ID</i> IE is included in the message, the <i>Global RNC-ID</i> IE in the <i>Relocation Source RNC-ID</i> IE shall be ignored.	YES	reject
Relocation Source Extended RNC-ID	O		Extended RNC Id 9.2.1.39a	The <i>Relocation Source Extended RNC-ID</i> IE shall be used if the RNC identity has a value larger than 4095.	YES	reject
Relocation Target RNC-ID	M		Global RNC-ID 9.2.1.39	If the <i>Relocation Target Extended RNC-ID</i> IE is included in the message, the <i>RNC-ID</i> IE in the <i>Target RNC-ID</i> IE shall be ignored.	YES	reject
Relocation Target Extended RNC-ID	O		9.2.1.39a	The <i>Relocation Target Extended RNC-ID</i> IE shall be used if the RNC identity has a value larger than 4095.	YES	reject
RABs Setup List	O				YES	reject
>RABs Setup Item IEs		1 to <maxnoofRABs >			EACH	reject
>>RAB ID	M		9.2.1.2		-	
>>Transport Layer Address	O		9.2.2.1	IPv6 or IPv4 address.	-	
>>Iu Transport Association	O		9.2.2.2	Related to TLA above.	-	
>>Assigned RAB Parameter Values	O		9.2.1.44		-	
Chosen Integrity Protection Algorithm	O		9.2.1.13	Indicates the Integrity	YES	ignore

IE/Group Name	Presence	Range	IE type and reference	Semantics description	Criticality	Assigned Criticality
				Protection algorithm that will be used by the target RNC.		
Chosen Encryption Algorithm	O		9.2.1.14	Indicates the Encryption algorithm that will be used by the target RNC.	YES	ignore
Higher bitrates than 16 Mbps flag	O		9.2.3.54	May only be included towards the PS domain.	YES	ignore
CSG ID	O		9.2.1.85	Applicable only to Enhanced Relocation from RNC towards hybrid cell	YES	reject
Cell Access Mode	O		9.2.1.93	Applicable only to Enhanced Relocation from RNC towards hybrid cell	YES	reject
Tunnel Information for BBF	O		Tunnel Information 9.2.2.6	Indicating HNB's Local IP Address assigned by the broadband access provider, UDP port Number.	YES	ignore

Range bound	Explanation
maxnoofRABs	Maximum no. of RABs for one UE. Value is 256.

9.1.78 ENHANCED RELOCATION COMPLETE RESPONSE

This message is sent by the CN to inform the RNC that an enhanced relocation is completed in CN.

Direction: CN → RNC.

Signalling bearer mode: Connection oriented.

IE/Group Name	Presence	Range	IE type and reference	Semantics description	Criticality	Assigned Criticality
Message Type	M		9.2.1.1		YES	ignore
RABs Setup List	O				YES	ignore
>RABs Setup Item IEs		1 to <maxnoofRABs >			EACH	reject
>>RAB ID	M		9.2.1.2		-	
>>RAB Parameters	O		9.2.1.3		-	
>>User Plane Information	M					
>>>User Plane Mode	M		9.2.1.18		-	
>>>UP Mode Versions	M		9.2.1.19		-	
>>Transport Layer Address	O		9.2.2.1		-	
>>lu Transport Association	O		9.2.2.2	Related to TLA above.	-	
>>Offload RAB parameters	O		9.2.1.94	Applicable only for SIPTO at lu-PS.	YES	ignore
RABs To Be Released List	O				YES	ignore
>RABs To Be Released Item		1 to <maxnoofRABs >			EACH	ignore
>>RAB ID	M		9.2.1.2		-	
>>Cause	M		9.2.1.4		-	
Criticality Diagnostics	O		9.2.1.35		YES	ignore
UE Aggregate Maximum Bit Rate	O		9.2.1.91		YES	ignore
MSISDN	O		9.2.1.95	Applicable only for SIPTO at lu-PS.	YES	ignore
CSG Membership Status	O		9.2.1.92	Applicable only to Enhanced Relocation from RNC towards hybrid cell	YES	ignore

Range bound	Explanation
maxnoofRABs	Maximum no. of RABs for one UE. Value is 256.

9.1.79 ENHANCED RELOCATION COMPLETE FAILURE

This message is sent by the CN to inform the RNC that a failure has occurred in the CN during the enhanced relocation procedure.

Direction: CN → RNC.

Signalling bearer mode: Connection oriented.

IE/Group Name	Presence	Range	IE type and reference	Semantics description	Criticality	Assigned Criticality
Message Type	M		9.2.1.1		YES	ignore
Cause	M		9.2.1.4		YES	ignore
Criticality Diagnostics	O		9.2.1.35		YES	ignore

9.1.80 ENHANCED RELOCATION COMPLETE CONFIRM

This message is sent by the RNC to inform the CN that an enhanced relocation is completed.

Direction: RNC → CN

Signalling bearer mode: Connection oriented.

IE/Group Name	Presence	Range	IE type and reference	Semantics description	Criticality	Assigned Criticality
Message Type	M		9.2.1.1		YES	ignore
RABs Failed To Initialise List	O				YES	ignore
>RABs Failed To Initialise Item IEs		1 to <maxnoofRABs >			EACH	ignore
>>RAB ID	M		9.2.1.2		-	
>>Cause	M		9.2.1.4		-	

Range bound	Explanation
maxnoofRABs	Maximum no. of RABs for one UE. Value is 256.

9.1.81 RANAP ENHANCED RELOCATION INFORMATION REQUEST

This message is part of a special RANAP Enhanced Relocation Information procedure, and is sent between RNCs during enhanced relocation.

Direction: RNC → RNC.

Signalling bearer mode: Not applicable.

IE/Group Name	Presence	Range	IE type and reference	Semantics description	Criticality	Assigned Criticality
Message Type	M		9.2.1.1		YES	ignore
Source RNC To Target RNC Transparent Container	M		9.2.1.28		YES	reject
Old Iu Signalling Connection Identifier CS domain	O		9.2.1.38		YES	ignore
Global CN-ID CS domain	O		9.2.1.46		YES	reject
Old Iu Signalling Connection Identifier PS domain	O		9.2.1.38		YES	ignore
Global CN-ID PS domain	O		9.2.1.46		YES	reject
RABs To Be Setup List	O				YES	reject
>RABs To Be Setup Item IEs		1 to <maxnoofRABs>			EACH	reject
>>CN Domain Indicator	M		9.2.1.5		-	
>>>RAB ID	M		9.2.1.2		-	
>>>RAB Parameters	M		9.2.1.3		-	
>>>Data Volume Reporting Indication	C – ifPS		9.2.1.17		-	
>>>PDP Type Information	C – ifPS		9.2.1.40		-	
>>>User Plane Information	M					
>>>>User Plane Mode	M		9.2.1.18		-	
>>>>UP Mode Versions	M		9.2.1.19		-	
>>>Data Forwarding TNL Information	O					
>>>>Transport Layer Address	M		9.2.2.1			
>>>>Transport Association	M		Iu Transport Association 9.2.2.2	Related to TLA above.		
>>>>Source Side Iu UL TNL Information	O					
>>>>>Transport Layer Address	M		9.2.2.1		-	
>>>>>Iu Transport Association	M		9.2.2.2		-	
>>>>>Service Handover	O		9.2.1.41		-	
>>>>>Alternative RAB Parameter Values	O		9.2.1.43		-	
>>>>>E-UTRAN Service Handover	O		9.2.1.90		YES	ignore
>>>>>PDP Type Information extension	O		9.2.1.40a	The PDP Type Information extension IE can only be included if PDP Type Information IE is present.	YES	Ignore
SNA Access Information	O		9.2.3.24		YES	ignore
UESBI-Iu	O		9.2.1.59		YES	ignore
Selected PLMN Identity	O		9.2.3.33		YES	ignore
CN MBMS Linking Information	O				YES	ignore
>Joined MBMS Bearer Service IEs		1 to <maxnoofMulticastServicesPerUE>			EACH	ignore
>>TMGI	M		9.2.3.37		-	
>>PTP RAB ID	M		9.2.1.75		-	
Integrity Protection Information	O		9.2.1.11	Integrity Protection Information includes key	YES	ignore

				and permitted algorithms.		
Encryption Information	O		9.2.1.12	Integrity Protection Information includes key and permitted algorithms.	YES	ignore
UE Aggregate Maximum Bit Rate	O		9.2.1.91		YES	ignore
RAB Parameters List	O		9.2.1.102	Applicable only to RNSAP relocation.	YES	reject
CSG ID	O		9.2.1.85	Applicable only to Enhanced Relocation from RNC towards a hybrid cell and RNSAP relocation.	YES	reject
CSG Membership Status	O		9.2.1.92	Applicable only to Enhanced Relocation from RNC towards a hybrid cell and RNSAP relocation.	YES	reject
Anchor PLMN Identity	O		9.2.3.33	Indicates the PS core network operator in case of SRVCC (see TS 23.251 [39]).	YES	ignore

Condition	Explanation
IfPS	This IE shall be present if the <i>CN domain indicator</i> IE is set to "PS domain".

Range bound	Explanation
maxnoofRABs	Maximum no. of RABs for one UE. Value is 256.
maxnoofMulticastServicesPerUE	Maximum no. of Multicast Services that a UE can join and leave respectively. Value is 128.

9.1.82 RANAP ENHANCED RELOCATION INFORMATION RESPONSE

This message is the response message of a special RANAP Enhanced Relocation Information procedure, and is sent between RNCs during enhanced relocation.

Direction: RNC → RNC.

Signalling bearer mode: Not applicable.

IE/Group Name	Presence	Range	IE type and reference	Semantics description	Criticality	Assigned Criticality
Message Type	M		9.2.1.1		YES	reject
Target RNC To Source RNC Transparent Container	O		9.2.1.30		YES	ignore
RABs Setup List	O				YES	ignore
>RABs Setup Item IEs		1 to <maxnoofRABs>			EACH	reject
>>CN Domain Indicator	M		9.2.1.5		-	-
>>RAB ID	M		9.2.1.2		-	
>>> Data Forwarding Information	O				-	
>>>DL Forwarding Transport Layer Address	M		Transport Layer Address 9.2.2.1		-	
>>>DL Forwarding Transport Association	M		Iu Transport Association 9.2.2.2	Related to TLA above.	-	
>>Assigned RAB Parameter Values	O		9.2.1.44		-	
RABs Failed To Setup List	O				YES	ignore
>RABs Failed To Setup Item IEs		1 to <maxnoofRABs>			EACH	ignore
>>CN Domain Indicator	M		9.2.1.5		-	-
>>RAB ID	M		9.2.1.2		-	
>>Cause	M		9.2.1.4		-	
Criticality Diagnostics	O		9.2.1.35		YES	ignore

Range bound	Explanation
maxnoofRABs	Maximum no. of RABs for one UE. Value is 256.

9.1.83 SRVCC CS KEYS REQUEST

This message is sent by the source RNC to the source SGSN to request security information for SRVCC operation.

Direction: RNC → SGSN.

Signalling bearer mode: Connection oriented.

IE/Group Name	Presence	Range	IE type and reference	Semantics description	Criticality	Assigned Criticality
Message Type	M		9.2.1.1		YES	reject

9.1.84 SRVCC CS KEYS RESPONSE

This message is sent by the source SGSN to the source RNC. It contains information necessary for SRVCC operation.

Direction: SGSN → RNC.

Signalling bearer mode: Connection oriented.

IE/Group Name	Presence	Range	IE type and reference	Semantics description	Criticality	Assigned Criticality
Message Type	M		9.2.1.1		YES	reject
Integrity Protection Key	M		BIT STRING (128)		YES	reject
Encryption Key	M		BIT STRING (128)		YES	reject
SRVCC Information	M		9.2.1.89		YES	reject
Criticality Diagnostics	O		9.2.1.35		YES	ignore

9.1.85 UE RADIO CAPABILITY MATCH REQUEST

This message is sent by the SGSN in order to request indications about compatibility between UE radio capabilities and network configuration.

Direction: SGSN → RNC.

Signalling bearer mode: Connection oriented.

IE/Group Name	Presence	Range	IE type and reference	Semantics description	Criticality	Assigned Criticality
Message Type	M		9.2.1.1		YES	ignore

9.1.86 UE RADIO CAPABILITY MATCH RESPONSE

This message is sent by the RNC in order to transfer indications about compatibility between UE radio capabilities and network configuration

Direction: RNC → SGSN.

IE/Group Name	Presence	Range	IE type and reference	Semantics description	Criticality	Assigned Criticality
Message Type	M		9.2.1.1		YES	ignore
Voice Support Match Indicator	M		9.2.1.113		YES	ignore

9.2 Information Element Definitions

9.2.0 General

Subclause 9.2 presents the RANAP IE definitions in tabular format. The corresponding ASN.1 definition is presented in subclause 9.3. In case there is contradiction between the tabular format in subclause 9.2 and the ASN.1 definition, the ASN.1 shall take precedence, except for the definition of conditions for the presence of conditional elements, where the tabular format shall take precedence.

When specifying information elements which are to be represented by bitstrings, if not otherwise specifically stated in the semantics description of the concerned IE or elsewhere, the following principle applies with regards to the ordering of bits:

- The first bit (leftmost bit) contains the most significant bit (MSB);
- The last bit (rightmost bit) contains the least significant bit (LSB);
- When importing bitstrings from other specifications, the first bit of the bitstring contains the first bit of the concerned information;

9.2.1 Radio Network Layer Related IEs

9.2.1.1 Message Type

The *Message Type* IE uniquely identifies the message being sent. It is mandatory for all messages.

IE/Group Name	Presence	Range	IE type and reference	Semantics description
Message Type				Assumed max no of messages is 256.
>Procedure Code	M		(RAB Assignment, RAB Release Request, lu Release Request, lu Release, Relocation Preparation, Relocation Resource Allocation, Relocation Detect, Relocation Complete Relocation Cancel, SRNS Context Transfer, SRNS Data Forwarding Initiation, SRNS Context Forwarding from Source RNC to CN, SRNS Context Forwarding to Target RNC from CN, Paging, Common ID, CN Invoke Trace, Security Mode Control, Location Reporting Control Location Report, Data Volume Report, Initial UE Message Direct Transfer, Overload Control, Reset, Error Indication, CN Deactivate Trace, RANAP Relocation Information, RANAP Enhanced Relocation Information Reset Resource, RAB Modify Request, Location Related Data, Information Transfer, UE Specific Information, Direct Information Transfer, Uplink Information Exchange, MBMS Session Start, MBMS Session Update, MBMS Session Stop, MBMS UE Linking, MBMS Registration, MBMS CN De- Registration, MBMS RAB Establishment Indication, MBMS RAB Release, Enhanced Relocation Complete, Enhanced Relocation Complete Confirm, SRVCC Preparation	

>Type of Message	M)	
			CHOICE (Initiating Message, Successful Outcome, Unsuccessful Outcome, Outcome, ...)	

9.2.1.2 RAB ID

This element uniquely identifies a radio access bearer for a specific CN domain for a particular UE, which makes the RAB ID unique over one Iu connection. The RAB ID shall remain the same for the duration of the RAB even when the RAB is relocated to another Iu connection.

The purpose of the element is to bind data stream from the Non Access Stratum point of view (e.g. bearer of call or PDP context) and radio access bearer in Access Stratum. The value is also used in the RNC to relate Radio Bearers to a RAB. The content of this information element is transferred unchanged from the CN node (i.e. MSC or SGSN) via the RNC to the UE by RANAP messages and RRC messages. For RRC messages refer to TS 25.331 [10].

The element contains binary representation of either the Stream Identifier (SI) for CS domain or the Network Service Access Point Identifier (NSAPI) for PS domain. These identifiers are coded in the RAB ID element in accordance with the coding of the *Stream Identifier* IE and with the coding of the *NSAPI* IE in TS 24.008 [8].

IE/Group Name	Presence	Range	IE type and reference	Semantics description
RAB ID	M		BIT STRING (8)	

9.2.1.3 RAB Parameters

The purpose of the *RAB parameters* IE group and other parameters within the *RAB parameters* IE group is to indicate all RAB attributes as defined in TS 23.107 [7] for both directions.

IE/Group Name	Presence	Range	IE type and reference	Semantics description	Criticality	Assigned Criticality
RAB parameters						
>Traffic Class	M		ENUMERATED (conversational, streaming, interactive, background, ...)	Desc.: This IE indicates the type of application for which the Radio Access Bearer service is optimised.	-	
>RAB Asymmetry Indicator	M		ENUMERATED (Symmetric bidirectional, Asymmetric Unidirectional downlink, Asymmetric Unidirectional Uplink, Asymmetric Bidirectional, ...)	Desc.: This IE indicates asymmetry or symmetry of the RAB and traffic direction.	-	
>Maximum Bit Rate	M	1 to <nr-SeparateTrafficDirections>	INTEGER (1..16,000,000)	Desc.: This IE indicates the maximum number of bits delivered by UTRAN and to UTRAN at a SAP within a period of time, divided by the duration of the period. The unit is: bit/s This IE shall be ignored if <i>Supported Maximum Bite Rate</i> IE is present. Usage: When nr-SeparateTrafficDirections is equal to 2, then Maximum Bit Rate attribute for downlink is signalled first, then Maximum Bit Rate attribute for uplink.	-	

IE/Group Name	Presence	Range	IE type and reference	Semantics description	Criticality	Assigned Criticality
RAB parameters						
>Guaranteed Bit Rate	C-iftrafficConv-Stream	1 to <nbr-SeparateTrafficDirections>	INTEGER (0..16,000,000)	<p>Desc.: This IE indicates the guaranteed number of bits delivered at a SAP within a period of time (provided that there is data to deliver), divided by the duration of the period. The unit is: bit/s.</p> <p>This IE shall be ignored if <i>Supported Guaranteed Bite Rate</i> IE is present.</p> <p>Usage:</p> <ol style="list-style-type: none"> When nbr-SeparateTrafficDirections is equal to 2, then Guaranteed Bit Rate for downlink is signalled first, then Guaranteed Bit Rate for uplink. Delay and reliability attributes only apply up to the guaranteed bit rate. Conditional valuefor the case of Support Mode for pre-defined SDU sizes: Set to highest not rate controllable bitrate, where bitrate is either – one of the <i>RAB subflow combination bitrate</i> IEs (when present) or – one of the calculated values given when dividing the compound Subflow combination SDU sizes by the value of the IE <i>Maximum SDU Size</i> and then multiplying this result by the value of the IE <i>Maximum Bit Rate</i>. 	-	
>Delivery Order	M		ENUMERATED (delivery order requested, delivery order not requested)	<p>Desc: This IE indicates whether the RAB shall provide in-sequence SDU delivery or not.</p> <p>Usage: Delivery order requested: in sequence delivery shall be guaranteed by UTRAN on all RAB SDUs Delivery order not requested: in sequence delivery is not required from UTRAN.</p>	-	

IE/Group Name	Presence	Range	IE type and reference	Semantics description	Criticality	Assigned Criticality
RAB parameters						
>Maximum SDU Size	M		INTEGER (0..32768)	Desc.: This IE indicates the maximum allowed SDU size. The unit is: bit. Usage: Conditional value: Set to largest RAB Subflow Combination compound SDU size (when present) among the different RAB Subflow Combinations.	-	
>SDU parameters		1 to <maxRABSubflows>	See below	Desc.: This IE contains the parameters characterizing the RAB SDUs Usage: Given per subflow with first occurrence corresponding to subflow#1 etc...	-	
>Transfer Delay	C-iftrafficConv-Stream		INTEGER (0..65535)	Desc.: This IE indicates the maximum delay for 95th percentile of the distribution of delay for all delivered SDUs during the lifetime of a RAB, where delay for an SDU is defined as the time from a request to transfer an SDU at one SAP to its delivery at the other SAP The unit is: millisecond.	-	
>Traffic Handling Priority	C - iftrafficInteractiv		INTEGER {spare (0), highest (1), ..., lowest (14), no priority (15)} (0..15)	Desc.: This IE specifies the relative importance for handling of all SDUs belonging to the radio access bearer compared to the SDUs of other bearers Usage: Values between 1 and 14 are ordered in decreasing order of priority, '1' being the highest and '14' the lowest. Value 0 shall be treated as a logical error if received.	-	

IE/Group Name	Presence	Range	IE type and reference	Semantics description	Criticality	Assigned Criticality
RAB parameters						
>Allocation/Retention priority	O		See below	Desc.: This IE specifies the relative importance compared to other Radio access bearers for allocation and retention of the Radio access bearer. Usage: If this IE is not received, the request is regarded as it cannot trigger the pre-emption process and it is vulnerable to the pre-emption process.	-	
>Source Statistics Descriptor	C-iftrafficConv-Stream		ENUMERATED (speech, unknown, ...)	Desc.: This IE specifies characteristics of the source of submitted SDUs.	-	
>Relocation Requirement	O		ENUMERATED (lossless, none, ..., realtime)	This IE shall be present for RABs towards the PS domain, otherwise it shall not be present. Desc.: This IE is no longer used. Usage: It shall always be set to "none" when sent and it shall always be ignored when received. Note: If the IE is not received, the procedure should continue based on the other IEs/IE Groups.	-	
>Signalling Indication	O		ENUMERATED (signalling, ...)	Desc.: Indicates the signalling nature of the submitted SDUs.	YES	ignore
>Extended Maximum Bit Rate	O	1 to <nbr-SeparateTrafficDirections>	INTEGER (16,000,001..256,000,000)	Desc.: This IE indicates the maximum number of bits delivered by UTRAN and to UTRAN at a SAP within a period of time, divided by the duration of the period. The unit is: bit/s. Usage: When nbr-SeparateTrafficDirections is equal to 2, then Maximum Bit Rate attribute for downlink is signalled first, then Maximum Bit Rate attribute for uplink.	YES	reject

IE/Group Name	Presence	Range	IE type and reference	Semantics description	Criticality	Assigned Criticality
RAB parameters						
>Extended Guaranteed Bit Rate	O	1 to <nbr-SeparateTrafficDirections>	INTEGER (16,000,001..256,000,000)	Desc.: This IE indicates the guaranteed number of bits delivered at a SAP within a period of time (provided that there is data to deliver), divided by the duration of the period. The unit is: bit/s. Usage: 1. When nbr-SeparateTrafficDirections is equal to 2, then Guaranteed Bit Rate for downlink is signalled first, then Guaranteed Bit Rate for uplink. 2. Delay and reliability attributes only apply up to the guaranteed bit rate.	YES	reject
>Supported Maximum Bit Rate		0 to <nbr-SeparateTrafficDirections>	INTEGER (1..1,000,000,000, ...)	Desc.: This IE indicates the maximum number of bits delivered by UTRAN and to UTRAN at a SAP within a period of time, divided by the duration of the period. The unit is: bit/s. Usage: When nbr-SeparateTrafficDirections is equal to 2, then Maximum Bit Rate attribute for downlink is signalled first, then Maximum Bit Rate attribute for uplink.	YES	reject
>Supported Guaranteed Bit Rate		0 to <nbr-SeparateTrafficDirections>	INTEGER (1..1,000,000,000, ...)	Desc.: This IE indicates the guaranteed number of bits delivered at a SAP within a period of time (provided that there is data to deliver), divided by the duration of the period. The unit is: bit/s. Usage: When nbr-SeparateTrafficDirections is equal to 2, then Guaranteed Bit Rate for downlink is signalled first, then Guaranteed Bit Rate for uplink Delay and reliability attributes only apply up to the guaranteed bit rate.	YES	reject

Range Bound	Explanation
nbr-SeparateTrafficDirections	Number of Traffic Directions being signalled separately. Set to 2 if RAB asymmetry indicator is asymmetric bidirectional. Set to 1 in all other cases.

Range Bound	Explanation
maxRABSubflows	Maximum number of Subflows per RAB. Value is 7.

Condition	Explanation
IftrafficConv-Stream	This IE shall be present if the <i>Traffic Class</i> IE is set to "Conversational" or "Streaming"
IftrafficInteractiv	This IE shall be present if the <i>Traffic Class</i> IE is set to "Interactive"

IE/Group Name	Presence	Range	IE type and reference	Semantics description	Criticality	Assigned Criticality
SDU parameters						
>SDU Error Ratio	C- ifErroneousSD U			Desc.: This IE indicates the fraction of SDUs lost or detected as erroneous. This is a Reliability attribute Usage: The attribute is coded as follows: Mantissa * 10 ^{-exponent}	-	
>>Mantissa	M		INTEGER (1..9)			
>>Exponent	M		INTEGER (1..6)			
>Residual Bit Error Ratio	M			Desc.: This IE indicates the undetected bit error ratio for each subflow in the delivered SDU. This is a Reliability attribute. Usage: The attribute is coded as follows: Mantissa * 10 ^{-exponent}	-	
>>Mantissa	M		INTEGER (1..9)			
>>Exponent	M		INTEGER (1..8)			
>Delivery Of Erroneous SDU	M		ENUMERATED (yes, no, no-error-detection-consideration)	Desc.: This IE indicates whether SDUs with detected errors shall be delivered or not. In case of unequal error protection, the attribute is set per subflow This is a Reliability attribute. Usage: Yes: error detection applied, erroneous SDU delivered No. Error detection is applied, erroneous SDU discarded no-error-detection-consideration: SDUs delivered without considering error detection. If the RNC receives this IE set to "Yes" and the <i>User Plane Mode</i> IE is set to "transparent mode", it should consider it as "no-error-detection-consideration".	-	
>SDU format information Parameter	O	1 to <maxRABSubflowCombinations>	See below	Desc.: This IE contains the list of possible exact sizes of SDUs and/or RAB Subflow Combination bit	-	

				rates. Given per RAB Subflow Combination with first occurrence corresponding to RAB Subflow Combination number 1. It shall always be present for rate controllable RABs.		
--	--	--	--	--	--	--

Range Bound	Explanation
maxRABSubflowCombinations	Maximum number of RAB Subflow Combinations. Value is 64.

Condition	Explanation
IfErroneousSDU	This IE shall be present if the <i>Delivery Of Erroneous SDU</i> IE is set to "Yes" or "No".

IE/Group Name	Presence	Range	IE type and reference	Semantics description	Criticality	Assigned Criticality
SDU Format Information Parameter				At least one of the <i>Subflow SDU size</i> IE and the <i>RAB Subflow Combination bit rate</i> IE shall be present when <i>SDU format information Parameter</i> IE is present. For the case subflow SDUs are transmitted at constant time interval, only one of the two IEs shall be present. Whenever only one IE is included, it shall be the same for all RAB Subflow Combinations.	-	
>Subflow SDU Size	O		INTEGER (0..4095)	Desc.: This IE indicates the exact size of the SDU. The unit is: bit. Usage: This IE is only used for RABs that have predefined SDU size(s). It shall be present for RABs having more than one subflow. For RABs having only one subflow, this IE shall be present only when the RAB is rate controllable and the SDU size of some RAB Subflow Combination(s) is different than the IE <i>Maximum SDU Size</i> . When this IE is not present and SDU format information Parameter is present, then the Subflow SDU size for the only existing subflow takes the value of the IE <i>Maximum SDU size</i> .	-	
>RAB Subflow Combination Bit Rate	O		INTEGER (0..16,000,000)	Desc.: This IE indicates the RAB Subflow Combination bit rate. The unit is: bit/s. Usage: When this IE is not present and SDU format information parameter is present then all Subflow SDUs are transmitted (when there is data to be transmitted) at a constant time interval. The value of this IE shall not exceed the maximum value of	-	

				the IEs " <i>Maximum Bit Rate</i> ". The value 0 of RAB Subflow Combination bitrate indicates that the RAB uses discontinuous transfer of the SDUs.		
--	--	--	--	--	--	--

IE/Group Name	Presence	Range	IE type and reference	Semantics description	Criticality	Assigned Criticality
Allocation/Retention on Priority					-	
>Priority Level	M		INTEGER {spare (0), highest (1), ..., lowest (14), no priority (15)} (0..15)	Desc.: This IE indicates the priority of the request. Usage: Values between 1 and 14 are ordered in decreasing order of priority, '1' being the highest and '14' the lowest. Value 0 shall be treated as a logical error if received. The priority level and the pre-emption indicators may be used to determine whether the request has to be performed unconditionally and immediately.		
>Pre-emption Capability	M		ENUMERATE D(shall not trigger pre-emption, may trigger pre-emption)	Desc.: This IE indicates the pre-emption capability of the request on other RABs Usage: The RAB shall not pre-empt other RABs or, the RAB may pre-empt other RABs The Pre-emption Capability indicator applies to the allocation of resources for a RAB and as such it provides the trigger to the pre-emption procedures/processes of the RNS.		
>Pre-emption Vulnerability	M		ENUMERATE D(not pre-emptable, pre-emptable)	Desc.: This IE indicates the vulnerability of the RAB to pre-emption of other RABs. Usage: The RAB shall not be pre-empted by other RABs or the RAB may be pre-empted by other RABs. Pre-emption Vulnerability indicator applies for the entire duration of the RAB, unless modified and as such indicates whether the RAB is a target of the pre-emption procedures/processes of the RNS.		
>Queuing Allowed	M		ENUMERATE D(queuing not allowed, queuing allowed)	Desc.: This IE indicates whether the request can be placed into a resource allocation queue or not.		

				Usage: Queuing of the RAB is allowed Queuing of the RAB is not allowed Queuing allowed indicator applies for the entire duration of the RAB, unless modified.		
--	--	--	--	---	--	--

9.2.1.4 Cause

The purpose of the *Cause* IE is to indicate the reason for a particular event for the RANAP protocol.

IE/Group Name	Presence	Range	IE type and reference	Semantics description
Choice Cause				
>Radio Network Layer				
>>Radio Network Layer Cause	M		INTEGER (RAB pre-empted(1), Trelocoverall Expiry(2), Trelocprep Expiry(3), Treloccomplete Expiry(4), Tqueuing Expiry(5), Relocation Triggered(6), Unable to Establish During Relocation(8), Unknown Target RNC(9), Relocation Cancelled(10), Successful Relocation(11), Requested Ciphering and/or Integrity Protection Algorithms not Supported(12), Conflict with already existing Integrity protection and/or Ciphering information (13), Failure in the Radio Interface Procedure(14), Release due to UTRAN Generated Reason(15), User Inactivity(16), Time Critical Relocation(17), Requested Traffic Class not Available(18), Invalid RAB Parameters Value(19), Requested Maximum Bit Rate not Available(20), Requested Maximum Bit Rate for DL not Available(33), Requested Maximum Bit Rate for UL not Available(34), Requested Guaranteed Bit Rate not Available(21), Requested Guaranteed Bit Rate for DL not Available(35), Requested Guaranteed Bit Rate for UL not Available(36), Requested Transfer Delay not Achievable(22), Invalid RAB Parameters Combination(23), Condition Violation for SDU Parameters(24), Condition Violation for Traffic Handling Priority(25), Condition Violation for Guaranteed Bit Rate(26), User Plane Versions not Supported(27), Iu UP Failure(28), TRELOAlloc Expiry (7), Relocation Failure in Target CN/RNC or Target System (29), Invalid RAB ID(30), No remaining RAB(31), Interaction with other	Value range is 1 – 64.

IE/Group Name	Presence	Range	IE type and reference	Semantics description
Choice Cause				
>Radio Network Layer				
			procedure(32), Repeated Integrity Checking Failure(37), Requested Request Type not supported(38), Request superseded(39), Release due to UE generated signalling connection release(40), Resource Optimisation Relocation(41), Requested Information Not Available(42), Relocation desirable for radio reasons (43), Relocation not supported in Target RNC or Target system(44), Directed Retry (45), Radio Connection With UE Lost(46), RNC unable to establish all RFCs (47), Deciphering Keys Not Available(48), Dedicated Assistance data Not Available(49), Relocation Target not allowed(50), Location Reporting Congestion(51), Reduce Load in Serving Cell (52), No Radio Resources Available in Target cell (53), GERAN Iu-mode failure (54), Access Restricted Due to Shared Networks(55), Incoming Relocation Not Supported Due To PUESBINE Feature(56), Traffic Load In The Target Cell Higher Than In The Source Cell(57), MBMS - No Multicast Service For This UE(58), MBMS - Unknown UE ID(59), Successful MBMS Session Start - No Data Bearer Necessary(60), MBMS - Superseded Due To NNSF(61), MBMS - UE Linking Already Done(62), MBMS - UE De-Linking Failure - No Existing UE Linking(63), TMGI Unknown(64)	
>Radio Network Layer				
>>Transport Layer Cause	M		INTEGER (Signalling Transport Resource Failure(65),	Value range is 65 – 80.

IE/Group Name	Presence	Range	IE type and reference	Semantics description
Choice Cause				
>Radio Network Layer				
			lu Transport Connection Failed to Establish(66))	
>NAS				
>>NAS Cause	M		INTEGER (User Restriction Start Indication(81), User Restriction End Indication(82), Normal Release(83) , CSG Subscription Expiry(84))	Value range is 81 – 96.
>Protocol				
>>Protocol Cause	M		INTEGER (Transfer Syntax Error(97), Semantic Error (98), Message not compatible with receiver state (99), Abstract Syntax Error (Reject) (100), Abstract Syntax Error (Ignore and Notify) (101), Abstract Syntax Error (Falsely Constructed Message) (102))	Value range is 97 – 112.
>Miscellaneous				
>>Miscellaneous Cause	M		INTEGER (O&M Intervention(113), No Resource Available(114), Unspecified Failure(115), Network Optimisation(116))	Value range is 113 – 128.
>Non-standard				
>>Non-standard Cause	M		INTEGER ()	Value range is 129 – 256. Cause value 256 shall not be used.
>Radio Network Layer Extension				
>>Radio Network Layer Cause Extension	M		INTEGER (IP Multicast Address And APN Not Valid(257), MBMS De-Registration Rejected Due To Implicit Registration(258), MBMS - Request Superseded(259), MBMS De-Registration During Session Not Allowed(260), MBMS - No Data Bearer Necessary(261) , Periodic Location Information not Available(262), GTP Resources Unavailable(263), TMGI in Use and Overlapping MBMS Service Area (264), MBMS – No cell in MBMS Service Area (265), No lu CS UP relocation (266) , Successful MBMS Session Start – IP Multicast Bearer established (267), CS Fallback triggered (268),	Value range is 257 – 512.

IE/Group Name	Presence	Range	IE type and reference	Semantics description
Choice Cause				
>Radio Network Layer				
			invalid CSG Id (269))	

The meaning of the different cause values is described in the following table. In general, "not supported" cause values indicate that the related capability is missing. On the other hand, "not available" cause values indicate that the related capability is present, but insufficient resources were available to perform the requested action.

Radio Network Layer cause	Meaning
Deciphering Keys Not Available	The action failed because RNC is not able to provide requested deciphering keys.
Conflict with already existing Integrity protection and/or Ciphering information	The action was not performed due to that the requested security mode configuration was in conflict with the already existing security mode configuration.
Condition Violation For Guaranteed Bit Rate	The action was not performed due to condition violation for guaranteed bit rate.
Condition Violation For SDU Parameters	The action was not performed due to condition violation for SDU parameters.
Condition Violation For Traffic Handling Priority	The action was not performed due to condition violation for traffic handling priority.
Dedicated Assistance data Not Available	The action failed because RNC is not able to successfully deliver the requested dedicated assistance data to the UE.
Directed Retry	The reason for action is Directed Retry
Failure In The Radio Interface Procedure	Radio interface procedure has failed.
Incoming Relocation Not Supported Due To PUESBINE Feature	The incoming relocation cannot be accepted by the target RNC because of the PUESBINE feature.
Interaction With Other Procedure	Relocation was cancelled due to interaction with other procedure.
Invalid RAB ID	The action failed because the RAB ID is unknown in the RNC.
Invalid RAB Parameters Combination	The action failed due to invalid RAB parameters combination.
Invalid RAB Parameters Value	The action failed due to invalid RAB parameters value.
Iu UP Failure	The action failed due to Iu UP failure.
No remaining RAB	The reason for the action is no remaining RAB.
RAB Pre-empted	The reason for the action is that RAB is pre-empted.
Radio Connection With UE Lost	The action is requested due to losing radio connection to the UE
Release Due To UE Generated Signalling Connection Release	Release requested due to UE generated signalling connection release.
Release Due To UTRAN Generated Reason	Release is initiated due to UTRAN generated reason.
Relocation Cancelled	The reason for the action is relocation cancellation.
Relocation Desirable for Radio Reasons	The reason for requesting relocation is radio related.
Relocation Failure In Target CN/RNC Or Target System	Relocation failed due to a failure in target CN/RNC or target system.
Relocation Not Supported In Target RNC Or Target System	Relocation failed because relocation was not supported in target RNC or target system.
Relocation Target not allowed	Relocation to the indicated target cell is not allowed for the UE in question.
Relocation Triggered	The action failed due to relocation.
Repeated Integrity Checking Failure	The action is requested due to repeated failure in integrity checking.
Request Superseded	The action failed because there was a second request on the same RAB.
Requested Ciphering And/Or Integrity Protection Algorithms Not Supported	The UTRAN or the UE is unable to support the requested ciphering and/or integrity protection algorithms.
Requested Guaranteed Bit Rate For DL Not Available	The action failed because requested guaranteed bit rate for DL is not available.
Requested Guaranteed Bit Rate For UL Not Available	The action failed because requested guaranteed bit rate for UL is not available.
Requested Guaranteed Bit Rate Not Available	The action failed because requested guaranteed bit rate is not available.
Requested Information Not Available	The action failed because requested information is not available.
Requested Maximum Bit Rate For DL Not Available	The action failed because requested maximum bit rate for DL is not available.
Requested Maximum Bit Rate For UL Not Available	The action failed because requested maximum bit rate for UL is not available.
Requested Maximum Bit Rate Not Available	The action failed because requested maximum bit rate is not available.
Requested Request Type Not Supported	The RNC is not supporting the requested location request type either because it doesn't support the requested event or

	it doesn't support the requested report area.
Location Reporting Congestion	The action was not performed due to an inability to support location reporting caused by overload.
Requested Traffic Class Not Available	The action failed because requested traffic class is not available.
Requested Transfer Delay Not Achievable	The action failed because requested transfer delay is not achievable.
Resource Optimisation Relocation	The reason for requesting relocation is resource optimisation.
Successful Relocation	The reason for the action is completion of successful relocation.
Time Critical Relocation	Relocation is requested for time critical reason i.e. this cause value is reserved to represent all critical cases where the connection is likely to be dropped if relocation is not performed.
T _{QUEUING} Expiry	The action failed due to expiry of the timer T _{QUEUING} .
T _{RELOCalloc} Expiry	Relocation Resource Allocation procedure failed due to expiry of the timer T _{RELOCalloc} .
T _{RELOCcomplete} Expiry	The reason for the action is expiry of timer T _{RELOCcomplete} .
T _{RELOCoverall} Expiry	The reason for the action is expiry of timer T _{RELOCoverall} .
T _{RELOCprep} Expiry	Relocation Preparation procedure is cancelled when timer T _{RELOCprep} expires.
Unable To Establish During Relocation	RAB failed to establish during relocation because it cannot be supported in the target RNC or the RAB did not exist in the source RNC.
Unknown Target RNC	Relocation rejected because the target RNC is not known to the CN.
User Inactivity	The action is requested due to user inactivity on one or several non real time RABs e.g. in order to optimise radio resource.
User Plane Versions Not Supported	The action failed because requested user plane versions were not supported.
RNC unable to establish all RFCs	RNC couldn't establish all RAB subflow combinations indicated within the <i>RAB Parameters</i> IE.
Reduce Load in Serving Cell	Load on serving cell needs to be reduced.
No Radio Resources Available in Target Cell	Load on target cell is too high.
GERAN Iu-mode failure	The RAB establishment/modification/relocation failed because the GERAN BSC cannot provide an appropriate RAB due to limited capabilities within GERAN.
Access Restricted Due to Shared Networks	Access is not permitted in the cell due to Shared Networks.
Traffic Load In The Target Cell Higher Than In The Source Cell	Relocation to reduce load in the source cell is rejected, as the target cell's traffic load is higher than that in the source cell.
MBMS - No Multicast Service For This UE	The request for the Multicast Service list of one UE was not fulfilled because the UE does not have any active multicast service.
MBMS - Unknown UE ID	The request for the Multicast Service list of one UE was not fulfilled because the CN does not know the UE.
Successful MBMS Session Start - No Data Bearer Necessary	The MBMS Session Start procedure was successfully performed, but the RNC does not have any interested UE.
MBMS - Superseded Due To NNSF	The MBMS Session Start procedure was rejected because of successful operation towards another CN node.
MBMS - UE Linking Already Done	The UE linking failed, because the UE has already been linked to the given Multicast service.
MBMS - UE De-Linking Failure - No Existing UE Linking	The UE de-linking failed, because the UE had not been linked to the given Multicast service.
TMGI Unknown	The requested MBMS action failed because the indicated TMGI is unknown.
Successful MBMS Session Start – IP Multicast Bearer established	The RNC was able to join the indicated IP Multicast Group.

Radio Network Layer cause extension	Meaning
IP Multicast Address And APN Not Valid	The MBMS registration failed because the IP Multicast Address and APN are not valid.
MBMS De-Registration Rejected Due To Implicit Registration	The MBMS De-registration was rejected because of implicit registration.
MBMS - Request Superseded	The MBMS Registration or De-registration was superseded due to another ongoing procedure.
MBMS De-Registration During Session Not Allowed	The MBMS De-registration is not allowed during the MBMS session.
MBMS - No Data Bearer Necessary	The RNC no longer have any UEs interested in the MBMS data bearer.
Periodic Location Information not Available	No UE position estimate was available when the periodic report was triggered.
GTP Resources Unavailable	The RNC initiates RAB Release Request procedure with this error cause value if it received a GTP-U error indication.
TMGI in Use and overlapping MBMS Service Area	The RNC has an MBMS Session up and running with that TMGI, a parallel MBMS session with the same TMGI in another overlapping MBMS Service Area is not allowed.
MBMS - No Cell in MBMS Service Area	The RNC does not have any cell of the indicated MBMS Service Area.
No Iu CS UP relocation	The relocation is triggered by CS call and the source RNC has no Iu CS user plane.
CS Fallback triggered	The relocation was triggered for CS Fallback reason at the source side.
Invalid CSG Id	The CSG ID provided to the target UTRAN was found invalid.

Transport Layer cause	Meaning
Iu Transport Connection Failed to Establish	The action failed because the Iu Transport Network Layer connection could not be established.
Signalling Transport Resource Failure	Signalling transport resources have failed (<i>e.g. processor reset</i>).

NAS cause	Meaning
Normal Release	The release is normal.
User Restriction Start Indication	A location report is generated due to entering a classified area set by O&M.
User Restriction End Indication	A location report is generated due to leaving a classified area set by O&M.
CSG Subscription Expiry	The action is due to the UE becoming a non-member of the currently used CSG.

Protocol cause	Meaning
Abstract Syntax Error (Reject)	The received message included an abstract syntax error and the concerning criticality indicated "reject".
Abstract Syntax Error (Ignore And Notify)	The received message included an abstract syntax error and the concerning criticality indicated "ignore and notify".
Abstract Syntax Error (Falsely Constructed Message)	The received message contained IEs or IE groups in wrong order or with too many occurrences.
Message Not Compatible With Receiver State	The received message was not compatible with the receiver state.
Semantic Error	The received message included a semantic error.
Transfer Syntax Error	The received message included a transfer syntax error.

Miscellaneous cause	Meaning
Network Optimisation	The action is performed for network optimisation.
No Resource Available	No requested resource is available.
O&M Intervention	The action is due to O&M intervention.
Unspecified Failure	Sent when none of the specified cause values applies.

9.2.1.5 CN Domain Indicator

Indicates the CN domain from which the message originates or to which the message is sent.

IE/Group Name	Presence	Range	IE type and reference	Semantics description
CN Domain Indicator	M		ENUMERATED (CS domain, PS domain)	

9.2.1.6 Trace Type

Indicates the type of trace information to be recorded. Applicable to GERAN Iu Mode only, not applicable to UTRAN.

IE/Group Name	Presence	Range	IE type and reference	Semantics description
Trace Type	M		OCTET STRING (1)	Coded as the Trace Type specified in 3GPP TS, as defined in TS 52.008 [62].

9.2.1.7 Trigger ID

Indicates the identity of the entity which initiated the trace. Applicable to GERAN Iu Mode only, not applicable to UTRAN.

IE/Group Name	Presence	Range	IE type and reference	Semantics description
Trigger ID	M		OCTET STRING (3..22)	Typically an OMC identity.

NOTE: Due to inconsistency in the definition of Trigger ID between TS 25.413 and TS 29.002 [24], it shall be ensured that the *Trigger ID* IE is coded with at least the minimum number of required octets.

9.2.1.8 Trace Reference

Identifies a trace session and is globally unique within one PLMN.

IE/Group Name	Presence	Range	IE type and reference	Semantics description
Trace Reference	M		OCTET STRING (2..3)	

9.2.1.9 UE Identity

This element identifies the element to be traced i.e. a subscriber or a user equipment.

IE/Group Name	Presence	Range	IE type and reference	Semantics description
Choice UE Identity				
> IMSI				
>>IMSI	M		OCTET STRING (SIZE (3..8))	<ul style="list-style-type: none"> - digits 0 to 9, encoded 0000 to 1001, - 1111 used as filler digit, two digits per octet, - bit 4 to 1 of octet n encoding digit 2n-1, - bit 8 to 5 of octet n encoding digit 2n. <p>Number of decimal digits shall be from 6 to 15 starting with the digits from the PLMN identity. When the IMSI is made of an odd number of digits, the filler digit shall be added at the end to make an even number of digits of length 2N. The filler digit shall then be consequently encoded as bit 8 to 5 of octet N.</p>
> IMEI				
>>IMEI	M		OCTET STRING (SIZE (8))	<ul style="list-style-type: none"> - hexadecimal digits 0 to F, two hexadecimal digits per octet, - each hexadecimal digit encoded 0000 to 1111, - 1111 used as filler for bits 8 to 5 of last octet, - bit 4 to 1 of octet n encoding digit 2n-1, - bit 8 to 5 of octet n encoding digit 2n. <p>Number of hexadecimal digits shall be 15.</p>
> IMEISV				
>>IMEISV	M		OCTET STRING (SIZE (8))	<ul style="list-style-type: none"> - hexadecimal digits 0 to F, two hexadecimal digits per octet, - each hexadecimal digit encoded 0000 to 1111, - bit 4 to 1 of octet n encoding digit 2n-1, - bit 8 to 5 of octet n encoding digit 2n. <p>Number of hexadecimal digits shall be 16.</p>

9.2.1.10 OMC ID

A variable length element indicating the destination address of the Operation and Maintenance Center (OMC) to which trace information is to be sent. Applicable to GERAN Iu Mode only, not applicable to UTRAN.

IE/Group Name	Presence	Range	IE type and reference	Semantics description
OMC ID	M		OCTET STRING (3..22)	Coded as the OMC ID specified in UMTS TS, as defined in GSM TS 12.20 [25].

NOTE: Due to inconsistency in the definition of OMC ID between TS 25.413 and TS 29.002 [24], it shall be ensured that the *OMC ID* IE is coded with at least the minimum number of required octets.

9.2.1.11 Integrity Protection Information

This element contains the integrity protection information (key and permitted algorithms).

IE/Group Name	Presence	Range	IE type and reference	Semantics description
Integrity Protection Information				
>Permitted Integrity Protection Algorithms		1 to 16		
>>Integrity Protection Algorithm	M		INTEGER (standard UIA1 (0), standard UIA2 (1))	Value range is 0 to 15. Only two values used.
>Integrity Protection Key	M		BIT STRING (128)	

9.2.1.12 Encryption Information

This element contains the user data encryption information (key and permitted algorithms) used to control any encryption equipment at the RNC.

IE/Group Name	Presence	Range	IE type and reference	Semantics description
Encryption Information				
>Permitted Encryption Algorithms		1 to 16		
>>Encryption Algorithm	M		INTEGER (no encryption (0), standard UEA1 (1), standard UEA 2 (2))	Value range is 0 to 15. Only three values used.
>Encryption Key	M		Bit string (128)	

9.2.1.13 Chosen Integrity Protection Algorithm

This element indicates the integrity protection algorithm being used by the RNC.

IE/Group Name	Presence	Range	IE type and reference	Semantics description
Chosen Integrity Protection Algorithm	M		INTEGER (standard UIA1 (0), standard UIA2 (1), no value (15))	Value range is 0 to 15. Only two values used over lu interface. The value "no value" shall only be used in case of RANAP signalling over MAP/E TS 29.108 [23].

9.2.1.14 Chosen Encryption Algorithm

This element indicates the encryption algorithm being used by the RNC.

IE/Group Name	Presence	Range	IE type and reference	Semantics description
Chosen Encryption Algorithm	M		INTEGER (no encryption (0), standard UEA1 (1), standard UEA 2 (2))	Value range is 0 to 15. Only three values used.

9.2.1.15 Categorisation Parameters

Void.

9.2.1.16 Request Type

This element indicates the type of location request to be handled by the RNC; the related reported area is either a Service Area or a Geographical Area.

IE/Group Name	Presence	Range	IE type and reference	Semantics description
Request Type				
>Event	M		ENUMERATED(Stop Change of service area, Direct, Change of service area, ..., Stop Direct, Periodic, Stop Periodic)	
>Report Area	M		ENUMERATED(Service Area, Geographical Area, ...)	When the Event IE is set to "Stop Change of service area" or to "Stop Direct", the value of the Report area IE shall be the same as in the LOCATION REPORTING CONTROL message that initiated the location reporting.
>Accuracy Code	O		INTEGER (0..127)	The requested accuracy "r" is derived from the "accuracy code" k by $r = 10 \times (1.1^k - 1)$. The <i>Accuracy Code</i> IE shall be understood as the horizontal accuracy code.

9.2.1.17 Data Volume Reporting Indication

This information element indicates whether or not the RNC has to calculate the unsuccessfully transmitted NAS data amount for a given RAB and to report the amount of unsuccessfully transmitted NAS data when the RAB is released.

IE/Group Name	Presence	Range	IE type and reference	Semantics description
Data Volume Reporting Indication	M		ENUMERATED (do report, do not report)	

9.2.1.18 User Plane Mode

This element indicates the mode of operation of the Iu User plane requested for realising the RAB. The Iu User plane modes are defined in TS 25.415 [6].

IE/Group Name	Presence	Range	IE type and reference	Semantics description
User Plane Mode	M		ENUMERATED (transparent mode, support mode for predefined SDU sizes, ...)	This IE contains the mode of operation of the Iu UP protocol.

9.2.1.19 UP Mode Versions

UP mode versions IE is an information element that is sent by CN to RNC. It is a bit string that indicates the versions for the selected Iu UP mode that are required and supported by the CN. The Iu User plane mode versions shall be defined and coded as the "Iu UP Mode versions supported" field defined in TS 25.415 [6]. This reference is applicable for both the transparent mode and the support mode for predefined SDU sizes.

IE/Group Name	Presence	Range	IE type and reference	Semantics description
UP Mode Versions	M		BIT STRING (16)	Indicates the versions of the selected UP mode that are required and supported by the CN.

9.2.1.20 Chosen UP Version

Void.

9.2.1.21 Paging Area ID

This element identifies the area where a PAGING message shall be broadcasted. The Paging area ID is either a Location Area ID or a Routing Area ID.

IE/Group Name	Presence	Range	IE type and reference	Semantics description
Choice Paging Area ID				
>LAI				
>>LAI	M		9.2.3.6	
>RAI				
>>RAI				
>>>LAI	M		9.2.3.6	
>>>RAC	M		9.2.3.7	

9.2.1.22 Non Searching Indication

This parameter allows the RNC not to search Common ID when receiving a PAGING message from the CN.

IE/Group Name	Presence	Range	IE type and reference	Semantics description
Non Searching Indication	M		ENUMERATED (non-searching, searching)	

9.2.1.23 Relocation Type

This information element indicates whether the relocation of SRNS is to be executed with or without involvement of the UE. If the UE is involved then a radio interface handover command shall be sent to the UE to trigger the execution of the relocation. If the UE is not involved then the relocation execution is triggered via Iur.

IE/Group Name	Presence	Range	IE type and reference	Semantics description
Relocation Type	M		ENUMERATED (UE not involved in relocation of SRNS, UE involved in relocation of SRNS, ...)	

9.2.1.24 Source ID

The *Source ID* IE identifies the source for the relocation of SRNS. The Source ID may be e.g. the source RNC-ID (for UMTS-UMTS relocation and UMTS to LTE relocation) or the SAI of the relocation source (in case of UMTS to GSM relocation).

IE/Group Name	Presence	Range	IE type and reference	Semantics description	Criticality	Assigned Criticality
Choice Source ID					-	
> Source RNC-ID					-	
>>PLMN identity	M		OCTET STRING (SIZE (3))	- digits 0 to 9, encoded 0000 to 1001, - 1111 used as filler digit, two digits per octet, - bits 4 to 1 of octet n encoding digit 2n-1, - bits 8 to 5 of octet n encoding digit 2n. - The PLMN identity consists of 3 digits from MCC followed by either - a filler digit plus 2 digits from MNC (in case of 2 digit MNC) or - 3 digits from MNC (in case of a 3 digit MNC).	-	
>>RNC-ID	M		INTEGER (0..4095)	If the <i>Extended RNC-ID</i> IE is included in the <i>Source ID</i> IE, the <i>RNC-ID</i> IE shall be ignored.	-	
>>Extended RNC-ID	O		9.2.1.39a	The <i>Extended RNC-ID</i> IE shall be used if the RNC identity has a value larger than 4095.	YES	reject
> SAI						
>>SAI	M		9.2.3.9		-	

9.2.1.25 Target ID

The *Target ID* IE identifies the target for the relocation of SRNS. The target ID may be e.g. the target RNC-ID (for UMTS-UMTS relocation) or the Cell Global ID of the relocation target (in case of UMTS to GSM relocation). In case of UMTS to E-UTRAN relocation, the *Target ID* may be either the eNB-ID or the Corresponding RNC-ID of the relocation target.

NOTE: The mapping between the Corresponding RNC-ID and the actual eNB-ID of the relocation target is defined by the network operator and is outside the scope of this specification. Preferably the Target RNC ID used for an eNB contains the LAI and RAC mapped from the GUMMEI of the MME serving the target eNB as specified within TS 23.003 [19]. This avoids configuration of additional identity resolutions and also gurantees that LAIs used for E-UTRAN and UTRAN are mutually exclusive.

IE/Group Name	Presence	Range	IE type and reference	Semantics description	Criticality	Assigned Criticality
Choice Target ID					-	
> Target RNC-ID					-	
>> Target RNC-ID	M					
>>>LAI	M		9.2.3.6		-	
>>>RAC	O		9.2.3.7		-	
>>>RNC-ID	M		INTEGER (0..4095)	If the <i>Extended RNC-ID</i> IE is included in the <i>Target ID</i> IE, the <i>RNC-ID</i> IE shall be ignored. In case of UMTS to E-UTRAN relocation, if included, this IE will contain the Corresponding RNC-ID of the target eNB.	-	
>>>Extended RNC-ID	O		9.2.1.39a	The <i>Extended RNC-ID</i> IE shall be used if the RNC identity has a value larger than 4095.	YES	reject
> CGI					-	
>> CGI	M					
>>>PLMN identity	M		OCTET STRING (SIZE (3))	- digits 0 to 9, encoded 0000 to 1001, - 1111 used as filler digit, two digits per octet, - bits 4 to 1 of octet n encoding digit 2n-1, - bits 8 to 5 of octet n encoding digit 2n. - The PLMN identity consists of 3 digits from MCC followed by either - a filler digit plus 2 digits from MNC (in case of 2 digit MNC) or - 3 digits from MNC (in case of a 3 digit MNC).	-	
>>>LAC	M		OCTET STRING (2)	0000 and FFFE not allowed.	-	
>>>CI	M		OCTET STRING (2)		-	
>>>RAC	O		9.2.3.7		YES	ignore
> Target eNB-ID						
>> Target eNB-ID						
>>>PLMN identity	M		OCTET STRING (SIZE (3))	- digits 0 to 9, encoded 0000 to 1001, - 1111 used as filler digit, two digits per octet, - bits 4 to 1 of octet n encoding digit 2n-1, - bits 8 to 5 of octet n encoding digit 2n. - The PLMN identity consists of 3 digits from MCC followed	-	

				by either - a filler digit plus 2 digits from MNC (in case of 2 digit MNC) or - 3 digits from MNC (in case of a 3 digit MNC).		
>>>Choice eNB ID					-	
>>>>Macro eNB ID	M		BIT STRING (20)	Equal to the 20 leftmost bits of the <i>Cell Identity</i> IE contained in the <i>E-UTRAN CGI</i> IE (see TS 36.413 [49]) of each cell served by the eNodeB.	-	
>>>>Home eNB ID	M		BIT STRING (28)	Equal to the <i>Cell Identity</i> IE contained in the <i>E-UTRAN CGI</i> IE (see TS 36.413 [49]) of the cell served by the eNodeB. NOTE: Inter-system handover to a Home eNB is not supported in Rel-8.	-	
>>>Selected TAI	M		9.2.1.30C	Contains the TAC of the target cell and the PLMN selected for that target cell.	-	

9.2.1.26 MS Classmark 2

The coding of this element is described in TS 25.331 [10].

IE/Group Name	Presence	Range	IE type and reference	Semantics description
MS Classmark 2	M		OCTET STRING	Coded as the <i>Mobile Station Classmark 2</i> IE, as defined in TS 25.331 [10].

9.2.1.27 MS Classmark 3

The coding of this element is described in TS 25.331 [10].

IE/Group Name	Presence	Range	IE type and reference	Semantics description
MS Classmark 3	M		OCTET STRING	Coded as the <i>Mobile Station Classmark 3</i> IE, as defined in TS 25.331 [10].

9.2.1.28 Source RNC to Target RNC Transparent Container

The *Source RNC to Target RNC Transparent Container* IE is an information element that is produced by the source RNC and is transmitted to the target RNC. In inter-system handovers to UTRAN, the IE is transmitted from the external relocation source to the target RNC.

This IE is transparent to the CN.

IE/Group Name	Presence	Range	IE type and reference	Semantics description	Criticality	Assigned Criticality
RRC Container	M		OCTET STRING		-	
Number of Iu Instances	M		INTEGER (1..2)		-	
Relocation Type	M		9.2.1.23		-	
Chosen Integrity Protection Algorithm	O		9.2.1.13	Indicates the integrity protection algorithm.	-	
Integrity Protection Key	O		Bit String (128)		-	
Chosen Encryption Algorithm	O		9.2.1.14	Indicates the algorithm for ciphering of signalling data.	-	
Ciphering Key	O		Bit String (128)		-	
Chosen Encryption Algorithm	O		9.2.1.14	Indicates the algorithm for ciphering of CS user data.	-	
Chosen Encryption Algorithm	O		9.2.1.14	Indicates the algorithm for ciphering of PS user data.	-	
d-RNTI	C - ifUEnotinvolved		INTEGER (0..1048575)		-	
Target Cell ID	C - ifUEinvolved		INTEGER (0..268435455)	This information element identifies a cell uniquely within UTRAN and consists of RNC-ID and C-ID as defined in TS 25.401 [3] or <i>Cell Identity</i> IE as defined in TS 25.331[10] if the target is a HNB TS 25.467 [55].	-	
Cell Load Information Group	O		9.2.1.60	For "Cell Load-Based Inter-System Handover".	-	
RAB TrCH Mapping	O	1 to <maxnoof RABs>			-	
>RAB ID	M		9.2.1.2		-	
>RAB Subflow	M	1 to <maxRAB-Subflows>		The RAB Subflows shall be presented in an order that corresponds to the order in which the RBs are presented per RAB in the RRC container included in this IE.	-	
>>Transport Channel IDs					-	
>>>DCH ID	O		INTEGER (0..255)	The DCH ID is the identifier of an active dedicated transport channel. It is unique for each active DCH among the active DCHs simultaneously allocated for the	-	

				same UE.		
>>>DSCH ID	O		INTEGER (0..255)	The DSCH ID is the identifier of an active downlink shared transport channel. It is unique for each DSCH among the active DSCHs simultaneously allocated for the same UE.	-	
>>>USCH ID	O		INTEGER (0..255)	The USCH ID is the identifier of an active uplink shared transport channel. It is unique for each USCH among the active USCHs simultaneously allocated for the same UE.	-	
>>>HS-DSCH MAC-d Flow ID	O		INTEGER (0..7)	The HS-DSCH MAC-d Flow ID is the identifier of an HS-DSCH MAC-d flow over lur.	YES	ignore
>>>E-DCH MAC-d Flow ID	O		INTEGER (0..7)	The E-DCH MAC-d Flow ID is the identifier of an E-DCH MAC-d flow over lur.	YES	ignore
>CN Domain Indicator	M		9.2.1.5		YES	ignore
SRB TrCH Mapping	O	1 to <maxnoofSRBs>			GLOBAL	reject
>SRB ID	M		INTEGER (1..32)	The SRB ID is the absolute value of the SRB.	-	
>DCH ID	O		INTEGER (0..255)	The DCH ID is the identifier of an active dedicated transport channel over lur. It is unique for each active DCH among the active DCHs simultaneously allocated for the same UE.	-	
>DSCH ID	O		INTEGER (0..255)	The DSCH ID is the identifier of an active downlink shared transport channel over lur. It is unique for each DSCH among the active DSCHs simultaneously allocated for the same UE.	-	
>USCH ID	O		INTEGER (0..255)	The USCH ID is the identifier of an active uplink shared transport channel over lur. It is unique for each USCH	-	

				among the active USCHs simultaneously allocated for the same UE.		
>HS-DSCH MAC-d Flow ID	O		INTEGER (0..7)	The HS-DSCH MAC-d Flow ID is the identifier of an HS-DSCH MAC-d flow over Iur.	YES	ignore
>E-DCH MAC-d Flow ID	O		INTEGER (0..7)	The E-DCH MAC-d Flow ID is the identifier of an E-DCH MAC-d flow over Iur.	YES	ignore
Trace Recording Session Information	O		9.2.1.66		YES	ignore
MBMS Linking Information	O		ENUMERATED (UE-has-joined-Multicast-Services, ...)		YES	ignore
d-RNTI for No IuCS UP	O		INTEGER (0..1048575)		YES	reject
UE History Information	O		OCTET STRING	Defined in TS 36.413 [49].	YES	ignore
Subscriber Profile ID for RAT/Frequency priority	O		9.2.1.86		YES	ignore
SRVCC Information	O		9.2.1.89	Included only in case of intra-UMTS SRVCC.	YES	reject
PS RAB To Be Replaced	O		RAB ID 9.2.1.2	Included only in case of intra-UMTS SRVCC.	YES	reject
CSFB Information	O		ENUMERATED (CSFB, CSFB High Priority, ...)		YES	ignore
IRAT Measurement Configuration	O		9.2.1.96		YES	ignore
Management Based MDT Allowed	O		9.2.1.110		YES	ignore
Management Based MDT PLMN List	O		MDT PLMN List 9.2.1.116		YES	ignore

Condition	Explanation
IfUEnotinvolvement	This IE shall be present if the <i>Relocation type</i> IE is set to "UE not involved in relocation of SRNS".
IfUEinvolved	This IE shall be present if the <i>Relocation type</i> IE is set to "UE involved in relocation of SRNS".

Range bound	Explanation
maxnoofRABs	Maximum no. of RABs for one UE. Value is 256.
maxRABSubflows	Maximum no. of subflows per RAB. Value is 7.
maxnoofSRBs	Maximum no. of SRBs per RAB. Value is 8.

9.2.1.29 Old BSS to New BSS Information

The coding of this element is described in TS 48.008 [11].

IE/Group Name	Presence	Range	IE type and reference	Semantics description
Old BSS To New BSS Information	M		OCTET STRING	Coded as the <i>Old BSS to New BSS information elements</i> field of the <i>Old BSS to New BSS Information</i> IE defined in TS 48.008 [11].

9.2.1.30 Target RNC to Source RNC Transparent Container

The *Target RNC to Source RNC Transparent Container* IE is an information element that is produced by the target RNC and is transmitted to the source RNC. In inter-system handovers to UTRAN, the IE is transmitted from the target RNC to the external relocation source.

This IE is transparent to CN.

IE/Group Name	Presence	Range	IE type and reference	Semantics description
RRC Container	M		OCTET STRING	
d-RNTI	O		INTEGER (0..1048575)	May be included to allow the triggering of the Relocation Detect procedure from the Iur Interface.

9.2.1.30a Source to Target Transparent Container

The *Source to Target Transparent Container* IE is an information element that is provided by the source RAN node to the target RAN node.

This IE is transparent to CN.

IE/Group Name	Presence	Range	IE type and reference	Semantics description
Source to Target Transparent Container	M		OCTET STRING	This IE includes a transparent container from the source RAN node to the target RAN node. In inter-system handovers from UTRAN, the IE is encoded according to the specifications of the target system. Note: In the current version of this specification, this IE may either carry the <i>Source RNC to Target RNC Transparent Container</i> or the <i>Source eNB to Target eNB Transparent Container</i> IE as defined in TS 36.413 [49].

9.2.1.30b Target to Source Transparent Container

The *Target to Source Transparent Container* IE is an information element that is provided by the target RAN node to the source RAN node.

This IE is transparent to CN.

IE/Group Name	Presence	Range	IE type and reference	Semantics description
Target to Source Transparent Container	M		OCTET STRING	Note: In the current version of this specification, this IE may either carry the <i>Target RNC to Source RNC Transparent Container</i> or the <i>Target eNB to Source eNB Transparent Container</i> IE as defined in TS 36.413 [49].

9.2.1.30c TAI

This element is used to uniquely identify a Tracking Area as defined in TS 36.413 [49].

IE/Group Name	Presence	Range	IE type and reference	Semantics description
PLMN identity	M		OCTET STRING (SIZE (3))	<ul style="list-style-type: none"> - digits 0 to 9, encoded 0000 to 1001, - 1111 used as filler digit, two digits per octet, - bits 4 to 1 of octet n encoding digit 2n-1, - bits 8 to 5 of octet n encoding digit 2n. <p>- The Selected PLMN identity consists of 3 digits from MCC followed by either</p> <ul style="list-style-type: none"> - a filler digit plus 2 digits from MNC (in case of 2 digit MNC) or - 3 digits from MNC (in case of a 3 digit MNC).
TAC	M		OCTET STRING (SIZE (2))	

9.2.1.31 L3 Information

The coding of this element is described in TS 48.008 [11].

IE/Group Name	Presence	Range	IE type and reference	Semantics description
L3 Information	M		OCTET STRING	Coded as the value part of the <i>Layer 3 Information</i> IE defined in TS 48.008 [11] (i.e. excluding the <i>Element Identifier</i> and the <i>Length</i> fields).

9.2.1.32 Number of Steps

Indicates the number of steps to reduce traffic in overload situation.

IE/Group Name	Presence	Range	IE type and reference	Semantics description
Number Of Steps	M		INTEGER (1..16)	

9.2.1.33 DL N-PDU Sequence Number

This IE indicates the radio interface sequence number (PDCP) TS 25.323 [17] of the next downlink N-PDU (PDCP SDU) that would have been sent to the UE by a source system.

IE/Group Name	Presence	Range	IE type and reference	Semantics description
DL N-PDU Sequence Number	M		INTEGER (0..65535)	This IE indicates the sequence number of the next DL N-PDU that would have been sent to the UE by a source system. This is the 16 bit sequence number.

9.2.1.34 UL N-PDU Sequence Number

This IE indicates the radio interface sequence number (PDCP) TS 25.323 [17] of the next uplink N-PDU (PDCP SDU) that would have been expected from the UE by a source system.

IE/Group Name	Presence	Range	IE type and reference	Semantics description
UL N-PDU Sequence Number	M		INTEGER (0..65535)	This IE indicates the sequence number of the next UL N-PDU that would have been expected from the UE by a source system. This is the 16 bit sequence number.

9.2.1.35 Criticality Diagnostics

The *Criticality Diagnostics* IE is sent by the RNC or the CN when parts of a received message have not been comprehended or were missing, or if the message contained logical errors. When applicable, it contains information about which IEs were not comprehended or were missing.

For further details on how to use the *Criticality Diagnostics* IE, see Annex A.2.

IE/Group Name	Presence	Range	IE type and reference	Semantics description
Criticality Diagnostics				
>Procedure Code	O		INTEGER (0..255)	Procedure Code is to be used if Criticality Diagnostics is part of Error Indication procedure, and not within the response message of the same procedure that caused the error.
>Triggering Message	O		ENUMERATED (initiating message, successful outcome, unsuccessful outcome, outcome)	The Triggering Message is used only if the Criticality Diagnostics is part of Error Indication procedure.
>Procedure Criticality	O		ENUMERATED (reject, ignore, notify)	This Procedure Criticality is used for reporting the Criticality of the Triggering message (Procedure).
Information Element Criticality Diagnostics		<i>0 to <maxnoof errors></i>		
>IE Criticality	M		ENUMERATED (reject, ignore, notify)	The IE Criticality is used for reporting the criticality of the triggering IE. The value 'ignore' shall not be used.
>IE ID	M		INTEGER (0..65535)	The IE ID of the not understood or missing IE.
>Repetition Number	O		INTEGER (0..255)	<p>The <i>Repetition Number</i> IE gives</p> <ul style="list-style-type: none"> in case of a not understood IE: The number of occurrences of the reported IE up to and including the not understood occurrence in case of a missing IE: The number of occurrences up to but not including the missing occurrence. <p>Note: All the counted occurrences of the reported IE must have the same topdown hierarchical message structure of IEs with assigned criticality above them.</p>
>Message Structure	O		9.2.1.42	The <i>Message Structure</i> IE describes the structure where the not understood or missing IE was detected. This IE is included if the not understood IE is not the top level of the message.
>Type of Error	M		ENUMERATED (not understood, missing, ...)	

Range bound	Explanation
maxnooferrors	Maximum no. of IE errors allowed to be reported with a single message. The value for maxnooferrors is 256.

9.2.1.36 Key Status

This IE tells if the keys included in a SECURITY MODE COMMAND message are new or if they have been used previously.

IE/Group Name	Presence	Range	IE type and reference	Semantics description
Key Status	M		ENUMERATED (old, new, ...)	

9.2.1.37 DRX Cycle Length Coefficient

This IE indicates the DRX cycle length coefficient (k) as defined in TS 25.331 [10].

IE/Group Name	Presence	Range	IE type and reference	Semantics description
DRX Cycle Length Coefficient	M		INTEGER (6..9)	

9.2.1.38 Iu Signalling Connection Identifier

This IE uniquely identifies an Iu signalling connection between a given RNC and a given CN node.

IE/Group Name	Presence	Range	IE type and reference	Semantics description
Iu Signalling Connection Identifier	M		BIT STRING (SIZE(24))	The most significant bit of this IE shall indicate the node, that has assigned the value. MSB = "0": assigned by the RNC; MSB = "1": assigned by the CN.

9.2.1.39 Global RNC-ID

The Global RNC-ID is used to globally identify an RNC.

IE/Group Name	Presence	Range	IE type and reference	Semantics description
PLMN identity	M		OCTET STRING (SIZE (3))	<ul style="list-style-type: none"> - digits 0 to 9, encoded 0000 to 1001, - 1111 used as filler digit, two digits per octet, - bits 4 to 1 of octet n encoding digit 2n-1, - bits 8 to 5 of octet n encoding digit 2n. <ul style="list-style-type: none"> - The PLMN identity consists of 3 digits from MCC followed by either <ul style="list-style-type: none"> - a filler digit plus 2 digits from MNC (in case of 2 digit MNC) or - 3 digits from MNC (in case of a 3 digit MNC).
RNC-ID	M		INTEGER (0..4095)	If the <i>Extended RNC-ID</i> IE is included in the message, the <i>RNC-ID</i> IE shall be ignored.

9.2.1.39a Extended RNC-ID

The Extended RNC-ID is used to identify an RNC.

IE/Group Name	Presence	Range	IE type and reference	Semantics description
Extended RNC-ID	M		INTEGER (4096..65535)	<p>The <i>Extended RNC-ID</i> IE shall be used if the RNC identity has a value larger than 4095.</p> <p>Note: Application of the <i>Extended RNC-ID</i> IE to very large networks is FFS.</p>

9.2.1.40 PDP Type Information

IE/Group Name	Presence	Range	IE type and reference	Semantics description
PDP Type Information	M	1 to <maxnoofPDPDirections>	ENUMERATED(empty, PPP, OSP:IHOSS, IPv4, IPv6,...)	<p>PDP Type is defined in TS 24.008 [8], and the restrictions on usage shall comply with TS 24.008 [8].</p> <p>Usage: When the IE is repeated then PDP Type for downlink is signalled first, followed by PDP Type for uplink; when the IE is not repeated, the PDP Type shall apply to both uplink and downlink. OSP:IHOSS: This value shall not be used.</p>

Range bound	Explanation
maxnoofPDPDirections	Number of directions for which PDP Type is signalled separately

9.2.1.40a PDP Type Information extension

IE/Group Name	Presence	Range	IE type and reference	Semantics description
PDP Type Information extension	M	1 to <maxnoofPDPDirections>	ENUMERATED (IPv4 and IPv6,...)	PDP Type is defined in TS 24.008 [8], and the restrictions on usage shall comply with TS 24.008 [8]. Usage: When the IE is repeated then PDP Type for downlink is signalled first, followed by PDP Type for uplink; when the IE is not repeated, the PDP Type shall apply to both uplink and downlink.

Range bound	Explanation
maxnoofPDPDirections	Number of directions for which PDP Type is signalled separately

9.2.1.41 Service Handover

This IE tells if intersystem handover to GSM should, should not, or shall not be performed for a given RAB.

IE/Group Name	Presence	Range	IE type and reference	Semantics description
Service Handover	M		ENUMERATED (Handover to GSM should be performed, Handover to GSM should not be performed, Handover to GSM shall not be performed, ...)	

9.2.1.42 Message Structure

The *Message Structure* IE gives information for each level with assigned criticality in a hierarchical message structure from top level down to the lowest level above the reported level for the occurred error (reported in the *Information Element Criticality Diagnostics* IE).

IE/Group Name	Presence	Range	IE type and reference	Semantics description	Criticality	Assigned Criticality
Message structure		1 to <maxnooflevels>		The first repetition of the <i>Message Structure</i> IE corresponds to the top level of the message. The last repetition of the <i>Message Structure</i> IE corresponds to the level above the reported level for the occurred error of the message.	GLOBAL	ignore
>IE ID	M		INTEGER (0..65535)	The IE ID of this level's IE containing the not understood or missing IE.	-	
>Repetition Number	O		INTEGER (1..256)	The <i>Repetition Number</i> IE gives, if applicable, the number of occurrences of this level's reported IE up to and including the occurrence containing the not understood or missing IE. Note: All the counted occurrences of the reported IE must have the same topdown hierarchical message structure of IEs with assigned criticality above them.	-	

Range bound	Explanation
maxnooflevels	Maximum no. of message levels to report. The value for maxnooflevels is 256.

9.2.1.43 Alternative RAB Parameter Values

The purpose of the *Alternative RAB Parameter Values* IE is to indicate that:

- Either RAB QoS negotiation is allowed for certain RAB parameters and, in some cases, to indicate also which alternative values to be used in the negotiation;
- Or an alternative RAB configuration can be requested by the RNC.

IE/Group Name	Presence	Range	IE type and reference	Semantics description	Criticality	Assigned Criticality
Alternative RAB parameter values						
>Alternative Maximum Bit Rate information	O			Included only if negotiation is allowed for this IE.	-	
>>Type of Alternative Maximum Bit Rate Information	M		ENUMERATED (Unspecified, Value range, Discrete values)	Unspecified means that negotiation is allowed, but no alternative values are provided from the CN, i.e., the RNC is allowed to assign any value equal or below the ones indicated in the <i>RAB Parameters</i> IE.		
>>Alternative Maximum Bit Rates	C - ifValueRangeorDiscreteValuesM BR	1 to <nr-Alternative Values>		For Value Range, one value limit is given here and the other given by Maximum Bit Rate in the <i>RAB Parameters</i> IE. For Discrete Values; 1 to 16 discrete values can be given.		
>>>Bit Rate	M	1 to <nr-Separate TrafficDirections>	INTEGER (1..16,000,000)	When nr-SeparateTrafficDirections is equal to 2, then the Bit Rate attribute for downlink is signalled first, then the Bit Rate attribute for uplink.		
>Alternative Guaranteed Bit Rate Information	O			Included only if negotiation is allowed for this IE.	-	
>>Type of Alternative Guaranteed Bit Rate Information	M		ENUMERATED (Unspecified, Value range, Discrete values)	Unspecified means that negotiation is allowed, but no alternative values are provided from the CN, i.e., the RNC is allowed to assign any value equal or below the ones indicated in the <i>RAB Parameters</i> IE.		
>>Alternative Guaranteed Bit Rates	C - ifValueRangeorDiscreteValuesG BR	1 to <nr-Alternative Values>		For Value Range, one value limit is given here and the other given by Guaranteed Bit Rate in the <i>RAB Parameters</i> IE. For Discrete Values, 1 to 16 discrete values can be given.		
>>>Bit Rate	M	1 to <nr-Separate TrafficDirections>	INTEGER (1..16,000,000)	When nr-SeparateTrafficDirections is equal to 2, then the Bit Rate attribute for downlink is signalled first, then the Bit Rate attribute for uplink.		
>Alternative RAB Configuration	O		RAB Parameters 9.2.1.3	Indicates the possibility for RNC to request CN to execute the included alternative RAB configuration, e.g., for network-initiated SCUDIF purpose TS 23.172 [43].	YES	ignore
>Extended Alternative Guaranteed Bit Rate Information	O			Included only if negotiation is allowed for this IE.	YES	ignore
>>Type of Extended Alternative Guaranteed Bit	M		ENUMERATED (Unspecified, Value range, Discrete values)	Unspecified means that negotiation is allowed, but no alternative values are provided from the CN, i.e., the RNC is		

Rate Information				allowed to assign any value equal or below the ones indicated in the <i>RAB Parameters</i> IE.		
>>Extended Alternative Guaranteed Bit Rates	C - ifValueRangeorDiscreteValuesGBR	1 to <nr-Alternative Values		For Value Range, one value limit is given here and the other given by Extended Guaranteed Bit Rate in the <i>RAB Parameters</i> IE. For Discrete Values; 1 to 16 discrete values can be given.		
>>>Extended Bit Rate	M	1 to <nr-SeparateTrafficDirections>	INTEGER (16,000,001..256,000,000)	When nr-SeparateTrafficDirections is equal to 2, then the Bit Rate attribute for downlink is signalled first, then the Bit Rate attribute for uplink.		
>Extended Alternative Maximum Bit Rate Information	O			Included only if negotiation is allowed for this IE.	YES	ignore
>>Type of Extended Alternative Maximum Bit Rate Information	M		ENUMERATED (Unspecified, Value range, Discrete values)	Unspecified means that negotiation is allowed, but no alternative values are provided from the CN, i.e., the RNC is allowed to assign any value equal or below the ones indicated in the <i>RAB Parameters</i> IE.		
>>Extended Alternative Maximum Bit Rates	C - ifValueRangeorDiscreteValuesMBR	1 to <nr-Alternative Values>		For Value Range, one value limit is given here and the other given by Extended Maximum Bit Rate in the <i>RAB Parameters</i> IE. For Discrete Values; 1 to 16 discrete values can be given.		
>>>Extended Bit Rate	M	1 to <nr-SeparateTrafficDirections>	INTEGER (16,000,001..256,000,000)	When nr-SeparateTrafficDirections is equal to 2, then the Bit Rate attribute for downlink is signalled first, then the Bit Rate attribute for uplink.		
>Supported Alternative Maximum Bit Rate Information	O			Included only if negotiation is allowed for this IE.	EACH	reject
>>Type of Supported Alternative Maximum Bit Rate Information	M		ENUMERATED (Unspecified, Value range, Discrete values)	Unspecified means that negotiation is allowed, but no alternative values are provided from the CN, i.e., the RNC is allowed to assign any value equal or below the ones indicated in the <i>RAB Parameters</i> IE.	-	
>>Supported Alternative Maximum Bit Rates	C - ifValueRangeorDiscreteValuesGBR	1 to <nr-Alternative Values>		For Value Range, one value limit is given here and the other given by Supported Maximum Bit Rate in the <i>RAB Parameters</i> IE. For Discrete Values; 1 to 16 discrete values can be given.	-	
>>>Supported Bit Rate		1 to <nr-SeparateTrafficDirections>	INTEGER (1..1,000,000,000)	When nr-SeparateTrafficDirections is equal to 2, then the Supported Bit Rate attribute for downlink is	-	

				signalled first, then the Supported Bit Rate attribute for uplink.		
>Supported Alternative Guaranteed Bit Rate Information	O			Included only if negotiation is allowed for this IE.	EACH	reject
>>Type of Supported Alternative Guaranteed Bit Rate Information	M		ENUMERATED (Unspecified, Value range, Discrete values)	Unspecified means that negotiation is allowed, but no alternative values are provided from the CN, i.e., the RNC is allowed to assign any value equal or below the ones indicated in the <i>RAB Parameters IE</i> .	-	
>>Supported Alternative Guaranteed Bit Rates	C - ifValueRangeorDiscreteValuesGBR	1 to <nr-AlternativeValues>		For Value Range, one value limit is given here and the other given by Supported Guaranteed Bit Rate in the <i>RAB Parameters IE</i> . For Discrete Values; 1 to 16 discrete values can be given.	-	
>>>Supported Bit Rate		1 to <nr-SeparateTrafficDirections>	INTEGER (1..1,000,000,000)	When nr-SeparateTrafficDirections is equal to 2, then the Supported Bit Rate attribute for downlink is signalled first, then the Supported Bit Rate attribute for uplink.	-	

Range Bound	Explanation
nr-AlternativeValues	Maximum number of alternative values. Value is 1 in case of Value Range and 16 in case of Discrete Values.
nr-SeparateTrafficDirections	Number of Traffic Directions being signalled separately. Set to 2 if RAB asymmetry indicator is asymmetric bidirectional. Set to 1 in all other cases.

Condition	Explanation
ifValueRangeorDiscreteValuesMBR	This IE shall be present if the <i>Type of Alternative Maximum Bit Rates Information IE</i> is set to "Value range" or "Discrete values".
ifValueRangeorDiscreteValuesGBR	This IE shall be present if the <i>Type of Guaranteed Bit Rates Information IE</i> is set to "Value range" or "Discrete values".

9.2.1.44 Assigned RAB Parameter Values

The purpose of the *Assigned RAB Parameter Values IE* is to indicate that RAB QoS negotiation has been performed for certain RAB parameters and which values have been chosen.

IE/Group Name	Presence	Range	IE type and reference	Semantics description	Criticality	Assigned Criticality
Assigned RAB parameter values						
>Assigned Maximum Bit Rate	O	1 to <nbr-SeparateTrafficDirections>	INTEGER (1..16,000,000)	When nbr-SeparateTrafficDirections is equal to 2, then Assigned Maximum Bit Rate attribute for downlink is signalled first, then Assigned Maximum Bit Rate attribute for uplink.	-	
>Assigned Guaranteed Bit Rate	O	1 to <nbr-SeparateTrafficDirections>	INTEGER (0..16,000,000)	When nbr-SeparateTrafficDirections is equal to 2, then Assigned Guaranteed Bit Rate for downlink is signalled first, then Assigned Guaranteed Bit Rate for uplink.	-	
>Extended Assigned Maximum Bit Rate	O	1 to <nbr-SeparateTrafficDirections>	INTEGER (16,000,001..256,000,000)	When nbr-SeparateTrafficDirections is equal to 2, then Assigned Maximum Bit Rate attribute for downlink is signalled first, then Assigned Maximum Bit Rate attribute for uplink.	YES	reject
>Extended Assigned Guaranteed Bit Rate	O	1 to <nbr-SeparateTrafficDirections>	INTEGER (16,000,001..256,000,000)	When nbr-SeparateTrafficDirections is equal to 2, then Assigned Guaranteed Bit Rate for downlink is signalled first, then Assigned Guaranteed Bit Rate for uplink.	YES	reject
>Supported Assigned Maximum Bit Rate		0 to <nbr-SeparateTrafficDirections>	INTEGER (1..1,000,000,000, ...)	When nbr-SeparateTrafficDirections is equal to 2, then Supported Assigned Maximum Bit Rate attribute for downlink is signalled first, then Supported Assigned Maximum Bit Rate attribute for uplink.	YES	ignore
>Supported Assigned Guaranteed Bit Rate		0 to <nbr-SeparateTrafficDirections>	INTEGER (1..1,000,000,000, ...)	When nbr-SeparateTrafficDirections is equal to 2, then Supported Assigned Guaranteed Bit Rate for downlink is signalled first, then Supported Assigned Guaranteed Bit Rate for uplink.	YES	ignore

Range Bound	Explanation
nbr-SeparateTrafficDirections	Number of Traffic Directions being signalled separately. Set to 2 if RAB asymmetry indicator is asymmetric bidirectional. Set to 1 in all other cases.

9.2.1.45 Requested RAB Parameter Values

The purpose of *Requested RAB Parameter Values* IE is to either indicate the RAB parameters for which the included different values are being requested, or indicate that the execution of the alternative RAB configuration is requested.

IE/Group Name	Presence	Range	IE type and reference	Semantics description	Criticality	Assigned Criticality
Requested RAB Parameter Values						
>Requested Maximum Bit Rate	O	1 to <nr-SeparateTrafficDirections>	INTEGER (1..16,000,000)	When nr-SeparateTrafficDirections is equal to 2, Requested Maximum Bit Rate attribute for downlink is signalled first, then Requested Maximum Bit Rate attribute for uplink.	-	
>Requested Guaranteed Bit Rate	O	1 to <nr-SeparateTrafficDirections>	INTEGER (0..16,000,000)	When nr-SeparateTrafficDirections is equal to 2, Requested Guaranteed Bit Rate for downlink is signalled first, then Requested Guaranteed Bit Rate for uplink.	-	
>Alternative RAB Configuration Request	O		ENUMERATED (Alternative RAB configuration Requested, ...)	Indicates a request to trigger the execution of the alternative RAB Configuration e.g. for network-initiated SCUDIF purpose TS 23.172 [43].	-	
>Extended Requested Maximum Bit Rate	O	1 to <nr-SeparateTrafficDirections>	INTEGER (16,000,001..256,000,000)	When nr-SeparateTrafficDirections is equal to 2, Requested Maximum Bit Rate attribute for downlink is signalled first, then Requested Maximum Bit Rate attribute for uplink.	YES	reject
>Extended Requested Guaranteed Bit Rate	O	1 to <nr-SeparateTrafficDirections>	INTEGER (16,000,001..256,000,000)	When nr-SeparateTrafficDirections is equal to 2, Requested Guaranteed Bit Rate for downlink is signalled first, then Requested Guaranteed Bit Rate for uplink.	YES	reject
>Supported Requested Maximum Bit Rate		0 to <nr-SeparateTrafficDirections>	INTEGER (1..1,000,000,000, ...)	When nr-SeparateTrafficDirections is equal to 2, Supported Requested Maximum Bit Rate attribute for downlink is signalled first, then Supported Requested Maximum Bit Rate attribute for uplink.	YES	reject
>Supported Requested Guaranteed Bit Rate		0 to <nr-SeparateTrafficDirections>	INTEGER (1..1,000,000,000, ...)	When nr-SeparateTrafficDirections is equal to 2, Supported Requested Guaranteed Bit Rate for downlink is signalled first,	YES	reject

IE/Group Name	Presence	Range	IE type and reference	Semantics description	Criticality	Assigned Criticality
Requested RAB Parameter Values						
				then Supported Requested Guaranteed Bit Rate for uplink.		

Range bound	Explanation
nbr-SeparateTrafficDirections	Number of Traffic Directions being signalled separately. Set to 2 if RAB Asymmetry Indicator is asymmetric bidirectional. Set to 1 in all other cases.

9.2.1.46 Global CN-ID

Global CN-ID is used to globally identify a CN node.

IE/Group Name	Presence	Range	IE type and reference	Semantics description
PLMN identity	M		OCTET STRING (SIZE (3))	<ul style="list-style-type: none"> - digits 0 to 9, encoded 0000 to 1001, - 1111 used as filler digit, two digits per octet, - bits 4 to 1 of octet n encoding digit 2n-1, - bits 8 to 5 of octet n encoding digit 2n. <ul style="list-style-type: none"> - The PLMN identity consists of 3 digits from MCC followed by either <ul style="list-style-type: none"> - a filler digit plus 2 digits from MNC (in case of 2 digit MNC) or - 3 digits from MNC (in case of a 3 digit MNC).
CN-ID	M		INTEGER (0..4095)	

9.2.1.46a Vertical Accuracy Code

This element includes information about the requested vertical accuracy.

IE/Group Name	Presence	Range	IE type and reference	Semantics description
Vertical Accuracy Code	M		INTEGER (0..127)	The requested accuracy "v" is derived from the "accuracy code" k by $v = 45x(1.025^k - 1)$.

9.2.1.46b Response Time

This element includes information about the requested response time.

IE/Group Name	Presence	Range	IE type and reference	Semantics description
Response Time	M		ENUMERATED (Low Delay, Delay Tolerant, ...)	The value refers to TS 22.071 [30].

9.2.1.46c Positioning Priority

This element includes information about the requested positioning priority.

IE/Group Name	Presence	Range	IE type and reference	Semantics description
Positioning Priority	M		ENUMERATED(High Priority, Normal Priority, ...)	The value refers to TS 22.071 [30].

9.2.1.46d Client Type

This element includes information about the client type.

IE/Group Name	Presence	Range	IE type and reference	Semantics description
Client Type	M		ENUMERATED(Emergency Services, Value Added Services, PLMN Operator Services, Lawful Intercept Services, PLMN Operator - broadcast services, PLMN Operator - O&M, PLMN Operator - anonymous statistics, PLMN Operator - Target MS service support, ...)	Identifies the type of client.

9.2.1.47 New BSS to Old BSS Information

The coding of this element is described in TS 48.008 [11].

IE/Group Name	Presence	Range	IE type and reference	Semantics description
New BSS To Old BSS Information	M		OCTET STRING	Contents defined in TS 48.008 [11].

9.2.1.48 Inter-System Information Transparent Container

The *Inter-System Information Transparent Container* IE is an information element that is produced by the external relocation target system and is transmitted to a source RNC. This IE is transparent to the CN.

IE/Group Name	Presence	Range	IE type and reference	Semantics description
Downlink Cell Load Information	O		Cell Load Information 9.2.1.49	For the Downlink.
Uplink Cell Load Information	O		Cell Load Information 9.2.1.49	For the Uplink.

9.2.1.49 Cell Load Information

The *Cell Load Information* IE contains the load information of a specific (serving or target) cell for either the Downlink or the Uplink. If the RNC supports cell load-based inter-system handover, this information shall be understood, when available, as the current traffic load in the target cell if included in a RELOCATION PREPARATION FAILURE message, or the traffic load in the target cell assuming a successful completion of the handover in progress if included in a RELOCATION COMMAND message.

IE/Group Name	Presence	Range	IE type and reference	Semantics description
Cell Capacity Class Value	M		9.2.1.50	
Load Value	M		9.2.1.51	
RT Load Value	O		9.2.1.52	
NRT Load Information Value	O		9.2.1.53	

9.2.1.50 Cell Capacity Class Value

The *Cell Capacity Class Value* IE is the value that classifies the cell capacity with regards to the other cells. The *Cell Capacity Class Value* IE only indicates resources that are configured for traffic purposes.

IE/Group Name	Presence	Range	IE type and reference	Semantics description
Cell Capacity Class Value	M		INTEGER (1..100,...)	Value 1 shall indicate the minimum cell capacity, and 100 shall indicate the maximum cell capacity. There should be linear relation between cell capacity and Cell Capacity Class Value.

9.2.1.51 Load Value

The *Load Value* IE contains the total cell load relative to the maximum planned load. It is defined as the load percentage of the Cell Capacity Class.

IE/Group Name	Presence	Range	IE type and reference	Semantics description
Load Value	M		INTEGER (0..100)	Value 0 shall indicate the minimum load, and 100 shall indicate the maximum load. Load Value should be measured on a linear scale.

9.2.1.52 RT Load Value

The *RT Load Value* IE indicates in percents the ratio of the load generated by Real Time traffic relative to the measured Load Value. Real Time traffic corresponds to the Conversational and Streaming traffic classes.

IE/Group Name	Presence	Range	IE type and reference	Semantics description
RT Load Value	M		INTEGER (0..100)	

9.2.1.53 NRT Load Information Value

The *NRT Load Information Value* IE indicates the load situation on the cell for the Non Real-Time traffic. Non Real Time traffic corresponds to the Interactive and Background traffic classes.

IE/Group Name	Presence	Range	IE type and reference	Semantics description
NRT Load Information Value	M		INTEGER (0..3)	Mapping of the status: 0: low: The NRT load is low. 1: medium: The NRT load is medium. 2: high: NRT load is high. Probability to admit a new user is low. 3: overloaded: NRT overload. The probability to admit a new user is low, packets are discarded and the source is recommended to reduce the data flow.

9.2.1.54 Source RNC PDCP context info

The purpose of the *Source RNC PDCP context info* IE is to transfer RNC PDCP context information from a source RNC to a target RNC during an SRNS relocation.

This IE is transparent to CN.

IE/Group Name	Presence	Range	IE type and reference	Semantics description
RRC Container	M		OCTET STRING	

9.2.1.55 Information Transfer ID

Indicates the identity of an information transfer.

IE/Group Name	Presence	Range	IE type and reference	Semantics description
Information Transfer ID	M		INTEGER (0..2 ²⁰ -1)	

9.2.1.56 Provided Data

Provides the data that is transferred in an information transfer.

IE/Group Name	Presence	Range	IE type and reference	Semantics description
Choice Provided Data				
> SNA				
>>Shared Network Information	M		9.2.3.23	

9.2.1.57 GERAN Classmark

The purpose of the *GERAN Classmark* IE is to transfer GERAN-specific information to the CN.

IE/Group Name	Presence	Range	IE type and reference	Semantics description
GERAN Classmark	M		OCTET STRING	Contents defined in TS 48.008 [11].

9.2.1.58 GERAN BSC Container

The purpose of the *GERAN BSC Container* IE is to transfer GERAN-specific information from the CN to the GERAN.

IE/Group Name	Presence	Range	IE type and reference	Semantics description
GERAN BSC Container	M		OCTET STRING	Contents defined in TS 48.008 [11].

9.2.1.59 UESBI-Iu

The purpose of the *UESBI-Iu* IE is to transfer the UE Specific Behaviour Information as defined in TR 25.994 [31] and TR 25.995 [32] from the CN to the RNC.

IE/Group Name	Presence	Range	IE type and reference	Semantics description
UESBI-IuA	O		BIT STRING (1..128)	<p>The <i>UESBI-IuA</i> provides compliance status information about the UE with regards to specific behaviours described in TR 25.994 [31].</p> <p>TR 25.994 [31] defines the mapping between the descriptions in TR 25.994 [31] and the <i>UESBI-IuA</i>.</p> <p>Each bit on a certain position is associated with a certain behaviour described in TR 25.994 [31].</p>
UESBI-IuB	O		BIT STRING (1..128)	<p>The <i>UESBI-IuB</i> provides compliance status information about the UE with regards to specific behaviours described in TR 25.995 [32].</p> <p>TR 25.995 [32] defines the mapping between the descriptions in TR 25.995 [32] and the <i>UESBI-IuB</i>.</p> <p>Each bit on a certain position is associated with a certain behaviour described in TR 25.995 [32].</p>

9.2.1.60 Cell Load Information Group

The *Cell Load Information Group* IE is an information element that is produced by source system BSC and is transmitted to target system RNC via transparent containers. This IE contains the load information of the source cell for

either the Downlink or the Uplink or both as well as the source cell identifier the included cell load information corresponds to. If the RNC supports cell load-based inter-system handover, this information shall be understood, when available, as the current traffic load in the indicated source cell prior to the relocation.

IE/Group Name	Presence	Range	IE type and reference	Semantics description
Source Cell Identifier	M		9.2.1.61	The source cell identifier the downlink and uplink cell load information correspond to.
Downlink Cell Load Information	O		Cell Load Information 9.2.1.49	For the Downlink.
Uplink Cell Load Information	O		Cell Load Information 9.2.1.49	For the Uplink.

9.2.1.61 Source Cell Identifier

The *Source Cell Identifier* IE identifies the involved cell of the source system for the relocation of SRNS. The *Source Cell Identifier* IE may be e.g. source GERAN Source Cell ID (in case of GSM to UMTS relocation) or the UTRAN Source Cell ID (in case of UMTS to GSM relocation).

IE/Group Name	Presence	Range	IE type and reference	Semantics description
Choice Source Cell Identifier				
> GERAN				
>> GERAN Source Cell ID	M			
>>>PLMN identity	M		OCTET STRING (SIZE (3))	<ul style="list-style-type: none"> - digits 0 to 9, encoded 0000 to 1001, - 1111 used as filler digit, two digits per octet, - bits 4 to 1 of octet n encoding digit 2n-1, - bits 8 to 5 of octet n encoding digit 2n. <ul style="list-style-type: none"> - The PLMN identity consists of 3 digits from MCC followed by either <ul style="list-style-type: none"> - a filler digit plus 2 digits from MNC (in case of 2 digit MNC) or - 3 digits from MNC (in case of a 3 digit MNC).
>>>LAC	M		OCTET STRING (2)	0000 and FFFE not allowed.
>>>CI	M		OCTET STRING (2)	
> UTRAN				
>> UTRAN Source Cell ID	M			
>>>PLMN identity	M		OCTET STRING (SIZE (3))	<ul style="list-style-type: none"> - digits 0 to 9, encoded 0000 to 1001, - 1111 used as filler digit, two digits per octet, - bits 4 to 1 of octet n encoding digit 2n-1- bits 8 to 5 of octet n encoding digit 2n. <ul style="list-style-type: none"> - The PLMN identity consists of 3 digits from MCC followed by either <ul style="list-style-type: none"> - a filler digit plus 2 digits from MNC (in case of 2 digit MNC) or - 3 digits from MNC (in case of a 3 digit MNC).
>>>Source Cell ID	M		INTEGER (0..268435455)	This information element identifies a cell uniquely within UTRAN and consists of RNC-ID and C-ID as defined in TS 25.401 [3].

9.2.1.62 Inter-system Information Transfer Type

Indicates the type of information that the RNC requests to transfer.

IE/Group Name	Presence	Range	IE type and reference	Semantics description
Choice Inter-system Information Transfer Type				
> RIM				
>>RIM Transfer	M		9.2.3.30	

9.2.1.63 Information Transfer Type

Indicates the type of information that the RNC requests to transfer.

IE/Group Name	Presence	Range	IE type and reference	Semantics description
Choice Information Transfer Type				
>RNC Trace				
>>RNC Trace Session Information	M		9.2.1.64	

9.2.1.64 RNC Trace Session Information

Indicates the information on a Trace Session activated by Management in the RNC.

IE/Group Name	Presence	Range	IE type and reference	Semantics description
Trace Reference	M		9.2.1.8	
Trace Activation Indicator	M		ENUMERATED (Activated, Deactivated)	
Equipments To Be Traced	C-IfActivated		9.2.1.65	
Trace Recording Session Reference	O		9.2.1.67	
IMSI	O		OCTET STRING (SIZE (3..8))	<ul style="list-style-type: none"> - digits 0 to 9, encoded 0000 to 1001, - 1111 used as filler digit, two digits per octet, - bit 4 to 1 of octet n encoding digit 2n-1 - bit 8 to 5 of octet n encoding digit 2n <p>-Number of decimal digits shall be from 6 to 15 starting with the digits from the PLMN identity. When the IMSI is made of an odd number of digits, the filler digit shall be added at the end to make an even number of digits of length 2N. The filler digit shall then be consequently encoded as bit 8 to 5 of octet N.</p>

Condition	Explanation
ifActivated	This IE shall be present if the <i>Trace Activation Indicator</i> IE is set to "Activated".

9.2.1.65 Equipments To Be Traced

Indicates the UEs that the RNC has to trace using a list of Equipment Identities or a mask on an Equipment Identity.

IE/Group Name	Presence	Range	IE type and reference	Semantics description
Choice Equipments To Be Traced				
>IMEI List				
>>IMEI List		1 to <MaxUEsToBeTraced>		
>>>IMEI	M		OCTET STRING (SIZE (8))	<ul style="list-style-type: none"> - hexadecimal digits 0 to F, two hexadecimal digits per octet, - each hexadecimal digit encoded 0000 to 1111, - 1111 used as filler for bits 8 to 5 of last octet - bit 4 to 1 of octet n encoding digit 2n-1 - bit 8 to 5 of octet n encoding digit 2n <p>Number of hexadecimal digits shall be 15.</p>
>IMEISV List				
>>IMEISV List		1 to <MaxUEsToBeTraced>		
>>>IMEISV	M		OCTET STRING (SIZE (8))	<ul style="list-style-type: none"> - hexadecimal digits 0 to F, two hexadecimal digits per octet, - each hexadecimal digit encoded 0000 to 1111, - bit 4 to 1 of octet n encoding digit 2n-1 - bit 8 to 5 of octet n encoding digit 2n <p>Number of hexadecimal digits shall be 16.</p>
>IMEI Group				
>>IMEI	M		OCTET STRING (SIZE (8))	<ul style="list-style-type: none"> - hexadecimal digits 0 to F, two hexadecimal digits per octet, - each hexadecimal digit encoded 0000 to 1111, - 1111 used as filler for bits 8 to 5 of last octet - bit 4 to 1 of octet n encoding digit 2n-1 - bit 8 to 5 of octet n encoding digit 2n <p>Number of hexadecimal digits shall be 15.</p>
>>IMEI Mask	M		BIT STRING (SIZE (7))	
>IMEISV Group				
>>IMEISV	M		OCTET STRING (SIZE (8))	<ul style="list-style-type: none"> - hexadecimal digits 0 to F, two hexadecimal digits per octet, - each hexadecimal digit encoded 0000 to 1111, - bit 4 to 1 of octet n encoding digit 2n-1 - bit 8 to 5 of octet n encoding digit 2n <p>Number of hexadecimal digits shall be 16.</p>

>>IMEISV Mask			BIT STRING (SIZE (8))	
---------------	--	--	--------------------------	--

Range Bound	Explanation
MaxUEsToBeTraced	Maximum number of UEs To Be Traced by the RNC in a Trace Session. Value is 64.

The IMEI Group is identified by all the IMEI values whose digits 1 to 8 are equal to the corresponding digits of the *IMEI* IE and whose digits n+9 are equal to the corresponding digits of the *IMEI* IE if the bit bn of the *IMEI Mask* IE is equal to 1.

The IMEISV Group is identified by all the IMEISV values whose digits 1 to 8 are equal to the corresponding digits of the *IMEISV* IE and whose digits n+9 are equal to the corresponding digits of the *IMEI* IE if the bit bn of the *IMEISV Mask* IE is equal to 1.

9.2.1.66 Trace Recording Session Information

Provides the information on a Trace Record being generated in the Source RNC at the time of.

IE/Group Name	Presence	Range	IE type and reference	Semantics description
Trace Reference	M		9.2.1.8	
Trace Recording Session Reference	M		9.2.1.67	

9.2.1.67 Trace Recording Session Reference

Identifier of a Trace Record.

IE/Group Name	Presence	Range	IE type and reference	Semantics description
Trace Recording Session Reference	M		INTEGER (0..65535)	

9.2.1.68 Trace Propagation Parameters

Indicates the trace parameters to activate a trace session by a trace parameter propagation.

IE/Group Name	Presence	Range	IE type and reference	Semantics description
Trace Recording Session Reference	M		9.2.1.67	
Trace Depth	M		9.2.1.69	
List Of Interfaces To Trace	O		9.2.1.70	

9.2.1.69 Trace Depth

Indicates how detailed information should be recorded for this trace session in the RNC.

IE/Group Name	Presence	Range	IE type and reference	Semantics description
Trace Depth	M		ENUMERATED(Minimum, Medium, Maximum, ...)	See TS 32.422 [38].

9.2.1.70 List Of Interfaces To Trace

Indicates the interface(s) to be traced by RNC.

IE/Group Name	Presence	Range	IE type and reference	Semantics description
List Of Interfaces To Trace				
> Interfaces To Trace		1 to <maxInterfaces>		
>>Interface	M		ENUMERATED(lu-CS, lu-PS, lur, lub, Uu, ...)	

Range bound	Explanation
maxInterfaces	Maximum no. of different UTRAN interfaces to trace. The value for maxInterfaces is 16.

9.2.1.71 Information Exchange ID

Indicates the identity of an information exchange.

IE/Group Name	Presence	Range	IE type and reference	Semantics description
Information Exchange ID	M		INTEGER (0..2 ²⁰ -1)	

9.2.1.72 Information Exchange Type

Indicates the nature of the information exchange i.e. transfer or request of specific information.

IE/Group Name	Presence	Range	IE type and reference	Semantics description
Information Exchange Type	M		ENUMERATED(transfer, request, ...)	

9.2.1.73 Information Request Type

Indicates the type of information requested by the RNC.

IE/Group Name	Presence	Range	IE type and reference	Semantics description
Choice Information Request Type				
> MBMS IP MC Address and APN Request				
>>MBMS IP Multicast Address and APN Request	M		9.2.1.78	
> Permanent NAS UE ID				
>>Permanent NAS UE Identity	M		9.2.3.1	

9.2.1.74 Information Requested

Provides the RNC with the requested information.

IE/Group Name	Presence	Range	IE type and reference	Semantics description
Choice Information Requested				
> Requested MBMS IP MC Address and APN				
>>Requested MBMS IP Multicast Address and APN	M		9.2.3.46	
> Requested MC Service List				
>>Requested Multicast Service List	M		9.2.3.47	

9.2.1.75 PTP RAB ID

This element uniquely identifies a MBMS PTP radio bearer for a particular UE.

The value is used in the RNC to relate MBMS PTP Radio Bearers to a MBMS RAB. The content of this information element is transferred unchanged from the SGSN via the RNC to the UE by RANAP messages and RRC messages. For RRC messages refer to TS 25.331 [10].

The element contains binary representation of the Network Service Access Point Identifier (NSAPI). This identifier is coded in the PTP RAB ID element in accordance with the coding of the *NSAPI* IE in TS 24.008 [8].

IE/Group Name	Presence	Range	IE type and reference	Semantics description
PTP RAB ID	M		BIT STRING (8)	

9.2.1.76 Frequency Layer Convergence Flag

Indicates to the RNC the requirement to not apply Frequency Layer Convergence for a given MBMS Bearer Service.

IE/Group Name	Presence	Range	IE type and reference	Semantics description
Frequency Layer Convergence Flag	M		ENUMERATED (no-FLC-flag, ...)	

9.2.1.77 Session Update ID

Indicates the identity of a Session Update procedure.

IE/Group Name	Presence	Range	IE type and reference	Semantics description
Session Update ID	M		INTEGER (0..2 ²⁰ -1)	

9.2.1.78 MBMS IP Multicast Address and APN Request

Indicates the list of MBMS Bearer Services identified by their respective TMGIs, for which the IP Multicast Address and APN are requested by the RNC.

IE/Group Name	Presence	Range	IE type and reference	Semantics description
MBMS IP Multicast Address and APN Request				
>TMGI	M	1 to <maxnoofMulticastServicesPerRNC >	9.2.3.37	

Range bound	Explanation
maxnoofMulticastServicesPerRNC	Maximum no. of Multicast Services that a RNC can have context for. Value is 512.

9.2.1.79 Source BSS to Target BSS Transparent Container

The coding of this element is described in TS 48.018 [36].

IE/Group Name	Presence	Range	IE type and reference	Semantics description
Source BSS to Target BSS Transparent Container	M		OCTET STRING	Coded as the value (V) part of the <i>Source BSS to Target BSS Transparent Container</i> IE defined in TS 48.018 [36].

9.2.1.80 Target BSS to Source BSS Transparent Container

This IE contains information provided by the external inter-system handover target.

IE/Group Name	Presence	Range	IE type and reference	Semantics description
Target BSS to Source BSS Transparent Container	M		OCTET STRING	Coded as the value (V) part of the <i>Target BSS to Source BSS Transparent Container</i> IE defined in TS 48.018 [36].

9.2.1.81 Include Velocity

This element indicates that the Location Report may include the UE's velocity.

IE/Group Name	Presence	Range	IE type and reference	Semantics description
Include Velocity	M		ENUMERATED(requested)	

9.2.1.82 Periodic Location Info

The *Periodic Location Info* IE contains the periodic reporting interval and reporting amount for periodic location.

IE/Group Name	Presence	Range	IE Type and Reference	Semantics Description
Reporting Amount	M		INTEGER(1..8639999,...)	This IE indicates the amount of periodic reports.
Reporting Interval	M		INTEGER(1..8639999,...)	This IE indicates the reporting interval in seconds.

9.2.1.83 Last Visited UTRAN Cell Information

The Last Visited UTRAN Cell Information contains information about a cell that is to be used for RRM purposes.

IE/Group Name	Presence	Range	IE type and reference	Semantics description	Criticality	Assigned Criticality
UTRAN Cell ID		1			-	
>PLMN identity	M		OCTET STRING (SIZE (3))	- digits 0 to 9, encoded 0000 to 1001, - 1111 used as filler digit, two digits per octet, - bits 4 to 1 of octet n encoding digit 2n-1- bits 8 to 5 of octet n encoding digit 2n. - The PLMN identity consists of 3 digits from MCC followed by either - a filler digit plus 2 digits from MNC (in case of 2 digit MNC) or - 3 digits from MNC (in case of a 3 digit MNC).	-	
>Cell ID	M		INTEGER (0..268435455)	This information element identifies a cell uniquely within UTRAN and consists of RNC-ID and C-ID as defined in TS 25.401 [3].	-	
Cell Type	M		ENUMERATED(macro, micro, pico, femto, ...)	Defined in TS 25.104 [50].	-	
Time UE Stayed In Cell	M		INTEGER (0..4095)	The duration of the time the UE stayed in the cell in seconds. If the UE stays in a cell more than 4095s, this IE is set to 4095.	-	
Time UE stayed in Cell Enhanced Granularity	O		INTEGER (0..40950)	The duration of the time the UE stayed in the cell in 1/10 seconds. If the UE stays in a cell more than 4095s, this IE is set to 40950.	YES	ignore
HO Cause Value	O		9.2.1.4	The cause for the outgoing relocation.	YES	ignore

9.2.1.84 MBMS HC Indicator

This element indicates whether the payload of user data packets of the MBMS RAB are provided with compressed IP header. Respective information within SYNC-protocol data frames are defined in TS 25.446 [51].

IE/Group Name	Presence	Range	IE type and reference	Semantics description
MBMS HC Indicator	M		ENUMERATED (uncompressed header, compressed header, ...)	

9.2.1.85 CSG Id

This information element indicates the identifier of the Closed Subscriber Group, as defined in TS 23.003 [19].

IE/Group Name	Presence	Range	IE type and reference	Semantics description
CSG Id	M		BIT STRING (SIZE (27))	

9.2.1.86 Subscriber Profile ID for RAT/Frequency priority

The *Subscriber Profile ID* IE for RAT/Frequency Selection Priority is used to define camp priorities in Idle mode and to control inter-RAT/inter-frequency handover in Active mode TS 23.401 [48].

IE/Group Name	Presence	Range	IE type and reference	Semantics description
Subscriber Profile ID for RAT/Frequency Priority	M		INTEGER (1..256)	

9.2.1.87 SRVCC operation possible

This information element is set by the CN to provide an indication that both UE and CN are SRVCC-capable.

IE/Group Name	Presence	Range	IE type and reference	Semantics description
SRVCC operation possible	M		ENUMERATED (SRVCC possible,...)	

9.2.1.88 SRVCC HO Indication

This information element is set by the source RNC to provide an indication that RAB bearers may be subjected to handover via SRVCC means.

IE/Group Name	Presence	Range	IE type and reference	Semantics description
SRVCC HO Indication	M		ENUMERATED (PS and CS, CS only,...)	

9.2.1.89 SRVCC Information

This IE contains information for SRVCC operation.

IE/Group Name	Presence	Range	IE type and reference	Semantics description
SRVCC Information				
>NONCE	M		BIT STRING (128)	The usage of NONCE IE is described in TS 33.102 [60].

9.2.1.90 E-UTRAN Service Handover

This IE tells if intersystem mobility to E-UTRAN, e.g., handover or redirection, shall not be performed for a given RAB.

IE/Group Name	Presence	Range	IE type and reference	Semantics description
E-UTRAN Service Handover	M		ENUMERATED (Handover to E-UTRAN shall not be performed, ...)	

9.2.1.91 UE Aggregate Maximum Bit Rate

The *UE Aggregate Maximum Bitrate* IE is applicable for all non-GBR bearers per UE which is defined for the Downlink and the Uplink direction and provided by the CN to the RNC. At least one of the *UE Aggregate Maximum Bit Rate Downlink* IE and *UE Aggregate Maximum Bit Rate Uplink* IE shall be included in the *UE Aggregate Maximum Bit Rate* IE.

IE/Group Name	Presence	Range	IE type and reference	Semantics description
UE Aggregate Maximum Bit Rate				Desc: Applicable for non-GBR bearers
>UE Aggregate Maximum Bit Rate Downlink	O		INTEGER (1..1,000,000,000)	Desc.: This IE indicates the aggregated maximum number of bits delivered by UTRAN and to UTRAN in DL within a period of time, divided by the duration of the period for all non-GBR bearers in one UE. The MBR of non-GBR bearers shall be ignored if this IE present.
>UE Aggregate Maximum Bit Rate Uplink	O		INTEGER (1..1,000,000,000)	Desc.: This IE indicates the aggregated maximum number of bits delivered by UTRAN and to UTRAN in UL within a period of time, divided by the duration of the period for all non-GBR bearers in one UE. The MBR of non-GBR bearers shall be ignored if this IE present.

9.2.1.92 CSG Membership Status

This element indicates the Membership status of the UE to a particular CSG.

IE/Group Name	Presence	Range	IE type and reference	Semantics description
CSG Membership Status	M		ENUMERATED (member, non-member,...)	

9.2.1.93 Cell Access Mode

This information element indicates that the cell operates in Hybrid Access mode as defined in TS 22.220 [56].

IE/Group Name	Presence	Range	IE type and reference	Semantics description
Cell Access Mode	M		ENUMERATED (hybrid,...)	

9.2.1.94 Offload RAB Parameters

The purpose of the *Offload RAB parameters* IE is to provide information related to the handling of the SIPTO at Iu-PS function, as specified in TS 23.060 [21].

IE/Group Name	Presence	Range	IE type and reference	Semantics description
Access Point Name	M		OCTET STRING (1..255)	This IE indicates the Access Point Name of the RAB to be offloaded. Defined in TS 23.003 [19].
Charging Characteristics	M		OCTET STRING (2)	This IE indicates the charging characteristics of the RAB to be offloaded. Defined in TS 29.060 [57].

9.2.1.95 MSISDN

The purpose of the *MSISDN* IE (TS 29.060 [57]) is to indicate the primary MSISDN of the subscriber for the handling of the SIPTO at Iu-PS function, as specified in TS 23.060 [21].

IE/Group Name	Presence	Range	IE type and reference	Semantics description
MSISDN	M		OCTET STRING (SIZE (1..9))	Coded as the <i>MSISDN</i> IE, as defined in TS 29.002 [24].

9.2.1.96 IRAT Measurement Configuration

The *IRAT Measurement Configuration* IE contains information for instructing the incoming UE to continue measuring the cells of the source RAT after a successful inter-system handover. It is used by the source RAT to specify the minimum radio quality and the period of time measurements should last for triggering a HO report for unnecessary HO to another RAT. A subset of source RAT frequencies to measure may be specified. The measurement bandwidth of a carrier frequency may also be specified in order to improve the measurement accuracy and reduce measurement time. The *IRAT Measurement Configuration* IE shall contain at least one of the RSRP or RSRQ thresholds. If only one of the thresholds is present, the target RAT will use the present threshold to compare against the measurement results received from the UE. HO Report should be sent if there is either a single source RAT cell whose measurement results exceed the threshold for the whole measurement duration, or a group of source RAT cells together provide such coverage. The cells that exceed the threshold in the first UE measurement report are included in the HO Report. If both thresholds are present, the received radio measurements must exceed both the RSRP and the RSRQ thresholds in order to satisfy the indicated radio conditions.

When the HO Report is sent from RNC at the end of the configured measurement duration, it shall set the *HO Report Type* IE to "Unnecessary HO to another RAT". If the measurement period expires due to an inter-RAT handover towards LTE executed within the configured measurement duration, the RNC shall set the *HO Report Type* IE in the HO Report to "Early IRAT Handover".

No HO Report shall be sent in case no E-UTRAN cell could be included, or if the indicated period of time is interrupted by an inter-RAT handover to a RAT different than LTE or by an intra-UMTS handover with SRNC relocation.

IE/Group Name	Presence	Range	IE type and reference	Semantics description
RSRP	O		INTEGER (0..97)	Threshold of RSRP.
RSRQ	O		INTEGER (0..34)	Threshold of RSRQ.
IRAT Measurement Parameters	M			
>Measurement Duration	M		INTEGER (1..100)	The period of time following the successful IRAT handover, during which the target RAT instructs the UE to measure cells of the source RAT. Unit: [second].
>E-UTRA frequencies		0 to <maxnoofEUTRAFreqs>		If present, designates the specific E-UTRAN frequencies which the target RAT may instruct the UE to measure.
>>E-ARFCN	M		INTEGER (0..65535)	EARFCN of the downlink carrier frequency TS 36.101 [58].
>>Measurement Bandwidth	O		ENUMERATED(6,15,25,50,75,100)	Measurement bandwidth of the carrier frequency as defined in TS 25.331 [10].

Range bound	Explanation
maxnoofEUTRAFreqs	Maximum no of EUTRA centre frequencies to measure

9.2.1.97 MDT Configuration

The purpose of the *MDT Configuration* IE is to provide configuration information for the MDT function.

IE/Group Name	Presence	Range	IE type and reference	Semantics description	Criticality	Assigned Criticality
MDT Activation	M		ENUMERATED(Immediate MDT only, Logged MDT only, Immediate MDT and Trace, ...)		-	-
CHOICE MDT Area Scope	M				-	-
>Cell Based					-	-
>>Cell ID List		1 to <maxnoof CellID>			-	-
>>>Cell-ID	M	INTEGER (0..268435455)		This information element identifies a cell uniquely within UTRAN and consists of RNC-ID and C-ID as defined in TS 25.401 [3]. The Cell is derived using the current serving PLMN.	-	-
>LA Based					-	-
>>LAI List		1 to <maxnoof LAIs>			-	-
>>>LAI	M		9.2.3.6		-	-
>RA Based					-	-
>>RAI List		1 to <maxnoof RAIs>			-	-
>>>RAI				This element identifies an area in which the MDT Configuration applies.	-	-
>>>>LAI	M		9.2.3.6		-	-
>>>>RAC	M		9.2.3.7		-	-
>PLMN Area Based			NULL		-	-
CHOICE MDT mode					-	-
>immediate MDT					-	-
>>Measurements to Activate	M		BITSTRING (SIZE(8))	Each position in the bitmap indicates a MDT measurement, as defined in TS 37.320 [64]. First Bit = M1, Second Bit = M2, Third Bit = M3, Fourth Bit = M4, Fifth Bit = M5, Sixth Bit = M6, Seventh Bit = M7. Eighth bit = logging of M1 or M2 from event triggered measurement reports according to existing RRM configuration [31]. Value "1"	-	-

				indicates 'activate' and value "0" indicates 'do not activate'.		
>>M1 Report	C-ifM1		9.2.1.98	M1: FDD only: CPICH RSCP and CPICH Ec/No measurement by UE.	-	-
>>M2 Report	C-ifM2		9.2.1.99	M2: TDD only: P-CCPCH RSCP and Timeslot ISCP for UTRA 1.28 TDD.	-	-
>>M4 Report	C-ifM4		9.2.1.117	M4: UPH measurement by UE.	-	-
>>M5 Report	C-ifM5		9.2.1.118	M5: RTWP measurement by NodeB.	-	-
>>M6 Report	C-ifM6		9.2.1.119	M6: Data volume measurement by RNC.	-	-
>>M7 Report	C-ifM7		9.2.1.120	M7: Throughput measurement by RNC.	-	-
>logged MDT					-	-
>>logging interval	M		ENUMERATED (1.28, 2.56, 5.12, 10.24, 20.48, 30.72, 40.96 and 61.44, ...)	The unit of this IE is second. This IE is defined in TS 25.331[10].	-	-
>>logging duration	M		ENUMERATED (10, 20, 40, 60, 90 and 120, ...)	The unit of this IE is minute. This IE is defined in TS 25.331[10].	-	-
Signalling based MDT PLMN List			MDT PLMN List 9.2.1.116		YES	ignore

Range bound	Explanation
maxnoofCellID	Maximum no. of Cell ID subject for MDT scope. Value is 32.
maxnoofLAIs	Maximum no. of LAI subject for MDT scope. Value is 8.
maxnoofRAIs	Maximum no of RAI subject for MDT scope. Value is 8.

Condition	Explanation
ifM1	This IE shall be present if the <i>Measurements to Activate</i> IE has the first bit set to '1'.
ifM2	This IE shall be present if the <i>Measurements to Activate</i> IE has the second bit set to '1'.
ifM4	This IE shall be present if the <i>Measurements to Activate</i> IE has the fourth bit set to '1'.
ifM5	This IE shall be present if the <i>Measurements to Activate</i> IE has the fifth bit set to '1'.
ifM6	This IE shall be present if the <i>Measurements to Activate</i> IE has the sixth bit set to '1'.
ifM7	This IE shall be present if the <i>Measurements to Activate</i> IE has the seventh bit set to '1'.

9.2.1.98 M1 Report

This IE defines the parameters for M1 report, FDD report of UE radio measurements as specified in TS 32.422 [38].

IE/Group Name	Presence	Range	IE type and reference	Semantics description
CHOICE M1 Report trigger				
>Periodic				
>>MDT Report Parameters	M		9.2.1.100	
>event1F				
>>Measurement quantity	M		ENUMERATED(CPICH Ec/No, CPICH RSCP, pathloss, ...)	
>>threshold	M		INTEGER(-120...165)	Range used depends on measurement quantity. CPICH RSCP -120..-25 dBm CPICH Ec/No -24..0 dB Pathloss 30..165dB

9.2.1.99 M2 Report

This IE defines the parameters for a M2 report, TDD report of UE radio measurements as specified in TS 32.422 [38].

IE/Group Name	Presence	Range	IE type and reference	Semantics description
CHOICE M2 Report trigger				
>Periodic				
>>MDT Report Parameters	M		9.2.1.100	
>Event1I				
>>threshold	M		INTEGER(-120..-25)	

9.2.1.100 MDT Report parameters

This IE defines the report parameters for MDT periodic reports of measurements M1 and M2 as specified in TS 32.422 [38].

IE/Group Name	Presence	Range	IE type and reference	Semantics description
Report interval	M		ENUMERATED (ms250, ms500, ms1000, ms2000, ms3000, ms4000, ms6000, ms12000, ms16000, ms20000, ms24000, ms32000, ms64000, ...)	This IE is defined in TS 25.331[10].
Report amount	M		ENUMERATED (1, 2, 4, 8, 16, 32, 64, infinity, ...)	

9.2.1.101 RNSAP Relocation Parameters

This IE provides additional information for RNSAP Relocation.

IE/Group Name	Presence	Range	IE Type and Reference	Semantics Description
RAB Parameters List	O		9.2.1.102	
Location Reporting Transfer Information	O		9.2.1.105	
Trace Information	O		9.2.1.106	
Source SAI	O		SAI 9.2.3.9	

Range bound	Explanation
maxnoofRABs	Maximum no. of RABs for one UE. Value is 256.

9.2.1.102 RAB Parameters List

This IE provides RAB specific information for RNSAP Relocation.

IE/Group Name	Presence	Range	IE Type and Reference	Semantics Description
Relocation Parameters List		<i>1 to <maxnoof RABs></i>		
>RAB ID	M		9.2.1.2	
>CN Domain Indicator	M		9.2.1.5	
>RAB Data Volume Report	O		9.2.1.103	
>UP Information	O		9.2.1.104	

9.2.1.103 RAB Data Volume Report

This information element indicates the data volume (octets) and the time when it was counted that was unsuccessfully transmitted over the radio interface in the DL direction for a RAB.

IE/Group Name	Presence	Range	IE type and reference	Semantics description
RAB Data Volume Report				
>RAB Data Volume Report Item IEs		<i>1 to <maxnoofVol></i>		
>>Unsuccessfully Transmitted DL Data Volume	M		Unsuccessfully transmitted data volume 9.2.3.12	
>>Data Volume Reference	O		9.2.3.13	

Range bound	Explanation
maxnoofVol	Maximum no. of reported data volume for one RAB. Value is 2.

9.2.1.104 UP Information

Provides information to enable the UP operation to be continued from the target RNC.

Information Element/Group name	Presence	Range	IE Type and reference	Semantics description
Frame Sequence Number UL	M		Frame Sequence Number 9.2.1.107	
Frame Sequence Number DL	M		Frame Sequence Number 9.2.1.107	
PDU Type 14 Frame Sequence Number UL	M		PDU Type 14 Frame Sequence Number 9.2.1.108	
PDU Type 14 Frame Sequence Number DL	M		PDU Type 14 Frame Sequence Number 9.2.1.108	
Timing Difference UL-DL	O		OCTET STRING (1)	Coded as the <i>Time Alignment</i> IE in TS 25.415 [6]. Specifies the difference in time at the Source RNC between reception of the DL user data frame with the frame number indicated in the <i>Frame Sequence Number DL</i> IE and the transmission of the UL user data frame with the frame number indicated in the <i>Frame Sequence Number UL</i> IE.
Data PDU Type	M		ENUMERATED (PDU type 0, PDU type 1,...)	
UP Initialisation Frame	M		OCTET STRING	Coded as in TS 25.415 [6] subclause 6.6.23.4.1, Frame Payload Part only.

Range bound	Explanation
maxnoofRFCIs	Maximum no. of RFCIs for one RAB. Value is 63.
maxnoofSubFlows	Maximum no of Subflows for one RFCI. Value is 7

9.2.1.105 Location Reporting Transfer Information

The *Location Reporting Transfer Information* IE contains information about location reporting function requested and started in the Source RNC. Only Request Types for periodic reporting and reporting upon change of Service Area are contained.

IE/Group Name	Presence	Range	IE type and reference	Semantics description
Report Change of Service Area Indicator	O		ENUMERATED (requested, ...)	
Periodic Reporting Indicator	O		ENUMERATED (periodic SAI, periodic Geo, ...)	
Direct Reporting Indicator	O		ENUMERATED (direct SAI, direct Geo, ...)	
Vertical Accuracy Code	C- ifGeoRequested		9.2.1.46a	
Positioning Priority Change SAI	C-ifChangeSAI		Positioning Priority 9.2.1.46c	
Positioning Priority Direct	O		Positioning Priority 9.2.1.46c	May be included if direct reporting or reporting upon change of Service Area is requested.
Client Type Periodic	O		Client Type 9.2.1.46d	May be included if periodic reporting is requested.
Client Type Direct	O		Client Type 9.2.1.46d	Included if direct reporting of Geographical Area is requested. Maybe included if direct reporting of SAI is requested.
Response Time	C-ifDirectGeo		9.2.1.46b	
Include Velocity	O		9.2.1.81	May be included if the <i>Periodic Reporting Indicator</i> IE is set to 'Geo Requested'
Periodic Location Info	C-ifPeriodicGeo		9.2.1.82	

Condition	Explanation
IfGeoRequested	This IE shall be present if the <i>Periodic Reporting Indicator</i> IE is set to "periodic Geo" or if the Direct Reporting Indicator IE is set to "direct Geo".
IfChangeSAI	This IE shall be present if the <i>Periodic Reporting Indicator</i> IE is set to "periodic SAI" or if the Direct Reporting Indicator IE is set to "direct SAI".
IfPeriodicGeo	This IE shall be included if the <i>Periodic Reporting Indicator</i> IE is set to 'Geo Requested'
IfDirectGeo	This IE shall be present if the <i>Direct Reporting Indicator</i> IE is set to 'direct Geo'.

9.2.1.106 Trace Information

The Trace Information contains information needed by the target RNC to maintain trace continuity.

IE/Group Name	Presence	Range	IE type and reference	Semantics description
Trace Reference	M		9.2.1.8	
UE Identity	O		9.2.1.9	
Trace Propagation Parameters	O		9.2.1.68	

9.2.1.107 Frame Sequence Number

The *Frame Sequence Number* IE is used for RNSAP Relocation and contains information needed by the target RNC to maintain continuity for numbering IuUP user data frames of PDU type 0 and 1 (see TS 25.415 [16]).

Information Element/Group name	Presence	Range	IE Type and reference	Semantics description
Frame Sequence Number			INTEGER(0..15)	

9.2.1.108 PDU Type 14 Frame Sequence Number

The *PDU Type 14 Frame Sequence Number* IE is used for RNSAP Relocation and contains information needed by the target RNC to maintain continuity for numbering IuUP user data frames of PDU type 14 (see TS 25.415 [16]).

Information Element/Group name	Presence	Range	IE Type and reference	Semantics description
PDU Type 14 Frame Sequence Number			INTEGER(0..3)	

9.2.1.109 Priority Class Indicator

This information element indicates that overload has occurred and traffic for the indicated priority class should be reduced.

IE/Group Name	Presence	Range	IE type and reference	Semantics description
Priority Class Indicator	M		BIT STRING(SIZE(8))	Each bit represents a priority class, as specified below. If a bit is set to '1', the signalling traffic of the respective priority class should be reduced. Bit (0) = Delay Tolerant traffic limited. Bits (1..7) reserved for future use.

9.2.1.110 Management Based MDT Allowed

This element indicates that the UE may perform management based MDT.

IE/Group Name	Presence	Range	IE type and reference	Semantics description
Management Based MDT Allowed			ENUMERATED (Allowed, ...)	

9.2.1.111 End Of CSFB

This element indicates that the Iu connection being released was established as a result of CS fallback.

IE/Group Name	Presence	Range	IE type and reference	Semantics description
End Of CSFB			ENUMERATED (end Of CSFB, ...)	

9.2.1.112 Out Of UTRAN

This element indicates that the UE has already moved from UTRAN.

IE/Group Name	Presence	Range	IE type and reference	Semantics description
Out Of UTRAN			ENUMERATED (cell reselection to EUTRAN, ...)	

9.2.1.113 Voice Support Match Indicator

This element indicates if the SRVCC and frequency supported by the UE match those the network relies upon for voice coverage.

IE/Group Name	Presence	Range	IE type and reference	Semantics description
Voice Support Match Indicator	M		ENUMERATED(Supported, Not Supported, ...)	

9.2.1.114 rSRVCC HO Indication

This information element is set by the source RNC to provide an indication that RAB bearers may be subjected to handover via rSRVCC means.

IE/Group Name	Presence	Range	IE type and reference	Semantics description
rSRVCC HO Indication	M		ENUMERATED (PS only, ...)	

9.2.1.115 rSRVCC Information

This IE contains information for rSRVCC operation.

IE/Group Name	Presence	Range	IE type and reference	Semantics description
rSRVCC Information				
>NONCE	M		BIT STRING (128)	The usage of NONCE IE is described in TS 33.102 [60] and in TS 33.401 [63].
>IMS information	M		Octet String(SIZE(1..32))	The usage of IMS information is described in TS 23.216 [54].

9.2.1.116 MDT PLMN List

The purpose of the *MDT PLMN List* IE is to provide the list of PLMN allowed for MDT.

IE/Group Name	Presence	Range	IE type and reference	Semantics description
MDT PLMN List		<i>1..<maxnoofMDTPLMNs></i>		
>PLMN Identity	M		Selected PLMN Identity 9.2.3.33	

Range bound	Explanation
maxnoofMDTPLMNs	Maximum no. of MDT PLMN Ids. Value is 16.

9.2.1.117 M4 Report

This IE defines the parameters for UE Power Headroom (M4) measurement collection.

IE/Group Name	Presence	Range	IE type and reference	Semantics description
CHOICE Collection mode				
>All				All available measurements are logged
>Periodic and event triggered periodic				One sample collected per period
>>M4 Collection period	M		ENUMERATED(ms100, ms250, ms500, ms1000, ms2000, ms3000, ms4000, ms6000, ...)	
>>M4 Threshold	O		INTEGER(0..31)	If included, logging shall be initiated when UPH value falls below the indicated threshold, and then for each period, until UPH value goes above the threshold. The mapping is defined in TS25.123 (TDD) and TS25.133 (FDD).

9.2.1.118 M5 Report

This IE defines the parameters for RTWP (M5) measurement collection.

IE/Group Name	Presence	Range	IE type and reference	Semantics description
CHOICE Collection mode				
>When available				All available measurements are logged
>Periodic				One sample collected per period
>>M5 Collection period	M		ENUMERATED(ms100, ms250, ms500, ms1000, ms2000, ms3000, ms4000, ms6000, ...)	

9.2.1.119 M6 Report

This IE defines the parameters for data volume (M6) measurement collection.

IE/Group Name	Presence	Range	IE type and reference	Semantics description
M6 Collection Period	M		ENUMERATED (ms1000, ms2000, ms3000, ms4000, ms6000, ms8000, ms12000, ms16000, ms20000, ms24000, ms28000, ms32000, ms64000, ...)	
M6 Links to log	M		ENUMERATED(uplink, downlink, both-uplink-and-downlink, ...)	

9.2.1.120 M7 Report

This IE defines the parameters for data volume (M7) measurement collection.

IE/Group Name	Presence	Range	IE type and reference	Semantics description
M7 Collection Period	M		ENUMERATED (ms1000, ms2000, ms3000, ms4000, ms6000, ms8000, ms12000, ms16000, ms20000, ms24000, ms28000, ms32000, ms64000, ...)	
M7 Links to log	M		ENUMERATED(uplink, downlink, both-uplink-and-downlink, ...)	

9.2.2 Transport Network Layer Related IEs

9.2.2.1 Transport Layer Address

For the PS domain, or for the CS domain in order to allow transport bearer establishment without ALCAP, this information element is an IP address to be used for the user plane transport. For the CS domain, in case of transport bearer establishment with ALCAP, this address is to be used for Transport Network Control Plane signalling to set up the transport bearer.

IE/Group Name	Presence	Range	IE type and reference	Semantics description
Transport Layer Address	M		BIT STRING (1..160, ...)	The Radio Network Layer is not supposed to interpret the address information. It should pass it to the transport layer for interpretation. For details on the Transport Layer Address, see ref. TS 25.414 [9].

9.2.2.2 Iu Transport Association

This element is used to associate the RAB and the corresponding transport bearer. For the CS domain this information element is either the Binding ID to be used in Transport Network Control Plane signalling during set up of the transport bearer or it contains the UDP port in order to allow transport bearer establishment without ALCAP. In PS domain this information element is the GTP Tunnel Endpoint Identifier.

IE/Group Name	Presence	Range	IE type and reference	Semantics description
Choice Iu Transport Association				
>TEID				
>>GTP TEID	M		OCTET STRING (4)	For details and range, see TS 29.281 [59]
>Binding ID				
>>Binding ID	M		OCTET STRING (4)	If the Binding ID includes an UDP port, the UDP port is included in octet 1 and 2. The first octet of the UDP port field shall be included in the first octet of the Binding ID.

9.2.2.3 DL GTP-PDU Sequence Number

This IE indicates the sequence number of the GTP-PDU which is the next to be sent to the UE.

IE/Group Name	Presence	Range	IE type and reference	Semantics description
DL GTP-PDU Sequence Number	M		INTEGER (0..65535)	This IE indicates the sequence number of the GTP-PDU which is next to be sent to the UE.

9.2.2.4 UL GTP-PDU Sequence Number

This IE indicates the sequence number of the GTP-PDU which is the next to be sent to the SGSN.

IE/Group Name	Presence	Range	IE type and reference	Semantics description
UL GTP-PDU Sequence Number	M		INTEGER (0..65535)	This IE indicates the sequence number of the GTP-PDU which is next to be sent to the SGSN.

9.2.2.5 Correlation ID

This IE contains the GTP Tunnel Endpoint Identifier or GRE key to be used for the user plane transport between RNC and the L-GW as specified in TS 23.401 [48].

IE/Group Name	Presence	Range	IE type and reference	Semantics description
Correlation ID	M		OCTET STRING (4)	

9.2.2.6 Tunnel Information

The *Tunnel Information* IE indicates the transport layer address and UDP port number

IE/Group Name	Presence	Range	IE type and reference	Semantics description
Transport Layer Address	M		9.2.2.1	HNB's Transport Layer Address.
UDP Port Numbers	O		OCTET STRING (2)	UDP Port Numbers if NAT/NAPT is deployed in the BBF access network.

9.2.3 NAS Related IEs

9.2.3.1 Permanent NAS UE Identity

This element is used to identify the UE commonly in the UTRAN and in the CN. The RNC uses it to find other existing signalling connections of the same UE (e.g. RRC or Iu signalling connections). It is an IMSI.

NOTE: IMSI is specified in TS 23.003 [19].

IE/Group Name	Presence	Range	IE type and reference	Semantics description
Choice Permanent NAS UE Identity				
> IMSI				
>>IMSI			OCTET STRING (SIZE (3..8))	<ul style="list-style-type: none"> - digits 0 to 9, encoded 0000 to 1001, - 1111 used as filler digit, two digits per octet, - bit 4 to 1 of octet n encoding digit 2n-1, - bit 8 to 5 of octet n encoding digit 2n. <p>- Number of decimal digits shall be from 6 to 15 starting with the digits from the PLMN identity.</p> <p>When the IMSI is made of an odd number of digits, the filler digit shall be added at the end to make an even number of digits of length 2N. The filler digit shall then be consequently encoded as bit 8 to 5 of octet N.</p>

9.2.3.2 Temporary UE ID

Temporary Mobile Subscriber Identity, used for security reasons to hide the identity of a subscriber.

IE/Group Name	Presence	Range	IE type and reference	Semantics description
Choice Temporary UE ID				
> TMSI				
>>TMSI	M		OCTET STRING (4)	
> P-TMSI				
>>P-TMSI	M		OCTET STRING (4)	

9.2.3.3 Paging Cause

This element indicates the cause for paging a UE.

IE/Group Name	Presence	Range	IE type and reference	Semantics description
Paging Cause	M		ENUMERATED(Terminating Conversational Call, Terminating Streaming Call, Terminating Interactive Call, Terminating Background Call, Terminating Low Priority Signalling, ..., Terminating High Priority Signalling)	

9.2.3.4 NAS Broadcast Information

Void

9.2.3.5 NAS PDU

This information element contains a CN – UE or UE – CN message that is transferred without interpretation in the RNC. Typically it contains call control, session management, supplementary services, short message service and mobility management messages.

IE/Group Name	Presence	Range	IE type and reference	Semantics description
NAS PDU	M		OCTET STRING	

9.2.3.6 LAI

This element is used to uniquely identify a Location Area.

IE/Group Name	Presence	Range	IE type and reference	Semantics description
PLMN identity	M		OCTET STRING (SIZE (3))	<ul style="list-style-type: none"> - digits 0 to 9, encoded 0000 to 1001, - 1111 used as filler digit, two digits per octet, - bits 4 to 1 of octet n encoding digit 2n-1, - bits 8 to 5 of octet n encoding digit 2n. <ul style="list-style-type: none"> - The PLMN identity consists of 3 digits from MCC followed by either <ul style="list-style-type: none"> - a filler digit plus 2 digits from MNC (in case of 2 digit MNC) or - 3 digits from MNC (in case of a 3 digit MNC).
LAC	M		OCTET STRING (2)	0000 and FFFE not allowed.

9.2.3.7 RAC

This element is used to identify a Routing Area within a Location Area. It is used for PS services.

IE/Group Name	Presence	Range	IE type and reference	Semantics description
RAC	M		OCTET STRING (1)	

9.2.3.8 SAPI

The *SAPI* IE is used to indicate the specific service to provide for the included NAS message.

IE/Group Name	Presence	Range	IE type and reference	Semantics description
SAPI	M		ENUMERATED (SAPI 0, SAPI 3, ...)	

9.2.3.9 SAI

The *SAI* IE (Service Area Identifier) (see ref. TS 25.401 [3]) is used to identify an area consisting of one or more cells belonging to the same Location Area. Such an area is called a Service Area and can be used for indicating the location of a UE to the CN. For this protocol, only a Service Area that is defined to be applicable to both the PS and the CS domains shall be used.

IE/Group Name	Presence	Range	IE type and reference	Semantics description
PLMN identity	M		OCTET STRING (SIZE (3))	<ul style="list-style-type: none"> - digits 0 to 9, encoded 0000 to 1001, - 1111 used as filler digit, two digits per octet, - bits 4 to 1 of octet n encoding digit 2n-1, - bits 8 to 5 of octet n encoding digit 2n. <ul style="list-style-type: none"> - The PLMN identity consists of 3 digits from MCC followed by either <ul style="list-style-type: none"> - a filler digit plus 2 digits from MNC (in case of 2 digit MNC) or - 3 digits from MNC (in case of a 3 digit MNC).
LAC	M		OCTET STRING (2)	0000 and FFFE not allowed.
SAC	M		OCTET STRING (2)	

9.2.3.10 Area Identity

This information element is used for indicating the location of a UE and is either a Service Area or a Geographical Area.

IE/Group Name	Presence	Range	IE type and reference	Semantics description
Choice Area Identity				
> SAI				
>>SAI	M		9.2.3.9	
> Geo				
>>Geographical Area	M		9.2.3.11	

9.2.3.11 Geographical Area

The *Geographical Area* IE is used to identify an area using geographical coordinates. The reference system is the same as the one used in TS 23.032 [20].

IE/Group Name	Presence	Range	IE type and reference	Semantics description
Choice Geographical Area				
> Point				
>>Point	M		See below	Ellipsoid point.
> Point With Uncertainty				
>>Point With Uncertainty	M		See below	Ellipsoid point with uncertainty circle.
> Polygon				
>>Polygon	M		See below	List of Ellipsoid points.
> Ellipsoid point with uncertainty Ellipse				
>>Ellipsoid point with uncertainty Ellipse	M		See below	Ellipsoid point with uncertainty Ellipse.
> Ellipsoid point with altitude				
>>Ellipsoid point with altitude	M		See below	Ellipsoid point with altitude.
> Ellipsoid point with altitude and uncertainty Ellipsoid				
>>Ellipsoid point with altitude and uncertainty Ellipsoid	M		See below	Ellipsoid point with altitude and uncertainty Ellipsoid.
> Ellipsoid Arc				
>>Ellipsoid Arc	M		See below	Ellipsoid Arc.

IE/Group Name	Presence	Range	IE type and reference	Semantics description
Point				
>Geographical Coordinates	M		See below	

IE/Group Name	Presence	Range	IE type and reference	Semantics description
Point With Uncertainty				
>Geographical Coordinates	M		See below	
>Uncertainty Code	M		INTEGER (0..127)	The uncertainty "r" is derived from the "uncertainty code" k by $r = 10x(1.1^k - 1)$.

IE/Group Name	Presence	Range	IE type and reference	Semantics description
Polygon				
>Geographical Coordinates	M	1 to <maxnoofPoints>	See below	

Range bound	Explanation
maxnoofPoints	Maximum no. of points in polygon. Value is 15.

IE/Group Name	Presence	Range	IE type and reference	Semantics description
Ellipsoid point with uncertainty Ellipse				
>Geographical Coordinates	M		See below	
>Uncertainty Ellipse	M		See below	
>Confidence	M		INTEGER (0..127)	

IE/Group Name	Presence	Range	IE type and reference	Semantics description
Ellipsoid point with altitude				
>Geographical Coordinates	M		See below	
>Altitude and direction	M		See below	

IE/Group Name	Presence	Range	IE type and reference	Semantics description
Ellipsoid point with altitude and uncertainty Ellipsoid				
>Geographical Coordinates	M		See below	
>Altitude and direction	M		See below	
>Uncertainty Ellipse	M		See below	
>Uncertainty Altitude	M		INTEGER (0..127)	
>Confidence	M		INTEGER (0..127)	

IE/Group Name	Presence	Range	IE type and reference	Semantics description
Ellipsoid Arc				
>Geographical Coordinates	M		See below	
>Inner radius	M		INTEGER (0..2 ¹⁶ -1)	The relation between the value (N) and the radius (r) in meters it describes is $5N \leq r < 5(N+1)$, except for $N=2^{16}-1$ for which the range is extended to include all greater values of (r).
>Uncertainty radius	M		INTEGER (0..127)	The uncertainty "r" is derived from the "uncertainty code" k by $r = 10 \times (1.1^k - 1)$.
>Offset angle	M		INTEGER (0..179)	The relation between the value (N) and the angle (a) in degrees it describes is $2N \leq a < 2(N+1)$.
>Included angle	M		INTEGER (0..179)	The relation between the value (N) and the angle (a) in degrees it describes is $2N < a \leq 2(N+1)$.
>Confidence	M		INTEGER (0..127)	

IE/Group Name	Presence	Range	IE type and reference	Semantics description
Geographical Coordinates				
>Latitude Sign	M		ENUMERATED (North, South)	
>Degrees Of Latitude	M		INTEGER (0..2 ²³ -1)	The IE value (N) is derived by this formula: $N \leq 2^{23} \times X / 90 < N+1$ X being the latitude in degree (0°.. 90°).
>Degrees Of Longitude	M		INTEGER (-2 ²³ ..2 ²³ -1)	The IE value (N) is derived by this formula: $N \leq 2^{24} \times X / 360 < N+1$ X being the longitude in degree (-180°..+180°).

IE/Group Name	Presence	Range	IE type and reference	Semantics description
Uncertainty Ellipse				
>Uncertainty semi-major	M		INTEGER (0..127)	The uncertainty "r" is derived from the "uncertainty code" k by $r = 10x(1.1^k - 1)$.
>Uncertainty semi-minor	M		INTEGER (0..127)	The uncertainty "r" is derived from the "uncertainty code" k by $r = 10x(1.1^k - 1)$.
>Orientation of major axis	M		INTEGER (0..179)	The relation between the IE value (N) and the angle (a) in degrees it describes is $2N \leq a < 2(N+1)$. The values 90..179 shall not be used.

IE/Group Name	Presence	Range	IE type and reference	Semantics description
Altitude and direction				
>Direction of Altitude	M		ENUMERATED (Height, Depth)	
>Altitude	M		INTEGER (0..2 ¹⁵ -1)	The relation between the value (N) and the altitude (a) in meters it describes is $N \leq a < N+1$, except for $N=2^{15}-1$ for which the range is extended to include all greater values of (a).

9.2.3.12 Unsuccessfully Transmitted Data Volume

This information element indicates the data volume (octets) that is unsuccessfully transmitted over the radio interface in the DL direction for a given RAB.

IE/Group Name	Presence	Range	IE type and reference	Semantics description
Unsuccessfully Transmitted Data Volume	M		INTEGER (0..2 ³² -1)	Unit is octet.

9.2.3.13 Data Volume Reference

This information element indicates the time when the data volume is counted. It is an operator/vendor specific matter to assign meanings for the different integer values.

IE/Group Name	Presence	Range	IE type and reference	Semantics description
Data Volume Reference	M		INTEGER (0..255)	

9.2.3.14 Information Identity

Void

9.2.3.15 Information Priority

Void

9.2.3.16 Information Control

Void

9.2.3.17 CN Broadcast Area

Void

9.2.3.18 NAS Synchronisation Indicator

This information element contains transparent NAS information that is transferred without interpretation in the RNC.

IE/Group Name	Presence	Range	IE type and reference	Semantics description
NAS Synchronisation Indicator	M		BIT STRING (4)	The coding of this IE, transparent for RNC, is described in the subclause "Speech Codec Selection" of TS 24.008 [8].

9.2.3.19 Location Related Data Request Type

This element indicates the type of the requested location related data for the indicated positioning method, and provides the assistance data for the Assisted GPS positioning method.

IE/Group Name	Presence	Range	IE type and reference	Semantics description
Requested Location Related Data Type	M		ENUMERATED(Deciphering Keys for UE Based OTDOA, Deciphering Keys for Assisted GPS, Dedicated Assistance Data for UE Based OTDOA, Dedicated Assistance Data for Assisted GPS, ..., Deciphering keys for Assisted GANSS, Dedicated Assistance Data for Assisted GANSS, Deciphering keys for Assisted GPS and GANSS, Dedicated Assistance Data for Assisted GPS and GANSS)	
Requested GPS Assistance Data	C – ifDedAssGPS		9.2.3.21	

Condition	Explanation
ifDedAssGPS	This IE shall be present if the <i>Requested Location Related Data Type</i> IE is set to "Dedicated Assistance Data for Assisted GPS" or "Dedicated Assistance Data for Assisted GPS and GANSS".

9.2.3.20 Broadcast Assistance Data Deciphering keys

This information element is used for indicating the deciphering keys that will be used by the UE for deciphering of broadcast assistance data.

IE/Group Name	Presence	Range	IE type and reference	Semantics description
Ciphering Key Flag	M		BIT STRING (SIZE(1))	Indicates the current Ciphering Key Flag that is used for the broadcast assistance data messages in the location area.
Current Deciphering key	M		BIT STRING (SIZE(56))	Current deciphering key that is used for deciphering broadcast assistance data.
Next Deciphering key	M		BIT STRING (SIZE(56))	Next deciphering key that will be used for deciphering broadcast assistance data.

9.2.3.21 Requested GPS Assistance Data

This information element is used for indicating the requested GPS assistance data.

This IE is transparent to CN.

IE/Group Name	Presence	Range	IE type and reference	Semantics description
Requested GPS Assistance Data			OCTET STRING (SIZE(1..38))	For the corresponding Information Element Definition see "gpsAssistanceData" TS 24.080 [22].

9.2.3.22 Last Known Service Area

This information element is used for indicating the last known Service Area and the elapsed time since the UE was known to be in this Service Area. The last known Service Area is reported when the current Service Area is unknown to the RNC.

IE/Group Name	Presence	Range	IE type and reference	Semantics description
SAI	M		9.2.3.9	
Age of SAI	M		INTEGER (0..32767)	The value represents the elapsed time in minutes since the reported last known SAI was stored by the RNC. Value "0" shall not be used. Value "32767" indicates that the age of SAI is at least 32767 minutes old.

9.2.3.23 Shared Network Information

For each LA contained in this IE, it provides the SNA(s) the LA belongs to.

IE/Group Name	Presence	Range	IE type and reference	Semantics description
PLMNs In Shared Network		1 to <maxPLMNsSN>		
>PLMN identity	M		OCTET STRING (SIZE (3))	<ul style="list-style-type: none"> - digits 0 to 9, two digits per octet, - each digit encoded 0000 to 1001, - 1111 used as filler - bit 4 to 1 of octet n encoding digit 2n-1, - bit 8 to 5 of octet n encoding digit 2n. <ul style="list-style-type: none"> - The PLMN identity consists of 3 digits from MCC followed by either - a filler plus 2 digits from MNC (in case of 2 digit MNC) or - 3 digits from MNC (in case of a 3 digit MNC).
>LA List		1 to <maxLAs>		
>>LAC	M		OCTET STRING (2)	0000 and FFFE not allowed.
>>List Of SNAs Containing LA		1 to <maxSNAs>		
>>>SNAC	M		9.2.3.25	

Range bound	Explanation
maxPLMNsSN	Maximum no. of PLMNs involved in a Shared Network agreement. The value for maxPLMNsSN is 32.
maxLAs	Maximum no. of LAs in a PLMN. The value for maxLAs is 65536.
maxSNAs	Maximum no. of SNAs in a PLMN. The value for maxSNAs is 65536.

9.2.3.24 SNA Access Information

Provides information on the area(s) in the PLMN(s) the UE is authorised to access.

IE/Group Name	Presence	Range	IE type and reference	Semantics description
Authorised PLMNs		1 to <maxPLMNsSN>		
>PLMN Identity	M		OCTET STRING (SIZE (3))	<ul style="list-style-type: none"> - digits 0 to 9, two digits per octet, - each digit encoded 0000 to 1001, - 1111 used as filler, - bit 4 to 1 of octet n encoding digit 2n-1, - bit 8 to 5 of octet n encoding digit 2n. <ul style="list-style-type: none"> - The PLMN identity consists of 3 digits from MCC followed by either <ul style="list-style-type: none"> - a filler plus 2 digits from MNC (in case of 2 digit MNC) or - 3 digits from MNC (in case of a 3 digit MNC).
>Authorised SNAs List	O			
>>Authorised SNAs		1 to <maxSNAs>		
>>>SNAC	M		9.2.3.25	

Range bound	Explanation
maxPLMNsSN	Maximum no. of PLMNs involved in a Shared Network agreement. The value for maxPLMNsSN is 32.
maxSNAs	Maximum no. of SNAs in a PLMN. The value for maxSNAs is 65536.

9.2.3.25 SNAC

Indicates the Identity of an SNA according to TS 23.003 [19].

IE/Group Name	Presence	Range	IE type and reference	Semantics description
SNAC	M		INTEGER (0..65535)	

9.2.3.26 Location Related Data Request Type Specific To GERAN Iu Mode

This element indicates the type of the requested location related data for the indicated specific positioning method supported only within GERAN Iu mode.

IE/Group Name	Presence	Range	IE type and reference	Semantics description
Location Related Data Request Type Specific To GERAN lu mode			ENUMERATED(Deciphering Keys for E-OTD, Dedicated Mobile-Assisted E-OTD Assistance Data, Dedicated Mobile-Based E-OTD Assistance Data, ...)	

9.2.3.27 Position Data

This IE provides data related to the positioning methods in relation with the Location Report procedure.

IE/Group Name	Presence	Range	IE type and reference	Semantics description	Criticality	Assigned Criticality
Positioning Data Discriminator	M		BIT STRING (4)	<p>The positioning data discriminator defines the type of data provided for each positioning method:</p> <p>0000 indicates the presence of the <i>Positioning Data Set</i> IE (that reports the usage of each non-GANSS method that was successfully used to obtain the location estimate);</p> <p>0001 indicates the presence of the <i>GANSS Positioning Data Set</i> IE (that reports the usage of each GANSS method that was successfully used to obtain the location estimate) and the absence of the <i>Positioning Data Set</i> IE.</p> <p>1 octet of data is provided for each positioning method included.</p> <p>All other values are reserved.</p>	–	
Positioning Data Set	C- ifDiscriminator=0				–	
>Positioning Method and Usage		1 to <maxSet >	OCTET STRING (1)	<p>Coding of positioning method (bits 8-4): 00000 Reserved (NOTE); 00001 Reserved (NOTE); 00010 Reserved (NOTE); 00011 Reserved (NOTE); 00100 Reserved (NOTE); 00101 Mobile Assisted GPS; 00110 Mobile Based GPS; 00111 Conventional GPS; 01000 U-TDOA; 01001 OTDOA; 01010 IPDL; 01011 RTT; 01100 Cell ID; 01101 to 01111 reserved for other location technologies; 10000 to 11111 reserved for network specific positioning methods.</p> <p>Coding of usage (bits 3-1): 000 Attempted unsuccessfully due to failure or interruption - not used. 001 Attempted successfully: results not used to generate location - not used.</p>	–	

				<p>010 Attempted successfully: results used to verify but not generate location - not used.</p> <p>011 Attempted successfully: results used to generate location.</p> <p>100 Attempted successfully: case where MS supports multiple mobile based positioning methods and the actual method or methods used by the MS cannot be determined.</p> <p>NOTE: Reserved because of GERAN use only.</p>		
GANSS Positioning Data Set	O				YES	ignore
>GANSS Positioning Method and Usage		1 to <maxGANSSSet>	OCTET STRING (1)	<p>Coding of positioning method (bits 8-7):</p> <p>00 MS-Based;</p> <p>01 MS-Assisted;</p> <p>10 Conventional;</p> <p>11 Reserved.</p> <p>Coding of GANSS ID (bits 6-4):</p> <p>000 Galileo;</p> <p>001 SBAS;</p> <p>010 Modernized GPS;</p> <p>011 QZSS;</p> <p>100 GLONASS;</p> <p>other values reserved.</p> <p>Coding of usage (bits 3-1):</p> <p>011 Attempted successfully: results used to generate location;</p> <p>100 Attempted successfully: case where MS supports multiple mobile based positioning methods and the actual method or methods used by the MS cannot be determined.</p>	-	

Condition	Explanation
C-ifDiscriminator=0	This IE is present if the Positioning Data Discriminator IE is set to "0000".

Range bound	Explanation
maxSet	Maximum size of the data set. Value is 9.
maxGANSSSet	Maximum size of the data. Value is 9.

9.2.3.28 Position Data Specific To GERAN Iu Mode

This IE provides data related to the positioning methods which are supported only within GERAN Iu mode in relation with the Location Report procedure. The coding of this element is described in TS 49.031 [34].

IE/Group Name	Presence	Range	IE type and reference	Semantics description
Position Data Specific To GERAN lu Mode	M		OCTET STRING	Coded as the value part of the <i>Positioning Data</i> IE or <i>GANSS Positioning Data</i> IE defined in TS 49.031 [34].

9.2.3.29 Accuracy Fulfilment Indicator

This IE indicates whether the returned position estimate satisfies the requested accuracy or not.

IE/Group Name	Presence	Range	IE type and reference	Semantics description
Accuracy Fulfilment Indicator	M		ENUMERATED (requested accuracy fulfilled, requested accuracy not fulfilled, ...)	

9.2.3.30 RIM Transfer

This IE contains the RIM Information (e.g. NACC information) and additionally in uplink transfer the RIM routing address of the destination of this RIM information.

IE/Group Name	Presence	Range	IE type and reference	Semantics description
RIM Information	M		9.2.3.31	
RIM Routing Address	O		9.2.3.32	

9.2.3.31 RIM Information

This IE contains the RIM Information (e.g. NACC information) i.e. the BSSGP RIM PDU from the RIM application part contained in the RNC, or the BSSGP RIM PDU to be forwarded to the RIM application part in the RNC.

IE/Group Name	Presence	Range	IE type and reference	Semantics description
RIM Information	M		OCTET STRING	Contains the BSSGP RIM PDU as defined in ref TS 48.018 [36].

9.2.3.32 RIM Routing Address

This IE identifies the destination node where the RIM Information needs to be routed by the CN.

IE/Group Name	Presence	Range	IE type and reference	Semantics description	Criticality	Assigned Criticality
Choice RIM Routing Address					-	
>Target RNC-ID						
>>Target RNC-ID	M			Applicable to GERAN Iu mode, not applicable to UTRAN.	-	
>>>LAI	M		9.2.3.6		-	
>>>RAC	O		9.2.3.7		-	
>>>RNC-ID	M		INTEGER (0..4095)	If the <i>Extended RNC-ID</i> IE is included in the <i>Target RNC-ID</i> IE, the <i>RNC-ID</i> IE shall be ignored.	-	
>>>Extended RNC-ID	O		9.2.1.39a	The <i>Extended RNC-ID</i> IE shall be used if the RNC identity has a value larger than 4095.	YES	reject
>GERAN-Cell-ID						
>>GERAN-Cell-ID	M				-	
>>>LAI	M		9.2.3.6		-	
>>>RAC	M		9.2.3.7		-	
>>>CI	M		OCTET STRING (2)		-	
>Target eNB-ID						
>>Target eNB-ID	M				-	
>>>PLMN identity	M		OCTET STRING (SIZE (3))	<ul style="list-style-type: none"> - digits 0 to 9, encoded 0000 to 1001, - 1111 used as filler digit, two digits per octet, - bits 4 to 1 of octet n encoding digit 2n-1, - bits 8 to 5 of octet n encoding digit 2n. - The PLMN identity consists of 3 digits from MCC followed by either - a filler digit plus 2 digits from MNC (in case of 2 digit MNC) or - 3 digits from MNC (in case of a 3 digit MNC). 		
>>>CHOICE eNB ID						
>>>>Macro eNB ID			BIT STRING (20)	Equal to the 20 leftmost bits of the <i>Cell Identity</i> IE contained in the <i>E-UTRAN CGI</i> IE (see TS 36.413 [49]) of each cell served by the eNodeB.	-	
>>>>Home eNB ID			BIT STRING (28)	Equal to the <i>Cell Identity</i> IE contained in the <i>E-UTRAN CGI</i> IE (see	-	

				TS 36.413 [49]) of the cell served by the eNodeB. NOTE: Inter-system route to a Home eNB is only supported for Enhanced CS Fallback purpose in this release.		
>>>Selected TAI	M		9.2.1.30C	Contains the TAC of the target cell and the PLMN selected for that target cell.	-	

9.2.3.33 Selected PLMN Identity

This information element indicates the selected core network operator in shared networks.

IE/Group Name	Presence	Range	IE type and reference	Semantics description
Selected PLMN identity	M		OCTET STRING (SIZE (3))	<ul style="list-style-type: none"> - digits 0 to 9, encoded 0000 to 1001, - 1111 used as filler digit, two digits per octet, - bits 4 to 1 of octet n encoding digit 2n-1, - bits 8 to 5 of octet n encoding digit 2n. <ul style="list-style-type: none"> - The Selected PLMN identity consists of 3 digits from MCC followed by either <ul style="list-style-type: none"> - a filler digit plus 2 digits from MNC (in case of 2 digit MNC) or - 3 digits from MNC (in case of a 3 digit MNC).

9.2.3.34 NAS Sequence Number

This IE is transparent for UTRAN.

IE/Group Name	Presence	Range	IE type and reference	Semantics description
NAS Sequence Number	M		BIT STRING (SIZE(2))	Contains the value of the N(SD) as defined in TS 24.008 [8].

9.2.3.35 Redirection Completed

This IE indicates to RNC that the redirection is completed.

Direction: CN → RNC

IE/Group Name	Presence	Range	IE type and reference	Semantics description
Redirection Completed	M		ENUMERATED (redirection completed, ...)	

9.2.3.36 Redirection Indication

This IE is used by a CN to request rerouting by the RNC to another CN operator. It is only used in MOCN configuration for network sharing non-supporting UEs.

IE/Group Name	Presence	Range	IE type and reference	Semantics description	Criticality	Assigned Criticality
Initial NAS-PDU	M		9.2.3.5	The initial NAS-PDU received from UE	YES	ignore
Reject Cause Value	M		ENUMERATED (PLMN not allowed, location area not allowed, roaming not allowed in this location area, no suitable cell in location area, GPRS services not allowed in this PLMN, CS/PS coordination required, ...)	This IE lists cause values which meaning is defined in TS 24.008 [8] with the exception of "CS/PS coordination required" that will never be forwarded to the UE.	YES	ignore
NAS Sequence Number	O		9.2.3.34		YES	ignore
Permanent NAS UE Identity	O		9.2.3.1		YES	ignore

9.2.3.37 TMGI

The TMGI uniquely identifies the MBMS Bearer Service.

IE/Group Name	Presence	Range	IE type and reference	Semantics description
PLMN identity	M		OCTET STRING (SIZE (3))	<ul style="list-style-type: none"> - digits 0 to 9, encoded 0000 to 1001, - 1111 used as filler digit, two digits per octet, - bits 4 to 1 of octet n encoding digit 2n-1, - bits 8 to 5 of octet n encoding digit 2n. <ul style="list-style-type: none"> - The PLMN identity consists of 3 digits from MCC followed by either <ul style="list-style-type: none"> - a filler digit plus 2 digits from MNC (in case of 2 digit MNC) or - 3 digits from MNC (in case of a 3 digit MNC).
Service ID	M		OCTET STRING (SIZE (3))	

9.2.3.38 MBMS Session Identity

The MBMS Session Identity identifies the session of a MBMS Bearer Service in UTRAN and is used by the UE to recognise repetitions of a session.

This IE is transparent to RAN.

IE/Group Name	Presence	Range	IE type and reference	Semantics description
MBMS Session Identity	M		OCTET STRING (SIZE (1))	Coded as the <i>MBMS Session Identity</i> IE, as defined in TS 29.061 [44].

9.2.3.39 MBMS Bearer Service Type

Indicates the type of the MBMS Bearer Service.

IE/Group Name	Presence	Range	IE type and reference	Semantics description
MBMS Bearer Service Type	M		ENUMERATED (multicast, broadcast, ...)	

9.2.3.39a MBMS Counting Information

Indicates to the RNC whether MBMS Counting procedures can be applied in MBMS Broadcast Mode.

IE/Group Name	Presence	Range	IE type and reference	Semantics description
MBMS Counting Information	M		ENUMERATED (counting, not counting, ...)	

9.2.3.40 MBMS Session Duration

This IE defines the duration of the MBMS Session.

IE/Group Name	Presence	Range	IE type and reference	Semantics description
MBMS Session Duration	M		OCTET STRING (SIZE (3))	Coded as the value part of MBMS-Session-Duration AVP as defined in TS 29.061 [44].

9.2.3.41 MBMS Service Area

The MBMS Service Area IE consists of a list of one or several MBMS Service Area Identities where each MBMS Service Area Identity is frequency agnostic and can be mapped onto one or more cells.

IE/Group Name	Presence	Range	IE type and reference	Semantics description
MBMS Service Area	M		OCTET STRING	Value part coded per MBMS Service Area AVP as defined in TS 29.061 [44].

9.2.3.42 RA List of Idle Mode UEs

Indicates the list of RAs where idle-mode UEs interested in a given Multicast Service are.

IE/Group Name	Presence	Range	IE type and reference	Semantics description	Criticality	Assigned Criticality
Choice RA List of Idle Mode UEs						
>Not Empty RA List of Idle Mode UEs				The same RAC+LAI combination must only be present once.		
>>RA of Idle Mode UEs		1 to <maxMBMSRA>		Each RAC in this list gives a valid RAI only if combined with an LAI of the same index contained in the LA of Idle Mode UEs IE.		
>>RAC	M		9.2.3.7			
>>LA List of Idle Mode UEs	C-IfRAofIdleModeUEs				YES	reject
>>>LA of Idle Mode UEs		1 to <maxMBMSRA>				
>>>>LAI	M		9.2.3.6		-	
>Empty/Full RA List of Idle Mode UEs						
>>Empty/Full RA List of Idle Mode UEs			ENUMERATED (emptylist, fulllist,...)			

Range bound	Explanation
maxMBMSRA	Maximum no. of Routing Areas where idle-mode UEs interested in a given Multicast Service are. The value for maxMBMSRA is 65536.

Condition	Explanation
IfRAofIdleModeUEs	This IE shall be present if the RA of Idle Mode UEs IE is included.

9.2.3.43 Delta RA List of Idle Mode UEs

Indicates the list of new RAs where idle-mode UEs interested in a given Multicast Service became or moved to, as well as the list of RAs where there is no interested idle-mode UEs in a given Multicast Service any longer.

IE/Group Name	Presence	Range	IE type and reference	Semantics description	Criticality	Assigned Criticality
Delta RA List of Idle Mode UEs				The same RAC+LAI combination must only be present once.		
>New RA List of Idle Mode UEs	O					
>>New RA of Idle Mode UEs		1 to <maxMB MSRA>		Each RAC in this list gives a valid RAI only if combined with an LAI of the same index contained in the LA of Idle Mode UEs IE.		
>>>RAC	M		9.2.3.7			
>RA List with No Idle Mode UEs Any More	O					
>>RA with No Idle Mode UEs Any More		1 to <maxMB MSRA>		Each RAC in this list gives a valid RAI only if combined with an LAI of the same index contained in the LA of Idle Mode UEs IE.		
>>>RAC	M		9.2.3.7			
>New LA List of Idle Mode UEs	C-IfNewRAListofIdleModeUEs				YES	reject
>>New LA of Idle Mode UEs		1 to <maxMB MSRA>				
>>>LAI	M		9.2.3.6			
>LA List with No Idle Mode UEs Any More	C-IfRAListWithNoIdleModeUEsAnyMore				YES	reject
>>LA with No Idle Mode UEs Any More		1 to <maxMB MSRA>				
>>>LAI	M		9.2.3.6			

Range bound	Explanation
maxMBMSRA	Maximum no. of Routing Areas where idle-mode UEs interested in a given Multicast Service are. The value for maxMBMSRA is 65536.

Condition	Explanation
IfNewRAListofIdleModeUEs	This IE shall be present if the <i>New RA List of Idle Mode UEs</i> IE is included.
IfRAListWithNoIdleModeUEsAnyMore	This IE shall be present if the <i>RA List with No Idle Mode UEs Any More</i> IE is included.

9.2.3.44 MBMS CN De-Registration

Indicates whether the MBMS Session Stop procedure is a normal Session Stop or a total de-registration for a given MBMS Bearer Service.

IE/Group Name	Presence	Range	IE type and reference	Semantics description
MBMS CN De-Registration	M		ENUMERATED(normal session stop, deregister, ...)	

9.2.3.45 MBMS Registration Request Type

Indicates the type of the MBMS Registration Request.

IE/Group Name	Presence	Range	IE type and reference	Semantics description
MBMS Registration Request Type	M		ENUMERATED(register, deregister, ...)	

9.2.3.46 Requested MBMS IP Multicast Address and APN

Informs the RNC about the requested pairs of IP Multicast Address and APN.

IE/Group Name	Presence	Range	IE type and reference	Semantics description
MBMS IP Multicast Address and APN list		1 to <maxnoofMulticastServicesPerRNC>		
>TMGI	M		9.2.3.37	
>IP Multicast Address	M		OCTET STRING (4..16)	Transparent information to RAN. Octet string size 4 represents Ipv4 address. Octet string size 16 represents Ipv6 address.
>APN	M		OCTET STRING (1..255)	Transparent information to RAN.

Range bound	Explanation
maxnoofMulticastServicesPerRNC	Maximum no. of Multicast Services that a RNC can have context for. Value is 512.

9.2.3.47 Requested Multicast Service List

Informs the RNC about the requested Multicast Service list for a particular UE.

IE/Group Name	Presence	Range	IE type and reference	Semantics description
TMGI	M	1 to <maxnoofMulticastServicesJoinedPerUE>	9.2.3.37	The same TMGI must only be present once.

Range bound	Explanation
maxnoofMulticastServicesJoinedPerUE	Maximum no. of Multicast Services that a UE can join respectively. Value is 128.

9.2.3.48 MBMS Session Repetition Number

Informs the RNC about the repetitions of a particular session of a MBMS Bearer Service.

IE/Group Name	Presence	Range	IE type and reference	Semantics description
MBMS Session Repetition Number	M		OCTET STRING (SIZE (1))	Coded as the value part of MBMS-Session - Repetition-Number AVP as defined in TS 29.061 [44].

9.2.3.49 Time to MBMS Data Transfer

This IE denotes the time occurring between the transmission of the MBMS SESSION START message to the RNS and the actual start of the data transfer. The coding of this element is described in TS 48.018 [36].

IE/Group Name	Presence	Range	IE type and reference	Semantics description
Time to MBMS Data Transfer	M		OCTET STRING (SIZE (1))	Coded as the value part of <i>Time to MBMS Data Transfer</i> IE defined in TS 48.018 [36].

9.2.3.50 Redirect Attempt Flag

This IE indicates that the CN should respond with a *Redirection Indication* IE or a *Redirection completed* IE.

IE/Group Name	Presence	Range	IE type and reference	Semantics description
Redirect Attempt Flag	M		NULL	

9.2.3.51 Velocity Estimate

The *Velocity Estimate* IE is used to describe the UE's velocity. The reference system is the same as used in TS 23.032 [20].

IE/Group Name	Presence	Range	IE type and reference	Semantics description
Choice Velocity Estimate				
> Horizontal Velocity				
>> Horizontal Velocity	M		See below	Horizontal speed and bearing (the direction of travel).
> Horizontal with Vertical Velocity				
>> Horizontal with Vertical Velocity	M		See below	Horizontal speed, bearing (the direction of travel), and vertical speed.
> Horizontal Velocity with Uncertainty				
>> Horizontal Velocity with Uncertainty	M		See below	Horizontal speed, bearing (the direction of travel), and the uncertainty of the reported speed.
> Horizontal with Vertical Velocity and Uncertainty				
>> Horizontal with Vertical Velocity and Uncertainty	M		See below	Horizontal speed, bearing (the direction of travel), vertical speed and the uncertainty of the reported speed.

IE/Group Name	Presence	Range	IE type and reference	Semantics description
Horizontal Velocity				
>Horizontal Speed and Bearing	M		See below	

IE/Group Name	Presence	Range	IE type and reference	Semantics description
Horizontal with Vertical Velocity				
>Horizontal Speed and Bearing	M		See below	
>Vertical Velocity	M		See below	

IE/Group Name	Presence	Range	IE type and reference	Semantics description
Horizontal Velocity with Uncertainty				
>Horizontal Speed and Bearing	M		See below	
>>Uncertainty Speed	M		INTEGER (0..255)	Uncertainty speed is encoded in increments of 1 kilometer per hour using an 8 bit binary coded number (N). The value of N gives the uncertainty speed except for N=255 which indicates that the uncertainty is not specified.

IE/Group Name	Presence	Range	IE type and reference	Semantics description
Horizontal with Vertical Velocity and Uncertainty				
>Horizontal Speed and Bearing	M		See below	
>>Vertical Velocity	M		See below	
>>Horizontal Uncertainty Speed	M		INTEGER (0..255)	Horizontal Uncertainty Speed is encoded in increments of 1 kilometer per hour using an 8 bit binary coded number (N). The value of N gives the uncertainty speed except for N=255 which indicates that the uncertainty is not specified.
>>Vertical Uncertainty Speed	M		INTEGER (0..255)	Vertical Uncertainty speed is encoded in increments of 1 kilometer per hour using an 8 bit binary coded number (N). The value of N gives the uncertainty speed except for N=255 which indicates that the uncertainty is not specified.

IE/Group Name	Presence	Range	IE type and reference	Semantics description
Horizontal Speed and Bearing				
>Bearing	M		INTEGER (0..359)	The direction of movement is given in degrees where "0" represents North, "90" represents East, etc.
>Horizontal Speed	M		INTEGER (0.. $2^{11}-1$)	The relationship between (N) and the horizontal speed (h) in kilometers per hour it describes is: $N \leq h < N + 0.5$ (N=0) $N - 0.5 \leq h < N + 0.5$ ($0 < N < 2^{11}-1$) $N - 0.5 \leq h$ (N = $2^{11}-1$).

IE/Group Name	Presence	Range	IE type and reference	Semantics description
Vertical Velocity				
>Vertical Speed	M		INTEGER (0.. 2^8-1)	The relationship between (N) and the vertical speed (v) in kilometers per hour it describes is: $N \leq v < N + 0.5$ (N = 0) $N - 0.5 \leq v < N + 0.5$ ($0 < N < 2^8-1$) $N - 0.5 \leq v$ (N = 2^8-1).
>Vertical Speed Direction	M		ENUMERATED (upward, downward)	

9.2.3.52 RAT Type

Indicates the RAT from which the context request originates.

IE/Group Name	Presence	Range	IE type and reference	Semantics description
RAT Type	O		ENUMERATED(UTRAN, GERAN, ...)	GERAN means GERAN Gb mode. UTRAN means UTRAN but may also include GERAN lu mode.

9.2.3.53 Requested GANSS Assistance Data

This information element is used for indicating the requested GANSS assistance data.

This IE is transparent to CN.

IE/Group Name	Presence	Range	IE type and reference	Semantics description
Requested GANSS Assistance Data			OCTET STRING (SIZE(1..201))	For the corresponding Information Element Definition see "ganssAssistanceData" TS 24.080 [22].

9.2.3.54 Higher bitrates than 16 Mbps flag

This information element indicates whether the UE is capable of handling NAS QoS extensions introduced in Rel-7, or not. See also TS 23.060 [21].

IE/Group Name	Presence	Range	IE type and reference	Semantics description
Higher bitrates than 16 Mbps flag			ENUMERATED (allowed, not-allowed, ...)	

9.3 Message and Information Element Abstract Syntax (with ASN.1)

9.3.0 General

RANAP ASN.1 definition conforms with ITU-T Rec. X.680 [14] and ITU-T Rec. X.681 [15].

The ASN.1 definition specifies the structure and content of RANAP messages. RANAP messages can contain any IEs specified in the object set definitions for that message without the order or number of occurrence being restricted by ASN.1. However, for this version of the standard, a sending entity shall construct a RANAP message according to the PDU definitions module and with the following additional rules:

- IEs shall be ordered (in an IE container) in the order they appear in object set definitions..
- Object set definitions specify how many times IEs may appear. An IE shall appear exactly once if the presence field in an object has value "mandatory". An IE may appear at most once if the presence field in an object has value "optional" or "conditional". If in a tabular format there is multiplicity specified for an IE (i.e. an IE list) then in the corresponding ASN.1 definition the list definition is separated into two parts. The first part defines an IE container list where the list elements reside. The second part defines list elements. The IE container list appears as an IE of its own. For this version of the standard an IE container list may contain only one kind of list elements.

NOTE: 'IE' means an IE in the object set with an explicit id. If one IE needed to appear more than once in one object set, then the different occurrences have different IE IDs.

If a RANAP message that is not constructed as defined above is received, this shall be considered as Abstract Syntax Error, and the message shall be handled as defined for Abstract Syntax Error in subclause 10.3.6.

Subclause 9.3 presents the Abstract Syntax of RANAP protocol with ASN.1. In case there is contradiction between the ASN.1 definition in this subclause and the tabular format in subclause 9.1 and 9.2, the ASN.1 shall take precedence, except for the definition of conditions for the presence of conditional elements, where the tabular format shall take precedence.

9.3.1 Usage of private message mechanism for non-standard use

The private message mechanism for non-standard use may be used:

- for special operator- (and/or vendor) specific features considered not to be part of the basic functionality, i.e. the functionality required for a complete and high-quality specification in order to guarantee multivendor interoperability;
- by vendors for research purposes, e.g. to implement and evaluate new algorithms/features before such features are proposed for standardisation.

The private message mechanism shall not be used for basic functionality. Such functionality shall be standardised.

9.3.2 Elementary Procedure Definitions

-- *****

```
--
-- Elementary Procedure definitions
--
-- *****

RANAP-PDU-Descriptions {
itu-t (0) identified-organization (4) etsi (0) mobileDomain (0)
umts-Access (20) modules (3) ranap (0) version1 (1) ranap-PDU-Descriptions (0)}

DEFINITIONS AUTOMATIC TAGS ::=

BEGIN

-- *****
--
-- IE parameter types from other modules.
--
-- *****

IMPORTS
    Criticality,
    ProcedureCode
FROM RANAP-CommonDataTypes

    Iu-ReleaseCommand,
    Iu-ReleaseComplete,
    RelocationCommand,
    RelocationPreparationFailure,
    RelocationRequired,
    RelocationRequest,
    RelocationRequestAcknowledge,
    RelocationFailure,
    RelocationCancel,
    RelocationCancelAcknowledge,
    EnhancedRelocationCompleteRequest,
    EnhancedRelocationCompleteResponse,
    EnhancedRelocationCompleteFailure,
    EnhancedRelocationCompleteConfirm,
    SRNS-ContextRequest,
    SRNS-ContextResponse,
    SecurityModeCommand,
    SecurityModeComplete,
    SecurityModeReject,
    DataVolumeReportRequest,
    DataVolumeReport,
    Reset,
    ResetAcknowledge,
    RAB-ReleaseRequest,
    Iu-ReleaseRequest,
    RelocationDetect,
    RelocationComplete,
    Paging,
    CommonID,
    CN-InvokeTrace,
```

CN-DeactivateTrace,
LocationReportingControl,
LocationReport,
InitialUE-Message,
DirectTransfer,
Overload,
ErrorIndication,
SRNS-DataForwardCommand,
ForwardSRNS-Context,
RAB-AssignmentRequest,
RAB-AssignmentResponse,
RAB-ModifyRequest,
PrivateMessage,
ResetResource,
ResetResourceAcknowledge,
RANAP-RelocationInformation,
RANAP-EnhancedRelocationInformationRequest,
RANAP-EnhancedRelocationInformationResponse,
LocationRelatedDataRequest,
LocationRelatedDataResponse,
LocationRelatedDataFailure,
InformationTransferIndication,
InformationTransferConfirmation,
InformationTransferFailure,
UESpecificInformationIndication,
DirectInformationTransfer,
UplinkInformationExchangeRequest,
UplinkInformationExchangeResponse,
UplinkInformationExchangeFailure,
MBMSSessionStart,
MBMSSessionStartResponse,
MBMSSessionStartFailure,
MBMSSessionUpdate,
MBMSSessionUpdateResponse,
MBMSSessionUpdateFailure,
MBMSSessionStop,
MBMSSessionStopResponse,
MBMSUELinkingRequest,
MBMSUELinkingResponse,
MBMSRegistrationRequest,
MBMSRegistrationResponse,
MBMSRegistrationFailure,
MBMSCNDe-RegistrationRequest,
MBMSCNDe-RegistrationResponse,
MBMSRABEstablishmentIndication,
MBMSRABReleaseRequest,
MBMSRABRelease,
MBMSRABReleaseFailure,
SRVCC-CSKeysRequest,
SRVCC-CSKeysResponse,
UeRadioCapabilityMatchRequest,
UeRadioCapabilityMatchResponse
FROM RANAP-PDU-Contents

```
id-LocationRelatedData,  
id-CN-DeactivateTrace,  
id-CN-InvokeTrace,  
id-CommonID,  
id-DataVolumeReport,  
id-DirectTransfer,  
id-ErrorIndication,  
id-ForwardSRNS-Context,  
id-InformationTransfer,  
id-InitialUE-Message,  
id-Iu-Release,  
id-Iu-ReleaseRequest,  
id-LocationReport,  
id-LocationReportingControl,  
id-OverloadControl,  
id-Paging,  
id-privateMessage,  
id-RAB-Assignment,  
id-RAB-ReleaseRequest,  
id-RAB-ModifyRequest,  
id-RANAP-Relocation,  
id-RANAPenhancedRelocation,  
id-RelocationCancel,  
id-RelocationComplete,  
id-RelocationDetect,  
id-RelocationPreparation,  
id-RelocationResourceAllocation,  
id-enhancedRelocationComplete,  
id-enhancedRelocationCompleteConfirm,  
id-Reset,  
id-SRNS-ContextTransfer,  
id-SRNS-DataForward,  
id-SecurityModeControl,  
id-ResetResource,  
id-UESpecificInformation,  
id-DirectInformationTransfer,  
id-UplinkInformationExchange,  
id-MBMSsessionStart,  
id-MBMSsessionUpdate,  
id-MBMSsessionStop,  
id-MBMSUELinking,  
id-MBMSRegistration,  
id-MBMSCNDe-Registration-Procedure,  
id-MBMSRABEstablishmentIndication,  
id-MBMSRABRelease,  
id-SRVCCPreparation,  
id-UeRadioCapabilityMatch
```

```
FROM RANAP-Constants;
```

```
-- *****  
--  
-- Interface Elementary Procedure Class  
--
```

```

-- *****
RANAP-ELEMENTARY-PROCEDURE ::= CLASS {
    &InitiatingMessage          ,
    &SuccessfulOutcome          OPTIONAL,
    &UnsuccessfulOutcome       OPTIONAL,
    &Outcome                    OPTIONAL,
    &procedureCode              ProcedureCode UNIQUE,
    &criticality                Criticality   DEFAULT ignore
}
WITH SYNTAX {
    INITIATING MESSAGE      &InitiatingMessage
    [SUCCESSFUL OUTCOME    &SuccessfulOutcome]
    [UNSUCCESSFUL OUTCOME  &UnsuccessfulOutcome]
    [OUTCOME                &Outcome]
    PROCEDURE CODE         &procedureCode
    [CRITICALITY           &criticality]
}
-- *****
--
-- Interface PDU Definition
--
-- *****

RANAP-PDU ::= CHOICE {
    initiatingMessage    InitiatingMessage,
    successfulOutcome    SuccessfulOutcome,
    unsuccessfulOutcome  UnsuccessfulOutcome,
    outcome              Outcome,
    ...
}

InitiatingMessage ::= SEQUENCE {
    procedureCode    RANAP-ELEMENTARY-PROCEDURE.&procedureCode    ({RANAP-ELEMENTARY-PROCEDURES}),
    criticality      RANAP-ELEMENTARY-PROCEDURE.&criticality        ({RANAP-ELEMENTARY-PROCEDURES}@procedureCode}),
    value           RANAP-ELEMENTARY-PROCEDURE.&InitiatingMessage  ({RANAP-ELEMENTARY-PROCEDURES}@procedureCode)
}

SuccessfulOutcome ::= SEQUENCE {
    procedureCode    RANAP-ELEMENTARY-PROCEDURE.&procedureCode    ({RANAP-ELEMENTARY-PROCEDURES}),
    criticality      RANAP-ELEMENTARY-PROCEDURE.&criticality        ({RANAP-ELEMENTARY-PROCEDURES}@procedureCode}),
    value           RANAP-ELEMENTARY-PROCEDURE.&SuccessfulOutcome  ({RANAP-ELEMENTARY-PROCEDURES}@procedureCode)
}

UnsuccessfulOutcome ::= SEQUENCE {
    procedureCode    RANAP-ELEMENTARY-PROCEDURE.&procedureCode    ({RANAP-ELEMENTARY-PROCEDURES}),
    criticality      RANAP-ELEMENTARY-PROCEDURE.&criticality        ({RANAP-ELEMENTARY-PROCEDURES}@procedureCode}),
    value           RANAP-ELEMENTARY-PROCEDURE.&UnsuccessfulOutcome ({RANAP-ELEMENTARY-PROCEDURES}@procedureCode)
}

Outcome ::= SEQUENCE {
    procedureCode    RANAP-ELEMENTARY-PROCEDURE.&procedureCode    ({RANAP-ELEMENTARY-PROCEDURES}),
    criticality      RANAP-ELEMENTARY-PROCEDURE.&criticality        ({RANAP-ELEMENTARY-PROCEDURES}@procedureCode}),
}

```

```

    value          RANAP-ELEMENTARY-PROCEDURE.&Outcome      ({RANAP-ELEMENTARY-PROCEDURES}{@procedureCode})
  }
-- *****
--
-- Interface Elementary Procedure List
--
-- *****

RANAP-ELEMENTARY-PROCEDURES RANAP-ELEMENTARY-PROCEDURE ::= {
  RANAP-ELEMENTARY-PROCEDURES-CLASS-1 |
  RANAP-ELEMENTARY-PROCEDURES-CLASS-2 |
  RANAP-ELEMENTARY-PROCEDURES-CLASS-3 ,
  ...
}

RANAP-ELEMENTARY-PROCEDURES-CLASS-1 RANAP-ELEMENTARY-PROCEDURE ::= {
  iu-Release          |
  relocationPreparation |
  relocationResourceAllocation |
  relocationCancel    |
  sRNS-ContextTransfer |
  securityModeControl |
  dataVolumeReport    |
  reset               |
  resetResource       ,
  ... ,
  locationRelatedData |
  informationTransfer  |
  uplinkInformationExchange |
  mBMSsessionStart    |
  mBMSsessionUpdate   |
  mBMSsessionStop     |
  mBMSUELinking       |
  mBMSRegistration    |
  mBMSCNDe-Registration |
  mBMSRABRelease      |
  enhancedRelocationComplete |
  rANAP-enhancedRelocation |
  sRVCCPreparation    |
  ueRadioCapabilityMatch }

RANAP-ELEMENTARY-PROCEDURES-CLASS-2 RANAP-ELEMENTARY-PROCEDURE ::= {
  rAB-ReleaseRequest |
  iu-ReleaseRequest  |
  relocationDetect    |
  relocationComplete  |
  paging              |
  commonID            |
  cN-InvokeTrace     |
  cN-DeactivateTrace |
  locationReportingControl |
  locationReport      |

```

```

    initialUE-Message      |
    directTransfer         |
    overloadControl        |
    errorIndication        |
    sRNS-DataForward       |
    forwardSRNS-Context    |
    privateMessage         |
    rANAP-Relocation       |
    ...,                  |
    rAB-ModifyRequest      |
    uESpecificInformation  |
    directInformationTransfer |
    mBMSRABEstablishmentIndication |
    enhancedRelocationCompleteConfirm
}

RANAP-ELEMENTARY-PROCEDURES-CLASS-3 RANAP-ELEMENTARY-PROCEDURE ::= {
    rAB-Assignment      ,
    ...
}

-- *****
--
-- Interface Elementary Procedures
--
-- *****

iu-Release RANAP-ELEMENTARY-PROCEDURE ::= {
    INITIATING MESSAGE   Iu-ReleaseCommand
    SUCCESSFUL OUTCOME   Iu-ReleaseComplete
    PROCEDURE CODE       id-Iu-Release
    CRITICALITY          reject
}

relocationPreparation RANAP-ELEMENTARY-PROCEDURE ::= {
    INITIATING MESSAGE   RelocationRequired
    SUCCESSFUL OUTCOME   RelocationCommand
    UNSUCCESSFUL OUTCOME RelocationPreparationFailure
    PROCEDURE CODE       id-RelocationPreparation
    CRITICALITY          reject
}

relocationResourceAllocation RANAP-ELEMENTARY-PROCEDURE ::= {
    INITIATING MESSAGE   RelocationRequest
    SUCCESSFUL OUTCOME   RelocationRequestAcknowledge
    UNSUCCESSFUL OUTCOME RelocationFailure
    PROCEDURE CODE       id-RelocationResourceAllocation
    CRITICALITY          reject
}

relocationCancel RANAP-ELEMENTARY-PROCEDURE ::= {
    INITIATING MESSAGE   RelocationCancel
    SUCCESSFUL OUTCOME   RelocationCancelAcknowledge
    PROCEDURE CODE       id-RelocationCancel
}

```

```
    CRITICALITY    reject
}

SRNS-ContextTransfer RANAP-ELEMENTARY-PROCEDURE ::= {
    INITIATING MESSAGE    SRNS-ContextRequest
    SUCCESSFUL OUTCOME    SRNS-ContextResponse
    PROCEDURE CODE        id-SRNS-ContextTransfer
    CRITICALITY           reject
}

securityModeControl RANAP-ELEMENTARY-PROCEDURE ::= {
    INITIATING MESSAGE    SecurityModeCommand
    SUCCESSFUL OUTCOME    SecurityModeComplete
    UNSUCCESSFUL OUTCOME SecurityModeReject
    PROCEDURE CODE        id-SecurityModeControl
    CRITICALITY           reject
}

dataVolumeReport RANAP-ELEMENTARY-PROCEDURE ::= {
    INITIATING MESSAGE    DataVolumeReportRequest
    SUCCESSFUL OUTCOME    DataVolumeReport
    PROCEDURE CODE        id-DataVolumeReport
    CRITICALITY           reject
}

reset RANAP-ELEMENTARY-PROCEDURE ::= {
    INITIATING MESSAGE    Reset
    SUCCESSFUL OUTCOME    ResetAcknowledge
    PROCEDURE CODE        id-Reset
    CRITICALITY           reject
}

rAB-ReleaseRequest RANAP-ELEMENTARY-PROCEDURE ::= {
    INITIATING MESSAGE    RAB-ReleaseRequest
    PROCEDURE CODE        id-RAB-ReleaseRequest
    CRITICALITY           ignore
}

iu-ReleaseRequest RANAP-ELEMENTARY-PROCEDURE ::= {
    INITIATING MESSAGE    Iu-ReleaseRequest
    PROCEDURE CODE        id-Iu-ReleaseRequest
    CRITICALITY           ignore
}

relocationDetect RANAP-ELEMENTARY-PROCEDURE ::= {
    INITIATING MESSAGE    RelocationDetect
    PROCEDURE CODE        id-RelocationDetect
    CRITICALITY           ignore
}

relocationComplete RANAP-ELEMENTARY-PROCEDURE ::= {
    INITIATING MESSAGE    RelocationComplete
    PROCEDURE CODE        id-RelocationComplete
}
```

```
    CRITICALITY    ignore
}

paging RANAP-ELEMENTARY-PROCEDURE ::= {
    INITIATING MESSAGE    Paging
    PROCEDURE CODE        id-Paging
    CRITICALITY           ignore
}

commonID RANAP-ELEMENTARY-PROCEDURE ::= {
    INITIATING MESSAGE    CommonID
    PROCEDURE CODE        id-CommonID
    CRITICALITY           ignore
}

cN-InvokeTrace RANAP-ELEMENTARY-PROCEDURE ::= {
    INITIATING MESSAGE    CN-InvokeTrace
    PROCEDURE CODE        id-CN-InvokeTrace
    CRITICALITY           ignore
}

cN-DeactivateTrace RANAP-ELEMENTARY-PROCEDURE ::= {
    INITIATING MESSAGE    CN-DeactivateTrace
    PROCEDURE CODE        id-CN-DeactivateTrace
    CRITICALITY           ignore
}

locationReportingControl RANAP-ELEMENTARY-PROCEDURE ::= {
    INITIATING MESSAGE    LocationReportingControl
    PROCEDURE CODE        id-LocationReportingControl
    CRITICALITY           ignore
}

locationReport RANAP-ELEMENTARY-PROCEDURE ::= {
    INITIATING MESSAGE    LocationReport
    PROCEDURE CODE        id-LocationReport
    CRITICALITY           ignore
}

initialUE-Message RANAP-ELEMENTARY-PROCEDURE ::= {
    INITIATING MESSAGE    InitialUE-Message
    PROCEDURE CODE        id-InitialUE-Message
    CRITICALITY           ignore
}

directTransfer RANAP-ELEMENTARY-PROCEDURE ::= {
    INITIATING MESSAGE    DirectTransfer
    PROCEDURE CODE        id-DirectTransfer
    CRITICALITY           ignore
}

overloadControl RANAP-ELEMENTARY-PROCEDURE ::= {
    INITIATING MESSAGE    Overload
    PROCEDURE CODE        id-OverloadControl
}
```

```
    CRITICALITY    ignore
  }

errorIndication RANAP-ELEMENTARY-PROCEDURE ::= {
  INITIATING MESSAGE  ErrorIndication
  PROCEDURE CODE      id-ErrorIndication
  CRITICALITY         ignore
}

sRNS-DataForward RANAP-ELEMENTARY-PROCEDURE ::= {
  INITIATING MESSAGE  sRNS-DataForwardCommand
  PROCEDURE CODE      id-sRNS-DataForward
  CRITICALITY         ignore
}

forwardSRNS-Context RANAP-ELEMENTARY-PROCEDURE ::= {
  INITIATING MESSAGE  ForwardSRNS-Context
  PROCEDURE CODE      id-ForwardSRNS-Context
  CRITICALITY         ignore
}

rAB-Assignment RANAP-ELEMENTARY-PROCEDURE ::= {
  INITIATING MESSAGE  RAB-AssignmentRequest
  OUTCOME              RAB-AssignmentResponse
  PROCEDURE CODE      id-rAB-Assignment
  CRITICALITY         reject
}

privateMessage RANAP-ELEMENTARY-PROCEDURE ::= {
  INITIATING MESSAGE  PrivateMessage

  PROCEDURE CODE      id-privateMessage
  CRITICALITY         ignore
}

resetResource RANAP-ELEMENTARY-PROCEDURE ::= {
  INITIATING MESSAGE  ResetResource
  SUCCESSFUL OUTCOME  ResetResourceAcknowledge
  PROCEDURE CODE      id-ResetResource
  CRITICALITY         reject
}

rANAP-Relocation RANAP-ELEMENTARY-PROCEDURE ::= {
  INITIATING MESSAGE  RANAP-RelocationInformation
  PROCEDURE CODE      id-rANAP-Relocation
  CRITICALITY         ignore
}

rAB-ModifyRequest RANAP-ELEMENTARY-PROCEDURE ::= {
  INITIATING MESSAGE  RAB-ModifyRequest
  PROCEDURE CODE      id-rAB-ModifyRequest
  CRITICALITY         ignore
}
```

```
locationRelatedData RANAP-ELEMENTARY-PROCEDURE ::= {
  INITIATING MESSAGE      LocationRelatedDataRequest
  SUCCESSFUL OUTCOME      LocationRelatedDataResponse
  UNSUCCESSFUL OUTCOME    LocationRelatedDataFailure
  PROCEDURE CODE          id-LocationRelatedData
  CRITICALITY             reject
}

informationTransfer RANAP-ELEMENTARY-PROCEDURE ::= {
  INITIATING MESSAGE      InformationTransferIndication
  SUCCESSFUL OUTCOME      InformationTransferConfirmation
  UNSUCCESSFUL OUTCOME    InformationTransferFailure
  PROCEDURE CODE          id-InformationTransfer
  CRITICALITY             reject
}

uESpecificInformation RANAP-ELEMENTARY-PROCEDURE ::= {
  INITIATING MESSAGE      UESpecificInformationIndication
  PROCEDURE CODE          id-UESpecificInformation
  CRITICALITY             ignore
}

directInformationTransfer RANAP-ELEMENTARY-PROCEDURE ::= {
  INITIATING MESSAGE      DirectInformationTransfer
  PROCEDURE CODE          id-DirectInformationTransfer
  CRITICALITY             ignore
}

uplinkInformationExchange RANAP-ELEMENTARY-PROCEDURE ::= {
  INITIATING MESSAGE      UplinkInformationExchangeRequest
  SUCCESSFUL OUTCOME      UplinkInformationExchangeResponse
  UNSUCCESSFUL OUTCOME    UplinkInformationExchangeFailure
  PROCEDURE CODE          id-UplinkInformationExchange
  CRITICALITY             reject
}

mBMSSessionStart RANAP-ELEMENTARY-PROCEDURE ::= {
  INITIATING MESSAGE      MBMSSessionStart
  SUCCESSFUL OUTCOME      MBMSSessionStartResponse
  UNSUCCESSFUL OUTCOME    MBMSSessionStartFailure
  PROCEDURE CODE          id-MBMSSessionStart
  CRITICALITY             reject
}

mBMSSessionUpdate RANAP-ELEMENTARY-PROCEDURE ::= {
  INITIATING MESSAGE      MBMSSessionUpdate
  SUCCESSFUL OUTCOME      MBMSSessionUpdateResponse
  UNSUCCESSFUL OUTCOME    MBMSSessionUpdateFailure
  PROCEDURE CODE          id-MBMSSessionUpdate
  CRITICALITY             reject
}

mBMSSessionStop RANAP-ELEMENTARY-PROCEDURE ::= {
  INITIATING MESSAGE      MBMSSessionStop
}
```

```
    SUCCESSFUL OUTCOME      MBMSSessionStopResponse
    PROCEDURE CODE          id-MBMSSessionStop
    CRITICALITY              reject
}

mBMSUELinking RANAP-ELEMENTARY-PROCEDURE ::= {
    INITIATING MESSAGE      MBMSUELinkingRequest
    OUTCOME                  MBMSUELinkingResponse
    PROCEDURE CODE          id-MBMSUELinking
    CRITICALITY              reject
}

mBMSRegistration RANAP-ELEMENTARY-PROCEDURE ::= {
    INITIATING MESSAGE      MBMSRegistrationRequest
    SUCCESSFUL OUTCOME      MBMSRegistrationResponse
    UNSUCCESSFUL OUTCOME    MBMSRegistrationFailure
    PROCEDURE CODE          id-MBMSRegistration
    CRITICALITY              reject
}

mBMSCNDe-Registration RANAP-ELEMENTARY-PROCEDURE ::= {
    INITIATING MESSAGE      MBMSCNDe-RegistrationRequest
    SUCCESSFUL OUTCOME      MBMSCNDe-RegistrationResponse
    PROCEDURE CODE          id-MBMSCNDe-Registration-Procedure
    CRITICALITY              reject
}

mBMSRABEstablishmentIndication RANAP-ELEMENTARY-PROCEDURE ::= {
    INITIATING MESSAGE      MBMSRABEstablishmentIndication
    PROCEDURE CODE          id-MBMSRABEstablishmentIndication
    CRITICALITY              ignore
}

mBMSRABRelease RANAP-ELEMENTARY-PROCEDURE ::= {
    INITIATING MESSAGE      MBMSRABReleaseRequest
    SUCCESSFUL OUTCOME      MBMSRABRelease
    UNSUCCESSFUL OUTCOME    MBMSRABReleaseFailure
    PROCEDURE CODE          id-MBMSRABRelease
    CRITICALITY              reject
}

enhancedRelocationComplete RANAP-ELEMENTARY-PROCEDURE ::= {
    INITIATING MESSAGE      EnhancedRelocationCompleteRequest
    SUCCESSFUL OUTCOME      EnhancedRelocationCompleteResponse
    UNSUCCESSFUL OUTCOME    EnhancedRelocationCompleteFailure
    PROCEDURE CODE          id-enhancedRelocationComplete
    CRITICALITY              reject
}

enhancedRelocationCompleteConfirm RANAP-ELEMENTARY-PROCEDURE ::= {
    INITIATING MESSAGE      EnhancedRelocationCompleteConfirm
    PROCEDURE CODE          id-enhancedRelocationCompleteConfirm
    CRITICALITY              ignore
}
```

```

rANAP-enhancedRelocation RANAP-ELEMENTARY-PROCEDURE ::= {
    INITIATING MESSAGE  RANAP-EnhancedRelocationInformationRequest
    SUCCESSFUL OUTCOME  RANAP-EnhancedRelocationInformationResponse
    PROCEDURE CODE      id-RANAPenhancedRelocation
    CRITICALITY         reject
}

SRVCCPreparation RANAP-ELEMENTARY-PROCEDURE ::= {
    INITIATING MESSAGE  SRVCC-CSKeysRequest
    OUTCOME              SRVCC-CSKeysResponse
    PROCEDURE CODE      id-SRVCCPreparation
    CRITICALITY         reject
}

ueRadioCapabilityMatch RANAP-ELEMENTARY-PROCEDURE ::= {
    INITIATING MESSAGE  UeRadioCapabilityMatchRequest
    OUTCOME              UeRadioCapabilityMatchResponse
    PROCEDURE CODE      id-UeRadioCapabilityMatch
    CRITICALITY         ignore
}

END

```

9.3.3 PDU Definitions

```

-- *****
--
-- PDU definitions for RANAP.
--
-- *****

RANAP-PDU-Contents {
itu-t (0) identified-organization (4) etsi (0) mobileDomain (0)
umts-Access (20) modules (3) ranap (0) version1 (1) ranap-PDU-Contents (1) }

DEFINITIONS AUTOMATIC TAGS ::=

BEGIN

-- *****
--
-- IE parameter types from other modules.
--
-- *****

IMPORTS
    AccuracyFulfilmentIndicator,
    APN,
    BroadcastAssistanceDataDecipheringKeys,
    LocationRelatedDataRequestType,
    LocationRelatedDataRequestTypeSpecificToGERANIuMode,
    DataVolumeReference,
    CellLoadInformation,

```

AreaIdentity,
CN-DomainIndicator,
Cause,
Cell-Access-Mode,
ClientType,
CriticalityDiagnostics,
ChosenEncryptionAlgorithm,
ChosenIntegrityProtectionAlgorithm,
ClassmarkInformation2,
ClassmarkInformation3,
CSG-ID,
CSG-Id-List,
CSG-Membership-Status,
DL-GTP-PDU-SequenceNumber,
DL-N-PDU-SequenceNumber,
DataVolumeReportingIndication,
DeltaRAListofIdleModeUEs,
DRX-CycleLengthCoefficient,
EncryptionInformation,
EncryptionKey,
E-UTRAN-Service-Handover,
ExtendedRNC-ID,
FrequencyLayerConvergenceFlag,
GERAN-BSC-Container,
GERAN-Classmark,
GlobalCN-ID,
GlobalRNC-ID,
GTP-TEI,
IncludeVelocity,
InformationExchangeID,
InformationExchangeType,
InformationRequested,
InformationRequestType,
InformationTransferID,
InformationTransferType,
InterSystemInformationTransferType,
IntegrityProtectionInformation,
IntegrityProtectionKey,
InterSystemInformation-TransparentContainer,
IPMulticastAddress,
IuSignallingConnectionIdentifier,
IuTransportAssociation,
KeyStatus,
L3-Information,
LAI,
LastKnownServiceArea,
Correlation-ID,
MBMS-PTP-RAB-ID,
MBMSBearerServiceType,
MBMSCountingInformation,
MBMSCNDe-Registration,
MBMSHCIndicator,
MBMSRegistrationRequestType,
MBMSServiceArea,

MBMSSessionDuration,
MBMSSessionIdentity,
MBMSSessionRepetitionNumber,
MSISDN,
NAS-PDU,
NAS-SequenceNumber,
NAS-SynchronisationIndicator,
NewBSS-To-OldBSS-Information,
NonSearchingIndication,
NumberOfSteps,
Offload-RAB-Parameters,
Offload-RAB-Parameters-APN,
Offload-RAB-Parameters-ChargingCharacteristics,
OMC-ID,
OldBSS-ToNewBSS-Information,
PagingAreaID,
PagingCause,
PDP-TypeInformation,
PDP-TypeInformation-extension,
PermanentNAS-UE-ID,
PLMNIdentity,
PositionData,
PositionDataSpecificToGERANIuMode,
PositioningPriority,
ProvidedData,
RAB-ID,
RAB-Parameters,
RAC,
RAListofIdleModeUEs,
RAT-Type,
RedirectAttemptFlag,
RedirectionCompleted,
RejectCauseValue,
RelocationType,
RequestedGANSSAssistanceData,
RequestType,
Requested-RAB-Parameter-Values,
ResponseTime,
RRC-Container,
SAI,
SAPI,
Service-Handover,
SessionUpdateID,
SNA-Access-Information,
SourceBSS-ToTargetBSS-TransparentContainer,
SourceID,
Source-ToTarget-TransparentContainer,
SourceRNC-ToTargetRNC-TransparentContainer,
SRVCC-HO-Indication,
SRVCC-Information,
SRVCC-Operation-Possible,
TargetBSS-ToSourceBSS-TransparentContainer,
TargetID,
Target-ToSource-TransparentContainer,

TargetRNC-ToSourceRNC-TransparentContainer,
TemporaryUE-ID,
TimeToMBMSDataTransfer,
TMGI,
TracePropagationParameters,
TraceReference,
TraceType,
UnsuccessfullyTransmittedDataVolume,
TransportLayerAddress,
TriggerID,
UE-AggregateMaximumBitRate,
UE-ID,
UESBI-Iu,
UL-GTP-PDU-SequenceNumber,
UL-N-PDU-SequenceNumber,
UP-ModeVersions,
UserPlaneMode,
VelocityEstimate,
VerticalAccuracyCode,
VoiceSupportMatchIndicator,
Alt-RAB-Parameters,
Ass-RAB-Parameters,
PeriodicLocationInfo,
SubscriberProfileIDforRFP,
RNSAPRelocationParameters,
RABParametersList,
MDT-Configuration,
Priority-Class-Indicator,
Management-Based-MDT-Allowed,
HigherBitratesThan16MbpsFlag,
End-Of-CSFB,
Out-Of-UTRAN,
RSRVCC-HO-Indication,
RSRVCC-Information,
MDT-PLMN-List,
TunnelInformation

FROM RANAP-IEs

PrivateIE-Container{},
ProtocolExtensionContainer{},
ProtocolIE-ContainerList{},
ProtocolIE-ContainerPair{},
ProtocolIE-ContainerPairList{},
ProtocolIE-Container{},
RANAP-PRIVATE-IES,
RANAP-PROTOCOL-EXTENSION,
RANAP-PROTOCOL-IES,
RANAP-PROTOCOL-IES-PAIR

FROM RANAP-Containers

maxNrOfDTs,
maxNrOfErrors,
maxNrOfIuSigConIds,

maxNrOfRABs,
maxNrOfVol,
maxnoofMulticastServicesPerUE,

id-AccuracyFulfilmentIndicator,
id-APN,
id-AreaIdentity,
id-Alt-RAB-Parameters,
id-Ass-RAB-Parameters,
id-BroadcastAssistanceDataDecipheringKeys,
id-LocationRelatedDataRequestType,
id-CN-DomainIndicator,
id-Cause,
id-Cell-Access-Mode,
id-ChosenEncryptionAlgorithm,
id-ChosenIntegrityProtectionAlgorithm,
id-ClassmarkInformation2,
id-ClassmarkInformation3,
id-ClientType,
id-CNMBMSLinkingInformation,
id-CriticalityDiagnostics,
id-CSG-Id,
id-CSG-Id-List,
id-CSG-Membership-Status,
id-DeltaRAListofIdleModeUEs,
id-DRX-CycleLengthCoefficient,
id-DirectTransferInformationItem-RANAP-RelocInf,
id-DirectTransferInformationList-RANAP-RelocInf,
id-DL-GTP-PDU-SequenceNumber,
id-EncryptionInformation,
id-EncryptionKey,
id-ExtendedRNC-ID,
id-FrequenceLayerConvergenceFlag,
id-GERAN-BSC-Container,
id-GERAN-Classmark,
id-GERAN-Iumode-RAB-Failed-RABAssgntResponse-Item,
id-GERAN-Iumode-RAB-FailedList-RABAssgntResponse,
id-GlobalCN-ID,
id-GlobalCN-IDCS,
id-GlobalCN-IDPS,
id-GlobalRNC-ID,
id-IncludeVelocity,
id-InformationExchangeID,
id-InformationExchangeType,
id-InformationRequested,
id-InformationRequestType,
id-InformationTransferID,
id-InformationTransferType,
id-IntegrityProtectionInformation,
id-IntegrityProtectionKey,
id-InterSystemInformationTransferType,
id-InterSystemInformation-TransparentContainer,
id-IPMulticastAddress,
id-IuSigConId,

id-OldIuSigConId,
id-OldIuSigConIdCS,
id-OldIuSigConIdPS,
id-IuSigConIdItem,
id-IuSigConIdList,
id-IuTransportAssociation,
id-JoinedMBMSBearerServicesList,
id-KeyStatus,
id-L3-Information,
id-LAI,
id-LastKnownServiceArea,
id-LeftMBMSBearerServicesList,
id-LocationRelatedDataRequestTypeSpecificToGERANIuMode,
id-MBMSBearerServiceType,
id-MBMSCountingInformation,
id-MBMSCNDe-Registration,
id-MBMSRegistrationRequestType,
id-MBMSynchronisationInformation,
id-MBMSServiceArea,
id-MBMSsessionDuration,
id-MBMSsessionIdentity,
id-MBMSsessionRepetitionNumber,
id-MSISDN,
id-NAS-PDU,
id-NAS-SequenceNumber,
id-NewBSS-To-OldBSS-Information,
id-NonSearchingIndication,
id-NumberOfSteps,
id-Offload-RAB-Parameters,
id-OMC-ID,
id-OldBSS-ToNewBSS-Information,
id-PagingAreaID,
id-PagingCause,
id-PDP-TypeInformation,
id-PDP-TypeInformation-extension,
id-PermanentNAS-UE-ID,
id-PositionData,
id-PositionDataSpecificToGERANIuMode,
id-PositioningPriority,
id-ProvidedData,
id-RAB-ContextItem,
id-RAB-ContextList,
id-RAB-ContextFailedtoTransferItem,
id-RAB-ContextFailedtoTransferList,
id-RAB-ContextItem-RANAP-RelocInf,
id-RAB-ContextList-RANAP-RelocInf,
id-RAB-DataForwardingItem,
id-RAB-DataForwardingItem-SRNS-CtxReq,
id-RAB-DataForwardingList,
id-RAB-DataForwardingList-SRNS-CtxReq,
id-RAB-DataVolumeReportItem,
id-RAB-DataVolumeReportList,
id-RAB-DataVolumeReportRequestItem,
id-RAB-DataVolumeReportRequestList,

id-RAB-FailedItem,
id-RAB-FailedList,
id-RAB-FailedList-EnhRelocInfoRes,
id-RAB-FailedItem-EnhRelocInfoRes,
id-RAB-FailedtoReportItem,
id-RAB-FailedtoReportList,
id-RAB-ID,
id-RAB-ModifyList,
id-RAB-ModifyItem,
id-RAB-Parameters,
id-RAB-QueuedItem,
id-RAB-QueuedList,
id-RAB-ReleaseFailedList,
id-RAB-ReleaseItem,
id-RAB-ReleasedItem-IuRelComp,
id-RAB-ReleaseList,
id-RAB-ReleasedItem,
id-RAB-ReleasedList,
id-RAB-ReleasedList-IuRelComp,
id-RAB-RelocationReleaseItem,
id-RAB-RelocationReleaseList,
id-RAB-SetupItem-RelocReq,
id-RAB-SetupItem-RelocReqAck,
id-RAB-SetupList-RelocReq,
id-RAB-SetupList-RelocReqAck,
id-RAB-SetupList-EnhRelocInfoReq,
id-RAB-SetupItem-EnhRelocInfoReq,
id-RAB-SetupList-EnhRelocInfoRes,
id-RAB-SetupItem-EnhRelocInfoRes,
id-RAB-SetupList-EnhancedRelocCompleteReq,
id-RAB-SetupItem-EnhancedRelocCompleteReq,
id-RAB-SetupList-EnhancedRelocCompleteRes,
id-RAB-SetupItem-EnhancedRelocCompleteRes,
id-RAB-SetupOrModifiedItem,
id-RAB-SetupOrModifiedList,
id-RAB-SetupOrModifyItem,
id-RAB-SetupOrModifyList,
id-RAB-ToBeReleasedItem-EnhancedRelocCompleteRes,
id-RAB-ToBeReleasedList-EnhancedRelocCompleteRes,
id-RAC,
id-RAListofIdleModeUEs,
id-RAT-Type,
id-RedirectAttemptFlag,
id-RedirectionCompleted,
id-RedirectionIndication,
id-RejectCauseValue,
id-RelocationType,
id-Relocation-SourceRNC-ID,
id-Relocation-SourceExtendedRNC-ID,
id-Relocation-TargetRNC-ID,
id-Relocation-TargetExtendedRNC-ID,
id-RequestedGANSAssistanceData,
id-RequestType,
id-ResponseTime,

id-SAI,
id-SAPI,
id-SelectedPLMN-ID,
id-SessionUpdateID,
id-SNA-Access-Information,
id-SourceBSS-ToTargetBSS-TransparentContainer,
id-SourceRNC-ID,
id-SourceExtendedRNC-ID,
id-SourceID,
id-Source-ToTarget-TransparentContainer,
id-SourceRNC-PDCP-context-info,
id-SRVCC-HO-Indication,
id-SRVCC-Information,
id-SRVCC-Operation-Possible,
id-TargetBSS-ToSourceBSS-TransparentContainer,
id-TargetID,
id-Target-ToSource-TransparentContainer,
id-TemporaryUE-ID,
id-TimeToMBMSDataTransfer,
id-TMGI,
id-TracePropagationParameters,
id-TraceReference,
id-TraceType,
id-TransportLayerAddress,
id-TransportLayerInformation,
id-TriggerID,
id-UE-AggregateMaximumBitRate,
id-UE-ID,
id-UESBI-Iu,
id-UL-GTP-PDU-SequenceNumber,
id-UnsuccessfulLinkingList,
id-VelocityEstimate,
id-VerticalAccuracyCode,
id-VoiceSupportMatchIndicator,
id-PeriodicLocationInfo,
id-BroadcastGANSSEAssistanceDataDecipheringKeys,
id-SubscriberProfileIDforRFP,
id-E-UTRAN-Service-Handover,
id-IP-Source-Address,
id-LGW-TransportLayerAddress,
id-Correlation-ID,
id-MDT-Configuration,
id-RNSAPRelocationParameters,
id-RABParametersList,
id-Priority-Class-Indicator,
id-Management-Based-MDT-Allowed,
id-HigherBitratesThan16MbpsFlag,
id-Trace-Collection-Entity-IP-Address,
id-End-Of-CSFB,
id-Out-Of-UTRAN,
id-RSRVCC-HO-Indication,
id-RSRVCC-Information,
id-AnchorPLMN-ID,
id-Management-Based-MDT-PLMN-List,

```

    id-Tunnel-Information-for-BBF
FROM RANAP-Constants;

-- *****
--
-- Common Container Lists
--
-- *****

RAB-IE-ContainerList          { RANAP-PROTOCOL-IES          : IEsSetParam } ::= ProtocolIE-ContainerList          { 1, maxNrOfRABs,
    {IEsSetParam} }
RAB-IE-ContainerPairList     { RANAP-PROTOCOL-IES-PAIR : IEsSetParam } ::= ProtocolIE-ContainerPairList { 1, maxNrOfRABs,
    {IEsSetParam} }
ProtocolError-IE-ContainerList { RANAP-PROTOCOL-IES          : IEsSetParam } ::= ProtocolIE-ContainerList          { 1, maxNrOfRABs,
    {IEsSetParam} }
IuSigConId-IE-ContainerList  { RANAP-PROTOCOL-IES          : IEsSetParam } ::= ProtocolIE-ContainerList          { 1, maxNrOfIuSigConIds,
    {IEsSetParam} }
DirectTransfer-IE-ContainerList { RANAP-PROTOCOL-IES          : IEsSetParam } ::= ProtocolIE-ContainerList          { 1, maxNrOfDFTs,
    {IEsSetParam} }

-- *****
--
-- Iu RELEASE ELEMENTARY PROCEDURE
--
-- *****

-- *****
--
-- Iu Release Command
--
-- *****

Iu-ReleaseCommand ::= SEQUENCE {
    protocolIEs          ProtocolIE-Container          { {Iu-ReleaseCommandIEs} },
    protocolExtensions   ProtocolExtensionContainer    { {Iu-ReleaseCommandExtensions} }          OPTIONAL,
    ...
}

Iu-ReleaseCommandIEs RANAP-PROTOCOL-IES ::= {
    { ID id-Cause          CRITICALITY ignore TYPE Cause          PRESENCE mandatory },
    ...
}

Iu-ReleaseCommandExtensions RANAP-PROTOCOL-EXTENSION ::= {
    { ID id-End-Of-CSFB          CRITICALITY ignore EXTENSION End-Of-CSFB          PRESENCE optional }|
    { ID id-Out-Of-UTRAN        CRITICALITY ignore EXTENSION Out-Of-UTRAN        PRESENCE optional },
    ...
}

-- *****
--
-- Iu Release Complete
--
-- *****

```

```

Iu-ReleaseComplete ::= SEQUENCE {
    protocolIEs          ProtocolIE-Container      { {Iu-ReleaseCompleteIEs} },
    protocolExtensions   ProtocolExtensionContainer { {Iu-ReleaseCompleteExtensions} }      OPTIONAL,
    ...
}

Iu-ReleaseCompleteIEs RANAP-PROTOCOL-IES ::= {
    { ID id-RAB-DataVolumeReportList          CRITICALITY ignore TYPE RAB-DataVolumeReportList          PRESENCE optional } |
    { ID id-RAB-ReleasedList-IuRelComp        CRITICALITY ignore TYPE RAB-ReleasedList-IuRelComp        PRESENCE optional } |
    { ID id-CriticalityDiagnostics            CRITICALITY ignore TYPE CriticalityDiagnostics            PRESENCE optional },
    ...
}

RAB-DataVolumeReportList ::= RAB-IE-ContainerList { {RAB-DataVolumeReportItemIEs} }

RAB-DataVolumeReportItemIEs RANAP-PROTOCOL-IES ::= {
    { ID id-RAB-DataVolumeReportItem          CRITICALITY ignore TYPE RAB-DataVolumeReportItem          PRESENCE mandatory },
    ...
}

RAB-DataVolumeReportItem ::= SEQUENCE {
    rAB-ID                RAB-ID,
    dl-UnsuccessfullyTransmittedDataVolume    DataVolumeList          OPTIONAL
    -- This IE shall always be present although its presence is optional --,
    iE-Extensions         ProtocolExtensionContainer { {RAB-DataVolumeReportItem-ExtIEs} }      OPTIONAL,
    ...
}

RAB-DataVolumeReportItem-ExtIEs RANAP-PROTOCOL-EXTENSION ::= {
    ...
}

RAB-ReleasedList-IuRelComp ::= RAB-IE-ContainerList { {RAB-ReleasedItem-IuRelComp-IEs} }

RAB-ReleasedItem-IuRelComp-IEs RANAP-PROTOCOL-IES ::= {
    { ID id-RAB-ReleasedItem-IuRelComp        CRITICALITY ignore TYPE RAB-ReleasedItem-IuRelComp        PRESENCE mandatory },
    ...
}

RAB-ReleasedItem-IuRelComp ::= SEQUENCE {
    rAB-ID                RAB-ID,
    dl-GTP-PDU-SequenceNumber    DL-GTP-PDU-SequenceNumber    OPTIONAL,
    ul-GTP-PDU-SequenceNumber    UL-GTP-PDU-SequenceNumber    OPTIONAL,
    iE-Extensions         ProtocolExtensionContainer { {RAB-ReleasedItem-IuRelComp-ExtIEs} }      OPTIONAL,
    ...
}

RAB-ReleasedItem-IuRelComp-ExtIEs RANAP-PROTOCOL-EXTENSION ::= {
    ...
}

Iu-ReleaseCompleteExtensions RANAP-PROTOCOL-EXTENSION ::= {

```

```

}
...
}
-- *****
--
-- RELOCATION PREPARATION ELEMENTARY PROCEDURE
--
-- *****

-- *****
--
-- Relocation Required
--
-- *****

RelocationRequired ::= SEQUENCE {
    protocolIEs          ProtocolIE-Container      { {RelocationRequiredIEs} },
    protocolExtensions   ProtocolExtensionContainer { {RelocationRequiredExtensions} }      OPTIONAL,
    ...
}

RelocationRequiredIEs RANAP-PROTOCOL-IES ::= {
    { ID id-RelocationType          CRITICALITY reject  TYPE RelocationType          PRESENCE mandatory } |
    { ID id-Cause                    CRITICALITY ignore  TYPE Cause                    PRESENCE mandatory } |
    { ID id-SourceID                 CRITICALITY ignore  TYPE SourceID                 PRESENCE mandatory } |
    { ID id-TargetID                 CRITICALITY reject  TYPE TargetID                 PRESENCE mandatory } |
    { ID id-ClassmarkInformation2     CRITICALITY reject  TYPE ClassmarkInformation2     PRESENCE conditional
    -- This IE shall be present if the Target ID IE contains a CGI IE and Source BSS To Target BSS Transparent Container is not included -- } |
    { ID id-ClassmarkInformation3     CRITICALITY ignore  TYPE ClassmarkInformation3     PRESENCE conditional
    -- This IE shall be present if the Target ID IE contains a CGI IE and Source BSS To Target BSS Transparent Container is not included -- } |
    { ID id-Source-ToTarget-TransparentContainer
    CRITICALITY reject  TYPE Source-ToTarget-TransparentContainer PRESENCE conditional
    -- This IE shall be present if the Target ID IE contains a RNC-ID IE or eNB-ID -- } |
    { ID id-OldBSS-ToNewBSS-Information CRITICALITY ignore  TYPE OldBSS-ToNewBSS-Information PRESENCE optional } ,
    ...
}

RelocationRequiredExtensions RANAP-PROTOCOL-EXTENSION ::= {
-- Extension for Release 5 to enable GERAN support over Iu-cs --
    { ID id-GERAN-Classmark          CRITICALITY ignore  EXTENSION GERAN-Classmark          PRESENCE
optional} |
-- Extension for Release 6 to enable Inter-RAT PS Handover between UTRAN and GERAN A/Gb --
    { ID id-SourceBSS-ToTargetBSS-TransparentContainer CRITICALITY ignore  EXTENSION SourceBSS-ToTargetBSS-TransparentContainer PRESENCE
optional} |
-- Extension for Release 8 for SRVCC operation --
    { ID id-SRVCC-HO-Indication      CRITICALITY reject  EXTENSION SRVCC-HO-Indication      PRESENCE
optional} |
-- Extension for Release 9 to communicate to the CN the CSG id of the target cell --
    { ID id-CSG-Id                  CRITICALITY reject  EXTENSION CSG-Id                  PRESENCE
optional} |
-- Extension for Release 9 to communicate to the CN the hybrid access status of the target cell --
    { ID id-Cell-Access-Mode        CRITICALITY reject  EXTENSION Cell-Access-Mode        PRESENCE
optional} |
-- Extension for Release 11 for rSRVCC operation --

```

```

    { ID id-RSRVCC-HO-Indication
optional},
    ...
}

-- *****
--
-- Relocation Command
--
-- *****

RelocationCommand ::= SEQUENCE {
    protocolIEs          ProtocolIE-Container      { {RelocationCommandIEs} },
    protocolExtensions   ProtocolExtensionContainer { {RelocationCommandExtensions} }      OPTIONAL,
    ...
}

RelocationCommandIEs RANAP-PROTOCOL-IES ::= {
    { ID id-Target-ToSource-TransparentContainer
      CRITICALITY reject TYPE Target-ToSource-TransparentContainer PRESENCE optional } |
    { ID id-L3-Information
      CRITICALITY ignore TYPE L3-Information PRESENCE optional } |
    { ID id-RAB-RelocationReleaseList
      CRITICALITY ignore TYPE RAB-RelocationReleaseList PRESENCE optional } |
    { ID id-RAB-DataForwardingList
      CRITICALITY ignore TYPE RAB-DataForwardingList PRESENCE optional } |
    { ID id-CriticalityDiagnostics
      CRITICALITY ignore TYPE CriticalityDiagnostics PRESENCE optional },
    ...
}

RAB-RelocationReleaseList ::= RAB-IE-ContainerList { {RAB-RelocationReleaseItemIEs} }

RAB-RelocationReleaseItemIEs RANAP-PROTOCOL-IES ::= {
    { ID id-RAB-RelocationReleaseItem
      CRITICALITY ignore TYPE RAB-RelocationReleaseItem PRESENCE mandatory },
    ...
}

RAB-RelocationReleaseItem ::= SEQUENCE {
    rAB-ID                RAB-ID,
    iE-Extensions         ProtocolExtensionContainer { {RAB-RelocationReleaseItem-ExtIEs} }      OPTIONAL,
    ...
}

RAB-RelocationReleaseItem-ExtIEs RANAP-PROTOCOL-EXTENSION ::= {
    ...
}

RAB-DataForwardingList ::= RAB-IE-ContainerList { {RAB-DataForwardingItemIEs} }

RAB-DataForwardingItemIEs RANAP-PROTOCOL-IES ::= {
    { ID id-RAB-DataForwardingItem
      CRITICALITY ignore TYPE RAB-DataForwardingItem PRESENCE mandatory },
    ...
}

RAB-DataForwardingItem ::= SEQUENCE {
    rAB-ID                RAB-ID,
    transportLayerAddress TransportLayerAddress,

```

```

    iuTransportAssociation          IuTransportAssociation,
    iE-Extensions                  ProtocolExtensionContainer { {RAB-DataForwardingItem-ExtIEs} }      OPTIONAL,
    ...
}

RAB-DataForwardingItem-ExtIEs RANAP-PROTOCOL-EXTENSION ::= {
-- Extension for Release 5 to allow transfer of a second pair of TLA and association --
    { ID id-TransportLayerAddress    CRITICALITY ignore  EXTENSION TransportLayerAddress PRESENCE optional } |
    { ID id-IuTransportAssociation    CRITICALITY ignore  EXTENSION IuTransportAssociation  PRESENCE optional },
    ...
}

RelocationCommandExtensions RANAP-PROTOCOL-EXTENSION ::= {
-- Extension for Release 5 to enable Inter RAN Load Information Exchange over Iu --
    { ID id-InterSystemInformation-TransparentContainer CRITICALITY ignore  EXTENSION InterSystemInformation-TransparentContainer PRESENCE optional } |
-- Extension for Release 6 to enable Inter-RAT PS Handover between UTRAN and GERAN A/Gb --
    { ID id-TargetBSS-ToSourceBSS-TransparentContainer CRITICALITY ignore  EXTENSION TargetBSS-ToSourceBSS-TransparentContainer PRESENCE optional } |
-- Extension for Release 8 for SRVCC operation --
    { ID id-SRVCC-Information          CRITICALITY reject  EXTENSION SRVCC-Information          PRESENCE optional } |
-- Extension for Release 11 for rSRVCC operation --
    { ID id-RSRVCC-Information         CRITICALITY reject  EXTENSION RSRVCC-Information         PRESENCE optional },
    ...
}

-- *****
--
-- Relocation Preparation Failure
--
-- *****

RelocationPreparationFailure ::= SEQUENCE {
    protocolIEs          ProtocolIE-Container          { {RelocationPreparationFailureIEs} },
    protocolExtensions   ProtocolExtensionContainer    { {RelocationPreparationFailureExtensions} }      OPTIONAL,
    ...
}

RelocationPreparationFailureIEs RANAP-PROTOCOL-IES ::= {
    { ID id-Cause          CRITICALITY ignore  TYPE Cause          PRESENCE mandatory } |
    { ID id-CriticalityDiagnostics CRITICALITY ignore  TYPE CriticalityDiagnostics PRESENCE optional },
    ...
}

RelocationPreparationFailureExtensions RANAP-PROTOCOL-EXTENSION ::= {
-- Extension for Release 5 to enable Inter RAN Load Information Exchange over Iu --
    { ID id-InterSystemInformation-TransparentContainer CRITICALITY ignore  EXTENSION InterSystemInformation-TransparentContainer PRESENCE optional },
    ...
}

-- *****

```

```

--
-- RELOCATION RESOURCE ALLOCATION ELEMENTARY PROCEDURE
--
-- *****
-- *****
-- Relocation Request
--
-- *****

RelocationRequest ::= SEQUENCE {
    protocolIEs          ProtocolIE-Container      { {RelocationRequestIEs} },
    protocolExtensions   ProtocolExtensionContainer { {RelocationRequestExtensions} }      OPTIONAL,
    ...
}

RelocationRequestIEs RANAP-PROTOCOL-IES ::= {
    { ID id-PermanentNAS-UE-ID          CRITICALITY ignore TYPE PermanentNAS-UE-ID          PRESENCE optional } |
    { ID id-Cause                        CRITICALITY ignore TYPE Cause                    PRESENCE mandatory } |
    { ID id-CN-DomainIndicator          CRITICALITY reject TYPE CN-DomainIndicator          PRESENCE mandatory } |
    { ID id-Source-ToTarget-TransparentContainer
      CRITICALITY reject TYPE SourceRNC-ToTargetRNC-TransparentContainer PRESENCE mandatory } |
    { ID id-RAB-SetupList-RelocReq      CRITICALITY reject TYPE RAB-SetupList-RelocReq      PRESENCE optional } |
    { ID id-IntegrityProtectionInformation
      CRITICALITY ignore TYPE IntegrityProtectionInformation      PRESENCE optional } |
    { ID id-EncryptionInformation      CRITICALITY ignore TYPE EncryptionInformation      PRESENCE optional } |
    { ID id-IuSigConId                  CRITICALITY ignore TYPE IuSignallingConnectionIdentifier PRESENCE mandatory },
    ...
}

RAB-SetupList-RelocReq ::= RAB-IE-ContainerList { {RAB-SetupItem-RelocReq-IEs} }

RAB-SetupItem-RelocReq-IEs RANAP-PROTOCOL-IES ::= {
    { ID id-RAB-SetupItem-RelocReq      CRITICALITY reject TYPE RAB-SetupItem-RelocReq      PRESENCE mandatory },
    ...
}

RAB-SetupItem-RelocReq ::= SEQUENCE {
    rAB-ID                RAB-ID,
    nAS-SynchronisationIndicator NAS-SynchronisationIndicator OPTIONAL,
    rAB-Parameters        RAB-Parameters,
    dataVolumeReportingIndication DataVolumeReportingIndication OPTIONAL
    -- This IE shall be present if the CN domain indicator IE is set to "PS domain" --,
    pdp-TypeInformation   PDP-TypeInformation OPTIONAL
    -- This IE shall be present if the CN domain indicator IE is set to "PS domain" --,
    userPlaneInformation  UserPlaneInformation,
    transportLayerAddress TransportLayerAddress,
    iuTransportAssociation IuTransportAssociation,
    service-Handover      Service-Handover OPTIONAL,
    iE-Extensions         ProtocolExtensionContainer { {RAB-SetupItem-RelocReq-ExtIEs} }      OPTIONAL,
    ...
}

RAB-SetupItem-RelocReq-ExtIEs RANAP-PROTOCOL-EXTENSION ::= {

```

```

-- Extension for Release 4 to enable RAB Quality of Service negotiation over Iu --
  { ID id-Alt-RAB-Parameters          CRITICALITY ignore  EXTENSION Alt-RAB-Parameters          PRESENCE optional}|
-- Extension for Release 5 to enable GERAN support over Iu-cs --
  { ID id-GERAN-BSC-Container         CRITICALITY ignore  EXTENSION GERAN-BSC-Container         PRESENCE optional}|
-- Extension for Release 8 to enable handover restriction to E-UTRAN --
  { ID id-E-UTRAN-Service-Handover   CRITICALITY ignore  EXTENSION E-UTRAN-Service-Handover   PRESENCE optional}|
-- Extension for Release 9 to enable a new value --
  { ID id-PDP-TypeInformation-extension CRITICALITY ignore  EXTENSION PDP-TypeInformation-extension PRESENCE optional}|
-- Extension for Release 10 to enable offload at Iu-PS for UTRAN --
  { ID id-Offload-RAB-Parameters      CRITICALITY ignore  EXTENSION Offload-RAB-Parameters     PRESENCE optional},
  ...
}

UserPlaneInformation ::= SEQUENCE {
  userPlaneMode          UserPlaneMode,
  uP-ModeVersions        UP-ModeVersions,
  iE-Extensions          ProtocolExtensionContainer { {UserPlaneInformation-ExtIEs} }    OPTIONAL,
  ...
}

UserPlaneInformation-ExtIEs RANAP-PROTOCOL-EXTENSION ::= {
  ...
}

RelocationRequestExtensions RANAP-PROTOCOL-EXTENSION ::= {
-- Extension for Release 4 --
  { ID id-GlobalCN-ID          CRITICALITY reject  EXTENSION GlobalCN-ID          PRESENCE optional}|
-- Extension for Release 5 to enable shared networks in connected mode --
  { ID id-SNA-Access-Information CRITICALITY ignore  EXTENSION SNA-Access-Information PRESENCE optional}|
-- Extension for Release 5 to enable specific behaviour by the RNC in relation with early UE handling --
  { ID id-UESBI-Iu            CRITICALITY ignore  EXTENSION UESBI-Iu            PRESENCE optional}|
-- Extension for Release 6 to convey the selected PLMN id in network sharing mobility scenarios --
  { ID id-SelectedPLMN-ID     CRITICALITY ignore  EXTENSION PLMNidentity        PRESENCE optional}|
-- Extension for Release 6 to enable MBMS UE linking at relocation --
  { ID id-CNMBMSLinkingInformation CRITICALITY ignore  EXTENSION CNMBMSLinkingInformation PRESENCE optional}|
  { ID id-UE-AggregateMaximumBitRate CRITICALITY ignore  EXTENSION UE-AggregateMaximumBitRate PRESENCE optional}|
-- Extension for Release 9 to communicate to the target cell the CSG id reported by the source --
  { ID id-CSG-Id              CRITICALITY reject  EXTENSION CSG-Id              PRESENCE optional}|
-- Extension for Release 9 for enabling UE prioritisation during access to hybrid cells --
  { ID id-CSG-Membership-Status CRITICALITY ignore  EXTENSION CSG-Membership-Status PRESENCE optional}|
-- Extension for Release 10 to enable offload at Iu-PS for UTRAN --
  { ID id-MSISDN              CRITICALITY ignore  EXTENSION MSISDN              PRESENCE optional}|
-- Extension for Release 11 to support rSRVCC in case of network sharing -
  { ID id-AnchorPLMN-ID       CRITICALITY ignore  EXTENSION PLMNidentity        PRESENCE optional},
  ...
}

CNMBMSLinkingInformation ::= SEQUENCE {
  joinedMBMSBearerService-IEs  JoinedMBMSBearerService-IEs,
  iE-Extensions                 ProtocolExtensionContainer { {CNMBMSLinkingInformation-ExtIEs} }    OPTIONAL,
  ...
}

CNMBMSLinkingInformation-ExtIEs RANAP-PROTOCOL-EXTENSION ::= {

```

```

}
...
}
JoinedMBMSBearerService-IEs ::= SEQUENCE (SIZE (1.. maxnoofMulticastServicesPerUE)) OF
  SEQUENCE {
    tMGI                TMGI,
    mBMS-PTP-RAB-ID    MBMS-PTP-RAB-ID,
    iE-Extensions      ProtocolExtensionContainer { {JoinedMBMSBearerService-ExtIEs} } OPTIONAL,
    ...
  }

JoinedMBMSBearerService-ExtIEs RANAP-PROTOCOL-EXTENSION ::= {
  ...
}

-- *****
--
-- Relocation Request Acknowledge
--
-- *****

RelocationRequestAcknowledge ::= SEQUENCE {
  protocolIEs          ProtocolIE-Container          { {RelocationRequestAcknowledgeIEs} },
  protocolExtensions   ProtocolExtensionContainer    { {RelocationRequestAcknowledgeExtensions} }   OPTIONAL,
  ...
}

RelocationRequestAcknowledgeIEs RANAP-PROTOCOL-IES ::= {
  { ID id-Target-ToSource-TransparentContainer
    CRITICALITY ignore TYPE TargetRNC-ToSourceRNC-TransparentContainer PRESENCE optional } |
  { ID id-RAB-SetupList-RelocReqAck
    CRITICALITY ignore TYPE RAB-SetupList-RelocReqAck PRESENCE optional } |
  { ID id-RAB-FailedList
    CRITICALITY ignore TYPE RAB-FailedList PRESENCE optional } |
  { ID id-ChosenIntegrityProtectionAlgorithm
    CRITICALITY ignore TYPE ChosenIntegrityProtectionAlgorithm PRESENCE optional } |
  { ID id-ChosenEncryptionAlgorithm
    CRITICALITY ignore TYPE ChosenEncryptionAlgorithm PRESENCE optional } |
  { ID id-CriticalityDiagnostics
    CRITICALITY ignore TYPE CriticalityDiagnostics PRESENCE optional },
  ...
}

RAB-SetupList-RelocReqAck ::= RAB-IE-ContainerList { {RAB-SetupItem-RelocReqAck-IEs} }

RAB-SetupItem-RelocReqAck-IEs RANAP-PROTOCOL-IES ::= {
  { ID id-RAB-SetupItem-RelocReqAck
    CRITICALITY reject TYPE RAB-SetupItem-RelocReqAck PRESENCE mandatory },
  ...
}

RAB-SetupItem-RelocReqAck ::= SEQUENCE {
  rAB-ID                RAB-ID,
  transportLayerAddress TransportLayerAddress OPTIONAL,
  iuTransportAssociation IuTransportAssociation OPTIONAL,
  iE-Extensions          ProtocolExtensionContainer { {RAB-SetupItem-RelocReqAck-ExtIEs} }   OPTIONAL,
  ...
}

RAB-SetupItem-RelocReqAck-ExtIEs RANAP-PROTOCOL-EXTENSION ::= {

```

```

-- Extension for Release 4 to enable RAB Quality of Service negotiation over Iu --
  {ID id-Ass-RAB-Parameters CRITICALITY ignore EXTENSION Ass-RAB-Parameters PRESENCE optional } |
-- Extension for Release 5 to allow transfer of a second pair of TLA and association --
  {ID id-TransportLayerAddress CRITICALITY ignore EXTENSION TransportLayerAddress PRESENCE optional} |
  {ID id-IuTransportAssociation CRITICALITY ignore EXTENSION IuTransportAssociation PRESENCE optional},
  ...
}

RAB-FailedList ::= RAB-IE-ContainerList { {RAB-FailedItemIEs} }

RAB-FailedItemIEs RANAP-PROTOCOL-IES ::= {
  { ID id-RAB-FailedItem CRITICALITY ignore TYPE RAB-FailedItem PRESENCE mandatory },
  ...
}

RAB-FailedItem ::= SEQUENCE {
  rAB-ID RAB-ID,
  cause Cause,
  iE-Extensions ProtocolExtensionContainer { {RAB-FailedItem-ExtIEs} } OPTIONAL,
  ...
}

RAB-FailedItem-ExtIEs RANAP-PROTOCOL-EXTENSION ::= {
  ...
}

RelocationRequestAcknowledgeExtensions RANAP-PROTOCOL-EXTENSION ::= {
-- Extension for Release 5 to enable Inter RAN Load Information Exchange over Iu --
  {ID id-NewBSS-To-OldBSS-Information CRITICALITY ignore EXTENSION NewBSS-To-OldBSS-Information PRESENCE optional }|
  {ID id-CSG-Id CRITICALITY ignore EXTENSION CSG-Id PRESENCE optional },
  ...
}

-- *****
--
-- Relocation Failure
--
-- *****

RelocationFailure ::= SEQUENCE {
  protocolIEs ProtocolIE-Container { {RelocationFailureIEs} },
  protocolExtensions ProtocolExtensionContainer { {RelocationFailureExtensions} } OPTIONAL,
  ...
}

RelocationFailureIEs RANAP-PROTOCOL-IES ::= {
  { ID id-Cause CRITICALITY ignore TYPE Cause PRESENCE mandatory } |
  { ID id-CriticalityDiagnostics CRITICALITY ignore TYPE CriticalityDiagnostics PRESENCE optional },
  ...
}

RelocationFailureExtensions RANAP-PROTOCOL-EXTENSION ::= {
-- Extension for Release 5 to enable Inter RAN Load Information Exchange over Iu --
  { ID id-NewBSS-To-OldBSS-Information CRITICALITY ignore EXTENSION NewBSS-To-OldBSS-Information PRESENCE optional } |

```

```

-- Extension for Release 5 to enable GERAN support over Iu-CS --
  { ID id-GERAN-Classmark          CRITICALITY ignore  EXTENSION GERAN-Classmark          PRESENCE optional },
  ...
}

-- *****
--
-- RELOCATION CANCEL ELEMENTARY PROCEDURE
--
-- *****

-- *****
--
-- Relocation Cancel
--
-- *****

RelocationCancel ::= SEQUENCE {
  protocolIEs          ProtocolIE-Container          { {RelocationCancelIEs} },
  protocolExtensions   ProtocolExtensionContainer    { {RelocationCancelExtensions} }          OPTIONAL,
  ...
}

RelocationCancelIEs RANAP-PROTOCOL-IES ::= {
  { ID id-Cause          CRITICALITY ignore  TYPE Cause          PRESENCE mandatory },
  ...
}

RelocationCancelExtensions RANAP-PROTOCOL-EXTENSION ::= {
  ...
}

-- *****
--
-- Relocation Cancel Acknowledge
--
-- *****

RelocationCancelAcknowledge ::= SEQUENCE {
  protocolIEs          ProtocolIE-Container          { {RelocationCancelAcknowledgeIEs} },
  protocolExtensions   ProtocolExtensionContainer    { {RelocationCancelAcknowledgeExtensions} }          OPTIONAL,
  ...
}

RelocationCancelAcknowledgeIEs RANAP-PROTOCOL-IES ::= {
  { ID id-CriticalityDiagnostics          CRITICALITY ignore  TYPE CriticalityDiagnostics          PRESENCE optional },
  ...
}

RelocationCancelAcknowledgeExtensions RANAP-PROTOCOL-EXTENSION ::= {
  ...
}

-- *****

```

```

--
-- SRNS CONTEXT TRANSFER OPEARATION
--
-- *****
--
-- *****
--
-- SRNS Context Request
--
-- *****

SRNS-ContextRequest ::= SEQUENCE {
    protocolIEs          ProtocolIE-Container          { {SRNS-ContextRequestIEs} },
    protocolExtensions   ProtocolExtensionContainer   { {SRNS-ContextRequestExtensions} }   OPTIONAL,
    ...
}

SRNS-ContextRequestIEs RANAP-PROTOCOL-IES ::= {
    { ID id-RAB-DataForwardingList-SRNS-CtxReq CRITICALITY ignore TYPE RAB-DataForwardingList-SRNS-CtxReq PRESENCE mandatory },
    ...
}

RAB-DataForwardingList-SRNS-CtxReq ::= RAB-IE-ContainerList { {RAB-DataForwardingItem-SRNS-CtxReq-IEs} }

RAB-DataForwardingItem-SRNS-CtxReq-IEs RANAP-PROTOCOL-IES ::= {
    { ID id-RAB-DataForwardingItem-SRNS-CtxReq CRITICALITY reject TYPE RAB-DataForwardingItem-SRNS-CtxReq PRESENCE mandatory },
    ...
}

RAB-DataForwardingItem-SRNS-CtxReq ::= SEQUENCE {
    rAB-ID                RAB-ID,
    iE-Extensions         ProtocolExtensionContainer { {RAB-DataForwardingItem-SRNS-CtxReq-ExtIEs} }   OPTIONAL,
    ...
}

RAB-DataForwardingItem-SRNS-CtxReq-ExtIEs RANAP-PROTOCOL-EXTENSION ::= {
    ...
}

SRNS-ContextRequestExtensions RANAP-PROTOCOL-EXTENSION ::= {
-- The SGSN may include the IE, when available to indicate the RAT from which the context request originates, to correct measurement points in
SRNC. --
    {ID id-RAT-Type          CRITICALITY ignore EXTENSION RAT-Type          PRESENCE optional },
    ...
}

-- *****
--
-- SRNS Context Response
--
-- *****

SRNS-ContextResponse ::= SEQUENCE {
    protocolIEs          ProtocolIE-Container          { {SRNS-ContextResponseIEs} },

```

```

    protocolExtensions      ProtocolExtensionContainer { {SRNS-ContextResponseExtensions} }          OPTIONAL,
    ...
}

SRNS-ContextResponseIEs RANAP-PROTOCOL-IES ::= {
  { ID id-RAB-ContextList          CRITICALITY ignore TYPE RAB-ContextList          PRESENCE optional } |
  { ID id-RAB-ContextFailedtoTransferList CRITICALITY ignore TYPE RAB-ContextFailedtoTransferList PRESENCE optional } |
  { ID id-CriticalityDiagnostics      CRITICALITY ignore TYPE CriticalityDiagnostics      PRESENCE optional },
  ...
}

RAB-ContextList ::= RAB-IE-ContainerList { {RAB-ContextItemIEs} }

RAB-ContextItemIEs RANAP-PROTOCOL-IES ::= {
  { ID id-RAB-ContextItem          CRITICALITY ignore TYPE RAB-ContextItem          PRESENCE mandatory },
  ...
}

RAB-ContextItem ::= SEQUENCE {
  rAB-ID          RAB-ID,
  dl-GTP-PDU-SequenceNumber DL-GTP-PDU-SequenceNumber OPTIONAL,
  ul-GTP-PDU-SequenceNumber UL-GTP-PDU-SequenceNumber OPTIONAL,
  dl-N-PDU-SequenceNumber DL-N-PDU-SequenceNumber OPTIONAL,
  ul-N-PDU-SequenceNumber UL-N-PDU-SequenceNumber OPTIONAL,
  iE-Extensions      ProtocolExtensionContainer { {RAB-ContextItem-ExtIEs} }          OPTIONAL,
  ...
}

RAB-ContextItem-ExtIEs RANAP-PROTOCOL-EXTENSION ::= {
  ...
}

RAB-ContextFailedtoTransferList ::= RAB-IE-ContainerList { {RABs-ContextFailedtoTransferItemIEs} }

RABs-ContextFailedtoTransferItemIEs RANAP-PROTOCOL-IES ::= {
  { ID id-RAB-ContextFailedtoTransferItem CRITICALITY ignore TYPE RABs-ContextFailedtoTransferItem PRESENCE mandatory },
  ...
}

RABs-ContextFailedtoTransferItem ::= SEQUENCE {
  rAB-ID          RAB-ID,
  cause          Cause,
  iE-Extensions      ProtocolExtensionContainer { { RABs-ContextFailedtoTransferItem-ExtIEs} }          OPTIONAL,
  ...
}

RABs-ContextFailedtoTransferItem-ExtIEs RANAP-PROTOCOL-EXTENSION ::= {
  ...
}

SRNS-ContextResponseExtensions RANAP-PROTOCOL-EXTENSION ::= {
  ...
}

```

```

-- *****
--
-- SECURITY MODE CONTROL ELEMENTARY PROCEDURE
--
-- *****

-- *****
--
-- Security Mode Command
--
-- *****

SecurityModeCommand ::= SEQUENCE {
    protocolIEs          ProtocolIE-Container          { {SecurityModeCommandIEs} },
    protocolExtensions   ProtocolExtensionContainer   { {SecurityModeCommandExtensions} }    OPTIONAL,
    ...
}

SecurityModeCommandIEs RANAP-PROTOCOL-IES ::= {
    { ID id-IntegrityProtectionInformation    CRITICALITY reject  TYPE IntegrityProtectionInformation  PRESENCE mandatory } |
    { ID id-EncryptionInformation            CRITICALITY ignore  TYPE EncryptionInformation          PRESENCE optional } |
    { ID id-KeyStatus                        CRITICALITY reject  TYPE KeyStatus                      PRESENCE mandatory},
    ...
}

SecurityModeCommandExtensions RANAP-PROTOCOL-EXTENSION ::= {
    ...
}

-- *****
--
-- Security Mode Complete
--
-- *****

SecurityModeComplete ::= SEQUENCE {
    protocolIEs          ProtocolIE-Container          { {SecurityModeCompleteIEs} },
    protocolExtensions   ProtocolExtensionContainer   { {SecurityModeCompleteExtensions} }    OPTIONAL,
    ...
}

SecurityModeCompleteIEs RANAP-PROTOCOL-IES ::= {
    { ID id-ChosenIntegrityProtectionAlgorithm CRITICALITY reject  TYPE ChosenIntegrityProtectionAlgorithm  PRESENCE mandatory } |
    { ID id-ChosenEncryptionAlgorithm          CRITICALITY ignore  TYPE ChosenEncryptionAlgorithm          PRESENCE optional } |
    { ID id-CriticalityDiagnostics             CRITICALITY ignore  TYPE CriticalityDiagnostics             PRESENCE optional },
    ...
}

SecurityModeCompleteExtensions RANAP-PROTOCOL-EXTENSION ::= {
    ...
}

-- *****

```

```

--
-- Security Mode Reject
--
-- *****
SecurityModeReject ::= SEQUENCE {
    protocolIEs          ProtocolIE-Container      { {SecurityModeRejectIEs} },
    protocolExtensions   ProtocolExtensionContainer { {SecurityModeRejectExtensions} }      OPTIONAL,
    ...
}

SecurityModeRejectIEs RANAP-PROTOCOL-IES ::= {
    { ID id-Cause          CRITICALITY ignore TYPE Cause          PRESENCE mandatory } |
    { ID id-CriticalityDiagnostics CRITICALITY ignore TYPE CriticalityDiagnostics PRESENCE optional },
    ...
}

SecurityModeRejectExtensions RANAP-PROTOCOL-EXTENSION ::= {
    ...
}

-- *****
--
-- DATA VOLUME REPORT ELEMENTARY PROCEDURE
--
-- *****
--
-- *****
--
-- Data Volume Report Request
--
-- *****

DataVolumeReportRequest ::= SEQUENCE {
    protocolIEs          ProtocolIE-Container      { {DataVolumeReportRequestIEs} },
    protocolExtensions   ProtocolExtensionContainer { {DataVolumeReportRequestExtensions} }      OPTIONAL,
    ...
}

DataVolumeReportRequestIEs RANAP-PROTOCOL-IES ::= {
    { ID id-RAB-DataVolumeReportRequestList CRITICALITY ignore TYPE RAB-DataVolumeReportRequestList PRESENCE mandatory },
    ...
}

RAB-DataVolumeReportRequestList ::= RAB-IE-ContainerList { {RAB-DataVolumeReportRequestItemIEs} }

RAB-DataVolumeReportRequestItemIEs RANAP-PROTOCOL-IES ::= {
    { ID id-RAB-DataVolumeReportRequestItem CRITICALITY reject TYPE RAB-DataVolumeReportRequestItem PRESENCE mandatory },
    ...
}

RAB-DataVolumeReportRequestItem ::= SEQUENCE {
    rAB-ID              RAB-ID,
    iE-Extensions       ProtocolExtensionContainer { {RAB-DataVolumeReportRequestItem-ExtIEs} }      OPTIONAL,

```

```

    ...
}
RAB-DataVolumeReportRequestItem-ExtIEs RANAP-PROTOCOL-EXTENSION ::= {
    ...
}
DataVolumeReportRequestExtensions RANAP-PROTOCOL-EXTENSION ::= {
    ...
}
-- *****
--
-- Data Volume Report
--
-- *****

DataVolumeReport ::= SEQUENCE {
    protocolIEs          ProtocolIE-Container          { {DataVolumeReportIEs} },
    protocolExtensions   ProtocolExtensionContainer    { {DataVolumeReportExtensions} }    OPTIONAL,
    ...
}

DataVolumeReportIEs RANAP-PROTOCOL-IES ::= {
    { ID id-RAB-DataVolumeReportList          CRITICALITY ignore TYPE RAB-DataVolumeReportList          PRESENCE optional } |
    { ID id-RAB-FailedtoReportList           CRITICALITY ignore TYPE RAB-FailedtoReportList           PRESENCE optional } |
    { ID id-CriticalityDiagnostics           CRITICALITY ignore TYPE CriticalityDiagnostics           PRESENCE optional },
    ...
}

DataVolumeReportExtensions RANAP-PROTOCOL-EXTENSION ::= {
    ...
}

RAB-FailedtoReportList ::= RAB-IE-ContainerList { {RABs-failed-to-reportItemIEs} }

RABs-failed-to-reportItemIEs RANAP-PROTOCOL-IES ::= {
    { ID id-RAB-FailedtoReportItem          CRITICALITY ignore TYPE RABs-failed-to-reportItem          PRESENCE mandatory },
    ...
}

RABs-failed-to-reportItem ::= SEQUENCE {
    rAB-ID          RAB-ID,
    cause           Cause,
    iE-Extensions   ProtocolExtensionContainer { { RABs-failed-to-reportItem-ExtIEs} }    OPTIONAL,
    ...
}

RABs-failed-to-reportItem-ExtIEs RANAP-PROTOCOL-EXTENSION ::= {
    ...
}

```

```

-- *****
--
-- RESET ELEMENTARY PROCEDURE
--
-- *****
--
-- *****
--
-- Reset
--
-- *****

Reset ::= SEQUENCE {
    protocolIEs      ProtocolIE-Container      { {ResetIEs} },
    protocolExtensions ProtocolExtensionContainer { {ResetExtensions} }          OPTIONAL,
    ...
}

ResetIEs RANAP-PROTOCOL-IES ::= {
    { ID id-Cause          CRITICALITY ignore TYPE Cause          PRESENCE mandatory } |
    { ID id-CN-DomainIndicator CRITICALITY reject TYPE CN-DomainIndicator PRESENCE mandatory } |
    { ID id-GlobalRNC-ID    CRITICALITY ignore TYPE GlobalRNC-ID    PRESENCE optional },
    ...
}

ResetExtensions RANAP-PROTOCOL-EXTENSION ::= {
-- Extension for Release 4 --
    { ID id-GlobalCN-ID          CRITICALITY ignore      EXTENSION GlobalCN-ID          PRESENCE optional } |
-- Extension for Release 7 to indicate extended RNC-ID --
    { ID id-ExtendedRNC-ID      CRITICALITY reject     EXTENSION ExtendedRNC-ID      PRESENCE optional },
    ...
}

-- *****
--
-- Reset Acknowledge
--
-- *****

ResetAcknowledge ::= SEQUENCE {
    protocolIEs      ProtocolIE-Container      { {ResetAcknowledgeIEs} },
    protocolExtensions ProtocolExtensionContainer { {ResetAcknowledgeExtensions} }          OPTIONAL,
    ...
}

ResetAcknowledgeIEs RANAP-PROTOCOL-IES ::= {
    { ID id-CN-DomainIndicator CRITICALITY reject TYPE CN-DomainIndicator PRESENCE mandatory } |
    { ID id-CriticalityDiagnostics CRITICALITY ignore TYPE CriticalityDiagnostics PRESENCE optional } |
    { ID id-GlobalRNC-ID      CRITICALITY ignore TYPE GlobalRNC-ID      PRESENCE optional },
    ...
}

ResetAcknowledgeExtensions RANAP-PROTOCOL-EXTENSION ::= {
-- Extension for Release 4 --

```

```

    { ID id-GlobalCN-ID          CRITICALITY ignore      EXTENSION GlobalCN-ID          PRESENCE optional } |
-- Extension for Release 7 to indicate extended RNC-ID --
    { ID id-ExtendedRNC-ID      CRITICALITY reject     EXTENSION ExtendedRNC-ID      PRESENCE optional },
    ...
}
-- *****
--
-- RESET RESOURCE ELEMENTARY PROCEDURE
--
-- *****

-- *****
--
-- Reset Resource
--
-- *****

ResetResource ::= SEQUENCE {
    protocolIEs          ProtocolIE-Container          { {ResetResourceIEs} },
    protocolExtensions   ProtocolExtensionContainer    { {ResetResourceExtensions} }          OPTIONAL,
    ...
}

ResetResourceIEs RANAP-PROTOCOL-IES ::= {
    { ID id-CN-DomainIndicator    CRITICALITY reject    TYPE CN-DomainIndicator    PRESENCE mandatory } |
    { ID id-Cause                 CRITICALITY ignore    TYPE Cause                 PRESENCE mandatory } |
    { ID id-IuSigConIdList        CRITICALITY ignore    TYPE ResetResourceList     PRESENCE mandatory } |
    { ID id-GlobalRNC-ID          CRITICALITY ignore    TYPE GlobalRNC-ID          PRESENCE optional },
    ...
}

ResetResourceList ::= IuSigConId-IE-ContainerList{ {ResetResourceItemIEs} }

ResetResourceItemIEs RANAP-PROTOCOL-IES ::= {
    { ID id-IuSigConIdItem        CRITICALITY reject    TYPE ResetResourceItem     PRESENCE mandatory },
    ...
}

ResetResourceItem ::= SEQUENCE {
    iuSigConId                IuSignallingConnectionIdentifier,
    iE-Extensions              ProtocolExtensionContainer { { ResetResourceItem-ExtIEs} }          OPTIONAL,
    ...
}

ResetResourceItem-ExtIEs RANAP-PROTOCOL-EXTENSION ::= {
    ...
}

ResetResourceExtensions RANAP-PROTOCOL-EXTENSION ::= {
-- Extension for Release 4 --
    { ID id-GlobalCN-ID          CRITICALITY ignore      EXTENSION GlobalCN-ID          PRESENCE optional } |
-- Extension for Release 7 to indicate extended RNC-ID --
    { ID id-ExtendedRNC-ID      CRITICALITY reject     EXTENSION ExtendedRNC-ID      PRESENCE optional },
}

```

```

}
...
}
-- *****
--
-- Reset Resource Acknowledge
--
-- *****

ResetResourceAcknowledge ::= SEQUENCE {
    protocolIEs          ProtocolIE-Container          { {ResetResourceAcknowledgeIEs} },
    protocolExtensions   ProtocolExtensionContainer    { {ResetResourceAcknowledgeExtensions} }    OPTIONAL,
    ...
}

ResetResourceAcknowledgeIEs RANAP-PROTOCOL-IES ::= {
    { ID id-CN-DomainIndicator          CRITICALITY reject  TYPE CN-DomainIndicator          PRESENCE mandatory } |
    { ID id-IuSigConIdList              CRITICALITY ignore TYPE ResetResourceAckList      PRESENCE mandatory } |
    { ID id-GlobalRNC-ID                CRITICALITY ignore TYPE GlobalRNC-ID          PRESENCE optional } |
    { ID id-CriticalityDiagnostics       CRITICALITY ignore TYPE CriticalityDiagnostics    PRESENCE optional },
    ...
}

ResetResourceAckList      ::= IuSigConId-IE-ContainerList{ {ResetResourceAckItemIEs} }

ResetResourceAckItemIEs RANAP-PROTOCOL-IES ::= {
    { ID id-IuSigConIdItem              CRITICALITY reject  TYPE      ResetResourceAckItem          PRESENCE mandatory },
    ...
}

ResetResourceAckItem ::= SEQUENCE {
    iuSigConId          IuSignallingConnectionIdentifier,
    iE-Extensions       ProtocolExtensionContainer { { ResetResourceAckItem-ExtIEs} }    OPTIONAL,
    ...
}

ResetResourceAckItem-ExtIEs RANAP-PROTOCOL-EXTENSION ::= {
    ...
}

ResetResourceAcknowledgeExtensions RANAP-PROTOCOL-EXTENSION ::= {
-- Extension for Release 4 --
    { ID id-GlobalCN-ID          CRITICALITY ignore    EXTENSION GlobalCN-ID          PRESENCE optional}|
-- Extension for Release 7 to indicate extended RNC-ID --
    { ID id-ExtendedRNC-ID      CRITICALITY reject  EXTENSION ExtendedRNC-ID      PRESENCE optional},
    ...
}

-- *****
--
-- RAB RELEASE REQUEST ELEMENTARY PROCEDURE
--
-- *****
-- *****

```

```

--
-- RAB Release Request
--
-- *****

RAB-ReleaseRequest ::= SEQUENCE {
    protocolIEs          ProtocolIE-Container          { {RAB-ReleaseRequestIEs} },
    protocolExtensions   ProtocolExtensionContainer   { {RAB-ReleaseRequestExtensions} }    OPTIONAL,
    ...
}

RAB-ReleaseRequestIEs RANAP-PROTOCOL-IES ::= {
    { ID id-RAB-ReleaseList          CRITICALITY ignore TYPE RAB-ReleaseList          PRESENCE mandatory },
    ...
}

RAB-ReleaseList ::= RAB-IE-ContainerList { {RAB-ReleaseItemIEs} }

RAB-ReleaseItemIEs RANAP-PROTOCOL-IES ::= {
    { ID id-RAB-ReleaseItem          CRITICALITY ignore TYPE RAB-ReleaseItem          PRESENCE mandatory },
    ...
}

RAB-ReleaseItem ::= SEQUENCE {
    rAB-ID                RAB-ID,
    cause                 Cause,
    iE-Extensions         ProtocolExtensionContainer { {RAB-ReleaseItem-ExtIEs} }    OPTIONAL,
    ...
}

RAB-ReleaseItem-ExtIEs RANAP-PROTOCOL-EXTENSION ::= {
    ...
}

RAB-ReleaseRequestExtensions RANAP-PROTOCOL-EXTENSION ::= {
    ...
}

-- *****
--
-- Iu RELEASE REQUEST ELEMENTARY PROCEDURE
--
-- *****

-- *****
--
-- Iu Release Request
--
-- *****

Iu-ReleaseRequest ::= SEQUENCE {
    protocolIEs          ProtocolIE-Container          { {Iu-ReleaseRequestIEs} },
    protocolExtensions   ProtocolExtensionContainer   { {Iu-ReleaseRequestExtensions} }    OPTIONAL,
    ...
}

```

```

}

Iu-ReleaseRequestIES RANAP-PROTOCOL-IES ::= {
  { ID id-Cause          CRITICALITY ignore  TYPE Cause          PRESENCE mandatory },
  ...
}

Iu-ReleaseRequestExtensions RANAP-PROTOCOL-EXTENSION ::= {
  ...
}

-- *****
--
-- RELOCATION DETECT ELEMENTARY PROCEDURE
--
-- *****

-- *****
--
-- Relocation Detect
--
-- *****

RelocationDetect ::= SEQUENCE {
  protocolIES          ProtocolIE-Container    { {RelocationDetectIES} },
  protocolExtensions   ProtocolExtensionContainer { {RelocationDetectExtensions} }
  ...
}

RelocationDetectIES RANAP-PROTOCOL-IES ::= {
  ...
}

RelocationDetectExtensions RANAP-PROTOCOL-EXTENSION ::= {
  ...
}

-- *****
--
-- RELOCATION COMPLETE ELEMENTARY PROCEDURE
--
-- *****

-- *****
--
-- Relocation Complete
--
-- *****

RelocationComplete ::= SEQUENCE {
  protocolIES          ProtocolIE-Container    { {RelocationCompleteIES} },
  protocolExtensions   ProtocolExtensionContainer { {RelocationCompleteExtensions} }
  ...
}

```

```

RelocationCompleteIEs RANAP-PROTOCOL-IES ::= {
  ...
}

RelocationCompleteExtensions RANAP-PROTOCOL-EXTENSION ::= {
-- Extension for Release 9 to enable the CN to handle potential UE NAS QoS issues related to higher bitrates --
  { ID id-HigherBitratesThan16MbpsFlag      CRITICALITY ignore  EXTENSION HigherBitratesThan16MbpsFlag  PRESENCE optional } |
-- Extension for Release 11 to support BBAI --
  { ID id-Tunnel-Information-for-BBF        CRITICALITY ignore  EXTENSION TunnelInformation          PRESENCE optional },
  ...
}

-- *****
--
-- ENHANCED RELOCATION COMPLETE ELEMENTARY PROCEDURE
--
-- *****
--
-- *****
--
-- Enhanced Relocation Complete Request
--
-- *****

EnhancedRelocationCompleteRequest ::= SEQUENCE {
  protocolIEs          ProtocolIE-Container      { { EnhancedRelocationCompleteRequestIEs } },
  protocolExtensions   ProtocolExtensionContainer { { EnhancedRelocationCompleteRequestExtensions } }      OPTIONAL,
  ...
}

EnhancedRelocationCompleteRequestIEs RANAP-PROTOCOL-IES ::= {
  { ID id-OldIuSigConId  CRITICALITY reject TYPE IuSignallingConnectionIdentifier  PRESENCE mandatory } |
  { ID id-IuSigConId     CRITICALITY reject TYPE IuSignallingConnectionIdentifier  PRESENCE mandatory } |
  { ID id-Relocation-SourceRNC-ID      CRITICALITY ignore TYPE GlobalRNC-ID          PRESENCE mandatory } |
  { ID id-Relocation-SourceExtendedRNC-ID  CRITICALITY ignore TYPE ExtendedRNC-ID          PRESENCE optional } |
  { ID id-Relocation-TargetRNC-ID       CRITICALITY reject TYPE GlobalRNC-ID          PRESENCE mandatory } |
  { ID id-Relocation-TargetExtendedRNC-ID CRITICALITY reject TYPE ExtendedRNC-ID          PRESENCE optional } |
  { ID id-RAB-SetupList-EnhancedRelocCompleteReq      CRITICALITY reject TYPE RAB-SetupList-EnhancedRelocCompleteReq PRESENCE optional }
  ,
  ...
}

RAB-SetupList-EnhancedRelocCompleteReq ::= RAB-IE-ContainerList { { RAB-SetupItem-EnhancedRelocCompleteReq-IEs } }

RAB-SetupItem-EnhancedRelocCompleteReq-IEs RANAP-PROTOCOL-IES ::= {
  { ID id-RAB-SetupItem-EnhancedRelocCompleteReq      CRITICALITY reject TYPE RAB-SetupItem-EnhancedRelocCompleteReq      PRESENCE mandatory
  },
  ...
}

RAB-SetupItem-EnhancedRelocCompleteReq ::= SEQUENCE {
  rAB-ID          RAB-ID,
  transportLayerAddressReq1      TransportLayerAddress      OPTIONAL,
  iuTransportAssociationReq1     IuTransportAssociation  OPTIONAL,

```

```

    ass-RAB-Parameters          Ass-RAB-Parameters OPTIONAL,
    iE-Extensions              ProtocolExtensionContainer { { RAB-SetupItem-EnhancedRelocCompleteReq-ExtIEs } } OPTIONAL,
    ...
}

RAB-SetupItem-EnhancedRelocCompleteReq-ExtIEs RANAP-PROTOCOL-EXTENSION ::= {
    ...
}

EnhancedRelocationCompleteRequestExtensions RANAP-PROTOCOL-EXTENSION ::= {
    { ID id-ChosenIntegrityProtectionAlgorithm CRITICALITY ignore EXTENSION ChosenIntegrityProtectionAlgorithm PRESENCE optional} |
    { ID id-ChosenEncryptionAlgorithm CRITICALITY ignore EXTENSION ChosenEncryptionAlgorithm PRESENCE optional} |
    -- Extension for Release 9 to enable the CN to handle potential UE NAS QoS issues related to higher bitrates --
    { ID id-HigherBitratesThan16MbpsFlag CRITICALITY ignore EXTENSION HigherBitratesThan16MbpsFlag PRESENCE optional} |
    -- Extensions for Release 11 to enable enhanced relocation from RNC to hybrid cell -
    { ID id-CSG-Id CRITICALITY reject EXTENSION CSG-Id PRESENCE optional} |
    { ID id-Cell-Access-Mode CRITICALITY reject EXTENSION Cell-Access-Mode PRESENCE optional} |
    -- Extension for Release 11 to support BBAI --
    { ID id-Tunnel-Information-for-BBF CRITICALITY ignore EXTENSION TunnelInformation PRESENCE optional},
    ...
}

-- *****
--
-- Enhanced Relocation Complete Response
--
-- *****

EnhancedRelocationCompleteResponse ::= SEQUENCE {
    protocolIEs          ProtocolIE-Container          { {EnhancedRelocationCompleteResponseIEs} },
    protocolExtensions   ProtocolExtensionContainer    { {EnhancedRelocationCompleteResponseExtensions} } OPTIONAL,
    ...
}

EnhancedRelocationCompleteResponseIEs RANAP-PROTOCOL-IES ::= {
    { ID id-RAB-SetupList-EnhancedRelocCompleteRes CRITICALITY ignore TYPE RAB-SetupList-EnhancedRelocCompleteRes PRESENCE optional} |
    { ID id-RAB-ToBeReleasedList-EnhancedRelocCompleteRes CRITICALITY ignore TYPE RAB-ToBeReleasedList-EnhancedRelocCompleteRes PRESENCE optional} |
    { ID id-CriticalityDiagnostics CRITICALITY ignore TYPE CriticalityDiagnostics PRESENCE optional },
    ...
}

RAB-SetupList-EnhancedRelocCompleteRes ::= RAB-IE-ContainerList { {RAB-SetupItem-EnhancedRelocCompleteRes-IEs} }

RAB-SetupItem-EnhancedRelocCompleteRes-IEs RANAP-PROTOCOL-IES ::= {
    { ID id-RAB-SetupItem-EnhancedRelocCompleteRes CRITICALITY reject TYPE RAB-SetupItem-EnhancedRelocCompleteRes PRESENCE mandatory },
    ...
}

RAB-SetupItem-EnhancedRelocCompleteRes ::= SEQUENCE {
    rAB-ID                RAB-ID,
    rAB-Parameters        RAB-Parameters OPTIONAL,
    userPlaneInformation  UserPlaneInformation,
    transportLayerAddressRes1 TransportLayerAddress OPTIONAL,

```

```

    IuTransportAssociationRes1          IuTransportAssociation OPTIONAL,
    rab2beReleasedList                 RAB-ToBeReleasedList-EnhancedRelocCompleteRes OPTIONAL,
    iE-Extensions                       ProtocolExtensionContainer { { RAB-SetupItem-EnhancedRelocCompleteRes-ExtIEs } } OPTIONAL,
    ...
}

RAB-SetupItem-EnhancedRelocCompleteRes-ExtIEs RANAP-PROTOCOL-EXTENSION ::= {
  -- Extension for Release 10 to enable Offload at Iu-ps for UTRAN --
  { ID id-Offload-RAB-Parameters          CRITICALITY ignore EXTENSION Offload-RAB-Parameters          PRESENCE optional},
  ...
}

RAB-ToBeReleasedList-EnhancedRelocCompleteRes ::= RAB-IE-ContainerList { {RAB-ToBeReleasedItem-EnhancedRelocCompleteRes-IEs} }

RAB-ToBeReleasedItem-EnhancedRelocCompleteRes-IEs RANAP-PROTOCOL-IES ::= {
  { ID id-RAB-ToBeReleasedItem-EnhancedRelocCompleteRes          CRITICALITY ignore TYPE RAB-ToBeReleasedItem-EnhancedRelocCompleteRes          PRESENCE
  mandatory },
  ...
}

RAB-ToBeReleasedItem-EnhancedRelocCompleteRes ::= SEQUENCE {
  rAB-ID                RAB-ID,
  cause                 Cause,
  iE-Extensions         ProtocolExtensionContainer { { RAB-ToBeReleasedItem-EnhancedRelocCompleteRes-ExtIEs } } OPTIONAL,
  ...
}

RAB-ToBeReleasedItem-EnhancedRelocCompleteRes-ExtIEs RANAP-PROTOCOL-EXTENSION ::= {
  ...
}

EnhancedRelocationCompleteResponseExtensions RANAP-PROTOCOL-EXTENSION ::= {
  { ID id-UE-AggregateMaximumBitRate          CRITICALITY ignore EXTENSION UE-AggregateMaximumBitRate PRESENCE optional}|
  -- Extension for Release 10 to enable Offload at Iu-ps for UTRAN --
  { ID id-MSISDN                CRITICALITY ignore EXTENSION MSISDN                PRESENCE optional}|
  -- Extension for Release 11 to enable enhanced relocation from RNC to hybrid cell -
  { ID id-CSG-Membership-Status          CRITICALITY ignore EXTENSION CSG-Membership-Status          PRESENCE optional},
  ...
}

-- *****
--
-- Enhanced Relocation Complete Failure
--
-- *****

EnhancedRelocationCompleteFailure ::= SEQUENCE {
  protocolIEs          ProtocolIE-Container          { {EnhancedRelocationCompleteFailureIEs} },
  protocolExtensions   ProtocolExtensionContainer { {EnhancedRelocationCompleteFailureExtensions} } OPTIONAL,
  ...
}

EnhancedRelocationCompleteFailureIEs RANAP-PROTOCOL-IES ::= {
  { ID id-Cause          CRITICALITY ignore TYPE Cause          PRESENCE mandatory } |

```

```

    { ID id-CriticalityDiagnostics          CRITICALITY ignore  TYPE CriticalityDiagnostics          PRESENCE optional },
    ...
}

EnhancedRelocationCompleteFailureExtensions RANAP-PROTOCOL-EXTENSION ::= {
    ...
}

-- *****
--
-- Enhanced Relocation Complete Confirm
--
-- *****

EnhancedRelocationCompleteConfirm ::= SEQUENCE {
    protocolIEs          ProtocolIE-Container          { {EnhancedRelocationCompleteConfirmIEs} },
    protocolExtensions   ProtocolExtensionContainer    { {EnhancedRelocationCompleteConfirmExtensions} }          OPTIONAL,
    ...
}

EnhancedRelocationCompleteConfirmIEs RANAP-PROTOCOL-IES ::= {
    { ID id-RAB-FailedList          CRITICALITY ignore  TYPE RAB-FailedList          PRESENCE optional },
    ...
}

EnhancedRelocationCompleteConfirmExtensions RANAP-PROTOCOL-EXTENSION ::= {
    ...
}

-- *****
--
-- PAGING ELEMENTARY PROCEDURE
--
-- *****

-- *****
--
-- Paging
--
-- *****

Paging ::= SEQUENCE {
    protocolIEs          ProtocolIE-Container          { {PagingIEs} },
    protocolExtensions   ProtocolExtensionContainer    { {PagingExtensions} }          OPTIONAL,
    ...
}

PagingIEs RANAP-PROTOCOL-IES ::= {
    { ID id-CN-DomainIndicator          CRITICALITY ignore  TYPE CN-DomainIndicator          PRESENCE mandatory } |
    { ID id-PermanentNAS-UE-ID          CRITICALITY ignore  TYPE PermanentNAS-UE-ID          PRESENCE mandatory } |
    { ID id-TemporaryUE-ID              CRITICALITY ignore  TYPE TemporaryUE-ID              PRESENCE optional } |
    { ID id-PagingAreaID                CRITICALITY ignore  TYPE PagingAreaID                PRESENCE optional } |
    { ID id-PagingCause                  CRITICALITY ignore  TYPE PagingCause                  PRESENCE optional } |

```

```

    { ID id-NonSearchingIndication          CRITICALITY ignore TYPE NonSearchingIndication          PRESENCE optional } |
    { ID id-DRX-CycleLengthCoefficient      CRITICALITY ignore TYPE DRX-CycleLengthCoefficient      PRESENCE optional } ,
    ...
}

PagingExtensions RANAP-PROTOCOL-EXTENSION ::= {
-- Extension for Release 5 to enable NNSF --
  { ID id-GlobalCN-ID          CRITICALITY ignore EXTENSION GlobalCN-ID          PRESENCE optional } |
-- Extension for Release 8 to support CSG --
  { ID id-CSG-Id-List         CRITICALITY ignore EXTENSION CSG-Id-List         PRESENCE optional } ,
  ...
}

-- *****
--
-- COMMON ID ELEMENTARY PROCEDURE
--
-- *****
--
-- *****
--
-- Common ID
--
-- *****

CommonID ::= SEQUENCE {
  protocolIEs          ProtocolIE-Container          { {CommonID-IEs} },
  protocolExtensions  ProtocolExtensionContainer    { {CommonIDExtensions} }
  ...
}

CommonID-IEs RANAP-PROTOCOL-IES ::= {
  { ID id-PermanentNAS-UE-ID          CRITICALITY ignore TYPE PermanentNAS-UE-ID          PRESENCE mandatory } ,
  ...
}

CommonIDExtensions RANAP-PROTOCOL-EXTENSION ::= {
-- Extension for Release 5 to enable shared networks in connected mode --
  { ID id-SNA-Access-Information      CRITICALITY ignore EXTENSION SNA-Access-Information      PRESENCE optional } |
-- Extension for Release 5 to enable specific behaviour by the RNC in relation with early UE handling --
  { ID id-UESBI-Iu                    CRITICALITY ignore EXTENSION UESBI-Iu                    PRESENCE optional } |
-- Extension for Release 6 to indicate the selected plmn in GWCN configuration for network sharing non-supporting UEs --
  { ID id-SelectedPLMN-ID            CRITICALITY ignore EXTENSION PLMNidentity            PRESENCE optional } |
-- Extension for Release 8 to indicate the Subscriber Profile ID for RAT/Frequency Selection Priority --
  { ID id-SubscriberProfileIDforRFP   CRITICALITY ignore EXTENSION SubscriberProfileIDforRFP   PRESENCE optional } |
-- Extension for Release 8 for SRVCC operation --
  { ID id-SRVCC-Operation-Possible    CRITICALITY ignore EXTENSION SRVCC-Operation-Possible    PRESENCE optional } |
-- Extension for Release 9 to allow for UE prioritisation during access to hybrid cells --
  { ID id-CSG-Membership-Status       CRITICALITY ignore EXTENSION CSG-Membership-Status       PRESENCE optional } |
-- Extension for Release 10 to indicate Management Based MDT Allowed --
  { ID id-Management-Based-MDT-Allowed CRITICALITY ignore EXTENSION Management-Based-MDT-Allowed PRESENCE optional } |
-- Extension for Release 11 to indicate MDT PLMN List --
  { ID id-Management-Based-MDT-PLMN-List CRITICALITY ignore EXTENSION MDT-PLMN-List          PRESENCE optional } ,
  ...
}

```

```

}
-- *****
--
-- CN INVOKE TRACE ELEMENTARY PROCEDURE
--
-- *****
--
-- CN Invoke Trace
--
-- *****

CN-InvokeTrace ::= SEQUENCE {
    protocolIEs          ProtocolIE-Container      { {CN-InvokeTraceIEs} },
    protocolExtensions   ProtocolExtensionContainer { {CN-InvokeTraceExtensions} }      OPTIONAL,
    ...
}

CN-InvokeTraceIEs RANAP-PROTOCOL-IES ::= {
    { ID id-TraceType          CRITICALITY ignore   TYPE TraceType          PRESENCE optional } |
    -- This information is mandatory for GERAN Iu Mode, not applicable to UTRAN --
    { ID id-TraceReference     CRITICALITY ignore   TYPE TraceReference          PRESENCE mandatory } |
    { ID id-TriggerID          CRITICALITY ignore   TYPE TriggerID              PRESENCE optional } |
    -- This information is mandatory for GERAN Iu Mode, not applicable to UTRAN --
    { ID id-UE-ID              CRITICALITY ignore   TYPE UE-ID                  PRESENCE optional } |
    -- This information is mandatory for UTRAN, optional for GERAN Iu mode --
    { ID id-OMC-ID             CRITICALITY ignore   TYPE OMC-ID                 PRESENCE optional },
    -- This information is mandatory for GERAN Iu Mode, not applicable to UTRAN --
    ...
}

CN-InvokeTraceExtensions RANAP-PROTOCOL-EXTENSION ::= {
-- Extension for Release 6 to enable signalling based activation for Subscriber and Equipment Trace over Iu interface --
    { ID id-TracePropagationParameters CRITICALITY ignore EXTENSION TracePropagationParameters PRESENCE optional}|
-- Extension for Release 10 to support MDT--
    { ID id-MDT-Configuration CRITICALITY ignore EXTENSION MDT-Configuration PRESENCE optional}|
-- Extension for Release 10 to support MDT--
    { ID id-Trace-Collection-Entity-IP-Address CRITICALITY ignore EXTENSION TransportLayerAddress PRESENCE optional},
    ...
}

-- *****
--
-- CN DEACTIVATE TRACE ELEMENTARY PROCEDURE
--
-- *****
--
-- CN Deactivate Trace
--
-- *****

```

```

CN-DeactivateTrace ::= SEQUENCE {
    protocolIEs          ProtocolIE-Container      { {CN-DeactivateTraceIEs} },
    protocolExtensions   ProtocolExtensionContainer { {CN-DeactivateTraceExtensions} }      OPTIONAL,
    ...
}

CN-DeactivateTraceIEs RANAP-PROTOCOL-IES ::= {
    { ID id-TraceReference          CRITICALITY ignore  TYPE TraceReference          PRESENCE mandatory } |
    { ID id-TriggerID              CRITICALITY ignore  TYPE TriggerID              PRESENCE optional },
    -- This information is optional for GERAN Iu Mode, not applicable to UTRAN --
    ...
}

CN-DeactivateTraceExtensions RANAP-PROTOCOL-EXTENSION ::= {
    ...
}

-- *****
--
-- LOCATION REPORTING CONTROL ELEMENTARY PROCEDURE
--
-- *****
--
-- *****
--
-- Location Reporting Control
--
-- *****

LocationReportingControl ::= SEQUENCE {
    protocolIEs          ProtocolIE-Container      { {LocationReportingControlIEs} },
    protocolExtensions   ProtocolExtensionContainer { {LocationReportingControlExtensions} }      OPTIONAL,
    ...
}

LocationReportingControlIEs RANAP-PROTOCOL-IES ::= {
    { ID id-RequestType          CRITICALITY ignore  TYPE RequestType          PRESENCE mandatory },
    ...
}

LocationReportingControlExtensions RANAP-PROTOCOL-EXTENSION ::= {
-- Extension for Release 4 to enhance the location request over Iu --
    { ID id-VerticalAccuracyCode          CRITICALITY ignore  EXTENSION VerticalAccuracyCode          PRESENCE optional } |
-- Extension for Release 4 to enhance the location request over Iu --
    { ID id-ResponseTime                  CRITICALITY ignore  EXTENSION ResponseTime                  PRESENCE optional } |
-- Extension for Release 4 to enhance the location request over Iu --
    { ID id-PositioningPriority            CRITICALITY ignore  EXTENSION PositioningPriority            PRESENCE optional } |
-- Extension for Release 4 to enhance the location request over Iu --
    { ID id-ClientType                    CRITICALITY ignore  EXTENSION ClientType                    PRESENCE optional } |
-- Extension for Release 7 to allow the request of velocity over Iu --
    { ID id-IncludeVelocity                CRITICALITY ignore  EXTENSION IncludeVelocity                PRESENCE optional } |
-- Extension for Release 7 to allow periodic reporting over Iu --
    { ID id-PeriodicLocationInfo          CRITICALITY ignore  EXTENSION PeriodicLocationInfo          PRESENCE optional },
}

```

```

}
...
}
-- *****
--
-- LOCATION REPORT ELEMENTARY PROCEDURE
--
-- *****

-- *****
--
-- Location Report
--
-- *****

LocationReport ::= SEQUENCE {
    protocolIEs          ProtocolIE-Container      { {LocationReportIEs} },
    protocolExtensions   ProtocolExtensionContainer { {LocationReportExtensions} }      OPTIONAL,
    ...
}

LocationReportIEs RANAP-PROTOCOL-IES ::= {
    { ID id-AreaIdentity          CRITICALITY ignore TYPE AreaIdentity          PRESENCE optional } |
    { ID id-Cause                 CRITICALITY ignore TYPE Cause                 PRESENCE optional } |
    { ID id-RequestType           CRITICALITY ignore TYPE RequestType           PRESENCE optional } ,
    ...
}

LocationReportExtensions RANAP-PROTOCOL-EXTENSION ::= {
-- Extension for Release 4 to enable report of Last Known Service Area with its Age over Iu --
    { ID id-LastKnownServiceArea CRITICALITY ignore EXTENSION LastKnownServiceArea PRESENCE optional } |
-- Extension for Release 5 to pass the positioning methods that have been used --
    { ID id-PositionData         CRITICALITY ignore EXTENSION PositionData         PRESENCE optional } |
-- Extension for Release 5 to pass the positioning methods that have been used for GERAN Iu mode --
    { ID id-PositionDataSpecificToGERANIuMode CRITICALITY ignore EXTENSION PositionDataSpecificToGERANIuMode PRESENCE optional } |
    -- This extension is optional for GERAN Iu mode only, not applicable for UTRAN --
-- Extension for Release 6 to indicate whether the returned position estimate satisfies the requested accuracy or not --
    { ID id-AccuracyFulfilmentIndicator CRITICALITY ignore EXTENSION AccuracyFulfilmentIndicator PRESENCE optional } |
-- Extension for Release 7 to provide a velocity estimate --
    { ID id-VelocityEstimate       CRITICALITY ignore EXTENSION VelocityEstimate       PRESENCE optional },
    ...
}

-- *****
--
-- INITIAL UE MESSAGE ELEMENTARY PROCEDURE
--
-- *****

-- *****
--
-- Initial UE Message
--
-- *****

```

```

InitialUE-Message ::= SEQUENCE {
    protocolIEs          ProtocolIE-Container          { {InitialUE-MessageIEs} },
    protocolExtensions   ProtocolExtensionContainer    { {InitialUE-MessageExtensions} }      OPTIONAL,
    ...
}

InitialUE-MessageIEs RANAP-PROTOCOL-IES ::= {
    { ID id-CN-DomainIndicator          CRITICALITY ignore TYPE CN-DomainIndicator          PRESENCE mandatory } |
    { ID id-LAI                         CRITICALITY ignore TYPE LAI                         PRESENCE mandatory } |
    { ID id-RAC                         CRITICALITY ignore TYPE RAC                         PRESENCE conditional
    -- This IE shall be present if the CN Domain Indicator IE is set to "PS domain"
    } |
    { ID id-SAI                         CRITICALITY ignore TYPE SAI                         PRESENCE mandatory } |
    { ID id-NAS-PDU                     CRITICALITY ignore TYPE NAS-PDU                     PRESENCE mandatory } |
    { ID id-IuSigConId                 CRITICALITY ignore TYPE IuSignallingConnectionIdentifier PRESENCE mandatory } |
    { ID id-GlobalRNC-ID               CRITICALITY ignore TYPE GlobalRNC-ID               PRESENCE mandatory },
    ...
}

InitialUE-MessageExtensions RANAP-PROTOCOL-EXTENSION ::= {
-- Extension for Release 5 to enable GERAN support over Iu-cs --
    { ID id-GERAN-Classmark             CRITICALITY ignore EXTENSION GERAN-Classmark             PRESENCE optional} |
-- Extension for Release 6 to convey the selected PLMN id in shared networks --
    { ID id-SelectedPLMN-ID            CRITICALITY ignore EXTENSION PLMNidentity                PRESENCE optional} |
-- Extension for Release 6 to enable rerouting in MOCN configuration for network sharing non-supporting UEs --
    { ID id-PermanentNAS-UE-ID         CRITICALITY ignore EXTENSION PermanentNAS-UE-ID         PRESENCE optional} |
-- Extension for Release 6 to enable rerouting in MOCN configuration for network sharing non-supporting UEs --
    { ID id-NAS-SequenceNumber         CRITICALITY ignore EXTENSION NAS-SequenceNumber         PRESENCE optional} |
-- Extension for Release 6 to indicate rerouting in MOCN configuration for network sharing non-supporting UEs --
    { ID id-RedirectAttemptFlag        CRITICALITY ignore EXTENSION RedirectAttemptFlag        PRESENCE optional} |
-- Extension for Release 7 to indicate extended RNC-ID --
    { ID id-ExtendedRNC-ID             CRITICALITY reject  EXTENSION ExtendedRNC-ID             PRESENCE optional} |
-- Extension for Release 8 to support CSG --
    { ID id-CSG-Id                    CRITICALITY reject  EXTENSION CSG-Id                    PRESENCE optional} |
-- Extension for Release 9 to allow communication of the cell access mode --
    { ID id-Cell-Access-Mode           CRITICALITY reject  EXTENSION Cell-Access-Mode           PRESENCE optional} |
-- Extension for Release 10 to support LIPA --
    { ID id-LGW-TransportLayerAddress   CRITICALITY ignore  EXTENSION TransportLayerAddress     PRESENCE optional} |
-- Extension for Release 9 to enable the CN to handle potential UE NAS QoS issues related to higher bitrates --
    { ID id-HigherBitratesThan16MbpsFlag CRITICALITY ignore  EXTENSION HigherBitratesThan16MbpsFlag PRESENCE optional} |
-- Extension for Release 11 to support BBAI --
    { ID id-Tunnel-Information-for-BBF  CRITICALITY ignore  EXTENSION TunnelInformation         PRESENCE optional},
    ...
}

-- *****
--
-- DIRECT TRANSFER ELEMENTARY PROCEDURE
--
-- *****

-- *****
--
-- Direct Transfer

```

```

--
-- *****
DirectTransfer ::= SEQUENCE {
    protocolIEs          ProtocolIE-Container    { {DirectTransferIEs} },
    protocolExtensions   ProtocolExtensionContainer { {DirectTransferExtensions} }      OPTIONAL,
    ...
}

DirectTransferIEs RANAP-PROTOCOL-IES ::= {
    { ID id-NAS-PDU          CRITICALITY ignore TYPE NAS-PDU          PRESENCE mandatory }|
    { ID id-LAI             CRITICALITY ignore TYPE LAI             PRESENCE optional }|
    { ID id-RAC             CRITICALITY ignore TYPE RAC             PRESENCE optional }|
    { ID id-SAI             CRITICALITY ignore TYPE SAI             PRESENCE optional }|
    { ID id-SAPI            CRITICALITY ignore TYPE SAPI            PRESENCE optional },
    ...
}

DirectTransferExtensions RANAP-PROTOCOL-EXTENSION ::= {
-- Extension for Release 6 to enable rerouting in MOCN configuration for network sharing non-supporting UEs --
    { ID id-RedirectionIndication          CRITICALITY ignore EXTENSION RedirectionIndication          PRESENCE optional }|
-- Extension for Release 6 to indicate the MOCN rerouting is completed --
    { ID id-RedirectionCompleted          CRITICALITY ignore EXTENSION RedirectionCompleted          PRESENCE optional }|
-- Extension for Release 8 to indicate the Subscriber Profile ID for RAT/Frequency Selection Priority --
    { ID id-SubscriberProfileIDforRFP     CRITICALITY ignore EXTENSION SubscriberProfileIDforRFP     PRESENCE optional }|
-- Extension for Release 10 to support LIPA --
    { ID id-LGW-TransportLayerAddress     CRITICALITY ignore EXTENSION TransportLayerAddress         PRESENCE optional },
    ...
}

RedirectionIndication ::= ProtocolIE-Container { {RedirectionIndication-IEs} }

RedirectionIndication-IEs RANAP-PROTOCOL-IES ::= {
    { ID id-NAS-PDU          CRITICALITY ignore TYPE NAS-PDU          PRESENCE mandatory }|
    { ID id-RejectCauseValue CRITICALITY ignore TYPE RejectCauseValue PRESENCE mandatory }|
    { ID id-NAS-SequenceNumber CRITICALITY ignore TYPE NAS-SequenceNumber PRESENCE optional }|
    { ID id-PermanentNAS-UE-ID CRITICALITY ignore TYPE PermanentNAS-UE-ID PRESENCE optional },
    ...
}

-- *****
--
-- OVERLOAD CONTROL ELEMENTARY PROCEDURE
--
-- *****

-- *****
--
-- Overload
--
-- *****

Overload ::= SEQUENCE {
    protocolIEs          ProtocolIE-Container    { {OverloadIEs} },

```

```

    protocolExtensions      ProtocolExtensionContainer { {OverloadExtensions} }
    ...
}

OverloadIEs RANAP-PROTOCOL-IES ::= {
  { ID id-NumberOfSteps      CRITICALITY ignore  TYPE NumberOfSteps      PRESENCE optional } |
  { ID id-GlobalRNC-ID       CRITICALITY ignore  TYPE GlobalRNC-ID          PRESENCE optional },
  ...
}

OverloadExtensions RANAP-PROTOCOL-EXTENSION ::= {
-- Extension for Release 99 to enable the indication to the RNC which CN domain is suffering the signalling traffic overload --
  { ID id-CN-DomainIndicator  CRITICALITY ignore  EXTENSION CN-DomainIndicator  PRESENCE optional } |
-- Extension for Release 5 to enable NNSF --
  { ID id-GlobalCN-ID         CRITICALITY ignore  EXTENSION GlobalCN-ID        PRESENCE optional } |
-- Extension for Release 7 to indicate extended RNC-ID --
  { ID id-ExtendedRNC-ID     CRITICALITY reject  EXTENSION ExtendedRNC-ID     PRESENCE optional } |
-- Extension for Release 10 to support Low Priority overload --
  { ID id-Priority-Class-Indicator  CRITICALITY ignore  EXTENSION Priority-Class-Indicator  PRESENCE optional },
  ...
}

-- *****
--
-- ERROR INDICATION ELEMENTARY PROCEDURE
--
-- *****
--
-- *****
--
-- Error Indication
--
-- *****

ErrorIndication ::= SEQUENCE {
  protocolIEs      ProtocolIE-Container      { {ErrorIndicationIEs} },
  protocolExtensions      ProtocolExtensionContainer { {ErrorIndicationExtensions} }
  ...
}

ErrorIndicationIEs RANAP-PROTOCOL-IES ::= {
  { ID id-Cause          CRITICALITY ignore  TYPE Cause          PRESENCE optional } |
  { ID id-CriticalityDiagnostics  CRITICALITY ignore  TYPE CriticalityDiagnostics  PRESENCE optional } |
  { ID id-CN-DomainIndicator  CRITICALITY ignore  TYPE CN-DomainIndicator  PRESENCE optional } |
  { ID id-GlobalRNC-ID       CRITICALITY ignore  TYPE GlobalRNC-ID       PRESENCE optional },
  ...
}

ErrorIndicationExtensions RANAP-PROTOCOL-EXTENSION ::= {
-- Extension for Release 4 --
  { ID id-GlobalCN-ID         CRITICALITY ignore  EXTENSION GlobalCN-ID        PRESENCE optional } |
-- Extension for Release 7 to indicate extended RNC-ID --
  { ID id-ExtendedRNC-ID     CRITICALITY reject  EXTENSION ExtendedRNC-ID     PRESENCE optional },
  ...
}

```

```

}

-- *****
--
-- SRNS DATA FORWARD ELEMENTARY PROCEDURE
--
-- *****

-- *****
--
-- SRNS Data Forward Command
--
-- *****

SRNS-DataForwardCommand ::= SEQUENCE {
    protocolIEs          ProtocolIE-Container          { {SRNS-DataForwardCommandIEs} },
    protocolExtensions   ProtocolExtensionContainer   { {SRNS-DataForwardCommandExtensions} }    OPTIONAL,
    ...
}

SRNS-DataForwardCommandIEs RANAP-PROTOCOL-IES ::= {
    { ID id-RAB-DataForwardingList          CRITICALITY ignore TYPE RAB-DataForwardingList          PRESENCE optional },
    ...
}

SRNS-DataForwardCommandExtensions RANAP-PROTOCOL-EXTENSION ::= {
    ...
}

-- *****
--
-- FORWARD SRNS CONTEXT ELEMENTARY PROCEDURE
--
-- *****

-- *****
--
-- Forward SRNS Context
--
-- *****

ForwardSRNS-Context ::= SEQUENCE {
    protocolIEs          ProtocolIE-Container          { {ForwardSRNS-ContextIEs} },
    protocolExtensions   ProtocolExtensionContainer   { {ForwardSRNS-ContextExtensions} }    OPTIONAL,
    ...
}

ForwardSRNS-ContextIEs RANAP-PROTOCOL-IES ::= {
    { ID id-RAB-ContextList          CRITICALITY ignore TYPE RAB-ContextList          PRESENCE mandatory },
    ...
}

ForwardSRNS-ContextExtensions RANAP-PROTOCOL-EXTENSION ::= {
-- Extension for Release 5 to enable relocation of Source RNC PDCP context info --

```

```

    { ID id-SourceRNC-PDCP-context-info      CRITICALITY ignore EXTENSION RRC-Container PRESENCE optional},
    ...
}

-- *****
--
-- RAB ASSIGNMENT ELEMENTARY PROCEDURE
--
-- *****
--
-- *****
--
-- RAB Assignment Request
--
-- *****

RAB-AssignmentRequest ::= SEQUENCE {
    protocolIEs          ProtocolIE-Container      { {RAB-AssignmentRequestIEs} },
    protocolExtensions   ProtocolExtensionContainer { {RAB-AssignmentRequestExtensions} }      OPTIONAL,
    ...
}

RAB-AssignmentRequestIEs RANAP-PROTOCOL-IES ::= {
    { ID id-RAB-SetupOrModifyList          CRITICALITY ignore TYPE RAB-SetupOrModifyList          PRESENCE optional } |
    { ID id-RAB-ReleaseList                CRITICALITY ignore TYPE RAB-ReleaseList                PRESENCE optional },
    ...
}

RAB-SetupOrModifyList ::= RAB-IE-ContainerPairList { {RAB-SetupOrModifyItem-IEs} }

RAB-SetupOrModifyItem-IEs RANAP-PROTOCOL-IES-PAIR ::= {
    { ID id-RAB-SetupOrModifyItem          FIRST CRITICALITY reject FIRST TYPE RAB-SetupOrModifyItemFirst
      SECOND CRITICALITY ignore SECOND TYPE RAB-SetupOrModifyItemSecond
      PRESENCE mandatory },
    ...
}

RAB-SetupOrModifyItemFirst ::= SEQUENCE {
    rAB-ID          RAB-ID,
    nAS-SynchronisationIndicator NAS-SynchronisationIndicator OPTIONAL,
    rAB-Parameters  RAB-Parameters OPTIONAL,
    userPlaneInformation UserPlaneInformation OPTIONAL,
    transportLayerInformation TransportLayerInformation OPTIONAL,
    service-Handover Service-Handover OPTIONAL,
    iE-Extensions   ProtocolExtensionContainer { {RAB-SetupOrModifyItemFirst-ExtIEs} }      OPTIONAL,
    ...
}

TransportLayerInformation ::= SEQUENCE {
    transportLayerAddress TransportLayerAddress,
    iuTransportAssociation IuTransportAssociation,
    iE-Extensions         ProtocolExtensionContainer { {TransportLayerInformation-ExtIEs} }      OPTIONAL,
    ...
}

```

```

TransportLayerInformation-ExtIEs RANAP-PROTOCOL-EXTENSION ::= {
  ...
}

RAB-SetupOrModifyItemFirst-ExtIEs RANAP-PROTOCOL-EXTENSION ::= {
-- Extension for Release 8 to enable handover restriction to E-UTRAN --
  { ID id-E-UTRAN-Service-Handover      CRITICALITY ignore  EXTENSION E-UTRAN-Service-Handover  PRESENCE optional}|
-- Extension for Release 10 to support LIPA --
  { ID id-Correlation-ID                CRITICALITY ignore  EXTENSION Correlation-ID                PRESENCE optional},
  ...
}

RAB-SetupOrModifyItemSecond ::= SEQUENCE {
  pdp-TypeInformation          PDP-TypeInformation          OPTIONAL,
  dataVolumeReportingIndication  DataVolumeReportingIndication  OPTIONAL,
  dl-GTP-PDU-SequenceNumber     DL-GTP-PDU-SequenceNumber     OPTIONAL,
  ul-GTP-PDU-SequenceNumber     UL-GTP-PDU-SequenceNumber     OPTIONAL,
  dl-N-PDU-SequenceNumber       DL-N-PDU-SequenceNumber       OPTIONAL,
  ul-N-PDU-SequenceNumber       UL-N-PDU-SequenceNumber       OPTIONAL,
  iE-Extensions                ProtocolExtensionContainer { {RAB-SetupOrModifyItemSecond-ExtIEs} }  OPTIONAL,
  ...
}

RAB-SetupOrModifyItemSecond-ExtIEs RANAP-PROTOCOL-EXTENSION ::= {
-- Extension for Release 4 to enable RAB Quality of Service negotiation over Iu --
  { ID id-Alt-RAB-Parameters          CRITICALITY ignore  EXTENSION Alt-RAB-Parameters          PRESENCE optional}|
-- Extension for Release 5 to enable GERAN support over Iu-cs --
  { ID id-GERAN-BSC-Container         CRITICALITY ignore  EXTENSION GERAN-BSC-Container         PRESENCE optional}|
-- Extension for Release Release 9 to enable a new value --
  { ID id-PDP-TypeInformation-extension CRITICALITY ignore  EXTENSION PDP-TypeInformation-extension PRESENCE optional}|
-- Extension for Release 10 to enable Offload at Iu-ps for UTRAN --
  { ID id-Offload-RAB-Parameters      CRITICALITY ignore  EXTENSION Offload-RAB-Parameters      PRESENCE optional},
  ...
}

RAB-AssignmentRequestExtensions RANAP-PROTOCOL-EXTENSION ::= {
  { ID id-UE-AggregateMaximumBitRate  CRITICALITY ignore  EXTENSION UE-AggregateMaximumBitRate PRESENCE optional}|
-- Extension for Release 10 to enable Offload at Iu-ps for UTRAN --
  { ID id-MSISDN                      CRITICALITY ignore  EXTENSION MSISDN                      PRESENCE optional},
  ...
}

-- *****
--
-- RAB Assignment Response
--
-- *****

RAB-AssignmentResponse ::= SEQUENCE {
  protocolIEs          ProtocolIE-Container          { {RAB-AssignmentResponseIEs} },
  protocolExtensions   ProtocolExtensionContainer { {RAB-AssignmentResponseExtensions} }  OPTIONAL,
  ...
}

```

```

RAB-AssignmentResponseIEs RANAP-PROTOCOL-IES ::= {
  { ID id-RAB-SetupOrModifiedList      CRITICALITY ignore  TYPE RAB-SetupOrModifiedList      PRESENCE optional } |
  { ID id-RAB-ReleasedList              CRITICALITY ignore  TYPE RAB-ReleasedList              PRESENCE optional } |

  { ID id-RAB-QueuedList                 CRITICALITY ignore  TYPE RAB-QueuedList                 PRESENCE optional } |
  { ID id-RAB-FailedList                 CRITICALITY ignore  TYPE RAB-FailedList                 PRESENCE optional } |
  { ID id-RAB-ReleaseFailedList          CRITICALITY ignore  TYPE RAB-ReleaseFailedList          PRESENCE optional } |
  { ID id-CriticalityDiagnostics          CRITICALITY ignore  TYPE CriticalityDiagnostics          PRESENCE optional },
  ...
}

RAB-SetupOrModifiedList ::= RAB-IE-ContainerList { {RAB-SetupOrModifiedItemIEs} }

RAB-SetupOrModifiedItemIEs RANAP-PROTOCOL-IES ::= {
  { ID id-RAB-SetupOrModifiedItem      CRITICALITY ignore  TYPE RAB-SetupOrModifiedItem      PRESENCE mandatory },
  ...
}

RAB-SetupOrModifiedItem ::= SEQUENCE {
  rAB-ID                RAB-ID,
  transportLayerAddress TransportLayerAddress OPTIONAL,
  iuTransportAssociation IuTransportAssociation OPTIONAL,
  dl-dataVolumes         DataVolumeList OPTIONAL,
  iE-Extensions          ProtocolExtensionContainer { {RAB-SetupOrModifiedItem-ExtIEs} } OPTIONAL,
  ...
}

RAB-SetupOrModifiedItem-ExtIEs RANAP-PROTOCOL-EXTENSION ::= {
-- Extension for Release 4 to enable RAB Quality of Service negotiation over Iu --
  { ID id-Ass-RAB-Parameters  CRITICALITY ignore  EXTENSION Ass-RAB-Parameters  PRESENCE optional },
  ...
}

RAB-ReleasedList ::= RAB-IE-ContainerList { {RAB-ReleasedItemIEs} }

RAB-ReleasedItemIEs RANAP-PROTOCOL-IES ::= {
  { ID id-RAB-ReleasedItem      CRITICALITY ignore  TYPE RAB-ReleasedItem      PRESENCE mandatory },
  ...
}

RAB-ReleasedItem ::= SEQUENCE {
  rAB-ID                RAB-ID,
  dl-dataVolumes         DataVolumeList OPTIONAL,
  dL-GTP-PDU-SequenceNumber DL-GTP-PDU-SequenceNumber OPTIONAL,
  uL-GTP-PDU-SequenceNumber UL-GTP-PDU-SequenceNumber OPTIONAL,
  iE-Extensions          ProtocolExtensionContainer { {RAB-ReleasedItem-ExtIEs} } OPTIONAL,
  ...
}

RAB-ReleasedItem-ExtIEs RANAP-PROTOCOL-EXTENSION ::= {
  ...
}

```

```

DataVolumeList ::= SEQUENCE (SIZE (1..maxNrOfVol)) OF
  SEQUENCE {
    dl-UnsuccessfullyTransmittedDataVolume      UnsuccessfullyTransmittedDataVolume,
    dataVolumeReference                        DataVolumeReference OPTIONAL,
    iE-Extensions                             ProtocolExtensionContainer { {DataVolumeList-ExtIEs} }      OPTIONAL,
    ...
  }

DataVolumeList-ExtIEs RANAP-PROTOCOL-EXTENSION ::= {
  ...
}

RAB-QueuedList ::= RAB-IE-ContainerList { {RAB-QueuedItemIEs} }

RAB-QueuedItemIEs RANAP-PROTOCOL-IES ::= {
  { ID id-RAB-QueuedItem                      CRITICALITY ignore  TYPE RAB-QueuedItem                PRESENCE mandatory },
  ...
}

RAB-QueuedItem ::= SEQUENCE {
  rAB-ID                                     RAB-ID,
  iE-Extensions                             ProtocolExtensionContainer { {RAB-QueuedItem-ExtIEs} }      OPTIONAL,
  ...
}

RAB-QueuedItem-ExtIEs RANAP-PROTOCOL-EXTENSION ::= {
  ...
}

RAB-ReleaseFailedList ::= RAB-FailedList

RAB-AssignmentResponseExtensions RANAP-PROTOCOL-EXTENSION ::= {
-- Extension for Release 5 to enable GERAN support over Iu-cs --
  { ID id-GERAN-Iumode-RAB-FailedList-RABAssgntResponse      CRITICALITY ignore  EXTENSION GERAN-Iumode-RAB-FailedList-RABAssgntResponse
    PRESENCE optional} ,
  ...
}

GERAN-Iumode-RAB-FailedList-RABAssgntResponse ::= RAB-IE-ContainerList { {GERAN-Iumode-RAB-Failed-RABAssgntResponse-ItemIEs} }

GERAN-Iumode-RAB-Failed-RABAssgntResponse-ItemIEs RANAP-PROTOCOL-IES ::= {
  { ID id-GERAN-Iumode-RAB-Failed-RABAssgntResponse-Item      CRITICALITY ignore  TYPE GERAN-Iumode-RAB-Failed-RABAssgntResponse-Item
    PRESENCE mandatory },
  ...
}

GERAN-Iumode-RAB-Failed-RABAssgntResponse-Item ::= SEQUENCE {
  rAB-ID                                     RAB-ID,
  cause                                       Cause,
  gGERAN-Classmark                           GERAN-Classmark      OPTIONAL,
  iE-Extensions                             ProtocolExtensionContainer { {GERAN-Iumode-RAB-Failed-RABAssgntResponse-Item-ExtIEs} }      OPTIONAL,
  ...
}

```

```

GERAN-Iumode-RAB-Failed-RABAssgntResponse-Item-ExtIEs RANAP-PROTOCOL-EXTENSION ::= {
  ...
}

-- *****
--
-- PRIVATE MESSAGE
--
-- *****

PrivateMessage ::= SEQUENCE {
  privateIEs      PrivateIE-Container      { {PrivateMessage-IEs } },
  ...
}

PrivateMessage-IEs RANAP-PRIVATE-IES ::= {
  ...
}

-- *****
--
-- RANAP RELOCATION INFORMATION ELEMENTARY PROCEDURE
--
-- *****

RANAP-RelocationInformation ::= SEQUENCE {
  protocolIEs      ProtocolIE-Container      { {RANAP-RelocationInformationIEs} },
  protocolExtensions ProtocolExtensionContainer { {RANAP-RelocationInformationExtensions} } OPTIONAL,
  ...
}

RANAP-RelocationInformationIEs RANAP-PROTOCOL-IES ::= {
  { ID id-DirectTransferInformationList-RANAP-RelocInf
    CRITICALITY ignore TYPE DirectTransferInformationList-RANAP-RelocInf
    PRESENCE optional } |
  { ID id-RAB-ContextList-RANAP-RelocInf      CRITICALITY ignore TYPE RAB-ContextList-RANAP-RelocInf      PRESENCE optional },
  ...
}

DirectTransferInformationList-RANAP-RelocInf ::= DirectTransfer-IE-ContainerList { {DirectTransferInformationItemIEs-RANAP-RelocInf} }

DirectTransferInformationItemIEs-RANAP-RelocInf RANAP-PROTOCOL-IES ::= {
  { ID id-DirectTransferInformationItem-RANAP-RelocInf
    CRITICALITY ignore TYPE DirectTransferInformationItem-RANAP-RelocInf
    PRESENCE mandatory },
  ...
}

DirectTransferInformationItem-RANAP-RelocInf ::= SEQUENCE {
  nAS-PDU          NAS-PDU,
  sAPI             SAPI,
  cN-DomainIndicator CN-DomainIndicator,
  iE-Extensions   ProtocolExtensionContainer { {RANAP-DirectTransferInformationItem-ExtIEs-RANAP-RelocInf} } OPTIONAL,
  ...
}

```

```

}

RANAP-DirectTransferInformationItem-ExtIEs-RANAP-RelocInf RANAP-PROTOCOL-EXTENSION ::= {
  ...
}

RAB-ContextList-RANAP-RelocInf ::= RAB-IE-ContainerList { {RAB-ContextItemIEs-RANAP-RelocInf} }

RAB-ContextItemIEs-RANAP-RelocInf RANAP-PROTOCOL-IES ::= {
  { ID id-RAB-ContextItem-RANAP-RelocInf CRITICALITY ignore TYPE RAB-ContextItem-RANAP-RelocInf PRESENCE mandatory },
  ...
}

RAB-ContextItem-RANAP-RelocInf ::= SEQUENCE {
  rAB-ID RAB-ID,
  dl-GTP-PDU-SequenceNumber DL-GTP-PDU-SequenceNumber OPTIONAL,
  ul-GTP-PDU-SequenceNumber UL-GTP-PDU-SequenceNumber OPTIONAL,
  dl-N-PDU-SequenceNumber DL-N-PDU-SequenceNumber OPTIONAL,
  ul-N-PDU-SequenceNumber UL-N-PDU-SequenceNumber OPTIONAL,
  iE-Extensions ProtocolExtensionContainer { {RAB-ContextItem-ExtIEs-RANAP-RelocInf} } OPTIONAL,
  ...
}

RAB-ContextItem-ExtIEs-RANAP-RelocInf RANAP-PROTOCOL-EXTENSION ::= {
  ...
}

RANAP-RelocationInformationExtensions RANAP-PROTOCOL-EXTENSION ::= {
  -- Extension for Release 5 to enable relocation of Source RNC PDCP context info --
  { ID id-SourceRNC-PDCP-context-info CRITICALITY ignore EXTENSION RRC-Container PRESENCE optional} |
  -- Extension for Release 10 to enable RNSAP Relocation --
  { ID id-RNSAPRelocationParameters CRITICALITY reject EXTENSION RNSAPRelocationParameters PRESENCE optional},
  ...
}

-- *****
--
-- RANAP ENHANCED RELOCATION INFORMATION ELEMENTARY PROCEDURE
--
-- *****
--
-- *****
--
-- RANAP Enhanced Relocation Information Request
--
-- *****

RANAP-EnhancedRelocationInformationRequest ::= SEQUENCE {
  protocolIEs ProtocolIE-Container { {RANAP-EnhancedRelocationInformationRequestIEs} },
  protocolExtensions ProtocolExtensionContainer { {RANAP-EnhancedRelocationInformationRequestExtensions} } OPTIONAL,
  ...
}

RANAP-EnhancedRelocationInformationRequestIEs RANAP-PROTOCOL-IES ::= {

```

```

{ ID id-Source-ToTarget-TransparentContainer
    CRITICALITY reject TYPE SourceRNC-ToTargetRNC-TransparentContainer PRESENCE mandatory } |
{ ID id-OldIuSigConIdCS CRITICALITY ignore TYPE IuSignallingConnectionIdentifier PRESENCE optional } |
{ ID id-GlobalCN-IDCS CRITICALITY reject TYPE GlobalCN-ID PRESENCE optional } |
{ ID id-OldIuSigConIdPS CRITICALITY ignore TYPE IuSignallingConnectionIdentifier PRESENCE optional } |
{ ID id-GlobalCN-IDPS CRITICALITY reject TYPE GlobalCN-ID PRESENCE optional } |
{ ID id-RAB-SetupList-EnhRelocInfoReq CRITICALITY reject TYPE RAB-SetupList-EnhRelocInfoReq PRESENCE optional } |
{ ID id-SNA-Access-Information CRITICALITY ignore TYPE SNA-Access-Information PRESENCE optional } |
{ ID id-UESBI-Iu CRITICALITY ignore TYPE UESBI-Iu PRESENCE optional } |
{ ID id-SelectedPLMN-ID CRITICALITY ignore TYPE PLMNidentity PRESENCE optional } |
{ ID id-CNMBMSLinkingInformation CRITICALITY ignore TYPE CNMBMSLinkingInformation PRESENCE optional },
...
}

RAB-SetupList-EnhRelocInfoReq ::= RAB-IE-ContainerList { { RAB-SetupItem-EnhRelocInfoReq-IEs } }

RAB-SetupItem-EnhRelocInfoReq-IEs RANAP-PROTOCOL-IES ::= {
    { ID id-RAB-SetupItem-EnhRelocInfoReq CRITICALITY reject TYPE RAB-SetupItem-EnhRelocInfoReq PRESENCE mandatory },
    ...
}

RAB-SetupItem-EnhRelocInfoReq ::= SEQUENCE {
    rAB-ID RAB-ID,
    cN-DomainIndicator CN-DomainIndicator,
    rAB-Parameters RAB-Parameters,
    dataVolumeReportingIndication DataVolumeReportingIndication OPTIONAL
    -- This IE shall be present if the CN domain indicator IE is set to "PS domain" --,
    pDP-TypeInformation PDP-TypeInformation OPTIONAL
    -- This IE shall be present if the CN domain indicator IE is set to "PS domain" --,
    userPlaneInformation UserPlaneInformation,
    dataForwardingInformation TNLInformationEnhRelInfoReq OPTIONAL,
    sourceSideIuULTNLInfo TNLInformationEnhRelInfoReq OPTIONAL,

    service-Handover Service-Handover OPTIONAL,
    alt-RAB-Parameters Alt-RAB-Parameters OPTIONAL,
    iE-Extensions ProtocolExtensionContainer { { RAB-SetupItem-EnhRelocInfoReq-ExtIEs } } OPTIONAL,
    ...
}

RAB-SetupItem-EnhRelocInfoReq-ExtIEs RANAP-PROTOCOL-EXTENSION ::= {
    -- Extension for Release 8 to enable handover restriction to E-UTRAN --
    { ID id-E-UTRAN-Service-Handover CRITICALITY ignore EXTENSION E-UTRAN-Service-Handover PRESENCE optional } |
    -- Extension for Release Release 9 to enable a new value --
    { ID id-PDP-TypeInformation-extension CRITICALITY ignore EXTENSION PDP-TypeInformation-extension PRESENCE optional },
    ...
}

TNLInformationEnhRelInfoReq ::= SEQUENCE {
    transportLayerAddress TransportLayerAddress,
    iuTransportAssociation IuTransportAssociation,
    iE-Extensions ProtocolExtensionContainer { { TNLInformationEnhRelInfoReq-ExtIEs } } OPTIONAL,
    ...
}

```

```

TNLInformationEnhRelInfoReq-ExtIEs RANAP-PROTOCOL-EXTENSION ::= {
    ...
}

RANAP-EnhancedRelocationInformationRequestExtensions RANAP-PROTOCOL-EXTENSION ::= {
    { ID id-IntegrityProtectionInformation CRITICALITY ignore EXTENSION IntegrityProtectionInformation PRESENCE optional } |
    { ID id-EncryptionInformation CRITICALITY ignore EXTENSION EncryptionInformation PRESENCE optional } |
    { ID id-UE-AggregateMaximumBitRate CRITICALITY ignore EXTENSION UE-AggregateMaximumBitRate PRESENCE optional } |
-- Extension for Release 10 to enable RNSAP Relocation --
    { ID id-RABParametersList CRITICALITY reject EXTENSION RABParametersList PRESENCE optional } |
    { ID id-CSG-Id CRITICALITY reject EXTENSION CSG-Id PRESENCE optional } |
    { ID id-CSG-Membership-Status CRITICALITY reject EXTENSION CSG-Membership-Status PRESENCE optional } |
-- Extension for Release 11 to support rSRVCC in case of network sharing -
    { ID id-AnchorPLMN-ID CRITICALITY ignore EXTENSION PLMNidentity PRESENCE optional },
    ...
}

-- *****
--
-- RANAP Enhanced Relocation Information Response
--
-- *****

RANAP-EnhancedRelocationInformationResponse ::= SEQUENCE {
    protocolIEs ProtocolIE-Container { {RANAP-EnhancedRelocationInformationResponseIEs} },
    protocolExtensions ProtocolExtensionContainer { {RANAP-EnhancedRelocationInformationResponseExtensions} } OPTIONAL,
    ...
}

RANAP-EnhancedRelocationInformationResponseIEs RANAP-PROTOCOL-IES ::= {
    { ID id-Target-ToSource-TransparentContainer
        CRITICALITY ignore TYPE TargetRNC-ToSourceRNC-TransparentContainer PRESENCE optional } |
    { ID id-RAB-SetupList-EnhRelocInfoRes CRITICALITY ignore TYPE RAB-SetupList-EnhRelocInfoRes PRESENCE optional } |
    { ID id-RAB-FailedList-EnhRelocInfoRes CRITICALITY ignore TYPE RAB-FailedList-EnhRelocInfoRes PRESENCE optional } |
    { ID id-CriticalityDiagnostics CRITICALITY ignore TYPE CriticalityDiagnostics PRESENCE optional },
    ...
}

RAB-SetupList-EnhRelocInfoRes ::= RAB-IE-ContainerList { { RAB-SetupItem-EnhRelocInfoRes-IEs } }

RAB-SetupItem-EnhRelocInfoRes-IEs RANAP-PROTOCOL-IES ::= {
    { ID id-RAB-SetupItem-EnhRelocInfoRes CRITICALITY reject TYPE RAB-SetupItem-EnhRelocInfoRes PRESENCE mandatory },
    ...
}

RAB-SetupItem-EnhRelocInfoRes ::= SEQUENCE {
    cN-DomainIndicator CN-DomainIndicator,
    rAB-ID RAB-ID,
    dataForwardingInformation TNLInformationEnhRelInfoRes OPTIONAL,
    ass-RAB-Parameters Ass-RAB-Parameters OPTIONAL,
    iE-Extensions ProtocolExtensionContainer { { RAB-SetupItem-EnhRelocInfoRes-ExtIEs } } OPTIONAL,
    ...
}

```

```

RAB-SetupItem-EnhRelocInfoRes-ExtIEs RANAP-PROTOCOL-EXTENSION ::= {
    ...
}

RAB-FailedList-EnhRelocInfoRes ::= RAB-IE-ContainerList { { RAB-FailedItem-EnhRelocInfoRes-IEs } }

RAB-FailedItem-EnhRelocInfoRes-IEs RANAP-PROTOCOL-IES ::= {
    { ID id-RAB-FailedItem-EnhRelocInfoRes CRITICALITY reject TYPE RAB-FailedItem-EnhRelocInfoRes PRESENCE mandatory },
    ...
}

RAB-FailedItem-EnhRelocInfoRes ::= SEQUENCE {
    cN-DomainIndicator CN-DomainIndicator,
    rAB-ID RAB-ID,
    cause Cause,
    iE-Extensions ProtocolExtensionContainer { { RAB-FailedItem-EnhRelocInfoRes-ExtIEs } } OPTIONAL,
    ...
}

RAB-FailedItem-EnhRelocInfoRes-ExtIEs RANAP-PROTOCOL-EXTENSION ::= {
    ...
}

TNLInformationEnhRelInfoRes ::= SEQUENCE {
    dl-forwardingTransportLayerAddress TransportLayerAddress,
    dl-forwardingTransportAssociation IuTransportAssociation,
    iE-Extensions ProtocolExtensionContainer { { TNLInformationEnhRelInfoRes-ExtIEs } } OPTIONAL,
    ...
}

TNLInformationEnhRelInfoRes-ExtIEs RANAP-PROTOCOL-EXTENSION ::= {
    ...
}

RANAP-EnhancedRelocationInformationResponseExtensions RANAP-PROTOCOL-EXTENSION ::= {
    ...
}

-- *****
--
-- RAB MODIFICATION REQUEST ELEMENTARY PROCEDURE
--
-- *****

-- *****
--
-- RAB Modify Request
--
-- *****

RAB-ModifyRequest ::= SEQUENCE {
    protocolIEs ProtocolIE-Container { {RAB-ModifyRequestIEs} },
    protocolExtensions ProtocolExtensionContainer { {RAB-ModifyRequestExtensions} } OPTIONAL,
    ...
}

```

```

RAB-ModifyRequestIEs RANAP-PROTOCOL-IES ::= {
  { ID id-RAB-ModifyList          CRITICALITY ignore  TYPE RAB-ModifyList          PRESENCE mandatory},
  ...
}

RAB-ModifyList          ::= RAB-IE-ContainerList { {RAB-ModifyItemIEs} }

RAB-ModifyItemIEs RANAP-PROTOCOL-IES ::= {
  { ID id-RAB-ModifyItem          CRITICALITY ignore  TYPE RAB-ModifyItem          PRESENCE mandatory },
  ...
}

RAB-ModifyItem ::= SEQUENCE {
  rAB-ID                RAB-ID,
  requested-RAB-Parameter-Values Requested-RAB-Parameter-Values,
  iE-Extensions         ProtocolExtensionContainer { {RAB-ModifyItem-ExtIEs} }          OPTIONAL,
  ...
}

RAB-ModifyItem-ExtIEs RANAP-PROTOCOL-EXTENSION ::= {
  ...
}

RAB-ModifyRequestExtensions RANAP-PROTOCOL-EXTENSION ::= {
  ...
}

-- *****
--
-- LOCATION RELATED DATA ELEMENTARY PROCEDURE
--
-- *****

-- *****
--
-- Location Related Data Request
--
-- *****

LocationRelatedDataRequest ::= SEQUENCE {
  protocolIEs          ProtocolIE-Container          { {LocationRelatedDataRequestIEs} },
  protocolExtensions   ProtocolExtensionContainer { {LocationRelatedDataRequestExtensions} }          OPTIONAL,
  ...
}

LocationRelatedDataRequestIEs RANAP-PROTOCOL-IES ::= {
  { ID id-LocationRelatedDataRequestType          CRITICALITY reject  TYPE LocationRelatedDataRequestType          PRESENCE optional },
  -- This IE is mandatory for UTRAN, optional for GERAN Iu Mode --
  ...
}

LocationRelatedDataRequestExtensions RANAP-PROTOCOL-EXTENSION ::= {
-- Extension for Release 5 to enable LCS support for GERAN Iu mode --

```

```

    { ID id-LocationRelatedDataRequestTypeSpecificToGERANIuMode    CRITICALITY reject  EXTENSION
LocationRelatedDataRequestTypeSpecificToGERANIuMode    PRESENCE optional  }|
-- The previous extension is optional for GERAN Iu Mode only, not applicable for UTRAN --
-- Extension for Release 7 to request GANSS Assistance Data. This IE shall be present if the Requested Location Related Data Type IE is set to
-- "Dedicated Assistance Data for Assisted GANSS" or `Dedicated Assistance Data for Assisted GPS and GANSS"--
    { ID id-RequestedGANSSAssistanceData    CRITICALITY reject  EXTENSION RequestedGANSSAssistanceData
    PRESENCE conditional  },
    ...
}

-- *****
--
-- Location Related Data Response
--
-- *****

LocationRelatedDataResponse ::= SEQUENCE {
    protocolIEs          ProtocolIE-Container    { { LocationRelatedDataResponseIEs } },
    protocolExtensions   ProtocolExtensionContainer { { LocationRelatedDataResponseExtensions } }    OPTIONAL,
    ...
}

LocationRelatedDataResponseIEs RANAP-PROTOCOL-IES ::= {
    { ID id-BroadcastAssistanceDataDecipheringKeys    CRITICALITY ignore  TYPE BroadcastAssistanceDataDecipheringKeys    PRESENCE optional },
    ...
}

LocationRelatedDataResponseExtensions RANAP-PROTOCOL-EXTENSION ::= {
-- Extension for error handling
    { ID id-CriticalityDiagnostics    CRITICALITY ignore  EXTENSION CriticalityDiagnostics    PRESENCE optional }|
    { ID id-BroadcastGANSSAssistanceDataDecipheringKeys    CRITICALITY ignore  EXTENSION BroadcastAssistanceDataDecipheringKeys    PRESENCE optional},
    ...
}

-- *****
--
-- Location Related Data Failure
--
-- *****

LocationRelatedDataFailure ::= SEQUENCE {
    protocolIEs          ProtocolIE-Container    { { LocationRelatedDataFailureIEs } },
    protocolExtensions   ProtocolExtensionContainer { { LocationRelatedDataFailureExtensions } }    OPTIONAL,
    ...
}

LocationRelatedDataFailureIEs RANAP-PROTOCOL-IES ::= {
    { ID id-Cause          CRITICALITY ignore  TYPE Cause          PRESENCE mandatory  },
    ...
}

LocationRelatedDataFailureExtensions RANAP-PROTOCOL-EXTENSION ::= {
-- Extension for error handling
    { ID id-CriticalityDiagnostics    CRITICALITY ignore  EXTENSION CriticalityDiagnostics    PRESENCE optional },

```

```

}
...
}
-- *****
--
-- INFORMATION TRANSFER ELEMENTARY PROCEDURE
--
-- *****

-- *****
--
-- Information Transfer Indication
--
-- *****

InformationTransferIndication ::= SEQUENCE {
    protocolIEs          ProtocolIE-Container      { { InformationTransferIndicationIEs } },
    protocolExtensions   ProtocolExtensionContainer { { InformationTransferIndicationExtensions } }      OPTIONAL,
    ...
}

InformationTransferIndicationIEs RANAP-PROTOCOL-IES ::= {
    { ID id-InformationTransferID          CRITICALITY reject TYPE InformationTransferID          PRESENCE mandatory } |
    { ID id-ProvidedData                  CRITICALITY reject TYPE ProvidedData          PRESENCE mandatory } |
    { ID id-CN-DomainIndicator            CRITICALITY reject TYPE CN-DomainIndicator      PRESENCE mandatory } |
    { ID id-GlobalCN-ID                   CRITICALITY ignore TYPE GlobalCN-ID          PRESENCE optional },
    ...
}

InformationTransferIndicationExtensions RANAP-PROTOCOL-EXTENSION ::= {
    ...
}

-- *****
--
-- Information Transfer Confirmation
--
-- *****

InformationTransferConfirmation ::= SEQUENCE {
    protocolIEs          ProtocolIE-Container      { { InformationTransferConfirmationIEs } },
    protocolExtensions   ProtocolExtensionContainer { { InformationTransferConfirmationExtensions } }      OPTIONAL,
    ...
}

InformationTransferConfirmationIEs RANAP-PROTOCOL-IES ::= {
    { ID id-InformationTransferID          CRITICALITY ignore TYPE InformationTransferID          PRESENCE mandatory } |
    { ID id-CN-DomainIndicator            CRITICALITY ignore TYPE CN-DomainIndicator      PRESENCE mandatory } |
    { ID id-CriticalityDiagnostics         CRITICALITY ignore TYPE CriticalityDiagnostics      PRESENCE optional } |
    { ID id-GlobalRNC-ID                   CRITICALITY ignore TYPE GlobalRNC-ID          PRESENCE mandatory } ,
    ...
}

InformationTransferConfirmationExtensions RANAP-PROTOCOL-EXTENSION ::= {

```

```

-- Extension for Release 7 to indicate extended RNC-ID --
  { ID id-ExtendedRNC-ID          CRITICALITY reject  EXTENSION ExtendedRNC-ID          PRESENCE optional },
  ...
}

-- *****
--
-- Information Transfer Failure
--
-- *****

InformationTransferFailure ::= SEQUENCE {
  protocolIEs          ProtocolIE-Container      { { InformationTransferFailureIEs } },
  protocolExtensions   ProtocolExtensionContainer { { InformationTransferFailureExtensions } }      OPTIONAL,
  ...
}

InformationTransferFailureIEs RANAP-PROTOCOL-IES ::= {
  { ID id-InformationTransferID      CRITICALITY ignore  TYPE InformationTransferID      PRESENCE mandatory } |
  { ID id-CN-DomainIndicator         CRITICALITY ignore  TYPE CN-DomainIndicator         PRESENCE mandatory } |
  { ID id-Cause                      CRITICALITY ignore  TYPE Cause                      PRESENCE mandatory } |
  { ID id-CriticalityDiagnostics     CRITICALITY ignore  TYPE CriticalityDiagnostics     PRESENCE optional } |
  { ID id-GlobalRNC-ID              CRITICALITY ignore  TYPE GlobalRNC-ID              PRESENCE mandatory } ,
  ...
}

InformationTransferFailureExtensions RANAP-PROTOCOL-EXTENSION ::= {
-- Extension for Release 7 to indicate extended RNC-ID --
  { ID id-ExtendedRNC-ID          CRITICALITY reject  EXTENSION ExtendedRNC-ID          PRESENCE optional },
  ...
}

-- *****
--
-- UE SPECIFIC INFORMATION ELEMENTARY PROCEDURE
--
-- *****

-- *****
--
-- UE Specific Information Indication
--
-- *****

UESpecificInformationIndication ::= SEQUENCE {
  protocolIEs          ProtocolIE-Container      { { UESpecificInformationIndicationIEs } },
  protocolExtensions   ProtocolExtensionContainer { { UESpecificInformationIndicationExtensions } }      OPTIONAL,
  ...
}

UESpecificInformationIndicationIEs RANAP-PROTOCOL-IES ::= {
  { ID id-UESBI-Iu          CRITICALITY ignore  TYPE UESBI-Iu          PRESENCE optional },
  ...
}

```

```

UESpecificInformationIndicationExtensions RANAP-PROTOCOL-EXTENSION ::= {
  ...
}

-- *****
--
-- DIRECT INFORMATION TRANSFER ELEMENTARY PROCEDURE
--
-- *****

-- *****
--
-- Direct Information Transfer
--
-- *****

DirectInformationTransfer ::= SEQUENCE {
  protocolIEs          ProtocolIE-Container      { { DirectInformationTransferIEs } },
  protocolExtensions  ProtocolExtensionContainer { { DirectInformationTransferExtensions } }   OPTIONAL,
  ...
}

DirectInformationTransferIEs RANAP-PROTOCOL-IES ::= {
  { ID id-InterSystemInformationTransferType CRITICALITY ignore TYPE InterSystemInformationTransferType PRESENCE optional } |
  { ID id-CN-DomainIndicator                 CRITICALITY ignore TYPE CN-DomainIndicator          PRESENCE mandatory } |
  { ID id-GlobalRNC-ID                       CRITICALITY ignore TYPE GlobalRNC-ID              PRESENCE optional } |
  { ID id-GlobalCN-ID                       CRITICALITY ignore TYPE GlobalCN-ID                PRESENCE optional },
  ...
}

DirectInformationTransferExtensions RANAP-PROTOCOL-EXTENSION ::= {
-- Extension for Release 7 to indicate extended RNC-ID --
  { ID id-ExtendedRNC-ID                     CRITICALITY reject EXTENSION ExtendedRNC-ID      PRESENCE optional },
  ...
}

-- *****
--
-- UPLINK INFORMATION EXCHANGE ELEMENTARY PROCEDURE
--
-- *****

-- *****
--
-- Uplink Information Exchange Request
--
-- *****

UplinkInformationExchangeRequest ::= SEQUENCE {
  protocolIEs          ProtocolIE-Container      { { UplinkInformationExchangeRequestIEs } },
  protocolExtensions  ProtocolExtensionContainer { { UplinkInformationExchangeRequestExtensions } }   OPTIONAL,
  ...
}

```

```

UplinkInformationExchangeRequestIEs RANAP-PROTOCOL-IES ::= {
  { ID id-InformationExchangeID      CRITICALITY reject  TYPE InformationExchangeID      PRESENCE mandatory } |
  { ID id-InformationExchangeType    CRITICALITY reject  TYPE InformationExchangeType    PRESENCE mandatory } |
  { ID id-InformationTransferType     CRITICALITY reject  TYPE InformationTransferType     PRESENCE conditional } |
  -- This IE shall be present if the Information Exchange Type IE is set to "transfer" -- } |
  { ID id-InformationRequestType     CRITICALITY reject  TYPE InformationRequestType     PRESENCE conditional } |
  -- This IE shall be present if the Information Exchange Type IE is set to "request" -- } |
  { ID id-CN-DomainIndicator         CRITICALITY reject  TYPE CN-DomainIndicator         PRESENCE mandatory } |
  { ID id-GlobalRNC-ID               CRITICALITY reject  TYPE GlobalRNC-ID               PRESENCE mandatory },
  ...
}

UplinkInformationExchangeRequestExtensions RANAP-PROTOCOL-EXTENSION ::= {
-- Extension for Release 7 to indicate extended RNC-ID --
  { ID id-ExtendedRNC-ID             CRITICALITY reject  EXTENSION ExtendedRNC-ID       PRESENCE optional },
  ...
}

-- *****
--
-- Uplink Information Exchange Response
--
-- *****

UplinkInformationExchangeResponse ::= SEQUENCE {
  protocolIEs          ProtocolIE-Container    { { UplinkInformationExchangeResponseIEs } },
  protocolExtensions   ProtocolExtensionContainer { { UplinkInformationExchangeResponseExtensions } }  OPTIONAL,
  ...
}

UplinkInformationExchangeResponseIEs RANAP-PROTOCOL-IES ::= {
  { ID id-InformationExchangeID      CRITICALITY ignore  TYPE InformationExchangeID      PRESENCE mandatory } |
  { ID id-InformationRequested        CRITICALITY ignore  TYPE InformationRequested        PRESENCE optional   } |
  { ID id-CN-DomainIndicator          CRITICALITY ignore  TYPE CN-DomainIndicator          PRESENCE mandatory } |
  { ID id-GlobalCN-ID                CRITICALITY ignore  TYPE GlobalCN-ID                PRESENCE optional   } |
  { ID id-CriticalityDiagnostics      CRITICALITY ignore  TYPE CriticalityDiagnostics      PRESENCE optional   },
  ...
}

UplinkInformationExchangeResponseExtensions RANAP-PROTOCOL-EXTENSION ::= {
  ...
}

-- *****
--
-- Uplink Information Exchange Failure
--
-- *****

UplinkInformationExchangeFailure ::= SEQUENCE {
  protocolIEs          ProtocolIE-Container    { { UplinkInformationExchangeFailureIEs } },
  protocolExtensions   ProtocolExtensionContainer { { UplinkInformationExchangeFailureExtensions } }  OPTIONAL,
  ...
}

```

```

}

UplinkInformationExchangeFailureIEs RANAP-PROTOCOL-IES ::= {
  { ID id-InformationExchangeID      CRITICALITY ignore TYPE InformationExchangeID  PRESENCE mandatory } |
  { ID id-CN-DomainIndicator         CRITICALITY ignore TYPE CN-DomainIndicator    PRESENCE mandatory } |
  { ID id-GlobalCN-ID                CRITICALITY ignore TYPE GlobalCN-ID          PRESENCE optional   } |
  { ID id-Cause                       CRITICALITY ignore TYPE Cause                PRESENCE mandatory } |
  { ID id-CriticalityDiagnostics      CRITICALITY ignore TYPE CriticalityDiagnostics  PRESENCE optional   } ,
  ...
}

UplinkInformationExchangeFailureExtensions RANAP-PROTOCOL-EXTENSION ::= {
  ...
}

-- *****
--
-- MBMS SESSION START PROCEDURE
--
-- *****

-- *****
--
-- MBMS Session Start
--
-- *****

MBMSSessionStart ::= SEQUENCE {
  protocolIEs          ProtocolIE-Container      { { MBMSSessionStartIEs } },
  protocolExtensions  ProtocolExtensionContainer { { MBMSSessionStartExtensions } }      OPTIONAL,
  ...
}

MBMSSessionStartIEs RANAP-PROTOCOL-IES ::= {
  { ID id-TMGI                CRITICALITY reject TYPE TMGI                PRESENCE mandatory } |
  { ID id-MBMSSessionIdentity CRITICALITY ignore TYPE MBMSSessionIdentity PRESENCE optional } |
  { ID id-MBMSBearerServiceType CRITICALITY reject TYPE MBMSBearerServiceType PRESENCE mandatory } |
  { ID id-IuSigConId          CRITICALITY reject TYPE IuSignallingConnectionIdentifier PRESENCE mandatory } |
  { ID id-RAB-Parameters      CRITICALITY reject TYPE RAB-Parameters          PRESENCE mandatory } |
  { ID id-PDP-TypeInformation  CRITICALITY ignore TYPE PDP-TypeInformation    PRESENCE optional } |
  { ID id-MBMSSessionDuration CRITICALITY reject TYPE MBMSSessionDuration  PRESENCE mandatory } |
  { ID id-MBMSServiceArea     CRITICALITY reject TYPE MBMSServiceArea     PRESENCE mandatory } |
  { ID id-FrequenceLayerConvergenceFlag CRITICALITY ignore TYPE FrequenceLayerConvergenceFlag PRESENCE optional } |
  { ID id-RAListofIdleModeUEs CRITICALITY ignore TYPE RAListofIdleModeUEs    PRESENCE optional } |
  { ID id-GlobalCN-ID        CRITICALITY reject TYPE GlobalCN-ID          PRESENCE optional } |
  { ID id-MBMSSessionRepetitionNumber CRITICALITY ignore TYPE MBMSSessionRepetitionNumber PRESENCE optional } |
  { ID id-TimeToMBMSDataTransfer CRITICALITY reject TYPE TimeToMBMSDataTransfer  PRESENCE mandatory } ,
  ...
}

MBMSSessionStartExtensions RANAP-PROTOCOL-EXTENSION ::= {
  -- Extension for Release 6 to enable MBMS counting in broadcast mode --
  { ID id-MBMSCountingInformation CRITICALITY ignore EXTENSION MBMSCountingInformation PRESENCE optional } |
  { ID id-MBMSynchronisationInformation CRITICALITY ignore EXTENSION MBMSynchronisationInformation PRESENCE optional } |
}

```

```

-- Extension for Release Release 9 to enable a new value --
  { ID id-PDP-TypeInformation-extension  CRITICALITY ignore      EXTENSION PDP-TypeInformation-extension  PRESENCE optional },
  ...
}

MBMSSynchronisationInformation ::= SEQUENCE {
  mBMShcIndicator          MBMShcIndicator,
  ipMulticastAddress       IPMulticastAddress,
  gTPDLTEID                GTP-TEI,
  iE-Extensions            ProtocolExtensionContainer { {MBMSSynchronisationInformation-ExtIEs} }  OPTIONAL,
  ...
}

MBMSSynchronisationInformation-ExtIEs RANAP-PROTOCOL-EXTENSION ::= {
  { ID id-IP-Source-Address          CRITICALITY reject      EXTENSION IPMulticastAddress          PRESENCE optional },
  ...
}

-- *****
--
-- MBMS Session Start Response
--
-- *****

MBMSSessionStartResponse ::= SEQUENCE {
  protocolIEs              ProtocolIE-Container      { {MBMSSessionStartResponseIEs} },
  protocolExtensions       ProtocolExtensionContainer { {MBMSSessionStartResponseExtensions} }  OPTIONAL,
  ...
}

MBMSSessionStartResponseIEs RANAP-PROTOCOL-IES ::= {
  { ID id-TransportLayerInformation  CRITICALITY ignore  TYPE TransportLayerInformation  PRESENCE optional  } |
  { ID id-Cause                      CRITICALITY ignore  TYPE Cause                      PRESENCE optional  } |
  { ID id-CriticalityDiagnostics     CRITICALITY ignore  TYPE CriticalityDiagnostics     PRESENCE optional  } ,
  ...
}

MBMSSessionStartResponseExtensions RANAP-PROTOCOL-EXTENSION ::= {
  ...
}

-- *****
--
-- MBMS Session Start Failure
--
-- *****

MBMSSessionStartFailure ::= SEQUENCE {
  protocolIEs              ProtocolIE-Container      { { MBMSSessionStartFailureIEs } },
  protocolExtensions       ProtocolExtensionContainer { { MBMSSessionStartFailureExtensions } }  OPTIONAL,
  ...
}

MBMSSessionStartFailureIEs RANAP-PROTOCOL-IES ::= {

```

```

    { ID id-Cause                CRITICALITY ignore TYPE Cause                PRESENCE mandatory } |
    { ID id-CriticalityDiagnostics CRITICALITY ignore TYPE CriticalityDiagnostics PRESENCE optional } ,
    ...
}

MBMSSessionStartFailureExtensions RANAP-PROTOCOL-EXTENSION ::= {
    ...
}

-- *****
--
-- MBMS SESSION UPDATE PROCEDURE
--
-- *****
--
-- *****
--
-- MBMS Session Update
--
-- *****

MBMSSessionUpdate ::= SEQUENCE {
    protocolIEs          ProtocolIE-Container      { { MBMSSessionUpdateIEs } },
    protocolExtensions   ProtocolExtensionContainer { { MBMSSessionUpdateExtensions } }    OPTIONAL,
    ...
}

MBMSSessionUpdateIEs RANAP-PROTOCOL-IES ::= {
    { ID id-SessionUpdateID          CRITICALITY reject TYPE SessionUpdateID          PRESENCE mandatory } |
    { ID id-DeltaRAListofIdleModeUEs CRITICALITY reject TYPE DeltaRAListofIdleModeUEs PRESENCE mandatory } ,
    ...
}

MBMSSessionUpdateExtensions RANAP-PROTOCOL-EXTENSION ::= {
    ...
}

-- *****
--
-- MBMS Session Update Response
--
-- *****

MBMSSessionUpdateResponse ::= SEQUENCE {
    protocolIEs          ProtocolIE-Container      { { MBMSSessionUpdateResponseIEs } },
    protocolExtensions   ProtocolExtensionContainer { { MBMSSessionUpdateResponseExtensions } }    OPTIONAL,
    ...
}

MBMSSessionUpdateResponseIEs RANAP-PROTOCOL-IES ::= {
    { ID id-SessionUpdateID          CRITICALITY ignore TYPE SessionUpdateID          PRESENCE mandatory } |
    { ID id-TransportLayerInformation CRITICALITY ignore TYPE TransportLayerInformation PRESENCE optional } |
    { ID id-Cause                    CRITICALITY ignore TYPE Cause                    PRESENCE optional } |
    { ID id-CriticalityDiagnostics    CRITICALITY ignore TYPE CriticalityDiagnostics PRESENCE optional } ,

```

```

}
...
}
MBMSSessionUpdateResponseExtensions RANAP-PROTOCOL-EXTENSION ::= {
  ...
}
-- *****
--
-- MBMS Session Update Failure
--
-- *****

MBMSSessionUpdateFailure ::= SEQUENCE {
  protocolIEs          ProtocolIE-Container      { { MBMSSessionUpdateFailureIEs } },
  protocolExtensions   ProtocolExtensionContainer { { MBMSSessionUpdateFailureExtensions } }  OPTIONAL,
  ...
}

MBMSSessionUpdateFailureIEs RANAP-PROTOCOL-IES ::= {
  { ID id-SessionUpdateID          CRITICALITY ignore TYPE SessionUpdateID          PRESENCE mandatory } |
  { ID id-Cause                     CRITICALITY ignore TYPE Cause                     PRESENCE mandatory } |
  { ID id-CriticalityDiagnostics     CRITICALITY ignore TYPE CriticalityDiagnostics     PRESENCE optional } ,
  ...
}

MBMSSessionUpdateFailureExtensions RANAP-PROTOCOL-EXTENSION ::= {
  ...
}
-- *****
--
-- MBMS SESSION STOP PROCEDURE
--
-- *****
--
-- *****
--
-- MBMS Session Stop
--
-- *****

MBMSSessionStop ::= SEQUENCE {
  protocolIEs          ProtocolIE-Container      { { MBMSSessionStopIEs } },
  protocolExtensions   ProtocolExtensionContainer { { MBMSSessionStopExtensions } }  OPTIONAL,
  ...
}

MBMSSessionStopIEs RANAP-PROTOCOL-IES ::= {
  { ID id-MBMSCNDe-Registration     CRITICALITY reject TYPE MBMSCNDe-Registration     PRESENCE mandatory } ,
  ...
}

MBMSSessionStopExtensions RANAP-PROTOCOL-EXTENSION ::= {

```

```

}
...
}
-- *****
--
-- MBMS Session Stop Response
--
-- *****

MBMSSessionStopResponse ::= SEQUENCE {
    protocolIEs          ProtocolIE-Container      { { MBMSSessionStopResponseIEs } },
    protocolExtensions   ProtocolExtensionContainer { { MBMSSessionStopResponseExtensions } } OPTIONAL,
    ...
}

MBMSSessionStopResponseIEs RANAP-PROTOCOL-IES ::= {
    { ID id-Cause          CRITICALITY ignore TYPE Cause          PRESENCE optional } |
    { ID id-CriticalityDiagnostics CRITICALITY ignore TYPE CriticalityDiagnostics PRESENCE optional } ,
    ...
}

MBMSSessionStopResponseExtensions RANAP-PROTOCOL-EXTENSION ::= {
    ...
}

-- *****
--
-- MBMS UE LINKING PROCEDURE
--
-- *****

-- *****
--
-- MBMS UE Linking Request
--
-- *****

MBMSUELinkingRequest ::= SEQUENCE {
    protocolIEs          ProtocolIE-Container      { { MBMSUELinkingRequestIEs } },
    protocolExtensions   ProtocolExtensionContainer { { MBMSUELinkingRequestExtensions } } OPTIONAL,
    ...
}

MBMSUELinkingRequestIEs RANAP-PROTOCOL-IES ::= {
    { ID id-JoinedMBMSBearerServicesList CRITICALITY reject TYPE JoinedMBMSBearerService-IEs PRESENCE optional } |
    { ID id-LeftMBMSBearerServicesList CRITICALITY reject TYPE LeftMBMSBearerService-IEs PRESENCE optional } ,
    ...
}

LeftMBMSBearerService-IEs ::= SEQUENCE (SIZE (1.. maxnoofMulticastServicesPerUE)) OF
    SEQUENCE {
        tMGI          TMGI,
        iE-Extensions ProtocolExtensionContainer { {LeftMBMSBearerService-ExtIEs} } OPTIONAL,
        ...
    }

```

```

    }
LeftMBMSBearerService-ExtIEs RANAP-PROTOCOL-EXTENSION ::= {
    ...
}
MBMSUELinkingRequestExtensions RANAP-PROTOCOL-EXTENSION ::= {
    ...
}
-- *****
--
-- MBMS UE Linking Response
--
-- *****

MBMSUELinkingResponse ::= SEQUENCE {
    protocolIEs          ProtocolIE-Container    { { MBMSUELinkingResponseIEs } },
    protocolExtensions  ProtocolExtensionContainer { { MBMSUELinkingResponseExtensions } } OPTIONAL,
    ...
}

MBMSUELinkingResponseIEs RANAP-PROTOCOL-IES ::= {
    { ID id-UnsuccessfulLinkingList          CRITICALITY ignore TYPE UnsuccessfulLinking-IEs PRESENCE optional } |
    { ID id-CriticalityDiagnostics          CRITICALITY ignore TYPE CriticalityDiagnostics PRESENCE optional } ,
    ...
}

UnsuccessfulLinking-IEs ::= SEQUENCE (SIZE (1.. maxnoofMulticastServicesPerUE)) OF
    SEQUENCE {
        tMGI          TMGI,
        cause         Cause,
        iE-Extensions ProtocolExtensionContainer { { UnsuccessfulLinking-ExtIEs } } OPTIONAL,
        ...
    }

UnsuccessfulLinking-ExtIEs RANAP-PROTOCOL-EXTENSION ::= {
    ...
}

MBMSUELinkingResponseExtensions RANAP-PROTOCOL-EXTENSION ::= {
    ...
}
-- *****
--
-- MBMS REGISTRATION PROCEDURE
--
-- *****
--
-- *****
--
-- MBMS Registration Request
--

```

```

-- *****
MBMSRegistrationRequest ::= SEQUENCE {
    protocolIEs          ProtocolIE-Container    { { MBMSRegistrationRequestIEs } },
    protocolExtensions   ProtocolExtensionContainer { { MBMSRegistrationRequestExtensions } }    OPTIONAL,
    ...
}

MBMSRegistrationRequestIEs RANAP-PROTOCOL-IES ::= {
    { ID id-MBMSRegistrationRequestType    CRITICALITY reject  TYPE MBMSRegistrationRequestType          PRESENCE mandatory } |
    { ID id-TMGI                           CRITICALITY reject  TYPE TMGI                               PRESENCE mandatory } |
    { ID id-IPMulticastAddress              CRITICALITY reject  TYPE IPMulticastAddress                 PRESENCE conditional } |
    -- This IE shall be present if the MBMS Registration Request Type IE is set to "register" --
    { ID id-APN                             CRITICALITY reject  TYPE APN                               PRESENCE conditional } |
    -- This IE shall be present if the MBMS Registration Request Type IE is set to "register" --
    { ID id-GlobalRNC-ID                    CRITICALITY reject  TYPE GlobalRNC-ID                      PRESENCE optional   },
    ...
}

MBMSRegistrationRequestExtensions RANAP-PROTOCOL-EXTENSION ::= {
-- Extension for Release 7 to indicate extended RNC-ID --
    { ID id-ExtendedRNC-ID                  CRITICALITY reject  EXTENSION ExtendedRNC-ID              PRESENCE optional },
    ...
}

-- *****
--
-- MBMS Registration Response
--
-- *****

MBMSRegistrationResponse ::= SEQUENCE {
    protocolIEs          ProtocolIE-Container    { { MBMSRegistrationResponseIEs } },
    protocolExtensions   ProtocolExtensionContainer { { MBMSRegistrationResponseExtensions } }    OPTIONAL,
    ...
}

MBMSRegistrationResponseIEs RANAP-PROTOCOL-IES ::= {
    { ID id-TMGI                           CRITICALITY ignore  TYPE TMGI                               PRESENCE optional   } |
    { ID id-GlobalCN-ID                     CRITICALITY ignore  TYPE GlobalCN-ID                       PRESENCE optional   } |
    { ID id-CriticalityDiagnostics           CRITICALITY ignore  TYPE CriticalityDiagnostics             PRESENCE optional   },
    ...
}

MBMSRegistrationResponseExtensions RANAP-PROTOCOL-EXTENSION ::= {
    ...
}

-- *****
--
-- MBMS Registration Failure
--
-- *****

```

```

MBMSRegistrationFailure ::= SEQUENCE {
    protocolIEs          ProtocolIE-Container      { { MBMSRegistrationFailureIEs } },
    protocolExtensions   ProtocolExtensionContainer { { MBMSRegistrationFailureExtensions } }    OPTIONAL,
    ...
}

MBMSRegistrationFailureIEs RANAP-PROTOCOL-IES ::= {
    { ID id-TMGI          CRITICALITY ignore TYPE TMGI          PRESENCE optional } |
    { ID id-GlobalCN-ID  CRITICALITY ignore TYPE GlobalCN-ID   PRESENCE optional } |
    { ID id-Cause        CRITICALITY ignore TYPE Cause         PRESENCE mandatory } |
    { ID id-CriticalityDiagnostics CRITICALITY ignore TYPE CriticalityDiagnostics PRESENCE optional } ,
    ...
}

MBMSRegistrationFailureExtensions RANAP-PROTOCOL-EXTENSION ::= {
    ...
}

-- *****
--
-- MBMS CN DE-REGISTRATION PROCEDURE
--
-- *****
--
-- *****
--
-- MBMS CN De-Registration Request
--
-- *****

MBMSCNDe-RegistrationRequest ::= SEQUENCE {
    protocolIEs          ProtocolIE-Container      { { MBMSCNDe-RegistrationRequestIEs } },
    protocolExtensions   ProtocolExtensionContainer { { MBMSCNDe-RegistrationRequestExtensions } }    OPTIONAL,
    ...
}

MBMSCNDe-RegistrationRequestIEs RANAP-PROTOCOL-IES ::= {
    { ID id-TMGI          CRITICALITY reject TYPE TMGI          PRESENCE mandatory } |
    { ID id-GlobalCN-ID  CRITICALITY reject TYPE GlobalCN-ID   PRESENCE optional } ,
    ...
}

MBMSCNDe-RegistrationRequestExtensions RANAP-PROTOCOL-EXTENSION ::= {
    ...
}

-- *****
--
-- MBMS CN De-Registration Response
--
-- *****

MBMSCNDe-RegistrationResponse ::= SEQUENCE {
    protocolIEs          ProtocolIE-Container      { { MBMSCNDe-RegistrationResponseIEs } },

```

```

    protocolExtensions      ProtocolExtensionContainer { { MBMSCNDe-RegistrationResponseExtensions} } OPTIONAL,
    ...
}

MBMSCNDe-RegistrationResponseIEs RANAP-PROTOCOL-IES ::= {
  { ID id-TMGI                CRITICALITY ignore TYPE TMGI                PRESENCE mandatory } |
  { ID id-GlobalRNC-ID        CRITICALITY ignore TYPE GlobalRNC-ID        PRESENCE mandatory } |
  { ID id-Cause                CRITICALITY ignore TYPE Cause                PRESENCE optional   } |
  { ID id-CriticalityDiagnostics CRITICALITY ignore TYPE CriticalityDiagnostics PRESENCE optional   } ,
  ...
}

MBMSCNDe-RegistrationResponseExtensions RANAP-PROTOCOL-EXTENSION ::= {
-- Extension for Release 7 to indicate extended RNC-ID --
  { ID id-ExtendedRNC-ID      CRITICALITY reject EXTENSION ExtendedRNC-ID      PRESENCE optional },
  ...
}

-- *****
--
-- MBMS RAB ESTABLISHMENT INDICATION PROCEDURE
--
-- *****
--
-- *****
--
-- MBMS RAB Establishment Indication
--
-- *****

MBMSRABEstablishmentIndication ::= SEQUENCE {
  protocolIEs      ProtocolIE-Container { { MBMSRABEstablishmentIndicationIEs} },
  protocolExtensions ProtocolExtensionContainer { { MBMSRABEstablishmentIndicationExtensions} } OPTIONAL,
  ...
}

MBMSRABEstablishmentIndicationIEs RANAP-PROTOCOL-IES ::= {
  { ID id-TransportLayerInformation CRITICALITY ignore TYPE TransportLayerInformation PRESENCE mandatory } ,
  ...
}

MBMSRABEstablishmentIndicationExtensions RANAP-PROTOCOL-EXTENSION ::= {
  ...
}

-- *****
--
-- MBMS RAB RELEASE PROCEDURE
--
-- *****
--
-- *****
--
-- MBMS RAB Release Request

```

```

--
-- *****
MBMSRABReleaseRequest ::= SEQUENCE {
    protocolIEs          ProtocolIE-Container    { {MBMSRABReleaseRequestIEs} },
    protocolExtensions   ProtocolExtensionContainer { {MBMSRABReleaseRequestExtensions} }    OPTIONAL,
    ...
}

MBMSRABReleaseRequestIEs RANAP-PROTOCOL-IES ::= {
    { ID id-Cause          CRITICALITY ignore TYPE Cause          PRESENCE mandatory },
    ...
}

MBMSRABReleaseRequestExtensions RANAP-PROTOCOL-EXTENSION ::= {
    ...
}

-- *****
--
-- MBMS RAB Release
--
-- *****

MBMSRABRelease ::= SEQUENCE {
    protocolIEs          ProtocolIE-Container    { {MBMSRABReleaseIEs} },
    protocolExtensions   ProtocolExtensionContainer { {MBMSRABReleaseExtensions} }    OPTIONAL,
    ...
}

MBMSRABReleaseIEs RANAP-PROTOCOL-IES ::= {
    { ID id-Cause          CRITICALITY ignore TYPE Cause          PRESENCE mandatory }|
    { ID id-CriticalityDiagnostics          CRITICALITY ignore TYPE CriticalityDiagnostics          PRESENCE optional },
    ...
}

MBMSRABReleaseExtensions RANAP-PROTOCOL-EXTENSION ::= {
    ...
}

-- *****
--
-- MBMS RAB Release Failure
--
-- *****

MBMSRABReleaseFailure ::= SEQUENCE {
    protocolIEs          ProtocolIE-Container    { {MBMSRABReleaseFailureIEs} },
    protocolExtensions   ProtocolExtensionContainer { {MBMSRABReleaseFailureExtensions} }    OPTIONAL,
    ...
}

MBMSRABReleaseFailureIEs RANAP-PROTOCOL-IES ::= {

```

```

    { ID id-Cause          CRITICALITY ignore  TYPE Cause          PRESENCE mandatory }|
    { ID id-CriticalityDiagnostics  CRITICALITY ignore  TYPE CriticalityDiagnostics  PRESENCE optional  },
    ...
}

MBMSRABReleaseFailureExtensions RANAP-PROTOCOL-EXTENSION ::= {
    ...
}

-- *****
--
-- SRVCC PREPARATION ELEMENTARY PROCEDURE
--
-- *****
--
-- *****
--
-- SRVCC CS Keys Request
--
-- *****

SRVCC-CSKeysRequest ::= SEQUENCE {
    protocolIEs          ProtocolIE-Container          { {SRVCC-CSKeysRequestIEs} },
    protocolExtensions   ProtocolExtensionContainer    { {SRVCC-CSKeysRequestExtensions} }    OPTIONAL,
    ...
}

SRVCC-CSKeysRequestIEs RANAP-PROTOCOL-IES ::= {
    ...
}

SRVCC-CSKeysRequestExtensions RANAP-PROTOCOL-EXTENSION ::= {
    ...
}

-- *****
--
-- SRVCC CS Keys Response
--
-- *****

SRVCC-CSKeysResponse ::= SEQUENCE {
    protocolIEs          ProtocolIE-Container          { {SRVCC-CSKeysResponseIEs} },
    protocolExtensions   ProtocolExtensionContainer    { {SRVCC-CSKeysResponseExtensions} }    OPTIONAL,
    ...
}

SRVCC-CSKeysResponseIEs RANAP-PROTOCOL-IES ::= {
    { ID id-IntegrityProtectionKey  CRITICALITY reject  TYPE IntegrityProtectionKey  PRESENCE mandatory }|
    { ID id-EncryptionKey           CRITICALITY reject  TYPE EncryptionKey           PRESENCE mandatory }|
    { ID id-SRVCC-Information        CRITICALITY reject  TYPE SRVCC-Information       PRESENCE mandatory }|
    { ID id-CriticalityDiagnostics   CRITICALITY ignore  TYPE CriticalityDiagnostics   PRESENCE optional  },
    ...
}

```

```

SRVCC-CSKeysResponseExtensions RANAP-PROTOCOL-EXTENSION ::= {
    ...
}

-- *****
--
-- UE RADIO CAPABILITY MATCH PROCEDURE
--
-- *****

-- *****
--
-- UE Radio Capability Match Request
--
-- *****

UeRadioCapabilityMatchRequest ::= SEQUENCE {
    protocolIEs          ProtocolIE-Container      { {UeRadioCapabilityMatchRequestIEs} },
    protocolExtensions   ProtocolExtensionContainer { {UeRadioCapabilityMatchRequestExtensions} }   OPTIONAL,
    ...
}

UeRadioCapabilityMatchRequestIEs RANAP-PROTOCOL-IES ::= {
    ...
}

UeRadioCapabilityMatchRequestExtensions RANAP-PROTOCOL-EXTENSION ::= {
    ...
}

-- *****
--
-- UE Radio Capability Match Response
--
-- *****

UeRadioCapabilityMatchResponse ::= SEQUENCE {
    protocolIEs          ProtocolIE-Container      { {UeRadioCapabilityMatchResponseIEs} },
    protocolExtensions   ProtocolExtensionContainer { {UeRadioCapabilityMatchResponseExtensions} }   OPTIONAL,
    ...
}

UeRadioCapabilityMatchResponseIEs RANAP-PROTOCOL-IES ::= {
    { ID id-VoiceSupportMatchIndicator          CRITICALITY reject TYPE VoiceSupportMatchIndicator PRESENCE mandatory },
    ...
}

UeRadioCapabilityMatchResponseExtensions RANAP-PROTOCOL-EXTENSION ::= {
    ...
}

END

```

9.3.4 Information Element Definitions

```

-- *****
--
-- Information Element Definitions
--
-- *****

RANAP-IEs {
itu-t (0) identified-organization (4) etsi (0) mobileDomain (0)
umts-Access (20) modules (3) ranap (0) version1 (1) ranap-IEs (2) }

DEFINITIONS AUTOMATIC TAGS ::=

BEGIN

IMPORTS
    maxNrOfCSGs,
    maxNrOfErrors,
    maxNrOfPDPDirections,
    maxNrOfPoints,
    maxNrOfRABs,
    maxNrOfSRBs,
    maxNrOfSeparateTrafficDirections,
    maxRAB-Subflows,
    maxRAB-SubflowCombination,
    maxNrOfLevels,
    maxNrOfAltValues,
    maxNrOfSNAs,
    maxNrOfLAs,
    maxNrOfPLMNSN,
    maxSet,
    maxNrOfHSDSCHMACdFlows-1,
    maxNrOfUEsToBeTraced,
    maxNrOfInterfaces,
    maxnoofMulticastServicesPerRNC,
    maxMBMSSA,
    maxMBMSRA,
    maxnoofMulticastServicesPerUE,
    maxNrOfEDCHMACdFlows-1,
    maxGANSSSet,
    maxNrOfEUTRAFreqs,
    maxNrOfCellIds,
    maxNrOfRAIs,
    maxNrOfLAIs,
    maxNrOfVol,
    maxSizeOfIMSInfo,
    maxnoofMDTPLMNs,

    id-CN-DomainIndicator,
    id-MessageStructure,
    id-SRB-TrCH-Mapping,

```

id-TypeOfError,
id-hS-DSCH-MAC-d-Flow-ID,
id-SignallingIndication,
id-CellLoadInformationGroup,
id-TraceRecordingSessionInformation,
id-MBMSLinkingInformation,
id-AlternativeRABConfiguration,
id-AlternativeRABConfigurationRequest,
id-E-DCH-MAC-d-Flow-ID,
id-RAC,
id-Alt-RAB-Parameter-ExtendedGuaranteedBitrateInf,
id-Alt-RAB-Parameter-ExtendedMaxBitrateInf,
id-Ass-RAB-Parameter-ExtendedGuaranteedBitrateList,
id-Ass-RAB-Parameter-ExtendedMaxBitrateList,
id-RAB-Parameter-ExtendedGuaranteedBitrateList,
id-RAB-Parameter-ExtendedMaxBitrateList,
id-Requested-RAB-Parameter-ExtendedMaxBitrateList,
id-Requested-RAB-Parameter-ExtendedGuaranteedBitrateList,
id-LAofIdleModeUEs,
id-newLAListofIdleModeUEs,
id-LAListwithNoIdleModeUEsAnyMore,
id-ExtendedRNC-ID,
id-GANSS-PositioningDataSet,
id-d-RNTI-for-NoIuCSUP,
id-UE-History-Information,
id-SubscriberProfileIDforRFP,
id-Alt-RAB-Parameter-SupportedGuaranteedBitrateInf,
id-Alt-RAB-Parameter-SupportedMaxBitrateInf,
id-Ass-RAB-Parameter-SupportedGuaranteedBitrateList,
id-Ass-RAB-Parameter-SupportedMaxBitrateList,
id-RAB-Parameter-SupportedGuaranteedBitrateList,
id-RAB-Parameter-SupportedMaxBitrateList,
id-Requested-RAB-Parameter-SupportedMaxBitrateList,
id-Requested-RAB-Parameter-SupportedGuaranteedBitrateList,
id-PSRABtobeReplaced,
id-SRVCC-Information,
id-CSG-Id,
id-CSFB-Information,
id-IRAT-Measurement-Configuration,
id-Management-Based-MDT-Allowed,
id-Time-UE-StayedInCell-EnhancedGranularity,
id-HO-Cause,
id-TraceRecordingSessionReference,
id-IMSI,
id-Management-Based-MDT-PLMN-List,
id-SignallingBasedMDTPLMNList,
id-M4Report,
id-M5Report,
id-M6Report,
id-M7Report

FROM RANAP-Constants

```

    Criticality,
    ProcedureCode,
    ProtocolIE-ID,
    TriggeringMessage
FROM RANAP-CommonDataTypes

    ProtocolExtensionContainer{ },
    RANAP-PROTOCOL-EXTENSION
FROM RANAP-Containers;

-- A

AccuracyFulfilmentIndicator ::= ENUMERATED{
    requested-Accuracy-Fulfilled,
    requested-Accuracy-Not-Fulfilled,
    ...
}

AllocationOrRetentionPriority ::= SEQUENCE {
    priorityLevel          PriorityLevel,
    pre-emptionCapability  Pre-emptionCapability,
    pre-emptionVulnerability Pre-emptionVulnerability,
    queuingAllowed        QueuingAllowed,
    iE-Extensions         ProtocolExtensionContainer { {AllocationOrRetentionPriority-ExtIEs} } OPTIONAL,
    ...
}

AllocationOrRetentionPriority-ExtIEs RANAP-PROTOCOL-EXTENSION ::= {
    ...
}

Alt-RAB-Parameters ::= SEQUENCE {
    altMaxBitrateInf          Alt-RAB-Parameter-MaxBitrateInf          OPTIONAL,
    altGuaranteedBitRateInf   Alt-RAB-Parameter-GuaranteedBitrateInf   OPTIONAL,
    iE-Extensions             ProtocolExtensionContainer { {Alt-RAB-Parameters-ExtIEs} } OPTIONAL,
    ...
}

Alt-RAB-Parameters-ExtIEs RANAP-PROTOCOL-EXTENSION ::= {
-- Extension for Release 6 to indicate an alternative RAB configuration --
    { ID id-AlternativeRABConfiguration    CRITICALITY ignore  EXTENSION RAB-Parameters    PRESENCE optional }|
-- Extension for Release 7 to indicate an alternative list of Extended Guaranteed Bitrates --
    { ID id-Alt-RAB-Parameter-ExtendedGuaranteedBitrateInf    CRITICALITY ignore  EXTENSION Alt-RAB-Parameter-ExtendedGuaranteedBitrateInf    PRESENCE optional }|
-- Extension for Release 7 to indicate an alternative list of Extended Maximum Bitrates --
    { ID id-Alt-RAB-Parameter-ExtendedMaxBitrateInf    CRITICALITY ignore  EXTENSION Alt-RAB-Parameter-ExtendedMaxBitrateInf    PRESENCE optional }|
-- Extension for Release 8 to indicate an alternative list of Supported Maximum Bitrates --
    { ID id-Alt-RAB-Parameter-SupportedMaxBitrateInf    CRITICALITY reject  EXTENSION Alt-RAB-Parameter-SupportedMaxBitrateInf    PRESENCE optional }|
-- Extension for Release 8 to indicate an alternative list of Supported Guaranteed Bitrates --
    { ID id-Alt-RAB-Parameter-SupportedGuaranteedBitrateInf    CRITICALITY reject  EXTENSION Alt-RAB-Parameter-SupportedGuaranteedBitrateInf    PRESENCE optional },
    ...
}

```

```

Alt-RAB-Parameter-ExtendedGuaranteedBitrateInf ::= SEQUENCE {
    altExtendedGuaranteedBitrateType      Alt-RAB-Parameter-GuaranteedBitrateType,
    altExtendedGuaranteedBitrates         Alt-RAB-Parameter-ExtendedGuaranteedBitrates      OPTIONAL
    -- This IE shall be present if the Type of Extended Guaranteed Bit Rates Information IE is set to "Value range" or "Discrete values" --,
    ...
}

Alt-RAB-Parameter-ExtendedGuaranteedBitrates ::= SEQUENCE (SIZE (1..maxNrOfAltValues)) OF
    Alt-RAB-Parameter-ExtendedGuaranteedBitrateList

Alt-RAB-Parameter-ExtendedGuaranteedBitrateList ::= SEQUENCE (SIZE (1..maxNrOfSeparateTrafficDirections)) OF ExtendedGuaranteedBitrate

Alt-RAB-Parameter-GuaranteedBitrateInf ::= SEQUENCE {
    altGuaranteedBitrateType              Alt-RAB-Parameter-GuaranteedBitrateType,
    altGuaranteedBitrates                 Alt-RAB-Parameter-GuaranteedBitrates      OPTIONAL
    -- This IE shall be present if the Type of Guaranteed Bit Rates Information IE is set to "Value range" or "Discrete values" --,
    ...
}

Alt-RAB-Parameter-GuaranteedBitrateType ::= ENUMERATED{
    unspecified,
    value-range,
    discrete-values,
    ...
}

Alt-RAB-Parameter-GuaranteedBitrates ::= SEQUENCE (SIZE (1..maxNrOfAltValues)) OF
    Alt-RAB-Parameter-GuaranteedBitrateList

Alt-RAB-Parameter-GuaranteedBitrateList ::= SEQUENCE (SIZE (1..maxNrOfSeparateTrafficDirections)) OF GuaranteedBitrate

Alt-RAB-Parameter-SupportedGuaranteedBitrateInf ::= SEQUENCE {
    altSupportedGuaranteedBitrateType      Alt-RAB-Parameter-GuaranteedBitrateType,
    altSupportedGuaranteedBitrates         Alt-RAB-Parameter-SupportedGuaranteedBitrates      OPTIONAL
    -- This IE shall be present if the Type of Supported Guaranteed Bit Rates Information IE is set to "Value range" or "Discrete values" --,
    iE-Extensions                          ProtocolExtensionContainer { { Alt-RAB-Parameter-SupportedGuaranteedBitrateInf-ExtIEs } } OPTIONAL,
    ...
}

Alt-RAB-Parameter-SupportedGuaranteedBitrateInf-ExtIEs RANAP-PROTOCOL-EXTENSION ::= {
    ...
}

Alt-RAB-Parameter-SupportedGuaranteedBitrates ::= SEQUENCE (SIZE (1..maxNrOfAltValues)) OF
    SupportedRAB-ParameterBitrateList

Alt-RAB-Parameter-ExtendedMaxBitrateInf ::= SEQUENCE {
    altExtendedMaxBitrateType              Alt-RAB-Parameter-MaxBitrateType,
    altExtendedMaxBitrates                 Alt-RAB-Parameter-ExtendedMaxBitrates      OPTIONAL
    -- This IE shall be present if the Type of Extended Alternative Maximum Bit Rates Information IE is set to "Value range" or "Discrete values" -
    -,
    ...
}

```

```

}

Alt-RAB-Parameter-ExtendedMaxBitrates ::= SEQUENCE (SIZE (1..maxNrOfAltValues)) OF
  Alt-RAB-Parameter-ExtendedMaxBitrateList

Alt-RAB-Parameter-ExtendedMaxBitrateList ::= SEQUENCE (SIZE (1..maxNrOfSeparateTrafficDirections)) OF ExtendedMaxBitrate

Alt-RAB-Parameter-MaxBitrateInf ::= SEQUENCE {
  altMaxBitrateType      Alt-RAB-Parameter-MaxBitrateType,
  altMaxBitrates         Alt-RAB-Parameter-MaxBitrates      OPTIONAL
  -- This IE shall be present if the Type of Alternative Maximun Bit Rates Information IE is set to "Value range" or "Discrete values" --,
  ...
}

Alt-RAB-Parameter-MaxBitrateType ::= ENUMERATED{
  unspecified,
  value-range,
  discrete-values,
  ...
}

Alt-RAB-Parameter-MaxBitrates ::= SEQUENCE (SIZE (1..maxNrOfAltValues)) OF
  Alt-RAB-Parameter-MaxBitrateList

Alt-RAB-Parameter-MaxBitrateList ::= SEQUENCE (SIZE (1..maxNrOfSeparateTrafficDirections)) OF MaxBitrate

Alt-RAB-Parameter-SupportedMaxBitrateInf ::= SEQUENCE {
  altSupportedMaxBitrateType      Alt-RAB-Parameter-MaxBitrateType,
  altSupportedMaxBitrates         Alt-RAB-Parameter-SupportedMaxBitrates      OPTIONAL
  -- This IE shall be present if the Type of Supported Alternative Maximun Bit Rates Information IE is set to "Value range" or "Discrete values"
  --,
  iE-Extensions                  ProtocolExtensionContainer { { Alt-RAB-Parameter-SupportedMaxBitrateInf-ExtIEs } }      OPTIONAL,
  ...
}

Alt-RAB-Parameter-SupportedMaxBitrateInf-ExtIEs RANAP-PROTOCOL-EXTENSION ::= {
  ...
}

Alt-RAB-Parameter-SupportedMaxBitrates ::= SEQUENCE (SIZE (1..maxNrOfAltValues)) OF
  SupportedRAB-ParameterBitrateList

AlternativeRABConfigurationRequest ::= ENUMERATED{
  alternative-RAB-configuration-Requested,
  ...
}

APN ::= OCTET STRING (SIZE (1..255))
-- Reference: 23.003

AreaIdentity ::= CHOICE {

```

```

    sAI          SAI,
    geographicalArea  GeographicalArea,
    ...
}

Ass-RAB-Parameters ::= SEQUENCE {
    assMaxBitrateInf          Ass-RAB-Parameter-MaxBitrateList          OPTIONAL,
    assGuaranteedBitRateInf    Ass-RAB-Parameter-GuaranteedBitrateList  OPTIONAL,
    iE-Extensions             ProtocolExtensionContainer { {Ass-RAB-Parameters-ExtIEs} } OPTIONAL,
    ...
}

Ass-RAB-Parameters-ExtIEs RANAP-PROTOCOL-EXTENSION ::= {
-- Extension for Release 7 to indicate an extended assigned Guaranteed Bitrate --
    { ID id-Ass-RAB-Parameter-ExtendedGuaranteedBitrateList    CRITICALITY reject  EXTENSION Ass-RAB-Parameter-ExtendedGuaranteedBitrateList
PRESENCE optional }|
-- Extension for Release 7 to indicate an extended assigned Maximum Bitrate --
    { ID id-Ass-RAB-Parameter-ExtendedMaxBitrateList            CRITICALITY reject  EXTENSION Ass-RAB-Parameter-ExtendedMaxBitrateList    PRESENCE
optional }|
-- Extension for Release 8 to indicate an supported assigned Maximum Bitrate --
    { ID id-Ass-RAB-Parameter-SupportedMaxBitrateList          CRITICALITY ignore  EXTENSION SupportedRAB-ParameterBitrateList PRESENCE optional }|
-- Extension for Release 8 to indicate an supported assigned Guaranteed Bitrate --
    { ID id-Ass-RAB-Parameter-SupportedGuaranteedBitrateList   CRITICALITY ignore  EXTENSION SupportedRAB-ParameterBitrateList PRESENCE
optional },
    ...
}

Ass-RAB-Parameter-ExtendedGuaranteedBitrateList ::= SEQUENCE (SIZE (1..maxNrOfSeparateTrafficDirections)) OF ExtendedGuaranteedBitrate

Ass-RAB-Parameter-ExtendedMaxBitrateList ::= SEQUENCE (SIZE (1..maxNrOfSeparateTrafficDirections)) OF ExtendedMaxBitrate

Ass-RAB-Parameter-GuaranteedBitrateList ::= SEQUENCE (SIZE (1..maxNrOfSeparateTrafficDirections)) OF GuaranteedBitrate

Ass-RAB-Parameter-MaxBitrateList ::= SEQUENCE (SIZE (1..maxNrOfSeparateTrafficDirections)) OF MaxBitrate

AuthorisedPLMNs ::= SEQUENCE (SIZE (1..maxNrOfPLMNsSN)) OF
    SEQUENCE {
        pLMNidentity          PLMNidentity,
        authorisedSNAsList     AuthorisedSNAs    OPTIONAL,
        iE-Extensions         ProtocolExtensionContainer { {AuthorisedPLMNs-ExtIEs} } OPTIONAL,
        ...
    }

AuthorisedPLMNs-ExtIEs RANAP-PROTOCOL-EXTENSION ::= {
    ...
}

AuthorisedSNAs ::= SEQUENCE (SIZE (1..maxNrOfSNAs)) OF SNAC

-- B

```

```
BindingID ::= OCTET STRING (SIZE (4))

BroadcastAssistanceDataDecipheringKeys ::= SEQUENCE {
    cipheringKeyFlag BIT STRING (SIZE (1)),
    currentDecipheringKey BIT STRING (SIZE (56)),
    nextDecipheringKey BIT STRING (SIZE (56)),
    ...
}

-- C

Cause ::= CHOICE {
    radioNetwork CauseRadioNetwork,
    transmissionNetwork CauseTransmissionNetwork,
    nAS CauseNAS,
    protocol CauseProtocol,
    misc CauseMisc,
    non-Standard CauseNon-Standard,
    ...,
    radioNetworkExtension CauseRadioNetworkExtension
}

CauseMisc ::= INTEGER {
    om-intervention (113),
    no-resource-available (114),
    unspecified-failure (115),
    network-optimisation (116)
} (113..128)

CauseNAS ::= INTEGER {
    user-restriction-start-indication (81),
    user-restriction-end-indication (82),
    normal-release (83),
    csg-subscription-expiry(84)
} (81..96)

CauseProtocol ::= INTEGER {
    transfer-syntax-error (97),
    semantic-error (98),
    message-not-compatible-with-receiver-state (99),
    abstract-syntax-error-reject (100),
    abstract-syntax-error-ignore-and-notify (101),
    abstract-syntax-error-falsely-constructed-message (102)
} (97..112)

CauseRadioNetwork ::= INTEGER {
    rab-pre-empted (1),
    trelocoverall-expiry (2),
    trelocprep-expiry (3),
    treloccomplete-expiry (4),
    tqueing-expiry (5),
    relocation-triggered (6),
    trellocalloc-expiry(7),
}
```

unable-to-establish-during-relocation (8),
unknown-target-rnc (9),
relocation-cancelled (10),
successful-relocation (11),
requested-ciphering-and-or-integrity-protection-algorithms-not-supported (12),
conflict-with-already-existing-integrity-protection-and-or-ciphering-information (13),
failure-in-the-radio-interface-procedure (14),
release-due-to-utran-generated-reason (15),
user-inactivity (16),
time-critical-relocation (17),
requested-traffic-class-not-available (18),
invalid-rab-parameters-value (19),
requested-maximum-bit-rate-not-available (20),
requested-guaranteed-bit-rate-not-available (21),
requested-transfer-delay-not-achievable (22),
invalid-rab-parameters-combination (23),
condition-violation-for-sdu-parameters (24),
condition-violation-for-traffic-handling-priority (25),
condition-violation-for-guaranteed-bit-rate (26),
user-plane-versions-not-supported (27),
iu-up-failure (28),
relocation-failure-in-target-CN-RNC-or-target-system(29),
invalid-RAB-ID (30),
no-remaining-rab (31),
interaction-with-other-procedure (32),
requested-maximum-bit-rate-for-dl-not-available (33),
requested-maximum-bit-rate-for-ul-not-available (34),
requested-guaranteed-bit-rate-for-dl-not-available (35),
requested-guaranteed-bit-rate-for-ul-not-available (36),
repeated-integrity-checking-failure (37),
requested-request-type-not-supported (38),
request-superseded (39),
release-due-to-UE-generated-signalling-connection-release (40),
resource-optimisation-relocation (41),
requested-information-not-available (42),
relocation-desirable-for-radio-reasons (43),
relocation-not-supported-in-target-RNC-or-target-system (44),
directed-retry (45),
radio-connection-with-UE-Lost (46),
rNC-unable-to-establish-all-RFCs (47),
deciphering-keys-not-available(48),
dedicated-assistance-data-not-available(49),
relocation-target-not-allowed (50),
location-reporting-congestion (51),
reduce-load-in-serving-cell (52),
no-radio-resources-available-in-target-cell (53),
gERAN-Iumode-failure (54),
access-restricted-due-to-shared-networks (55),
incoming-relocation-not-supported-due-to-PUESBINE-feature (56),
traffic-load-in-the-target-cell-higher-than-in-the-source-cell (57),
mBMS-no-multicast-service-for-this-UE(58),
mBMS-unknown-UE-ID(59),
successful-mBMS-session-start-no-data-bearer-necessary(60),
mBMS-superseded-due-to-NNSF(61),

```

    mBMS-UE-linking-already-done(62),
    mBMS-UE-de-linking-failure-no-existing-UE-linking(63),
    tMGI-unknown(64)
} (1..64)

CauseRadioNetworkExtension ::= INTEGER {
    iP-multicast-address-and-APN-not-valid(257),
    mBMS-de-registration-rejected-due-to-implicit-registration(258),
    mBMS-request-superseded(259),
    mBMS-de-registration-during-session-not-allowed(260),
    mBMS-no-data-bearer-necessary(261),
    periodicLocationInformationNotAvailable(262),
    gTP-Resources-Unavailable(263),
    tMGI-inUse-overlapping-MBMS-service-area(264),
    mBMS-no-cell-in-MBMS-service-area(265),
    no-Iu-CS-UP-relocation(266),
    successful-MBMS-Session-Start-IP-Multicast-Bearer-established(267),
    cS-fallback-triggered(268),
    invalid-CSG-Id(269)
} (257..512)

CauseNon-Standard ::= INTEGER (129..256)
-- Cause value 256 shall not be used --

CauseTransmissionNetwork ::= INTEGER {
    signalling-transport-resource-failure (65),
    iu-transport-connection-failed-to-establish (66)
} (65..80)

Cell-Access-Mode ::= ENUMERATED {
    hybrid,
    ...
}

CellBased ::= SEQUENCE {
    cellIdList          CellIdList,
    iE-Extensions       ProtocolExtensionContainer { {CellBased-ExtIEs} } OPTIONAL,
    ...
}

CellBased-ExtIEs RANAP-PROTOCOL-EXTENSION ::= {
    ...
}

CellIdList ::= SEQUENCE (SIZE (1..maxNrOfCellIds)) OF
    Cell-Id

Cell-Id ::= INTEGER (0..268435455)

Cell-Capacity-Class-Value ::= INTEGER (1..100,...)

CellLoadInformation ::= SEQUENCE {
    cell-Capacity-Class-Value Cell-Capacity-Class-Value,
    loadValue                 LoadValue,

```

```

    rTLoadValue          RTLoadValue          OPTIONAL,
    nRTLoadInformationValue NRTLoadInformationValue OPTIONAL,
    iE-Extensions       ProtocolExtensionContainer { { CellLoadInformation-ExtIEs } } OPTIONAL,
    ...
}

CellLoadInformation-ExtIEs RANAP-PROTOCOL-EXTENSION ::= {
    ...
}

CellLoadInformationGroup ::= SEQUENCE {
    sourceCellID          SourceCellID,
    uplinkCellLoadInformation CellLoadInformation OPTIONAL,
    downlinkCellLoadInformation CellLoadInformation OPTIONAL,
    iE-Extensions       ProtocolExtensionContainer { { CellLoadInformationGroup-ExtIEs } } OPTIONAL,
    ...
}

CellLoadInformationGroup-ExtIEs RANAP-PROTOCOL-EXTENSION ::= {
    ...
}

CellType ::= ENUMERATED{
    macro,
    micro,
    pico,
    femto,
    ...
}

ClientType ::= ENUMERATED {
    emergency-Services,
    value-Added-Services,
    pLMN-Operator-Services,
    lawful-Intercept-Services,
    pLMN-Operator-Broadcast-Services,
    pLMN-Operator-O-et-M,
    pLMN-Operator-Anonymous-Statistics,
    pLMN-Operator-Target-MS-Service-Support,
    ...
}

CriticalityDiagnostics ::= SEQUENCE {
    procedureCode          ProcedureCode          OPTIONAL,
    triggeringMessage       TriggeringMessage       OPTIONAL,
    procedureCriticality    Criticality             OPTIONAL,
    iEsCriticalityDiagnostics CriticalityDiagnostics-IE-List OPTIONAL,
    iE-Extensions         ProtocolExtensionContainer { {CriticalityDiagnostics-ExtIEs} } OPTIONAL,
    ...
}

CriticalityDiagnostics-ExtIEs RANAP-PROTOCOL-EXTENSION ::= {
    ...
}

```

```

CriticalityDiagnostics-IE-List ::= SEQUENCE (SIZE (1..maxNrOfErrors)) OF
  SEQUENCE {
    iECriticality      Criticality,
    iE-ID              ProtocolIE-ID,
    repetitionNumber   RepetitionNumber0      OPTIONAL,
    iE-Extensions      ProtocolExtensionContainer { {CriticalityDiagnostics-IE-List-ExtIEs} } OPTIONAL,
    ...
  }

CriticalityDiagnostics-IE-List-ExtIEs RANAP-PROTOCOL-EXTENSION ::= {
-- Extension for Release 99 to enable reporting the message structure down to the erroneous IE --
  { ID id-MessageStructure CRITICALITY ignore EXTENSION MessageStructure PRESENCE optional } |
-- Extension for Release 99 to enable reporting if a reported error is due to a not understood or a missing IE --
  { ID id-TypeOfError CRITICALITY ignore EXTENSION TypeOfError PRESENCE mandatory },
  ...
}

MessageStructure ::= SEQUENCE (SIZE (1..maxNrOfLevels)) OF
  SEQUENCE {
    iE-ID              ProtocolIE-ID,
    repetitionNumber   RepetitionNumber1      OPTIONAL,
    iE-Extensions      ProtocolExtensionContainer { {MessageStructure-ExtIEs} } OPTIONAL,
    ...
  }

MessageStructure-ExtIEs RANAP-PROTOCOL-EXTENSION ::= {
  ...
}

CGI ::= SEQUENCE {
  pLMNidentity        PLMNidentity,
  LAC                  LAC,
  cI                   CI,
  iE-Extensions       ProtocolExtensionContainer { {CGI-ExtIEs} } OPTIONAL
}

CGI-ExtIEs RANAP-PROTOCOL-EXTENSION ::= {
-- Extension for Release 6 to enable Inter-RAT PS Handover between UTRAN and GERAN A/Gb --
  { ID id-RAC CRITICALITY ignore EXTENSION RAC PRESENCE optional },
  ...
}

ChosenEncryptionAlgorithm ::= EncryptionAlgorithm

ChosenIntegrityProtectionAlgorithm ::= IntegrityProtectionAlgorithm

CI ::= OCTET STRING (SIZE (2))

ClassmarkInformation2 ::= OCTET STRING

ClassmarkInformation3 ::= OCTET STRING

CN-DomainIndicator ::= ENUMERATED {

```

```
    cs-domain,
    ps-domain
}

CN-ID ::= INTEGER (0..4095)

Correlation-ID ::= OCTET STRING (SIZE (4))

CSFB-Information ::= ENUMERATED {
    csfb,
    csfb-high-priority,
    ...
}

CSG-Id ::= BIT STRING (SIZE (27))

CSG-Id-List ::= SEQUENCE (SIZE (1..maxNrOfCSGs)) OF
    CSG-Id

CSG-Membership-Status ::= ENUMERATED {
    member,
    non-member,
    ...
}

-- D

DataPDUType ::= ENUMERATED {
    pduType0,
    pduType1,
    ...
}

DataVolumeReference ::= INTEGER (0..255)

DataVolumeReportingIndication ::= ENUMERATED {
    do-report,
    do-not-report
}

DCH-ID ::= INTEGER (0..255)

DeliveryOfErroneousSDU ::= ENUMERATED {
    yes,
    no,
    no-error-detection-consideration
}

DeliveryOrder ::= ENUMERATED {
    delivery-order-requested,
    delivery-order-not-requested
}

DeltaRAListofIdleModeUEs ::= SEQUENCE {
```

```

    newRAListofIdleModeUEs          NewRAListofIdleModeUEs OPTIONAL,
    rAListwithNoIdleModeUEsAnyMore  RAListwithNoIdleModeUEsAnyMore OPTIONAL,
    iE-Extensions                    ProtocolExtensionContainer { {DeltaRAListofIdleModeUEs-ExtIEs} } OPTIONAL
}

NewRAListofIdleModeUEs ::= SEQUENCE (SIZE (1..maxMBMSRA)) OF
    RAC

RAListwithNoIdleModeUEsAnyMore ::= SEQUENCE (SIZE (1..maxMBMSRA)) OF
    RAC

DeltaRAListofIdleModeUEs-ExtIEs RANAP-PROTOCOL-EXTENSION ::= {
{ ID id-newLAListofIdleModeUEs          CRITICALITY reject  EXTENSION LAListofIdleModeUEs          PRESENCE conditional }|
  -- This IE shall be present if the New RA List of Idle Mode UEs IE is included. --
{ ID id-LAListwithNoIdleModeUEsAnyMore  CRITICALITY reject  EXTENSION LAListofIdleModeUEs          PRESENCE conditional },
  -- This IE shall be present if the RA List with No Idle Mode UEs Any More IE is included. --
  ...
}

ForwardingIndication ::= ENUMERATED {
    forwarding-admitted,
    ...
}

DL-GTP-PDU-SequenceNumber ::= INTEGER (0..65535)

DL-N-PDU-SequenceNumber ::= INTEGER (0..65535)

D-RNTI ::= INTEGER (0..1048575)

DRX-CycleLengthCoefficient ::= INTEGER (6..9)

DSCH-ID ::= INTEGER (0..255)

-- E

E-DCH-MAC-d-Flow-ID ::= INTEGER (0.. maxNrOfEDCHMACdFlows-1)

ENB-ID ::= CHOICE {
    macroENB-ID          BIT STRING (SIZE(20)),
    homeENB-ID           BIT STRING (SIZE(28)),
    ...
}

EncryptionAlgorithm ::= INTEGER { no-encryption (0), standard-UMTS-encryption-algorithm-UEA1 (1), standard-UMTS-encryption-algorithm-UEA2 (2) } (0..15)

EncryptionInformation ::= SEQUENCE {
    permittedAlgorithms  PermittedEncryptionAlgorithms,
    key                  EncryptionKey,
    iE-Extensions        ProtocolExtensionContainer { {EncryptionInformation-ExtIEs} } OPTIONAL
}

```

```
EncryptionInformation-ExtIEs RANAP-PROTOCOL-EXTENSION ::= {
  ...
}

EncryptionKey ::= BIT STRING (SIZE (128))
-- Reference: 33.102

End-Of-CSFB ::= ENUMERATED{
  end-of-CSFB,
  ...
}

EquipmentsToBeTraced ::= CHOICE {
  iMEIlist           IMEIList,
  iMEISVlist         IMEISVList,
  iMEIgroup          IMEIGroup,
  iMEISVgroup        IMEISVGroup,
  ...
}

E-UTRAN-Service-Handover ::= ENUMERATED {
  handover-to-E-UTRAN-shall-not-be-performed,
  ...
}

Event ::= ENUMERATED {
  stop-change-of-service-area,
  direct,
  change-of-servicearea,
  ...,
  stop-direct,
  periodic,
  stop-periodic
}

Event1F-Parameters ::= SEQUENCE {
  measurementQuantity MeasurementQuantity,
  threshold             INTEGER(-120..165),
  ...
}

Event1I-Parameters ::= SEQUENCE {
  threshold             INTEGER(-120..-25),
  ...
}

ExtendedGuaranteedBitrate ::= INTEGER (16000001..256000000)
-- Unit is bits per sec

ExtendedMaxBitrate ::= INTEGER (16000001..256000000)
-- Unit is bits per sec

ExtendedRNC-ID ::= INTEGER (4096..65535)
```

```

-- F
FrameSequenceNumber ::= INTEGER(0..15)

FrequencyLayerConvergenceFlag ::= ENUMERATED {
    no-FLC-flag,
    ...
}

-- G
GANSS-PositioningDataSet ::= SEQUENCE(SIZE(1..maxGANSSSet)) OF GANSS-PositioningMethodAndUsage

GANSS-PositioningMethodAndUsage ::= OCTET STRING (SIZE(1))

GeographicalArea ::= CHOICE {
    point                GA-Point,
    pointWithUncertainty GA-PointWithUncertainty,
    polygon              GA-Polygon,
    ...,
    pointWithUncertaintyEllipse GA-PointWithUncertaintyEllipse,
    pointWithAltitude      GA-PointWithAltitude,
    pointWithAltitudeAndUncertaintyEllipsoid GA-PointWithAltitudeAndUncertaintyEllipsoid,
    ellipsoidArc          GA-EllipsoidArc
}

GeographicalCoordinates ::= SEQUENCE {
    latitudeSign      ENUMERATED { north, south },
    latitude          INTEGER (0..8388607),
    longitude         INTEGER (-8388608..8388607),
    iE-Extensions     ProtocolExtensionContainer { {GeographicalCoordinates-ExtIEs} } OPTIONAL,
    ...
}

GeographicalCoordinates-ExtIEs RANAP-PROTOCOL-EXTENSION ::= {
    ...
}

GA-AltitudeAndDirection ::= SEQUENCE {
    directionOfAltitude ENUMERATED {height, depth},
    altitude            INTEGER (0..32767),
    ...
}

GA-EllipsoidArc ::= SEQUENCE {
    geographicalCoordinates GeographicalCoordinates,
    innerRadius             INTEGER (0..65535),
    uncertaintyRadius       INTEGER (0..127),
    offsetAngle             INTEGER (0..179),
    includedAngle          INTEGER (0..179),
    confidence              INTEGER (0..127),
    iE-Extensions          ProtocolExtensionContainer { { GA-EllipsoidArc-ExtIEs} } OPTIONAL,
    ...
}

```

```

GA-EllipsoidArc-ExtIEs RANAP-PROTOCOL-EXTENSION ::= {
    ...
}

GA-Point ::= SEQUENCE {
    geographicalCoordinates    GeographicalCoordinates,
    iE-Extensions              ProtocolExtensionContainer { {GA-Point-ExtIEs} } OPTIONAL,
    ...
}

GA-Point-ExtIEs RANAP-PROTOCOL-EXTENSION ::= {
    ...
}

GA-PointWithAltitude ::= SEQUENCE {
    geographicalCoordinates    GeographicalCoordinates,
    altitudeAndDirection      GA-AltitudeAndDirection,
    iE-Extensions              ProtocolExtensionContainer { { GA-PointWithAltitude-ExtIEs} } OPTIONAL,
    ...
}

GA-PointWithAltitude-ExtIEs RANAP-PROTOCOL-EXTENSION ::= {
    ...
}

GA-PointWithAltitudeAndUncertaintyEllipsoid ::= SEQUENCE {
    geographicalCoordinates    GeographicalCoordinates,
    altitudeAndDirection      GA-AltitudeAndDirection,
    uncertaintyEllipse         GA-UncertaintyEllipse,
    uncertaintyAltitude        INTEGER (0..127),
    confidence                  INTEGER (0..127),
    iE-Extensions              ProtocolExtensionContainer { { GA-PointWithAltitudeAndUncertaintyEllipsoid-ExtIEs} } OPTIONAL,
    ...
}

GA-PointWithAltitudeAndUncertaintyEllipsoid-ExtIEs RANAP-PROTOCOL-EXTENSION ::= {
    ...
}

GA-PointWithUnCertainty ::=SEQUENCE {
    geographicalCoordinates    GeographicalCoordinates,
    iE-Extensions              ProtocolExtensionContainer { {GA-PointWithUnCertainty-ExtIEs} } OPTIONAL,
    uncertaintyCode            INTEGER (0..127)
}

GA-PointWithUnCertainty-ExtIEs RANAP-PROTOCOL-EXTENSION ::= {
    ...
}

GA-PointWithUnCertaintyEllipse ::= SEQUENCE {
    geographicalCoordinates    GeographicalCoordinates,
    uncertaintyEllipse         GA-UncertaintyEllipse,
    confidence                  INTEGER (0..127),
}

```

```

    iE-Extensions          ProtocolExtensionContainer { { GA-PointWithUnCertaintyEllipse-ExtIEs } } OPTIONAL,
    ...
}

GA-PointWithUnCertaintyEllipse-ExtIEs RANAP-PROTOCOL-EXTENSION ::= {
    ...
}

GA-Polygon ::= SEQUENCE (SIZE (1..maxNrOfPoints)) OF
    SEQUENCE {
        geographicalCoordinates    GeographicalCoordinates,
        iE-Extensions              ProtocolExtensionContainer { {GA-Polygon-ExtIEs} } OPTIONAL,
        ...
    }

GA-Polygon-ExtIEs RANAP-PROTOCOL-EXTENSION ::= {
    ...
}

GA-UncertaintyEllipse ::= SEQUENCE {
    uncertaintySemi-major          INTEGER (0..127),
    uncertaintySemi-minor         INTEGER (0..127),
    orientationOfMajorAxis        INTEGER (0..179), -- The values 90..179 shall not be used.
    ...
}

GERAN-BSC-Container          ::= OCTET STRING
    -- GERAN BSC Container as defined in TS 48.008 [11] --

GERAN-Cell-ID ::= SEQUENCE {
    LAI                        LAI,
    rAC                        RAC,
    cI                        CI,
    iE-Extensions              ProtocolExtensionContainer { {GERAN-Cell-ID-ExtIEs} } OPTIONAL
}

GERAN-Cell-ID-ExtIEs RANAP-PROTOCOL-EXTENSION ::= {
    ...
}

GERAN-Classmark              ::= OCTET STRING
    -- GERAN Classmark as defined in TS 48.008 [11] --

GlobalCN-ID ::= SEQUENCE {
    PLMNidentity                PLMNidentity,
    cN-ID                      CN-ID
}

GlobalRNC-ID ::= SEQUENCE {
    PLMNidentity                PLMNidentity,
    rNC-ID                      RNC-ID
}

```

```

GTP-TEI                ::= OCTET STRING (SIZE (4))

GuaranteedBitrate      ::= INTEGER (0..16000000)
-- Unit is bits per sec

-- H

HigherBitratesThan16MbpsFlag ::= ENUMERATED{
    allowed,
    not-allowed,
    ...
}

HS-DSCH-MAC-d-Flow-ID  ::= INTEGER (0.. maxNrOfHSDSCHMACdFlows-1)

-- I

IMEI                   ::= OCTET STRING (SIZE (8))
-- Reference: 23.003

IMEIGroup              ::= SEQUENCE {
    iMEI                IMEI,
    iMEIMask             BIT STRING (SIZE (7)),
    iE-Extensions       ProtocolExtensionContainer { { IMEIGroup-ExtIEs } } OPTIONAL
}

IMEIGroup-ExtIEs RANAP-PROTOCOL-EXTENSION ::= {
    ...
}

IMEIList               ::= SEQUENCE (SIZE (1..maxNrOfUEsToBeTraced)) OF IMEI

IMEISV                 ::= OCTET STRING (SIZE (8))
-- Reference: 23.003

IMEISVGroup           ::= SEQUENCE {
    iMEISV              IMEISV,
    iMEISVMask          BIT STRING (SIZE (7)),
    iE-Extensions       ProtocolExtensionContainer { { IMEISVGroup-ExtIEs } } OPTIONAL
}

IMEISVGroup-ExtIEs RANAP-PROTOCOL-EXTENSION ::= {
    ...
}

IMEISVList            ::= SEQUENCE (SIZE (1..maxNrOfUEsToBeTraced)) OF IMEISV

ImmediateMDT          ::= SEQUENCE {
    measurementsToActivate MeasurementsToActivate,
    m1report              M1Report                OPTIONAL,
    -- Included in case of event-triggered reporting for measurement M1
    m2report              M2Report                OPTIONAL,

```

```

-- Included in case of event-triggered reporting for measurement M2
...
iE-Extensions      ProtocolExtensionContainer { { ImmediateMDT-ExtIEs } } OPTIONAL
}

ImmediateMDT-ExtIEs RANAP-PROTOCOL-EXTENSION ::= {
  {ID id-M4Report      CRITICALITY ignore  EXTENSION M4Report      PRESENCE optional}|
  -- Included in case that measurement M4 is activated
  {ID id-M5Report      CRITICALITY ignore  EXTENSION M5Report      PRESENCE optional}|
  -- Included in case that measurement M5 is activated
  {ID id-M6Report      CRITICALITY ignore  EXTENSION M6Report      PRESENCE optional}|
  -- Included in case that measurement M6 is activated
  {ID id-M7Report      CRITICALITY ignore  EXTENSION M7Report      PRESENCE optional},
  ...
}

IMSI                ::= TBCD-STRING (SIZE (3..8))
-- Reference: 23.003

IncludeVelocity      ::= ENUMERATED {
  requested
}

InformationExchangeID ::= INTEGER (0.. 1048575)

InformationExchangeType ::= ENUMERATED {
  transfer,
  request,
  ...
}

InformationRequested ::= CHOICE {
  requestedMBMSIPMulticastAddressandAPNRequest      RequestedMBMSIPMulticastAddressandAPNRequest,
  requestedMulticastServiceList                     RequestedMulticastServiceList,
  ...
}

InformationRequestType ::= CHOICE {
  mBMSIPMulticastAddressandAPNRequest      MBMSIPMulticastAddressandAPNRequest,
  permanentNAS-UE-ID                       PermanentNAS-UE-ID,
  ...
}

InformationTransferID ::= INTEGER (0.. 1048575)

InformationTransferType ::= CHOICE {
  rNCTraceInformation      RNCTraceInformation,
  ...
}

IntegrityProtectionAlgorithm ::= INTEGER {
  standard-UMTS-integrity-algorithm-UIA1 (0), standard-UMTS-integrity-algorithm-UIA2 (1),

```

```

    no-value (15)
  } (0..15)

IntegrityProtectionInformation ::= SEQUENCE {
    permittedAlgorithms    PermittedIntegrityProtectionAlgorithms,
    key                    IntegrityProtectionKey,
    iE-Extensions          ProtocolExtensionContainer { {IntegrityProtectionInformation-ExtIEs} } OPTIONAL
}

IntegrityProtectionInformation-ExtIEs RANAP-PROTOCOL-EXTENSION ::= {
    ...
}

IntegrityProtectionKey          ::= BIT STRING (SIZE (128))

InterSystemInformationTransferType ::= CHOICE {
    rIM-Transfer                RIM-Transfer,
    ...
}

InterSystemInformation-TransparentContainer ::= SEQUENCE {
    downlinkCellLoadInformation    CellLoadInformation    OPTIONAL,
    uplinkCellLoadInformation      CellLoadInformation    OPTIONAL,
    iE-Extensions                  ProtocolExtensionContainer { { InterSystemInformation-TransparentContainer-ExtIEs} } OPTIONAL,
    ...
}

InterSystemInformation-TransparentContainer-ExtIEs RANAP-PROTOCOL-EXTENSION ::= {
    ...
}

IPMulticastAddress ::= OCTET STRING (SIZE (4..16))
-- Reference: 23.003

IuSignallingConnectionIdentifier ::= BIT STRING (SIZE (24))

IuTransportAssociation ::= CHOICE {
    gTP-TEI                    GTP-TEI,
    bindingID                  BindingID,
    ...
}

-- J
-- K

KeyStatus ::= ENUMERATED {
    old,
    new,
    ...
}
-- L

LA-LIST ::= SEQUENCE (SIZE (1..maxNrOfLAs)) OF
SEQUENCE {

```

```

        lAC                LAC,
        listOF-SNAs        ListOF-SNAs,
        iE-Extensions      ProtocolExtensionContainer { { LA-LIST-ExtIEs } } OPTIONAL,
        ...
    }

LA-LIST-ExtIEs RANAP-PROTOCOL-EXTENSION ::= {
    ...
}

LAC ::= OCTET STRING (SIZE (2))

LAI ::= SEQUENCE {
    pLMNidentity          PLMNidentity,
    lAC                  LAC,
    iE-Extensions        ProtocolExtensionContainer { {LAI-ExtIEs} } OPTIONAL
}

LAI-ExtIEs RANAP-PROTOCOL-EXTENSION ::= {
    ...
}

LastKnownServiceArea ::= SEQUENCE {
    sAI                  SAI,
    ageOfSAI             INTEGER (0..32767),
    iE-Extensions        ProtocolExtensionContainer { {LastKnownServiceArea-ExtIEs} } OPTIONAL,
    ...
}

LastKnownServiceArea-ExtIEs RANAP-PROTOCOL-EXTENSION ::= {
    ...
}

LastVisitedUTRANCell-Item ::= SEQUENCE {
    uTRAN-CellID         UTRAN-CellID,
    cellType             CellType,
    time-UE-StayedInCell Time-UE-StayedInCell,
    iE-Extensions        ProtocolExtensionContainer { {LastVisitedUTRANCell-Item-ExtIEs} } OPTIONAL,
    ...
}

LastVisitedUTRANCell-Item-ExtIEs RANAP-PROTOCOL-EXTENSION ::= {
-- Extension for Rel-11 to support enhanced granularity for time UE stayed in cell --
    { ID id-Time-UE-StayedInCell-EnhancedGranularity    CRITICALITY ignore    EXTENSION Time-UE-StayedInCell-EnhancedGranularity    PRESENCE optional
} |
    { ID id-HO-Cause                                    CRITICALITY ignore    EXTENSION Cause                                    PRESENCE optional
},
    ...
}

Links-to-log ::= ENUMERATED {uplink, downlink, both-uplink-and-downlink, ...}

ListOF-SNAs ::= SEQUENCE (SIZE (1..maxNrOfSNAs)) OF SNAC

```

```

ListOfInterfacesToTrace ::= SEQUENCE (SIZE (1..maxNrOfInterfaces)) OF InterfacesToTraceItem

InterfacesToTraceItem ::= SEQUENCE {
    interface          ENUMERATED {iu-cs, iu-ps, iur, iub, uu, ...},
    iE-Extensions      ProtocolExtensionContainer { {InterfacesToTraceItem-ExtIEs} } OPTIONAL,
    ...
}

InterfacesToTraceItem-ExtIEs RANAP-PROTOCOL-EXTENSION ::= {
    ...
}

LoadValue ::= INTEGER (0..100)

LocationRelatedDataRequestType ::= SEQUENCE {
    requestedLocationRelatedDataType RequestedLocationRelatedDataType,
    requestedGPSAssistanceData       RequestedGPSAssistanceData OPTIONAL,
    -- This IE shall be present if the Requested Location Related Data Type IE is set to "Dedicated Assistance Data for Assisted GPS" or
    -- `Dedicated Assistance Data for Assisted GPS and GANSS"
    ...
}

LocationRelatedDataRequestTypeSpecificToGERANIuMode ::= ENUMERATED {
    decipheringKeysEOTD,
    dedicatedMobileAssistedEOTDAssistanceData,
    dedicatedMobileBasedEOTDAssistanceData,
    ...
}

LocationReportingTransferInformation ::= SEQUENCE {
    reportChangeOfSAI          ReportChangeOfSAI          OPTIONAL,
    periodicReportingIndicator  PeriodicReportingIndicator OPTIONAL,
    directReportingIndicator    DirectReportingIndicator   OPTIONAL,
    verticalAccuracyCode        VerticalAccuracyCode       OPTIONAL,
    positioningPriorityChangeSAI PositioningPriority      OPTIONAL,
    positioningPriorityDirect    PositioningPriority      OPTIONAL,
    clientTypePeriodic          ClientType                OPTIONAL,
    clientTypeDirect            ClientType                OPTIONAL,
    responseTime                ResponseTime              OPTIONAL,
    includeVelocity             IncludeVelocity           OPTIONAL,
    periodicLocationInfo        PeriodicLocationInfo      OPTIONAL,
    iE-Extensions              ProtocolExtensionContainer { { LocationReportingTransferInformation-ExtIEs } } OPTIONAL,
    ...
}

LocationReportingTransferInformation-ExtIEs RANAP-PROTOCOL-EXTENSION ::= {
    ...
}

ReportChangeOfSAI ::= ENUMERATED {
    requested,
    ...
}

```

```
PeriodicReportingIndicator ::= ENUMERATED {
    periodicSAI,
    periodicGeo,
    ...
}

DirectReportingIndicator ::= ENUMERATED {
    directSAI,
    directGeo,
    ...
}

L3-Information ::= OCTET STRING

-- M

M1Report ::= CHOICE {
    periodic      MDT-Report-Parameters,
    event1F      Event1F-Parameters,
    ...
}

M2Report ::= CHOICE {
    periodic      MDT-Report-Parameters,
    event1I      Event1I-Parameters,
    ...
}

M4Report ::= CHOICE {
    all          NULL,
    m4-collection-parameters M4-Collection-Parameters,
    ...
}

M4-Collection-Parameters ::= SEQUENCE {
    m4-period      M4-Period,
    m4-threshold   M4-Threshold OPTIONAL,
    iE-Extensions ProtocolExtensionContainer { { M4-Collection-Parameters-ExtIEs } } OPTIONAL,
    ...
}

M4-Collection-Parameters-ExtIEs RANAP-PROTOCOL-EXTENSION ::= {
    ...
}

M4-Period ::= ENUMERATED {ms100, ms250, ms500, ms1000, ms2000, ms3000, ms4000, ms6000, ...}

M4-Threshold ::= INTEGER (0..31)

M5Report ::= CHOICE {
    when-available NULL,
    m5-period      M5-Period,
}
```

```
    ...
  }
M5-Period ::= ENUMERATED {ms100, ms250, ms500, ms1000, ms2000, ms3000, ms4000, ms6000, ...}

M6Report ::= SEQUENCE {
    m6-period          M6-Period,
    m6-links-to-log    Links-to-log,
    iE-Extensions      ProtocolExtensionContainer { { M6Report-ExtIEs } } OPTIONAL,
    ...
}

M6Report-ExtIEs RANAP-PROTOCOL-EXTENSION ::= {
    ...
}

M6-Period ::= ENUMERATED {ms1000, ms2000, ms3000, ms4000, ms6000, ms8000, ms12000, ms16000, ms20000, ms24000, ms28000, ms32000, ms64000, ...}

M7Report ::= SEQUENCE {
    m7-period          M7-Period,
    m7-links-to-log    Links-to-log,
    iE-Extensions      ProtocolExtensionContainer { { M7Report-ExtIEs } } OPTIONAL,
    ...
}

M7Report-ExtIEs RANAP-PROTOCOL-EXTENSION ::= {
    ...
}

M7-Period ::= ENUMERATED {ms1000, ms2000, ms3000, ms4000, ms6000, ms8000, ms12000, ms16000, ms20000, ms24000, ms28000, ms32000, ms64000, ...}

Management-Based-MDT-Allowed ::= ENUMERATED {
    allowed, ... }

MaxBitrate          ::= INTEGER (1..16000000)
-- Unit is bits per sec

MaxSDU-Size         ::= INTEGER (0..32768)
-- MaxSDU-Size
-- Unit is bit

MBMS-PTP-RAB-ID ::= BIT STRING (SIZE (8))

MBMSBearerServiceType ::= ENUMERATED {
    multicast,
    broadcast,
    ...
}

MBMSCNDe-Registration ::= ENUMERATED {
    normalsessionstop,
    deregister,
    ...
}
```

```
}

MBMSCountingInformation ::= ENUMERATED {
    counting,
    notcounting,
    ...
}

MBMSHCIndicator ::= ENUMERATED {
    uncompressed-header,
    compressed-header,
    ...
}

MBMSIPMulticastAddressandAPNRequest ::= SEQUENCE (SIZE (1..maxnoofMulticastServicesPerRNC)) OF
    TMGI

MBMSLinkingInformation ::= ENUMERATED {
    uE-has-joined-multicast-services,
    ...
}

MBMSRegistrationRequestType ::= ENUMERATED {
    register,
    deregister,
    ...
}

MBMSServiceArea ::= OCTET STRING

MBMSSessionDuration ::= OCTET STRING (SIZE (3))

MBMSSessionIdentity ::= OCTET STRING (SIZE (1))

MBMSSessionRepetitionNumber ::= OCTET STRING (SIZE (1))

MDT-Activation      ::= ENUMERATED { immediateMDTonly,
    loggedMDTonly,
    immediateMDTandTrace,
    ... }

MDTAreaScope       ::= CHOICE {
    cellbased        CellBased,
    labased          LABased,
    rabased          RABased,
    plmn-area-based  NULL,
    ...
}

MDT-Configuration  ::= SEQUENCE {
    mdtActivation    MDT-Activation,
```

```

        mdtAreaScope          MDTAreaScope,
        mdtMode                MDTMode,
        iE-Extensions          ProtocolExtensionContainer { { MDT-Configuration-ExtIEs } } OPTIONAL,
        ...
    }

MDT-Configuration-ExtIEs RANAP-PROTOCOL-EXTENSION ::= {
    { ID id-SignallingBasedMDTPLMNList          CRITICALITY ignore EXTENSION MDT-PLMN-List PRESENCE optional },
    ...
}

MDTMode ::= CHOICE {
    immediateMDT          ImmediateMDT,
    loggedMDT             LoggedMDT,
    ...
}

MDT-PLMN-List ::= SEQUENCE (SIZE (1..maxnoofMDTPLMNs)) OF
    PLMNIdentity

MDT-Report-Parameters ::= SEQUENCE {
    reportInterval        ReportInterval,
    reportAmount          ReportAmount,
    ...
}

MeasurementQuantity ::= ENUMERATED {
    cpichEcNo,
    cpichRSCP,
    pathloss,
    ...
}

MeasurementsToActivate ::= BIT STRING (SIZE (8))

MSISDN ::= OCTET STRING (SIZE (1..9))

-- N

NAS-PDU ::= OCTET STRING

NAS-SequenceNumber ::= BIT STRING (SIZE (2))
-- Reference: 24.008

NAS-SynchronisationIndicator ::= BIT STRING (SIZE (4))

NewBSS-To-OldBSS-Information ::= OCTET STRING

NonSearchingIndication ::= ENUMERATED {
    non-searching,
    searching
}

```

```
NRTLoadInformationValue ::= INTEGER (0..3)

NumberOfIuInstances      ::= INTEGER (1..2)

NumberOfSteps           ::= INTEGER (1..16)

-- O

Offload-RAB-Parameters ::= SEQUENCE {
    accessPointName      Offload-RAB-Parameters-APN,
    chargingCharacteristics Offload-RAB-Parameters-ChargingCharacteristics,
    iE-Extensions        ProtocolExtensionContainer { { Offload-RAB-Parameters-ExtIEs} } OPTIONAL,
    ...
}

Offload-RAB-Parameters-ExtIEs RANAP-PROTOCOL-EXTENSION ::= {
    ...
}

Offload-RAB-Parameters-APN ::= OCTET STRING (SIZE (1..255))

Offload-RAB-Parameters-ChargingCharacteristics ::= OCTET STRING (SIZE (2))

OldBSS-ToNewBSS-Information ::= OCTET STRING

OMC-ID ::= OCTET STRING (SIZE (3..22))
-- Reference: GSM TS 12.20 [25]

Out-Of-UTRAN ::= ENUMERATED{
    cell-reselection-to-EUTRAN,
    ...
}

-- P

PagingAreaID ::= CHOICE {
    LAI          LAI,
    rAI          RAI,
    ...
}

PagingCause ::= ENUMERATED {
    terminating-conversational-call,
    terminating-streaming-call,
    terminating-interactive-call,
    terminating-background-call,
    terminating-low-priority-signalling,
    ...,
    terminating-high-priority-signalling
}

PDP-TypeInformation ::= SEQUENCE (SIZE (1..maxNrOfPDPDirections)) OF
    PDP-Type
```

```

PDP-Type ::= ENUMERATED {
    empty,
    PPP,
    osp-ihoss -- this value shall not be used -- ,
    ipv4,
    ipv6,
    ...
}
PDP-TypeInformation-extension ::= SEQUENCE (SIZE (1..maxNrOfPDPDirections)) OF
    PDP-Type-extension

PDP-Type-extension ::= ENUMERATED {
    ipv4-and-ipv6,
    ...
}

PDUType14FrameSequenceNumber ::= INTEGER(0..3)

PeriodicLocationInfo ::= SEQUENCE {
    reportingAmount          INTEGER (1..8639999, ...),
    reportingInterval        INTEGER (1..8639999, ...),
    iE-Extensions            ProtocolExtensionContainer { { PeriodicLocationInfo-ExtIEs } } OPTIONAL,
    ...
}

PeriodicLocationInfo-ExtIEs RANAP-PROTOCOL-EXTENSION ::= {
    ...
}

PermanentNAS-UE-ID ::= CHOICE {
    IMSI                    IMSI,
    ...
}

PermittedEncryptionAlgorithms ::= SEQUENCE (SIZE (1..16)) OF
    EncryptionAlgorithm

PermittedIntegrityProtectionAlgorithms ::= SEQUENCE (SIZE (1..16)) OF
    IntegrityProtectionAlgorithm

LABased ::= SEQUENCE {
    laiList                LAI-List,
    iE-Extensions          ProtocolExtensionContainer { {LABased-ExtIEs} } OPTIONAL,
    ...
}

LABased-ExtIEs RANAP-PROTOCOL-EXTENSION ::= {
    ...
}

LAI-List ::= SEQUENCE (SIZE (1..maxNrOfLAIs)) OF
    LAI

```

```

LoggedMDT ::= SEQUENCE {
    loggingInterval      LoggingInterval,
    loggingDuration      LoggingDuration,
    iE-Extensions        ProtocolExtensionContainer { {LoggedMDT-ExtIEs} } OPTIONAL,
    ...
}

LoggedMDT-ExtIEs RANAP-PROTOCOL-EXTENSION ::= {
    ...
}

LoggingInterval ::= ENUMERATED {
    s1d28,
    s2d56,
    s5d12,
    s10d24,
    s20d48,
    s30d72,
    s40d96,
    s61d44,
    ...
}

LoggingDuration ::= ENUMERATED {
    min10,
    min20,
    min40,
    min60,
    min90,
    min120,
    ...}

PLMNidentity                ::= TBCD-STRING (SIZE (3))

PLMNs-in-shared-network ::= SEQUENCE (SIZE (1..maxNrOfPLMNsSN)) OF
    SEQUENCE {
        pLMNidentity          PLMNidentity,
        lA-LIST                LA-LIST,
        iE-Extensions          ProtocolExtensionContainer { { PLMNs-in-shared-network-ExtIEs } } OPTIONAL,
        ...
    }

PLMNs-in-shared-network-ExtIEs RANAP-PROTOCOL-EXTENSION ::= {
    ...
}

Port-Number ::= OCTET STRING (SIZE (2))

PositioningDataDiscriminator ::= BIT STRING (SIZE(4))

```

```

PositioningDataSet ::= SEQUENCE(SIZE(1..maxSet)) OF PositioningMethodAndUsage
PositioningMethodAndUsage ::= OCTET STRING (SIZE(1))

PositioningPriority ::= ENUMERATED {
    high-Priority,
    normal-Priority,
    ...
}

PositionData ::= SEQUENCE {
    positioningDataDiscriminator      PositioningDataDiscriminator,
    positioningDataSet                PositioningDataSet          OPTIONAL,
-- This IE shall be present if the PositioningDataDiscriminator IE is set to the value "0000" --
    iE-Extensions                    ProtocolExtensionContainer { {PositionData-ExtIEs} } OPTIONAL,
    ...
}

PositionData-ExtIEs RANAP-PROTOCOL-EXTENSION ::= {
    { ID id-GANSS-PositioningDataSet      CRITICALITY ignore  EXTENSION GANSS-PositioningDataSet      PRESENCE optional },
    ...
}

PositionDataSpecificToGERANIuMode ::= OCTET STRING

Pre-emptionCapability ::= ENUMERATED {
    shall-not-trigger-pre-emption,
    may-trigger-pre-emption
}

Pre-emptionVulnerability ::= ENUMERATED {
    not-pre-emptable,
    pre-emptable
}

PriorityLevel          ::= INTEGER { spare (0), highest (1), lowest (14), no-priority (15) } (0..15)

Priority-Class-Indicator ::= BIT STRING (SIZE(8))

ProvidedData ::= CHOICE {
    shared-network-information          Shared-Network-Information,
    ...
}

P-TMSI                ::= OCTET STRING (SIZE (4))

-- Q

QueuingAllowed ::= ENUMERATED {
    queueing-not-allowed,
    queueing-allowed
}

```

```

-- R
RAB-AsymmetryIndicator ::= ENUMERATED {
    symmetric-bidirectional,
    asymmetric-unidirectional-downlink,
    asymmetric-unidirectional-uplink,
    asymmetric-bidirectional,
    ...
}

RABased ::= SEQUENCE {
    raiList          RAI-List,
    iE-Extensions   ProtocolExtensionContainer { {RABased-ExtIEs} } OPTIONAL,
    ...
}

RABased-ExtIEs RANAP-PROTOCOL-EXTENSION ::= {
    ...
}

RAI-List ::= SEQUENCE (SIZE (1..maxNrOfRAIs)) OF
    RAI

RABDataVolumeReport ::= SEQUENCE (SIZE (1..maxNrOfVol)) OF
    SEQUENCE {
        dl-UnsuccessfullyTransmittedDataVolume  UnsuccessfullyTransmittedDataVolume,
        dataVolumeReference                     DataVolumeReference OPTIONAL,
        iE-Extensions                           ProtocolExtensionContainer { {RABDataVolumeReport-ExtIEs} } OPTIONAL,
        ...
    }

RABDataVolumeReport-ExtIEs RANAP-PROTOCOL-EXTENSION ::= {
    ...
}

RAB-ID ::= BIT STRING (SIZE (8))

RAB-Parameter-ExtendedGuaranteedBitrateList ::= SEQUENCE (SIZE (1..maxNrOfSeparateTrafficDirections)) OF ExtendedGuaranteedBitrate

RAB-Parameter-ExtendedMaxBitrateList ::= SEQUENCE (SIZE (1..maxNrOfSeparateTrafficDirections)) OF ExtendedMaxBitrate

RAB-Parameter-GuaranteedBitrateList ::= SEQUENCE (SIZE (1..maxNrOfSeparateTrafficDirections)) OF GuaranteedBitrate
--This IE shall be ignored if Supported Guaranteed Bit rate is present--

RAB-Parameter-MaxBitrateList ::= SEQUENCE (SIZE (1..maxNrOfSeparateTrafficDirections)) OF MaxBitrate
--This IE shall be ignored if Supported Maximum Bit rate is present--

RAB-Parameters ::= SEQUENCE {
    trafficClass          TrafficClass,
    rAB-AsymmetryIndicator RAB-AsymmetryIndicator,
    maxBitrate            RAB-Parameter-MaxBitrateList,
    guaranteedBitRate     RAB-Parameter-GuaranteedBitrateList OPTIONAL
    -- This IE shall be present the traffic class IE is set to "Conversational" or "Streaming" --,

```

```

deliveryOrder          DeliveryOrder,
maxSDU-Size            MaxSDU-Size,
sDU-Parameters        SDU-Parameters,
transferDelay          TransferDelay OPTIONAL
-- This IE shall be present the traffic class IE is set to "Conversational" or "Streaming" --,
trafficHandlingPriority TrafficHandlingPriority OPTIONAL
-- This IE shall be present the traffic class IE is set to "Interactive" --,
allocationOrRetentionPriority AllocationOrRetentionPriority OPTIONAL,
sourceStatisticsDescriptor SourceStatisticsDescriptor OPTIONAL
-- This IE shall be present the traffic class IE is set to "Conversational" or "Streaming" --,
relocationRequirement RelocationRequirement OPTIONAL,
iE-Extensions          ProtocolExtensionContainer { {RAB-Parameters-ExtIEs} } OPTIONAL,
...
}

RAB-Parameters-ExtIEs RANAP-PROTOCOL-EXTENSION ::= {
-- Extension for Release 5 to enable indication that Interactive User Plane data is of a signalling nature --
{ ID id-SignallingIndication CRITICALITY ignore EXTENSION SignallingIndication PRESENCE optional }|
-- Extension for Release 7 to indicate an Extended Guaranteed Bitrate --
{ ID id-RAB-Parameter-ExtendedGuaranteedBitrateList CRITICALITY reject EXTENSION RAB-Parameter-ExtendedGuaranteedBitrateList PRESENCE optional }|
-- Extension for Release 7 to indicate an Extended Maximum Bitrate --
{ ID id-RAB-Parameter-ExtendedMaxBitrateList CRITICALITY reject EXTENSION RAB-Parameter-ExtendedMaxBitrateList PRESENCE optional }|
-- Extension for Release 8 to indicate an Supported Maximum Bitrate --
{ ID id-RAB-Parameter-SupportedMaxBitrateList CRITICALITY reject EXTENSION SupportedRAB-ParameterBitrateList PRESENCE optional }|
-- Extension for Release 8 to indicate an Supported Guaranteed Bitrate --
{ ID id-RAB-Parameter-SupportedGuaranteedBitrateList CRITICALITY reject EXTENSION SupportedRAB-ParameterBitrateList PRESENCE optional },
...
}

RABParametersList ::= SEQUENCE (SIZE (1.. maxNrOfRABs)) OF SEQUENCE {
rab-Id RAB-ID,
cn-domain CN-DomainIndicator,
rabDataVolumeReport RABDataVolumeReport OPTIONAL,
upInformation UPInformation OPTIONAL,
iE-Extensions ProtocolExtensionContainer { { RABParametersList-ExtIEs } } OPTIONAL,
...
}

RABParametersList-ExtIEs RANAP-PROTOCOL-EXTENSION ::= {
...
}

RAB-SubflowCombinationBitRate ::= INTEGER (0..16000000)

RAB-TrCH-Mapping ::= SEQUENCE ( SIZE (1..maxNrOfRABs)) OF
RAB-TrCH-MappingItem

RAB-TrCH-MappingItem ::= SEQUENCE {
rAB-ID RAB-ID,
trCH-ID-List TrCH-ID-List,
iE-Extensions ProtocolExtensionContainer { { RAB-TrCH-MappingItem-ExtIEs } } OPTIONAL,
...
}

```

```

RAB-TrCH-MappingItem-ExtIEs RANAP-PROTOCOL-EXTENSION ::= {
-- Extension for Release 99 to enable transfer of RAB Subflow mapping onto Iur transport channel Ids for a given indicated domain --
  { ID id-CN-DomainIndicator    CRITICALITY ignore    EXTENSION CN-DomainIndicator    PRESENCE optional },
  ...
}

RAC ::= OCTET STRING (SIZE (1))

RAI ::= SEQUENCE {
  LAI,
  rAC,
  iE-Extensions    ProtocolExtensionContainer { {RAI-ExtIEs} } OPTIONAL,
  ...
}

RAI-ExtIEs RANAP-PROTOCOL-EXTENSION ::= {
  ...
}

RAListofIdleModeUEs ::= CHOICE {
  notEmptyRAListofIdleModeUEs    NotEmptyRAListofIdleModeUEs,
  emptyFullRAListofIdleModeUEs    ENUMERATED {emptylist,fulllist,...},
  ...
}

NotEmptyRAListofIdleModeUEs ::= SEQUENCE {
  rAofIdleModeUEs    RAofIdleModeUEs,
  iE-Extensions    ProtocolExtensionContainer { {NotEmptyRAListofIdleModeUEs-ExtIEs} } OPTIONAL
}

RAofIdleModeUEs ::= SEQUENCE (SIZE (1..maxMBMSRA)) OF
  RAC

NotEmptyRAListofIdleModeUEs-ExtIEs RANAP-PROTOCOL-EXTENSION ::= {
{ ID id-LAofIdleModeUEs    CRITICALITY reject    EXTENSION LAListofIdleModeUEs PRESENCE conditional },
  -- This IE shall be present if the RA of Idle Mode UEs IE is included. --
  ...
}

LAListofIdleModeUEs ::= SEQUENCE (SIZE (1..maxMBMSRA)) OF
  LAI

RAT-Type ::= ENUMERATED {
  utran,
  geran,
  ...
}

RateControlAllowed ::= ENUMERATED {
  not-allowed,
  allowed
}

```

```
RedirectAttemptFlag ::= NULL

RedirectionCompleted ::= ENUMERATED {
    redirection-completed,
    ...
}

RejectCauseValue ::= ENUMERATED {
    pLMN-Not-Allowed,
    location-Area-Not-Allowed,
    roaming-Not-Allowed-In-This-Location-Area,
    no-Suitable-Cell-In-Location-Area,
    gPRS-Services-Not-Allowed-In-This-PLMN,
    cS-PS-coordination-required,
    ...
}

RelocationRequirement ::= ENUMERATED {
    lossless,
    none,
    ...,
    realtime
}

RelocationType ::= ENUMERATED {
    ue-not-involved,
    ue-involved,
    ...
}

RepetitionNumber0 ::= INTEGER (0..255)

RepetitionNumber1 ::= INTEGER (1..256)

ReportArea ::= ENUMERATED {
    service-area,
    geographical-area,
    ...
}

ReportInterval ::= ENUMERATED {
    ms250,
    ms500,
    ms1000,
    ms2000,
    ms3000,
    ms4000,
    ms6000,
    ms12000,
    ms16000,
    ms20000,
    ms24000,
```

```

        ms32000,
        ms64000,
        ... }

ReportAmount ::= ENUMERATED { n1, n2, n4, n8, n16, n32, n64, infinity, ... }

RequestedGPSAssistanceData ::= OCTET STRING (SIZE (1 .. 38 ))
-- gpsAssistanceData as defined in 24.080 --

RequestedGANSSAssistanceData ::= OCTET STRING (SIZE (1 .. 201 ))
-- ganssAssistanceData as defined in 24.080 --

RequestedLocationRelatedDataType ::= ENUMERATED {
    decipheringKeysUEBasedOTDOA,
    decipheringKeysAssistedGPS,
    dedicatedAssistanceDataUEBasedOTDOA,
    dedicatedAssistanceDataAssistedGPS,
    ...,
-- Release 7 extension elements --
    decipheringKeysAssistedGANSS,
    dedicatedAssistanceDataAssistedGANSS,
    decipheringKeysAssistedGPSandGANSS,
    dedicatedAssistanceDataAssistedGPSandGANSS
}

RequestedMBMSIPMulticastAddressandAPNRequest ::= SEQUENCE (SIZE (1..maxnoofMulticastServicesPerRNC)) OF
    MBMSIPMulticastAddressandAPNlist

MBMSIPMulticastAddressandAPNlist ::= SEQUENCE {
    tMGI TMGI,
    iPMulticastAddress IPMulticastAddress,
    aPN APN,
    iE-Extensions ProtocolExtensionContainer { {MBMSIPMulticastAddressandAPNlist-ExtIEs} } OPTIONAL,
    ...
}

MBMSIPMulticastAddressandAPNlist-ExtIEs RANAP-PROTOCOL-EXTENSION ::= {
    ...
}

RequestedMulticastServiceList ::= SEQUENCE (SIZE (1.. maxnoofMulticastServicesPerUE)) OF
    TMGI

Requested-RAB-Parameter-Values ::= SEQUENCE {
    requestedMaxBitrates Requested-RAB-Parameter-MaxBitrateList OPTIONAL,
    requestedGuaranteedBitrates Requested-RAB-Parameter-GuaranteedBitrateList OPTIONAL,
    iE-Extensions ProtocolExtensionContainer { { Requested-RAB-Parameter-Values-ExtIEs} } OPTIONAL,
    ...
}

Requested-RAB-Parameter-Values-ExtIEs RANAP-PROTOCOL-EXTENSION ::= {
-- Extension for Release 6 to enable RNC to request the execution of an alternative RAB configuration --
    { ID id-AlternativeRABConfigurationRequest CRITICALITY ignore EXTENSION AlternativeRABConfigurationRequest PRESENCE optional }|
-- Extension for Release 7 to request an Extended Maximum Bitrate --

```

```

    { ID id-Requested-RAB-Parameter-ExtendedMaxBitrateList      CRITICALITY reject  EXTENSION Requested-RAB-Parameter-ExtendedMaxBitrateList
      PRESENCE optional }|
-- Extension for Release 7 to request an Extended Guaranteed Bitrate --
    { ID id-Requested-RAB-Parameter-ExtendedGuaranteedBitrateList  CRITICALITY reject  EXTENSION Requested-RAB-Parameter-
ExtendedGuaranteedBitrateList  PRESENCE optional }|
-- Extension for Release 8 to request an Supported Maximum Bitrate --
    { ID id-Requested-RAB-Parameter-SupportedMaxBitrateList      CRITICALITY reject  EXTENSION SupportedRAB-ParameterBitrateList  PRESENCE optional
}|
-- Extension for Release 8 to request an Supported Guaranteed Bitrate --
    { ID id-Requested-RAB-Parameter-SupportedGuaranteedBitrateList  CRITICALITY reject  EXTENSION SupportedRAB-ParameterBitrateList PRESENCE
optional },
    ...
}

Requested-RAB-Parameter-ExtendedMaxBitrateList ::= SEQUENCE (SIZE (1..maxNrOfSeparateTrafficDirections)) OF ExtendedMaxBitrate

Requested-RAB-Parameter-ExtendedGuaranteedBitrateList ::= SEQUENCE (SIZE (1..maxNrOfSeparateTrafficDirections)) OF ExtendedGuaranteedBitrate

Requested-RAB-Parameter-MaxBitrateList ::= SEQUENCE (SIZE (1..maxNrOfSeparateTrafficDirections)) OF MaxBitrate

Requested-RAB-Parameter-GuaranteedBitrateList ::= SEQUENCE (SIZE (1..maxNrOfSeparateTrafficDirections)) OF GuaranteedBitrate

RequestType ::= SEQUENCE {
    event          Event,
    reportArea     ReportArea,
    accuracyCode   INTEGER (0..127)    OPTIONAL,
    ...
}

ResidualBitErrorRatio ::= SEQUENCE {
    mantissa       INTEGER (1..9),
    exponent       INTEGER (1..8),
    iE-Extensions  ProtocolExtensionContainer { {ResidualBitErrorRatio-ExtIEs} } OPTIONAL
}
-- ResidualBitErrorRatio = mantissa * 10^-exponent

ResidualBitErrorRatio-ExtIEs RANAP-PROTOCOL-EXTENSION ::= {
    ...
}

ResponseTime ::= ENUMERATED {
    lowdelay,
    delaytolerant,
    ...
}

RIMInformation ::= OCTET STRING

RIM-Transfer ::= SEQUENCE {
    rIMInformation      RIMInformation,
    rIMRoutingAddress   RIMRoutingAddress  OPTIONAL,
    iE-Extensions       ProtocolExtensionContainer { {RIM-Transfer-ExtIEs} } OPTIONAL
}

```

```

RIM-Transfer-ExtIEs RANAP-PROTOCOL-EXTENSION ::= {
  ...
}

RIMRoutingAddress ::= CHOICE {
  targetRNC-ID          TargetRNC-ID,
  gERAN-Cell-ID        GERAN-Cell-ID,
  ... ,
  targeteNB-ID         TargetENB-ID
}

RNC-ID                ::= INTEGER (0..4095)
-- RNC-ID              ::= BIT STRING (SIZE (12))
-- Harmonized with RNSAP and NBAP definitions

RNCTraceInformation ::= SEQUENCE {
  traceReference        TraceReference,
  traceActivationIndicator  ENUMERATED {activated,deactivated},
  equipmentsToBeTraced EquipmentsToBeTraced OPTIONAL,
  -- This IE shall be present if the Trace Activation Indicator IE is set to "Activated".
  iE-Extensions        ProtocolExtensionContainer { { RNCTraceInformation-ExtIEs } } OPTIONAL
}

RNCTraceInformation-ExtIEs RANAP-PROTOCOL-EXTENSION ::= {
-- Extension for Release 10 to enable anonymization MDT for area based MDT --
  {ID id-TraceRecordingSessionReference CRITICALITY ignore EXTENSION TraceRecordingSessionReference PRESENCE optional}|
  {ID id-IMSI CRITICALITY ignore EXTENSION IMSI PRESENCE optional},
  ...
}

RNSAPRelocationParameters ::= SEQUENCE {
  rabParametersList    RABParametersList OPTIONAL,
  locationReporting    LocationReportingTransferInformation OPTIONAL,
  traceInformation     TraceInformation OPTIONAL,
  sourceSAI            SAI OPTIONAL,
  iE-Extensions        ProtocolExtensionContainer { { RNSAPRelocationParameters-ExtIEs } } OPTIONAL,
  ...
}

RNSAPRelocationParameters-ExtIEs RANAP-PROTOCOL-EXTENSION ::= {
  ...
}

RRC-Container          ::= OCTET STRING

RTLloadValue ::= INTEGER (0..100)

RSRVCC-HO-Indication ::= ENUMERATED {
  ps-only,
  ...
}

```

```

RSRVCC-Information ::= SEQUENCE {
    nonce                BIT STRING (SIZE (128)),
    IMSInformation        OCTET STRING(SIZE(1.. maxSizeOfIMSInfo)),
    iE-Extensions         ProtocolExtensionContainer { { RSRVCC-Information-ExtIEs} } OPTIONAL,
    ...
}

RSRVCC-Information-ExtIEs RANAP-PROTOCOL-EXTENSION ::= {
    ...
}

-- S

SAC ::= OCTET STRING (SIZE (2))
SAI ::= SEQUENCE {
    pLMNidentity          PLMNidentity,
    LAC                   LAC,
    sAC                   SAC,
    iE-Extensions         ProtocolExtensionContainer { {SAI-ExtIEs} } OPTIONAL
}

SAI-ExtIEs RANAP-PROTOCOL-EXTENSION ::= {
    ...
}

SAPI ::= ENUMERATED {
    sapi-0,
    sapi-3,
    ...
}

SessionUpdateID ::= INTEGER (0.. 1048575)
Shared-Network-Information ::= SEQUENCE {
    pLMNs-in-shared-network PLMNs-in-shared-network,
    iE-Extensions           ProtocolExtensionContainer { {Shared-Network-Information-ExtIEs} } OPTIONAL,
    ...
}

Shared-Network-Information-ExtIEs RANAP-PROTOCOL-EXTENSION ::= {
    ...
}

SignallingIndication ::= ENUMERATED {
    signalling,
    ...
}

SDU-ErrorRatio ::= SEQUENCE {
    mantissa              INTEGER (1..9),
    exponent              INTEGER (1..6),
    iE-Extensions         ProtocolExtensionContainer { {SDU-ErrorRatio-ExtIEs} } OPTIONAL
}

```

```

-- SDU-ErrorRatio = mantissa * 10^-exponent

SDU-ErrorRatio-ExtIEs RANAP-PROTOCOL-EXTENSION ::= {
    ...
}
SDU-FormatInformationParameters ::= SEQUENCE (SIZE (1..maxRAB-SubflowCombination)) OF
    SEQUENCE {
        subflowSDU-Size          SubflowSDU-Size          OPTIONAL,
        rAB-SubflowCombinationBitRate RAB-SubflowCombinationBitRate OPTIONAL,
        iE-Extensions            ProtocolExtensionContainer { {SDU-FormatInformationParameters-ExtIEs} } OPTIONAL,
        ...
    }

SDU-FormatInformationParameters-ExtIEs RANAP-PROTOCOL-EXTENSION ::= {
    ...
}

SDU-Parameters ::= SEQUENCE (SIZE (1..maxRAB-Subflows)) OF
    SEQUENCE {
        sDU-ErrorRatio          SDU-ErrorRatio OPTIONAL
        -- This IE shall be present if the Delivery Of Erroneous SDU IE is set to "Yes" or "No" --,
        residualBitErrorRatio    ResidualBitErrorRatio,
        deliveryOfErroneousSDU    DeliveryOfErroneousSDU,
        sDU-FormatInformationParameters SDU-FormatInformationParameters OPTIONAL,
        iE-Extensions            ProtocolExtensionContainer { {SDU-Parameters-ExtIEs} } OPTIONAL,
        ...
    }

SDU-Parameters-ExtIEs RANAP-PROTOCOL-EXTENSION ::= {
    ...
}

SNA-Access-Information ::= SEQUENCE {
    authorisedPLMNs            AuthorisedPLMNs,
    iE-Extensions            ProtocolExtensionContainer { {SNA-Access-Information-ExtIEs} } OPTIONAL,
    ...
}

SNA-Access-Information-ExtIEs RANAP-PROTOCOL-EXTENSION ::= {
    ...
}

SNAC ::= INTEGER (0..65535)

Service-Handover ::= ENUMERATED {
    handover-to-GSM-should-be-performed,
    handover-to-GSM-should-not-be-performed,
    handover-to-GSM-shall-not-be-performed,
    ...
}

Source-ToTarget-TransparentContainer ::= OCTET STRING
-- This IE is a transparent container, the IE shall be encoded not as an OCTET STRING but according to the type specifications of the target system.

```

-- Note: In the current version of this specification, this IE may either carry the *Source RNC to Target RNC Transparent Container* or the *Source eNB to Target eNB Transparent Container* IE as defined in TS 36.413 [49]

SourceNodeB-ToTargetNodeB-TransparentContainer ::= OCTET STRING

```
SourceCellID ::= CHOICE {
    sourceUTRANCellID      SourceUTRANCellID,
    sourceGERANCellID      CGI,
    ...
}
```

SourceBSS-ToTargetBSS-TransparentContainer ::= OCTET STRING

```
SourceID ::= CHOICE {
    sourceRNC-ID           SourceRNC-ID,
    sAI                    SAI,
    ...
}
```

```
SourceRNC-ID ::= SEQUENCE {
    plmnIdentity           PLMNIdentity,
    rnc-ID                 RNC-ID,
    ie-Extensions         ProtocolExtensionContainer { {SourceRNC-ID-ExtIEs} } OPTIONAL
}
```

```
SourceRNC-ID-ExtIEs RANAP-PROTOCOL-EXTENSION ::= {
-- Extension for Release 7 to indicate extended RNC-ID --
    { ID id-ExtendedRNC-ID          CRITICALITY reject EXTENSION ExtendedRNC-ID          PRESENCE optional },
    ...
}
```

```
SourceRNC-ToTargetRNC-TransparentContainer ::= SEQUENCE {
    rrc-Container          RRC-Container,
    numberOfIuInstances   NumberOfIuInstances,
    relocationType        RelocationType,
    chosenIntegrityProtectionAlgorithm ChosenIntegrityProtectionAlgorithm OPTIONAL,
    integrityProtectionKey IntegrityProtectionKey OPTIONAL,
    chosenEncryptionAlgorithmForSignalling ChosenEncryptionAlgorithm OPTIONAL,
    cipheringKey          EncryptionKey OPTIONAL,
    chosenEncryptionAlgorithmForCS ChosenEncryptionAlgorithm OPTIONAL,
    chosenEncryptionAlgorithmForPS ChosenEncryptionAlgorithm OPTIONAL,
    d-RNTI                D-RNTI OPTIONAL
    -- This IE shall be present if the Relocation type IE is set to "UE not involved in relocation of SRNS" --,
    targetCellId          TargetCellId OPTIONAL
    -- This IE shall be present if the Relocation type IE is set to "UE involved in relocation of SRNS" --,
    rab-TrCH-Mapping      RAB-TrCH-Mapping OPTIONAL,
    ie-Extensions         ProtocolExtensionContainer { {SourceRNC-ToTargetRNC-TransparentContainer-ExtIEs} } OPTIONAL,
    ...
}
```

```
SourceRNC-ToTargetRNC-TransparentContainer-ExtIEs RANAP-PROTOCOL-EXTENSION ::= {
```

```

-- Extension for Release 99 to enable transfer of SRB mapping onto Iur transport channel Ids --
  {ID id-SRB-TrCH-Mapping          CRITICALITY reject  EXTENSION SRB-TrCH-Mapping          PRESENCE optional}}
-- Extension for Release 5 to enable Inter RAN Load Information Exchange over Iu --
  {ID id-CellLoadInformationGroup   CRITICALITY ignore  EXTENSION CellLoadInformationGroup   PRESENCE optional}}
-- Extension for Release 6 to provide Trace Recording Session Information to the Target RNC --
  {ID id-TraceRecordingSessionInformation CRITICALITY ignore  EXTENSION TraceRecordingSessionInformation PRESENCE optional}}
-- Extension for Release 6 to indicate to the Target RNC that the UE has activated Multicast Service --
  {ID id-MBMSLinkingInformation     CRITICALITY ignore  EXTENSION MBMSLinkingInformation     PRESENCE optional}}
  {ID id-d-RNTI-for-NoIuCSUP       CRITICALITY reject  EXTENSION D-RNTI                     PRESENCE optional}}
  {ID id-UE-History-Information     CRITICALITY ignore  EXTENSION UE-History-Information     PRESENCE optional}}
  {ID id-SubscriberProfileIDforRFP  CRITICALITY ignore  EXTENSION SubscriberProfileIDforRFP  PRESENCE optional}}
-- Extension for Release 8 to transfer to the Target RNC parameters required for SRVCC operation --
  {ID id-SRVCC-Information          CRITICALITY reject  EXTENSION SRVCC-Information          PRESENCE optional}}
  {ID id-PSRABtoBeReplaced         CRITICALITY reject  EXTENSION RAB-ID                     PRESENCE optional}}
-- Extension for Release 9 to transfer to the Target RNC parameters required for CSFB operation --
  {ID id-CSFB-Information          CRITICALITY ignore  EXTENSION CSFB-Information          PRESENCE optional}}
-- Extension for Release 10 to indicate to the Target RNC the need of continued IRAT measurement --
  {ID id-IRAT-Measurement-Configuration CRITICALITY ignore  EXTENSION IRAT-Measurement-Configuration PRESENCE optional}}
-- Extension for Release 10 to indicate Management Based MDT Allowed --
  {ID id-Management-Based-MDT-Allowed CRITICALITY ignore  EXTENSION Management-Based-MDT-Allowed PRESENCE optional}}
-- Extension for Release 11 to indicate Management Based MDT PLMN List --
  {ID id-Management-Based-MDT-PLMN-List CRITICALITY ignore  EXTENSION MDT-PLMN-List             PRESENCE optional},
  ...
}

IRAT-Measurement-Configuration ::= SEQUENCE {
  rSRP          INTEGER (0..97)          OPTIONAL,
  rSRQ          INTEGER (0..34)          OPTIONAL,
  iRATmeasurementParameters  IRATmeasurementParameters,
  iE-Extensions ProtocolExtensionContainer { {IRAT-Measurement-Configuration-ExtIEs} } OPTIONAL}

IRAT-Measurement-Configuration-ExtIEs RANAP-PROTOCOL-EXTENSION ::= {
  ...
}

IRATmeasurementParameters ::= SEQUENCE {
  measurementDuration  INTEGER (1..100),
  eUTRANFrequencies   EUTRANFrequencies          OPTIONAL,
  iE-Extensions       ProtocolExtensionContainer { { IRATmeasurementParameters-ExtIEs} } OPTIONAL}

IRATmeasurementParameters-ExtIEs RANAP-PROTOCOL-EXTENSION ::= {
  ...
}

EUTRANFrequencies ::= SEQUENCE (SIZE (1..maxNrOfEUTRAFreqs)) OF SEQUENCE {
  earfcn          INTEGER (0..65535),
  measBand        MeasBand          OPTIONAL,
  iE-Extensions  ProtocolExtensionContainer { {EUTRANFrequencies-ExtIEs} } OPTIONAL}

MeasBand ::= ENUMERATED {
  v6,
  v15,
  v25,
  v50,

```

```
v75,  
v100  
}  
  
EUTRANFrequencies-ExtIEs RANAP-PROTOCOL-EXTENSION ::= {  
  ...  
}  
  
SubscriberProfileIDforRFP ::= INTEGER (1..256)  
  
SourceStatisticsDescriptor ::= ENUMERATED {  
  speech,  
  unknown,  
  ...  
}  
  
SupportedRAB-ParameterBitrateList ::= SEQUENCE (SIZE (1..maxNrOfSeparateTrafficDirections)) OF SupportedBitrate  
  
SupportedBitrate ::= INTEGER (1..1000000000, ...)  
-- Unit is bits per sec  
  
SourceUTRANCellID ::= SEQUENCE {  
  PLMNidentity          PLMNidentity,  
  uTRANcellID          TargetCellId,  
  iE-Extensions        ProtocolExtensionContainer { {SourceUTRANCellID-ExtIEs} } OPTIONAL  
}  
  
SourceUTRANCellID-ExtIEs RANAP-PROTOCOL-EXTENSION ::= {  
  ...  
}  
  
SRB-ID ::= INTEGER (1..32)  
  
SRB-TrCH-Mapping ::= SEQUENCE ( SIZE (1..maxNrOfSRBs)) OF  
  SRB-TrCH-MappingItem  
  
SRB-TrCH-MappingItem ::= SEQUENCE {  
  sRB-ID          SRB-ID,  
  trCH-ID         TrCH-ID,  
  iE-Extensions   ProtocolExtensionContainer { { SRB-TrCH-MappingItem-ExtIEs} } OPTIONAL,  
  ...  
}  
  
SRB-TrCH-MappingItem-ExtIEs RANAP-PROTOCOL-EXTENSION ::= {  
  ...  
}  
  
SRVCC-HO-Indication ::= ENUMERATED {  
  ps-and-cs,  
  cs-only,  
  ...  
}
```

```

SRVCC-Information ::= SEQUENCE {
  nonce          BIT STRING (SIZE (128)),
  iE-Extensions  ProtocolExtensionContainer { { SRVCC-Information-ExtIEs } } OPTIONAL,
  ...
}

SRVCC-Information-ExtIEs RANAP-PROTOCOL-EXTENSION ::= {
  ...
}

SRVCC-Operation-Possible ::= ENUMERATED {
  srvcc-possible,
  ...
}

SubflowSDU-Size          ::= INTEGER (0..4095)
-- Unit is bit

-- T
TAC ::= OCTET STRING (SIZE (2))

TAI ::= SEQUENCE {
  pLMNidentity          PLMNidentity,
  TAC                   TAC,
  iE-Extensions         ProtocolExtensionContainer { { TAI-ExtIEs } } OPTIONAL
}

TAI-ExtIEs RANAP-PROTOCOL-EXTENSION ::= {
  ...
}

Target-ToSource-TransparentContainer ::= OCTET STRING
-- This IE is a transparent container, the IE shall be encoded not as an OCTET STRING but according to the type specifications of the target
system.
-- Note: In the current version of this specification, this IE may either carry the Target RNC to
Source RNC Transparent Container or the Target eNB to Source eNB Transparent Container IE as
-- defined in TS 36.413 [49]

TargeteNodeB-ToSourceeNodeB-TransparentContainer ::= OCTET STRING

TargetBSS-ToSourceBSS-TransparentContainer      ::= OCTET STRING

TargetCellId          ::= INTEGER (0..268435455)

TargetID ::= CHOICE {
  targetRNC-ID          TargetRNC-ID,
  CGI                   CGI,
  ...,
  targeteNB-ID          TargeteNB-ID
}

```

```

TargetENB-ID ::= SEQUENCE {
    pLMNidentity          PLMNidentity,
    eNB-ID                ENB-ID,
    iE-Extensions        ProtocolExtensionContainer { {TargetENB-ID-ExtIEs} } OPTIONAL,
    selectedTAI          TAI,
    ...
}

TargetENB-ID-ExtIEs RANAP-PROTOCOL-EXTENSION ::= {
    ...
}

TargetRNC-ID ::= SEQUENCE {
    LAI                  LAI,
    rAC                  RAC          OPTIONAL,
    rNC-ID              RNC-ID,
    iE-Extensions      ProtocolExtensionContainer { {TargetRNC-ID-ExtIEs} } OPTIONAL
}

TargetRNC-ID-ExtIEs RANAP-PROTOCOL-EXTENSION ::= {
    -- Extension for Release 7 to indicate extended RNC-ID --
    { ID id-ExtendedRNC-ID          CRITICALITY reject EXTENSION ExtendedRNC-ID          PRESENCE optional },
    ...
}

TargetRNC-ToSourceRNC-TransparentContainer ::= SEQUENCE {
    rRC-Container        RRC-Container,
    d-RNTI              D-RNTI          OPTIONAL
    -- May be included to allow the triggering of the Relocation Detect procedure from the Iur Interface --,
    iE-Extensions      ProtocolExtensionContainer { {TargetRNC-ToSourceRNC-TransparentContainer-ExtIEs} } OPTIONAL,
    ...
}

TargetRNC-ToSourceRNC-TransparentContainer-ExtIEs RANAP-PROTOCOL-EXTENSION ::= {
    ...
}

TBCD-STRING          ::= OCTET STRING

TemporaryUE-ID ::= CHOICE {
    tMSI              TMSI,
    p-TMSI            P-TMSI,
    ...
}

Time-UE-StayedInCell ::= INTEGER (0..4095)

Time-UE-StayedInCell-EnhancedGranularity ::= INTEGER (0..40950)

TimeToMBMSDataTransfer ::= OCTET STRING(SIZE(1))

TMGI ::= SEQUENCE {

```

```

    pLMNidentity          PLMNidentity,
    serviceID             OCTET STRING (SIZE (3)),
    iE-Extensions         ProtocolExtensionContainer { {TMGI-ExtIEs} } OPTIONAL
}

TMGI-ExtIEs RANAP-PROTOCOL-EXTENSION ::= {
    ...
}

TMSI ::= OCTET STRING (SIZE (4))

TraceDepth ::= ENUMERATED {
    minimum,
    medium,
    maximum,
    ...
}

TraceInformation ::= SEQUENCE {
    traceReference          TraceReference,
    ue-identity            UE-ID,
    tracePropagationParameters TracePropagationParameters OPTIONAL,
    iE-Extensions         ProtocolExtensionContainer { { TraceInformation-ExtIEs } } OPTIONAL,
    ...
}

TraceInformation-ExtIEs RANAP-PROTOCOL-EXTENSION ::= {
    ...
}

TracePropagationParameters ::= SEQUENCE {
    traceRecordingSessionReference TraceRecordingSessionReference,
    traceDepth                    TraceDepth,
    listOfInterfacesToTrace       ListOfInterfacesToTrace OPTIONAL,
    iE-Extensions                 ProtocolExtensionContainer { { TracePropagationParameters-ExtIEs } } OPTIONAL,
    ...
}

TracePropagationParameters-ExtIEs RANAP-PROTOCOL-EXTENSION ::= {
    ...
}

TraceRecordingSessionInformation ::= SEQUENCE {
    traceReference          TraceReference,
    traceRecordingSessionReference TraceRecordingSessionReference,
    iE-Extensions         ProtocolExtensionContainer { { TraceRecordingSessionInformation-ExtIEs } } OPTIONAL,
    ...
}

TraceRecordingSessionInformation-ExtIEs RANAP-PROTOCOL-EXTENSION ::= {
    ...
}

TraceRecordingSessionReference ::= INTEGER (0..65535)

```

```

TraceReference          ::= OCTET STRING (SIZE (2..3))

TraceType               ::= OCTET STRING (SIZE (1))
-- Reference: GSM TS 12.08

TrafficClass ::= ENUMERATED {
    conversational,
    streaming,
    interactive,
    background,
    ...
}

TrafficHandlingPriority ::= INTEGER { spare (0), highest (1), lowest (14), no-priority-used (15) } (0..15)

TransferDelay          ::= INTEGER (0..65535)
-- Unit is millisecond

UnsuccessfullyTransmittedDataVolume ::= INTEGER (0..4294967295)

TransportLayerAddress  ::= BIT STRING (SIZE (1..160, ...))

TrCH-ID ::= SEQUENCE {
    dCH-ID      DCH-ID      OPTIONAL,
    dSCH-ID     DSCH-ID     OPTIONAL,
    uSCH-ID     USCH-ID     OPTIONAL,
    iE-Extensions ProtocolExtensionContainer { { TrCH-ID-ExtIEs } } OPTIONAL,
    ...
}

TrCH-ID-ExtIEs RANAP-PROTOCOL-EXTENSION ::= {
-- Extension for Release 5 to enable transfer of HS-DSCH-MAC-d-Flow-ID onto Iur transport channel ID --
    {ID id-hS-DSCH-MAC-d-Flow-ID    CRITICALITY ignore      EXTENSION HS-DSCH-MAC-d-Flow-ID    PRESENCE optional}|
-- Extension for Release 6 to enable transfer of E-DCH-MAC-d-Flow-ID onto Iur transport channel ID --
    {ID id-E-DCH-MAC-d-Flow-ID    CRITICALITY ignore      EXTENSION E-DCH-MAC-d-Flow-ID PRESENCE optional},
    ...
}

TrCH-ID-List ::= SEQUENCE (SIZE (1..maxRAB-Subflows)) OF
    TrCH-ID

TriggerID          ::= OCTET STRING (SIZE (3..22))

TunnelInformation ::= SEQUENCE {
    transportLayerAddress TransportLayerAddress,
    uDP-Port-Number      Port-Number          OPTIONAL,
    iE-Extensions        ProtocolExtensionContainer { {Tunnel-Information-ExtIEs} } OPTIONAL,
    ...
}

Tunnel-Information-ExtIEs RANAP-PROTOCOL-EXTENSION ::= {
    ...
}

```

```

TypeOfError ::= ENUMERATED {
    not-understood,
    missing,
    ...
}

-- U

UE-AggregateMaximumBitRate ::= SEQUENCE {
    uE-AggregateMaximumBitRateDownlink    UE-AggregateMaximumBitRateDownlink    OPTIONAL,
    uE-AggregateMaximumBitRateUplink      UE-AggregateMaximumBitRateUplink      OPTIONAL,
    ...
}

UE-AggregateMaximumBitRateDownlink      ::= INTEGER (1..1000000000)
-- Unit is bits per sec

UE-AggregateMaximumBitRateUplink        ::= INTEGER (1..1000000000)
-- Unit is bits per sec

UE-History-Information ::= OCTET STRING

UE-ID ::= CHOICE {
    imsi                IMSI,
    imei                IMEI,
    ...,
    imeisv              IMEISV
}

UESBI-Iu ::= SEQUENCE {
    uESBI-IuA          UESBI-IuA    OPTIONAL,
    uESBI-IuB          UESBI-IuB    OPTIONAL,
    iE-Extensions      ProtocolExtensionContainer { {UESBI-Iu-ExtIEs} } OPTIONAL,
    ...
}

UESBI-Iu-ExtIEs RANAP-PROTOCOL-EXTENSION ::= {
    ...
}

UESBI-IuA          ::= BIT STRING (SIZE(1..128))
-- Reference: TR25.994 --
UESBI-IuB          ::= BIT STRING (SIZE(1..128))
-- Reference: TR25.995 --

UL-GTP-PDU-SequenceNumber      ::= INTEGER (0..65535)

UL-N-PDU-SequenceNumber        ::= INTEGER (0..65535)

```

```

UPInformation ::= SEQUENCE {
    frameSeqNoUL      FrameSequenceNumber,
    frameSeqNoDL      FrameSequenceNumber,
    pdu14FrameSeqNoUL PDUType14FrameSequenceNumber,
    pdu14FrameSeqNoDL PDUType14FrameSequenceNumber,
    dataPDUType       DataPDUType,
    upinitialisationFrame UPInitialisationFrame,
    iE-Extensions     ProtocolExtensionContainer { { UPInformation-ExtIEs } } OPTIONAL,
    ...
}

UPInformation-ExtIEs RANAP-PROTOCOL-EXTENSION ::= {
    ...
}

UPInitialisationFrame ::= OCTET STRING

UP-ModeVersions ::= BIT STRING (SIZE (16))

USCH-ID ::= INTEGER (0..255)

UserPlaneMode ::= ENUMERATED {
    transparent-mode,
    support-mode-for-predefined-SDU-sizes,
    ...
}

UTRAN-CellID ::= SEQUENCE {
    plMNidentity      PLMNidentity,
    cellID            TargetCellId,
    iE-Extensions     ProtocolExtensionContainer { { UTRAN-CellID-ExtIEs } } OPTIONAL
}

UTRAN-CellID-ExtIEs RANAP-PROTOCOL-EXTENSION ::= {
    ...
}

-- V

VelocityEstimate ::= CHOICE {
    horizontalVelocity           HorizontalVelocity,
    horizontalWithVerticalVelocity HorizontalWithVerticalVelocity,
    horizontalVelocityWithUncertainty HorizontalVelocityWithUncertainty,
    horizontalWithVerticalVelocityAndUncertainty HorizontalWithVerticalVelocityAndUncertainty,
    ...
}

HorizontalVelocity ::= SEQUENCE {
    horizontalSpeedAndBearing      HorizontalSpeedAndBearing,
    iE-Extensions                 ProtocolExtensionContainer { { HorizontalVelocity-ExtIEs } } OPTIONAL,
    ...
}

```

```

HorizontalVelocity-ExtIEs RANAP-PROTOCOL-EXTENSION ::= {
    ...
}

HorizontalWithVerticalVelocity ::= SEQUENCE {
    horizontalSpeedAndBearing          HorizontalSpeedAndBearing,
    verticalVelocity                    VerticalVelocity,
    iE-Extensions      ProtocolExtensionContainer { { HorizontalWithVerticalVelocity-ExtIEs} } OPTIONAL,
    ...
}

HorizontalWithVerticalVelocity-ExtIEs RANAP-PROTOCOL-EXTENSION ::= {
    ...
}

HorizontalVelocityWithUncertainty ::= SEQUENCE {
    horizontalSpeedAndBearing          HorizontalSpeedAndBearing,
    uncertaintySpeed                   INTEGER (0..255),
    iE-Extensions      ProtocolExtensionContainer { { HorizontalVelocityWithUncertainty-ExtIEs} } OPTIONAL,
    ...
}

HorizontalVelocityWithUncertainty-ExtIEs RANAP-PROTOCOL-EXTENSION ::= {
    ...
}

HorizontalWithVerticalVelocityAndUncertainty ::= SEQUENCE {
    horizontalSpeedAndBearing          HorizontalSpeedAndBearing,
    verticalVelocity                    VerticalVelocity,
    horizontalUncertaintySpeed         INTEGER (0..255),
    verticalUncertaintySpeed           INTEGER (0..255),
    iE-Extensions      ProtocolExtensionContainer { { HorizontalWithVerticalVelocityAndUncertainty-ExtIEs} } OPTIONAL,
    ...
}

HorizontalWithVerticalVelocityAndUncertainty-ExtIEs RANAP-PROTOCOL-EXTENSION ::= {
    ...
}

HorizontalSpeedAndBearing ::= SEQUENCE {
    bearing          INTEGER (0..359),
    horizontalSpeed  INTEGER (0..2047)
}

VerticalVelocity ::= SEQUENCE {
    verticalSpeed          INTEGER (0..255),
    verticalSpeedDirection VerticalSpeedDirection
}

VerticalSpeedDirection ::= ENUMERATED {
    upward,
    downward
}

```

```
VerticalAccuracyCode ::= INTEGER (0..127)
```

```
VoiceSupportMatchIndicator ::= ENUMERATED {
    supported,
    not-supported,
    ...
}
```

```
END
```

9.3.5 Common Definitions

```
-- *****
--
-- Common definitions
--
-- *****
```

```
RANAP-CommonDataTypes {
    itu-t (0) identified-organization (4) etsi (0) mobileDomain (0)
    umts-Access (20) modules (3) ranap (0) version1 (1) ranap-CommonDataTypes (3) }
```

```
DEFINITIONS AUTOMATIC TAGS ::=
```

```
BEGIN
```

```
Criticality ::= ENUMERATED { reject, ignore, notify }
```

```
Presence ::= ENUMERATED { optional, conditional, mandatory }
```

```
PrivateIE-ID ::= CHOICE {
    local INTEGER (0..65535),
    global OBJECT IDENTIFIER
}
```

```
ProcedureCode ::= INTEGER (0..255)
```

```
ProtocolExtensionID ::= INTEGER (0..65535)
```

```
ProtocolIE-ID ::= INTEGER (0..65535)
```

```
TriggeringMessage ::= ENUMERATED { initiating-message, successful-outcome, unsuccessful-outcome, outcome }
```

```
END
```

9.3.6 Constant Definitions

```
-- *****
--
-- Constant definitions
```

```
--
-- *****
RANAP-Constants {
itu-t (0) identified-organization (4) etsi (0) mobileDomain (0)
umts-Access (20) modules (3) ranap (0) version1 (1) ranap-Constants (4) }

DEFINITIONS AUTOMATIC TAGS ::=

BEGIN

-- *****
--
-- Elementary Procedures
--
-- *****

id-RAB-Assignment                INTEGER ::= 0
id-Iu-Release                    INTEGER ::= 1
id-RelocationPreparation         INTEGER ::= 2
id-RelocationResourceAllocation INTEGER ::= 3
id-RelocationCancel             INTEGER ::= 4
id-SRNS-ContextTransfer         INTEGER ::= 5
id-SecurityModeControl          INTEGER ::= 6
id-DataVolumeReport            INTEGER ::= 7
id-Reset                        INTEGER ::= 9
id-RAB-ReleaseRequest           INTEGER ::= 10
id-Iu-ReleaseRequest           INTEGER ::= 11
id-RelocationDetect            INTEGER ::= 12
id-RelocationComplete          INTEGER ::= 13
id-Paging                      INTEGER ::= 14
id-CommonID                    INTEGER ::= 15
id-CN-InvokeTrace              INTEGER ::= 16
id-LocationReportingControl     INTEGER ::= 17
id-LocationReport              INTEGER ::= 18
id-InitialUE-Message           INTEGER ::= 19
id-DirectTransfer              INTEGER ::= 20
id-OverloadControl             INTEGER ::= 21
id-ErrorIndication             INTEGER ::= 22
id-SRNS-DataForward            INTEGER ::= 23
id-ForwardSRNS-Context         INTEGER ::= 24
id-privateMessage              INTEGER ::= 25
id-CN-DeactivateTrace          INTEGER ::= 26
id-ResetResource               INTEGER ::= 27
id-RANAP-Relocation            INTEGER ::= 28
id-RAB-ModifyRequest           INTEGER ::= 29
id-LocationRelatedData         INTEGER ::= 30
id-InformationTransfer          INTEGER ::= 31
id-UESpecificInformation        INTEGER ::= 32
id-UplinkInformationExchange   INTEGER ::= 33
id-DirectInformationTransfer    INTEGER ::= 34
id-MBMSsessionStart            INTEGER ::= 35
id-MBMSsessionUpdate           INTEGER ::= 36
id-MBMSsessionStop             INTEGER ::= 37
```

```

id-MBMSUELinking                INTEGER ::= 38
id-MBMSRegistration              INTEGER ::= 39
id-MBMSCNDe-Registration-Procedure  INTEGER ::= 40
id-MBMSRABEstablishmentIndication  INTEGER ::= 41
id-MBMSRABRelease                INTEGER ::= 42
id-enhancedRelocationComplete     INTEGER ::= 43
id-enhancedRelocationCompleteConfirm  INTEGER ::= 44
id-RANAPenhancedRelocation        INTEGER ::= 45
id-SRVCCPreparation              INTEGER ::= 46
id-UeRadioCapabilityMatch         INTEGER ::= 47

-- *****
--
-- Extension constants
--
-- *****

maxPrivateIEs                    INTEGER ::= 65535
maxProtocolExtensions             INTEGER ::= 65535
maxProtocolIEs                   INTEGER ::= 65535

-- *****
--
-- Lists
--
-- *****

maxNrOfDTs                       INTEGER ::= 15
maxNrOfErrors                     INTEGER ::= 256
maxNrOfIuSigConIds               INTEGER ::= 250
maxNrOfPDPDirections             INTEGER ::= 2
maxNrOfPoints                     INTEGER ::= 15
maxNrOfRABs                       INTEGER ::= 256
maxNrOfSeparateTrafficDirections  INTEGER ::= 2
maxNrOfSRBs                       INTEGER ::= 8
maxNrOfVol                       INTEGER ::= 2
maxNrOfLevels                     INTEGER ::= 256
maxNrOfAltValues                  INTEGER ::= 16
maxNrOfPLMNsSN                   INTEGER ::= 32
maxNrOfLAs                        INTEGER ::= 65536
maxNrOfSNAs                       INTEGER ::= 65536
maxNrOfUEsToBeTraced             INTEGER ::= 64
maxNrOfInterfaces                 INTEGER ::= 16
maxRAB-Subflows                   INTEGER ::= 7
maxRAB-SubflowCombination         INTEGER ::= 64
maxSet                             INTEGER ::= 9
maxNrOfHSDSCHMACdFlows-1         INTEGER ::= 7
maxnoofMulticastServicesPerUE     INTEGER ::= 128
maxnoofMulticastServicesPerRNC    INTEGER ::= 512
maxMBMSSA                         INTEGER ::= 256
maxMBMSRA                         INTEGER ::= 65536
maxNrOfEDCHMACdFlows-1           INTEGER ::= 7
maxGANSSSet                       INTEGER ::= 9

```

```

maxNrOfCSGs                INTEGER ::= 256
maxNrOfEUTRAFreqs          INTEGER ::= 8
maxNrOfCellIds              INTEGER ::= 32
maxNrOfRAIs                 INTEGER ::= 8
maxNrOfLAIs                 INTEGER ::= 8
maxSizeOfIMSInfo           INTEGER ::= 32
maxnoofMDTPLMNs            INTEGER ::= 16

-- *****
--
-- IEs
--
-- *****

id-AreaIdentity              INTEGER ::= 0
id-CN-DomainIndicator        INTEGER ::= 3
id-Cause                     INTEGER ::= 4
id-ChosenEncryptionAlgorithm INTEGER ::= 5
id-ChosenIntegrityProtectionAlgorithm INTEGER ::= 6
id-ClassmarkInformation2     INTEGER ::= 7
id-ClassmarkInformation3     INTEGER ::= 8
id-CriticalityDiagnostics    INTEGER ::= 9
id-DL-GTP-PDU-SequenceNumber INTEGER ::= 10
id-EncryptionInformation     INTEGER ::= 11
id-IntegrityProtectionInformation INTEGER ::= 12
id-IuTransportAssociation    INTEGER ::= 13
id-L3-Information            INTEGER ::= 14
id-LAI                       INTEGER ::= 15
id-NAS-PDU                   INTEGER ::= 16
id-NonSearchingIndication    INTEGER ::= 17
id-NumberOfSteps             INTEGER ::= 18
id-OMC-ID                    INTEGER ::= 19
id-OldBSS-ToNewBSS-Information INTEGER ::= 20
id-PagingAreaID              INTEGER ::= 21
id-PagingCause               INTEGER ::= 22
id-PermanentNAS-UE-ID       INTEGER ::= 23
id-RAB-ContextItem           INTEGER ::= 24
id-RAB-ContextList           INTEGER ::= 25
id-RAB-DataForwardingItem    INTEGER ::= 26
id-RAB-DataForwardingItem-SRNS-CtxReq INTEGER ::= 27
id-RAB-DataForwardingList    INTEGER ::= 28
id-RAB-DataForwardingList-SRNS-CtxReq INTEGER ::= 29
id-RAB-DataVolumeReportItem  INTEGER ::= 30
id-RAB-DataVolumeReportList  INTEGER ::= 31
id-RAB-DataVolumeReportRequestItem INTEGER ::= 32
id-RAB-DataVolumeReportRequestList INTEGER ::= 33
id-RAB-FailedItem            INTEGER ::= 34
id-RAB-FailedList            INTEGER ::= 35
id-RAB-ID                     INTEGER ::= 36
id-RAB-QueuedItem            INTEGER ::= 37
id-RAB-QueuedList            INTEGER ::= 38
id-RAB-ReleaseFailedList     INTEGER ::= 39
id-RAB-ReleaseItem           INTEGER ::= 40
id-RAB-ReleaseList           INTEGER ::= 41

```

id-RAB-ReleasedItem	INTEGER ::= 42
id-RAB-ReleasedList	INTEGER ::= 43
id-RAB-ReleasedList-IuRelComp	INTEGER ::= 44
id-RAB-RelocationReleaseItem	INTEGER ::= 45
id-RAB-RelocationReleaseList	INTEGER ::= 46
id-RAB-SetupItem-RelocReq	INTEGER ::= 47
id-RAB-SetupItem-RelocReqAck	INTEGER ::= 48
id-RAB-SetupList-RelocReq	INTEGER ::= 49
id-RAB-SetupList-RelocReqAck	INTEGER ::= 50
id-RAB-SetupOrModifiedItem	INTEGER ::= 51
id-RAB-SetupOrModifiedList	INTEGER ::= 52
id-RAB-SetupOrModifyItem	INTEGER ::= 53
id-RAB-SetupOrModifyList	INTEGER ::= 54
id-RAC	INTEGER ::= 55
id-RelocationType	INTEGER ::= 56
id-RequestType	INTEGER ::= 57
id-SAI	INTEGER ::= 58
id-SAPI	INTEGER ::= 59
id-SourceID	INTEGER ::= 60
id-Source-ToTarget-TransparentContainer	INTEGER ::= 61
id-TargetID	INTEGER ::= 62
id-Target-ToSource-TransparentContainer	INTEGER ::= 63
id-TemporaryUE-ID	INTEGER ::= 64
id-TraceReference	INTEGER ::= 65
id-TraceType	INTEGER ::= 66
id-TransportLayerAddress	INTEGER ::= 67
id-TriggerID	INTEGER ::= 68
id-UE-ID	INTEGER ::= 69
id-UL-GTP-PDU-SequenceNumber	INTEGER ::= 70
id-RAB-FailedtoReportItem	INTEGER ::= 71
id-RAB-FailedtoReportList	INTEGER ::= 72
id-KeyStatus	INTEGER ::= 75
id-DRX-CycleLengthCoefficient	INTEGER ::= 76
id-IuSigConIdList	INTEGER ::= 77
id-IuSigConIdItem	INTEGER ::= 78
id-IuSigConId	INTEGER ::= 79
id-DirectTransferInformationItem-RANAP-RelocInf	INTEGER ::= 80
id-DirectTransferInformationList-RANAP-RelocInf	INTEGER ::= 81
id-RAB-ContextItem-RANAP-RelocInf	INTEGER ::= 82
id-RAB-ContextList-RANAP-RelocInf	INTEGER ::= 83
id-RAB-ContextFailedtoTransferItem	INTEGER ::= 84
id-RAB-ContextFailedtoTransferList	INTEGER ::= 85
id-GlobalRNC-ID	INTEGER ::= 86
id-RAB-ReleasedItem-IuRelComp	INTEGER ::= 87
id-MessageStructure	INTEGER ::= 88
id-Alt-RAB-Parameters	INTEGER ::= 89
id-Ass-RAB-Parameters	INTEGER ::= 90
id-RAB-ModifyList	INTEGER ::= 91
id-RAB-ModifyItem	INTEGER ::= 92
id-TypeOfError	INTEGER ::= 93
id-BroadcastAssistanceDataDecipheringKeys	INTEGER ::= 94
id-LocationRelatedDataRequestType	INTEGER ::= 95
id-GlobalCN-ID	INTEGER ::= 96
id-LastKnownServiceArea	INTEGER ::= 97

id-SRB-TrCH-Mapping	INTEGER ::= 98
id-InterSystemInformation-TransparentContainer	INTEGER ::= 99
id-NewBSS-To-OldBSS-Information	INTEGER ::= 100
id-SourceRNC-PDCP-context-info	INTEGER ::= 103
id-InformationTransferID	INTEGER ::= 104
id-SNA-Access-Information	INTEGER ::= 105
id-ProvidedData	INTEGER ::= 106
id-GERAN-BSC-Container	INTEGER ::= 107
id-GERAN-Classmark	INTEGER ::= 108
id-GERAN-Iumode-RAB-Failed-RABAssgntResponse-Item	INTEGER ::= 109
id-GERAN-Iumode-RAB-FailedList-RABAssgntResponse	INTEGER ::= 110
id-VerticalAccuracyCode	INTEGER ::= 111
id-ResponseTime	INTEGER ::= 112
id-PositioningPriority	INTEGER ::= 113
id-ClientType	INTEGER ::= 114
id-LocationRelatedDataRequestTypeSpecificToGERANIuMode	INTEGER ::= 115
id-SignallingIndication	INTEGER ::= 116
id-hS-DSCH-MAC-d-Flow-ID	INTEGER ::= 117
id-UESBI-Iu	INTEGER ::= 118
id-PositionData	INTEGER ::= 119
id-PositionDataSpecificToGERANIuMode	INTEGER ::= 120
id-CellLoadInformationGroup	INTEGER ::= 121
id-AccuracyFulfilmentIndicator	INTEGER ::= 122
id-InformationTransferType	INTEGER ::= 123
id-TraceRecordingSessionInformation	INTEGER ::= 124
id-TracePropagationParameters	INTEGER ::= 125
id-InterSystemInformationTransferType	INTEGER ::= 126
id-SelectedPLMN-ID	INTEGER ::= 127
id-RedirectionCompleted	INTEGER ::= 128
id-RedirectionIndication	INTEGER ::= 129
id-NAS-SequenceNumber	INTEGER ::= 130
id-RejectCauseValue	INTEGER ::= 131
id-APN	INTEGER ::= 132
id-CNMBMSLinkingInformation	INTEGER ::= 133
id-DeltaRAListofIdleModeUEs	INTEGER ::= 134
id-FrequenceLayerConvergenceFlag	INTEGER ::= 135
id-InformationExchangeID	INTEGER ::= 136
id-InformationExchangeType	INTEGER ::= 137
id-InformationRequested	INTEGER ::= 138
id-InformationRequestType	INTEGER ::= 139
id-IPMulticastAddress	INTEGER ::= 140
id-JoinedMBMSBearerServicesList	INTEGER ::= 141
id-LeftMBMSBearerServicesList	INTEGER ::= 142
id-MBMSBearerServiceType	INTEGER ::= 143
id-MBMSCNDe-Registration	INTEGER ::= 144
id-MBMSServiceArea	INTEGER ::= 145
id-MBMSSessionDuration	INTEGER ::= 146
id-MBMSSessionIdentity	INTEGER ::= 147
id-PDP-TypeInformation	INTEGER ::= 148
id-RAB-Parameters	INTEGER ::= 149
id-RAListofIdleModeUEs	INTEGER ::= 150
id-MBMSRegistrationRequestType	INTEGER ::= 151
id-SessionUpdateID	INTEGER ::= 152
id-TMGI	INTEGER ::= 153

id-TransportLayerInformation	INTEGER ::= 154
id-UnsuccessfulLinkingList	INTEGER ::= 155
id-MBMSLinkingInformation	INTEGER ::= 156
id-MBMSSessionRepetitionNumber	INTEGER ::= 157
id-AlternativeRABConfiguration	INTEGER ::= 158
id-AlternativeRABConfigurationRequest	INTEGER ::= 159
id-E-DCH-MAC-d-Flow-ID	INTEGER ::= 160
id-SourceBSS-ToTargetBSS-TransparentContainer	INTEGER ::= 161
id-TargetBSS-ToSourceBSS-TransparentContainer	INTEGER ::= 162
id-TimeToMBMSDataTransfer	INTEGER ::= 163
id-IncludeVelocity	INTEGER ::= 164
id-VelocityEstimate	INTEGER ::= 165
id-RedirectAttemptFlag	INTEGER ::= 166
id-RAT-Type	INTEGER ::= 167
id-PeriodicLocationInfo	INTEGER ::= 168
id-MBMSCountingInformation	INTEGER ::= 169
id-170-not-to-be-used-for-IE-ids	INTEGER ::= 170
id-ExtendedRNC-ID	INTEGER ::= 171
id-Alt-RAB-Parameter-ExtendedGuaranteedBitrateInf	INTEGER ::= 172
id-Alt-RAB-Parameter-ExtendedMaxBitrateInf	INTEGER ::= 173
id-Ass-RAB-Parameter-ExtendedGuaranteedBitrateList	INTEGER ::= 174
id-Ass-RAB-Parameter-ExtendedMaxBitrateList	INTEGER ::= 175
id-RAB-Parameter-ExtendedGuaranteedBitrateList	INTEGER ::= 176
id-RAB-Parameter-ExtendedMaxBitrateList	INTEGER ::= 177
id-Requested-RAB-Parameter-ExtendedMaxBitrateList	INTEGER ::= 178
id-Requested-RAB-Parameter-ExtendedGuaranteedBitrateList	INTEGER ::= 179
id-LAofIdleModeUEs	INTEGER ::= 180
id-newLAListofIdleModeUEs	INTEGER ::= 181
id-LAListwithNoIdleModeUEsAnyMore	INTEGER ::= 182
id-183-not-to-be-used-for-IE-ids	INTEGER ::= 183
id-GANSS-PositioningDataSet	INTEGER ::= 184
id-RequestedGANSSAssistanceData	INTEGER ::= 185
id-BroadcastGANSSAssistanceDataDecipheringKeys	INTEGER ::= 186
id-d-RNTI-for-NoIuCSUP	INTEGER ::= 187
id-RAB-SetupList-EnhancedRelocCompleteReq	INTEGER ::= 188
id-RAB-SetupItem-EnhancedRelocCompleteReq	INTEGER ::= 189
id-RAB-SetupList-EnhancedRelocCompleteRes	INTEGER ::= 190
id-RAB-SetupItem-EnhancedRelocCompleteRes	INTEGER ::= 191
id-RAB-SetupList-EnhRelocInfoReq	INTEGER ::= 192
id-RAB-SetupItem-EnhRelocInfoReq	INTEGER ::= 193
id-RAB-SetupList-EnhRelocInfoRes	INTEGER ::= 194
id-RAB-SetupItem-EnhRelocInfoRes	INTEGER ::= 195
id-OldIuSigConId	INTEGER ::= 196
id-RAB-FailedList-EnhRelocInfoRes	INTEGER ::= 197
id-RAB-FailedItem-EnhRelocInfoRes	INTEGER ::= 198
id-Global-ENB-ID	INTEGER ::= 199
id-UE-History-Information	INTEGER ::= 200
id-MBMSynchronisationInformation	INTEGER ::= 201
id-SubscriberProfileIDforRFP	INTEGER ::= 202
id-CSG-Id	INTEGER ::= 203
id-OldIuSigConIdCS	INTEGER ::= 204
id-OldIuSigConIdPS	INTEGER ::= 205
id-GlobalCN-IDCS	INTEGER ::= 206
id-GlobalCN-IDPS	INTEGER ::= 207

id-SourceExtendedRNC-ID	INTEGER ::= 208
id-RAB-ToBeReleasedItem-EnhancedRelocCompleteRes	INTEGER ::= 209
id-RAB-ToBeReleasedList-EnhancedRelocCompleteRes	INTEGER ::= 210
id-SourceRNC-ID	INTEGER ::= 211
id-Relocation-TargetRNC-ID	INTEGER ::= 212
id-Relocation-TargetExtendedRNC-ID	INTEGER ::= 213
id-Alt-RAB-Parameter-SupportedGuaranteedBitrateInf	INTEGER ::= 214
id-Alt-RAB-Parameter-SupportedMaxBitrateInf	INTEGER ::= 215
id-Ass-RAB-Parameter-SupportedGuaranteedBitrateList	INTEGER ::= 216
id-Ass-RAB-Parameter-SupportedMaxBitrateList	INTEGER ::= 217
id-RAB-Parameter-SupportedGuaranteedBitrateList	INTEGER ::= 218
id-RAB-Parameter-SupportedMaxBitrateList	INTEGER ::= 219
id-Requested-RAB-Parameter-SupportedMaxBitrateList	INTEGER ::= 220
id-Requested-RAB-Parameter-SupportedGuaranteedBitrateList	INTEGER ::= 221
id-Relocation-SourceRNC-ID	INTEGER ::= 222
id-Relocation-SourceExtendedRNC-ID	INTEGER ::= 223
id-EncryptionKey	INTEGER ::= 224
id-IntegrityProtectionKey	INTEGER ::= 225
id-SRVCC-HO-Indication	INTEGER ::= 226
id-SRVCC-Information	INTEGER ::= 227
id-SRVCC-Operation-Possible	INTEGER ::= 228
id-CSG-Id-List	INTEGER ::= 229
id-PSRABtoBeReplaced	INTEGER ::= 230
id-E-UTRAN-Service-Handover	INTEGER ::= 231
id-UE-AggregateMaximumBitRate	INTEGER ::= 233
id-CSG-Membership-Status	INTEGER ::= 234
id-Cell-Access-Mode	INTEGER ::= 235
id-IP-Source-Address	INTEGER ::= 236
id-CSFB-Information	INTEGER ::= 237
id-PDP-TypeInformation-extension	INTEGER ::= 238
id-MSISDN	INTEGER ::= 239
id-Offload-RAB-Parameters	INTEGER ::= 240
id-LGW-TransportLayerAddress	INTEGER ::= 241
id-Correlation-ID	INTEGER ::= 242
id-IRAT-Measurement-Configuration	INTEGER ::= 243
id-MDT-Configuration	INTEGER ::= 244
id-Priority-Class-Indicator	INTEGER ::= 245
id-RNSAPRelocationParameters	INTEGER ::= 247
id-RABParametersList	INTEGER ::= 248
id-Management-Based-MDT-Allowed	INTEGER ::= 249
id-HigherBitratesThan16MbpsFlag	INTEGER ::= 250
id-Trace-Collection-Entity-IP-Address	INTEGER ::= 251
id-End-Of-CSFB	INTEGER ::= 252
id-Time-UE-StayedInCell-EnhancedGranularity	INTEGER ::= 253
id-Out-Of-UTRAN	INTEGER ::= 254
id-TraceRecordingSessionReference	INTEGER ::= 255
id-IMSI	INTEGER ::= 256
id-HO-Cause	INTEGER ::= 257
id-VoiceSupportMatchIndicator	INTEGER ::= 258
id-RSRVCC-HO-Indication	INTEGER ::= 259
id-RSRVCC-Information	INTEGER ::= 260
id-AnchorPLMN-ID	INTEGER ::= 261
id-Tunnel-Information-for-BBF	INTEGER ::= 262
id-Management-Based-MDT-PLMN-List	INTEGER ::= 263

```

id-SignallingBasedMDTPLMNList      INTEGER ::= 264
id-M4Report                         INTEGER ::= 265
id-M5Report                         INTEGER ::= 266
id-M6Report                         INTEGER ::= 267
id-M7Report                         INTEGER ::= 268

```

END

9.3.7 Container Definitions

```

-- *****
--
-- Container definitions
--
-- *****

RANAP-Containers {
itu-t (0) identified-organization (4) etsi (0) mobileDomain (0)
umts-Access (20) modules (3) ranap (0) version1 (1) ranap-Containers (5) }

DEFINITIONS AUTOMATIC TAGS ::=

BEGIN

-- *****
--
-- IE parameter types from other modules.
--
-- *****

IMPORTS
    Criticality,
    Presence,
    PrivateIE-ID,
    ProtocolExtensionID,
    ProtocolIE-ID
FROM RANAP-CommonDataTypes

    maxPrivateIEs,
    maxProtocolExtensions,
    maxProtocolIEs
FROM RANAP-Constants;

-- *****
--
-- Class Definition for Protocol IEs
--
-- *****

RANAP-PROTOCOL-IES ::= CLASS {
    &id          ProtocolIE-ID          UNIQUE,
    &criticality Criticality,
    &Value,

```

```

    &presence          Presence
}
WITH SYNTAX {
    ID                &id
    CRITICALITY       &criticality
    TYPE              &Value
    PRESENCE          &presence
}

-- *****
--
-- Class Definition for Protocol IEs
--
-- *****

RANAP-PROTOCOL-IES-PAIR ::= CLASS {
    &id                ProtocolIE-ID                UNIQUE,
    &firstCriticality  Criticality,
    &FirstValue,
    &secondCriticality Criticality,
    &SecondValue,
    &presence          Presence
}
WITH SYNTAX {
    ID                &id
    FIRST CRITICALITY &firstCriticality
    FIRST TYPE        &FirstValue
    SECOND CRITICALITY &secondCriticality
    SECOND TYPE       &SecondValue
    PRESENCE          &presence
}

-- *****
--
-- Class Definition for Protocol Extensions
--
-- *****

RANAP-PROTOCOL-EXTENSION ::= CLASS {
    &id                ProtocolExtensionID          UNIQUE,
    &criticality       Criticality,
    &Extension,
    &presence          Presence
}
WITH SYNTAX {
    ID                &id
    CRITICALITY       &criticality
    EXTENSION          &Extension
    PRESENCE          &presence
}

-- *****
--
-- Class Definition for Private IEs

```

```

--
-- *****
RANAP-PRIVATE-IES ::= CLASS {
    &id          PrivateIE-ID,
    &criticality Criticality,
    &Value,
    &presence    Presence
}
WITH SYNTAX {
    ID          &id
    CRITICALITY &criticality
    TYPE        &Value
    PRESENCE    &presence
}
-- *****
--
-- Container for Protocol IES
--
-- *****

ProtocolIE-Container {RANAP-PROTOCOL-IES : IESSetParam} ::=
    SEQUENCE (SIZE (0..maxProtocolIEs)) OF
    ProtocolIE-Field {{IESSetParam}}

ProtocolIE-Field {RANAP-PROTOCOL-IES : IESSetParam} ::= SEQUENCE {
    id          RANAP-PROTOCOL-IES.&id          ({IESSetParam}),
    criticality RANAP-PROTOCOL-IES.&criticality  ({IESSetParam}@id),
    value       RANAP-PROTOCOL-IES.&Value       ({IESSetParam}@id)
}
-- *****
--
-- Container for Protocol IE Pairs
--
-- *****

ProtocolIE-ContainerPair {RANAP-PROTOCOL-IES-PAIR : IESSetParam} ::=
    SEQUENCE (SIZE (0..maxProtocolIEs)) OF
    ProtocolIE-FieldPair {{IESSetParam}}

ProtocolIE-FieldPair {RANAP-PROTOCOL-IES-PAIR : IESSetParam} ::= SEQUENCE {
    id          RANAP-PROTOCOL-IES-PAIR.&id          ({IESSetParam}),
    firstCriticality RANAP-PROTOCOL-IES-PAIR.&firstCriticality  ({IESSetParam}@id),
    firstValue     RANAP-PROTOCOL-IES-PAIR.&FirstValue          ({IESSetParam}@id),
    secondCriticality RANAP-PROTOCOL-IES-PAIR.&secondCriticality ({IESSetParam}@id),
    secondValue     RANAP-PROTOCOL-IES-PAIR.&SecondValue        ({IESSetParam}@id)
}
-- *****
--
-- Container Lists for Protocol IE Containers
--

```

```

-- *****
ProtocolIE-ContainerList {INTEGER : lowerBound, INTEGER : upperBound, RANAP-PROTOCOL-IES : IEsSetParam} ::=
  SEQUENCE (SIZE (lowerBound..upperBound)) OF
    ProtocolIE-Container {{IEsSetParam}}

ProtocolIE-ContainerPairList {INTEGER : lowerBound, INTEGER : upperBound, RANAP-PROTOCOL-IES-PAIR : IEsSetParam} ::=
  SEQUENCE (SIZE (lowerBound..upperBound)) OF
    ProtocolIE-ContainerPair {{IEsSetParam}}

-- *****
--
-- Container for Protocol Extensions
--
-- *****

ProtocolExtensionContainer {RANAP-PROTOCOL-EXTENSION : ExtensionSetParam} ::=
  SEQUENCE (SIZE (1..maxProtocolExtensions)) OF
    ProtocolExtensionField {{ExtensionSetParam}}

ProtocolExtensionField {RANAP-PROTOCOL-EXTENSION : ExtensionSetParam} ::= SEQUENCE {
  id                RANAP-PROTOCOL-EXTENSION.&id                ({ExtensionSetParam}),
  criticality       RANAP-PROTOCOL-EXTENSION.&criticality       ({ExtensionSetParam}@id}),
  extensionValue    RANAP-PROTOCOL-EXTENSION.&Extension         ({ExtensionSetParam}@id)
}

-- *****
--
-- Container for Private IEs
--
-- *****

PrivateIE-Container {RANAP-PRIVATE-IES : IEsSetParam} ::=
  SEQUENCE (SIZE (1.. maxPrivateIEs)) OF
    PrivateIE-Field {{IEsSetParam}}

PrivateIE-Field {RANAP-PRIVATE-IES : IEsSetParam} ::= SEQUENCE {
  id                RANAP-PRIVATE-IES.&id                ({IEsSetParam}),
  criticality       RANAP-PRIVATE-IES.&criticality       ({IEsSetParam}@id}),
  value            RANAP-PRIVATE-IES.&Value            ({IEsSetParam}@id)
}

END

```

9.4 Message Transfer Syntax

RANAP shall use the ASN.1 Basic Packed Encoding Rules (BASIC-PER) Aligned Variant as transfer syntax as specified in ref. ITU-T Rec. X.691 [13].

9.5 Timers

$T_{\text{RELOCprep}}$

- Specifies the maximum time for Relocation Preparation procedure in the source RNC.

$T_{\text{RELOCoverall}}$

- Specifies the maximum time for the protection of overall Relocation procedure in the source RNC.

$T_{\text{RELOCalloc}}$

- Specifies the maximum time for Relocation Resource Allocation procedure in the CN.

$T_{\text{RELOCcomplete}}$

- Specifies the maximum time for waiting the relocation completion in the CN.

T_{RABassgt}

- Specifies the maximum time in the CN for the whole RAB Assignment procedure.

T_{QUEUING}

- Specifies the maximum time in the RNC for queuing of the request of RAB establishment or modification.

T_{DATAfwd}

- Specifies the maximum time for GTP-PDU forwarding at the source RNC during relocation of SRNS.

T_{igOC}

- While this timer is running, all OVERLOAD messages or signalling point congested information received at the CN are ignored.

T_{igOR}

- While this timer is running, all OVERLOAD messages or signalling point congested information received at the RNC are ignored.

T_{inTC}

- While this timer is running, the CN is not allowed to increase traffic.

T_{inTR}

- While this timer is running, the RNC is not allowed to increase traffic.

T_{RafC}

- Specifies the maximum time for Reset procedure in the RNC.

T_{RatC}

- Specifies a guard period in the RNC before sending a RESET ACKNOWLEDGE message.

T_{RafR}

- Specifies the maximum time for Reset procedure in the CN.

T_{RatR}

- Specifies a guard period in the CN before sending a RESET ACKNOWLEDGE message.

T_{NNSF}

- Specifies the maximum time the RNC may store *Permanent NAS UE Identity IE* (and the related *Global CN-ID IE*) when NNSF is active.

10 Handling of Unknown, Unforeseen and Erroneous Protocol Data

10.1 General

Protocol Error cases can be divided into three classes:

- Transfer Syntax Error.
- Abstract Syntax Error.
- Logical Error.

Protocol errors can occur in the following functions within a receiving node:

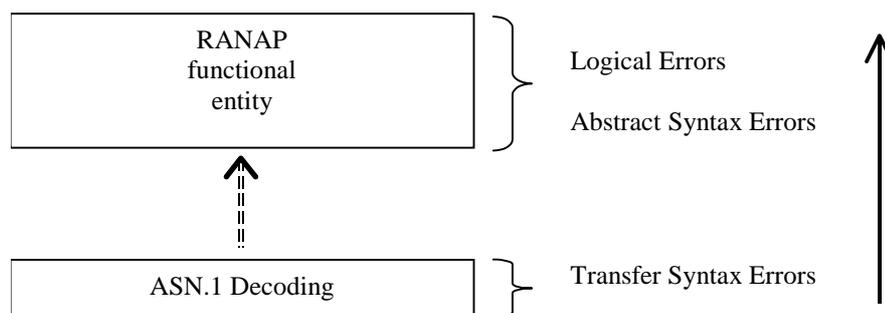

Figure 10.1: Protocol Errors in RANAP.

The information stated in subclauses 10.2, 10.3 and 10.4, to be included in the message used when reporting an error, is what at minimum shall be included. Other optional information elements within the message may also be included, if available. This is also valid for the case when the reporting is done with a response message. The latter is an exception to what is stated in subclause 4.1.

10.2 Transfer Syntax Error

A Transfer Syntax Error occurs when the receiver is not able to decode the received physical message. Transfer syntax errors are always detected in the process of ASN.1 decoding. If a Transfer Syntax Error occurs, the receiver should initiate Error Indication procedure with appropriate cause value for the Transfer Syntax protocol error.

Examples for Transfer Syntax Errors are:

- Violation of value ranges in ASN.1 definition of messages. e.g.: If an IE has a defined value range of 0 to 10 (ASN.1: INTEGER (0..10)), and 12 will be received, then this will be treated as a transfer syntax error.
- Violation in list element constraints. e.g.: If a list is defined as containing 1 to 10 elements, and 12 elements will be received, than this case will be handled as a transfer syntax error.
- Missing mandatory elements in ASN.1 SEQUENCE definitions (as sent by the originator of the message).
- Wrong order of elements in ASN.1 SEQUENCE definitions (as sent by the originator of the message).

10.3 Abstract Syntax Error

10.3.1 General

An Abstract Syntax Error occurs when the receiving functional RANAP entity:

1. receives IEs or IE groups that cannot be understood (unknown IE ID);
2. receives IEs for which the logical range is violated (e.g.: ASN.1 definition: 0 to 15, the logical range is 0 to 10 (values 11 to 15 are undefined), and 12 will be received; this case will be handled as an abstract syntax error using criticality information sent by the originator of the message);
3. does not receive IEs or IE groups but according to the specified presence of the concerning object, the IEs or IE groups should have been present in the received message.
4. receives IEs or IE groups that are defined to be part of that message in wrong order or with too many occurrences of the same IE or IE group;
5. receives IEs or IE groups but according to the conditional presence of the concerning object and the specified condition, the IEs or IE groups should not have been present in the received message.

Cases 1 and 2 (not comprehended IE/IE group) are handled based on received Criticality information. Case 3 (missing IE/IE group) is handled based on Criticality information and Presence information for the missing IE/IE group specified in the version of the specification used by the receiver. Case 4 (IEs or IE groups in wrong order or with too many occurrences) and Case 5 (erroneously present conditional IEs or IE groups) result in rejecting the procedure.

If an Abstract Syntax Error occurs, the receiver shall read the remaining message and shall then for each detected Abstract Syntax Error that belong to cases 1-3 act according to the Criticality Information and Presence Information for the IE/IE group due to which Abstract Syntax Error occurred in accordance with subclauses 10.3.4 and 10.3.5. The handling of cases 4 and 5 is specified in subclause 10.3.6.

10.3.2 Criticality Information

In the RANAP messages there is criticality information set for individual IEs and/or IE groups. This criticality information instructs the receiver how to act when receiving an IE or an IE group that is not comprehended, i.e. the entire item (IE or IE group) which is not (fully or partially) comprehended shall be treated in accordance with its own criticality information as specified in subclause 10.3.4.

In addition, the criticality information is used in case of the missing IE/IE group abstract syntax error (see subclause 10.3.5).

The receiving node shall take different actions depending on the value of the Criticality Information. The three possible values of the Criticality Information for an IE/IE group are:

- Reject IE.
- Ignore IE and Notify Sender.
- Ignore IE.

The following rules restrict when a receiving entity may consider an IE, an IE group, or an EP not comprehended (not implemented), and when action based on criticality information is applicable:

1. IE or IE group: When one new or modified IE or IE group is implemented for one EP from a standard version, then other new or modified IEs or IE groups specified for that EP in that standard version shall be considered comprehended by a receiving entity (some may still remain unsupported).
2. EP: The comprehension of different EPs within a standard version or between different standard versions is not mandated. Any EP that is not supported may be considered not comprehended, even if another EP from that standard version is comprehended, and action based on criticality shall be applied.

10.3.3 Presence Information

For many IEs/IE groups which are optional according to the ASN.1 transfer syntax, RANAP specifies separately if the presence of these IEs/IE groups is optional or mandatory with respect to RNS application by means of the presence field of the concerning object of class RANAP-PROTOCOL-IES, RANAP-PROTOCOL-IES-PAIR, RANAP-PROTOCOL-EXTENSION or RANAP-PRIVATE-IES.

The presence field of the indicated classes supports three values:

1. Optional;
2. Conditional;
3. Mandatory.

If an IE/IE group is not included in a received message and the presence of the IE/IE group is mandatory or the presence is conditional and the condition is true according to the version of the specification used by the receiver, an abstract syntax error occurs due to a missing IE/IE group.

If an IE/IE group is included in a received message and the presence of the IE/IE group is conditional and the condition is false according to the version of the specification used by the receiver, an abstract syntax error occurs due to this erroneously present conditional IE/IE group.

10.3.4 Not comprehended IE/IE group

10.3.4.1 Procedure Code

The receiving node shall treat the different types of received criticality information of the *Procedure Code* IE according to the following:

Reject IE:

- If a message is received with a *Procedure Code* IE marked with "*Reject IE*" which the receiving node does not comprehend, the receiving node shall reject the procedure using the Error Indication procedure.

Ignore IE and Notify Sender:

- If a message is received with a *Procedure Code* IE marked with "*Ignore IE and Notify Sender*" which the receiving node does not comprehend, the receiving node shall ignore the procedure and initiate the Error Indication procedure.

Ignore IE:

- If a message is received with a *Procedure Code* IE marked with "*Ignore IE*" which the receiving node does not comprehend, the receiving node shall ignore the procedure.

When using the Error Indication procedure to reject a procedure or to report an ignored procedure it shall include the *Procedure Code* IE, the *Triggering Message* IE, and the *Procedure Criticality* IE in the *Criticality Diagnostics* IE.

10.3.4.1A Type of Message

When the receiving node cannot decode the *Type of Message* IE, the Error Indication procedure shall be initiated with an appropriate cause value.

10.3.4.2 IEs other than the Procedure Code and Type of Message

The receiving node shall treat the different types of received criticality information of an IE/IE group other than the *Procedure Code* IE and *Type of Message* IE according to the following:

Reject IE:

- If a message *initiating* a procedure is received containing one or more IEs/IE group marked with "*Reject IE*" which the receiving node does not comprehend; none of the functional requests of the message shall be executed.

The receiving node shall reject the procedure and report the rejection of one or more IEs/IE group using the message normally used to report unsuccessful outcome of the procedure. In case the information received in the initiating message was insufficient to determine a value for all IEs that are required to be present in the message used to report the unsuccessful outcome of the procedure, the receiving node shall instead terminate the procedure and initiate the Error Indication procedure.

- If a message *initiating* a procedure that does not have a message to report unsuccessful outcome is received containing one or more IEs/IE groups marked with "*Reject IE*" which the receiving node does not comprehend, the receiving node shall terminate the procedure and initiate the Error Indication procedure.
- If a *response* message is received containing one or more IEs marked with "*Reject IE*", that the receiving node does not comprehend, the receiving node shall consider the procedure as unsuccessfully terminated and initiate local error handling.

Ignore IE and Notify Sender:

- If a message *initiating* a procedure is received containing one or more IEs/IE groups marked with "*Ignore IE and Notify Sender*" which the receiving node does not comprehend, the receiving node shall ignore the content of the not comprehended IEs/IE groups, continue with the procedure as if the not comprehended IEs/IE groups were not received (except for the reporting) using the understood IEs/IE groups, and report in the response message of the procedure that one or more IEs/IE groups have been ignored. In case the information received in the initiating message was insufficient to determine a value for all IEs that are required to be present in the response message, the receiving node shall instead terminate the procedure and initiate the Error Indication procedure.
- if a message *initiating* a procedure that does not have a message to report the outcome of the procedure is received containing one or more IEs/IE groups marked with "*Ignore IE and Notify Sender*" which the receiving node does not comprehend, the receiving node shall ignore the content of the not comprehended IEs/IE groups, continue with the procedure as if the not comprehended IEs/IE groups were not received (except for the reporting) using the understood IEs/IE groups, and initiate the Error Indication procedure to report that one or more IEs/IE groups have been ignored.
- If a *response* message is received containing one or more IEs/IE groups marked with "*Ignore IE and Notify Sender*" which the receiving node does not comprehend, the receiving node shall ignore the content of the not comprehended IEs/IE groups, continue with the procedure as if the not comprehended IEs/IE groups were not received (except for the reporting) using the understood IEs/IE groups and initiate the Error Indication procedure.

Ignore IE:

- If a message *initiating* a procedure is received containing one or more IEs/IE groups marked with "*Ignore IE*" which the receiving node does not comprehend, the receiving node shall ignore the content of the not comprehended IEs/IE groups and continue with the procedure as if the not comprehended IEs/IE groups were not received using the understood IEs/IE groups.
- If a *response* message is received containing one or more IEs/IE groups marked with "*Ignore IE*" which the receiving node does not comprehend, the receiving node shall ignore the content of the not comprehended IEs/IE groups and continue with the procedure as if the not comprehended IEs/IE groups were not received using the understood IEs/IE groups.

When reporting not comprehended IEs/IE groups marked with "*Reject IE*" or "*Ignore IE and Notify Sender*" using a response message defined for the procedure, the *Information Element Criticality Diagnostics* IE shall be included in the *Criticality Diagnostics* IE for each reported IE/IE group. In the *Information Element Criticality Diagnostics* IE the *Repetition Number* IE shall be included and in addition, if the not comprehended IE/IE group is not at message hierarchy level 1 (top level; see annex A2) also the *Message Structure* IE shall be included.

When reporting not comprehended IEs/IE groups marked with "*Reject IE*" or "*Ignore IE and Notify Sender*" using the Error Indication procedure, the *Procedure Code* IE, the *Triggering Message* IE, *Procedure Criticality* IE, and the *Information Element Criticality Diagnostics* IE shall be included in the *Criticality Diagnostics* IE for each reported IE/IE group. In the *Information Element Criticality Diagnostics* IE the *Repetition Number* IE shall be included and in addition, if the not comprehended IE/IE group is not at message hierarchy level 1 (top level; see annex A2) also the *Message Structure* IE shall be included.

10.3.5 Missing IE or IE group

The receiving node shall treat the missing IE/IE group according to the criticality information for the missing IE/IE group in the received message specified in the version of this specification used by the receiver:

Reject IE:

- if a received message initiating a procedure is missing one or more IEs/IE groups with specified criticality "Reject IE"; none of the functional requests of the message shall be executed. The receiving node shall reject the procedure and report the missing IEs/IE groups using the message normally used to report unsuccessful outcome of the procedure. In case the information received in the initiating message was insufficient to determine a value for all IEs that are required to be present in the message used to report the unsuccessful outcome of the procedure, the receiving node shall instead terminate the procedure and initiate the Error Indication procedure.
- if a received message initiating a procedure that does not have a message to report unsuccessful outcome is missing one or more IEs/IE groups with specified criticality "Reject IE", the receiving node shall terminate the procedure and initiate the Error Indication procedure.
- if a received response message is missing one or more IEs/IE groups with specified criticality "Reject IE", the receiving node shall consider the procedure as unsuccessfully terminated and initiate local error handling.

Ignore IE and Notify Sender:

- if a received message *initiating* a procedure is missing one or more IEs/IE groups with specified criticality "Ignore IE and Notify Sender", the receiving node shall ignore that those IEs are missing and continue with the procedure based on the other IEs/IE groups present in the message and report in the response message of the procedure that one or more IEs/IE groups were missing. In case the information received in the initiating message was insufficient to determine a value for all IEs that are required to be present in the response message, the receiving node shall instead terminate the procedure and initiate the Error Indication procedure.
- if a received message *initiating* a procedure that does not have a message to report the outcome of the procedure is missing one or more IEs/IE groups with specified criticality "Ignore IE and Notify Sender", the receiving node shall ignore that those IEs are missing and continue with the procedure based on the other IEs/IE groups present in the message and initiate the Error Indication procedure to report that one or more IEs/IE groups were missing.
- if a received *response* message is missing one or more IEs/IE groups with specified criticality "Ignore IE and Notify Sender", the receiving node shall ignore that those IEs are missing and continue with the procedure based on the other IEs/IE groups present in the message and initiate the Error Indication procedure to report that one or more IEs/IE groups were missing.

Ignore IE:

- if a received message initiating a procedure is missing one or more IEs/IE groups with specified criticality "Ignore IE", the receiving node shall ignore that those IEs are missing and continue with the procedure based on the other IEs/IE groups present in the message.
- if a received response message is missing one or more IEs/IE groups with specified criticality "Ignore IE", the receiving node shall ignore that those IEs/IE groups are missing and continue with the procedure based on the other IEs/IE groups present in the message.

When reporting missing IEs/IE groups with specified criticality "Reject IE" or "Ignore IE and Notify Sender" using a response message defined for the procedure, the *Information Element Criticality Diagnostics* IE shall be included in the *Criticality Diagnostics* IE for each reported IE/IE group. In the *Information Element Criticality Diagnostics* IE the *Repetition Number* IE shall be included and in addition, if the missing IE/IE group is not at message hierarchy level 1 (top level; see annex A2) also the *Message Structure* IE shall be included.

When reporting missing IEs/IE groups with specified criticality "Reject IE" or "Ignore IE and Notify Sender" using the Error Indication procedure, the *Procedure Code* IE, the *Triggering Message* IE, *Procedure Criticality* IE, and the *Information Element Criticality Diagnostics* IE shall be included in the *Criticality Diagnostics* IE for each reported IE/IE group. In the *Information Element Criticality Diagnostics* IE the *Repetition Number* IE shall be included and in addition, if the missing IE/IE group is not at message hierarchy level 1 (top level; see annex A2) also the *Message Structure* IE shall be included.

10.3.6 IEs or IE groups received in wrong order or with too many occurrences or erroneously present

If a message with IEs or IE groups in wrong order or with too many occurrences is received or if IEs or IE groups with a conditional presence are present when the condition is not met (i.e. erroneously present), the receiving node shall behave according to the following:

- If a message *initiating* a procedure is received containing IEs or IE groups in wrong order or with too many occurrences or erroneously present, none of the functional requests of the message shall be executed. The receiving node shall reject the procedure and report the cause value "Abstract Syntax Error (Falsely Constructed Message)" using the message normally used to report unsuccessful outcome of the procedure. In case the information received in the initiating message was insufficient to determine a value for all IEs that are required to be present in the message used to report the unsuccessful outcome of the procedure, the receiving node shall instead terminate the procedure and initiate the Error Indication procedure.
- If a message *initiating* a procedure that does not have a message to report unsuccessful outcome is received containing IEs or IE groups in wrong order or with too many occurrences or erroneously present, the receiving node shall terminate the procedure and initiate the Error Indication procedure, and use cause value "Abstract Syntax Error (Falsely Constructed Message)".
- If a *response* message is received containing IEs or IE groups in wrong order or with too many occurrences or erroneously present, the receiving node shall consider the procedure as unsuccessfully terminated and initiate local error handling.

When determining the correct order only the IEs specified in the specification version used by the receiver shall be considered.

10.4 Logical Error

Logical error situations occur when a message is comprehended correctly, but the information contained within the message is not valid (i.e. semantic error), or describes a procedure which is not compatible with the state of the receiver. In these conditions, the following behaviour shall be performed (unless otherwise specified) as defined by the class of the elementary procedure, irrespective of the criticality information of the IEs/IE groups containing the erroneous values.

Class 1:

Where the logical error occurs in a request message of a class 1 procedure, and the procedure has a message to report this unsuccessful outcome, this message shall be sent with an appropriate cause value. Typical cause values are:

- Semantic Error.
- Message not compatible with receiver state.

Where the logical error is contained in a request message of a class 1 procedure, and the procedure does not have a message to report this unsuccessful outcome, the procedure shall be terminated and the Error Indication procedure shall be initiated with an appropriate cause value. The *Procedure Code* IE and the *Triggering Message* IE within the *Criticality Diagnostics* IE shall then be included in order to identify the message containing the logical error.

Where the logical error exists in a response message of a class 1 procedure, the procedure shall be considered as unsuccessfully terminated and local error handling shall be initiated.

Class 2:

Where the logical error occurs in a message of a class 2 procedure, the procedure shall be terminated and the Error Indication procedure shall be initiated with an appropriate cause value. The *Procedure Code* IE and the *Triggering Message* IE within the *Criticality Diagnostics* IE shall then be included in order to identify the message containing the logical error.

Class 3:

Where the logical error occurs in a request message of a class 3 procedure, and the procedure has a message to report this unsuccessful outcome, this message shall be sent with an appropriate cause value. Typical cause values are:

- Semantic Error.
- Message not compatible with receiver state.

Where the logical error is contained in a request message of a class 3 procedure, and the procedure does not have a message to report this unsuccessful outcome, the procedure shall be terminated and the Error Indication procedure shall be initiated with an appropriate cause value. The *Procedure Code* IE and the *Triggering Message* IE within the *Criticality Diagnostics* IE shall then be included in order to identify the message containing the logical error.

Where the logical error exists in a response message of a class 3 procedure, the procedure shall be considered as unsuccessfully terminated and local error handling shall be initiated.

10.5 Exceptions

The error handling for all the cases described hereafter shall take precedence over any other error handling described in the other subclauses of clause 10.

- If any type of error (Transfer Syntax Error, Abstract Syntax Error or Logical Error) is detected in the ERROR INDICATION message, it shall not trigger the Error Indication procedure in the receiving Node but local error handling.
- In case a response message or Error Indication message needs to be returned, but the information necessary to determine the receiver of that message is missing, the procedure shall be considered as unsuccessfully terminated and local error handling shall be initiated.
- If an error that terminates a procedure occurs, the returned cause value shall reflect the error that caused the termination of the procedure even if one or more abstract syntax errors with criticality "ignore and notify" have earlier occurred within the same procedure.

11 Special Procedures for RNC to RNC Communication

11.1 General

This subclause specifies special procedures that are used for RNC to RNC communication, and that use other transport means than the RANAP procedures specified in clause 8.

11.2 RANAP Relocation Information

11.2.1 General

The purpose of the RANAP Relocation Information procedure is to handle the RANAP-related information that is carried transparently during relocation from a source RNC to a target RNC by RNSAP via the Iur Interface.

11.2.2 Operation

When during relocation it becomes necessary in the source RNC to generate RANAP information for transfer to the relocation target, the RNC shall form a RANAP RELOCATION INFORMATION message. The message shall be encoded according to the encoding rules specified for RANAP in the similar manner as for the normal RANAP messages. The outcome of the encoding will be an octet string, which shall not be sent to the CN via the Iu Interface, but shall be given to the appropriate local process for transparent transfer to the target RNC.

When the RANAP process in the target RNC receives an octet string containing a RANAP RELOCATION INFORMATION message that had been transparently transferred from the source RNC, it shall decode it according to the encoding rules specified for RANAP. This process is similar to receiving any normal RANAP message. The decoded information shall be passed to the appropriate processes in the RNC.

The RANAP RELOCATION INFORMATION message may contain the *Direct Transfer Information List* IE, the *RAB Contexts List* IE and the *Source RNC PDCP context info* IE. If present, the *Direct Transfer Information List* IE shall contain the *NAS-PDU* IE, the *SAPI* IE and the *CN Domain Indicator* IE. If present, the *RAB Contexts List* IE shall contain for each addressed RAB:

- the RAB ID IE;
- if available, the DL GTP-PDU Sequence Number IE;
- if available, the UL GTP-PDU Sequence Number IE;
- if available, the DL N-PDU Sequence Number IE;
- if available, the UL N-PDU Sequence Number IE.

Handling in case of RNSAP Relocation:

In case of RNSAP Relocation for each CS RAB operated in support mode (see TS 25.415 [6] for the definition of 'support mode') the source RNC shall include within the RANAP RELOCATION INFORMATION message the *RNSAP Relocation Parameters* IE containing the *RAB Parameters List* IE which shall include the *UP Information* IE. For each CS RAB operated in support mode for which the user data frame numbering is based on time the source RNC shall include the *Timing Difference UL-DL* IE within the *UP Information* IE.

In case of RNSAP Relocation for each PS RAB for which data volume reporting was configured, the source RNC shall include the *RAB Data Volume Reports* IE within the *RAB Parameters List* IE included in the RANAP RELOCATION INFORMATION message.

In case Location Reporting was configured at the source RNC for periodic reporting and/or report upon change of Service area and/or direct reporting, the source RNC shall include the *Location Reporting Transfer Information* IE within the RANAP RELOCATION INFORMATION message.

The *Periodic Reporting Indicator* IE within the *Location Reporting Transfer Information* IE shall be set to 'periodic SAI' if periodic reporting is requested and the location information is requested to be a Service Area Identifier, to 'periodic Geo' if periodic reporting is requested and the location information is requested to be a geographical area.

The *Direct Reporting Indicator* IE within the *Location Reporting Transfer Information* IE shall be set to 'direct SAI' if periodic reporting is requested and the location information is requested to be a Service Area Identifier, to 'direct Geo' if periodic reporting is requested and the location information is requested to be a geographical area.

The conditions for the presence of further IEs within the Location Reporting Transfer Information are specified in subclause 8.19.2.

If signalling based trace activation was triggered at the source RNC, the RANAP RELOCATION INFORMATION shall contain the *UE Trace Identity* IE and the *Trace Propagation Parameters* IE in order to continue tracing at the target RNC accordingly.

11.3 RANAP Enhanced Relocation Information

11.3.1 General

The purpose of the RANAP Enhanced Relocation Information procedure is to handle the RANAP-related information that is carried transparently during enhanced relocation from a source RNC to a target RNC by RNSAP via the Iur Interface.

11.3.2 Operation

When during enhanced relocation it becomes necessary in the source RNC to generate RANAP information for transfer to the relocation target, the source RNC shall form a RANAP ENHANCED RELOCATION INFORMATION REQUEST message. The message shall be encoded according to the encoding rules specified for RANAP in the similar manner as for the normal RANAP messages. The outcome of the encoding will be an octet string, which shall be given to the appropriate local process for transparent transfer to the target RNC.

When the RANAP process in the target RNC receives an octet string containing a RANAP ENHANCED RELOCATION INFORMATION REQUEST message that had been transparently transferred from the source RNC, it shall decode it according to the encoding rules specified for RANAP. This process is similar to receiving any normal RANAP message. The decoded information shall be passed to the appropriate processes in the RNC.

Upon reception of the RANAP ENHANCED RELOCATION INFORMATION REQUEST message, the target RNC shall initiate allocation of requested resources.

The RANAP ENHANCED RELOCATION INFORMATION REQUEST message shall contain the following IE:

- *Source RNC To Target RNC Transparent Container IE;*

The RANAP ENHANCED RELOCATION INFORMATION REQUEST message may contain the following IEs:

- *Old Iu Signalling Connection Identifier CS domain IE;* if a connection to the CS domain exist;
- *Old Iu Signalling Connection Identifier PS domain IE;* if a connection to the PS domain exist;
- *Global CN-ID for CS,* if a connection to the CS domain exist;
- *Global CN-ID for PS,* if a connection to the PS domain exist;
- *RABs to be Setup List;*
- *SNA Access Information IE* (if available);
- *UESBI-Iu IE* (if available);
- *Selected PLMN identity IE* if in MOCN or GWCN configuration;
- *CN MBMS Linking Information IE* (if available);
- *UE Aggregate Maximum Bit Rate IE;*
- *Anchor PLMN Identity IE* (if available).

For each RAB requested to relocate in the RABs to be Setup List, the RANAP ENHANCED RELOCATION INFORMATION REQUEST message shall contain the following IEs in the *RABs To Be Setup List IE*:

- *RAB ID IE;*
- *CN domain indicator IE;*
- *RAB parameters IE;*
- *User Plane Information IE;*
- *Source Side Iu UL TNL Information IE;*
- *Data Volume Reporting Indication IE* (only for PS);
- *PDP Type Information IE* (only for PS).

For each RAB requested to relocate the message may include the following IEs:

- *Data Forwarding TNL Information IE;*
- *Service Handover IE;*
- *Alternative RAB Parameter Values IE;*
- *E-UTRAN Service Handover IE;*
- *PDP Type Information extension IE* (may be included if *PDP Type Information IE* is included).

If the *Data Forwarding TNL Information IE* is included in the RANAP ENHANCED RELOCATION INFORMATION REQUEST message, it indicates Iur UP resources, made available by the source RNC for forwarding of UL user data.

Note: The *Source Side Iu UL TNL Information IE* (in contrary to the *Data Forwarding TNL Information IE*) contains information to enable the target RNC to start transmission of user data towards the CN once the relocations has been successfully executed.

If the *UE Aggregate Maximum Bit Rate IE* is included in the RANAP ENHANCED RELOCATION INFORMATION REQUEST message, the target side shall, if supported, store the received UE Aggregate Maximum Bit Rate parameters to control the aggregate data rate of non-GBR traffic for this UE.

The RANAP ENHANCED RELOCATION INFORMATION REQUEST message shall contain the information (if any) required by the target RNC to build at least the same set of RABs as existing for the UE before the relocation and therefore the RANAP ENHANCED RELOCATION INFORMATION REQUEST may contain the *RABs to be SETUP List IE*.

The resource allocation actions executed by the target RNC are:

If the *Relocation Type IE* is set to "UE involved in relocation of SRNS":

- The target RNC should not accept a requested RAB if the RAB did not exist in the source RNC before the relocation;
- The target RNC may accept a requested RAB only if the RAB can be supported by the target RNC;
- Other RABs shall be rejected by the target RNC in the RANAP ENHANCED RELOCATION INFORMATION RESPONSE message with an appropriate value in the *Cause IE*, e.g. "Unable to Establish During Relocation";
- The target RNC shall include information adapted to the resulting RAB configuration in the target to source RNC transparent container to be included in the RANAP ENHANCED RELOCATION INFORMATION RESPONSE message sent to the source RNC;
- If any alternative RAB parameter values have been used when allocating the resources, these RAB parameter values shall be included in the RANAP ENHANCED RELOCATION INFORMATION RESPONSE message within the *Assigned RAB Parameter Values IE*;
- If *d-RNTI for No IuCS UP IE* is contained in the RANAP ENHANCED RELOCATION INFORMATION REQUEST message, the target RNC shall use this information to configure the resource for the UE over Iur during the relocation.

If the *Relocation Type IE* is set to "UE not involved in relocation of SRNS":

- The target RNC shall not accept a requested RAB if the RAB did not exist in the source RNC before the relocation;
- The target RNC may accept a RAB only if the radio bearer(s) for the RAB either exist(s) already and can be used for the RAB by the target RNC, or do(es) not exist before the relocation but can be established in order to support the RAB in the target RNC;
- If existing radio bearers are not related to any RAB that is accepted by the target RNC, the radio bearers shall be ignored during the relocation of SRNS and the radio bearers shall be released by the radio interface protocols after completion of relocation of SRNS;
- Usage of alternative RAB parameter values is not applicable for any relocation of type "UE not involved in relocation of SRNS".

If the *UE History Information IE* is included in the RANAP ENHANCED RELOCATION INFORMATION REQUEST message and the target RNC is configured to collect the information, the target RNC shall, if supported, collect information defined in the *UE History Information IE*.

The *Global CN ID IE* and *Old Iu Signalling Identifier IE* (for PS and/or for CS) are used by the target RNC to establish new Iu Signalling connection(s) between the target RNC towards the CS and/or PS domain.

The RANAP ENHANCED RELOCATION INFORMATION REQUEST message may also include an alternative RAB configuration for a RAB specified in the *Alternative RAB configuration IE* in the *Alternative RAB Parameter Values IE*. If *Alternative RAB configuration IE* for a RAB is included in the RANAP ENHANCED RELOCATION INFORMATION REQUEST message, the target RNC is allowed to use the alternative configuration.

The RNC shall, if supported, use the *UESBI-Iu* IE when included in the RANAP ENHANCED RELOCATION INFORMATION REQUEST message.

If the *CN MBMS Linking Information* IE is included in the RANAP ENHANCED RELOCATION INFORMATION REQUEST message, the RNC shall, if supported, use the *CN MBMS Linking Information* IE to perform suitable UE linking as described in TS 25.346 [42].

If the *SNA Access Information* IE is contained in the RANAP ENHANCED RELOCATION INFORMATION REQUEST message, the target RNC shall store this information and use it to determine whether the UE has access to radio resources in the UTRAN. The target RNC shall consider that the UE is authorised to access only the PLMNs identified by the *PLMN identity* IE in the *SNA Access Information* IE. If the *Authorised SNAs* IE is included for a given PLMN (identified by the *PLMN identity* IE), then the target RNC shall consider that the access to radio resources for the concerned UE is restricted to the LAs contained in the SNAs identified by the *SNAC* IEs.

If the *SNA Access Information* IE is not contained in the RANAP ENHANCED RELOCATION INFORMATION REQUEST message, the target RNC shall consider that no access restriction applies to the UE in the UTRAN.

If the *Trace Recording Session Information* IE is provided within the *Source RNC to Target RNC Transparent Container* IE, the Target RNC should store that information to include it in a potential future Trace Record for that UE.

After all necessary resources for accepted RABs including the initialised Iu user plane, are successfully allocated, the target RNC shall send a RANAP ENHANCED RELOCATION INFORMATION RESPONSE message to the source RNC.

For each RAB successfully setup the RNC shall include the following IEs in the *RABs Setup List* IE:

- *RAB ID*.

For each RAB the target RNC has admitted to execute data forwarding, the target RNC shall include the *Data Forwarding Information* IE in the RANAP ENHANCED RELOCATION INFORMATION RESPONSE message. If no ALCAP is used, the RNC shall include the *DL Forwarding Transport Layer Address* IE and the *DL Forwarding Transport Association* IE within the *Data Forwarding Information* IE in the RANAP ENHANCED RELOCATION INFORMATION RESPONSE message.

If applicable, the target RNC shall have executed the initialisation of the user plane mode between the source and the target RNC as requested by the source RNC in the *User Plane Mode* IE. If the target RNC can not initialise the requested user plane mode for any of the user plane mode versions in the *UP Mode Versions* IE according to the rules for initialisation of the respective user plane mode versions, as described in TS 25.415 [6], the target RNC may either decide to not relocate the respective RAB or to omit data forwarding for that RAB.

For each RAB the RNC is not able to setup during the Enhanced Relocation Information procedure, the RNC shall include the *CN Domain Indicator* IE *RAB ID* IE and the *Cause* IE within the *RABs Failed To Setup* IE. The resources associated with the RABs indicated as failed to set up shall not be released in the source RNC until the relocation is completed. This is in order to make a return to the old configuration possible in case of a failed or cancelled relocation.

The RANAP ENHANCED RELOCATION INFORMATION RESPONSE message sent to the source RNC shall, if applicable, include the *Target RNC To Source RNC Transparent Container* IE.

Handling in case of RNSAP Relocation:

In case of RNSAP Relocation for each CS RAB operated in support mode (see TS 25.415 [6] for the definition of 'support mode') the source RNC shall include within the RANAP ENHANCED RELOCATION INFORMATION REQUEST message the *RAB Parameters List* IE which shall include the *UP Information* IE. For each CS RAB operated in support mode for which the user data frame numbering is based on time the source RNC shall include the *Timing Difference UL-DL* IE within the *UP Information* IE.

The source RNC shall also include within the RANAP ENHANCED RELOCATION INFORMATION REQUEST message

- the *CSG ID* IE (if available),
- the *CSG Membership Status* IE (if available).

Handling in case of Enhanced Relocation between RNC and hybrid cell:

The source RNC shall also include within the RANAP ENHANCED RELOCATION INFORMATION REQUEST message the *CSG ID* IE, if available. If the *CSG ID* IE is included, the *CSG Membership Status* IE shall be included as well.

Annex A (informative): RANAP guidelines

A.1 Rules for building RANAP messages

A.1.1 Rules for RANAP messages that shall contain the CN Domain Indicator IE

Based on the principles described in TS 25.401 [3], the following rules can be deduced:

- 1) The following RANAP messages initiating a connection oriented signalling connection shall contain the *CN Domain Indicator IE*: INITIAL UE MESSAGE message and RELOCATION REQUEST message.
- 2) Any RANAP message belonging to class 1 procedures and which uses connectionless signalling shall contain the *CN Domain Indicator IE*.
- 3) The following RANAP messages belonging to class 2 procedures and using connectionless signalling shall contain the *CN Domain Indicator IE*: PAGING message and ERROR INDICATION message, the OVERLOAD message in DL direction (see chapter 8.25.3.1) may contain the *CN Domain Indicator IE*.

A.2 Guidelines for Usage of the Criticality Diagnostics IE

A.2.1 EXAMPLE MESSAGE Layout

Assume the following message format:

IE/Group Name	Presence	Range	IE type and reference	Semantics description	Criticality	Assigned Criticality
Message Type	M				YES	reject
A	M				YES	reject
B	M				YES	reject
>E		1..<maxE>			EACH	ignore
>>F		1..<maxF>			-	
>>>G		0..3, ...			EACH	ignore
>>H		1..<maxH>			EACH	ignore
>>>G		0..3, ...			EACH	ignore and notify
>>G	M				YES	reject
>>J		1..<maxJ>			-	
>>>G		0..3, ...			EACH	reject
C	M				YES	reject
>K		1..<maxK>			EACH	ignore and notify
>>L		1..<maxL>			-	
>>>M	O				-	
D	M				YES	reject

NOTE 1: The IEs F, J, and L do not have assigned criticality. The IEs F, J, and L are consequently realised as the ASN.1 type SEQUENCE OF of "ordinary" ASN.1 type, e.g. INTEGER. On the other hand, the repeatable IEs with assigned criticality are realised as the ASN.1 type SEQUENCE OF of an IE object, e.g. ProtocolIE-Container.

For the corresponding ASN.1 layout, see subclause A.2.4.

A.2.2 Example on a Received EXAMPLE MESSAGE

Assume further more that a received message based on the above tabular format is according to the figure below.

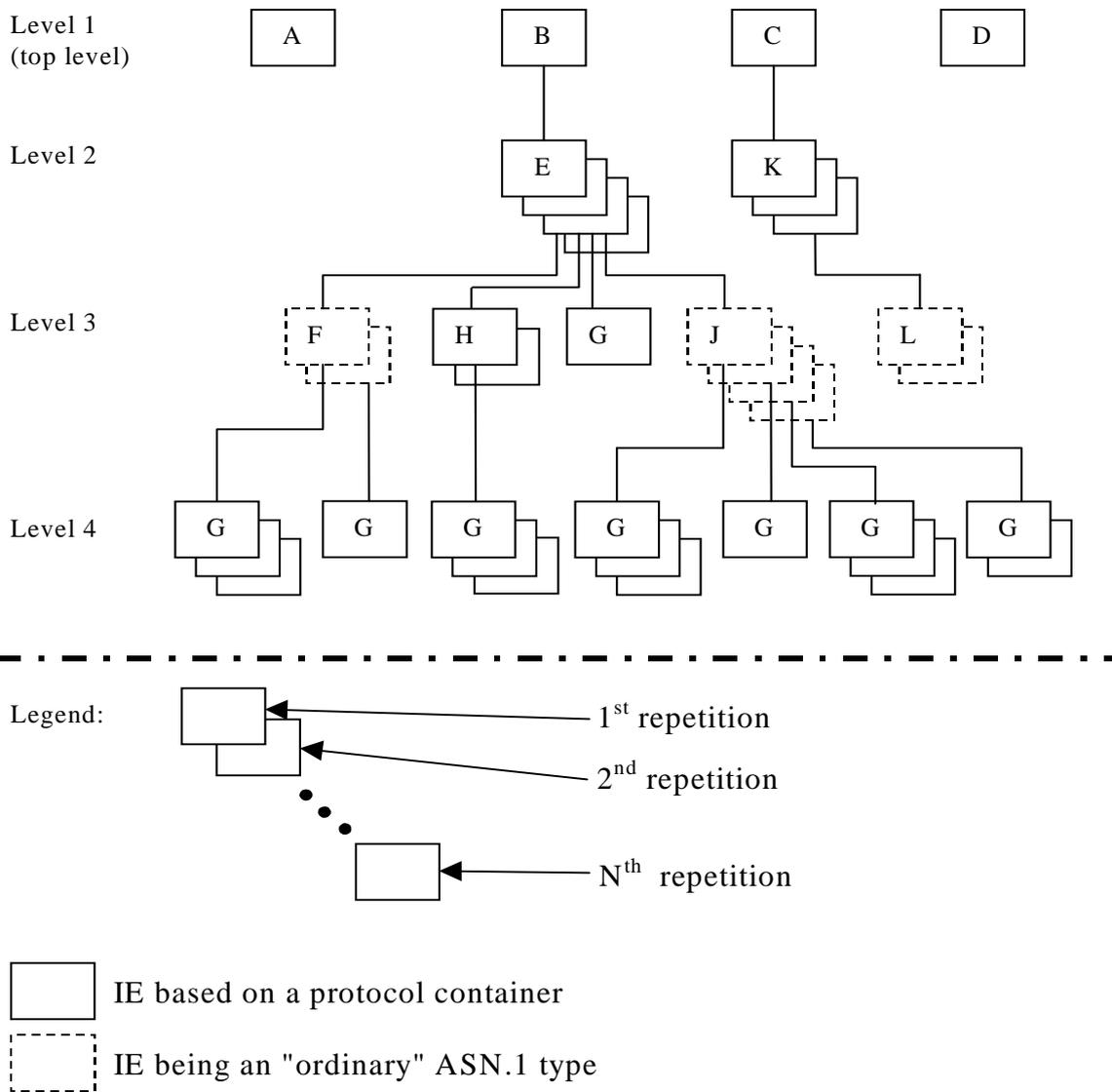

Figure A.1: Example of content of a received RANAP message based on the EXAMPLE MESSAGE

A.2.3 Content of Criticality Diagnostics

A.2.3.1 Example 1

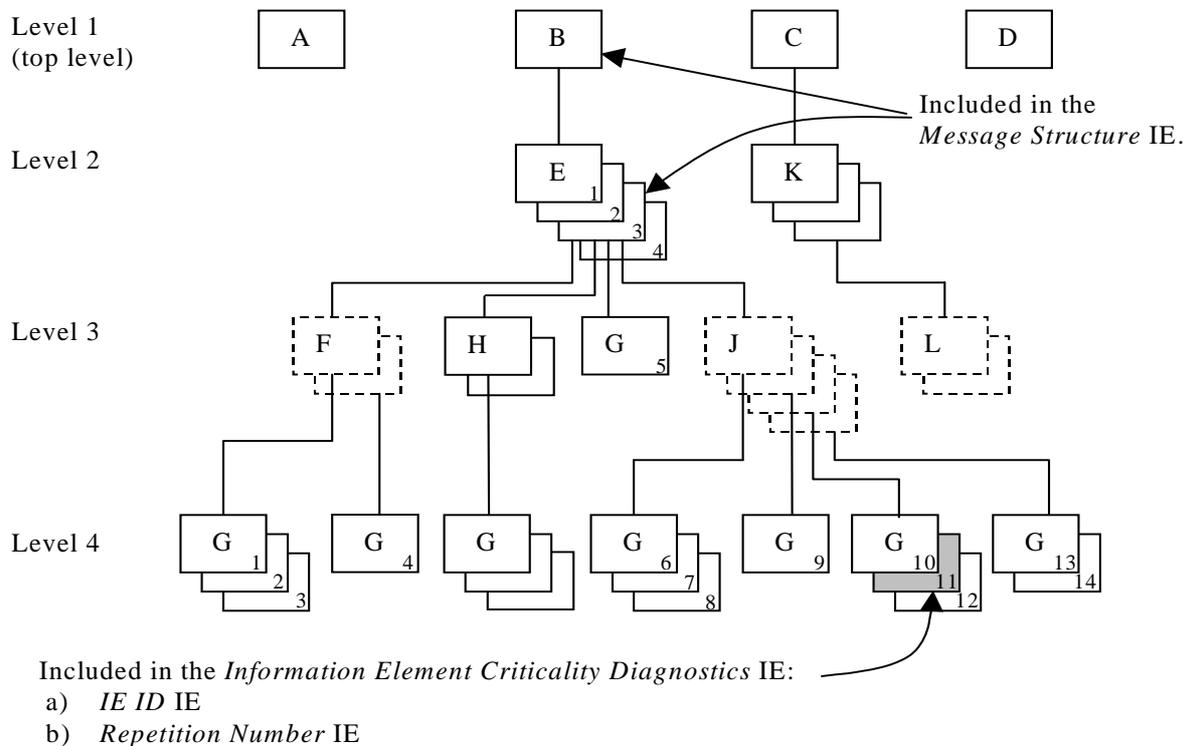

Figure A.2: Example of a received RANAP message containing a not comprehended IE

If there is an error within the instance marked as grey in the IE G in the IE J shown in the figure A.2 above, this will be reported within the *Information Element Criticality Diagnostics IE* within the *Criticality Diagnostics IE* as follows:

IE name	Value	Comment
IE Criticality	reject	Criticality for IE on the reported level, i.e. level 4.
IE ID	id-G	IE ID from the reported level, i.e. level 4.
Repetition Number	11	Repetition number on the reported level, i.e. level 4. (Since the IE E (level 2) is the lowest level included in the <i>Message Structure IE</i> this is the eleventh occurrence of IE G within the IE E (level 2).
Type of Error	not understood	
<i>Message Structure, first repetition</i>		
>IE ID	id-B	IE ID from level 1.
<i>Message Structure, second repetition</i>		
>IE ID	id-E	IE ID from the lowest level above the reported level, i.e. level 2.
>Repetition Number	3	Repetition number from the lowest level above the reported level, i.e. level 2.

NOTE 2: The IE J on level 3 cannot be included in the *Message Structure IE* since they have no criticality of their own.

NOTE 3: The repetition number of the reported IE indicates the number of repetitions of IE G received up to the detected erroneous repetition, counting all occurrences of the IE G below the same instance of the previous level with assigned criticality (instance 3 of IE E on level 2).

A.2.3.2 Example 2

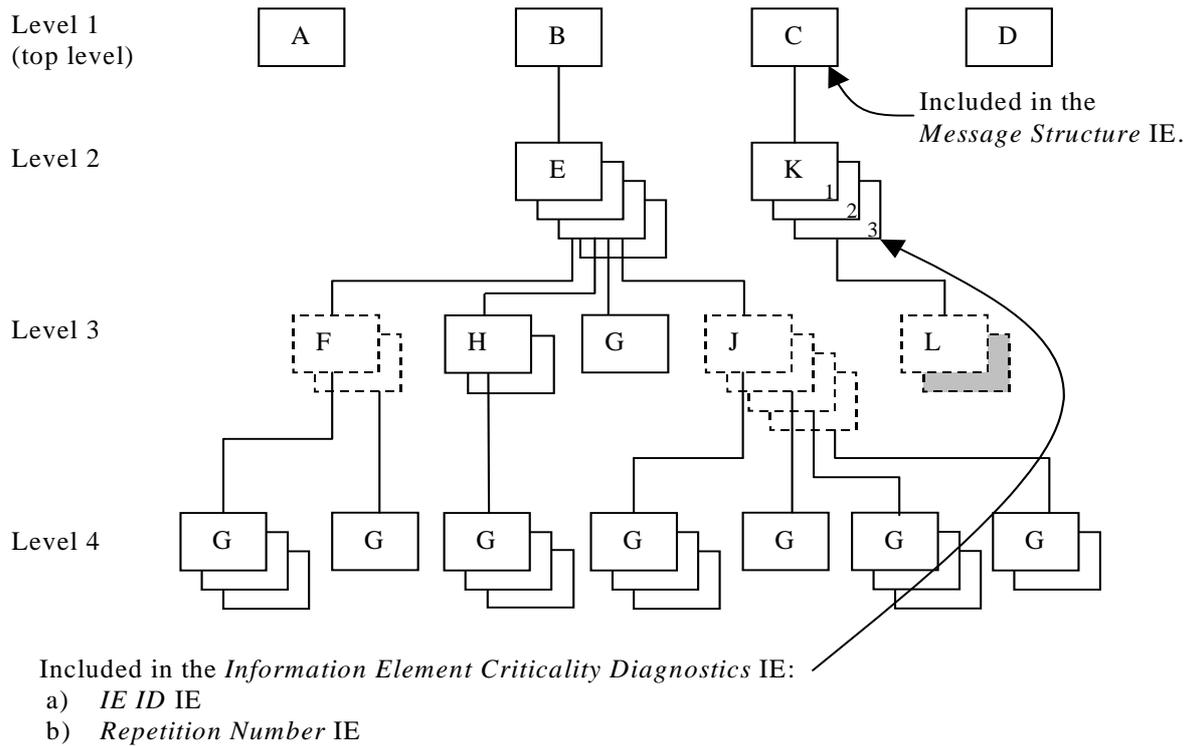

Figure A.3: Example of a received RANAP message containing a not comprehended IE

If there is an error within the second instance (marked as grey) in the sequence (IE L in the tabular format) on level 3 below IE K in the structure shown in the figure A.3 above, this will be reported within the *Information Element Criticality Diagnostics* IE within the *Criticality Diagnostics* IE as follows:

IE name	Value	Comment
IE Criticality	ignore and notify	Criticality for IE on the reported level, i.e. level 2.
IE ID	id-K	IE ID from the reported level, i.e. level 2.
Repetition Number	3	Repetition number on the reported level, i.e. level 2.
Type of Error	not understood	
<i>Message Structure, first repetition</i>		
>IE ID	id-C	IE ID from the lowest level above the reported level, i.e. level 1.

NOTE 4: The IE L on level 3 cannot be reported individually included in the *Message Structure* IE since it has no criticality of its own.

A.2.3.3 Example 3

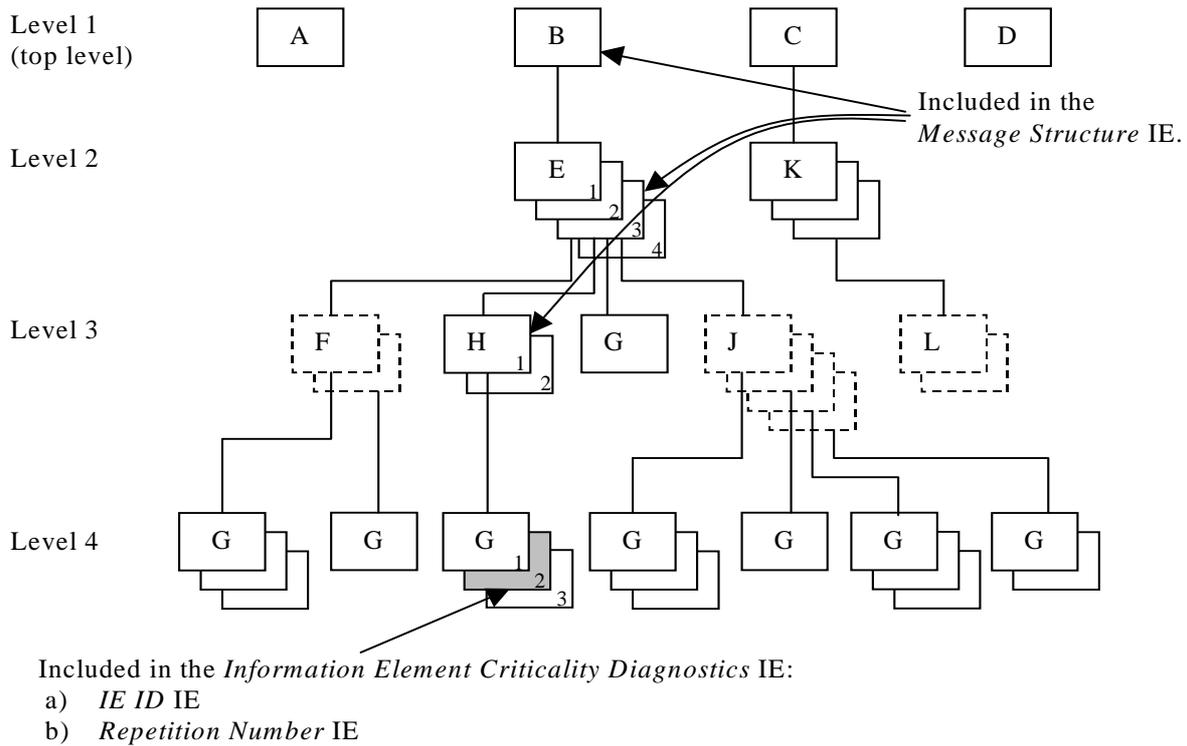

Figure A.4: Example of a received RANAP message containing a not comprehended IE

If there is an error within the instance marked as grey in the IE G in the IE H shown in the figure A.4 above, this will be reported within the *Information Element Criticality Diagnostics IE* within the *Criticality Diagnostics IE* as follows:

IE name	Value	Comment
IE Criticality	ignore and notify	Criticality for IE on the reported level, i.e. level 4.
IE ID	id-G	IE ID from the reported level, i.e. level 4.
Repetition Number	2	Repetition number on the reported level, i.e. level 4.
Type of Error	not understood	
<i>Message Structure, first repetition</i>		
>IE ID	id-B	IE ID from level 1.
<i>Message Structure, second repetition</i>		
>IE ID	id-E	IE ID from level 2.
>Repetition Number	3	Repetition number from level 2.
<i>Message Structure, third repetition</i>		
>IE ID	id-H	IE ID from the lowest level above the reported level, i.e. level 3.
>Repetition Number	1	Repetition number from the lowest level above the reported level, i.e. level 3.

NOTE 5: The repetition number of level 4 indicates the number of repetitions of IE G received up to the detected erroneous repetition, counted below the same instance of the previous level with assigned criticality (instance 1 of IE H on level 3).

A.2.3.4 Example 4

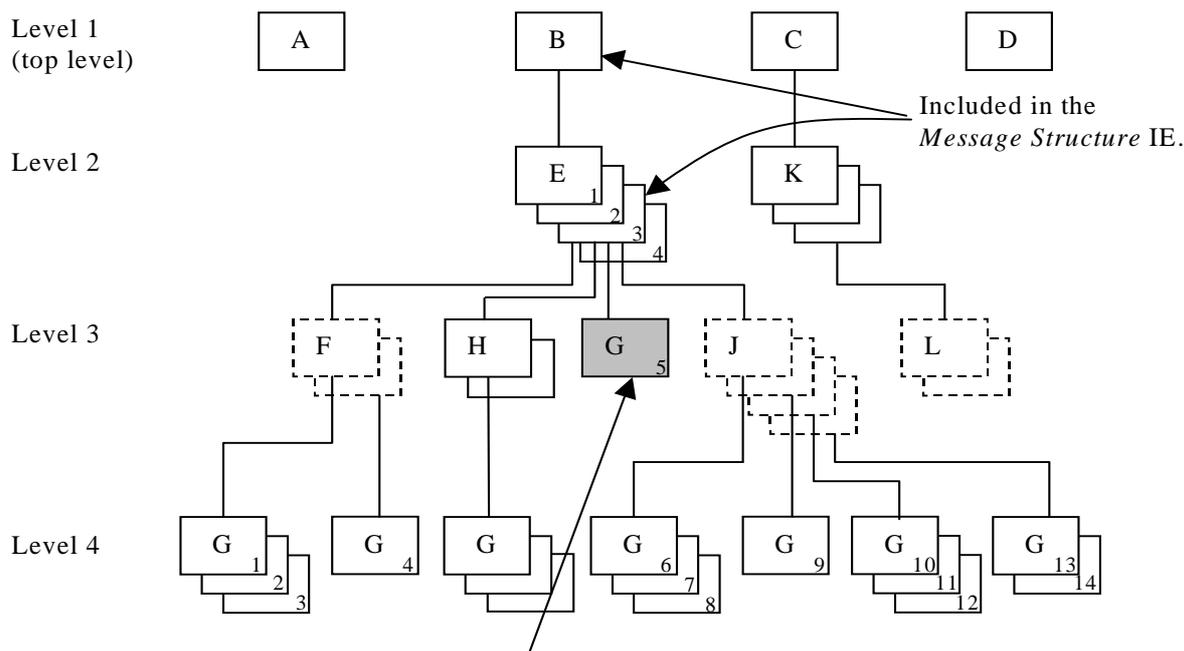

Included in the *Information Element Criticality Diagnostics IE*:

- a) *IE ID IE*
- b) *Repetition Number IE*

Figure A.5: Example of a received RANAP message containing a not comprehended IE

If there is an error within the instance marked as grey in the IE G in the IE E shown in the figure A.5 above, this will be reported within the *Information Element Criticality Diagnostics IE* within the *Criticality Diagnostics IE* as follows:

IE name	Value	Comment
IE Criticality	reject	Criticality for IE on the reported level, i.e. level 3.
IE ID	id-G	IE ID from the reported level, i.e. level 3.
Repetition Number	5	Repetition number on the reported level, i.e. level 3. (Since the IE E (level 2) is the lowest level included in the <i>Message Structure IE</i> this is the fifth occurrence of IE G within the IE E (level 2).
Type of Error	not understood	
<i>Message Structure, first repetition</i>		
>IE ID	id-B	IE ID from level 1.
<i>Message Structure, second repetition</i>		
>IE ID	id-E	IE ID from the lowest level above the reported level, i.e. level 2.
>Repetition Number	3	Repetition number from the lowest level above the reported level, i.e. level 2.

NOTE 6: The repetition number of the reported IE indicates the number of repetitions of IE G received up to the detected erroneous repetition, counting all occurrences of the IE G below the same instance of the previous level with assigned criticality (instance 3 of IE E on level 2).

A.2.3.5 Example 5

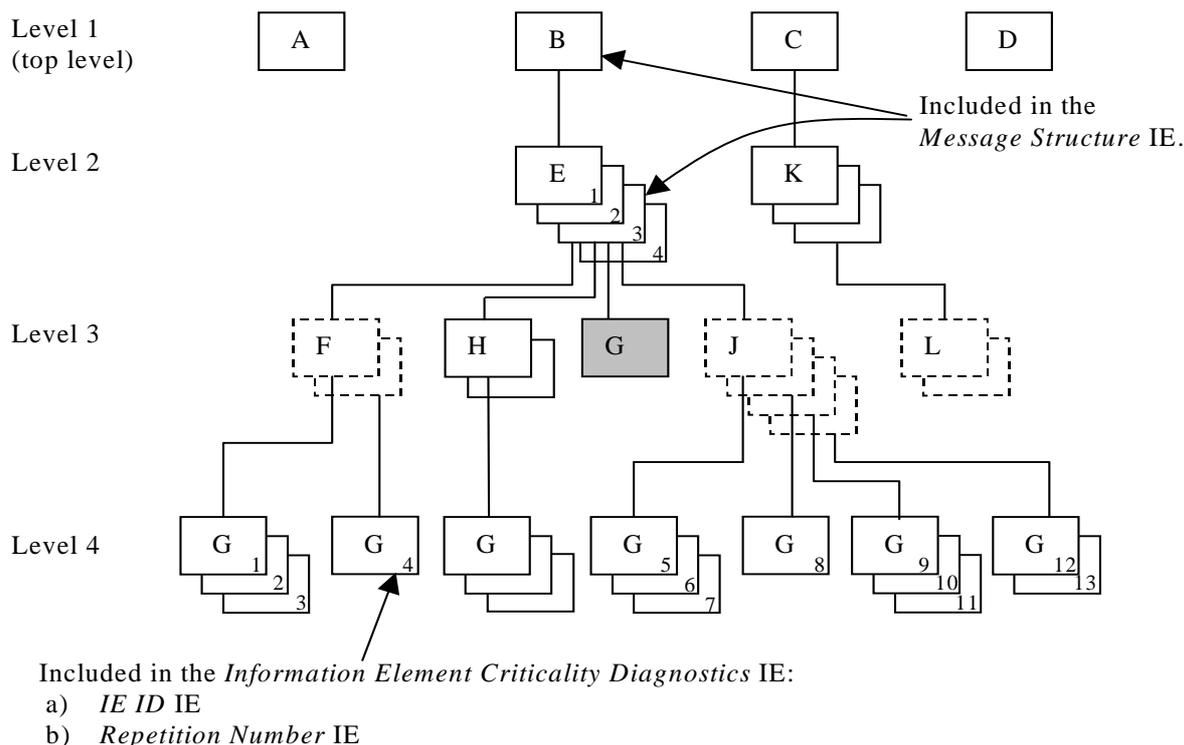

Figure A.6: Example of a received RANAP message with a missing IE

If the instance marked as grey in the IE G in the IE E shown in the figure A.6 above, is missing this will be reported within the *Information Element Criticality Diagnostics* IE within the *Criticality Diagnostics* IE as follows:

IE name	Value	Comment
IE Criticality	reject	Criticality for IE on the reported level, i.e. level 3.
IE ID	id-G	IE ID from the reported level, i.e. level 3.
Repetition Number	4	Repetition number up to the missing IE on the reported level, i.e. level 3. (Since the IE E (level 2) is the lowest level included in the <i>Message Structure</i> IE there have been four occurrences of IE G within the IE E (level 2) up to the missing occurrence.
Type of Error	missing	
<i>Message Structure, first repetition</i>		
>IE ID	id-B	IE ID from level 1.
<i>Message Structure, second repetition</i>		
>IE ID	id-E	IE ID from the lowest level above the reported level, i.e. level 2.
>Repetition Number	3	Repetition number from the lowest level above the reported level, i.e. level 2.

NOTE 7: The repetition number of the reported IE indicates the number of repetitions of IE G received up to but not including the missing occurrence, counting all occurrences of the IE G below the same instance of the previous level with assigned criticality (instance 3 of IE E on level 2).

A.2.4 ASN.1 of EXAMPLE MESSAGE

```

ExampleMessage ::= SEQUENCE {
    ProtocolIEs          ProtocolIE-Container          {{ExampleMessage-IEs}},
    ProtocolExtensions  ProtocolExtensionContainer  {{ExampleMessage-Extensions}}  OPTIONAL,
    ...
}

ExampleMessage-IEs RANAP-PROTOCOL-IES ::= {
    { ID id-A    CRITICALITY reject  TYPE A  PRESENCE mandatory } |
    { ID id-B    CRITICALITY reject  TYPE B  PRESENCE mandatory } |
    { ID id-C    CRITICALITY reject  TYPE C  PRESENCE mandatory } |
    { ID id-D    CRITICALITY reject  TYPE D  PRESENCE mandatory } ,
    ...
}

B ::= SEQUENCE {
    e                E-List,
    iE-Extensions  ProtocolExtensionContainer { {B-ExtIEs} }  OPTIONAL,
    ...
}

B-ExtIEs RANAP-PROTOCOL-EXTENSION ::= {
    ...
}

E-List ::= SEQUENCE (SIZE (1..maxE)) OF ProtocolIE-Container { {E-IEs} }

E-IEs RANAP-PROTOCOL-IES ::= {
    { ID id-E    CRITICALITY ignore  TYPE E  PRESENCE mandatory } ,
    ...
}

E ::= SEQUENCE {
    f                F-List,
    h                H-List,
    g                G-List1,
    j                J-List,
    iE-Extensions  ProtocolExtensionContainer { {E-ExtIEs} }  OPTIONAL,
    ...
}

E-ExtIEs RANAP-PROTOCOL-EXTENSION ::= {
    ...
}

F-List ::= SEQUENCE (SIZE (1..maxF)) OF F

F ::= SEQUENCE {
    g                G-List2 OPTIONAL,
    iE-Extensions  ProtocolExtensionContainer { {F-ExtIEs} }  OPTIONAL,
    ...
}

F-ExtIEs RANAP-PROTOCOL-EXTENSION ::= {
    ...
}

G-List2 ::= SEQUENCE (SIZE (1..3, ...)) OF ProtocolIE-Container { {G2-IEs} }

G2-IEs RANAP-PROTOCOL-IES ::= {
    { ID id-G    CRITICALITY ignore  TYPE G  PRESENCE mandatory } ,
    ...
}

H-List ::= SEQUENCE (SIZE (1..maxH)) OF ProtocolIE-Container { {H-IEs} }

H-IEs RANAP-PROTOCOL-IES ::= {
    { ID id-H    CRITICALITY ignore  TYPE H  PRESENCE mandatory } ,
    ...
}

H ::= SEQUENCE {
    g                G-List3 OPTIONAL,
    iE-Extensions  ProtocolExtensionContainer { {H-ExtIEs} }  OPTIONAL,
    ...
}

```

```

H-ExtIEs RANAP-PROTOCOL-EXTENSION ::= {
  ...
}

G-List3 ::= SEQUENCE (SIZE (1..3, ...)) OF ProtocolIE-Container { {G3-IEs} }

G3-IEs RANAP-PROTOCOL-IES ::= {
  { ID id-G    CRITICALITY notify  TYPE G  PRESENCE mandatory },
  ...
}

G-List1 ::= ProtocolIE-Container { {G1-IEs} }

G1-IEs RANAP-PROTOCOL-IES ::= {
  { ID id-G    CRITICALITY reject  TYPE G  PRESENCE mandatory },
  ...
}

J-List ::= SEQUENCE (SIZE (1..maxJ)) OF J

J ::= SEQUENCE {
  g          G-List4 OPTIONAL,
  iE-Extensions ProtocolExtensionContainer { {J-ExtIEs} } OPTIONAL,
  ...
}

J-ExtIEs RANAP-PROTOCOL-EXTENSION ::= {
  ...
}

G-List4 ::= SEQUENCE (SIZE (1..3, ...)) OF ProtocolIE-Container { {G4-IEs} }

G4-IEs RANAP-PROTOCOL-IES ::= {
  { ID id-G    CRITICALITY reject  TYPE G  PRESENCE mandatory },
  ...
}

C ::= SEQUENCE {
  k          K-List,
  iE-Extensions ProtocolExtensionContainer { {C-ExtIEs} } OPTIONAL,
  ...
}

C-ExtIEsA -PROTOCOL-EXTENSION ::= {
  ...
}

K-List ::= SEQUENCE (SIZE (1..maxK)) OF ProtocolIE-Container { {K-IEs} }

K-IEs RANAP-PROTOCOL-IES ::= {
  { ID id-K    CRITICALITY notify  TYPE K  PRESENCE mandatory },
  ...
}

K ::= SEQUENCE {
  l          L-List,
  iE-Extensions ProtocolExtensionContainer { {K-ExtIEs} } OPTIONAL,
  ...
}

K-ExtIEs RANAP-PROTOCOL-EXTENSION ::= {
  ...
}

L-List ::= SEQUENCE (SIZE (1..maxL)) OF L

L ::= SEQUENCE {
  m          M OPTIONAL,
  iE-Extensions ProtocolExtensionContainer { {L-ExtIEs} } OPTIONAL,
  ...
}

L-ExtIEs RANAP-PROTOCOL-EXTENSION ::= {
  ...
}

ExampleMessage-Extensions RANAP-PROTOCOL-EXTENSION ::= {

```

} ...

Annex B (informative): RANAP Transparent containers content

Transparent containers are used in order to transfer information from one RAN node to another RAN node. Depending on the particular scenario the behaviour of both involved RAN nodes may be either specified according to the same radio system or according to different radio systems. During an inter-system handover the source RAN node has to adopt to the target RAN node and its requirements.

In RANAP, for intra-system relocation and inter-system handover to and from E-UTRAN, there is a single transparent container defined for transporting information from the source to the target RAN node and a single transparent container for transporting information from the target to the source RAN node during relocation/handover preparation: the *Source to Target Transparent Container* IE and the *Target to Source Transparent Container* IE, which may carry either UTRAN or E-UTRAN specific information.

Note: The definition of generic transparent containers for relocation/handover purposes allows to transport them through the core network in a RAT-agnostic way. Inter-system handover to GERAN is not affected by this scheme.

Therefore the container content is encoded according to the rules which are specified for in the target radio system. In subclause 8.6.2, it is described how the transparent container shall be encoded with respect to the scenario in which it is used.

The table below is showing all possible scenarios and definitions according to which the content of the transparent container shall be encoded. Additionally the reference to the specification defining particular IE is given.

Table B.1: Specification of Transparent Containers referenced in RANAP.

Scenario	<i>Source to Target Transparent Container</i> IE in RANAP: RELOCATION REQUIRED message		<i>Target to Source Transparent Container</i> IE in RANAP: RELOCATION COMMAND message	
	Name of the IE	Definition in specification	Name of the IE	Definition in specification
Intra UTRAN relocation	Source RNC to Target RNC Transparent Container	25.413	Target RNC to Source RNC Transparent Container	25.413
Inter-system handover to E-UTRAN	Source eNB to Target eNB Transparent Container	36.413	Target eNB to Source eNB Transparent Container	36.413

Annex C (informative): Processing of Transparent Containers at the SGSN

Irrespective of the mobility scenario (inter-RAT or intra-UMTS), the SGSN always processes the *Source to Target Transparent Container* IE and the *Target to Source Transparent Container* IE in the following way:

- The SGSN shall convey to the RNC the information received within
 - the GTPv1-C "UTRAN transparent field" of the "UTRAN Transparent Container" IE across the Gn interface (see subclause 7.7.38 of TS 29.060 [35]), or
 - the GTPv2 "F-container field" of the "F-Container" IE across the S3/S16 interface (see subclause 8.48 of TS 29.274 [36])by including it in either the *Source to Target Transparent Container* IE or the *Target to Source Transparent Container* of the corresponding RANAP message.
- The SGSN shall convey to the GTP peer the information received within either the *Source to Target Transparent Container* IE or the *Target to Source Transparent Container* IE by including it in
 - the GTPv1-C "UTRAN transparent field" of the "UTRAN Transparent Container" IE across the Gn interface (see subclause 7.7.38 of TS 29.060 [35]), or
 - the GTPv2 "F-container field" of the "F-Container" IE across the S3/S16 interface (see subclause 8.48 of TS 29.274 [36]).

Annex D (informative): Change History

TSG #	TSG Doc.	CR	Rev	Subject/Comment	New
06	RP-99746	-		Approved at TSG RAN #6 and placed under Change Control	3.0.0
07	-	-		Approved at TSG RAN #7	3.1.0
08	-	-		Approved at TSG RAN #8	3.2.0
09	RP-000373	124- 136, 138, 168- 171, 173, 174		Approved at TSG RAN #9	3.3.0
09	RP-000374	175, 177- 179, 181- 184		Approved at TSG RAN #9	3.3.0
10	RP-000613 RP-000695	185- 191, 194- 199, 201, 203- 207, 210- 214, 219, 221- 232, 234, 235		Approved at TSG RAN #10	3.4.0
11	RP-010110	236, 238, 240- 243, 245- 246, 248, 249, 253- 258, 260, 261, 263, 266		Approved at TSG RAN #11	3.5.0
11	RP-010111	268, 275		Approved at TSG RAN #11	3.5.0
11	RP-010158	271		Approved at TSG RAN #11 and placed under Change Control	4.0.0
11	RP-010189	265		Approved at TSG RAN #11 and placed under Change Control	4.0.0
11	RP-010156	272, 273, 274		Approved at TSG RAN #11 and placed under Change Control	4.0.0
11	RP-010155	252		Approved at TSG RAN #11 and placed under Change Control	4.0.0
11	RP-010163	250		Approved at TSG RAN #11 and placed under Change Control	4.0.0
12	RP-010454	277, 279, 281, 285, 287, 289, 291, 294,		Approved at TSG RAN #12	4.1.0

		296, 299			
--	--	-------------	--	--	--

12	RP-010375	301, 315, 317, 319, 323		Approved at TSG RAN #12	4.1.0
12	RP-010392	303, 320		Approved at TSG RAN #12	4.1.0
13	RP-010578	324	1	Correction to the Error handling of the ERROR INDICATION message	4.2.0
13	RP-010578	326	1	Alignment of Conditional Presence with RAN3 Specification Principles	4.2.0
13	RP-010578	328		NAS Synchronisation Indicator also at RAB Establishment	4.2.0
13	RP-010578	329	2	Old BSS to New BSS IE optional in UMTS to GSM handover	4.2.0
13	RP-010578	330		Order of elements in bitstrings	4.2.0
13	RP-010578	337		Data Forwarding related IEs in RELOCATION COMMAND message	4.2.0
13	RP-010578	339	1	Error handling of the Erroneously Present Conditional IEs	4.2.0
13	RP-010578	345	1	Rapporteurs corrections in RANAP	4.2.0
13	RP-010578	347	3	Inconsistency in definition of parameters used in INVOKE_TRACE message	4.2.0
13	RP-010579	359	1	Clarification of chapter 10	4.2.0
13	RP-010579	364	1	Condition of SDU format information IE	4.2.0
13	RP-010579	368	1	Relocation Requirement not to be used	4.2.0
13	RP-010594	297	2	Clarification on User Plane Version Indication	4.2.0
13	RP-010594	302	7	Release 4 additions in Lu to support new positioning methods	4.2.0
13	RP-010698	244	7	N-to-M relation between CN and UTRAN	4.2.0
14	RP-010895	361	3	CR on Priority range	4.3.0
14	RP-010848	365		Bitstrings ordering	4.3.0
14	RP-010848	369	2	UP Versions not supported	4.3.0
14	RP-010848	371	1	Location Report Area	4.3.0
14	RP-010848	378	1	Reason for LOCATION REPORT message is not clear	4.3.0
14	RP-010848	380	1	Corrections to RRC information containers	4.3.0
14	RP-010848	383		Procedure Code Criticality in Error Indication	4.3.0
14	RP-010848	386	2	Addition of amendment to clarify the PER encoding of bitstrings	4.3.0
14	RP-010848	388	2	Chosen Integrity Protection Algorithm IE over MAP/E interface	4.3.0
14	RP-010848	390		Rapporteurs corrections in RANAP (MCC/MNC)	4.3.0
14	RP-010849	394	1	Clarification on Location Request not fulfilled	4.3.0
14	RP-010849	396	1	Subflow SDU Size clarification	4.3.0
14	RP-010849	400		Correction the Clause 10 Error Handling	4.3.0
14	RP-010871	363	1	Cause value for not accepted relocation request	4.3.0
14	RP-010871	367	1	Correction to Release 4 additions in Lu to support new positioning methods	4.3.0
14	RP-010871	372		Chapter A.2.1 (EXAMPLE MESSAGE Layout) missing in version 4.2.0	4.3.0
14	RP-010871	373	1	N-to-M relation between CN and UTRAN impacts on CN initiated Reset Resource procedure	4.3.0
14	RP-010871	374		Stop Direct Report	4.3.0
14	RP-010871	384	1	MCC implementation CR for corrections to Release 4 additions in Lu to support new positioning methods.	4.3.0
14	RP-010871	397	1	Correction to LCS Vertical Accuracy	4.3.0
15	RP-020164	402		Question regarding SRNS Context Transfer and SRNS Data Forwarding Initiation	4.4.0
15	RP-020164	407		Intersystem Change and inter-system Handover corrections	4.4.0
15	RP-020164	418		RAB Modification Parameters	4.4.0
15	RP-020164	422	1	Delivery of erroneous SDUs	4.4.0
15	RP-020164	424	2	Handling of Global RNC-ID in Reset and Reset resource	4.4.0
15	RP-020164	426	2	RABs concerned by contexts transfer	4.4.0
15	RP-020164	432		Alignment of definition of Guaranteed Bitrate with 25.415	4.4.0
15	RP-020262	435	4	Inclusion of "Age of Location IE into LOCATION REPORT"	4.4.0
15	RP-020179	408		Requirements on user plane initialisation moved to 25.415	4.4.0
15	RP-020179	429	1	Correction to LCS Vertical Accuracy Code IE	4.4.0
15	RP-020189	419	3	Introduction of IP Transport option in UTRAN	5.0.0
15	RP-020257	431	1	NNSF Functional Description	5.0.0
15	RP-020188	409	2	Transport Layer Address at RAB modification	5.0.0
15	RP-020188	428	3	Implementation of Handover/Relocation Solution for Inter-RAN Load Information Exchange between RAN and GERAN for Rel'5	5.0.0
16	RP-020423	404	6	Release 5 additions of ROHC context relocation support during SRNS relocation	5.1.0
16	RP-020401	437		Criticality Information Decoding Failure Handling	5.1.0

16	RP-020401	440	2	Erroneous Security Mode Control procedure	5.1.0
16	RP-020401	443		Correction of Target RNC-ID	5.1.0
16	RP-020401	444	1	SDU Format Information Presence	5.1.0
16	RP-020417	448		Extension container for Last Known Service Area IE	5.1.0
16	RP-020401	451		'EXTENSION INDICATION' PROPOSAL	5.1.0
16	RP-020417	453		Correction of wrong implementation for CR429	5.1.0
16	RP-020401	462	1	RNL-TNL coordination in RANAP	5.1.0
16	RP-020401	465	2	Correction of RNC lu Coordinated relocation	5.1.0
16	RP-020421	466	1	IPv4-IPv6 interworking for data forwarding	5.1.0
16	RP-020401	469	1	Clarification for the usage of the cause value	5.1.0
16	RP-020417	479	1	Correction due to the wrong implementation of CR326&244 and error in the CR424	5.1.0
17	RP-020606	481		Erroneous criticality in DATA VOLUME REPORT REQUEST a.o.	5.2.0
17	RP-020600	484	2	Handling of security at relocation	5.2.0
17	RP-020629	488	1	CRRM Corrections	5.2.0
17	RP-020600	495	1	Codec change during SRNS relocation	5.2.0
17	RP-020606	503	1	New cause value for RAB release request	5.2.0
17	RP-020625	504	2	Shared Networks in connected mode – Information Transfer	5.2.0
17	RP-020624	506	2	GERAN specific impacts on the lu-cs interface	5.2.0
17	RP-020600	509	1	Correction to RANAP cause value range	5.2.0
17	RP-020606	513		LCS alignment with stage 2	5.2.0
17	RP-020643	515		Signalling enhancements for GERAN lu Mode LCS	5.2.0
18	RP-020517	517		Correction to RANAP RESET procedure	5.3.0
18	RP-020522	522	1	Rel4 Common CR after RANAP review	5.3.0
18	RP-020526	526	4	Correction to enable Rel4 extensions in Location Reporting Control procedure.	5.3.0
18	RP-020529	529	2	Correction of RAB Subflows and SRBs mapping onto the transport channel identifiers of lur in the Source RNC to Target RNC transparent container	5.3.0
18	RP-020532	532	1	Correction of coding of GSM IEs	5.3.0
18	RP-020533	533	1	New cause codes for Network sharing in connected mode	5.3.0
18	RP-020535	535	1	Encoding of information elements.	5.3.0
19	RP-030060	546	1	Addition of RAB Subflows mapping onto the transport channel identifiers of lur in the Source RNC to Target RNC transparent container for HSDPA	5.4.0
19	RP-030067	550		Alignment of 'Uncertainty Ellipse' with RRC	5.4.0
19	RP-030056	552	1	Duplicated lu connection identifiers	5.4.0
19	RP-030060	557	1	Inclusion of IMS Signalling Indication into R5 RANAP	5.4.0
19	RP-030060	558		Correction to RANAP due to GERAN lu mode	5.4.0
19	RP-030056	562		Essential correction of IMSI coding	5.4.0
20	RP-030314	570	2	Essential Correction of lu Release Issue	5.5.0
20	RP-030326	572	1	Correction of Failure message used for logical errors	5.5.0
20	RP-030339	573	2	Introduction of Early UE Handling – Bitmap Option	5.5.0
20	RP-030316	576	2	lu UP Initialisation during RAB modification	5.5.0
21	RP-030445	578		Alignment of title and sub-clause text of chapter 10.3.4.2	5.6.0
21	RP-030437	584	1	Essential Correction of lu Release Request	5.6.0
21	RP-030439	586	2	Introduction of positioning methods over lu	5.6.0
21	RP-030439	590	1	Alignment of RANAP and RNSAP CRRM solutions	5.6.0
21	RP-030439	594		RNC use of IMSI within Relocation Resource Allocation	5.6.0
21	RP-030446	595		Removal of the note in chapter 10	5.6.0
22	RP-030671	597	-	Backwards Compatibility for LCS- Limited Solution	5.7.0
22	RP-030676	601	2	Serious Correction for Rescue handover	5.7.0
22	RP-030676	604	-	Serious Correction for Security in Multi-domain calls	5.7.0
22	RP-030715	606	2	Correction of RAB Release Request Inter-working	5.7.0
22	RP-030676	607	3	RANAP Review issue 2: Correction of Position Data	5.7.0
22	RP-030676	608	-	RANAP Review issue 3: LCS Accuracy	5.7.0
22	RP-030671	613	1	Add IE 'Criticality Diagnostics' for LOCATION RELATED DATA FAILURE message	5.7.0
22	RP-030686	614	1	RT Load Value Clarification	5.7.0
22	RP-030671	618	1	Correction of Reference section	5.7.0
22	RP-030676	620	1	Corrections to the data volume reporting function	5.7.0
22	RP-030676	622	2	Big clarification CR based on RANAP Rel-5 review	5.7.0
22	RP-030676	623	2	Correction to CRRM lu solution	5.7.0
22	-	-	-	Introduction of Release 6 specification	6.0.0
23	RP-040053	641		Alignment with 23.032 correction of Included Angle for Ellipsoid Arc	6.1.0

23	RP-040062	634		Correction of GERAN related Release 5 IEs	6.1.0
23	RP-040062	636	1	Causes used in RANAP	6.1.0
23	RP-040062	638		Inaccuracies in the specification of the Overload procedure	6.1.0
23	RP-040062	643	1	Clarification on lu reset procedure	6.1.0
23	RP-040062	652		Integrity Status Correction	6.1.0
23	RP-040062	654		Coding of Discontinuous Transmission/No_Data mode	6.1.0
24	RP-040216	658		Introduction of an indication of achieved accuracy in Location Report procedure over lu interface.	6.2.0
24	RP-040174	662	3	Data Volume Reporting Correction	6.2.0
24	RP-040174	667	1	SNA Coding correction	6.2.0
24	RP-040182	668	2	Introduction of RIM mechanisms for NACC over the lu interface	6.2.0
24	RP-040174	672		Correction of Transport Layer Address and lu Transport Association handling in RAB Assignment	6.2.0
24	RP-040183	673	1	Management Based Activation in the UTRAN over the lu	6.2.0
24	RP-040183	674	1	Enhancement of Trace handling during Relocation	6.2.0
24	RP-040183	675	1	Modification of CN Invoke Trace for Subscriber and Equipment Trace support over lu	6.2.0
25	RP-040298	681	4	Addition of Relocation Failure cause code to match GERAN cause code	6.3.0
25	RP-040299	692	3	Data Volume Reporting Correction	6.3.0
25	RP-040299	696	2	Service Handover Timing and Priority	6.3.0
25	RP-040299	700	1	presence of ciphering key in the RANAP container	6.3.0
26	RP-040439	701		Indication of selected PLMN in shared networks	6.4.0
26	RP-040439	702	1	Rerouting in MOCN	6.4.0
26	RP-040437	706	2	MBMS stage 3 support over lu	6.4.0
26	RP-040439	715	2	Support of full Mobility/Backwards Compatibility in Network Sharing	6.4.0
26	RP-040441	719		Correction of reference to outdated ITU-T recommendations	6.4.0
				space removed in ASN.1 from "MBMSSessionStartResponse"	6.4.1
27	RP-050057	721	3	MBMS Session Repetition Number on Session Start	6.5.0
27	RP-050057	724	3	MBMS RAB Management	6.5.0
27	RP-050052	730	2	Essential Correction on Direct Transfer Messages	6.5.0
27	RP-050057	734		MBMS Contexts	6.5.0
27	RP-050057	737	3	MBMS IE codings	6.5.0
27	RP-050057	738		MBMS Session Failure	6.5.0
27	RP-050059	739	2	Support of Network-initiated Scudif (revision of R3-041734)	6.5.0
27	RP-050052	740	1	Correction of RANAP Containers and CRRM	6.5.0
28	RP-050227	741		MBMS Session Duration IE	6.6.0
28	RP-050229	742	1	Addition of E-DCH MAC-d Flow ID in transparent Container	6.6.0
28	RP-050233	743	1	Correction to the RANAP in lu-Flex Paging without TMSI.	6.6.0
28	RP-050227	745	2	Enhancement for MBMS SESSION START message	6.6.0
28	RP-050233	747	1	Presence information for RAC in Target ID towards PS domain	6.6.0
28	RP-050217	749		Correction of CR729	6.6.0
28	RP-050227	750	1	Correction of MBMS figure title	6.6.0
28	RP-050236	752		Release after rerouting attempt	6.6.0
28	RP-050236	753		No Relocation during MOCN Rerouting	6.6.0
28	RP-050217	763		Correction of Cell Load Information Group	6.6.0
28	RP-050233	768		Correction of queuing at relocation	6.6.0
29	RP-050443	773		MBMS applies for the PS domain	6.7.0
29	RP-050473	782		Inclusion of Inter-RAT PS Handover between UTRAN and GERAN A/Gb	6.7.0
29	RP-050444	784	1	Clarification of the Relocation Cancel and Relocation Preparation	6.7.0
30	RP-050692	791	1	Introduction of the Time to MBMS Data Transfer	6.8.0
30	RP-050693	796		Correction of SCUDIF Relocation	6.8.0
30	RP-050693	797	1	Error Handling of unused IEs	6.8.0
30	RP-050693	801	1	Rewording of interaction text from CR784	6.8.0
30	RP-050693	803	1	Rapporteur's Review of 25.413	6.8.0
30	RP-050692	804	1	MBMS Service Area List IE Encoding Correction	6.8.0
03/2006	-	-		Release 7 version created based on v6.8.0	7.0.0
31	RP-060072	0770	10	Enabling the Providing of Velocity	7.1.0
31	RP-060061	0806		Correction of IE name in procedure text for MBMS Session Update	7.1.0
31	RP-060061	0810	2	Correction of signaling bearer mode for MBMS Registration Failure	7.1.0
31	RP-060061	0825	2	PS/CS coordination in shared RAN for MOCN	7.1.0
31	RP-060061	0827	2	Inclusion of redirect attempt flag in Initial UE Message	7.1.0
31	RP-060061	0829		SRB mapping toward HS-DSCH and E-DCH MAC-d flows	7.1.0
31	RP-060062	0831	1	lu Release when detecting double lu	7.1.0
32	RP-060288	0834	4	Correction of performance measurement point IRATHO.SuccOutPSUE	7.2.0

32	RP-060289	0835	1	Clarification on setting the Accuracy Fulfilment Indicator IE by the RNC	7.2.0
32	RP-060278	0843	3	SI/PSI information transfer for PS handover	7.2.0
32	RP-060386	0844	2	Correction of positioning confidence reporting inconsistencies	7.2.0
32	RP-060278	0849		Unclear presence of Selected PLMN identity IE in case of network sharing non supporting UEs	7.2.0
32	RP-060278	0851	1	Handling of preserved nrt RABs	7.2.0
32	RP-060278	0853	1	Target RNC ID in RIM Routing Information towards an RNC	7.2.0
33	RP-060499	0856	1	Criticality Diagnostics IE for MBMS RAB Release	7.3.0
33	RP-060514	0857	2	Status of Service Handover IE	7.3.0
33	RP-060514	0858		Alignment of PLMN identity	7.3.0
33	RP-060499	0860		Correction of the Meaning of cause value	7.3.0
33	RP-060510	0861	1	Addition of Periodic Location Procedures	7.3.0
33	RP-060579	0871	2	Inclusion of the MBMS Counting Information IE to the MBMS Session Start Request	7.3.0
33	RP-060590	0873		Removal of MBMS SAI Semantic Description in RANAP	7.3.0
34	RP-060724	0854	2	Introduction of inter-RAT DTM Handover	7.4.0
34	RP-060713	0865	4	Introduction of new ciphering algorithm UEA2 and integrity protection algorithm UIA2	7.4.0
34	RP-060698	0879	2	Conditions for MBMS RAB set up	7.4.0
34	RP-060706	0883	5	Introducing Direct Tunnel in RANAP	7.4.0
34	RP-060698	0885	3	RNC Rejection of MBMS Session Setup with a TMGI already used for another ongoing MBMS session	7.4.0
34	RP-060698	0889	1	MBMS session Repetition Number Corrections	7.4.0
35	RP-070063	0891	2	Direct Tunnel Correction	7.5.0
35	RP-070063	0895	2	Signalling RABs	7.5.0
35	RP-070063	0898	1	Mandatory use of transport layer information	7.5.0
35	RP-070063	0900		Modification of Rules for Building RANAP Messages	7.5.0
35	RP-070054	0902	2	Correction on MBMS SESSION START and MBMS SESSION UPDATE	7.5.0
35	RP-070061	0906	3	Introduction of MIMO in RANAP	7.5.0
35	RP-070056	0908	2	MBMS Session setup of a parallel session of the same service in a distinct MBMS service area	7.5.0
35	RP-070054	0910		Update of MBMS Session Duration	7.5.0
36	RP-070474	0905	5	Introduction of Extended RNC-ID	7.6.0
36	RP-070322	0914	3	Clarification on distinguishing MBMS Service Areas of Multiple parallel MBMS Sessions of the same service	7.6.0
36	RP-070339	0924	2	Frequency Layer Convergence	7.6.0
36	RP-070337	0925	2	Introduction of GANSS (Galileo and Additional Navigation Systems) in RANAP	7.6.0
37	RP-070567	0928	1	Correction to GANSS Location Related Data Request	7.7.0
37	RP-070565	0930		MBMS broadcast RAB Set Up	7.7.0
37	RP-070578	0932		Correction for RNC ID	7.7.0
37	RP-070578	0934	1	Maximum number of Iu Signalling Connection Identifiers	7.7.0
37	RP-070581	0935		UE Involved Relocation for source RNC not having Iu-CS UP	7.7.0
38	RP-070838	0939	1	ASN1-Tabular alignment for GANSS feature in TS25.413	7.8.0
38	RP-070837	0941		Explicit references to TRs 25.994 and 25.995	7.8.0
38	RP-070842	0942		Rapporteurs Review	7.8.0
38	RP-070844	0943	2	Introduction of cause value for CS-triggered relocation	7.8.0
40	RP-080297	0950		Correction of the Release of MBMS Signalling Connection	7.9.0
09/2008	-	-		Rel-8 version created based on v7.9.0	8.0.0
41	RP-080589	0952	2	Introduction of Enhanced Relocation	8.0.0
41	-	-		ASN.1 error corrected	8.0.1
42	RP-080852	0953		Support for additional navigation satellite systems in RANAP	8.1.0
42	RP-080849	0959	3	Introduction of UE History Information	8.1.0
42	RP-080849	0960	1	Introduction of MBMS Improved Solution	8.1.0
42	RP-080848	0961	3	Inter-RAT Mobility to/from E-UTRAN	8.1.0
42	RP-080855	0962		Introduction of the Subscriber Profile ID for RAT/Frequency priority	8.1.0
42	RP-080840	0963		ASN.1 changes for enhanced relocation	8.1.0
42	RP-080854	0965	2	RANAP changes to support the use of CSG Identifiers	8.1.0
42	RP-080856	0966		Removal of Recovery and Restoration from 23.060	8.1.0
43	RP-090083	0971		Cause value mapping for CSFB	8.2.0
43	RP-090079	0974	2	Clarification of usage of MBMS RAB release for MBMS broadcast	8.2.0
43	RP-090075	0977	2	Clarification of usage of Extended MBR and GBR	8.2.0
43	RP-090076	0978		Clarification on Source ID	8.2.0
43	RP-090078	0979	1	Editorial Updates TS 25.413	8.2.0

43	RP-090245	0980		Transparent Container content – informative annex	8.2.0
43	RP-090093	0981		Introduction of HSPA SRVCC	8.2.0
43	RP-090079	0982	2	Further Corrections for Enhanced Relocation	8.2.0
43	RP-090081	0983		Inclusion of CSG ID in initial UE message	8.2.0
43	RP-090078	0984		Clarification on ASN.1 for Generic Container	8.2.0
43	RP-090263	0985		Rename of Source RNC ID in ENHANCD RELOCATION COMPLETE REQUEST	8.3.0
March 2009	-	-	-	ASN.1 debugging before freezing	8.3.1
44	RP-090638	0988		Addition of Integrity Protection Information IE and Encryption Information IE into Enhanced SRNS Relocation	8.3.0
44	RP-090641	0989	4	RANAP changes to support paging optimisation	8.3.0
44	RP-090633	0994		Correction of extended alternative bit rate	8.3.0
44	RP-090633	0996		Structure of procedure text for Relocation Preparation	8.3.0
44	RP-090635	0998	1	Interaction between Enhanced Relocation and RAB Assignment Procedure	8.3.0
44	RP-090642	0999	1	Correction of introduction of HSPA SRVCC	8.3.0
44	RP-090642	1000		Correction of the Global CN-ID for the PS domain	8.3.0
44	RP-090636	1002		Introduction of E-UTRAN Service Handover IE	8.3.0
45	RP-090770	1015		Correction of ASN.1 Target Cell ID missing	8.4.0
09/2009	-	-	-	Rel-9 version created based on v8.4.0	9.0.0
45	RP-090777	1009	2	Introduction of UE-AMBR Concept in UMTS	9.0.0
46	RP-091191	1008	4	Support for paging optimization with CSG membership changes	9.1.0
46	RP-091191	1018	1	Target Cell ID for HNB in-bound HO	9.1.0
46	RP-091191	1037	1	Inclusion of CSG information for access control in 3G handover procedures and UE prioritization in 3G hybrid cells.	9.1.0
47	RP-100219	1038	-	Correction of CSG Cell and Hybrid Cell Definition	9.2.0
47	RP-100222	1039	1	Clarification on the Access Control of Non-CSG UE During Inbound Handover	9.2.0
47	RP-100222	1041	1	Handling of CSG ID check failure in hybrid cells	9.2.0
47	RP-100215	1043	-	Correct name of Target eNB ID to align with 36.413	9.2.0
47	RP-100228	1044	-	Inter RAT Mobility Load Balancing on lu	9.2.0
47	RP-100222	1047	-	Correct wrong CSG ID reference	9.2.0
47	RP-100229	1048	1	Description of Transparent Container Encoding	9.2.0
47	RP-100229	1049	-	Rapporteur"s update for RANAP protocol	9.2.0
47	RP-100219	1051	2	Addition of IP Source Address in MBMS Synchronisation Information in MBMS Session Start	9.2.0
47	RP-100348	1053	4	CSG expiry Handling	9.2.0
47	RP-100214	1056	1	Correction of CSFB	9.2.0
48	RP-100592	1058	1	UTRAN Trace ID Abnormal Conditions	9.3.0
48	RP-100595	1059	-	Some Corrections to the Inbound Mobility Procedure	9.3.0
48	RP-100599	1061	4	Introduction of IPv4 and Ipv6 Dual Stack option	9.3.0
48	RP-100595	1063	1	Correct the description on the Relocation Failure handling	9.3.0
48	RP-100599	1064	3	Release 7 QoS subscription data for Pre-Release 7 UE	9.3.0
48	RP-100599	1067	1	Enhancement of Location Reporting functionality interaction with Enhanced Relocation	9.3.0
49	RP-100907	1074	-	Correction of Forwarding TNL IE for Enhanced Relocation	9.4.0
49	RP-100907	1075	-	Correction of the interaction between CN Invoke Trace and Enhanced Relocation	9.4.0
49	RP-100907	1076	-	Correction of inconsistencies between tabular, procedural text and ASN.1 code for Enhanced Relocation	9.4.0
50	RP-101269	1081		Correction of Inter-system SRVCC	9.5.0
12/2010				Rel-10 version created based on v9.5.0	10.0.0
50	RP-101389	1084		Introduction of the SIPTO at lu-PS Function	10.0.0
50	RP-101389	1086	2	LIPA Impact In RAN3	10.0.0
50	RP-101304	1087	2	Inter-RAT MRO for Detection of too early inter-RAT handover with no RLF	10.0.0
01/2011				Editorial change: highlighting removed	10.0.1
SP-49	SP-100629			Clarification on the use of References (TS 21.801 CR#0030)	10.1.0
51	RP-110226	1090		Correction to Integrity Protection Information and Encryption Information	10.1.0
51	RP-110239	1091	1	Addition of MeasurementBandwidth and ASN.1 clean-up for IRAT measurement configuration	10.1.0
51	RP-110230	1094	1	Introduction of MDT	10.1.0
51	RP-110231	1095	1	Additional IEs needed to support optimized HNB-HNB mobility	10.1.0
51	RP-110233	1096	3	Introduction of Low Priority Traffic Overload support	10.1.0

51	RP-110226	1099	2	Clarification on TEID value range for RANAP	10.1.0
51	RP-110225	1100	1	the description usage of NONCE in RNC	10.1.0
52	RP-110695	1104	3	User consent indication for MDT in RANAP	10.2.0
52	RP-110713	1111	1	Clarification to detection of unnecessary IRAT handover	10.2.0
52	RP-110681	1114	2	Correction of SRVCC from LTE to UMTS	10.2.0
52	RP-110684	1115	-	Correction of References	10.2.0
52	RP-110686	1116	2	General clean-up before Rel-10 ASN.1 closure	10.2.0
52	RP-110695	1118	2	MDT UTRAN amendments	10.2.0
53	RP-111197	1120	1	Addition of SRVCC preparation into message type tabular	10.3.0
53	RP-111195	1122	-	Correct definition of condition IfM2 in MDT Configuration	10.3.0
53	RP-111195	1123	3	Clarification on MDT Recording Session Reference in MDT Configuration	10.3.0
53	RP-111195	1124	2	Area scope RAI list in MDT configuration	10.3.0
53	RP-111195	1130	2	Definition of value of bit in Measurements to Activate	10.3.0
53	RP-111193	1132	2	Correction of Rel-7 QoS handling for Pre-Rel-7 UEs	10.3.0
53	RP-111196	1133	-	Correction of some generic references to dated references	10.3.0
53	RP-111195	1134	1	Small correction on unnecessary IRAT HO	10.3.0
53	RP-111198	1139	-	Alignment of the transparent containers' IE names with CT4 specifications	10.3.0
54	RP-111651	1140	-	Introduction of the annex on the processing of transparent containers at SGSN	10.4.0
54	RP-111649	1141	2	Addition of TCE IP in CN INVOKE TRACE	10.4.0
54	RP-111646	1143	-	Correction of Emergency Call	10.4.0
54	RP-111651	1148	1	Fast Return after CSFB	10.4.0
54	RP-111651	1149	1	Correction of Routing	10.4.0
55	RP-120232	1153	1	Correction on unnecessary HO	10.5.0
56	RP-120743	1166	1	Correction to assigned criticality of L-GW Transport Layer Address	10.6.0
56	RP-120752	1167	1	Introduction of the new IE for cell reselection from UTRA connected mode	11.0.0
56	RP-120752	1172	1	Improved granularity for the time UE stayed in cell	11.0.0
57	RP-121130	1177	2	Correction on handover to a CSG cell with an emergency call	11.1.0
57	RP-121135	1190	2	Addition of HO cause value to the UE history information in RANAP	11.1.0
57	RP-121140	1194	3	Introduction of UE Radio Capability Match procedure	11.1.0
57	RP-121140	1195	1	Introduction of Anonymization of MDT data for area based MDT in UTRAN	11.1.0
58	RP-121736	1196	-	ASN.1 correction	11.2.0
58	RP-121736	1197	-	Improved granularity for the time UE stayed in cell for enhanced relocation	11.2.0
58	RP-121728	1198	-	Introduction of rSRVCC	11.2.0
58	RP-121728	1202	2	Introduction of the support for rSRVCC network sharing	11.2.0
58	RP-121737	1203	-	Rapporteur editorial corrections	11.2.0
58	RP-121730	1204	2	Multi-PLMN MDT	11.2.0
58	RP-121732	1208	1	Introduction of connectivity between HNB and RNC via HNB-GW for RNSAP signaling: Enhanced Relocation between HNB and RNC	11.2.0
58	RP-121730	1209	2	Introduction of new MDT measurements	11.2.0
58	RP-121739	1211	2	New Information for BBF access	11.2.0
58	RP-121736	1214	2	Clarification of E-UTRAN Service Handover IE for inter-RAT roaming restrictions	11.2.0

History

Document history		
V11.1.0	October 2012	Publication
V11.2.0	January 2013	Publication