

ETSI TS 125 415 V4.2.0 (2001-09)

Technical Specification

Universal Mobile Telecommunications System (UMTS); UTRAN Iu interface user plane protocols (3GPP TS 25.415 version 4.2.0 Release 4)



Reference

RTS/TSGR-0325415Uv4R2

Keywords

UMTS

ETSI

650 Route des Lucioles
F-06921 Sophia Antipolis Cedex - FRANCE

Tel.: +33 4 92 94 42 00 Fax: +33 4 93 65 47 16

Siret N° 348 623 562 00017 - NAF 742 C
Association à but non lucratif enregistrée à la
Sous-Préfecture de Grasse (06) N° 7803/88

Important notice

Individual copies of the present document can be downloaded from:

<http://www.etsi.org>

The present document may be made available in more than one electronic version or in print. In any case of existing or perceived difference in contents between such versions, the reference version is the Portable Document Format (PDF). In case of dispute, the reference shall be the printing on ETSI printers of the PDF version kept on a specific network drive within ETSI Secretariat.

Users of the present document should be aware that the document may be subject to revision or change of status. Information on the current status of this and other ETSI documents is available at

<http://portal.etsi.org/tb/status/status.asp>

If you find errors in the present document, send your comment to:

editor@etsi.fr

Copyright Notification

No part may be reproduced except as authorized by written permission.
The copyright and the foregoing restriction extend to reproduction in all media.

© European Telecommunications Standards Institute 2001.
All rights reserved.

Intellectual Property Rights

IPRs essential or potentially essential to the present document may have been declared to ETSI. The information pertaining to these essential IPRs, if any, is publicly available for **ETSI members and non-members**, and can be found in ETSI SR 000 314: "*Intellectual Property Rights (IPRs); Essential, or potentially Essential, IPRs notified to ETSI in respect of ETSI standards*", which is available from the ETSI Secretariat. Latest updates are available on the ETSI Web server (<http://www.etsi.org/legal/home.htm>).

Pursuant to the ETSI IPR Policy, no investigation, including IPR searches, has been carried out by ETSI. No guarantee can be given as to the existence of other IPRs not referenced in ETSI SR 000 314 (or the updates on the ETSI Web server) which are, or may be, or may become, essential to the present document.

Foreword

This Technical Specification (TS) has been produced by ETSI 3rd Generation Partnership Project (3GPP).

The present document may refer to technical specifications or reports using their 3GPP identities, UMTS identities or GSM identities. These should be interpreted as being references to the corresponding ETSI deliverables.

The cross reference between GSM, UMTS, 3GPP and ETSI identities can be found under www.etsi.org/key.

Contents

Intellectual Property Rights	2
Foreword.....	2
Foreword.....	6
1 Scope	7
2 References	7
3 Definitions and abbreviations.....	7
3.1 Definitions	7
3.2 Abbreviations	9
3.3 Concepts	9
4 General	10
4.1 General aspects.....	10
4.2 Operational and Functional Aspects.....	11
4.2.1 Iu UP protocol modes of operation.....	11
4.2.2 Transparent mode (TrM)	11
4.2.3 Support mode.....	11
5 Transparent mode, version 1	12
5.1 General	12
5.1.1 Operation of the Iu UP in Transparent mode.....	12
5.1.2 Interfaces of the Iu UP protocol layer in Transparent mode	12
5.2 Iu UP Protocol layer Services in Transparent mode.....	13
5.3 Services Expected from the UP Data Transport layer	13
5.4 Elements for Iu UP communication in Transparent mode	13
5.4.1 Frame Format for transparent mode.....	13
6 Support mode for predefined SDU sizes, version 2	13
6.1 General	13
6.1.1 Operation of the Iu UP in Support mode	13
6.1.2 Interfaces of the Iu UP protocol layer in Support mode	13
6.2 Iu UP Protocol layer Services in Support mode	14
6.3 Services Expected from the UP Data Transport layer	14
6.4 Functions of the Iu UP Protocol Layer in Support mode	14
6.4.1 Functional model of the Iu UP Protocol Layer in Support mode.....	14
6.4.2 Frame Handler function	15
6.4.3 Procedure Control functions	15
6.4.4 Non Access Stratum Data Streams specific function(s).....	15
6.4.4.1 Frame Quality Classification function	15
6.4.4.1.1 General	15
6.4.4.1.2 Handling of FQC information in uplink path	16
6.4.4.1.3 Handling of FQC information in downlink path	17
6.5 Elementary procedures	17
6.5.1 Transfer of User Data procedure.....	17
6.5.1.1 Successful operation.....	17
6.5.1.2 Unsuccessful operation	18
6.5.2 Initialisation procedure	18
6.5.2.1 Successful operation.....	18
6.5.2.2 Unsuccessful operation	20
6.5.3 Iu Rate Control procedure.....	21
6.5.3.1 Successful operation.....	21
6.5.3.2 Unsuccessful operation	22
6.5.3.2A Frequent Rate Control Procedures	23
6.5.4 Time Alignment procedure	24
6.5.4.1 Successful operation.....	24
6.5.4.2 Unsuccessful operation	25

6.5.5	Handling of Error Event procedure.....	26
6.5.5.1	Successful operation.....	26
6.5.5.2	Unsuccessful operation	26
6.5.6	Frame Quality Classification procedure	27
6.6	Elements for Iu UP communication in Support mode.....	27
6.6.1	General.....	27
6.6.2	Frame Format for predefined size SDUs	28
6.6.2.1	PDU Type 0	28
6.6.2.2	PDU Type 1	29
6.6.2.3	PDU Type 14	30
6.6.2.3.1	General	30
6.6.2.3.2	Positive Acknowledgement	31
6.6.2.3.3	Negative Acknowledgement.....	32
6.6.2.3.4	Procedures Coding.....	33
6.6.3	Coding of information elements in frames	36
6.6.3.1	PDU Type	36
6.6.3.2	Ack/Nack	36
6.6.3.3	Frame Number	37
6.6.3.4	PDU Type 14 Frame Number	37
6.6.3.5	Frame Quality Classification (FQC)	37
6.6.3.6	RAB sub-Flow Combination Indicator (RFCI).....	37
6.6.3.7	Procedure Indicator	37
6.6.3.8	Header CRC	38
6.6.3.9	Payload CRC.....	38
6.6.3.10	Chain Indicator.....	38
6.6.3.11	Number of Subflows per RFCI	38
6.6.3.12	Length Indicator (LI).....	38
6.6.3.13	Number of RFCI Indicators	38
6.6.3.14	RFCI n Indicator	38
6.6.3.15	Error distance	39
6.6.3.16	Error Cause value.....	39
6.6.3.17	Padding	39
6.6.3.18	Time alignment	40
6.6.3.19	Spare	40
6.6.3.20	Spare extension	40
6.6.3.21	LRI, Last RFCI Indicator	40
6.6.3.22	Length of subflow	40
6.6.3.23	TI.....	40
6.6.3.24	IPTI of n th RFCI	41
6.6.3.25	Iu UP Mode versions supported.....	41
6.6.3.26	Iu UP Mode Version	41
6.6.3.27	Payload fields.....	41
6.6.3.28	Data PDU type	41
6.6.4	Timers	42
6.6.5	Maximum values of repetition counters.....	42
6.7	Handling of unknown, unforeseen and erroneous protocol data	42
6.7.1	General.....	42
6.7.2	Error detected by Iu UP functions	43
6.7.3	Request by upper layers	43
6.7.4	Error event frame over the Iu UP protocol	43
6.7.5	Handling of error reports	43
6.7.5.1	General	43
6.7.5.2	Error distance	44
6.7.6	List of errors in Iu UP	44
6.7.7	Error detection	46
6.7.7.1	General	46
6.7.7.2	CRC Calculation	46
6.7.7.3	Relation between input and output of the Cyclic Redundancy Check	46
7	Communication Primitives for the Iu UP protocol layer.....	46
7.1	Modelling Principle.....	46
7.2	Primitives towards the upper layers at the RNL SAP.....	47

7.2.1	General.....	47
7.2.2	Iu-UP-DATA-REQUEST	48
7.2.3	Iu-UP-DATA-INDICATION	48
7.2.4	Iu-UP-STATUS-REQUEST	48
7.2.5	Iu-UP-STATUS-INDICATION	48
7.2.6	Iu-UP-UNIT-DATA-REQUEST	48
7.2.7	Iu-UP-UNIT-DATA-INDICATION.....	48
7.3	Primitives towards the transport layers at TNL SAP.....	49
7.3.1	General.....	49
7.3.2	ATM/AAL2 based Transport layer.....	49
7.3.2.1	General	49
7.3.2.2	AAL2 Service Primitives used by the Iu UP protocol	49
7.3.3	GTP-U based Transport Layer.....	49
7.3.3.1	General	49
7.3.3.2	Generic Service Primitives used by the Iu UP protocol	49
8	Evolution of Iu UP Protocol.....	50
8.1	Principles for Protocol Evolution	50
8.1.1	Unknown field value.....	50
8.1.2	Adding a new field to an existing frame	51
8.1.3	Adding a new PDU type	51
8.1.4	Protocol version handling	51
Annex A (informative): Illustration of usage of RFCI for AMR speech RAB.....		53
Annex B (informative): Illustration of protocol states in the Iu UP		56
B.1	Protocol state model for transparent mode.....	56
B.1.1	Null State.....	56
B.1.2	Transparent Mode Data Transfer Ready State.....	56
B.2	Protocol state model for support mode for predefined SDU sizes	57
B.2.1	Null State.....	57
B.2.2	Initialisation State.....	57
B.2.3	Support Mode Data Transfer Ready State.....	58
Annex C (informative): Open Issues of the Iu UP		59
Annex D (informative): Distributed rate decision within RNC.....		60
Annex E (informative): Change History.....		61
History		62

Foreword

This Technical Specification (TS) has been produced by the 3rd Generation Partnership Project (3GPP).

The contents of the present document are subject to continuing work within the TSG and may change following formal TSG approval. Should the TSG modify the contents of the present document, it will be re-released by the TSG with an identifying change of release date and an increase in version number as follows:

Version x.y.z

where:

- x the first digit:
 - 1 presented to TSG for information;
 - 2 presented to TSG for approval;
 - 3 or greater indicates TSG approved document under change control.
- y the second digit is incremented for all changes of substance, i.e. technical enhancements, corrections, updates, etc.
- z the third digit is incremented when editorial only changes have been incorporated in the document.

1 Scope

The present document defines the Radio Network Layer user plane protocol being used over the Iu interface.

2 References

The following documents contain provisions which, through reference in this text, constitute provisions of the present document.

- References are either specific (identified by date of publication, edition number, version number, etc.) or non-specific.
- For a specific reference, subsequent revisions do not apply.
- For a non-specific reference, the latest version applies. In the case of a reference to a 3GPP document (including a GSM document), a non-specific reference implicitly refers to the latest version of that document *in the same Release as the present document*.

- [1] 3GPP TS 25.401: "UTRAN Overall Description".
- [2] 3GPP TS 25.410: "UTRAN Iu interface: General Aspects and Principles".
- [3] 3GPP TS 25.413: "UTRAN Iu interface RANAP Signalling".
- [4] 3GPP TS 25.414: "UTRAN Iu Interface Data Transport and Transport Signalling".
- [5] 3GPP TS 23.110: "UMTS Access Stratum Services and Functions".
- [6] 3GPP TS 23.121: "Architectural requirements for Release 1999".
- [7] ITU-T Recommendation I.363.2 (11/2000): "B-ISDN ATM Adaptation Layer specification: Type 2 AAL".
- [8] ITU-T Recommendation I.366.1 (1998): "Segmentation and reassembly service specific convergence sublayer for the AAL type 2".
- [9] 3GPP TR 25.990: "Vocabulary".
- [10] 3GPP TS 25.321: "Medium Access Control (MAC) protocol specification".
- [11] 3GPP TS 25.322: "Radio Link Control (RLC) protocol specification".
- [12] 3GPP TS 26.102: "Mandatory speech codec; AMR speech codec; Interface to Iu and Uu".
- [13] 3GPP TS 23.153: "Out of Band Transcoder Control; Stage 2".

3 Definitions and abbreviations

3.1 Definitions

For the purposes of the present document, the following terms and definitions apply.

Iu Timing Interval (ITI): Iu Timing Interval is the minimum time interval between sent Iu UP PDUs for a specific RAB. The ITI can be calculated for conversational and streaming traffic classes by the following formula:

$$ITI = \frac{MaxSDUsize}{MaxBitrate}$$

Inter PDU Transmission Interval (IPTI): inter PDU Transmission Interval is the actual interval at which Iu UP PDUs can be sent at a certain time for a specific RAB subflow combination. The IPTI of a RAB subflow combination is calculated based on the RAB subflow combination size and the RAB subflow combination bitrate by dividing the RAB subflow combination size with the RAB subflow combination bitrate.

$$IPTI_g = \frac{RFC_size_g}{RFC_Bitrate_g}, \quad g = 1, \dots, n, \quad n = \text{number of subflow combinations}$$

NOTE: If RFC_Bitrate is not defined then IPTI=ITI. If RFC_size is not defined then RFC_size=MaxSDUsize.

Non Access Stratum (NAS) Data Streams: non Access Stratum Data Streams is a generic term to identify these data streams exchanged at the Dedicated Service Access Points between the Non Access Stratum and the Access Stratum.

RAB sub-flows: RAB as defined in [9] is realised by UTRAN through one to several sub-flows. These sub-flows correspond to the NAS service data streams that have QoS characteristics that differ in a predefined manner within a RAB e.g. different reliability classes.

RAB sub-flows characteristics:

- 1) the sub-flows of a RAB are established and released together at the RAB establishment and release, respectively;
- 2) the sub-flows of a RAB are submitted and delivered together at the RAB SAP;
- 3) the sub-flows of a RAB are carried over the same Iu transmission connection;
- 4) the sub-flows of a RAB are organised in a predefined manner at the RAB SAP and over the Iu interface. The organisation is imposed by the NAS as part of its co-ordination responsibility.

RAB sub-flows numbering (applies to support mode for predefined SDU size only):

- 1) RAB sub-flows are numbered from 1 to N (N is the number of sub-flows);
- 2) RAB sub-flow number 1 corresponds to the highest reliability class and the RAB sub-flow number N corresponds to the lowest reliability class;
- 3) RAB sub-flows order inside the Iu frame is predefined so that RAB sub-flow number one comes first and the RAB sub-flow number N comes last.

RAB sub-Flow Combination (RFC): RAB sub-flow combination is defined as an authorised combination of the RAB sub-flows variable attributes (e.g. SDU sizes) of currently valid RAB sub-flows that can be submitted simultaneously to the Iu UP for transmission over Iu interface. Each combination is given by the CN and cannot be altered by the SRNC.

RAB sub-Flow Combination Indicator (RFCI): this indicator uniquely identifies a RAB sub-flow combination for the duration of the Iu UP peer protocol instances i.e. it is valid until the termination of the call or until a new initialisation is performed. Usage of RFCI applies only to Iu UP protocol operated in support mode for predefined SDU size.

Principles related to RFCI allocation and initialisation procedure:

- 1) RFCI value is present in every Iu user frame;
- 2) in the Initialisation procedure in Iu UP, the size of every RAB sub-flow SDU for each RFCI is signalled.

Syntactical error: field is defined to be syntactically incorrect in a message if it contains at least one value defined as "reserved", or if its value part violates syntactic rules given in the specification of the value part. However it is not a syntactical error that a value specified as "spare" is being used.

Semantical error: message is defined to have semantically incorrect contents if it contains information which, possibly dependant on the state of the receiver, is in contradiction to the resources of the receiver and/or to the procedural part.

3.2 Abbreviations

For the purposes of the present document, the following abbreviations apply:

AMR	Adaptive Multi-Rate codec
AS	Access Stratum
BER	Bit Error Rate
CN	Core Network
DS	Data Service
DTX	Discontinuous Transmission
DU	Data Unit
GF	Galois Field
IPTI	Inter PDU Transmission Interval
ITI	Iu Timing Interval
NAS	Non Access Stratum
PCE	Procedure Control Extension
PDU	Protocol Data Unit
PME	Procedure Control Bitmap Extension
QoS	Quality of Service
RAB	Radio Access Bearer
RANAP	Radio Access Network Application Part
RFC	RAB sub Flow Combination
RFCI	RFC Indicator
RNL	Radio Network Layer
SAP	Service Access Point
SDU	Service Data Unit
SID	Silence Insertion Descriptor
SMpSDU	Support Mode for predefined SDU size
SRNC	Serving RNC
SRNS	Serving RNS
SSSAR	Service Specific Segmentation and Reassembly
TFCI	Transport Format Combination Indicator
TFI	Transport Format Identification
TFO	Tandem Free Operation
TNL	Transport Network Layer
TrFO	Transcoder Free Operation
TrM	Transparent Mode
UP	User Plane
UUI	User to User Information

3.3 Concepts

Iu UP mode of operation:

One objective of the Iu User Plane (UP) protocol is to remain independent of the CN domain (Circuit Switched or Packet Switched) and to have limited or no dependency with the Transport Network Layer. Meeting this objective provides the flexibility to evolve services regardless of the CN domain and to migrate services across CN domains.

The Iu UP protocol is therefore defined with modes of operation that can be activated on a RAB basis rather than on a CN domain basis or (tele) service basis. The Iu UP mode of operation determines if and which set of features shall be provided to meet e.g. the RAB QoS requirements.

Iu UP protocol PDU Type:

The Iu UP protocol PDU Types are defined for a given Iu UP mode of operation. An Iu UP PDU Type represents a defined structure of an Iu UP protocol frame. For instance, a frame made of a certain Frame Header mask part and a Frame Payload part would be specified as a certain PDU type valid for a given Iu UP mode of operation.

Tandem Free Operation (TFO):

Configuration of a Speech or Multimedia call for which Transcoders are physically present in the communication path but transcoding functions are disabled or partially disabled. The Transcoders may perform control and/or protocol conversion functions.

Transcoder (TC):

Physical device present in the network responsible for the transcoding of the speech data between two speech codecs or coding schemes (The Transcoder may also include other functions, i.e. Rate Adaptation in GSM).

Transcoder Free Operation (TrFO):

Configuration of a Speech or Multimedia call for which Transcoders are not present in the communication path.

4 General

4.1 General aspects

The Iu UP protocol is located in the User plane of the Radio Network layer over the Iu interface: the Iu UP protocol layer.

The Iu UP protocol is used to convey user data associated to Radio Access Bearers.

One Iu UP protocol instance is associated to one RAB and one RAB only. If several RABs are established towards one given UE, then these RABs make use of several Iu UP protocol instances.

In general, Iu UP protocol instances exist at Iu access point as defined [2] i.e. at CN and UTRAN. However, as described in [13], if TrFO is possible and the Iu UP protocol instances operate in support mode the Iu UP protocol instance in CN may resume performing Iu UP specific functions or vanish completely during stable call states. In this case the partner peer entity actually interacting with the UTRAN Iu UP protocol instance (i.e. performing all Iu UP specific functions except UP initialisation) may either be located within another UTRAN or within a CN node that is not the serving CN node of the UTRAN.

Whenever a RAB requires transfer of user data in the Iu UP, an Iu UP protocol instance exists at each Iu interface access points. These Iu UP protocol instances are established, relocated and release together with the associated RAB.

Whether these peer protocol instances perform some RAB related function depends on the mode of operation of the Iu UP as defined below.

The following figure illustrates the logical placement of the Iu UP protocol layer and the placement of the Data Streams sources outside of the Access Stratum.

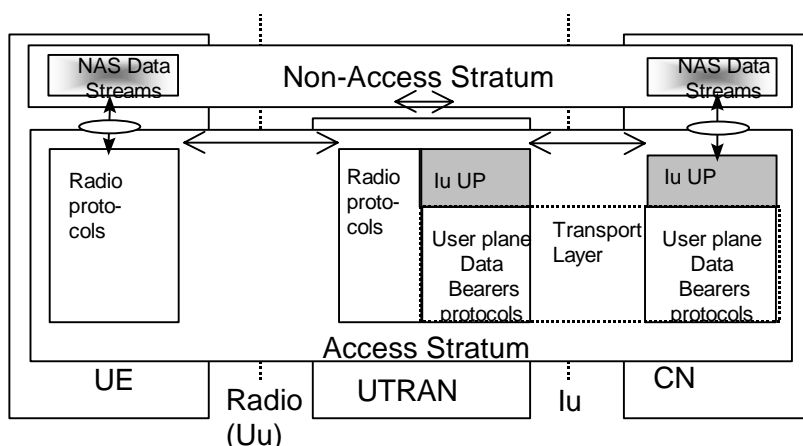

Figure 1: Iu UP protocol layer occurrence in UTRAN overall architecture (User Plane View)

4.2 Operational and Functional Aspects

4.2.1 Iu UP protocol modes of operation

The Iu UP protocol operates in mode according to the concept described in earlier subclause.

Modes of operation of the protocol are defined:

- 1) Transparent mode (TrM);
- 2) Support mode for predefined SDU size (SMpSDU).

Determination of the Iu UP protocol instance mode of operation is a CN decision taken at RAB establishment based on e.g. the RAB characteristics. It is signalled in the Radio Network layer control plane at RAB assignment and relocation for each RAB. It is internally indicated to the Iu UP protocol layer at user plane establishment.

The choice of a mode is bound to the nature of the associated RAB and cannot be changed unless the RAB is changed.

4.2.2 Transparent mode (TrM)

The transparent mode is intended for those RABs that do not require any particular feature from the Iu UP protocol other than transfer of user data.

The following figure illustrates the transparent mode of operation of the Iu UP protocol layer.

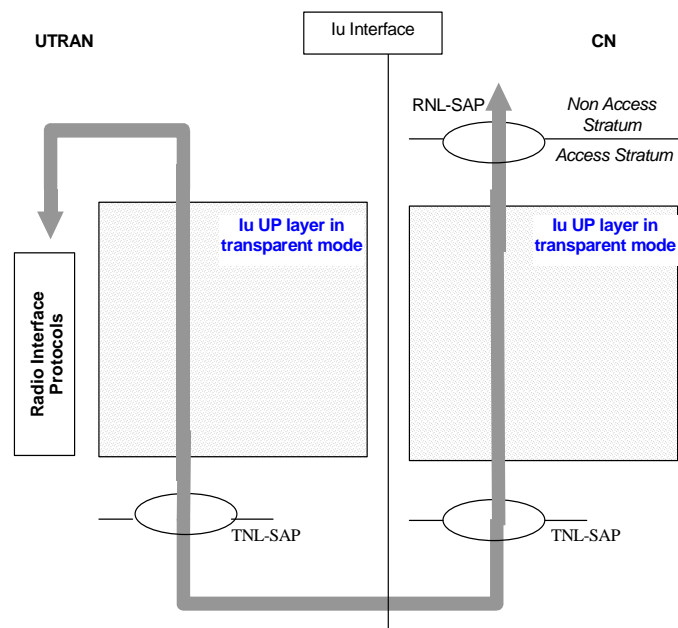

Figure 2: Iu UP protocol layer in transparent occurrence over Iu interface

In this mode, the Iu UP protocol instance does not perform any Iu UP protocol information exchange with its peer over the Iu interface: no Iu frame is sent. The Iu UP protocol layer is crossed through by PDUs being exchanged between upper layers and transport network layer.

For instance, the transfer of GTP-U PDUs could utilise the transparent mode of the Iu UP protocol.

4.2.3 Support mode

The support modes are intended for those RABs that do require particular features from the Iu UP protocol in addition to transfer of user data. When operating in a support mode, the peer Iu UP protocol instances exchange Iu UP frames whereas in transparent mode, no Iu UP frames are generated.

The following figure illustrates the functional model of the Iu UP protocol layer in support mode of operation.

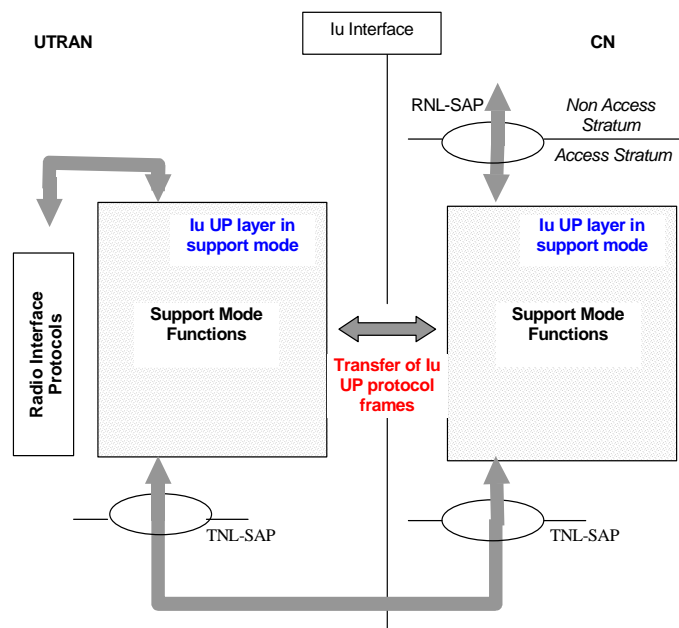

Figure 3: Iu UP protocol layer in support mode occurrence over Iu interface

Some RABs requesting Iu UP protocol support, constrain the Iu UP protocol and possibly the radio interface protocols in specific ways. For instance, certain RABs can have variable predefined rates.

The Iu UP support mode is prepared to support variations.

The only support mode defined here is the:

- Support mode for predefined SDU size (SMpSDU).

For instance, the transfer of AMR speech PDUs would utilise the support mode for predefined SDU size of the Iu UP protocol because it requires some procedure control functions and some data streams specific functions while the sizes of the user data being transferred can vary in a predefined manner.

5 Transparent mode, version 1

5.1 General

5.1.1 Operation of the Iu UP in Transparent mode

The Iu UP layer in transparent mode is present in the Iu User plane for transferring data transparently over the Iu interface.

The two strata communicate through a Service Access Point for Non Access Stratum (NAS) Data Streams transfer.

5.1.2 Interfaces of the Iu UP protocol layer in Transparent mode

Interfaces of the Iu UP protocol layer in transparent mode are the transport network layer and the upper layers. The Iu UP protocol layer in transparent mode is an empty layer through which NAS Data Streams PDUs are crossing between the Transport Network Layer and upper layers.

The Iu UP protocol layer in transparent mode is using services of the Transport layers in order to transfer the Iu UP PDUs over the Iu interface.

5.2 Iu UP Protocol layer Services in Transparent mode

The following functions are needed to support this mode:

- Transfer of user data.

5.3 Services Expected from the UP Data Transport layer

The Iu UP protocol layer in transparent mode expects the following services from the Transport Network Layer:

- Transfer of user data.
- Delivery of SDUs in sequence when requested by the RAB parameter 'Delivery Order' [3].

5.4 Elements for Iu UP communication in Transparent mode

5.4.1 Frame Format for transparent mode

The following shows the format of the PDU crossing the Iu UP protocol layer in transparent mode. This frame is transferred transparently between the Iu UP protocol upper layers and transport network layer (TNL-SAP).

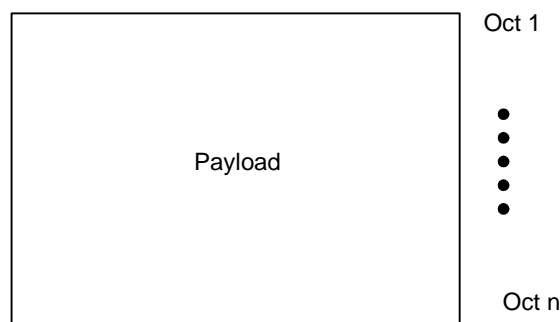

Figure 4: Frame format for transparent mode

This PDU has a variable length of n octets, whose maximum range depends on the type of user data (e.g. IP packet). No explicit length indication is visible at the Iu UP protocol layer.

6 Support mode for predefined SDU sizes, version 2

6.1 General

6.1.1 Operation of the Iu UP in Support mode

The Iu UP protocol layer in Support mode is present for data streams that need frame handling in the UP.

The two strata communicate through a Service Access Point for Non Access Stratum (NAS) Data Streams transfer.

6.1.2 Interfaces of the Iu UP protocol layer in Support mode

As part of the Access Stratum responsibility, the Iu UP protocol layer in support mode provides the services and functions that are necessary to handle non access stratum data streams. The Iu UP protocol layer in support mode is providing these services to the UP upper layers through a Dedicated Service Access Point used for Information Transfer as specified in [5].

The Iu UP protocol layer in support mode is using services of the Transport layers in order to transfer the Iu UP PDUs over the Iu interface.

6.2 Iu UP Protocol layer Services in Support mode

Support mode for predefined SDU size Service

The following functions are needed to support this mode:

- Transfer of user data;
- Initialisation;
- Rate control;
- Time alignment;
- Handling of error event;
- Frame quality classification.

6.3 Services Expected from the UP Data Transport layer

The Iu UP protocol layer in Support Mode expects the following services from the Transport Network Layer:

- Transfer of user data.
- Delivery of SDUs in sequence when requested by the RAB parameter 'Delivery Order' [3].

6.4 Functions of the Iu UP Protocol Layer in Support mode

6.4.1 Functional model of the Iu UP Protocol Layer in Support mode

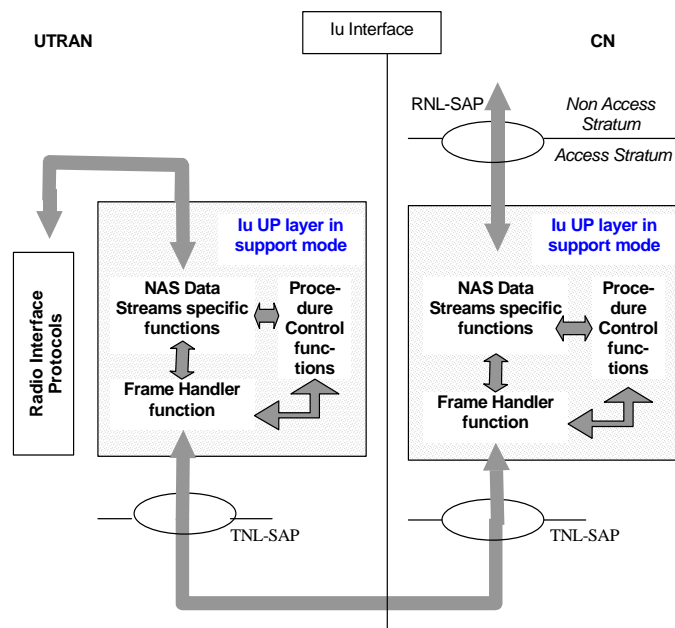

Figure 5: Functional model of the Iu UP protocol layer in Support mode

The Iu UP protocol layer in Support mode is made of three sets of functions:

- 1) Frame Handler function;
- 2) Procedure Control functions;
- 3) Non Access Stratum Data Streams specific functions.

6.4.2 Frame Handler function

This function is responsible for framing and de-framing the different parts of an Iu UP protocol frame. This function takes the different parts of the Iu UP protocol frame and set the control part field to the correct values, including the handling of the frame number. It also ensures that the frame control part is semantically correct. This function is responsible for interacting with the Transport layers. This function is also responsible for the CRC check of the Iu UP frame header. The Iu UP frame with header CRC check error is discarded.

6.4.3 Procedure Control functions

This set of functions offers the control of a number of procedures handled at the Iu UP protocol level. These functions are responsible for the procedure control part of the Iu UP frames.

Namely, these procedures are:

- **Rate Control:** is the procedure which controls over the Iu UP the maximum rate that is allowed to be sent downlink among the rates that can be controlled. The set of rates is represented by RFCI indicators. The function controlling this procedure interacts with functions outside of the Iu UP protocol layer.
- **Initialisation:** is the procedure which controls the exchange of initialisation information that is required for operation in support mode for predefined SDU size. Such information can contain the RFCI Set to be used until termination of the connection or until the next initialisation procedure. This procedure is also used for negotiating the version of the Iu UP Mode among the versions the CN requested for the related RAB.
- **Time Alignment:** is the procedure that controls the timing of the downlink data to the RNC over Iu. The function controlling this procedure interacts with functions outside of the Iu UP protocol layer.
- **Handling of Error Event:** is the procedure that controls the information exchanged over the Iu related to detection of a fault situation. The function controlling this procedure interacts with functions outside of the Iu UP protocol layer.

6.4.4 Non Access Stratum Data Streams specific function(s)

These functions are responsible for a "limited manipulation" of the payload and the consistency check of the frame number. If a frame loss is detected due a gap in the sequence of the received frame numbers (for a RAB where frame numbers does not relate to time), this shall be reported to the procedure control function. These functions are responsible for the CRC check and calculation of the Iu UP frame payload part. These functions are also responsible for the Frame Quality Classification handling as described below.

These functions interact with the upper layers by exchanging Iu data stream blocks of Iu UP frame payload. These functions also handles the padding and depadding of the Iu UP frame payloads when needed.

These functions interact with the procedure control functions.

These functions provide service access to the upper layers for the procedure control functions.

6.4.4.1 Frame Quality Classification function

6.4.4.1.1 General

On the Iu UP in Support Mode the frames are classified with the Frame Quality Classifier (FQC). This classifying is based on the radio frame classification and the setting of the RAB attributes 'Delivery of erroneous SDUs'. The RAB attribute 'Delivery of erroneous SDUs' tells if erroneous frames shall be delivered or not.

Figure 6 shows the main input and output information for frame quality classification function on the Iu UP.

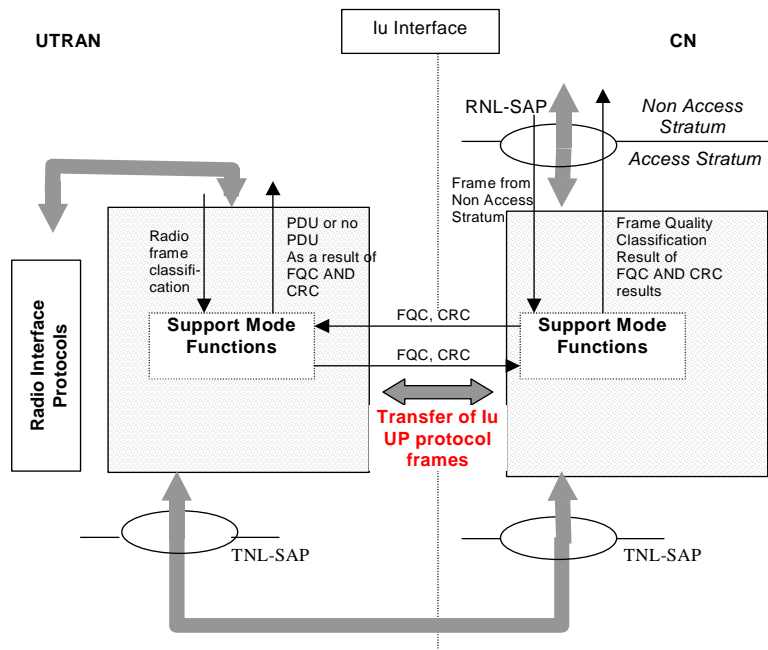

Figure 6: Frame quality classification in Iu UP

6.4.4.1.2 Handling of FQC information in uplink path

6.4.4.1.2.1 Handling of FQC information at RNC

In SRNC on the sending side, the Support Mode Functions takes as input the radio frame quality information together with the frame. Based on this, the FQC is set for the frame, a CRC is or is not added (depending on PDU type) and the frame is sent to CN. The following steps shall be sequentially applied to derive the SRNC behaviour and the FQC field setting:

- If there is at least one subflow with the "Delivery of erroneous SDUs" set to "No" and for at least one of those subflows the radio frame classification is "Bad" then the Iu UP frame shall not be sent;
- Otherwise, if there is at least one subflow with the "Delivery of erroneous SDUs" set to "Yes" and for at least one of those subflows the radio frame classification is "Bad" then the Iu UP frame shall be sent with FQC set to "Frame bad due to radio";
- Otherwise the Iu UP frame shall be sent with FQC set to "frame good".

6.4.4.1.2.2 Handling of FQC information at CN

The Support Mode Functions in CN on the receiving side makes a CRC check of the frame payload, if CRC is present and passes the appropriate frame and the appropriate frame quality classification information through the RNL-SAP. The following steps shall be sequentially applied to derive the CN behaviour and the FQC field setting:

- If a CRC is available and the CRC check indicates that the Iu UP is "Bad" and at least one subflow has the "delivery of erroneous SDUs" set to "No", then the Iu UP frame shall be dropped;
- Otherwise, if a CRC is available and the CRC check indicates that the Iu UP is "Bad" and at least one subflow has the "delivery of erroneous SDUs" set to "Yes", then the Iu UP frame shall be forwarded with the FQC set to "Bad";
- Otherwise the Iu UP frame shall be forwarded with the FQC as set by UTRAN.

6.4.4.1.3 Handling of FQC information in downlink path

The Support Mode Functions in CN on the sending side adds a CRC, if necessary to the frame payload and passes it together with the FQC. If the payload stems from a transcoding unit of the NAS within the CN the FQC is always set to good. Otherwise it may be set by a partner peer entity residing in another RNC.

The Support Mode Functions in SRNC then makes a CRC-check, if the CRC is present. Based on the CRC check, a decision is made whether to deliver the frame or not based on the following sequential steps:

- a) If a CRC is available and the CRC check indicates that the Iu UP is "Bad" then the frame shall be dropped;
- b) Otherwise, if the FQC value of the Iu UP frame is set to "frame bad" or "Frame bad due to radio", regardless of the CRC check indication;
- c) Otherwise, the frame shall be passed to radio interface protocols.

NOTE: The case where SRNC receives a frame with the FQC set to "Frame bad due to radio" (respectively: "frame bad"), corresponds to a TrFO (respectively: TFO) case. The frame is then trashed by the receiving RNC since there is currently no means to pass the frame quality indicator down to the UE.

6.5 Elementary procedures

6.5.1 Transfer of User Data procedure

6.5.1.1 Successful operation

The purpose of the transfer of user data procedure is to transfer Iu UP frames between the two Iu UP protocol layers at both ends of the Iu interface. Since an Iu UP instance is associated to a RAB and a RAB only, the user data being transferred only relate to the associated RAB.

The procedure is controlled at both ends of the Iu UP instance i.e. SRNC and the CN. Exceptions in case of TrFO, where the partner peer entity does not reside within the serving CN node are described in subclause 4.1 and [13].

The transfer of user data procedure is invoked whenever user data for that particular RAB needs to be sent across the Iu interface.

The procedure is invoked by the Iu UP upper layers upon reception of the upper layer PDU and associated control information: RFCI.

The upper layers may deliver a frame quality classification information together with the RFCI.

The NAS Data streams functions makes the padding of the payload (if needed) so that the Iu UP frame payload will be an integer number of octets. Then the NAS Data streams functions perform, if needed, CRC calculation of the Iu frame payload and passes the Iu UP frame payload down to the frame handler together with the RFCI.

The frame handler function retrieves the frame number from its internal memory, formats the frame header and frame payload into the appropriate PDU Type and sends the Iu UP frame PDU to the lower layers for transfer across the Iu interface. If the UTRAN initialises the RAB it shall base the selection of the PDU type (in both directions) on the reliability attributes (see [3]) for the RAB. If the reliability attribute 'Delivery of erroneous SDUs' equals 'no-error-detection-consideration' for all subflows then PDU type 1 shall be used, otherwise PDU type 0 shall be used.

For RABs with the traffic class conversational or streaming the frame number shall be based on time (stepped at each ITI). For RABs with another type of traffic class the frame numbering shall be based on sent Iu UP PDU (stepped at each sent Iu UP PDU). See description of Frame number.

Upon reception of a user data frame, the Iu UP protocol layer checks the consistency of the Iu UP frame as follows:

- The Frame handler checks the consistency of the frame header. If correct, the frame handler stores the frame number and passes the Iu UP frame payload and associated CRC, if any to the NAS Data Streams functions. The received RFCI is passed to the Procedure Control Function;
- The NAS Data Streams functions check the payload CRC, if any. If the RFCI is correct (i.e. RFCI is used at Initialisation) and matches the Iu UP frame payload (i.e. frame payload is not too short for the RFCI) as indicated by the Procedure Control functions, the NAS Data Streams removes the padding bits and the spare extension field when present from the Iu UP frame payload based on the RFCI information. Then the NAS Data Streams forwards to the upper layers the RFCI and the payload.

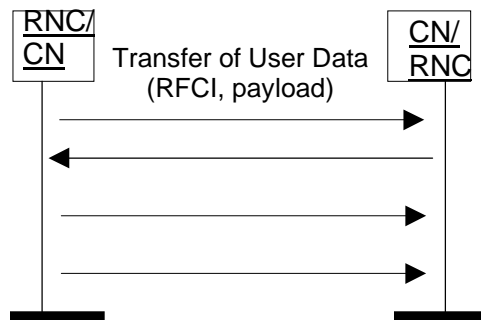

Figure 7: Successful Transfers of User Data

6.5.1.2 Unsuccessful operation

If the Iu UP frame carrying the user data is incorrectly formatted or cannot be correctly treated by the receiving Iu UP protocol layer, the Iu UP protocol layer shall either discard the frame or pass it to the upper layers with a frame classification indicating a corrupted frame. This decision is based on configuration data of the Iu UP instance for that particular RAB (i.e. if the RAB requests delivery of corrupted frame).

If the Iu UP protocol layer detects a frame loss because of a gap in the received frame number sequence while the frame number does not relate to time (see subclause Frame Number), the receiving Iu UP protocol layer shall report this to the procedure control function.

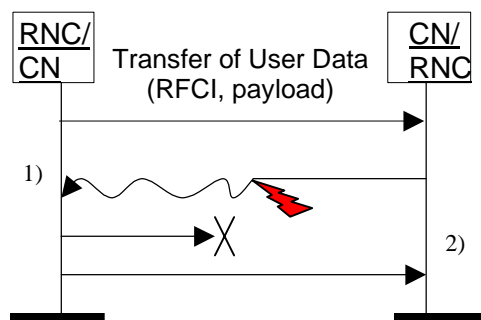

Figure 8: Unsuccessful Transfers of User Data: 1) Corrupted Frame, 2) Detection of Frame loss

6.5.2 Initialisation procedure

6.5.2.1 Successful operation

This procedure is mandatory for RABs using the support mode for predefined SDU size. The purpose of the initialisation procedure is to configure both termination points of the Iu UP with RAB Subflows Combinations, RFCIs, and associated RAB Sub Flows SDU sizes necessary to be supported during the transfer of user data phase. Additional parameters may also be passed, such as the Inter PDU Timing Interval (IPTI) information.

Additional parameters may also be passed, such as the Inter PDU Timing Interval (IPTI) information.

The initialisation procedure may be controlled at both end of the Iu access point, i.e. the CN and UTRAN.

The initialisation procedure is invoked whenever indicated by the Iu UP Procedure Control function e.g. as a result of a relocation of SRNS or at RAB establishment over Iu or if the CN decides to resolve RFCI mismatch in case of TrFO (see [13]). The initialisation procedure shall not be re-invoked by the SRNC for the RAB without a RAB modification requested via RANAP [3].

When this procedure is invoked all other Iu UP procedures are suspended until termination of the initialisation procedure.

The Iu UP protocol entity invoking this procedure shall indicate the Iu UP Mode version it uses for the initialisation as well as the Iu UP Mode versions it supports for the related RAB among the versions the CN requested for the related RAB. The sender should use the lowest version for the initialisation that has enough information to initialise the highest proposed protocol version.

The invoking entity allocates a RAB sub-Flow Combination indicator (RFCI) to each RAB sub-Flow Combination it initialises. The association of indicators to RAB Flow Combinations is valid for both the uplink and downlink direction in the Iu UP until a new initialisation procedure is performed or the connection is terminated.

The procedure control function may also generate additional Iu UP protocol parameters necessary for the RAB service to operate properly over Iu.

To each RAB sub-Flow combination indicator is associated the size of each RAB sub-Flow SDU of that combination. The list of RAB sub-Flow Combination Indicators and their respective SDU sizes constitutes the RAB sub-Flow Combination set passed over the Iu UP in the initialisation frame i.e. into an appropriate Iu UP PDU Type.

The first RAB sub-Flow Combination proposed in the list of RAB sub-Flow Combination indicates the initial RAB sub-Flow Combination i.e. the first RAB sub-Flow Combination to be used when starting the communication phase i.e. the transfer of user data procedure. The RAB sub-Flow Combination "NO_DATA" (defined by the length of all subflows set to zero) shall not be used as the first RFC in the proposed list of RAB sub-Flow Combinations.

Any RAB Sub-Flow Combination of the set that is initialised shall be supported by the two Iu UP termination points and may optionally be used by the sender (except for the first in the list that shall be used when starting). In particular, the use by the sender of the RFC "NO_DATA" is optional even when it is included in the initialisation procedure.

Conversely, any RAB Sub-Flow Combination that is not part of the initialised set shall not be used even if supported. In particular, the two Iu UP termination points shall be capable of operating without the use of the RFC NO_DATA.

The complete set of information is framed by the Iu UP Frame Handler function and transferred in an Iu UP initialisation frame. If needed, the initialisation frame CRC is calculated and set accordingly in the respective frame field.

A supervision timer T_{INIT} is started after sending the Iu UP initialisation frame. This timer supervises the reception of the initialisation acknowledgement frame.

Upon reception of a frame indicating that an initialisation control procedure is active in the peer Iu UP entity, the Iu UP protocol layer forwards the whole protocol information contained in the initialisation frame to the upper layers. It also stores the RAB sub-Flow Combination set (and thus replaces a possible previous set) in order to control during the transfer of user data, that the Iu UP payload is correctly formatted (e.g. RFCI matches the expected Iu UP frame payload total length). The peer Iu UP entity receiving the initialisation message shall choose a version that it supports, which is among a set of required versions and for which the peer Iu UP entity has enough initialisation information.

If the initialisation frame is correctly formatted and treated by the receiving Iu UP protocol layer, this latter sends an initialisation acknowledgement frame using the version of the Iu UP Mode that is chosen.

Upon reception of an initialisation acknowledgement frame, the Iu UP protocol layer in the SRNC stops the supervision timer T_{INIT} .

If the initialisation procedure requires that several frames are to be sent, each frame shall be acknowledged individually (i.e. any frame to be sent shall wait for the acknowledgement of the previous sent frame to be received before being sent). The supervision timer shall be used individually for each frame being sent.

The successful operation of the initialisation procedure may require that one or several chained frames are positively acknowledged. The number of initialisation frames in such a chain shall not exceed 4. Each chained frame shall be positively acknowledged before the one with the next frame number can be sent.

The frame number of an initialisation frame shall always be set to zero when the chain has only one frame. When several initialisation frames are used in a chain the frame number shall be set to zero for the first one and incremented by one in the sending direction for each new frame in the chain. The positive acknowledgement or negative acknowledgement shall carry the frame number of the frame being acknowledged.

Upon reception of an initialisation negative acknowledgement frame, an erroneous acknowledgement or at timer T_{INIT} expiry, the Iu UP protocol entity controlling the initialisation procedure shall reset and restart the T_{INIT} supervision timer and repeat one initialisation frame with the same frame number. The repetition shall be performed up to N_{INIT} times, N_{INIT} being chosen by the operator (default $N_{INIT} = 3$). The N_{INIT} (maximum number of allowed repetition) is the aggregate count for each frame in the chain and is restart each time a frame is positively acknowledged.

Consequently, when in the communication phase (as indicated by internal functions in the Radio Network layer), the frame transmission starts in downlink in the initial RFCI.

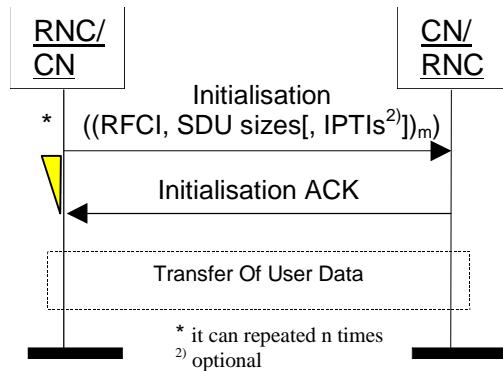

Figure 9: Successful Initialisation of Iu UP for m RFCIs

6.5.2.2 Unsuccessful operation

If the initialisation frame is incorrectly formatted and cannot be correctly treated by the receiving Iu UP protocol layer, this latter sends an initialisation negative acknowledgement frame.

If the receiver does not support the Iu UP Mode version for the initialisation procedure, it shall send a negative acknowledgement using the highest version it supports among the versions proposed by the sender. If none of the proposed versions are supported, the receiver shall respond with a negative acknowledgement using the highest version it supports.

After N_{INIT} successive negative acknowledgment, erroneous acknowledgment or T_{INIT} expiry for initialisation frames having the same frame number, the initialisation procedure is unsuccessfully terminated and the Iu UP protocol layers in RNC take appropriate local actions.

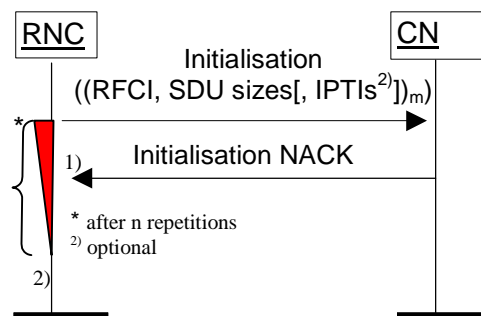

Figure 10: Unsuccessful initialization of Iu UP: 1) N_{INIT} negative acknowledgement or 2) N_{INIT} expiries of timer T_{INIT}

6.5.3 Iu Rate Control procedure

6.5.3.1 Successful operation

The purpose of the rate control procedure is to signal to the peer Iu UP protocol layer the maximum rate over Iu in the reverse direction of the sent rate control frame.

The rate control procedure over Iu UP is normally controlled by the entity controlling the rate control over UTRAN i.e. the SRNC. The Iu rate control procedure is invoked whenever the SRNC decides that the maximum rate permitted downlink over Iu shall be modified, or when a rate control command is received from the CN. Within the context of TrFO the SRNC may also receive rate control frames from the TrFO partner.

The rates that can be controlled by the SRNC are all the rates that are defined by the Iu-Initialisation procedure and which are above the guaranteed bitrate (indicated to the Iu UP at establishment) Rates below the guaranteed bitrate, e.g. the lowest speech rate or the SID frames, cannot be controlled (i.e. cannot be forbidden) by the SRNC.

The procedure can be signalled at any time when transfer of user data is not suspended by another control procedure. When the user plane was initiated due to SRNS relocation reasons no rate control shall be signalled before the reception of the relocation execution trigger (see [3]). At the reception of the relocation execution trigger the RNC shall start the rate control procedure. This enables both TrFO partners to exchange current maximum rates and proceed user data transport based on latest rate decisions. Further, the reception of the first rate control frame from the target RNC, which indicates the CN the successful relocation execution on user plane level, should cause the CN to switch the user plane from the source RNC to the target RNC.

The Procedure control function upon request of upper layer prepares the Rate control frame payload containing the maximum rate of the reverse direction of the rate control frame. To align the Rate Control procedure with version 1 of the Iu UP protocol the permitted maximum rate is given as a set of RFCI indicators, that shall contain the maximum rate and all rates below the maximum rate, i.e. all rate controllable and non rate controllable rates. In the context of TrFO and TFO the Rate Control procedure may also be controlled by a remote peer.

The frame handler function calculates the frame CRC, formats the frame header into the appropriate PDU Type and sends the Iu UP frame PDU to the lower layers for transfer across the Iu interface.

A supervision timer T_{RC} is started after sending the Iu UP rate control frame. This timer supervises the reception of the rate control acknowledgement frame. Upon reception of a rate control acknowledgement frame, the Iu UP protocol layer in the SRNC stops the supervision timer T_{RC} .

Upon reception of a rate control frame, the Iu UP protocol layer checks the consistency of the Iu UP frame as follows:

- The Frame handler checks the consistency of the frame header and associated CRC. If correct, the frame handler passes procedure control part to the procedure control functions;
- The procedure control functions check that all RFCIs in the initial RFCI set are indicated as either allowed or barred. They also verify that non-rate controllable rates are still permitted. If the whole rate control information is correct, the procedure control functions passes the rate control information to the NAS Data Streams specific functions;
- The NAS data streams specific functions forward to the upper layers the complete protocol data in a Iu-UP-Status indication primitive;
- Upon reception of the Iu-UP-Status request primitive, the procedure control functions shall acknowledge the Rate Control by including it's own maximum rate control information.

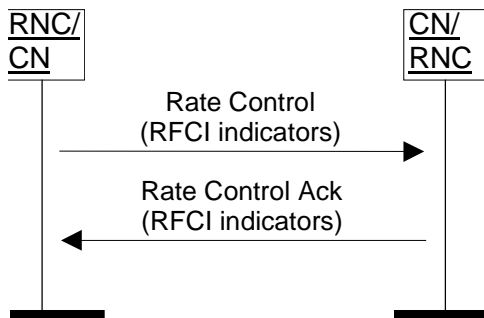

Figure 11: Successful Rate Control

Figure 12: Void

6.5.3.2 Unsuccessful operation

If the Iu UP protocol layer receives a rate control frame that is badly formatted or corrupted, it shall ignore the rate control frame, but sent a negative rate control acknowledgement frame back (figure 13a).

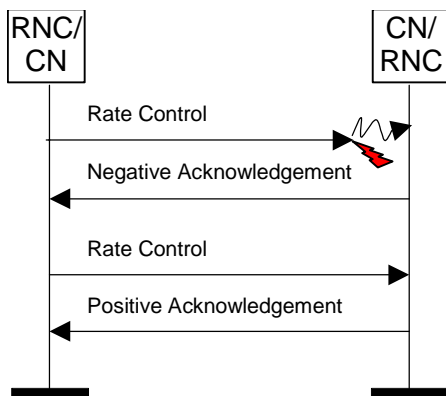

Figure 13a: Negative Acknowledgement received from the peer

If the Iu UP in the SRNC detects that the rate control command has not been correctly interpreted or received (e.g. the observed rate is outside the set of permitted rates in the reverse direction of the rate control frame (figure 13b), or a NACK message has been received, or no ACK message was received before the supervision timer T_{RC} expires (figure 13c)), the Iu UP shall retrigger a rate control procedure. If after N_{RC} repetitions, the error situation persists, the Iu UP protocol layers (sending and receiving) take the appropriate local actions.

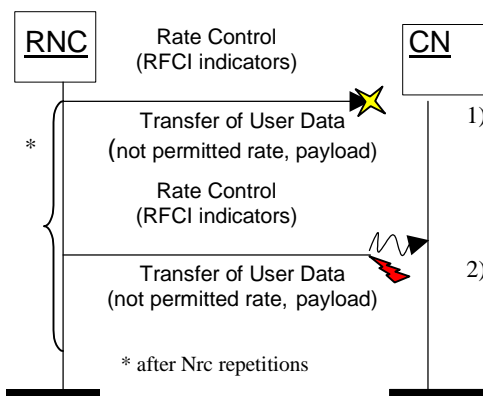

Figure 13: Unsuccessful Transfer of rate control from RNC: 1) Frame loss 2) Corrupted Frame

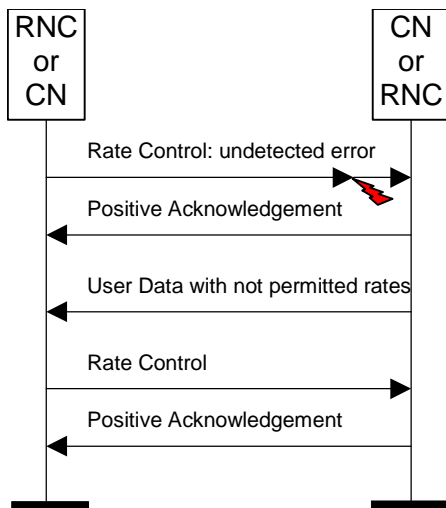

Figure 13b: Unsuccessful Transfer of rate control: undetected error

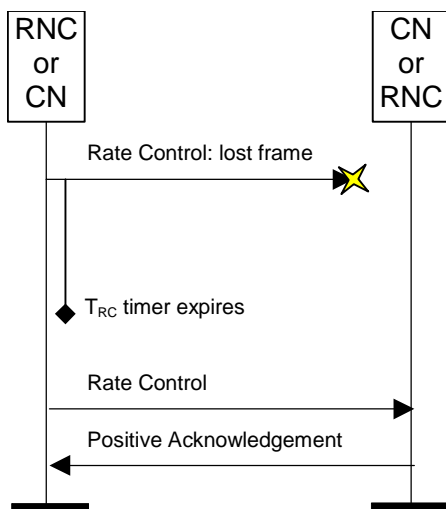

Figure 13c: Unsuccessful Transfer of rate control: lost rate control

6.5.3.2A Frequent Rate Control Procedures

Typically a new rate control command should not be sent in the same direction before the previous rate control procedure was terminated successfully.

If for some reasons (e.g. frequently received rate control commands from the CN in a TFO connection to GSM) a rate control command has to be sent before the previous rate control procedure was terminated successfully, then the previous rate control procedure is defined as terminated successfully: the supervision timer T_{RC} shall be stopped and acknowledgement frames (positive or negative) for the previous rate command shall be ignored, i.e. only the most recent rate control procedure shall be active in the same direction.

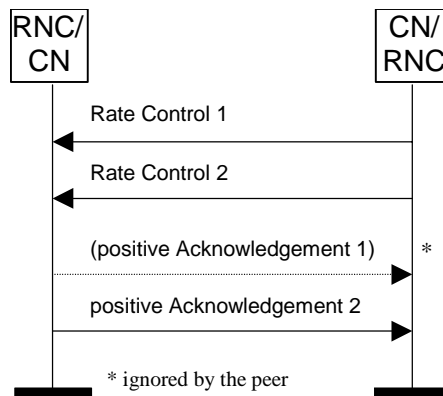

Figure 14: Frequent Rate Control: only most recent one is important

Figure 15: Void

6.5.4 Time Alignment procedure

6.5.4.1 Successful operation

The purpose of the time alignment procedure is to minimise the buffer delay in RNC by controlling the downlink transmission timing in the peer Iu UP protocol layer entity.

The time alignment procedure is controlled by SRNC.

The time alignment procedure is invoked whenever the SRNC detects the reception of Iu UP PDU at an inappropriate timing that leads to an unnecessary buffer delay. The actual detection of the trigger in SRNC is an internal SRNC matter and is out of the scope of the present document.

The Iu UP protocol layer entity in SRNC indicates the peer entity the necessary amount of the delay or advance adjustment in the number of 500 µs steps.

A supervision timer T_{TA} is started after sending the Iu UP time alignment frame. This timer supervises the reception of the time alignment acknowledgement frame.

The requested Iu UP protocol layer entity in the peer node adjusts the transmission timing by the amount as indicated by SRNC.

If the time alignment frame is correctly formatted and treated by the receiving Iu UP protocol layer and the time alignment is treated correctly by the upper layers, this latter sends an time alignment acknowledgement frame.

Upon reception of a time alignment acknowledgement frame, the Iu UP protocol layer in the SRNC stops the supervision timer T_{TA} .

The procedure can be signalled at any time when transfer of user data is not suspended by another control procedure.

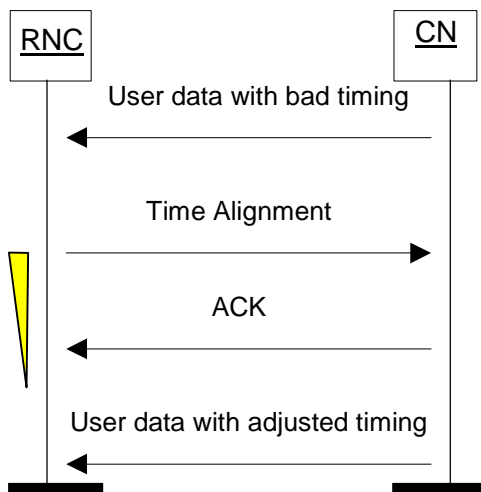

Figure 15a: Successful Time Alignment

Figure 16: Void

6.5.4.2 Unsuccessful operation

If the Time Alignment could not be handled by the peer side, the peer side should send a NACK with a corresponding cause. When the Iu UP protocol layer in the SRNC receives a NACK with cause "Time Alignment not supported", then the SRNC shall not send additional Time Alignment frames for that RAB (unless the Iu UP conditions change for that RAB). The cause value "Requested Time Alignment not possible" is used to indicate that the requested time alignment was not possible at that moment. At a later moment the SRNC may initiate a new Time Alignment command when needed. If the Time Alignment is received by the RNC, it shall respond with a NACK with the cause "Time Alignment not supported".

If the Iu UP protocol layer in the SRNC detects that the time alignment command has not been correctly interpreted or received, i.e NACK received or timer expires, and the time alignment need still persists, the Iu UP should retrigger a time alignment procedure. If after N_{TA} repetitions, the error situation persists, the Iu UP protocol layers take appropriate local actions.

Upon reception of a time alignment negative acknowledgement frame, the Iu UP protocol layer in the SRNC stops the supervision timer T_{TA} .

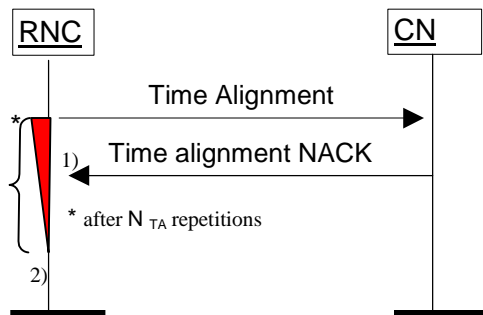

Figure 16a: Unsuccessful Time Alignment: 1) N_{TA} negative acknowledgements or 2) N_{TA} expiries of timer T_{TA}

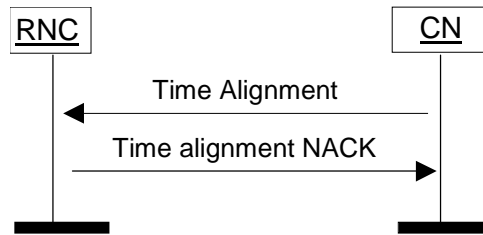

Figure 16b: Time Alignment received by the RNC

6.5.5 Handling of Error Event procedure

6.5.5.1 Successful operation

The purpose of the Error event procedure is to handle the error reporting. Over the Iu UP protocol the error reports are made with Error event frames. The Error event procedure in the Iu UP can be triggered by:

- An error detected by the Iu UP functions (by receiving an erroneous frame or by receiving a frame with unknown or unexpected data). In this case an Iu UP- Status Indication may be used to inform the upper layers;
- A request by the upper layers.

When an Error event is reported by an Error event frame the following information shall be included:

- A cause value;
- Error distance (=0 if Iu UP function detected, =1 if requested by upper layers).

Upon reception of an Error report frame the Iu UP functions should take appropriate local actions based on the cause value. This may include reporting the error to the upper layers with an Iu UP status indication.

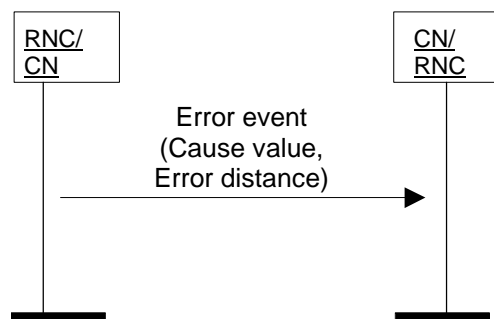

Figure 15b: Successful Error event

6.5.5.2 Unsuccessful operation

If the error event frame is incorrectly formatted and cannot be correctly treated by the receiving Iu UP protocol layer appropriate local actions are taken (e.g. upper layers are informed). An error in an Error event frame should not generate the sending of a new Error event frame.

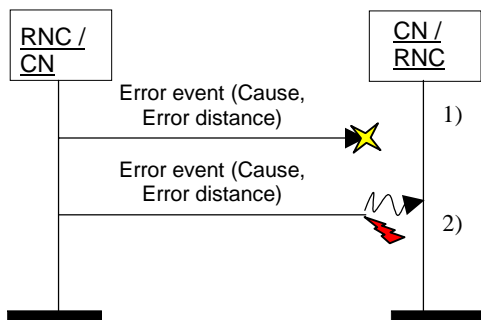

Figure 16c: Unsuccessful Transfer of Error event frame: 1) Frame loss 2) Corrupted Frame

6.5.6 Frame Quality Classification procedure

The Frame Quality Classification procedure uses the services of the Transfer of User Data procedure to exchange across the Iu UP interface the Frame Quality Classification information.

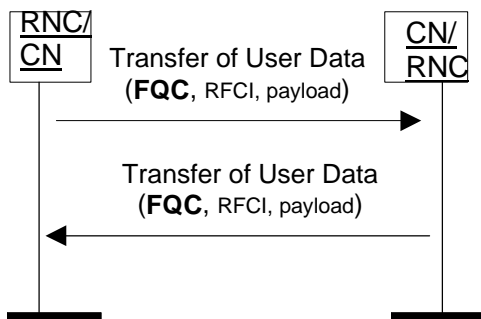

Figure 17: Successful Transfers of User Data with FQC information

6.6 Elements for Iu UP communication in Support mode

6.6.1 General

In the present document the structure of frames will be specified by using figures similar to figure 18.

Bits								Number of Octets		
7	6	5	4	3	2	1	0			
Field 1				Field 2				1	Octet 1	Header part
Field 3					Field 4			2	Octet 2	
Field 4 continue				Spare					Octet 3	
Field 6								2	Octet 4	Payload part
Field 6 continue				Padding						
Spare extension								0-m		

Figure 18: Example frame format

Unless otherwise indicated, fields which consist of multiple bits within an octet will have the more significant bit located at the higher bit position (indicated above frame in figure 18). In addition, if a field spans several octets, more significant bits will be located in lower numbered octets (right of frame in figure 18).

On the Iu interface, the frame will be transmitted starting from the lowest numbered octet. Within each octet, the bits are sent according decreasing bit position (bit position 7 first).

Spare bits should be set to 0 by the sender and should not be checked by the receiver.

The header part of the frame is always an integer number of octets. The payload part is octet rounded (by adding 'Padding' when needed).

The receiver should be able to remove an additional spare extension field that may be present at the end of a frame. See description of Spare extension field.

6.6.2 Frame Format for predefined size SDUs

6.6.2.1 PDU Type 0

PDU Type 0 is defined to transfer user data over the Iu UP in support mode for pre-defined SDU sizes. Error detection scheme is provided over the Iu UP for the payload part.

The following shows the Iu frame structure for PDU type 0 of the Iu UP protocol at the SAP towards the transport layers (TNL-SAP).

Bits								Number of Octets	
7	6	5	4	3	2	1	0		
PDU Type (=0)				Frame Number				1	Frame Control Part
FQC		RFCI						1	
Header CRC						Payload CRC		2	Frame Check Sum Part
Payload CRC									
Payload Fields								0-n	Frame Payload part
Payload Fields				Padding					
Spare extension								0-4	

Figure 19: Iu UP PDU Type 0 Format

The Iu UP PDU Type 0 is made of three parts:

- 1) Iu UP Frame Control part (fixed size);
- 2) Iu UP Frame Check Sum part (fixed size);
- 3) Iu UP Frame Payload part (pre-defined SDU sizes rounded up to octets [Note: this does not consider the usage of spare extension field]).

The Iu UP Frame Control Part and the Iu UP Frame Check Sum constitute the Iu UP PDU Type 0 Frame Header.

6.6.2.2 PDU Type 1

PDU Type 1 is defined to transfer user data over the Iu UP in support mode for pre-defined SDU sizes when no payload error detection scheme is necessary over Iu UP (i.e. no payload CRC).

The following shows the Iu frame structure for PDU type 1 of the Iu UP protocol at the SAP towards the transport layers (TNL-SAP).

Bits								Number of Octets	
7	6	5	4	3	2	1	0		
PDU Type (=1)				Frame Number				1	Frame Control Part
FQC		RFCI						1	
Header CRC						Spare		1	Frame Check Sum Part
Payload Fields								0-n	Frame Payload part
Payload Fields				Padding					
Spare extension								0-4	

Figure 20: Iu UP PDU Type 1 Format

The Iu UP PDU Type 1 is made of three parts:

- 1) Iu UP Frame Control part (fixed size);
- 2) Iu UP Frame Check Sum part (fixed size);
- 3) Iu UP Frame Payload part (pre-defined SDU sizes, rounded up to octets [Note: this does not consider the usage of spare extension field]).

The Iu UP Frame Control Part and the Iu UP Frame Check Sum constitute the Iu UP PDU Type 1 Frame Header.

6.6.2.3 PDU Type 14

6.6.2.3.1 General

PDU Type 14 is defined to perform control procedures over the Iu UP in support mode for pre-defined SDU sizes. The control procedure is identified by the procedure indicator. The Frame Payload contains the data information related to the control procedure.

Figure 21 shows the Iu frame structure for PDU Type 14 of the Iu UP protocol at the SAP towards the transport layers (TNL-SAP).

Bits								Number of Octets	
7	6	5	4	3	2	1	0		
PDU Type (=14)				Ack/Nack (=0, i.e. procedure)		PDU Type 14 Frame Number		1	Frame Control Part
Iu UP Mode version				Procedure Indicator				1	
Header CRC						Payload CRC		1	Frame Checksum Part
Payload CRC								1	
Reserved for procedure data								0-n	Frame payload part
Spare extension								0-32	

Figure 21: Iu UP PDU Type 14 Format for procedure sending

The Iu UP PDU Type 14 is made of three parts:

- 1) Iu UP Frame Control part (fixed size);
- 2) Iu UP Frame Check Sum part (fixed size);
- 3) Iu UP Frame Payload part (variable length, rounded up to octet).

The Iu UP Frame Control Part and the Iu UP Frame Check Sum constitute the Iu UP PDU Type 14 Frame Header.

6.6.2.3.2 Positive Acknowledgement

When the PDU Type 14 is used to positively acknowledge a control procedure, the PDU Type 14 frame takes the following structure at the TNL-SAP.

Bits								Number of Octets	
7	6	5	4	3	2	1	0		
PDU Type (=14)				Ack/Nack (=1, i.e. Ack)		PDU Type 14 Frame Number		1	Frame Control Part
Iu UP Mode version				Procedure Indicator (indicating the procedure being positively acknowledged)				1	
Header CRC						Spare		1	Frame Checksum Part
Spare								1	
Spare extension								0-32	Frame Payload part

Figure 22: Iu UP PDU Type 14 Format for positive acknowledgement

The Iu UP Frame Control Part and the Iu UP Frame Check Sum constitute the Iu UP PDU Type 14 Frame Header for positive acknowledgement.

6.6.2.3.3 Negative Acknowledgement

When the PDU Type 14 is used to negatively acknowledge a control procedure, the PDU Type 14 frame takes the following structure at the TNL-SAP.

Bits								Number of Octets	
7	6	5	4	3	2	1	0		
PDU Type (=14)				Ack/Nack (=2, i.e. Nack)		PDU Type 14 Frame Number		1	Frame Control Part
Iu UP Mode version				Procedure Indicator (indicating the procedure being negatively acknowledged)				1	
Header CRC						Spare		1	Frame Checksum Part
Spare								1	
Error Cause value						Spare		1	Frame payload part
Spare extension								0-32	

Figure 23: Iu UP PDU Type 14 Format for negative acknowledgement

The Iu UP Frame Control Part and the Iu UP Frame Check Sum constitute the Iu UP PDU Type 14 Frame Header for negative acknowledgement.

6.6.2.3.4 Procedures Coding

6.6.2.3.4.1 Initialisation

Figure 24 specifies how the initialisation procedure frame is coded.

Bits								Number of Octets	
7	6	5	4	3	2	1	0		
PDU Type (=14)				Ack/Nack (=0. I.e. Procedure)		PDU Type 14 Frame Number		1	Frame Control Part
Iu UP Mode version				Procedure Indicator (=0)				1	
Header CRC						Payload CRC		2	Frame Checksum part
Payload CRC									
Spare			TI	Number of subflows per RFCI (N)		Chain Ind		1	Frame payload part
LRI	LI	1 st RFCI						1	
Length of subflow 1								1 or 2 (dep. LI)	
Length of subflow 2 to N								(N-1)x(1 or 2)	
LRI	LI	2 nd RFCI						1	
Length of subflow 1								1 or 2 (dep. LI)	
Length of subflow 2 to N								(N-1)x(1 or 2)	
...									
IPTI of 1 st RFCI				IPTI of 2 nd RFCI				0 or M/2 (M: Number of RFCIs in frame)	
IPTI of 3 rd RFCI				...					
Iu UP Mode Versions supported (bitmap)								2	
Data PDU type				Spare				1	
Spare extension								0-32	

Figure 24: Iu UP PDU Type 14 used for Initialisation

6.6.2.3.4.2 Rate Control

6.6.2.3.4.2.1 Rate Control procedure

Figure 25 specifies how the rate control procedure frame is coded.

Bits								Number of Octets	
7	6	5	4	3	2	1	0		
PDU Type (=14)				Ack/Nack (=0, i.e. Procedure)		PDU Type 14 Frame Number		1	Frame Control Part
lu UP Mode version				Procedure Indicator (=1)				1	
Header CRC						Payload CRC		1	Frame Checksum Part
Payload CRC								1	
Spare		Number of RFCI Indicators (M)						1	Frame payload part
RFCI 0 Ind.	RFCI 1 Ind.	...	RFCI M-1 Ind.	Padding				0-n	
Spare extension								0-32	

Figure 25: lu UP PDU Type 14 Format used for Rate Control

6.6.2.3.4.2.2 Rate Control positive acknowledgement

Figure 25a specifies how the rate control positive acknowledgement frame is coded.

Bits								Number of Octets	
7	6	5	4	3	2	1	0		
PDU Type (=14)				Ack/Nack (=1, i.e. Ack)		PDU Type 14 Frame Number		1	Frame Control Part
lu UP Mode version				Procedure Indicator (indicating the procedure being positively acknowledged)				1	
Header CRC						Spare		1	Frame Checksum Part
Spare								1	
Spare		Number of RFCI Indicators (M)						1	Frame Payload part
RFCI 0 Ind.	RFCI 1 Ind.	...	RFCI M-1 Ind.	Padding				0-n	
Spare extension								0 - (31-n)	

Figure 25a: lu UP PDU Type 14 Format for positive acknowledgement

6.6.2.3.4.3 Time Alignment

Figure 26 specifies how the time alignment procedure is coded.

Bits								Number of Octets	
7	6	5	4	3	2	1	0		
PDU Type (=14)				Ack/Nack(=0)		PDU Type 14 Frame Number		1	Frame Control Part
lu UP Mode version				Procedure Indicator (=2)				1	
Header CRC						Payload CRC		1	Frame Checksum Part
Payload CRC								1	
Time alignment								1	Frame payload part
Spare extension								0-32	

Figure 26: lu UP PDU Type 14 Format used for Time Alignment

6.6.2.3.4.4 Error Event

Figure 27 specifies how the Error Event procedure is coded.

Bits								Number of Octets	
7	6	5	4	3	2	1	0		
PDU Type (=14)				Ack/Nack(=0)		PDU Type 14 Frame Number		1	Frame Control Part
Iu UP Mode version				Procedure Indicator (=3)				1	
Header CRC						Payload CRC		1	Frame Checksum Part
Payload CRC								1	
Error distance		Error Cause value						1	Frame payload part
Spare extension								0-32	

Figure 27: Iu UP PDU Type 14 Format used for Error Event

6.6.3 Coding of information elements in frames

6.6.3.1 PDU Type

Description: The PDU type indicates the structure of the Iu UP frame. The field takes the value of the PDU Type it identifies: i.e. 0 for PDU Type 0. The PDU type is in bit 4 to bit 7 in the first octet of the frame. PDU type is used in all frames in support mode for predefined SDU sizes.

Value range: {0-1 and 14 in use, 2-13: reserved for future PDU types, 15=reserved for future PDU type extensions}

Field length: 4 bits

6.6.3.2 Ack/Nack

Description: The Ack/Nack field tells if the frame is:

- A control procedure frame;
- A positive acknowledgement (ACK) of a control procedure frame;
- A negative acknowledgement (NACK) of a control procedure frame.

Value range: {0=control procedure frame, 1=ACK, 2=NACK, 3=reserved}

Field length: 2 bits

6.6.3.3 Frame Number

Description: The Iu UP frame numbering is handled by a Frame Number. The frame numbering can be based on either time or sent Iu UP PDU. In case the frame numbering is based on time the purpose of the frame number is to be of help in handling the Time Alignment functionality. When the frame number is based on time, the Frame number is incremented by one (modulo 16) at each new ITI. In case the Frame number relates to sent Iu UP PDU the purpose of the Frame Number is to provide the receiving entity with a mechanism to keep track of lost Iu UP frames. When the frame number is based on sent Iu UP PDU, the Frame number is incremented by one (modulo 16) for each sent Iu UP PDU. For a given user data connection, there is no relations between the frame numbers of frames sent in the downlink direction and the frame numbers of frames sent in the uplink direction.

In the case the Frame Number relates to sent Iu UP PDU, the following applies:

- Frame loss is when an incoming PDU frame has a frame number that is equal to (previous PDU frame number + 2) modulo [max. PDU frame number + 1]. This indicates that one and only one PDU frame has been lost.
- Unexpected frame number is when an incoming PDU does not have the expected frame number and is not considered as a Frame Loss.

Value range: {0-15}.

Field length: 4 bits.

6.6.3.4 PDU Type 14 Frame Number

Description: The Iu UP frame numbering is handled by a Frame Number. The purpose of the PDU Type 14 Frame Number is to provide the receiving entity with a mechanism to keep track of lost Iu UP frames. It is also used to relate the acknowledgment frame to the frame being acknowledged i.e. the same PDU Type 14 Frame Number is used in the acknowledgement frame as the one used in the frame being acknowledged.

Value range: {0-3}.

Field length: 2 bits.

6.6.3.5 Frame Quality Classification (FQC)

Description: Frame Quality Classification is used to classify the Iu UP frames depending on whether errors have occurred in the frame or not. Frame Quality Classification is dependent on the RAB attribute 'Delivery of erroneous SDUs'.

Value range: {0=frame good, 1=frame bad, 2=Frame bad due to radio, 3=spare}.

Field length: 2 bits.

6.6.3.6 RAB sub-Flow Combination Indicator (RFCI)

Description: The RFCI identifies the structure of the payload. This can be used to specify the sizes of the subflows.

Value range: {0-62, 63=RFCI not applicable}.

Field length: 6 bits.

6.6.3.7 Procedure Indicator

Description: The Procedure Indicator identifies the control procedure in the current frame.

Value range: {0=initialization, 1=rate control, 2=time alignment, 3=error event, 4-15=reserved}.

Field length: 4 bits.

6.6.3.8 Header CRC

Description: This field contains the CRC of all fields in Frame Control Part. The CRC is a 6-bit checksum based on the generator polynomial $G(D) = D^6 + D^5 + D^3 + D^2 + D^1 + 1$, see subclause 6.7.7. With this CRC all error bursts shorter than 7 bits are detected, as well as all odd number of bits faulty (and two-bit faults) when the protected area is shorter than 24 bits, (max 3 octets).

Field length: 6 bits.

6.6.3.9 Payload CRC

Description: This field contains the CRC of all the fields (including Padding and possible Spare extension) of the Frame Payload Part. The CRC is a 10 bit checksum based on the generator polynomial $G(D) = D^{10} + D^9 + D^5 + D^4 + D^1 + 1$, see subclause 6.7.7. With this CRC all error bursts shorter than 11 bits are detected, as well as all odd number of bits faulty (and two-bit faults) when the protected area is shorter than 500 bits (max 62 octets).

Field length: 10 bits.

6.6.3.10 Chain Indicator

Description: Chain indicator is used to indicate whether the control procedure frame is the last frame related to the control procedure.

Value range: {0=this frame is the last frame for the procedure, 1=additional frames will be sent for the procedure}.

Field length: 1 bit.

6.6.3.11 Number of Subflows per RFCI

Description: Number of Subflows per RFCI field indicates the number of subflows the RAB is made of. It is used to decode the SDU size information data lengths. All RFCs consist of the same number of subflows within a specific RAB.

Value range: {0=reserved, 1-7}.

Field length: 3 bits.

6.6.3.12 Length Indicator (LI)

Description: Length Indicator, indicates if 1 or 2 octets is used for the RAB subflow size information.

Value range: {0=one octet used, 1=two octets used}.

Field length: 1 bit.

6.6.3.13 Number of RFCI Indicators

Description: Number of RFCI indicators indicates the number of RFCI indicators present in the control procedure frame.

Value range: {0-63}.

Field length: 6 bits.

6.6.3.14 RFCI n Indicator

Description: RFCI n Indicator indicates if the RFCI with value n is allowed or barred (n is a value between 0-62). E.g. RFCI 4 Indicator set to "0" indicates that RFCI =4 is allowed, RFCI 5 Indicator set to "1" indicates that RFCI =5 is barred, etc...

Value range: {0=RFCI allowed, 1=RFCI barred}.

Field length: 1 bit.

6.6.3.15 Error distance

Description: Indicates if the error occurred at the error reporting entity (=0) or in a more distant entity. The error distance is incremented by one (or kept at its maximum value) when an error report is forwarded.

- 0: Reporting local error.
- 1: First forwarding of error event report.
- 2: Second forwarding of error event report.
- 3: Reserved for future use.

Value range: {0: Reporting local error, 1: First forwarding of error event report, 2: Second forwarding of error event, 3: Reserved for future use}.

Field length: 2 bit.

6.6.3.16 Error Cause value

Description: Cause value is used to indicate what kind of error caused the error. Error cause value is used in NACK and Error Event frames.

- 0: CRC error of frame header.
- 1: CRC error of frame payload.
- 2: Unexpected frame number.
- 3: Frame loss.
- 4: PDU type unknown.
- 5: Unknown procedure.
- 6: Unknown reserved value.
- 7: Unknown field.
- 8: Frame too short.
- 9: Missing fields.
- 10–15: spare.
- 16: Unexpected PDU type.
- 17: spare.
- 18: Unexpected procedure.
- 19: Unexpected RFCI.
- 20: Unexpected value.
- 21–41: spare.
- 42: Initialisation failure.
- 43: Initialisation failure (network error, timer expiry).
- 44: Initialisation failure (Iu UP function error, repeated NACK).
- 45: Rate control failure.
- 46: Error event failure.
- 47: Time Alignment not supported.
- 48: Requested Time Alignment not possible.
- 49: Iu UP Mode version not supported.
- 50–63: spare.

Value range: {0–15 Used for syntactical protocol errors, 16–41 Used for semantical protocol errors, 42–63 Used for other errors}.

Field length: 6 bit.

6.6.3.17 Padding

Description: This field is an additional field used to make the frame payload part an integer number of octets when needed. Padding is set to 0 by the sender and is not interpreted by the receiver.

Value range: {0–127}.

Field length: 0–7 bits.

6.6.3.18 Time alignment

Description: Time alignment indicates the amount the sending time should be advanced or delayed.

0: Reserved.
 1: Delay 1*500µs.
 ...
 80: Delay 80*500µs.
 81–127 Reserved.
 128: Reserved.
 129: Advance 1*500µs.
 ...
 208: Advance 80*500µs.
 209–255 Reserved.

Value range: {0: Reserved, 1–80: used for delay, 81–128: Reserved, 129–208 used for advance, 209–255: Reserved}.

Field length: 8 bit.

6.6.3.19 Spare

Description: The spare field is set to 0 by the sender and should not be interpreted by the receiver.

Value range: $(0-2^n-1)$.

Field Length: n bits.

6.6.3.20 Spare extension

Description: The spare extension field shall not be sent. The receiver should be capable of receiving a spare extension. The spare extension should not be interpreted by the receiver. This since in later versions of the present document additional new fields might be added in place of the spare extension. The spare extension can be an integer number of octets carrying new fields or additional information; the maximum length of the spare extension field (m) depends on the PDU type.

Value range: $0-2^{m*8}-1$.

Field Length: 0–m octets. For PDU Types in the set {0,1}, m=4. For PDU Types in the set {14}, m=32.

6.6.3.21 LRI, Last RFCI Indicator

Description: The Last RFCI Indicator is used to indicate which is the last RFCI in the current Initialisation frame. This makes it possible for a receiver to detect a spare extension field.

Value range: (0: Not last RFCI, 1: Last RFCI in current frame).

Field Length: 1 bit.

6.6.3.22 Length of subflow

Description: This field indicates the length of the corresponding subflow as number of bits per SDU.

Value range: (0–255 if LI=0, 0–65535 if LI=1).

Field Length: 8 or 16 bits (depending on LI).

6.6.3.23 TI

Description: This field indicates if Timing Information is included in the Initialisation frame.

Value range: {0: IPTIs not present, 1: IPTIs present in frame}.

Field length: 1 bit.

6.6.3.24 IPTI of nth RFCI

Description: This field indicates the IPTI value in number of ITIs for the corresponding RFCI (in the same order as the RFCIs occur in the Initialisation frame).

Value range: {0–15}.

Field length: 4 bits.

6.6.3.25 Iu UP Mode versions supported

Description: This field indicates the Iu UP Mode Versions supported by the RNC for the related RAB. Up to 16 Iu UP Mode versions can be simultaneously indicated.

Value range:

Each bit, in the two octet field, indicates a Iu UP Protocol version: (First octet, bit 7) indicates version 16, (Second octet, bit 0) indicates version 1.

Bit = 0 means "Version not supported or not allowed"

Bit = 1 means "Version supported among the required versions"

Field length: 2 octets

6.6.3.26 Iu UP Mode Version

Description: This field indicates the Iu UP Mode version. Up to 16 Iu UP Mode Versions can be simultaneously available.

Value range: {1-16} The binary coded value is the version number minus 1 (e.g. version 1 is coded '0000', ..., version 16 is coded '1111').

Field length: 4 bits

6.6.3.27 Payload fields

Description: This field contains the Subflow SDUs, starting with the Subflow 1 SDU. The MSB of the Subflow 1 SDU is placed in bit 7 of the first octet (see example in figure 27a).

Value range: {any value}.

Field length: Sum of the lengths of the included Subflow SDUs.

Bits								Number of Octets
7	6	5	4	3	2	1	0	
Subflow 1 SDU								1
Subflow 1 SDU cont.				Subflow 2 SDU				1
Subflow 2 SDU cont.						Padding (Not part of 'Payload fields')		1

Figure 27a: Example of 'Payload fields' with two Subflow SDUs

6.6.3.28 Data PDU type

Description: This field indicates the PDU type that shall be used (in both directions) for transferring user data.

Value range: {0: PDU type 0, 1: PDU type 1, 2–15: Reserved for future use}.

Field length: 4 bits.

6.6.4 Timers

T_{INIT}

This Timer is used to supervise the reception of the initialisation acknowledgement frame from the peer Iu UP instance. This Timer is set by O&M.

T_{TA}

This Timer is used to supervise the reception of the time alignment acknowledgement frame from the peer Iu UP instance. This Timer is set by O&M.

T_{RC}

This Timer is used to supervise the reception of the rate control frame from the peer Iu UP instance. This Timer is set by O&M.

6.6.5 Maximum values of repetition counters

N_{INIT}

Maximum number of repetitions of an Initialisation frame due to failure at the Initialisation procedure.

N_{RC}

Maximum number of repetitions of a Rate Control frame due to failure at the Rate Control procedure.

N_{TA}

Maximum number of repetitions of a Time Alignment frame due to failure at the Time Alignment procedure.

6.7 Handling of unknown, unforeseen and erroneous protocol data

6.7.1 General

Error handling in Iu UP protocol is applicable only for Iu UP in Support mode.

The Error Event procedure is the procedure handling error reporting. The Error event procedure in the Iu UP can be triggered by:

- An error detected by the Iu UP functions (by receiving an erroneous frame or by receiving a frame with unknown or unexpected data);
- A request by the upper layers;
- An Error event frame over the Iu UP protocol.

The error can be reported either by:

- An Error event frame over the Iu UP protocol;
- An Iu UP Status Indication to upper layers (e.g. to be used by O&M).

When an Error event is reported, either by an Iu-UP-Status-Indication, or by an Error event frame the following information shall be included:

- Type of the error (syntactical error, semantical error or other error);

- Error distance, i.e. information where the error occurred.

6.7.2 Error detected by Iu UP functions

When an error is detected within the Iu UP functions (by receiving a frame containing erroneous, unknown or unexpected data) one of the following actions is taken depending on the type of the error:

1. Error indicated to upper layers by sending a Iu-UP-Status-Indication primitive;
2. Error event frame sent;
3. Error event frame sent and error indicated to upper layers by sending a Iu-UP-Status-Indication primitive;
4. No action.

6.7.3 Request by upper layers

When the Iu UP receives an Iu-UP-Status-Request indicating Error event then an Error event frame should be sent over the Iu UP protocol indicating the appropriate error type.

6.7.4 Error event frame over the Iu UP protocol

When an Error event frame is received over the Iu UP protocol an Iu-UP-Status-Indication with 'Error event' information indicating the error type should be made to the upper layers. The Error event report contains a 'Cause value' that tells the type of the error. The Error event report also contains a field 'Error distance' that tells the distance to the entity reporting the error event. The 'Error distance' is 0 when the error is originally sent. When an Error event report is forwarded the 'Error distance' is incremented by one.

6.7.5 Handling of error reports

6.7.5.1 General

Figure 28 shows the external error case when the error event procedure is originally triggered by an Iu-UP-Status-Request. As an action on this the error event procedure sends an error event frame over the Iu UP. On the other side the reception of error event frame triggers the error event procedure, and an Iu-UP-Status-Indication is sent to upper layers. The handling is symmetrical over the Iu UP protocol.

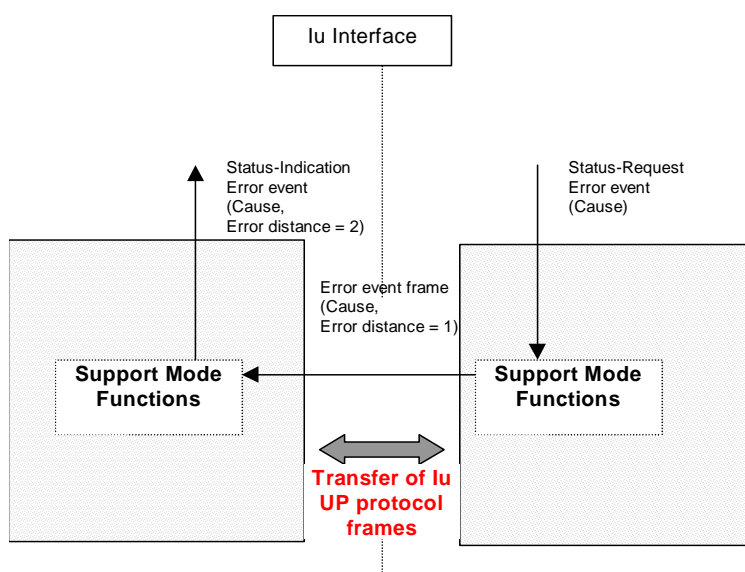

Figure 28: External error

Figure 29 shows the internal error case when the error event procedure is originally triggered by the Iu UP functions. As an action on this the error event procedure sends an error event frame over the Iu UP. On the other side the reception of

error event frame triggers the error event procedure, and an Iu-UP-Status-Indication is sent to the upper layers. The handling is symmetrical over the Iu UP protocol.

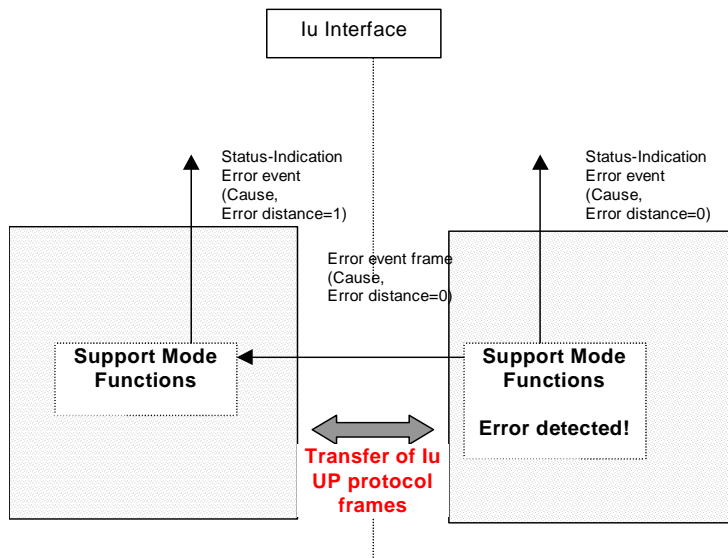

Figure 29: Internal error

6.7.5.2 Error distance

In an error event frame the error distance has the following meaning:

- 0: Error report relates to an Iu UP function error at the other side.
- 1: Error report relates to an error at the other side reported by the upper layers.

In an Iu UP-Status indication the error distance has the following meaning:

- 0: Error report relates to a local Iu UP function error.
- 1: Error report relates to an Iu UP function error at the other side.
- 2: Error report relates to an error at the other side reported by the upper layers.

6.7.6 List of errors in Iu UP

Table 0: List of errors in Iu UP

Error Type	Error Cause	Recommended action by Error event procedure	Possibly detected by function	Comment
Syntactical	CRC error of Frame payload (CRC check)	No action	NAS data streams functions	Handled by Frame Quality Classification, when applied
	CRC error of Frame Header (CRC check)	Iu-UP-Status-Indication(Error event)	Frame handler functions	Frame discarded
	Unexpected Frame Number	Iu-UP-Status-Indication(Error event)	NAS data streams functions	See 6.6.3.3
	Frame loss	Iu-UP-Status-Indication(Error event) and Error event frame	NAS data streams functions	See 6.6.3.3
	PDU type Unknown	Iu-UP-Status-Indication(Error event) and Error event frame	Frame handler functions	Used when PDU type is not 0, 1, or 14
	Unknown procedure	Iu-UP-Status-Indication(Error event) and Error event frame	Frame handler functions	Used when procedure value is neither 0, 1, 2, or 3

Error Type	Error Cause	Recommended action by Error event procedure	Possibly detected by function	Comment
	Unknown reserved value	See 8.1.1		
	Unknown field			This error cause shall not be sent.
	Frame too short	lu-UP-Status-Indication(Error event) and Error event frame	Frame handler functions	Used when: - the length of the entire received PDU is less than the expected (calculated) PDU header length, or - the length of the payload (entire received PDU minus PDU header length) is less than the expected (calculated) payload length
	Missing fields	lu-UP-Status-Indication(Error event) and Error event frame	Frame handler functions	This error cause shall not be sent.
Semantical	Unexpected PDU type	lu-UP-Status-Indication(Error event) and Error event frame	Frame handler functions	
	Unexpected procedure	lu-UP-Status-Indication(Error event) and Error event frame	Frame handler functions	
	Unexpected RFCI	lu-UP-Status-Indication(Error event) and Error event frame	NAS data streams functions	
	Unexpected value	lu-UP-Status-Indication(Error event) and Error event frame	Procedure control functions	
Other error	Initialisation failure (outside lu UP)	Error event frame	Function outside lu UP	
	Initialisation failure (network error, timer expiry)	lu-UP-Status-Indication(Error event)	Procedure control functions	
	Initialisation failure (lu UP function error, repeated NACK)	lu-UP-Status-Indication(Error event)	Procedure control functions	
	Rate control failure	lu-UP-Status-Indication(Error event)	Procedure control functions	
	Error event failure	lu-UP-Status-Indication(Error event)	Procedure control functions	
	Time Alignment not supported	lu-UP-Status-Indication(Error event)	Procedure control functions	
	Requested Time Alignment not possible	lu-UP-Status-Indication(Error event)	Function outside lu UP	
	lu UP version not supported	lu-UP-Status-Indication(Error event)	Procedure control functions	

6.7.7 Error detection

6.7.7.1 General

Error detection is provided on frames through a Cyclic Redundancy Check. The CRC for the payload is 10 bits and for the header it is 6 bits.

6.7.7.2 CRC Calculation

The parity bits are generated by one of the following cyclic generator polynomials:

$$g_{\text{CRC6}}(D) = D^6 + D^5 + D^3 + D^2 + D^1 + 1;$$

$$g_{\text{CRC10}}(D) = D^{10} + D^9 + D^5 + D^4 + D^1 + 1.$$

Denote the bits to be protected of a frame by $a_1, a_2, a_3, \dots, a_{A_i}$ (a_1 being the bit with the highest bit position in the first octet), and the parity bits by $p_1, p_2, p_3, \dots, p_{L_i}$. A_i is the length of the protected data and L_i is 6 or 10 depending on the CRC length.

The encoding is performed in a systematic form, which means that in GF(2), the polynomial

$$a_1 D^{A_i+5} + a_2 D^{A_i+4} + \dots + a_{A_i} D^6 + p_1 D^5 + p_2 D^4 + \dots + p_5 D^1 + p_6$$

yields a remainder equal to 0 when divided by $g_{\text{CRC6}}(D)$ and the polynomial

$$a_1 D^{A_i+9} + a_2 D^{A_i+8} + \dots + a_{A_i} D^{10} + p_1 D^9 + p_2 D^8 + \dots + p_9 D^1 + p_{10}$$

yields a remainder equal to 0 when divided by $g_{\text{CRC10}}(D)$. If $A_i = 0$, $p_1 = p_2 = p_3 = \dots = p_{L_i} = 0$.

6.7.7.3 Relation between input and output of the Cyclic Redundancy Check

The protected bits are left unchanged in the frame. The parity bits for the Header CRC are put in the Header CRC field with p_1 being the highest bit position of the first octet of the Header CRC field. The parity bits for the Payload CRC are put in the Payload CRC field with p_1 being the highest bit position of the first octet of the Payload CRC field.

7 Communication Primitives for the Iu UP protocol layer

7.1 Modelling Principle

The principle illustrated by figure 30 is used for modelling the primitives towards the protocol layer.

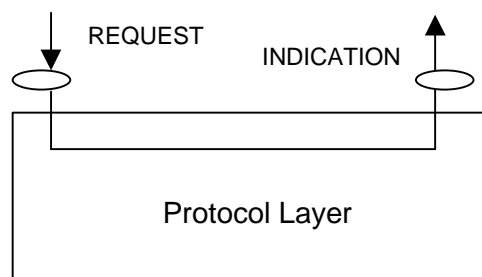

Figure 30: Modelling principle

7.2 Primitives towards the upper layers at the RNL SAP

7.2.1 General

The Iu UP protocol layer interacts with upper layers as illustrated in the figure above. The interactions with the upper layers are shown in terms of primitives where the primitives represent the logical exchange of information and control between the upper layer and the Iu UP protocol layer. They do not specify or constrain implementations.

The following primitives are defined:

- Iu-UP-DATA;
- Iu-UP-STATUS;
- Iu-UP-UNIT-DATA.

Table 1: Iu UP protocol layer service primitives towards the upper layer at the RNL SAP

Primitive	Type	Parameters	Comments
Iu-UP-DATA	Request	Iu-UP-payload	Subflow 1 SDU, ..., Subflow n SDU
		Iu-UP-control	RFCI
			FQC
	Frame Number		
Iu-UP-DATA	Indication	Iu-UP-payload	Subflow 1 SDU, ..., Subflow n SDU
		Iu-UP-control	RFCI
			FQC
	Frame Number		
Iu-UP-Status	Indication	Iu-UP-Procedure-Control	Error Cause, Error Distance
			Complete protocol data for Initialisation, Rate Control, Time Alignment and Error Event
	Request	Iu-UP-Procedure-Control	Error Cause
			Complete protocol data for Initialisation, Rate Control, Time Alignment and Error Event
Iu-UP-UNIT-DATA	Request	Iu-UP-payload	
	Indication	Iu-UP-payload	

Primitive usage is a function of the mode of operation of the Iu UP protocol. Table 2 provides the association between Iu UP primitives towards the upper layers and the Iu UP modes of operation.

Table 2: Iu UP protocol layer service primitives related to the Iu UP mode of operation and function within the mode of operation

Primitive	Type	Mode of Operation
Iu-UP-DATA	Request	SMpSDU
	Indication	SMpSDU
Iu-UP-Status	Request	SMpSDU
	Indication	SMpSDU
Iu-UP-UNIT-DATA	Request	TrM
	Indication	TrM

7.2.2 Iu-UP-DATA-REQUEST

This primitive is used as a request from the upper layer Iu NAS Data Stream entity to send the RAB subflow SDU(s) on the established transport connection. This primitive includes the RFCI, the Frame Number and FQC information of the payload.

The Iu UP protocol layer forms the Iu UP data frame, the Iu Data Stream DU being the payload of the Iu UP frame, and transfers the frame by means of the lower layer services.

7.2.3 Iu-UP-DATA-INDICATION

This primitive is used as an indication to the upper layer entity to pass the Iu NAS Data Stream User Plane information of a received Iu UP frame.

This primitive includes the RFCI, the Frame Number and FQC information of the payload.

This primitive may also include information aiming at informing the upper layers of a faulty situation that relates to the payload included in the primitive.

7.2.4 Iu-UP-STATUS-REQUEST

This primitive is used to pass control procedure information from the upper layer.

This primitive shall contain the complete protocol data for the respective procedure.

7.2.5 Iu-UP-STATUS-INDICATION

This primitive is used to pass control procedure information to the upper layer.

This primitive shall contain the complete protocol data for the respective procedure.

7.2.6 Iu-UP-UNIT-DATA-REQUEST

This primitive is used as a request from the upper layer to send an Iu UP payload on the established transport connection.

The Iu UP protocol layer transfers the Iu Data Stream DU by means of the lower layer services without adding any protocol header overhead.

7.2.7 Iu-UP-UNIT-DATA-INDICATION

This primitive is used as an indication to the upper layer entity to pass the Iu UP payload.

7.3 Primitives towards the transport layers at TNL SAP

7.3.1 General

Access to the Transport network Layer is performed through a generic SAP: TNL-SAP.

When the Transport Network upper layer consists of AAL2, the TNL SAP maps onto the AAL-SAP through which communication is performed using specific AAL primitives.

When the Transport Network upper layer consists of GTP-U, the TNL SAP maps onto the GTP-U SAP through which communication is performed using generic primitives.

The choice of communication, specific or generic, through the TNL SAP is fixed by the Radio Network Layer control plane logic. This choice is based on the requirements placed by e.g. the RAB characteristics, the CN domain requesting the RAB establishment or other operator's choice.

7.3.2 ATM/AAL2 based Transport layer

7.3.2.1 General

When the Iu UP protocol layer uses the services of an ATM/AAL2 transport, it uses an established AAL2 connection for transferring frames between the peer TNL-SAPs at both ends of the Iu User plane access points. The Transport Network Control Plane over Iu handles the signalling to establish and release the AAL2 call connections.

7.3.2.2 AAL2 Service Primitives used by the Iu UP protocol

AAL2 services and primitives used at the Service Access Point from the AAL2 layer are shown in table 3.

Table 3: AAL2 primitives and parameters

Primitive	Type	Parameters	Comments
SSSAR-UNITDATA	Request	SSSAR-INFO	
		SSSAR-UUI	Not used (note)
SSSAR-UNITDATA	Indication	SSSAR-INFO	
		SSSAR-UUI	Not used (note)
NOTE: The setting of this field is set to not used i.e. decimal value 26 according to [8].			

The primitives of table 3 are the standard primitives of [8]. These primitives are intended to be used in the Iu UP.

7.3.3 GTP-U based Transport Layer

7.3.3.1 General

When the Iu UP protocol layer uses the services of a GTP-U transport, it uses an established GTP-U tunnel for transferring frames between the GTP-U tunnel endpoints at both ends of the Iu User plane access points. The RANAP Control Plane signalling over Iu handles the signalling to establish and release the GTP-U tunnels.

7.3.3.2 Generic Service Primitives used by the Iu UP protocol

Generic primitives are used at the GTP-U SAP. They are shown in table 4.

Table 4: Generic primitives and parameters to and from GTP-U layer

Primitive	Type	Parameters	Comments
Iu-UP-UNITDATA	Request	Iu-UP-payload	
Iu-UP-UNITDATA	Indication	Iu-UP-payload	

8 Evolution of Iu UP Protocol

8.1 Principles for Protocol Evolution

8.1.1 Unknown field value

The Iu UP protocol may be evolved by taking into use field values that have been specified to be reserved for future use or have been specified as spare values. When a UP protocol entity receives an unknown field value, it can react differently depending whether the unknown value is reserved for future use or if it is a spare value. The following principles are recommended for receiver reactions:

- If a spare value is used by the sender, but not understood by the receiver, there should be a default action for the receiver. This default action should be defined on a field basis;
- If a value that is reserved for future use is used by the sender, but not understood by the receiver, the value should be rejected by the receiver. This should be done by sending a Negative Acknowledgement to the peer entity, if possible. Otherwise an Error Event should be generated in order to inform the upper layers and the peer entity;
- A received Error Event message shall not trigger another Error Event message back to the sender, even though e.g. the Cause value in the received Error Event message would not be understood.

In the following the recommended actions of the receiver are handled field by field when an unknown field value is received.

PDU Type

Recommended action if reserved values used: Generate Error Event, i.e. the upper layers and the peer entity are informed about the error event with Cause: Unknown PDU Type.

FQC

Recommended action if spare values used: Ignore the field and pass it onwards.

ACK/NACK

Proposed action if reserved values used: Generate an Error Event, i.e. the upper layers and the peer entity are informed about the error event with Cause: Unknown reserved value.

Procedure Indicator

Recommended action if reserved values used: Generate an Error Event, i.e. the upper layers and the peer entity are informed about the error event with Cause: Unknown procedure

Error Cause value

Value 49 is reserved for "Iu UP version not supported" whatever the Iu UP Mode version.

Recommended action if reserved values used: Generate Error Event, i.e. the upper layers and the peer entity are informed about the error event with Cause: Unknown reserved value.

Recommended action if spare values used: Ignore the field and pass it onwards.

8.1.2 Adding a new field to an existing frame

If there is a need to add a new field to an existing procedure, the following principles shall be applied:

- The PDU type defines the header mask. Therefore, a new field shall not be added to the header part of an existing frame and possible spare bits in the header shall not be taken into use since these would be violations of the header mask;
- The Procedure Indicator shall define the fields that should be in a control frame;
- There shall be only one Procedure Indicator for each procedure;
- If a new field needs to be introduced to an existing procedure (i.e. existing procedure that is defined in an existing UP version), the new field shall not be *added* to the payload part. Instead, the new field may be introduced by placing it to a spare field in the payload part of the frame, if possible;
- However, if a new field needs to be introduced to an existing procedure, but spare fields(s) in the payload part cannot be used to introduce the new field, then a new procedure shall be created and hence a new Procedure Indicator value shall be allocated for the new procedure;
- To enable simple protocol evolution, when a new Procedure Indicator will be introduced, the new frame shall include both the new fields and the fields of the old frame;
- When an implementation receives an unknown Procedure Indicator it may use the Error Event message with Cause: Unknown procedure to report this. This indicates to the sender that the procedure was not understood and it may try with an older procedure.

8.1.3 Adding a new PDU type

In the future, the Iu UP protocol may evolve so that there is a need to add a new PDU type. The criteria for introducing a new PDU type could be e.g.:

- The Procedure Indicators may run out and there is a need to have more;
- There is a need to change the header mask, e.g. the Frame Number field may need to be increased or the CRC field needs to be modified.

While the PDU type 15 is reserved for future PDU type extensions, there may be 'subtypes' under PDU type 15 in the future and there also may be new procedures in these 'subtypes'.

Thus it has to be ensured that if the same Procedure Indicator value is used under several PDU types, it should be made clear e.g. in the Error Event cause element, which PDU type it concerns.

The maximum length of the Spare Extension field is defined per PDU type. Thus when a new PDU type is added, an appropriate length for the Spare Extension field (if any) has to be defined. For Release '99, a length of 4 octets has been used for data PDUs, and 32 octets for control PDUs.

8.1.4 Protocol version handling

In the future, new versions of the Iu UP protocol may be introduced. A reason for a new version of the protocol could be, e.g.:

- The earlier introduced new features or functions are required to be mandatory in the new version;
- Due to technical development, the new version of the protocol could be totally different (and incompatible) from the earlier version.

The following principles shall be applied to version handling of Iu UP protocol:

- It shall be possible to introduce additional modes of operation;
- It shall be possible to evolve the operation modes independently of each other;

- There shall be independent version numbers for each mode of operation;
- The mode of operation of an Iu UP protocol instance is decided by the CN. Further, the CN shall indicate those versions that are required to support certain features, e.g. TrFO. The version of the mode among the required ones shall be negotiated between the CN and UTRAN during initialisation procedure;
- The version number of a UP operation mode may change or be unchanged between different releases;
- When the protocol is evolved it shall be made clear in the specification, which features belong to which versions;
- A new version may be an evolution (i.e. compatible) of the old version or the new version may be totally different from the old version.
- The structure of the PDU Type 14 header, up to and including header CRC, shall remain unchanged whatever the Iu UP version.

Annex A (informative): Illustration of usage of RFCI for AMR speech RAB

This annex contains information related to usage of RFCIs in the context of AMR speech RAB.

The following figure illustrates the RFCI allocation and flow throughout the UTRAN.

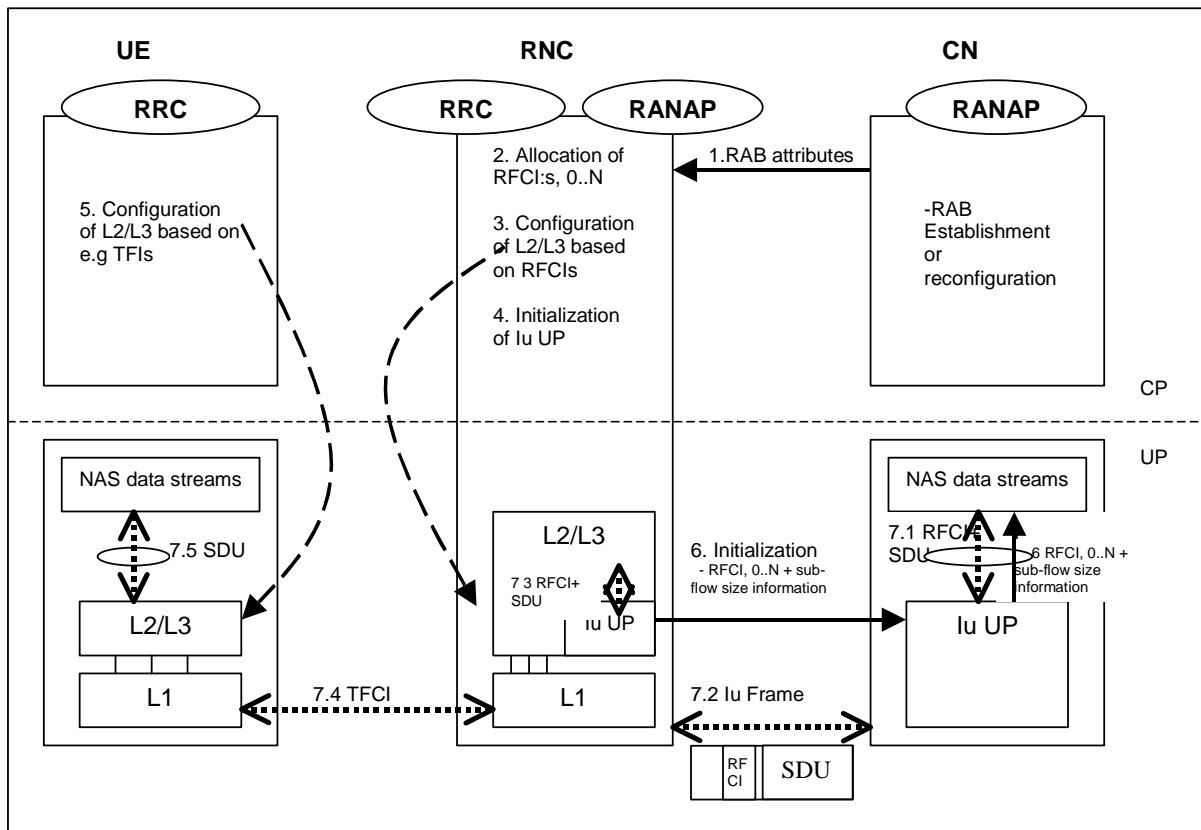

1. **RAB Attributes:** at RAB establishment or reconfiguration, the SDU format information parameter is passed to UTRAN. The SDU information is organised per BER i.e. RAB sub Flow. For instance, 12,2 kbits/s AMR codec is passed as RAB sub flow 1 SDU size: 81 bits –class A bits-, as RAB sub flow 2 SDU size: 103 bits –class B bits-, as RAB sub flow 3 SDU size: 60 bits –class C-, which makes one RAB sub Flow Combination. This is done for all source rates (i.e. all codec modes, DTX also if included). So using the RAB subflows combination set from Table A.1, the SDU Formation Information Parameters for RAB subflow 1 is [81,39,39,0], for RAB subflow 2 is [103,56,0,0], and for RAB subflow 3 is [60,0,0,0]. The Iu UP is used in support mode for predefined SDU size.
2. **Allocation of RFCIs:** the RNC dynamically allocates an identification (RFCI) to each permitted/possible combinations it can offer. E.g. for 0 kbits/s, the RNC allocates RFCI 0, for the SID, the RNC allocates RFCI 3, for 4,75 kbits/s, the RNC allocates RFCI 2, and for 12,2. kbits/s, the RNC allocates RFCI 1 (according to the example table A.1).
3. **Configuration of L2/L3 based on RFCIs:** RFCIs are used to configure the L2/L3. RLC is used in transparent mode. MAC configures its co-ordinated DCHs with the RFCIs and associates one RFCI to one TFI.
4. **Initialisation of Iu UP:** the RNC reports the permitted combinations it can offer to the transcoder using an inband Iu initialisation frame containing the RFCIs and associated RAB sub Flow sizes.
5. **Configuration of L2/L3 based on e.g. TFIs:** idem as 3. L2/L3 may use e.g. TFI to communicate with the Codec about the RAB sub-Flow structure of the SDU received or to be sent.
6. **RFCIs+ SDU size information:** the RFCIs and associated RAB sub Flow sizes received within the Iu initialisation frame are passed to the Codec for configuration.
7. **Example of DL frame transfer:**
 - 7.1. The Codec encodes a 12,2 kbits/s frame. It sends down to the Iu UP an SDU with an associated RFCI equals to 1 (in this example).
 - 7.2. The Iu UP packs a frame with a header containing an RFCI set to value 1, and the payload made of the SDU received from the Codec.
 - 7.3. The Iu UP passes to L2/L3, the Iu frame payload (the Codec SDU) and the RFCI. The L2/L3 uses this RFCI to break the Iu frame onto the co-ordinated DCHs corresponding to the different bits protection classes. The corresponding TFI is selected.
 - 7.4. The radio frame is sent with the TFCI chosen by MAC.
 - 7.5. The L2/L3 receives the SDUs on the co-ordinated DCHs, combines them back and uses e.g. the TFI to indicate to the codec the structure of the received frame.

Figure A.1

For information on RAB subflow combinations used for AMR speech see reference [12].

SRNC allocates one or more possible/available RAB sub-flow combination(s) and generates RAB sub-flow combination set. RAB sub-flow combination number is dynamically generated by SRNC. This RAB sub-flow combination set is signalled towards CN with user plane signalling as described in [1]. The signalling towards UE is to be defined by TSG-RAN WG2.

RAB sub-flow combination set:

A RAB sub-flow combination indicator, RFCI, indicates which RAB sub flow combination will be used for the Iu user frames. In the communication phase the RFCI is included in the user frame, and the RFCI state the structure of the user frame.

Table A.1 exemplifies the allocation of 4 different RAB sub-flows combinations for 3 sub-flows and generating of RAB sub-flows combination set.

Table A.1: Example of Allocation of RAB sub-flows combination indicator

	RFCI (RAB sub- Flow Combination Indicator)	RAB sub- Flow 1	RAB sub- flow 2	RAB sub- flow 3	Total	Source rate
RAB sub- flows combina tion set	1	81	103	60	244	Source rate 1
	2	39	56	0	95	Source rate 2
	3	39	0	0	39	Source rate 3
	0	0	0	0	0	Source rate 4
NOTE:	In the table above the greyed area shows the part that is sent in the initialisation procedure in Iu UP. This is what constitutes the RAB subflow combination set.					

Annex B (informative): Illustration of protocol states in the Iu UP

This annex contains information related to possible protocol states for operation of the Iu UP. This annex does not constraint implementation and is for illustration purposes only.

The state model is common for both ends of the Iu UP so that the protocol machines are operating symmetrically. This approach is taken to facilitate state description for all cases including possible future scenarios where the Iu UP could be terminated elsewhere.

NOTE: Primitive Iu-UP-CONFIG-Req is used by upper layers to configure the Iu UP protocol layer. It is used in this annex for illustrative purposes and therefore it is not defined in clause 7.

B.1 Protocol state model for transparent mode

Figure B.1 illustrates the state model for transparent mode Iu UP instances. A transparent mode instance can be in one of following states.

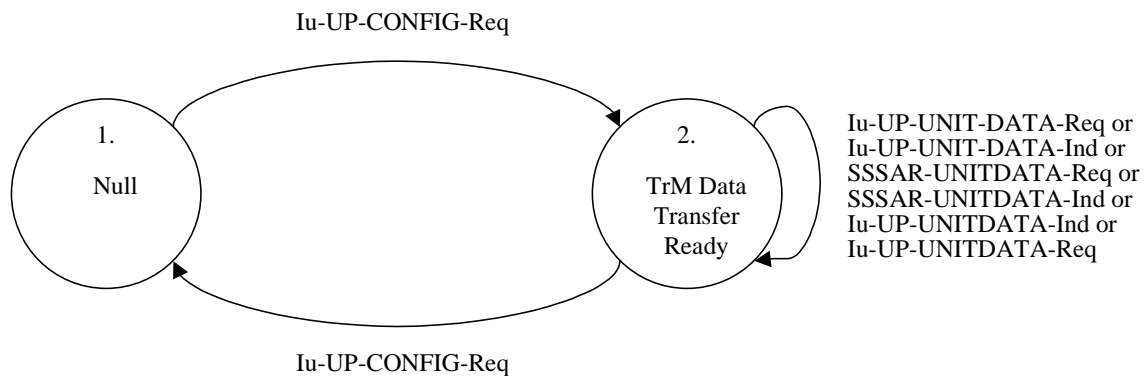

Figure B.1: Protocol state model for transparent mode

B.1.1 Null State

In the null state the Iu UP instance does not exist and therefore it is not possible to transfer any data through it.

Upon reception of a Iu-UP-CONFIG-Req from higher layer the Iu UP instance is created and transparent mode data transfer ready state is entered. The mode information is received either through RANAP signalling or directly in the CN node. In the Iu-UP-CONFIG-Req e.g. the following information will be indicated:

- Transparent mode.

B.1.2 Transparent Mode Data Transfer Ready State

In the transparent mode data transfer ready state, transparent mode data can be exchanged between the entities.

Upon reception of Iu-UP-CONFIG-Req indicating release from higher layer, the Iu UP instance is terminated and the null state is entered.

B.2 Protocol state model for support mode for predefined SDU sizes

Figure B.2 illustrates the state model for support mode Iu UP instances. A support mode instance can be in one of the following states.

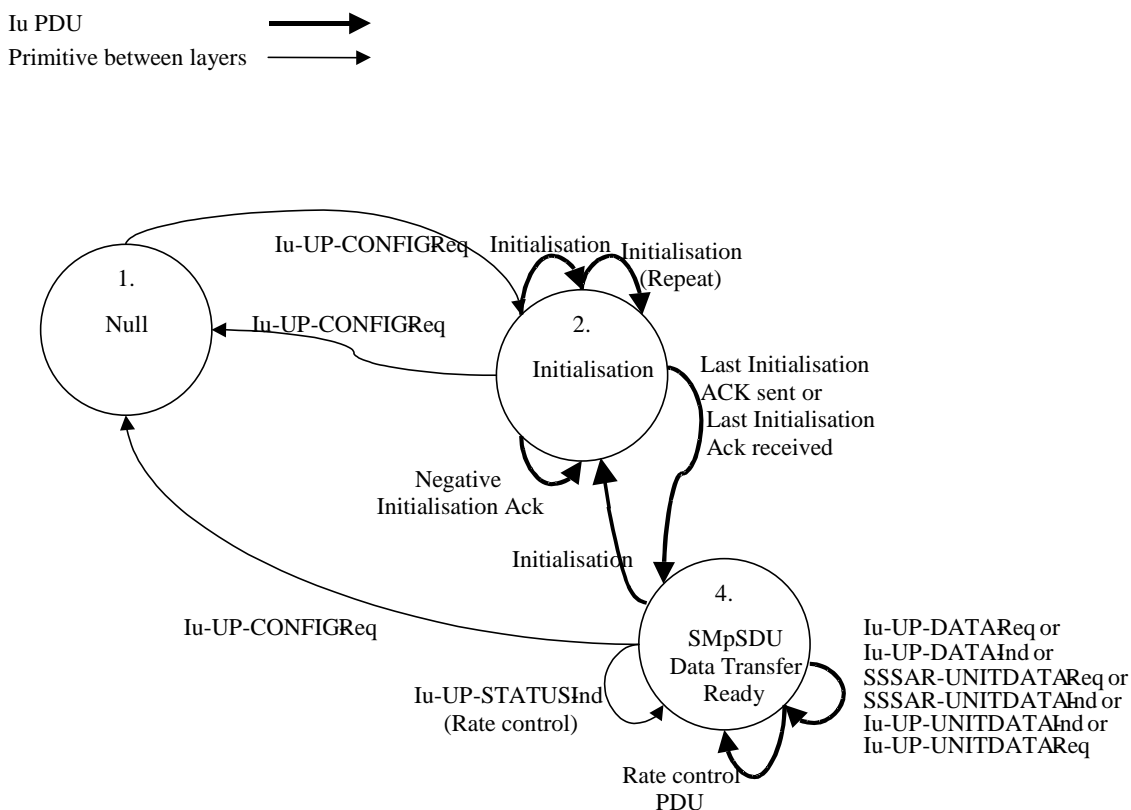

Figure B.2: Protocol state model for support mode

B.2.1 Null State

In the null state the Iu UP instance does not exist and therefore it is not possible to transfer any data through it.

Upon reception of a Iu-UP-CONFIG-Req from higher layer the Iu UP instance is created and initialisation state is entered. In the Iu-UP-CONFIG-Req e.g. the following information could be indicated:

- Support mode for predefined SDU sizes;
- Time alignment (FFS);
- Indication of delivery of erroneous SDUs;
- Periodicity;
- required UP versions.

B.2.2 Initialisation State

In the initialisation state the instance exchanges initialisation information with its peer Iu UP instance.

Upon reception of Iu-UP-CONFIG-Req indicating release from higher layer, the Iu UP instance is terminated and the null state is entered.

Upon sending or receiving of an initialisation frame the Iu UP instance remains in the Initialisation state. The sending side starts a supervision timer T_{INIT} . The receiving side acknowledges the initialisation frame with a positive acknowledgement or a negative acknowledgement.

Upon reception of the last initialisation acknowledgement frame, the supervision timer T_{INIT} is stopped and the Iu UP instance enters SMpSDU data transfer ready state.

After sending a positive acknowledgement of the last initialisation frame, the Iu UP instance enters SMpSDU data transfer ready state. Note that CN does not know if the initialisation ACK was correctly received by the RNC (and initialisation procedure successfully completed) until it receives RAB assignment response, or use data from the RNC. The CN must therefore be able to continue receiving initialisation frames by re-entering the Initialisation state (from Support Mode Data Transfer Ready State), if the CN has started to send user data before receiving the indication that Initialisation was successfully completed.

Upon reception of an initialisation negative acknowledgement frame (INIT NACK) initialisation frame can be repeated n times.

If after n repetitions, the initialisation procedure is unsuccessfully terminated (due to n negative acknowledgements or timer expires) the Error event procedure is used to report the Initialisation failure and the Iu UP instance remains in the initialisation state. Upon reception of an Initialisation frame the Initialisation state is entered.

B.2.3 Support Mode Data Transfer Ready State

In the support mode data transfer ready state, support mode data can be exchanged between the peer Iu UP instances.

Upon reception of Iu-UP-DATA-Request from the upper layer or SSSAR-UNITDATA-Indication or Iu-UP-UNITDATA-Indication from TNL layer, appropriate user data transfer procedures are performed. Iu UP instance remains in the SMpSDU data transfer ready state.

Upon sending of Iu-UP-DATA- Indication or SSSAR-UNITDATA-Request or Iu-UP-UNITDATA-Request the Iu UP instance remains in the SMpSDU data transfer ready state.

Upon sending or receiving of a rate control PDU the Iu UP instance remains in the SMpSDU data transfer ready state.

Upon sending of a Iu-UP-STATUS-Indication (rate control) the Iu UP instance remains in the SMpSDU data transfer ready state.

Upon reception of Iu-UP-CONFIG-Req from higher layer the Iu UP instance is terminated and the null state is entered.

Upon detection of a protocol fault, Iu-UP-STATUS-Indication is sent to upper layer an error event frame may be sent over Iu UP.

In case of handover or relocation, initialisation procedures may have to be performed and Iu UP instance may have to enter the initialisation state.

Annex C (informative): Open Issues of the Iu UP

This annex contains information related to open issues left in the Iu UP protocol.

Annex D (informative): Distributed rate decision within RNC

This annex contains information related to the distributed rate decision within an RNC (see also within [13])

The rate control procedure over Iu UP is normally controlled by the entity controlling the rate control over UTRAN i.e. the SRNC. The SRNC may send rate control commands in uplink (to the CN) to control the rates in downlink. The SRNC may also send rate control commands in downlink (to the UE) to control the rates in uplink. The rate control procedures for both directions are independent of each other, i.e. different rates may be permitted in uplink and downlink, see figure D.1.

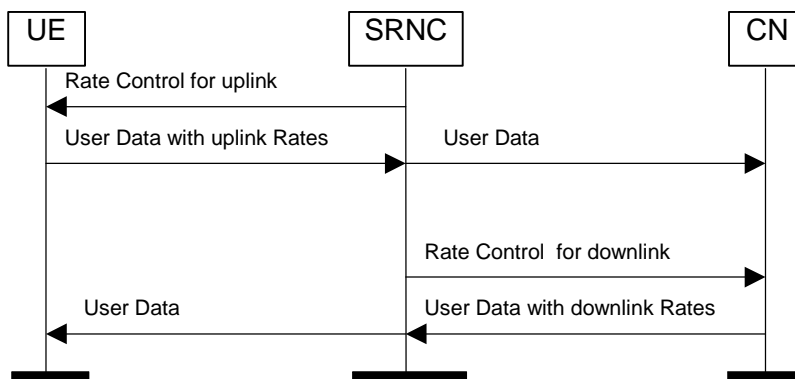

Figure D.1: Rate Control for uplink and downlink

The rates associated with the service could be rank ordered from "lower" to "higher" according to their SDU bit rates and RFCI values, with RFCI=0 having the lowest rate. A rate lower than the currently allowed maximum rate shall not be forbidden while a higher rate is forbidden. In order to stabilise the rate control procedure and its influences on the radio link and the network, typically only one additional rate shall be forbidden or permitted in subsequent rate control commands.

In some cases, as TrFO and TFO, the rate is also controlled by the remote partner at the other end of the Iu UP. The SRNC may then also receive rate control commands in downlink (from the CN) controlling the rates in uplink. Only rates that are permitted by both sides for one direction shall be used in that direction. The SRNC shall therefore combine these rate commands from the CN with its own control commands for the uplink direction by taking the rate control command with the lowest maximum rate and shall sent this rate control command downlink to the UE. This combination is denoted in figure D.2 with "Rate Control (CN ⊕ RNC)".

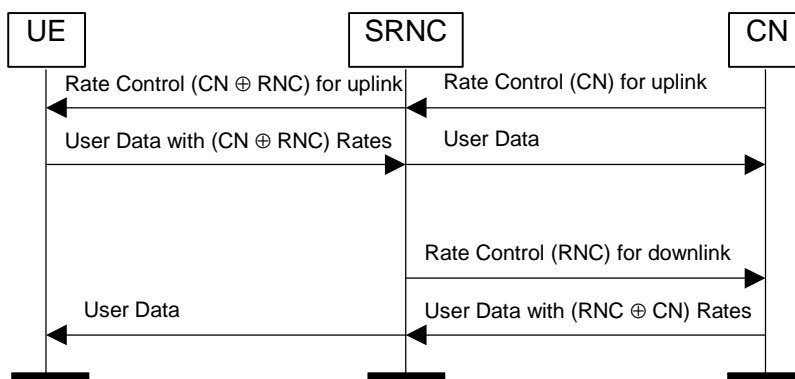

Figure D.2: Distributed Rate Control for uplink and downlink

Annex E (informative): Change History

Change history					
TSG RAN#	Version	CR	Tdoc RAN	New Version	Subject/Comment
RAN_05	-	-	-	3.0.0	Approved at TSG RAN #5 and placed under Change Control
RAN_06	3.0.0	-	RP-99748	3.1.0	Approved at TSG RAN #6
RAN_06	3.0.0	-	RP-99749	3.1.0	Approved at TSG RAN #6
RAN_06	3.0.0	-	RP-99750	3.1.0	Approved at TSG RAN #6
RAN_07	3.1.0	-	-	3.2.0	Approved at TSG RAN #7
RAN_08	3.2.0	-	RP-000238	3.3.0	Approved at TSG RAN #8
RAN_09	3.3.0	028 029 030 032 034 035	RP-000376	3.4.0	Approved at TSG RAN #9
RAN_10	3.4.0	036 037 038 040 041 042 043 044	RP-000615	3.5.0	Approved at TSG RAN #10
RAN_11	3.5.0	045 046 047 049 050 053 054 056	RP-010113	3.6.0	Approved at TSG RAN #11

Change history							
Date	TSG #	TSG Doc.	CR	Rev	Subject/Comment	Old	New
March 01	11	RP-010162	051		Approved at TSG RAN #11 and placed under Change Control	-	4.0.0
March 01	11	RP-010158	057, 058, 059, 060		Approved at TSG RAN #11 and placed under Change Control	-	4.0.0
06/2001	12	RP-010376	061, 066		Approved at TSG RAN #12	4.0.0	4.1.0
06/2001	12	RP-010393	064, 063		Approved at TSG RAN #12	4.0.0	4.1.0
09/2001	13	RP-010581	067		Clarification of "RFCI n Indicator"	4.1.0	4.2.0
09/2001	13	RP-010581	074	3	General Corrections on Iu User Plane	4.1.0	4.2.0
09/2001	13	RP-010696	072	2	Coding of no_data mode	4.1.0	4.2.0
09/2001	13	RP-010595	062	3	Iu UP version handling (Rel 4)	4.1.0	4.2.0

History

Document history		
V4.0.0	March 2001	Publication
V4.1.0	June 2001	Publication
V4.2.0	September 2001	Publication