

ETSI TS 125 423 V3.13.0 (2003-03)

Technical Specification

**Universal Mobile Telecommunications System (UMTS);
UTRAN Iur interface RNSAP signalling
(3GPP TS 25.423 version 3.13.0 Release 1999)**



Reference

RTS/TSGR-0325423v3d0

Keywords

UMTS

ETSI

650 Route des Lucioles
F-06921 Sophia Antipolis Cedex - FRANCE

Tel.: +33 4 92 94 42 00 Fax: +33 4 93 65 47 16

Siret N° 348 623 562 00017 - NAF 742 C
Association à but non lucratif enregistrée à la
Sous-Préfecture de Grasse (06) N° 7803/88

Important notice

Individual copies of the present document can be downloaded from:

<http://www.etsi.org>

The present document may be made available in more than one electronic version or in print. In any case of existing or perceived difference in contents between such versions, the reference version is the Portable Document Format (PDF). In case of dispute, the reference shall be the printing on ETSI printers of the PDF version kept on a specific network drive within ETSI Secretariat.

Users of the present document should be aware that the document may be subject to revision or change of status. Information on the current status of this and other ETSI documents is available at

<http://portal.etsi.org/tb/status/status.asp>

If you find errors in the present document, send your comment to:

editor@etsi.org

Copyright Notification

No part may be reproduced except as authorized by written permission.
The copyright and the foregoing restriction extend to reproduction in all media.

© European Telecommunications Standards Institute 2003.
All rights reserved.

DECTTM, **PLUGTESTS**TM and **UMTS**TM are Trade Marks of ETSI registered for the benefit of its Members.
TIPHONTM and the **TIPHON logo** are Trade Marks currently being registered by ETSI for the benefit of its Members.
3GPPTM is a Trade Mark of ETSI registered for the benefit of its Members and of the 3GPP Organizational Partners.

Intellectual Property Rights

IPRs essential or potentially essential to the present document may have been declared to ETSI. The information pertaining to these essential IPRs, if any, is publicly available for **ETSI members and non-members**, and can be found in ETSI SR 000 314: "*Intellectual Property Rights (IPRs); Essential, or potentially Essential, IPRs notified to ETSI in respect of ETSI standards*", which is available from the ETSI Secretariat. Latest updates are available on the ETSI Web server (<http://webapp.etsi.org/IPR/home.asp>).

All published ETSI deliverables shall include information which directs the reader to the above source of information.

Foreword

This Technical Specification (TS) has been produced by ETSI 3rd Generation Partnership Project (3GPP).

The present document may refer to technical specifications or reports using their 3GPP identities, UMTS identities or GSM identities. These should be interpreted as being references to the corresponding ETSI deliverables.

The cross reference between GSM, UMTS, 3GPP and ETSI identities can be found under <http://webapp.etsi.org/key/queryform.asp>.

Contents

Intellectual Property Rights	2
Foreword.....	2
Foreword.....	12
1 Scope	13
2 References	13
3 Definitions, Symbols and Abbreviations.....	14
3.1 Definitions	14
3.2 Symbols.....	15
3.3 Abbreviations	15
4 General	16
4.1 Procedure Specification Principles.....	16
4.2 Forwards and Backwards Compatibility	16
4.3 Source Signalling Address Handling.....	17
4.4 Specification Notations	17
5 RNSAP Services	17
5.1 RNSAP Procedure Modules	17
5.2 Parallel Transactions	18
6 Services Expected from Signalling Transport.....	18
7 Functions of RNSAP	18
8 RNSAP Procedures	19
8.1 Elementary Procedures.....	19
8.2 Basic Mobility Procedures	21
8.2.1 Uplink Signalling Transfer	21
8.2.1.1 General	21
8.2.1.2 Successful Operation.....	21
8.2.1.3 Abnormal Conditions	21
8.2.2 Downlink Signalling Transfer.....	22
8.2.2.1 General	22
8.2.2.2 Successful Operation.....	22
8.2.2.3 Abnormal Conditions	22
8.2.3 Relocation Commit	22
8.2.3.1 General	22
8.2.3.2 Successful Operation.....	23
8.2.3.3 Abnormal Conditions	23
8.2.4 Paging	23
8.2.4.1 General	23
8.2.4.2 Successful Operation.....	23
8.2.4.3 Abnormal Conditions	23
8.3 DCH Procedures.....	24
8.3.1 Radio Link Setup	24
8.3.1.1 General	24
8.3.1.2 Successful Operation.....	24
8.3.1.3 Unsuccessful Operation	29
8.3.1.4 Abnormal Conditions	30
8.3.2 Radio Link Addition	30
8.3.2.1 General	30
8.3.2.2 Successful Operation.....	31
8.3.2.3 Unsuccessful Operation	34
8.3.2.4 Abnormal Conditions	35
8.3.3 Radio Link Deletion.....	36
8.3.3.1 General	36

8.3.3.2	Successful Operation.....	36
8.3.3.3	Unsuccessful Operation	36
8.3.3.4	Abnormal Conditions	36
8.3.4	Synchronised Radio Link Reconfiguration Preparation.....	36
8.3.4.1	General	36
8.3.4.2	Successful Operation.....	37
8.3.4.3	Unsuccessful Operation	43
8.3.4.4	Abnormal Conditions	43
8.3.5	Synchronised Radio Link Reconfiguration Commit.....	44
8.3.5.1	General	44
8.3.5.2	Successful Operation.....	44
8.3.5.3	Abnormal Conditions	44
8.3.6	Synchronised Radio Link Reconfiguration Cancellation.....	45
8.3.6.1	General	45
8.3.6.2	Successful Operation.....	45
8.3.6.3	Abnormal Conditions	45
8.3.7	Unsynchronised Radio Link Reconfiguration.....	45
8.3.7.1	General	45
8.3.7.2	Successful Operation.....	45
8.3.7.3	Unsuccessful Operation	49
8.3.7.4	Abnormal Conditions	49
8.3.8	Physical Channel Reconfiguration.....	49
8.3.8.1	General	49
8.3.8.2	Successful Operation.....	50
8.3.8.3	Unsuccessful Operation	50
8.3.8.4	Abnormal Conditions	51
8.3.9	Radio Link Failure	51
8.3.9.1	General	51
8.3.9.2	Successful Operation.....	51
8.3.9.3	Abnormal Conditions	52
8.3.10	Radio Link Restoration	52
8.3.10.1	General	52
8.3.10.2	Successful Operation.....	52
8.3.10.3	Abnormal Conditions	53
8.3.11	Dedicated Measurement Initiation.....	53
8.3.11.1	General	53
8.3.11.2	Successful Operation.....	53
8.3.11.3	Unsuccessful Operation	55
8.3.11.4	Abnormal Conditions	56
8.3.12	Dedicated Measurement Reporting.....	56
8.3.12.1	General	56
8.3.12.2	Successful Operation.....	56
8.3.12.3	Abnormal Conditions	56
8.3.13	Dedicated Measurement Termination	57
8.3.13.1	General	57
8.3.13.2	Successful Operation.....	57
8.3.13.3	Abnormal Conditions	57
8.3.14	Dedicated Measurement Failure	57
8.3.14.1	General	57
8.3.14.2	Successful Operation.....	57
8.3.14.3	Abnormal Conditions	58
8.3.15	Downlink Power Control [FDD]	58
8.3.15.1	General	58
8.3.15.2	Successful Operation.....	58
8.3.15.3	Abnormal Conditions	59
8.3.16	Compressed Mode Command [FDD]	59
8.3.16.1	General	59
8.3.16.2	Successful Operation.....	59
8.3.16.3	Abnormal Conditions	59
8.3.17	Downlink Power Timeslot Control [TDD]	60
8.3.17.1	General	60
8.3.17.2	Successful Operation.....	60

8.3.17.3	Abnormal Conditions	60
8.3.18	Radio Link Pre-emption.....	60
8.3.18.1	General	60
8.3.18.2	Successful Operation.....	61
8.3.18.3	Abnormal Conditions	61
8.4	Common Transport Channel Procedures.....	61
8.4.1	Common Transport Channel Resources Initialisation	61
8.4.1.1	General	61
8.4.1.2	Successful Operation.....	61
8.4.1.3	Unsuccessful Operation	62
8.4.1.4	Abnormal Conditions	63
8.4.2	Common Transport Channel Resources Release	63
8.4.2.1	General	63
8.4.2.2	Successful Operation.....	63
8.4.2.3	Abnormal Conditions	63
8.5	Global Procedures	63
8.5.1	Error Indication.....	63
8.5.1.1	General	63
8.5.1.2	Successful Operation.....	64
8.5.1.3	Abnormal Conditions	64
9	Elements for RNSAP Communication.....	65
9.1	Message Functional Definition and Content	65
9.1.1	General.....	65
9.1.2	Message Contents	65
9.1.2.1	Presence	65
9.1.2.2	Criticality	65
9.1.2.3	Range	65
9.1.2.4	Assigned Criticality.....	65
9.1.3	RADIO LINK SETUP REQUEST	66
9.1.3.1	FDD Message.....	66
9.1.3.2	TDD Message	68
9.1.4	RADIO LINK SETUP RESPONSE	70
9.1.4.1	FDD Message.....	70
9.1.4.2	TDD Message	72
9.1.5	RADIO LINK SETUP FAILURE	74
9.1.5.1	FDD Message.....	74
9.1.5.2	TDD Message	75
9.1.6	RADIO LINK ADDITION REQUEST	76
9.1.6.1	FDD Message.....	76
9.1.6.2	TDD Message	77
9.1.7	RADIO LINK ADDITION RESPONSE.....	78
9.1.7.1	FDD Message.....	78
9.1.7.2	TDD Message	79
9.1.8	RADIO LINK ADDITION FAILURE.....	81
9.1.8.1	FDD Message.....	81
9.1.8.2	TDD Message	82
9.1.9	RADIO LINK DELETION REQUEST.....	82
9.1.10	RADIO LINK DELETION RESPONSE.....	82
9.1.11	RADIO LINK RECONFIGURATION PREPARE.....	83
9.1.11.1	FDD Message.....	83
9.1.11.2	TDD Message	85
9.1.12	RADIO LINK RECONFIGURATION READY.....	87
9.1.12.1	FDD Message.....	87
9.1.12.2	TDD Message	88
9.1.13	RADIO LINK RECONFIGURATION COMMIT	90
9.1.14	RADIO LINK RECONFIGURATION FAILURE.....	90
9.1.15	RADIO LINK RECONFIGURATION CANCEL.....	90
9.1.16	RADIO LINK RECONFIGURATION REQUEST.....	91
9.1.16.1	FDD Message.....	91
9.1.16.2	TDD Message	91
9.1.17	RADIO LINK RECONFIGURATION RESPONSE.....	92

9.1.17.1	FDD Message.....	92
9.1.17.2	TDD Message	92
9.1.18	RADIO LINK FAILURE INDICATION	93
9.1.19	RADIO LINK RESTORE INDICATION	94
9.1.20	DL POWER CONTROL REQUEST [FDD].....	94
9.1.21	PHYSICAL CHANNEL RECONFIGURATION REQUEST	95
9.1.21.1	FDD Message.....	95
9.1.21.2	TDD Message	96
9.1.22	PHYSICAL CHANNEL RECONFIGURATION COMMAND.....	96
9.1.23	PHYSICAL CHANNEL RECONFIGURATION FAILURE	97
9.1.24	UPLINK SIGNALLING TRANSFER INDICATION	97
9.1.24.1	FDD Message.....	97
9.1.24.2	TDD Message	97
9.1.25	DOWNLINK SIGNALLING TRANSFER REQUEST	98
9.1.26	RELOCATION COMMIT	98
9.1.27	PAGING REQUEST	98
9.1.28	DEDICATED MEASUREMENT INITIATION REQUEST	99
9.1.29	DEDICATED MEASUREMENT INITIATION RESPONSE.....	100
9.1.30	DEDICATED MEASUREMENT INITIATION FAILURE.....	100
9.1.31	DEDICATED MEASUREMENT REPORT	101
9.1.32	DEDICATED MEASUREMENT TERMINATION REQUEST.....	101
9.1.33	DEDICATED MEASUREMENT FAILURE INDICATION	101
9.1.34	COMMON TRANSPORT CHANNEL RESOURCES RELEASE REQUEST.....	102
9.1.35	COMMON TRANSPORT CHANNEL RESOURCES REQUEST	102
9.1.36	COMMON TRANSPORT CHANNEL RESOURCES RESPONSE.....	102
9.1.36.1	FDD Message.....	102
9.1.36.2	TDD Message	103
9.1.37	COMMON TRANSPORT CHANNEL RESOURCES FAILURE	103
9.1.38	COMPRESSED MODE COMMAND [FDD].....	103
9.1.39	ERROR INDICATION.....	103
9.1.40	DL POWER TIMESLOT CONTROL REQUEST [TDD].....	104
9.1.41	RADIO LINK PREEMPTION REQUIRED INDICATION.....	104
9.2	Information Element Functional Definition and Contents	104
9.2.0	General.....	104
9.2.1	Common Parameters.....	104
9.2.1.1	Allocation/Retention Priority	104
9.2.1.2	Allowed Queuing Time.....	105
9.2.1.3	Binding ID.....	105
9.2.1.4	BLER	105
9.2.1.4A	Block STTD Indicator.....	105
9.2.1.5	Cause.....	106
9.2.1.5A	Cell Geographical Area Identity (Cell GAI).....	108
9.2.1.6	Cell Identifier (C-Id)	108
9.2.1.7	Cell Individual Offset.....	109
9.2.1.8	Cell Parameter ID.....	109
9.2.1.9	CFN.....	109
9.2.1.10	CFN Offset.....	109
9.2.1.11	CN CS Domain Identifier.....	109
9.2.1.11A	CN Domain Type	110
9.2.1.12	CN PS Domain Identifier	110
9.2.1.13	Criticality Diagnostics.....	111
9.2.1.14	C-RNTI	113
9.2.1.15	DCH Combination Indicator	113
9.2.1.16	DCH ID	113
9.2.1.16A	DCH Information Response	113
9.2.1.17	Dedicated Measurement Object Type	114
9.2.1.18	Dedicated Measurement Type.....	114
9.2.1.19	Dedicated Measurement Value	114
9.2.1.19A	Dedicated Measurement Value Information	115
9.2.1.20	Diversity Control Field	115
9.2.1.21	Diversity Indication.....	115
9.2.1.21A	DL Power	116

9.2.1.22	Downlink SIR Target	116
9.2.1.23	DPCH Constant Value	116
9.2.1.24	D-RNTI	116
9.2.1.25	D-RNTI Release Indication	116
9.2.1.26	DRX Cycle Length Coefficient	116
9.2.1.26A	DSCH ID	117
9.2.1.26B	DSCH Flow Control Information	117
9.2.1.26Ba	DSCH-RNTI	117
9.2.1.26Bb	Extended GSM Cell Individual Offset	117
9.2.1.26C	FACH Flow Control Information	118
9.2.1.27	FACH Initial Window Size	118
9.2.1.28	FACH Priority Indicator	118
9.2.1.28A	FN Reporting Indicator	118
9.2.1.29	Frame Handling Priority	118
9.2.1.30	Frame Offset	119
9.2.1.31	IMSI	119
9.2.1.32	L3 Information	119
9.2.1.33	Limited Power Increase	119
9.2.1.34	MAC-c/sh SDU Length	119
9.2.1.35	Maximum Allowed UL Tx Power	120
9.2.1.35A	Measurement Availability Indicator	120
9.2.1.35B	Measurement Change Time	120
9.2.1.36	Measurement Filter Coefficient	120
9.2.1.36A	Measurement Hysteresis Time	120
9.2.1.37	Measurement ID	120
9.2.1.38	Measurement Increase/Decrease Threshold	121
9.2.1.39	Measurement Threshold	121
9.2.1.39A	Message Structure	122
9.2.1.40	Message Type	123
9.2.1.41	Multiple URAs Indicator	124
9.2.1.41A	Neighbouring UMTS Cell Information	125
9.2.1.41B	Neighbouring FDD Cell Information	125
9.2.1.41C	Neighbouring GSM Cell Information	125
9.2.1.41D	Neighbouring TDD Cell Information	127
9.2.1.41E	Paging Cause	128
9.2.1.41F	Paging Record Type	129
9.2.1.42	Payload CRC Present Indicator	129
9.2.1.43	PCCPCH Power	129
9.2.1.44	Primary CPICH Power	129
9.2.1.45	Primary Scrambling Code	129
9.2.1.46	Puncture Limit	130
9.2.1.46A	QE-Selector	130
9.2.1.47	RANAP Relocation Information	130
9.2.1.48	Report Characteristics	130
9.2.1.48a	Report Periodicity	131
9.2.1.48A	Restriction State Indicator	132
9.2.1.49	RL ID	132
9.2.1.50	RNC-Id	132
9.2.1.51	SCH Time Slot	132
9.2.1.51A	Scheduling Priority Indicator	133
9.2.1.52	Service Area Identifier (SAI)	133
9.2.1.53	S-RNTI	133
9.2.1.54	Sync Case	133
9.2.1.55	TFCI Presence	134
9.2.1.56	Time Slot	134
9.2.1.57	ToAWE	134
9.2.1.58	ToAWS	134
9.2.1.59	Transaction ID	134
9.2.1.60	Transport Bearer ID	135
9.2.1.61	Transport Bearer Request Indicator	135
9.2.1.62	Transport Layer Address	135
9.2.1.63	Transport Format Combination Set (TFCS)	135

9.2.1.64	Transport Format Set.....	138
9.2.1.65	TrCh Source Statistics Descriptor	140
9.2.1.66	UARFCN	140
9.2.1.67	UL FP Mode.....	140
9.2.1.68	UL Interference Level.....	140
9.2.1.69	Uplink SIR	140
9.2.1.70	URA ID	140
9.2.1.70A	UTRAN Access Point Position	141
9.2.1.70B	URA Information	141
9.2.1.71	UTRAN Cell Identifier (UC-Id).....	141
9.2.1.72	Permanent NAS UE Identity	141
9.2.1.73	SCTD Indicator	141
9.2.2	FDD Specific Parameters.....	142
9.2.2.A	Active Pattern Sequence Information.....	142
9.2.2.B	Adjustment Period.....	142
9.2.2.C	Adjustment Ratio	142
9.2.2.1	Chip Offset.....	143
9.2.2.2	Closed Loop Mode1 Support Indicator	143
9.2.2.3	Closed Loop Mode2 Support Indicator	143
9.2.2.3A	Closed Loop Timing Adjustment Mode.....	143
9.2.2.4	Compressed Mode Method	144
9.2.2.4A	DCH FDD Information	144
9.2.2.5	D-Field Length.....	144
9.2.2.6	Diversity Control Field	144
9.2.2.7	Diversity Indication.....	144
9.2.2.8	Diversity Mode	144
9.2.2.9	DL DPCH Slot Format.....	145
9.2.2.10	DL Power	145
9.2.2.11	DL Scrambling Code.....	145
9.2.2.12	Downlink Frame Type	145
9.2.2.13	DRAC Control	145
9.2.2.13A	DSCH FDD Information	145
9.2.2.13B	DSCH FDD Information Response.....	146
9.2.2.13Bb	DSCH-RNTI	146
9.2.2.13C	FDD DCHs To Modify	146
9.2.2.14	FDD DL Channelisation Code Number	147
9.2.2.14A	FDD DL Code Information	147
9.2.2.15	FDD S-CCPCH Offset.....	147
9.2.2.16	FDD TPC Downlink Step Size.....	148
9.2.2.16A	First RLS Indicator.....	148
9.2.2.17	Gap Position Mode.....	148
9.2.2.18	Gap Period (TGP)	148
9.2.2.19	Gap Starting Slot Number (SN)	148
9.2.2.20	IB_SG_POS	148
9.2.2.21	IB_SG_REP	148
9.2.2.21a	Inner Loop DL PC Status	149
9.2.2.21A	Limited Power Increase.....	149
9.2.2.21B	Length of TFCI2	149
9.2.2.22	Max Adjustment Period	149
9.2.2.23	Max Adjustment Step.....	149
9.2.2.24	Max Number of UL DPDCHs.....	150
9.2.2.24A	Min DL Channelisation Code Length	150
9.2.2.25	Min UL Channelisation Code Length	150
9.2.2.26	Multiplexing Position.....	150
9.2.2.26A	Number of DL Channelisation Codes	150
9.2.2.27	Pattern Duration (PD)	150
9.2.2.27a	PC Preamble.....	150
9.2.2.27A	PDSCH Code Mapping.....	151
9.2.2.28	Power Adjustment Type.....	154
9.2.2.29	Power Control Mode (PCM).....	154
9.2.2.30	Power Offset	154
9.2.2.31	Power Resume Mode (PRM)	154

9.2.2.31A	Preamble Signatures.....	154
9.2.2.32	Primary CPICH Ec/No.....	154
9.2.2.33	Propagation Delay (PD).....	155
9.2.2.33A	PRACH Minimum Spreading Factor.....	155
9.2.2.34	QE-Selector.....	155
9.2.2.34A	RACH Sub Channel Numbers.....	155
9.2.2.35	RL Set ID.....	155
9.2.2.35A	Received Total Wide Band Power.....	155
9.2.2.36	S-Field Length.....	155
9.2.2.37	Scrambling Code Change.....	155
9.2.2.37A	Scrambling Code Number.....	155
9.2.2.37B	Secondary CCPCH Info.....	156
9.2.2.38	Secondary CCPCH Slot Format.....	156
9.2.2.39	Slot Number (SN).....	156
9.2.2.39a	Split Type.....	157
9.2.2.39A	SRB Delay.....	157
9.2.2.40	SSDT Cell Identity.....	157
9.2.2.41	SSDT Cell Identity Length.....	157
9.2.2.42	SSDT Indication.....	157
9.2.2.43	SSDT Support Indicator.....	158
9.2.2.44	STTD Indicator.....	158
9.2.2.45	STTD Support Indicator.....	158
9.2.2.46	TFCI Signalling Mode.....	158
9.2.2.47	Transmission Gap Distance (TGD).....	158
9.2.2.47A	Transmission Gap Pattern Sequence Information.....	159
9.2.2.47B	Transmission Gap Pattern Sequence Scrambling Code Information.....	161
9.2.2.48	Transmit Diversity Indicator.....	161
9.2.2.49	Transmit Gap Length (TGL).....	161
9.2.2.50	Tx Diversity Indicator.....	162
9.2.2.51	UL/DL Compressed Mode Selection.....	162
9.2.2.52	UL DPCCCH Slot Format.....	162
9.2.2.53	UL Scrambling Code.....	162
9.2.2.54	Uplink Delta SIR.....	162
9.2.2.55	Uplink Delta SIR After.....	162
9.2.3	TDD Specific Parameters.....	162
9.2.3.a	Alpha Value.....	162
9.2.3.A	Block STTD Indicator.....	163
9.2.3.1	Burst Type.....	163
9.2.3.2	CCTrCH ID.....	163
9.2.3.2A	DCH TDD Information.....	163
9.2.3.2B	DCH TDD Information Response.....	164
9.2.3.2C	DL Timeslot Information.....	164
9.2.3.2D	DL Time Slot ISCP Info.....	164
9.2.3.3	DPCH ID.....	164
9.2.3.3a	DSCH TDD Information.....	165
9.2.3.3A	Maximum Number of Timeslots per Frame.....	165
9.2.3.3B	Maximum Number of UL Physical Channels per Timeslot.....	165
9.2.3.3C	Maximum Number of DL Physical Channels per Frame.....	165
9.2.3.4	Midamble Shift And Burst Type.....	166
9.2.3.4A	Minimum Spreading Factor.....	166
9.2.3.5	Primary CCPCH RSCP.....	167
9.2.3.5A	PRACH Midamble.....	167
9.2.3.5B	RB Identity.....	167
9.2.3.6	Repetition Length.....	167
9.2.3.7	Repetition Period.....	167
9.2.3.7A	Rx Timing Deviation.....	167
9.2.3.7B	Secondary CCPCH Info TDD.....	168
9.2.3.7C	Secondary CCPCH TDD Code Information.....	168
9.2.3.7D	Special Burst Scheduling.....	168
9.2.3.7E	Synchronisation Configuration.....	169
9.2.3.8	TDD Channelisation Code.....	169
9.2.3.8A	TDD DPCH Offset.....	169

9.2.3.8B	TDD DCHs To Modify	169
9.2.3.8C	TDD DL Code Information	170
9.2.3.9	TDD Physical Channel Offset	170
9.2.3.10	TDD TPC Downlink Step Size	170
9.2.3.10A	TDD UL Code Information	171
9.2.3.11	TFCI Coding	171
9.2.3.12	DL Timeslot ISCP	171
9.2.3.12A	Timing Advance Applied	171
9.2.3.13	Transport Format Management	171
9.2.3.13A	UL Timeslot ISCP	172
9.2.3.13B	UL PhysCH SF Variation	172
9.2.3.13C	UL Timeslot Information	172
9.2.3.13D	UL Time Slot ISCP Info	172
9.2.3.14	USCH ID	173
9.2.3.15	USCH Information	173
9.3	Message and Information Element Abstract Syntax (with ASN.1)	174
9.3.0	General	174
9.3.1	Usage of Private Message Mechanism for Non-standard Use	174
9.3.2	Elementary Procedure Definitions	174
9.3.3	PDU Definitions	183
9.3.4	Information Element Definitions	263
9.3.5	Common Definitions	304
9.3.6	Constant Definitions	305
9.3.7	Container Definitions	311
9.4	Message Transfer Syntax	316
9.5	Timers	316
10	Handling of Unknown, Unforeseen and Erroneous Protocol Data	316
10.1	General	316
10.2	Transfer Syntax Error	317
10.3	Abstract Syntax Error	317
10.3.1	General	317
10.3.2	Criticality Information	317
10.3.3	Presence Information	318
10.3.4	Not Comprehended IE/IE Group	318
10.3.4.1	Procedure ID	318
10.3.4.1A	Type of Message	319
10.3.4.2	IEs Other Than the Procedure ID and Type of Message	319
10.3.5	Missing IE or IE Group	320
10.3.6	IEs or IE Groups Received in Wrong Order or With Too Many Occurrences or Erroneously Present ...	321
10.4	Logical Error	321
10.5	Exceptions	322
Annex A (normative):	Allocation and Pre-emption of Radio Links in the DRNS	323
A.1	Deriving Allocation Information for a Radio Link	323
A.1.1	Establishment of a New Radio Link	323
A.1.2	Modification of an Existing Radio Link	323
A.2	Deriving Retention Information for a Radio Link	324
A.3	The Allocation/Retention Process	324
A.4	The Pre-emption Process	325
Annex B (informative):	Measurement Reporting	326
Annex C (informative):	Guidelines for Usage of the Criticality Diagnostics IE	330
C.1	EXAMPLE MESSAGE Layout	330
C.2	Example on a Received EXAMPLE MESSAGE	331
C.3	Content of Criticality Diagnostics	332
C.3.1	Example 1	332
C.3.2	Example 2	333
C.3.3	Example 3	334

C.3.4	Example 4	335
C.3.5	Example 5	336
C.4	ASN.1 of EXAMPLE MESSAGE	337
Annex D (normative): DRNS Behaviour at SRNC or RNSAP Signalling Bearer Failure		339
D.1	Detection of SRNC or RNSAP Signalling Bearer/Connection Failure	339
D.1.1	Termination of All UE Contexts Related to a Specific SRNC	339
D.1.2	Termination of Specific UE Context	339
D.2	DRNC Actions at UE Context Termination	339
Annex E (informative): Change History		340
History		343

Foreword

This Technical Specification (TS) has been produced by the 3rd Generation Partnership Project (3GPP).

The contents of the present document are subject to continuing work within the TSG and may change following formal TSG approval. Should the TSG modify the contents of the present document, it will be re-released by the TSG with an identifying change of release date and an increase in version number as follows:

Version x.y.z

where:

- x the first digit:
 - 1 presented to TSG for information;
 - 2 presented to TSG for approval;
 - 3 or greater indicates TSG approved document under change control.
- y the second digit is incremented for all changes of substance, i.e. technical enhancements, corrections, updates, etc.
- z the third digit is incremented when editorial only changes have been incorporated in the document.

1 Scope

The present document specifies the radio network layer signalling procedures of the control plane between RNCs in UTRAN.

2 References

The following documents contain provisions which, through reference in this text, constitute provisions of the present document.

- References are either specific (identified by date of publication, edition number, version number, etc.) or non-specific.
- For a specific reference, subsequent revisions do not apply.
- For a non-specific reference, the latest version applies. In the case of a reference to a 3GPP document (including a GSM document), a non-specific reference implicitly refers to the latest version of that document *in the same Release as the present document*.

- [1] 3GPP TS 23.003: "Numbering, addressing and identification".
- [2] 3GPP TS 25.413: "UTRAN Iu Interface RANAP Signalling".
- [3] 3GPP TS 25.426: "UTRAN Iur and Iub Interface Data Transport & Transport Layer Signalling for DCH Data Streams".
- [4] 3GPP TS 25.427: "UTRAN Iur and Iub Interface User Plane Protocols for DCH Data Streams".
- [5] 3GPP TS 25.435: "UTRAN Iub interface User Plane Protocols for Common Transport Channel Data Streams".
- [6] 3GPP TS 25.104: "UTRA (BS) FDD; Radio transmission and Reception".
- [7] 3GPP TS 25.105: "UTRA (BS) TDD; Radio Transmission and Reception".
- [8] 3GPP TS 25.211: "Physical Channels and Mapping of Transport Channels onto Physical Channels (FDD)".
- [9] 3GPP TS 25.212: "Multiplexing and Channel Coding (FDD)".
- [10] 3GPP TS 25.214: "Physical Layer Procedures (FDD)".
- [11] 3GPP TS 25.215: "Physical Layer – Measurements (FDD)".
- [12] 3GPP TS 25.221: "Physical Channels and Mapping of Transport Channels onto Physical Channels (TDD)".
- [13] 3GPP TS 25.223: "Spreading and Modulation (TDD)".
- [14] 3GPP TS 25.225: "Physical Layer – Measurements (TDD)".
- [15] 3GPP TS 25.304: "UE Procedures in Idle Mode"
- [16] 3GPP TS 25.331: "RRC Protocol Specification".
- [17] 3GPP TS 25.402: "Synchronisation in UTRAN, Stage 2".
- [18] ITU-T Recommendation X.680 (12/97): "Information technology - Abstract Syntax Notation One (ASN.1): Specification of basic notation".
- [19] ITU-T Recommendation X.681 (12/97): "Information technology - Abstract Syntax Notation One (ASN.1): Information object specification".

- [20] ITU-T Recommendation X.691 (12/97): "Information technology - ASN.1 encoding rules - Specification of Packed Encoding Rules (PER)".
- [21] 3GPP TS 25.213: "Spreading and modulation (FDD)".
- [22] 3GPP TS 25.224: "Physical Layer Procedures (TDD)".
- [23] 3GPP TS 25.133 (V3.3): "Requirements for support of Radio Resource management (FDD)".
- [24] 3GPP TS 25.123 (V3.5): "Requirements for support of Radio Resource management (TDD)".
- [25] 3GPP TS 23.032: "Universal Graphical Area Description (GAD)".
- [26] 3GPP TS 25.302: "Services Provided by the Physical Layer".
- [27] 3GPP TS 25.213: "Spreading and modulation (FDD)".
- [28] 3GPP TR 25.921: "Guidelines and Principles for Protocol Description and Error Handling".
- [29] GSM TS 05.05: "Digital cellular telecommunications system (Phase 2+); Radio transmission and reception".
- [30] 3GPP TS 25.425: "UTRAN Iur and Iub Interface User Plane Protocols for Common Transport Channel data streams".

3 Definitions, Symbols and Abbreviations

3.1 Definitions

For the purposes of the present document, the following terms and definitions apply:

Elementary Procedure: RNSAP protocol consists of Elementary Procedures (EPs). An Elementary Procedure is a unit of interaction between two RNCs. An EP consists of an initiating message and possibly a response message. Two kinds of EPs are used:

- **Class 1:** Elementary Procedures with response (success or failure);
- **Class 2:** Elementary Procedures without response.

For Class 1 EPs, the types of responses can be as follows:

Successful

- A signalling message explicitly indicates that the elementary procedure has been successfully completed with the receipt of the response.

Unsuccessful

- A signalling message explicitly indicates that the EP failed.

Class 2 EPs are considered always successful.

Prepared Reconfiguration: A Prepared Reconfiguration exists when the Synchronised Radio Link Reconfiguration Preparation procedure has been completed successfully. The Prepared Reconfiguration does not exist any more after either of the procedures Synchronised Radio Link Reconfiguration Commit or Synchronised Radio Link Reconfiguration Cancellation has been completed.

UE Context: The UE Context contains the necessary information for the DRNC to communicate with a specific UE. The UE Context is created by the Radio Link Setup procedure or by the Uplink Signalling Transfer procedure when the UE makes its first access in a cell controlled by the DRNS. The UE Context is deleted by the Radio Link Deletion procedure, by the Common Transport Channel Resources Release procedure, or by the Downlink Signalling Transfer procedure when neither any Radio Links nor any common transport channels are established towards the concerned UE. The UE Context is identified by the SCCP Connection for messages using connection oriented mode of the signalling

bearer and the D-RNTI for messages using connectionless mode of the signalling bearer, unless specified otherwise in the procedure text.

3.2 Symbols

Void.

3.3 Abbreviations

For the purposes of the present document, the following abbreviations apply:

ASN.1	Abstract Syntax Notation One
BLER	Block Error Rate
CCCH	Common Control Channel
CCPCH	Common Control Physical Channel
CCTrCH	Coded Composite Transport Channel
CFN	Connection Frame Number
CM	Compressed Mode
CN	Core Network
CPCH	Common Packet Channel
CPICH	Common Pilot Channel
CRNC	Controlling RNC
DCH	Dedicated Channel
DL	Downlink
DPCCH	Dedicated Physical Control Channel
DPCH	Dedicated Physical Channel
DRNC	Drift RNC
DRNS	Drift RNS
D-RNTI	Drift Radio Network Temporary Identifier
DRX	Discontinuous Reception
DSCH	Downlink Shared Channel
EP	Elementary Procedure
FACH	Forward Access Channel
FDD	Frequency Division Duplex
FP	Frame Protocol
IE	Information Element
IMSI	International Mobile Subscriber Identity
ISCP	Interference Signal Code Power
MAC	Medium Access Control
NAS	Non Access Stratum
O&M	Operation and Maintenance
P-CCPCH	Primary CCPCH
PCH	Paging Channel
P-CIPCH	Primary CIPCH
PCPCH	Physical Common Packet Channel
PDU	Protocol Data Unit
PICH	Paging Indication Channel
PRACH	Physical Random Access Channel
RACH	Random Access Channel
RL	Radio Link
RLC	Radio Link Control
RLS	Radio Link Set
RNS	Radio Network Subsystem
RNSAP	Radio Network Subsystem Application Part
RNTI	Radio Network Temporary Identifier
RRC	Radio Resource Control
RSCP	Received Signal Code Power
S-CCPCH	Secondary CCPCH
SCH	Synchronisation Channel
SCTD	Space Code Transmit Diversity

SDU	Service Data Unit
SFN	System Frame Number
SIR	Signal-to-Interference Ratio
SRNC	Serving RNC
SRNS	Serving RNS
SSDT	Site Selection Diversity Transmission
STTD	Space Time Transmit Diversity
TDD	Time Division Duplex
TFCI	Transport Format Combination Indicator
TFCS	Transport Format Combination Set
TFS	Transport Format Set
ToAWS	Time of Arrival Window Endpoint
TPC	Transmit Power Control
TrCh	Transport Channel
TSTD	Time Switched Transmit Diversity
UARFCN	UTRA Absolute Radio Frequency Channel Number
UE	User Equipment
UL	Uplink
URA	UTRAN Registration Area
USCH	Uplink Shared Channel
UTRA	Universal Terrestrial Radio Access
UTRAN	Universal Terrestrial Radio Access Network

4 General

4.1 Procedure Specification Principles

The principle for specifying the procedure logic is to specify the functional behaviour of the DRNC/CRNC exactly and completely. The SRNC functional behaviour is left unspecified. The Physical Channel Reconfiguration procedure is an exception from this principle.

The following specification principles have been applied for the procedure text in subclause 8:

- The procedure text discriminates between:

- 1) Functionality which "shall" be executed

The procedure text indicates that the receiving node "shall" perform a certain function Y under a certain condition. If the receiving node supports procedure X but cannot perform functionality Y requested in the REQUEST message of a Class 1 EP, the receiving node shall respond with the message used to report unsuccessful outcome for this procedure, containing an appropriate cause value.

- 2) Functionality which "shall, if supported" be executed

The procedure text indicates that the receiving node "shall, if supported," perform a certain function Y under a certain condition. If the receiving node supports procedure X, but does not support functionality Y, the receiving node shall proceed with the execution of the EP, possibly informing the requesting node about the not supported functionality.

- Any required inclusion of an optional IE in a response message is explicitly indicated in the procedure text. If the procedure text does not explicitly indicate that an optional IE shall be included in a response message, the optional IE shall not be included.

4.2 Forwards and Backwards Compatibility

The forwards and backwards compatibility of the protocol is assured by a mechanism where all current and future messages, and IEs or groups of related IEs, include Id and criticality fields that are coded in a standard format that will not be changed in the future. These parts can always be decoded regardless of the standard version.

4.3 Source Signalling Address Handling

The sender of an RNSAP messages shall include the Source Signalling Address, i.e. the Signalling Address of the sending node.

4.4 Specification Notations

For the purposes of the present document, the following notations apply:

[FDD]	This tagging of a word indicates that the word preceding the tag "[FDD]" applies only to FDD. This tagging of a heading indicates that the heading preceding the tag "[FDD]" and the section following the heading applies only to FDD.
[TDD]	This tagging of a word indicates that the word preceding the tag "[TDD]" applies only to TDD. This tagging of a heading indicates that the heading preceding the tag "[TDD]" and the section following the heading applies only to TDD.
[FDD - ...]	This tagging indicates that the enclosed text following the "[FDD - " applies only to FDD. Multiple sequential paragraphs applying only to FDD are enclosed separately to enable insertion of TDD specific (or common) paragraphs between the FDD specific paragraphs.
[TDD - ...]	This tagging indicates that the enclosed text following the "[TDD - " applies only to TDD. Multiple sequential paragraphs applying only to TDD are enclosed separately to enable insertion of FDD specific (or common) paragraphs between the TDD specific paragraphs.
Procedure	When referring to an elementary procedure in the specification, the Procedure Name is written with the first letters in each word in upper case characters followed by the word "procedure", e.g. Radio Link Setup procedure.
Message	When referring to a message in the specification, the MESSAGE NAME is written with all letters in upper case characters followed by the word "message", e.g. RADIO LINK SETUP REQUEST message.
IE	When referring to an information element (IE) in the specification, the <i>Information Element Name</i> is written with the first letters in each word in upper case characters and all letters in Italic font followed by the abbreviation "IE", e.g. <i>Transport Format Set</i> IE.
Value of an IE	When referring to the value of an information element (IE) in the specification, the "Value" is written as it is specified in subclause 9.2 enclosed by quotation marks, e.g. "Abstract Syntax Error (Reject)" or "SSDT Active in the UE".

5 RNSAP Services

5.1 RNSAP Procedure Modules

The Iur interface RNSAP procedures are divided into four modules as follows:

1. RNSAP Basic Mobility Procedures;
2. RNSAP DCH Procedures;
3. RNSAP Common Transport Channel Procedures;
4. RNSAP Global Procedures.

The Basic Mobility Procedures module contains procedures used to handle the mobility within UTRAN.

The DCH Procedures module contains procedures that are used to handle DCHs, DSCHs, and USCHs between two RNSs. If procedures from this module are not used in a specific Iur, then the usage of DCH, DSCH, and USCH traffic between corresponding RNSs is not possible.

The Common Transport Channel Procedures module contains procedures that are used to control common transport channel data streams (excluding the DSCH and USCH) over Iur interface.

The Global Procedures module contains procedures that are not related to a specific UE. The procedures in this module are in contrast to the above modules involving two peer CRNCs.

5.2 Parallel Transactions

Unless explicitly indicated in the procedure specification, at any instance in time one protocol peer shall have a maximum of one ongoing RNSAP DCH procedure related to a certain UE.

6 Services Expected from Signalling Transport

The signalling transport shall provide two different service modes for the RNSAP.

1. Connection oriented data transfer service. This service is supported by a signalling connection between two RNCs. It shall be possible to dynamically establish and release signalling connections based on the need. Each active UE shall have its own signalling connection. The signalling connection shall provide in sequence delivery of RNSAP messages. RNSAP shall be notified if the signalling connection breaks.
2. Connectionless data transfer service. RNSAP shall be notified in case a RNSAP message did not reach the intended peer RNSAP entity.

7 Functions of RNSAP

The RNSAP protocol provides the following functions:

- Radio Link Management. This function allows the SRNC to manage radio links using dedicated resources in a DRNS;
- Physical Channel Reconfiguration. This function allows the DRNC to reallocate the physical channel resources for a Radio Link;
- Radio Link Supervision. This function allows the DRNC to report failures and restorations of a Radio Link;
- Compressed Mode Control [FDD]. This function allows the SRNC to control the usage of compressed mode within a DRNS;
- Measurements on Dedicated Resources. This function allows the SRNC to initiate measurements on dedicated resources in the DRNS. The function also allows the DRNC to report the result of the measurements;
- DL Power Drifting Correction [FDD]. This function allows the SRNC to adjust the DL power level of one or more Radio Links in order to avoid DL power drifting between the Radio Links;
- CCCH Signalling Transfer. This function allows the SRNC and DRNC to pass information between the UE and the SRNC on a CCCH controlled by the DRNS;
- Paging. This function allows the SRNC to page a UE in a URA or a cell in the DRNS;
- Common Transport Channel Resources Management. This function allows the SRNC to utilise Common Transport Channel Resources within the DRNS (excluding DSCH resources for FDD);
- Relocation Execution. This function allows the SRNC to finalise a Relocation previously prepared via other interfaces;
- Reporting of General Error Situations. This function allows reporting of general error situations, for which function specific error messages have not been defined.
- DL Power Timeslot Correction [TDD]. This function enables the DRNS to apply an individual offset to the transmission power in each timeslot according to the downlink interference level at the UE.

The mapping between the above functions and RNSAP elementary procedures is shown in the Table 1.

Table 1: Mapping between functions and RNSAP elementary procedures

Function	Elementary Procedure(s)
Radio Link Management	a) Radio Link Setup b) Radio Link Addition c) Radio Link Deletion d) Unsynchronised Radio Link Reconfiguration e) Synchronised Radio Link Reconfiguration Preparation f) Synchronised Radio Link Reconfiguration Commit g) Synchronised Radio Link Reconfiguration Cancellation h) Radio Link Pre-emption
Physical Channel Reconfiguration	Physical Channel Reconfiguration
Radio Link Supervision	a) Radio Link Failure b) Radio Link Restoration
Compressed Mode Control [FDD]	a) Radio Link Setup b) Radio Link Addition c) Compressed Mode Command d) Unsynchronised Radio Link Reconfiguration e) Synchronised Radio Link Reconfiguration Preparation f) Synchronised Radio Link Reconfiguration Commit g) Synchronised Radio Link Reconfiguration Cancellation
Measurements on Dedicated Resources	a) Dedicated Measurement Initiation b) Dedicated Measurement Reporting c) Dedicated Measurement Termination d) Dedicated Measurement Failure
DL Power Drifting Correction [FDD]	Downlink Power Control
CCCH Signalling Transfer	a) Uplink Signalling Transfer b) Downlink Signalling Transfer
Paging	Paging
Common Transport Channel Resources Management	a) Common Transport Channel Resources Initiation b) Common Transport Channel Resources Release
Relocation Execution	Relocation Commit
Reporting of General Error Situations	Error Indication
DL Power Timeslot Correction [TDD]	Downlink Power Timeslot Control

8 RNSAP Procedures

8.1 Elementary Procedures

In the following tables, all EPs are divided into Class 1 and Class 2 EPs.

Table 2: Class 1 Elementary Procedures

Elementary Procedure	Initiating Message	Successful Outcome	Unsuccessful Outcome
		Response message	Response message
Radio Link Setup	RADIO LINK SETUP REQUEST	RADIO LINK SETUP RESPONSE	RADIO LINK SETUP FAILURE
Radio Link Addition	RADIO LINK ADDITION REQUEST	RADIO LINK ADDITION RESPONSE	RADIO LINK ADDITION FAILURE
Radio Link Deletion	RADIO LINK DELETION REQUEST	RADIO LINK DELETION RESPONSE	
Synchronised Radio Link Reconfiguration Preparation	RADIO LINK RECONFIGURATION PREPARE	RADIO LINK RECONFIGURATION READY	RADIO LINK RECONFIGURATION FAILURE
Unsynchronised Radio Link Reconfiguration	RADIO LINK RECONFIGURATION REQUEST	RADIO LINK RECONFIGURATION RESPONSE	RADIO LINK RECONFIGURATION FAILURE
Physical Channel Reconfiguration	PHYSICAL CHANNEL RECONFIGURATION REQUEST	PHYSICAL CHANNEL RECONFIGURATION COMMAND	PHYSICAL CHANNEL RECONFIGURATION FAILURE
Dedicated Measurement Initiation	DEDICATED MEASUREMENT INITIATION REQUEST	DEDICATED MEASUREMENT INITIATION RESPONSE	DEDICATED MEASUREMENT INITIATION FAILURE
Common Transport Channel Resources Initialisation	COMMON TRANSPORT CHANNEL RESOURCES REQUEST	COMMON TRANSPORT CHANNEL RESOURCES RESPONSE	COMMON TRANSPORT CHANNEL RESOURCES FAILURE

Table 3: Class 2 Elementary Procedures

Elementary Procedure	Initiating Message
Uplink Signalling Transfer	UPLINK SIGNALLING TRANSFER INDICATION
Downlink Signalling Transfer	DOWNLINK SIGNALLING TRANSFER REQUEST
Relocation Commit	RELOCATION COMMIT
Paging	PAGING REQUEST
Synchronised Radio Link Reconfiguration Commit	RADIO LINK RECONFIGURATION COMMIT
Synchronised Radio Link Reconfiguration Cancellation	RADIO LINK RECONFIGURATION CANCEL
Radio Link Failure	RADIO LINK FAILURE INDICATION
Radio Link Restoration	RADIO LINK RESTORE INDICATION
Dedicated Measurement Reporting	DEDICATED MEASUREMENT REPORT
Dedicated Measurement Termination	DEDICATED MEASUREMENT TERMINATION REQUEST
Dedicated Measurement Failure	DEDICATED MEASUREMENT FAILURE INDICATION
Downlink Power Control [FDD]	DL POWER CONTROL REQUEST
Compressed Mode Command [FDD]	COMPRESSED MODE COMMAND
Common Transport Channel Resources Release	COMMON TRANSPORT CHANNEL RESOURCES RELEASE REQUEST
Error Indication	ERROR INDICATION
Downlink Power Timeslot Control [TDD]	DL POWER TIMESLOT CONTROL REQUEST
Radio Link Pre-emption	RADIO LINK PREEMPTION REQUIRED INDICATION

8.2 Basic Mobility Procedures

8.2.1 Uplink Signalling Transfer

8.2.1.1 General

The procedure is used by the DRNC to forward a Uu message received on the CCCH to the SRNC.

This procedure shall use the connectionless mode of the signalling bearer.

8.2.1.2 Successful Operation

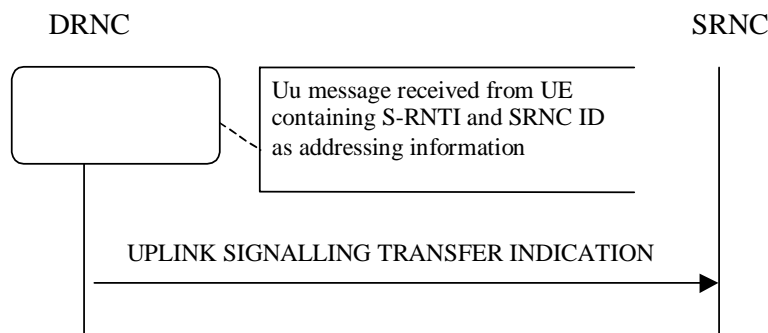

Figure 1: Uplink Signalling Transfer procedure, Successful Operation

When the DRNC receives an Uu message on the CCCH where the UE addressing information is U-RNTI, i.e. S-RNTI and SRNC-ID, DRNC shall send the UPLINK SIGNALLING TRANSFER INDICATION message to the SRNC identified by the SRNC-ID received from the UE.

If at least one URA Identity is being broadcast in the cell where the Uu message was received (the accessed cell), the DRNC shall include a URA Identity for this cell in the *URA ID IE*, the *Multiple URAs Indicator IE* indicating whether or not multiple URA Identities are being broadcast in the accessed cell, and the RNC Identity of all other RNCs that are having at least one cell within the URA where the Uu message was received in the *URA Information IE* in the UPLINK SIGNALLING TRANSFER INDICATION message.

The DRNC shall include in the message the C-RNTI that it allocates to identify the UE in the radio interface in the accessed cell. If there is no valid C-RNTI for the UE in the accessed cell, the DRNS shall allocate a new C-RNTI for the UE. If the DRNS allocates a new C-RNTI it shall also release any C-RNTI previously allocated for the UE.

If the DRNS has any RACH, [FDD - CPCH], and/or FACH resources allocated for the UE identified by the U-RNTI in another cell than the accessed cell, the DRNS shall release these RACH, [FDD - CPCH,] and/or FACH resources.

If no context exists for this UE in the DRNC, the DRNC shall create a UE Context for this UE, allocate a D-RNTI for the UE Context, and include the *D-RNTI IE* and the identifiers for the CN CS Domain and CN PS Domain that the DRNC is connected to in the UPLINK SIGNALLING TRANSFER INDICATION message. These CN Domain Identifiers shall be based on the LAC and RAC respectively of the cell where the message was received from the UE.

Depending on local configuration in the DRNS, it may include the geographical co-ordinates of the cell where the Uu message was received in the UPLINK SIGNALLING TRANSFER INDICATION message.

8.2.1.3 Abnormal Conditions

-

8.2.2 Downlink Signalling Transfer

8.2.2.1 General

The procedure is used by the SRNC to request to the DRNC the transfer of a Uu message on the CCCH in a cell. When used, the procedure is in response to a received Uplink Signalling Transfer procedure.

This procedure shall use the connectionless mode of the signalling bearer.

8.2.2.2 Successful Operation



Figure 2: Downlink Signalling Transfer procedure, Successful Operation

The procedure consists of the DOWNLINK SIGNALLING TRANSFER REQUEST message sent by the SRNC to the DRNC.

The message contains the Cell Identifier (C-Id) contained in the received UPLINK SIGNALLING TRANSFER INDICATION message and the D-RNTI.

At the reception of the message, the DRNC shall send the L3 Information on the CCCH in the cell indicated by the *C-Id* IE to the UE identified by the *D-RNTI* IE.

If the *D-RNTI Release Indication* IE is set to "Release D-RNTI" and the DRNS has no dedicated resources (DCH, [TDD - USCH,] and/or DSCH) allocated for the UE, the DRNS shall release the D-RNTI and thus the UE Context and any RACH, [FDD - CPCH,] and FACH resources and any C-RNTI allocated to the UE Context at the reception of the DOWNLINK SIGNALLING TRANSFER REQUEST message.

If the *D-RNTI Release Indication* IE is set to "Release D-RNTI" and the DRNS has dedicated resources allocated for the UE, the DRNS shall only release any RACH, [FDD - CPCH,] and FACH resources and any C-RNTI allocated to the UE Context at the reception of the DOWNLINK SIGNALLING TRANSFER REQUEST message.

8.2.2.3 Abnormal Conditions

If the user identified by the *D-RNTI* IE has already accessed another cell controlled by the DRNC than the cell identified by the *C-Id* IE in the DOWNLINK SIGNALLING TRANSFER REQUEST message, the message shall be ignored.

8.2.3 Relocation Commit

8.2.3.1 General

The Relocation Commit procedure is used by source RNC to execute the Relocation. This procedure supports the Relocation procedures described in [2].

This procedure shall use the signalling bearer mode specified below.

8.2.3.2 Successful Operation



Figure 3: Relocation Commit procedure, Successful Operation

The source RNC sends the RELOCATION COMMIT message to the target RNC to request the target RNC to proceed with the Relocation. When the UE is utilising one or more radio links in the DRNC the message shall be sent using the connection oriented service of the signalling bearer and no further identification of the UE Context in the DRNC is required. If on the other hand, the UE is not utilising any radio link the message shall be sent using the connectionless service of the signalling bearer and the *D-RNTI* IE shall be included in the message to identify the UE Context in the DRNC.

At reception of the RELOCATION COMMIT message from the source RNC the target RNC finalises the Relocation. If the message contains the transparent *RANAP Relocation Information* IE the target RNC shall use this information when finalising the Relocation.

8.2.3.3 Abnormal Conditions

-

8.2.4 Paging

8.2.4.1 General

This procedure is used by the SRNC to indicate to a CRNC that a UE shall be paged in a cell or URA that is under the control of the CRNC.

This procedure shall use the connectionless mode of the signalling bearer.

8.2.4.2 Successful Operation



Figure 4: Paging procedure, Successful Operation

The procedure is initiated with a PAGING REQUEST message sent from the SRNC to the CRNC.

If the message contains the *C-Id* IE, the CRNC shall page in the indicated cell. Alternatively, if the message contains the *URA-Id* IE, the CRNC shall page in all cells that it controls in the indicated URA.

If the PAGING REQUEST message includes the *CN Originated Page to Connected Mode UE* IE, the CRNC shall include the information contained in the *CN Originated Page to Connected Mode UE* IE when paging the UE.

The CRNC shall calculate the Paging Occasions from the *IMSI* IE and the *DRX Cycle Length Coefficient* IE according to specification in ref. [15] and apply transmission on PICH and PCH accordingly.

8.2.4.3 Abnormal Conditions

-

8.3 DCH Procedures

8.3.1 Radio Link Setup

8.3.1.1 General

This procedure is used for establishing the necessary resources in the DRNS for one or more radio links.

The connection-oriented service of the signalling bearer shall be established in conjunction with this procedure.

8.3.1.2 Successful Operation

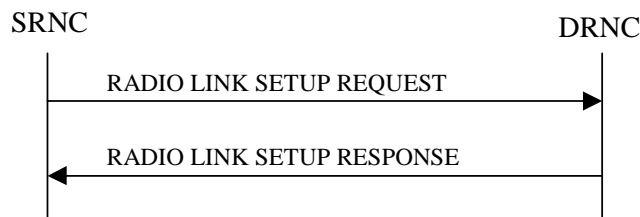

Figure 5: Radio Link Setup procedure: Successful Operation

When the SRNC makes an algorithmic decision to add the first cell or set of cells from a DRNS to the active set of a specific UE-UTRAN connection, the RADIO LINK SETUP REQUEST message is sent to the corresponding DRNC to request establishment of the radio link(s).

The DRNS shall prioritise resource allocation for the RL(s) to be established according to Annex A.

If the RADIO LINK SETUP REQUEST message includes the *Allowed Queuing Time* IE the DRNS may queue the request the time corresponding to the value of the *Allowed Queuing Time* IE before starting to execute the request.

If no *D-RNTI* IE was included in the RADIO LINK SETUP REQUEST message, the DRNC shall assign a new *D-RNTI* for this UE.

Transport Channels Handling:

DCH(s):

[TDD - If the *DCH Information* IE is present in the RADIO LINK SETUP REQUEST message, the DRNS shall configure the new DCHs according to the parameters given in the message.]

If the RADIO LINK SETUP REQUEST message includes a *DCH Information* IE with multiple *DCH Specific Info* IEs, then the DRNS shall treat the DCHs in the *DCH Information* IE as a set of co-ordinated DCHs.

[FDD - For DCHs which do not belong to a set of co-ordinated DCHs with the *QE-Selector* IE set to "selected", the Transport channel BER from that DCH shall be the base for the QE in the UL data frames. If no Transport channel BER is available for the selected DCH, the Physical channel BER shall be used for the QE, ref. [4]. If the *QE-Selector* IE is set to "non-selected", the Physical channel BER shall be used for the QE in the UL data frames, ref. [4].]

For a set of co-ordinated DCHs the Transport channel BER from the DCH with the *QE-Selector* IE set to "selected" shall be used for the QE in the UL data frames, ref. [4]. [FDD - If no Transport channel BER is available for the selected DCH the Physical channel BER shall be used for the QE, ref. [4]. If all DCHs have *QE-Selector* IE set to "non-selected" the Physical channel BER shall be used for the QE, ref. [4].]

The DRNS shall use the included *UL DCH FP Mode* IE for a DCH or a set of co-ordinated DCHs as the DCH FP Mode in the Uplink of the user plane for the DCH or the set of co-ordinated DCHs.

The DRNS shall use the included *ToAWS* IE for a DCH or a set of co-ordinated DCHs as the Time of Arrival Window Start Point in the user plane for the DCH or the set of co-ordinated DCHs.

The DRNS shall use the included *ToAWE* IE for a DCH or a set of co-ordinated DCHs as the Time of Arrival Window End Point in the user plane for the DCH or the set of co-ordinated DCHs.

The *Frame Handling Priority* IE defines the priority level that should be used by the DRNS to prioritise between different frames of the data frames of the DCHs in the downlink on the radio interface in congestion situations once the new RL(s) have been activated.

DSCH(s):

If the *DSCH Information* IE is included in the RADIO LINK SETUP REQUEST message, the DRNC shall establish the requested DSCHs [FDD - on the RL indicated by the PDSCH RL ID IE]. In addition, the DRNC shall send a valid set of *DSCH Scheduling Priority* IE and *MAC-c/sh SDU Length* IE parameters to the SRNC in the RADIO LINK SETUP RESPONSE message. If the *PDSCH RL ID* IE indicates a radio link in the DRNS, then the DRNC shall allocate a DSCH-RNTI to the UE Context and include the *DSCH-RNTI* IE in the RADIO LINK SETUP RESPONSE message.

[TDD - USCH(s)]:

[TDD – The DRNS shall use the list of RB Identities in the *RB Info* IE in the *USCH information* IE to map each *RB Identity* IE to the corresponding USCH.]

Physical Channels Handling:

[FDD - Compressed Mode]:

[FDD - If the RADIO LINK SETUP REQUEST message includes the *Transmission Gap Pattern Sequence Information* IE, the DRNS shall store the information about the Transmission Gap Pattern Sequences to be used in the Compressed Mode Configuration. This Compressed Mode Configuration shall be valid in the DRNS until the next Compressed Mode Configuration is configured in the DRNS or the last Radio Link is deleted.]

[FDD - If the RADIO LINK SETUP REQUEST message includes the *Transmission Gap Pattern Sequence Information* IE and the *Active Pattern Sequence Information* IE, the DRNS shall use the information to activate the indicated Transmission Gap Pattern Sequence(s) in the new RL. The received *CM Configuration Change CFN* IE refers to latest passed CFN with that value. The DRNS shall treat the received *TGCFN* IEs as follows:]

- [FDD - If any received *TGCFN* IE has the same value as the received *CM Configuration Change CFN* IE, the DRNS shall consider the concerned Transmission Gap Pattern Sequence as activated at that CFN.]
- [FDD - If any received *TGCFN* IE does not have the same value as the received *CM Configuration Change CFN* IE but the first CFN after the CM Configuration Change CFN with a value equal to the *TGCFN* IE has already passed, the DRNS shall consider the concerned Transmission Gap Pattern Sequence as activated at that CFN.]
- [FDD - For all other Transmission Gap Pattern Sequences included in the *Active Pattern Sequence Information* IE, the DRNS shall activate each Transmission Gap Pattern Sequence at the first CFN after the CM Configuration Change CFN with a value equal to the *TGCFN* IE for the Transmission Gap Pattern Sequence.]

[FDD- If the *Downlink Compressed Mode Method* IE in one or more Transmission Gap Pattern Sequence is set to "SF/2" in the RADIO LINK SETUP REQUEST message, the DRNS shall include the *Transmission Gap Pattern Sequence Scrambling Code Information* IE in the RADIO LINK SETUP RESPONSE message indicating for each DL Channelisation Code whether the alternative scrambling code shall be used or not.]

[FDD - DL Code Information]:

[FDD – When more than one DL DPDCH are assigned per RL, the segmented physical channel shall be mapped on to DL DPDCHs according to [8]. When p number of DL DPDCHs are assigned to each RL, the first pair of DL Scrambling Code and FDD DL Channelisation Code Number corresponds to "*PhCH number 1*", the second to "*PhCH number 2*", and so on until the p th to "*PhCH number p*".]

General:

[FDD - If the *Propagation Delay* IE is included, the DRNS may use this information to speed up the detection of UL synchronisation on the Uu interface.]

[FDD – If the received *Limited Power Increase* IE is set to "Used", the DRNS shall, if supported, use Limited Power Increase according to ref. [10] subclause 5.2.1 for the inner loop DL power control.]

Radio Link Handling:

Diversity Combination Control:

[FDD - The *Diversity Control Field* IE indicates for each RL except for the first RL whether the DRNS shall combine the RL with any of the other RLs or not.

- If the *Diversity Control Field* IE is set to "May" (be combined with another RL), the DRNS shall decide for any of the alternatives.
- If the *Diversity Control Field* IE is set to "Must", the DRNS shall combine the RL with one of the other RL. When an RL is to be combined, the DRNS shall choose which RL(s) to combine it with.
- If the *Diversity Control Field* IE is set to "Must not", the DRNS shall not combine the RL with any other existing RL.]

[FDD - In the RADIO LINK SETUP RESPONSE message, the DRNC shall indicate for each RL with the Diversity Indication in the *RL Information Response* IE whether the RL is combined or not.]

- [FDD - In case of not combining with a RL previously listed in the RADIO LINK SETUP RESPONSE message or for the first RL in the RADIO LINK SETUP RESPONSE message, the DRNC, the DRNC shall include in the *DCH Information Response* IE in the RADIO LINK SETUP RESPONSE message the *Binding ID* IE and *Transport Layer Address* IE for the transport bearer to be established for each DCH of this RL.]
- [FDD - Otherwise in case of combining, the *RL ID* IE indicates (one of) the RL(s) previously listed in this RADIO LINK SETUP RESPONSE message with which the concerned RL is combined.]

[TDD - The DRNC shall always include in the RADIO LINK SETUP RESPONSE message both the *Transport Layer Address* IE and the *Binding ID* IE for the transport bearer to be established for each DCH, DSCH and USCH of the RL.]

In the case of a set of co-ordinated DCHs requiring a new transport bearer the *Binding ID* IE and the *Transport Layer Address* IE shall be included only for one of the DCHs in the set of co-ordinated DCHs.

[FDD-Transmit Diversity]:

[FDD – If the cell in which the RL is being set up is capable to provide Close loop Tx diversity, the DRNC shall include the *Closed Loop Timing Adjustment Mode* IE in the RADIO LINK SETUP RESPONSE message indicating the configured Closed loop timing adjustment mode of the cell.]

[FDD – When the *Diversity Mode* IE is set to "STTD", "Closed loop mode1", or "Closed loop mode2", the DRNC shall activate/deactivate the Transmit Diversity for each Radio Link in accordance with the *Transmit Diversity Indicator* IE].

DL Power Control:

[FDD - If both the *Initial DL TX Power* IE and *Uplink SIR Target* IE are included in the message, the DRNS shall use the indicated DL TX Power and Uplink SIR Target as initial value. If the value of the *Initial DL TX Power* IE is outside the configured DL TX power range, the DRNS shall apply these constrains when setting the initial DL TX power. The DRNS shall also include the configured DL TX power range defined by *Maximum DL TX Power* IE and *Minimum DL TX Power* IE in the RADIO LINK SETUP RESPONSE message. The DRNS shall not transmit with a higher power than indicated by the *Maximum DL TX Power* IE or lower than indicated by the *Minimum DL TX Power* IE on any DL DPCH of the RL except during compressed mode, when the δP_{curr} , as described in ref.[10] subclause 5.2.1.3, shall be added to the maximum DL power for the associated compressed frame.]

[FDD - If both the *Initial DL TX Power* and the *Uplink SIR Target* IEs are not included in the RADIO LINK SETUP REQUEST message, then DRNC shall determine the initial Uplink SIR Target and include it in the *Uplink SIR Target* IE in the RADIO LINK SETUP RESPONSE message.]

[FDD - If the *Primary CPICH Ec/No* IE is present, the DRNC should use the indicated value when deciding the Initial DL TX Power.]

[TDD - If the *Primary CCPCH RSCP* IE and/or the *DL Time Slot ISCP Info* IE are present, the DRNC should use the indicated values when deciding the Initial DL TX Power.]

[FDD – The DRNS shall start the DL transmission using the indicated DL TX power level (if received) or the decided DL TX power level on each DL channelisation code of a RL until UL synchronisation is achieved on the Uu interface for the concerned RLS or Power Balancing is activated. No inner loop power control or power balancing shall be performed during this period. The DL power shall then vary according to the inner loop power control (see ref.[10] subclause 5.2.1.2) with DPC_MODE=0 and the power control procedure (see 8.3.7).]

[TDD – The DRNS shall start the DL transmission using the decided DL TX power level on each DL channelisation code and on each Time Slot of a RL until UL synchronisation is achieved on the Uu interface for the concerned RL. No inner loop power control shall be performed during this period. The DL power shall then vary according to the inner loop power control (see ref.[22] subclause 4.2.3.3).]

[FDD – If the received *Inner Loop DL PC Status* IE is set to "Active", the DRNS shall activate the inner loop DL power control for all RLs. If *Inner Loop DL PC Status* IE is set to "Inactive", the DRNS shall deactivate the inner loop DL power control for all RLs according to ref. [10]]

Neighbouring Cell Handling:

If there are UMTS neighbouring cell(s) to the cell in which a Radio Link was established then:

- The DRNC shall include the *Neighbouring FDD Cell Information* IE and/or *Neighbouring TDD Cell Information* IE in the *Neighbouring UMTS Cell Information* IE for each neighbouring FDD cell and/or TDD cell respectively. In addition, if the information is available, the DRNC shall include the *Frame Offset* IE, *Primary CPICH Power* IE, *Cell Individual Offset* IE, *STTD Support Indicator* IE, *Closed Loop Mode1 Support Indicator* IE and *Closed Loop Mode2 Support Indicator* IE in the *Neighbouring FDD Cell Information* IE, and the *Frame Offset* IE, *Cell Individual Offset* IE, *DPCH Constant Value* IE and the *PCCPCH Power* IE in the *Neighbouring TDD Cell Information* IE.
- If a UMTS neighbouring cell is not controlled by the same DRNC, the DRNC shall also include the *CN PS Domain Identifier* IE and/or *CN CS Domain Identifier* IE which are the identifiers of the CN nodes connected to the RNC controlling the UMTS neighbouring cell.

For the UMTS neighbouring cells which are controlled by the DRNC, the DRNC shall report in the RADIO LINK SETUP RESPONSE message the restriction state of those cells, otherwise *Restriction state indicator* IE may be absent. The DRNC shall include the *Restriction state indicator* IE for the neighbouring cells which are controlled by the DRNC in the *Neighbouring FDD Cell Information* IE and the *Neighbouring TDD Cell Information* IE.

If there are GSM neighbouring cells to the cell(s) where a radio link is established, the DRNC shall include the *Neighbouring GSM Cell Information* IE in the RADIO LINK SETUP RESPONSE message for each of the GSM neighbouring cells. If available the DRNC shall include the *Cell Individual Offset* IE, and if the *Cell Individual Offset* IE alone cannot represent the value of the offset, the DRNC shall also include the *Extended GSM Cell Individual Offset* IE in the *Neighbouring GSM Cell Information* IE.

General:

[FDD - If the RADIO LINK SETUP REQUEST message includes the *SSDT Cell Identity* IE and the *S-Field Length* IE, the DRNS shall activate SSDT, if supported, using the *SSDT Cell Identity* IE and *SSDT Cell Identity Length* IE.]

[FDD - If the *DRAC Control* IE is set to "requested" in the RADIO LINK SETUP REQUEST message for at least one DCH and if the DRNS supports the DRAC, the DRNC shall indicate in the RADIO LINK SETUP RESPONSE message the *Secondary CCPCH Info* IE for the FACH where the DRAC information is sent, for each Radio Link established in a cell where DRAC is active. If the DRNS does not support DRAC, the DRNC shall not provide these IEs in the RADIO LINK SETUP RESPONSE message.]

If no *D-RNTI* IE was included in the RADIO LINK SETUP REQUEST message, the DRNC shall include the node identifications of the CN Domain nodes that the RNC is connected to (using LAC and RAC of the current cell), and the *D-RNTI* IE in the RADIO LINK SETUP RESPONSE message.

[FDD - If the *D-RNTI* IE was included the RADIO LINK SETUP REQUEST message the DRNC shall include the *Primary Scrambling Code* IE, the *UL UARFCN* IE and the *DL UARFCN* IE in the RADIO LINK SETUP RESPONSE message.]

[TDD – If the *D-RNTI* IE was included in the RADIO LINK SETUP REQUEST message the DRNC shall include the *UARFCN* IE, the *Cell Parameter ID* IE, the *Sync Case* IE, the *SCH Time Slot* IE or *Time Slot* IE, the *SCTD Indicator* IE, and the *PCCPCH Power* IE in the RADIO LINK SETUP RESPONSE message.]

[TDD - The DRNC shall include the *Secondary CCPCH Info TDD* IE in the RADIO LINK SETUP RESPONSE message if at least one *DSCH Information Response* IE or *USCH Information Response* IE is included in the message and at least one DCH is configured for the radio link. The DRNC shall also include the *Secondary CCPCH Info TDD* IE in the RADIO LINK SETUP RESPONSE message if at least one *DSCH Information Response* IE or *USCH Information Response* IE is included in the message and the SHCCH messages for this radio link will be transmitted over a different secondary CCPCH than selected by the UE from system information.]

For each Radio Link established in a cell where at least one URA Identity is being broadcast, the DRNC shall include a URA Identity for this cell in the *URA ID* IE, the *Multiple URAs Indicator* IE indicating whether or not multiple URA Identities are being broadcast in the cell, and the RNC Identity of all other RNCs that are having at least one cell within the URA in the cell in the *URA Information* IE in the RADIO LINK SETUP RESPONSE message.

Depending on local configuration in the DRNS, it may include the geographical co-ordinates of the cell and the UTRAN access point position for each of the established RLs in the RADIO LINK SETUP RESPONSE message.

If the *Permanent NAS UE Identity* IE is included in the RADIO LINK SETUP REQUEST message, the DRNC shall store the information for the considered UE Context for the life-time of the UE Context.

If the RADIO LINK SETUP REQUEST message includes the *Permanent NAS UE Identity* IE and a *C-ID* IE corresponding to a cell reserved for operator use, the DRNC shall use this information to determine whether it can set up a Radio Link on this cell or not for the considered UE Context.

The DRNS shall start reception on the new RL(s) after the RLs are successfully established.

[FDD - Radio Link Set Handling]:

[FDD - The *First RLS Indicator* IE indicates if the concerned RL shall be considered part of the first RLS established towards this UE. The *First RLS Indicator* IE shall be used by the DRNS to determine the initial TPC pattern in the DL of the concerned RL and all RLs which are part of the same RLS, as described in [10], section 5.1.2.2.1.2.

[FDD – For each RL not having a common generation of the TPC commands in the DL with another RL, the DRNS shall assign the *RL Set ID* IE included in the RADIO LINK SETUP RESPONSE message a value that uniquely identifies the RL Set within the UE Context.]

[FDD – For all RLs having a common generation of the TPC commands in the DL with another RL, the DRNS shall assign the *RL Set ID* IE included in the RADIO LINK SETUP RESPONSE message the same value. This value shall uniquely identify the RL Set within the UE Context.]

[FDD –The UL out-of-sync algorithm defined in ref. [10] shall for each of the established RL Set(s) use the maximum value of the parameters *N_OUTSYNC_IND* and *T_RLFailure* that are configured in the cells supporting the radio links of the RL Set. The UL in-sync algorithm defined in [10] shall, for each of the established RL Set(s), use the minimum value of the parameters *N_INSYNC_IND* that are configured in the cells supporting the radio links of the RL Set.]

Response Message:

At the reception of the RADIO LINK SETUP REQUEST message, the DRNS allocates the requested type of channelisation codes and other physical channel resources for each RL and assigns a binding identifier and a transport layer address for each DCH or set of co-ordinated DCHs and for each DSCH [TDD – and USCH]. This information

shall be sent to the SRNC in the message RADIO LINK SETUP RESPONSE when all the RLs have been successfully established.

After sending the RADIO LINK SETUP RESPONSE message the DRNS shall continuously attempt to obtain UL synchronisation on the Uu interface. [FDD - The DRNS shall start transmission on the DL DPDCH(s) of the new RL as specified in ref. [4].] [TDD – The DRNS shall start transmission on the new RL immediately as specified in ref. [4].]

8.3.1.3 Unsuccessful Operation

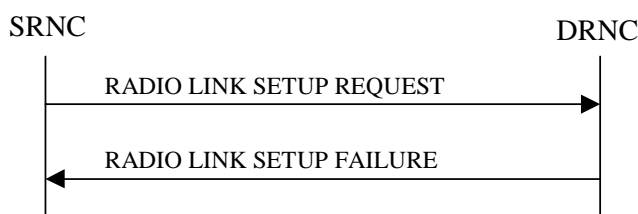

Figure 6: Radio Link Setup procedure: Unsuccessful Operation

In unsuccessful case (i.e. one or more RLs can not be established) the RADIO LINK SETUP FAILURE message shall be sent to the SRNC, indicating the reason for failure. If some radio links were established successfully, the DRNC shall indicate this in the RADIO LINK SETUP FAILURE message in the same way as in the RADIO LINK SETUP RESPONSE message.

If the RADIO LINK SETUP REQUEST message includes a *C-ID* IE corresponding to a cell reserved for operator use and the *Permanent NAS UE Identity* IE is not present, the DRNC shall consider the procedure as failed and send the RADIO LINK SETUP FAILURE message.

[FDD – If the RL identified by the PDSCH RL ID IE is a radio link in the DRNS and this RL is successfully established, then the DRNC shall allocate a DSCH-RNTI to the UE Context and include the DSCH-RNTI IE in the RADIO LINK SETUP FAILURE message.]

Typical cause values are:

Radio Network Layer Causes:

- [FDD - UL Scrambling Code Already in Use];
- DL Radio Resources not Available;
- UL Radio Resources not Available;
- [FDD - Combining Resources not available];
- Combining not Supported
- Requested Configuration not Supported;
- Cell not Available;
- [FDD - Requested Tx Diversity Mode not Supported];
- Power Level not Supported;
- Number of DL codes not supported;
- Number of UL codes not supported;
- Dedicated Transport Channel Type not Supported;
- DL Shared Channel Type not Supported;
- [TDD - UL Shared Channel Type not Supported];
- [FDD - UL Spreading Factor not Supported];

- [FDD - DL Spreading Factor not Supported];
- CM not Supported;
- Cell reserved for operator use.

Transport Layer Causes:

- Transport Resource Unavailable.

Miscellaneous Causes:

- Control Processing Overload;
- HW Failure;
- Not enough User Plane Processing Resources.

8.3.1.4 Abnormal Conditions

If the DRNC receives either an S-RNTI or a D-RNTI which already has RL(s) established the DRNC shall send the RADIO LINK SETUP FAILURE message to the SRNC, indicating the reason for failure.

[FDD - If the RADIO LINK SETUP REQUEST message includes the *Active Pattern Sequence Information* IE, but the *Transmission Gap Pattern Sequence Information* IE is not present, then the DRNC shall reject the procedure using the RADIO LINK SETUP FAILURE message.]

[FDD – If the RADIO LINK SETUP REQUEST message includes both the *Initial DL TX Power* IE and the *Primary CPICH Ec/No* IE or does not include either of these IEs, then the DRNC shall reject the procedure using the RADIO LINK SETUP FAILURE message.]

If more than one DCH of a set of co-ordinated DCHs has the *QE-Selector* IE set to "selected" [TDD – or no DCH of a set of co-ordinated DCHs has the *QE-Selector* IE set to "selected"], the DRNS shall regard the Radio Link Setup procedure as failed and shall respond with a RADIO LINK SETUP FAILURE message.

[FDD - If only the *Initial DL TX Power* IE or the *Uplink SIR Target* IE is included in the RADIO LINK SETUP REQUEST message, then DRNC shall regard the Radio Link Setup procedure as failed and shall respond with the RADIO LINK SETUP FAILURE message.]

If the RADIO LINK SETUP REQUEST message includes a *DCH Information* IE with multiple *DCH Specific Info* IEs, and if the DCHs in the *DCH Information* IE do not have the same *Transmission Time Interval* IE in the *Semi-static Transport Format Information* IE, then the DRNC shall reject the procedure using the RADIO LINK SETUP FAILURE message.

8.3.2 Radio Link Addition

8.3.2.1 General

This procedure is used for establishing the necessary resources in the DRNS for one or more additional RLs towards a UE when there is already at least one RL established to the concerned UE via this DRNS.

This procedure shall use the signalling bearer connection for the relevant UE Context.

The Radio Link Addition procedure shall not be initiated if a Prepared Reconfiguration exists, as defined in subclause 3.1.

[FDD – The Radio Link Addition procedure serves to establish one or more new Radio Links which do not contain the DSCH. If the DSCH shall be moved into a new Radio Link, the Radio Link reconfiguration procedure shall be applied.]

[TDD – The Radio Link Addition procedure serves to establish a new Radio Link with the DSCH and USCH included, if they existed before.]

8.3.2.2 Successful Operation

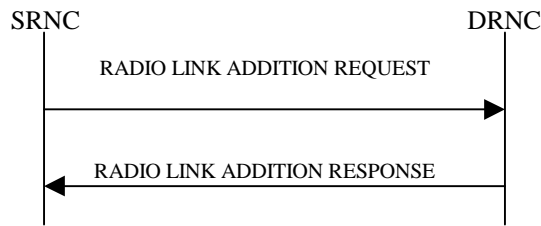

Figure 7: Radio Link Addition procedure: Successful Operation

The procedure is initiated with a RADIO LINK ADDITION REQUEST message sent from the SRNC to the DRNC.

Upon reception, the DRNS shall reserve the necessary resources and configure the new RL(s) according to the parameters given in the message. Unless specified below, the meaning of parameters is specified in other specifications.

The DRNS shall prioritise resource allocation for the RL(s) to be established according to Annex A.

Transport Channel Handling:

DSCH:

[TDD - If the radio link to be added includes a DSCH, the DRNC shall send a set of valid *DSCH Scheduling Priority* IE and *MAC-c/sh SDU Length* IE parameters to the SRNC in the message RADIO LINK ADDITION RESPONSE message.]

Physical Channels Handling:

[FDD-Compressed Mode]:

[FDD - If the RADIO LINK ADDITION REQUEST message includes the *Active Pattern Sequence Information* IE, the DRNS shall use the information to activate the indicated (all ongoing) Transmission Gap Pattern Sequence(s) in the new RL. The received *CM Configuration Change CFN* IE refers to the latest passed CFN with that value. The DRNS shall treat the received *TGCFN* IEs as follows:]

- [FDD - If any received *TGCFN* IE has the same value as the received *CM Configuration Change CFN* IE, the DRNS shall consider the concerned Transmission Gap Pattern Sequence as activated at that CFN.]
- [FDD - If any received *TGCFN* IE does not have the same value as the received *CM Configuration Change CFN* IE but the first CFN after the CM Configuration Change CFN with a value equal to the *TGCFN* IE has already passed, the DRNS shall consider the concerned Transmission Gap Pattern Sequence as activated at that CFN.]
- [FDD - For all other Transmission Gap Pattern Sequences included in the *Active Pattern Sequence Information* IE, the DRNS shall activate each Transmission Gap Pattern Sequence at the first CFN after the CM Configuration Change CFN with a value equal to the *TGCFN* IE for the Transmission Gap Pattern Sequence.]

[FDD - If the *Active Pattern Sequence Information* IE is not included, the DRNS shall not activate the ongoing compressed mode pattern in the new RLs, but the ongoing pattern in the existing RL shall be maintained.]

[FDD - If some Transmission Gap Pattern sequences using SF/2 method are initialised in the DRNS, DRNS shall include the *Transmission Gap Pattern Sequence Scrambling Code Information IE* in the RADIO LINK ADDITION RESPONSE message to indicate the Scrambling code change method that it selects for each channelisation code]

[FDD-DL Code Information]:

[FDD – When more than one DL DPDCH are assigned per RL, the segmented physical channel shall be mapped on to DL DPDCHs according to [8]. When *p* number of DL DPDCHs are assigned to each RL, the first pair of DL Scrambling Code and FDD DL Channelisation Code Number corresponds to "*PhCH number 1*", the second to "*PhCH number 2*", and so on until the *p*th to "*PhCH number p*".]

General:

[FDD - The DRNS shall use the provided Uplink SIR Target value as the current target for the inner-loop power control.]

Radio Link Handling:**Diversity Combination Control:**

The *Diversity Control Field* IE indicates for each RL whether the DRNS shall combine the new RL with existing RL(s) or not on the Iur.

If the *Diversity Control Field* IE is set to "May" (be combined with another RL), the DRNS shall decide for any of the alternatives.

If the *Diversity Control Field* IE is set to "Must", the DRNS shall combine the RL with one of the other RL.

If the *Diversity Control Field* IE is set to "Must not", the DRNS shall not combine the RL with any other existing RL.

When a new RL is to be combined the DRNS shall choose which RL(s) to combine it with.

In the case of not combining a RL with a RL established with a previous Radio Link Setup or Radio Link Addition Procedure or a RL previously listed in the RADIO LINK ADDITION RESPONSE message, the DRNC shall indicate with the Diversity Indication in the *RL Information Response* IE in the RADIO LINK ADDITION RESPONSE message that no combining is done. In this case the DRNC shall include in the *DCH Information Response* IE both the *Transport Layer Address* IE and the *Binding ID* IE for the transport bearer to be established for each DCH of the RL in the RADIO LINK ADDITION RESPONSE message.

In the case of combining with a RL established with a previous Radio Link Setup or Radio Link Addition Procedure or with a RL previously listed in this RADIO LINK ADDITION RESPONSE message, the DRNC shall indicate with the Diversity Indication in the *RL Information Response* IE in the RADIO LINK ADDITION RESPONSE message that the RL is combined. In this case, the *RL ID* IE indicates (one of) the previously established RL(s) or a RL previously listed in this RADIO LINK ADDITION RESPONSE message with which the new RL is combined.

In the case of a set of co-ordinated DCHs, the *Binding ID* IE and the *Transport Layer Address* IE shall be included for only one of the DCHs in a set of co-ordinated DCHs.

[FDD-Transmit Diversity]:

The DRNS shall activate any feedback mode diversity according to the received settings.

[FDD – If the cell in which the RL is being added is capable to provide Close loop Tx diversity, the DRNC shall include the *Closed Loop Timing Adjustment Mode* IE in the RADIO LINK ADDITION RESPONSE message indicating the Closed loop timing adjustment mode of the cell.]

[FDD – When the *Transmit Diversity Indicator* IE is present the DRNS shall activate/deactivate the Transmit Diversity for each new Radio Link in accordance with the *Transmit Diversity Indicator* IE using the diversity mode of the existing Radio Link(s).]

DL Power Control:

[FDD - If the *Primary CPICH Ec/No* IE measured by the UE is included for an RL in the RADIO LINK ADDITION REQUEST message, the DRNS shall use this in the calculation of the Initial DL TX Power for this RL. If the *Primary CPICH Ec/No* IE is not present, the DRNS shall set the Initial DL TX Power based on the power relative to the Primary CPICH power used by the existing RLs.]

[TDD - If the *Primary CCPCH RSCP* IE and/or the *DL Time Slot ISCP Info* IE are included in the RADIO LINK ADDITION REQUEST message, the DRNS shall use them in the calculation of the Initial DL TX Power. If the *Primary CCPCH RSCP* IE and *DL Time Slot ISCP Info* IE are not present, the DRNS shall set the Initial DL TX Power based on the power relative to the Primary CCPCH power used by the existing RLs.]

[FDD - The Initial DL TX Power shall be applied until UL synchronisation is achieved on the Uu interface for that RLS or Power Balancing is activated. No inner loop power control or power balancing shall be

performed during this period. The DL power shall then vary according to the inner loop power control (see ref. [10] subclause 5.2.1.2) with DPC_MODE=0 and the power control procedure (see 8.3.7)].

[TDD – The Initial DL TX Power shall be applied until UL synchronisation is achieved on the Uu interface for that RL. No inner loop power control shall be performed during this period. The DL power shall then vary according to the inner loop power control (see ref. [22] subclause 4.2.3.3)].

The DRNC shall also provide the configured UL Maximum SIR and UL Minimum SIR for every new RL to the SRNC in the RADIO LINK ADDITION RESPONSE message. These values are taken into consideration by DRNS admission control and shall be used by the SRNC as limits for the UL inner-loop power control target.

The DRNC shall provide the configured *Maximum DL TX Power* IE and *Minimum DL TX Power* IE for every new RL to the SRNC in the RADIO LINK ADDITION RESPONSE message. The DRNS shall not transmit with a higher power than indicated by the *Maximum DL TX Power* IE or lower than indicated by the *Minimum DL TX Power* IE on any DL DPCH of the RL [FDD – except during compressed mode, when the δP_{curr} , as described in ref.[10] subclause 5.2.1.3, shall be added to the maximum DL power for the associated compressed frame.].

DL Code Information:

The DRNC shall also provide the selected scrambling and channelisation codes of the new RLs in order to enable the SRNC to inform the UE about the selected codes.

Neighbouring Cell Handling:

If there are UMTS neighbouring cell(s) to the cell in which a Radio Link was established then:

- The DRNC shall include the *Neighbouring FDD Cell Information* IE and/or *Neighbouring TDD Cell Information* IE in the *Neighbouring UMTS Cell Information* IE for each neighbouring FDD cell and/or TDD cell respectively. In addition, if the information is available, the DRNC shall include the *Frame Offset* IE, *Primary CPICH Power* IE, *Cell Individual Offset* IE, *STTD Support Indicator* IE, *Closed Loop Mode1 Support Indicator* IE and *Closed Loop Mode2 Support Indicator* IE in the *Neighbouring FDD Cell Information* IE, and the *Frame Offset* IE, *Cell Individual Offset* IE, *DPCH Constant Value* IE and the *PCCPCH Power* IE in the *Neighbouring TDD Cell Information* IE.
- If a UMTS neighbouring cell is not controlled by the same DRNC, the DRNC shall also include the *CN PS Domain Identifier* IE and/or *CN CS Domain Identifier* IE which are the identifiers of the CN nodes connected to the RNC controlling the UMTS neighbouring cell.
- For the UMTS neighbouring cells which are controlled by the DRNC, the DRNC shall report in the RADIO LINK ADDITION RESPONSE message the restriction state of those cells, otherwise *Restriction state indicator* IE may be absent. The DRNC shall include the *Restriction state indicator* IE for the neighbouring cells which are controlled by the DRNC in the *Neighbouring FDD Cell Information* IE, the *Neighbouring TDD Cell Information* IE and the *Neighbouring TDD Cell Information LCR* IE.

If there are GSM neighbouring cells to the cell(s) where a radio link is established, the DRNC shall include the *Neighbouring GSM Cell Information* IE in the RADIO LINK ADDITION RESPONSE message for each of the GSM neighbouring cells. If available the DRNC shall include the *Cell Individual Offset* IE, and if the *Cell Individual Offset* IE alone cannot represent the value of the offset, the DRNC shall also include the *Extended GSM Cell Individual Offset* IE in the *Neighbouring GSM Cell Information* IE.

General:

[FDD - If the RADIO LINK ADDITION REQUEST message contains an *SSDT Cell Identity* IE, SSDT shall, if supported, be activated for the concerned new RL, with the indicated SSDT Cell Identity used for that RL.]

Depending on local configuration in the DRNS, it may include the geographical co-ordinates of the cell and the UTRAN access point position for each of the added RLs in the RADIO LINK ADDITION RESPONSE message.

For each Radio Link established in a cell where at least one URA Identity is being broadcast, the DRNC shall include a URA Identity for this cell in the *URA ID* IE, the *Multiple URAs Indicator* IE indicating whether or not multiple URA Identities are being broadcast in the cell, and the RNC Identity of all other RNCs that are

having at least one cell within the URA in the cell in the *URA Information IE* in the RADIO LINK ADDITION RESPONSE message.

[FDD - If the UE has been allocated one or several DCH controlled by DRAC and if the DRNS supports the DRAC, the DRNC shall indicate in the RADIO LINK ADDITION RESPONSE message the *Secondary CCPCH Info IE* for the FACH where the DRAC information is sent, for each Radio Link established in a cell where DRAC is active. If the DRNS does not support DRAC, the DRNC shall not provide these IEs in the RADIO LINK ADDITION RESPONSE message.]

[TDD - The DRNC shall include the *Secondary CCPCH Info TDD IE* in the RADIO LINK ADDITION RESPONSE message if at least one *DSCH Information Response IE* or *USCH Information Response IE* is included in the message and at least one DCH is configured for the radio link. The DRNC shall also include the *Secondary CCPCH Info TDD IE* in the RADIO LINK ADDITION RESPONSE message if at least one *DSCH Information Response IE* or *USCH Information Response IE* is included in the message and the SHCCH messages for this radio link will be transmitted over a different secondary CCPCH than selected by the UE from system information.]

If the *Permanent NAS UE Identity IE* is present in the RADIO LINK ADDITION REQUEST message, the DRNC shall store the information for the considered UE Context for the life-time of the UE Context.

If the RADIO LINK ADDITION REQUEST message includes a *C-ID IE* corresponding to a cell reserved for operator use and the Permanent NAS UE Identity is available in the DRNC for the considered UE Context, the DRNC shall use this information to determine whether it can add the Radio Link on this cell or not.

The DRNS shall start reception on the new RL(s) after the RLs are successfully established.

[FDD-Radio Link Set Handling]:

[FDD – For each RL not having a common generation of the TPC commands in the DL with another RL, the DRNS shall assign the *RL Set ID IE* included in the RADIO LINK ADDITION RESPONSE message a value that uniquely identifies the RL Set within the UE Context.]

[FDD – For all RLs having a common generation of the TPC commands in the DL with another new or existing RL, the DRNS shall assign the *RL Set ID IE* included in the RADIO LINK ADDITION RESPONSE message the same value. This value shall uniquely identify the RL Set within the UE Context.]

[FDD – After addition of the new RL(s), the UL out-of-sync algorithm defined in ref. [10] shall, for each of the previously existing and newly established RL Set(s), use the maximum value of the parameters *N_OUTSYNC_IND* and *T_RLFAILURE* that are configured in the cells supporting the radio links of the RL Set. The UL in-sync algorithm defined in [10] shall, for each of the established RL Set(s), use the minimum value of the parameters *N_INSYNC_IND* that are configured in the cells supporting the radio links of the RL Set.]

Response message:

If all requested RLs are successfully added, the DRNC shall respond with a RADIO LINK ADDITION RESPONSE message.

After sending the RADIO LINK ADDITION RESPONSE message, the DRNS shall continuously attempt to obtain UL synchronisation on the Uu interface. [FDD - The DRNS shall start transmission on the DL DPDCH(s) of the new RL as specified in ref. [4].] [TDD – The DRNS shall start transmission on the new RL immediately as specified in ref. [4].]

8.3.2.3 Unsuccessful Operation

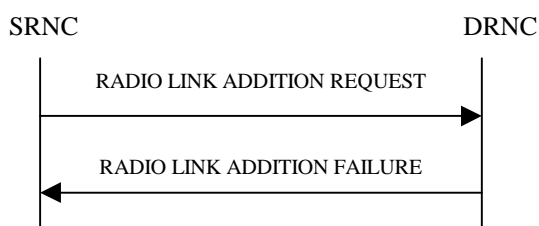

Figure 8: Radio Link Addition procedure: Unsuccessful Operation

If the establishment of at least one RL is unsuccessful, the DRNC shall send a RADIO LINK ADDITION FAILURE as response.

If some RL(s) were established successfully, the DRNC shall indicate this in the RADIO LINK ADDITION FAILURE message in the same way as in the RADIO LINK ADDITION RESPONSE message.

Typical cause values are:

Radio Network Layer Causes:

- DL Radio Resources not Available;
- UL Radio Resources not Available;
- Combining Resources not Available;
- Combining not Supported;
- Cell not Available;
- [FDD - Requested Tx Diversity Mode not Supported];
- Power Level not Supported;
- CM not Supported;
- Reconfiguration CFN not Elapsed;
- Number of DL Codes not Supported;
- Number of UL codes not supported;
- Cell reserved for operator use.

Transport Layer Causes:

- Transport Resource Unavailable.

Miscellaneous Causes:

- Control Processing Overload;
- HW Failure;
- Not enough User Plane Processing Resources.

8.3.2.4 Abnormal Conditions

If the RADIO LINK ADDITION REQUEST message includes a *C-ID* IE corresponding to a cell reserved for operator use and the Permanent NAS UE Identity is not available in the DRNC for the considered UE Context, the DRNC shall consider the procedure as failed for this particular Radio Link and send the RADIO LINK ADDITION FAILURE message.

[FDD – If the RADIO LINK ADDITION REQUEST message includes the *Transmission Gap Pattern Sequence Status* IEs in the *Active Pattern Sequence Information* IE and it does not address exactly all ongoing compressed mode patterns the DRNS shall regard the Radio Link Addition procedure as failed and shall respond with a RADIO LINK ADDITION FAILURE message with the cause value "Invalid CM settings".]

[FDD - If the RADIO LINK ADDITION REQUEST message is used to establish a new RL without compressed mode when compressed mode is active for the existing RL(s) (as specified in subclause 8.3.2.2), but at least one new RL is to be established in a cell that has the same UARFCN (both UL and DL) as at least one cell with an already existing RL, the DRNS shall regard the Radio Link Addition procedure as failed and shall respond with a RADIO LINK ADDITION FAILURE message with the cause value "Invalid CM settings".]

8.3.3 Radio Link Deletion

8.3.3.1 General

The Radio Link Deletion procedure is used to release the resources in a DRNS for one or more established radio links towards a UE.

This procedure shall use the signalling bearer connection for the relevant UE Context.

The Radio Link Deletion procedure may be initiated by the SRNC at any time after establishing a Radio Link.

8.3.3.2 Successful Operation

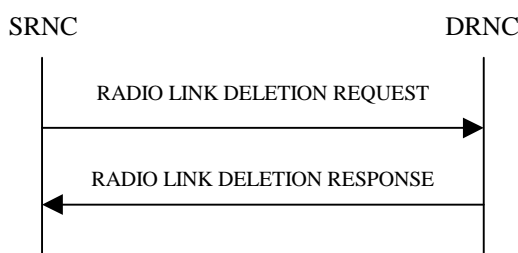

Figure 9: Radio Link Deletion procedure, Successful Operation

The procedure is initiated with a RADIO LINK DELETION REQUEST message sent from the SRNC to the DRNC.

Upon receipt of this message, the DRNS shall delete the radio link(s) identified in the message and release all associated resources and respond to the SRNC with a RADIO LINK DELETION RESPONSE message.

If the radio link(s) to be deleted represent the last radio link(s) for the UE in the DRNS then the DRNC shall also release the UE Context, unless the UE is using common resources in the DRNS.

[FDD – After deletion of the RL(s), the UL out-of-sync algorithm defined in ref. [10] shall for each of the remaining RL Set(s) use the maximum value of the parameters N_OUTSYNC_IND and T_RLFAILURE, that are configured in the cells supporting the radio links of the RL Set and the UL in-sync algorithm defined in ref. [10] shall for each of the remaining RL Set(s) use the minimum value of the parameters N_INSYNC_IND that are configured in the cells supporting the radio links of the RL Set].

8.3.3.3 Unsuccessful Operation

-

8.3.3.4 Abnormal Conditions

If the RL indicated by the *RL ID* IE does not exist, the DRNC shall respond with the RADIO LINK DELETION RESPONSE message.

8.3.4 Synchronised Radio Link Reconfiguration Preparation

8.3.4.1 General

The Synchronised Radio Link Reconfiguration Preparation procedure is used to prepare a new configuration of Radio Link(s) related to one UE-UTRAN connection within a DRNS.

This procedure shall use the signalling bearer connection for the relevant UE Context.

The Synchronised Radio Link Reconfiguration Preparation procedure shall not be initiated if a Prepared Reconfiguration exists, as defined in subclause 3.1.

8.3.4.2 Successful Operation

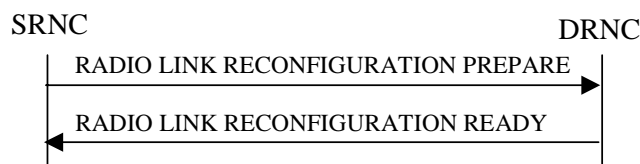

Figure 10: Synchronised Radio Link Reconfiguration Preparation procedure, Successful Operation

The Synchronised Radio Link Reconfiguration Preparation procedure is initiated by the SRNC by sending the RADIO LINK RECONFIGURATION PREPARE message to the DRNC.

Upon reception, the DRNS shall reserve necessary resources for the new configuration of the Radio Link(s) according to the parameters given in the message. Unless specified below, the meaning of parameters is specified in other specifications.

If the RADIO LINK RECONFIGURATION PREPARE message includes the *Allowed Queuing Time* IE the DRNS may queue the request the time corresponding to the value of the *Allowed Queuing Time* IE before starting to execute the request.

The DRNS shall prioritise resource allocation for the RL(s) to be modified according to Annex A.

DCH Modification:

If the RADIO LINK RECONFIGURATION PREPARE message includes any *DCHs To Modify* IE, then the DRNS shall treat them each as follows:

- If the *DCHs To Modify* IE includes multiple *DCH Specific Info* IEs, the DRNS shall treat the DCHs in the *DCHs To Modify* IE as a set of co-ordinated DCHs. The DRNS shall include these DCHs in the new configuration only if it can include all of them in the new configuration.
- If the *DCHs To Modify* IE includes the *UL FP Mode* IE for a DCH or a set of co-ordinated DCHs to be modified, the DRNS shall apply the new FP Mode in the Uplink of the user plane for the DCH or the set of co-ordinated DCHs in the new configuration.
- If the *DCHs To Modify* IE includes the *ToAWS* IE for a DCH or a set of co-ordinated DCHs to be modified, the DRNS shall apply the new ToAWS in the user plane for the DCH or the set of co-ordinated DCHs in the new configuration.
- If the *DCHs To Modify* IE includes the *ToAWE* IE for a DCH or a set of co-ordinated DCHs to be modified, the DRNS shall apply the new ToAWE in the user plane for the DCH or the set of co-ordinated DCHs in the new configuration.
- If the *DCH Specific Info* IE includes the *Frame Handling Priority* IE for a DCH to be modified, the DRNS should store this information for this DCH in the new configuration. The received Frame Handling Priority should be used when prioritising between different frames in the downlink on the radio interface in congestion situations within the DRNS once the new configuration has been activated.
- If the *DCH Specific Info* IE includes the *Transport Format Set* IE for the UL of a DCH to be modified, the DRNS shall apply the new Transport Format Set in the Uplink of this DCH in the new configuration.
- If the *DCH Specific Info* IE includes the *Transport Format Set* IE for the DL of a DCH to be modified, the DRNS shall apply the new Transport Format Set in the Downlink of this DCH in the new configuration.
- [FDD - If, in the *DCH Specific Info* IE, the *DRAC Control* IE is present and set to "requested" for at least one DCH and if the DRNS supports the DRAC, the DRNC shall indicate in the RADIO LINK RECONFIGURATION READY message the *Secondary CCPCH Info* IE for the FACH where the DRAC information is sent, for each Radio Link established in a cell where DRAC is active. If the DRNS does not support DRAC, DRNC shall not provide these IEs in the RADIO LINK RECONFIGURATION READY message.]
- [TDD - If the *DCH Specific Info* IE includes the *CCTrCH ID* IE for the UL, the DRNS shall map the DCH onto the referenced UL CCTrCH.]

- [TDD - If the *DCH Specific Info* IE includes the *CCTrCH ID* IE for the DL, the DRNS shall map the DCH onto the referenced DL CCTrCH.]

DCH Addition:

If the RADIO LINK RECONFIGURATION PREPARE message includes any *DCHs To Add* IE, the DRNS shall treat them each as follows:

- The DRNS shall reserve necessary resources for the new configuration of the Radio Link(s) according to the parameters given in the message and include these DCH in the new configuration.
- If the *DCHs To Add* IE includes a *DCHs To Add* IE with multiple *DCH Specific Info* IEs, the DRNS shall treat the DCHs in the *DCHs To Add* IE as a set of co-ordinated DCHs. The DRNS shall include these DCHs in the new configuration only if it can include all of them in the new configuration.
- [FDD - For DCHs which do not belong to a set of co-ordinated DCHs with the *QE-Selector* IE set to "selected", the Transport channel BER from that DCH shall be the base for the QE in the UL data frames. If no Transport channel BER is available for the selected DCH, the Physical channel BER shall be used for the QE, ref. [4]. If the *QE-Selector* IE is set to "non-selected", the Physical channel BER shall be used for the QE in the UL data frames, ref. [4].]
- [FDD - For a set of co-ordinated DCHs the Transport channel BER from the DCH with the *QE-Selector* IE set to "selected" shall be used for the QE in the UL data frames, ref. [4]. [FDD - If no Transport channel BER is available for the selected DCH the Physical channel BER shall be used for the QE, ref. [4]. If all DCHs have the *QE-Selector* IE set to "non-selected" the Physical channel BER shall be used for the QE, ref. [4].]
- The DRNS should store the *Frame Handling Priority* IE received for a DCH to be added in the new configuration. The received Frame Handling Priority should be used when prioritising between different frames in the downlink on the radio interface in congestion situations within the DRNS once the new configuration has been activated.
- The DRNS shall use the included *UL FP Mode* IE for a DCH or a set of co-ordinated DCHs to be added as the new FP Mode in the Uplink of the user plane for the DCH or the set of co-ordinated DCHs in the new configuration.
- The DRNS shall use the included *ToAWS* IE for a DCH or a set of co-ordinated DCHs to be added as the new Time of Arrival Window Start Point in the user plane for the DCH or the set of co-ordinated DCHs in the new configuration.
- The DRNS shall use the included *ToAWE* IE for a DCH or a set of co-ordinated DCHs to be added as the new Time of Arrival Window End Point in the user plane for the DCH or the set of co-ordinated DCHs in the new configuration.
- [TDD - The DRNC shall include the *Secondary CCPCH Info TDD* IE in the RADIO LINK RECONFIGURATION READY message if at least one DSCH or USCH exists in the new configuration.]
- [FDD - If the *DRAC Control* IE is set to "requested" in the *DCH Specific Info* IE for at least one DCH and if the DRNS supports the DRAC, the DRNC shall indicate in the RADIO LINK RECONFIGURATION READY message the *Secondary CCPCH Info* IE for the FACH where the DRAC information is sent, for each Radio Link supported by a cell where DRAC is active. If the DRNS does not support DRAC, the DRNC shall not provide these IEs in the RADIO LINK RECONFIGURATION READY message.]

DCH Deletion:

If the RADIO LINK RECONFIGURATION PREPARE message includes any *DCH To Delete* IEs, the DRNS shall not include the referenced DCHs in the new configuration.

If all of the DCHs belonging to a set of co-ordinated DCHs are requested to be deleted, the DRNS shall not include this set of co-ordinated DCHs in the new configuration.

Physical Channel Modification:

[FDD - If the RADIO LINK RECONFIGURATION PREPARE message includes an *UL DPCH Information* IE, the DRNS shall apply the parameters to the new configuration as follows:]

- [FDD - If the *UL DPCH Information IE* includes the *Uplink Scrambling Code IE*, the DRNS shall apply this Uplink Scrambling Code to the new configuration.]
- [FDD - If the *UL DPCH Information IE* includes the *Min UL Channelisation Code Length IE*, the DRNS shall apply the new Min UL Channelisation Code Length in the new configuration. The DRNS shall apply the contents of the *Max Number of UL DPDCHs IE* (if it is included) in the new configuration.]
- [FDD - If the *UL DPCH Information IE* includes the *TFCS IE*, the DRNS shall use the *TFCS IE* for the UL when reserving resources for the uplink of the new configuration. The DRNS shall apply the new TFCS in the Uplink of the new configuration.]
- [FDD - If the *UL DPCH Information IE* includes the *UL DPCCH Slot Format IE*, the DRNS shall apply the new Uplink DPCCH Slot Format to the new configuration.]
- [FDD – If the *UL DPCH Information IE* includes the *UL SIR Target IE*, the DRNS shall set the UL inner loop power control to the UL SIR target when the new configuration is being used.]
- [FDD – If the *UL DPCH Information IE* includes the *Puncture Limit IE*, the DRNS shall apply the value in the uplink of the new configuration.]
- [FDD - If the *UL DPCH Information IE* includes the *Diversity Mode IE*, the DRNS shall apply diversity according to the given value.]
- [FDD – If the *UL DPCH Information IE* includes an *SSDT Cell Identity Length IE* and/or an *S-Field Length IE*, the DRNS shall apply the values in the new configuration.]

[FDD - If the RADIO LINK RECONFIGURATION PREPARE message includes a *DL DPCH Information IE*, the DRNS shall apply the parameters to the new configuration as follows:]

- [FDD - If the *DL DPCH Information IE* includes *Number of DL Channelisation Codes IE*, the DRNS shall allocate given number of Downlink Channelisation Codes per Radio Link and apply the new Downlink Channelisation Code(s) to the new configuration. Each Downlink Channelisation Code allocated for the new configuration shall be included as a FDD DL Channelisation Code Number IE in the RADIO LINK RECONFIGURATION READY message when sent to the SRNC. If some Transmission Gap Pattern sequences using 'SF/2' method are already initialised in the DRNS, DRNC shall include the *Transmission Gap Pattern Sequence Scrambling Code Information IE* in the RADIO LINK RECONFIGURATION READY message in case the DRNS selects to change the Scrambling code change method for one or more DL Channelisation Code.]
- [FDD – When more than one DL DPDCH are assigned per RL, the segmented physical channel shall be mapped on to DL DPDCHs according to [8]. When p number of DL DPDCHs are assigned to each RL, the first pair of DL Scrambling Code and FDD DL Channelisation Code Number corresponds to "*PhCH number 1*", the second to "*PhCH number 2*", and so on until the p th to "*PhCH number p*".]
- [FDD - If the *DL DPCH Information IE* includes the *TFCS IE*, the DRNS shall use the *TFCS IE* for the DL when reserving resources for the downlink of the new configuration. The DRNS shall apply the new TFCS in the Downlink of the new configuration.]
- [FDD – If the *DL DPCH Information IE* includes the *DL DPCH Slot Format IE*, the DRNS shall apply the new slot format used in DPCH in DL.]
- [FDD – If the *DL DPCH Information IE* includes the *TFCI Signalling Mode IE*, the DRNS shall apply the new signalling mode of the TFCI.]
- [FDD – If the *DL DPCH Information IE* includes the *Multiplexing Position IE*, the DRNS shall apply the new parameter to define whether fixed or flexible positions of transport channels shall be used in the physical channel.]
- [FDD – If the *DL DPCH Information IE* includes the *Limited Power Increase IE* set to "Used", the DRNS shall, if supported, use Limited Power Increase according to ref. [10] subclause 5.2.1 for the inner loop DL power control in the new configuration.]
- [FDD – If the *DL DPCH Information IE* includes the *Limited Power Increase IE* set to "Not Used", the DRNS shall not use Limited Power Increase for the inner loop DL power control in the new configuration.]

[FDD – If the RADIO LINK RECONFIGURATION PREPARE message includes the *Transmission Gap Pattern Sequence Information* IE, the DRNS shall store the new information about the Transmission Gap Pattern Sequences to be used in the new Compressed Mode Configuration. This new Compressed Mode Configuration shall be valid in the DRNS until the next Compressed Mode Configuration is configured in the DRNS or last Radio Link is deleted.]

[FDD – If the RADIO LINK RECONFIGURATION PREPARE message includes the *Transmission Gap Pattern Sequence Information* IE and the *Downlink Compressed Mode Method* IE in one or more Transmission Gap Pattern Sequence within the *Transmission Gap Pattern Sequence Information* IE is set to 'SF/2', the DRNC shall include the *Transmission Gap Pattern Sequence Scrambling Code Information* IE to the RADIO LINK RECONFIGURATION READY message indicating for each Channelisation Code whether the alternative scrambling code shall be used or not].

[TDD - UL/DL CCTrCH Modification]

[TDD - If the RADIO LINK RECONFIGURATION PREPARE message includes any *UL CCTrCH To Modify* IEs or *DL CCTrCH To Modify* IEs, then the DRNS shall treat them each as follows:]

[TDD - If any of the *UL CCTrCH To Modify* IEs or *DL CCTrCH To Modify* IEs includes any of the *TFCS* IE, *TFCI coding* IE, *Puncture limit* IE, or *TPC CCTrCH ID* IEs the DRNS shall apply these as the new values, otherwise the old values specified for this CCTrCH are still applicable.]

- [TDD – The DRNC shall include in the RADIO LINK RECONFIGURATION READY message DPCH information to be modified, and the IEs modified if any, of *Repetition Period* IE, *Repetition Length* IE, *TDD DPCH Offset* IE or timeslot information was modified. The DRNC shall include timeslot information and the IEs modified if any of *Midamble Shift And Burst Type* IE, *Time Slot* IE, *TFCI Presence* IE or Code information was modified. The DRNC shall include code information if *TDD Channelisation Code* IE was modified.]

[TDD – UL/DL CCTrCH Addition]

[TDD – If the RADIO LINK RECONFIGURATION PREPARE message includes any *UL CCTrCH To Add* IEs or *DL CCTrCH To Add* IEs, the DRNS shall include this CCTrCH in the new configuration.]

[TDD – If the DRNS has reserved the required resources for any requested DPCHs, the DRNC shall include the DPCH information within DPCH to be added in the RADIO LINK RECONFIGURATION READY message. If no DPCH was active before the reconfiguration, and if a valid Rx Timing Deviation measurement is known in DRNC, then the DRNC shall include the *Rx Timing Deviation* IE in the RADIO LINK RECONFIGURATION READY message.]

[TDD – If the RADIO LINK RECONFIGURATION PREPARE message includes a *DL CCTrCH To Add* IE, the DRNS shall set the TPC step size of that CCTrCH to the same value as the lowest numbered DL CCTrCH in the current configuration.]

[TDD – UL/DL CCTrCH Deletion]

[TDD - If the RADIO LINK RECONFIGURATION PREPARE message includes any *UL CCTrCH To Delete* IEs or *DL CCTrCH To Delete* IEs, the DRNS shall remove this CCTrCH in the new configuration.]

SSDT Activation/Deactivation:

- [FDD - If the *RL Information* IE includes the *SSDT Indication* IE set to "SSDT Active in the UE", the DRNS shall activate SSDT, if supported, using the *SSDT Cell Identity* IE in *RL Information* IE, and the *SSDT Cell Identity Length* IE in *UL DPCH Information* IE, in the new configuration.]
- [FDD - If the *RL Information* IE includes the *SSDT Indication* IE set to "SSDT not Active in the UE", the DRNS shall deactivate SSDT in the new configuration.]

DSCH Addition/Modification/Deletion:

If the RADIO LINK RECONFIGURATION PREPARE message includes any *DSCH To Add*, *DSCH To Modify* or *DSCH To Delete* IEs, then the DRNS shall use this information to add/modify/delete the indicated DSCH channels to/from the radio link, in the same way as the DCH info is used to add/modify/release DCHs.

If the RADIO LINK RECONFIGURATION PREPARE message includes any *DSCH To Add* IE, then the DRNS shall use the *Allocation/Retention Priority* IE, *Scheduling Priority Indicator* IE and *TrCH Source Statistics Descriptor* IE to define a set of DSCH Priority classes each of which is associated with a set of supported MAC-c/sh SDU lengths.

If the RADIO LINK RECONFIGURATION PREPARE message includes any *DSCH To Modify* IE, then the DRNS shall treat them each as follows:

- [FDD – If the *DSCH To Modify* IE includes any *DSCH Info* IEs, then the DRNS shall treat them each as follows:]
 - [FDD – If the *DSCH Info* IE includes any of the *Allocation/Retention Priority* IE, *Scheduling Priority Indicator* IE or *TrCH Source Statistics Descriptor* IE, the DRNS shall use them to update the set of DSCH Priority classes each of which is associated with a set of supported MAC-c/sh SDU lengths.]
 - [FDD – If the *DSCH Info* IE includes any of the *Transport Format Set* IE or *BLER* IE, the DRNS shall apply the parameters to the new configuration.]
- [FDD – If the *DSCH To Modify* IE includes the *PDSCH RL ID* IE, then the DRNS shall use it as the new DSCH RL identifier.]
 - [FDD - If the indicated PDSCH RL ID is in the DRNS and there was no DSCH-RNTI allocated to the UE Context, the DRNC shall allocate a DSCH-RNTI to the UE Context and include the *DSCH-RNTI* IE in the RADIO LINK RECONFIGURATION READY message.]
 - [FDD - If the indicated PDSCH RL ID is in the DRNS and there was a DSCH-RNTI allocated to the UE Context, the DRNC shall allocate a new DSCH-RNTI to the UE Context, release the old DSCH-RNTI and include the *DSCH-RNTI* IE in the RADIO LINK RECONFIGURATION READY message.]
 - [FDD - If the indicated PDSCH RL ID is not in the DRNS and there was a DSCH-RNTI allocated to the UE Context, the DRNC shall release this DSCH-RNTI.]
- [FDD – If the *DSCH To Modify* IE includes the *Transport Format Combination Set* IE, then the DRNS shall use it as the new Transport Format Combination Set associated with the DSCH.]
- [TDD – If the *DSCHs To Modify* IE includes the *CCTrCH Id* IE, then the DRNS shall map the DSCH onto the referenced DL CCTrCH.]
- [TDD – If the *DSCHs To Modify* IE includes any of the *Allocation/Retention Priority* IE, *Scheduling Priority Indicator* IE or *TrCH Source Statistics Descriptor* IE, the DRNS shall use them to update the set of DSCH Priority classes each of which is associated with a set of supported MAC-c/sh SDU lengths.]
- [TDD – If the *DSCHs To Modify* IE includes any of the *Transport Format Set* IE or *BLER* IE, the DRNS shall apply the parameters to the new configuration.]
- [TDD – The DRNC shall include the *Secondary CCPCH Info TDD* IE in the RADIO LINK RECONFIGURATION READY message if a DSCH is added and at least one DCH exists in the new configuration. The DRNC shall also include the *Secondary CCPCH Info TDD* IE in the RADIO LINK RECONFIGURATION READY message if the SHCCH messages for this radio link will be transmitted over a different secondary CCPCH than selected by the UE from system information.]

[FDD – If the RADIO LINK RECONFIGURATION PREPARE message includes a *DSCHs To Delete* IE requesting the deletion of all DSCH resources for the UE Context, then the DRNC shall release the DSCH-RNTI allocated to the UE Context, if there was one.]

If the requested modifications are allowed by the DRNS and the DRNS has successfully reserved the required resources for the new configuration of the Radio Link(s), it shall respond to the SRNC with the RADIO LINK RECONFIGURATION READY message.

[TDD] USCH Addition/Modification/Deletion

If the RADIO LINK RECONFIGURATION PREPARE message includes any *USCH to modify*, *USCH to add* or *USCH to delete* IEs, then the DRNS shall use this information to add/modify/delete the indicated USCH channels to/from the radio link, in the same way as the DCH info is used to add/modify/release DCHs.

If the RADIO LINK RECONFIGURATION PREPARE message includes any *USCH To Add* IE, then, the DRNS shall use the *Allocation/Retention Priority* IE, *Scheduling Priority Indicator* IE and *TrCH Source Statistics Descriptor* IE to define a set of USCH Priority classes each of which is associated with a set of supported MAC-c/sh SDU lengths.

If the RADIO LINK RECONFIGURATION PREPARE message includes any *USCH To Modify* IE, then the DRNS shall treat them each as follows:

- If the *USCH To Modify* IE includes any of the Allocation/Retention Priority IE, Scheduling Priority Indicator IE or TrCH Source Statistics Descriptor IE, the DRNS shall use them to update the set of USCH Priority classes.
- If the *USCH To Modify* IE includes any of the CCTrCH Id IE, Transport Format Set IE, BLER IE or RB Info IE, the DRNS shall apply the parameters to the new configuration.
- [TDD - The DRNC shall include the *Secondary CCPCH Info TDD* IE in the RADIO LINK RECONFIGURATION READY message if a USCH is added and at least one DCH exists in the new configuration. The DRNC shall also include the *Secondary CCPCH Info TDD* IE in the RADIO LINK RECONFIGURATION READY message if the SHCCH messages for this radio link will be transmitted over a different secondary CCPCH than selected by the UE from system information.]

General

If the requested modifications are allowed by the DRNC and the DRNC has successfully reserved the required resources for the new configuration of the Radio Link(s), it shall respond to the SRNC with the RADIO LINK RECONFIGURATION READY message.

[TDD] DSCH RNTI Addition/Deletion

[TDD - If the RADIO LINK RECONFIGURATION PREPARE message includes the *PDSCH RL ID* IE, then the DRNS shall use it as the new RL identifier for PDSCH and PUSCH.]

- [TDD - If the indicated PDSCH RL ID is in the DRNS and there was no DSCH-RNTI allocated to the UE Context, the DRNC shall allocate a DSCH-RNTI to the UE Context and include the *DSCH-RNTI* IE in the RADIO LINK RECONFIGURATION READY message.]
- [TDD - If the indicated PDSCH RL ID is in the DRNS and there was a DSCH-RNTI allocated to the UE Context, the DRNC shall allocate a new DSCH-RNTI to the UE Context, release the old DSCH-RNTI and include the *DSCH-RNTI* IE in the RADIO LINK RECONFIGURATION READY message.]
- [TDD - If the indicated PDSCH RL ID is not in the DRNS and there was a DSCH-RNTI allocated to the UE Context, the DRNC shall release this DSCH-RNTI.]

[TDD – If the RADIO LINK RECONFIGURATION PREPARE message includes a *DSCHs to Delete* IE and/or a *USCHs to Delete* IE which results in the deletion of all DSCH and USCH resources for the UE Context, then the DRNC shall release the DSCH-RNTI allocated to the UE Context, if there was one.]

The DRNS shall include in the RADIO LINK RECONFIGURATION READY message the *Transport Layer Address* IE and the *Binding ID* IE in the *DCH Information Response* IE for any Transport Channel being added or any Transport Channel being modified for which a new transport bearer was requested with the *Transport Bearer Request Indicator* IE. In the case of a set of co-ordinated DCHs requiring a new transport bearer on the Iur interface, the *Transport Layer Address* IE and the *Binding ID* IE in the *DCH Information Response* IE shall be included only for one of the DCHs in the set of co-ordinated DCHs.

In the case of a Radio Link being combined with another Radio Link within the DRNS, the *Transport Layer Address* IE and the *Binding ID* IE in the *DCH Information Response* IE shall be included only for one of the combined Radio Links.

If the requested modifications are allowed by the DRNS, and the DRNS has successfully reserved the required resources for the new configuration of the Radio Link(s) it shall respond to the SRNC with the RADIO LINK RECONFIGURATION READY message. When this procedure has been completed successfully there exists a Prepared Reconfiguration, as defined in subclause 3.1.

The DRNS decides the maximum and minimum SIR for the uplink of the Radio Link(s) and shall return this in the *Maximum Uplink SIR* IE and *Minimum Uplink SIR* IE for each Radio Link in the RADIO LINK RECONFIGURATION READY message.

If the DL TX power upper or lower limit has been re-configured the DRNC shall return this in the *Maximum DL TX Power* IE and *Minimum DL TX Power* IE respectively in the RADIO LINK RECONFIGURATION READY message. The DRNS shall not transmit with a higher power than indicated by the *Maximum DL TX Power* IE or lower than indicated by the *Minimum DL TX Power* IE on any DL DPCH of the RL [FDD – except during compressed mode, when

the δP_{curr} as described in ref.[10] subclause 5.2.1.3, shall be added to the maximum DL power for the associated compressed frame.].

[TDD - If the *Primary CCPCH RSCP* IE and/or the *DL Time Slot ISCP Info* IE are present, the DRNC should use the indicated values when deciding the Initial DL TX Power.]

8.3.4.3 Unsuccessful Operation

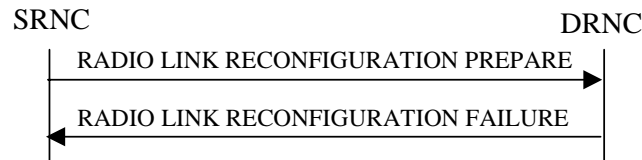

Figure 11: Synchronised Radio Link Reconfiguration Preparation procedure, Unsuccessful Operation

If the DRNS cannot reserve the necessary resources for all the new DCHs of a set of co-ordinated DCHs requested to be added, it shall regard the Synchronised Radio Link Preparation procedure as having failed.

If the requested Synchronised Radio Link Reconfiguration Preparation procedure fails for one or more RLs, the DRNC shall send the RADIO LINK RECONFIGURATION FAILURE message to the SRNC, indicating the reason for failure.

Typical cause values are:

Radio Network Layer Causes:

- UL Scrambling Code Already in Use;
- DL Radio Resources not Available;
- UL Radio Resources not Available;
- Requested Configuration not Supported;
- Number of DL Codes not Supported;
- Number of UL Codes not Supported;
- Dedicated Transport Channel Type not Supported;
- DL Shared Channel Type not Supported;
- [TDD - UL Shared Channel Type not Supported];
- [FDD - UL Spreading Factor not Supported];
- [FDD - DL Spreading Factor not Supported];
- CM not Supported.

Miscellaneous Causes:

- Control Processing Overload;
- Not enough User Plane Processing Resources.

8.3.4.4 Abnormal Conditions

If only a subset of all the DCHs belonging to a set of co-ordinated DCHs is requested to be deleted, the DRNS shall regard the Synchronised Radio Link Reconfiguration Preparation procedure as having failed and shall send the RADIO LINK RECONFIGURATION FAILURE message to the SRNC.

If more than one DCH of a set of co-ordinated DCHs has the *QE-Selector* IE set to "selected" [TDD – or no DCH of a set of co-ordinated DCHs has the *QE-Selector* IE set to "selected"] the DRNS shall regard the Synchronised Radio Link

Reconfiguration Preparation procedure as failed and the DRNC shall respond with a RADIO LINK RECONFIGURATION FAILURE message.

If the RADIO LINK RECONFIGURATION PREPARE message includes a *DCHs To Modify* IE or *DCHs To Add* IE with multiple *DCH Specific Info* IEs, and if the DCHs in the *DCHs To Modify* IE or *DCHs To Add* IE do not have the same *Transmission Time Interval* IE in the *Semi-Static Transport Format Information* IE, then the DRNC shall reject the procedure using the RADIO LINK RECONFIGURATION FAILURE message.

8.3.5 Synchronised Radio Link Reconfiguration Commit

8.3.5.1 General

This procedure is used to order the DRNS to switch to the new configuration for the Radio Link(s) within the DRNS, previously prepared by the Synchronised Radio Link Reconfiguration Preparation procedure.

This procedure shall use the signalling bearer connection for the relevant UE Context.

8.3.5.2 Successful Operation



Figure 12: Synchronised Radio Link Reconfiguration Commit procedure, Successful Operation

The DRNS shall switch to the new configuration previously prepared by the Synchronised Radio Link Reconfiguration Preparation procedure at the next coming CFN with a value equal to the value requested by the SRNC in the *CFN* IE when receiving the RADIO LINK RECONFIGURATION COMMIT message from the SRNC.

[FDD – If the *Active Pattern Sequence Information* IE is included in the RADIO LINK RECONFIGURATION COMMIT message, the *CM Configuration Change CFN* IE in the *Active Pattern Sequence Information* IE shall be ignored by the DRNS.]

When this procedure has been completed the Prepared Reconfiguration does not exist any more, see subclause 3.1

In the case of a transport channel modification for which a new transport bearer was requested and established, the switch to the new transport bearer shall also take place at the indicated CFN. The detailed frame protocol handling during transport bearer replacement is described in [4], subclause 5.10.1 and in [30] subclause 5.3.1.

[FDD - If the RADIO LINK RECONFIGURATION COMMIT includes the *Active Pattern Sequence Information* IE, the DRNS shall deactivate all the ongoing Transmission Gap Pattern Sequences at the *CFN* IE. From that moment on, all Transmission Gap Pattern Sequences included in *Transmission Gap Pattern Sequence Status* IE repetitions shall be started when the indicated *TGCFN* IE elapses. The *CFN* IE and *TGCFN* IE for each sequence refer to the next coming CFN with that value. If the values of the *CFN* IE and the *TGCFN* IE are equal, the concerned Transmission Gap Pattern Sequence shall be started immediately at the CFN with a value equal to the value received in the *CFN* IE.]

8.3.5.3 Abnormal Conditions

If a new transport bearer is required for the new configuration and it is not available at the requested CFN, the DRNS shall initiate the Radio Link Failure procedure.

8.3.6 Synchronised Radio Link Reconfiguration Cancellation

8.3.6.1 General

This procedure is used to order the DRNS to release the new configuration for the Radio Link(s) within the DRNS, previously prepared by the Synchronised Radio Link Reconfiguration Preparation procedure.

This procedure shall use the signalling bearer connection for the relevant UE Context.

8.3.6.2 Successful Operation



Figure 13: Synchronised Radio Link Reconfiguration Cancellation procedure, Successful Operation

The DRNS shall release the new configuration ([FDD – including the new Transmission Gap Pattern Sequence parameters (if existing)]) previously prepared by the Synchronised RL Reconfiguration Preparation procedure and continue using the old configuration when receiving the RADIO LINK RECONFIGURATION CANCEL message from the SRNC. When this procedure has been completed the Prepared Reconfiguration does not exist any more, see subclause 3.1.

8.3.6.3 Abnormal Conditions

-

8.3.7 Unsynchronised Radio Link Reconfiguration

8.3.7.1 General

The Unsynchronised Radio Link Reconfiguration procedure is used to reconfigure Radio Link(s) related to one UE-UTRAN connection within a DRNS.

The procedure is used when there is no need to synchronise the time of the switching from the old to the new radio link configuration in the cells used by the UE-UTRAN connection within the DRNS.

This procedure shall use the signalling bearer connection for the relevant UE Context.

The Unsynchronised Radio Link Reconfiguration procedure shall not be initiated if a Prepared Reconfiguration exists, as defined in subclause 3.1.

8.3.7.2 Successful Operation

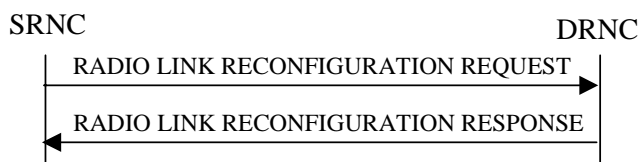

Figure 14: Unsynchronised Radio Link Reconfiguration procedure, Successful Operation

The Unsynchronised Radio Link Reconfiguration procedure is initiated by the SRNC by sending the RADIO LINK RECONFIGURATION REQUEST message to the DRNC.

Upon reception, the DRNS shall modify the configuration of the Radio Link(s) according to the parameters given in the message. Unless specified below, the meaning of parameters is specified in other specifications.

If the RADIO LINK RECONFIGURATION REQUEST message includes the *Allowed Queuing Time* IE the DRNS may queue the request the time corresponding to the value of the *Allowed Queuing Time* IE before starting to execute the request.

The DRNS shall prioritise resource allocation for the RL to be modified according to Annex A.

DCH Modification:

If the RADIO LINK RECONFIGURATION REQUEST message includes any *DCHs To Modify* IEs, then the DRNS shall treat them as follows:

- If the *DCHs To Modify* IE includes multiple *DCH Specific Info* IEs, then the DRNS shall treat the DCHs as a set of co-ordinated DCHs. The DRNS shall include these DCHs in the new configuration only if it can include all of them in the new configuration.
- If the *DCHs To Modify* IE includes the *UL FP Mode* IE for a DCH or a set of co-ordinated DCHs to be modified, the DRNS shall apply the new FP Mode in the Uplink of the user plane for the DCH or the set of co-ordinated DCHs in the new configuration.
- If the *DCHs To Modify* IE includes the *ToAWS* IE for a DCH or a set of co-ordinated DCHs to be modified, the DRNS shall apply the new ToAWS in the user plane for the DCH or the set of co-ordinated DCHs in the new configuration.
- If the *DCHs To Modify* IE includes the *ToAWE* IE for a DCH or a set of co-ordinated DCHs to be modified, the DRNS shall apply the new ToAWE in the user plane for the DCH or the set of co-ordinated DCHs in the new configuration.
- If the *DCH Specific Info* IE includes on the *Transport Format Set* IE for the UL of a DCH to be modified, the DRNS shall apply the new Transport Format Set in the Uplink of this DCH in the new configuration.
- If the *DCH Specific Info* IE includes on the *Transport Format Set* IE for the DL of a DCH to be modified, the DRNS shall apply the new Transport Format Set in the Downlink of this DCH in the new configuration.
- If the *DCH Specific Info* IE includes the *Frame Handling Priority* IE, the DRNS should store this information for this DCH in the new configuration. The received Frame Handling Priority should be used when prioritising between different frames in the downlink on the radio interface in congestion situations within the DRNS once the new configuration has been activated.
- [FDD - If the *DRAC Control* IE is present and set to "requested" in *DCH Specific Info* IE for at least one DCH, and if the DRNS supports the DRAC, the DRNC shall indicate in the RADIO LINK RECONFIGURATION RESPONSE message the *Secondary CCPCH Info* IE for the FACH where the DRAC information is sent, for each Radio Link supported by a cell where DRAC is active. If the DRNS does not support DRAC, the DRNC shall not provide these IEs in the RADIO LINK RECONFIGURATION RESPONSE message.]
- [TDD - If the *DCH Specific Info* IE includes the *CCTrCH ID* IE for the UL, the DRNS shall map the DCH onto the referenced UL CCTrCH.]
- [TDD - If the *DCH Specific Info* IE includes the *CCTrCH ID* IE for the DL, the DRNS shall map the DCH onto the referenced DL CCTrCH.]

DCH Addition:

If the RADIO LINK RECONFIGURATION REQUEST message includes any *DCHs To Add* IEs, then the DRNS shall treat them each as follows:

- The DRNS shall reserve necessary resources for the new configuration of the Radio Link(s) according to the parameters given in the message and include these DCH in the new configuration.
- If the *DCHs To Add* IE includes multiple *DCH Specific Info* IEs then the DRNS shall treat the DCHs in the *DCHs To Add* IE as a set of co-ordinated DCHs. The DRNS shall include these DCHs in the new configuration only if all of them can be in the new configuration.
- [FDD - For DCHs which do not belong to a set of co-ordinated DCHs with the *QE-Selector* IE set to "selected", the Transport channel BER from that DCH shall be the base for the QE in the UL data frames. If no Transport channel BER is available for the selected DCH the Physical channel BER shall be used for the QE, ref. [4]. If the

QE-Selector IE is set to "non-selected", the Physical channel BER shall be used for the QE in the UL data frames, ref. [4].]

- For a set of co-ordinated DCHs the Transport channel BER from the DCH with the *QE-Selector* IE set to "selected" shall be used for the QE in the UL data frames, ref. [4]. [FDD - If no Transport channel BER is available for the selected DCH the Physical channel BER shall be used for the QE, ref. [4]. If all DCHs have the *QE-Selector* IE set to "non-selected" the Physical channel BER shall be used for the QE, ref. [4].]
- The DRNS should store the *Frame Handling Priority* IE received for a DCH to be added in the new configuration. The received Frame Handling Priority should be used when prioritising between different frames in the downlink on the radio interface in congestion situations within the DRNS once the new configuration has been activated.
- The DRNS shall use the included *UL FP Mode* IE for a DCH or a set of co-ordinated DCHs to be added as the new FP Mode in the Uplink of the user plane for the DCH or the set of co-ordinated DCHs in the new configuration.
- The DRNS shall use the included *ToAWS* IE for a DCH or a set of co-ordinated DCHs to be added as the new Time of Arrival Window Start Point in the user plane for the DCH or the set of co-ordinated DCHs in the new configuration.
- The DRNS shall use the included *ToAWE* IE for a DCH or a set of co-ordinated DCHs to be added as the new Time of Arrival Window End Point in the user plane for the DCH or the set of co-ordinated DCHs in the new configuration.
- [FDD - If the *DRAC Control* IE is set to "requested" in *DCH Specific Info* IE for at least one DCH, and if the DRNS supports the DRAC, the DRNC shall indicate in the RADIO LINK RECONFIGURATION RESPONSE message the *Secondary CCPCH Info* IE for the FACH where the DRAC information is sent, for each Radio Link supported by a cell where DRAC is active. If the DRNS does not support DRAC, the DRNC shall not provide these IEs in the RADIO LINK RECONFIGURATION RESPONSE message.

DCH Deletion:

If the RADIO LINK RECONFIGURATION REQUEST message includes any *DCH to delete* IE, the DRNS shall not include the referenced DCHs in the new configuration.

If all of the DCHs belonging to a set of co-ordinated DCHs are requested to be deleted, the DRNS shall not include this set of coordinated DCHs in the new configuration.

Physical Channel Modification:

[FDD - If the RADIO LINK RECONFIGURATION REQUEST message includes an *UL DPCH Information* IE, then the DRNS shall apply the parameters to the new configuration as follows:]

- [FDD - If the *UL DPCH Information* IE includes the *TFCS* IE for the UL, the DRNS shall apply the new TFCS in the Uplink of the new configuration.]

[FDD - If the RADIO LINK RECONFIGURATION REQUEST message includes a *DL DPCH Information* IE, then the DRNS shall apply the parameters to the new configuration as follows:]

- [FDD - If the *DL DPCH Information* IE includes the *TFCS* IE for the DL, the DRNS shall apply the new TFCS in the Downlink of the new configuration.]
- [FDD - If the *DL DPCH Information* IE includes the *TFCI Signalling Mode* IE for the DL, the DRNS shall apply the new TFCI Signalling Mode in the Downlink of the new configuration.]
- [FDD – If the *DL DPCH Information* IE includes the *Limited Power Increase* IE set to "Used", the DRNS shall, if supported, use Limited Power Increase according to ref. [10] subclause 5.2.1 for the inner loop DL power control in the new configuration.]
- [FDD – If the *DL DPCH Information* IE includes the *Limited Power Increase* IE set to "Not Used", the DRNS shall not use Limited Power Increase for the inner loop DL power control in the new configuration.]

[FDD - If the RADIO LINK RECONFIGURATION REQUEST message includes the *Transmission Gap Pattern Sequence Information* IE, the DRNS shall store the new information about the Transmission Gap Pattern Sequences to

be used in the new Compressed Mode configuration This new Compressed Mode Configuration shall be valid in the DRNS until the next Compressed Mode Configuration is configured in the DRNS or last Radio Link is deleted.]

[FDD - If the RADIO LINK RECONFIGURATION REQUEST message includes the *Transmission Gap Pattern Sequence Information* IE, and if the *Downlink Compressed Mode Method* in one or more *Transmission Gap Pattern Sequence* within the *Transmission Gap Pattern Sequence Information* IE is set to 'SF/2', the DRNC shall include the *DL Code Information* IE in the RADIO LINK RECONFIGURATION RESPONSE message, without changing any of the DL Channelisation Codes or DL Scrambling Codes, indicating for each DL Channelisation Code whether the alternative scrambling code shall be used or not.]

[TDD - UL/DL CCTrCH Modification]

[TDD - If the RADIO LINK RECONFIGURATION REQUEST message includes any *UL CCTrCH Information to modify* IEs or *DL CCTrCH Information to modify* IEs and it includes *TFCS* IE, the DRNS shall apply the included *TFCS* IE as the new value to the referenced CCTrCH.]

[TDD – UL/DL CCTrCH Deletion]

[TDD - If the RADIO LINK RECONFIGURATION REQUEST message includes any *UL CCTrCH Information to delete* IEs or *DL CCTrCH Information to delete* IEs, the DRNS shall remove the referenced CCTrCH in the new configuration.]

General:

If the requested modifications are allowed by the DRNS, and if the DRNS has successfully allocated the required resources and changed to the new configuration, the DRNC shall respond to the SRNC with the RADIO LINK RECONFIGURATION RESPONSE message.

The DRNS shall include in the RADIO LINK RECONFIGURATION RESPONSE message the *Transport Layer Address* IE and the *Binding ID* IE in the *DCH Information Response* IE for any Transport Channel being added, or any Transport Channel being modified for which a new transport bearer was requested with the *Transport Bearer Request Indicator* IE. The detailed frame protocol handling during transport bearer replacement is described in [4], subclause 5.10.1.

In the case of a set of co-ordinated DCHs requiring a new transport bearer on the Iur interface, the *Transport Layer Address* IE and the *Binding ID* IE in the *DCH Information Response* IE shall be included only for one of the DCHs in the set of co-ordinated DCHs.

In the case of a Radio Link being combined with another Radio Link within the DRNS, the DRNC shall return the *Transport Layer Address* IE and the *Binding ID* IE in the *DCH Information Response* IE in the RADIO LINK RECONFIGURATION RESPONSE message only for one of the combined Radio Links.

The DRNS decides the maximum and minimum SIR for the uplink of the Radio Link(s), and the DRNC shall return this in the IEs *Maximum Uplink SIR* and *Minimum Uplink SIR* for each Radio Link in the RADIO LINK RECONFIGURATION RESPONSE message.

If the DL TX power upper or lower limit has been re-configured, the DRNC shall return this in the *Maximum DL TX Power* IE and *Minimum DL TX Power* IE respectively in the RADIO LINK RECONFIGURATION RESPONSE message. The DRNS shall not transmit with a higher power than indicated by the *Maximum DL TX Power* IE or lower than indicated by the *Minimum DL TX Power* IE on any DL DPCH of the RL [FDD – except during compressed mode, when the δP_{curr} , as described in ref.[10] subclause 5.2.1.3, shall be added to the maximum DL power for the associated compressed frame].

8.3.7.3 Unsuccessful Operation

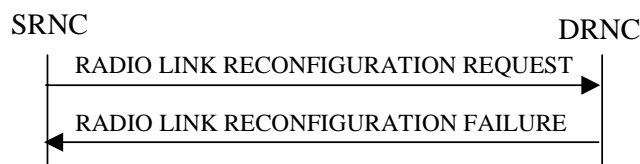

Figure 15: Unsynchronised Radio Link Reconfiguration procedure, Unsuccessful Operation

If the DRNS cannot allocate the necessary resources for all the new DCHs of a set of coordinated DCHs requested to be added, it shall regard the Unsynchronised Radio Link Reconfiguration procedure as having failed.

If the requested Unsynchronised Radio Link Reconfiguration procedure fails for one or more Radio Link(s), the DRNC shall send the RADIO LINK RECONFIGURATION FAILURE message to the SRNC, indicating the reason for failure.

Typical cause values are:

Radio Network Layer Causes:

- UL Scrambling Code Already in Use;
- DL Radio Resources not Available;
- UL Radio Resources not Available;
- Requested Configuration not Supported;
- CM not Supported.

Miscellaneous Causes:

- Control Processing Overload;
- Not enough User Plane Processing Resources.

8.3.7.4 Abnormal Conditions

If only a subset of all the DCHs belonging to a set of co-ordinated DCHs is requested to be deleted, the DRNS shall regard the Unsynchronised Radio Link Reconfiguration procedure as having failed, and the DRNC shall send the RADIO LINK RECONFIGURATION FAILURE message to the SRNC.

If more than one DCH of a set of co-ordinated DCHs has the *QE-Selector* IE set to "selected" [TDD – or no DCH of a set of co-ordinated DCHs has the *QE-Selector* IE set to "selected"], the DRNS shall regard the Unsynchronised Radio Link Reconfiguration procedure as failed, and the DRNC shall respond with a RADIO LINK RECONFIGURATION FAILURE message.

If the RADIO LINK RECONFIGURATION REQUEST message includes a *DCHs To Modify* IE or *DCHs To Add* IE with multiple *DCH Specific Info* IEs, and if the DCHs in the *DCHs To Modify* IE or *DCHs To Add* IE do not have the same *Transmission Time Interval* IE in the *Semi-static Transport Format Information* IE, then the DRNC shall reject the procedure using the RADIO LINK RECONFIGURATION FAILURE message.

8.3.8 Physical Channel Reconfiguration

8.3.8.1 General

The Physical Channel Reconfiguration procedure is used by the DRNC to request to SRNC for the reconfiguration of one of its physical channels.

This procedure shall use the signalling bearer connection for the relevant UE Context.

The Physical Channel Reconfiguration procedure shall not be initiated if a Prepared Reconfiguration exists as defined in subclause 3.1, or if a Synchronised Radio Link Reconfiguration Preparation procedure, Unsynchronised Radio Link Reconfiguration procedure or Radio Link Deletion procedure is ongoing.

8.3.8.2 Successful Operation

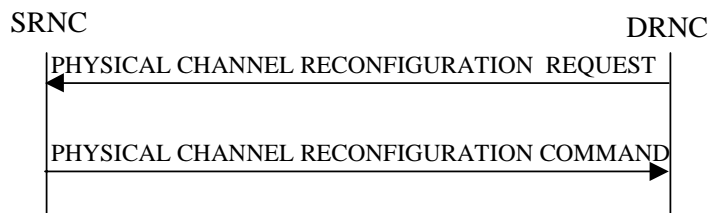

Figure 16: Physical Channel Reconfiguration procedure, Successful Operation

When the DRNC detects the need to modify one of its physical channels, it shall send a PHYSICAL CHANNEL RECONFIGURATION REQUEST to the SRNC.

The message contains the new value of the physical channel parameter(s) that shall be reconfigured and in which radio link.

[FDD- If compressed mode is prepared or active and at least one of the downlink compressed mode methods is "SF/2", the DRNC shall include the *Transmission Gap Pattern Sequence Scrambling Code Information IE* in the *DL Code Information IE* in the PHYSICAL CHANNEL RECONFIGURATION REQUEST message indicating for each DL Channelisation Code whether the alternative scrambling code will be used or not if the downlink compressed mode methods "SF/2" is activated.]

[TDD – The SRNC shall apply the new values for any of *TDD Channelisation Code IE*, *Midamble Shift And Burst Type IE*, *Time Slot IE*, *TDD Physical Channel Offset IE*, *Repetition Period IE*, *Repetition Length IE*, or *TFCI presence IE* included in the *UL DPCH Information IE* given in the PHYSICAL CHANNEL RECONFIGURATION REQUEST message, otherwise the old values specified for this DPCH shall still apply.]

[TDD – The SRNC shall apply the new values for any of *TDD Channelisation Code IE*, *Midamble Shift And Burst Type IE*, *Time Slot IE*, *TDD Physical Channel Offset IE*, *Repetition Period IE*, *Repetition Length IE*, or *TFCI presence IE* included in the *DL DPCH Information IE* given in the PHYSICAL CHANNEL RECONFIGURATION REQUEST message, otherwise the old values specified for this DPCH shall still apply.]

Upon reception of the PHYSICAL CHANNEL RECONFIGURATION REQUEST, the SRNC shall decide an appropriate execution time for the change. The SRNC shall respond with a PHYSICAL CHANNEL RECONFIGURATION COMMAND message to the DRNC that includes the *CFN IE* indicating the execution time.

At the CFN, the DRNS shall switch to the new configuration that has been requested, and release the resources related to the old physical channel configuration.

8.3.8.3 Unsuccessful Operation

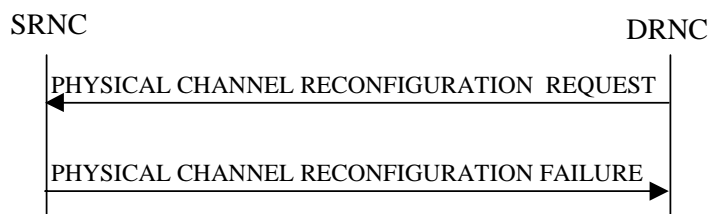

Figure 17: Physical Channel Reconfiguration procedure, Unsuccessful Operation

If the SRNC cannot accept the reconfiguration request it shall send the PHYSICAL CHANNEL RECONFIGURATION FAILURE message to the DRNC, including the cause for the failure.

Typical cause values are:

Radio Network Layer Causes:

- Reconfiguration not Allowed.

8.3.8.4 Abnormal Conditions

If the DRNC receives any of the RADIO LINK RECONFIGURATION PREPARE, RADIO LINK RECONFIGURATION REQUEST, or RADIO LINK DELETION REQUEST messages while waiting for the PHYSICAL CHANNEL RECONFIGURATION COMMAND message, this shall be regarded as a Physical Channel Reconfiguration failure. These messages thus override the DRNC request for physical channel reconfiguration.

When the SRNC receives a PHYSICAL CHANNEL RECONFIGURATION REQUEST message while a Synchronised Radio Link Reconfiguration procedure, Unsynchronised Radio Link Reconfiguration procedure or Radio Link Deletion procedure is ongoing, it shall assume that reception of any of the messages RADIO LINK RECONFIGURATION PREPARE, RADIO LINK RECONFIGURATION REQUEST or RADIO LINK DELETION REQUEST by the DRNC has terminated the Physical Channel Reconfiguration procedure. No separate response message for the Physical Channel Reconfiguration procedure shall be returned by the SRNC in this situation.

8.3.9 Radio Link Failure**8.3.9.1 General**

This procedure is started by the DRNS when one or more Radio Links [FDD - or Radio Link Sets][TDD - or CCTrCHs within a Radio Link] are no longer available.

This procedure shall use the signalling bearer connection for the relevant UE Context.

The DRNC may initiate the Radio Link Failure procedure at any time after establishing a Radio Link.

8.3.9.2 Successful Operation

Figure 18: Radio Link Failure procedure, Successful Operation

When the DRNC detects that a one or more Radio Links [FDD - or Radio Link Sets] [TDD – or CCTrCHs within a Radio Link] are no longer available, it shall send the RL FAILURE INDICATION message to the SRNC. The message indicates the failed Radio Links or Radio Link Sets or CCTrCHs with the most appropriate cause value defined in the *Cause IE*. If the failure concerns one or more individual Radio Links the DRNS shall indicate the affected Radio Link(s) using the *RL Information IE*. [FDD - If the failure concerns one or more Radio Link Sets the DRNS shall indicate the affected Radio Link Set(s) using the *RL Set Information IE*.] [TDD – If the failure concerns only the failure of one or more CCTrCHs within a radio link the DRNS shall indicate the affected CCTrCHs using the *CCTrCH ID IE*].

When the RL Failure procedure is used to notify loss of UL synchronisation of a [FDD – Radio Link Set] [TDD – Radio Link or CCTrCHs within a Radio Link] on the Uu interface, the message shall be sent when indicated by the UL synchronisation detection algorithm defined in ref. [10] subclause 4.3 and [22] subclause 4.4.2, and with the cause value 'Synchronisation Failure'.

[FDD – When the Radio Link Failure procedure is used to indicate permanent failure in one or more Radio Links/Radio Link Sets due to the occurrence of an UL or DL frame with more than one transmission gap caused by one or more compressed mode pattern sequences, the DL transmission shall be stopped and the RADIO LINK FAILURE INDICATION message shall be sent with the *Cause Value IE* set to "Invalid CM Settings". After sending the RADIO

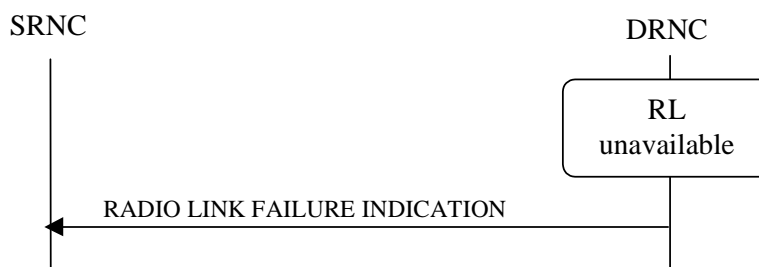
LINK FAILURE INDICATION message to notify the permanent failure, the DRNS shall not remove the Radio Link(s)/Radio Link Set(s) from the UE Context, or the UE Context itself.]

In the other cases the Radio Link Failure procedure is used to indicate that one or more Radio Links or Radio Link Sets are permanently unavailable and cannot be restored. After sending the RADIO LINK FAILURE INDICATION message to notify the permanent failure, the DRNS shall not remove the Radio Link from the UE Context or the UE Context itself. When applicable, the allocation retention priorities associated to the transport channels shall be used by the DRNS to prioritise which Radio Links to indicate as unavailable to the SRNC.

Typical cause values are:

Radio Network Layer Causes:

- Synchronisation Failure;
- Invalid CM Settings.

Transport Layer Causes:

- Transport Resources Unavailable.

Miscellaneous Causes:

- Control Processing Overload;
- HW Failure;
- O&M Intervention.

8.3.9.3 Abnormal Conditions

-

8.3.10 Radio Link Restoration

8.3.10.1 General

This procedure is used to notify establishment and re-establishment of UL synchronisation on the Uu interface.

This procedure shall use the signalling bearer connection for the relevant UE Context.

The DRNC may initiate the Radio Link Restoration procedure at any time after establishing a Radio Link.

8.3.10.2 Successful Operation



Figure 19: Radio Link Restoration procedure, Successful Operation

The DRNC shall send the RADIO LINK RESTORE INDICATION message to the SRNC when indicated by the UL Uu synchronisation detection algorithm defined in ref. [10] subclause 4.3 and [22] subclause 4.4.2. [FDD – The algorithm in ref. [10] shall use the minimum value of the parameters *N_INSYNC_IND* that are configured in the cells supporting the radio links of the RL Set].

[TDD - If the re-established UL Uu synchronisation concerns one or more individual Radio Links the DRNC shall indicate the affected Radio Link(s) using the *RL Information IE*.] [TDD – If the re-established synchronisation concerns one or more individual CCTrCHs within a radio link the DRNS shall indicate the affected CCTrCHs using the *CCTrCH*

ID IE.] [FDD - If the re-established UL Uu synchronisation concerns one or more Radio Link Sets the DRNC shall indicate the affected Radio Link Set(s) using the *RL Set Information IE.*]

8.3.10.3 Abnormal Conditions

-

8.3.11 Dedicated Measurement Initiation

8.3.11.1 General

This procedure is used by an SRNS to request the initiation of dedicated measurements in a DRNS.

This procedure shall use the signalling bearer connection for the relevant UE Context.

The Dedicated Measurement Initiation procedure shall not be initiated if a Prepared Reconfiguration exists, as defined in subclause 3.1.

8.3.11.2 Successful Operation

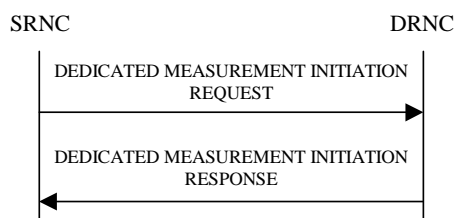

Figure 20: Dedicated Measurement Initiation procedure, Successful Operation

The procedure is initiated with a DEDICATED MEASUREMENT INITIATION REQUEST message sent from the SRNC to the DRNC.

Upon reception, the DRNC shall initiate the requested dedicated measurement according to the parameters given in the request.

If the Dedicated Measurement Object Type is indicated as being "RL" in the DEDICATED MEASUREMENT INITIATION REQUEST message, measurement results shall be reported for all the indicated Radio Links.

[FDD - If the Dedicated Measurement Object Type is indicated as being "RLS" in the DEDICATED MEASUREMENT INITIATION REQUEST message, measurement results shall be reported for all the indicated Radio Link Sets.]

[FDD - If the Dedicated Measurement Object Type is indicated as being "ALL RL" in the DEDICATED MEASUREMENT INITIATION REQUEST message, measurement results shall be reported for all current and future Radio Links within the UE Context.]

[TDD - If the Dedicated Measurement Object Type is indicated as being "ALL RL" in the DEDICATED MEASUREMENT INITIATION REQUEST message, measurement results shall be reported for one existing DPCH per CCTrCH in each used time slot of current and future Radio Links within the UE Context, provided the measurement type is applicable for the respective DPCH.]

[FDD - If the Dedicated Measurement Object Type is indicated as being "ALL RLS" in the DEDICATED MEASUREMENT INITIATION REQUEST message, measurement results shall be reported for all the existing and future Radio Link Sets within the UE Context.]

[TDD - If the *DPCH ID IE* is provided within the RL Information, the measurement request shall apply for the requested physical channel individually. If no *DPCH ID IE* is provided within the RL Information the measurement request shall apply for one existing DPCH per CCTrCH in each used time slot of the Radio Link, provided the measurement type is applicable for this DPCH.]

If the *CFN Reporting Indicator* IE is set to "FN Reporting Required", the *CFN* IE shall be included in the DEDICATED MEASUREMENT REPORT message or in the DEDICATED MEASUREMENT RESPONSE message, the latter only in the case the *Report Characteristics* IE is set to "On Demand". The reported CFN shall be the CFN at the time when the dedicated measurement value was reported by the layer 3 filter, referred to as point C in the measurement model [26].

Report characteristics

The *Report Characteristics* IE indicates how the reporting of the dedicated measurement shall be performed. See also Annex B.

If the *Report Characteristics* IE is set to "On Demand" and if the *CFN* IE is not provided, the DRNS shall report the measurement result immediately. If the *CFN* IE is provided, it indicates the frame for which the measurement value shall be provided. The provided measurement value shall be the one reported by the layer 3 filter, referred to as point C in the measurement model [26].

If the *Report Characteristics* IE is set to "Periodic", the DRNS shall periodically initiate the Dedicated Measurement Report procedure for this measurement, with the requested report periodicity. If the *CFN* IE is provided, it indicates the frame for which the first measurement value of a periodic reporting shall be provided. The provided measurement value shall be the one reported by the layer 3 filter, referred to as point C in the measurement model [26].

If the *Report Characteristics* IE is set to "Event A", the DRNS shall initiate the Dedicated Measurement Reporting procedure when the measured entity rises above the requested threshold and stays there for the requested hysteresis time. If the *Measurement Hysteresis Time* IE is not included, the DRNC shall use the value zero for the hysteresis time.

If the *Report Characteristics* IE is set to "Event B", the DRNS shall initiate the Dedicated Measurement Reporting procedure when the measured entity falls below the requested threshold and stays there for the requested hysteresis time. If the *Measurement Hysteresis Time* IE is not included, the DRNC shall use the value zero for the hysteresis time.

If the *Report Characteristics* IE is set to "Event C", the DRNS shall initiate the Dedicated Measurement Reporting procedure when the measured entity rises by an amount greater than the requested threshold within the requested time. After having reported this type of event, the next C event reporting for the same measurement cannot be initiated before the rising time specified by the *Measurement Change Time* IE has elapsed since the previous event reporting.

If the *Report Characteristics* IE is set to "Event D", the DRNS shall initiate the Dedicated Measurement Reporting procedure when the measured entity falls by an amount greater than the requested threshold within the requested time. After having reported this type of event, the next D event reporting for the same measurement cannot be initiated before the falling time specified by the *Measurement Change Time* IE has elapsed since the previous event reporting.

If the *Report Characteristics* IE is set to "Event E", the DRNS shall initiate the Dedicated Measurement Reporting procedure when the measured entity rises above the 'Measurement Threshold 1' and stays there for the 'Measurement Hysteresis Time' (Report A). When the conditions for Report A are met and the *Report Periodicity* IE is provided the DRNS shall also initiate the Dedicated Measurement Reporting procedure periodically. If the conditions for Report A have been met and the measured entity falls below the 'Measurement Threshold 2' and stays there for the 'Measurement Hysteresis Time', the DRNS shall initiate the Dedicated Measurement Reporting procedure (Report B) as well as terminating any corresponding periodic reporting. If the *Measurement Threshold 2* IE is not present, the DRNS shall use the value of the *Measurement Threshold 1* IE instead. If the *Measurement Hysteresis Time* IE is not included, the DRNC shall use the value zero as hysteresis times for both Report A and Report B.

If the *Report Characteristics* IE is set to "Event F", the DRNS shall initiate the Dedicated Measurement Reporting procedure when the measured entity falls below the 'Measurement Threshold 1' and stays there for the 'Measurement Hysteresis Time' (Report A). When the conditions for Report A are met and the *Report Periodicity* IE is provided the DRNS shall also initiate the Dedicated Measurement Reporting procedure periodically. If the conditions for Report A have been met and the measured entity rises above the 'Measurement Threshold 2' and stays there for the 'Measurement Hysteresis Time', the DRNS shall initiate the Dedicated Measurement Reporting procedure (Report B) as well as terminating any corresponding periodic reporting. . If the *Measurement Threshold 2* IE is not present, the DRNS shall use the value of the *Measurement Threshold 1* IE instead. If the *Measurement Hysteresis Time* IE is not included, the DRNC shall use the value zero as hysteresis times for both Report A and Report B.

If the *Report Characteristics* IE is not set to "On Demand", the DRNS is required to perform reporting for a dedicated measurement object, in accordance with the conditions provided in the DEDICATED MEASUREMENT INITIATION REQUEST message, as long as the object exists. If no dedicated measurement object(s) for which a measurement is defined exists any more the DRNS shall terminate the measurement locally without reporting this to the SRNC.

If at the start of the measurement, the reporting criteria are fulfilled for any of Event A, Event B, Event E or Event F, the DRNS shall initiate the Dedicated Measurement Reporting procedure immediately, and then continue with the measurements as specified in the DEDICATED MEASUREMENT INITIATION REQUEST message.

Higher layer filtering

The *Measurement Filter Coefficient* IE indicates how filtering of the dedicated measurement values shall be performed before measurement event evaluation and reporting.

The averaging shall be performed according to the following formula.

$$F_n = (1 - a) \cdot F_{n-1} + a \cdot M_n$$

The variables in the formula are defined as follows:

F_n is the updated filtered measurement result

F_{n-1} is the old filtered measurement result

M_n is the latest received measurement result from physical layer measurements, the unit used for M_n is the same unit as the reported unit in the DEDICATED MEASUREMENT INITIATION RESPONSE, DEDICATED MEASUREMENT REPORT messages or the unit used in the event evaluation (i.e. same unit as for F_n).

$a = 1/2^{(k/2)}$, where k is the parameter received in the *Measurement Filter Coefficient* IE. If the *Measurement Filter Coefficient* IE is not present, a shall be set to 1 (no filtering)

In order to initialise the averaging filter, F_0 is set to M_1 when the first measurement result from the physical layer measurement is received.

Response message

If the DRNS was able to initiate the measurement requested by the SRNS it shall respond with the DEDICATED MEASUREMENT INITIATION RESPONSE message. The message shall include the same Measurement Id that was used in the DEDICATED MEASUREMENT INITIATION REQUEST message.

Only in the case where the *Report Characteristics* IE is set to "On-Demand", the DEDICATED MEASUREMENT INITIATION RESPONSE message shall contain the measurement result. In this case also the *Dedicated Measurement Object* IE shall be included if it was included in the DEDICATED MEASUREMENT INITIATION REQUEST message.

8.3.11.3 Unsuccessful Operation

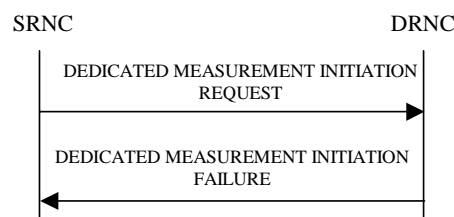

Figure 21: Dedicated Measurement Initiation procedure, Unsuccessful Operation

If the requested measurement cannot be initiated, the DRNC shall send a DEDICATED MEASUREMENT INITIATION FAILURE message. The message shall include the same Measurement Id that was used in the DEDICATED MEASUREMENT INITIATION REQUEST message and the *Cause* IE set to an appropriate value.

Typical cause values are:

Radio Network Layer Causes:

- Measurement not Supported For The Object;
- Measurement Temporarily not Available.

Miscellaneous Causes:

- Control Processing Overload;
- HW Failure.

8.3.11.4 Abnormal Conditions

If the Dedicated Measurement Type received in the *Dedicated Measurement Type* IE is not defined in ref. [11] or [14] to be measured on the Dedicated Measurement Object Type received in the DEDICATED MEASUREMENT INITIATION REQUEST message the DRNS shall regard the Dedicated Measurement Initiation procedure as failed.

If the *CFN* IE is included in the DEDICATED MEASUREMENT INITIATION REQUEST message and the *Report Characteristics* IE is other than "Periodic" or "On Demand", the DRNS shall regard the Dedicated Measurement Initiation procedure as failed.

8.3.12 Dedicated Measurement Reporting**8.3.12.1 General**

This procedure is used by the DRNS to report results of measurements requested by the SRNS with the Dedicated Measurement Initiation procedure.

This procedure shall use the signalling bearer connection for the relevant UE Context.

The DRNC may initiate the Dedicated Measurement Reporting procedure at any time after establishing a Radio Link.

8.3.12.2 Successful Operation

Figure 22: Dedicated Measurement Reporting procedure, Successful Operation

If the requested measurement reporting criteria are met, the DRNS shall initiate the Dedicated Measurement Reporting procedure. If the measurement was initiated (by the Dedicated Measurement Initiation procedure) for multiple dedicated measurement objects, the DRNC may include dedicated measurement values in the *Dedicated Measurement Value Information* IE for multiple objects in the DEDICATED MEASUREMENT REPORT message.

The *Measurement Id* IE shall be set to the Measurement Id provided by the SRNC when initiating the measurement with the Dedicated Measurement Initiation procedure.

If the achieved measurement accuracy does not fulfil the given accuracy requirement specified in ref. [23] and [24], the Measurement not available shall be reported in the *Dedicated Measurement Value Information* IE.

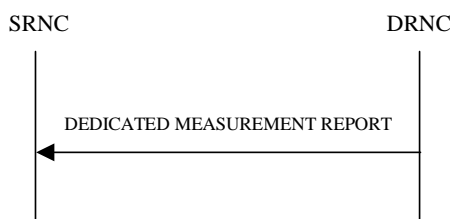
8.3.12.3 Abnormal Conditions

-

8.3.13 Dedicated Measurement Termination

8.3.13.1 General

This procedure is used by the SRNS to terminate a measurement previously requested by the Dedicated Measurement Initiation procedure.

This procedure shall use the signalling bearer connection for the relevant UE Context.

The Dedicated Measurement Termination procedure shall not be initiated if a Prepared Reconfiguration exists, as defined in subclause 3.1.

8.3.13.2 Successful Operation

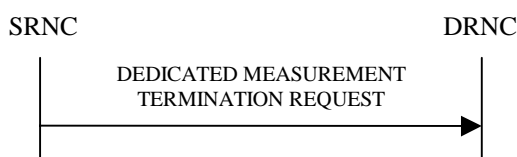

Figure 23: Dedicated Measurement Termination procedure, Successful Operation

This procedure is initiated with a DEDICATED MEASUREMENT TERMINATION REQUEST message, sent from the SRNC to the DRNC.

Upon reception, the DRNS shall terminate reporting of dedicated measurements corresponding to the received *Measurement ID IE*.

8.3.13.3 Abnormal Conditions

-

8.3.14 Dedicated Measurement Failure

8.3.14.1 General

This procedure is used by the DRNS to notify the SRNS that a measurement previously requested by the Dedicated Measurement Initiation procedure can no longer be reported.

This procedure shall use the signalling bearer connection for the relevant UE Context.

The DRNC may initiate the Dedicated Measurement Failure procedure at any time after establishing a Radio Link.

8.3.14.2 Successful Operation



Figure 24: Dedicated Measurement Failure procedure, Successful Operation

This procedure is initiated with a DEDICATED MEASUREMENT FAILURE INDICATION message, sent from the DRNC to the SRNC, to inform the SRNC that a previously requested dedicated measurement can no longer be reported. The DRNC has locally terminated the indicated measurement.

Typical cause values are:

Miscellaneous Causes:

- Control Processing Overload
- HW Failure
- O&M Intervention

8.3.14.3 Abnormal Conditions

-

8.3.15 Downlink Power Control [FDD]

8.3.15.1 General

The purpose of this procedure is to balance the DL transmission powers of the radio links for one UE.

This procedure shall use the signalling bearer connection for the relevant UE Context.

The Downlink Power Control procedure may be initiated by the SRNC at any time after establishing a Radio Link. If the SRNC has initiated deletion of the last Radio Link in this DRNS the Downlink Power Control procedure shall not be initiated.

8.3.15.2 Successful Operation



Figure 25: Downlink Power Control procedure, Successful Operation

The Downlink Power Control procedure is initiated by the SRNC sending a DL POWER CONTROL REQUEST message to the DRNC.

The *Power Adjustment Type* IE defines the characteristic of the power adjustment.

If the value of the *Power Adjustment Type* IE is "Common", the Power Balancing Adjustment Type of the UE Context shall be set to "Common". As long as the Power Balancing Adjustment Type of the UE Context is set to "Common", the DRNS shall perform the power adjustment (see below) for all existing and future radio links for the UE Context and use a common DL reference power level.

If the value of the *Power Adjustment Type* IE is "Individual", the Power Balancing Adjustment Type of the UE Context shall be set to "Individual". The DRNS shall perform the power adjustment (see below) for all radio links addressed in the message using the given DL Reference Power per RL. If the Power Balancing Adjustment Type of the UE Context was set to "Common" before this message was received, power balancing on all radio links not addressed by the DL POWER CONTROL REQUEST message shall remain to be executed in accordance with the existing power balancing parameters which are now considered RL individual parameters. Power balancing will not be started on future radio links without a specific request.

If the value of the *Power Adjustment Type* IE is "None", the Power Balancing Adjustment Type of the UE Context shall be set to "None" and the DRNS shall suspend on going power adjustments for all radio links for the UE Context.

If the *Inner Loop DL PC Status* IE is present and set to "Active", the DRNS shall activate inner loop DL power control for all radio links for the UE Context. If the *Inner Loop DL PC Status* IE is present and set to "Inactive", the DRNS shall deactivate inner loop DL power control for all radio links for the UE Context according to ref. [10].

Power Adjustment

The power balancing adjustment shall be superimposed on the inner loop power control adjustment (see ref. [10]) if activated. The power balancing adjustment shall be such that:

$$\sum P_{bal} = (1 - r)(P_{ref} + P_{P-CPICH} - P_{init}) \text{ with an accuracy of } \pm 0.5 \text{ dB}$$

where the sum is performed over an adjustment period corresponding to a number of frames equal to the value of the *Adjustment Period* IE, P_{ref} is the value of the *DL Reference Power* IE, $P_{P-CPICH}$ is the power used on the primary CPICH, P_{init} is the code power of the last slot of the previous adjustment period and r is given by the *Adjustment Ratio* IE. If the last slot of the previous adjustment period is within a transmission gap due to compressed mode, P_{init} shall be set to the same value as the code power of the slot just before the transmission gap.

The adjustment within one adjustment period shall in any case be performed with the constraints given by the *Max Adjustment Step* IE and the DL TX power range set by the DRNC.

The power adjustments shall be started at the first slot of a frame with CFN modulo the value of *Adjustment Period* IE equal to 0 and shall be repeated for every adjustment period and shall be restarted at the first slot of a frame with CFN=0, until a new DL POWER CONTROL REQUEST message is received or the RL is deleted.

8.3.15.3 Abnormal Conditions

-

8.3.16 Compressed Mode Command [FDD]

8.3.16.1 General

The Compressed Mode Command procedure is used to activate or deactivate the compressed mode in the DRNS for one UE-UTRAN connection. This procedure shall use the signalling bearer connection for the relevant UE Context.

The Compressed Mode Command procedure shall not be initiated if a Prepared Reconfiguration exists, as defined in subclause 3.1.

8.3.16.2 Successful Operation



Figure 26: Compressed Mode Command procedure, Successful Operation

The DRNS shall deactivate all the ongoing Transmission Gap Pattern Sequences at the *CM Configuration Change CFN* IE requested by the SRNC when receiving the COMPRESSED MODE COMMAND message from the SRNC. From that moment on all Transmission Gap Pattern Sequences included in *Transmission Gap Pattern Sequence Status* IE repetitions (if present) shall be started when the indicated *TGCFN* IE elapses. The *CM Configuration Change CFN* IE in the *Active Pattern Sequence Information* IE and *TGCFN* IE for each sequence refer to the next coming CFN with that value.

If the values of the *CM Configuration Change CFN* IE and the *TGCFN* IE are equal, the concerned Transmission Gap Pattern Sequence shall be started immediately at the CFN with a value equal to the value received in the *CM Configuration Change CFN* IE.

8.3.16.3 Abnormal Conditions

-

8.3.17 Downlink Power Timeslot Control [TDD]

8.3.17.1 General

The purpose of this procedure is to enable the DRNS to use the indicated DL Timeslot ISCP values when deciding the DL TX Power for each timeslot.

This procedure shall use the signalling bearer connection for the relevant UE Context.

The Downlink Power Timeslot Control procedure can be initiated by the SRNC at any time after establishing a Radio Link. If the SRNC has initiated deletion of the last Radio Link in this DRNS, the Downlink Power Timeslot Control procedure shall not be initiated.

8.3.17.2 Successful Operation



Figure 26A: Downlink Power Timeslot Control procedure, Successful Operation

The Downlink Power Timeslot Control procedure is initiated by the SRNC sending a DL POWER TIMESLOT CONTROL REQUEST message to the DRNC.

Upon reception, the DRNS shall use the indicated DL Timeslot ISCP value when deciding the DL TX Power for each timeslot as specified in [22], i.e. it shall reduce the DL TX power in those downlink timeslots of the radio link where the interference is low, and increase the DL TX power in those timeslots where the interference is high, while keeping the total downlink power in the radio link unchanged.

8.3.17.3 Abnormal Conditions

-

8.3.18 Radio Link Pre-emption

8.3.18.1 General

This procedure is started by the DRNS when resources need to be freed.

This procedure shall use the signalling bearer connection for the UE Context that owns the RL to be pre-empted.

The DRNS may initiate the Radio Link Pre-emption procedure at any time after establishing a Radio Link.

8.3.18.2 Successful Operation

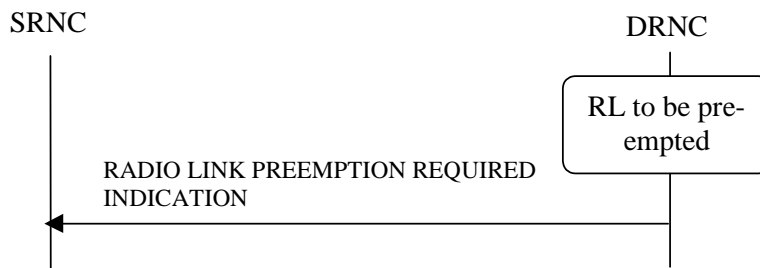

Figure 26B: Radio Link Pre-emption procedure, Successful Operation

When the DRNC detects that a one or more Radio Links should be pre-empted (see Annex A), it shall send the RADIO LINK PREEMPTION REQUIRED INDICATION message to the SRNC. If all Radio Links for an UE Context should be pre-empted, the *RL Information* IE shall be omitted. If one or several but not all Radio Links should be pre-empted for an UE Context, the Radio Links that should be pre-empted shall be indicated in the *RL Information* IE. The Radio Link(s) that should be pre-empted, should be deleted by the SRNC.

8.3.18.3 Abnormal Conditions

-

8.4 Common Transport Channel Procedures

8.4.1 Common Transport Channel Resources Initialisation

8.4.1.1 General

The Common Transport Channel Resources Initialisation procedure is used by the SRNC for the initialisation of the Common Transport Channel user plane towards the DRNC and/or for the initialisation of the Common Transport Channel resources in the DRNC to be used by a UE.

This procedure shall use the connectionless mode of the signalling bearer.

8.4.1.2 Successful Operation

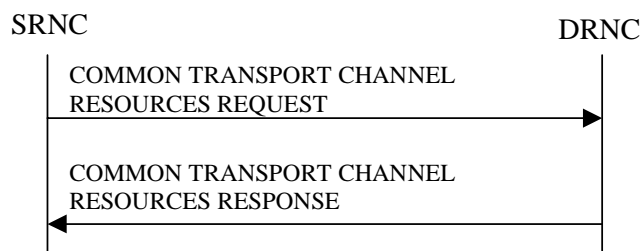

Figure 27: Common Transport Channel Resources Initialisation procedure, Successful Operation

The SRNC initiates the procedure by sending the message COMMON TRANSPORT CHANNEL RESOURCES REQUEST to the DRNC.

If the value of the *Transport Bearer Request Indicator* IE is set to "Bearer Requested", the DRNC shall store the received *Transport Bearer ID* IE and include the *Binding ID* IE and *Transport Layer Address* IE in the COMMON TRANSPORT CHANNEL RESOURCES RESPONSE message.

If the value of the *Transport Bearer Request Indicator* IE is set to "Bearer not Requested", the DRNC shall use the transport bearer indicated by the *Transport Bearer ID* IE.

If the *C-ID* IE is included in the COMMON TRANSPORT CHANNEL RESOURCES REQUEST message, the DRNC shall allocate a C-RNTI for the indicated cell and include the *C-RNTI* IE in the COMMON TRANSPORT CHANNEL RESOURCES RESPONSE message.

If the *C-ID* IE is included in the COMMON TRANSPORT CHANNEL RESOURCES REQUEST message, the DRNC shall include the *FACH Info for UE Selected S-CCPCH* IE valid for the cell indicated by the *C-ID* IE and the corresponding *C-ID* IE in the COMMON TRANSPORT CHANNEL RESOURCES RESPONSE message. If the *C-ID* IE is not included in the COMMON TRANSPORT CHANNEL RESOURCES REQUEST message, the DRNC shall include the *FACH Info for UE Selected S-CCPCH* IE valid for the cell where the UE is located and the corresponding *C-ID* IE. The DRNC shall include the *FACH Scheduling Priority* IE and *FACH Initial Window Size* IE in the *FACH Flow Control Information* IE of the *FACH Info for UE Selected S-CCPCH* IE for each priority class that the DRNC has determined shall be used. The DRNC may include several *MAC-c/sh SDU Length* IEs for each priority class.

If the DRNS has any RACH, [FDD - CPCH,] and/or FACH resources previously allocated for the UE in another cell than the cell where resources are currently being allocated, the DRNS shall release the previously allocated RACH, [FDD - CPCH,] and/or FACH resources.

If the DRNS has successfully reserved the required resources, the DRNC shall respond to the SRNC with the COMMON TRANSPORT CHANNEL RESOURCES RESPONSE message.

If the *Permanent NAS UE Identity* IE is present in the COMMON TRANSPORT CHANNEL RESOURCES REQUEST message, the DRNC shall store the information for the considered UE Context for the lifetime of the UE Context.

If the COMMON TRANSPORT CHANNEL RESOURCES REQUEST message includes a *C-ID* IE corresponding to a cell reserved for operator use and the Permanent NAS UE Identity is available in the DRNC for the considered UE Context, the DRNC shall use this information to determine whether it can reserve resources on a common transport channel in this cell or not.

8.4.1.3 Unsuccessful Operation

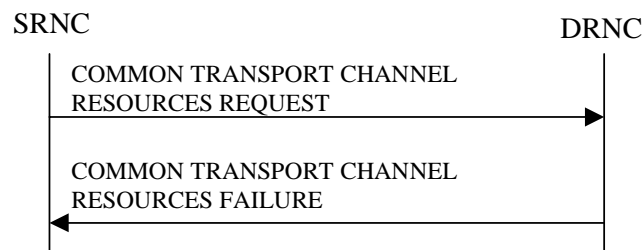

Figure 28: Common Transport Channel Resources Initialisation procedure, Unsuccessful Operation

If the *Transport Bearer Request Indicator* IE is set to "Bearer Requested" and the DRNC is not able to provide a Transport Bearer, the DRNC shall respond to the SRNC with the COMMON TRANSPORT CHANNEL RESOURCES FAILURE message, indicating the cause of the failure.

If the COMMON TRANSPORT CHANNEL RESOURCES REQUEST message contains a *C-ID* IE corresponding to a cell reserved for operator use and the Permanent NAS UE Identity is not available for the considered UE Context, the DRNC shall consider the procedure as failed and send the COMMON TRANSPORT CHANNEL RESOURCES FAILURE message.

Typical cause values are:

Radio Network Layer Causes:

- Common Transport Channel Type not Supported;
- Cell reserved for operator use.

Transport Layer Causes:

- Transport Resource Unavailable.

8.4.1.4 Abnormal Conditions

-

8.4.2 Common Transport Channel Resources Release

8.4.2.1 General

This procedure is used by the SRNC to request release of Common Transport Channel Resources for a given UE in the DRNS. The SRNC uses this procedure either to release the UE Context from the DRNC (and thus both the D-RNTI and the C-RNTI) or to release only the C-RNTI.

This procedure shall use the connectionless mode of the signalling bearer.

8.4.2.2 Successful Operation



Figure 29: Common Transport Channel Resources Release procedure, Successful Operation

The SRNC initiates the Common Transport Channel Resources Release procedure by sending the message COMMON TRANSPORT CHANNEL RESOURCES RELEASE REQUEST to the DRNC. At the reception of the message the DRNC shall release the UE Context identified by the D-RNTI and all its related RACH, [FDD - CPCH,] and/or FACH resources, unless the UE is using dedicated resources (DCH, [TDD - USCH,] and/or DSCH) in the DRNS in which case the DRNC shall release only the C-RNTI and all its related RACH, [FDD - CPCH,] and/or FACH resources allocated for the UE.

8.4.2.3 Abnormal Conditions

-

8.5 Global Procedures

8.5.1 Error Indication

8.5.1.1 General

The Error Indication procedure is initiated by a node to report detected errors in a received message, provided they cannot be reported by an appropriate response message.

This procedure shall use the signalling bearer mode specified below.

8.5.1.2 Successful Operation

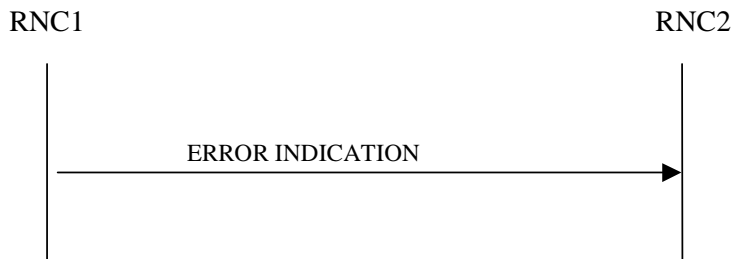

Figure 30: Error Indication procedure, Successful Operation

When the conditions defined in clause 10 are fulfilled, the Error Indication procedure is initiated by an ERROR INDICATION message sent from the receiving node. This message shall use the same mode of the signalling bearer and the same signalling bearer connection (if connection oriented) as the message that triggers the procedure.

When the ERROR INDICATION message is sent from a DRNC to an SRNC using connectionless mode of the signalling bearer, the *S-RNTI* IE shall be included in the message if the UE Context addressed by the *D-RNTI* IE which was received in the message triggering the Error Indication procedure exists. When the ERROR INDICATION message is sent from an SRNC to a DRNC using connectionless mode of the signalling bearer, the *D-RNTI* IE shall be included in the message if the UE addressed by the *S-RNTI* IE which was received in the message triggering the Error Indication procedure exists.

When a message using connectionless mode of the signalling bearer is received in the DRNC and there is no UE Context in the DRNC as indicated by the *D-RNTI* IE, the DRNC shall include the *D-RNTI* from the received message in the *D-RNTI* IE in the ERROR INDICATION message, unless another handling is specified in the procedure text for the affected procedure.

When a message using connectionless mode of the signalling bearer is received in the SRNC and there is no UE in the SRNC as indicated by the *S-RNTI* IE, the SRNC shall include the *S-RNTI* from the received message in the *S-RNTI* IE in the ERROR INDICATION message, unless another handling is specified in the procedure text for the affected procedure.

The ERROR INDICATION message shall include either the *Cause* IE, or the *Criticality Diagnostics* IE, or both the *Cause* IE and the *Criticality Diagnostics* IE.

Typical cause values for the ERROR INDICATION message are:

Protocol Causes:

- Transfer Syntax Error
- Abstract Syntax Error (Reject)
- Abstract Syntax Error (Ignore and Notify)
- Message not Compatible with Receiver State
- Unspecified

8.5.1.3 Abnormal Conditions

-

9 Elements for RNSAP Communication

9.1 Message Functional Definition and Content

9.1.1 General

This subclause defines the structure of the messages required for the RNSAP protocol in tabular format. The corresponding ASN.1 definition is presented in subclause 9.3. In case there is contradiction between the tabular format in subclause 9.1 and the ASN.1 definition, the ASN.1 shall take precedence, except for the definition of conditions for the presence of conditional IEs, where the tabular format shall take precedence.

NOTE: The messages have been defined in accordance to the guidelines specified in [28].

9.1.2 Message Contents

9.1.2.1 Presence

An information element can be of the following *types*:

M	IEs marked as Mandatory (M) shall always be included in the message.
O	IEs marked as Optional (O) may or may not be included in the message.
C	IEs marked as Conditional (C) shall be included in a message only if the condition is satisfied. Otherwise the IE shall not be included.

In the case of an Information Element group, the group is preceded by a name for the info group (in bold). It is also indicated how many times a group may be repeated in the message and whether the group is conditional. Each group may be also repeated within one message. The presence field of the Information Elements inside one group defines if the Information Element is mandatory, optional or conditional if the group is present.

9.1.2.2 Criticality

Each information element or Group of information elements may have criticality information applied to it. Following cases are possible:

-	No criticality information is applied explicitly.
YES	Criticality information is applied. 'YES' is usable only for non-repeatable information elements.
GLOBAL	The information element and all its repetitions together have one common criticality information. 'GLOBAL' is usable only for repeatable information elements.
EACH	Each repetition of the information element has its own criticality information. It is not allowed to assign different criticality values to the repetitions. 'EACH' is usable only for repeatable information elements.

9.1.2.3 Range

The Range column indicates the allowed number of copies of repetitive IEs/IE groups.

9.1.2.4 Assigned Criticality

This column provides the actual criticality information as defined in subclause 10.3.2, if applicable.

9.1.3 RADIO LINK SETUP REQUEST

9.1.3.1 FDD Message

IE/Group Name	Presence	Range	IE Type and Reference	Semantics Description	Criticality	Assigned Criticality
Message Type	M		9.2.1.40		YES	reject
Transaction ID	M		9.2.1.59		–	
SRNC-Id	M		RNC-Id 9.2.1.50		YES	reject
S-RNTI	M		9.2.1.53		YES	reject
D-RNTI	O		9.2.1.24		YES	reject
Allowed Queuing Time	O		9.2.1.2		YES	reject
UL DPCH Information		1			YES	reject
>UL Scrambling Code	M		9.2.2.53		–	
>Min UL Channelisation Code Length	M		9.2.2.25		–	
>Max Number of UL DPDCHs	C – CodeLen		9.2.2.24		–	
>Puncture Limit	M		9.2.1.46	For the UL.	–	
>TFCS	M		TFCS for the UL 9.2.1.63		–	
>UL DPCH Slot Format	M		9.2.2.52		–	
>Uplink SIR Target	O		Uplink SIR 9.2.1.69		–	
>Diversity mode	M		9.2.2.8		–	
>SSDT Cell Identity Length	O		9.2.2.41		–	
>S Field Length	O		9.2.2.36		–	
DL DPCH Information		1			YES	reject
>TFCS	M		TFCS for the DL. 9.2.1.63		–	
>DL DPCH Slot Format	M		9.2.2.9		–	
>Number of DL Channelisation Codes	M		9.2.2.26A		–	
>TFCI Signalling Mode	M		9.2.2.46		–	
>TFCI Presence	C- SlotFormat		9.2.1.55		–	
>Multiplexing Position	M		9.2.2.26		–	
>Power Offset Information		1			–	
>>PO1	M		Power Offset 9.2.2.30	Power offset for the TFCI bits.	–	
>>PO2	M		Power Offset 9.2.2.30	Power offset for the TPC bits.	–	
>>PO3	M		Power Offset 9.2.2.30	Power offset for the pilot bits.	–	
>FDD TPC Downlink Step Size	M		9.2.2.16		–	
>Limited Power Increase	M		9.2.2.21A		–	
>Inner Loop DL PC Status	M		9.2.2.21a		–	
>Split Type	C-IfSplit		9.2.2.39a		YES	reject
>Length of TFCI2	C-SplitType		9.2.2.21B		YES	reject
DCH Information	M		DCH FDD Information 9.2.2.4A		YES	reject
DSCH Information	O		DSCH FDD Information 9.2.2.13A		YES	reject

IE/Group Name	Presence	Range	IE Type and Reference	Semantics Description	Criticality	Assigned Criticality
RL Information		<i>1...<maxnoofRLs></i>			EACH	notify
>RL ID	M		9.2.1.49		–	
>C-Id	M		9.2.1.6		–	
>First RLS Indicator	M		9.2.2.16A		–	
>Frame Offset	M		9.2.1.30		–	
>Chip Offset	M		9.2.2.1		–	
>Propagation Delay	O		9.2.2.33		–	
>Diversity Control Field	C – NotFirstRL		9.2.1.20		–	
>Initial DL TX Power	O		DL Power 9.2.1.21A		–	
>Primary CPICH Ec/No	O		9.2.2.32		–	
>SSDT Cell Identity	O		9.2.2.40		–	
>Transmit Diversity Indicator	C – Diversity Mode		9.2.2.48		–	
Transmission Gap Pattern Sequence Information	O		9.2.2.47A		YES	reject
Active Pattern Sequence Information	O		9.2.2.A		YES	reject
Permanent NAS UE Identity	O		9.2.1.72		YES	ignore

Condition	Explanation
CodeLen	The IE shall be present if <i>Min UL Channelisation Code Length</i> IE equals to 4.
SlotFormat	The IE shall be present if the <i>DL DPCH Slot Format</i> IE is equal to any of the values from 12 to 16.
NotFirstRL	The IE shall be present if the RL is not the first one in the <i>RL Information</i> IE.
Diversity mode	This IE shall be present if <i>Diversity Mode</i> IE is present in <i>UL DPCH Information</i> IE and is not set to "none".
IfSplit	The IE shall be present if the <i>TFCI Signalling Mode</i> IE is set to 'Split'.
SplitType	The IE shall be present if the <i>Split Type</i> IE is set to 'Logical'.

Range bound	Explanation
<i>maxnoofRLs</i>	Maximum number of RLs for one UE.

9.1.3.2 TDD Message

IE/Group Name	Presence	Range	IE Type and Reference	Semantics Description	Criticality	Assigned Criticality
Message Type	M		9.2.1.40		YES	reject
Transaction ID	M		9.2.1.59		–	
SRNC-Id	M		RNC-Id 9.2.1.50		YES	reject
S-RNTI	M		9.2.1.53		YES	reject
D-RNTI	O		9.2.1.24		YES	reject
UL Physical Channel Information		1			YES	reject
>Maximum Number of Timeslots per Frame	M		9.2.3.3A	For the UL	–	
>Minimum Spreading Factor	M		9.2.3.4A	For the UL	–	
>Maximum Number of UL Physical Channels per Timeslot	M		9.2.3.3B		–	
DL Physical Channel Information		1			YES	reject
>Maximum Number of Timeslots per Frame	M		9.2.3.3A	For the DL	–	
>Minimum Spreading Factor	M		9.2.3.4A	For the DL	–	
>Maximum Number of DL Physical Channels per Frame	M		9.2.3.3C		–	
Allowed Queuing Time	O		9.2.1.2		YES	reject
UL CCTrCH Information		0..<maxno of CCTrCHs>		For DCH and USCH	EACH	notify
>CCTrCH ID	M		9.2.3.2		–	
>TFCS	M		9.2.1.63	For the UL.	–	
>TFCI Coding	M		9.2.3.11		–	
>Puncture Limit	M		9.2.1.46		–	
DL CCTrCH Information		0..<maxno of CCTrCHs>		For DCH and DSCH	EACH	notify
>CCTrCH ID	M		9.2.3.2		–	
>TFCS	M		9.2.1.63	For the DL.	–	
>TFCI Coding	M		9.2.3.11		–	
>Puncture Limit	M		9.2.1.46		–	
>TDD TPC Downlink Step Size	M		9.2.3.10		–	
>TPC CCTrCH List		0..<maxno CCTrCHs>		List of uplink CCTrCH which provide TPC	–	
>>TPC CCTrCH ID	M		CCTrCH ID 9.2.3.2		–	
DCH Information	O		DCH TDD Information 9.2.3.2A		YES	reject
DSCH Information	O		DSCH TDD Information 9.2.3.3a		YES	reject
USCH Information	O		9.2.3.15		YES	reject
RL Information		1			YES	reject
>RL ID	M		9.2.1.49		–	
>C-Id	M		9.2.1.6		–	
>Frame Offset	M		9.2.1.30		–	
>Special Burst Scheduling	M		9.2.3.7D		–	

>Primary CCPCH RSCP	O		9.2.3.5		-	
>DL Time Slot ISCP Info	O		9.2.3.2D		-	
Permanent NAS UE Identity	O		9.2.1.72		YES	ignore
PDSCH-RL-ID	O		RL ID 9.2.1.49		YES	ignore

Range bound	Explanation
<i>maxnoofCCTrCHs</i>	Maximum number of CCTrCH for one UE.

9.1.4 RADIO LINK SETUP RESPONSE

9.1.4.1 FDD Message

IE/Group Name	Presence	Range	IE Type and Reference	Semantics Description	Criticality	Assigned Criticality
Message Type	M		9.2.1.40		YES	reject
Transaction ID	M		9.2.1.59		–	
D-RNTI	O		9.2.1.24		YES	ignore
CN PS Domain Identifier	O		9.2.1.12		YES	ignore
CN CS Domain Identifier	O		9.2.1.11		YES	ignore
RL Information Response		<i>1..<maxno ofRLs></i>			EACH	ignore
>RL ID	M		9.2.1.49		–	
>RL Set ID	M		9.2.2.35		–	
>URA Information	O		9.2.1.70B		–	
>SAI	M		9.2.1.52		–	
>Cell GAI	O		9.2.1.5A		–	
>UTRAN Access Point Position	O		9.2.1.70A		–	
>Received Total Wide Band Power	M		9.2.2.35A		–	
>Secondary CCPCH Info	O		9.2.2.37B		–	
>DL Code Information	M		FDD DL Code Information 9.2.2.14A		–	
>CHOICE <i>Diversity Indication</i>	M				–	
>> <i>Combining</i>					–	
>>>RL ID	M		9.2.1.49	Reference RL ID for the combining	–	
>> <i>Non Combining or First RL</i>					–	
>>>DCH Information Response	M		9.2.1.16A		–	
>SSDT Support Indicator	M		9.2.2.43		–	
>Maximum Uplink SIR	M		Uplink SIR 9.2.1.69		–	
>Minimum Uplink SIR	M		Uplink SIR 9.2.1.69		–	
>Closed Loop Timing Adjustment Mode	O		9.2.2.3A		–	
>Maximum Allowed UL Tx Power	M		9.2.1.35		–	
>Maximum DL TX Power	M		DL Power 9.2.1.21A		–	
>Minimum DL TX Power	M		DL Power 9.2.1.21A		–	
>Primary Scrambling Code	O		9.2.1.45		–	
>UL UARFCN	O		UARFCN 9.2.1.66	Corresponds to Nu in ref. [6]	–	
>DL UARFCN	O		UARFCN 9.2.1.66	Corresponds to Nd in ref. [6]	–	
>Primary CPICH Power	M		9.2.1.44		–	
>DSCH Information Response	O		DSCH FDD Information Response 9.2.2.13B		YES	ignore
>Neighbouring UMTS Cell Information	O		9.2.1.41A		–	

IE/Group Name	Presence	Range	IE Type and Reference	Semantics Description	Criticality	Assigned Criticality
>Neighbouring GSM Cell Information	O		9.2.1.41C		–	
>PC Preamble	M		9.2.2.27a		–	
>SRB Delay	M		9.2.2.39A		–	
Uplink SIR Target	O		Uplink SIR 9.2.1.69		YES	ignore
Criticality Diagnostics	O		9.2.1.13		YES	ignore
DSCH-RNTI	O		9.2.1.26Ba		YES	ignore

Range bound	Explanation
<i>maxnoofRLs</i>	Maximum number of RLs for one UE.

9.1.4.2 TDD Message

IE/Group Name	Presence	Range	IE Type and Reference	Semantics Description	Criticality	Assigned Criticality
Message Type	M		9.2.1.40		YES	reject
Transaction ID	M		9.2.1.59		–	
D-RNTI	O		9.2.1.24		YES	ignore
CN PS Domain Identifier	O		9.2.1.12		YES	ignore
CN CS Domain Identifier	O		9.2.1.11		YES	ignore
RL Information Response		1			YES	ignore
>RL ID	M		9.2.1.49		–	
>URA Information	O		9.2.1.70B		–	
>SAI	M		9.2.1.52		–	
>Cell GAI	O		9.2.1.5A		–	
>UTRAN Access Point Position	O		9.2.1.70A		–	
>UL Time Slot ISCP Info	M		9.2.3.13D		–	
>Maximum Uplink SIR	M		Uplink SIR 9.2.1.69		–	
>Minimum Uplink SIR	M		Uplink SIR 9.2.1.69		–	
>Maximum Allowed UL Tx Power	M		9.2.1.35		–	
>Maximum DL TX Power	M		DL Power 9.2.1.21A		–	
>Minimum DL TX Power	M		DL Power 9.2.1.21A		–	
>UARFCN	O		UARFCN 9.2.1.66	Corresponds to Nt in ref. [7]	–	
>Cell Parameter ID	O		9.2.1.8		–	
>Sync Case	O		9.2.1.54		–	
>SCH Time Slot	C-Case2		9.2.1.51		–	
>SCTD Indicator	O		9.2.1.73		–	
>PCCPCH Power	M		9.2.1.43		–	
>Timing Advance Applied	M		9.2.3.12A		–	
>Alpha Value	M		9.2.3.a		–	
>UL PhysCH SF Variation	M		9.2.3.13B		–	
>Synchronisation Configuration	M		9.2.3.7E		–	
>Secondary CCPCH Info TDD	O		9.2.3.7B		–	
>UL CCTrCH Information		0..<maxno of CCTrCHs>		For DCH	GLOBAL	ignore
>>CCTrCH ID	M		9.2.3.2		–	
>>UL DPCH Information		0..1			YES	ignore
>>>Repetition Period	M		9.2.3.7		–	
>>>Repetition Length	M		9.2.3.6		–	
>>>TDD DPCH Offset	M		9.2.3.8A		–	
>>>UL Timeslot Information	M		9.2.3.13C		–	
>DL CCTrCH Information		0..<maxno of CCTrCHs>		For DCH	GLOBAL	ignore
>>CCTrCH ID	M		9.2.3.2		–	
>>DL DPCH Information		0..1			YES	ignore
>>>Repetition Period	M		9.2.3.7		–	
>>>Repetition Length	M		9.2.3.6		–	
>>>TDD DPCH Offset	M		9.2.3.8A		–	
>>>DL Timeslot Information	M		9.2.3.2C			
>DCH Information Response	O		9.2.1.16A		YES	ignore
>DSCH Information Response		0..<maxno of DSCHs>			GLOBAL	ignore

IE/Group Name	Presence	Range	IE Type and Reference	Semantics Description	Criticality	Assigned Criticality
		<i>DSCHs</i> >				
>>DSCH ID	M		9.2.1.26A		–	
>>DSCH Flow Control Information	M		9.2.1.26B		–	
>>Binding ID	O		9.2.1.3		–	
>>Transport Layer Address	O		9.2.1.62		–	
>>Transport Format Management	M		9.2.3.13		–	
>USCH Information Response		<i>0 .. <maxnoof USCHs></i>			GLOBAL	ignore
>>USCH ID	M		9.2.3.14		–	
>>Binding ID	O		9.2.1.3		–	
>>Transport Layer Address	O		9.2.1.62		–	
>>Transport Format Management	M		9.2.3.13		–	
>Neighbouring UMTS Cell Information	O		9.2.1.41A		–	
>Neighbouring GSM Cell Information	O		9.2.1.41C		–	
>Time Slot	C-Case1		9.2.1.56		YES	ignore
Uplink SIR Target	M		Uplink SIR 9.2.1.69		YES	ignore
Criticality Diagnostics	O		9.2.1.13		YES	ignore
DSCH RNTI	O		9.2.1.26Ba		YES	ignore

Condition	Explanation
Case2	This IE shall be present if <i>Sync Case</i> IE is "Case2".
Case1	This IE shall be present if <i>Sync Case</i> IE is "Case1".

Range bound	Explanation
<i>maxnoofDSCHs</i>	Maximum number of DSCHs for one UE.
<i>maxnoofUSCHs</i>	Maximum number of USCHs for one UE.
<i>maxnoofCCTrCHs</i>	Maximum number of CCTrCH for one UE.

9.1.5 RADIO LINK SETUP FAILURE

9.1.5.1 FDD Message

IE/Group Name	Presence	Range	IE Type and Reference	Semantics Description	Criticality	Assigned Criticality
Message Type	M		9.2.1.40		YES	reject
Transaction ID	M		9.2.1.59		–	
D-RNTI	O		9.2.1.24		YES	ignore
CN PS Domain Identifier	O		9.2.1.12		YES	ignore
CN CS Domain Identifier	O		9.2.1.11		YES	ignore
CHOICE Cause Level	M				YES	ignore
>General					–	
>>Cause	M		9.2.1.5		–	
>RL Specific					–	
>>Unsuccessful RL Information Response		1..<maxno ofRLs>			EACH	ignore
>>>RL ID	M		9.2.1.49		–	
>>>Cause	M		9.2.1.5		–	
>>Successful RL Information Response		0..<maxno ofRLs-1>			EACH	ignore
>>>RL ID	M		9.2.1.49		–	
>>>RL Set ID	M		9.2.2.35		–	
>>>URA Information	O		9.2.1.70B		–	
>>>SAI	M		9.2.1.52		–	
>>>Cell GAI	O		9.2.1.5A		–	
>>>UTRAN Access Point Position	O		9.2.1.70A		–	
>>>Received Total Wide Band Power	M		9.2.2.35A		–	
>>>Secondary CCPCH Info	O		9.2.2.37B		–	
>>>DL Code Information	M		FDD DL Code Information 9.2.2.14A		–	
>>>CHOICE Diversity Indication	M				–	
>>>>Combining					–	
>>>>>RL ID	M		9.2.1.49	Reference RL ID for the combining	–	
>>>>>Non Combining or First RL					–	
>>>>>DCH Information Response	M		9.2.1.16A		–	
>>>SSDT Support Indicator	M		9.2.2.43		–	
>>>Maximum Uplink SIR	M		Uplink SIR 9.2.1.69		–	
>>>Minimum Uplink SIR	M		Uplink SIR 9.2.1.69		–	
>>>Closed Loop Timing Adjustment Mode	O		9.2.2.3A		–	
>>>Maximum Allowed UL Tx Power	M		9.2.1.35		–	
>>>Maximum DL TX Power	M		DL Power 9.2.1.21A		–	
>>>Minimum DL TX Power	M		DL Power 9.2.1.21A		–	
>>>Primary CPICH Power	M		9.2.1.44		–	
>>>Primary Scrambling Code	O		9.2.1.45		–	

IE/Group Name	Presence	Range	IE Type and Reference	Semantics Description	Criticality	Assigned Criticality
>>>UL UARFCN	O		UARFCN 9.2.1.66	Corresponds to Nu in ref. [6]	–	
>>>DL UARFCN	O		UARFCN 9.2.1.66	Corresponds to Nd in ref. [6]	–	
>>>DSCH Information Response	O		DSCH FDD Information Response 9.2.2.13B		YES	ignore
>>>Neighbouring UMTS Cell Information	O		9.2.1.41A		–	
>>>Neighbouring GSM Cell Information	O		9.2.1.41C		–	
>>>PC Preamble	M		9.2.2.27a		-	
>>>SRB Delay	M		9.2.2.39A		-	
>>DSCH-RNTI	O		9.2.1.26Ba		YES	ignore
Uplink SIR Target	O		Uplink SIR 9.2.1.69		YES	ignore
Criticality Diagnostics	O		9.2.1.13		YES	ignore

Range bound	Explanation
<i>maxnoofRLs</i>	Maximum number of RLs for one UE.

9.1.5.2 TDD Message

IE/Group Name	Presence	Range	IE Type and Reference	Semantics Description	Criticality	Assigned Criticality
Message Type	M		9.2.1.40		YES	reject
Transaction ID	M		9.2.1.59		–	
CHOICE Cause Level	M				YES	ignore
>General					–	
>>Cause	M		9.2.1.5		–	
>RL Specific					–	
>>Unsuccessful RL Information Response		1			YES	ignore
>>>RL ID	M		9.2.1.49		–	
>>>Cause	M		9.2.1.5		–	
Criticality Diagnostics	O		9.2.1.13		YES	ignore

9.1.6 RADIO LINK ADDITION REQUEST

9.1.6.1 FDD Message

IE/Group Name	Presence	Range	IE Type and Reference	Semantics Description	Criticality	Assigned Criticality
Message Type	M		9.2.1.40		YES	reject
Transaction ID	M		9.2.1.59		–	
Uplink SIR Target	M		Uplink SIR 9.2.1.69		YES	reject
RL Information		<i>1..<maxnoofRLs-1></i>			EACH	notify
>RL ID	M		9.2.1.49		–	
>C-Id	M		9.2.1.6		–	
>Frame Offset	M		9.2.1.30		–	
>Chip Offset	M		9.2.2.1		–	
>Diversity Control Field	M		9.2.1.20		–	
>Primary CPICH Ec/No	O		9.2.2.32		–	
>SSDT Cell Identity	O		9.2.2.40			
>Transmit Diversity Indicator	O		9.2.2.48		–	
Active Pattern Sequence Information	O		9.2.2A	Either all the already active Transmission Gap Sequence(s) are addressed (Transmission Gap Pattern sequence shall overlap with the existing one) or none of the transmission gap sequences is activated.	YES	reject
Permanent NAS UE Identity	O		9.2.1.72		YES	ignore

Range bound	Explanation
<i>maxnoofRLs</i>	Maximum number of radio links for one UE.

9.1.6.2 TDD Message

IE/Group Name	Presence	Range	IE Type and Reference	Semantics Description	Criticality	Assigned Criticality
Message Type	M		9.2.1.40		YES	reject
Transaction ID	M		9.2.1.59		–	
RL Information		1			YES	reject
>RL ID	M		9.2.1.49		–	
>C-Id	M		9.2.1.6		–	
>Frame Offset	M		9.2.1.30		–	
>Diversity Control Field	M		9.2.1.20		–	
>Primary CCPCH RSCP	O		9.2.3.5		–	
>DL Time Slot ISCP Info	O		9.2.3.2D		–	
Permanent NAS UE Identity	O		9.2.1.72		YES	ignore

9.1.7 RADIO LINK ADDITION RESPONSE

9.1.7.1 FDD Message

IE/Group Name	Presence	Range	IE Type and Reference	Semantics Description	Criticality	Assigned Criticality
Message Type	M		9.2.1.40		YES	reject
Transaction ID	M		9.2.1.59		–	
RL Information Response		<i>1..<maxnoof RLS-1></i>			EACH	ignore
>RL ID	M		9.2.1.49		–	
>RL Set ID	M		9.2.2.35		–	
>URA Information	O		9.2.1.70B		–	
>SAI	M		9.2.1.52		–	
>Cell GAI	O		9.2.1.5A		–	
>UTRAN Access Point Position	O		9.2.1.70A		–	
>Received Total Wide Band Power	M		9.2.2.35A		–	
>Secondary CCPCH Info	O		9.2.2.37B		–	
>DL Code Information	M		FDD DL Code Information 9.2.2.14A		YES	ignore
>CHOICE <i>Diversity Indication</i>	M				–	
>> <i>Combining</i>					–	
>>>RL ID	M		9.2.1.49	Reference RL ID	–	
>> <i>Non Combining</i>					–	
>>>DCH Information Response	M		9.2.1.16A		–	
>SSDT Support Indicator	M		9.2.2.43		–	
>Minimum Uplink SIR	M		Uplink SIR 9.2.1.69		–	
>Maximum Uplink SIR	M		Uplink SIR 9.2.1.69		–	
>Closed Loop Timing Adjustment Mode	O		9.2.2.3A		–	
>Maximum Allowed UL Tx Power	M		9.2.1.35		–	
>Maximum DL TX Power	M		DL Power 9.2.1.21A		–	
>Minimum DL TX Power	M		DL Power 9.2.1.21A		–	
>Neighbouring UMTS Cell Information	O		9.2.1.41A		–	
>Neighbouring GSM Cell Information	O		9.2.1.41C		–	
>PC Preamble	M		9.2.2.27a		–	
>SRB Delay	M		9.2.2.39A		–	
>Primary CPICH Power	M		9.2.1.44		–	
Criticality Diagnostics	O		9.2.1.13		YES	ignore

Range bound	Explanation
<i>maxnoofRLs</i>	Maximum number of radio links for one UE.

9.1.7.2 TDD Message

IE/Group Name	Presence	Range	IE Type and Reference	Semantics Description	Criticality	Assigned Criticality
Message Type	M		9.2.1.40		YES	reject
Transaction ID	M		9.2.1.59		–	
RL Information Response		1			YES	ignore
>RL ID	M		9.2.1.49		–	
>URA Information	O		9.2.1.70B		–	
>SAI	M		9.2.1.52		–	
>Cell GAI	O		9.2.1.5A		–	
>UTRAN Access Point Position	O		9.2.1.70A		–	
>UL Time Slot ISCP Info	M		9.2.3.13D		–	
>Minimum Uplink SIR	M		Uplink SIR 9.2.1.69		–	
>Maximum Uplink SIR	M		Uplink SIR 9.2.1.69		–	
>Maximum Allowed UL Tx Power	M		9.2.1.35		–	
>Maximum DL TX Power	M		DL Power 9.2.1.21A		–	
>Minimum DL TX Power	M		DL Power 9.2.1.21A		–	
>PCCPCH Power	M		9.2.1.43		–	
>Timing Advance Applied	M		9.2.3.12A		–	
>Alpha Value	M		9.2.3.a		–	
>UL PhysCH SF Variation	M		9.2.3.13B		–	
>Synchronisation Configuration	M		9.2.3.7E		–	
>Secondary CCPCH Info TDD	O		9.2.3.7B		–	
>UL CCTrCH Information		0..<maxnoof CCTrCHs>		For DCH	GLOBAL	ignore
>>CCTrCH ID	M		9.2.3.2		–	
>>UL DPCH Information		0..1			YES	ignore
>>>Repetition Period	M		9.2.3.7		–	
>>>Repetition Length	M		9.2.3.6		–	
>>>TDD DPCH Offset	M		9.2.3.8A		–	
>>>UL Timeslot Information	M		9.2.3.13C		–	
>DL CCTrCH Information		0..<maxnoof CCTrCHs>		For DCH	GLOBAL	ignore
>>CCTrCH ID	M		9.2.3.2		–	
>>DL DPCH Information		0..1			YES	ignore
>>>Repetition Period	M		9.2.3.7		–	
>>>Repetition Length	M		9.2.3.6		–	
>>>TDD DPCH Offset	M		9.2.3.8A		–	
>>>DL Timeslot Information	M		9.2.3.2C		–	
>DCH Information		0..1			–	
>>CHOICE Diversity Indication	M				–	
>>>Combining					–	
>>>>RL ID	M		9.2.1.49	Reference RL	–	
>>>>Non Combining					–	
>>>>DCH Information Response	M		9.2.1.16A		–	
>DSCH Information Response		0 .. <maxnoof DSCHs>			GLOBAL	ignore

IE/Group Name	Presence	Range	IE Type and Reference	Semantics Description	Criticality	Assigned Criticality
>>DSCH ID	M		9.2.1.26A		–	
>>Transport Format Management	M		9.2.3.13		–	
>>DSCH Flow Control Information	M		9.2.1.26B		–	
>>CHOICE <i>Diversity Indication</i>	O				–	
>>> <i>Non Combining</i>					–	
>>>>Binding ID	O		9.2.1.3		–	
>>>>Transport Layer Address	O		9.2.1.62		–	
>USCH Information Response		0 .. <maxnoof USCHs>			GLOBAL	ignore
>>USCH ID	M		9.2.3.14		–	
>>Transport Format Management	M		9.2.3.13		–	
>>CHOICE <i>Diversity Indication</i>	O				–	
>>> <i>Non Combining</i>					–	
>>>>Binding ID	O		9.2.1.3		–	
>>>>Transport Layer Address	O		9.2.1.62		–	
>Neighbouring UMTS Cell Information	O		9.2.1.41A		–	
>Neighbouring GSM Cell Information	O		9.2.1.41C		–	
Criticality Diagnostics	O		9.2.1.13		YES	ignore

Range Bound	Explanation
<i>maxnoofDSCHs</i>	Maximum number of DSCHs for one UE.
<i>maxnoofUSCHs</i>	Maximum number of USCHs for one UE.
<i>maxnoofCCTrCHs</i>	Maximum number of CCTrCHs for one UE.

9.1.8 RADIO LINK ADDITION FAILURE

9.1.8.1 FDD Message

IE/Group Name	Presence	Range	IE Type and Reference	Semantics Description	Criticality	Assigned Criticality
Message Type	M		9.2.1.40		YES	reject
Transaction ID	M		9.2.1.59		–	
CHOICE <i>Cause Level</i>	M				YES	ignore
> <i>General</i>					–	
>> <i>Cause</i>	M		9.2.1.5		–	
> <i>RL Specific</i>					–	
>> Unsuccessful RL Information Response		1..<maxnoof RLs-1>			EACH	ignore
>>>RL ID	M		9.2.1.49		–	
>>>Cause	M		9.2.1.5		–	
>> Successful RL Information Response		0..<maxnoof RLs-2>			EACH	ignore
>>>RL ID	M		9.2.1.49		–	
>>>RL Set ID	M		9.2.2.35		–	
>>>URA Information	O		9.2.1.70B		–	
>>>SAI	M		9.2.1.52		–	
>>>Cell GAI	O		9.2.1.5A		–	
>>>UTRAN Access Point Position	O		9.2.1.70A		–	
>>>Received Total Wide Band Power	M		9.2.2.35A		–	
>>>Secondary CCPCCH Info	O		9.2.2.37B		–	
>>>DL Code Information	M		FDD DL Code Information 9.2.2.14A		YES	ignore
>>>CHOICE <i>Diversity Indication</i>	M				–	
>>>> <i>Combining</i>					–	
>>>>>RL ID	M		9.2.1.49	Reference RL ID	–	
>>>>> <i>Non Combining</i>					–	
>>>>>DCH Information Response	M		9.2.1.16A		–	
>>>SSDT Support Indicator	M		9.2.2.43		–	
>>>Minimum Uplink SIR	M		Uplink SIR 9.2.1.69		–	
>>>Maximum Uplink SIR	M		Uplink SIR 9.2.1.69		–	
>>>Closed Loop Timing Adjustment Mode	O		9.2.2.3A		–	
>>>Maximum Allowed UL Tx Power	M		9.2.1.35		–	
>>>Maximum DL TX Power	M		DL Power 9.2.1.21A		–	
>>>Minimum DL TX Power	M		DL Power 9.2.1.21A		–	
>>>Neighbouring UMTS Cell Information	O		9.2.1.41A		–	
>>>Neighbouring GSM Cell Information	O		9.2.1.41C		–	
>>>Primary CPICH Power	M		9.2.1.44		–	
>>>PC Preamble	M		9.2.2.27a		–	
>>>SRB Delay	M		9.2.2.39A		–	

IE/Group Name	Presence	Range	IE Type and Reference	Semantics Description	Criticality	Assigned Criticality
Criticality Diagnostics	O		9.2.1.13		YES	ignore

Range bound	Explanation
<i>maxnoofRLs</i>	Maximum number of radio links for one UE.

9.1.8.2 TDD Message

IE/Group Name	Presence	Range	IE Type and Reference	Semantics Description	Criticality	Assigned Criticality
Message Type	M		9.2.1.40		YES	reject
Transaction ID	M		9.2.1.59		–	
CHOICE Cause Level	M				YES	ignore
>General					–	
>>Cause	M		9.2.1.5		–	
>RL Specific					–	
>>Unsuccessful RL Information Response		1			YES	ignore
>>>RL ID	M		9.2.1.49		–	
>>>Cause	M		9.2.1.5		–	
Criticality Diagnostics	O		9.2.1.13		YES	ignore

9.1.9 RADIO LINK DELETION REQUEST

IE/Group Name	Presence	Range	IE Type and Reference	Semantics Description	Criticality	Assigned Criticality
Message Type	M		9.2.1.40		YES	reject
Transaction ID	M		9.2.1.59		–	
RL Information		1..<maxno ofRLs>			EACH	notify
>RL ID	M		9.2.1.49		–	

Range bound	Explanation
<i>maxnoofRLs</i>	Maximum number of radio links for one UE

9.1.10 RADIO LINK DELETION RESPONSE

IE/Group Name	Presence	Range	IE Type and Reference	Semantics Description	Criticality	Assigned Criticality
Message Type	M		9.2.1.40		YES	reject
Transaction ID	M		9.2.1.59		–	
Criticality Diagnostics	O		9.2.1.13		YES	ignore

9.1.11 RADIO LINK RECONFIGURATION PREPARE

9.1.11.1 FDD Message

IE/Group Name	Presence	Range	IE Type and Reference	Semantics Description	Criticality	Assigned Criticality
Message Type	M		9.2.1.40		YES	reject
Transaction ID	M		9.2.1.59		–	
Allowed Queuing Time	O		9.2.1.2		YES	reject
UL DPCH Information		0..1			YES	reject
>UL Scrambling Code	O		9.2.2.53		–	
>UL SIR Target	O		Uplink SIR 9.2.1.69		–	
>Min UL Channelisation Code Length	O		9.2.2.25		–	
>Max Number of UL DPDCHs	C – CodeLen		9.2.2.24		–	
>Puncture Limit	O		9.2.1.46	For the UL.	–	
>TFCS	O		9.2.1.63	TFCS for the UL.	–	
>UL DPCCH Slot Format	O		9.2.2.52		–	
>Diversity Mode	O		9.2.2.8		–	
>SSDT Cell Identity Length	O		9.2.2.41		–	
>S-Field Length	O		9.2.2.36		–	
DL DPCH Information		0..1			YES	reject
>TFCS	O		9.2.1.63	TFCS for the DL.	–	
>DL DPCH Slot Format	O		9.2.2.9		–	
>Number of DL Channelisation Codes	O		9.2.2.26A		–	
>TFCI Signalling Mode	O		9.2.2.46		–	
>TFCI Presence	C- SlotFormat		9.2.1.55		–	
>Multiplexing Position	O		9.2.2.26		–	
>Limited Power Increase	O		9.2.2.21A		–	
>Split Type	C-IfSplit		9.2.2.39a		YES	reject
>Length of TFCI2	C- SplitType		9.2.2.21B		YES	reject
DCHs To Modify	O		FDD DCHs To Modify 9.2.2.13C		YES	reject
DCHs To Add	O		DCH FDD Information 9.2.2.4A		YES	reject
DCHs To Delete		0..<maxnoof DCHs>			GLOBAL	reject
>DCH ID	M		9.2.1.16		–	
DSCHs To Modify		0..1			YES	reject
>DSCH Info		0..<maxnoof DSCHs>			–	
>>DSCH ID	M		9.2.1.26A		–	
>>TrCh Source Statistics Descriptor	O		9.2.1.65		–	
>>Transport Format Set	O		9.2.1.64	For DSCH	–	
>>Allocation/Retention Priority	O		9.2.1.1		–	
>>Scheduling Priority Indicator	O		9.2.1.51A		–	
>>BLER	O		9.2.1.4		–	

IE/Group Name	Presence	Range	IE Type and Reference	Semantics Description	Criticality	Assigned Criticality
>>Transport Bearer Request Indicator	M		9.2.1.61		–	
>PDSCH RL ID	O		RL ID 9.2.1.49		–	
>TFCS	O		9.2.1.63	For DSCH	–	
DSCHs To Add	O		DSCH FDD Information 9.2.2.13A		YES	reject
DSCHs To Delete		0..1			YES	reject
>DSCH Info		1..<maxnoof DSCHs>			–	
>>DSCH ID	M		9.2.1.26A		–	
RL Information		0..<maxnoof RLs>			EACH	reject
>RL ID	M		9.2.1.49		–	
>SSDT Indication	O		9.2.2.42		–	
>SSDT Cell Identity	C - SSDTIndON		9.2.2.40		–	
>Transmit Diversity Indicator	C – Diversity mode		9.2.2.48		–	
Transmission Gap Pattern Sequence Information	O		9.2.2.47A		YES	reject

Condition	Explanation
SSDTIndON	The IE shall be present if the <i>SSDT Indication</i> IE is set to "SSDT Active in the UE".
CodeLen	The IE shall be present if the <i>Min UL Channelisation Code Length</i> IE equals to 4.
SlotFormat	The IE shall be present if the <i>DL DPCH Slot Format</i> IE is equal to any of the values from 12 to 16.
Diversity mode	The IE shall be present if <i>Diversity Mode</i> IE is present in the <i>UL DPCH Information</i> IE and is not equal to "none".
IfSplit	The IE shall be present if the <i>TFCI Signalling Mode</i> IE is set to 'Split'.
SplitType	The IE shall be present if the <i>Split Type</i> IE is set to 'Logical'.

Range bound	Explanation
<i>maxnoofDCHs</i>	Maximum number of DCHs for a UE.
<i>maxnoofDSCHs</i>	Maximum number of DSCHs for one UE.
<i>maxnoofRLs</i>	Maximum number of RLs for a UE.

9.1.11.2 TDD Message

IE/Group Name	Presence	Range	IE Type and Reference	Semantics Description	Criticality	Assigned Criticality
Message Type	M		9.2.1.40		YES	reject
Transaction ID	M		9.2.1.59		–	
Allowed Queuing Time	O		9.2.1.2		YES	reject
UL CCTrCH To Add		<i>0..<maxno of CCTrCHs></i>		For DCH and USCH	EACH	notify
>CCTrCH ID	M		9.2.3.2		–	
>TFCS	M		9.2.1.63	For the UL.	–	
>TFCI Coding	M		9.2.3.11		–	
>Puncture Limit	M		9.2.1.46		–	
UL CCTrCH To Modify		<i>0..<maxno of CCTrCHs></i>			EACH	notify
>CCTrCH ID	M		9.2.3.2		–	
>TFCS	O		9.2.1.63	For the UL.	–	
>TFCI Coding	O		9.2.3.11		–	
>Puncture Limit	O		9.2.1.46		–	
UL CCTrCH to Delete		<i>0..<maxno of CCTrCHs></i>			EACH	notify
>CCTrCH ID	M		9.2.3.2		–	
DL CCTrCH To Add		<i>0..<maxno of CCTrCHs></i>		For DCH and DSCH	EACH	notify
>CCTrCH ID	M		9.2.3.2		–	
>TFCS	M		9.2.1.63	For the DL.	–	
>TFCI Coding	M		9.2.3.11		–	
>Puncture Limit	M		9.2.1.46		–	
>TPC CCTrCH List		<i>0..<maxno CCTrCHs></i>		List of uplink CCTrCH which provide TPC	–	
>>TPC CCTrCH ID	M		CCTrCH ID 9.2.3.2		–	
DL CCTrCH To Modify		<i>0..<maxno of CCTrCHs></i>			EACH	notify
>CCTrCH ID	M		9.2.3.2		–	
>TFCS	O		9.2.1.63	For the DL.	–	
>TFCI Coding	O		9.2.3.11		–	
>Puncture Limit	O		9.2.1.46		–	
>TPC CCTrCH List		<i>0..<maxno CCTrCHs></i>		List of uplink CCTrCH which provide TPC	–	
>>TPC CCTrCH ID	M		CCTrCH ID 9.2.3.3		–	
DL CCTrCH To Delete		<i>0..<maxno of CCTrCHs></i>			EACH	notify
>CCTrCH ID	M		9.2.3.2		–	
DCHs To Modify	O		TDD DCHs To Modify 9.2.3.8B		YES	reject
DCHs To Add	O		DCH TDD Information 9.2.3.2A		YES	reject
DCHs To Delete		<i>0..<maxno of DCHs></i>			GLOBAL	reject

IE/Group Name	Presence	Range	IE Type and Reference	Semantics Description	Criticality	Assigned Criticality
>DCH ID	M		9.2.1.16		–	
DSCHs To Modify		0..<maxno ofDSCHs>			GLOBAL	reject
>DSCH ID	M		9.2.1.26A		–	
>CCTrCH Id	O		9.2.3.2	DL CCTrCH in which the DSCH is mapped.	–	
>TrCh Source Statistics Descriptor	O		9.2.1.65		–	
>Transport Format Set	O		9.2.1.64		–	
>Allocation/Retention Priority	O		9.2.1.1		–	
>Scheduling Priority Indicator	O		9.2.1.51A		–	
>BLER	O		9.2.1.4		–	
>Transport Bearer Request Indicator	M		9.2.1.61		–	
DSCHs To Add	O		DSCH TDD Information 9.2.3.3a		YES	reject
DSCHs To Delete		0..<maxno ofDSCHs>			GLOBAL	reject
>DSCH ID	M		9.2.1.26A		–	
USCHs To Modify		0..<maxno ofUSCHs>			GLOBAL	reject
>USCH ID	M		9.2.3.14		–	
>CCTrCH Id	O		9.2.3.2	UL CCTrCH in which the USCH is mapped.	–	
>TrCh Source Statistics Descriptor	O		9.2.1.65		–	
>Transport Format Set	O		9.2.1.64		–	
>Allocation/Retention Priority	O		9.2.1.1		–	
>Scheduling Priority Indicator	O		9.2.1.51A		–	
>BLER	O		9.2.1.4		–	
>Transport Bearer Request Indicator	M		9.2.1.61		–	
>RB Info		0..<maxno ofRB>		All Radio Bearers using this USCH	–	
>>RB Identity	M		9.2.3.5B		–	
USCHs To Add	O		USCH Information 9.2.3.15		YES	reject
USCHs To Delete		0..<maxno ofUSCHs>			GLOBAL	reject
>USCH ID	M		9.2.3.14		–	
Primary CCPCH RSCP	O		9.2.3.5		YES	ignore
DL Time Slot ISCP Info	O		9.2.3.2D		YES	ignore
PDSCH-RL-ID	O		RL ID 9.2.1.49		YES	ignore

Range bound	Explanation
<i>maxnoofDCHs</i>	Maximum number of DCHs for a UE.
<i>maxnoofCCTrCHs</i>	Maximum number of CCTrCHs for a UE.
<i>maxnoofDSCHs</i>	Maximum number of DSCHs for one UE.
<i>maxnoofUSCHs</i>	Maximum number of USCHs for one UE.

9.1.12 RADIO LINK RECONFIGURATION READY

9.1.12.1 FDD Message

IE/Group Name	Presence	Range	IE Type and Reference	Semantics Description	Criticality	Assigned Criticality
Message Type	M		9.2.1.40		YES	reject
Transaction ID	M		9.2.1.59		–	
RL Information Response		<i>0..<maxno ofRLs></i>			EACH	ignore
>RL ID	M		9.2.1.49		–	
>Maximum Uplink SIR	O		Uplink SIR 9.2.1.69		–	
>Minimum Uplink SIR	O		Uplink SIR 9.2.1.69		–	
>Maximum DL TX Power	O		DL Power 9.2.1.21A		–	
>Minimum DL TX Power	O		DL Power 9.2.1.21A		–	
>Secondary CCPCH Info	O		9.2.2.37B		–	
>DL Code Information	O		FDD DL Code Information 9.2.2.14A		YES	ignore
>DCH Information Response	O		9.2.1.16A		YES	ignore
>DSCHs to be Added or Modified	O		DSCH FDD Information Response 9.2.2.13B		YES	ignore
Criticality Diagnostics	O		9.2.1.13		YES	ignore
DSCH-RNTI	O		9.2.1.26Ba		YES	ignore

Range bound	Explanation
<i>maxnoofRLs</i>	Maximum number of RLs for a UE.

9.1.12.2 TDD Message

IE/Group Name	Presence	Range	IE Type and Reference	Semantics Description	Criticality	Assigned Criticality
Message Type	M		9.2.1.40		YES	reject
Transaction ID	M		9.2.1.59		–	
RL Information Response		0..1			YES	ignore
>RL ID	M		9.2.1.49		–	
>Maximum Uplink SIR	O		Uplink SIR 9.2.1.69		–	
>Minimum Uplink SIR	O		Uplink SIR 9.2.1.69		–	
>Maximum DL TX Power	O		DL Power 9.2.1.21A		–	
>Minimum DL TX Power	O		DL Power 9.2.1.21A		–	
>Secondary CCPCH Info TDD	O		9.2.3.7B		–	
>UL CCTrCH Information		0..<maxnoof CCTrCHs>		For DCH	GLOBAL	ignore
>>CCTrCH ID	M		9.2.3.2		–	
>>UL DPCH to be Added		0..1			YES	ignore
>>>Repetition Period	M		9.2.3.7		–	
>>>Repetition Length	M		9.2.3.6		–	
>>>TDD DPCH Offset	M		9.2.3.8A		–	
>>> Rx Timing Deviation	O		9.2.3.7A		–	
>>>UL Timeslot Information	M		9.2.3.13C		–	
>>UL DPCH to be Modified		0..1			YES	ignore
>>>Repetition Period	O		9.2.3.7		–	
>>>Repetition Length	O		9.2.3.6		–	
>>>TDD DPCH Offset	O		9.2.3.8A		–	
>>>UL Timeslot Information		0..<maxnoO fTS>			–	
>>>>Time Slot	M		9.2.1.56		–	
>>>>Midamble Shift And Burst Type	O		9.2.3.4		–	
>>>>TFCI Presence	O		9.2.1.55		–	
>>>>UL Code Information		0..<maxnoO fDPCHs>			–	
>>>>>DPCH ID	M		9.2.3.3		–	
>>>>>TDD Channelisation Code	O		9.2.3.8		–	
>>UL DPCH to be Deleted		0..<maxnoof DPCHs>			GLOBAL	ignore
>>>DPCH ID	M		9.2.3.3		–	
>DL CCTrCH Information		0..<maxnoof CCTrCHs>		For DCH	GLOBAL	ignore
>>CCTrCH ID	M		9.2.3.2		–	
>>DL DPCH to be Added		0..1			YES	ignore
>>>Repetition Period	M		9.2.3.7		–	
>>>Repetition Length	M		9.2.3.6		–	
>>>TDD DPCH Offset	M		9.2.3.8A		–	
>>>DL Timeslot Information	M		9.2.3.2C		–	

IE/Group Name	Presence	Range	IE Type and Reference	Semantics Description	Criticality	Assigned Criticality
>>DL DPCH to be Modified		0..1			YES	ignore
>>>Repetition Period	O		9.2.3.7		–	
>>>Repetition Length	O		9.2.3.6		–	
>>>TDD DPCH Offset	O		9.2.3.8A		–	
>>>DL Timeslot Information		0..<maxnoOfTS>			–	
>>>>Time Slot	M		9.2.1.56		–	
>>>>Midamble Shift And Burst Type	O		9.2.3.4		–	
>>>>TFCI Presence	O		9.2.1.55		–	
>>>>DL Code Information		0..<maxnoOfDPCHs>			–	
>>>>>DPCH ID	M		9.2.3.3		–	
>>>>>TDD Channelisation Code	O		9.2.3.8		–	
>>DL DPCH to be Deleted		0..<maxnoofDPCHs>			GLOBAL	ignore
>>>DPCH ID	M		9.2.3.3		–	
>DCH Information Response	O		9.2.1.16A		YES	ignore
>DSCH to be Added or Modified		0 .. <maxnoofDSCHs>			GLOBAL	ignore
>>DSCH ID	M		9.2.1.26A		–	
>>Transport Format Management	M		9.2.3.13		–	
>>DSCH Flow Control Information	M		9.2.1.26B		–	
>>Binding ID	O		9.2.1.3		–	
>>Transport Layer Address	O		9.2.1.62		–	
>USCH to be Added or Modified		0 .. <maxnoofUSCHs>			GLOBAL	ignore
>>USCH ID	M		9.2.3.14		–	
>>Transport Format Management	M		9.2.3.13		–	
>>Binding ID	O		9.2.1.3		–	
>>Transport Layer Address	O		9.2.1.62		–	
Criticality Diagnostics	O		9.2.1.13		YES	ignore
DSCH-RNTI	O		9.2.1.26Ba		YES	ignore

Range bound	Explanation
<i>maxnoofDSCHs</i>	Maximum number of DSCHs for one UE.
<i>maxnoofUSCHs</i>	Maximum number of USCHs for one UE.
<i>maxnoofCCTrCHs</i>	Maximum number of CCTrCHs for a UE.
<i>maxnoofTS</i>	Maximum number of Timeslots for a UE.
<i>maxnoofDPCH</i>	Maximum number of DPCH for a UE.

9.1.13 RADIO LINK RECONFIGURATION COMMIT

IE/Group Name	Presence	Range	IE Type and Reference	Semantics Description	Criticality	Assigned Criticality
Message Type	M		9.2.1.40		YES	ignore
Transaction ID	M		9.2.1.59		–	
CFN	M		9.2.1.9		YES	ignore
Active Pattern Sequence Information	O		9.2.2.A	FDD only	YES	ignore

9.1.14 RADIO LINK RECONFIGURATION FAILURE

IE/Group Name	Presence	Range	IE Type and Reference	Semantics Description	Criticality	Assigned Criticality
Message Type	M		9.2.1.40		YES	reject
Transaction ID	M		9.2.1.59		–	
CHOICE Cause Level	M				YES	ignore
>General					–	
>>Cause	M		9.2.1.5		–	
> RL Specific					–	
>>>RLs Causing Reconfiguration Failure		0..<maxnoof RLs>			EACH	ignore
>>>RL ID	M		9.2.1.49		–	
>>>Cause	M		9.2.1.5		–	
Criticality Diagnostics	O		9.2.1.13		YES	ignore

Range bound	Explanation
<i>maxnoofRLs</i>	Maximum number of RLs for a UE.

9.1.15 RADIO LINK RECONFIGURATION CANCEL

IE/Group Name	Presence	Range	IE Type and Reference	Semantics Description	Criticality	Assigned Criticality
Message Type	M		9.2.1.40		YES	ignore
Transaction ID	M		9.2.1.59		–	

9.1.16 RADIO LINK RECONFIGURATION REQUEST

9.1.16.1 FDD Message

IE/Group Name	Presence	Range	IE Type and Reference	Semantics Description	Criticality	Assigned Criticality
Message Type	M		9.2.1.40		YES	reject
Transaction ID	M		9.2.1.59		–	
Allowed Queuing Time	O		9.2.1.2		YES	reject
UL DPCH Information		0..1			YES	reject
>TFCS	O		9.2.1.63	TFCS for the UL.	–	
DL DPCH Information		0..1			YES	reject
>TFCS	O		9.2.1.63	TFCS for the DL.	–	
>TFCI Signalling Mode	O		9.2.2.46		–	
>Limited Power Increase	O		9.2.2.21A		–	
DCHs To Modify	O		FDD DCHs To Modify 9.2.2.13C		YES	reject
DCHs To Add	O		DCH FDD Information 9.2.2.4A		YES	reject
DCHs To Delete		0..<maxno ofDCHs>			GLOBAL	reject
>DCH ID	M		9.2.1.16		–	
Transmission Gap Pattern Sequence Information	O		9.2.2.47A		YES	reject

9.1.16.2 TDD Message

IE/Group Name	Presence	Range	IE Type and Reference	Semantics Description	Criticality	Assigned Criticality
Message Type	M		9.2.1.40		YES	reject
Transaction ID	M		9.2.1.59		–	
Allowed Queuing Time	O		9.2.1.2		YES	reject
UL CCTrCH Information To Modify		0..<maxnoof CCTrCHs>			EACH	notify
>CCTrCH ID	M		9.2.3.2		–	
>TFCS	O		9.2.1.63		–	
UL CCTrCH Information To Delete		0..<maxnoof CCTrCHs>			EACH	notify
>CCTrCH ID	M		9.2.3.2		–	
DL CCTrCH Information To Modify		0..<maxnoof CCTrCHs>			EACH	notify
>CCTrCH ID	M		9.2.3.2		–	
>TFCS	O		9.2.1.63		–	
DL CCTrCH Information To Delete		0..<maxnoof CCTrCHs>			EACH	notify
>CCTrCH ID	M		9.2.3.2		–	
DCHs To Modify	O		TDD DCHs To Modify 9.2.3.8B		YES	reject
DCHs To Add	O		DCH TDD Information 9.2.3.2A		YES	reject
DCHs To Delete		0..<maxnoof DCHs>			GLOBAL	reject
>DCH ID	M		9.2.1.16		–	

Range Bound	Explanation
<i>maxnoofCCTrCHs</i>	Maximum number of CCTrCHs for a UE.
<i>maxnoofDCHs</i>	Maximum number of DCHs for one UE.

9.1.17 RADIO LINK RECONFIGURATION RESPONSE

9.1.17.1 FDD Message

IE/Group Name	Presence	Range	IE Type and Reference	Semantics Description	Criticality	Assigned Criticality
Message Type	M		9.2.1.40		YES	reject
Transaction ID	M		9.2.1.59		–	
RL Information Response		<i>0..<maxno ofRLs></i>			EACH	ignore
>RL ID	M		9.2.1.49		–	
>Maximum Uplink SIR	O		Uplink SIR 9.2.1.69		–	
>Minimum Uplink SIR	O		Uplink SIR 9.2.1.69		–	
>Maximum DL TX Power	O		DL Power 9.2.1.21A		–	
>Minimum DL TX Power	O		DL Power 9.2.1.21A		–	
>Secondary CCPCH Info	O		9.2.2.37B		–	
>DCH Information Response	O		9.2.1.16A		YES	ignore
>DL Code Information	O		FDD DL Code Information 9.2.2.14A		YES	ignore
Criticality Diagnostics	O		9.2.1.13		YES	ignore

Range Bound	Explanation
<i>maxnoofRLs</i>	Maximum number of RLs for a UE.

9.1.17.2 TDD Message

IE/Group Name	Presence	Range	IE Type and Reference	Semantics Description	Criticality	Assigned Criticality
Message Type	M		9.2.1.40		YES	reject
Transaction ID	M		9.2.1.59		–	
RL Information Response		<i>0..1</i>			YES	ignore
>RL ID	M		9.2.1.49		–	
>Maximum Uplink SIR	O		Uplink SIR 9.2.1.69		–	
>Minimum Uplink SIR	O		Uplink SIR 9.2.1.69		–	
>Maximum DL TX Power	O		DL Power 9.2.1.21A		–	
>Minimum DL TX Power	O		DL Power 9.2.1.21A		–	
>DCH Information Response	O		9.2.1.16A		YES	ignore
Criticality Diagnostics	O		9.2.1.13		YES	ignore

9.1.18 RADIO LINK FAILURE INDICATION

IE/Group Name	Presence	Range	IE Type and Reference	Semantics Description	Criticality	Assigned Criticality
Message Type	M		9.2.1.40		YES	ignore
Transaction ID	M		9.2.1.59		–	
CHOICE <i>Reporting Object</i>	M			Object for which the Failure shall be reported.	YES	ignore
>RL					–	
>>RL Information		1 .. <maxnoofRLs>			EACH	ignore
>>>RL ID	M		9.2.1.49		–	
>>>Cause	M		9.2.1.5		–	
>RLS				FDD only	–	
>>RL Set Information		1 .. <maxnoofRLSets>			EACH	ignore
>>>RL Set ID	M		9.2.2.35		–	
>>>Cause	M		9.2.1.5		–	
>CCTrCH				TDD only		
>>RL ID	M		9.2.1.53		–	
>>CCTrCH List		1..<maxnoCCTrCHs>			EACH	ignore
>>>CCTrCH ID	M		9.2.3.2		–	
>>>Cause	M		9.2.1.5		–	

Range bound	Explanation
<i>maxnoofRLs</i>	Maximum number of RLs for one UE.
<i>maxnoofRLSets</i>	Maximum number of RL Sets for one UE.
<i>maxnoofCCTrCHs</i>	Maximum number of CCTrCHs for a UE.

9.1.19 RADIO LINK RESTORE INDICATION

IE/Group Name	Presence	Range	IE Type and Reference	Semantics Description	Criticality	Assigned Criticality
Message Type	M		9.2.1.40		YES	ignore
Transaction ID	M		9.2.1.59		–	
CHOICE Reporting Object	M			Object for which the Restoration shall be reported.	YES	ignore
>RL				TDD only	–	
>>RL Information		1 .. <maxno ofRLs>			EACH	ignore
>>>RL ID	M		9.2.1.49		–	
>RLS				FDD only	–	
>>RL Set Information		1 .. <maxno ofRLSets>			EACH	ignore
>>>RL Set ID	M		9.2.2.35		–	
>CCTrCH				TDD only	–	
>>RL ID	M		9.2.1.53		–	
>>>CCTrCH List		1..<maxnoCCTrCHs>			EACH	ignore
>>>CCTrCH ID	M		9.2.3.2		–	

Range bound	Explanation
maxnoofRLs	Maximum number of RLs for one UE.
maxnoofRLSets	Maximum number of RL Sets for one UE.
maxnoofCCTrCHs	Maximum number of CCTrCHs for a UE.

9.1.20 DL POWER CONTROL REQUEST [FDD]

IE/Group Name	Presence	Range	IE Type and Reference	Semantics Description	Criticality	Assigned Criticality
Message Type	M		9.2.1.40		YES	ignore
Transaction ID	M		9.2.1.59		–	
Power Adjustment Type	M		9.2.2.28		YES	ignore
DL Reference Power	C-Common		DL Power 9.2.1.21A		YES	ignore
Inner Loop DL PC Status	O		9.2.2.21a		YES	ignore
DL Reference Power Information	C-Individual	1..<maxnoofRLs>			EACH	ignore
>RL ID	M		9.2.1.49		–	
>DL Reference Power	M		DL Power 9.2.1.21A		–	
Max Adjustment Step	C-Common O Individual		9.2.2.23		YES	ignore
Adjustment Period	C-Common O Individual		9.2.2.B		YES	ignore
Adjustment Ratio	C-Common O Individual		9.2.2.C		YES	ignore

Condition	Explanation
Common	The IE shall be present if the <i>Power Adjustment Type</i> IE is set to "Common".
Individual	The IE shall be present if the <i>Power Adjustment Type</i> IE is set to "Individual".
CommonOrIndividual	The IE shall be present if the <i>Power Adjustment Type</i> IE is set to "Common" or "Individual".

Range Bound	Explanation
<i>maxnoofRLs</i>	Maximum number of RLs for one UE.

9.1.21 PHYSICAL CHANNEL RECONFIGURATION REQUEST

9.1.21.1 FDD Message

IE/Group Name	Presence	Range	IE Type and Reference	Semantics Description	Criticality	Assigned Criticality
Message Type	M		9.2.1.40		YES	reject
Transaction ID	M		9.2.1.59		–	
RL Information		1			YES	reject
>RL ID	M		9.2.1.49		–	
>DL Code Information	M		FDD DL Code Information 9.2.2.14A		YES	notify

9.1.21.2 TDD Message

IE/Group Name	Presence	Range	IE Type and Reference	Semantics Description	Criticality	Assigned Criticality
Message Type	M		9.2.1.40		YES	reject
Transaction ID	M		9.2.1.59		–	
RL Information		1			YES	reject
>RL ID	M		9.2.1.49		–	
>UL CCTrCH Information		0.. <maxnoof CCTrCHs>			GLOBAL	reject
>>CCTrCH ID	M		9.2.3.2		–	
>>UL DPCH Information		1			YES	notify
>>>Repetition Period	O		9.2.3.7		–	
>>>Repetition Length	O		9.2.3.6		–	
>>>TDD DPCH Offset	O		9.2.3.8A		–	
>>>UL Timeslot Information		0..<maxno OfTS>			–	
>>>>Time Slot	M		9.2.1.56		–	
>>>>Midamble Shift And Burst Type	O		9.2.3.4		–	
>>>>TFCI Presence	O		9.2.1.55		–	
>>>>UL Code Information	O		TDD UL Code Information 9.2.3.10A		–	
>DL CCTrCH Information		0..<maxno ofCCTrCH s>			GLOBAL	reject
>>CCTrCH ID	M		9.2.3.2		–	
>>DL DPCH Information		1			YES	notify
>>>Repetition Period	O		9.2.3.7		–	
>>>Repetition Length	O		9.2.3.6		–	
>>>TDD DPCH Offset	O		9.2.3.8A		–	
>>>DL Timeslot Information		0..<maxno OfTS>			–	
>>>>Time Slot	M		9.2.1.56		–	
>>>>Midamble Shift And Burst Type	O		9.2.3.4		–	
>>>>TFCI Presence	O		9.2.1.55		–	
>>>>DL Code Information	O		TDD DL Code Information 9.2.3.8C		–	

Range bound	Explanation
<i>maxnoofCCTrCHs</i>	Maximum number of CCTrCHs for a UE.
<i>maxnoofTS</i>	Maximum number of Timeslots for a UE

9.1.22 PHYSICAL CHANNEL RECONFIGURATION COMMAND

IE/Group Name	Presence	Range	IE Type and Reference	Semantics Description	Criticality	Assigned Criticality
Message Type	M		9.2.1.40		YES	reject
Transaction ID	M		9.2.1.59		–	
CFN	M		9.2.1.9		YES	ignore
Criticality Diagnostics	O		9.2.1.13		YES	ignore

9.1.23 PHYSICAL CHANNEL RECONFIGURATION FAILURE

IE/Group Name	Presence	Range	IE Type and Reference	Semantics Description	Criticality	Assigned Criticality
Message Type	M		9.2.1.40		YES	reject
Transaction ID	M		9.2.1.59		–	
Cause	M		9.2.1.5		YES	ignore
Criticality Diagnostics	O		9.2.1.13		YES	ignore

9.1.24 UPLINK SIGNALLING TRANSFER INDICATION

9.1.24.1 FDD Message

IE/Group Name	Presence	Range	IE Type and Reference	Semantics Description	Criticality	Assigned Criticality
Message Type	M		9.2.1.40		YES	ignore
Transaction ID	M		9.2.1.59		–	
UC-Id	M		9.2.1.71		YES	ignore
SAI	M		9.2.1.52		YES	ignore
Cell GAI	O		9.2.1.5A		YES	ignore
C-RNTI	M		9.2.1.14		YES	ignore
S-RNTI	M		9.2.1.54		YES	ignore
D-RNTI	O		9.2.1.24		YES	ignore
Propagation Delay	M		9.2.2.33		YES	ignore
STTD Support Indicator	M		9.2.2.45		YES	ignore
Closed Loop Mode1 Support Indicator	M		9.2.2.2		YES	ignore
Closed Loop Mode2 Support Indicator	M		9.2.2.3		YES	ignore
L3 Information	M		9.2.1.32		YES	ignore
CN PS Domain Identifier	O		9.2.1.12		YES	ignore
CN CS Domain Identifier	O		9.2.1.11		YES	ignore
URA Information	O		9.2.1.70B		YES	ignore

9.1.24.2 TDD Message

IE/Group Name	Presence	Range	IE Type and Reference	Semantics Description	Criticality	Assigned Criticality
Message Type	M		9.2.1.40		YES	ignore
Transaction ID	M		9.2.1.59		–	
UC-Id	M		9.2.1.71		YES	ignore
SAI	M		9.2.1.52		YES	ignore
Cell GAI	O		9.2.1.5A		YES	ignore
C-RNTI	M		9.2.1.14		YES	ignore
S-RNTI	M		9.2.1.54		YES	ignore
D-RNTI	O		9.2.1.24		YES	ignore
Rx Timing Deviation	M		9.2.3.7A		YES	ignore
L3 Information	M		9.2.1.32		YES	ignore
CN PS Domain Identifier	O		9.2.1.12		YES	ignore
CN CS Domain Identifier	O		9.2.1.11		YES	ignore
URA Information	O		9.2.1.70B		YES	ignore

9.1.25 DOWNLINK SIGNALLING TRANSFER REQUEST

IE/Group Name	Presence	Range	IE Type and Reference	Semantics Description	Criticality	Assigned Criticality
Message Type	M		9.2.1.40		YES	ignore
Transaction ID	M		9.2.1.59		–	
C-Id	M		9.2.1.6		YES	ignore
D-RNTI	M		9.2.1.24		YES	ignore
L3 Information	M		9.2.1.32		YES	ignore
D-RNTI Release Indication	M		9.2.1.25		YES	ignore

9.1.26 RELOCATION COMMIT

IE/Group Name	Presence	Range	IE Type and Reference	Semantics Description	Criticality	Assigned Criticality
Message Type	M		9.2.1.40		YES	ignore
Transaction ID	M		9.2.1.59		–	
D-RNTI	O		9.2.1.24		YES	ignore
RANAP Relocation Information	O		9.2.1.47		YES	ignore

9.1.27 PAGING REQUEST

IE/Group Name	Presence	Range	IE Type and Reference	Semantics Description	Criticality	Assigned Criticality
Message Type	M		9.2.1.40		YES	ignore
Transaction ID	M		9.2.1.59		–	
CHOICE <i>Paging Area</i>	M				YES	ignore
> <i>URA</i>					–	
>>URA-Id	M		9.2.1.70		–	
> <i>Cell</i>					–	
>>C-Id	M		9.2.1.6		–	
SRNC-Id	M		RNC-Id 9.2.1.50		YES	ignore
S-RNTI	M		9.2.1.53		YES	ignore
IMSI	M		9.2.1.31		YES	ignore
DRX Cycle Length Coefficient	M		9.2.1.26		YES	ignore
CN Originated Page to Connected Mode UE		0..1			YES	ignore
>Paging Cause	M		9.2.1.41E		–	
>CN Domain Type	M		9.2.1.11A		–	
>Paging Record Type	M		9.2.1.41F		–	

9.1.28 DEDICATED MEASUREMENT INITIATION REQUEST

IE/Group Name	Presence	Range	IE Type and Reference	Semantics Description	Criticality	Assigned Criticality
Message Type	M		9.2.1.40		YES	reject
Transaction ID	M		9.2.1.59		–	
Measurement Id	M		9.2.1.37		YES	reject
CHOICE <i>Dedicated Measurement Object Type</i>	M				YES	reject
>RL					–	
>>RL Information		1..<maxn oofRLs>			EACH	reject
>>>RL-ID	M		9.2.1.49		–	
>>>DPCH ID	O		9.2.3.3	TDD only	–	
>RLS				FDD only	–	
>>RL Set Information		1..<maxn oofRLSets>			EACH	ignore
>>>RL-Set-ID	M		9.2.2.35		–	
>ALL RL			NULL		–	
>ALL RLS			NULL	FDD only	–	
Dedicated Measurement Type	M		9.2.1.18		YES	reject
Measurement Filter Coefficient	O		9.2.1.36		YES	reject
Report Characteristics	M		9.2.1.48		YES	reject
CFN reporting indicator	M		FN reporting indicator 9.2.1.28A		YES	reject
CFN	O		9.2.1.9		YES	reject

Range bound	Explanation
<i>maxnoofRLs</i>	Maximum number of individual RLs a measurement can be started on.
<i>maxnoofRLSets</i>	Maximum number of individual RL Sets a measurement can be started on.

9.1.29 DEDICATED MEASUREMENT INITIATION RESPONSE

IE/Group Name	Presence	Range	IE Type and Reference	Semantics Description	Criticality	Assigned Criticality
Message Type	M		9.2.1.40		YES	reject
Transaction ID	M		9.2.1.59		–	
Measurement Id	M		9.2.1.37		YES	ignore
CHOICE <i>Dedicated Measurement Object Type</i>	O			Dedicated Measurement Object Type the measurement was initiated with	YES	ignore
>RL or ALL RL					–	
>>RL Information		1..<maxno ofRLs>			EACH	ignore
>>>RL ID	M		9.2.1.49		–	
>>>DPCH ID	O		9.2.3.3	TDD only	–	
>>>Dedicated Measurement Value	M		9.2.1.19		–	
>>>CFN	O		9.2.1.9	Dedicated Measurement Time Reference	–	
>RLS or ALL RLS				FDD only	–	
>>RL Set Information		1..<maxno ofRLSets>			EACH	ignore
>>>RL Set ID	M		9.2.2.35		–	
>>>Dedicated Measurement Value	M		9.2.1.19		–	
>>>CFN	O		9.2.1.9	Dedicated Measurement Time Reference	–	
Criticality Diagnostics	O		9.2.1.13		YES	Ignore

Range bound	Explanation
<i>maxnoofRLs</i>	Maximum number of individual RLs the measurement can be started on.
<i>maxnoofRLSets</i>	Maximum number of individual RL Sets the measurement can be started on.

9.1.30 DEDICATED MEASUREMENT INITIATION FAILURE

IE/Group Name	Presence	Range	IE Type and Reference	Semantics Description	Criticality	Assigned Criticality
Message Type	M		9.2.1.40		YES	reject
Transaction ID	M		9.2.1.59		–	
Measurement Id	M		9.2.1.37		YES	ignore
Cause	M		9.2.1.5		YES	ignore
Criticality Diagnostics	O		9.2.1.13		YES	ignore

9.1.31 DEDICATED MEASUREMENT REPORT

IE/Group Name	Presence	Range	IE Type and Reference	Semantics Description	Criticality	Assigned Criticality
Message Type	M		9.2.1.40		YES	ignore
Transaction ID	M		9.2.1.59		–	
Measurement Id	M		9.2.1.37		YES	ignore
CHOICE <i>Dedicated Measurement Object Type</i>	M			Dedicated Measurement Object Type the measurement was initiated with	YES	ignore
>RL or ALL RL					–	
>>RL Information		1..<maxnofRLs>			EACH	ignore
>>>RL-ID	M		9.2.1.49		–	
>>>DPCH ID	O		9.2.3.3	TDD only	–	
>>>Dedicated Measurement Value Information	M		9.2.1.19A		–	
>RLS or ALL RLS				FDD only	–	
>>RL Set Information		1..<maxnofRLSets>			EACH	ignore
>>>RL Set ID	M		9.2.2.35		–	
>>>Dedicated Measurement Value Information	M		9.2.1.19A		–	

Range bound	Explanation
<i>maxnofRLs</i>	Maximum number of individual RLs the measurement can be started on.
<i>maxnofRLSets</i>	Maximum number of individual RL Sets the measurement can be started on.

9.1.32 DEDICATED MEASUREMENT TERMINATION REQUEST

IE/Group Name	Presence	Range	IE Type and Reference	Semantics Description	Criticality	Assigned Criticality
Message Type	M		9.2.1.40		YES	ignore
Transaction ID	M		9.2.1.59		–	
Measurement Id	M		9.2.1.37		YES	ignore

9.1.33 DEDICATED MEASUREMENT FAILURE INDICATION

IE/Group Name	Presence	Range	IE Type and Reference	Semantics Description	Criticality	Assigned Criticality
Message Type	M		9.2.1.40		YES	ignore
Transaction ID	M		9.2.1.59		–	
Measurement Id	M		9.2.1.37		YES	ignore
Cause	M		9.2.1.5		YES	ignore

9.1.34 COMMON TRANSPORT CHANNEL RESOURCES RELEASE REQUEST

IE/Group Name	Presence	Range	IE Type and Reference	Semantics Description	Criticality	Assigned Criticality
Message Type	M		9.2.1.40		YES	ignore
Transaction ID	M		9.2.1.59		–	
D-RNTI	M		9.2.1.24		YES	ignore

9.1.35 COMMON TRANSPORT CHANNEL RESOURCES REQUEST

IE/Group Name	Presence	Range	IE Type and Reference	Semantics Description	Criticality	Assigned Criticality
Message Type	M		9.2.1.40		YES	reject
Transaction ID	M		9.2.1.59		–	
D-RNTI	M		9.2.1.24		YES	reject
C-ID	O		9.2.1.6		YES	reject
Transport Bearer Request Indicator	M		9.2.1.61	Request a new transport bearer or to use an existing bearer for the user plane.	YES	reject
Transport Bearer ID	M		9.2.1.60	Indicates the lur transport bearer to be used for the user plane.	YES	reject
Permanent NAS UE Identity	O		9.2.1.72		YES	ignore

9.1.36 COMMON TRANSPORT CHANNEL RESOURCES RESPONSE

9.1.36.1 FDD Message

IE/Group Name	Presence	Range	IE Type and Reference	Semantics Description	Criticality	Assigned Criticality
Message Type	M		9.2.1.40		YES	reject
Transaction ID	M		9.2.1.59		–	
S-RNTI	M		9.2.1.53		YES	ignore
C-RNTI	O		9.2.1.14		YES	ignore
FACH Info for UE Selected S-CCPCH		1			YES	ignore
>FACH Flow Control Information	M		9.2.1.26C		YES	ignore
Transport Layer Address	O		9.2.1.62		YES	ignore
Binding Identity	O		9.2.1.3		YES	ignore
Criticality Diagnostics	O		9.2.1.13		YES	ignore
C-ID	M		9.2.1.6		YES	ignore

9.1.36.2 TDD Message

IE/Group Name	Presence	Range	IE Type and Reference	Semantics Description	Criticality	Assigned Criticality
Message Type	M		9.2.1.40		YES	reject
Transaction ID	M		9.2.1.59		–	
S-RNTI	M		9.2.1.53		YES	ignore
C-RNTI	O		9.2.1.14		YES	ignore
FACH Info for UE Selected S-CCPCHs		1			YES	ignore
>FACH Flow Control Information	M		9.2.1.26C		YES	ignore
Transport Layer Address	O		9.2.1.62		YES	ignore
Binding Identity	O		9.2.1.3		YES	ignore
Criticality Diagnostics	O		9.2.1.13		YES	ignore
C-ID	M		9.2.1.6		YES	ignore

9.1.37 COMMON TRANSPORT CHANNEL RESOURCES FAILURE

IE/Group Name	Presence	Range	IE Type and Reference	Semantics Description	Criticality	Assigned Criticality
Message Type	M		9.2.1.40		YES	reject
Transaction ID	M		9.2.1.59		–	
S-RNTI	M		9.2.1.53		YES	ignore
Cause	M		9.2.1.5		YES	ignore
Criticality Diagnostics	O		9.2.1.13		YES	ignore

9.1.38 COMPRESSED MODE COMMAND [FDD]

IE/Group Name	Presence	Range	IE Type and Reference	Semantics Description	Criticality	Assigned Criticality
Message Type	M		9.2.1.40		YES	ignore
Transaction ID	M		9.2.1.59		–	
Active Pattern Sequence Information	M		9.2.2.A		YES	ignore

9.1.39 ERROR INDICATION

IE/Group Name	Presence	Range	IE Type and Reference	Semantics Description	Criticality	Assigned Criticality
Message Type	M		9.2.1.40		YES	ignore
Transaction ID	M		9.2.1.59		–	
Cause	O		9.2.1.5		YES	ignore
Criticality Diagnostics	O		9.2.1.13		YES	ignore
S-RNTI	O		9.2.1.53		YES	ignore
D-RNTI	O		9.2.1.24		YES	ignore

9.1.40 DL POWER TIMESLOT CONTROL REQUEST [TDD]

IE/Group Name	Presence	Range	IE Type and Reference	Semantics Description	Criticality	Assigned Criticality
Message Type	M		9.2.1.40		YES	ignore
Transaction ID	M		9.2.1.59		–	
DL Time Slot ISCP Info	M		9.2.3.2D		YES	ignore

9.1.41 RADIO LINK PREEMPTION REQUIRED INDICATION

IE/Group Name	Presence	Range	IE Type and Reference	Semantics Description	Criticality	Assigned Criticality
Message Type	M		9.2.1.40		YES	ignore
Transaction ID	M		9.2.1.59		–	
RL Information		<i>0..<maxno ofRLs></i>			EACH	ignore
>RL ID	M		9.2.1.49		–	

Range bound	Explanation
<i>maxnoofRLs</i>	Maximum number of radio links for one UE

9.2 Information Element Functional Definition and Contents

9.2.0 General

Subclause 9.2 presents the RNSAP IE definitions in tabular format. The corresponding ASN.1 definition is presented in subclause 9.3. In case there is a contradiction between the tabular format in subclause 9.2 and the ASN.1 definition, the ASN.1 shall take precedence, except for the definition of conditions for the presence of conditional elements, where the tabular format shall take precedence.

When specifying information elements which are to be represented by bitstrings, if not otherwise specifically stated in the semantics description of the concerned IE or elsewhere, the following principle applies with regards to the ordering of bits:

- The first bit (leftmost bit) contains the most significant bit (MSB);
- The last bit (rightmost bit) contains the least significant bit (LSB);
- When importing bitstrings from other specifications, the first bit of the bitstring contains the first bit of the concerned information;

9.2.1 Common Parameters

This subclause contains parameters that are common to FDD and TDD.

9.2.1.1 Allocation/Retention Priority

This parameter indicates the priority level in the allocation and retention of transport channel resources in DRNS. DRNS may use the Allocation/Retention priority information of the transport channels composing the RL to prioritise requests for RL Setup/addition and reconfiguration. In similar way, DRNS may use the allocation/Retention priority information of the transport channels composing the RL to prioritise which RL shall be set to failure, in case prioritisation is possible. See Annex A.

IE/Group Name	Presence	Range	IE Type and Reference	Semantics Description
Priority Level	M		INTEGER (0..15)	This IE indicates the priority of the request. Usage: Value "0" means "Spare"; It shall be treated as a logical error if received. Values between 1 and 14 are ordered in decreasing order of priority, '1' being the highest and '14' the lowest. Value "15" means "No Priority".
Pre-emption Capability	M		ENUMERATED (shall not trigger pre-emption, may trigger pre-emption)	
Pre-emption Vulnerability	M		ENUMERATED (not pre-emptable, pre-emptable)	

9.2.1.2 Allowed Queuing Time

This parameter specifies the maximum queuing time that is allowed in the DRNS until the DRNS must start to execute the request.

IE/Group Name	Presence	Range	IE Type and Reference	Semantics Description
Allowed Queuing Time			INTEGER(1..60)	Seconds

9.2.1.3 Binding ID

The Binding ID is the identifier of a user data stream. It is allocated at the DRNS and it is unique for each transport bearer under establishment to/from the DRNS.

IE/Group Name	Presence	Range	IE Type and Reference	Semantics Description
Binding ID			OCTET STRING (1..4,...)	

9.2.1.4 BLER

This Block Error Rate defines the target radio interface Transport Block Error Rate of the transport channel . BLER is used by the DRNS to determine the needed SIR targets, for admission control and power management reasons.

IE/Group Name	Presence	Range	IE Type and Reference	Semantics Description
BLER			INTEGER (-63..0)	Step 0.1. (Range -6.3...0). It is the Log10 of the BLER

9.2.1.4A Block STTD Indicator

Void.

9.2.1.5 Cause

The purpose of the cause information element is to indicate the reason for a particular event for the whole protocol.

IE/Group Name	Presence	Range	IE Type and Reference	Semantics Description
CHOICE <i>Cause Group</i>				
> <i>Radio Network Layer</i>				
>>Radio Network Layer Cause	M		ENUMERATED (Unknown C-ID, Cell not Available, Power Level not Supported, UL Scrambling Code Already in Use, DL Radio Resources not Available, UL Radio Resources not Available, Measurement not Supported For The Object, Combining Resources Not Available, Combining not Supported, Reconfiguration not Allowed, Requested Configuration not Supported, Synchronisation Failure, Requested Tx Diversity Mode not Supported, Measurement Temporarily not Available, Unspecified, Invalid CM Settings, Reconfiguration CFN not Elapsed, Number of DL Codes Not Supported, Dedicated Transport Channel Type not Supported, DL Shared Channel Type not Supported, UL Shared Channel Type not Supported, Common Transport Channel Type not Supported, UL Spreading Factor not Supported, DL Spreading Factor not Supported, CM not Supported, Transaction not Supported by Destination Node B, RL Already Activated/Allocated, Number of UL Codes Not Supported, Cell reserved for operator use)	
> <i>Transport Layer</i>				
>>Transport Layer Cause	M		ENUMERATED (Transport Resource Unavailable, Unspecified, ...)	
> <i>Protocol</i>				
>>Protocol Cause			ENUMERATED (Transfer Syntax Error, Abstract Syntax Error (Reject), Abstract Syntax Error (Ignore and Notify), Message not Compatible with Receiver State, Semantic Error, Unspecified, Abstract Syntax Error (Falsely Constructed Message),...)	
> <i>Misc</i>				
>>Miscellaneous Cause	M		ENUMERATED (Control Processing Overload, Hardware Failure, O&M Intervention, Not enough User Plane Processing Resources, Unspecified,...)	

The meaning of the different cause values is described in the following table. In general, "not supported" cause values indicate that the concerned capability is missing. On the other hand, "not available" cause values indicate that the concerned capability is present, but insufficient resources were available to perform the requested action.

Radio Network Layer cause	Meaning
Cell not Available	The concerned cell is not available
Combining not Supported	The DRNS does not support the RL combining for the concerned cells
Cell reserved for operator use	The concerned cell is reserved for operator use
Combining Resources Not Available	The value of the received <i>Diversity Control Field</i> IE was set to 'Must', but the DRNS cannot perform the requested combining
CM not Supported	The concerned cell(s) do not support Compressed Mode
Common Transport Channel Type not Supported	The concerned cell(s) do not support the RACH and/or FACH and/or CPCH Common Transport Channel Type
Dedicated Transport Channel Type not Supported	The concerned cell(s) do not support the Dedicated Transport Channel Type
DL Radio Resources not Available	The DRNS does not have sufficient DL radio resources available
DL SF not Supported	The concerned cell(s) do not support the requested DL SF
DL Shared Channel Type not Supported	The concerned cell(s) do not support the Downlink Shared Channel Type
Invalid CM Settings	The concerned cell(s) consider the requested Compressed Mode settings invalid
Measurement not Supported For The Object	At least one of the concerned cell(s) does not support the requested measurement on the concerned object type
Measurement Temporarily not Available	The DRNS can temporarily not provide the requested measurement value
Number of DL Codes not Supported	The concerned cell(s) do not support the requested number of DL codes
Number of UL Codes not Supported	The concerned cell(s) do not support the requested number of UL codes
Power Level not Supported	A DL power level was requested which the concerned cell(s) do not support
Reconfiguration CFN not Elapsed	The requested action cannot be performed due to that a COMMIT message was received previously, but the concerned CFN has not yet elapsed
Reconfiguration not Allowed	The SRNC does currently not allow the requested reconfiguration
Requested Configuration not Supported	The concerned cell(s) do not support the requested configuration i.e. power levels, Transport Formats, physical channel parameters,.....
Requested Tx Diversity mode not Supported	The concerned cell(s) do not support the requested transmit diversity mode
RL Already Activated/ Allocated	The DRNS has already allocated an RL with the requested RL ID for this UE Context
Synchronisation Failure	Loss of UL Uu synchronisation
Transaction not Supported by Destination Node B	The requested action cannot be performed due to lack of support of the corresponding action in the destination Node B
UL Radio Resources not Available	The DRNS does not have sufficient UL radio resources available
UL Scrambling Code Already in Use	The concerned UL scrambling code is already in use for another UE
UL SF not Supported	The concerned cell(s) do not support the requested minimum UL SF
UL Shared Channel Type not Supported	The concerned cell(s) do not support the Uplink Shared Channel Type
Unknown C-ID	The DRNS is not aware of a cell with the provided C-Id
Unspecified	Sent when none of the above cause values applies but still the cause is Radio Network Layer related

Transport Network Layer cause	Meaning
Transport resource unavailable	The required transport resources are not available
Unspecified	Sent when none of the above cause values applies but still the cause is Transport Network Layer related

Protocol cause	Meaning
Abstract Syntax Error (Reject)	The received message included an abstract syntax error and the concerned criticality indicated "reject" (see subclause 10.3)
Abstract Syntax Error (Ignore and Notify)	The received message included an abstract syntax error and the concerned criticality indicated "ignore and notify" (see subclause 10.3)
Abstract syntax error (falsely constructed message)	The received message contained IEs or IE groups in wrong order or with too many occurrences (see subclause 10.3)
Message not Compatible with Receiver State	The received message was not compatible with the receiver state (see subclause 10.4)
Semantic Error	The received message included a semantic error (see subclause 10.4)
Transfer Syntax Error	The received message included a transfer syntax error (see subclause 10.2)
Unspecified	Sent when none of the above cause values applies but still the cause is Protocol related

Miscellaneous cause	Meaning
Control Processing Overload	DRNS control processing overload
Hardware Failure	DRNS hardware failure
Not enough User Plane Processing Resources	DRNS has insufficient user plane processing resources available
O&M Intervention	Operation and Maintenance intervention related to DRNS equipment
Unspecified	Sent when none of the above cause values applies and the cause is not related to any of the categories Radio Network Layer, Transport Network Layer or Protocol.

9.2.1.5A Cell Geographical Area Identity (Cell GAI)

The Cell Geographical Area is used to identify the geographical area of a cell. The area is represented as a polygon. See ref. [25].

IE/Group Name	Presence	Range	IE Type and Reference	Semantics Description
Geographical Coordinates		1 .. <maxnoofPoints>		
>Latitude Sign	M		ENUMERATED (North, South)	
>Degrees of Latitude	M		INTEGER (0..2 ²³ -1)	The IE value (N) is derived by this formula: $N \leq 2^{23} \times X / 90 < N+1$ X being the latitude in degree (0°.. 90°)
>Degrees of Longitude	M		INTEGER (-2 ²³ ..2 ²³ -1)	The IE value (N) is derived by this formula: $N \leq 2^{24} \times X / 360 < N+1$ X being the longitude in degree (-180°..+180°)

Range bound	Explanation
maxnoofPoints	Maximum no. of points in polygon.

9.2.1.6 Cell Identifier (C-Id)

The C-Id (Cell Identifier) is the identifier of a cell in one RNS.

IE/Group Name	Presence	Range	IE Type and Reference	Semantics Description
C-Id			INTEGER (0..65535)	

9.2.1.7 Cell Individual Offset

Cell individual offset is an offset that will be applied by UE to the measurement results for a Primary-CPICH [FDD]/ Primary-CCPCH [TDD] or for GSM Carrier RSSI according to [16].

IE/Group Name	Presence	Range	IE Type and Reference	Semantics Description
Cell Individual Offset			INTEGER (-20,...,+20)	-20 -> -10dB -19 -> -9.5dB ... +20 -> +10dB

9.2.1.8 Cell Parameter ID

The Cell Parameter ID identifies unambiguously the Code Groups, Scrambling Codes, Midambles and Toffset (see table 9 of ref. [13]).

IE/Group Name	Presence	Range	IE Type and Reference	Semantics Description
Cell Parameter ID			INTEGER (0..127,...)	

9.2.1.9 CFN

Connection Frame Number for the radio connection, see ref. [17].

IE/Group Name	Presence	Range	IE Type and Reference	Semantics Description
CFN			INTEGER (0.. 255)	

9.2.1.10 CFN Offset

Void

9.2.1.11 CN CS Domain Identifier

Identification of the CN node in the CS Domain.

IE/Group Name	Presence	Range	IE Type and Reference	Semantics Description
PLMN Identity	M		OCTET STRING (3)	<ul style="list-style-type: none"> - digits 0 to 9, two digits per octet, - each digit encoded 0000 to 1001, - 1111 used as filler - bit 4 to 1 of octet n encoding digit 2n-1 - bit 8 to 5 of octet n encoding digit 2n <p>-The PLMN Identity consists of 3 digits from MCC followed by either</p> <ul style="list-style-type: none"> -a filler plus 2 digits from MNC (in case of 2 digit MNC) or -3 digits from MNC (in case of a 3 digit MNC).
LAC	M		OCTET STRING (2)	0000 and FFFE not allowed

9.2.1.11A CN Domain Type

Identifies the type of core network domain.

IE/Group Name	Presence	Range	IE Type and Reference	Semantics Description
CN Domain Type			ENUMERATED (CS domain, PS domain, Don't care,...)	See in [16]

9.2.1.12 CN PS Domain Identifier

Identification of the CN Node in the PS Domain.

IE/Group Name	Presence	Range	IE Type and Reference	Semantics Description
PLMN Identity	M		OCTET STRING (3)	<ul style="list-style-type: none"> - digits 0 to 9, two digits per octet, - each digit encoded 0000 to 1001, - 1111 used as filler - bit 4 to 1 of octet n encoding digit 2n-1 - bit 8 to 5 of octet n encoding digit 2n <p>-The PLMN Identity consists of 3 digits from MCC followed by either</p> <ul style="list-style-type: none"> -a filler plus 2 digits from MNC (in case of 2 digit MNC) or -3 digits from MNC (in case of a 3 digit MNC).
LAC	M		OCTET STRING (2)	0000 and FFFE not allowed
RAC	M		OCTET STRING (1)	

9.2.1.13 Criticality Diagnostics

The *Criticality Diagnostics* IE is sent by an RNC when parts of a received message have not been comprehended or were missing, or if the message contained logical errors. When applicable, it contains information about which IEs that were not comprehended or were missing.

For further details on how to use the *Criticality Diagnostics* IE, see Annex C.

IE/Group Name	Presence	Range	IE Type and Reference	Semantics Description	Criticality	Assigned Criticality
Procedure ID		0..1		Procedure ID is to be used if Criticality Diagnostics is part of Error Indication procedure, and not within the response message of the same procedure that caused the error	–	
>Procedure Code	M		INTEGER (0..255)		–	
>Ddmode	M		ENUMERATED (TDD, FDD, Common)	Common = common to FDD and TDD.	–	
Triggering Message	O		ENUMERATED (initiating message, successful outcome, unsuccessful outcome)	The Triggering Message is used only if the Criticality Diagnostics is part of Error Indication.	–	
Procedure Criticality	O		ENUMERATED (reject, ignore, notify)	This Procedure Criticality is used for reporting the Criticality of the Triggering message (Procedure).	–	
Transaction ID	O		9.2.1.59		–	
Information Element Criticality Diagnostics		0..<max noof errors>			–	
>IE Criticality	M		ENUMERATED (reject, ignore, notify)	The IE Criticality is used for reporting the criticality of the triggering IE. The value 'Ignore' shall never be used.	–	
>IE Id	M		INTEGER (0..65535)	The IE Id of the not understood or missing IE as defined in the ASN.1 part of the specification.	–	
>Repetition Number	O		INTEGER (0..255)	The <i>Repetition Number</i> IE gives <ul style="list-style-type: none"> in case of a not understood IE: The number of occurrences of the reported IE up to and including the not understood occurrence in case of a missing IE: The number of occurrences up to but not including the missing occurrence. 	–	
Note: All the counted						

				occurrences of the reported IE must have the same topdown hierachical message structure of IEs with assigned criticality above them.		
>Message Structure	O		9.2.1.39A	The <i>Message Structure</i> IE describes the structure where the not understood or missing IE was detected. This IE is included if the not understood IE is not the top level of the message.	YES	ignore
>Type of Error	M		ENUMERATED(not understood, missing, ...)		YES	ignore

Range bound	Explanation
<i>maxnooferrors</i>	Maximum number of IE errors allowed to be reported with a single message.

9.2.1.14 C-RNTI

C-RNTI (Cell RNTI) is the UE identifier allocated by the DRNS to be used over the radio interface. It is unique in the cell. One UE Context has one unique C-RNTI value allocated in the DRNS.

IE/Group Name	Presence	Range	IE Type and Reference	Semantics Description
C-RNTI			INTEGER(0..65535)	

9.2.1.15 DCH Combination Indicator

Void

9.2.1.16 DCH ID

The DCH ID is the identifier of an active dedicated transport channel. It is unique for each active DCH among the active DCHs simultaneously allocated for the same UE.

IE/Group Name	Presence	Range	IE Type and Reference	Semantics Description
DCH ID			INTEGER (0..255)	

9.2.1.16A DCH Information Response

The *DCH Information* IE provides information for DCHs that have been established or modified.

IE/Group Name	Presence	Range	IE Type and Reference	Semantics Description	Criticality	Assigned Criticality
DCH Information Response		<i>1..<maxno ofDCHs></i>			–	
>DCH ID	M		9.2.1.16		–	
>Binding ID	O		9.2.1.3		–	
>Transport Layer Address	O		9.2.1.62		–	

Range bound	Explanation
<i>maxnoofDCHs</i>	Maximum number of DCHs for one UE.

9.2.1.17 Dedicated Measurement Object Type

Void

9.2.1.18 Dedicated Measurement Type

The Dedicated Measurement Type identifies the type of measurement that shall be performed.

IE/Group Name	Presence	Range	IE Type and Reference	Semantics Description
Dedicated Measurement Type			ENUMERATED (SIR, SIR Error, Transmitted Code Power, RSCP, Rx Timing Deviation, Round Trip Time, ...)	RSCP, Rx Timing Deviation are used by TDD only, Round Trip Time, SIR Error are used by FDD only.

NOTE: For definitions of the measurement types refer to ref. [11] and [14].

9.2.1.19 Dedicated Measurement Value

The Dedicated Measurement Value shall be the most recent value for this measurement, for which the reporting criteria were met.

IE/Group Name	Presence	Range	IE Type and Reference	Semantics Description
CHOICE <i>Dedicated Measurement Value</i>				
> <i>SIR Value</i>				
>>SIR Value	M		INTEGER(0..63)	According to mapping in ref. [23] and [24]
> <i>SIR Error Value</i>				FDD Only
>>SIR Error Value	M		INTEGER(0..125)	According to mapping in [23]
> <i>Transmitted Code Power Value</i>				
>>Transmitted Code Power Value	M		INTEGER(0..127)	According to mapping in ref. [23] and [24] Values 0 to 9 and 123 to 127 shall not be used.
> <i>RSCP</i>				TDD Only
>>RSCP	M		INTEGER(0..127)	According to mapping in ref. [24]
> <i>Rx Timing Deviation</i>				TDD Only
>>Rx Timing Deviation	M		INTEGER(0..8191)	According to mapping in [24]
> <i>Round Trip Time</i>				FDD Only
>>Round Trip Time	M		INTEGER(0..32767)	According to mapping in [23]

9.2.1.19A Dedicated Measurement Value Information

The *Dedicated Measurement Value Information* IE provides information both on whether or not the Dedicated Measurement Value is provided in the message and if provided also the Dedicated Measurement Value itself.

IE/Group Name	Presence	Range	IE Type and Reference	Semantics Description	Criticality	Assigned Criticality
CHOICE <i>Measurement Availability Indicator</i>	M				–	
> <i>Measurement Available</i>					–	
>>Dedicated Measurement Value	M		9.2.1.19		–	
>>CFN	O		9.2.1.9	Dedicated Measurement Time Reference	–	
> <i>Measurement not Available</i>			NULL		–	

9.2.1.20 Diversity Control Field

The Diversity Control Field indicates if the current RL may, must or must not be combined with the already existing RLs.

IE/Group Name	Presence	Range	IE Type and Reference	Semantics Description
Diversity Control Field			ENUMERATED(May, Must, Must not)	

9.2.1.21 Diversity Indication

Void.

9.2.1.21A DL Power

The *DL Power* IE indicates a power level relative to the [FDD - primary CPICH power] [TDD - PCCPCH power] configured in a cell [FDD - If referred to a DPCH, it indicates the power of the transmitted DPDCH symbols].

IE/Group Name	Presence	Range	IE Type and Reference	Semantics Description
DL Power			INTEGER (-350..150)	Value = DL Power /10 Unit dB Range -35.0 .. +15.0 Step 0.1dB

9.2.1.22 Downlink SIR Target

Void

9.2.1.23 DPCH Constant Value

DPCH Constant Value is the power margin used by a UE to set the proper uplink power.

IE/Group Name	Presence	Range	IE Type and Reference	Semantics Description
DPCH Constant Value			INTEGER (-10..10)	Unit dB Granularity 1 dB.

9.2.1.24 D-RNTI

The D-RNTI identifies the UE Context in the DRNC.

IE/Group Name	Presence	Range	IE Type and Reference	Semantics Description
D-RNTI			INTEGER (0..2 ²⁰ -1)	

9.2.1.25 D-RNTI Release Indication

The D-RNTI Release Indication indicates whether or not a DRNC shall release the D-RNTI allocated for a particular UE.

IE/Group Name	Presence	Range	IE Type and Reference	Semantics Description
D-RNTI Release Indication			ENUMERATED (Release D-RNTI, not Release D-RNTI)	

9.2.1.26 DRX Cycle Length Coefficient

The DRX Cycle Length Coefficient is used as input for the formula to establish the paging occasions to be used in DRX.

IE/Group Name	Presence	Range	IE Type and Reference	Semantics Description
DRX Cycle Length Coefficient			INTEGER (3..9)	Refers to 'k' in the formula as specified in ref. [15], Discontinuous Reception.

9.2.1.26A DSCH ID

The DSCH ID is the identifier of an active downlink shared channel. It is unique for each active DSCH among the active DSCHs simultaneously allocated for the same UE.

IE/Group Name	Presence	Range	IE Type and Reference	Semantics Description
DSCH ID			INTEGER (0..255)	

9.2.1.26B DSCH Flow Control Information

The *DSCH Flow Control Information* IE provides flow control information for each scheduling priority class for the DSCH FP over Iur.

IE/Group Name	Presence	Range	IE Type and Reference	Semantics Description	Criticality	Assigned Criticality
DSCH Flow Control Information		1..16			–	
>DSCH Scheduling Priority	M		Scheduling Priority Indicator 9.2.1.51A		–	
>MAC-c/sh SDU Length		1..<maxNb MAC-c/shSDULength>			–	
>>MAC-c/sh SDU Length	M		9.2.1.34		–	

Range bound	Explanation
maxNbMAC-c/shSDULength	Maximum number of different MAC-c/sh SDU lengths.

9.2.1.26Ba DSCH-RNTI

DSCH-RNTI is the UE identifier allocated by DRNS to be used over the radio interface by UEs having one or several DSCHs [TDD – and/or USCHs]. It is unique within a cell.

IE/Group Name	Presence	Range	IE type and reference	Semantics description
DSCH-RNTI			INTEGER(0..65535)	

9.2.1.26Bb Extended GSM Cell Individual Offset

Extended GSM Cell individual offset is an offset that will be applied by UE to the measurement results for GSM carrier RSSI according to [16]. It shall be used when the offset exceeds the range of values that can be indicated using the *Cell Individual Offset* IE (Subclause 9.2.1.7).

IE/Group Name	Presence	Range	IE Type and Reference	Semantics Description
Extended GSM Cell Individual Offset			INTEGER (-50..-11 11..50)	Unit in dB. Step size is 1 dB.

9.2.1.26C FACH Flow Control Information

The *FACH Flow Control Information* IE provides flow control information for each scheduling priority class for the FACH FP over Iur.

IE/Group Name	Presence	Range	IE Type and Reference	Semantics Description	Criticality	Assigned Criticality
FACH Flow Control Information		1..16			–	
>FACH Scheduling Priority	M		Scheduling Priority Indicator 9.2.1.51A		–	
>MAC-c/sh SDU Length		1..<maxNb MAC-c/shSDULength>			–	
>>MAC-c/sh SDU Length	M		9.2.1.34		–	
>FACH Initial Window Size	M		9.2.1.27		–	

Range bound	Explanation
maxNbMAC-c/shSDULength	Maximum number of different MAC-c/sh SDU lengths.

9.2.1.27 FACH Initial Window Size

Indicates the initial number of MAC-c/sh SDUs that may be transmitted before an acknowledgement is received from the DRNC.

IE/Group Name	Presence	Range	IE Type and Reference	Semantics Description
FACH Initial Window Size			INTEGER (0..255)	Number of frames (MAC-c/sh SDUs.) 255 = Unlimited number of FACH data frames.

9.2.1.28 FACH Priority Indicator

Void

9.2.1.28A FN Reporting Indicator

Frame Number reporting indicator.

Indicates if the CFN shall be included together with the reported measurement value.

IE/Group Name	Presence	Range	IE Type and Reference	Semantics Description
FN reporting indicator			ENUMERATED(FN reporting required, FN reporting not required)	

9.2.1.29 Frame Handling Priority

This parameter indicates the priority level to be used during the lifetime of the DCH/DSCH for temporary restriction of the allocated resources due overload reason.

IE/Group Name	Presence	Range	IE Type and Reference	Semantics Description
Frame Handling Priority			INTEGER (0..15)	0=Lowest Priority, ... 15=Highest Priority

9.2.1.30 Frame Offset

Frame Offset is the required offset between the dedicated channel downlink transmission frames (CFN, Connection Frame Number) and the broadcast channel frame offset (Cell Frame Number). The Frame_offset is used in the translation between Connection Frame Number (CFN) on Iub/Iur and least significant 8 bits of SFN (System Frame Number) on Uu. The Frame Offset is UE and cell specific.

IE/Group Name	Presence	Range	IE Type and Reference	Semantics Description
Frame Offset			INTEGER (0..255)	Frames

9.2.1.31 IMSI

The IMSI is the permanent UE user Identity, see ref. [1].

IE/Group Name	Presence	Range	IE Type and Reference	Semantics Description
IMSI			OCTET STRING (SIZE(3..8))	-Decimal digits coded in BCD -'1111' used as filler -bit 4 to 1 of octet n is encoding digit 2n-1 -bit 8 to 5 of octet n is encoding digit 2n

9.2.1.32 L3 Information

This parameter contains the Layer 3 Information from a Uu message as received from the UE over the Uu interface or the Layer 3 Information for a Uu message to be sent to a UE by the DRNC, as defined in ref. [16].

IE/Group Name	Presence	Range	IE Type and Reference	Semantics Description
L3 Information			BIT STRING	The content is defined in ref. [16]

9.2.1.33 Limited Power Increase

Void.

9.2.1.34 MAC-c/sh SDU Length

Indicates the MAC-c/sh SDU Length. Which is used for FACH, DSCH and USCH. There may be multiple MAC-c/sh SDU Lengths per priority class.

IE/Group Name	Presence	Range	IE Type and Reference	Semantics Description
MAC-c/sh SDU Length			INTEGER (1..5000)	Size of the MAC-c/sh SDU in number of bits.

9.2.1.35 Maximum Allowed UL Tx Power

Maximum Allowed UL Tx Power is the maximum power that a UE in a particular cell is allowed to transmit.

IE/Group Name	Presence	Range	IE Type and Reference	Semantics Description
Maximum Allowed UL Tx Power			INTEGER (-50..+33)	dBm

9.2.1.35A Measurement Availability Indicator

Void

9.2.1.35B Measurement Change Time

IE/Group Name	Presence	Range	IE Type and Reference	Semantics Description
Measurement Change Time			INTEGER (1..6000,...)	Unit: ms Range: 10..60000 ms Step: 10 ms

9.2.1.36 Measurement Filter Coefficient

The Measurement Filter Coefficient determines the amount of filtering to be applied for measurements.

IE/Group Name	Presence	Range	IE Type and Reference	Semantics Description
Measurement Filter Coefficient			ENUMERATED(0, 1, 2, 3, 4, 5, 6, 7, 8, 9, 11, 13, 15, 17, 19,...)	

9.2.1.36A Measurement Hysteresis Time

The Measurement Hysteresis Time provides the duration during which a reporting criterion has to be fulfilled for the Measurement Reporting procedure to be triggered.

IE/Group Name	Presence	Range	IE Type and Reference	Semantics Description
Measurement Hysteresis Time			INTEGER (1..6000,...)	Unit: ms Range: 10..60000 ms Step: 10 ms

9.2.1.37 Measurement ID

The Measurement Id uniquely identifies a dedicated measurement within a UE Context.

IE/Group Name	Presence	Range	IE Type and Reference	Semantics Description
Measurement ID			INTEGER(0 .. 2 ²⁰ -1)	

9.2.1.38 Measurement Increase/Decrease Threshold

The Measurement Increase/Decrease Threshold defines the threshold that shall trigger Event C or D.

IE/Group Name	Presence	Range	IE Type and Reference	Semantics Description
CHOICE <i>Measurement Increase/Decrease Threshold</i>				
> <i>SIR</i>				
>>SIR	M		INTEGER(0..62)	0: 0 dB 1: 0.5 dB 2: 1 dB ... 62: 31dB
> <i>SIR Error</i>				FDD Only
>>SIR Error	M		INTEGER(0..124)	0: 0 dB 1: 0.5 dB 2: 1 dB ... 124: 62 dB
> <i>Transmitted Code Power</i>				
>>Transmitted Code Power	M		INTEGER(0..112,...)	0: 0 dB 1: 0.5 dB 2: 1 dB ... 112: 56 dB
> <i>RSCP</i>				TDD Only
>>RSCP	M		INTEGER(0..126)	0: 0 dB 1: 0.5 dB 2: 1 dB ... 126: 63 dB
> <i>Round Trip Time</i>				FDD Only
>>Round Trip Time	M		INTEGER(0..32766)	0: 0 chips 1: 0.0625 chips 2: 0.1250 chips ... 32766: 2047.875 chips

9.2.1.39 Measurement Threshold

The Measurement Threshold defines which threshold that shall trigger Event A, B, E or F.

IE/Group Name	Presence	Range	IE Type and Reference	Semantics Description
CHOICE <i>Measurement Threshold</i>				
> <i>SIR</i>				
>> <i>SIR</i>	M		INTEGER(0..63)	According to mapping in ref. [23] and [24].
> <i>SIR Error</i>				FDD Only
>> <i>SIR Error</i>	M		INTEGER(0..125)	According to mapping in [23]
> <i>Transmitted Code Power</i>				
>> <i>Transmitted Code Power</i>	M		INTEGER(0..127)	According to mapping in ref. [23] and [24].
> <i>RSCP</i>				TDD Only
>> <i>RSCP</i>	M		INTEGER(0..127)	According to mapping in ref. [24]
> <i>Rx Timing Deviation</i>				TDD Only
>> <i>Rx Timing Deviation</i>	M		INTEGER(0..8191)	According to mapping in [24]
> <i>Round Trip Time</i>				FDD Only
>> <i>Round Trip Time</i>	M		INTEGER(0..32767)	According to mapping in [23]

9.2.1.39A Message Structure

The *Message Structure* IE gives information for each level with assigned criticality in an hierarchical message structure from top level down to the lowest level above the reported level for the occurred error (reported in the *Information Element Criticality Diagnostics* IE).

IE/Group Name	Presence	Range	IE Type and Reference	Semantics Description	Criticality	Assigned Criticality
Message structure		1.. <maxnooflevels>		The first repetition of the <i>Message Structure</i> IE corresponds to the top level of the message. The last repetition of the <i>Message Structure</i> IE corresponds to the level above the reported level for the occurred error of the message.	GLOBAL	ignore
>IE ID	M		INTEGER (0..65535)	The IE ID of this level's IE containing the not understood or missing IE.	-	
>Repetition Number	O		INTEGER (1..256)	The <i>Repetition Number</i> IE gives, if applicable, the number of occurrences of this level's reported IE up to and including the occurrence containing the not understood or missing IE. Note: All the counted occurrences of the reported IE must have the same topdown hierarchical message structure of IEs with assigned criticality above them.	-	

Range bound	Explanation
<i>maxnooflevels</i>	Maximum no. of message levels to report. The value for <i>maxnooflevels</i> is 256.

9.2.1.40 Message Type

The Message Type uniquely identifies the message being sent.

IE/Group Name	Presence	Range	IE Type and Reference	Semantics Description
Procedure ID		1		
>Procedure Code	M		INTEGER (0..255)	"0" = Common Transport Channel Resources Initialisation "1" = Common Transport Channel Resources Release "2" = Compressed Mode Command "3" = Downlink Power Control "4" = Downlink Power Timeslot Control "5" = Downlink Signalling Transfer "6" = Error Indication "7" = Dedicated Measurement Failure "8" = Dedicated Measurement Initiation "9" = Dedicated Measurement Reporting "10" = Dedicated Measurement Termination "11" = Paging "12" = Physical Channel Reconfiguration "14" = Radio Link Addition "15" = Radio Link Deletion "16" = Radio Link Failure "17" = Radio Link Preemption "18" = Radio Link Restoration "19" = Radio Link Setup "20" = Relocation Commit "21" = Synchronised Radio Link Reconfiguration Cancellation "22" = Synchronised Radio Link Reconfiguration Commit "23" = Synchronised Radio Link Reconfiguration Preparation "24" = UnSynchronised Radio Link Reconfiguration "25" = Uplink Signalling Transfer
>Ddmode	M		ENUMERATED (FDD, TDD, Common, ...)	Common = common to FDD and TDD.
Type of Message	M		ENUMERATED (Initiating Message, Successful Outcome, Unsuccessful Outcome, Outcome)	

9.2.1.41 Multiple URAs Indicator

The Multiple URAs Indicator indicates whether the accessed cell has multiple URAs.

IE/Group Name	Presence	Range	IE Type and Reference	Semantics Description
Multiple URAs Indicator			ENUMERATED (Multiple URAs exist, Single URA Exists)	

9.2.1.41A Neighbouring UMTS Cell Information

The *Neighbouring UMTS Cell Information* IE provides information for UMTS Cells that are neighbouring cells to a cell in the DRNC. The neighbouring cell information is provided for each RNC (including the DRNC) that has cells that are neighbouring cells to the cell in the DRNC.

IE/Group Name	Presence	Range	IE Type and Reference	Semantics Description	Criticality	Assigned Criticality
Neighbouring UMTS Cell Information		1..<maxnoofneighbouringRNCs>			EACH	ignore
>RNC-Id	M		9.2.1.50		–	
>CN PS Domain Identifier	O		9.2.1.12		–	
>CN CS Domain Identifier	O		9.2.1.11		–	
>Neighbouring FDD Cell Information	O		9.2.1.41B		–	
>Neighbouring TDD Cell Information	O		9.2.1.41D		–	

Range bound	Explanation
<i>maxnoofneighbouringRNCs</i>	Maximum number of neighbouring RNCs.

9.2.1.41B Neighbouring FDD Cell Information

The *Neighbouring FDD Cell Information* IE provides information for FDD cells that are a neighbouring cells to a cell in the DRNC.

IE/Group Name	Presence	Range	IE Type and Reference	Semantics Description	Criticality	Assigned Criticality
Neighbouring FDD Cell Information		1..<maxnoofFDDneighbours>			–	
>C-Id	M		9.2.1.6		–	
>UL UARFCN	M		UARFCN 9.2.1.66	Corresponds to Nu in ref. [6]	–	
>DL UARFCN	M		UARFCN 9.2.1.66	Corresponds to Nd in ref. [6]	–	
>Frame Offset	O		9.2.1.30		–	
>Primary Scrambling Code	M		9.2.1.45		–	
>Primary CPICH Power	O		9.2.1.44		–	
>Cell Individual Offset	O		9.2.1.7		–	
>Tx Diversity Indicator	M		9.2.2.50		–	
>STTD Support Indicator	O		9.2.2.45		–	
>Closed Loop Mode1 Support Indicator	O		9.2.2.2		–	
>Closed Loop Mode2 Support Indicator	O		9.2.2.3		–	
>Restriction State Indicator	O		9.2.1.48A		YES	ignore

Range bound	Explanation
<i>maxnoofFDDneighbours</i>	Maximum number of neighbouring FDD cell for one cell.

9.2.1.41C Neighbouring GSM Cell Information

The *Neighbouring GSM Cell Information* IE provides information for all GSM Cells that are a neighbouring cell to a cell in the DRNC.

IE/Group Name	Presence	Range	IE Type and Reference	Semantics Description	Criticality	Assigned Criticality
Neighbouring GSM Cell Information		1..<maxnoof GSMneighbours>			GLOBAL	ignore
>CGI		1		Cell Global Identity as defined in ref. [1].	–	
>>LAI		1			–	
>>>PLMN Identity	M		OCTET STRING (3)	<ul style="list-style-type: none"> - digits 0 to 9, two digits per octet, - each digit encoded 0000 to 1001, - 1111 used as filler - bit 4 to 1 of octet n encoding digit 2n-1 - bit 8 to 5 of octet n encoding digit 2n <p>-The PLMN Identity consists of 3 digits from MCC followed by either</p> <ul style="list-style-type: none"> -a filler plus 2 digits from MNC (in case of 2 digit MNC) or -3 digits from MNC (in case of a 3 digit MNC). 	–	
>>>LAC	M		OCTET STRING (2)	0000 and FFFE not allowed	–	
>>CI	M		OCTET STRING (2)		–	
>Cell Individual Offset	O		9.2.1.7	<p>The Cell Individual Offset to be used for UEs using DCHs. If the <i>Extended GSM Cell Individual Offset</i> IE is present, the <i>Cell Individual Offset</i> IE shall be set to</p> <ul style="list-style-type: none"> a) –10dB if the <i>Extended GSM Cell Individual Offset</i> IE is < -10dB and b) 10dB if 	–	

				the <i>Extended GSM Cell Individual Offset</i> IE is > 10dB.		
>BSIC		1		Base Station Identity Code as defined in ref. [1].	–	
>>NCC	M		BIT STRING(3)	Network Colour Code.	–	
>>BCC	M		BIT STRING(3)	Base Station Colour Code.	–	
>Band Indicator	M		ENUMERATED (DCS 1800 band, PCS 1900 band, ...)	Indicates whether or not the BCCH ARFCN belongs to the 1800 band or 1900 band of GSM frequencies.	–	
>BCCH ARFCN	M		INTEGER (0..1023)	BCCH Frequency as defined in ref. [29].	–	
>Extended GSM Cell Individual Offset	O		9.2.1.26Bb	The Extended GSM Cell Individual Offset to be used for UEs using DCHs, for values that exceed the range of the <i>Cell Individual Offset</i> IE.	YES	ignore

Range bound	Explanation
<i>maxnoofGSMneighbours</i>	Maximum number of neighbouring GSM cells for one cell.

9.2.1.41D Neighbouring TDD Cell Information

The *Neighbouring TDD Cell Information* IE provides information for TDD cells that are a neighbouring cells to a cell in the DRNC.

IE/Group Name	Presence	Range	IE Type and Reference	Semantics Description	Criticality	Assigned Criticality
Neighbouring TDD Cell Information		<i>1..<maxno ofTDDneighbours></i>			–	
>C-Id	M		9.2.1.6		–	
>UARFCN	M		9.2.1.66	Corresponds to Nt in ref. [7]	–	
>Frame Offset	O		9.2.1.30		–	
>Cell Parameter ID	M		9.2.1.8		–	
>Sync Case	M		9.2.1.54		–	
>Time Slot	C-Case1		9.2.1.56		–	
>SCH Time Slot	C-Case2		9.2.1.51		–	
>SCTD Indicator	M		9.2.1.73		–	
>Cell Individual Offset	O		9.2.1.7		–	
>DPCH Constant Value	O		9.2.1.23		–	
>PCCPCH Power	O		9.2.1.43		–	
>Restriction State Indicator	O		9.2.1.48A		YES	ignore

Condition	Explanation
Case1	The IE shall be present if <i>Sync Case</i> IE is set to "Case1".
Case2	The IE shall be present if <i>Sync Case</i> IE is set to "Case2".

Range bound	Explanation
<i>maxnoofTDDneighbours</i>	Maximum number of neighbouring TDD cell for one cell.

9.2.1.41E Paging Cause

Cause for a CN originated page.

IE/Group Name	Presence	Range	IE Type and Reference	Semantics Description
Paging Cause			ENUMERATED(Terminating Conversational Call, Terminating Streaming Call, Terminating Interactive Call, Terminating Background Call, Terminating Low Priority Signalling,... , Terminating High Priority Signalling, Terminating – cause unknown)	See in [16]

9.2.1.41F Paging Record Type

IE/Group Name	Presence	Range	IE Type and Reference	Semantics Description
Paging Record Type			ENUMERATED (IMSI (GSM-MAP), TMSI (GSM-MAP), P-TMSI (GSM-MAP), IMSI (DS-41), TMSI (DS-41),...)	See ref. [16]

9.2.1.42 Payload CRC Present Indicator

This parameter indicates whether FP payload 16 bit CRC is used or not.

IE/Group Name	Presence	Range	IE Type and Reference	Semantics Description
Payload CRC Presence Indicator			ENUMERATED (CRC Included, CRC not included)	

9.2.1.43 PCCPCH Power

Primary CCPCH power is the power that shall be used for reference power value in a TDD cell.

IE/Group Name	Presence	Range	IE Type and Reference	Semantics Description
PCCPCH Power			INTEGER (-150..400,...)	Unit dBm Range -15.0 to 40.0 dBm, Step size 0.1 dB. -15.0 shall indicate $P_{\leq} -15\text{dBm}$ +40.0 shall indicate $P_{\geq} 40\text{dBm}$.

9.2.1.44 Primary CPICH Power

Primary CPICH power is the power that is used for transmitting the Primary CPICH in a cell. The reference point is the antenna connector.

IE/Group Name	Presence	Range	IE Type and Reference	Semantics Description
Primary CPICH Power			INTEGER (-100..500)	Value = Primary CPICH Power/10 Unit dBm Range -10.0..+50.0 Step 0.1 dB

9.2.1.45 Primary Scrambling Code

The Primary scrambling code to be used in the cell.

IE/Group Name	Presence	Range	IE Type and Reference	Semantics Description
Primary Scrambling Code			INTEGER (0 .. 511)	

9.2.1.46 Puncture Limit

The maximum amount of puncturing for a transport channel in rate matching.

IE/Group Name	Presence	Range	IE Type and Reference	Semantics Description
Puncture Limit			INTEGER (0..15)	0: 40% 1: 44 % ... 14: 96% 15: 100% (no puncturing)

9.2.1.46A QE-Selector

The QE-Selector indicates from which source the value for the quality estimate (QE) shall be taken.

IE/Group Name	Presence	Range	IE Type and Reference	Semantics Description
QE-Selector			ENUMERATED(selected, non-selected)	

9.2.1.47 RANAP Relocation Information

This parameter is transparent to the RNSAP. The parameter contains information for the Relocation procedure as defined in [2].

IE/Group Name	Presence	Range	IE Type and Reference	Semantics Description
RANAP Relocation Information			BIT STRING	The contents is defined in ref. [2].

9.2.1.48 Report Characteristics

The Report Characteristics, defines how the reporting shall be performed.

IE/Group Name	Presence	Range	IE Type and Reference	Semantics Description
CHOICE <i>Report Characteristics</i>				
> <i>OnDemand</i>			NULL	
> <i>Periodic</i>				
>>Report Periodicity	M		9.2.1.48a	The periodicity with which the DRNS shall send measurement reports.
> <i>Event A</i>				
>>Measurement Threshold	M		9.2.1.39	The threshold for which the DRNS shall trigger a measurement report.
>>Measurement Hysteresis Time	O		9.2.1.36A	
> <i>Event B</i>				
>>Measurement Threshold	M		9.2.1.39	The threshold for which the DRNS shall trigger a measurement report.
>>Measurement Hysteresis Time	O		9.2.1.36A	
> <i>Event C</i>				
>>Measurement Increase/Decrease Threshold	M		9.2.1.38	
>>Measurement Change Time	M		9.2.1.35B	The time within which the measurement entity shall rise, in order to trigger a measurement report.
> <i>Event D</i>				
>>Measurement Increase/Decrease Threshold	M		9.2.1.38	
>>Measurement Change Time	M		9.2.1.35B	The time within which the measurement entity shall fall, in order to trigger a measurement report.
> <i>Event E</i>				
>>Measurement Threshold 1	M		9.2.1.39	
>>Measurement Threshold 2	O		9.2.1.39	
>>Measurement Hysteresis Time	O		9.2.1.36A	The hysteresis time in ms
>>Report Periodicity	O		9.2.1.48a	The periodicity with which the DRNS shall send measurement reports.
> <i>Event F</i>				
>>Measurement Threshold 1	M		9.2.1.39	
>>Measurement Threshold 2	O		9.2.1.39	
>>Measurement Hysteresis Time	O		9.2.1.36A	The hysteresis time in ms
>>Report Periodicity	O		9.2.1.48a	The periodicity with which the DRNS shall send measurement reports.

9.2.1.48a Report Periodicity

The Report Periodicity defines the frequency at which the Node B shall send measurement reports.

IE/Group Name	Presence	Range	IE Type and Reference	Semantics Description
CHOICE <i>Report Periodicity Scale</i>				
> <i>millisecond</i>				
>>Report Periodicity Value	M		INTEGER (1..6000,...)	Unit: ms Range: 10..60000 ms Step: 10 ms
> <i>minute</i>				
>>Report Periodicity Value	M		INTEGER (1..60,...)	Unit: min Range: 1..60 min Step: 1 min

9.2.1.48A Restriction State Indicator

The Restriction state indicator is the identifier indicates whether the cell is "Cell Reserved for Operator Use" or not. It is provided by DRNS and reported to SRNC.

IE/Group Name	Presence	Range	IE Type and Reference	Semantics Description
Restriction state indicator			ENUMERATED(Cell Not Reserved for Operator Use, Cell Reserved for Operator Use, ...)	

9.2.1.49 RL ID

The RL ID is the unique identifier for one RL associated with a UE.

IE/Group Name	Presence	Range	IE Type and Reference	Semantics Description
RL ID			INTEGER (0..31)	

9.2.1.50 RNC-Id

This is the identifier of one RNC in UTRAN.

IE/Group Name	Presence	Range	IE Type and Reference	Semantics Description
RNC-Id			INTEGER (0..4095)	

9.2.1.51 SCH Time Slot

The *SCH Time Slot* IE represents the first time slot (k) of a pair of time slots inside a Radio Frame that is assigned to the Physical Channel SCH. The *SCH Time Slot* IE is only applicable if the value of *Sync Case* IE is Case 2 since in this case the SCH is allocated in TS#k and TS#k+8.

IE/Group Name	Presence	Range	IE Type and Reference	Semantics Description
SCH Time Slot			INTEGER(0..6)	

9.2.1.51A Scheduling Priority Indicator

Indicates the relative priority of the FACH, DSCH, or USCH data frame. Used by the DRNC when scheduling FACH, DSCH, or USCH traffic.

IE/Group Name	Presence	Range	IE Type and Reference	Semantics Description
Scheduling Priority Indicator			INTEGER (0..15)	Relative priority of the FACH, DSCH, or USCH data frame: 0=Lowest Priority ... 15=Highest Priority

9.2.1.52 Service Area Identifier (SAI)

This information element is used to identify an area consisting of one or more cells belonging to the same Location Area. Such an area is called a Service Area and can be used for indicating the location of a UE to the CN. For this protocol, only a Service Area that is defined to be applicable to the PS and CS domains shall be used.

IE/Group Name	Presence	Range	IE Type and Reference	Semantics Description
PLMN Identity	M		OCTET STRING (3)	- digits 0 to 9, two digits per octet, - each digit encoded 0000 to 1001, - 1111 used as filler - bit 4 to 1 of octet n encoding digit 2n-1 - bit 8 to 5 of octet n encoding digit 2n -The PLMN Identity consists of 3 digits from MCC followed by either -a filler plus 2 digits from MNC (in case of 2 digit MNC) or -3 digits from MNC (in case of a 3 digit MNC).
LAC	M		OCTET STRING (2)	0000 and FFFE not allowed
SAC	M		OCTET STRING (2)	

9.2.1.53 S-RNTI

The S-RNTI identifies the UE in the SRNC.

IE/Group Name	Presence	Range	IE Type and Reference	Semantics Description
S-RNTI			INTEGER(0.. $2^{20}-1$)	

9.2.1.54 Sync Case

The SCH and PCCPCH in a TDD cell are mapped on one or two downlink slots per frame. There are two cases of Sync Case as follows:

- Case 1) SCH and PCCPCH allocated in a single TS#k
- Case 2) SCH allocated in two TS: TS#k and TS#k+8
PCCPCH allocated in TS#k

IE/Group Name	Presence	Range	IE Type and Reference	Semantics Description
Sync Case			INTEGER (1..2,...)	

9.2.1.55 TFCI Presence

The TFCI Presence parameter indicates whether the TFCI shall be included. [TDD - If it is present in the timeslot, it will be mapped to the channelisation code defined by [12].]

IE/Group Name	Presence	Range	IE Type and Reference	Semantics Description
TFCI Presence			ENUMERATED (Present, not present)	

9.2.1.56 Time Slot

The Time Slot represents the time interval assigned to a Physical Channel referred to the start of a Radio Frame.

IE/Group Name	Presence	Range	IE Type and Reference	Semantics Description
Time Slot			INTEGER (0..14)	

9.2.1.57 ToAWE

ToAWE is the window endpoint. DL data frames are expected to be received before this window endpoint. ToAWE is defined with a positive value relative Latest Time of Arrival (LToA). A data frame arriving after ToAWE gives a Timing Adjustment Control frame response.

IE/Group Name	Presence	Range	IE Type and Reference	Semantics Description
ToAWE			INTEGER (0..2559)	msec.

9.2.1.58 ToAWS

ToAWS is the window startpoint. DL data frames are expected to be received after this window startpoint. ToAWS is defined with a positive value relative Time of Arrival Window Endpoint (ToAWE). A data frame arriving before ToAWS gives a Timing Adjustment Control frame response.

IE/Group Name	Presence	Range	IE Type and Reference	Semantics Description
ToAWS			INTEGER (0..1279)	msec.

9.2.1.59 Transaction ID

The Transaction ID is used to associate all the messages belonging to the same procedure. Messages belonging to the same procedure shall use the same Transaction ID.

The Transaction ID is determined by the initiating peer of a procedure.

For procedures addressed to a specific UE Context, the Transaction ID shall uniquely identify a procedure among all ongoing parallel procedures for the same UE using the same procedure code, and initiated by the same protocol peer.

For procedures not addressed to a specific UE Context, the Transaction ID shall uniquely identify a procedure among all ongoing parallel procedures using the same procedure code, and initiated by the same protocol peer.

IE/Group Name	Presence	Range	IE Type and Reference	Semantics Description
Transaction ID			CHOICE INTEGER (0..127) or INTEGER (0..32767)	The Transaction ID shall be interpreted for its integer value, not for the type of encoding ("short" or "long").

9.2.1.60 Transport Bearer ID

The Transport Bearer ID uniquely identifies an Iur transport bearer.

IE/Group Name	Presence	Range	IE Type and Reference	Semantics Description
Transport Bearer ID			INTEGER (0..4095)	

9.2.1.61 Transport Bearer Request Indicator

Indicates whether a new Iur transport bearer needs to be established for carrying the corresponding data stream(s), or whether an existing transport bearer will be used.

IE/Group Name	Presence	Range	IE Type and Reference	Semantics Description
Transport Bearer Request Indicator			ENUMERATED (Bearer Requested, Bearer not Requested, ...)	

9.2.1.62 Transport Layer Address

Transport Layer Address defines the transport address of the DRNS. For details on the Transport Address used see [3].

IE/Group Name	Presence	Range	IE Type and Reference	Semantics Description
Transport Layer Address			BIT STRING(1..1 60, ...)	

9.2.1.63 Transport Format Combination Set (TFCS)

The Transport Format Combination Set is defined as a set of Transport Format Combinations on a Coded Composite Transport Channel. It is the allowed Transport Format Combinations of the corresponding Transport Channels. The DL Transport Format Combination Set is applicable to DL Transport Channels.

[FDD - Where the UE is assigned access to one or more DSCH transport channels then the UTRAN has the choice of two methods for signalling the mapping between TFCI (field 2) values and the corresponding TFC:

Method #1 - TFCI range

The mapping is described in terms of a number of groups, each group corresponding to a given transport format combination (value of CTFC (field2)). The CTFC (field2) value specified in the first group applies for all values of TFCI (field 2) between 0 and the specified 'Max TFCI (field2) value'. The CTFC (field2) value specified in the second group applies for all values of TFCI (field 2) between the 'Max TFCI (field2) value' specified in the last group plus one and the specified 'Max TFCI (field2) value' in the second group. The process continues in the same way for the

following groups with the TFCI (field 2) value used by the UE in constructing its mapping table starting at the largest value reached in the previous group plus one.

Method #2 - Explicit

The mapping between TFCI (field 2) value and CTFC (field2) is spelt out explicitly for each value of TFCI (field2)].

IE/Group Name	Presence	Range	IE Type and Reference	Semantics Description
CHOICE DSCH				
>No Split in the TFCI				This choice is made if: a) The TFCS refers to the uplink OR b) The mode is FDD and none of the Radio Links of the concerned UE are assigned any DSCH transport channels OR c) The mode is TDD
>>TFCS		1..<maxnoofTFCs >		The first instance of the parameter corresponds to TFCI zero, the second to 1 and so on. [TDD - The first entry (for TFCI 0) should be ignored by the receiver.]
>>>CTFC	M		INTEGER(0..MaxCTFC)	Integer number calculated according to ref. [16].
>>>CHOICE Gain Factors	C-PhysChan			
>>>>Signalled Gain Factors				
>>>>>Gain Factor β_c	M		INTEGER (0..15)	[FDD - For UL DPCCH or control part of PRACH ref. [21].] [TDD - β for UL DPCH mapping in accordance to [13].]
>>>>>Gain Factor β_D	M		INTEGER (0..15)	[FDD - For UL DPDCH or data part of PRACH ref. [21].] [TDD - Should be set to 0 by the sender, and shall be ignored by the receiver.]
>>>>>Reference TFC nr	O		INTEGER (0..15)	If this TFC is a reference TFC, this IE indicates the reference number
>>>>>Computed Gain Factors				
>>>>>Reference TFC nr	M		INTEGER (0..15)	Indicates the reference TFC to be used to calculate the gain factors for this TFC
>There is a split in the TFCI				This choice is made if : a) The TFCS refers to the downlink AND b) The mode is FDD and one of the Radio Links of the concerned UE is assigned one or more DSCH transport channels
>>Transport Format Combination_DCH		1..<maxTFCI_1_Combs>		The first instance of the <i>Transport format combination_DCH IE</i> corresponds to TFCI (field 1) = 0, the second to TFCI (field 1) = 1 and so on.
>>>CTFC(field1)	M		INTEGER(0..MaxCTFC)	Integer number calculated according to [16] . The calculation of CTFC ignores any DSCH transport channels which may be assigned
>>Choice Signalling Method				
>>>TFCI Range				

>>>>TFC Mapping on DSCH		1..<maxNoTFCIGroups>		
>>>>>Max TFCI(field2) Value	M		INTEGER(1..maxTFCI_2_Combs - 1)	This is the Maximum value in the range of TFCI(field2) values for which the specified CTFC(field2) applies
>>>>>CTFC(field 2)	M		INTEGER(0..MaxCTFC)	Integer number calculated according to [16] The calculation of CTFC ignores any DCH transport channels which may be assigned
>>>>Explicit				
>>>>>Transport Format Combination_DSCH		1..<maxTFCI_2_Combs>		The first instance of the <i>Transport format combination_DSCH</i> IE corresponds to TFCI (field2) = 0, the second to TFCI (field 2) = 1 and so on.
>>>>>CTFC(field 2)	M		INTEGER(0..MaxCTFC)	Integer number calculated according to [16] . The calculation of CTFC ignores any DCH transport channels which may be assigned

Condition	Explanation
PhysChan	The IE shall be present if the TFCS concerns a UL DPCH [FDD – or PRACH channel].

Range bound	Explanation
maxnoofTFCs	The maximum number of Transport Format Combinations.
maxTFCI_1_Combs	Maximum number of TFCI (field 1) combinations (given by 2 raised to the power of the length of the TFCI (field 1)).
maxTFCI_2_Combs	Maximum number of TFCI (field 2) combinations (given by 2 raised to the power of the length of the TFCI (field 2)).
maxNoTFCIGroups	Maximum number of groups, each group described in terms of a range of TFCI(field 2) values for which a single value of CTFC(field2) applies.
MaxCTFC	Maximum number of the CTFC value is calculated according to the following: $\sum_{i=1}^I (L_i - 1)P_i$ with the notation according to ref. [16].

9.2.1.64 Transport Format Set

The Transport Format Set is defined as the set of Transport Formats associated to a Transport Channel, e.g. DCH.

IE/Group Name	Presence	Range	IE Type and Reference	Semantics Description
Dynamic Transport Format Information		$1..<maxTFcount>$		The first instance of the parameter corresponds to TFI zero, the second to 1 and so on.
>Number of Transport Blocks	M		INTEGER (0..512)	
>Transport Block Size	C – Blocks		INTEGER (0..5000)	Bits
>CHOICE Mode	M			
>>TDD				
>>>Transmission Time Interval Information	C-TTIdynamic	$1..<maxTTIcount>$		
>>>>Transmission Time Interval	M		ENUMERATED(10, 20, 40, 80,...)	msec
Semi-static Transport Format Information		1		
>Transmission Time Interval	M		ENUMERATED(10, 20, 40, 80, dynamic, ...)	msec Value "dynamic" for TDD only
>Type of Channel Coding	M		ENUMERATED(No codingTDD, Convolutional, Turbo,...)	[FDD - The value "No codingTDD" shall be treated as logical error if received]
>Coding Rate	C – Coding		ENUMERATED(1/2, 1/3,...)	
>Rate Matching Attribute	M		INTEGER (1..maxRM)	
>CRC size	M		ENUMERATED(0, 8, 12, 16, 24,...)	
>CHOICE Mode	M			
>>TDD				
>>>2 nd Interleaving Mode	M		ENUMERATED(Frame related, Timeslot related,...)	

Condition	Explanation
Blocks	The IE shall be present if the <i>Number of Transport Blocks</i> IE is set to a value greater than 0.
Coding	The IE shall be present if the <i>Type of Channel Coding</i> IE is set to "Convolutional" or "Turbo".
TTIdynamic	The IE shall be present if the <i>Transmission Time Interval</i> IE of the <i>Semi-static Transport Format Information</i> IE is set to "dynamic".

Range bound	Explanation
<i>maxTFcount</i>	The maximum number of different transport formats that can be included in the Transport format set for one transport channel.
<i>maxRM</i>	The maximum number that could be set as rate matching attribute for a transport channel.
<i>maxTTIcount</i>	The amount of different TTI that are possible for that transport format is.

9.2.1.65 TrCh Source Statistics Descriptor

Defines the statistics of the data transmitted in the transport channel. This information may be used in reserving resources in the DRNS.

IE/Group Name	Presence	Range	IE Type and Reference	Semantics Description
TrCh Source Statistics Descriptor			ENUMERATED (Speech, RRC, Unknown, ...)	'Speech' = Statistics of the data corresponds to speech. 'RRC' = Statistics of the data corresponds to RRC signalling 'Unknown' = The statistics of the data is unknown

9.2.1.66 UARFCN

The UTRA Absolute Radio Frequency Channel Number defines the carrier.

IE/Group Name	Presence	Range	IE Type and Reference	Semantics Description
UARFCN			INTEGER (0..16383, ...)	Corresponds to: 0.0Hz.. 3276.6MHz see ref. [6] and ref. [7].

9.2.1.67 UL FP Mode

This parameter defines if normal or silent mode of the Frame Protocol shall be used for the UL.

IE/Group Name	Presence	Range	IE Type and Reference	Semantics Description
UL FP Mode			ENUMERATED(Normal, Silent,...)	

9.2.1.68 UL Interference Level

Void

9.2.1.69 Uplink SIR

The UL SIR indicates a received UL SIR.

IE/Group Name	Presence	Range	IE Type and Reference	Semantics Description
Uplink SIR			INTEGER (-82..173)	Value = Uplink SIR/10 Unit dB Range -8.2..+17.3 Step 0.1 dB

9.2.1.70 URA ID

IE/Group Name	Presence	Range	IE Type and Reference	Semantics Description
URA ID			INTEGER (0..65 535)	

9.2.1.70A UTRAN Access Point Position

The UTRAN Access Point Position indicates the exact geographical position of the base station antenna.

IE/Group Name	Presence	Range	IE Type and Reference	Semantics Description
Latitude Sign	M		ENUMERATED (North, South)	
Degrees of Latitude	M		INTEGER (0.. $2^{23}-1$)	The IE value (N) is derived by this formula: $N \leq 2^{23} X / 90 < N+1$ X being the latitude in degree (0°.. 90°)
Degrees of Longitude	M		INTEGER ($-2^{23}..2^{23}-1$)	The IE value (N) is derived by this formula: $N \leq 2^{24} X / 360 < N+1$ X being the longitude in degree (-180°..+180°)

9.2.1.70B URA Information

The *URA Information* IE contains URA Information for one cell.

IE/Group Name	Presence	Range	IE Type and Reference	Semantics Description
URA ID	M		9.2.1.70	
Multiple URAs Indicator	M		9.2.1.41	
RNCs with Cells in the Accessed URA		0 .. $\langle maxRNCinURA-1 \rangle$		Other RNCs having at least one cell in the URA identified by the <i>URA ID</i> IE.
>RNC-Id	M		9.2.1.50	

Range Bound	Explanation
$maxRNCinURA$	Maximum number of RNC in one URA.

9.2.1.71 UTRAN Cell Identifier (UC-Id)

The UC-Id (UTRAN Cell identifier) is the identifier of a cell in one UTRAN.

IE/Group Name	Presence	Range	IE Type and Reference	Semantics Description
RNC-Id	M		9.2.1.50	
C-Id	M		9.2.1.6	

9.2.1.72 Permanent NAS UE Identity

This element is used to identify the UE in UTRAN.

IE/Group Name	Presence	Range	IE Type and Reference	Semantics Description
Choice <i>Permanent NAS UE Identity</i>				
>IMSI				
>>IMSI	M		9.2.1.31	

9.2.1.73 SCTD Indicator

Indicates if SCTD antenna diversity is applied or not to the PCCPCH and PICH.

IE/Group Name	Presence	Range	IE Type and Reference	Semantics Description
SCTD Indicator			ENUMERATED(active, inactive)	

9.2.2 FDD Specific Parameters

This subclause contains parameters that are specific to FDD.

9.2.2.A Active Pattern Sequence Information

Defines the parameters for the compressed mode gap pattern sequence activation. For details see ref. [16].

IE/Group Name	Presence	Range	IE Type and Reference	Semantics Description
CM Configuration Change CFN	M		CFN 9.2.1.9	
Transmission Gap Pattern Sequence Status		$0..<maxTGPS>$		If the group is not present, none of the pattern sequences are activated.
>TGPSI Identifier	M		INTEGER(1..<MaxTGPS>)	Establish a reference to the compressed mode pattern sequence. Up to <MaxAPS> simultaneous compressed mode pattern sequences can be activated.
>TGPRC	M		INTEGER(0..511)	The number of transmission gap patterns within the Transmission Gap Pattern Sequence. 0=Infinity.
>TGCFN	M		CFN 9.2.1.9	Connection Frame Number of the first frame of the first pattern 1 within the Transmission Gap Pattern Sequence.

Range bound	Explanation
$maxTGPS$	Maximum number of active pattern sequences. Value 6.

9.2.2.B Adjustment Period

Adjustment Period IE defines the period to be used for power balancing.

IE/Group Name	Presence	Range	IE Type and Reference	Semantics Description
Adjustment Period			INTEGER (1 .. 256)	Frames

9.2.2.C Adjustment Ratio

Adjustment Ratio IE (*Radj*) defines the convergence rate used for the associated Adjustment Period.

IE/Group Name	Presence	Range	IE Type and Reference	Semantics Description
Adjustment Ratio			INTEGER (0 .. 100)	The Adjustment Ratio is given with a granularity of 0.01 0 -> 0.00 1 -> 0.01 ... 100 -> 1.00

9.2.2.1 Chip Offset

The Chip Offset is defined as the radio timing offset inside a radio frame. The Chip Offset is used as offset for the DL DPCH relative to the Primary CPICH timing.

IE/Group Name	Presence	Range	IE Type and Reference	Semantics Description
Chip Offset			INTEGER (0..38399)	Chips

9.2.2.2 Closed Loop Mode1 Support Indicator

The Closed Loop Mode1 Support Indicator indicates whether the particular cell is capable to support Closed loop mode1 or not.

IE/Group Name	Presence	Range	IE Type and Reference	Semantics Description
Closed Loop Mode1 Support Indicator			ENUMERATED (Closed loop mode1 Supported, Closed loop mode1 not supported).	

9.2.2.3 Closed Loop Mode2 Support Indicator

The Closed Loop Mode2 Support Indicator indicates whether the particular cell is capable to support Closed loop mode2 or not.

IE/Group Name	Presence	Range	IE Type and Reference	Semantics Description
Closed Loop Mode2 Support Indicator			ENUMERATED (Closed loop mode2 Supported, Closed loop mode2 not supported).	

9.2.2.3A Closed Loop Timing Adjustment Mode

Indicates when the phase/amplitude adjustment is performed in the DL in relation to the receipt of the UL feedback command in case of closed loop mode transmit diversity on DPCH.

IE/Group Name	Presence	Range	IE Type and Reference	Semantics Description
Closed Loop Timing Adjustment Mode			ENUMERATED (Offset1, Offset2,...)	According to [10] subclause 7.1: Offset1 = slot(j+1)mod15 Offset2 = slot(j+2)mod15

9.2.2.4 Compressed Mode Method

Void

9.2.2.4A DCH FDD Information

The *DCH FDD Information* IE provides information for DCHs to be established.

IE/Group Name	Presence	Range	IE Type and Reference	Semantics Description	Criticality	Assigned Criticality
DCH FDD Information		1..<maxno ofDCHs>			–	
>Payload CRC Presence Indicator	M		9.2.1.42		–	
>UL FP Mode	M		9.2.1.67		–	
>ToAWS	M		9.2.1.58		–	
>ToAWE	M		9.2.1.57		–	
>DCH Specific Info		1..<maxno ofDCHs>			–	
>>DCH ID	M		9.2.1.16		–	
>>TrCh Source Statistics Descriptor	M		9.2.1.65		–	
>>Transport Format Set	M		9.2.1.64	For the UL.	–	
>>Transport Format Set	M		9.2.1.64	For the DL.	–	
>>BLER	M		9.2.1.4	For the UL.	–	
>>BLER	M		9.2.1.4	For the DL.	–	
>>Allocation/Retention Priority	M		9.2.1.1		–	
>>Frame Handling Priority	M		9.2.1.29		–	
>>QE-Selector	M		9.2.1.46A		–	
>>DRAC control	M		9.2.2.13		–	

Range bound	Explanation
<i>maxnoofDCHs</i>	Maximum number of DCHs for one UE.

9.2.2.5 D-Field Length

Void

9.2.2.6 Diversity Control Field

Void.

9.2.2.7 Diversity Indication

Void.

9.2.2.8 Diversity Mode

Define the diversity mode to be applied.

IE/Group Name	Presence	Range	IE Type and Reference	Semantics Description
Diversity Mode			ENUMERATED ED(None, STTD, Closed loop mode 1, Closed loop mode2,...)	

9.2.2.9 DL DPCH Slot Format

Indicates the slot format used in DPCH in DL, according to ref. [8].

IE/Group Name	Presence	Range	IE Type and Reference	Semantics Description
DL DPCH Slot Format			INTEGER (0..16,...)	

9.2.2.10 DL Power

Void

9.2.2.11 DL Scrambling Code

DL Scrambling code to be used by the RL. One cell may have multiple DL Scrambling codes available.

IE/Group Name	Presence	Range	IE Type and Reference	Semantics Description
DL Scrambling Code			INTEGER (0..15)	0= Primary scrambling code of the cell 1...15= Secondary scrambling code

9.2.2.12 Downlink Frame Type

Void

9.2.2.13 DRAC Control

This IE indicates whether the DCH is control by DRAC or not.

IE/Group Name	Presence	Range	IE Type and Reference	Semantics Description
DRAC Control			ENUMERATED (Requested, Not-Requested)	Requested means that DCH is controlled by DRAC

9.2.2.13A DSCH FDD Information

The *DSCH FDD Information* IE provides information for DSCHs to be established.

IE/Group Name	Presence	Range	IE Type and Reference	Semantics Description	Criticality	Assigned Criticality
DSCH Specific FDD Information		<i>1..<maxno of DSCHs></i>			–	
>DSCH ID	M		9.2.1.26A		–	
>TrCh Source Statistics Descriptor	M		9.2.1.65		–	
>Transport Format Set	M		9.2.1.64	For DSCH	–	
>Allocation/Retention Priority	M		9.2.1.1		–	
>Scheduling Priority Indicator	M		9.2.1.51A		–	
>BLER	M		9.2.1.4		–	
PDSCH RL ID	M		RL ID 9.2.1.49		–	
TFCS	M		9.2.1.63	For DSCH	–	

Range bound	Explanation
<i>maxnoofDSCHs</i>	Maximum number of DSCHs for one UE.

9.2.2.13B DSCH FDD Information Response

The *DSCH FDD Information Response* IE provides information for DSCHs that have been established or modified.

IE/Group Name	Presence	Range	IE Type and Reference	Semantics Description	Criticality	Assigned Criticality
DSCH Specific FDD Information Response		<i>1..<maxno of DSCHs></i>			–	
>DSCH ID	M		9.2.1.26A		–	
>DSCH Flow Control Information	M		9.2.1.26B		–	
>Binding ID	O		9.2.1.3		–	
>Transport Layer Address	O		9.2.1.62		–	
PDSCH Code Mapping	M		9.2.2.27A	PDSCH code mapping to be used	–	

Range bound	Explanation
<i>maxnoofDSCHs</i>	Maximum number of DSCHs for one UE.

9.2.2.13Bb DSCH-RNTI

Void.

9.2.2.13C FDD DCHs To Modify

The *FDD DCHs To Modify* IE provides information for DCHs to be modified.

IE/Group Name	Presence	Range	IE Type and Reference	Semantics Description	Criticality	Assigned Criticality
FDD DCHs To Modify		1..<maxno ofDCHs>			–	
>UL FP Mode	O		9.2.1.67		–	
>ToAWS	O		9.2.1.58		–	
>ToAWE	O		9.2.1.57		–	
>Transport Bearer Request Indicator	M		9.2.1.61		–	
>DCH Specific Info		1..<maxno ofDCHs>			–	
>>DCH ID	M		9.2.1.16		–	
>>Transport Format Set	O		9.2.1.64	For the UL.	–	
>>Transport Format Set	O		9.2.1.64	For the DL.	–	
>>Allocation/Retention Priority	O		9.2.1.1		–	
>>Frame Handling Priority	O		9.2.1.29		–	
>>DRAC Control	O		9.2.2.13		–	

Range bound	Explanation
<i>maxnoofDCHs</i>	Maximum number of DCHs for one UE.

9.2.2.14 FDD DL Channelisation Code Number

The DL Channelisation Code Number indicates the DL Channelisation Code number for a specific DL physical channel.

IE/Group Name	Presence	Range	IE Type and Reference	Semantics Description
FDD DL Channelisation Code Number			INTEGER(0..511)	According to the mapping in [27]. The maximum value is equal to the DL spreading factor –1

9.2.2.14A FDD DL Code Information

The *FDD DL Code Information* IE provides FDD DL Code information for all DPCHs of one Radio Link.

IE/Group Name	Presence	Range	IE Type and Reference	Semantics Description	Criticality	Assigned Criticality
FDD DL Code Information		1..<maxnoof DLCodes>			–	
>DL Scrambling Code	M		9.2.2.11		–	
>FDD DL Channelisation Code Number	M		9.2.2.14		–	
>Transmission Gap Pattern Sequence Scrambling Code Information	O		9.2.2.47B		–	

Range bound	Explanation
<i>maxnoofDLCodes</i>	Maximum number of DL Channelisation Codes for one UE.

9.2.2.15 FDD S-CCPCH Offset

The Secondary CCPCH offset is defined as the time offset towards the Primary CCPCH in the cell. The offset is a multiple of 256 chips.

IE/Group Name	Presence	Range	IE Type and Reference	Semantics Description
FDD S-CCPCH Offset			INTEGER(0..149)	0: 0 chip 1: 256 chip 2: 512 chip .. 149: 38144 chip ref. [8]

9.2.2.16 FDD TPC Downlink Step Size

This parameter indicates step size for the DL power adjustment.

IE/Group Name	Presence	Range	IE Type and Reference	Semantics Description
FDD TPC Downlink Step Size			ENUMERATED (0.5, 1, 1.5, 2,...)	

9.2.2.16A First RLS Indicator

The First *RLS Indicator* IE indicates if a specific Radio Link and all Radio Links which are part of the same Radio Link Set, shall be considered as the first radio links established towards the UE or not.

IE/Group Name	Presence	Range	IE Type and Reference	Semantics Description
First RLS Indicator			ENUMERATED (first RLS, not first RLS)	

9.2.2.17 Gap Position Mode

Void.

9.2.2.18 Gap Period (TGP)

Void.

9.2.2.19 Gap Starting Slot Number (SN)

Void

9.2.2.20 IB_SG_POS

First position of an Information Block segment in the SFN cycle ($IB_SG_POS < IB_SG_REP$).

IE/Group Name	Presence	Range	IE Type and Reference	Semantics Description
IB_SG_POS			INTEGER (0..4094)	Only even positions allowed. Reference [16]

9.2.2.21 IB_SG_REP

Repetition distance for an Information Block segment. The segment shall be transmitted when $SFN \bmod IB_SG_REP = IB_SG_POS$.

IE/Group Name	Presence	Range	IE Type and Reference	Semantics Description
IB_SG_REP			ENUMERATED (4, 8, 16, 32, 64, 128, 256, 512, 1024, 2048, 4096)	Repetition period for the IB segment in frames

9.2.2.21a Inner Loop DL PC Status

The *Inner Loop DL PC Status* IE indicates whether inner loop DL control shall be active or inactive for all radio links for the UE Context.

IE/Group Name	Presence	Range	IE Type and Reference	Semantics Description
Inner Loop DL PC Status			ENUMERATED (Active, Inactive)	

9.2.2.21A Limited Power Increase

The parameter is used for a more efficient use of the inner loop DL power control for non real time data.

If the limited power increase is used, DRNS shall use the limited power increase algorithm as specified in [10], subclause 5.2.

IE/Group Name	Presence	Range	IE Type and Reference	Semantics Description
Limited Power Increase			ENUMERATED (Used, Not used ,)	

9.2.2.21B Length of TFCI2

This IE indicates the length measured in number of bits of TFCI(field 2). The length of TFCI (field 1) is set to the 10's complement of the length of TFCI(field 2).

IE/Group Name	Presence	Range	IE Type and Reference	Semantics Description
Length of TFCI2			INTEGER (1..10)	

9.2.2.22 Max Adjustment Period

Void.

9.2.2.23 Max Adjustment Step

Defines the maximum allowed value for the change of DL power level during a certain number of slots that can be utilised by the downlink power balancing algorithm. *Max Adjustment Step* IE defines a time period, in terms of number of slots, in which the accumulated power adjustments shall be maximum 1 dB. This value does not include the DL inner loop PC adjustment.

IE/Group Name	Presence	Range	IE Type and Reference	Semantics Description
Max Adjustment Step			INTEGER (1..10)	Slots

9.2.2.24 Max Number of UL DPDCHs

Maximum number of uplink DPDCHs during the connection. Needed by the rate matching algorithm.

IE/Group Name	Presence	Range	IE Type and Reference	Semantics Description
Max Number of UL DPDCHs			INTEGER (1..6)	

9.2.2.24A Min DL Channelisation Code Length

Void

9.2.2.25 Min UL Channelisation Code Length

Minimum UL channelisation code length (spreading factor) of a DPDCH during the connection. Needed by rate matching algorithm.

IE/Group Name	Presence	Range	IE Type and Reference	Semantics Description
Min UL Channelisation Code Length			ENUMERATED(4,8,16,32,64,128,256)	

9.2.2.26 Multiplexing Position

Multiplexing Position specifies whether fixed or flexible positions of transport channels shall be used in the physical channel.

IE/Group Name	Presence	Range	IE Type and Reference	Semantics Description
Multiplexing Position			ENUMERATED(Fixed, Flexible)	

9.2.2.26A Number of DL Channelisation Codes

This parameter notifies DRNS of the number of DL channelisation codes required for the Radio Link(s).

IE/Group Name	Presence	Range	IE Type and Reference	Semantics Description
Number of DL Channelisation Codes			INTEGER (1..8)	

9.2.2.27 Pattern Duration (PD)

Void

9.2.2.27a PC Preamble

Indicates DPDCH power control preamble length see ref. [7].

IE/Group Name	Presence	Range	IE Type and Reference	Semantics Description
PCP Preamble			INTEGER(0..7,...)	In number of frames.

9.2.2.27A PDSCH Code Mapping

This IE indicates the association between each possible value of TFCI(field 2) and the corresponding PDSCH channelisation code. There are three ways which the UTRAN must choose between in order to signal the mapping information, these are described below. The signalling capacity consumed by the different methods will typically vary depending on the way in which the UTRAN configures usage of the DSCH. A fourth option is also provided which allows the UTRAN to replace individual entries in the TFCI(field 2) to PDSCH code mapping table with new PDSCH code values.

Method #1 - Using code range

The mapping is described in terms of a number of groups, each group associated with a given spreading factor. Each TFCI(field2) value corresponds to a given PDSCH channelisation code or set of PDSCH codes for multi-code. The DRNS maps TFCI(field2) values to PDSCH codes in the following way:

- The PDSCH codes used for TFCI(field 2) = 0 are given by the SF of the Code Group 1 (i.e. first instance in *PDSCH code mapping*) and the code numbers between CodeNumber₀ (where CodeNumber₀ = "Start code number" of Code Group 1) and CodeNumber₀ + "multi-code info" - 1.
- This continues with unit increments in the value of TFCI (Field2) mapped to either unit increments in code numbers or groups of contiguous code numbers in case of multi-code, this until "Stop code number" is reached: So the PDSCH codes used for TFCI(field 2) = k (for k > 0 and k < ("Stop code number" - "Start code number" + 1) DIV k) are given by the SF of the Code Group 1 and the code numbers between CodeNumber_k = CodeNumber_{k-1} + "multi-code info" and CodeNumber_k + "multi-code info" - 1. If "Stop code number" = "Start code number" + "multi-code info" - 1 then this is to be interpreted as defining the mapping between the channelisation code(s) and a single TFCI.
- The DRNS constructs its mapping table by repeating this process for all the Code Groups in the order they are instantiated in *PDSCH code mapping*. The first TFCI(field 2) value used in each group is the largest TFCI(field 2) value reached in the previous group incremented by one.

Note: This imposes that "Stop code number" - "Start code number" + 1 is a multiple of the value "multi-code info" for each instance of *PDSCH code mapping*. Furthermore, in the case where multi-code is not used, then "multi-code info" = 1 and the process above also applies.

Method #2 - Using TFCI range

The mapping is described in terms of a number of groups, each group corresponding to a given PDSCH channelisation code or set of PDSCH codes for multi-code.

- The set of PDSCH codes specified in the first instance applies for all values of TFCI(field 2) between 0 and the specified "Max TFCI(field2)".
- The process continues in the same way for the following groups with the TFCI(field 2) value starting at the largest value reached in the previous instance incremented by one. So the set of PDSCH codes specified in a given instance apply for all the values of TFCI(field 2) between the "Max TFCI(field2) value" specified in the previous instance incremented by one and the specified "Max TFCI(field2)" of the considered instance.

A set of PDSCH codes is composed of all the codes between "Code Number" and "Code Number" + "multicode" - 1. So if multi-code is not used, the set of PDSCH codes is reduced to one element indicated by the *Code Number* IE.

Method #3 - Explicit

The mapping between TFCI (field 2) value and PDSCH channelisation code (or a set of PDSCH codes for multicode) is spelt out explicitly for each value of TFCI (field2).

A set of PDSCH codes is composed of all the codes between "Code Number" and "Code Number" + "multicode" - 1. So if multi-code is not used, the set of PDSCH codes is reduced to one element indicated by the *Code Number* IE.

Method #4 - Replace

The "TFCI (field2)" value(s) for which the mapping to PDSCH channelisation code (or a set of PDSCH codes for multicode) is changed are explicitly signalled. Furthermore, the new mapping between TFCI(field 2) value and PDSCH channelisation code(s) is spelt out explicitly for each value of TFCI (field2).

A set of PDSCH codes is composed of all the codes between "Code Number" and "Code Number" + "multicode" - 1. So if multi-code is not used, the set of PDSCH codes is reduced to one element indicated by the *Code Number* IE.

IE/Group name	Presence	Range	IE Type and Reference	Semantics Description
DL Scrambling Code	M		INTEGER (0..15)	Scrambling code on which PDSCH is transmitted. 0= Primary scrambling code of the cell 1...15 = Secondary scrambling code

<i>Choice Signalling Method</i>				
<i>>Code Range</i>				
>>PDSCH Code Mapping			<i>1..<maxNo CodeGroups></i>	
>>>Spreading Factor	M		ENUMERATED(4, 8, 16, 32, 64, 128, 256)	
>>>Multi-code Info	M		INTEGER(1..16)	
>>>Start Code Number	M		INTEGER(0..maxCodeNumComp-1)	PDSCH code start, Numbering as described in [16]
>>>Stop Code Number	M		INTEGER(0..maxCodeNumComp-1)	PDSCH code stop, Numbering as described in [16]
<i>>TFCI Range</i>				
>>DSCH Mapping			<i>1..<maxNo TFCIGroups>1</i>	
>>>Max TFCI(field2) Value	M		INTEGER(1..1023)	This is the maximum value in the range of TFCI(field 2) values for which the specified PDSCH code applies
>>>Spreading Factor	M		ENUMERATED(4, 8, 16, 32, 64, 128, 256)	SF of PDSCH code
>>>Multi-code Info	M		INTEGER(1..16)	
>>>Code Number	M		INTEGER(0..maxCodeNumComp-1)	Code number of PDSCH code. Numbering as described in [16]
<i>>Explicit</i>				
>>PDSCH Code			<i>1..<maxTFCI_2_Combos></i>	The first instance of the parameter PDSCH code corresponds to TFCI (field2) = 0, the second to TFCI(field 2) = 1 and so on.
>>>Spreading Factor	M		ENUMERATED(4, 8, 16, 32, 64, 128, 256)	SF of PDSCH code
>>>Multi-code Info	M		INTEGER(1..16)	
>>>Code Number	M		INTEGER(0..maxCodeNumComp-1)	Code number of PDSCH code. Numbering as described in [16]
<i>>Replace</i>				
>>Replaced PDSCH code			<i>1..<maxTFCI_2_Combos></i>	
>>>TFCI (field2)	M		INTEGER (1..1023)	Value of TFCI(field 2) for which PDSCH code mapping will be changed
>>>Spreading Factor	M		ENUMERATED(4, 8, 16, 32, 64, 128, 256)	SF of PDSCH code
>>>Multi-code Info	M		INTEGER(1..16)	
>>>Code Number	M		INTEGER(0..maxCodeNumComp-1)	Code number of PDSCH code. Numbering as described in [16]

Range Bound	Explanation
<i>maxCodeNumComp</i>	Maximum number of codes at the defined spreading factor, within the complete code tree.
<i>maxTFCI_2_Combs</i>	Maximum number of TFCI (field 2) combinations (given by 2 raised to the power of the length of the TFCI field 2)
<i>maxNoTFCIGroups</i>	Maximum number of groups, each group described in terms of a range of TFCI(field 2) values for which a single PDSCH code applies.
<i>maxNoCodeGroups</i>	Maximum number of groups, each group described in terms of a range of PDSCH channelisation code values for which a single spreading factor applies.

9.2.2.28 Power Adjustment Type

Defines the characteristic of the power adjustment.

IE/Group Name	Presence	Range	IE Type and Reference	Semantics Description
Power Adjustment Type			ENUMERATED (None, Common, Individual)	

9.2.2.29 Power Control Mode (PCM)

Void.

9.2.2.30 Power Offset

This IE defines a power offset respect the Downlink transmission power of a DPCH.

IE/Group Name	Presence	Range	IE Type and Reference	Semantics Description
Power Offset			INTEGER (0..24)	Unit dB, Step 0.25 dB, range 0-6 dB

9.2.2.31 Power Resume Mode (PRM)

Void.

9.2.2.31A Preamble Signatures

Void.

9.2.2.32 Primary CPICH Ec/No

Energy per chip divided by the power density per band measured on the Primary CPICH by the terminal.

IE/Group Name	Presence	Range	IE Type and Reference	Semantics Description
Primary CPICH Ec/No			INTEGER (-30..+30)	Unit dB, step 1 dB The value range is typically within the range of -24 dB to 0 dB according to the CPICH Ec/No UE measurement defined in ref. [23].

9.2.2.33 Propagation Delay (PD)

Propagation delay is the one-way propagation delay of the radio signal from the UE to the Node B.

IE/Group Name	Presence	Range	IE Type and Reference	Semantics Description
Propagation Delay			INTEGER (0..255)	Chips. Step size is 3 chips. 0=0 chips, 1=3 chips, ...

9.2.2.33A PRACH Minimum Spreading Factor

Void.

9.2.2.34 QE-Selector

Void.

9.2.2.34A RACH Sub Channel Numbers

Void.

9.2.2.35 RL Set ID

The RL Set ID uniquely identifies one RL Set within a UE Context.

IE/Group Name	Presence	Range	IE Type and Reference	Semantics Description
RL Set ID			INTEGER (0..31)	

9.2.2.35A Received Total Wide Band Power

The parameter indicates the Received total wide band power in a cell, see ref. [11].

IE/Group Name	Presence	Range	IE Type and Reference	Semantics Description
Received Total Wide Band Power			INTEGER(0..621)	According to mapping in [23].

9.2.2.36 S-Field Length

The UE uses the S Field of the UL DPCCH slot to send the SSID Cell ID to the network.

IE/Group Name	Presence	Range	IE Type and Reference	Semantics Description
S Field Length			ENUMERATED (1, 2,...)	

9.2.2.37 Scrambling Code Change

Void.

9.2.2.37A Scrambling Code Number

Void.

9.2.2.37B Secondary CCPCH Info

The *Secondary CCPCH Info* IE provides information on scheduling of broadcast information for DRAC on a Secondary CCPCH in one cell.

IE/Group Name	Presence	Range	IE Type and Reference	Semantics Description	Criticality	Assigned Criticality
FDD S-CCPCH Offset	M		9.2.2.15	Corresponds to: $\tau_{S-CCPCH,k}$, see ref. [8]	–	
DL Scrambling Code	M		9.2.2.11		–	
FDD DL Channelisation Code Number	M		9.2.2.14		–	
TFCS	M		9.2.1.63	For the DL.	–	
Secondary CCPCH Slot Format	M		9.2.2.38		–	
TFCI Presence	C - SlotFormat		9.2.1.55		–	
Multiplexing Position	M		9.2.2.26		–	
STTD Indicator	M		9.2.2.44		–	
FACH/PCH Information		1 .. <maxFACHcount+1>			–	
>TFS			9.2.1.64	For each FACH, and the PCH when multiplexed on the same Secondary CCPCH	–	
IB Scheduling Information		1			–	
>IB_SG_REP	M		9.2.2.21		–	
>IB Segment Information		1.. <maxIBSEG>			–	
>>IB_SG_POS	M		9.2.2.20		–	

Condition	Explanation
SlotFormat	The IE shall be present if the <i>Secondary CCPCH Slot Format</i> IE is equal to any of the values from 8 to 17.

Range bound	Explanation
maxFACHCount	Maximum number of FACHs mapped onto a Secondary CCPCH.
maxIBSEG	Maximum number of segments for one Information Block.

9.2.2.38 Secondary CCPCH Slot Format

IE/Group Name	Presence	Range	IE Type and Reference	Semantics Description
Secondary CCPCH Slot Format			INTEGER (0..17,...)	See ref. [8].

9.2.2.39 Slot Number (SN)

Void

9.2.2.39a Split Type

This parameter indicates if the "Hard" or "Logical" is used for the TFCI.split mode.

IE/Group Name	Presence	Range	IE Type and Reference	Semantics Description
Split Type			ENUMERATED (Hard, Logical)	'Hard': meaning that TFCI (field 1) and TFCI (field 2) are each 5 bits long and each field is block coded separately. 'Logical': meaning that on the physical layer TFCI (field 1) and TFCI (field 2) are concatenated, field 1 taking the most significant bits and field 2 taking the least significant bits). The whole is then encoded with a single block code.

9.2.2.39A SRB Delay

Indicates the number of frames after the PC Preamble period during which transmission of data on some RRC Signalling Bearers shall be prohibited by UE in accordance with ref. [16].

IE/Group Name	Presence	Range	IE Type and Reference	Semantics Description
SRB Delay			INTEGER(0..7,...)	In number of frames.

9.2.2.40 SSDT Cell Identity

The SSDT Cell Identity is a temporary ID for SSDT assigned to a cell.

IE/Group Name	Presence	Range	IE Type and Reference	Semantics Description
SSDT Cell Identity			ENUMERATED (a..h)	

9.2.2.41 SSDT Cell Identity Length

The SSDT Cell Identity Length parameter shows the length of the SSDT Cell ID.

IE/Group Name	Presence	Range	IE Type and Reference	Semantics Description
SSDT Cell Identity Length			ENUMERATED (Short, Medium, Long)	

9.2.2.42 SSDT Indication

The SSDT Indication indicates whether SSDT is in use by the UE or not.

IE/Group Name	Presence	Range	IE Type and Reference	Semantics Description
SSDT Indication			ENUMERATED (SSDT Active in the UE, SSDT not Active in the UE)	

9.2.2.43 SSDT Support Indicator

The SSDT Support Indicator indicates whether a RL supports SSDT or not.

IE/Group Name	Presence	Range	IE Type and Reference	Semantics Description
SSDT Support Indicator			ENUMERATED (SSDT Supported, SSDT not supported).	

9.2.2.44 STTD Indicator

Indicates if STTD is active or not.

IE/Group Name	Presence	Range	IE Type and Reference	Semantics Description
STTD Indicator			ENUMERATED (active, inactive)	

9.2.2.45 STTD Support Indicator

The STTD Support Indicator indicates whether the STTD can be applied to DL DPCH in the cell or not.

IE/Group Name	Presence	Range	IE Type and Reference	Semantics Description
STTD Support Indicator			ENUMERATED (STTD Supported, STTD not Supported).	

9.2.2.46 TFCI Signalling Mode

This parameter indicates if the normal or split mode is used for the TFCI.

IE/Group Name	Presence	Range	IE Type and Reference	Semantics Description
TFCI Signalling Mode			ENUMERATED (Normal, Split)	

9.2.2.47 Transmission Gap Distance (TGD)

Void.

9.2.2.47A Transmission Gap Pattern Sequence Information

Defines the parameters for the compressed mode gap pattern sequence. For details see [16].

IE/Group Name	Presence	Range	IE Type and Reference	Semantics Description
Transmission Gap Pattern Sequence Information		1..<MaxTGPS>		
>TGPSI Identifier	M		INTEGER(1..<MaxTGPS>)	Transmission Gap Pattern Sequence Identifier Establish a reference to the compressed mode pattern sequence. Up to <MaxTGPS> simultaneous compressed mode pattern sequences can be used.
>TGSN	M		INTEGER (0..14)	Transmission Gap Starting Slot Number The slot number of the first transmission gap slot within the TGCFN.
>TGL1	M		INTEGER(1..14)	The length of the first Transmission Gap within the transmission gap pattern expressed in number of slots.
>TGL2	O		INTEGER (1..14)	The length of the second Transmission Gap within the transmission gap pattern. If omitted, then TGL2=TGL1.
>TGD	M		INTEGER (0, 15.. 269)	Transmission gap distance indicates the number of slots between the starting slots of two consecutive transmission gaps within a transmission gap pattern. If there is only one transmission gap in the transmission gap pattern, this parameter shall be set to 0 (0 =undefined).
>TGPL1	M		INTEGER (1..144,...)	The duration of transmission gap pattern 1 in frames.
>TGPL2	O		INTEGER (1..144,...)	The duration of transmission gap pattern 2 in frames. If omitted, then TGPL2=TGPL1.
>UL/DL mode	M		ENUMERATED (UL only, DL only, UL/DL)	Defines whether only DL, only UL, or combined UL/DL compressed mode is used.
>Downlink Compressed Mode Method	C-DL		ENUMERATED (puncturing, SF/2, higher layer scheduling, ...)	Method for generating downlink compressed mode gap None means that compressed mode pattern is stopped.
>Uplink Compressed Mode Method	C-UL		ENUMERATED (SF/2, higher layer scheduling, ...)	Method for generating uplink compressed mode gap.
>Downlink Frame Type	M		ENUMERATED (A, B,...)	Defines if frame type 'A' or 'B' shall be used in downlink compressed mode.
>DeltaSIR1	M		INTEGER (0..30)	Delta in SIR target value to be set in the DRNS during the frame containing the start of the first transmission gap in the transmission gap pattern (without including the effect of the bit-rate increase)
				Step 0.1 dB, Range 0-3dB

>DeltaSIRafter1	M		INTEGER (0..30)	Delta in SIR target value to be set in the DRNS one frame after the frame containing the start of the first transmission gap in the transmission gap pattern,. Step 0.1 dB, Range 0-3dB
>DeltaSIR2	O		INTEGER (0..30)	Delta in SIR target value to be set in the DRNS during the frame containing the start of the second transmission gap in the transmission gap pattern (without including the effect of the bit-rate increase) When omitted, DeltaSIR2 = DeltaSIR1. Step 0.1 dB, Range 0-3dB
>DeltaSIRafter2	O		INTEGER (0..30)	Delta in SIR target value to be set in the DRNS one frame after the frame containing the start of the second transmission gap in the transmission gap pattern. When omitted, DeltaSIRafter2 = DeltaSIRafter1. Step 0.1 dB, Range 0-3dB

Condition	Explanation
UL	The IE shall be present if the <i>UL/DL mode</i> IE is "UL only" or "UL/DL".
DL	The IE shall be present if the <i>UL/DL mode</i> IE is "DL only" or "UL/DL".

Range bound	Explanation
<i>maxTGPS</i>	Maximum number of transmission gap pattern sequences.

9.2.2.47B Transmission Gap Pattern Sequence Scrambling Code Information

This IE indicates whether or not the alternative scrambling code will be used in the DRNS for the Downlink compressed mode method 'SF/2' in the Transmission Gap Pattern Sequence. For details see ref [16].

IE/Group Name	Presence	Range	IE Type and Reference	Semantics Description
Transmission Gap Pattern Sequence Scrambling Code Information			ENUMERATED (code change, no code change)	Code change = alternative scrambling code will be used.

9.2.2.48 Transmit Diversity Indicator

IE/Group Name	Presence	Range	IE Type and Reference	Semantics Description
Transmit Diversity Indicator			ENUMERATED (active, inactive)	

9.2.2.49 Transmit Gap Length (TGL)

Void

The Transmit Diversity Indicator indicates whether Transmit Diversity shall be active or not.

9.2.2.50 Tx Diversity Indicator

The Tx Diversity Indicator indicates if the following conditions are satisfied:

- Primary CPICH is broadcast from two antennas
- STTD is applied to Primary CCPCH
- TSTD is applied to Primary SCH and Secondary SCH

IE/Group Name	Presence	Range	IE Type and Reference	Semantics Description
Tx Diversity Indicator			ENUMERATED (true, false).	

9.2.2.51 UL/DL Compressed Mode Selection

Void

9.2.2.52 UL DPCCH Slot Format

Indicates the slot format used in DPCCH in UL, according to ref. [8].

IE/Group Name	Presence	Range	IE Type and Reference	Semantics Description
UL DPCCH Slot Format			INTEGER (0..5,...)	

9.2.2.53 UL Scrambling Code

The UL Scrambling Code is the scrambling code used by UE. Every UE has its specific UL Scrambling Code.

IE/Group Name	Presence	Range	IE Type and Reference	Semantics Description
UL Scrambling Code Number	M		INTEGER (0.. $2^{24}-1$)	
UL Scrambling Code Length	M		ENUMERATED (Short, Long)	

9.2.2.54 Uplink Delta SIR

Void

9.2.2.55 Uplink Delta SIR After

Void

9.2.3 TDD Specific Parameters

This subclause contains parameters that are specific to TDD.

9.2.3.a Alpha Value

Used to support signalling of cell specific Alpha Value to SRNS.

IE/Group Name	Presence	Range	IE Type and Reference	Semantics Description
Alpha Value			ENUMERATED(0, 1/8, 2/8, 3/8, 4/8, 5/8, 6/8, 7/8, 1)	

9.2.3.A Block STTD Indicator

Void.

9.2.3.1 Burst Type

Void.

9.2.3.2 CCTrCH ID

The CCTrCH ID identifies unambiguously a CCTrCH inside a Radio Link.

IE/Group Name	Presence	Range	IE Type and Reference	Semantics Description
CCTrCH ID			INTEGER (0..15)	

9.2.3.2A DCH TDD Information

The *DCH TDD Information* IE provides information for DCHs to be established.

IE/Group Name	Presence	Range	IE Type and Reference	Semantics Description	Criticality	Assigned Criticality
DCH Information		<i>1..<maxno ofDCHs></i>			–	
>Payload CRC Presence Indicator	M		9.2.1.42		–	
>UL FP Mode	M		9.2.1.67		–	
>ToAWS	M		9.2.1.58		–	
>ToAWE	M		9.2.1.57		–	
>DCH Specific Info		<i>1..<maxno ofDCHs></i>			–	
>>DCH ID	M		9.2.1.16		–	
>>CCTrCH ID	M		9.2.3.2	UL CCTrCH in which the DCH is mapped	–	
>>CCTrCH ID	M		9.2.3.2	DL CCTrCH in which the DCH is mapped	–	
>>TrCh Source Statistics Descriptor	M		9.2.1.65		–	
>>Transport Format Set	M		9.2.1.64	For the UL.	–	
>>Transport Format Set	M		9.2.1.64	For the DL.	–	
>>BLER	M		9.2.1.4	For the UL.	–	
>>BLER	M		9.2.1.4	For the DL.	–	
>>Allocation/Retention Priority	M		9.2.1.1		–	
>>Frame Handling Priority	M		9.2.1.29		–	
>>QE-Selector	C-CoordCH		9.2.1.46A		–	

Condition	Explanation
CoordCH	The IE shall be present if this DCH is part of a set of coordinated DCHs (number of instances of the <i>DCH Specific Info</i> IE is greater than 1).

Range bound	Explanation
<i>maxnoofDCHs</i>	Maximum number of DCHs for one UE.

9.2.3.2B DCH TDD Information Response

Void

9.2.3.2C DL Timeslot Information

The *DL Timeslot Information* IE provides information on the time slot allocation for a DL DPCH.

IE/Group Name	Presence	Range	IE Type and Reference	Semantics Description	Criticality	Assigned Criticality
DL Timeslot Information		<i>1..<maxno ofTS></i>			–	
>Time Slot	M		9.2.1.56		–	
>Midamble Shift And Burst Type	M		9.2.3.4		–	
>TFCI Presence	M		9.2.1.55		–	
>DL Code Information	M		TDD DL Code Information 9.2.3.8C		–	

Range bound	Explanation
<i>maxnoofTS</i>	Maximum number of Timeslots for a UE.

9.2.3.2D DL Time Slot ISCP Info

The *DL Time Slot ISCP Info* IE gives interference level for each DL time slot within the Radio Link.

IE/Group Name	Presence	Range	IE Type and Reference	Semantics Description	Criticality	Assigned Criticality
DL Time Slot ISCP Info		<i>1..<maxno ofDLts></i>			–	
>Time Slot	M		9.2.1.56		–	
>DL Timeslot ISCP	M		9.2.3.12		–	

Range bound	Explanation
<i>maxnoofDLts</i>	Maximum number of downlink time slots per Radio Link.

9.2.3.3 DPCH ID

The DPCH ID identifies unambiguously a DPCH inside a Radio Link.

IE/Group Name	Presence	Range	IE Type and Reference	Semantics Description
DPCH ID			INTEGER (0..239)	

9.2.3.3a DSCH TDD Information

The *DSCH TDD Information* IE provides information for DSCHs to be established.

IE/Group Name	Presence	Range	IE Type and Reference	Semantics Description	Criticality	Assigned Criticality
DSCH TDD Information		<i>1..<maxno of DSCHs></i>			–	
>DSCH ID	M		9.2.1.26A		–	
>CCTrCH ID	M		9.2.3.2	DL CCTrCH in which the DSCH is mapped.	–	
>TrCh Source Statistics Descriptor	M		9.2.1.65		–	
>Transport Format Set	M		9.2.1.64		–	
>Allocation/Retention Priority	M		9.2.1.1		–	
>Scheduling Priority Indicator	M		9.2.1.51A		–	
>BLER	M		9.2.1.4		–	

Range bound	Explanation
<i>maxnoofDSCHs</i>	Maximum number of DSCHs for one UE.

9.2.3.3A Maximum Number of Timeslots per Frame

Defines the maximum number of timeslots the UE has the capability of receiving or transmitting.

IE/Group Name	Presence	Range	IE Type and Reference	Semantics Description
Maximum Number of Timeslots per Frame			INTEGER (1..14)	

9.2.3.3B Maximum Number of UL Physical Channels per Timeslot

Defines the maximum number of physical channels per frame that the UE is capable to transmit.

IE/Group Name	Presence	Range	IE Type and Reference	Semantics Description
Maximum Number of UL Physical Channels per Timeslot			INTEGER (1..2)	

9.2.3.3C Maximum Number of DL Physical Channels per Frame

Defines the maximum number of physical channels per frame that the UE is capable to receive.

IE/Group Name	Presence	Range	IE Type and Reference	Semantics Description
Maximum Number of DL Physical Channels per Frame			INTEGER (1..224)	

9.2.3.4 Midamble Shift And Burst Type

This information element indicates burst type and midamble allocation.

Three different midamble allocation schemes exist:

- Default midamble: the midamble shift is selected by layer 1 depending on the associated channelisation code (DL and UL);
- Common midamble: the midamble shift is chosen by layer 1 depending on the number of channelisation codes (possible in DL only);
- UE specific midamble: a UE specific midamble is explicitly assigned (DL and UL).

IE/Group Name	Presence	Range	IE Type and Reference	Semantics Description
CHOICE <i>Burst Type</i>				
> <i>Type 1</i>				
>> Midamble Configuration Burst Type 1 And 3	M		ENUMERATED(4, 8, 16)	As defined in [12]
>>Midamble Allocation Mode	M		ENUMERATED (Default midamble, Common midamble, UE specific midamble)	
>>Midamble Shift	C-UE		INTEGER(0..15)	
> <i>Type 2</i>				
>> Midamble Configuration Burst Type 2	M		ENUMERATED(3,6)	As defined in [12]
>>Midamble Allocation Mode	M		ENUMERATED (Default midamble, Common midamble, UE specific midamble)	
>>Midamble Shift Short			INTEGER (0..5)	
> <i>Type 3</i>				UL only
>> Midamble Configuration Burst Type 1 And 3	M		ENUMERATED(4, 8, 16)	As defined in [12]
>>Midamble Allocation Mode	M		ENUMERATED (Default midamble, UE specific midamble)	
>>Midamble Shift Long	C-UE		INTEGER(0..15)	

Condition	Explanation
UE	The IE shall be present if the <i>Midamble Allocation Mode</i> IE is set to "UE-specific midamble".

9.2.3.4A Minimum Spreading Factor

Defines the minimum spreading factor the UE has the capability of receiving or transmitting.

IE/Group Name	Presence	Range	IE Type and Reference	Semantics Description
Minimum Spreading Factor			INTEGER (1..16)	

9.2.3.5 Primary CCPCH RSCP

Received Signal Code Power is the received power on PCCPCH of the target cell after despreading. The reference point for the RSCP is the antenna connector at the UE, see ref. [14].

IE/Group Name	Presence	Range	IE Type and Reference	Semantics Description
Primary CCPCH RSCP			INTEGER (0..91)	According to mapping in in ref. [14].

9.2.3.5A PRACH Midamble

Void.

9.2.3.5B RB Identity

The RB Identity is the identifier of a radio bearer. It is unique for each active Radio bearer among the active radio bearers simultaneously allocated for the same UE.

IE/Group Name	Presence	Range	IE Type and Reference	Semantics Description
RB Identity			INTEGER (0..31)	In line with [16], ch. 10.3.4.11

9.2.3.6 Repetition Length

The Repetition Length represents the number of consecutive Radio Frames inside a Repetition Period in which the same Time Slot is assigned to the same Physical Channel see ref. [16].

IE/Group Name	Presence	Range	IE Type and Reference	Semantics Description
Repetition Length			INTEGER(1..63)	

9.2.3.7 Repetition Period

The Repetition Period represents the number of consecutive Radio Frames after which the same assignment scheme of Time Slots to a Physical Channel is repeated. This means that if the Time Slot K is assigned to a physical channel in the Radio Frame J , it is assigned to the same physical channel also in all the Radio Frames $J+n*Repetition\ Period$ (where n is an integer) see ref [16].

IE/Group Name	Presence	Range	IE Type and Reference	Semantics Description
Repetition Period			ENUMERATED (1,2,4,8,16,32,64)	

9.2.3.7A Rx Timing Deviation

Measured Rx Timing Deviation as a basis for timing advance, either measured directly from a RACH burst, or calculated from the Rx Timing Deviation measurement on the USCH by adding the current Timing Advance value.

IE/Group Name	Presence	Range	IE Type and Reference	Semantics Description
Rx Timing Deviation			INTEGER (0..127)	As specified in [5], ch. 6.2.7.6

9.2.3.7B Secondary CCPCH Info TDD

The *Secondary CCPCH Info TDD* IE provides information on the Secondary CCPCH that carries the logical channel SHCCH for the UE.

IE/Group Name	Presence	Range	IE Type and Reference	Semantics Description	Criticality	Assigned Criticality
TFCS	M		9.2.1.63	For the DL.	–	
TFCI Coding	M		9.2.3.11		–	
Secondary CCPCH		<i>0..<maxno ofSCCPC Hs></i>			–	
>Time Slot	M		9.2.1.56		–	
>Midamble Shift And Burst Type	M		9.2.3.4		–	
>TFCI Presence	M		9.2.1.55		–	
> Secondary CCPCH TDD Code Information	M		9.2.3.7C		–	
>TDD Physical Channel Offset	M		9.2.3.9			
>Repetition Length	M		9.2.3.6		–	
>Repetition Period	M		9.2.3.7		–	
FACH		<i>0..<maxno ofFACHs></i>			–	
> TFS	M		9.2.1.64	For the DL.	–	
PCH		<i>0..1</i>			–	
> TFS	M		9.2.1.64	For the DL.	–	

Range bound	Explanation
<i>maxnoofSCCPCs</i>	Maximum number of Secondary CCPCHs per CCTrCH.
<i>maxnoofFACHs</i>	Maximum number of FACHs mapped onto a Secondary CCPCH.

9.2.3.7C Secondary CCPCH TDD Code Information

The *Secondary CCPCH TDD Code Information* IE provides TDD Channelisation Code information for all SCCPCHs of one Time Slot.

IE/Group Name	Presence	Range	IE Type and Reference	Semantics Description	Criticality	Assigned Criticality
Secondary CCPCH TDD Code Information		<i>1..<maxno ofSCCPC Hs></i>			–	
>TDD Channelisation Code	M		9.2.3.8		–	

Range bound	Explanation
<i>maxnoofSCCPCs</i>	Maximum number of SCCPCHs for one CCTrCH.

9.2.3.7D Special Burst Scheduling

The number of frames between special burst transmissions during DTX.

IE/Group Name	Presence	Range	IE Type and Reference	Semantics Description
Special Burst Scheduling			INTEGER (1, 2, ..., 256)	Number of frames between special burst transmissions during DTX

9.2.3.7E Synchronisation Configuration

The Synchronisation Configuration parameters that are used by the DRNS in the Radio Link Failure/Restore procedure.

IE/Group Name	Presence	Range	IE Type and Reference	Semantics Description
N_INSYNC_IND	M		INTEGER (1, 2, .., 256)	
N_OUTSYNC_IND	M		INTEGER (1, 2, .., 256)	
T_RLFAILURE	M		ENUMERATED (0, 0.1, 0.2, .., 25.5)	In seconds

9.2.3.8 TDD Channelisation Code

The Channelisation Code Number indicates which Channelisation Code is used for a given Physical Channel. In TDD the Channelisation Code is an Orthogonal Variable Spreading Factor code that can have a spreading factor of 1, 2, 4, 8 or 16.

IE/Group Name	Presence	Range	IE Type and Reference	Semantics Description
TDD Channelisation Code			ENUMERATED ((1/1), (2/1), (2/2), (4/1), .. (4/4), (8/1), .. (8/8), (16/1), .. (16/16)...))	

9.2.3.8A TDD DPCH Offset

The Offset represents the phase information for the allocation of a group of dedicated physical channels. The first range is used when a starting offset is not required and the TDD Physical channel offset for each DPCH in the CCTrCH shall be directly determined from the TDD DPCH Offset. The second range is used when a starting offset is required. The TDD DPCH Offset shall map to the CFN and the TDD Physical Channel Offset for each DPCH in this CCTrCH shall be calculated by TDD DPCH Offset *mod* Repetition period, see ref [16].

IE/Group Name	Presence	Range	IE Type and Reference	Semantics Description
TDD DPCH Offset			CHOICE INTEGER (0..63) or INTEGER (0..255)	

9.2.3.8B TDD DCHs To Modify

The *TDD DCHs To Modify* IE provides information for DCHs to be modified.

IE/Group Name	Presence	Range	IE Type and Reference	Semantics Description	Criticality	Assigned Criticality
TDD DCHs To Modify		<i>1..<maxno ofDCHs></i>			–	
>UL FP Mode	O		9.2.1.67		–	
>ToAWS	O		9.2.1.58		–	
>ToAWE	O		9.2.1.57		–	
>Transport Bearer Request Indicator	M		9.2.1.61		–	
>DCH Specific Info		<i>1..<maxno ofDCHs></i>			–	
>>DCH ID	M		9.2.1.16		–	
>>CCTrCH ID	O		9.2.3.2	UL CCTrCH in which the DCH is mapped.	–	
>>CCTrCH ID	O		9.2.3.2	DL CCTrCH in which the DCH is mapped	–	
>>Transport Format Set	O		9.2.1.64	For the UL.	–	
>>Transport Format Set	O		9.2.1.64	For the DL.	–	
>>Allocation/Retention Priority	O		9.2.1.1		–	
>>Frame Handling Priority	O		9.2.1.29		–	

Range bound	Explanation
<i>maxnoofDCHs</i>	Maximum number of DCHs for one UE.

9.2.3.8C TDD DL Code Information

The *TDD DL Code Information* IE provides TDD DL Code information for all DPCHs of one DL Time Slot.

IE/Group Name	Presence	Range	IE Type and Reference	Semantics Description	Criticality	Assigned Criticality
TDD DL Code Information		<i>1..<maxno ofDPCHs ></i>			–	
>DPCH ID	M		9.2.3.3		–	
>TDD Channelisation Code	M		9.2.3.8		–	

Range bound	Explanation
<i>maxnoofDPCHs</i>	Maximum number of DPCHs for one CCTrCH.

9.2.3.9 TDD Physical Channel Offset

The TDD Physical Channel Offset represents the phase information for the allocation of a non DPCH physical channel. (CFN mod Repetition Period = TDD Physical Channel Offset) see ref [16].

IE/Group Name	Presence	Range	IE Type and Reference	Semantics Description
TDD Physical Channel Offset			INTEGER (0..63)	

9.2.3.10 TDD TPC Downlink Step Size

This parameter indicates step size for the DL power adjustment.

IE/Group Name	Presence	Range	IE Type and Reference	Semantics Description
TDD TPC Downlink Step Size			ENUMERATED (1, 2, 3,...)	

9.2.3.10A TDD UL Code Information

The *TDD UL Code Information* IE provides TDD UL Code information for all DPCHs of one UL Time Slot.

IE/Group Name	Presence	Range	IE Type and Reference	Semantics Description	Criticality	Assigned Criticality
TDD UL Code Information		$1..<maxno\ OfDPCHs>$			–	
>DPCH ID	M		9.2.3.3		–	
>TDD Channelisation Code	M		9.2.3.8		–	

Range bound	Explanation
$maxnoofDPCHs$	Maximum number of DPCHs for one CCTrCH.

9.2.3.11 TFCI Coding

The TFCI Coding describes how the TFCI bits are coded. By default 1 TFCI bit is coded with 4 bits, 2 TFCI bits are coded with 8 bits, 3-5 TFCI bits are coded with 16 bits and 6-10 TFCI bits are coded with 32 bits.

IE/Group Name	Presence	Range	IE Type and Reference	Semantics Description
TFCI Coding			ENUMERATED (4, 8, 16, 32,...)	

9.2.3.12 DL Timeslot ISCP

DL Timeslot ISCP is the measured interference in a downlink timeslot at the UE, see ref. [14].

IE/Group Name	Presence	Range	IE Type and Reference	Semantics Description
DL Timeslot ISCP			INTEGER (0..91)	According to mapping in [24].

9.2.3.12A Timing Advance Applied

Defines the need for Timing Advance functions such as Rx Timing Deviation measurement in a particular cell.

IE/Group Name	Presence	Range	IE Type and Reference	Semantics Description
Timing Advance Applied			ENUMERATED (Yes, No)	

9.2.3.13 Transport Format Management

Defines whether the cell transmits the transport format information via broadcast or whether the transport format information is transmitted to the UE using dedicated RRC procedures.

IE/Group Name	Presence	Range	IE Type and Reference	Semantics Description
Transport Format Management			ENUMERATED (Cell Based, UE Based,...)	

9.2.3.13A UL Timeslot ISCP

UL Timeslot ISCP is the measured interference in a uplink timeslot at the DRNS, see ref. [14].

IE/Group Name	Presence	Range	IE Type and Reference	Semantics Description
UL Timeslot ISCP			INTEGER (0..127)	According to mapping in [24].

9.2.3.13B UL PhysCH SF Variation

Indicates whether variation of SF in UL is supported by Radio Link or not.

IE/Group Name	Presence	Range	IE Type and Reference	Semantics Description
UL PhysCH SF Variation			ENUMERATED (SF_Variation_supported, SF_Variation_NOT_supported)	

9.2.3.13C UL Timeslot Information

The *UL Timeslot Information* IE provides information on the time slot allocation for a UL DPCH.

IE/Group Name	Presence	Range	IE Type and Reference	Semantics Description	Criticality	Assigned Criticality
UL Timeslot Information		<i>1..<maxnoOfTS></i>			–	
>Time Slot	M		9.2.1.56		–	
>Midamble Shift And Burst Type	M		9.2.3.4		–	
>TFCI Presence	M		9.2.1.55		–	
>UL Code Information	M		TDD UL Code Information 9.2.3.10A		–	

Range bound	Explanation
<i>maxnoofTS</i>	Maximum number of Timeslots for a UE.

9.2.3.13D UL Time Slot ISCP Info

The *UL Time Slot ISCP Info* IE gives interference level for each UL time slot within the Radio Link.

IE/Group Name	Presence	Range	IE Type and reference	Semantics Description	Criticality	Assigned Criticality
UL Time Slot ISCP Info		1 .. <maxnoof ULts>			–	
>Time Slot	M		9.2.1.56		–	
>UL Timeslot ISCP	M		9.2.3.13A		–	

Range bound	Explanation
maxnoofULts	Maximum number of uplink time slots per Radio Link.

9.2.3.14 USCH ID

The USCH ID is the identifier of an uplink shared channel. It is unique among the USCHs simultaneously allocated for the same UE.

IE/Group Name	Presence	Range	IE Type and reference	Semantics Description
USCH ID			INTEGER (0..255)	

9.2.3.15 USCH Information

The *USCH Information* IE provides information for USCHs to be established.

IE/Group Name	Presence	Range	IE Type and reference	Semantics Description	Criticality	Assigned Criticality
USCH Information		1.. <maxnoof USCHs>			–	
>USCH ID	M		9.2.3.14		–	
>CCTrCH ID	M		9.2.3.2	UL CCTrCH in which the USCH is mapped	–	
>TrCh Source Statistics Descriptor	M		9.2.1.65		–	
>Transport Format Set	M		9.2.1.64	For USCH	–	
>Allocation/Retention Priority	M		9.2.1.1		–	
>Scheduling Priority Indicator	M		9.2.1.51A		–	
>BLER	M		9.2.1.4		–	
>RB Info		1..<maxno ofRB>		All Radio Bearers using this USCH	–	
>>RB Identity	M		9.2.3.5B		–	

Range bound	Explanation
maxnoofUSCHs	Maximum number of USCHs for one UE.
maxnoofRBs	Maximum number of Radio Bearers for one UE.

9.3 Message and Information Element Abstract Syntax (with ASN.1)

9.3.0 General

Subclause 9.3 presents the Abstract Syntax of RNSAP protocol with ASN.1. In case there is contradiction between the ASN.1 definition in this subclause and the tabular format in subclause 9.1 and 9.2, the ASN.1 shall take precedence, except for the definition of conditions for the presence of conditional elements, where the tabular format shall take precedence.

The ASN.1 definition specifies the structure and content of RNSAP messages. RNSAP messages can contain any IEs specified in the object set definitions for that message without the order or number of occurrence being restricted by ASN.1. However, for this version of the standard, a sending entity shall construct a RNSAP message according to the PDU definitions module and with the following additional rules (Note that in the following IE means an IE in the object set with an explicit id. If one IE needed to appear more than once in one object set, then the different occurrences have different IE ids):

- IEs shall be ordered (in an IE container) in the order they appear in object set definitions.
- Object set definitions specify how many times IEs may appear. An IE shall appear exactly once if the presence field in an object has value "mandatory". An IE may appear at most once if the presence field in an object has value "optional" or "conditional". If in a tabular format there is multiplicity specified for an IE (i.e. an IE list) then in the corresponding ASN.1 definition the list definition is separated into two parts. The first part defines an IE container list where the list elements reside. The second part defines list elements. The IE container list appears as an IE of its own. For this version of the standard an IE container list may contain only one kind of list elements.

If a RNSAP message that is not constructed as defined above is received, this shall be considered as Abstract Syntax Error, and the message shall be handled as defined for Abstract Syntax Error in subclause 10.3.6.

9.3.1 Usage of Private Message Mechanism for Non-standard Use

The private message mechanism for non-standard use may be used:

- for special operator (and/or vendor) specific features considered not to be part of the basic functionality, i.e. the functionality required for a complete and high-quality specification in order to guarantee multivendor inter-operability.
- by vendors for research purposes, e.g. to implement and evaluate new algorithms/features before such features are proposed for standardisation.

The private message mechanism shall not be used for basic functionality. Such functionality shall be standardised.

9.3.2 Elementary Procedure Definitions

```
-- *****
--
-- Elementary Procedure definitions
--
-- *****
```

```
RNSAP-PDU-Descriptions {
itu-t (0) identified-organization (4) etsi (0) mobileDomain (0)
umts-Access (20) modules (3) rnsap (1) version1 (1) rnsap-PDU-Descriptions (0) }
```

```
DEFINITIONS AUTOMATIC TAGS ::=
```

```
BEGIN
```

```
-- *****
--
-- IE parameter types from other modules.
--
-- *****
```

```
IMPORTS
```

```
    Criticality,
    ProcedureID,
    TransactionID
```

```
FROM RNSAP-CommonDataTypes
```

```
    CommonTransportChannelResourcesFailure,
    CommonTransportChannelResourcesRequest,
    CommonTransportChannelResourcesReleaseRequest,
    CommonTransportChannelResourcesResponseFDD,
    CommonTransportChannelResourcesResponseTDD,
    CompressedModeCommand,
    DedicatedMeasurementFailureIndication,
    DedicatedMeasurementInitiationFailure,
    DedicatedMeasurementInitiationRequest,
    DedicatedMeasurementInitiationResponse,
    DedicatedMeasurementReport,
    DedicatedMeasurementTerminationRequest,
    DL-PowerControlRequest,
    DL-PowerTimeslotControlRequest,
    DownlinkSignallingTransferRequest,
    ErrorIndication,
    PagingRequest,
    PhysicalChannelReconfigurationCommand,
    PhysicalChannelReconfigurationFailure,
    PhysicalChannelReconfigurationRequestFDD,
    PhysicalChannelReconfigurationRequestTDD,
    PrivateMessage,
    RadioLinkAdditionFailureFDD,
    RadioLinkAdditionFailureTDD,
    RadioLinkAdditionRequestFDD,
    RadioLinkAdditionRequestTDD,
    RadioLinkAdditionResponseFDD,
    RadioLinkAdditionResponseTDD,
    RadioLinkDeletionRequest,
    RadioLinkDeletionResponse,
    RadioLinkFailureIndication,
    RadioLinkPreemptionRequiredIndication,
    RadioLinkReconfigurationCancel,
    RadioLinkReconfigurationCommit,
```



```

RadioLinkReconfigurationFailure,
RadioLinkReconfigurationPrepareFDD,
RadioLinkReconfigurationPrepareTDD,
RadioLinkReconfigurationReadyFDD,
RadioLinkReconfigurationReadyTDD,
RadioLinkReconfigurationRequestFDD,
RadioLinkReconfigurationRequestTDD,
RadioLinkReconfigurationResponseFDD,
RadioLinkReconfigurationResponseTDD,
RadioLinkRestoreIndication,
RadioLinkSetupFailureFDD,
RadioLinkSetupFailureTDD,
RadioLinkSetupRequestFDD,
RadioLinkSetupRequestTDD,
RadioLinkSetupResponseFDD,
RadioLinkSetupResponseTDD,
RelocationCommit,
UplinkSignallingTransferIndicationFDD,
UplinkSignallingTransferIndicationTDD
FROM RNSAP-PDU-Contents

```

```

id-commonTransportChannelResourcesInitialisation,
id-commonTransportChannelResourcesRelease,
id-compressedModeCommand,
id-downlinkPowerControl,
id-downlinkSignallingTransfer,
id-downlinkPowerTimeslotControl,
id-errorIndication,
id-dedicatedMeasurementFailure,
id-dedicatedMeasurementInitiation,
id-dedicatedMeasurementReporting,
id-dedicatedMeasurementTermination,
id-paging,
id-physicalChannelReconfiguration,
id-privateMessage,
id-radioLinkAddition,
id-radioLinkDeletion,
id-radioLinkFailure,
id-radioLinkPreemption,
id-radioLinkRestoration,
id-radioLinkSetup,
id-relocationCommit,
id-synchronisedRadioLinkReconfigurationCancellation,
id-synchronisedRadioLinkReconfigurationCommit,
id-synchronisedRadioLinkReconfigurationPreparation,
id-unSynchronisedRadioLinkReconfiguration,
id-uplinkSignallingTransfer
FROM RNSAP-Constants;

```

```

-- *****
--
-- Interface Elementary Procedure Class
--
-- *****

```

```

RNSAP-ELEMENTARY-PROCEDURE ::= CLASS {
    &InitiatingMessage          ,
    &SuccessfulOutcome          OPTIONAL,
    &UnsuccessfulOutcome        OPTIONAL,
    &Outcome                    OPTIONAL,
    &procedureID                ProcedureID  UNIQUE,
    &criticality                Criticality  DEFAULT ignore
}
WITH SYNTAX {
    INITIATING MESSAGE          &InitiatingMessage
    [SUCCESSFUL OUTCOME        &SuccessfulOutcome]
    [UNSUCCESSFUL OUTCOME      &UnsuccessfulOutcome]
    [OUTCOME                   &Outcome]
    PROCEDURE ID               &procedureID
    [CRITICALITY               &criticality]
}

-- *****
--
-- Interface PDU Definition
--
-- *****

RNSAP-PDU ::= CHOICE {
    initiatingMessage  InitiatingMessage,
    successfulOutcome  SuccessfulOutcome,
    unsuccessfulOutcome UnsuccessfulOutcome,
    outcome            Outcome,
    ...
}

InitiatingMessage ::= SEQUENCE {
    procedureID RNSAP-ELEMENTARY-PROCEDURE.&procedureID      ({RNSAP-ELEMENTARY-PROCEDURES}),
    criticality RNSAP-ELEMENTARY-PROCEDURE.&criticality        ({RNSAP-ELEMENTARY-PROCEDURES}{@procedureID}),
    transactionID TransactionID,
    value       RNSAP-ELEMENTARY-PROCEDURE.&InitiatingMessage  ({RNSAP-ELEMENTARY-PROCEDURES}{@procedureID})
}

SuccessfulOutcome ::= SEQUENCE {
    procedureID RNSAP-ELEMENTARY-PROCEDURE.&procedureID      ({RNSAP-ELEMENTARY-PROCEDURES}),
    criticality RNSAP-ELEMENTARY-PROCEDURE.&criticality        ({RNSAP-ELEMENTARY-PROCEDURES}{@procedureID}),
    transactionID TransactionID,
    value       RNSAP-ELEMENTARY-PROCEDURE.&SuccessfulOutcome  ({RNSAP-ELEMENTARY-PROCEDURES}{@procedureID})
}

UnsuccessfulOutcome ::= SEQUENCE {
    procedureID RNSAP-ELEMENTARY-PROCEDURE.&procedureID      ({RNSAP-ELEMENTARY-PROCEDURES}),
    criticality RNSAP-ELEMENTARY-PROCEDURE.&criticality        ({RNSAP-ELEMENTARY-PROCEDURES}{@procedureID}),
    transactionID TransactionID,
    value       RNSAP-ELEMENTARY-PROCEDURE.&UnsuccessfulOutcome ({RNSAP-ELEMENTARY-PROCEDURES}{@procedureID})
}

Outcome ::= SEQUENCE {

```

```

    procedureID RNSAP-ELEMENTARY-PROCEDURE.&procedureID      ( {RNSAP-ELEMENTARY-PROCEDURES} ),
    criticality RNSAP-ELEMENTARY-PROCEDURE.&criticality      ( {RNSAP-ELEMENTARY-PROCEDURES}{@procedureID} ),
    transactionID TransactionID,
    value       RNSAP-ELEMENTARY-PROCEDURE.&Outcome        ( {RNSAP-ELEMENTARY-PROCEDURES}{@procedureID} )
}

-- *****
--
-- Interface Elementary Procedure List
--
-- *****

RNSAP-ELEMENTARY-PROCEDURES RNSAP-ELEMENTARY-PROCEDURE ::= {
    RNSAP-ELEMENTARY-PROCEDURES-CLASS-1      |
    RNSAP-ELEMENTARY-PROCEDURES-CLASS-2      |
    RNSAP-ELEMENTARY-PROCEDURES-CLASS-3      |
    ...                                       ,
}

RNSAP-ELEMENTARY-PROCEDURES-CLASS-1 RNSAP-ELEMENTARY-PROCEDURE ::= {
    radioLinkSetupFDD                       |
    radioLinkSetupTDD                       |
    radioLinkAdditionFDD                    |
    radioLinkAdditionTDD                    |
    radioLinkDeletion                       |
    synchronisedRadioLinkReconfigurationPreparationFDD |
    synchronisedRadioLinkReconfigurationPreparationTDD |
    unSynchronisedRadioLinkReconfigurationFDD |
    unSynchronisedRadioLinkReconfigurationTDD |
    physicalChannelReconfigurationFDD       |
    physicalChannelReconfigurationTDD       |
    dedicatedMeasurementInitiation          |
    commonTransportChannelResourcesInitialisationFDD |
    commonTransportChannelResourcesInitialisationTDD |
    ...                                       ,
}

RNSAP-ELEMENTARY-PROCEDURES-CLASS-2 RNSAP-ELEMENTARY-PROCEDURE ::= {
    uplinkSignallingTransferFDD             |
    uplinkSignallingTransferTDD             |
    downlinkSignallingTransfer              |
    relocationCommit                        |
    paging                                  |
    synchronisedRadioLinkReconfigurationCommit |
    synchronisedRadioLinkReconfigurationCancellation |
    radioLinkFailure                        |
    radioLinkPreemption                     |
    radioLinkRestoration                    |
    dedicatedMeasurementReporting           |
    dedicatedMeasurementTermination         |
    dedicatedMeasurementFailure             |
    downlinkPowerControlFDD                 |
    downlinkPowerTimeslotControl            |
    compressedModeCommandFDD                |

```

```

    commonTransportChannelResourcesRelease      |
    errorIndication                            |
    privateMessage                             ,
    ...
}

RNSAP-ELEMENTARY-PROCEDURES-CLASS-3 RNSAP-ELEMENTARY-PROCEDURE ::= {
    ...
}

-- *****
--
-- Interface Elementary Procedures
--
-- *****

radioLinkSetupFDD RNSAP-ELEMENTARY-PROCEDURE ::= {
    INITIATING MESSAGE  RadioLinkSetupRequestFDD
    SUCCESSFUL OUTCOME  RadioLinkSetupResponseFDD
    UNSUCCESSFUL OUTCOME RadioLinkSetupFailureFDD
    PROCEDURE ID        { procedureCode id-radioLinkSetup, ddMode fdd }
    CRITICALITY         reject
}

radioLinkSetupTDD RNSAP-ELEMENTARY-PROCEDURE ::= {
    INITIATING MESSAGE  RadioLinkSetupRequestTDD
    SUCCESSFUL OUTCOME  RadioLinkSetupResponseTDD
    UNSUCCESSFUL OUTCOME RadioLinkSetupFailureTDD
    PROCEDURE ID        { procedureCode id-radioLinkSetup, ddMode tdd }
    CRITICALITY         reject
}

radioLinkAdditionFDD RNSAP-ELEMENTARY-PROCEDURE ::= {
    INITIATING MESSAGE  RadioLinkAdditionRequestFDD
    SUCCESSFUL OUTCOME  RadioLinkAdditionResponseFDD
    UNSUCCESSFUL OUTCOME RadioLinkAdditionFailureFDD
    PROCEDURE ID        { procedureCode id-radioLinkAddition , ddMode fdd }
    CRITICALITY         reject
}

radioLinkAdditionTDD RNSAP-ELEMENTARY-PROCEDURE ::= {
    INITIATING MESSAGE  RadioLinkAdditionRequestTDD
    SUCCESSFUL OUTCOME  RadioLinkAdditionResponseTDD
    UNSUCCESSFUL OUTCOME RadioLinkAdditionFailureTDD
    PROCEDURE ID        { procedureCode id-radioLinkAddition , ddMode tdd }
    CRITICALITY         reject
}

radioLinkDeletion RNSAP-ELEMENTARY-PROCEDURE ::= {
    INITIATING MESSAGE  RadioLinkDeletionRequest
    SUCCESSFUL OUTCOME  RadioLinkDeletionResponse
    PROCEDURE ID        { procedureCode id-radioLinkDeletion, ddMode common }
    CRITICALITY         reject
}

```

```
synchronisedRadioLinkReconfigurationPreparationFDD RNSAP-ELEMENTARY-PROCEDURE ::= {
  INITIATING MESSAGE  RadioLinkReconfigurationPrepareFDD
  SUCCESSFUL OUTCOME  RadioLinkReconfigurationReadyFDD
  UNSUCCESSFUL OUTCOME  RadioLinkReconfigurationFailure
  PROCEDURE ID        { procedureCode id-synchronisedRadioLinkReconfigurationPreparation, ddMode fdd }
  CRITICALITY         reject
}

synchronisedRadioLinkReconfigurationPreparationTDD RNSAP-ELEMENTARY-PROCEDURE ::= {
  INITIATING MESSAGE  RadioLinkReconfigurationPrepareTDD
  SUCCESSFUL OUTCOME  RadioLinkReconfigurationReadyTDD
  UNSUCCESSFUL OUTCOME  RadioLinkReconfigurationFailure
  PROCEDURE ID        { procedureCode id-synchronisedRadioLinkReconfigurationPreparation, ddMode tdd }
  CRITICALITY         reject
}

unSynchronisedRadioLinkReconfigurationFDD RNSAP-ELEMENTARY-PROCEDURE ::= {
  INITIATING MESSAGE  RadioLinkReconfigurationRequestFDD
  SUCCESSFUL OUTCOME  RadioLinkReconfigurationResponseFDD
  UNSUCCESSFUL OUTCOME  RadioLinkReconfigurationFailure
  PROCEDURE ID        { procedureCode id-unSynchronisedRadioLinkReconfiguration, ddMode fdd }
  CRITICALITY         reject
}

unSynchronisedRadioLinkReconfigurationTDD RNSAP-ELEMENTARY-PROCEDURE ::= {
  INITIATING MESSAGE  RadioLinkReconfigurationRequestTDD
  SUCCESSFUL OUTCOME  RadioLinkReconfigurationResponseTDD
  UNSUCCESSFUL OUTCOME  RadioLinkReconfigurationFailure
  PROCEDURE ID        { procedureCode id-unSynchronisedRadioLinkReconfiguration, ddMode tdd }
  CRITICALITY         reject
}

physicalChannelReconfigurationFDD RNSAP-ELEMENTARY-PROCEDURE ::= {
  INITIATING MESSAGE  PhysicalChannelReconfigurationRequestFDD
  SUCCESSFUL OUTCOME  PhysicalChannelReconfigurationCommand
  UNSUCCESSFUL OUTCOME  PhysicalChannelReconfigurationFailure
  PROCEDURE ID        { procedureCode id-physicalChannelReconfiguration, ddMode fdd }
  CRITICALITY         reject
}

physicalChannelReconfigurationTDD RNSAP-ELEMENTARY-PROCEDURE ::= {
  INITIATING MESSAGE  PhysicalChannelReconfigurationRequestTDD
  SUCCESSFUL OUTCOME  PhysicalChannelReconfigurationCommand
  UNSUCCESSFUL OUTCOME  PhysicalChannelReconfigurationFailure
  PROCEDURE ID        { procedureCode id-physicalChannelReconfiguration, ddMode tdd }
  CRITICALITY         reject
}

dedicatedMeasurementInitiation RNSAP-ELEMENTARY-PROCEDURE ::= {
  INITIATING MESSAGE  DedicatedMeasurementInitiationRequest
  SUCCESSFUL OUTCOME  DedicatedMeasurementInitiationResponse
  UNSUCCESSFUL OUTCOME  DedicatedMeasurementInitiationFailure
  PROCEDURE ID        { procedureCode id-dedicatedMeasurementInitiation, ddMode common }
}
```

```

    CRITICALITY    reject
}

commonTransportChannelResourcesInitialisationFDD RNSAP-ELEMENTARY-PROCEDURE ::= {
    INITIATING MESSAGE    CommonTransportChannelResourcesRequest
    SUCCESSFUL OUTCOME    CommonTransportChannelResourcesResponseFDD
    UNSUCCESSFUL OUTCOME    CommonTransportChannelResourcesFailure
    PROCEDURE ID          { procedureCode id-commonTransportChannelResourcesInitialisation, ddMode fdd }
    CRITICALITY          reject
}

commonTransportChannelResourcesInitialisationTDD RNSAP-ELEMENTARY-PROCEDURE ::= {
    INITIATING MESSAGE    CommonTransportChannelResourcesRequest
    SUCCESSFUL OUTCOME    CommonTransportChannelResourcesResponseTDD
    UNSUCCESSFUL OUTCOME    CommonTransportChannelResourcesFailure
    PROCEDURE ID          { procedureCode id-commonTransportChannelResourcesInitialisation, ddMode tdd }
    CRITICALITY          reject
}

uplinkSignallingTransferFDD RNSAP-ELEMENTARY-PROCEDURE ::= {
    INITIATING MESSAGE    UplinkSignallingTransferIndicationFDD
    PROCEDURE ID          { procedureCode id-uplinkSignallingTransfer, ddMode fdd }
    CRITICALITY          ignore
}

uplinkSignallingTransferTDD RNSAP-ELEMENTARY-PROCEDURE ::= {
    INITIATING MESSAGE    UplinkSignallingTransferIndicationTDD
    PROCEDURE ID          { procedureCode id-uplinkSignallingTransfer, ddMode tdd }
    CRITICALITY          ignore
}

downlinkSignallingTransfer RNSAP-ELEMENTARY-PROCEDURE ::= {
    INITIATING MESSAGE    DownlinkSignallingTransferRequest
    PROCEDURE ID          { procedureCode id-downlinkSignallingTransfer, ddMode common }
    CRITICALITY          ignore
}

relocationCommit RNSAP-ELEMENTARY-PROCEDURE ::= {
    INITIATING MESSAGE    RelocationCommit
    PROCEDURE ID          { procedureCode id-relocationCommit, ddMode common }
    CRITICALITY          ignore
}

paging RNSAP-ELEMENTARY-PROCEDURE ::= {
    INITIATING MESSAGE    PagingRequest
    PROCEDURE ID          { procedureCode id-paging, ddMode common }
    CRITICALITY          ignore
}

synchronisedRadioLinkReconfigurationCommit RNSAP-ELEMENTARY-PROCEDURE ::= {
    INITIATING MESSAGE    RadioLinkReconfigurationCommit
    PROCEDURE ID          { procedureCode id-synchronisedRadioLinkReconfigurationCommit, ddMode common }
    CRITICALITY          ignore
}

```

```
synchronisedRadioLinkReconfigurationCancellation RNSAP-ELEMENTARY-PROCEDURE ::= {
  INITIATING MESSAGE  RadioLinkReconfigurationCancel
  PROCEDURE ID        { procedureCode id-synchronisedRadioLinkReconfigurationCancellation, ddMode common }
  CRITICALITY         ignore
}

radioLinkFailure RNSAP-ELEMENTARY-PROCEDURE ::= {
  INITIATING MESSAGE  RadioLinkFailureIndication
  PROCEDURE ID        { procedureCode id-radioLinkFailure, ddMode common }
  CRITICALITY         ignore
}

radioLinkPreemption RNSAP-ELEMENTARY-PROCEDURE ::= {
  INITIATING MESSAGE  RadioLinkPreemptionRequiredIndication
  PROCEDURE ID        { procedureCode id-radioLinkPreemption, ddMode common }
  CRITICALITY         ignore
}

radioLinkRestoration RNSAP-ELEMENTARY-PROCEDURE ::= {
  INITIATING MESSAGE  RadioLinkRestoreIndication
  PROCEDURE ID        { procedureCode id-radioLinkRestoration, ddMode common }
  CRITICALITY         ignore
}

dedicatedMeasurementReporting RNSAP-ELEMENTARY-PROCEDURE ::= {
  INITIATING MESSAGE  DedicatedMeasurementReport
  PROCEDURE ID        { procedureCode id-dedicatedMeasurementReporting, ddMode common }
  CRITICALITY         ignore
}

dedicatedMeasurementTermination RNSAP-ELEMENTARY-PROCEDURE ::= {
  INITIATING MESSAGE  DedicatedMeasurementTerminationRequest
  PROCEDURE ID        { procedureCode id-dedicatedMeasurementTermination, ddMode common }
  CRITICALITY         ignore
}

dedicatedMeasurementFailure RNSAP-ELEMENTARY-PROCEDURE ::= {
  INITIATING MESSAGE  DedicatedMeasurementFailureIndication
  PROCEDURE ID        { procedureCode id-dedicatedMeasurementFailure, ddMode common }
  CRITICALITY         ignore
}

downlinkPowerControlFDD RNSAP-ELEMENTARY-PROCEDURE ::= {
  INITIATING MESSAGE  DL-PowerControlRequest
  PROCEDURE ID        { procedureCode id-downlinkPowerControl, ddMode fdd }
  CRITICALITY         ignore
}

downlinkPowerTimeslotControl RNSAP-ELEMENTARY-PROCEDURE ::= {
  INITIATING MESSAGE  DL-PowerTimeslotControlRequest
  PROCEDURE ID        { procedureCode id-downlinkPowerTimeslotControl, ddMode tdd }
  CRITICALITY         ignore
}
```

```

compressedModeCommandFDD RNSAP-ELEMENTARY-PROCEDURE ::= {
  INITIATING MESSAGE  CompressedModeCommand
  PROCEDURE ID        { procedureCode id-compressedModeCommand, ddMode fdd }
  CRITICALITY         ignore
}

commonTransportChannelResourcesRelease RNSAP-ELEMENTARY-PROCEDURE ::= {
  INITIATING MESSAGE  CommonTransportChannelResourcesReleaseRequest
  PROCEDURE ID        { procedureCode id-commonTransportChannelResourcesRelease, ddMode common }
  CRITICALITY         ignore
}

errorIndication RNSAP-ELEMENTARY-PROCEDURE ::= {
  INITIATING MESSAGE  ErrorIndication
  PROCEDURE ID        { procedureCode id-errorIndication, ddMode common }
  CRITICALITY         ignore
}

privateMessage RNSAP-ELEMENTARY-PROCEDURE ::= {
  INITIATING MESSAGE  PrivateMessage
  PROCEDURE ID        { procedureCode id-privateMessage, ddMode common }
  CRITICALITY         ignore
}

END

```

9.3.3 PDU Definitions

```

-- *****
--
-- PDU definitions for RNSAP.
--
-- *****

RNSAP-PDU-Contents {
itu-t (0) identified-organization (4) etsi (0) mobileDomain (0)
umts-Access (20) modules (3) rnsap (1) version1 (1) rnsap-PDU-Contents (1) }

DEFINITIONS AUTOMATIC TAGS ::=

BEGIN

-- *****
--
-- IE parameter types from other modules.
--
-- *****

IMPORTS
  Active-Pattern-Sequence-Information,
  AllocationRetentionPriority,
  AllowedQueuingTime,

```

AlphaValue,
BLER,
SCTD-Indicator,
BindingID,
C-ID,
C-RNTI,
CCTrCH-ID,
CFN,
ClosedLoopModel-SupportIndicator,
ClosedLoopMode2-SupportIndicator,
Closedlooptimingadjustmentmode,
CN-CS-DomainIdentifier,
CN-PS-DomainIdentifier,
CNDomainType,
Cause,
CellParameterID,
ChipOffset,
CriticalityDiagnostics,
D-RNTI,
D-RNTI-ReleaseIndication,
DCH-FDD-Information,
DCH-ID,
DCH-InformationResponse,
DCH-TDD-Information,
DL-DPCH-SlotFormat,
DL-TimeslotISCP,
DL-Power,
DL-ScramblingCode,
DL-Timeslot-Information,
DL-TimeSlot-ISCP-Info,
DPCH-ID,
DRACControl,
DRXCycleLengthCoefficient,
DedicatedMeasurementType,
DedicatedMeasurementValue,
DedicatedMeasurementValueInformation,
DiversityControlField,
DiversityMode,
DSCH-FDD-Information,
DSCH-FDD-InformationResponse,
DSCH-FlowControlInformation,
DSCH-FlowControlItem,
DSCH-TDD-Information,
DSCH-ID,
DSCH-RNTI,
SchedulingPriorityIndicator,
FACH-FlowControlInformation,
FDD-DCHs-to-Modify,
FDD-DL-ChannelisationCodeNumber,
FDD-DL-CodeInformation,
FDD-S-CCPCH-Offset,
FDD-TPC-DownlinkStepSize,
FirstRLS-Indicator,
FNReportingIndicator,

FrameHandlingPriority,
FrameOffset,
GA-AccessPointPosition,
GA-Cell,
IMSI,
InnerLoopDLPCStatus,
L3-Information,
SplitType,
LengthOfTFICI2,
LimitedPowerIncrease,
MaximumAllowedULTxPower,
MaxNrDLPhysicalchannels,
MaxNrOfUL-DPCHs,
MaxNrTimeslots,
MaxNrULPhysicalchannels,
MeasurementFilterCoefficient,
MeasurementID,
MidambleShiftAndBurstType,
MinimumSpreadingFactor,
MinUL-ChannelisationCodeLength,
MultiplexingPosition,
Neighbouring-GSM-CellInformation,
Neighbouring-UMTS-CellInformation,
NrOfDLchannelisationcodes,
PagingCause,
PagingRecordType,
PDSCHCodeMapping,
PayloadCRC-PresenceIndicator,
PCCPCH-Power,
PC-Preamble,
Permanent-NAS-UE-Identity,
PowerAdjustmentType,
PowerOffset,
PrimaryCCPCH-RSCP,
PrimaryCPICH-EcNo,
PrimaryCPICH-Power,
PrimaryScramblingCode,
PropagationDelay,
PunctureLimit,
QE-Selector,
RANAP-RelocationInformation,
RB-Info,
RL-ID,
RL-Set-ID,
RNC-ID,
RepetitionLength,
RepetitionPeriod,
ReportCharacteristics,
Received-total-wide-band-power,
RxTimingDeviationForTA,
S-FieldLength,
S-RNTI,
SCH-TimeSlot,
SAI,

Secondary-CCPCH-Info,
Secondary-CCPCH-Info-TDD,
SpecialBurstScheduling,
SSDT-CellID,
SSDT-CellID-Length,
SSDT-Indication,
SSDT-SupportIndicator,
STTD-Indicator,
STTD-SupportIndicator,
AdjustmentPeriod,
ScaledAdjustmentRatio,
MaxAdjustmentStep,
SecondaryCCPCH-SlotFormat,
SRB-Delay,
SyncCase,
SynchronisationConfiguration,
TDD-ChannelisationCode,
TDD-DCHs-to-Modify,
TDD-DL-Code-Information,
TDD-DPCHOffset,
TDD-PhysicalChannelOffset,
TDD-TPC-DownlinkStepSize,
TDD-UL-Code-Information,
TFCI-Coding,
TFCI-Presence,
TFCI-SignallingMode,
TimeSlot,
TimingAdvanceApplied,
ToAWE,
ToAWS,
TransmitDiversityIndicator,
TransportBearerID,
TransportBearerRequestIndicator,
TFCS,
Transmission-Gap-Pattern-Sequence-Information,
TransportFormatManagement,
TransportFormatSet,
TransportLayerAddress,
TrCH-SrcStatisticsDescr,
UARFCN,
UC-ID,
UL-DPCCH-SlotFormat,
UL-SIR,
UL-FP-Mode,
UL-PhysCH-SF-Variation,
UL-ScramblingCode,
UL-TimeSlot-Information,
UL-TimeSlot-ISCP-Info,
URA-ID,
URA-Information,
USCH-ID,
USCH-Information
FROM RNSAP-IEs

```
PrivateIE-Container {},
ProtocolExtensionContainer {},
ProtocolIE-ContainerList {},
ProtocolIE-ContainerPair {},
ProtocolIE-ContainerPairList {},
ProtocolIE-Container {},
ProtocolIE-Single-Container {},
RNSAP-PRIVATE-IES,
RNSAP-PROTOCOL-EXTENSION,
RNSAP-PROTOCOL-IES,
RNSAP-PROTOCOL-IES-PAIR
FROM RNSAP-Containers

maxNoOfDSCHs,
maxNoOfUSCHs,
maxNrOfCCTrCHs,
maxNrOfDCHs,
maxNrOfTS,
maxNrOfDPCHs,
maxNrOfRLs,
maxNrOfRLSets,
maxNrOfRLs-1,
maxNrOfRLs-2,
maxNrOfULTs,
maxNrOfDLTs,

id-Active-Pattern-Sequence-Information,
id-AdjustmentRatio,
id-AllowedQueuingTime,
id-BindingID,
id-C-ID,
id-C-RNTI,
id-CFN,
id-CFNReportingIndicator,
id-CN-CS-DomainIdentifier,
id-CN-PS-DomainIdentifier,
id-Cause,
id-CauseLevel-RL-AdditionFailureFDD,
id-CauseLevel-RL-AdditionFailureTDD,
id-CauseLevel-RL-ReconfFailure,
id-CauseLevel-RL-SetupFailureFDD,
id-CauseLevel-RL-SetupFailureTDD,
id-CCTrCH-InformationItem-RL-FailureInd,
id-CCTrCH-InformationItem-RL-RestoreInd,
id-ClosedLoopModel-SupportIndicator,
id-ClosedLoopMode2-SupportIndicator,
id-CNOriginatedPage-PagingRqst,
id-CriticalityDiagnostics,
id-D-RNTI,
id-D-RNTI-ReleaseIndication,
id-DCHs-to-Add-FDD,
id-DCHs-to-Add-TDD,
id-DCH-DeleteList-RL-ReconfPrepFDD,
id-DCH-DeleteList-RL-ReconfPrepTDD,
```

id-DCH-DeleteList-RL-ReconfRqstFDD,
id-DCH-DeleteList-RL-ReconfRqstTDD,
id-DCH-FDD-Information,
id-DCH-TDD-Information,
id-FDD-DCHs-to-Modify,
id-TDD-DCHs-to-Modify,
id-DCH-InformationResponse,
id-DL-CCTrCH-InformationAddItem-RL-ReconfPrepTDD,
id-DL-CCTrCH-InformationDeleteItem-RL-ReconfPrepTDD,
id-DL-CCTrCH-InformationModifyItem-RL-ReconfPrepTDD,
id-DL-CCTrCH-InformationListIE-RL-ReconfReadyTDD,
id-DL-CCTrCH-InformationModifyItem-RL-ReconfRqstTDD,
id-DL-CCTrCH-InformationDeleteItem-RL-ReconfRqstTDD,
id-DL-CCTrCH-InformationItem-SetupRqstTDD,
id-DL-CCTrCH-InformationListIE-PhyChReconfRqstTDD,
id-DL-CCTrCH-InformationListIE-RL-AdditionRspTDD,
id-DL-CCTrCH-InformationListIE-RL-SetupRspTDD,
id-DL-CCTrCH-InformationAddList-RL-ReconfPrepTDD,
id-DL-CCTrCH-InformationDeleteList-RL-ReconfPrepTDD,
id-DL-CCTrCH-InformationModifyList-RL-ReconfPrepTDD,
id-DL-CCTrCH-InformationDeleteList-RL-ReconfRqstTDD,
id-DL-CCTrCH-InformationModifyList-RL-ReconfRqstTDD,
id-DL-CCTrCH-InformationList-RL-SetupRqstTDD,
id-FDD-DL-CodeInformation,
id-DL-DPCH-Information-RL-ReconfPrepFDD,
id-DL-DPCH-Information-RL-SetupRqstFDD,
id-DL-DPCH-Information-RL-ReconfRqstFDD,
id-DL-DPCH-InformationItem-PhyChReconfRqstTDD,
id-DL-DPCH-InformationItem-RL-AdditionRspTDD,
id-DL-DPCH-InformationItem-RL-SetupRspTDD,
id-DL-DPCH-InformationAddListIE-RL-ReconfReadyTDD,
id-DL-DPCH-InformationDeleteListIE-RL-ReconfReadyTDD,
id-DL-DPCH-InformationModifyListIE-RL-ReconfReadyTDD,
id-DL-Physical-Channel-Information-RL-SetupRqstTDD,
id-DLReferencePower,
id-DLReferencePowerList-DL-PC-Rqst,
id-DL-ReferencePowerInformation-DL-PC-Rqst,
id-DRXCycleLengthCoefficient,
id-DedicatedMeasurementObjectType-DM-Rprt,
id-DedicatedMeasurementObjectType-DM-Rqst,
id-DedicatedMeasurementObjectType-DM-Rsp,
id-DedicatedMeasurementType,
id-DSCHs-to-Add-FDD,
id-DSCHs-to-Add-TDD,
id-DSCH-DeleteList-RL-ReconfPrepTDD,
id-DSCH-Delete-RL-ReconfPrepFDD,
id-DSCH-FDD-Information,
id-DSCH-InformationListIE-RL-AdditionRspTDD,
id-DSCH-InformationListIEs-RL-SetupRspTDD,
id-DSCH-TDD-Information,
id-DSCH-FDD-InformationResponse,
id-DSCH-ModifyList-RL-ReconfPrepTDD,
id-DSCH-Modify-RL-ReconfPrepFDD,
id-DSCH-RNTI,

id-DSCHsToBeAddedOrModified-FDD,
id-DSCHToBeAddedOrModifiedList-RL-ReconfReadyTDD,
id-FACH-InfoForUESelectedS-CCPCH-CTCH-ResourceRspFDD,
id-FACH-InfoForUESelectedS-CCPCH-CTCH-ResourceRspTDD,
id-GA-Cell,
id-IMSI,
id-InnerLoopDLPCStatus,
id-SplitType,
id-LengthOfTFCI2,
id-L3-Information,
id-AdjustmentPeriod,
id-MaxAdjustmentStep,
id-MeasurementFilterCoefficient,
id-MeasurementID,
id-PagingArea-PagingRqst,
id-Permanent-NAS-UE-Identity,
id-PDSCH-RL-ID,
id-FACH-FlowControlInformation,
id-PowerAdjustmentType,
id-PropagationDelay,
id-RANAP-RelocationInformation,
id-RL-Information-PhyChReconfRqstFDD,
id-RL-Information-PhyChReconfRqstTDD,
id-RL-Information-RL-AdditionRqstFDD,
id-RL-Information-RL-AdditionRqstTDD,
id-RL-Information-RL-DeletionRqst,
id-RL-Information-RL-FailureInd,
id-RL-Information-RL-ReconfPrepFDD,
id-RL-Information-RL-RestoreInd,
id-RL-Information-RL-SetupRqstFDD,
id-RL-Information-RL-SetupRqstTDD,
id-RL-InformationItem-DM-Rprt,
id-RL-InformationItem-DM-Rqst,
id-RL-InformationItem-DM-Rsp,
id-RL-InformationItem-RL-PreemptRequiredInd,
id-RL-InformationItem-RL-SetupRqstFDD,
id-RL-InformationList-RL-AdditionRqstFDD,
id-RL-InformationList-RL-DeletionRqst,
id-RL-InformationList-RL-PreemptRequiredInd,
id-RL-InformationList-RL-ReconfPrepFDD,
id-RL-InformationResponse-RL-AdditionRspTDD,
id-RL-InformationResponse-RL-ReconfReadyTDD,
id-RL-InformationResponse-RL-ReconfRspTDD,
id-RL-InformationResponse-RL-SetupRspTDD,
id-RL-InformationResponseItem-RL-AdditionRspFDD,
id-RL-InformationResponseItem-RL-ReconfReadyFDD,
id-RL-InformationResponseItem-RL-ReconfRspFDD,
id-RL-InformationResponseItem-RL-SetupRspFDD,
id-RL-InformationResponseList-RL-AdditionRspFDD,
id-RL-InformationResponseList-RL-ReconfReadyFDD,
id-RL-InformationResponseList-RL-ReconfRspFDD,
id-RL-InformationResponseList-RL-SetupRspFDD,
id-RL-ReconfigurationFailure-RL-ReconfFail,
id-RL-Set-InformationItem-DM-Rprt,

id-RL-Set-InformationItem-DM-Rqst,
id-RL-Set-InformationItem-DM-Rsp,
id-RL-Set-Information-RL-FailureInd,
id-RL-Set-Information-RL-RestoreInd,
id-ReportCharacteristics,
id-Reporting-Object-RL-FailureInd,
id-Reporting-Object-RL-RestoreInd,
id-RxTimingDeviationForTA,
id-S-RNTI,
id-SAI,
id-SRNC-ID,
id-STTD-SupportIndicator,
id-SuccessfulRL-InformationResponse-RL-AdditionFailureFDD,
id-SuccessfulRL-InformationResponse-RL-SetupFailureFDD,
id-timeSlot-ISCP,
id-TimeSlot-RL-SetupRspTDD,
id-TransportBearerID,
id-TransportBearerRequestIndicator,
id-TransportLayerAddress,
id-UC-ID,
id-Transmission-Gap-Pattern-Sequence-Information,
id-UL-CCTrCH-AddInformation-RL-ReconfPrepTDD,
id-UL-CCTrCH-DeleteInformation-RL-ReconfPrepTDD,
id-UL-CCTrCH-ModifyInformation-RL-ReconfPrepTDD,
id-UL-CCTrCH-InformationDeleteItem-RL-ReconfRqstTDD,
id-UL-CCTrCH-InformationModifyItem-RL-ReconfRqstTDD,
id-UL-CCTrCH-InformationAddList-RL-ReconfPrepTDD,
id-UL-CCTrCH-InformationDeleteList-RL-ReconfPrepTDD,
id-UL-CCTrCH-InformationModifyList-RL-ReconfPrepTDD,
id-UL-CCTrCH-InformationDeleteList-RL-ReconfRqstTDD,
id-UL-CCTrCH-InformationModifyList-RL-ReconfRqstTDD,
id-UL-CCTrCH-InformationItem-RL-SetupRqstTDD,
id-UL-CCTrCH-InformationList-RL-SetupRqstTDD,
id-UL-CCTrCH-InformationListIE-PhyChReconfRqstTDD,
id-UL-CCTrCH-InformationListIE-RL-AdditionRspTDD,
id-UL-CCTrCH-InformationListIE-RL-ReconfReadyTDD,
id-UL-CCTrCH-InformationListIE-RL-SetupRspTDD,
id-UL-DPCH-Information-RL-ReconfPrepFDD,
id-UL-DPCH-Information-RL-ReconfRqstFDD,
id-UL-DPCH-Information-RL-SetupRqstFDD,
id-UL-DPCH-InformationItem-PhyChReconfRqstTDD,
id-UL-DPCH-InformationItem-RL-AdditionRspTDD,
id-UL-DPCH-InformationItem-RL-SetupRspTDD,
id-UL-DPCH-InformationAddListIE-RL-ReconfReadyTDD,
id-UL-DPCH-InformationDeleteListIE-RL-ReconfReadyTDD,
id-UL-DPCH-InformationModifyListIE-RL-ReconfReadyTDD,
id-UL-Physical-Channel-Information-RL-SetupRqstTDD,
id-UL-SIRTarget,
id-URA-Information,
id-UnsuccessfulRL-InformationResponse-RL-AdditionFailureFDD,
id-UnsuccessfulRL-InformationResponse-RL-AdditionFailureTDD,
id-UnsuccessfulRL-InformationResponse-RL-SetupFailureFDD,
id-UnsuccessfulRL-InformationResponse-RL-SetupFailureTDD,
id-USCHs-to-Add,

```

id-USCH-DeleteList-RL-ReconfPrepTDD,
id-USCH-InformationListIE-RL-AdditionRspTDD,
id-USCH-InformationListIEs-RL-SetupRspTDD,
id-USCH-Information,
id-USCH-ModifyList-RL-ReconfPrepTDD,
id-USCHToBeAddedOrModifiedList-RL-ReconfReadyTDD,
id-PrimaryCCPCH-RSCP-RL-ReconfPrepTDD,
id-DL-TimeSlot-ISCP-Info-RL-ReconfPrepTDD
FROM RNSAP-Constants;

```

```

-- *****
--
-- RADIO LINK SETUP REQUEST FDD
--
-- *****

```

```

RadioLinkSetupRequestFDD ::= SEQUENCE {
    protocolIEs                ProtocolIE-Container    {{RadioLinkSetupRequestFDD-IEs}},
    protocolExtensions         ProtocolExtensionContainer {{RadioLinkSetupRequestFDD-Extensions}} OPTIONAL,
    ...
}

```

```

RadioLinkSetupRequestFDD-IEs RNSAP-PROTOCOL-IES ::= {
    { ID id-SRNC-ID                CRITICALITY reject TYPE RNC-ID                PRESENCE mandatory } |
    { ID id-S-RNTI                 CRITICALITY reject TYPE S-RNTI                PRESENCE mandatory } |
    { ID id-D-RNTI                 CRITICALITY reject TYPE D-RNTI                PRESENCE optional  } |
    { ID id-AllowedQueuingTime     CRITICALITY reject TYPE AllowedQueuingTime PRESENCE optional  } |
    { ID id-UL-DPCH-Information-RL-SetupRqstFDD CRITICALITY reject TYPE UL-DPCH-Information-RL-SetupRqstFDD PRESENCE mandatory } |
    { ID id-DL-DPCH-Information-RL-SetupRqstFDD CRITICALITY reject TYPE DL-DPCH-Information-RL-SetupRqstFDD PRESENCE mandatory } |
    { ID id-DCH-FDD-Information     CRITICALITY reject TYPE DCH-FDD-Information PRESENCE mandatory } |
    { ID id-DSCH-FDD-Information    CRITICALITY reject TYPE DSCH-FDD-Information PRESENCE optional  } |
    { ID id-RL-Information-RL-SetupRqstFDD CRITICALITY notify TYPE RL-InformationList-RL-SetupRqstFDD PRESENCE mandatory } |
    { ID id-Transmission-Gap-Pattern-Sequence-Information CRITICALITY reject TYPE Transmission-Gap-Pattern-Sequence-Information PRESENCE optional } |
    { ID id-Active-Pattern-Sequence-Information CRITICALITY reject TYPE Active-Pattern-Sequence-Information PRESENCE optional },
    ...
}

```

```

UL-DPCH-Information-RL-SetupRqstFDD ::= SEQUENCE {
    ul-ScramblingCode            UL-ScramblingCode,
    minUL-ChannelisationCodeLength MinUL-ChannelisationCodeLength,
    maxNrOfUL-DPCHs              MaxNrOfUL-DPCHs OPTIONAL
    -- This IE shall be present if minUL-ChannelisationCodeLength equals to 4 -- ,
    ul-PunctureLimit             PunctureLimit,
    ul-TFCS                       TFCS,
    ul-DPCCH-SlotFormat          UL-DPCCH-SlotFormat,
    ul-SIRTarget                  UL-SIR OPTIONAL,
    diversityMode                 DiversityMode,
    sSDT-CellIdLength             SSDT-CellIdLength OPTIONAL,
    s-FieldLength                 S-FieldLength OPTIONAL,
    iE-Extensions                 ProtocolExtensionContainer { {UL-DPCH-Information-RL-SetupRqstFDD-ExtIEs} } OPTIONAL,
    ...
}

```



```

UL-DPCH-Information-RL-SetupRqstFDD-ExtIEs RNSAP-PROTOCOL-EXTENSION ::= {
  ...
}

DL-DPCH-Information-RL-SetupRqstFDD ::= SEQUENCE {
  tFCS                TFCS,
  dl-DPCH-SlotFormat DL-DPCH-SlotFormat,
  nrOfDLchannelisationcodes NrOfDLchannelisationcodes,
  tFCI-SignallingMode TFCI-SignallingMode,
  tFCI-Presence       TFCI-Presence          OPTIONAL
  -- This IE shall be present if DL DPCH Slot Format IE is from 12 to 16 --,
  multiplexingPosition MultiplexingPosition,
  powerOffsetInformation PowerOffsetInformation-RL-SetupRqstFDD,
  fdd-dl-TPC-DownlinkStepSize FDD-TPC-DownlinkStepSize,
  limitedPowerIncrease LimitedPowerIncrease,
  innerLoopDLPCStatus InnerLoopDLPCStatus,
  iE-Extensions        ProtocolExtensionContainer { {DL-DPCH-Information-RL-SetupRqstFDD-ExtIEs} } OPTIONAL,
  ...
}

DL-DPCH-Information-RL-SetupRqstFDD-ExtIEs RNSAP-PROTOCOL-EXTENSION ::= {
  { ID id-SplitType CRITICALITY reject EXTENSION SplitType PRESENCE conditional } |
  -- This IE shall be present if the TFCI signalling mode is split --
  { ID id-LengthOfTFCI2 CRITICALITY reject EXTENSION LengthOfTFCI2 PRESENCE conditional },
  -- This IE shall be present if the split type is logical --
  ...
}

PowerOffsetInformation-RL-SetupRqstFDD ::= SEQUENCE {
  po1-ForTFCI-Bits PowerOffset,
  po2-ForTPC-Bits PowerOffset,
  po3-ForPilotBits PowerOffset,
  iE-Extensions ProtocolExtensionContainer { { PowerOffsetInformation-RL-SetupRqstFDD-ExtIEs } } OPTIONAL,
  ...
}

PowerOffsetInformation-RL-SetupRqstFDD-ExtIEs RNSAP-PROTOCOL-EXTENSION ::= {
  ...
}

RL-InformationList-RL-SetupRqstFDD ::= SEQUENCE (SIZE (1..maxNrOfRLs)) OF ProtocolIE-Single-Container { {RL-InformationItemIEs-RL-SetupRqstFDD} }

RL-InformationItemIEs-RL-SetupRqstFDD RNSAP-PROTOCOL-IES ::= {
  { ID id-RL-InformationItem-RL-SetupRqstFDD CRITICALITY notify TYPE RL-InformationItem-RL-SetupRqstFDD PRESENCE mandatory }
}

RL-InformationItem-RL-SetupRqstFDD ::= SEQUENCE {
  rL-ID RL-ID,
  c-ID C-ID,
  firstRLS-indicator FirstRLS-Indicator,
  frameOffset FrameOffset,
  chipOffset ChipOffset,
  propagationDelay PropagationDelay          OPTIONAL,
}

```

```

diversityControlField      DiversityControlField      OPTIONAL
-- This IE shall be present if the RL is not the first one in the RL-InformationList-RL-SetupRqstFDD --,
dl-InitialTX-Power        DL-Power          OPTIONAL,
primaryCPICH-EcNo         PrimaryCPICH-EcNo   OPTIONAL,
sSDT-CellID              SSDT-CellID        OPTIONAL,
transmitDiversityIndicator TransmitDiversityIndicator OPTIONAL,
-- This IE shall be present unless Diversity Mode IE in UL DPCH Information group is "none"
IE-Extensions            ProtocolExtensionContainer { {RL-InformationItem-RL-SetupRqstFDD-ExtIEs} } OPTIONAL,
...
}

RL-InformationItem-RL-SetupRqstFDD-ExtIEs RNSAP-PROTOCOL-EXTENSION ::= {
...
}

RadioLinkSetupRequestFDD-Extensions RNSAP-PROTOCOL-EXTENSION ::= {
  { ID id-Permanent-NAS-UE-Identity          CRITICALITY ignore          EXTENSION Permanent-NAS-UE-Identity PRESENCE optional },
  ...
}

-- *****
--
-- RADIO LINK SETUP REQUEST TDD
--
-- *****

RadioLinkSetupRequestTDD ::= SEQUENCE {
  protocolIEs          ProtocolIE-Container      {{RadioLinkSetupRequestTDD-IEs}},
  protocolExtensions  ProtocolExtensionContainer {{RadioLinkSetupRequestTDD-Extensions}}          OPTIONAL,
  ...
}

RadioLinkSetupRequestTDD-IEs RNSAP-PROTOCOL-IES ::= {
  { ID id-SRNC-ID          CRITICALITY reject TYPE RNC-ID          PRESENCE mandatory } |
  { ID id-S-RNTI          CRITICALITY reject TYPE S-RNTI          PRESENCE mandatory } |
  { ID id-D-RNTI          CRITICALITY reject TYPE D-RNTI          PRESENCE optional } |
  { ID id-UL-Physical-Channel-Information-RL-SetupRqstTDD CRITICALITY reject TYPE UL-Physical-Channel-Information-RL-SetupRqstTDD PRESENCE mandatory } |
  { ID id-DL-Physical-Channel-Information-RL-SetupRqstTDD CRITICALITY reject TYPE DL-Physical-Channel-Information-RL-SetupRqstTDD PRESENCE mandatory } |
  { ID id-AllowedQueuingTime          CRITICALITY reject TYPE AllowedQueuingTime          PRESENCE optional } |
  { ID id-UL-CCTrCH-InformationList-RL-SetupRqstTDD CRITICALITY notify TYPE UL-CCTrCH-InformationList-RL-SetupRqstTDD PRESENCE optional } |
  { ID id-DL-CCTrCH-InformationList-RL-SetupRqstTDD CRITICALITY notify TYPE DL-CCTrCH-InformationList-RL-SetupRqstTDD PRESENCE optional } |
  { ID id-DCH-TDD-Information          CRITICALITY reject TYPE DCH-TDD-Information          PRESENCE optional } |
  { ID id-DSCH-TDD-Information          CRITICALITY reject TYPE DSCH-TDD-Information          PRESENCE optional } |
  { ID id-USCH-Information          CRITICALITY reject TYPE USCH-Information          PRESENCE optional } |
  { ID id-RL-Information-RL-SetupRqstTDD CRITICALITY reject TYPE RL-Information-RL-SetupRqstTDD PRESENCE mandatory },
  ...
}

UL-Physical-Channel-Information-RL-SetupRqstTDD ::= SEQUENCE {
  maxNrTimeslots-UL          MaxNrTimeslots,
  minimumSpreadingFactor-UL MinimumSpreadingFactor,
  maxNrULPhysicalchannels    MaxNrULPhysicalchannels,

```

```

    iE-Extensions          ProtocolExtensionContainer { {UL-Physical-Channel-InformationItem-RL-SetupRqstTDD-ExtIEs} } OPTIONAL,
    ...
}

UL-Physical-Channel-InformationItem-RL-SetupRqstTDD-ExtIEs RNSAP-PROTOCOL-EXTENSION ::= {
    ...
}

DL-Physical-Channel-Information-RL-SetupRqstTDD ::= SEQUENCE {
    maxNrTimeslots-DL      MaxNrTimeslots,
    minimumSpreadingFactor-DL  MinimumSpreadingFactor,
    maxNrDLPhysicalchannels  MaxNrDLPhysicalchannels,
    iE-Extensions          ProtocolExtensionContainer { {DL-Physical-Channel-InformationItem-RL-SetupRqstTDD-ExtIEs} } OPTIONAL,
    ...
}

DL-Physical-Channel-InformationItem-RL-SetupRqstTDD-ExtIEs RNSAP-PROTOCOL-EXTENSION ::= {
    ...
}

UL-CCTrCH-InformationList-RL-SetupRqstTDD          ::= SEQUENCE (SIZE (1..maxNrOfCCTrCHs)) OF ProtocolIE-Single-Container { {UL-CCTrCH-InformationItemIEs-RL-SetupRqstTDD} }

UL-CCTrCH-InformationItemIEs-RL-SetupRqstTDD RNSAP-PROTOCOL-IES ::= {
    { ID id-UL-CCTrCH-InformationItem-RL-SetupRqstTDD  CRITICALITY notify  TYPE UL-CCTrCH-InformationItem-RL-SetupRqstTDD  PRESENCE mandatory  }
}

UL-CCTrCH-InformationItem-RL-SetupRqstTDD ::= SEQUENCE {
    cCTrCH-ID          CCTrCH-ID,
    ul-TFCS            TFCS,
    tFCI-Coding        TFCI-Coding,
    ul-PunctureLimit   PunctureLimit,
    iE-Extensions      ProtocolExtensionContainer { {UL-CCTrCH-InformationItem-RL-SetupRqstTDD-ExtIEs} } OPTIONAL,
    ...
}

UL-CCTrCH-InformationItem-RL-SetupRqstTDD-ExtIEs RNSAP-PROTOCOL-EXTENSION ::= {
    ...
}

DL-CCTrCH-InformationList-RL-SetupRqstTDD          ::= SEQUENCE (SIZE (1..maxNrOfCCTrCHs)) OF ProtocolIE-Single-Container { {DL-CCTrCH-InformationItemIEs-RL-SetupRqstTDD} }

DL-CCTrCH-InformationItemIEs-RL-SetupRqstTDD RNSAP-PROTOCOL-IES ::= {
    { ID id-DL-CCTrCH-InformationItem-RL-SetupRqstTDD  CRITICALITY notify  TYPE DL-CCTrCH-InformationItem-RL-SetupRqstTDD  PRESENCE mandatory  }
}

DL-CCTrCH-InformationItem-RL-SetupRqstTDD ::= SEQUENCE {
    cCTrCH-ID          CCTrCH-ID,
    dl-TFCS            TFCS,
    tFCI-Coding        TFCI-Coding,
    dl-PunctureLimit   PunctureLimit,
    tdd-TPC-DownlinkStepSize  TDD-TPC-DownlinkStepSize,
    cCTrCH-TPCList     CCTrCH-TPCList-RL-SetupRqstTDD  OPTIONAL,
}

```

```

    iE-Extensions          ProtocolExtensionContainer { {DL-CCTrCH-InformationItem-RL-SetupRqstTDD-ExtIEs} } OPTIONAL,
  }
  ...
}
DL-CCTrCH-InformationItem-RL-SetupRqstTDD-ExtIEs RNSAP-PROTOCOL-EXTENSION ::= {
  ...
}
CCTrCH-TPCList-RL-SetupRqstTDD ::= SEQUENCE (SIZE (1..maxNrOfCCTrCHs)) OF CCTrCH-TPCItem-RL-SetupRqstTDD
CCTrCH-TPCItem-RL-SetupRqstTDD ::= SEQUENCE {
  cCCTrCH-ID              CCTrCH-ID,
  iE-Extensions          ProtocolExtensionContainer { { CCTrCH-TPCItem-RL-SetupRqstTDD-ExtIEs} } OPTIONAL,
  ...
}
CCTrCH-TPCItem-RL-SetupRqstTDD-ExtIEs RNSAP-PROTOCOL-EXTENSION ::= {
  ...
}
RL-Information-RL-SetupRqstTDD ::= SEQUENCE {
  rL-ID                  RL-ID,
  c-ID                   C-ID,
  frameOffset            FrameOffset,
  specialBurstScheduling SpecialBurstScheduling,
  primaryCCPCH-RSCP      PrimaryCCPCH-RSCP OPTIONAL,
  dL-TimeSlot-ISCP       DL-TimeSlot-ISCP-Info OPTIONAL,
  iE-Extensions          ProtocolExtensionContainer { {RL-Information-RL-SetupRqstTDD-ExtIEs} } OPTIONAL,
  ...
}
RL-Information-RL-SetupRqstTDD-ExtIEs RNSAP-PROTOCOL-EXTENSION ::= {
  ...
}
RadioLinkSetupRequestTDD-Extensions RNSAP-PROTOCOL-EXTENSION ::= {
  { ID id-Permanent-NAS-UE-Identity CRITICALITY ignore EXTENSION Permanent-NAS-UE-Identity PRESENCE optional } |
  { ID id-PDSCH-RL-ID CRITICALITY ignore EXTENSION RL-ID PRESENCE optional },
  ...
}
-- *****
--
-- RADIO LINK SETUP RESPONSE FDD
--
-- *****

RadioLinkSetupResponseFDD ::= SEQUENCE {
  protocolIEs            ProtocolIE-Container {{RadioLinkSetupResponseFDD-IEs}},
  protocolExtensions     ProtocolExtensionContainer {{RadioLinkSetupResponseFDD-Extensions}} OPTIONAL,
  ...
}
RadioLinkSetupResponseFDD-IEs RNSAP-PROTOCOL-IES ::= {

```

```

{ ID id-D-RNTI                CRITICALITY ignore TYPE D-RNTI                PRESENCE optional } |
{ ID id-CN-PS-DomainIdentifier CRITICALITY ignore TYPE CN-PS-DomainIdentifier PRESENCE optional } |
{ ID id-CN-CS-DomainIdentifier CRITICALITY ignore TYPE CN-CS-DomainIdentifier PRESENCE optional } |
{ ID id-RL-InformationResponseList-RL-SetupRspFDD CRITICALITY ignore TYPE RL-InformationResponseList-RL-SetupRspFDD PRESENCE mandatory }
|
{ ID id-UL-SIRTarget          CRITICALITY ignore TYPE UL-SIR                PRESENCE optional } |
{ ID id-CriticalityDiagnostics CRITICALITY ignore TYPE CriticalityDiagnostics PRESENCE optional },
...
}

```

```

RL-InformationResponseList-RL-SetupRspFDD ::= SEQUENCE (SIZE (1..maxNrOfRLs)) OF ProtocolIE-Single-Container { {RL-InformationResponseItemIEs-RL-SetupRspFDD} }

```

```

RL-InformationResponseItemIEs-RL-SetupRspFDD RNSAP-PROTOCOL-IES ::= {
  { ID id-RL-InformationResponseItem-RL-SetupRspFDD
    CRITICALITY ignore TYPE RL-InformationResponseItem-RL-SetupRspFDD PRESENCE mandatory }
}

```

```

RL-InformationResponseItem-RL-SetupRspFDD ::= SEQUENCE {
  rL-ID                RL-ID,
  rL-Set-ID            RL-Set-ID,
  uRA-Information      URA-Information OPTIONAL,
  sAI                  SAI,
  gA-Cell              GA-Cell OPTIONAL,
  gA-AccessPointPosition GA-AccessPointPosition OPTIONAL,
  received-total-wide-band-power Received-total-wide-band-power,
  secondary-CCPCH-Info Secondary-CCPCH-Info OPTIONAL,
  dl-CodeInformation   FDD-DL-CodeInformation,
  diversityIndication DiversityIndication-RL-SetupRspFDD,
  -- This IE represents both the Diversity Indication IE and the choice based on the diversity indication as described in
  -- the tabular message format in subclause 9.1.
  sSDT-SupportIndicator SSDT-SupportIndicator,
  maxUL-SIR            UL-SIR,
  minUL-SIR            UL-SIR,
  closedlooptimingadjustmentmode Closedlooptimingadjustmentmode OPTIONAL,
  maximumAllowedULTxPower MaximumAllowedULTxPower,
  maximumDLTxPower    DL-Power,
  minimumDLTxPower    DL-Power,
  primaryScramblingCode PrimaryScramblingCode OPTIONAL,
  uL-UARFCN            UARFCN OPTIONAL,
  dL-UARFCN            UARFCN OPTIONAL,
  primaryCPICH-Power   PrimaryCPICH-Power,
  dSCHInformationResponse DSCH-InformationResponse-RL-SetupRspFDD OPTIONAL,
  neighbouring-UMTS-CellInformation Neighbouring-UMTS-CellInformation OPTIONAL,
  neighbouring-GSM-CellInformation Neighbouring-GSM-CellInformation OPTIONAL,
  pC-Preamble          PC-Preamble,
  sRB-Delay            SRB-Delay,
  iE-Extensions        ProtocolExtensionContainer { {RL-InformationResponseItem-RL-SetupRspFDD-ExtIEs} } OPTIONAL,
  ...
}

```

```

RL-InformationResponseItem-RL-SetupRspFDD-ExtIEs RNSAP-PROTOCOL-EXTENSION ::= {
  ...
}

```

```

DiversityIndication-RL-SetupRspFDD ::= CHOICE {
    combining                Combining-RL-SetupRspFDD,
    nonCombiningOrFirstRL   NonCombiningOrFirstRL-RL-SetupRspFDD
}

Combining-RL-SetupRspFDD ::= SEQUENCE {
    rL-ID                    RL-ID,
    iE-Extensions            ProtocolExtensionContainer { { CombiningItem-RL-SetupRspFDD-ExtIEs } } OPTIONAL,
    ...
}

CombiningItem-RL-SetupRspFDD-ExtIEs RNSAP-PROTOCOL-EXTENSION ::= {
    ...
}

NonCombiningOrFirstRL-RL-SetupRspFDD ::= SEQUENCE {
    dCH-InformationResponse  DCH-InformationResponse,
    iE-Extensions            ProtocolExtensionContainer { { NonCombiningOrFirstRLItem-RL-SetupRspFDD-ExtIEs } } OPTIONAL,
    ...
}

NonCombiningOrFirstRLItem-RL-SetupRspFDD-ExtIEs RNSAP-PROTOCOL-EXTENSION ::= {
    ...
}

DSCH-InformationResponse-RL-SetupRspFDD ::= ProtocolIE-Single-Container {{ DSCH-InformationResponseIE-RL-SetupRspFDD }}

DSCH-InformationResponseIE-RL-SetupRspFDD RNSAP-PROTOCOL-IES ::= {
    { ID id-DSCH-FDD-InformationResponse  CRITICALITY ignore  TYPE  DSCH-FDD-InformationResponse  PRESENCE mandatory }
}

RadioLinkSetupResponseFDD-Extensions RNSAP-PROTOCOL-EXTENSION ::= {
    { ID id-DSCH-RNTI                    CRITICALITY ignore          EXTENSION DSCH-RNTI          PRESENCE optional },
    ...
}

-- *****
--
-- RADIO LINK SETUP RESPONSE TDD
--
-- *****

RadioLinkSetupResponseTDD ::= SEQUENCE {
    protocolIEs                ProtocolIE-Container    {{RadioLinkSetupResponseTDD-IEs}},
    protocolExtensions          ProtocolExtensionContainer {{RadioLinkSetupResponseTDD-Extensions}}          OPTIONAL,
    ...
}

RadioLinkSetupResponseTDD-IEs RNSAP-PROTOCOL-IES ::= {
    { ID id-D-RNTI                CRITICALITY ignore  TYPE D-RNTI                PRESENCE optional } |
    { ID id-CN-PS-DomainIdentifier CRITICALITY ignore  TYPE CN-PS-DomainIdentifier PRESENCE optional } |
    { ID id-CN-CS-DomainIdentifier CRITICALITY ignore  TYPE CN-CS-DomainIdentifier PRESENCE optional } |
    { ID id-RL-InformationResponse-RL-SetupRspTDD CRITICALITY ignore  TYPE RL-InformationResponse-RL-SetupRspTDD PRESENCE mandatory } |
}

```

```

    { ID id-UL-SIRTarget          CRITICALITY ignore TYPE UL-SIR          PRESENCE mandatory } |
    { ID id-CriticalityDiagnostics CRITICALITY ignore TYPE CriticalityDiagnostics PRESENCE optional },
    ...
}

RL-InformationResponse-RL-SetupRspTDD ::= SEQUENCE {
    rL-ID                RL-ID,
    uRA-Information      URA-Information OPTIONAL,
    sAI                  SAI,
    gA-Cell              GA-Cell OPTIONAL,
    gA-AccessPointPosition GA-AccessPointPosition OPTIONAL,
    ul-TimeSlot-ISCP-Info UL-TimeSlot-ISCP-Info,
    maxUL-SIR            UL-SIR,
    minUL-SIR            UL-SIR,
    maximumAllowedULTxPower MaximumAllowedULTxPower,
    maximumDLTxPower    DL-Power,
    minimumDLTxPower    DL-Power,
    uARFCNforNt         UARFCN OPTIONAL,
    cellParameterID     CellParameterID OPTIONAL,
    syncCase             SyncCase OPTIONAL,
    sCH-TimeSlot        SCH-TimeSlot OPTIONAL,
    -- This IE shall be present if Sync Case IE is Case2. --
    sCTD-Indicator      SCTD-Indicator OPTIONAL,
    pCCPCH-Power        PCCPCH-Power,
    timingAdvanceApplied TimingAdvanceApplied,
    alphaValue          AlphaValue,
    ul-PhysCH-SF-Variation UL-PhysCH-SF-Variation,
    synchronisationConfiguration SynchronisationConfiguration,
    secondary-CCPCH-Info-TDD Secondary-CCPCH-Info-TDD OPTIONAL,
    ul-CCTrCHInformation UL-CCTrCHInformationList-RL-SetupRspTDD OPTIONAL,
    dl-CCTrCHInformation DL-CCTrCHInformationList-RL-SetupRspTDD OPTIONAL,
    dCH-InformationResponse DCH-InformationResponseList-RL-SetupRspTDD OPTIONAL,
    dsch-InformationResponse DSCH-InformationResponse-RL-SetupRspTDD OPTIONAL,
    usch-InformationResponse USCH-InformationResponse-RL-SetupRspTDD OPTIONAL,
    neighbouring-UMTS-CellInformation Neighbouring-UMTS-CellInformation OPTIONAL,
    neighbouring-GSM-CellInformation Neighbouring-GSM-CellInformation OPTIONAL,
    iE-Extensions        ProtocolExtensionContainer { {RL-InformationResponse-RL-SetupRspTDD-ExtIEs} } OPTIONAL,
    ...
}

RL-InformationResponse-RL-SetupRspTDD-ExtIEs RNSAP-PROTOCOL-EXTENSION ::= {
    { ID id-TimeSlot-RL-SetupRspTDD CRITICALITY ignore EXTENSION TimeSlot PRESENCE conditional },
    -- This IE shall be present if Sync Case IE is Case1. --
    ...
}

UL-CCTrCHInformationList-RL-SetupRspTDD ::= ProtocolIE-Single-Container {{UL-CCTrCHInformationListIEs-RL-SetupRspTDD}}

UL-CCTrCHInformationListIEs-RL-SetupRspTDD RNSAP-PROTOCOL-IES ::= {
    { ID id-UL-CCTrCH-InformationListIE-RL-SetupRspTDD CRITICALITY ignore TYPE UL-CCTrCHInformationListIE-RL-SetupRspTDD PRESENCE mandatory }
}

UL-CCTrCHInformationListIE-RL-SetupRspTDD ::= SEQUENCE (SIZE (1..maxNrOfCCTrCHs)) OF UL-CCTrCHInformationItem-RL-SetupRspTDD

```

```

UL-CCTrCHInformationItem-RL-SetupRspTDD ::= SEQUENCE {
    cCTrCH-ID                CCTrCH-ID,
    ul-DPCH-Information      UL-DPCH-InformationList-RL-SetupRspTDD    OPTIONAL,
    iE-Extensions            ProtocolExtensionContainer { {UL-CCTrCHInformationItem-RL-SetupRspTDD-ExtIEs} } OPTIONAL,
    ...
}

UL-CCTrCHInformationItem-RL-SetupRspTDD-ExtIEs RNSAP-PROTOCOL-EXTENSION ::= {
    ...
}

UL-DPCH-InformationList-RL-SetupRspTDD ::= ProtocolIE-Single-Container { {UL-DPCH-InformationListIEs-RL-SetupRspTDD} }

UL-DPCH-InformationListIEs-RL-SetupRspTDD RNSAP-PROTOCOL-IES ::= {
    { ID id-UL-DPCH-InformationItem-RL-SetupRspTDD    CRITICALITY ignore    TYPE UL-DPCH-InformationItem-RL-SetupRspTDD    PRESENCE mandatory}
}

UL-DPCH-InformationItem-RL-SetupRspTDD ::= SEQUENCE {
    repetitionPeriod        RepetitionPeriod,
    repetitionLength        RepetitionLength,
    tDD-DPCHOffset          TDD-DPCHOffset,
    uL-Timeslot-Information UL-Timeslot-Information,
    iE-Extensions            ProtocolExtensionContainer { {UL-DPCH-InformationItem-RL-SetupRspTDD-ExtIEs} } OPTIONAL,
    ...
}

UL-DPCH-InformationItem-RL-SetupRspTDD-ExtIEs RNSAP-PROTOCOL-EXTENSION ::= {
    ...
}

DL-CCTrCHInformationList-RL-SetupRspTDD ::= ProtocolIE-Single-Container { {DL-CCTrCHInformationListIEs-RL-SetupRspTDD} }

DL-CCTrCHInformationListIEs-RL-SetupRspTDD RNSAP-PROTOCOL-IES ::= {
    { ID id-DL-CCTrCH-InformationListIE-RL-SetupRspTDD    CRITICALITY ignore    TYPE DL-CCTrCHInformationListIE-RL-SetupRspTDD    PRESENCE mandatory }
}

DL-CCTrCHInformationListIE-RL-SetupRspTDD ::= SEQUENCE (SIZE (1..maxNrOfCCTrCHs)) OF DL-CCTrCHInformationItem-RL-SetupRspTDD

DL-CCTrCHInformationItem-RL-SetupRspTDD ::= SEQUENCE {
    cCTrCH-ID                CCTrCH-ID,
    dl-DPCH-Information      DL-DPCH-InformationList-RL-SetupRspTDD    OPTIONAL,
    iE-Extensions            ProtocolExtensionContainer { {DL-CCTrCHInformationItem-RL-SetupRspTDD-ExtIEs} } OPTIONAL,
    ...
}

DL-CCTrCHInformationItem-RL-SetupRspTDD-ExtIEs RNSAP-PROTOCOL-EXTENSION ::= {
    ...
}

DL-DPCH-InformationList-RL-SetupRspTDD ::= ProtocolIE-Single-Container { {DL-DPCH-InformationListIEs-RL-SetupRspTDD} }

DL-DPCH-InformationListIEs-RL-SetupRspTDD RNSAP-PROTOCOL-IES ::= {
    { ID id-DL-DPCH-InformationItem-RL-SetupRspTDD    CRITICALITY ignore    TYPE DL-DPCH-InformationItem-RL-SetupRspTDD    PRESENCE mandatory}
}

```



```

}

DL-DPCH-InformationItem-RL-SetupRspTDD ::= SEQUENCE {
    repetitionPeriod          RepetitionPeriod,
    repetitionLength          RepetitionLength,
    tDD-DPCHOffset            TDD-DPCHOffset,
    dL-Timeslot-Information    DL-Timeslot-Information,
    iE-Extensions              ProtocolExtensionContainer { {DL-DPCH-InformationItem-RL-SetupRspTDD-ExtIEs} } OPTIONAL,
    ...
}

DL-DPCH-InformationItem-RL-SetupRspTDD-ExtIEs RNSAP-PROTOCOL-EXTENSION ::= {
    ...
}

DCH-InformationResponseList-RL-SetupRspTDD ::= ProtocolIE-Single-Container {{DCH-InformationResponseListIEs-RL-SetupRspTDD}}

DCH-InformationResponseListIEs-RL-SetupRspTDD RNSAP-PROTOCOL-IES ::= {
    { ID id-DCH-InformationResponse    CRITICALITY ignore    TYPE DCH-InformationResponse    PRESENCE mandatory }
}

DSCH-InformationResponse-RL-SetupRspTDD ::= ProtocolIE-Single-Container {{DSCH-InformationList-RL-SetupRspTDD}}

DSCH-InformationList-RL-SetupRspTDD RNSAP-PROTOCOL-IES ::= {
    { ID id-DSCH-InformationListIEs-RL-SetupRspTDD    CRITICALITY ignore    TYPE DSCH-InformationListIEs-RL-SetupRspTDD    PRESENCE mandatory }
}

DSCH-InformationListIEs-RL-SetupRspTDD ::= SEQUENCE (SIZE(0..maxNoOfDSCHs)) OF DSCHInformationItem-RL-SetupRspTDD

DSCHInformationItem-RL-SetupRspTDD ::= SEQUENCE {
    dsch-ID                    DSCH-ID,
    dsch-FlowControlInformation DSCH-FlowControlInformation,
    bindingID                   BindingID    OPTIONAL,
    transportLayerAddress        TransportLayerAddress    OPTIONAL,
    transportFormatManagement    TransportFormatManagement,
    iE-Extensions                ProtocolExtensionContainer { {DSCHInformationItem-RL-SetupRspTDD-ExtIEs} } OPTIONAL,
    ...
}

DSCHInformationItem-RL-SetupRspTDD-ExtIEs RNSAP-PROTOCOL-EXTENSION ::= {
    ...
}

USCH-InformationResponse-RL-SetupRspTDD ::= ProtocolIE-Single-Container {{USCH-InformationList-RL-SetupRspTDD}}

USCH-InformationList-RL-SetupRspTDD RNSAP-PROTOCOL-IES ::= {
    { ID id-USCH-InformationListIEs-RL-SetupRspTDD    CRITICALITY ignore    TYPE USCH-InformationListIEs-RL-SetupRspTDD    PRESENCE mandatory }
}

USCH-InformationListIEs-RL-SetupRspTDD ::= SEQUENCE (SIZE(0..maxNoOfUSCHs)) OF USCHInformationItem-RL-SetupRspTDD

USCHInformationItem-RL-SetupRspTDD ::= SEQUENCE {
    usch-ID                    USCH-ID,
    bindingID                   BindingID    OPTIONAL,
}

```

```

transportLayerAddress      TransportLayerAddress  OPTIONAL,
transportFormatManagement  TransportFormatManagement,
iE-Extensions              ProtocolExtensionContainer { {USCHInformationItem-RL-SetupRspTDD-ExtIEs} } OPTIONAL,
...
}

USCHInformationItem-RL-SetupRspTDD-ExtIEs RNSAP-PROTOCOL-EXTENSION ::= {
...
}

RadioLinkSetupResponseTDD-Extensions RNSAP-PROTOCOL-EXTENSION ::= {
  { ID id-DSCH-RNTI          CRITICALITY ignore          EXTENSION DSCH-RNTI          PRESENCE optional },
  ...
}

-- *****
--
-- RADIO LINK SETUP FAILURE FDD
--
-- *****

RadioLinkSetupFailureFDD ::= SEQUENCE {
  protocolIEs                ProtocolIE-Container      {{RadioLinkSetupFailureFDD-IEs}},
  protocolExtensions         ProtocolExtensionContainer {{RadioLinkSetupFailureFDD-Extensions}}
  ...
}

RadioLinkSetupFailureFDD-IEs RNSAP-PROTOCOL-IES ::= {
  { ID id-D-RNTI              CRITICALITY ignore          TYPE D-RNTI              PRESENCE optional } |
  { ID id-CN-PS-DomainIdentifier CRITICALITY ignore          TYPE CN-PS-DomainIdentifier PRESENCE optional } |
  { ID id-CN-CS-DomainIdentifier CRITICALITY ignore          TYPE CN-CS-DomainIdentifier PRESENCE optional } |
  { ID id-CauseLevel-RL-SetupFailureFDD CRITICALITY ignore          TYPE CauseLevel-RL-SetupFailureFDD PRESENCE mandatory } |
  { ID id-UL-SIRTarget         CRITICALITY ignore          TYPE UL-SIR              PRESENCE optional } |
  { ID id-CriticalityDiagnostics CRITICALITY ignore          TYPE CriticalityDiagnostics PRESENCE optional },
  ...
}

CauseLevel-RL-SetupFailureFDD ::= CHOICE {
  generalCause                GeneralCauseList-RL-SetupFailureFDD,
  rLSpecificCause             RLSpecificCauseList-RL-SetupFailureFDD,
  ...
}

GeneralCauseList-RL-SetupFailureFDD ::= SEQUENCE {
  cause                        Cause,
  iE-Extensions                ProtocolExtensionContainer { { GeneralCauseItem-RL-SetupFailureFDD-ExtIEs} }
  ...
}

GeneralCauseItem-RL-SetupFailureFDD-ExtIEs RNSAP-PROTOCOL-EXTENSION ::= {
...
}

RLSpecificCauseList-RL-SetupFailureFDD ::= SEQUENCE {

```

```

    unsuccessful-RL-InformationRespList-RL-SetupFailureFDD      UnsuccessfulRL-InformationResponseList-RL-SetupFailureFDD,
    successful-RL-InformationRespList-RL-SetupFailureFDD      SuccessfulRL-InformationResponseList-RL-SetupFailureFDD OPTIONAL,
    iE-Extensions                                             ProtocolExtensionContainer { { RLSpecificCauseItem-RL-SetupFailureFDD-ExtIEs} } OPTIONAL,
    ...
}

RLSpecificCauseItem-RL-SetupFailureFDD-ExtIEs RNSAP-PROTOCOL-EXTENSION ::= {
    { ID id-DSCH-RNTI          CRITICALITY ignore          EXTENSION DSCH-RNTI          PRESENCE optional },
    ...
}

UnsuccessfulRL-InformationResponseList-RL-SetupFailureFDD ::= SEQUENCE (SIZE (1..maxNrOfRLs)) OF ProtocolIE-Single-Container { {UnsuccessfulRL-
InformationResponse-RL-SetupFailureFDD-IEs} }

UnsuccessfulRL-InformationResponse-RL-SetupFailureFDD-IEs RNSAP-PROTOCOL-IES ::= {
    { ID id-UnsuccessfulRL-InformationResponse-RL-SetupFailureFDD          CRITICALITY ignore          TYPE UnsuccessfulRL-InformationResponse-RL-
SetupFailureFDD          PRESENCE mandatory }
}

UnsuccessfulRL-InformationResponse-RL-SetupFailureFDD ::= SEQUENCE {
    rL-ID          RL-ID,
    cause          Cause,
    iE-Extensions          ProtocolExtensionContainer { {UnsuccessfulRL-InformationResponse-RL-SetupFailureFDD-ExtIEs} } OPTIONAL,
    ...
}

UnsuccessfulRL-InformationResponse-RL-SetupFailureFDD-ExtIEs RNSAP-PROTOCOL-EXTENSION ::= {
    ...
}

SuccessfulRL-InformationResponseList-RL-SetupFailureFDD ::= SEQUENCE (SIZE (0..maxNrOfRLs-1)) OF ProtocolIE-Single-Container { {SuccessfulRL-
InformationResponse-RL-SetupFailureFDD-IEs} }

SuccessfulRL-InformationResponse-RL-SetupFailureFDD-IEs RNSAP-PROTOCOL-IES ::= {
    { ID id-SuccessfulRL-InformationResponse-RL-SetupFailureFDD          CRITICALITY ignore          TYPE SuccessfulRL-InformationResponse-RL-SetupFailureFDD
PRESENCE mandatory }
}

SuccessfulRL-InformationResponse-RL-SetupFailureFDD ::= SEQUENCE {
    rL-ID          RL-ID,
    rL-Set-ID          RL-Set-ID,
    uRA-Information          URA-Information          OPTIONAL,
    sAI          SAI,
    gA-Cell          GA-Cell          OPTIONAL,
    gA-AccessPointPosition          GA-AccessPointPosition          OPTIONAL,
    received-total-wide-band-power          Received-total-wide-band-power,
    secondary-CCPCH-Info          Secondary-CCPCH-Info          OPTIONAL,
    dl-CodeInformation          FDD-DL-CodeInformation,
    diversityIndication          DiversityIndication-RL-SetupFailureFDD,
    -- This IE represents both the Diversity Indication IE and the choice based on the diversity indication as described in
    -- the tabular message format in subclause 9.1.
    sSDT-SupportIndicator          sSDT-SupportIndicator,
    maxUL-SIR          UL-SIR,
    minUL-SIR          UL-SIR,

```

```

closedlooptimingadjustmentmode      Closedlooptimingadjustmentmode  OPTIONAL,
maximumAllowedULTxPower              MaximumAllowedULTxPower,
maximumDLTxPower                     DL-Power,
minimumDLTxPower                     DL-Power,
primaryCPICH-Power                   PrimaryCPICH-Power,
primaryScramblingCode                PrimaryScramblingCode  OPTIONAL,
uL-UARFCN                             UARFCN                 OPTIONAL,
dL-UARFCN                             UARFCN                 OPTIONAL,
dSCH-InformationResponse-RL-SetupFailureFDD  DSCH-InformationResponseList-RL-SetupFailureFDD  OPTIONAL,
neighbouring-UMTS-CellInformation     Neighbouring-UMTS-CellInformation  OPTIONAL,
neighbouring-GSM-CellInformation      Neighbouring-GSM-CellInformation  OPTIONAL,
pC-Preamble                          PC-Preamble,
sRB-Delay                             SRB-Delay,
iE-Extensions                         ProtocolExtensionContainer { {SuccessfulRL-InformationResponse-RL-SetupFailureFDD-ExtIEs} } OPTIONAL,
...
}

SuccessfulRL-InformationResponse-RL-SetupFailureFDD-ExtIEs  RNSAP-PROTOCOL-EXTENSION ::= {
...
}

DiversityIndication-RL-SetupFailureFDD ::= CHOICE {
  combining                      Combining-RL-SetupFailureFDD,
  nonCombiningOrFirstRL         NonCombiningOrFirstRL-RL-SetupFailureFDD
}

Combining-RL-SetupFailureFDD ::= SEQUENCE {
  rL-ID                          RL-ID,
  iE-Extensions                  ProtocolExtensionContainer { { CombiningItem-RL-SetupFailureFDD-ExtIEs} } OPTIONAL,
  ...
}

CombiningItem-RL-SetupFailureFDD-ExtIEs  RNSAP-PROTOCOL-EXTENSION ::= {
...
}

NonCombiningOrFirstRL-RL-SetupFailureFDD ::= SEQUENCE {
  dCH-InformationResponse        DCH-InformationResponse,
  iE-Extensions                  ProtocolExtensionContainer { { NonCombiningOrFirstRLItem-RL-SetupFailureFDD-ExtIEs} } OPTIONAL,
  ...
}

NonCombiningOrFirstRLItem-RL-SetupFailureFDD-ExtIEs  RNSAP-PROTOCOL-EXTENSION ::= {
...
}

DSCH-InformationResponseList-RL-SetupFailureFDD ::= ProtocolIE-Single-Container {{ DSCH-InformationResponseListIEs-RL-SetupFailureFDD }}

DSCH-InformationResponseListIEs-RL-SetupFailureFDD  RNSAP-PROTOCOL-IES ::= {
  { ID id-DSCH-FDD-InformationResponse  CRITICALITY ignore  TYPE DSCH-FDD-InformationResponse  PRESENCE mandatory }
}

RadioLinkSetupFailureFDD-Extensions  RNSAP-PROTOCOL-EXTENSION ::= {
...
}

```

```

}
-- *****
--
-- RADIO LINK SETUP FAILURE TDD
--
-- *****

RadioLinkSetupFailureTDD ::= SEQUENCE {
    protocolIEs          ProtocolIE-Container          {{RadioLinkSetupFailureTDD-IEs}},
    protocolExtensions   ProtocolExtensionContainer    {{RadioLinkSetupFailureTDD-Extensions}}    OPTIONAL,
    ...
}

RadioLinkSetupFailureTDD-IEs RNSAP-PROTOCOL-IES ::= {
    { ID id-CauseLevel-RL-SetupFailureTDD    CRITICALITY ignore    TYPE CauseLevel-RL-SetupFailureTDD    PRESENCE mandatory }|
    { ID id-CriticalityDiagnostics          CRITICALITY ignore    TYPE CriticalityDiagnostics          PRESENCE optional },
    ...
}

CauseLevel-RL-SetupFailureTDD ::= CHOICE {
    generalCause          GeneralCauseList-RL-SetupFailureTDD,
    rLSpecificCause       RLSpecificCauseList-RL-SetupFailureTDD,
    ...
}

GeneralCauseList-RL-SetupFailureTDD ::= SEQUENCE {
    cause                  Cause,
    iE-Extensions         ProtocolExtensionContainer { { GeneralCauseItem-RL-SetupFailureTDD-ExtIEs} }    OPTIONAL,
    ...
}

GeneralCauseItem-RL-SetupFailureTDD-ExtIEs RNSAP-PROTOCOL-EXTENSION ::= {
    ...
}

RLSpecificCauseList-RL-SetupFailureTDD ::= SEQUENCE {
    unsuccessful-RL-InformationRespItem-RL-SetupFailureTDD    Unsuccessful-RL-InformationRespItem-RL-SetupFailureTDD,
    iE-Extensions                                             ProtocolExtensionContainer { { RLSpecificCauseItem-RL-SetupFailureTDD-ExtIEs} }
    OPTIONAL,
    ...
}

RLSpecificCauseItem-RL-SetupFailureTDD-ExtIEs RNSAP-PROTOCOL-EXTENSION ::= {
    ...
}

Unsuccessful-RL-InformationRespItem-RL-SetupFailureTDD ::= ProtocolIE-Single-Container { {Unsuccessful-RL-InformationRespItemIE-RL-SetupFailureTDD}
}

Unsuccessful-RL-InformationRespItemIE-RL-SetupFailureTDD RNSAP-PROTOCOL-IES ::= {
    { ID id-UnsuccessfulRL-InformationResponse-RL-SetupFailureTDD    CRITICALITY ignore    TYPE UnsuccessfulRL-InformationResponse-RL-
    SetupFailureTDD    PRESENCE    mandatory    }
}

```

```

UnsuccessfulRL-InformationResponse-RL-SetupFailureTDD ::= SEQUENCE {
    rL-ID                RL-ID,
    cause                Cause,
    iE-Extensions        ProtocolExtensionContainer { {UnsuccessfulRL-InformationResponse-RL-SetupFailureTDD-ExtIEs} } OPTIONAL,
    ...
}

UnsuccessfulRL-InformationResponse-RL-SetupFailureTDD-ExtIEs RNSAP-PROTOCOL-EXTENSION ::= {
    ...
}

RadioLinkSetupFailureTDD-Extensions RNSAP-PROTOCOL-EXTENSION ::= {
    ...
}

-- *****
--
-- RADIO LINK ADDITION REQUEST FDD
--
-- *****

RadioLinkAdditionRequestFDD ::= SEQUENCE {
    protocolIEs          ProtocolIE-Container    {{RadioLinkAdditionRequestFDD-IEs}},
    protocolExtensions   ProtocolExtensionContainer {{RadioLinkAdditionRequestFDD-Extensions}}          OPTIONAL,
    ...
}

RadioLinkAdditionRequestFDD-IEs RNSAP-PROTOCOL-IES ::= {
    { ID id-UL-SIRTarget          CRITICALITY reject TYPE UL-SIR          PRESENCE mandatory } |
    { ID id-RL-InformationList-RL-AdditionRqstFDD CRITICALITY notify TYPE RL-InformationList-RL-AdditionRqstFDD PRESENCE mandatory } |
    { ID id-Active-Pattern-Sequence-Information CRITICALITY reject TYPE Active-Pattern-Sequence-Information PRESENCE optional },
    ...
}

RL-InformationList-RL-AdditionRqstFDD          ::= SEQUENCE (SIZE (1..maxNrOfRLs-1)) OF ProtocolIE-Single-Container { {RL-Information-RL-AdditionRqstFDD-IEs} }

RL-Information-RL-AdditionRqstFDD-IEs RNSAP-PROTOCOL-IES ::= {
    { ID id-RL-Information-RL-AdditionRqstFDD CRITICALITY notify TYPE RL-Information-RL-AdditionRqstFDD PRESENCE mandatory }
}

RL-Information-RL-AdditionRqstFDD ::= SEQUENCE {
    rL-ID                RL-ID,
    c-ID                C-ID,
    frameOffset          FrameOffset,
    chipOffset           ChipOffset,
    diversityControlField DiversityControlField,
    primaryCPICH-EcNo    PrimaryCPICH-EcNo          OPTIONAL,
    sSDT-CellID          SSDT-CellID          OPTIONAL,
    transmitDiversityIndicator TransmitDiversityIndicator          OPTIONAL,
    iE-Extensions        ProtocolExtensionContainer { {RL-Information-RL-AdditionRqstFDD-ExtIEs} } OPTIONAL,
    ...
}

```

```

RL-Information-RL-AdditionRqstFDD-ExtIEs RNSAP-PROTOCOL-EXTENSION ::= {
    ...
}

RadioLinkAdditionRequestFDD-Extensions RNSAP-PROTOCOL-EXTENSION ::= {
    { ID id-Permanent-NAS-UE-Identity          CRITICALITY ignore          EXTENSION Permanent-NAS-UE-Identity  PRESENCE optional },
    ...
}

-- *****
--
-- RADIO LINK ADDITION REQUEST TDD
--
-- *****

RadioLinkAdditionRequestTDD ::= SEQUENCE {
    protocolIEs          ProtocolIE-Container    {{RadioLinkAdditionRequestTDD-IEs}},
    protocolExtensions   ProtocolExtensionContainer {{RadioLinkAdditionRequestTDD-Extensions}}          OPTIONAL,
    ...
}

RadioLinkAdditionRequestTDD-IEs RNSAP-PROTOCOL-IES ::= {
    { ID id-RL-Information-RL-AdditionRqstTDD  CRITICALITY reject  TYPE RL-Information-RL-AdditionRqstTDD  PRESENCE mandatory  },
    ...
}

RL-Information-RL-AdditionRqstTDD ::= SEQUENCE {
    rL-ID                RL-ID,
    c-ID                 C-ID,
    frameOffset          FrameOffset,
    diversityControlField DiversityControlField,
    primaryCCPCH-RSCP    PrimaryCCPCH-RSCP    OPTIONAL,
    dL-TimeSlot-ISCP-Info DL-TimeSlot-ISCP-Info  OPTIONAL,
    iE-Extensions        ProtocolExtensionContainer { {RL-Information-RL-AdditionRqstTDD-ExtIEs} } OPTIONAL,
    ...
}

RL-Information-RL-AdditionRqstTDD-ExtIEs RNSAP-PROTOCOL-EXTENSION ::= {
    ...
}

RadioLinkAdditionRequestTDD-Extensions RNSAP-PROTOCOL-EXTENSION ::= {
    { ID id-Permanent-NAS-UE-Identity          CRITICALITY ignore          EXTENSION Permanent-NAS-UE-Identity  PRESENCE optional },
    ...
}

-- *****
--
-- RADIO LINK ADDITION RESPONSE FDD
--
-- *****

RadioLinkAdditionResponseFDD ::= SEQUENCE {

```

```

    protocolIEs          ProtocolIE-Container    {{RadioLinkAdditionResponseFDD-IEs}},
    protocolExtensions  ProtocolExtensionContainer {{RadioLinkAdditionResponseFDD-Extensions}}
    ...
}

RadioLinkAdditionResponseFDD-IEs RNSAP-PROTOCOL-IES ::= {
    { ID id-RL-InformationResponseList-RL-AdditionRspFDD    CRITICALITY ignore TYPE RL-InformationResponseList-RL-AdditionRspFDD    PRESENCE
mandatory } |
    { ID id-CriticalityDiagnostics          CRITICALITY ignore TYPE CriticalityDiagnostics          PRESENCE optional },
    ...
}

RL-InformationResponseList-RL-AdditionRspFDD ::= SEQUENCE (SIZE (1..maxNrOfRLs-1)) OF ProtocolIE-Single-Container { {RL-
InformationResponseItemIEs-RL-AdditionRspFDD} }

RL-InformationResponseItemIEs-RL-AdditionRspFDD RNSAP-PROTOCOL-IES ::= {
    { ID id-RL-InformationResponseItem-RL-AdditionRspFDD    CRITICALITY ignore TYPE RL-InformationResponseItem-RL-AdditionRspFDD    PRESENCE
mandatory }
}

RL-InformationResponseItem-RL-AdditionRspFDD ::= SEQUENCE {
    rL-ID                RL-ID,
    rL-Set-ID            RL-Set-ID,
    uRA-Information      URA-Information    OPTIONAL,
    sAI                  SAI,
    gA-Cell              GA-Cell    OPTIONAL,
    gA-AccessPointPosition GA-AccessPointPosition OPTIONAL,
    received-total-wide-band-power Received-total-wide-band-power,
    secondary-CCPCH-Info Secondary-CCPCH-Info    OPTIONAL,
    dl-CodeInformation   DL-CodeInformationList-RL-AdditionRspFDD,
    diversityIndication DiversityIndication-RL-AdditionRspFDD,
    -- This IE represents both the Diversity Indication IE and the choice based on the diversity indication as described in
    -- the tabular message format in subclause 9.1.
    sSDT-SupportIndicator SSDT-SupportIndicator,
    minUL-SIR            UL-SIR,
    maxUL-SIR            UL-SIR,
    closedlooptimingadjustmentmode Closedlooptimingadjustmentmode OPTIONAL,
    maximumAllowedULTxPower MaximumAllowedULTxPower,
    maximumDLTxPower    DL-Power,
    minimumDLTxPower    DL-Power,
    neighbouring-UMTS-CellInformation Neighbouring-UMTS-CellInformation OPTIONAL,
    neighbouring-GSM-CellInformation Neighbouring-GSM-CellInformation OPTIONAL,
    pC-Preamble          PC-Preamble,
    sRB-Delay            SRB-Delay,
    primaryCPICH-Power   PrimaryCPICH-Power,
    iE-Extensions        ProtocolExtensionContainer { {RL-InformationResponseItem-RL-AdditionRspFDD-ExtIEs} } OPTIONAL,
    ...
}

RL-InformationResponseItem-RL-AdditionRspFDD-ExtIEs RNSAP-PROTOCOL-EXTENSION ::= {
    ...
}

DL-CodeInformationList-RL-AdditionRspFDD ::= ProtocolIE-Single-Container { { DL-CodeInformationListIEs-RL-AdditionRspFDD } }

```



```

DL-CodeInformationListIEs-RL-AdditionRspFDD RNSAP-PROTOCOL-IES ::= {
  { ID id-FDD-DL-CodeInformation    CRITICALITY ignore TYPE FDD-DL-CodeInformation    PRESENCE mandatory }
}

DiversityIndication-RL-AdditionRspFDD ::= CHOICE {
  combining                Combining-RL-AdditionRspFDD,
  nonCombining             NonCombining-RL-AdditionRspFDD
}

Combining-RL-AdditionRspFDD ::= SEQUENCE {
  rL-ID                    RL-ID,
  iE-Extensions            ProtocolExtensionContainer { { CombiningItem-RL-AdditionRspFDD-ExtIEs } } OPTIONAL,
  ...
}

CombiningItem-RL-AdditionRspFDD-ExtIEs RNSAP-PROTOCOL-EXTENSION ::= {
  ...
}

NonCombining-RL-AdditionRspFDD ::= SEQUENCE {
  dCH-InformationResponse  DCH-InformationResponse,
  iE-Extensions            ProtocolExtensionContainer { { NonCombiningItem-RL-AdditionRspFDD-ExtIEs } } OPTIONAL,
  ...
}

NonCombiningItem-RL-AdditionRspFDD-ExtIEs RNSAP-PROTOCOL-EXTENSION ::= {
  ...
}

RadioLinkAdditionResponseFDD-Extensions RNSAP-PROTOCOL-EXTENSION ::= {
  ...
}

-- *****
--
-- RADIO LINK ADDITION RESPONSE TDD
--
-- *****

RadioLinkAdditionResponseTDD ::= SEQUENCE {
  protocolIEs              ProtocolIE-Container      {{RadioLinkAdditionResponseTDD-IEs}},
  protocolExtensions       ProtocolExtensionContainer {{RadioLinkAdditionResponseTDD-Extensions}}
  ...
}

RadioLinkAdditionResponseTDD-IEs RNSAP-PROTOCOL-IES ::= {
  { ID id-RL-InformationResponse-RL-AdditionRspTDD
    CRITICALITY ignore TYPE RL-InformationResponse-RL-AdditionRspTDD PRESENCE mandatory } |
  { ID id-CriticalityDiagnostics
    CRITICALITY ignore TYPE CriticalityDiagnostics PRESENCE optional },
  ...
}

RL-InformationResponse-RL-AdditionRspTDD ::= SEQUENCE {

```

```

rL-ID                RL-ID,
uRA-Information      URA-Information    OPTIONAL,
sAI                 SAI,
gA-Cell             GA-Cell    OPTIONAL,
gA-AccessPointPosition  GA-AccessPointPosition  OPTIONAL,
ul-TimeSlot-ISCP-Info  UL-TimeSlot-ISCP-Info,
minUL-SIR           UL-SIR,
maxUL-SIR           UL-SIR,
maximumAllowedULTxPower  MaximumAllowedULTxPower,
maximumDLTxPower    DL-Power,
minimumDLTxPower    DL-Power,
pCCPCH-Power        PCCPCH-Power,
timingAdvanceApplied TimingAdvanceApplied,
alphaValue          AlphaValue,
ul-PhysCH-SF-Variation  UL-PhysCH-SF-Variation,
synchronisationConfiguration  SynchronisationConfiguration,
secondary-CCPCH-Info-TDD  Secondary-CCPCH-Info-TDD          OPTIONAL,
ul-CCTrCHInformation  UL-CCTrCHInformationList-RL-AdditionRspTDD  OPTIONAL,
dl-CCTrCHInformation  DL-CCTrCHInformationList-RL-AdditionRspTDD  OPTIONAL,
dCH-Information      DCH-Information-RL-AdditionRspTDD          OPTIONAL,
dSCH-InformationResponse  DSCH-InformationResponse-RL-AdditionRspTDD  OPTIONAL,
uSCH-InformationResponse  USCH-InformationResponse-RL-AdditionRspTDD  OPTIONAL,
neighbouring-UMTS-CellInformation  Neighbouring-UMTS-CellInformation  OPTIONAL,
neighbouring-GSM-CellInformation  Neighbouring-GSM-CellInformation  OPTIONAL,
IE-Extensions        ProtocolExtensionContainer { {RL-InformationResponse-RL-AdditionRspTDD-ExtIEs} } OPTIONAL,
...
}

RL-InformationResponse-RL-AdditionRspTDD-ExtIEs RNSAP-PROTOCOL-EXTENSION ::= {
...
}

UL-CCTrCHInformationList-RL-AdditionRspTDD ::= ProtocolIE-Single-Container {{UL-CCTrCHInformationListIEs-RL-AdditionRspTDD}}

UL-CCTrCHInformationListIEs-RL-AdditionRspTDD RNSAP-PROTOCOL-IES ::= {
  { ID id-UL-CCTrCH-InformationListIE-RL-AdditionRspTDD  CRITICALITY ignore  TYPE UL-CCTrCHInformationListIE-RL-AdditionRspTDD  PRESENCE
mandatory }
}

UL-CCTrCHInformationListIE-RL-AdditionRspTDD ::= SEQUENCE (SIZE (1..maxNrOfCCTrCHs)) OF UL-CCTrCHInformationItem-RL-AdditionRspTDD

UL-CCTrCHInformationItem-RL-AdditionRspTDD ::= SEQUENCE {
  cCTrCH-ID                CCTrCH-ID,
  ul-DPCH-Information      UL-DPCH-InformationList-RL-AdditionRspTDD          OPTIONAL,
  IE-Extensions            ProtocolExtensionContainer { {UL-CCTrCHInformationItem-RL-AdditionRspTDD-ExtIEs} } OPTIONAL,
  ...
}

UL-CCTrCHInformationItem-RL-AdditionRspTDD-ExtIEs RNSAP-PROTOCOL-EXTENSION ::= {
...
}

UL-DPCH-InformationList-RL-AdditionRspTDD ::= ProtocolIE-Single-Container { {UL-DPCH-InformationListIEs-RL-AdditionRspTDD} }

```

```

UL-DPCH-InformationListIEs-RL-AdditionRspTDD RNSAP-PROTOCOL-IES ::= {
  { ID id-UL-DPCH-InformationItem-RL-AdditionRspTDD          CRITICALITY ignore  TYPE UL-DPCH-InformationItem-RL-AdditionRspTDD  PRESENCE mandatory
  }
}

UL-DPCH-InformationItem-RL-AdditionRspTDD ::= SEQUENCE {
  repetitionPeriod          RepetitionPeriod,
  repetitionLength          RepetitionLength,
  tDD-DPCHOffset           TDD-DPCHOffset,
  uL-Timeslot-Information   UL-Timeslot-Information,
  iE-Extensions            ProtocolExtensionContainer { {UL-DPCH-InformationItem-RL-AdditionRspTDD-ExtIEs} } OPTIONAL,
  ...
}

UL-DPCH-InformationItem-RL-AdditionRspTDD-ExtIEs RNSAP-PROTOCOL-EXTENSION ::= {
  ...
}

DL-CCTrCHInformationList-RL-AdditionRspTDD ::= ProtocolIE-Single-Container {{DL-CCTrCHInformationListIEs-RL-AdditionRspTDD}}

DL-CCTrCHInformationListIEs-RL-AdditionRspTDD RNSAP-PROTOCOL-IES ::= {
  { ID id-DL-CCTrCH-InformationListIE-RL-AdditionRspTDD  CRITICALITY ignore  TYPE DL-CCTrCHInformationListIE-RL-AdditionRspTDD  PRESENCE
  mandatory }
}

DL-CCTrCHInformationListIE-RL-AdditionRspTDD ::= SEQUENCE (SIZE (1..maxNrOfCCTrCHs)) OF DL-CCTrCHInformationItem-RL-AdditionRspTDD

DL-CCTrCHInformationItem-RL-AdditionRspTDD ::= SEQUENCE {
  cCTrCH-ID                CCTrCH-ID,
  dl-DPCH-Information      DL-DPCH-InformationList-RL-AdditionRspTDD          OPTIONAL,
  iE-Extensions            ProtocolExtensionContainer { {DL-CCTrCHInformationItem-RL-AdditionRspTDD-ExtIEs} } OPTIONAL,
  ...
}

DL-CCTrCHInformationItem-RL-AdditionRspTDD-ExtIEs RNSAP-PROTOCOL-EXTENSION ::= {
  ...
}

DL-DPCH-InformationList-RL-AdditionRspTDD ::= ProtocolIE-Single-Container { {DL-DPCH-InformationListIEs-RL-AdditionRspTDD} }

DL-DPCH-InformationListIEs-RL-AdditionRspTDD RNSAP-PROTOCOL-IES ::= {
  { ID id-DL-DPCH-InformationItem-RL-AdditionRspTDD          CRITICALITY ignore  TYPE DL-DPCH-InformationItem-RL-AdditionRspTDD  PRESENCE mandatory
  }
}

DL-DPCH-InformationItem-RL-AdditionRspTDD ::= SEQUENCE {
  repetitionPeriod          RepetitionPeriod,
  repetitionLength          RepetitionLength,
  tDD-DPCHOffset           TDD-DPCHOffset,
  dL-Timeslot-Information   DL-Timeslot-Information,
  iE-Extensions            ProtocolExtensionContainer { {DL-DPCH-InformationItem-RL-AdditionRspTDD-ExtIEs} } OPTIONAL,
  ...
}

```

```

DL-DPCH-InformationItem-RL-AdditionRspTDD-ExtIEs RNSAP-PROTOCOL-EXTENSION ::= {
    ...
}

DCH-Information-RL-AdditionRspTDD ::= SEQUENCE {
    diversityIndication          DiversityIndication-RL-AdditionRspTDD,
    -- This IE represents both the Diversity Indication IE and the choice based on the diversity indication as described in
    -- the tabular message format in subclause 9.1.
    iE-Extensions                ProtocolExtensionContainer { { DCH-Information-RL-AdditionRspTDD-ExtIEs } } OPTIONAL,
    ...
}

DCH-Information-RL-AdditionRspTDD-ExtIEs RNSAP-PROTOCOL-EXTENSION ::= {
    ...
}

DiversityIndication-RL-AdditionRspTDD ::= CHOICE {
    combining          Combining-RL-AdditionRspTDD,
    nonCombining      NonCombining-RL-AdditionRspTDD
}

Combining-RL-AdditionRspTDD ::= SEQUENCE {
    rL-ID              RL-ID,
    iE-Extensions     ProtocolExtensionContainer { { CombiningItem-RL-AdditionRspTDD-ExtIEs } } OPTIONAL,
    ...
}

CombiningItem-RL-AdditionRspTDD-ExtIEs RNSAP-PROTOCOL-EXTENSION ::= {
    ...
}

NonCombining-RL-AdditionRspTDD ::= SEQUENCE {
    dCH-InformationResponse DCH-InformationResponse,
    iE-Extensions          ProtocolExtensionContainer { { NonCombiningItem-RL-AdditionRspTDD-ExtIEs } } OPTIONAL,
    ...
}

NonCombiningItem-RL-AdditionRspTDD-ExtIEs RNSAP-PROTOCOL-EXTENSION ::= {
    ...
}

DSCH-InformationResponse-RL-AdditionRspTDD ::= ProtocolIE-Single-Container {{DSCH-InformationListIEs-RL-AdditionRspTDD}}

DSCH-InformationListIEs-RL-AdditionRspTDD RNSAP-PROTOCOL-IES ::= {
    { ID id-DSCH-InformationListIE-RL-AdditionRspTDD    CRITICALITY ignore    TYPE DSCH-InformationListIE-RL-AdditionRspTDD    PRESENCE mandatory }
}

DSCH-InformationListIE-RL-AdditionRspTDD ::= SEQUENCE (SIZE(0..maxNoOfDSCHs)) OF DSCHInformationItem-RL-AdditionRspTDD

DSCHInformationItem-RL-AdditionRspTDD ::= SEQUENCE {
    dsch-ID              DSCH-ID,
    transportFormatManagement TransportFormatManagement,
    dsch-FlowControlInformation DSCH-FlowControlInformation,
    diversityIndication  DiversityIndication-RL-AdditionRspTDD2 OPTIONAL,
}

```

```

-- diversityIndication present, if CHOICE = nonCombining
iE-Extensions      ProtocolExtensionContainer { {DSCHInformationItem-RL-AdditionRspTDD-ExtIEs} } OPTIONAL,
...
}

DSCHInformationItem-RL-AdditionRspTDD-ExtIEs RNSAP-PROTOCOL-EXTENSION ::= {
...
}

DiversityIndication-RL-AdditionRspTDD2 ::= SEQUENCE {
bindingID          BindingID      OPTIONAL,
transportLayerAddress TransportLayerAddress OPTIONAL,
iE-Extensions      ProtocolExtensionContainer { {DiversityIndication-RL-AdditionRspTDD2-ExtIEs} } OPTIONAL,
...
}
DiversityIndication-RL-AdditionRspTDD2-ExtIEs RNSAP-PROTOCOL-EXTENSION ::= {
...
}

USCH-InformationResponse-RL-AdditionRspTDD ::= ProtocolIE-Single-Container {{USCH-InformationListIEs-RL-AdditionRspTDD}}

USCH-InformationListIEs-RL-AdditionRspTDD RNSAP-PROTOCOL-IES ::= {
{ ID id-USCH-InformationListIE-RL-AdditionRspTDD    CRITICALITY ignore    TYPE USCH-InformationListIE-RL-AdditionRspTDD    PRESENCE mandatory }
}

USCH-InformationListIE-RL-AdditionRspTDD ::= SEQUENCE (SIZE(0..maxNoOfUSCHs)) OF USCHInformationItem-RL-AdditionRspTDD

USCHInformationItem-RL-AdditionRspTDD ::= SEQUENCE {
uSCH-ID          USCH-ID,
transportFormatManagement TransportFormatManagement,
diversityIndication DiversityIndication-RL-AdditionRspTDD2 OPTIONAL,
-- diversityIndication present, if CHOICE = nonCombining
iE-Extensions      ProtocolExtensionContainer { {USCHInformationItem-RL-AdditionRspTDD-ExtIEs} } OPTIONAL,
...
}

USCHInformationItem-RL-AdditionRspTDD-ExtIEs RNSAP-PROTOCOL-EXTENSION ::= {
...
}

RadioLinkAdditionResponseTDD-Extensions RNSAP-PROTOCOL-EXTENSION ::= {
...
}

-- *****
--
-- RADIO LINK ADDITION FAILURE FDD
--
-- *****

RadioLinkAdditionFailureFDD ::= SEQUENCE {
protocolIEs      ProtocolIE-Container    {{RadioLinkAdditionFailureFDD-IEs}},
protocolExtensions ProtocolExtensionContainer {{RadioLinkAdditionFailureFDD-Extensions}}
...
OPTIONAL,

```

```

}

RadioLinkAdditionFailureFDD-IEs RNSAP-PROTOCOL-IES ::= {
  { ID id-CauseLevel-RL-AdditionFailureFDD          CRITICALITY ignore          TYPE CauseLevel-RL-AdditionFailureFDD
    PRESENCE mandatory }|
  { ID id-CriticalityDiagnostics          CRITICALITY ignore TYPE CriticalityDiagnostics          PRESENCE optional },
  ...
}

CauseLevel-RL-AdditionFailureFDD ::= CHOICE {
  generalCause          GeneralCauseList-RL-AdditionFailureFDD,
  rLSpecificCause      RLSpecificCauseList-RL-AdditionFailureFDD,
  ...
}

GeneralCauseList-RL-AdditionFailureFDD ::= SEQUENCE {
  cause          Cause,
  iE-Extensions          ProtocolExtensionContainer { { GeneralCauseItem-RL-AdditionFailureFDD-ExtIEs} }          OPTIONAL,
  ...
}

GeneralCauseItem-RL-AdditionFailureFDD-ExtIEs RNSAP-PROTOCOL-EXTENSION ::= {
  ...
}

RLSpecificCauseList-RL-AdditionFailureFDD ::= SEQUENCE {
  unsuccessful-RL-InformationRespList-RL-AdditionFailureFDD          UnsuccessfulRL-InformationResponseList-RL-AdditionFailureFDD,
  successful-RL-InformationRespList-RL-AdditionFailureFDD          SuccessfulRL-InformationResponseList-RL-AdditionFailureFDD          OPTIONAL,
  iE-Extensions          ProtocolExtensionContainer { { RLSpecificCauseItem-RL-AdditionFailureFDD-ExtIEs} }          OPTIONAL,
  ...
}

RLSpecificCauseItem-RL-AdditionFailureFDD-ExtIEs RNSAP-PROTOCOL-EXTENSION ::= {
  ...
}

UnsuccessfulRL-InformationResponseList-RL-AdditionFailureFDD ::= SEQUENCE (SIZE (1..maxNrOfRLs-1)) OF ProtocolIE-Single-Container {
  {UnsuccessfulRL-InformationResponse-RL-AdditionFailureFDD-IEs} }

UnsuccessfulRL-InformationResponse-RL-AdditionFailureFDD-IEs RNSAP-PROTOCOL-IES ::= {
  { ID id-UnsuccessfulRL-InformationResponse-RL-AdditionFailureFDD          CRITICALITY ignore          TYPE UnsuccessfulRL-InformationResponse-RL-
  AdditionFailureFDD          PRESENCE mandatory }
}

UnsuccessfulRL-InformationResponse-RL-AdditionFailureFDD ::= SEQUENCE {
  rL-ID          RL-ID,
  cause          Cause,
  iE-Extensions          ProtocolExtensionContainer { {UnsuccessfulRL-InformationResponse-RL-AdditionFailureFDD-ExtIEs} }          OPTIONAL,
  ...
}

UnsuccessfulRL-InformationResponse-RL-AdditionFailureFDD-ExtIEs RNSAP-PROTOCOL-EXTENSION ::= {
  ...
}

```

```
SuccessfulRL-InformationResponseList-RL-AdditionFailureFDD ::= SEQUENCE (SIZE (0..maxNrOfRLs-2)) OF ProtocolIE-Single-Container { {SuccessfulRL-InformationResponse-RL-AdditionFailureFDD-IEs} }
```

```
SuccessfulRL-InformationResponse-RL-AdditionFailureFDD-IEs RNSAP-PROTOCOL-IES ::= {
  { ID id-SuccessfulRL-InformationResponse-RL-AdditionFailureFDD CRITICALITY ignore TYPE SuccessfulRL-InformationResponse-RL-AdditionFailureFDD PRESENCE mandatory }
}
```

```
SuccessfulRL-InformationResponse-RL-AdditionFailureFDD ::= SEQUENCE {
  rL-ID RL-ID,
  rL-Set-ID RL-Set-ID,
  uRA-Information URA-Information OPTIONAL,
  sAI SAI,
  gA-Cell GA-Cell OPTIONAL,
  gA-AccessPointPosition GA-AccessPointPosition OPTIONAL,
  received-total-wide-band-power Received-total-wide-band-power,
  secondary-CCPCH-Info Secondary-CCPCH-Info OPTIONAL,
  dl-CodeInformation DL-CodeInformationList-RL-AdditionFailureFDD,
  diversityIndication DiversityIndication-RL-AdditionFailureFDD,
  -- This IE represents both the Diversity Indication IE and the choice based on the diversity indication as described in
  -- the tabular message format in subclause 9.1.
  sSDT-SupportIndicator SSDT-SupportIndicator,
  minUL-SIR UL-SIR,
  maxUL-SIR UL-SIR,
  closedloopTimingAdjustmentMode ClosedloopTimingAdjustmentMode OPTIONAL,
  maximumAllowedULTxPower MaximumAllowedULTxPower,
  maximumDLTxPower DL-Power,
  minimumDLTxPower DL-Power,
  neighbouring-UMTS-CellInformation Neighbouring-UMTS-CellInformation OPTIONAL,
  neighbouring-GSM-CellInformation Neighbouring-GSM-CellInformation OPTIONAL,
  primaryCPICH-Power PrimaryCPICH-Power,
  pC-Preamble PC-Preamble,
  sRB-Delay SRB-Delay,
  iE-Extensions ProtocolExtensionContainer { {SuccessfulRL-InformationResponse-RL-AdditionFailureFDD-ExtIEs} } OPTIONAL,
  ...
}
```

```
SuccessfulRL-InformationResponse-RL-AdditionFailureFDD-ExtIEs RNSAP-PROTOCOL-EXTENSION ::= {
  ...
}
```

```
DL-CodeInformationList-RL-AdditionFailureFDD ::= ProtocolIE-Single-Container { { DL-CodeInformationListIEs-RL-AdditionFailureFDD } }
```

```
DL-CodeInformationListIEs-RL-AdditionFailureFDD RNSAP-PROTOCOL-IES ::= {
  { ID id-FDD-DL-CodeInformation CRITICALITY ignore TYPE FDD-DL-CodeInformation PRESENCE mandatory }
}
```

```
DiversityIndication-RL-AdditionFailureFDD ::= CHOICE {
  combining Combining-RL-AdditionFailureFDD,
  nonCombining NonCombining-RL-AdditionFailureFDD
}
```

```
Combining-RL-AdditionFailureFDD ::= SEQUENCE {
```

```

    rL-ID                RL-ID,
    iE-Extensions        ProtocolExtensionContainer { { CombiningItem-RL-AdditionFailureFDD-ExtIEs } } OPTIONAL,
    ...
}

CombiningItem-RL-AdditionFailureFDD-ExtIEs RNSAP-PROTOCOL-EXTENSION ::= {
    ...
}

NonCombining-RL-AdditionFailureFDD ::= SEQUENCE {
    dCH-InformationResponse    DCH-InformationResponse,
    iE-Extensions              ProtocolExtensionContainer { { NonCombiningItem-RL-AdditionFailureFDD-ExtIEs } } OPTIONAL,
    ...
}

NonCombiningItem-RL-AdditionFailureFDD-ExtIEs RNSAP-PROTOCOL-EXTENSION ::= {
    ...
}

RadioLinkAdditionFailureFDD-Extensions RNSAP-PROTOCOL-EXTENSION ::= {
    ...
}

-- *****
--
-- RADIO LINK ADDITION FAILURE TDD
--
-- *****

RadioLinkAdditionFailureTDD ::= SEQUENCE {
    protocolIEs                ProtocolIE-Container    {{RadioLinkAdditionFailureTDD-IEs}},
    protocolExtensions          ProtocolExtensionContainer {{RadioLinkAdditionFailureTDD-Extensions}}
    ...
}

RadioLinkAdditionFailureTDD-IEs RNSAP-PROTOCOL-IEs ::= {
    { ID id-CauseLevel-RL-AdditionFailureTDD    CRITICALITY ignore    TYPE CauseLevel-RL-AdditionFailureTDD    PRESENCE mandatory }|
    { ID id-CriticalityDiagnostics              CRITICALITY ignore    TYPE CriticalityDiagnostics    PRESENCE optional },
    ...
}

CauseLevel-RL-AdditionFailureTDD ::= CHOICE {
    generalCause                GeneralCauseList-RL-AdditionFailureTDD,
    rLspecificCause              RLspecificCauseList-RL-AdditionFailureTDD,
    ...
}

GeneralCauseList-RL-AdditionFailureTDD ::= SEQUENCE {
    cause                        Cause,
    iE-Extensions                ProtocolExtensionContainer { { GeneralCauseItem-RL-AdditionFailureTDD-ExtIEs } }
    ...
}

GeneralCauseItem-RL-AdditionFailureTDD-ExtIEs RNSAP-PROTOCOL-EXTENSION ::= {

```



```

    ...
}

RLSpecificCauseList-RL-AdditionFailureTDD ::= SEQUENCE {
    unsuccessful-RL-InformationRespItem-RL-AdditionFailureTDD Unsuccessful-RL-InformationRespItem-RL-AdditionFailureTDD,
    iE-Extensions ProtocolExtensionContainer { { RLSpecificCauseItem-RL-AdditionFailureTDD-ExtIEs } }
    OPTIONAL,
    ...
}

RLSpecificCauseItem-RL-AdditionFailureTDD-ExtIEs RNSAP-PROTOCOL-EXTENSION ::= {
    ...
}

Unsuccessful-RL-InformationRespItem-RL-AdditionFailureTDD ::= ProtocolIE-Single-Container { {Unsuccessful-RL-InformationRespItemIE-RL-
AdditionFailureTDD } }

Unsuccessful-RL-InformationRespItemIE-RL-AdditionFailureTDD RNSAP-PROTOCOL-IES ::= {
    { ID id-UnsuccessfulRL-InformationResponse-RL-AdditionFailureTDD CRITICALITY ignore TYPE UnsuccessfulRL-InformationResponse-RL-
AdditionFailureTDD PRESENCE mandatory}
}

UnsuccessfulRL-InformationResponse-RL-AdditionFailureTDD ::= SEQUENCE {
    rL-ID RL-ID,
    cause Cause,
    iE-Extensions ProtocolExtensionContainer { {UnsuccessfulRL-InformationResponse-RL-AdditionFailureTDD-ExtIEs } } OPTIONAL,
    ...
}

UnsuccessfulRL-InformationResponse-RL-AdditionFailureTDD-ExtIEs RNSAP-PROTOCOL-EXTENSION ::= {
    ...
}

RadioLinkAdditionFailureTDD-Extensions RNSAP-PROTOCOL-EXTENSION ::= {
    ...
}

-- *****
--
-- RADIO LINK DELETION REQUEST
--
-- *****

RadioLinkDeletionRequest ::= SEQUENCE {
    protocolIEs ProtocolIE-Container {{RadioLinkDeletionRequest-IEs}},
    protocolExtensions ProtocolExtensionContainer {{RadioLinkDeletionRequest-Extensions}} OPTIONAL,
    ...
}

RadioLinkDeletionRequest-IEs RNSAP-PROTOCOL-IES ::= {
    { ID id-RL-InformationList-RL-DeletionRqst CRITICALITY notify TYPE RL-InformationList-RL-DeletionRqst PRESENCE mandatory },
    ...
}

```

```
RL-InformationList-RL-DeletionRqst ::= SEQUENCE (SIZE (1..maxNrOfRLs)) OF ProtocolIE-Single-Container { {RL-Information-RL-DeletionRqst-
IEs} }
```

```
RL-Information-RL-DeletionRqst-IEs RNSAP-PROTOCOL-IES ::= {
  { ID id-RL-Information-RL-DeletionRqst CRITICALITY notify TYPE RL-Information-RL-DeletionRqst PRESENCE mandatory }
}
```

```
RL-Information-RL-DeletionRqst ::= SEQUENCE {
  rL-ID RL-ID,
  iE-Extensions ProtocolExtensionContainer { {RL-Information-RL-DeletionRqst-ExtIEs} } OPTIONAL,
  ...
}
```

```
RL-Information-RL-DeletionRqst-ExtIEs RNSAP-PROTOCOL-EXTENSION ::= {
  ...
}
```

```
RadioLinkDeletionRequest-Extensions RNSAP-PROTOCOL-EXTENSION ::= {
  ...
}
```

```
-- *****
--
-- RADIO LINK DELETION RESPONSE
--
-- *****
```

```
RadioLinkDeletionResponse ::= SEQUENCE {
  protocolIEs ProtocolIE-Container {{RadioLinkDeletionResponse-IEs}},
  protocolExtensions ProtocolExtensionContainer {{RadioLinkDeletionResponse-Extensions}} OPTIONAL,
  ...
}
```

```
RadioLinkDeletionResponse-IEs RNSAP-PROTOCOL-IES ::= {
  { ID id-CriticalityDiagnostics CRITICALITY ignore TYPE CriticalityDiagnostics PRESENCE optional },
  ...
}
```

```
RadioLinkDeletionResponse-Extensions RNSAP-PROTOCOL-EXTENSION ::= {
  ...
}
```

```
-- *****
--
-- RADIO LINK RECONFIGURATION PREPARE FDD
--
-- *****
```

```
RadioLinkReconfigurationPrepareFDD ::= SEQUENCE {
  protocolIEs ProtocolIE-Container {{RadioLinkReconfigurationPrepareFDD-IEs}},
  protocolExtensions ProtocolExtensionContainer {{RadioLinkReconfigurationPrepareFDD-Extensions}} OPTIONAL,
  ...
}
```

```

RadioLinkReconfigurationPrepareFDD-IEs RNSAP-PROTOCOL-IES ::= {
  { ID id-AllowedQueuingTime          CRITICALITY reject  TYPE AllowedQueuingTime          PRESENCE optional } |
  { ID id-UL-DPCH-Information-RL-ReconfPrepFDD          CRITICALITY reject  TYPE UL-DPCH-Information-RL-ReconfPrepFDD          PRESENCE optional }
  |
  { ID id-DL-DPCH-Information-RL-ReconfPrepFDD          CRITICALITY reject  TYPE DL-DPCH-Information-RL-ReconfPrepFDD          PRESENCE optional }
  |
  { ID id-FDD-DCHs-to-Modify          CRITICALITY reject  TYPE FDD-DCHs-to-Modify          PRESENCE optional } |
  { ID id-DCHs-to-Add-FDD             CRITICALITY reject  TYPE DCH-FDD-Information          PRESENCE optional } |
  { ID id-DCH-DeleteList-RL-ReconfPrepFDD          CRITICALITY reject  TYPE DCH-DeleteList-RL-ReconfPrepFDD          PRESENCE optional } |
  { ID id-DSCH-Modify-RL-ReconfPrepFDD          CRITICALITY reject  TYPE DSCH-Modify-RL-ReconfPrepFDD          PRESENCE optional } |
  { ID id-DSCHs-to-Add-FDD            CRITICALITY reject  TYPE DSCH-FDD-Information          PRESENCE optional } |
  { ID id-DSCH-Delete-RL-ReconfPrepFDD          CRITICALITY reject  TYPE DSCH-Delete-RL-ReconfPrepFDD          PRESENCE optional } |
  { ID id-RL-InformationList-RL-ReconfPrepFDD          CRITICALITY reject  TYPE RL-InformationList-RL-ReconfPrepFDD          PRESENCE optional } |
  { ID id-Transmission-Gap-Pattern-Sequence-Information          CRITICALITY reject  TYPE Transmission-Gap-Pattern-Sequence-Information          PRESENCE optional },
  ...
}

```

```

UL-DPCH-Information-RL-ReconfPrepFDD ::= SEQUENCE {
  ul-ScramblingCode          UL-ScramblingCode          OPTIONAL,
  ul-SIRTarget               UL-SIR                      OPTIONAL,
  minUL-ChannelisationCodeLength  MinUL-ChannelisationCodeLength  OPTIONAL,
  maxNrOfUL-DPDCHs          MaxNrOfUL-DPDCHs          OPTIONAL
  -- This IE shall be present if minUL-ChannelisationCodeLength equals to 4 --,
  ul-PunctureLimit          PunctureLimit          OPTIONAL,
  tFCS                       TFCS          OPTIONAL,
  ul-DPCCH-SlotFormat       UL-DPCCH-SlotFormat       OPTIONAL,
  diversityMode              DiversityMode              OPTIONAL,
  sSDT-CellIDLength         SSDT-CellID-Length         OPTIONAL,
  s-FieldLength              S-FieldLength              OPTIONAL,
  iE-Extensions              ProtocolExtensionContainer { {UL-DPCH-Information-RL-ReconfPrepFDD-ExtIEs} } OPTIONAL,
  ...
}

```

```

UL-DPCH-Information-RL-ReconfPrepFDD-ExtIEs RNSAP-PROTOCOL-EXTENSION ::= {
  ...
}

```

```

DL-DPCH-Information-RL-ReconfPrepFDD ::= SEQUENCE {
  tFCS                       TFCS          OPTIONAL,
  dl-DPCH-SlotFormat         DL-DPCH-SlotFormat         OPTIONAL,
  nrOfDLchannelisationcodes  NrOfDLchannelisationcodes  OPTIONAL,
  tFCI-SignallingMode        TFCI-SignallingMode        OPTIONAL,
  tFCI-Presence              TFCI-Presence              OPTIONAL
  -- This IE shall be present if DL DPCH Slot Format IE is equal to any of the values from 12 to 16 --,
  multiplexingPosition        MultiplexingPosition        OPTIONAL,
  limitedPowerIncrease        LimitedPowerIncrease        OPTIONAL,
  iE-Extensions              ProtocolExtensionContainer { {DL-DPCH-Information-RL-ReconfPrepFDD-ExtIEs} } OPTIONAL,
  ...
}

```

```

DL-DPCH-Information-RL-ReconfPrepFDD-ExtIEs RNSAP-PROTOCOL-EXTENSION ::= {
  { ID id-SplitType          CRITICALITY reject  EXTENSION  SplitType          PRESENCE conditional } |
  -- This IE shall be present if the TFCI signalling mode is split --
}

```

```

    { ID id-LengthOfTFCI2 CRITICALITY reject EXTENSION LengthOfTFCI2 PRESENCE conditional },
    -- This IE shall be present if the split type is logical --
    ...
}

DCH-DeleteList-RL-ReconfPrepFDD ::= SEQUENCE (SIZE (0..maxNrOfDCHs)) OF DCH-DeleteItem-RL-ReconfPrepFDD

DCH-DeleteItem-RL-ReconfPrepFDD ::= SEQUENCE {
    dCH-ID DCH-ID,
    iE-Extensions ProtocolExtensionContainer { {DCH-DeleteItem-RL-ReconfPrepFDD-ExtIEs} } OPTIONAL,
    ...
}

DCH-DeleteItem-RL-ReconfPrepFDD-ExtIEs RNSAP-PROTOCOL-EXTENSION ::= {
    ...
}

DSCH-Modify-RL-ReconfPrepFDD ::= SEQUENCE {
    dSCH-Information DSCH-ModifyInfo-RL-ReconfPrepFDD OPTIONAL,
    pdSCH-RL-ID RL-ID OPTIONAL,
    tFCS TFCS OPTIONAL,
    iE-Extensions ProtocolExtensionContainer { {DSCH-Modify-RL-ReconfPrepFDD-ExtIEs} } OPTIONAL,
    ...
}

DSCH-Modify-RL-ReconfPrepFDD-ExtIEs RNSAP-PROTOCOL-EXTENSION ::= {
    ...
}

DSCH-ModifyInfo-RL-ReconfPrepFDD ::= SEQUENCE (SIZE(0..maxNoOfDSCHs)) OF DSCH-ModifyInformationItem-RL-ReconfPrepFDD

DSCH-ModifyInformationItem-RL-ReconfPrepFDD ::= SEQUENCE {
    dSCH-ID DSCH-ID,
    trChSourceStatisticsDescriptor TrCh-SrcStatisticsDescr OPTIONAL,
    transportFormatSet TransportFormatSet OPTIONAL,
    allocationRetentionPriority AllocationRetentionPriority OPTIONAL,
    schedulingPriorityIndicator SchedulingPriorityIndicator OPTIONAL,
    bLER BLER OPTIONAL,
    transportBearerRequestIndicator TransportBearerRequestIndicator,
    iE-Extensions ProtocolExtensionContainer { {DSCH-ModifyInformationItem-RL-ReconfPrepFDD-ExtIEs} } OPTIONAL,
    ...
}

DSCH-ModifyInformationItem-RL-ReconfPrepFDD-ExtIEs RNSAP-PROTOCOL-EXTENSION ::= {
    ...
}

DSCH-Delete-RL-ReconfPrepFDD ::= SEQUENCE {
    dSCH-Information DSCH-Info-Delete-RL-ReconfPrepFDD,
    iE-Extensions ProtocolExtensionContainer { {DSCH-Delete-RL-ReconfPrepFDD-ExtIEs} } OPTIONAL,
    ...
}

DSCH-Delete-RL-ReconfPrepFDD-ExtIEs RNSAP-PROTOCOL-EXTENSION ::= {

```

```

}
...
}
DSCH-Info-Delete-RL-ReconfPrepFDD ::= SEQUENCE (SIZE(1..maxNoOfDSCHs)) OF DSCH-DeleteInformationItem-RL-ReconfPrepFDD
DSCH-DeleteInformationItem-RL-ReconfPrepFDD ::= SEQUENCE {
    dSCH-ID                DSCH-ID,
    iE-Extensions          ProtocolExtensionContainer { {DSCH-DeleteInformationItem-RL-ReconfPrepFDD-ExtIEs} } OPTIONAL,
    ...
}
DSCH-DeleteInformationItem-RL-ReconfPrepFDD-ExtIEs RNSAP-PROTOCOL-EXTENSION ::= {
    ...
}
RL-InformationList-RL-ReconfPrepFDD ::= SEQUENCE (SIZE (0..maxNrOfRLs)) OF ProtocolIE-Single-Container { {RL-Information-RL-ReconfPrepFDD-IEs} }
RL-Information-RL-ReconfPrepFDD-IEs RNSAP-PROTOCOL-IES ::= {
    { ID id-RL-Information-RL-ReconfPrepFDD    CRITICALITY reject    TYPE RL-Information-RL-ReconfPrepFDD    PRESENCE mandatory }
}
RL-Information-RL-ReconfPrepFDD ::= SEQUENCE {
    rL-ID                RL-ID,
    sSDT-Indication      SSDT-Indication    OPTIONAL,
    sSDT-CellIdentity    SSDT-CellID      OPTIONAL
    -- The IE shall be present if the sSDT-Indication is set to 'sSDT-active-in-the-UE' --,
    transmitDiversityIndicator    TransmitDiversityIndicator    OPTIONAL,
    -- This IE shall be present if Diversity Mode IE is present in UL DPCH Information IE and is not equal to 'none'
    iE-Extensions        ProtocolExtensionContainer { {RL-Information-RL-ReconfPrepFDD-ExtIEs} } OPTIONAL,
    ...
}
RL-Information-RL-ReconfPrepFDD-ExtIEs RNSAP-PROTOCOL-EXTENSION ::= {
    ...
}
RadioLinkReconfigurationPrepareFDD-Extensions RNSAP-PROTOCOL-EXTENSION ::= {
    ...
}
-- *****
--
-- RADIO LINK RECONFIGURATION PREPARE TDD
--
-- *****

RadioLinkReconfigurationPrepareTDD ::= SEQUENCE {
    protocolIEs          ProtocolIE-Container    {{RadioLinkReconfigurationPrepareTDD-IEs}},
    protocolExtensions   ProtocolExtensionContainer {{RadioLinkReconfigurationPrepareTDD-Extensions}}
    ...
}
RadioLinkReconfigurationPrepareTDD-IEs RNSAP-PROTOCOL-IES ::= {

```

```

    { ID id-AllowedQueuingTime          CRITICALITY reject  TYPE AllowedQueuingTime          PRESENCE optional } |
    { ID id-UL-CCTrCH-InformationAddList-RL-ReconfPrepTDD  CRITICALITY notify  TYPE UL-CCTrCH-InformationAddList-RL-ReconfPrepTDD PRESENCE optional
    } |
    { ID id-UL-CCTrCH-InformationModifyList-RL-ReconfPrepTDD  CRITICALITY notify  TYPE UL-CCTrCH-InformationModifyList-RL-ReconfPrepTDD PRESENCE
optional
} |
    { ID id-UL-CCTrCH-InformationDeleteList-RL-ReconfPrepTDD  CRITICALITY notify  TYPE UL-CCTrCH-InformationDeleteList-RL-ReconfPrepTDD PRESENCE
optional
} |
    { ID id-DL-CCTrCH-InformationAddList-RL-ReconfPrepTDD  CRITICALITY notify  TYPE DL-CCTrCH-InformationAddList-RL-ReconfPrepTDD PRESENCE optional
    } |
    { ID id-DL-CCTrCH-InformationModifyList-RL-ReconfPrepTDD  CRITICALITY notify  TYPE DL-CCTrCH-InformationModifyList-RL-ReconfPrepTDD PRESENCE
optional
} |
    { ID id-DL-CCTrCH-InformationDeleteList-RL-ReconfPrepTDD  CRITICALITY notify  TYPE DL-CCTrCH-InformationDeleteList-RL-ReconfPrepTDD PRESENCE
optional
} |
    { ID id-TDD-DCHs-to-Modify          CRITICALITY reject  TYPE TDD-DCHs-to-Modify          PRESENCE optional } |
    { ID id-DCHs-to-Add-TDD             CRITICALITY reject  TYPE DCH-TDD-Information          PRESENCE optional } |
    { ID id-DCH-DeleteList-RL-ReconfPrepTDD  CRITICALITY reject  TYPE DCH-DeleteList-RL-ReconfPrepTDD  PRESENCE optional } |
    { ID id-DSCH-ModifyList-RL-ReconfPrepTDD  CRITICALITY reject  TYPE DSCH-ModifyList-RL-ReconfPrepTDD  PRESENCE optional } |
    { ID id-DSCHs-to-Add-TDD            CRITICALITY reject  TYPE DSCH-TDD-Information          PRESENCE optional } |
    { ID id-DSCH-DeleteList-RL-ReconfPrepTDD  CRITICALITY reject  TYPE DSCH-DeleteList-RL-ReconfPrepTDD  PRESENCE optional } |
    { ID id-USCH-ModifyList-RL-ReconfPrepTDD  CRITICALITY reject  TYPE USCH-ModifyList-RL-ReconfPrepTDD  PRESENCE optional } |
    { ID id-USCHs-to-Add                CRITICALITY reject  TYPE USCH-Information              PRESENCE optional } |
    { ID id-USCH-DeleteList-RL-ReconfPrepTDD  CRITICALITY reject  TYPE USCH-DeleteList-RL-ReconfPrepTDD  PRESENCE optional },
    ...
}

UL-CCTrCH-InformationAddList-RL-ReconfPrepTDD ::= SEQUENCE (SIZE (0..maxNrOfCCTrCHs)) OF ProtocolIE-Single-Container { {UL-CCTrCH-
AddInformation-RL-ReconfPrepTDD-IEs} }

UL-CCTrCH-AddInformation-RL-ReconfPrepTDD-IEs RNSAP-PROTOCOL-IES ::= {
    { ID id-UL-CCTrCH-AddInformation-RL-ReconfPrepTDD  CRITICALITY notify  TYPE UL-CCTrCH-AddInformation-RL-ReconfPrepTDD  PRESENCE mandatory }
}

UL-CCTrCH-AddInformation-RL-ReconfPrepTDD ::= SEQUENCE {
    cCTrCH-ID          CCTrCH-ID,
    tFCS               TFCS,
    tFCI-Coding        TFCI-Coding,
    punctureLimit      PunctureLimit,
    iE-Extensions      ProtocolExtensionContainer { {UL-CCTrCH-AddInformation-RL-ReconfPrepTDD-ExtIEs} } OPTIONAL,
    ...
}

UL-CCTrCH-AddInformation-RL-ReconfPrepTDD-ExtIEs RNSAP-PROTOCOL-EXTENSION ::= {
    ...
}

UL-CCTrCH-InformationModifyList-RL-ReconfPrepTDD ::= SEQUENCE (SIZE (0..maxNrOfCCTrCHs)) OF ProtocolIE-Single-Container { {UL-CCTrCH-
ModifyInformation-RL-ReconfPrepTDD-IEs} }

UL-CCTrCH-ModifyInformation-RL-ReconfPrepTDD-IEs RNSAP-PROTOCOL-IES ::= {
    { ID id-UL-CCTrCH-ModifyInformation-RL-ReconfPrepTDD  CRITICALITY notify  TYPE UL-CCTrCH-ModifyInformation-RL-ReconfPrepTDD  PRESENCE
mandatory
}
}

UL-CCTrCH-ModifyInformation-RL-ReconfPrepTDD ::= SEQUENCE {

```

```

cCtRCH-ID          CcTtRCH-ID,
tFCS               TFCS          OPTIONAL,
tFCI-Coding        tFCI-Coding   OPTIONAL,
punctureLimit      PunctureLimit OPTIONAL,
iE-Extensions      ProtocolExtensionContainer { {UL-CcTtRCH-ModifyInformation-RL-ReconfPrepTDD-ExtIEs} } OPTIONAL,
...
}

UL-CcTtRCH-ModifyInformation-RL-ReconfPrepTDD-ExtIEs RNSAP-PROTOCOL-EXTENSION ::= {
...
}

UL-CcTtRCH-InformationDeleteList-RL-ReconfPrepTDD ::= SEQUENCE (SIZE (0..maxNrOfCcTtRCHs)) OF ProtocolIE-Single-Container { {UL-CcTtRCH-DeleteInformation-RL-ReconfPrepTDD-IEs} }

UL-CcTtRCH-DeleteInformation-RL-ReconfPrepTDD-IEs RNSAP-PROTOCOL-IES ::= {
  { ID id-UL-CcTtRCH-DeleteInformation-RL-ReconfPrepTDD   CRITICALITY notify TYPE UL-CcTtRCH-DeleteInformation-RL-ReconfPrepTDD PRESENCE
    mandatory }
}

UL-CcTtRCH-DeleteInformation-RL-ReconfPrepTDD ::= SEQUENCE {
  cCtRCH-ID          CcTtRCH-ID,
  iE-Extensions      ProtocolExtensionContainer { {UL-CcTtRCH-DeleteInformation-RL-ReconfPrepTDD-ExtIEs} } OPTIONAL,
  ...
}

UL-CcTtRCH-DeleteInformation-RL-ReconfPrepTDD-ExtIEs RNSAP-PROTOCOL-EXTENSION ::= {
...
}

DL-CcTtRCH-InformationAddList-RL-ReconfPrepTDD ::= SEQUENCE (SIZE (0..maxNrOfCcTtRCHs)) OF ProtocolIE-Single-Container { {DL-CcTtRCH-AddInformation-RL-ReconfPrepTDD-IEs} }

DL-CcTtRCH-AddInformation-RL-ReconfPrepTDD-IEs RNSAP-PROTOCOL-IES ::= {
  { ID id-DL-CcTtRCH-InformationAddItem-RL-ReconfPrepTDD   CRITICALITY notify TYPE DL-CcTtRCH-InformationAddItem-RL-ReconfPrepTDD PRESENCE
    mandatory }
}

DL-CcTtRCH-InformationAddItem-RL-ReconfPrepTDD ::= SEQUENCE {
  cCtRCH-ID          CcTtRCH-ID,
  tFCS               TFCS,
  tFCI-Coding        tFCI-Coding,
  punctureLimit      PunctureLimit,
  cCtRCH-TPCList     CcTtRCH-TPCAddList-RL-ReconfPrepTDD OPTIONAL,
  iE-Extensions      ProtocolExtensionContainer { {DL-CcTtRCH-InformationAddItem-RL-ReconfPrepTDD-ExtIEs} } OPTIONAL,
  ...
}

DL-CcTtRCH-InformationAddItem-RL-ReconfPrepTDD-ExtIEs RNSAP-PROTOCOL-EXTENSION ::= {
...
}

CcTtRCH-TPCAddList-RL-ReconfPrepTDD ::= SEQUENCE (SIZE (1..maxNrOfCcTtRCHs)) OF CcTtRCH-TPCAddItem-RL-ReconfPrepTDD

```

```

CCTrCH-TPCAddItem-RL-ReconfPrepTDD ::= SEQUENCE {
    cCtTrCH-ID          CCTrCH-ID,
    iE-Extensions      ProtocolExtensionContainer { { CCTrCH-TPCAddItem-RL-ReconfPrepTDD-ExtIEs } } OPTIONAL,
    ...
}

CCTrCH-TPCAddItem-RL-ReconfPrepTDD-ExtIEs RNSAP-PROTOCOL-EXTENSION ::= {
    ...
}

DL-CCTrCH-InformationModifyList-RL-ReconfPrepTDD ::= SEQUENCE (SIZE (0..maxNrOfCCTrCHs)) OF ProtocolIE-Single-Container { {DL-CCTrCH-
ModifyInformation-RL-ReconfPrepTDD-IEs} }

DL-CCTrCH-ModifyInformation-RL-ReconfPrepTDD-IEs RNSAP-PROTOCOL-IES ::= {
    { ID id-DL-CCTrCH-InformationModifyItem-RL-ReconfPrepTDD    CRITICALITY notify    TYPE DL-CCTrCH-InformationModifyItem-RL-ReconfPrepTDD    PRESENCE
mandatory }
}

DL-CCTrCH-InformationModifyItem-RL-ReconfPrepTDD ::= SEQUENCE {
    cCtTrCH-ID          CCTrCH-ID,
    tFCS                TFCS          OPTIONAL,
    tFCI-Coding         TFCI-Coding   OPTIONAL,
    punctureLimit       PunctureLimit  OPTIONAL,
    cCtTrCH-TPCList     CCTrCH-TPCModifyList-RL-ReconfPrepTDD    OPTIONAL,
    iE-Extensions      ProtocolExtensionContainer { {DL-CCTrCH-InformationModifyItem-RL-ReconfPrepTDD-ExtIEs} } OPTIONAL,
    ...
}

DL-CCTrCH-InformationModifyItem-RL-ReconfPrepTDD-ExtIEs RNSAP-PROTOCOL-EXTENSION ::= {
    ...
}

CCTrCH-TPCModifyList-RL-ReconfPrepTDD ::= SEQUENCE (SIZE (1..maxNrOfCCTrCHs)) OF CCTrCH-TPCModifyItem-RL-ReconfPrepTDD

CCTrCH-TPCModifyItem-RL-ReconfPrepTDD ::= SEQUENCE {
    cCtTrCH-ID          CCTrCH-ID,
    iE-Extensions      ProtocolExtensionContainer { { CCTrCH-TPCModifyItem-RL-ReconfPrepTDD-ExtIEs } } OPTIONAL,
    ...
}

CCTrCH-TPCModifyItem-RL-ReconfPrepTDD-ExtIEs RNSAP-PROTOCOL-EXTENSION ::= {
    ...
}

DL-CCTrCH-InformationDeleteList-RL-ReconfPrepTDD ::= SEQUENCE (SIZE (0..maxNrOfCCTrCHs)) OF ProtocolIE-Single-Container { {DL-CCTrCH-
DeleteInformation-RL-ReconfPrepTDD-IEs} }

DL-CCTrCH-DeleteInformation-RL-ReconfPrepTDD-IEs RNSAP-PROTOCOL-IES ::= {
    { ID id-DL-CCTrCH-InformationDeleteItem-RL-ReconfPrepTDD    CRITICALITY notify    TYPE DL-CCTrCH-InformationDeleteItem-RL-ReconfPrepTDD    PRESENCE
mandatory }
}

DL-CCTrCH-InformationDeleteItem-RL-ReconfPrepTDD ::= SEQUENCE {
    cCtTrCH-ID          CCTrCH-ID,

```



```

    iE-Extensions          ProtocolExtensionContainer { {DL-CCTrCH-InformationDeleteItem-RL-ReconfPrepTDD-ExtIEs} } OPTIONAL,
  }
  ...
}
DL-CCTrCH-InformationDeleteItem-RL-ReconfPrepTDD-ExtIEs RNSAP-PROTOCOL-EXTENSION ::= {
  ...
}
DCH-DeleteList-RL-ReconfPrepTDD ::= SEQUENCE (SIZE (0..maxNrOfDCHs)) OF DCH-DeleteItem-RL-ReconfPrepTDD
DCH-DeleteItem-RL-ReconfPrepTDD ::= SEQUENCE {
  dCH-ID                  DCH-ID,
  iE-Extensions          ProtocolExtensionContainer { {DCH-DeleteItem-RL-ReconfPrepTDD-ExtIEs} } OPTIONAL,
  ...
}
DCH-DeleteItem-RL-ReconfPrepTDD-ExtIEs RNSAP-PROTOCOL-EXTENSION ::= {
  ...
}
DSCH-ModifyList-RL-ReconfPrepTDD ::= SEQUENCE (SIZE(0..maxNoOfDSCHs)) OF DSCH-ModifyItem-RL-ReconfPrepTDD
DSCH-ModifyItem-RL-ReconfPrepTDD ::= SEQUENCE {
  dSCH-ID                DSCH-ID,
  dl-ccTrCHID            CCTrCH-ID                      OPTIONAL,
  trChSourceStatisticsDescriptor TrCH-SrcStatisticsDescr OPTIONAL,
  transportFormatSet     TransportFormatSet             OPTIONAL,
  allocationRetentionPriority AllocationRetentionPriority OPTIONAL,
  schedulingPriorityIndicator SchedulingPriorityIndicator OPTIONAL,
  bLER                   BLER                          OPTIONAL,
  transportBearerRequestIndicator TransportBearerRequestIndicator,
  iE-Extensions          ProtocolExtensionContainer { {DSCH-ModifyItem-RL-ReconfPrepTDD-ExtIEs} } OPTIONAL,
  ...
}
DSCH-ModifyItem-RL-ReconfPrepTDD-ExtIEs RNSAP-PROTOCOL-EXTENSION ::= {
  ...
}
DSCH-DeleteList-RL-ReconfPrepTDD ::= SEQUENCE (SIZE(0..maxNoOfDSCHs)) OF DSCH-DeleteItem-RL-ReconfPrepTDD
DSCH-DeleteItem-RL-ReconfPrepTDD ::= SEQUENCE {
  dSCH-ID                DSCH-ID,
  iE-Extensions          ProtocolExtensionContainer { {DSCH-DeleteItem-RL-ReconfPrepTDD-ExtIEs} } OPTIONAL,
  ...
}
DSCH-DeleteItem-RL-ReconfPrepTDD-ExtIEs RNSAP-PROTOCOL-EXTENSION ::= {
  ...
}
USCH-ModifyList-RL-ReconfPrepTDD ::= SEQUENCE (SIZE(0..maxNoOfUSCHs)) OF USCH-ModifyItem-RL-ReconfPrepTDD
USCH-ModifyItem-RL-ReconfPrepTDD ::= SEQUENCE {

```

```

uSCH-ID                USCH-ID,
ul-ccTrCHID            CCH-CH-ID                OPTIONAL,
trChSourceStatisticsDescriptor TrCH-SourceStatisticsDescr OPTIONAL,
transportFormatSet     TransportFormatSet          OPTIONAL,
allocationRetentionPriority AllocationRetentionPriority  OPTIONAL,
schedulingPriorityIndicator SchedulingPriorityIndicator  OPTIONAL,
bLER                   BLER                        OPTIONAL,
transportBearerRequestIndicator TransportBearerRequestIndicator,
rb-Info                RB-Info                    OPTIONAL,
iE-Extensions          ProtocolExtensionContainer { {USCH-ModifyItem-RL-ReconfPrepTDD-ExtIEs} } OPTIONAL,
...
}

USCH-ModifyItem-RL-ReconfPrepTDD-ExtIEs RNSAP-PROTOCOL-EXTENSION ::= {
...
}

USCH-DeleteList-RL-ReconfPrepTDD ::= SEQUENCE (SIZE(0..maxNoOfUSCHs)) OF USCH-DeleteItem-RL-ReconfPrepTDD

USCH-DeleteItem-RL-ReconfPrepTDD ::= SEQUENCE {
uSCH-ID                USCH-ID,
iE-Extensions          ProtocolExtensionContainer { {USCH-DeleteItem-RL-ReconfPrepTDD-ExtIEs} } OPTIONAL,
...
}

USCH-DeleteItem-RL-ReconfPrepTDD-ExtIEs RNSAP-PROTOCOL-EXTENSION ::= {
...
}

RadioLinkReconfigurationPrepareTDD-Extensions RNSAP-PROTOCOL-EXTENSION ::= {
{ ID id-PrimaryCCPCH-RSCP-RL-ReconfPrepTDD CRITICALITY ignore EXTENSION PrimaryCCPCH-RSCP PRESENCE optional }|
{ ID id-DL-TimeSlot-ISCP-Info-RL-ReconfPrepTDD CRITICALITY ignore EXTENSION DL-TimeSlot-ISCP-Info PRESENCE optional }|
{ ID id-PDSCH-RL-ID CRITICALITY ignore EXTENSION RL-ID PRESENCE optional },
...
}

-- *****
--
-- RADIO LINK RECONFIGURATION READY FDD
--
-- *****

RadioLinkReconfigurationReadyFDD ::= SEQUENCE {
protocolIEs            ProtocolIE-Container      {{RadioLinkReconfigurationReadyFDD-IEs}},
protocolExtensions     ProtocolExtensionContainer {{RadioLinkReconfigurationReadyFDD-Extensions}}
...
}

RadioLinkReconfigurationReadyFDD-IEs RNSAP-PROTOCOL-IES ::= {
{ ID id-RL-InformationResponseList-RL-ReconfReadyFDD CRITICALITY ignore TYPE RL-InformationResponseList-RL-ReconfReadyFDD PRESENCE optional }|
{ ID id-CriticalityDiagnostics CRITICALITY ignore TYPE CriticalityDiagnostics PRESENCE optional },
...
}

```

```

RL-InformationResponseList-RL-ReconfReadyFDD ::= SEQUENCE (SIZE (0..maxNrOfRLs)) OF ProtocolIE-Single-Container { {RL-InformationResponse-
RL-ReconfReadyFDD-IEs} }

RL-InformationResponse-RL-ReconfReadyFDD-IEs RNSAP-PROTOCOL-IES ::= {
  { ID id-RL-InformationResponseItem-RL-ReconfReadyFDD CRITICALITY ignore TYPE RL-InformationResponseItem-RL-ReconfReadyFDD PRESENCE
mandatory }
}

RL-InformationResponseItem-RL-ReconfReadyFDD ::= SEQUENCE {
  rL-ID RL-ID,
  max-UL-SIR UL-SIR OPTIONAL,
  min-UL-SIR UL-SIR OPTIONAL,
  maximumDLTxPower DL-Power OPTIONAL,
  minimumDLTxPower DL-Power OPTIONAL,
  secondary-CCPCH-Info Secondary-CCPCH-Info OPTIONAL,
  dl-CodeInformationList DL-CodeInformationList-RL-ReconfReadyFDD OPTIONAL,
  dCHInformationResponse DCH-InformationResponseList-RL-ReconfReadyFDD OPTIONAL,
  dSCHsToBeAddedOrModified DSCHsToBeAddedOrModified-RL-ReconfReadyFDD OPTIONAL,
  iE-Extensions ProtocolExtensionContainer { {RL-InformationResponseItem-RL-ReconfReadyFDD-ExtIEs} } OPTIONAL,
  ...
}

RL-InformationResponseItem-RL-ReconfReadyFDD-ExtIEs RNSAP-PROTOCOL-EXTENSION ::= {
  ...
}

DL-CodeInformationList-RL-ReconfReadyFDD ::= ProtocolIE-Single-Container {{ DL-CodeInformationListIEs-RL-ReconfReadyFDD }}

DL-CodeInformationListIEs-RL-ReconfReadyFDD RNSAP-PROTOCOL-IES ::= {
  { ID id-FDD-DL-CodeInformation CRITICALITY ignore TYPE FDD-DL-CodeInformation PRESENCE mandatory }
}

DCH-InformationResponseList-RL-ReconfReadyFDD ::= ProtocolIE-Single-Container { {DCH-InformationResponseListIEs-RL-ReconfReadyFDD} }

DCH-InformationResponseListIEs-RL-ReconfReadyFDD RNSAP-PROTOCOL-IES ::= {
  { ID id-DCH-InformationResponse CRITICALITY ignore TYPE DCH-InformationResponse PRESENCE mandatory }
}

DSCHsToBeAddedOrModified-RL-ReconfReadyFDD ::= ProtocolIE-Single-Container { {DSCHsToBeAddedOrModifiedIEs-RL-ReconfReadyFDD} }

DSCHsToBeAddedOrModifiedIEs-RL-ReconfReadyFDD RNSAP-PROTOCOL-IES ::= {
  { ID id-DSCHsToBeAddedOrModified-FDD CRITICALITY ignore TYPE DSCH-FDD-InformationResponse PRESENCE mandatory }
}

RadioLinkReconfigurationReadyFDD-Extensions RNSAP-PROTOCOL-EXTENSION ::= {
  { ID id-DSCH-RNTI CRITICALITY ignore EXTENSION DSCH-RNTI PRESENCE optional },
  ...
}

-- *****
--
-- RADIO LINK RECONFIGURATION READY TDD
--

```

```

-- *****

RadioLinkReconfigurationReadyTDD ::= SEQUENCE {
    protocolIEs                ProtocolIE-Container    {{RadioLinkReconfigurationReadyTDD-IEs}},
    protocolExtensions         ProtocolExtensionContainer {{RadioLinkReconfigurationReadyTDD-Extensions}}
    ...
}

RadioLinkReconfigurationReadyTDD-IEs RNSAP-PROTOCOL-IES ::= {
    { ID id-RL-InformationResponse-RL-ReconfReadyTDD
      CRITICALITY ignore TYPE RL-InformationResponse-RL-ReconfReadyTDD PRESENCE optional } |
    { ID id-CriticalityDiagnostics
      CRITICALITY ignore TYPE CriticalityDiagnostics PRESENCE optional },
    ...
}

RL-InformationResponse-RL-ReconfReadyTDD ::= SEQUENCE {
    rL-ID                      RL-ID,
    max-UL-SIR                 UL-SIR                OPTIONAL,
    min-UL-SIR                 UL-SIR                OPTIONAL,
    maximumDLTxPower          DL-Power         OPTIONAL,
    minimumDLTxPower          DL-Power         OPTIONAL,
    secondary-CCPCH-Info-TDD   Secondary-CCPCH-Info-TDD OPTIONAL,
    ul-CCTrCH-Information      UL-CCTrCH-InformationList-RL-ReconfReadyTDD OPTIONAL,
    dl-CCTrCH-Information      DL-CCTrCH-InformationList-RL-ReconfReadyTDD OPTIONAL,
    dCHInformationResponse     DCH-InformationResponseList-RL-ReconfReadyTDD OPTIONAL,
    dSCHsToBeAddedOrModified   DSCHToBeAddedOrModified-RL-ReconfReadyTDD OPTIONAL,
    uSCHsToBeAddedOrModified   USCHToBeAddedOrModified-RL-ReconfReadyTDD OPTIONAL,
    iE-Extensions              ProtocolExtensionContainer { {RL-InformationResponse-RL-ReconfReadyTDD-ExtIEs} } OPTIONAL,
    ...
}

RL-InformationResponse-RL-ReconfReadyTDD-ExtIEs RNSAP-PROTOCOL-EXTENSION ::= {
    ...
}

UL-CCTrCH-InformationList-RL-ReconfReadyTDD ::= ProtocolIE-Single-Container {{UL-CCTrCHInformationListIEs-RL-ReconfReadyTDD}}

UL-CCTrCHInformationListIEs-RL-ReconfReadyTDD RNSAP-PROTOCOL-IES ::= {
    { ID id-UL-CCTrCH-InformationListIE-RL-ReconfReadyTDD CRITICALITY ignore TYPE UL-CCTrCHInformationListIE-RL-ReconfReadyTDD PRESENCE
    mandatory }
}

UL-CCTrCHInformationListIE-RL-ReconfReadyTDD ::= SEQUENCE (SIZE (0..maxNrOfCCTrCHs)) OF UL-CCTrCH-InformationItem-RL-ReconfReadyTDD

UL-CCTrCH-InformationItem-RL-ReconfReadyTDD ::= SEQUENCE {
    cCtRch-ID                  CCTrCH-ID,
    ul-DPCH-AddInformation     UL-DPCH-InformationAddList-RL-ReconfReadyTDD OPTIONAL,
    ul-DPCH-ModifyInformation  UL-DPCH-InformationModifyList-RL-ReconfReadyTDD OPTIONAL,
    ul-DPCH-DeleteInformation  UL-DPCH-InformationDeleteList-RL-ReconfReadyTDD OPTIONAL,
    iE-Extensions              ProtocolExtensionContainer { {UL-CCTrCH-InformationItem-RL-ReconfReadyTDD-ExtIEs} } OPTIONAL,
    ...
}

UL-CCTrCH-InformationItem-RL-ReconfReadyTDD-ExtIEs RNSAP-PROTOCOL-EXTENSION ::= {

```

```

}
...
}
UL-DPCH-InformationAddList-RL-ReconfReadyTDD ::= ProtocolIE-Single-Container {{UL-DPCH-InformationAddListIEs-RL-ReconfReadyTDD}}
UL-DPCH-InformationAddListIEs-RL-ReconfReadyTDD RNSAP-PROTOCOL-IES ::= {
  { ID id-UL-DPCH-InformationAddListIE-RL-ReconfReadyTDD  CRITICALITY ignore  TYPE UL-DPCH-InformationAddListIE-RL-ReconfReadyTDD  PRESENCE
  mandatory }
}
UL-DPCH-InformationAddListIE-RL-ReconfReadyTDD ::= SEQUENCE {
  repetitionPeriod          RepetitionPeriod,
  repetitionLength          RepetitionLength,
  tDD-DPCHOffset           TDD-DPCHOffset,
  rxTimingDeviationForTA   RxTimingDeviationForTA          OPTIONAL,
  uL-Timeslot-Information   UL-Timeslot-Information,
  iE-Extensions             ProtocolExtensionContainer { {UL-DPCH-InformationAddItem-RL-ReconfReadyTDD-ExtIEs} } OPTIONAL,
  ...
}
UL-DPCH-InformationAddItem-RL-ReconfReadyTDD-ExtIEs RNSAP-PROTOCOL-EXTENSION ::= {
  ...
}
UL-DPCH-InformationModifyList-RL-ReconfReadyTDD ::= ProtocolIE-Single-Container {{UL-DPCH-InformationModifyListIEs-RL-ReconfReadyTDD}}
UL-DPCH-InformationModifyListIEs-RL-ReconfReadyTDD RNSAP-PROTOCOL-IES ::= {
  { ID id-UL-DPCH-InformationModifyListIE-RL-ReconfReadyTDD  CRITICALITY ignore  TYPE UL-DPCH-InformationModifyListIE-RL-ReconfReadyTDD
  PRESENCE mandatory }
}
UL-DPCH-InformationModifyListIE-RL-ReconfReadyTDD ::= SEQUENCE {
  repetitionPeriod          RepetitionPeriod          OPTIONAL,
  repetitionLength          RepetitionLength          OPTIONAL,
  tDD-DPCHOffset           TDD-DPCHOffset            OPTIONAL,
  uL-Timeslot-InformationModifyList-RL-ReconfReadyTDD  UL-Timeslot-InformationModifyList-RL-ReconfReadyTDD  OPTIONAL,
  iE-Extensions             ProtocolExtensionContainer { {UL-DPCH-InformationModifyItem-RL-ReconfReadyTDD-ExtIEs} } OPTIONAL,
  ...
}
UL-DPCH-InformationModifyItem-RL-ReconfReadyTDD-ExtIEs RNSAP-PROTOCOL-EXTENSION ::= {
  ...
}
UL-Timeslot-InformationModifyList-RL-ReconfReadyTDD ::= SEQUENCE ( SIZE (1..maxNrOfTS)) OF UL-Timeslot-InformationModifyItem-RL-ReconfReadyTDD
UL-Timeslot-InformationModifyItem-RL-ReconfReadyTDD ::= SEQUENCE {
  timeSlot                  TimeSlot,
  midambleShiftAndBurstType MidambleShiftAndBurstType          OPTIONAL,
  tFCI-Presence             TFCI-Presence                      OPTIONAL,
  uL-Code-Information        TDD-UL-Code-InformationModifyList-RL-ReconfReadyTDD  OPTIONAL,
  iE-Extensions             ProtocolExtensionContainer { {UL-Timeslot-InformationModifyItem-RL-ReconfReadyTDD-ExtIEs} } OPTIONAL,
  ...
}

```

```

UL-Timeslot-InformationModifyItem-RL-ReconfReadyTDD-ExtIEs RNSAP-PROTOCOL-EXTENSION ::= {
    ...
}

TDD-UL-Code-InformationModifyList-RL-ReconfReadyTDD ::= SEQUENCE ( SIZE (1..maxNrOfDPCHs)) OF TDD-UL-Code-InformationModifyItem-RL-ReconfReadyTDD

TDD-UL-Code-InformationModifyItem-RL-ReconfReadyTDD ::= SEQUENCE {
    dPCH-ID                DPCH-ID,
    tDD-ChannelisationCode TDD-ChannelisationCode OPTIONAL,
    iE-Extensions          ProtocolExtensionContainer { {TDD-UL-Code-InformationModifyItem-RL-ReconfReadyTDD-ExtIEs} } OPTIONAL,
    ...
}

TDD-UL-Code-InformationModifyItem-RL-ReconfReadyTDD-ExtIEs RNSAP-PROTOCOL-EXTENSION ::= {
    ...
}

UL-DPCH-InformationDeleteList-RL-ReconfReadyTDD ::= ProtocolIE-Single-Container { {UL-DPCH-InformationDeleteListIEs-RL-ReconfReadyTDD} }

UL-DPCH-InformationDeleteListIEs-RL-ReconfReadyTDD RNSAP-PROTOCOL-IES ::= {
    { ID id-UL-DPCH-InformationDeleteListIE-RL-ReconfReadyTDD CRITICALITY ignore TYPE UL-DPCH-InformationDeleteListIE-RL-ReconfReadyTDD
    PRESENCE mandatory }
}

UL-DPCH-InformationDeleteListIE-RL-ReconfReadyTDD ::= SEQUENCE (SIZE (0..maxNrOfDPCHs)) OF UL-DPCH-InformationDeleteItem-RL-ReconfReadyTDD

UL-DPCH-InformationDeleteItem-RL-ReconfReadyTDD ::= SEQUENCE {
    dPCH-ID                DPCH-ID,
    iE-Extensions          ProtocolExtensionContainer { {UL-DPCH-InformationDeleteList-RL-ReconfReadyTDD-ExtIEs} } OPTIONAL,
    ...
}

UL-DPCH-InformationDeleteList-RL-ReconfReadyTDD-ExtIEs RNSAP-PROTOCOL-EXTENSION ::= {
    ...
}

DL-CCTrCH-InformationList-RL-ReconfReadyTDD ::= ProtocolIE-Single-Container { {DL-CCTrCHInformationListIEs-RL-ReconfReadyTDD} }

DL-CCTrCHInformationListIEs-RL-ReconfReadyTDD RNSAP-PROTOCOL-IES ::= {
    { ID id-DL-CCTrCH-InformationListIE-RL-ReconfReadyTDD CRITICALITY ignore TYPE DL-CCTrCHInformationListIE-RL-ReconfReadyTDD
    PRESENCE mandatory }
}

DL-CCTrCHInformationListIE-RL-ReconfReadyTDD ::= SEQUENCE (SIZE (0..maxNrOfCCTrCHs)) OF DL-CCTrCH-InformationItem-RL-ReconfReadyTDD

DL-CCTrCH-InformationItem-RL-ReconfReadyTDD ::= SEQUENCE {
    cCTrCH-ID                CCTrCH-ID,
    dl-DPCH-AddInformation    DL-DPCH-InformationAddList-RL-ReconfReadyTDD OPTIONAL,
    dl-DPCH-ModifyInformation DL-DPCH-InformationModifyList-RL-ReconfReadyTDD OPTIONAL,
    dl-DPCH-DeleteInformation DL-DPCH-InformationDeleteList-RL-ReconfReadyTDD OPTIONAL,
    iE-Extensions            ProtocolExtensionContainer { {DL-CCTrCH-InformationItem-RL-ReconfReadyTDD-ExtIEs} } OPTIONAL,
    ...
}

```

```

DL-CCTrCH-InformationItem-RL-ReconfReadyTDD-ExtIEs RNSAP-PROTOCOL-EXTENSION ::= {
    ...
}

DL-DPCH-InformationAddList-RL-ReconfReadyTDD ::= ProtocolIE-Single-Container {{DL-DPCH-InformationAddListIEs-RL-ReconfReadyTDD}}

DL-DPCH-InformationAddListIEs-RL-ReconfReadyTDD RNSAP-PROTOCOL-IES ::= {
    { ID id-DL-DPCH-InformationAddListIE-RL-ReconfReadyTDD    CRITICALITY ignore TYPE DL-DPCH-InformationAddListIE-RL-ReconfReadyTDD    PRESENCE
    mandatory }
}

DL-DPCH-InformationAddListIE-RL-ReconfReadyTDD ::= SEQUENCE {
    repetitionPeriod          RepetitionPeriod,
    repetitionLength          RepetitionLength,
    tDD-DPCHOffset            TDD-DPCHOffset,
    dL-Timeslot-Information    DL-Timeslot-Information,
    iE-Extensions              ProtocolExtensionContainer { {DL-DPCH-InformationAddItem-RL-ReconfReadyTDD-ExtIEs} } OPTIONAL,
    ...
}

DL-DPCH-InformationAddItem-RL-ReconfReadyTDD-ExtIEs RNSAP-PROTOCOL-EXTENSION ::= {
    ...
}

DL-DPCH-InformationModifyList-RL-ReconfReadyTDD ::= ProtocolIE-Single-Container {{DL-DPCH-InformationModifyListIEs-RL-ReconfReadyTDD}}

DL-DPCH-InformationModifyListIEs-RL-ReconfReadyTDD RNSAP-PROTOCOL-IES ::= {
    { ID id-DL-DPCH-InformationModifyListIE-RL-ReconfReadyTDD    CRITICALITY ignore TYPE DL-DPCH-InformationModifyListIE-RL-ReconfReadyTDD
    PRESENCE mandatory }
}

DL-DPCH-InformationModifyListIE-RL-ReconfReadyTDD ::= SEQUENCE {
    repetitionPeriod          RepetitionPeriod          OPTIONAL,
    repetitionLength          RepetitionLength          OPTIONAL,
    tDD-DPCHOffset            TDD-DPCHOffset            OPTIONAL,
    dL-Timeslot-InformationModifyList-RL-ReconfReadyTDD    DL-Timeslot-InformationModifyList-RL-ReconfReadyTDD    OPTIONAL,
    iE-Extensions              ProtocolExtensionContainer { {DL-DPCH-InformationModifyItem-RL-ReconfReadyTDD-ExtIEs} } OPTIONAL,
    ...
}

DL-DPCH-InformationModifyItem-RL-ReconfReadyTDD-ExtIEs RNSAP-PROTOCOL-EXTENSION ::= {
    ...
}

DL-Timeslot-InformationModifyList-RL-ReconfReadyTDD ::= SEQUENCE ( SIZE (1..maxNrOfTS)) OF DL-Timeslot-InformationModifyItem-RL-ReconfReadyTDD

DL-Timeslot-InformationModifyItem-RL-ReconfReadyTDD ::= SEQUENCE {
    timeSlot                  TimeSlot,
    midambleShiftAndBurstType MidambleShiftAndBurstType          OPTIONAL,
    tFCI-Presence              TFCI-Presence                      OPTIONAL,
    dL-Code-Information          TDD-DL-Code-InformationModifyList-RL-ReconfReadyTDD    OPTIONAL,
    iE-Extensions              ProtocolExtensionContainer { {DL-Timeslot-InformationModifyItem-RL-ReconfReadyTDD-ExtIEs} } OPTIONAL,
    ...
}

```

```

}
DL-Timeslot-InformationModifyItem-RL-ReconfReadyTDD-ExtIEs RNSAP-PROTOCOL-EXTENSION ::= {
  ...
}
TDD-DL-Code-InformationModifyList-RL-ReconfReadyTDD ::= SEQUENCE ( SIZE (1..maxNrOfDPCHs)) OF TDD-DL-Code-InformationModifyItem-RL-ReconfReadyTDD
TDD-DL-Code-InformationModifyItem-RL-ReconfReadyTDD ::= SEQUENCE {
  dPCH-ID                DPCH-ID,
  tDD-ChannelisationCode TDD-ChannelisationCode OPTIONAL,
  iE-Extensions          ProtocolExtensionContainer { {TDD-DL-Code-InformationModifyItem-RL-ReconfReadyTDD-ExtIEs} } OPTIONAL,
  ...
}
TDD-DL-Code-InformationModifyItem-RL-ReconfReadyTDD-ExtIEs RNSAP-PROTOCOL-EXTENSION ::= {
  ...
}
DL-DPCH-InformationDeleteList-RL-ReconfReadyTDD ::= ProtocolIE-Single-Container { {DL-DPCH-InformationDeleteListIEs-RL-ReconfReadyTDD} }
DL-DPCH-InformationDeleteListIEs-RL-ReconfReadyTDD RNSAP-PROTOCOL-IES ::= {
  { ID id-DL-DPCH-InformationDeleteListIE-RL-ReconfReadyTDD CRITICALITY ignore TYPE DL-DPCH-InformationDeleteListIE-RL-ReconfReadyTDD
  PRESENCE mandatory }
}
DL-DPCH-InformationDeleteListIE-RL-ReconfReadyTDD ::= SEQUENCE (SIZE (0..maxNrOfDPCHs)) OF DL-DPCH-InformationDeleteItem-RL-ReconfReadyTDD
DL-DPCH-InformationDeleteItem-RL-ReconfReadyTDD ::= SEQUENCE {
  dPCH-ID                DPCH-ID,
  iE-Extensions          ProtocolExtensionContainer { {DL-DPCH-InformationDeleteList-RL-ReconfReadyTDD-ExtIEs} } OPTIONAL,
  ...
}
DL-DPCH-InformationDeleteList-RL-ReconfReadyTDD-ExtIEs RNSAP-PROTOCOL-EXTENSION ::= {
  ...
}
DCH-InformationResponseList-RL-ReconfReadyTDD ::= ProtocolIE-Single-Container { {DCH-InformationResponseListIEs-RL-ReconfReadyTDD} }
DCH-InformationResponseListIEs-RL-ReconfReadyTDD RNSAP-PROTOCOL-IES ::= {
  { ID id-DCH-InformationResponse CRITICALITY ignore TYPE DCH-InformationResponse PRESENCE mandatory }
}
DSCHToBeAddedOrModified-RL-ReconfReadyTDD ::= ProtocolIE-Single-Container { {DSCHToBeAddedOrModifiedIEs-RL-ReconfReadyTDD} }
DSCHToBeAddedOrModifiedIEs-RL-ReconfReadyTDD RNSAP-PROTOCOL-IES ::= {
  { ID id-DSCHToBeAddedOrModifiedList-RL-ReconfReadyTDD CRITICALITY ignore TYPE DSCHToBeAddedOrModifiedList-RL-ReconfReadyTDD PRESENCE
  mandatory }
}
DSCHToBeAddedOrModifiedList-RL-ReconfReadyTDD ::= SEQUENCE (SIZE (0..maxNoOfDSCHs)) OF DSCHToBeAddedOrModifiedItem-RL-ReconfReadyTDD
DSCHToBeAddedOrModifiedItem-RL-ReconfReadyTDD ::= SEQUENCE {

```



```

    dsch-ID                DSCH-ID,
    transportFormatManagement TransportFormatManagement,
    dsch-FlowControlInformation DSCH-FlowControlInformation,
    bindingID              BindingID OPTIONAL,
    transportLayerAddress  TransportLayerAddress OPTIONAL,
    iE-Extensions          ProtocolExtensionContainer { {DSCHToBeAddedOrModifiedItem-RL-ReconfReadyTDD-ExtIEs} } OPTIONAL,
    ...
}

DSCHToBeAddedOrModifiedItem-RL-ReconfReadyTDD-ExtIEs RNSAP-PROTOCOL-EXTENSION ::= {
    ...
}

USCHToBeAddedOrModified-RL-ReconfReadyTDD ::= ProtocolIE-Single-Container { {USCHToBeAddedOrModifiedIEs-RL-ReconfReadyTDD}
}USCHToBeAddedOrModifiedIEs-RL-ReconfReadyTDD RNSAP-PROTOCOL-IES ::= {
    { ID id-USCHToBeAddedOrModifiedList-RL-ReconfReadyTDD CRITICALITY ignore TYPE USCHToBeAddedOrModifiedList-RL-ReconfReadyTDD PRESENCE
mandatory }
}

USCHToBeAddedOrModifiedList-RL-ReconfReadyTDD ::= SEQUENCE (SIZE (0..maxNoOfUSCHs)) OF USCHToBeAddedOrModifiedItem-RL-ReconfReadyTDD

USCHToBeAddedOrModifiedItem-RL-ReconfReadyTDD ::= SEQUENCE {
    uSCH-ID                USCH-ID,
    transportFormatManagement TransportFormatManagement,
    bindingID              BindingID OPTIONAL,
    transportLayerAddress  TransportLayerAddress OPTIONAL,
    iE-Extensions          ProtocolExtensionContainer { {USCHToBeAddedOrModifiedItem-RL-ReconfReadyTDD-ExtIEs} } OPTIONAL,
    ...
}

USCHToBeAddedOrModifiedItem-RL-ReconfReadyTDD-ExtIEs RNSAP-PROTOCOL-EXTENSION ::= {
    ...
}

RadioLinkReconfigurationReadyTDD-Extensions RNSAP-PROTOCOL-EXTENSION ::= {
    { ID id-DSCH-RNTI          CRITICALITY ignore          EXTENSION DSCH-RNTI          PRESENCE optional },
    ...
}

-- *****
--
-- RADIO LINK RECONFIGURATION COMMIT
--
-- *****

RadioLinkReconfigurationCommit ::= SEQUENCE {
    protocolIEs              ProtocolIE-Container          {{RadioLinkReconfigurationCommit-IEs}},
    protocolExtensions       ProtocolExtensionContainer    {{RadioLinkReconfigurationCommit-Extensions}}          OPTIONAL,
    ...
}

RadioLinkReconfigurationCommit-IEs RNSAP-PROTOCOL-IES ::= {
    { ID id-CFN                CRITICALITY ignore TYPE CFN                PRESENCE mandatory }|
    { ID id-Active-Pattern-Sequence-Information CRITICALITY ignore TYPE Active-Pattern-Sequence-Information PRESENCE optional },--FDD only
}

```

```

}
...
RadioLinkReconfigurationCommit-Extensions RNSAP-PROTOCOL-EXTENSION ::= {
}
...
-- *****
--
-- RADIO LINK RECONFIGURATION FAILURE
--
-- *****

RadioLinkReconfigurationFailure ::= SEQUENCE {
    protocolIEs                ProtocolIE-Container        {{RadioLinkReconfigurationFailure-IEs}},
    protocolExtensions          ProtocolExtensionContainer  {{RadioLinkReconfigurationFailure-Extensions}}      OPTIONAL,
    ...
}

RadioLinkReconfigurationFailure-IEs RNSAP-PROTOCOL-IES ::= {
    { ID id-CauseLevel-RL-ReconfFailure    CRITICALITY ignore TYPE CauseLevel-RL-ReconfFailure PRESENCE mandatory } |
    { ID id-CriticalityDiagnostics         CRITICALITY ignore TYPE CriticalityDiagnostics PRESENCE optional },
    ...
}

CauseLevel-RL-ReconfFailure ::= CHOICE {
    generalCause                GeneralCauseList-RL-ReconfFailure,
    rLSpecificCause             RLSpecificCauseList-RL-ReconfFailure,
    ...
}

GeneralCauseList-RL-ReconfFailure ::= SEQUENCE {
    cause                        Cause,
    iE-Extensions                ProtocolExtensionContainer { { GeneralCauseItem-RL-ReconfFailure-ExtIEs } }      OPTIONAL,
    ...
}

GeneralCauseItem-RL-ReconfFailure-ExtIEs RNSAP-PROTOCOL-EXTENSION ::= {
}
...

RLSpecificCauseList-RL-ReconfFailure ::= SEQUENCE {
    rL-ReconfigurationFailureList-RL-ReconfFailure    RL-ReconfigurationFailureList-RL-ReconfFailure    OPTIONAL,
    iE-Extensions                                     ProtocolExtensionContainer { { RLSpecificCauseItem-RL-ReconfFailure-ExtIEs } }
    OPTIONAL,
    ...
}

RLSpecificCauseItem-RL-ReconfFailure-ExtIEs RNSAP-PROTOCOL-EXTENSION ::= {
}
...

RL-ReconfigurationFailureList-RL-ReconfFailure ::= SEQUENCE (SIZE (0..maxNrOfRLs)) OF ProtocolIE-Single-Container { {RL-ReconfigurationFailure-RL-ReconfFailure-IEs} }

```

```

RL-ReconfigurationFailure-RL-ReconfFailure-IEs RNSAP-PROTOCOL-IES ::= {
  { ID id-RL-ReconfigurationFailure-RL-ReconfFail CRITICALITY ignore TYPE RL-ReconfigurationFailure-RL-ReconfFail PRESENCE mandatory }
}

```

```

RL-ReconfigurationFailure-RL-ReconfFail ::= SEQUENCE {
  rL-ID          RL-ID,
  cause          Cause,
  iE-Extensions ProtocolExtensionContainer { {RL-ReconfigurationFailure-RL-ReconfFailure-ExtIEs} } OPTIONAL,
  ...
}

```

```

RL-ReconfigurationFailure-RL-ReconfFailure-ExtIEs RNSAP-PROTOCOL-EXTENSION ::= {
  ...
}

```

```

RadioLinkReconfigurationFailure-Extensions RNSAP-PROTOCOL-EXTENSION ::= {
  ...
}

```

```

-- *****
--
-- RADIO LINK RECONFIGURATION CANCEL
--
-- *****

```

```

RadioLinkReconfigurationCancel ::= SEQUENCE {
  protocolIEs          ProtocolIE-Container    {{RadioLinkReconfigurationCancel-IEs}},
  protocolExtensions  ProtocolExtensionContainer {{RadioLinkReconfigurationCancel-Extensions}}
  ...
}

```

```

RadioLinkReconfigurationCancel-IEs RNSAP-PROTOCOL-IES ::= {
  ...
}

```

```

RadioLinkReconfigurationCancel-Extensions RNSAP-PROTOCOL-EXTENSION ::= {
  ...
}

```

```

-- *****
--
-- RADIO LINK RECONFIGURATION REQUEST FDD
--
-- *****

```

```

RadioLinkReconfigurationRequestFDD ::= SEQUENCE {
  protocolIEs          ProtocolIE-Container    {{RadioLinkReconfigurationRequestFDD-IEs}},
  protocolExtensions  ProtocolExtensionContainer {{RadioLinkReconfigurationRequestFDD-Extensions}}
  ...
}

```

```

RadioLinkReconfigurationRequestFDD-IEs RNSAP-PROTOCOL-IES ::= {
  { ID id-AllowedQueuingTime          CRITICALITY reject TYPE AllowedQueuingTime PRESENCE optional } |

```

```

    { ID id-UL-DPCH-Information-RL-ReconfRqstFDD          CRITICALITY reject TYPE UL-DPCH-Information-RL-ReconfRqstFDD PRESENCE optional } |
    { ID id-DL-DPCH-Information-RL-ReconfRqstFDD          CRITICALITY reject TYPE DL-DPCH-Information-RL-ReconfRqstFDD PRESENCE optional } |
    { ID id-FDD-DCHs-to-Modify          CRITICALITY reject TYPE FDD-DCHs-to-Modify          PRESENCE optional } |
    { ID id-DCHs-to-Add-FDD          CRITICALITY reject TYPE DCH-FDD-Information          PRESENCE optional } |
    { ID id-DCH-DeleteList-RL-ReconfRqstFDD          CRITICALITY reject TYPE DCH-DeleteList-RL-ReconfRqstFDD          PRESENCE optional } |
    { ID id-Transmission-Gap-Pattern-Sequence-Information CRITICALITY reject TYPE Transmission-Gap-Pattern-Sequence-Information PRESENCE optional },
    optional },
    ...
}

UL-DPCH-Information-RL-ReconfRqstFDD ::= SEQUENCE {
    tFCS                TFCS          OPTIONAL,
    iE-Extensions       ProtocolExtensionContainer { {UL-DPCH-Information-RL-ReconfRqstFDD-ExtIEs} } OPTIONAL,
    ...
}

UL-DPCH-Information-RL-ReconfRqstFDD-ExtIEs RNSAP-PROTOCOL-EXTENSION ::= {
    ...
}

DL-DPCH-Information-RL-ReconfRqstFDD ::= SEQUENCE {
    tFCS                TFCS          OPTIONAL,
    tFCI-SignallingMode TFCS-SignallingMode OPTIONAL,
    limitedPowerIncrease LimitedPowerIncrease OPTIONAL,
    iE-Extensions       ProtocolExtensionContainer { {DL-DPCH-Information-RL-ReconfRqstFDD-ExtIEs} } OPTIONAL,
    ...
}

DL-DPCH-Information-RL-ReconfRqstFDD-ExtIEs RNSAP-PROTOCOL-EXTENSION ::= {
    ...
}

DCH-DeleteList-RL-ReconfRqstFDD ::= SEQUENCE (SIZE (0..maxNrOfDCHs)) OF DCH-DeleteItem-RL-ReconfRqstFDD

DCH-DeleteItem-RL-ReconfRqstFDD ::= SEQUENCE {
    dCH-ID              DCH-ID,
    iE-Extensions       ProtocolExtensionContainer { {DCH-DeleteItem-RL-ReconfRqstFDD-ExtIEs} } OPTIONAL,
    ...
}

DCH-DeleteItem-RL-ReconfRqstFDD-ExtIEs RNSAP-PROTOCOL-EXTENSION ::= {
    ...
}

RadioLinkReconfigurationRequestFDD-Extensions RNSAP-PROTOCOL-EXTENSION ::= {
    ...
}

-- *****
--
-- RADIO LINK RECONFIGURATION REQUEST TDD
--
-- *****

```

```

RadioLinkReconfigurationRequestTDD ::= SEQUENCE {
    protocolIEs          ProtocolIE-Container          {{RadioLinkReconfigurationRequestTDD-IEs}},
    protocolExtensions   ProtocolExtensionContainer    {{RadioLinkReconfigurationRequestTDD-Extensions}}
    ...
}

RadioLinkReconfigurationRequestTDD-IEs RNSAP-PROTOCOL-IES ::= {
    { ID id-AllowedQueuingTime          CRITICALITY reject  TYPE AllowedQueuingTime          PRESENCE optional } |
    { ID id-UL-CCTrCH-InformationModifyList-RL-ReconfRqstTDD  CRITICALITY notify  TYPE UL-CCTrCH-InformationModifyList-RL-ReconfRqstTDD  PRESENCE
optional } |
    { ID id-UL-CCTrCH-InformationDeleteList-RL-ReconfRqstTDD  CRITICALITY notify  TYPE UL-CCTrCH-InformationDeleteList-RL-ReconfRqstTDD  PRESENCE
optional } |
    { ID id-DL-CCTrCH-InformationModifyList-RL-ReconfRqstTDD  CRITICALITY notify  TYPE DL-CCTrCH-InformationModifyList-RL-ReconfRqstTDD  PRESENCE
optional } |
    { ID id-DL-CCTrCH-InformationDeleteList-RL-ReconfRqstTDD  CRITICALITY notify  TYPE DL-CCTrCH-InformationDeleteList-RL-ReconfRqstTDD  PRESENCE
optional } |
    { ID id-TDD-DCHs-to-Modify          CRITICALITY reject  TYPE TDD-DCHs-to-Modify          PRESENCE optional } |
    { ID id-DCHs-to-Add-TDD             CRITICALITY reject  TYPE DCH-TDD-Information          PRESENCE optional } |
    { ID id-DCH-DeleteList-RL-ReconfRqstTDD  CRITICALITY reject  TYPE DCH-DeleteList-RL-ReconfRqstTDD  PRESENCE optional },
    ...
}

UL-CCTrCH-InformationModifyList-RL-ReconfRqstTDD ::= SEQUENCE (SIZE (0..maxNrOfCCTrCHs)) OF ProtocolIE-Single-Container { {UL-CCTrCH-
InformationModifyList-RL-ReconfRqstTDD-IEs} }

UL-CCTrCH-InformationModifyList-RL-ReconfRqstTDD-IEs RNSAP-PROTOCOL-IES ::= {
    { ID id-UL-CCTrCH-InformationModifyItem-RL-ReconfRqstTDD  CRITICALITY notify  TYPE UL-CCTrCH-InformationModifyItem-RL-ReconfRqstTDD  PRESENCE
mandatory }
}

UL-CCTrCH-InformationModifyItem-RL-ReconfRqstTDD ::= SEQUENCE {
    cCtRch-ID          CCTrCH-ID,
    tFCS              TFCS          OPTIONAL,
    iE-Extensions     ProtocolExtensionContainer { {UL-CCTrCH-InformationModifyItem-RL-ReconfRqstTDD-ExtIEs} } OPTIONAL,
    ...
}

UL-CCTrCH-InformationModifyItem-RL-ReconfRqstTDD-ExtIEs RNSAP-PROTOCOL-EXTENSION ::= {
    ...
}

UL-CCTrCH-InformationDeleteList-RL-ReconfRqstTDD ::= SEQUENCE (SIZE (0..maxNrOfCCTrCHs)) OF ProtocolIE-Single-Container { {UL-CCTrCH-
InformationDeleteList-RL-ReconfRqstTDD-IEs} }

UL-CCTrCH-InformationDeleteList-RL-ReconfRqstTDD-IEs RNSAP-PROTOCOL-IES ::= {
    { ID id-UL-CCTrCH-InformationDeleteItem-RL-ReconfRqstTDD  CRITICALITY notify  TYPE UL-CCTrCH-InformationDeleteItem-RL-ReconfRqstTDD  PRESENCE
mandatory }
}

UL-CCTrCH-InformationDeleteItem-RL-ReconfRqstTDD ::= SEQUENCE {
    cCtRch-ID          CCTrCH-ID,
    iE-Extensions     ProtocolExtensionContainer { {UL-CCTrCH-InformationDeleteItem-RL-ReconfRqstTDD-ExtIEs} } OPTIONAL,
    ...
}

```

```

UL-CCTrCH-InformationDeleteItem-RL-ReconfRqstTDD-ExtIEs RNSAP-PROTOCOL-EXTENSION ::= {
    ...
}

DL-CCTrCH-InformationModifyList-RL-ReconfRqstTDD ::= SEQUENCE (SIZE (0..maxNrOfCCTrCHs)) OF ProtocolIE-Single-Container { {DL-CCTrCH-
InformationModifyList-RL-ReconfRqstTDD-IEs} }

DL-CCTrCH-InformationModifyList-RL-ReconfRqstTDD-IEs RNSAP-PROTOCOL-IES ::= {
    { ID id-DL-CCTrCH-InformationModifyItem-RL-ReconfRqstTDD    CRITICALITY notify    TYPE DL-CCTrCH-InformationModifyItem-RL-ReconfRqstTDD    PRESENCE
mandatory    }
}

DL-CCTrCH-InformationModifyItem-RL-ReconfRqstTDD ::= SEQUENCE {
    cCtRCH-ID                CCTrCH-ID,
    tFCS                    TFCS    OPTIONAL,
    iE-Extensions            ProtocolExtensionContainer { {DL-CCTrCH-InformationModifyItem-RL-ReconfRqstTDD-ExtIEs} } OPTIONAL,
    ...
}

DL-CCTrCH-InformationModifyItem-RL-ReconfRqstTDD-ExtIEs RNSAP-PROTOCOL-EXTENSION ::= {
    ...
}

DL-CCTrCH-InformationDeleteList-RL-ReconfRqstTDD ::= SEQUENCE (SIZE (0..maxNrOfCCTrCHs)) OF ProtocolIE-Single-Container { {DL-CCTrCH-
InformationDeleteList-RL-ReconfRqstTDD-IEs} }

DL-CCTrCH-InformationDeleteList-RL-ReconfRqstTDD-IEs RNSAP-PROTOCOL-IES ::= {
    { ID id-DL-CCTrCH-InformationDeleteItem-RL-ReconfRqstTDD    CRITICALITY notify    TYPE DL-CCTrCH-InformationDeleteItem-RL-ReconfRqstTDD    PRESENCE
mandatory    }
}

DL-CCTrCH-InformationDeleteItem-RL-ReconfRqstTDD ::= SEQUENCE {
    cCtRCH-ID                CCTrCH-ID,
    iE-Extensions            ProtocolExtensionContainer { {DL-CCTrCH-InformationDeleteItem-RL-ReconfRqstTDD-ExtIEs} } OPTIONAL,
    ...
}

DL-CCTrCH-InformationDeleteItem-RL-ReconfRqstTDD-ExtIEs RNSAP-PROTOCOL-EXTENSION ::= {
    ...
}

DCH-DeleteList-RL-ReconfRqstTDD ::= SEQUENCE (SIZE(0..maxNrOfDCHs)) OF DCH-DeleteItem-RL-ReconfRqstTDD

DCH-DeleteItem-RL-ReconfRqstTDD ::= SEQUENCE {
    dCH-ID                DCH-ID,
    iE-Extensions            ProtocolExtensionContainer { {DCH-DeleteItem-RL-ReconfRqstTDD-ExtIEs} } OPTIONAL,
    ...
}

DCH-DeleteItem-RL-ReconfRqstTDD-ExtIEs RNSAP-PROTOCOL-EXTENSION ::= {
    ...
}

```

```

RadioLinkReconfigurationRequestTDD-Extensions RNSAP-PROTOCOL-EXTENSION ::= {
  ...
}

-- *****
--
-- RADIO LINK RECONFIGURATION RESPONSE FDD
--
-- *****

RadioLinkReconfigurationResponseFDD ::= SEQUENCE {
  protocolIEs          ProtocolIE-Container    {{RadioLinkReconfigurationResponseFDD-IEs}},
  protocolExtensions  ProtocolExtensionContainer {{RadioLinkReconfigurationResponseFDD-Extensions}}      OPTIONAL,
  ...
}

RadioLinkReconfigurationResponseFDD-IEs RNSAP-PROTOCOL-IES ::= {
  { ID id-RL-InformationResponseList-RL-ReconfRspFDD      CRITICALITY ignore  TYPE RL-InformationResponseList-RL-ReconfRspFDD      PRESENCE
  optional } |
  { ID id-CriticalityDiagnostics          CRITICALITY ignore  TYPE CriticalityDiagnostics          PRESENCE optional },
  ...
}

RL-InformationResponseList-RL-ReconfRspFDD ::= SEQUENCE (SIZE (0..maxNrOfRLs)) OF ProtocolIE-Single-Container { {RL-InformationResponse-RL-
ReconfRspFDD-IEs} }

RL-InformationResponse-RL-ReconfRspFDD-IEs RNSAP-PROTOCOL-IES ::= {
  { ID id-RL-InformationResponseItem-RL-ReconfRspFDD      CRITICALITY ignore  TYPE RL-InformationResponseItem-RL-ReconfRspFDD      PRESENCE
  mandatory }
}

RL-InformationResponseItem-RL-ReconfRspFDD ::= SEQUENCE {
  rL-ID              RL-ID,
  max-UL-SIR         UL-SIR          OPTIONAL,
  min-UL-SIR         UL-SIR          OPTIONAL,
  maximumDLTxPower  DL-Power        OPTIONAL,
  minimumDLTxPower  DL-Power        OPTIONAL,
  secondary-CCPCH-Info Secondary-CCPCH-Info OPTIONAL,
  dCHsInformationResponseList DCH-InformationResponseList-RL-ReconfRspFDD OPTIONAL,
  dL-CodeInformationList-RL-ReconfResp DL-CodeInformationList-RL-ReconfRspFDD OPTIONAL,
  iE-Extensions     ProtocolExtensionContainer { {RL-InformationResponseItem-RL-ReconfRspFDD-ExtIEs} } OPTIONAL,
  ...
}

RL-InformationResponseItem-RL-ReconfRspFDD-ExtIEs RNSAP-PROTOCOL-EXTENSION ::= {
  ...
}

DCH-InformationResponseList-RL-ReconfRspFDD ::= ProtocolIE-Single-Container { {DCH-InformationResponseListIEs-RL-ReconfRspFDD} }

DCH-InformationResponseListIEs-RL-ReconfRspFDD RNSAP-PROTOCOL-IES ::= {
  { ID id-DCH-InformationResponse      CRITICALITY ignore  TYPE DCH-InformationResponse      PRESENCE mandatory }
}

```

```

DL-CodeInformationList-RL-ReconfRspFDD ::= ProtocolIE-Single-Container { { DL-CodeInformationListIEs-RL-ReconfRspFDD } }

DL-CodeInformationListIEs-RL-ReconfRspFDD RNSAP-PROTOCOL-IES ::= {
  { ID id-FDD-DL-CodeInformation    CRITICALITY ignore TYPE FDD-DL-CodeInformation    PRESENCE optional }
}

RadioLinkReconfigurationResponseFDD-Extensions RNSAP-PROTOCOL-EXTENSION ::= {
  ...
}

-- *****
--
-- RADIO LINK RECONFIGURATION RESPONSE TDD
--
-- *****

RadioLinkReconfigurationResponseTDD ::= SEQUENCE {
  protocolIEs          ProtocolIE-Container    {{RadioLinkReconfigurationResponseTDD-IEs}},
  protocolExtensions  ProtocolExtensionContainer {{RadioLinkReconfigurationResponseTDD-Extensions}}      OPTIONAL,
  ...
}

RadioLinkReconfigurationResponseTDD-IEs RNSAP-PROTOCOL-IES ::= {
  { ID id-RL-InformationResponse-RL-ReconfRspTDD    CRITICALITY ignore TYPE RL-InformationResponse-RL-ReconfRspTDD    PRESENCE optional }
  |
  { ID id-CriticalityDiagnostics                    CRITICALITY ignore TYPE CriticalityDiagnostics                    PRESENCE optional },
  ...
}

RL-InformationResponse-RL-ReconfRspTDD ::= SEQUENCE {
  rL-ID                RL-ID,
  max-UL-SIR           UL-SIR          OPTIONAL,
  min-UL-SIR           UL-SIR          OPTIONAL,
  maximumDLTxPower     DL-Power        OPTIONAL,
  minimumDLTxPower     DL-Power        OPTIONAL,
  dCHsInformationResponseList DCH-InformationResponseList-RL-ReconfRspTDD OPTIONAL,
  iE-Extensions        ProtocolExtensionContainer { {RL-InformationResponse-RL-ReconfRspTDD-ExtIEs} } OPTIONAL,
  ...
}

RL-InformationResponse-RL-ReconfRspTDD-ExtIEs RNSAP-PROTOCOL-EXTENSION ::= {
  ...
}

DCH-InformationResponseList-RL-ReconfRspTDD ::= ProtocolIE-Single-Container { {DCH-InformationResponseListIEs-RL-ReconfRspTDD} }

DCH-InformationResponseListIEs-RL-ReconfRspTDD RNSAP-PROTOCOL-IES ::= {
  { ID id-DCH-InformationResponse CRITICALITY ignore TYPE DCH-InformationResponse PRESENCE optional }
}

RadioLinkReconfigurationResponseTDD-Extensions RNSAP-PROTOCOL-EXTENSION ::= {
  ...
}

```



```

-- *****
--
-- RADIO LINK FAILURE INDICATION
--
-- *****

RadioLinkFailureIndication ::= SEQUENCE {
    protocolIEs          ProtocolIE-Container    {{RadioLinkFailureIndication-IEs}},
    protocolExtensions  ProtocolExtensionContainer {{RadioLinkFailureIndication-Extensions}}    OPTIONAL,
    ...
}

RadioLinkFailureIndication-IEs RNSAP-PROTOCOL-IES ::= {
    { ID id-Reporting-Object-RL-FailureInd  CRITICALITY ignore  TYPE Reporting-Object-RL-FailureInd  PRESENCE mandatory  },
    ...
}

Reporting-Object-RL-FailureInd ::= CHOICE {
    rL          RL-RL-FailureInd,
    rL-Set      RL-Set-RL-FailureInd, --FDD only
    ...,
    cCTrCH      CCTrCH-RL-FailureInd --TDD only
}

RL-RL-FailureInd ::= SEQUENCE {
    rL-InformationList-RL-FailureInd  RL-InformationList-RL-FailureInd,
    iE-Extensions                    ProtocolExtensionContainer { { RLItem-RL-FailureInd-ExtIEs } } OPTIONAL,
    ...
}

RLItem-RL-FailureInd-ExtIEs RNSAP-PROTOCOL-EXTENSION ::= {
    ...
}

RL-InformationList-RL-FailureInd ::= SEQUENCE (SIZE (1..maxNrOfRLs)) OF ProtocolIE-Single-Container { {RL-Information-RL-FailureInd-IEs}
}

RL-Information-RL-FailureInd-IEs RNSAP-PROTOCOL-IES ::= {
    { ID id-RL-Information-RL-FailureInd  CRITICALITY ignore  TYPE RL-Information-RL-FailureInd  PRESENCE mandatory  }
}

RL-Information-RL-FailureInd ::= SEQUENCE {
    rL-ID          RL-ID,
    cause          Cause,
    iE-Extensions  ProtocolExtensionContainer { {RL-Information-RL-FailureInd-ExtIEs} } OPTIONAL,
    ...
}

RL-Information-RL-FailureInd-ExtIEs RNSAP-PROTOCOL-EXTENSION ::= {
    ...
}

RL-Set-RL-FailureInd ::= SEQUENCE {
    rL-Set-InformationList-RL-FailureInd  RL-Set-InformationList-RL-FailureInd,

```

```

    iE-Extensions          ProtocolExtensionContainer { { RL-SetItem-RL-FailureInd-ExtIEs } } OPTIONAL,
    ...
}

RL-SetItem-RL-FailureInd-ExtIEs RNSAP-PROTOCOL-EXTENSION ::= {
    ...
}

RL-Set-InformationList-RL-FailureInd ::= SEQUENCE (SIZE (1..maxNrOfRLSets)) OF ProtocolIE-Single-Container { {RL-Set-Information-RL-
FailureInd-IEs} }

RL-Set-Information-RL-FailureInd-IEs RNSAP-PROTOCOL-IES ::= {
    { ID id-RL-Set-Information-RL-FailureInd          CRITICALITY ignore   TYPE RL-Set-Information-RL-FailureInd   PRESENCE mandatory }
}

RL-Set-Information-RL-FailureInd ::= SEQUENCE {
    rL-Set-ID          RL-Set-ID,
    cause              Cause,
    iE-Extensions      ProtocolExtensionContainer { {RL-Set-Information-RL-FailureInd-ExtIEs} } OPTIONAL,
    ...
}

RL-Set-Information-RL-FailureInd-ExtIEs RNSAP-PROTOCOL-EXTENSION ::= {
    ...
}

RadioLinkFailureIndication-Extensions RNSAP-PROTOCOL-EXTENSION ::= {
    ...
}

CCTrCH-RL-FailureInd ::= SEQUENCE {
    rL-ID          RL-ID,
    cCTrCH-InformationList-RL-FailureInd          CCTrCH-InformationList-RL-FailureInd,
    iE-Extensions      ProtocolExtensionContainer { { CCTrCHItem-RL-FailureInd-ExtIEs } }          OPTIONAL,
    ...
}

CCTrCHItem-RL-FailureInd-ExtIEs RNSAP-PROTOCOL-EXTENSION ::= {
    ...
}

CCTrCH-InformationList-RL-FailureInd ::= SEQUENCE (SIZE (1..maxNrOfCCTrCHs)) OF ProtocolIE-Single-Container {{ CCTrCH-InformationItemIE-RL-
FailureInd}}

CCTrCH-InformationItemIE-RL-FailureInd RNSAP-PROTOCOL-IES ::= {
    { ID      id-CCTrCH-InformationItem-RL-FailureInd          CRITICALITY   ignore          TYPE CCTrCH-InformationItem-RL-FailureInd
PRESENCE    mandatory}
}

CCTrCH-InformationItem-RL-FailureInd ::= SEQUENCE {
    cCTrCH-ID          CCTrCH-ID,
    cause              Cause,
    iE-Extensions      ProtocolExtensionContainer { { CCTrCH-InformationItem-RL-FailureInd-ExtIEs } }          OPTIONAL,
    ...
}

```

```

}
CCTrCH-InformationItem-RL-FailureInd-ExtIEs RNSAP-PROTOCOL-EXTENSION ::= {
  ...
}
-- *****
--
-- RADIO LINK PREEMPTION REQUIRED INDICATION
--
-- *****

RadioLinkPreemptionRequiredIndication ::= SEQUENCE {
  protocolIEs          ProtocolIE-Container  {{RadioLinkPreemptionRequiredIndication-IEs}},
  protocolExtensions   ProtocolExtensionContainer {{RadioLinkPreemptionRequiredIndication-Extensions}}
  ...
}

RadioLinkPreemptionRequiredIndication-IEs RNSAP-PROTOCOL-IES ::= {
  { ID id-RL-InformationList-RL-PreemptRequiredInd  CRITICALITY ignore  TYPE RL-InformationList-RL-PreemptRequiredInd  PRESENCE optional },
  ...
}

RL-InformationList-RL-PreemptRequiredInd ::= SEQUENCE (SIZE (1..maxNrOfRLs)) OF ProtocolIE-Single-Container { {RL-InformationItemIEs-RL-PreemptRequiredInd} }

RL-InformationItemIEs-RL-PreemptRequiredInd RNSAP-PROTOCOL-IES ::= {
  { ID id-RL-InformationItem-RL-PreemptRequiredInd  CRITICALITY ignore  TYPE RL-InformationItem-RL-PreemptRequiredInd  PRESENCE
  mandatory }
}

RL-InformationItem-RL-PreemptRequiredInd ::= SEQUENCE {
  rL-ID          RL-ID,
  iE-Extensions  ProtocolExtensionContainer { {RL-Information-RL-PreemptRequiredInd-ExtIEs} } OPTIONAL,
  ...
}

RL-Information-RL-PreemptRequiredInd-ExtIEs RNSAP-PROTOCOL-EXTENSION ::= {
  ...
}

RadioLinkPreemptionRequiredIndication-Extensions RNSAP-PROTOCOL-EXTENSION ::= {
  ...
}
-- *****
--
-- RADIO LINK RESTORE INDICATION
--
-- *****

RadioLinkRestoreIndication ::= SEQUENCE {
  protocolIEs          ProtocolIE-Container  {{RadioLinkRestoreIndication-IEs}},
  protocolExtensions   ProtocolExtensionContainer {{RadioLinkRestoreIndication-Extensions}}
  ...
}

```

```

}
...
}
RadioLinkRestoreIndication-IEs RNSAP-PROTOCOL-IES ::= {
  { ID id-Reporting-Object-RL-RestoreInd    CRITICALITY ignore  TYPE Reporting-Object-RL-RestoreInd    PRESENCE mandatory  },
  ...
}

Reporting-Object-RL-RestoreInd ::= CHOICE {
  rL                RL-RL-RestoreInd, --TDD only
  rL-Set            RL-Set-RL-RestoreInd, --FDD only
  ...,
  cCTrCH            CCTrCH-RL-RestoreInd --TDD only
}

RL-RL-RestoreInd ::= SEQUENCE {
  rL-InformationList-RL-RestoreInd          RL-InformationList-RL-RestoreInd,
  iE-Extensions                            ProtocolExtensionContainer { { RLItem-RL-RestoreInd-ExtIEs } } OPTIONAL,
  ...
}

RLItem-RL-RestoreInd-ExtIEs RNSAP-PROTOCOL-EXTENSION ::= {
  ...
}

RL-InformationList-RL-RestoreInd          ::= SEQUENCE (SIZE (1..maxNrOfRLs)) OF ProtocolIE-Single-Container { {RL-Information-RL-RestoreInd-IEs} }

RL-Information-RL-RestoreInd-IEs RNSAP-PROTOCOL-IES ::= {
  { ID id-RL-Information-RL-RestoreInd          CRITICALITY ignore  TYPE RL-Information-RL-RestoreInd          PRESENCE mandatory  }
}

RL-Information-RL-RestoreInd ::= SEQUENCE {
  rL-ID                RL-ID,
  iE-Extensions        ProtocolExtensionContainer { {RL-Information-RL-RestoreInd-ExtIEs} } OPTIONAL,
  ...
}

RL-Information-RL-RestoreInd-ExtIEs RNSAP-PROTOCOL-EXTENSION ::= {
  ...
}

RL-Set-RL-RestoreInd ::= SEQUENCE {
  rL-Set-InformationList-RL-RestoreInd      RL-Set-InformationList-RL-RestoreInd,
  iE-Extensions                            ProtocolExtensionContainer { { RL-SetItem-RL-RestoreInd-ExtIEs } } OPTIONAL,
  ...
}

RL-SetItem-RL-RestoreInd-ExtIEs RNSAP-PROTOCOL-EXTENSION ::= {
  ...
}

RL-Set-InformationList-RL-RestoreInd      ::= SEQUENCE (SIZE (1..maxNrOfRLSets)) OF ProtocolIE-Single-Container { {RL-Set-Information-RL-RestoreInd-IEs} }

```

```

RL-Set-Information-RL-RestoreInd-IEs RNSAP-PROTOCOL-IES ::= {
  { ID id-RL-Set-Information-RL-RestoreInd          CRITICALITY ignore  TYPE RL-Set-Information-RL-RestoreInd  PRESENCE mandatory  }
}

RL-Set-Information-RL-RestoreInd ::= SEQUENCE {
  rL-Set-ID          RL-Set-ID,
  iE-Extensions      ProtocolExtensionContainer { {RL-Set-Information-RL-RestoreInd-ExtIEs} } OPTIONAL,
  ...
}

RL-Set-Information-RL-RestoreInd-ExtIEs RNSAP-PROTOCOL-EXTENSION ::= {
  ...
}

RadioLinkRestoreIndication-Extensions RNSAP-PROTOCOL-EXTENSION ::= {
  ...
}

CCTrCH-RL-RestoreInd ::= SEQUENCE {
  rL-ID          RL-ID,
  cCTrCH-InformationList-RL-RestoreInd  CCTrCH-InformationList-RL-RestoreInd,
  iE-Extensions      ProtocolExtensionContainer { { CCTrCHItem-RL-RestoreInd-ExtIEs } }      OPTIONAL,
  ...
}

CCTrCHItem-RL-RestoreInd-ExtIEs RNSAP-PROTOCOL-EXTENSION ::= {
  ...
}

CCTrCH-InformationList-RL-RestoreInd ::= SEQUENCE (SIZE (1..maxNrOfCCTrCHs)) OF ProtocolIE-Single-Container {{ CCTrCH-InformationItemIE-RL-RestoreInd}}

CCTrCH-InformationItemIE-RL-RestoreInd RNSAP-PROTOCOL-IES ::= {
  { ID id-CCTrCH-InformationItem-RL-RestoreInd          CRITICALITY ignore          TYPE CCTrCH-InformationItem-RL-RestoreInd
  PRESENCE mandatory}
}

CCTrCH-InformationItem-RL-RestoreInd ::= SEQUENCE {
  cCTrCH-ID          CCTrCH-ID,
  iE-Extensions      ProtocolExtensionContainer { { CCTrCH-InformationItem-RL-RestoreInd-ExtIEs } }      OPTIONAL,
  ...
}

CCTrCH-InformationItem-RL-RestoreInd-ExtIEs RNSAP-PROTOCOL-EXTENSION ::= {
  ...
}

-- *****
--
-- DOWNLINK POWER CONTROL REQUEST
--
-- *****

```

```

DL-PowerControlRequest ::= SEQUENCE {
  protocolIEs          ProtocolIE-Container    {{DL-PowerControlRequest-IEs}},
  protocolExtensions  ProtocolExtensionContainer {{DL-PowerControlRequest-Extensions}}
  ...
}

DL-PowerControlRequest-IEs RNSAP-PROTOCOL-IES ::= {
  { ID id-PowerAdjustmentType          CRITICALITY ignore TYPE PowerAdjustmentType          PRESENCE mandatory} |
  { ID id-DLReferencePower              CRITICALITY ignore TYPE DL-Power                  PRESENCE conditional} |
  -- This IE shall be present if Power Adjustment Type IE equals to 'Common'
  { ID id-InnerLoopDLPCStatus           CRITICALITY ignore TYPE InnerLoopDLPCStatus       PRESENCE optional } |
  { ID id-DLReferencePowerList-DL-PC-Rqst CRITICALITY ignore TYPE DL-ReferencePowerInformationList-DL-PC-Rqst PRESENCE conditional} |
  -- This IE shall be present if Power Adjustment Type IE equals to 'Individual'
  { ID id-MaxAdjustmentStep             CRITICALITY ignore TYPE MaxAdjustmentStep           PRESENCE conditional} |
  -- This IE shall be present if Power Adjustment Type IE equals to 'Common' or 'Individual'
  { ID id-AdjustmentPeriod              CRITICALITY ignore TYPE AdjustmentPeriod         PRESENCE conditional} |
  -- This IE shall be present if Power Adjustment Type IE equals to 'Common' or 'Individual'
  { ID id-AdjustmentRatio               CRITICALITY ignore TYPE ScaledAdjustmentRatio     PRESENCE conditional},
  -- This IE shall be present if Power Adjustment Type IE equals to 'Common' or 'Individual'
  ...
}

DL-ReferencePowerInformationList-DL-PC-Rqst ::= SEQUENCE (SIZE (1..maxNrOfRLs)) OF ProtocolIE-Single-Container { {DL-ReferencePowerInformation-DL-PC-Rqst-IEs} }

DL-ReferencePowerInformation-DL-PC-Rqst-IEs RNSAP-PROTOCOL-IES ::= {
  { ID id-DL-ReferencePowerInformation-DL-PC-Rqst CRITICALITY ignore TYPE DL-ReferencePowerInformation-DL-PC-Rqst PRESENCE mandatory }
}

DL-ReferencePowerInformation-DL-PC-Rqst ::= SEQUENCE {
  rL-ID          RL-ID,
  dl-Reference-Power DL-Power,
  iE-Extensions  ProtocolExtensionContainer { {DL-ReferencePowerInformation-DL-PC-Rqst-ExtIEs} } OPTIONAL,
  ...
}

DL-ReferencePowerInformation-DL-PC-Rqst-ExtIEs RNSAP-PROTOCOL-EXTENSION ::= {
  ...
}

DL-PowerControlRequest-Extensions RNSAP-PROTOCOL-EXTENSION ::= {
  ...
}

-- *****
--
-- DOWNLINK POWER TIMESLOT CONTROL REQUEST TDD
--
-- *****

DL-PowerTimeslotControlRequest ::= SEQUENCE {
  protocolIEs          ProtocolIE-Container    {{DL-PowerTimeslotControlRequest-IEs}},
  protocolExtensions  ProtocolExtensionContainer {{DL-PowerTimeslotControlRequest-Extensions}}
  ...
}

```

```

}
DL-PowerTimeslotControlRequest-IEs RNSAP-PROTOCOL-IES ::= {
  { ID id-timeSlot-ISCP   CRITICALITY ignore   TYPE DL-TimeSlot-ISCP-Info   PRESENCE mandatory},
  ...
}
DL-PowerTimeslotControlRequest-Extensions RNSAP-PROTOCOL-EXTENSION ::= {
  ...
}
-- *****
--
-- PHYSICAL CHANNEL RECONFIGURATION REQUEST FDD
--
-- *****

PhysicalChannelReconfigurationRequestFDD ::= SEQUENCE {
  protocolIEs           ProtocolIE-Container      {{PhysicalChannelReconfigurationRequestFDD-IEs}},
  protocolExtensions   ProtocolExtensionContainer {{PhysicalChannelReconfigurationRequestFDD-Extensions}}      OPTIONAL,
  ...
}

PhysicalChannelReconfigurationRequestFDD-IEs RNSAP-PROTOCOL-IES ::= {
  { ID id-RL-Information-PhyChReconfRqstFDD   CRITICALITY reject   TYPE RL-Information-PhyChReconfRqstFDD   PRESENCE mandatory   },
  ...
}

RL-Information-PhyChReconfRqstFDD ::= SEQUENCE {
  rL-ID                 RL-ID,
  dl-CodeInformation    DL-CodeInformationList-PhyChReconfRqstFDD,
  iE-Extensions        ProtocolExtensionContainer { {RL-Information-PhyChReconfRqstFDD-ExtIEs} } OPTIONAL,
  ...
}

RL-Information-PhyChReconfRqstFDD-ExtIEs RNSAP-PROTOCOL-EXTENSION ::= {
  ...
}

DL-CodeInformationList-PhyChReconfRqstFDD ::= ProtocolIE-Single-Container { {DL-CodeInformationListIEs-PhyChReconfRqstFDD} }

DL-CodeInformationListIEs-PhyChReconfRqstFDD RNSAP-PROTOCOL-IES ::= {
  { ID id-FDD-DL-CodeInformation   CRITICALITY notify   TYPE FDD-DL-CodeInformation   PRESENCE mandatory   }
}

PhysicalChannelReconfigurationRequestFDD-Extensions RNSAP-PROTOCOL-EXTENSION ::= {
  ...
}
-- *****
--
-- PHYSICAL CHANNEL RECONFIGURATION REQUEST TDD
--
-- *****

```

```

PhysicalChannelReconfigurationRequestTDD ::= SEQUENCE {
    protocolIEs                ProtocolIE-Container    {{PhysicalChannelReconfigurationRequestTDD-IEs}},
    protocolExtensions          ProtocolExtensionContainer {{PhysicalChannelReconfigurationRequestTDD-Extensions}}
    ...
}

PhysicalChannelReconfigurationRequestTDD-IEs RNSAP-PROTOCOL-IES ::= {
    { ID id-RL-Information-PhyChReconfRqstTDD    CRITICALITY reject    TYPE RL-Information-PhyChReconfRqstTDD    PRESENCE mandatory    },
    ...
}

RL-Information-PhyChReconfRqstTDD ::= SEQUENCE {
    rL-ID                RL-ID,
    ul-CCTrCH-Information    UL-CCTrCH-InformationList-PhyChReconfRqstTDD    OPTIONAL,
    dl-CCTrCH-Information    DL-CCTrCH-InformationList-PhyChReconfRqstTDD    OPTIONAL,
    iE-Extensions          ProtocolExtensionContainer { {RL-Information-PhyChReconfRqstTDD-ExtIEs} } OPTIONAL,
    ...
}

RL-Information-PhyChReconfRqstTDD-ExtIEs RNSAP-PROTOCOL-EXTENSION ::= {
    ...
}

UL-CCTrCH-InformationList-PhyChReconfRqstTDD ::= ProtocolIE-Single-Container { {UL-CCTrCH-InformationListIEs-PhyChReconfRqstTDD} }

UL-CCTrCH-InformationListIEs-PhyChReconfRqstTDD RNSAP-PROTOCOL-IES ::= {
    { ID id-UL-CCTrCH-InformationListIE-PhyChReconfRqstTDD    CRITICALITY reject    TYPE UL-CCTrCH-InformationListIE-PhyChReconfRqstTDD    PRESENCE
    mandatory    }
}

UL-CCTrCH-InformationListIE-PhyChReconfRqstTDD ::= SEQUENCE (SIZE (1..maxNrOfCCTrCHs)) OF UL-CCTrCH-InformationItem-PhyChReconfRqstTDD

UL-CCTrCH-InformationItem-PhyChReconfRqstTDD ::= SEQUENCE {
    cCCTrCH-ID                CCTrCH-ID,
    ul-DPCH-Information        UL-DPCH-InformationList-PhyChReconfRqstTDD,
    iE-Extensions          ProtocolExtensionContainer { {UL-CCTrCH-InformationItem-PhyChReconfRqstTDD-ExtIEs} } OPTIONAL,
    ...
}

UL-CCTrCH-InformationItem-PhyChReconfRqstTDD-ExtIEs RNSAP-PROTOCOL-EXTENSION ::= {
    ...
}

UL-DPCH-InformationList-PhyChReconfRqstTDD ::= ProtocolIE-Single-Container {{UL-DPCH-InformationListIEs-PhyChReconfRqstTDD}}

UL-DPCH-InformationListIEs-PhyChReconfRqstTDD RNSAP-PROTOCOL-IES ::= {
    { ID id-UL-DPCH-InformationItem-PhyChReconfRqstTDD    CRITICALITY notify    TYPE UL-DPCH-InformationItem-PhyChReconfRqstTDD    PRESENCE mandatory    }
}

UL-DPCH-InformationItem-PhyChReconfRqstTDD ::= SEQUENCE {
    repetitionPeriod                RepetitionPeriod    OPTIONAL,
    repetitionLength                RepetitionLength    OPTIONAL,
    tDD-DPCHOffset                TDD-DPCHOffset    OPTIONAL,
}

```



```

    uL-Timeslot-InformationList-PhyChReconfRqstTDD          UL-Timeslot-InformationList-PhyChReconfRqstTDD  OPTIONAL,
    iE-Extensions          ProtocolExtensionContainer { {UL-DPCH-InformationItem-PhyChReconfRqstTDD-ExtIEs} } OPTIONAL,
    ...
}

UL-DPCH-InformationItem-PhyChReconfRqstTDD-ExtIEs RNSAP-PROTOCOL-EXTENSION ::= {
    ...
}

UL-Timeslot-InformationList-PhyChReconfRqstTDD ::= SEQUENCE ( SIZE (1..maxNrOfTS)) OF UL-Timeslot-InformationItem-PhyChReconfRqstTDD

UL-Timeslot-InformationItem-PhyChReconfRqstTDD ::= SEQUENCE {
    timeSlot          TimeSlot,
    midambleShiftAndBurstType          MidambleShiftAndBurstType          OPTIONAL,
    tFCI-Presence          TFCI-Presence          OPTIONAL,
    uL-Code-Information          TDD-UL-Code-Information          OPTIONAL,
    iE-Extensions          ProtocolExtensionContainer { {UL-Timeslot-InformationItem-PhyChReconfRqstTDD-ExtIEs} } OPTIONAL,
    ...
}

UL-Timeslot-InformationItem-PhyChReconfRqstTDD-ExtIEs RNSAP-PROTOCOL-EXTENSION ::= {
    ...
}

DL-CCTrCH-InformationList-PhyChReconfRqstTDD          ::= ProtocolIE-Single-Container { {DL-CCTrCH-InformationListIEs-PhyChReconfRqstTDD} }

DL-CCTrCH-InformationListIEs-PhyChReconfRqstTDD RNSAP-PROTOCOL-IES ::= {
    { ID id-DL-CCTrCH-InformationListIE-PhyChReconfRqstTDD          CRITICALITY reject TYPE DL-CCTrCH-InformationListIE-PhyChReconfRqstTDD          PRESENCE
mandatory }
}

DL-CCTrCH-InformationListIE-PhyChReconfRqstTDD ::= SEQUENCE (SIZE (1..maxNrOfCCTrCHs)) OF DL-CCTrCH-InformationItem-PhyChReconfRqstTDD

DL-CCTrCH-InformationItem-PhyChReconfRqstTDD ::= SEQUENCE {
    cCCTrCH-ID          CCTrCH-ID,
    dl-DPCH-Information          DL-DPCH-InformationList-PhyChReconfRqstTDD,
    iE-Extensions          ProtocolExtensionContainer { {DL-CCTrCH-InformationItem-PhyChReconfRqstTDD-ExtIEs} } OPTIONAL,
    ...
}

DL-CCTrCH-InformationItem-PhyChReconfRqstTDD-ExtIEs RNSAP-PROTOCOL-EXTENSION ::= {
    ...
}

DL-DPCH-InformationList-PhyChReconfRqstTDD ::= ProtocolIE-Single-Container {{DL-DPCH-InformationListIEs-PhyChReconfRqstTDD}}

DL-DPCH-InformationListIEs-PhyChReconfRqstTDD RNSAP-PROTOCOL-IES ::= {
    { ID id-DL-DPCH-InformationItem-PhyChReconfRqstTDD          CRITICALITY notify TYPE DL-DPCH-InformationItem-PhyChReconfRqstTDD          PRESENCE mandatory }
}

DL-DPCH-InformationItem-PhyChReconfRqstTDD ::= SEQUENCE {
    repetitionPeriod          RepetitionPeriod          OPTIONAL,
    repetitionLength          RepetitionLength          OPTIONAL,
    tDD-DPCHOffset          TDD-DPCHOffset          OPTIONAL,

```

```

    DL-Timeslot-InformationList-PhyChReconfRqstTDD          DL-Timeslot-InformationList-PhyChReconfRqstTDD  OPTIONAL,
    IE-Extensions          ProtocolExtensionContainer { {DL-DPCH-InformationItem-PhyChReconfRqstTDD-ExtIEs} } OPTIONAL,
    ...
}

DL-DPCH-InformationItem-PhyChReconfRqstTDD-ExtIEs RNSAP-PROTOCOL-EXTENSION ::= {
    ...
}

DL-Timeslot-InformationList-PhyChReconfRqstTDD ::= SEQUENCE ( SIZE (1..maxNrOfTS)) OF DL-Timeslot-InformationItem-PhyChReconfRqstTDD

DL-Timeslot-InformationItem-PhyChReconfRqstTDD ::= SEQUENCE {
    timeSlot          TimeSlot,
    midambleShiftAndBurstType          MidambleShiftAndBurstType          OPTIONAL,
    tFCI-Presence          TFCI-Presence          OPTIONAL,
    dL-Code-Information          TDD-DL-Code-Information          OPTIONAL,
    IE-Extensions          ProtocolExtensionContainer { {DL-Timeslot-InformationItem-PhyChReconfRqstTDD-ExtIEs} } OPTIONAL,
    ...
}

DL-Timeslot-InformationItem-PhyChReconfRqstTDD-ExtIEs RNSAP-PROTOCOL-EXTENSION ::= {
    ...
}

PhysicalChannelReconfigurationRequestTDD-Extensions RNSAP-PROTOCOL-EXTENSION ::= {
    ...
}

-- *****
--
-- PHYSICAL CHANNEL RECONFIGURATION COMMAND
--
-- *****

PhysicalChannelReconfigurationCommand ::= SEQUENCE {
    protocolIEs          ProtocolIE-Container          {{PhysicalChannelReconfigurationCommand-IEs}},
    protocolExtensions          ProtocolExtensionContainer {{PhysicalChannelReconfigurationCommand-Extensions}}          OPTIONAL,
    ...
}

PhysicalChannelReconfigurationCommand-IEs RNSAP-PROTOCOL-IES ::= {
    { ID id-CFN          CRITICALITY ignore TYPE CFN          PRESENCE mandatory } |
    { ID id-CriticalityDiagnostics          CRITICALITY ignore TYPE CriticalityDiagnostics          PRESENCE optional },
    ...
}

PhysicalChannelReconfigurationCommand-Extensions RNSAP-PROTOCOL-EXTENSION ::= {
    ...
}

-- *****
--
-- PHYSICAL CHANNEL RECONFIGURATION FAILURE
--

```

```

-- *****
PhysicalChannelReconfigurationFailure ::= SEQUENCE {
    protocolIEs                ProtocolIE-Container    {{PhysicalChannelReconfigurationFailure-IEs}},
    protocolExtensions         ProtocolExtensionContainer {{PhysicalChannelReconfigurationFailure-Extensions}}
    ...
}

PhysicalChannelReconfigurationFailure-IEs RNSAP-PROTOCOL-IES ::= {
    { ID id-Cause                CRITICALITY ignore TYPE Cause                PRESENCE mandatory } |
    { ID id-CriticalityDiagnostics CRITICALITY ignore TYPE CriticalityDiagnostics PRESENCE optional },
    ...
}

PhysicalChannelReconfigurationFailure-Extensions RNSAP-PROTOCOL-EXTENSION ::= {
    ...
}

-- *****
--
-- UPLINK SIGNALLING TRANSFER INDICATION FDD
--
-- *****

UplinkSignallingTransferIndicationFDD ::= SEQUENCE {
    protocolIEs                ProtocolIE-Container    {{UplinkSignallingTransferIndicationFDD-IEs}},
    protocolExtensions         ProtocolExtensionContainer {{UplinkSignallingTransferIndicationFDD-Extensions}}
    ...
}

UplinkSignallingTransferIndicationFDD-IEs RNSAP-PROTOCOL-IES ::= {
    { ID id-UC-ID                CRITICALITY ignore TYPE UC-ID                PRESENCE mandatory } |
    { ID id-SAI                  CRITICALITY ignore TYPE SAI                  PRESENCE mandatory } |
    { ID id-GA-Cell              CRITICALITY ignore TYPE GA-Cell              PRESENCE optional } |
    { ID id-C-RNTI               CRITICALITY ignore TYPE C-RNTI               PRESENCE mandatory } |
    { ID id-S-RNTI               CRITICALITY ignore TYPE S-RNTI               PRESENCE mandatory } |
    { ID id-D-RNTI               CRITICALITY ignore TYPE D-RNTI               PRESENCE optional } |
    { ID id-PropagationDelay      CRITICALITY ignore TYPE PropagationDelay      PRESENCE mandatory } |
    { ID id-STTD-SupportIndicator CRITICALITY ignore TYPE STTD-SupportIndicator PRESENCE mandatory } |
    { ID id-ClosedLoopModel-SupportIndicator CRITICALITY ignore TYPE ClosedLoopModel-SupportIndicator PRESENCE mandatory } |
    { ID id-ClosedLoopMode2-SupportIndicator CRITICALITY ignore TYPE ClosedLoopMode2-SupportIndicator PRESENCE mandatory } |
    { ID id-L3-Information        CRITICALITY ignore TYPE L3-Information        PRESENCE mandatory } |
    { ID id-CN-PS-DomainIdentifier CRITICALITY ignore TYPE CN-PS-DomainIdentifier PRESENCE optional } |
    { ID id-CN-CS-DomainIdentifier CRITICALITY ignore TYPE CN-CS-DomainIdentifier PRESENCE optional } |
    { ID id-URA-Information      CRITICALITY ignore TYPE URA-Information      PRESENCE optional },
    ...
}

UplinkSignallingTransferIndicationFDD-Extensions RNSAP-PROTOCOL-EXTENSION ::= {
    ...
}

-- *****
--

```

```

-- UPLINK SIGNALLING TRANSFER INDICATION TDD
--
-- *****

UplinkSignallingTransferIndicationTDD ::= SEQUENCE {
    protocolIEs          ProtocolIE-Container    {{UplinkSignallingTransferIndicationTDD-IEs}},
    protocolExtensions   ProtocolExtensionContainer {{UplinkSignallingTransferIndicationTDD-Extensions}}
    OPTIONAL,
    ...
}

UplinkSignallingTransferIndicationTDD-IEs RNSAP-PROTOCOL-IES ::= {
    { ID id-UC-ID          CRITICALITY ignore TYPE UC-ID          PRESENCE mandatory } |
    { ID id-SAI           CRITICALITY ignore TYPE SAI            PRESENCE mandatory } |
    { ID id-GA-Cell       CRITICALITY ignore TYPE GA-Cell        PRESENCE optional } |
    { ID id-C-RNTI        CRITICALITY ignore TYPE C-RNTI         PRESENCE mandatory } |
    { ID id-S-RNTI        CRITICALITY ignore TYPE S-RNTI         PRESENCE mandatory } |
    { ID id-D-RNTI        CRITICALITY ignore TYPE D-RNTI         PRESENCE optional } |
    { ID id-RxTimingDeviationForTA CRITICALITY ignore TYPE RxTimingDeviationForTA PRESENCE mandatory } |
    { ID id-L3-Information CRITICALITY ignore TYPE L3-Information PRESENCE mandatory } |
    { ID id-CN-PS-DomainIdentifier CRITICALITY ignore TYPE CN-PS-DomainIdentifier PRESENCE optional } |
    { ID id-CN-CS-DomainIdentifier CRITICALITY ignore TYPE CN-CS-DomainIdentifier PRESENCE optional } |
    { ID id-URA-Information CRITICALITY ignore TYPE URA-Information PRESENCE optional },
    ...
}

UplinkSignallingTransferIndicationTDD-Extensions RNSAP-PROTOCOL-EXTENSION ::= {
    ...
}

-- *****
--
-- DOWNLINK SIGNALLING TRANSFER REQUEST
--
-- *****

DownlinkSignallingTransferRequest ::= SEQUENCE {
    protocolIEs          ProtocolIE-Container    {{DownlinkSignallingTransferRequest-IEs}},
    protocolExtensions   ProtocolExtensionContainer {{DownlinkSignallingTransferRequest-Extensions}}
    OPTIONAL,
    ...
}

DownlinkSignallingTransferRequest-IEs RNSAP-PROTOCOL-IES ::= {
    { ID id-C-ID          CRITICALITY ignore TYPE C-ID          PRESENCE mandatory } |
    { ID id-D-RNTI        CRITICALITY ignore TYPE D-RNTI         PRESENCE mandatory } |
    { ID id-L3-Information CRITICALITY ignore TYPE L3-Information PRESENCE mandatory } |
    { ID id-D-RNTI-ReleaseIndication CRITICALITY ignore TYPE D-RNTI-ReleaseIndication PRESENCE mandatory },
    ...
}

DownlinkSignallingTransferRequest-Extensions RNSAP-PROTOCOL-EXTENSION ::= {
    ...
}

-- *****

```

```

--
-- RELOCATION COMMIT
--
-- *****

RelocationCommit ::= SEQUENCE {
    protocolIEs          ProtocolIE-Container    {{RelocationCommit-IEs}},
    protocolExtensions   ProtocolExtensionContainer {{RelocationCommit-Extensions}}           OPTIONAL,
    ...
}

RelocationCommit-IEs RNSAP-PROTOCOL-IES ::= {
    { ID id-D-RNTI          CRITICALITY ignore TYPE D-RNTI          PRESENCE optional } |
    { ID id-RANAP-RelocationInformation CRITICALITY ignore TYPE RANAP-RelocationInformation PRESENCE optional },
    ...
}

RelocationCommit-Extensions RNSAP-PROTOCOL-EXTENSION ::= {
    ...
}

-- *****
--
-- PAGING REQUEST
--
-- *****

PagingRequest ::= SEQUENCE {
    protocolIEs          ProtocolIE-Container    {{PagingRequest-IEs}},
    protocolExtensions   ProtocolExtensionContainer {{PagingRequest-Extensions}}           OPTIONAL,
    ...
}

PagingRequest-IEs RNSAP-PROTOCOL-IES ::= {
    { ID id-PagingArea-PagingRqst          CRITICALITY ignore TYPE PagingArea-PagingRqst          PRESENCE mandatory } |
    { ID id-SRNC-ID          CRITICALITY ignore TYPE RNC-ID          PRESENCE mandatory } |
    { ID id-S-RNTI          CRITICALITY ignore TYPE S-RNTI          PRESENCE mandatory } |
    { ID id-IMSI          CRITICALITY ignore TYPE IMSI          PRESENCE mandatory } |
    { ID id-DRXCycleLengthCoefficient          CRITICALITY ignore TYPE DRXCycleLengthCoefficient          PRESENCE mandatory } |
    { ID id-CNOriginatedPage-PagingRqst          CRITICALITY ignore TYPE CNOriginatedPage-PagingRqst          PRESENCE optional },
    ...
}

PagingArea-PagingRqst ::= CHOICE {
    uRA          URA-PagingRqst,
    cell          Cell-PagingRqst,
    ...
}

URA-PagingRqst ::= SEQUENCE {
    uRA-ID          URA-ID,
    iE-Extensions   ProtocolExtensionContainer { { URAItem-PagingRqst-ExtIEs } } OPTIONAL,
    ...
}

```

```

URAIItem-PagingRqst-ExtIEs RNSAP-PROTOCOL-EXTENSION ::= {
    ...
}

Cell-PagingRqst ::= SEQUENCE {
    c-ID                C-ID,
    iE-Extensions       ProtocolExtensionContainer { { CellItem-PagingRqst-ExtIEs } } OPTIONAL,
    ...
}

CellItem-PagingRqst-ExtIEs RNSAP-PROTOCOL-EXTENSION ::= {
    ...
}

CNOriginatedPage-PagingRqst ::= SEQUENCE {
    pagingCause         PagingCause,
    cNDomainType        CNDomainType,
    pagingRecordType    PagingRecordType,
    iE-Extensions       ProtocolExtensionContainer { { CNOriginatedPage-PagingRqst-ExtIEs } } OPTIONAL,
    ...
}

CNOriginatedPage-PagingRqst-ExtIEs RNSAP-PROTOCOL-EXTENSION ::= {
    ...
}

PagingRequest-Extensions RNSAP-PROTOCOL-EXTENSION ::= {
    ...
}

-- *****
--
-- DEDICATED MEASUREMENT INITIATION REQUEST
--
-- *****

DedicatedMeasurementInitiationRequest ::= SEQUENCE {
    protocolIEs         ProtocolIE-Container    {{DedicatedMeasurementInitiationRequest-IEs}},
    protocolExtensions  ProtocolExtensionContainer {{DedicatedMeasurementInitiationRequest-Extensions}}
    ...
}

DedicatedMeasurementInitiationRequest-IEs RNSAP-PROTOCOL-IES ::= {
    { ID id-MeasurementID                CRITICALITY reject TYPE MeasurementID                PRESENCE mandatory } |
    { ID id-DedicatedMeasurementObjectType-DM-Rqst CRITICALITY reject TYPE DedicatedMeasurementObjectType-DM-Rqst PRESENCE mandatory } |
    -- This IE represents both the Dedicated Measurement Object Type IE and the choice based on the Dedicated Measurement Object Type
    -- as described in the tabular message format in subclause 9.1.
    { ID id-DedicatedMeasurementType        CRITICALITY reject TYPE DedicatedMeasurementType        PRESENCE mandatory } |
    { ID id-MeasurementFilterCoefficient    CRITICALITY reject TYPE MeasurementFilterCoefficient    PRESENCE optional } |
    { ID id-ReportCharacteristics           CRITICALITY reject TYPE ReportCharacteristics           PRESENCE mandatory } |
    { ID id-CFNReportingIndicator           CRITICALITY reject TYPE FNReportingIndicator           PRESENCE mandatory } |
    { ID id-CFN                             CRITICALITY reject TYPE CFN                             PRESENCE optional },
    ...
}

```

```

}

DedicatedMeasurementObjectType-DM-Rqst ::= CHOICE {
    rL                RL-DM-Rqst,
    rLS               RL-Set-DM-Rqst,
    allRL             All-RL-DM-Rqst,
    allRLS           All-RL-Set-DM-Rqst,
    ...
}

RL-DM-Rqst ::= SEQUENCE {
    rL-InformationList-DM-Rqst    RL-InformationList-DM-Rqst,
    iE-Extensions                 ProtocolExtensionContainer { { RLItem-DM-Rqst-ExtIEs } } OPTIONAL,
    ...
}

RLItem-DM-Rqst-ExtIEs RNSAP-PROTOCOL-EXTENSION ::= {
    ...
}

RL-InformationList-DM-Rqst ::= SEQUENCE (SIZE (1..maxNrOfRLs)) OF ProtocolIE-Single-Container { {RL-Information-DM-Rqst-IEs} }

RL-Information-DM-Rqst-IEs RNSAP-PROTOCOL-IEs ::= {
    { ID id-RL-InformationItem-DM-Rqst    CRITICALITY reject    TYPE RL-InformationItem-DM-Rqst    PRESENCE mandatory    }
}

RL-InformationItem-DM-Rqst ::= SEQUENCE {
    rL-ID                RL-ID,
    dPCH-ID              DPCH-ID    OPTIONAL,
    iE-Extensions        ProtocolExtensionContainer { {RL-InformationItem-DM-Rqst-ExtIEs} } OPTIONAL,
    ...
}

RL-InformationItem-DM-Rqst-ExtIEs RNSAP-PROTOCOL-EXTENSION ::= {
    ...
}

RL-Set-DM-Rqst ::= SEQUENCE {
    rL-Set-InformationList-DM-Rqst    RL-Set-InformationList-DM-Rqst,
    iE-Extensions                     ProtocolExtensionContainer { { RL-SetItem-DM-Rqst-ExtIEs } } OPTIONAL,
    ...
}

RL-SetItem-DM-Rqst-ExtIEs RNSAP-PROTOCOL-EXTENSION ::= {
    ...
}

RL-Set-InformationList-DM-Rqst ::= SEQUENCE (SIZE (1..maxNrOfRLSets)) OF ProtocolIE-Single-Container { {RL-Set-Information-DM-Rqst-IEs} }

RL-Set-Information-DM-Rqst-IEs RNSAP-PROTOCOL-IEs ::= {
    { ID id-RL-Set-InformationItem-DM-Rqst    CRITICALITY ignore    TYPE RL-Set-InformationItem-DM-Rqst    PRESENCE mandatory    }
}

```

```

RL-Set-InformationItem-DM-Rqst ::= SEQUENCE {
    rL-Set-ID          RL-Set-ID,
    iE-Extensions      ProtocolExtensionContainer { {RL-Set-InformationItem-DM-Rqst-ExtIEs} } OPTIONAL,
    ...
}

RL-Set-InformationItem-DM-Rqst-ExtIEs RNSAP-PROTOCOL-EXTENSION ::= {
    ...
}

All-RL-DM-Rqst ::= NULL

All-RL-Set-DM-Rqst ::= NULL

DedicatedMeasurementInitiationRequest-Extensions RNSAP-PROTOCOL-EXTENSION ::= {
    ...
}

-- *****
--
-- DEDICATED MEASUREMENT INITIATION RESPONSE
--
-- *****

DedicatedMeasurementInitiationResponse ::= SEQUENCE {
    protocolIEs          ProtocolIE-Container    {{DedicatedMeasurementInitiationResponse-IEs}},
    protocolExtensions  ProtocolExtensionContainer {{DedicatedMeasurementInitiationResponse-Extensions}}
    ...
}

DedicatedMeasurementInitiationResponse-IEs RNSAP-PROTOCOL-IES ::= {
    { ID id-MeasurementID          CRITICALITY ignore TYPE MeasurementID          PRESENCE mandatory } |
    { ID id-DedicatedMeasurementObjectType-DM-Rsp CRITICALITY ignore TYPE DedicatedMeasurementObjectType-DM-Rsp PRESENCE optional } |
    { ID id-CriticalityDiagnostics CRITICALITY ignore TYPE CriticalityDiagnostics PRESENCE optional },
    ...
}

DedicatedMeasurementObjectType-DM-Rsp ::= CHOICE {
    rLs          RL-DM-Rsp,
    rLS          RL-Set-DM-Rsp,
    allRL        RL-DM-Rsp,
    allRLS       RL-Set-DM-Rsp,
    ...
}

RL-DM-Rsp ::= SEQUENCE {
    rL-InformationList-DM-Rsp  RL-InformationList-DM-Rsp,
    iE-Extensions              ProtocolExtensionContainer { { RLItem-DM-Rsp-ExtIEs } } OPTIONAL,
    ...
}

RLItem-DM-Rsp-ExtIEs RNSAP-PROTOCOL-EXTENSION ::= {
    ...
}

```



```

RL-Set-DM-Rsp ::= SEQUENCE {
    rL-Set-InformationList-DM-Rsp  RL-Set-InformationList-DM-Rsp,
    iE-Extensions                  ProtocolExtensionContainer { { RL-SetItem-DM-Rsp-ExtIEs } } OPTIONAL,
    ...
}

RL-SetItem-DM-Rsp-ExtIEs RNSAP-PROTOCOL-EXTENSION ::= {
    ...
}

RL-InformationList-DM-Rsp          ::= SEQUENCE (SIZE (1..maxNrOfRLs)) OF ProtocolIE-Single-Container { {RL-Information-DM-Rsp-IEs} }

RL-Information-DM-Rsp-IEs RNSAP-PROTOCOL-IES ::= {
    { ID id-RL-InformationItem-DM-Rsp          CRITICALITY ignore  TYPE RL-InformationItem-DM-Rsp          PRESENCE mandatory  }
}

RL-InformationItem-DM-Rsp ::= SEQUENCE {
    rL-ID                RL-ID,
    dPCH-ID              DPCH-ID                OPTIONAL,
    dedicatedMeasurementValue  DedicatedMeasurementValue,
    cFN                  CFN                    OPTIONAL,
    iE-Extensions        ProtocolExtensionContainer { {RL-InformationItem-DM-Rsp-ExtIEs} } OPTIONAL,
    ...
}

RL-InformationItem-DM-Rsp-ExtIEs RNSAP-PROTOCOL-EXTENSION ::= {
    ...
}

RL-Set-InformationList-DM-Rsp          ::= SEQUENCE (SIZE (1..maxNrOfRLSets)) OF ProtocolIE-Single-Container { {RL-Set-Information-DM-Rsp-IEs} }

RL-Set-Information-DM-Rsp-IEs RNSAP-PROTOCOL-IES ::= {
    { ID id-RL-Set-InformationItem-DM-Rsp          CRITICALITY ignore  TYPE RL-Set-InformationItem-DM-Rsp          PRESENCE mandatory  }
}

RL-Set-InformationItem-DM-Rsp ::= SEQUENCE {
    rL-Set-ID                RL-Set-ID,
    dedicatedMeasurementValue  DedicatedMeasurementValue,
    cFN                      CFN                    OPTIONAL,
    iE-Extensions            ProtocolExtensionContainer { {RL-Set-InformationItem-DM-Rspns-ExtIEs} } OPTIONAL,
    ...
}

RL-Set-InformationItem-DM-Rspns-ExtIEs RNSAP-PROTOCOL-EXTENSION ::= {
    ...
}

DedicatedMeasurementInitiationResponse-Extensions RNSAP-PROTOCOL-EXTENSION ::= {
    ...
}

-- *****

```

```

--
-- DEDICATED MEASUREMENT INITIATION FAILURE
--
-- *****

DedicatedMeasurementInitiationFailure ::= SEQUENCE {
    protocolIEs          ProtocolIE-Container    {{DedicatedMeasurementInitiationFailure-IEs}},
    protocolExtensions   ProtocolExtensionContainer {{DedicatedMeasurementInitiationFailure-Extensions}}
    ...
}

DedicatedMeasurementInitiationFailure-IEs RNSAP-PROTOCOL-IES ::= {
    { ID id-MeasurementID          CRITICALITY ignore TYPE MeasurementID          PRESENCE mandatory } |
    { ID id-Cause                  CRITICALITY ignore TYPE Cause                  PRESENCE mandatory } |
    { ID id-CriticalityDiagnostics CRITICALITY ignore TYPE CriticalityDiagnostics PRESENCE optional },
    ...
}

DedicatedMeasurementInitiationFailure-Extensions RNSAP-PROTOCOL-EXTENSION ::= {
    ...
}

-- *****
--
-- DEDICATED MEASUREMENT REPORT
--
-- *****

DedicatedMeasurementReport ::= SEQUENCE {
    protocolIEs          ProtocolIE-Container    {{DedicatedMeasurementReport-IEs}},
    protocolExtensions   ProtocolExtensionContainer {{DedicatedMeasurementReport-Extensions}}
    ...
}

DedicatedMeasurementReport-IEs RNSAP-PROTOCOL-IES ::= {
    { ID id-MeasurementID          CRITICALITY ignore TYPE MeasurementID          PRESENCE mandatory } |
    { ID id-DedicatedMeasurementObjectType-DM-Rprt CRITICALITY ignore TYPE DedicatedMeasurementObjectType-DM-Rprt PRESENCE mandatory },
    ...
}

DedicatedMeasurementObjectType-DM-Rprt ::= CHOICE {
    rLs          RL-DM-Rprt,
    rLS          RL-Set-DM-Rprt,
    allRL       RL-DM-Rprt,
    allRLS     RL-Set-DM-Rprt,
    ...
}

RL-DM-Rprt ::= SEQUENCE {
    rL-InformationList-DM-Rprt  RL-InformationList-DM-Rprt,
    iE-Extensions              ProtocolExtensionContainer { { RLItem-DM-Rprt-ExtIEs } } OPTIONAL,
    ...
}

```

```

RLItem-DM-Rprt-ExtIEs RNSAP-PROTOCOL-EXTENSION ::= {
    ...
}

RL-Set-DM-Rprt ::= SEQUENCE {
    rL-Set-InformationList-DM-Rprt RL-Set-InformationList-DM-Rprt,
    iE-Extensions ProtocolExtensionContainer { { RL-SetItem-DM-Rprt-ExtIEs } } OPTIONAL,
    ...
}

RL-SetItem-DM-Rprt-ExtIEs RNSAP-PROTOCOL-EXTENSION ::= {
    ...
}

RL-InformationList-DM-Rprt ::= SEQUENCE (SIZE (1..maxNrOfRLs)) OF ProtocolIE-Single-Container { {RL-Information-DM-Rprt-IEs} }

RL-Information-DM-Rprt-IEs RNSAP-PROTOCOL-IES ::= {
    { ID id-RL-InformationItem-DM-Rprt CRITICALITY ignore TYPE RL-InformationItem-DM-Rprt PRESENCE mandatory }
}

RL-InformationItem-DM-Rprt ::= SEQUENCE {
    rL-ID RL-ID,
    dPCH-ID DPCH-ID OPTIONAL,
    dedicatedMeasurementValueInformation DedicatedMeasurementValueInformation,
    iE-Extensions ProtocolExtensionContainer { {RL-InformationItem-DM-Rprt-ExtIEs} } OPTIONAL,
    ...
}

RL-InformationItem-DM-Rprt-ExtIEs RNSAP-PROTOCOL-EXTENSION ::= {
    ...
}

RL-Set-InformationList-DM-Rprt ::= SEQUENCE (SIZE (1..maxNrOfRLSets)) OF ProtocolIE-Single-Container { {RL-Set-Information-DM-Rprt-IEs} }

RL-Set-Information-DM-Rprt-IEs RNSAP-PROTOCOL-IES ::= {
    { ID id-RL-Set-InformationItem-DM-Rprt CRITICALITY ignore TYPE RL-Set-InformationItem-DM-Rprt PRESENCE mandatory }
}

RL-Set-InformationItem-DM-Rprt ::= SEQUENCE {
    rL-Set-ID RL-Set-ID,
    dedicatedMeasurementValueInformation DedicatedMeasurementValueInformation,
    iE-Extensions ProtocolExtensionContainer { {RL-Set-InformationItem-DM-Rprt-ExtIEs} } OPTIONAL,
    ...
}

RL-Set-InformationItem-DM-Rprt-ExtIEs RNSAP-PROTOCOL-EXTENSION ::= {
    ...
}

DedicatedMeasurementReport-Extensions RNSAP-PROTOCOL-EXTENSION ::= {
    ...
}

```

```

-- *****
--
-- DEDICATED MEASUREMENT TERMINATION REQUEST
--
-- *****

DedicatedMeasurementTerminationRequest ::= SEQUENCE {
    protocolIEs          ProtocolIE-Container    {{DedicatedMeasurementTerminationRequest-IEs}},
    protocolExtensions   ProtocolExtensionContainer {{DedicatedMeasurementTerminationRequest-Extensions}}
    ...
}

DedicatedMeasurementTerminationRequest-IEs RNSAP-PROTOCOL-IES ::= {
    { ID id-MeasurementID          CRITICALITY ignore TYPE MeasurementID          PRESENCE mandatory },
    ...
}

DedicatedMeasurementTerminationRequest-Extensions RNSAP-PROTOCOL-EXTENSION ::= {
    ...
}

-- *****
--
-- DEDICATED MEASUREMENT FAILURE INDICATION
--
-- *****

DedicatedMeasurementFailureIndication ::= SEQUENCE {
    protocolIEs          ProtocolIE-Container    {{DedicatedMeasurementFailureIndication-IEs}},
    protocolExtensions   ProtocolExtensionContainer {{DedicatedMeasurementFailureIndication-Extensions}}
    ...
}

DedicatedMeasurementFailureIndication-IEs RNSAP-PROTOCOL-IES ::= {
    { ID id-MeasurementID          CRITICALITY ignore TYPE MeasurementID          PRESENCE mandatory } |
    { ID id-Cause                  CRITICALITY ignore TYPE Cause                  PRESENCE mandatory },
    ...
}

DedicatedMeasurementFailureIndication-Extensions RNSAP-PROTOCOL-EXTENSION ::= {
    ...
}

-- *****
--
-- COMMON TRANSPORT CHANNEL RESOURCES RELEASE REQUEST
--
-- *****

CommonTransportChannelResourcesReleaseRequest ::= SEQUENCE {
    protocolIEs          ProtocolIE-Container    {{CommonTransportChannelResourcesReleaseRequest-IEs}},
    protocolExtensions   ProtocolExtensionContainer {{CommonTransportChannelResourcesReleaseRequest-Extensions}}
OPTIONAL,
    ...
}

```

```

}

CommonTransportChannelResourcesReleaseRequest-IEs RNSAP-PROTOCOL-IES ::= {
  { ID id-D-RNTI          CRITICALITY ignore  TYPE D-RNTI          PRESENCE mandatory },
  ...
}

CommonTransportChannelResourcesReleaseRequest-Extensions RNSAP-PROTOCOL-EXTENSION ::= {
  ...
}

-- *****
--
-- COMMON TRANSPORT CHANNEL RESOURCES REQUEST
--
-- *****

CommonTransportChannelResourcesRequest ::= SEQUENCE {
  protocolIEs          ProtocolIE-Container    {{CommonTransportChannelResourcesRequest-IEs}},
  protocolExtensions   ProtocolExtensionContainer {{CommonTransportChannelResourcesRequest-Extensions}}  OPTIONAL,
  ...
}

CommonTransportChannelResourcesRequest-IEs RNSAP-PROTOCOL-IES ::= {
  { ID id-D-RNTI          CRITICALITY reject  TYPE D-RNTI          PRESENCE mandatory } |
  { ID id-C-ID           CRITICALITY reject  TYPE C-ID            PRESENCE optional   } |
  { ID id-TransportBearerRequestIndicator CRITICALITY reject  TYPE TransportBearerRequestIndicator PRESENCE mandatory } |
  { ID id-TransportBearerID CRITICALITY reject  TYPE TransportBearerID PRESENCE mandatory },
  ...
}

CommonTransportChannelResourcesRequest-Extensions RNSAP-PROTOCOL-EXTENSION ::= {
  { ID id-Permanent-NAS-UE-Identity          CRITICALITY ignore          EXTENSION Permanent-NAS-UE-Identity PRESENCE optional },
  ...
}

-- *****
--
-- COMMON TRANSPORT CHANNEL RESOURCES RESPONSE FDD
--
-- *****

CommonTransportChannelResourcesResponseFDD ::= SEQUENCE {
  protocolIEs          ProtocolIE-Container    {{CommonTransportChannelResourcesResponseFDD-IEs}},
  protocolExtensions   ProtocolExtensionContainer {{CommonTransportChannelResourcesResponseFDD-Extensions}}  OPTIONAL,
  ...
}

CommonTransportChannelResourcesResponseFDD-IEs RNSAP-PROTOCOL-IES ::= {
  { ID id-S-RNTI          CRITICALITY ignore  TYPE S-RNTI          PRESENCE mandatory } |
  { ID id-C-RNTI          CRITICALITY ignore  TYPE C-RNTI          PRESENCE optional   } |
  { ID id-FACH-InfoForUESelectedS-CCPCH-CTCH-ResourceRspFDD CRITICALITY ignore  TYPE FACH-InfoForUESelectedS-CCPCH-CTCH-ResourceRspFDD PRESENCE mandatory } |
  { ID id-TransportLayerAddress CRITICALITY ignore  TYPE TransportLayerAddress PRESENCE optional } |

```

```

    { ID id-BindingID                CRITICALITY ignore TYPE BindingID                PRESENCE optional } |
    { ID id-CriticalityDiagnostics    CRITICALITY ignore TYPE CriticalityDiagnostics    PRESENCE optional },
    ...
}

FACH-InfoForUESelectedS-CCPCH-CTCH-ResourceRspFDD ::= SEQUENCE {
    fACH-FlowControlInformation      FACH-FlowControlInformation-CTCH-ResourceRspFDD,
    iE-Extensions                    ProtocolExtensionContainer { {FACH-InfoForUESelectedS-CCPCH-CTCH-ResourceRspFDD-ExtIEs} } OPTIONAL,
    ...
}

FACH-InfoForUESelectedS-CCPCH-CTCH-ResourceRspFDD-ExtIEs RNSAP-PROTOCOL-EXTENSION ::= {
    ...
}

FACH-FlowControlInformation-CTCH-ResourceRspFDD ::= ProtocolIE-Single-Container {{ FACH-FlowControlInformationIEs-CTCH-ResourceRspFDD }}

FACH-FlowControlInformationIEs-CTCH-ResourceRspFDD RNSAP-PROTOCOL-IES ::= {
    { ID id-FACH-FlowControlInformation CRITICALITY ignore TYPE FACH-FlowControlInformation PRESENCE mandatory }
}

CommonTransportChannelResourcesResponseFDD-Extensions RNSAP-PROTOCOL-EXTENSION ::= {
    { ID id-C-ID                      CRITICALITY ignore EXTENSION C-ID PRESENCE mandatory },
    ...
}

-- *****
--
-- COMMON TRANSPORT CHANNEL RESOURCES RESPONSE TDD
--
-- *****

CommonTransportChannelResourcesResponseTDD ::= SEQUENCE {
    protocolIEs                      ProtocolIE-Container {{CommonTransportChannelResourcesResponseTDD-IEs}},
    protocolExtensions                ProtocolExtensionContainer {{CommonTransportChannelResourcesResponseTDD-Extensions}} OPTIONAL,
    ...
}

CommonTransportChannelResourcesResponseTDD-IEs RNSAP-PROTOCOL-IES ::= {
    { ID id-S-RNTI                    CRITICALITY ignore TYPE S-RNTI PRESENCE mandatory } |
    { ID id-C-RNTI                    CRITICALITY ignore TYPE C-RNTI PRESENCE optional } |
    { ID id-FACH-InfoForUESelectedS-CCPCH-CTCH-ResourceRspTDD CRITICALITY ignore TYPE FACH-InfoForUESelectedS-CCPCH-CTCH-ResourceRspTDD PRESENCE mandatory } |
    { ID id-TransportLayerAddress      CRITICALITY ignore TYPE TransportLayerAddress PRESENCE optional } |
    { ID id-BindingID                  CRITICALITY ignore TYPE BindingID PRESENCE optional } |
    { ID id-CriticalityDiagnostics     CRITICALITY ignore TYPE CriticalityDiagnostics PRESENCE optional },
    ...
}

FACH-InfoForUESelectedS-CCPCH-CTCH-ResourceRspTDD ::= SEQUENCE {
    fACH-FlowControlInformation      FACH-FlowControlInformation-CTCH-ResourceRspTDD,
    iE-Extensions                    ProtocolExtensionContainer { {FACH-InfoForUESelectedS-CCPCH-CTCH-ResourceRspTDD-ExtIEs} } OPTIONAL,
    ...
}

```

```

FACH-InfoForUESelectedS-CCPCH-CTCH-ResourceRspTDD-ExtIEs RNSAP-PROTOCOL-EXTENSION ::= {
    ...
}

FACH-FlowControlInformation-CTCH-ResourceRspTDD ::= ProtocolIE-Single-Container {{ FACH-FlowControlInformationIEs-CTCH-ResourceRspTDD }}

FACH-FlowControlInformationIEs-CTCH-ResourceRspTDD RNSAP-PROTOCOL-IES ::= {
    { ID id-FACH-FlowControlInformation CRITICALITY ignore TYPE FACH-FlowControlInformation PRESENCE mandatory }
}

CommonTransportChannelResourcesResponseTDD-Extensions RNSAP-PROTOCOL-EXTENSION ::= {
    { ID id-C-ID CRITICALITY ignore EXTENSION C-ID PRESENCE mandatory },
    ...
}

-- *****
--
-- COMMON TRANSPORT CHANNEL RESOURCES FAILURE
--
-- *****

CommonTransportChannelResourcesFailure ::= SEQUENCE {
    protocolIEs ProtocolIE-Container {{CommonTransportChannelResourcesFailure-IEs}},
    protocolExtensions ProtocolExtensionContainer {{CommonTransportChannelResourcesFailure-Extensions}} OPTIONAL,
    ...
}

CommonTransportChannelResourcesFailure-IEs RNSAP-PROTOCOL-IES ::= {
    { ID id-S-RNTI CRITICALITY ignore TYPE S-RNTI PRESENCE mandatory } |
    { ID id-Cause CRITICALITY ignore TYPE Cause PRESENCE mandatory } |
    { ID id-CriticalityDiagnostics CRITICALITY ignore TYPE CriticalityDiagnostics PRESENCE optional },
    ...
}

CommonTransportChannelResourcesFailure-Extensions RNSAP-PROTOCOL-EXTENSION ::= {
    ...
}

-- *****
--
-- COMPRESSED MODE COMMAND
--
-- *****

CompressedModeCommand ::= SEQUENCE {
    protocolIEs ProtocolIE-Container {{CompressedModeCommand-IEs}},
    protocolExtensions ProtocolExtensionContainer {{CompressedModeCommand-Extensions}} OPTIONAL,
    ...
}

CompressedModeCommand-IEs RNSAP-PROTOCOL-IES ::= {
    { ID id-Active-Pattern-Sequence-Information CRITICALITY ignore TYPE Active-Pattern-Sequence-Information PRESENCE mandatory },
    ...
}

```

```

}
CompressedModeCommand-Extensions RNSAP-PROTOCOL-EXTENSION ::= {
  ...
}
-- *****
--
-- ERROR INDICATION
--
-- *****

ErrorIndication ::= SEQUENCE {
  protocolIES          ProtocolIE-Container    {{ErrorIndication-IEs}},
  protocolExtensions  ProtocolExtensionContainer {{ErrorIndication-Extensions}}          OPTIONAL,
  ...
}

ErrorIndication-IEs RNSAP-PROTOCOL-IES ::= {
  { ID id-Cause          CRITICALITY ignore TYPE Cause          PRESENCE optional } |
  { ID id-CriticalityDiagnostics CRITICALITY ignore TYPE CriticalityDiagnostics PRESENCE optional },
  ...
}

ErrorIndication-Extensions RNSAP-PROTOCOL-EXTENSION ::= {
  { ID id-S-RNTI          CRITICALITY ignore EXTENSION S-RNTI    PRESENCE optional } |
  { ID id-D-RNTI          CRITICALITY ignore EXTENSION D-RNTI    PRESENCE optional },
  ...
}

-- *****
--
-- PRIVATE MESSAGE
--
-- *****

PrivateMessage ::= SEQUENCE {
  privateIES          PrivateIE-Container    {{PrivateMessage-IEs}},
  ...
}

PrivateMessage-IEs RNSAP-PRIVATE-IES ::= {
  ...
}

END

```

9.3.4 Information Element Definitions

```

-- *****
--
-- Information Element Definitions
--

```



```
-- *****  
  
RNSAP-IEs {  
itu-t (0) identified-organization (4) etsi (0) mobileDomain (0)  
umts-Access (20) modules (3) rnsap (1) version1 (1) rnsap-IEs (2) }  
  
DEFINITIONS AUTOMATIC TAGS ::=  
  
BEGIN  
  
IMPORTS  
    maxCodeNumComp-1,  
    maxNrOfFACHs,  
    maxFACHCountPlus1,  
    maxIBSEG,  
    maxNoOfDSCHs,  
    maxNoOfDSCHs-1,  
    maxNoOfUSCHs,  
    maxNoTFCIGroups,  
    maxNoCodeGroups,  
    maxNrOfDCHs,  
    maxNrOfDL-Codes,  
    maxNrOfDLTs,  
    maxNrOfDPCHs,  
    maxNrOfErrors,  
    maxNrOfFDDNeighboursPerRNC,  
    maxNrOfMACcshSDU-Length,  
    maxNrOfNeighbouringRNCs,  
    maxNrOfTDDNeighboursPerRNC,  
    maxNrOfTS,  
    maxNrOfULTs,  
    maxNrOfGSMNeighboursPerRNC,  
    maxRateMatching,  
    maxNrOfPoints,  
    maxNoOfRB,  
    maxNrOfTFCs,  
    maxNrOfTFs,  
    maxCTFC,  
    maxRNCinURA-1,  
    maxNrOfSCCPCHs,  
    maxTFCI1Combs,  
    maxTFCI2Combs,  
    maxTFCI2Combs-1,  
    maxTGPS,  
    maxTTI-Count,  
  
    id-DSCH-Specific-FDD-Additional-List,  
    id-Neighbouring-GSM-CellInformation,  
    id-Neighbouring-UMTS-CellInformationItem,  
    maxNrOfLevels,  
    id-MessageStructure,  
    id-RestrictionStateIndicator,  
    id-TypeOfError,  
    id-ExtendedGSMCellIndividualOffset
```

```
FROM RNSAP-Constants

    Criticality,
    ProcedureID,
    ProtocolIE-ID,
    TransactionID,
    TriggeringMessage
FROM RNSAP-CommonDataTypes

    ProtocolIE-Single-Container{},
    ProtocolExtensionContainer{},
    RNSAP-PROTOCOL-IES,
    RNSAP-PROTOCOL-EXTENSION
FROM RNSAP-Containers;

-- A

Active-Pattern-Sequence-Information ::= SEQUENCE {
    cMConfigurationChangeCFN          CFN,
    transmission-Gap-Pattern-Sequence-Status  Transmission-Gap-Pattern-Sequence-Status-List  OPTIONAL,
    iE-Extensions          ProtocolExtensionContainer { {Active-Pattern-Sequence-Information-ExtIEs} } OPTIONAL,
    ...
}

Active-Pattern-Sequence-Information-ExtIEs RNSAP-PROTOCOL-EXTENSION ::= {
    ...
}

AdjustmentPeriod          ::= INTEGER(1..256)
-- Unit Frame

AllocationRetentionPriority ::= SEQUENCE {
    priorityLevel          PriorityLevel,
    pre-emptionCapability  Pre-emptionCapability,
    pre-emptionVulnerability  Pre-emptionVulnerability,
    iE-Extensions          ProtocolExtensionContainer { {AllocationRetentionPriority-ExtIEs} } OPTIONAL,
    ...
}

AllocationRetentionPriority-ExtIEs RNSAP-PROTOCOL-EXTENSION ::= {
    ...
}

AllowedQueuingTime          ::= INTEGER (1..60)
-- seconds

AlphaValue          ::= INTEGER (0..8)
-- Actual value = Alpha / 8

-- B

Band-Indicator ::= ENUMERATED {
    dcs1800Band,
```

```
    pcs1900Band,
    ...
}

BCC ::= BIT STRING (SIZE (3))

BCCH-ARFCN ::= INTEGER (0..1023)

BetaCD ::= INTEGER (0..15)

BindingID          ::= OCTET STRING (SIZE (1..4,...))

BLER               ::= INTEGER (-63..0)
-- Step 0.1 (Range -6.3..0). It is the Log10 of the BLER

SCTD-Indicator ::= ENUMERATED {
    active,
    inactive
}

BSIC ::= SEQUENCE {
    nCC      NCC,
    bCC      BCC
}

-- C

Cause ::= CHOICE {
    radioNetwork      CauseRadioNetwork,
    transport         CauseTransport,
    protocol           CauseProtocol,
    misc              CauseMisc,
    ...
}

CauseMisc ::= ENUMERATED {
    control-processing-overload,
    hardware-failure,
    om-intervention,
    not-enough-user-plane-processing-resources,
    unspecified,
    ...
}

CauseProtocol ::= ENUMERATED {
    transfer-syntax-error,
    abstract-syntax-error-reject,
    abstract-syntax-error-ignore-and-notify,
    message-not-compatible-with-receiver-state,
    semantic-error,
    unspecified,
    abstract-syntax-error-falsely-constructed-message,
    ...
}
```

```

CauseRadioNetwork ::= ENUMERATED {
    unknown-C-ID,
    cell-not-available,
    power-level-not-supported,
    ul-scrambling-code-already-in-use,
    dl-radio-resources-not-available,
    ul-radio-resources-not-available,
    measurement-not-supported-for-the-object,
    combining-resources-not-available,
    combining-not-supported,
    reconfiguration-not-allowed,
    requested-configuration-not-supported,
    synchronisation-failure,
    requested-tx-diversity-mode-not-supported,
    measurement-temporarily-not-available,
    unspecified,
    invalid-CM-settings,
    reconfiguration-CFN-not-elapsed,
    number-of-DL-codes-not-supported,
    dedicated-transport-channel-type-not-supported,
    dl-shared-channel-type-not-supported,
    ul-shared-channel-type-not-supported,
    common-transport-channel-type-not-supported,
    ul-spreading-factor-not-supported,
    dl-spreading-factor-not-supported,
    cm-not-supported,
    transaction-not-supported-by-destination-node-b,
    rl-already-activated-or-allocated,
    ...,
    number-of-UL-codes-not-supported,
    cell-reserved-for-operator-use
}

CauseTransport ::= ENUMERATED {
    transport-resource-unavailable,
    unspecified,
    ...
}

C-ID ::= INTEGER (0..65535)

CCTrCH-ID ::= INTEGER (0..15)

CellIndividualOffset ::= INTEGER (-20..20)

CellParameterID ::= INTEGER (0..127,...)

CFN ::= INTEGER (0..255)

CGI ::= SEQUENCE {
    LAI SEQUENCE {
        pLMN-Identity PLMN-Identity,
        lAC LAC,
    }
}

```

```

        iE-Extensions          ProtocolExtensionContainer { {LAI-ExtIEs} } OPTIONAL,
        ...
    },
    cI          CI,
    iE-Extensions          ProtocolExtensionContainer { {CGI-ExtIEs} } OPTIONAL
}

LAI-ExtIEs RNSAP-PROTOCOL-EXTENSION ::= {
    ...
}

CGI-ExtIEs RNSAP-PROTOCOL-EXTENSION ::= {
    ...
}

ChannelCodingType ::= ENUMERATED {
    no-codingTDD,
    convolutional-coding,
    turbo-coding,
    ...
}

ChipOffset          ::= INTEGER (0..38399)

CI          ::= OCTET STRING (SIZE (2))

ClosedLoopModel-SupportIndicator    ::= ENUMERATED {
    closedLoop-Model-Supported,
    closedLoop-Model-not-Supported
}

ClosedLoopMode2-SupportIndicator    ::= ENUMERATED {
    closedLoop-Mode2-Supported,
    closedLoop-Mode2-not-Supported
}

Closedlooptimingadjustmentmode    ::= ENUMERATED {
    adj-1-slot,
    adj-2-slot,
    ...
}

CodeNumber ::= INTEGER (0..maxCodeNumComp-1)

CodingRate ::= ENUMERATED {
    half,
    third,
    ...
}

CRC-Size          ::= ENUMERATED {
    v0,
    v8,
    v12,

```

```

    v16,
    v24,
    ...
}

CriticalityDiagnostics ::= SEQUENCE {
    procedureID          ProcedureID          OPTIONAL,
    triggeringMessage    TriggeringMessage    OPTIONAL,
    procedureCriticality Criticality          OPTIONAL,
    transactionID       TransactionID        OPTIONAL,
    iEsCriticalityDiagnostics CriticalityDiagnostics-IE-List OPTIONAL,
    iE-Extensions       ProtocolExtensionContainer { {CriticalityDiagnostics-ExtIEs} } OPTIONAL,
    ...
}

CriticalityDiagnostics-ExtIEs RNSAP-PROTOCOL-EXTENSION ::= {
    ...
}

CriticalityDiagnostics-IE-List ::= SEQUENCE (SIZE (1..maxNrOfErrors)) OF
    SEQUENCE {
        iECriticality          Criticality,
        iE-ID                  ProtocolIE-ID,
        repetitionNumber       RepetitionNumber0          OPTIONAL,
        iE-Extensions          ProtocolExtensionContainer { {CriticalityDiagnostics-IE-List-ExtIEs} } OPTIONAL,
        ...
    }

CriticalityDiagnostics-IE-List-ExtIEs RNSAP-PROTOCOL-EXTENSION ::= {
    { ID id-MessageStructure          CRITICALITY ignore          EXTENSION MessageStructure          PRESENCE optional }|
    { ID id-TypeOfError               CRITICALITY ignore          EXTENSION TypeOfError          PRESENCE mandatory },
    ...
}

MessageStructure ::= SEQUENCE (SIZE (1..maxNrOfLevels)) OF
    SEQUENCE {
        iE-ID                  ProtocolIE-ID,
        repetitionNumber       RepetitionNumber1          OPTIONAL,
        iE-Extensions          ProtocolExtensionContainer { {MessageStructure-ExtIEs} } OPTIONAL,
        ...
    }

MessageStructure-ExtIEs RNSAP-PROTOCOL-EXTENSION ::= {
    ...
}

CN-CS-DomainIdentifier ::= SEQUENCE {
    pLMN-Identity            PLMN-Identity,
    lAC                      LAC,
    iE-Extensions            ProtocolExtensionContainer { {CN-CS-DomainIdentifier-ExtIEs} } OPTIONAL
}

CN-CS-DomainIdentifier-ExtIEs RNSAP-PROTOCOL-EXTENSION ::= {

```

```

    ...
}

CN-PS-DomainIdentifier ::= SEQUENCE {
    plmn-Identity      PLMN-Identity,
    lac               LAC,
    rac               RAC,
    ie-Extensions     ProtocolExtensionContainer { {CN-PS-DomainIdentifier-ExtIEs} } OPTIONAL
}

CN-PS-DomainIdentifier-ExtIEs RNSAP-PROTOCOL-EXTENSION ::= {
    ...
}

CNDomainType ::= ENUMERATED {
    cs-domain,
    ps-domain,
    dont-care,
    ...
}
-- See in [16]

C-RNTI ::= INTEGER (0..65535)

-- D
DCH-FDD-Information ::= SEQUENCE (SIZE (1..maxNrOfDCHs)) OF DCH-FDD-InformationItem

DCH-FDD-InformationItem ::= SEQUENCE {
    payloadCRC-PresenceIndicator PayloadCRC-PresenceIndicator,
    ul-FP-Mode                  UL-FP-Mode,
    toAWS                       ToAWS,
    toAWE                       ToAWE,
    dch-SpecificInformationList DCH-Specific-FDD-InformationList,
    ie-Extensions               ProtocolExtensionContainer { {DCH-FDD-InformationItem-ExtIEs} } OPTIONAL,
    ...
}

DCH-FDD-InformationItem-ExtIEs RNSAP-PROTOCOL-EXTENSION ::= {
    ...
}

DCH-Specific-FDD-InformationList ::= SEQUENCE (SIZE (1..maxNrOfDCHs)) OF DCH-Specific-FDD-Item

DCH-Specific-FDD-Item ::= SEQUENCE {
    dch-ID                    DCH-ID,
    trch-SrcStatisticsDescr   Trch-SrcStatisticsDescr,
    ul-transportFormatSet    TransportFormatSet,
    dl-transportFormatSet    TransportFormatSet,
    ul-BLER                  BLER,
    dl-BLER                  BLER,
    allocationRetentionPriority AllocationRetentionPriority,
    frameHandlingPriority    FrameHandlingPriority,
    qe-Selector              QE-Selector,
    dracControl              DRACControl,

```

```

    iE-Extensions          ProtocolExtensionContainer { {DCH-FDD-SpecificItem-ExtIEs} } OPTIONAL,
    ...
}

DCH-FDD-SpecificItem-ExtIEs RNSAP-PROTOCOL-EXTENSION ::= {
    ...
}

DCH-ID                    ::= INTEGER (0..255)

DCH-InformationResponse ::= SEQUENCE (SIZE (1..maxNrOfDCHs)) OF DCH-InformationResponseItem

DCH-InformationResponseItem ::= SEQUENCE {
    dCH-ID                DCH-ID,
    bindingID              BindingID                OPTIONAL,
    transportLayerAddress  TransportLayerAddress    OPTIONAL,
    iE-Extensions          ProtocolExtensionContainer { {DCH-InformationResponseItem-ExtIEs} } OPTIONAL,
    ...
}

DCH-InformationResponseItem-ExtIEs RNSAP-PROTOCOL-EXTENSION ::= {
    ...
}

DCH-TDD-Information      ::= SEQUENCE (SIZE (1..maxNrOfDCHs)) OF DCH-TDD-InformationItem

DCH-TDD-InformationItem ::= SEQUENCE {
    payloadCRC-PresenceIndicator  PayloadCRC-PresenceIndicator,
    ul-FP-Mode                    UL-FP-Mode,
    toAWS                          ToAWS,
    toAWE                          ToAWE,
    dCH-SpecificInformationList    DCH-Specific-TDD-InformationList,
    iE-Extensions                  ProtocolExtensionContainer { {DCH-TDD-InformationItem-ExtIEs} } OPTIONAL,
    ...
}

DCH-TDD-InformationItem-ExtIEs RNSAP-PROTOCOL-EXTENSION ::= {
    ...
}

DCH-Specific-TDD-InformationList ::= SEQUENCE (SIZE (1..maxNrOfDCHs)) OF DCH-Specific-TDD-Item

DCH-Specific-TDD-Item ::= SEQUENCE {
    dCH-ID                DCH-ID,
    ul-cCTrCH-ID          CCTrCH-ID, -- UL CCTrCH in which the DCH is mapped
    dl-cCTrCH-ID          CCTrCH-ID, -- DL CCTrCH in which the DCH is mapped
    trCH-SrcStatisticsDescr  TrCH-SrcStatisticsDescr,
    ul-transportFormatSet    TransportFormatSet,
    dl-transportFormatSet    TransportFormatSet,
    ul-BLER                BLER,
    dl-BLER                BLER,
    allocationRetentionPriority  AllocationRetentionPriority,
    frameHandlingPriority      FrameHandlingPriority,
    qE-Selector              QE-Selector            OPTIONAL,
}

```



```

-- This IE shall be present if DCH is part of set of Coordinated DCHs
ie-Extensions          ProtocolExtensionContainer { {DCH-Specific-TDD-Item-ExtIEs} } OPTIONAL,
...
}

DCH-Specific-TDD-Item-ExtIEs RNSAP-PROTOCOL-EXTENSION ::= {
...
}

DedicatedMeasurementType ::= ENUMERATED {
sir,
sir-error,
transmitted-code-power,
rSCP,
rx-timing-deviation,
round-trip-time,
...
}

DedicatedMeasurementValue ::= CHOICE {
sIR-Value          SIR-Value,
sIR-ErrorValue     SIR-Error-Value,
transmittedCodePowerValue  Transmitted-Code-Power-Value,
rSCP               RSCP-Value, -- TDD only
rxTimingDeviationValue  Rx-Timing-Deviation-Value, -- TDD only
roundTripTime      Round-Trip-Time-Value, -- FDD only
...
}

DedicatedMeasurementValueInformation ::= CHOICE {
measurementAvailable      DedicatedMeasurementAvailable,
measurementnotAvailable   DedicatedMeasurementnotAvailable
}

DedicatedMeasurementAvailable ::= SEQUENCE {
dedicatedmeasurementValue  DedicatedMeasurementValue,
cFN                        CFN OPTIONAL,
ie-Extensions              ProtocolExtensionContainer { { DedicatedMeasurementAvailableItem-ExtIEs} } OPTIONAL,
...
}

DedicatedMeasurementAvailableItem-ExtIEs RNSAP-PROTOCOL-EXTENSION ::= {
...
}

DedicatedMeasurementnotAvailable ::= NULL

DeltaSIR              ::= INTEGER (0..30)
-- Step 0.1 dB, Range 0..3 dB.

DiversityControlField ::= ENUMERATED {
may,
must,
must-not
}

```

```

}

DiversityMode ::= ENUMERATED {
    none,
    sTTD,
    closedLoopModel,
    closedLoopMode2,
    ...
}

DL-DPCH-SlotFormat ::= INTEGER (0..16,...)

DL-Power ::= INTEGER (-350..150)
-- Value = DL-Power / 10
-- Unit dB, Range -35dB .. +15dB, Step 0.1dB

D-RNTI ::= INTEGER (0..1048575)

D-RNTI-ReleaseIndication ::= ENUMERATED {
    release-D-RNTI,
    not-release-D-RNTI
}

DL-ScramblingCode ::= INTEGER (0..15)

DL-FrameType ::= ENUMERATED {
    typeA,
    typeB,
    ...
}

DL-Timeslot-Information ::= SEQUENCE ( SIZE (1..maxNrOfTS)) OF DL-Timeslot-InformationItem

DL-Timeslot-InformationItem ::= SEQUENCE {
    timeSlot TimeSlot,
    midambleShiftAndBurstType MidambleShiftAndBurstType,
    tFCI-Presence TFCI-Presence,
    dL-Code-Information TDD-DL-Code-Information,
    iE-Extensions ProtocolExtensionContainer { {DL-Timeslot-InformationItem-ExtIEs} } OPTIONAL,
    ...
}

DL-Timeslot-InformationItem-ExtIEs RNSAP-PROTOCOL-EXTENSION ::= {
    ...
}

DL-TimeSlot-ISCP-Info ::= SEQUENCE (SIZE (1..maxNrOfDLTs)) OF DL-TimeSlot-ISCP-InfoItem

DL-TimeSlot-ISCP-InfoItem ::= SEQUENCE {
    timeSlot TimeSlot,
    dL-TimeslotISCP DL-TimeslotISCP,
    iE-Extensions ProtocolExtensionContainer { { DL-TimeSlot-ISCP-InfoItem-ExtIEs} } OPTIONAL,
    ...
}

```

```

DL-TimeSlot-ISCP-InfoItem-ExtIEs RNSAP-PROTOCOL-EXTENSION ::= {
    ...
}

DL-TimeslotISCP ::= INTEGER (0..91)
-- According to mapping in [24]

Downlink-Compressed-Mode-Method ::= ENUMERATED {
    puncturing,
    sFdiv2,
    higher-layer-scheduling,
    ...
}

DPCH-ID ::= INTEGER (0..239)

DPCHConstantValue ::= INTEGER (-10..10)
-- Unit dB, Step 1dB

DRACControl ::= ENUMERATED {
    requested,
    not-requested
}

DRXCycleLengthCoefficient ::= INTEGER (3..9)
-- See in [16]

DSCH-FDD-Information ::= SEQUENCE {
    dSCH-Specific-Information DSCH-Specific-FDD-Item,
    -- This DSCH-Specific-FDD-Item is the first DSCH-Specific-FDD-Item in DSCH-FDD-Information. If more than one DSCH-Specific-FDD-Item/s should be
    -- defined in a DSCH-FDD-Information, from 2nd DSCH-Specific-FDD Item, they will be included in the DSCH-Specific-FDD-Additional-List in the DSCH-FDD-
    -- Information-ExtIEs.
    pdSCH-RL-ID RL-ID,
    tFCS TFCS,
    iE-Extensions ProtocolExtensionContainer { {DSCH-FDD-Information-ExtIEs} } OPTIONAL,
    ...
}

DSCH-FDD-Information-ExtIEs RNSAP-PROTOCOL-EXTENSION ::= {
    { ID id-DSCH-Specific-FDD-Additional-List CRITICALITY reject EXTENSION DSCH-Specific-FDD-Additional-List PRESENCE optional },
    ...
}

DSCH-RNTI ::= INTEGER (0..65535)

DSCH-Specific-FDD-Item ::= SEQUENCE {
    dSCH-ID DSCH-ID,
    trChSourceStatisticsDescriptor TrCH-SrcStatisticsDescr,
    transportFormatSet TransportFormatSet,
    allocationRetentionPriority AllocationRetentionPriority,
    schedulingPriorityIndicator SchedulingPriorityIndicator,
    BLER BLER,
    iE-Extensions ProtocolExtensionContainer { {DSCH-Specific-FDD-Item-ExtIEs} } OPTIONAL,

```

```

}
...
}
DSCH-Specific-FDD-Item-ExtIEs RNSAP-PROTOCOL-EXTENSION ::= {
...
}
DSCH-Specific-FDD-Additional-List ::= SEQUENCE (SIZE(1..maxNoOfDSCHs-1)) OF DSCH-Specific-FDD-Item
DSCH-FDD-InformationResponse ::= SEQUENCE {
dsch-Specific-InformationResponse DSCH-Specific-FDD-InformationResponse,
pdSCHCodeMapping PDSCHCodeMapping,
iE-Extensions ProtocolExtensionContainer { { DSCH-FDD-InformationResponse-ExtIEs } } OPTIONAL,
...
}
DSCH-FDD-InformationResponse-ExtIEs RNSAP-PROTOCOL-EXTENSION ::= {
...
}
DSCH-Specific-FDD-InformationResponse ::= SEQUENCE (SIZE(1..maxNoOfDSCHs)) OF DSCH-Specific-FDD-Response-Item
DSCH-Specific-FDD-Response-Item ::= SEQUENCE {
dsch-ID DSCH-ID,
dsch-FlowControlInformation DSCH-FlowControlInformation,
bindingID BindingID OPTIONAL,
transportLayerAddress TransportLayerAddress OPTIONAL,
iE-Extensions ProtocolExtensionContainer { {DSCH-Specific-FDD-Response-Item-ExtIEs} } OPTIONAL,
...
}
DSCH-Specific-FDD-Response-Item-ExtIEs RNSAP-PROTOCOL-EXTENSION ::= {
...
}
DSCH-FlowControlInformation ::= SEQUENCE (SIZE(1..16)) OF DSCH-FlowControlItem
DSCH-FlowControlItem ::= SEQUENCE {
dsch-SchedulingPriority SchedulingPriorityIndicator,
mac-c-sh-SDU-Lengths MAC-c-sh-SDU-LengthList,
iE-Extensions ProtocolExtensionContainer { {DSCH-FlowControlItem-ExtIEs} } OPTIONAL,
...
}
DSCH-FlowControlItem-ExtIEs RNSAP-PROTOCOL-EXTENSION ::= {
...
}
DSCH-ID ::= INTEGER (0..255)
DSCH-TDD-Information ::= SEQUENCE (SIZE (1..maxNoOfDSCHs)) OF DSCH-TDD-InformationItem
DSCH-TDD-InformationItem ::= SEQUENCE {
dsch-ID DSCH-ID,

```

```

dl-ccTrCHID                CCTrCH-ID, -- DL CCTrCH in which the DSCH is mapped
trChSourceStatisticsDescriptor TrCH-SrcStatisticsDescr,
transportFormatSet          TransportFormatSet,
allocationRetentionPriority  AllocationRetentionPriority,
schedulingPriorityIndicator  SchedulingPriorityIndicator,
bLER                        BLER,
iE-Extensions               ProtocolExtensionContainer { {DSCH-TDD-InformationItem-ExtIEs} } OPTIONAL,
...
}

DSCH-TDD-InformationItem-ExtIEs RNSAP-PROTOCOL-EXTENSION ::= {
...
}

-- E

EventA ::= SEQUENCE {
  measurementTreshold      MeasurementThreshold,
  measurementHysteresisTime MeasurementHysteresisTime      OPTIONAL,
  iE-Extensions            ProtocolExtensionContainer { {EventA-ExtIEs} } OPTIONAL,
  ...
}

EventA-ExtIEs RNSAP-PROTOCOL-EXTENSION ::= {
...
}

EventB ::= SEQUENCE {
  measurementTreshold      MeasurementThreshold,
  measurementHysteresisTime MeasurementHysteresisTime      OPTIONAL,
  iE-Extensions            ProtocolExtensionContainer { {EventB-ExtIEs} } OPTIONAL,
  ...
}

EventB-ExtIEs RNSAP-PROTOCOL-EXTENSION ::= {
...
}

EventC ::= SEQUENCE {
  measurementIncreaseDecreaseThreshold MeasurementIncreaseDecreaseThreshold,
  measurementChangeTime      MeasurementChangeTime,
  iE-Extensions              ProtocolExtensionContainer { {EventC-ExtIEs} } OPTIONAL,
  ...
}

EventC-ExtIEs RNSAP-PROTOCOL-EXTENSION ::= {
...
}

EventD ::= SEQUENCE {
  measurementIncreaseDecreaseThreshold MeasurementIncreaseDecreaseThreshold,
  measurementChangeTime      MeasurementChangeTime,
  iE-Extensions              ProtocolExtensionContainer { {EventD-ExtIEs} } OPTIONAL,

```

```

    ...
}

EventD-ExtIEs RNSAP-PROTOCOL-EXTENSION ::= {
    ...
}

EventE ::= SEQUENCE {
    measurementThreshold1      MeasurementThreshold,
    measurementThreshold2      MeasurementThreshold      OPTIONAL,
    measurementHysteresisTime  MeasurementHysteresisTime  OPTIONAL,
    reportPeriodicity          ReportPeriodicity          OPTIONAL,
    iE-Extensions              ProtocolExtensionContainer { {EventE-ExtIEs} } OPTIONAL,
    ...
}

EventE-ExtIEs RNSAP-PROTOCOL-EXTENSION ::= {
    ...
}

EventF ::= SEQUENCE {
    measurementThreshold1      MeasurementThreshold,
    measurementThreshold2      MeasurementThreshold      OPTIONAL,
    measurementHysteresisTime  MeasurementHysteresisTime  OPTIONAL,
    reportPeriodicity          ReportPeriodicity          OPTIONAL,
    iE-Extensions              ProtocolExtensionContainer { {EventF-ExtIEs} } OPTIONAL,
    ...
}

EventF-ExtIEs RNSAP-PROTOCOL-EXTENSION ::= {
    ...
}

ExtendedGSMCellIndividualOffset ::= INTEGER (-50..-11|11..50)

-- F

FACH-FlowControlInformation ::= SEQUENCE (SIZE (1..16)) OF FACH-FlowControlInformationItem

FACH-FlowControlInformationItem ::= SEQUENCE {
    fACH-SchedulingPriority      SchedulingPriorityIndicator,
    mAC-c-sh-SDU-Lengths        MAC-c-sh-SDU-LengthList,
    fACH-InitialWindowSize      FACH-InitialWindowSize,
    iE-Extensions              ProtocolExtensionContainer { {FACH-FlowControlInformationItem-ExtIEs} } OPTIONAL,
    ...
}

FACH-FlowControlInformationItem-ExtIEs RNSAP-PROTOCOL-EXTENSION ::= {
    ...
}

FACH-InitialWindowSize ::= INTEGER { unlimited(255) } (0..255)
-- Number of frames MAC-c-sh SDUs.
-- 255 = Unlimited number of FACH data frames

```

```

FACH-InformationList ::= SEQUENCE (SIZE(0.. maxNrOfFACHs)) OF FACH-InformationItem

FACH-InformationItem ::= SEQUENCE {
    transportFormatSet      TransportFormatSet,
    iE-Extensions           ProtocolExtensionContainer { { FACH-InformationItem-ExtIEs } } OPTIONAL,
    ...
}

FACH-InformationItem-ExtIEs RNSAP-PROTOCOL-EXTENSION ::= {
    ...
}

FACH-PCH-InformationList ::= SEQUENCE (SIZE(1..maxFACHCountPlus1)) OF FACH-PCH-InformationItem

FACH-PCH-InformationItem ::= SEQUENCE {
    transportFormatSet      TransportFormatSet,
    iE-Extensions           ProtocolExtensionContainer { { FACH-PCH-InformationItem-ExtIEs } } OPTIONAL,
    ...
}

FACH-PCH-InformationItem-ExtIEs RNSAP-PROTOCOL-EXTENSION ::= {
    ...
}

FDD-DCHs-to-Modify          ::= SEQUENCE (SIZE (1..maxNrOfDCHs)) OF FDD-DCHs-to-ModifyItem

FDD-DCHs-to-ModifyItem ::= SEQUENCE {
    ul-FP-Mode              UL-FP-Mode          OPTIONAL,
    toAWS                   ToAWS              OPTIONAL,
    toAWE                   ToAWE              OPTIONAL,
    transportBearerRequestIndicator TransportBearerRequestIndicator,
    dCH-SpecificInformationList FDD-DCHs-to-ModifySpecificInformationList,
    iE-Extensions           ProtocolExtensionContainer { {FDD-DCHs-to-ModifyItem-ExtIEs} } OPTIONAL,
    ...
}

FDD-DCHs-to-ModifyItem-ExtIEs RNSAP-PROTOCOL-EXTENSION ::= {
    ...
}

FDD-DCHs-to-ModifySpecificInformationList ::= SEQUENCE (SIZE (1..maxNrOfDCHs)) OF FDD-DCHs-to-ModifySpecificItem

FDD-DCHs-to-ModifySpecificItem ::= SEQUENCE {
    dCH-ID                  DCH-ID,
    ul-TransportformatSet   TransportFormatSet      OPTIONAL,
    dl-TransportformatSet   TransportFormatSet      OPTIONAL,
    allocationRetentionPriority AllocationRetentionPriority  OPTIONAL,
    frameHandlingPriority   FrameHandlingPriority    OPTIONAL,
    dRACControl             DRACControl          OPTIONAL,
    iE-Extensions           ProtocolExtensionContainer { {FDD-DCHs-to-ModifySpecificItem-ExtIEs} } OPTIONAL,
    ...
}

```

```

FDD-DCHs-to-ModifySpecificItem-ExtIEs RNSAP-PROTOCOL-EXTENSION ::= {
    ...
}

FDD-DL-ChannelisationCodeNumber ::= INTEGER (0..511)
-- According to the mapping in [27]. The maximum value is equal to the DL spreading factor -1--

FDD-DL-CodeInformation ::= SEQUENCE (SIZE (1..maxNrOfDL-Codes)) OF FDD-DL-CodeInformationItem

FDD-DL-CodeInformationItem ::= SEQUENCE {
    dl-ScramblingCode                DL-ScramblingCode,
    fdd-DL-ChannelisationCodeNumber  FDD-DL-ChannelisationCodeNumber,
    transmission-Gap-Pattern-Sequence-ScramblingCode-Information  Transmission-Gap-Pattern-Sequence-ScramblingCode-Information OPTIONAL,
    iE-Extensions                    ProtocolExtensionContainer { {FDD-DL-CodeInformationItem-ExtIEs} } OPTIONAL,
    ...
}

FDD-DL-CodeInformationItem-ExtIEs RNSAP-PROTOCOL-EXTENSION ::= {
    ...
}

FDD-S-CCPCH-Offset ::= INTEGER (0..149)

FDD-TPC-DownlinkStepSize ::= ENUMERATED {
    step-size0-5,
    step-size1,
    step-size1-5,
    step-size2,
    ...
}

SchedulingPriorityIndicator ::= INTEGER { lowest(0), highest(15) } (0..15)

FirstRLS-Indicator ::= ENUMERATED {
    first-RLS,
    not-first-RLS
}

FNReportingIndicator ::= ENUMERATED {
    fN-reporting-required,
    fN-reporting-not-required
}

FrameHandlingPriority ::= INTEGER { lowest(0), highest(15) } (0..15)

FrameOffset ::= INTEGER (0..255)
-- Frames

-- G

GapLength ::= INTEGER (1..14)
-- Unit Slot

GapDuration ::= INTEGER (1..144,...)

```



```

-- Unit Frame

GA-Cell ::= SEQUENCE (SIZE (1..maxNrOfPoints)) OF
  SEQUENCE {
    geographicalCoordinate      GeographicalCoordinate,
    iE-Extensions                ProtocolExtensionContainer { {GA-Cell-ExtIEs} } OPTIONAL,
    ...
  }

GA-Cell-ExtIEs RNSAP-PROTOCOL-EXTENSION ::= {
  ...
}

GA-AccessPointPosition ::= SEQUENCE {
  geographicalCoordinate      GeographicalCoordinate,
  iE-Extensions                ProtocolExtensionContainer { {GA-AccessPoint-ExtIEs} } OPTIONAL,
  ...
}

GA-AccessPoint-ExtIEs RNSAP-PROTOCOL-EXTENSION ::= {
  ...
}

GeographicalCoordinate ::= SEQUENCE {
  latitudeSign                ENUMERATED { north, south },
  latitude                    INTEGER (0..8388607),
  longitude                    INTEGER (-8388608..8388607),
  iE-Extensions                ProtocolExtensionContainer { {GeographicalCoordinate-ExtIEs} } OPTIONAL,
  ...
}

GeographicalCoordinate-ExtIEs RNSAP-PROTOCOL-EXTENSION ::= {
  ...
}

-- H

-- I

IB-SchedulingInformation ::= SEQUENCE {
  iB-SG-Rep                    IB-SG-REP,
  iB-segmentInformationList    IB-SegmentInformationList,
  iE-Extensions                ProtocolExtensionContainer { { IB-SchedulingInformation-ExtIEs } } OPTIONAL,
  ...
}

IB-SchedulingInformation-ExtIEs RNSAP-PROTOCOL-EXTENSION ::= {
  ...
}

IB-SegmentInformationList ::= SEQUENCE (SIZE(1..maxIBSEG)) OF IB-SegmentInformationItem

IB-SegmentInformationItem ::= SEQUENCE {
  iB-SG-POS                    IB-SG-POS,

```

```

    iE-Extensions          ProtocolExtensionContainer { { IB-SegmentInformationItem-ExtIEs } } OPTIONAL,
    ...
}

IB-SegmentInformationItem-ExtIEs RNSAP-PROTOCOL-EXTENSION ::= {
    ...
}

IB-SG-POS ::= INTEGER (0..4094)
-- Only even positions allowed

IB-SG-REP ::= ENUMERATED {rep4, rep8, rep16, rep32, rep64, rep128, rep256, rep512, rep1024, rep2048, rep4096}

IMSI ::= OCTET STRING (SIZE(3..8))

InnerLoopDLPCStatus ::= ENUMERATED {active, inactive}

-- J
-- K
-- L

LAC ::= OCTET STRING (SIZE (2)) --(EXCEPT ('0000'H|'FFFE'H))

LengthOfTFCI2 ::= INTEGER(1..10)

LimitedPowerIncrease ::= ENUMERATED {
    used,
    not-used
}

L3-Information ::= BIT STRING

-- M

MaxNrOfUL-DPCHs ::= INTEGER (1..6)

MAC-c-sh-SDU-Length ::= INTEGER (1..5000)

MAC-c-sh-SDU-LengthList ::= SEQUENCE(SIZE(1..maxNrOfMACcshSDU-Length)) OF MAC-c-sh-SDU-Length

MaximumAllowedULTxPower ::= INTEGER (-50..33)

MaxNrDLPhysicalchannels ::= INTEGER (1..224)

MaxNrTimeslots ::= INTEGER (1..14)

MaxNrULPhysicalchannels ::= INTEGER (1..2)

MaxTFCIvalue ::= INTEGER (1..1023)

MeasurementFilterCoefficient ::= ENUMERATED{k0, k1, k2, k3, k4, k5, k6, k7, k8, k9, k11, k13, k15, k17, k19,...}
-- Measurement Filter Coefficient to be used for measurement

MeasurementID ::= INTEGER (0..1048575)

```

```

MinimumSpreadingFactor ::= INTEGER (1..16)

Multi-code-info ::= INTEGER (1..16)

MultipleURAsIndicator ::= ENUMERATED {
    multiple-URAs-exist,
    single-URA-exists
}

MaxAdjustmentStep ::= INTEGER(1..10)
-- Unit Slot

MeasurementChangeTime ::= INTEGER (1..6000,...)
-- The MeasurementChangeTime gives the MeasurementChangeTime
-- in number of 10 ms periods.
-- E.g. Value 6000 means 60000ms(1min)
-- Unit is ms, Step is 10 ms

MeasurementHysteresisTime ::= INTEGER (1..6000,...)
-- The MeasurementHysteresisTime gives the
-- MeasurementHysteresisTime in number of 10 ms periods.
-- E.g. Value 6000 means 60000ms(1min)
-- Unit is ms, Step is 10ms

MeasurementIncreaseDecreaseThreshold ::= CHOICE {
    sir SIR-Value-IncrDecrThres,
    sir-error SIR-Error-Value-IncrDecrThres,
    transmitted-code-power Transmitted-Code-Power-Value-IncrDecrThres,
    rscp RSCP-Value-IncrDecrThres,
    round-trip-time Round-Trip-Time-IncrDecrThres,
    ...
}

MeasurementThreshold ::= CHOICE {
    sir SIR-Value,
    sir-error SIR-Error-Value,
    transmitted-code-power Transmitted-Code-Power-Value,
    rscp RSCP-Value,
    rx-timing-deviation Rx-Timing-Deviation-Value,
    round-trip-time Round-Trip-Time-Value,
    ...
}

MidambleConfigurationBurstType1And3 ::= ENUMERATED {v4, v8, v16}

MidambleConfigurationBurstType2 ::= ENUMERATED {v3, v6}

MidambleShiftAndBurstType ::= CHOICE {
    type1 SEQUENCE {
        midambleConfigurationBurstType1And3 MidambleConfigurationBurstType1And3,
        midambleAllocationMode CHOICE {
            defaultMidamble NULL,
            commonMidamble NULL,
        }
    }
}

```

```

        ueSpecificMidamble                MidambleShiftLong,
        ...
    },
    ...
},
type2                SEQUENCE {
    midambleConfigurationBurstType2      MidambleConfigurationBurstType2,
    midambleAllocationMode                CHOICE {
        defaultMidamble                    NULL,
        commonMidamble                     NULL,
        ueSpecificMidamble                 MidambleShiftShort,
        ...
    },
    ...
},
type3                SEQUENCE {
    midambleConfigurationBurstType1And3  MidambleConfigurationBurstType1And3,
    midambleAllocationMode                CHOICE {
        defaultMidamble                    NULL,
        ueSpecificMidamble                 MidambleShiftLong,
        ...
    },
    ...
},
...
}

MidambleShiftLong ::= INTEGER (0..15)

MidambleShiftShort ::= INTEGER (0..5)

MinUL-ChannelisationCodeLength ::= ENUMERATED {
    v4,
    v8,
    v16,
    v32,
    v64,
    v128,
    v256
}

MultiplexingPosition ::= ENUMERATED {
    fixed,
    flexible
}

-- N

NCC ::= BIT STRING (SIZE (3))

Neighbouring-UMTS-CellInformation ::= SEQUENCE (SIZE (1..maxNrOfNeighbouringRNCs)) OF ProtocolIE-Single-Container {{ Neighbouring-UMTS-CellInformationItemIE }}

Neighbouring-UMTS-CellInformationItemIE RNSAP-PROTOCOL-IES ::= {

```

```

    { ID id-Neighbouring-UMTS-CellInformationItem CRITICALITY ignore TYPE Neighbouring-UMTS-CellInformationItem PRESENCE mandatory }
}

```

```

Neighbouring-UMTS-CellInformationItem ::= SEQUENCE {
    rNC-ID RNC-ID,
    cN-PS-DomainIdentifier CN-PS-DomainIdentifier OPTIONAL,
    cN-CS-DomainIdentifier CN-CS-DomainIdentifier OPTIONAL,
    neighbouring-FDD-CellInformation Neighbouring-FDD-CellInformation OPTIONAL,
    neighbouring-TDD-CellInformation Neighbouring-TDD-CellInformation OPTIONAL,
    iE-Extensions ProtocolExtensionContainer { { Neighbouring-UMTS-CellInformationItem-ExtIEs } } OPTIONAL,
    ...
}

```

```

Neighbouring-UMTS-CellInformationItem-ExtIEs RNSAP-PROTOCOL-EXTENSION ::= {
    ...
}

```

```

Neighbouring-FDD-CellInformation ::= SEQUENCE ( SIZE (1..maxNrOfFDDNeighboursPerRNC,...)) OF Neighbouring-FDD-CellInformationItem

```

```

Neighbouring-FDD-CellInformationItem ::= SEQUENCE {
    c-ID C-ID,
    uARFCNforNu UARFCN,
    uARFCNforNd UARFCN,
    frameOffset FrameOffset OPTIONAL,
    primaryScramblingCode PrimaryScramblingCode,
    primaryCPICH-Power PrimaryCPICH-Power OPTIONAL,
    cellIndividualOffset CellIndividualOffset OPTIONAL,
    txDiversityIndicator TxDiversityIndicator,
    sTTD-SupportIndicator STTD-SupportIndicator OPTIONAL,
    closedLoopMode1-SupportIndicator ClosedLoopMode1-SupportIndicator OPTIONAL,
    closedLoopMode2-SupportIndicator ClosedLoopMode2-SupportIndicator OPTIONAL,
    iE-Extensions ProtocolExtensionContainer { { Neighbouring-FDD-CellInformationItem-ExtIEs } } OPTIONAL,
    ...
}

```

```

Neighbouring-FDD-CellInformationItem-ExtIEs RNSAP-PROTOCOL-EXTENSION ::= {
    { ID id-RestrictionStateIndicator CRITICALITY ignore EXTENSION RestrictionStateIndicator PRESENCE optional },
    ...
}

```

```

Neighbouring-GSM-CellInformation ::= ProtocolIE-Single-Container {{ Neighbouring-GSM-CellInformationIE }}

```

```

Neighbouring-GSM-CellInformationIE RNSAP-PROTOCOL-IES ::= {
    { ID id-Neighbouring-GSM-CellInformation CRITICALITY ignore TYPE Neighbouring-GSM-CellInformationIEs PRESENCE mandatory }
}

```

```

Neighbouring-GSM-CellInformationIEs ::= SEQUENCE ( SIZE (1..maxNrOfGSMNeighboursPerRNC,...)) OF Neighbouring-GSM-CellInformationItem

```

```

Neighbouring-GSM-CellInformationItem ::= SEQUENCE {
    CGI CGI,
    cellIndividualOffset CellIndividualOffset OPTIONAL,
    bSIC BSIC,
    band-Indicator Band-Indicator,
    bCCH-ARFCN BCCH-ARFCN,
}

```

```

    iE-Extensions          ProtocolExtensionContainer { { Neighbouring-GSM-CellInformationItem-ExtIEs} } OPTIONAL,
    ...
}

Neighbouring-GSM-CellInformationItem-ExtIEs RNSAP-PROTOCOL-EXTENSION ::= {
{ ID id-ExtendedGSMCellIndividualOffset          CRITICALITY ignore          EXTENSION ExtendedGSMCellIndividualOffset  PRESENCE optional},
    ...
}

Neighbouring-TDD-CellInformation ::= SEQUENCE ( SIZE (1..maxNrOfTDDNeighboursPerRNC,...)) OF Neighbouring-TDD-CellInformationItem

Neighbouring-TDD-CellInformationItem ::= SEQUENCE {
    c-ID                    C-ID,
    uARFCNforNt             UARFCN,
    frameOffset             FrameOffset          OPTIONAL,
    cellParameterID        CellParameterID,
    syncCase                SyncCase,
    timeSlot                TimeSlot            OPTIONAL
    -- This IE shall be present if Sync Case = Case1 -- ,
    sCH-TimeSlot            SCH-TimeSlot        OPTIONAL
    -- This IE shall be present if Sync Case = Case2 -- ,
    sCTD-Indicator          SCTD-Indicator,
    cellIndividualOffset    CellIndividualOffset OPTIONAL,
    dPCHConstantValue       DPCHConstantValue  OPTIONAL,
    pCCPCH-Power            PCCPCH-Power       OPTIONAL,
    iE-Extensions          ProtocolExtensionContainer { { Neighbouring-TDD-CellInformationItem-ExtIEs} } OPTIONAL,
    ...
}

Neighbouring-TDD-CellInformationItem-ExtIEs RNSAP-PROTOCOL-EXTENSION ::= {
{ ID id-RestrictionStateIndicator          CRITICALITY ignore          EXTENSION RestrictionStateIndicator  PRESENCE optional },
    ...
}

NrOfDLchannelisationcodes ::= INTEGER (1..8)

NrOfTransportBlocks       ::= INTEGER (0..512)

-- O

-- P

PagingCause ::= ENUMERATED {
    terminating-conversational-call,
    terminating-streaming-call,
    terminating-interactive-call,
    terminating-background-call,
    terminating-low-priority-signalling,
    ...,
    terminating-high-priority-signalling,
    terminating-cause-unknown
}
-- See in [16]

```

```

PagingRecordType ::= ENUMERATED {
    imsi-gsm-map,
    tmsi-gsm-map,
    p-tmsi-gsm-map,
    imsi-ds-41,
    tmsi-ds-41,
    ...
}
-- See in [16]

PayloadCRC-PresenceIndicator ::= ENUMERATED {
    crc-included,
    crc-not-included
}

PCCPCH-Power ::= INTEGER (-150..400,...)
-- PCCPCH-power = power * 10
-- If power <= -15 PCCPCH shall be set to -150
-- If power >= 40 PCCPCH shall be set to 400
-- Unit dBm, Range -15dBm .. +40 dBm, Step 0.1dBm

PCH-InformationList ::= SEQUENCE (SIZE(0..1)) OF PCH-InformationItem

PCH-InformationItem ::= SEQUENCE {
    transportFormatSet          TransportFormatSet,
    iE-Extensions                ProtocolExtensionContainer { { PCH-InformationItem-ExtIEs } } OPTIONAL,
    ...
}

PCH-InformationItem-ExtIEs RNSAP-PROTOCOL-EXTENSION ::= {
    ...
}

PC-Preamble ::= INTEGER(0..7,...)

PDSCHCodeMapping ::= SEQUENCE {
    dL-ScramblingCode           DL-ScramblingCode,
    signallingMethod             PDSCHCodeMapping-SignallingMethod,
    iE-Extensions                ProtocolExtensionContainer { { PDSCHCodeMapping-ExtIEs } } OPTIONAL,
    ...
}

PDSCHCodeMapping-ExtIEs RNSAP-PROTOCOL-EXTENSION ::= {
    ...
}

PDSCHCodeMapping-SignallingMethod ::= CHOICE {
    pDSCHCodeMapping-SignallingMethod-CodeRange,
    PDSCHCodeMapping-SignallingMethod-TFCIRange,
    PDSCHCodeMapping-SignallingMethod-Explicit,
    ...,
    pDSCHCodeMapping-SignallingMethod-Replace          PDSCHCodeMapping-SignallingMethod-Replace
}

```

```

PDSCHCodeMapping-SignallingMethod-CodeRange ::= SEQUENCE (SIZE (1..maxNoCodeGroups)) OF
SEQUENCE {
    spreadingFactor          SpreadingFactor,
    multi-code-info         Multi-code-info,
    start-CodeNumber        CodeNumber,
    stop-CodeNumber         CodeNumber,
    iE-Extensions           ProtocolExtensionContainer { { PDSCHCodeMapping-SignallingMethod-CodeRange-ExtIEs } } OPTIONAL,
    ...
}

PDSCHCodeMapping-SignallingMethod-CodeRange-ExtIEs RNSAP-PROTOCOL-EXTENSION ::= {
    ...
}

PDSCHCodeMapping-SignallingMethod-TFCIRange ::= SEQUENCE (SIZE (1..maxNoTFCIGroups)) OF
SEQUENCE {
    maxTFCIvalue            MaxTFCIvalue,
    spreadingFactor         SpreadingFactor,
    multi-code-info         Multi-code-info,
    codeNumber              CodeNumber,
    iE-Extensions           ProtocolExtensionContainer { { PDSCHCodeMapping-SignallingMethod-TFCIRange-ExtIEs } } OPTIONAL,
    ...
}

PDSCHCodeMapping-SignallingMethod-TFCIRange-ExtIEs RNSAP-PROTOCOL-EXTENSION ::= {
    ...
}

PDSCHCodeMapping-SignallingMethod-Explicit ::= SEQUENCE (SIZE (1..maxTFCI2Combs)) OF
SEQUENCE {
    spreadingFactor          SpreadingFactor,
    multi-code-info         Multi-code-info,
    codeNumber              CodeNumber,
    iE-Extensions           ProtocolExtensionContainer { { PDSCHCodeMapping-SignallingMethod-Explicit-ExtIEs } } OPTIONAL,
    ...
}

PDSCHCodeMapping-SignallingMethod-Explicit-ExtIEs RNSAP-PROTOCOL-EXTENSION ::= {
    ...
}

PDSCHCodeMapping-SignallingMethod-Replace ::= SEQUENCE (SIZE (1..maxTFCI2Combs)) OF
SEQUENCE {
    tfci-Field2             TFCI-MaxTFCI-field2-Value,
    spreadingFactor         SpreadingFactor,
    multi-CodeInfo          Multi-code-info,
    codeNumber              CodeNumber,
    iE-Extensions           ProtocolExtensionContainer { { PDSCHCodeMapping-SignallingMethod-Replace-ExtIEs } } OPTIONAL,
    ...
}

PDSCHCodeMapping-SignallingMethod-Replace-ExtIEs RNSAP-PROTOCOL-EXTENSION ::= {
    ...
}

```



```

Periodic ::= SEQUENCE {
    reportPeriodicity      ReportPeriodicity,
    iE-Extensions          ProtocolExtensionContainer { {Periodic-ExtIEs} } OPTIONAL,
    ...
}

Periodic-ExtIEs RNSAP-PROTOCOL-EXTENSION ::= {
    ...
}

Permanent-NAS-UE-Identity ::= CHOICE {
    imsi      IMSI,
    ...
}

PLMN-Identity ::= OCTET STRING (SIZE(3))

PowerAdjustmentType ::= ENUMERATED {
    none,
    common,
    individual
}

PowerOffset ::= INTEGER (0..24)

Pre-emptionCapability ::= ENUMERATED {
    shall-not-trigger-pre-emption,
    may-trigger-pre-emption
}

Pre-emptionVulnerability ::= ENUMERATED {
    not-pre-emptable,
    pre-emptable
}

PrimaryCPICH-Power ::= INTEGER (-100..500)
-- step 0.1 (Range -10.0..50.0) Unit is dBm

PrimaryCPICH-EcNo ::= INTEGER (-30..30)

PrimaryCCPCH-RSCP ::= INTEGER (0..91)
-- According to mapping in [14]

PrimaryScramblingCode ::= INTEGER (0..511)

PriorityLevel ::= INTEGER (0..15)
-- 0 = spare, 1 = highest priority, ...14 = lowest priority and 15 = no priority

PropagationDelay ::= INTEGER (0..255)

PunctureLimit ::= INTEGER (0..15)
-- 0: 40%; 1: 44%; ... 14: 96%; 15: 100

```

```
-- Q
QE-Selector ::= ENUMERATED {
    selected,
    non-selected
}

-- R
RAC ::= OCTET STRING (SIZE(1))

RANAP-RelocationInformation ::= BIT STRING

RateMatchingAttribute ::= INTEGER (1..maxRateMatching)

RB-Identity ::= INTEGER (0..31)

RB-Info ::= SEQUENCE (SIZE(1..maxNoOfRB)) OF RB-Identity

RefTFCNumber ::= INTEGER (0..15)

RepetitionLength ::= INTEGER (1..63)

RepetitionPeriod ::= ENUMERATED {
    v1,
    v2,
    v4,
    v8,
    v16,
    v32,
    v64
}

RepetitionNumber0 ::= INTEGER (0..255)

RepetitionNumber1 ::= INTEGER (1..256)

ReportCharacteristics ::= CHOICE {
    onDemand        NULL,
    periodic        Periodic,
    eventA          EventA,
    eventB          EventB,
    eventC          EventC,
    eventD          EventD,
    eventE          EventE,
    eventF          EventF,
    ...
}

ReportPeriodicity ::= CHOICE {
    ten-msec        INTEGER (1..6000,...),
    -- The Report Periodicity gives the reporting periodicity in number of 10 ms periods.
    -- E.g. value 6000 means 60000ms (i.e. 1min)
    -- Unit ms, Step 10ms
```

```

    min          INTEGER (1..60,...),
-- Unit min, Step 1min
    ...
}

RestrictionStateIndicator ::= ENUMERATED {
    cellNotResevedForOperatorUse,
    cellResevedForOperatorUse,
    ...
}

RL-ID ::= INTEGER (0..31)

RL-Set-ID ::= INTEGER (0..31)

RNC-ID ::= INTEGER (0..4095)

Round-Trip-Time-IncrDecrThres ::= INTEGER(0..32766)

Round-Trip-Time-Value ::= INTEGER(0..32767)
-- According to mapping in [23]

RSCP-Value ::= INTEGER (0..127)
-- According to mapping in [24]

RSCP-Value-IncrDecrThres ::= INTEGER (0..126)

Received-total-wide-band-power ::= INTEGER (0..621)
-- According to mapping in [23]

RxTimingDeviationForTA ::= INTEGER (0..127)
-- As specified in [5], ch. 6.2.7.6

Rx-Timing-Deviation-Value ::= INTEGER (0..8191)

-- S

SAC ::= OCTET STRING (SIZE (2))

SAI ::= SEQUENCE {
    pLMN-Identity    PLMN-Identity,
    LAC              LAC,
    sAC              SAC,
    iE-Extensions   ProtocolExtensionContainer { {SAI-ExtIEs} } OPTIONAL
}

SAI-ExtIEs RNSAP-PROTOCOL-EXTENSION ::= {
    ...
}

SCH-TimeSlot ::= INTEGER (0..6)

ScaledAdjustmentRatio ::= INTEGER(0..100)
-- AdjustmentRatio = ScaledAdjustmentRatio / 100

```

```

Secondary-CCPCH-Info ::= SEQUENCE {
    fdd-s-ccpch-offset          FDD-S-CCPCH-Offset,
    dl-scramblingCode          DL-ScramblingCode,
    fdd-dl-channelisationCodeNumber FDD-DL-ChannelisationCodeNumber,
    dl-tfcs                    TFCS,
    secondaryCCPCH-SlotFormat  SecondaryCCPCH-SlotFormat,
    tfci-presence              TFCI-Presence OPTIONAL,
    -- This IE shall be present if the Secondary CCPCH Slot Format is equal to any of the values from 8 to 17
    multiplexingPosition      MultiplexingPosition,
    sttd-indicator            STTD-Indicator,
    fach-pch-informationList  FACH-PCH-InformationList,
    ib-schedulingInformation  IB-SchedulingInformation,
    ie-extensions             ProtocolExtensionContainer { { Secondary-CCPCH-Info-ExtIEs } } OPTIONAL,
    ...
}

Secondary-CCPCH-Info-ExtIEs RNSAP-PROTOCOL-EXTENSION ::= {
    ...
}

Secondary-CCPCH-Info-TDD ::= SEQUENCE {
    dl-tfcs                    TFCS,
    tfci-coding                TFCI-Coding,
    secondary-CCPCH-TDD-InformationList Secondary-CCPCH-TDD-InformationList,
    fach-informationList      FACH-InformationList,
    pch-informationList       PCH-InformationList,
    ie-extensions             ProtocolExtensionContainer { { Secondary-CCPCH-Info-TDD-ExtIEs } } OPTIONAL,
    ...
}

Secondary-CCPCH-Info-TDD-ExtIEs RNSAP-PROTOCOL-EXTENSION ::= {
    ...
}

Secondary-CCPCH-TDD-InformationList ::= SEQUENCE (SIZE(0.. maxNrOfSCCPCHs)) OF Secondary-CCPCH-TDD-InformationItem

Secondary-CCPCH-TDD-InformationItem ::= SEQUENCE {
    timeSlot                    TimeSlot,
    midambleShiftAndBurstType  MidambleShiftAndBurstType,
    tfci-presence              TFCI-Presence,
    secondary-CCPCH-TDD-Code-Information Secondary-CCPCH-TDD-Code-Information,
    tdd-physicalChannelOffset  TDD-PhysicalChannelOffset,
    repetitionLength          RepetitionLength,
    repetitionPeriod          RepetitionPeriod,
    ie-extensions             ProtocolExtensionContainer { { Secondary-CCPCH-TDD-InformationItem-ExtIEs } } OPTIONAL,
    ...
}

Secondary-CCPCH-TDD-InformationItem-ExtIEs RNSAP-PROTOCOL-EXTENSION ::= {
    ...
}

Secondary-CCPCH-TDD-Code-Information ::= SEQUENCE ( SIZE ( 1..maxNrOfSCCPCHs)) OF Secondary-CCPCH-TDD-Code-InformationItem

```

```
Secondary-CCPCH-TDD-Code-InformationItem ::= SEQUENCE {
    tDD-ChannelisationCode      TDD-ChannelisationCode,
    iE-Extensions               ProtocolExtensionContainer { {Secondary-CCPCH-TDD-Code-InformationItem-ExtIEs} } OPTIONAL,
    ...
}

Secondary-CCPCH-TDD-Code-InformationItem-ExtIEs RNSAP-PROTOCOL-EXTENSION ::= {
    ...
}

SecondInterleavingMode ::= ENUMERATED {
    frame-related,
    timeslot-related,
    ...
}

SIR-Error-Value          ::= INTEGER (0..125)

SIR-Error-Value-IncrDecrThres      ::= INTEGER (0..124)

SIR-Value                ::= INTEGER (0..63)
-- According to mapping in 25.215/25.225

SIR-Value-IncrDecrThres ::= INTEGER (0..62)

SecondaryCCPCH-SlotFormat      ::= INTEGER (0..17,...)
-- refer to 25.211

S-FieldLength               ::= ENUMERATED {
    v1,
    v2,
    ...
}

SpecialBurstScheduling ::= INTEGER (1..256)

SplitType ::= ENUMERATED {
    hard,
    logical
}

SpreadingFactor            ::= INTEGER (4| 8| 16| 32| 64| 128| 256)

S-RNTI                     ::= INTEGER (0..1048575)
-- From 0 to 2^20-1

SRB-Delay ::= INTEGER(0..7,...)

SSDT-CellID ::= ENUMERATED {
    a,
    b,
    c,
    d,
}
```

```

    e,
    f,
    g,
    h
}

SSDT-CellID-Length ::= ENUMERATED {
    short,
    medium,
    long
}

SSDT-Indication ::= ENUMERATED {
    sSDT-active-in-the-UE,
    sSDT-not-active-in-the-UE
}

SSDT-SupportIndicator ::= ENUMERATED {
    sSDT-supported,
    sSDT-not-supported
}

STTD-Indicator ::= ENUMERATED {
    active,
    inactive
}

STTD-SupportIndicator ::= ENUMERATED {
    sTTD-Supported,
    sTTD-not-Supported
}

SyncCase ::= INTEGER (1..2,...)

SynchronisationConfiguration ::= SEQUENCE {
    n-INSYNC-IND          INTEGER (1..256),
    n-OUTSYNC-IND        INTEGER (1..256),
    t-RLFFAILURE         INTEGER (0..255),
    -- Unit seconds, Range 0s .. 25.5s, Step 0.1s
    iE-Extensions       ProtocolExtensionContainer { { SynchronisationConfiguration-ExtIEs} } OPTIONAL,
    ...
}

SynchronisationConfiguration-ExtIEs RNSAP-PROTOCOL-EXTENSION ::= {
    ...
}

-- T

TDD-ChannelisationCode ::= ENUMERATED {
    chCode1div1,
    chCode2div1,
    chCode2div2,
    chCode4div1,

```

```

    chCode4div2,
    chCode4div3,
    chCode4div4,
    chCode8div1,
    chCode8div2,
    chCode8div3,
    chCode8div4,
    chCode8div5,
    chCode8div6,
    chCode8div7,
    chCode8div8,
    chCode16div1,
    chCode16div2,
    chCode16div3,
    chCode16div4,
    chCode16div5,
    chCode16div6,
    chCode16div7,
    chCode16div8,
    chCode16div9,
    chCode16div10,
    chCode16div11,
    chCode16div12,
    chCode16div13,
    chCode16div14,
    chCode16div15,
    chCode16div16,
    ...
}

TDD-DCHs-to-Modify ::= SEQUENCE (SIZE (1..maxNrOfDCHs)) OF TDD-DCHs-to-ModifyItem

TDD-DCHs-to-ModifyItem ::= SEQUENCE {
    ul-FP-Mode          UL-FP-Mode    OPTIONAL,
    toAWS              ToAWS         OPTIONAL,
    toAWE              ToAWE         OPTIONAL,
    transportBearerRequestIndicator TransportBearerRequestIndicator,
    dCH-SpecificInformationList TDD-DCHs-to-ModifySpecificInformationList,
    iE-Extensions      ProtocolExtensionContainer { {TDD-DCHs-to-ModifyItem-ExtIEs} } OPTIONAL,
    ...
}

TDD-DCHs-to-ModifyItem-ExtIEs RNSAP-PROTOCOL-EXTENSION ::= {
    ...
}

TDD-DCHs-to-ModifySpecificInformationList ::= SEQUENCE (SIZE (1..maxNrOfDCHs)) OF TDD-DCHs-to-ModifySpecificItem

TDD-DCHs-to-ModifySpecificItem ::= SEQUENCE {
    dCH-ID              DCH-ID,
    ul-CCTrCH-ID        CCTrCH-ID    OPTIONAL,
    dl-CCTrCH-ID        CCTrCH-ID    OPTIONAL,
    ul-TransportformatSet TransportFormatSet OPTIONAL,
    dl-TransportformatSet TransportFormatSet OPTIONAL,
}

```

```

    allocationRetentionPriority      AllocationRetentionPriority OPTIONAL,
    frameHandlingPriority            FrameHandlingPriority   OPTIONAL,
    iE-Extensions                    ProtocolExtensionContainer { {TDD-DCHs-to-ModifySpecificItem-ExtIEs} } OPTIONAL,
    ...
}

TDD-DCHs-to-ModifySpecificItem-ExtIEs RNSAP-PROTOCOL-EXTENSION ::= {
    ...
}

TDD-DL-Code-Information ::= SEQUENCE ( SIZE (1..maxNrOfDPCHs)) OF TDD-DL-Code-InformationItem

TDD-DL-Code-InformationItem ::= SEQUENCE {
    dPCH-ID                DPCH-ID,
    tDD-ChannelisationCode TDD-ChannelisationCode,
    iE-Extensions          ProtocolExtensionContainer { {TDD-DL-Code-InformationItem-ExtIEs} } OPTIONAL,
    ...
}

TDD-DL-Code-InformationItem-ExtIEs RNSAP-PROTOCOL-EXTENSION ::= {
    ...
}

TDD-DPCHOffset ::= CHOICE {
    initialOffset      INTEGER (0..255),
    noinitialOffset    INTEGER (0..63)
}

TDD-PhysicalChannelOffset ::= INTEGER (0..63)

TDD-TPC-DownlinkStepSize ::= ENUMERATED {
    step-size1,
    step-size2,
    step-size3,
    ...
}

TDD-UL-Code-Information ::= SEQUENCE ( SIZE (1..maxNrOfDPCHs)) OF TDD-UL-Code-InformationItem

TDD-UL-Code-InformationItem ::= SEQUENCE {
    dPCH-ID                DPCH-ID,
    tDD-ChannelisationCode TDD-ChannelisationCode,
    iE-Extensions          ProtocolExtensionContainer { {TDD-UL-Code-InformationItem-ExtIEs} } OPTIONAL,
    ...
}

TDD-UL-Code-InformationItem-ExtIEs RNSAP-PROTOCOL-EXTENSION ::= {
    ...
}

TFCI-Coding ::= ENUMERATED {
    v4,
    v8,
    v16,

```



```

    v32,
    ...
}

TFCI-Presence ::= ENUMERATED {
    present,
    not-present
}

TFCI-SignallingMode ::= ENUMERATED {
    normal,
    split
}

TGD ::= INTEGER (0..269)
-- 0 = Undefined, only one transmission gap in the transmission gap pattern sequence

TGPRC ::= INTEGER (0..511)
-- 0 = infinity

TGPSID ::= INTEGER (1.. maxTGPS)

TGSN ::= INTEGER (0..14)

TimeSlot ::= INTEGER (0..14)

TimingAdvanceApplied ::= ENUMERATED {
    yes,
    no
}

ToAWE ::= INTEGER (0..2559)

ToAWS ::= INTEGER (0..1279)

Transmission-Gap-Pattern-Sequence-Information ::= SEQUENCE (SIZE (1..maxTGPS)) OF
    SEQUENCE {
        tGPSID          TGPSID,
        tGSN            TGSN,
        tGL1            GapLength,
        tGL2            GapLength OPTIONAL,
        tGD             TGD,
        tGPL1           GapDuration,
        tGPL2           GapDuration OPTIONAL,
        uL-DL-mode      UL-DL-mode,
        downlink-Compressed-Mode-Method Downlink-Compressed-Mode-Method OPTIONAL,
        -- This IE shall be present if the value of the UL/DL mode IE is "DL only" or "UL/DL"
        uplink-Compressed-Mode-Method Uplink-Compressed-Mode-Method OPTIONAL,
        -- This IE shall be present if the value of the UL/DL mode IE is "UL only" or "UL/DL"
        dL-FrameType    DL-FrameType,
        delta-SIR1       DeltaSIR,
        delta-SIR-after1 DeltaSIR,
        delta-SIR2       DeltaSIR OPTIONAL,
        delta-SIR-after2 DeltaSIR OPTIONAL,
    }

```

```

        iE-Extensions          ProtocolExtensionContainer { {Transmission-Gap-Pattern-Sequence-Information-ExtIEs} } OPTIONAL,
        ...
    }

Transmission-Gap-Pattern-Sequence-Information-ExtIEs RNSAP-PROTOCOL-EXTENSION ::= {
    ...
}

Transmission-Gap-Pattern-Sequence-ScramblingCode-Information ::= ENUMERATED{
    code-change,
    nocode-change
}

Transmission-Gap-Pattern-Sequence-Status-List ::= SEQUENCE (SIZE (0..maxTGPS)) OF
    SEQUENCE {
        tGPSID          TGPSID,
        tGPRC           TGPRC,
        tGCFN           CFN,
        iE-Extensions  ProtocolExtensionContainer { { Transmission-Gap-Pattern-Sequence-Status-List-ExtIEs } } OPTIONAL,
        ...
    }

Transmission-Gap-Pattern-Sequence-Status-List-ExtIEs RNSAP-PROTOCOL-EXTENSION ::= {
    ...
}

TransmissionTimeIntervalDynamic ::= ENUMERATED {
    msec-10,
    msec-20,
    msec-40,
    msec-80,
    ...
}

TransmissionTimeIntervalSemiStatic ::= ENUMERATED {
    msec-10,
    msec-20,
    msec-40,
    msec-80,
    dynamic,
    ...
}

TransmitDiversityIndicator ::= ENUMERATED {
    active,
    inactive
}

TransportBearerID ::= INTEGER (0..4095)

TransportBearerRequestIndicator ::= ENUMERATED {
    bearer-requested,
    bearer-not-requested,
    ...
}

```

```

}

TransportBlockSize ::= INTEGER (0..5000)
-- Unit is bits

TransportFormatCombination-Beta ::= CHOICE {
    signalledGainFactors SEQUENCE {
        betaC BetaCD,
        betaD BetaCD,
        refTFCNumber RefTFCNumber OPTIONAL,
        iE-Extensions ProtocolExtensionContainer { { SignalledGainFactors-ExtIEs } } OPTIONAL,
        ...
    },
    refTFCNumber RefTFCNumber,
    ...
}

SignalledGainFactors-ExtIEs RNSAP-PROTOCOL-EXTENSION ::= {
    ...
}

TFCS ::= SEQUENCE {
    tFCSvalues CHOICE {
        no-Split-in-TFCI TFCS-TFCSList,
        split-in-TFCI SEQUENCE {
            transportFormatCombination-DCH TFCS-DCHList,
            signallingMethod CHOICE {
                tFCI-Range TFCS-MappingOnDSCHList,
                explicit TFCS-DSCHList,
                ...
            },
            iE-Extensions ProtocolExtensionContainer { { Split-in-TFCI-ExtIEs } } OPTIONAL,
            ...
        },
        ...
    },
    iE-Extensions ProtocolExtensionContainer { { TFCS-ExtIEs } } OPTIONAL,
    ...
}

Split-in-TFCI-ExtIEs RNSAP-PROTOCOL-EXTENSION ::= {
    ...
}

TFCS-ExtIEs RNSAP-PROTOCOL-EXTENSION ::= {
    ...
}

TFCS-TFCSList ::= SEQUENCE (SIZE (1..maxNrOfTFCS)) OF
SEQUENCE {
    cTFC TFCS-CTFC,
    tFC-Beta TransportFormatCombination-Beta OPTIONAL,
    -- The IE shall be present if the TFCS concerns a UL DPCH [FDD - or PRACH channel in FDD].--
    iE-Extensions ProtocolExtensionContainer { { TFCS-TFCSList-ExtIEs } } OPTIONAL,
}

```

```

    ...
}

TFCS-TFCSList-ExtIEs RNSAP-PROTOCOL-EXTENSION ::= {
    ...
}

TFCS-CTFC ::= CHOICE {
    ctfc2bit          INTEGER (0..3),
    ctfc4bit          INTEGER (0..15),
    ctfc6bit          INTEGER (0..63),
    ctfc8bit          INTEGER (0..255),
    ctfc12bit         INTEGER (0..4095),
    ctfc16bit         INTEGER (0..65535),
    ctfcmaxbit        INTEGER (0..maxCTFC)
}

TFCS-DCHList ::= SEQUENCE (SIZE (1..maxTFCI1Combs)) OF
    SEQUENCE {
        cTFC          TFCS-CTFC,
        iE-Extensions ProtocolExtensionContainer { { TFCS-DCHList-ExtIEs } } OPTIONAL,
        ...
    }

TFCS-DCHList-ExtIEs RNSAP-PROTOCOL-EXTENSION ::= {
    ...
}

TFCS-MappingOnDSCHList ::= SEQUENCE (SIZE (1..maxNoTFCIGroups)) OF
    SEQUENCE {
        maxTFCI-field2-Value    TFCS-MaxTFCI-field2-Value,
        cTFC-DSCH              TFCS-CTFC,
        iE-Extensions          ProtocolExtensionContainer { { TFCS-MappingOnDSCHList-ExtIEs } } OPTIONAL,
        ...
    }

TFCS-MappingOnDSCHList-ExtIEs RNSAP-PROTOCOL-EXTENSION ::= {
    ...
}

TFCS-MaxTFCI-field2-Value ::= INTEGER (1..maxTFCI2Combs-1)

TFCS-DSCHList ::= SEQUENCE (SIZE (1..maxTFCI2Combs)) OF
    SEQUENCE {
        cTFC-DSCH          TFCS-CTFC,
        iE-Extensions      ProtocolExtensionContainer { { TFCS-DSCHList-ExtIEs } } OPTIONAL,
        ...
    }

TFCS-DSCHList-ExtIEs RNSAP-PROTOCOL-EXTENSION ::= {
    ...
}

TransportFormatSet ::= SEQUENCE {

```

```

dynamicParts          TransportFormatSet-DynamicPartList,
semi-staticPart      TransportFormatSet-Semi-staticPart,
iE-Extensions        ProtocolExtensionContainer { {TransportFormatSet-ExtIEs} } OPTIONAL,
...
}

TransportFormatSet-ExtIEs RNSAP-PROTOCOL-EXTENSION ::= {
...
}

TransportFormatSet-DynamicPartList ::= SEQUENCE (SIZE (1..maxNrOfTFs)) OF
SEQUENCE {
nrOfTransportBlocks  NrOfTransportBlocks,
transportBlockSize   TransportBlockSize OPTIONAL
-- This IE shall be present if nrOfTransportBlocks is greater than 0 --,
mode                 TransportFormatSet-ModeDP,
iE-Extensions        ProtocolExtensionContainer { {TransportFormatSet-DynamicPartList-ExtIEs} } OPTIONAL,
...
}

TransportFormatSet-DynamicPartList-ExtIEs RNSAP-PROTOCOL-EXTENSION ::= {
...
}

TransportFormatSet-ModeDP ::= CHOICE {
tdd                  TDD-TransportFormatSet-ModeDP,
notApplicable       NULL,
...
}

TDD-TransportFormatSet-ModeDP ::= SEQUENCE {
transmissionTimeIntervalInformation TransmissionTimeIntervalInformation OPTIONAL,
-- This IE shall be present if the 'Transmission Time Interval' of the 'Semi-static Transport Format Information' is 'dynamic'. Otherwise it is
absent.
iE-Extensions        ProtocolExtensionContainer { {TDD-TransportFormatSet-ModeDP-ExtIEs} } OPTIONAL,
...
}

TDD-TransportFormatSet-ModeDP-ExtIEs RNSAP-PROTOCOL-EXTENSION ::= {
...
}

TransmissionTimeIntervalInformation ::= SEQUENCE (SIZE (1..maxTTI-Count)) OF
SEQUENCE {
transmissionTimeInterval TransmissionTimeIntervalDynamic,
iE-Extensions           ProtocolExtensionContainer { {TransmissionTimeIntervalInformation-ExtIEs} } OPTIONAL,
...
}

TransmissionTimeIntervalInformation-ExtIEs RNSAP-PROTOCOL-EXTENSION ::= {
...
}

Transmitted-Code-Power-Value ::= INTEGER (0..127)

```

```
-- According to mapping in 25.215/25.225

Transmitted-Code-Power-Value-IncrDecrThres ::= INTEGER (0..112,...)

TransportFormatManagement ::= ENUMERATED {
    cell-based,
    ue-based,
    ...
}

TransportFormatSet-Semi-staticPart ::= SEQUENCE {
    transmissionTime      TransmissionTimeIntervalSemiStatic,
    channelCoding         ChannelCodingType,
    codingRate            CodingRate OPTIONAL
    -- This IE shall be present if channelCoding is 'convolutional' or 'turbo' --,
    rateMatchingAttribute RateMatchingAttribute,
    cRC-Size             CRC-Size,
    mode                 TransportFormatSet-ModeSSP,
    iE-Extensions        ProtocolExtensionContainer { {TransportFormatSet-Semi-staticPart-ExtIEs} } OPTIONAL,
    ...
}

TransportFormatSet-Semi-staticPart-ExtIEs RNSAP-PROTOCOL-EXTENSION ::= {
    ...
}

TransportFormatSet-ModeSSP ::= CHOICE {
    tdd                SecondInterleavingMode,
    notApplicable      NULL,
    ...
}

TransportLayerAddress      ::= BIT STRING (SIZE(1..160, ...))

TrCH-SrcStatisticsDescr   ::= ENUMERATED {
    speech,
    rRC,
    unknown,
    ...
}

TxDiversityIndicator      ::= ENUMERATED {
    true,
    false
}

TypeOfError ::= ENUMERATED {
    not-understood,
    missing,
    ...
}

-- U
```

```

UARFCN                ::= INTEGER (0..16383,...)
-- Corresponds to: 0.0Hz..3276.6Mhz. See 25.101, 25.105

UL-DL-mode ::= ENUMERATED {
    ul-only,
    dl-only,
    both-ul-and-dl
}

UL-Timeslot-Information ::= SEQUENCE ( SIZE (1..maxNrOfTS)) OF UL-Timeslot-InformationItem

UL-Timeslot-InformationItem ::= SEQUENCE {
    timeSlot                TimeSlot,
    midambleShiftAndBurstType MidambleShiftAndBurstType,
    tFCI-Presence           TFCI-Presence,
    uL-Code-Information     TDD-UL-Code-Information,
    iE-Extensions           ProtocolExtensionContainer { {UL-Timeslot-InformationItem-ExtIEs} } OPTIONAL,
    ...
}

UL-Timeslot-InformationItem-ExtIEs RNSAP-PROTOCOL-EXTENSION ::= {
    ...
}

UL-TimeSlot-ISCP-Info ::= SEQUENCE (SIZE (1..maxNrOfULTs)) OF UL-TimeSlot-ISCP-InfoItem

UL-TimeSlot-ISCP-InfoItem ::= SEQUENCE {
    timeSlot                TimeSlot,
    uL-TimeslotISCP         UL-TimeslotISCP,
    iE-Extensions           ProtocolExtensionContainer { { UL-TimeSlot-ISCP-InfoItem-ExtIEs} } OPTIONAL,
    ...
}

UL-TimeSlot-ISCP-InfoItem-ExtIEs RNSAP-PROTOCOL-EXTENSION ::= {
    ...
}

Uplink-Compressed-Mode-Method ::= ENUMERATED {
    sFdiv2,
    higher-layer-scheduling,
    ...
}

UL-SIR                ::= INTEGER (-82..173)
-- The UL-SIR gives the UL-SIR in number of 0.1 dB steps.
-- E.g. Value 173 means 17.3 dB
-- Unit dB. Step 0.1 dB.

UC-ID ::= SEQUENCE {
    rNC-ID                RNC-ID,
    c-ID                  C-ID,
    iE-Extensions         ProtocolExtensionContainer { {UC-ID-ExtIEs} } OPTIONAL,
    ...
}

```

```

UC-ID-ExtIEs RNSAP-PROTOCOL-EXTENSION ::= {
    ...
}

UL-DPCCH-SlotFormat ::= INTEGER (0..5,...)

UL-FP-Mode ::= ENUMERATED {
    normal,
    silent,
    ...
}

UL-PhysCH-SF-Variation ::= ENUMERATED {
    sf-variation-supported,
    sf-variation-not-supported
}

UL-ScramblingCode ::= SEQUENCE {
    ul-ScramblingCodeNumber      UL-ScramblingCodeNumber,
    ul-ScramblingCodeLength      UL-ScramblingCodeLength,
    iE-Extensions                ProtocolExtensionContainer { {UL-ScramblingCode-ExtIEs} } OPTIONAL
}

UL-ScramblingCode-ExtIEs RNSAP-PROTOCOL-EXTENSION ::= {
    ...
}

UL-ScramblingCodeLength ::= ENUMERATED {
    short,
    long
}

UL-ScramblingCodeNumber ::= INTEGER (0..16777215)

UL-TimeslotISCP ::= INTEGER (0..127)
-- According to mapping in [14]

URA-ID ::= INTEGER (0..65535)

URA-Information ::= SEQUENCE {
    uRA-ID                        URA-ID,
    multipleURAsIndicator         MultipleURAsIndicator,
    rNCsWithCellsInTheAccessedURA-List  RNCsWithCellsInTheAccessedURA-List OPTIONAL,
    iE-Extensions                ProtocolExtensionContainer { {URA-Information-ExtIEs} } OPTIONAL,
    ...
}

URA-Information-ExtIEs RNSAP-PROTOCOL-EXTENSION ::= {
    ...
}

RNCsWithCellsInTheAccessedURA-List ::= SEQUENCE (SIZE (1..maxRNCinURA-1)) OF RNCsWithCellsInTheAccessedURA-Item

```



```

RNCsWithCellsInTheAccessedURA-Item ::= SEQUENCE {
    rNC-ID                RNC-ID,
    iE-Extensions        ProtocolExtensionContainer { {RNCsWithCellsInTheAccessedURA-Item-ExtIEs} } OPTIONAL,
    ...
}

RNCsWithCellsInTheAccessedURA-Item-ExtIEs RNSAP-PROTOCOL-EXTENSION ::= {
    ...
}

USCH-ID                ::= INTEGER (0..255)

USCH-Information ::= SEQUENCE (SIZE (1..maxNoOfUSCHs)) OF USCH-InformationItem

USCH-InformationItem ::= SEQUENCE {
    uSCH-ID                USCH-ID,
    ul-CCTrCH-ID          CCTrCH-ID,
    trChSourceStatisticsDescriptor TrCh-SrcStatisticsDescr,
    transportFormatSet    TransportFormatSet,
    allocationRetentionPriority AllocationRetentionPriority,
    schedulingPriorityIndicator SchedulingPriorityIndicator,
    rb-Info                RB-Info,
    iE-Extensions        ProtocolExtensionContainer { {USCH-InformationItem-ExtIEs} } OPTIONAL,
    ...
}

USCH-InformationItem-ExtIEs RNSAP-PROTOCOL-EXTENSION ::= {
    ...
}

-- V
-- W
-- X
-- Y
-- Z

END

```

9.3.5 Common Definitions

```

-- *****
--
-- Common definitions
--
-- *****

RNSAP-CommonDataTypes {
itu-t (0) identified-organization (4) etsi (0) mobileDomain (0)
umts-Access (20) modules (3) rnsap (1) version1 (1) rnsap-CommonDataTypes (3) }

DEFINITIONS AUTOMATIC TAGS ::=

BEGIN

```

```

-- *****
--
-- Extension constants
--
-- *****

maxPrivateIEs          INTEGER ::= 65535
maxProtocolExtensions  INTEGER ::= 65535
maxProtocolIEs        INTEGER ::= 65535

-- *****
--
-- Common Data Types
--
-- *****

Criticality           ::= ENUMERATED { reject, ignore, notify }

Presence              ::= ENUMERATED { optional, conditional, mandatory }

PrivateIE-ID         ::= CHOICE {
    local              INTEGER (0.. maxPrivateIEs),
    global              OBJECT IDENTIFIER
}

ProcedureCode        ::= INTEGER (0..255)

ProcedureID ::= SEQUENCE {
    procedureCode      ProcedureCode,
    ddMode              ENUMERATED { tdd, fdd, common, ... }
}

ProtocolIE-ID        ::= INTEGER (0..maxProtocolIEs)

TransactionID        ::= CHOICE {
    shortTransActionId INTEGER (0..127),
    longTransActionId  INTEGER (0..32767)
}

TriggeringMessage    ::= ENUMERATED { initiating-message, successful-outcome, unsuccessful-outcome, outcome }

END

```

9.3.6 Constant Definitions

```

-- *****
--
-- Constant definitions
--
-- *****

RNSAP-Constants {

```

```
itu-t (0) identified-organization (4) etsi (0) mobileDomain (0)
umts-Access (20) modules (3) rnsap (1) version1 (1) rnsap-Constants (4) }
```

```
DEFINITIONS AUTOMATIC TAGS ::=
```

```
BEGIN
```

```
IMPORTS
```

```
    ProcedureCode,
    ProtocolIE-ID
```

```
FROM RNSAP-CommonDataTypes;
```

```
-- *****
--
-- Elementary Procedures
--
-- *****
```

```
id-commonTransportChannelResourcesInitialisation      ProcedureCode ::= 0
id-commonTransportChannelResourcesRelease             ProcedureCode ::= 1
id-compressedModeCommand                             ProcedureCode ::= 2
id-downlinkPowerControl                              ProcedureCode ::= 3
id-downlinkPowerTimeslotControl                      ProcedureCode ::= 4
id-downlinkSignallingTransfer                        ProcedureCode ::= 5
id-errorIndication                                  ProcedureCode ::= 6
id-dedicatedMeasurementFailure                      ProcedureCode ::= 7
id-dedicatedMeasurementInitiation                   ProcedureCode ::= 8
id-dedicatedMeasurementReporting                    ProcedureCode ::= 9
id-dedicatedMeasurementTermination                  ProcedureCode ::= 10
id-paging                                             ProcedureCode ::= 11
id-physicalChannelReconfiguration                    ProcedureCode ::= 12
id-privateMessage                                    ProcedureCode ::= 13
id-radioLinkAddition                                 ProcedureCode ::= 14
id-radioLinkDeletion                                 ProcedureCode ::= 15
id-radioLinkFailure                                  ProcedureCode ::= 16
id-radioLinkPreemption                              ProcedureCode ::= 17
id-radioLinkRestoration                             ProcedureCode ::= 18
id-radioLinkSetup                                    ProcedureCode ::= 19
id-relocationCommit                                  ProcedureCode ::= 20
id-synchronisedRadioLinkReconfigurationCancellation  ProcedureCode ::= 21
id-synchronisedRadioLinkReconfigurationCommit        ProcedureCode ::= 22
id-synchronisedRadioLinkReconfigurationPreparation  ProcedureCode ::= 23
id-unSynchronisedRadioLinkReconfiguration           ProcedureCode ::= 24
id-uplinkSignallingTransfer                          ProcedureCode ::= 25
```

```
-- *****
--
-- Lists
--
-- *****
```

```
maxCodeNumComp-1      INTEGER ::= 255
maxRateMatching       INTEGER ::= 256
maxNoCodeGroups       INTEGER ::= 256
```

```

maxNoOfDSCHs                INTEGER ::= 10
maxNoOfRB                    INTEGER ::= 32
maxNoOfUSCHs                INTEGER ::= 10
maxNoTFCIGroups             INTEGER ::= 256
maxNrOfTFCs                 INTEGER ::= 1024
maxNrOfTFs                  INTEGER ::= 32
maxNrOfCCTrCHs              INTEGER ::= 16
maxNrOfDCHs                 INTEGER ::= 128
maxNrOfDL-Codes             INTEGER ::= 8
maxNrOfDPCHs                INTEGER ::= 240
maxNrOfErrors               INTEGER ::= 256
maxNrOfMACcshSDU-Length     INTEGER ::= 16
maxNrOfPoints               INTEGER ::= 15
maxNrOfRLs                  INTEGER ::= 16
maxNrOfRLSets               INTEGER ::= maxNrOfRLs
maxNrOfRLs-1                INTEGER ::= 15 -- maxNrOfRLs - 1
maxNrOfRLs-2                INTEGER ::= 14 -- maxNrOfRLs - 2
maxNrOfULTs                 INTEGER ::= 15
maxNrOfDLTs                 INTEGER ::= 15
maxRNCinURA-1              INTEGER ::= 15
maxTTI-Count                INTEGER ::= 4
maxCTFC                     INTEGER ::= 16777215
maxNrOfNeighbouringRNCs     INTEGER ::= 10
maxNrOfFDDNeighboursPerRNC  INTEGER ::= 256
maxNrOfGSMNeighboursPerRNC INTEGER ::= 256
maxNrOfTDDNeighboursPerRNC INTEGER ::= 256
maxNrOfFACHs                INTEGER ::= 8
maxFACHCountPlus1          INTEGER ::= 10
maxIBSEG                    INTEGER ::= 16
maxNrOfSCCPCHs              INTEGER ::= 8
maxTFCI1Combs               INTEGER ::= 512
maxTFCI2Combs               INTEGER ::= 1024
maxTFCI2Combs-1             INTEGER ::= 1023
maxTGPS                     INTEGER ::= 6
maxNrOfTS                   INTEGER ::= 15
maxNrOfLevels               INTEGER ::= 256
maxNoOfDSCHs-1             INTEGER ::= 9

-- *****
--
-- IEs
--
-- *****

id-AllowedQueuingTime        ProtocolIE-ID ::= 4
id-BindingID                 ProtocolIE-ID ::= 5
id-C-ID                      ProtocolIE-ID ::= 6
id-C-RNTI                    ProtocolIE-ID ::= 7
id-CFN                       ProtocolIE-ID ::= 8
id-CN-CS-DomainIdentifier    ProtocolIE-ID ::= 9
id-CN-PS-DomainIdentifier    ProtocolIE-ID ::= 10
id-Cause                     ProtocolIE-ID ::= 11
id-CriticalityDiagnostics    ProtocolIE-ID ::= 20
id-D-RNTI                    ProtocolIE-ID ::= 21

```

id-D-RNTI-ReleaseIndication	ProtocolIE-ID ::= 22
id-DCHs-to-Add-FDD	ProtocolIE-ID ::= 26
id-DCHs-to-Add-TDD	ProtocolIE-ID ::= 27
id-DCH-DeleteList-RL-ReconfPrepFDD	ProtocolIE-ID ::= 30
id-DCH-DeleteList-RL-ReconfPrepTDD	ProtocolIE-ID ::= 31
id-DCH-DeleteList-RL-ReconfRqstFDD	ProtocolIE-ID ::= 32
id-DCH-DeleteList-RL-ReconfRqstTDD	ProtocolIE-ID ::= 33
id-DCH-FDD-Information	ProtocolIE-ID ::= 34
id-DCH-TDD-Information	ProtocolIE-ID ::= 35
id-FDD-DCHs-to-Modify	ProtocolIE-ID ::= 39
id-TDD-DCHs-to-Modify	ProtocolIE-ID ::= 40
id-DCH-InformationResponse	ProtocolIE-ID ::= 43
id-DL-CCTrCH-InformationAddItem-RL-ReconfPrepTDD	ProtocolIE-ID ::= 44
id-DL-CCTrCH-InformationListIE-RL-ReconfReadyTDD	ProtocolIE-ID ::= 45
id-DL-CCTrCH-InformationDeleteItem-RL-ReconfRqstTDD	ProtocolIE-ID ::= 46
id-DL-CCTrCH-InformationItem-RL-SetupRqstTDD	ProtocolIE-ID ::= 47
id-DL-CCTrCH-InformationListIE-PhyChReconfRqstTDD	ProtocolIE-ID ::= 48
id-DL-CCTrCH-InformationListIE-RL-AdditionRspTDD	ProtocolIE-ID ::= 49
id-DL-CCTrCH-InformationListIE-RL-SetupRspTDD	ProtocolIE-ID ::= 50
id-DL-CCTrCH-InformationAddList-RL-ReconfPrepTDD	ProtocolIE-ID ::= 51
id-DL-CCTrCH-InformationDeleteList-RL-ReconfRqstTDD	ProtocolIE-ID ::= 52
id-DL-CCTrCH-InformationList-RL-SetupRqstTDD	ProtocolIE-ID ::= 53
id-FDD-DL-CodeInformation	ProtocolIE-ID ::= 54
id-DL-DPCH-Information-RL-ReconfPrepFDD	ProtocolIE-ID ::= 59
id-DL-DPCH-Information-RL-SetupRqstFDD	ProtocolIE-ID ::= 60
id-DL-DPCH-Information-RL-ReconfRqstFDD	ProtocolIE-ID ::= 61
id-DL-DPCH-InformationItem-PhyChReconfRqstTDD	ProtocolIE-ID ::= 62
id-DL-DPCH-InformationItem-RL-AdditionRspTDD	ProtocolIE-ID ::= 63
id-DL-DPCH-InformationItem-RL-SetupRspTDD	ProtocolIE-ID ::= 64
id-DLReferencePower	ProtocolIE-ID ::= 67
id-DLReferencePowerList-DL-PC-Rqst	ProtocolIE-ID ::= 68
id-DL-ReferencePowerInformation-DL-PC-Rqst	ProtocolIE-ID ::= 69
id-DRXCycleLengthCoefficient	ProtocolIE-ID ::= 70
id-DedicatedMeasurementObjectType-DM-Rprt	ProtocolIE-ID ::= 71
id-DedicatedMeasurementObjectType-DM-Rqst	ProtocolIE-ID ::= 72
id-DedicatedMeasurementObjectType-DM-Rsp	ProtocolIE-ID ::= 73
id-DedicatedMeasurementType	ProtocolIE-ID ::= 74
id-FACH-InfoForUESelectedS-CCPCH-CTCH-ResourceRspFDD	ProtocolIE-ID ::= 82
id-FACH-InfoForUESelectedS-CCPCH-CTCH-ResourceRspTDD	ProtocolIE-ID ::= 83
id-IMSI	ProtocolIE-ID ::= 84
id-L3-Information	ProtocolIE-ID ::= 85
id-AdjustmentPeriod	ProtocolIE-ID ::= 90
id-MaxAdjustmentStep	ProtocolIE-ID ::= 91
id-MeasurementFilterCoefficient	ProtocolIE-ID ::= 92
id-MessageStructure	ProtocolIE-ID ::= 57
id-MeasurementID	ProtocolIE-ID ::= 93
id-Neighbouring-GSM-CellInformation	ProtocolIE-ID ::= 13
id-Neighbouring-UMTS-CellInformationItem	ProtocolIE-ID ::= 95
id-PagingArea-PagingRqst	ProtocolIE-ID ::= 102
id-FACH-FlowControlInformation	ProtocolIE-ID ::= 103
id-Permanent-NAS-UE-Identity	ProtocolIE-ID ::= 17
id-PowerAdjustmentType	ProtocolIE-ID ::= 107
id-RANAP-RelocationInformation	ProtocolIE-ID ::= 109
id-RL-Information-PhyChReconfRqstFDD	ProtocolIE-ID ::= 110

id-RL-Information-PhyChReconfRqstTDD	ProtocolIE-ID ::= 111
id-RL-Information-RL-AdditionRqstFDD	ProtocolIE-ID ::= 112
id-RL-Information-RL-AdditionRqstTDD	ProtocolIE-ID ::= 113
id-RL-Information-RL-DeletionRqst	ProtocolIE-ID ::= 114
id-RL-Information-RL-FailureInd	ProtocolIE-ID ::= 115
id-RL-Information-RL-ReconfPrepFDD	ProtocolIE-ID ::= 116
id-RL-Information-RL-RestoreInd	ProtocolIE-ID ::= 117
id-RL-Information-RL-SetupRqstFDD	ProtocolIE-ID ::= 118
id-RL-Information-RL-SetupRqstTDD	ProtocolIE-ID ::= 119
id-RL-InformationItem-DM-Rprt	ProtocolIE-ID ::= 120
id-RL-InformationItem-DM-Rqst	ProtocolIE-ID ::= 121
id-RL-InformationItem-DM-Rsp	ProtocolIE-ID ::= 122
id-RL-InformationItem-RL-PreemptRequiredInd	ProtocolIE-ID ::= 2
id-RL-InformationItem-RL-SetupRqstFDD	ProtocolIE-ID ::= 123
id-RL-InformationList-RL-AdditionRqstFDD	ProtocolIE-ID ::= 124
id-RL-InformationList-RL-DeletionRqst	ProtocolIE-ID ::= 125
id-RL-InformationList-RL-PreemptRequiredInd	ProtocolIE-ID ::= 1
id-RL-InformationList-RL-ReconfPrepFDD	ProtocolIE-ID ::= 126
id-RL-InformationResponse-RL-AdditionRspTDD	ProtocolIE-ID ::= 127
id-RL-InformationResponse-RL-ReconfReadyTDD	ProtocolIE-ID ::= 128
id-RL-InformationResponse-RL-SetupRspTDD	ProtocolIE-ID ::= 129
id-RL-InformationResponseItem-RL-AdditionRspFDD	ProtocolIE-ID ::= 130
id-RL-InformationResponseItem-RL-ReconfReadyFDD	ProtocolIE-ID ::= 131
id-RL-InformationResponseItem-RL-ReconfRspFDD	ProtocolIE-ID ::= 132
id-RL-InformationResponseItem-RL-SetupRspFDD	ProtocolIE-ID ::= 133
id-RL-InformationResponseList-RL-AdditionRspFDD	ProtocolIE-ID ::= 134
id-RL-InformationResponseList-RL-ReconfReadyFDD	ProtocolIE-ID ::= 135
id-RL-InformationResponseList-RL-ReconfRspFDD	ProtocolIE-ID ::= 136
id-RL-InformationResponse-RL-ReconfRspTDD	ProtocolIE-ID ::= 28
id-RL-InformationResponseList-RL-SetupRspFDD	ProtocolIE-ID ::= 137
id-RL-ReconfigurationFailure-RL-ReconfFail	ProtocolIE-ID ::= 141
id-RL-Set-InformationItem-DM-Rprt	ProtocolIE-ID ::= 143
id-RL-Set-InformationItem-DM-Rqst	ProtocolIE-ID ::= 144
id-RL-Set-InformationItem-DM-Rsp	ProtocolIE-ID ::= 145
id-RL-Set-Information-RL-FailureInd	ProtocolIE-ID ::= 146
id-RL-Set-Information-RL-RestoreInd	ProtocolIE-ID ::= 147
id-ReportCharacteristics	ProtocolIE-ID ::= 152
id-Reporting-Object-RL-FailureInd	ProtocolIE-ID ::= 153
id-Reporting-Object-RL-RestoreInd	ProtocolIE-ID ::= 154
id-S-RNTI	ProtocolIE-ID ::= 155
id-SAI	ProtocolIE-ID ::= 156
id-SRNC-ID	ProtocolIE-ID ::= 157
id-SuccessfulRL-InformationResponse-RL-AdditionFailureFDD	ProtocolIE-ID ::= 159
id-SuccessfulRL-InformationResponse-RL-SetupFailureFDD	ProtocolIE-ID ::= 160
id-TransportBearerID	ProtocolIE-ID ::= 163
id-TransportBearerRequestIndicator	ProtocolIE-ID ::= 164
id-TransportLayerAddress	ProtocolIE-ID ::= 165
id-TypeOfError	ProtocolIE-ID ::= 140
id-UC-ID	ProtocolIE-ID ::= 166
id-UL-CCTrCH-AddInformation-RL-ReconfPrepTDD	ProtocolIE-ID ::= 167
id-UL-CCTrCH-InformationAddList-RL-ReconfPrepTDD	ProtocolIE-ID ::= 169
id-UL-CCTrCH-InformationItem-RL-SetupRqstTDD	ProtocolIE-ID ::= 171
id-UL-CCTrCH-InformationList-RL-SetupRqstTDD	ProtocolIE-ID ::= 172
id-UL-CCTrCH-InformationListIE-PhyChReconfRqstTDD	ProtocolIE-ID ::= 173

id-UL-CCTrCH-InformationListIE-RL-AdditionRspTDD	ProtocolIE-ID ::= 174
id-UL-CCTrCH-InformationListIE-RL-ReconfReadyTDD	ProtocolIE-ID ::= 175
id-UL-CCTrCH-InformationListIE-RL-SetupRspTDD	ProtocolIE-ID ::= 176
id-UL-DPCH-Information-RL-ReconfPrepFDD	ProtocolIE-ID ::= 177
id-UL-DPCH-Information-RL-ReconfRqstFDD	ProtocolIE-ID ::= 178
id-UL-DPCH-Information-RL-SetupRqstFDD	ProtocolIE-ID ::= 179
id-UL-DPCH-InformationItem-PhyChReconfRqstTDD	ProtocolIE-ID ::= 180
id-UL-DPCH-InformationItem-RL-AdditionRspTDD	ProtocolIE-ID ::= 181
id-UL-DPCH-InformationItem-RL-SetupRspTDD	ProtocolIE-ID ::= 182
id-UL-DPCH-InformationAddListIE-RL-ReconfReadyTDD	ProtocolIE-ID ::= 183
id-UL-SIRTarget	ProtocolIE-ID ::= 184
id-URA-Information	ProtocolIE-ID ::= 185
id-UnsuccessfulRL-InformationResponse-RL-AdditionFailureFDD	ProtocolIE-ID ::= 188
id-UnsuccessfulRL-InformationResponse-RL-SetupFailureFDD	ProtocolIE-ID ::= 189
id-UnsuccessfulRL-InformationResponse-RL-SetupFailureTDD	ProtocolIE-ID ::= 190
id-Active-Pattern-Sequence-Information	ProtocolIE-ID ::= 193
id-AdjustmentRatio	ProtocolIE-ID ::= 194
id-CauseLevel-RL-AdditionFailureFDD	ProtocolIE-ID ::= 197
id-CauseLevel-RL-AdditionFailureTDD	ProtocolIE-ID ::= 198
id-CauseLevel-RL-ReconfFailure	ProtocolIE-ID ::= 199
id-CauseLevel-RL-SetupFailureFDD	ProtocolIE-ID ::= 200
id-CauseLevel-RL-SetupFailureTDD	ProtocolIE-ID ::= 201
id-DL-CCTrCH-InformationDeleteItem-RL-ReconfPrepTDD	ProtocolIE-ID ::= 205
id-DL-CCTrCH-InformationModifyItem-RL-ReconfPrepTDD	ProtocolIE-ID ::= 206
id-DL-CCTrCH-InformationModifyItem-RL-ReconfRqstTDD	ProtocolIE-ID ::= 207
id-DL-CCTrCH-InformationDeleteList-RL-ReconfPrepTDD	ProtocolIE-ID ::= 208
id-DL-CCTrCH-InformationModifyList-RL-ReconfPrepTDD	ProtocolIE-ID ::= 209
id-DL-CCTrCH-InformationModifyList-RL-ReconfRqstTDD	ProtocolIE-ID ::= 210
id-DL-DPCH-InformationAddListIE-RL-ReconfReadyTDD	ProtocolIE-ID ::= 212
id-DL-DPCH-InformationDeleteListIE-RL-ReconfReadyTDD	ProtocolIE-ID ::= 213
id-DL-DPCH-InformationModifyListIE-RL-ReconfReadyTDD	ProtocolIE-ID ::= 214
id-DSCHs-to-Add-TDD	ProtocolIE-ID ::= 215
id-DSCHs-to-Add-FDD	ProtocolIE-ID ::= 216
id-DSCH-DeleteList-RL-ReconfPrepTDD	ProtocolIE-ID ::= 217
id-DSCH-Delete-RL-ReconfPrepFDD	ProtocolIE-ID ::= 218
id-DSCH-FDD-Information	ProtocolIE-ID ::= 219
id-DSCH-InformationListIE-RL-AdditionRspTDD	ProtocolIE-ID ::= 220
id-DSCH-InformationListIEs-RL-SetupRspTDD	ProtocolIE-ID ::= 221
id-DSCH-TDD-Information	ProtocolIE-ID ::= 222
id-DSCH-FDD-InformationResponse	ProtocolIE-ID ::= 223
id-DSCH-Information-RL-SetupRqstFDD	ProtocolIE-ID ::= 226
id-DSCH-ModifyList-RL-ReconfPrepTDD	ProtocolIE-ID ::= 227
id-DSCH-Modify-RL-ReconfPrepFDD	ProtocolIE-ID ::= 228
id-DSCH-Specific-FDD-Additional-List	ProtocolIE-ID ::= 324
id-DSCHsToBeAddedOrModified-FDD	ProtocolIE-ID ::= 229
id-DSCHToBeAddedOrModifiedList-RL-ReconfReadyTDD	ProtocolIE-ID ::= 230
id-GA-Cell	ProtocolIE-ID ::= 232
id-Transmission-Gap-Pattern-Sequence-Information	ProtocolIE-ID ::= 255
id-UL-CCTrCH-DeleteInformation-RL-ReconfPrepTDD	ProtocolIE-ID ::= 256
id-UL-CCTrCH-ModifyInformation-RL-ReconfPrepTDD	ProtocolIE-ID ::= 257
id-UL-CCTrCH-InformationModifyItem-RL-ReconfRqstTDD	ProtocolIE-ID ::= 258
id-UL-CCTrCH-InformationDeleteList-RL-ReconfPrepTDD	ProtocolIE-ID ::= 259
id-UL-CCTrCH-InformationModifyList-RL-ReconfPrepTDD	ProtocolIE-ID ::= 260
id-UL-CCTrCH-InformationModifyList-RL-ReconfRqstTDD	ProtocolIE-ID ::= 261

id-UL-CCTrCH-InformationDeleteItem-RL-ReconfRqstTDD	ProtocolIE-ID ::= 262
id-UL-CCTrCH-InformationDeleteList-RL-ReconfRqstTDD	ProtocolIE-ID ::= 263
id-UL-DPCH-InformationDeleteListIE-RL-ReconfReadyTDD	ProtocolIE-ID ::= 264
id-UL-DPCH-InformationModifyListIE-RL-ReconfReadyTDD	ProtocolIE-ID ::= 265
id-UnsuccessfulRL-InformationResponse-RL-AdditionFailureTDD	ProtocolIE-ID ::= 266
id-USCHs-to-Add	ProtocolIE-ID ::= 267
id-USCH-DeleteList-RL-ReconfPrepTDD	ProtocolIE-ID ::= 268
id-USCH-InformationListIE-RL-AdditionRspTDD	ProtocolIE-ID ::= 269
id-USCH-InformationListIEs-RL-SetupRspTDD	ProtocolIE-ID ::= 270
id-USCH-Information	ProtocolIE-ID ::= 271
id-USCH-ModifyList-RL-ReconfPrepTDD	ProtocolIE-ID ::= 272
id-USCHToBeAddedOrModifiedList-RL-ReconfReadyTDD	ProtocolIE-ID ::= 273
id-DL-Physical-Channel-Information-RL-SetupRqstTDD	ProtocolIE-ID ::= 274
id-UL-Physical-Channel-Information-RL-SetupRqstTDD	ProtocolIE-ID ::= 275
id-ClosedLoopModel-SupportIndicator	ProtocolIE-ID ::= 276
id-ClosedLoopMode2-SupportIndicator	ProtocolIE-ID ::= 277
id-STTD-SupportIndicator	ProtocolIE-ID ::= 279
id-CFNReportingIndicator	ProtocolIE-ID ::= 14
id-CNOriginatedPage-PagingRqst	ProtocolIE-ID ::= 23
id-InnerLoopDLPCStatus	ProtocolIE-ID ::= 24
id-PropagationDelay	ProtocolIE-ID ::= 25
id-RxTimingDeviationForTA	ProtocolIE-ID ::= 36
id-timeSlot-ISCP	ProtocolIE-ID ::= 37
id-CCTrCH-InformationItem-RL-FailureInd	ProtocolIE-ID ::= 15
id-CCTrCH-InformationItem-RL-RestoreInd	ProtocolIE-ID ::= 16
id-RestrictionStateIndicator	ProtocolIE-ID ::= 142
id-SplitType	ProtocolIE-ID ::= 247
id-LengthOfTFCI2	ProtocolIE-ID ::= 295
id-PrimaryCCPCH-RSCP-RL-ReconfPrepTDD	ProtocolIE-ID ::= 202
id-DL-TimeSlot-ISCP-Info-RL-ReconfPrepTDD	ProtocolIE-ID ::= 203
id-DSCH-RNTI	ProtocolIE-ID ::= 249
id-PDSCH-RL-ID	ProtocolIE-ID ::= 323
id-TimeSlot-RL-SetupRspTDD	ProtocolIE-ID ::= 325
id-ExtendedGSMCellIndividualOffset	ProtocolIE-ID ::= 514

END

9.3.7 Container Definitions

```
-- *****
--
-- Container definitions
--
-- *****

RNSAP-Containers {
itu-t (0) identified-organization (4) etsi (0) mobileDomain (0)
umts-Access (20) modules (3) rnsap (1) version1 (1) rnsap-Containers (5) }
```

DEFINITIONS AUTOMATIC TAGS ::=

BEGIN

```

-- *****
--
-- IE parameter types from other modules.
--
-- *****

IMPORTS
    maxPrivateIEs,
    maxProtocolExtensions,
    maxProtocolIEs,
    Criticality,
    Presence,
    PrivateIE-ID,
    ProtocolIE-ID
FROM RNSAP-CommonDataTypes;

-- *****
--
-- Class Definition for Protocol IEs
--
-- *****

RNSAP-PROTOCOL-IES ::= CLASS {
    &id          ProtocolIE-ID          UNIQUE,
    &criticality Criticality,
    &Value,
    &presence    Presence
}
WITH SYNTAX {
    ID          &id
    CRITICALITY &criticality
    TYPE        &Value
    PRESENCE    &presence
}

-- *****
--
-- Class Definition for Protocol IEs
--
-- *****

RNSAP-PROTOCOL-IES-PAIR ::= CLASS {
    &id          ProtocolIE-ID          UNIQUE,
    &firstCriticality Criticality,
    &FirstValue,
    &secondCriticality Criticality,
    &SecondValue,
    &presence    Presence
}
WITH SYNTAX {
    ID          &id
    FIRST CRITICALITY &firstCriticality
    FIRST TYPE        &FirstValue
    SECOND CRITICALITY &secondCriticality
}

```

```

    SECOND TYPE      &SecondValue
    PRESENCE         &presence
}
-- *****
--
-- Class Definition for Protocol Extensions
--
-- *****

RNSAP-PROTOCOL-EXTENSION ::= CLASS {
    &id              ProtocolIE-ID          UNIQUE,
    &criticality     Criticality,
    &Extension,
    &presence        Presence
}
WITH SYNTAX {
    ID              &id
    CRITICALITY     &criticality
    EXTENSION       &Extension
    PRESENCE        &presence
}
-- *****
--
-- Class Definition for Private IEs
--
-- *****

RNSAP-PRIVATE-IES ::= CLASS {
    &id              PrivateIE-ID,
    &criticality     Criticality,
    &Value,
    &presence        Presence
}
WITH SYNTAX {
    ID              &id
    CRITICALITY     &criticality
    TYPE            &Value
    PRESENCE        &presence
}
-- *****
--
-- Container for Protocol IEs
--
-- *****

ProtocolIE-Container {RNSAP-PROTOCOL-IES : IEsSetParam} ::=
    SEQUENCE (SIZE (0..maxProtocolIEs)) OF
    ProtocolIE-Field {{IEsSetParam}}

ProtocolIE-Single-Container {RNSAP-PROTOCOL-IES : IEsSetParam} ::=
    ProtocolIE-Field {{IEsSetParam}}

```

```

ProtocolIE-Field {RNSAP-PROTOCOL-IES : IEsSetParam} ::= SEQUENCE {
    id                RNSAP-PROTOCOL-IES.&id                ({IEsSetParam}),
    criticality       RNSAP-PROTOCOL-IES.&criticality       ({IEsSetParam}@id}),
    value            RNSAP-PROTOCOL-IES.&Value            ({IEsSetParam}@id)
}

-- *****
--
-- Container for Protocol IE Pairs
--
-- *****

ProtocolIE-ContainerPair {RNSAP-PROTOCOL-IES-PAIR : IEsSetParam} ::=
    SEQUENCE (SIZE (0..maxProtocolIEs)) OF
    ProtocolIE-FieldPair {{IEsSetParam}}

ProtocolIE-FieldPair {RNSAP-PROTOCOL-IES-PAIR : IEsSetParam} ::= SEQUENCE {
    id                RNSAP-PROTOCOL-IES-PAIR.&id                ({IEsSetParam}),
    firstCriticality  RNSAP-PROTOCOL-IES-PAIR.&firstCriticality  ({IEsSetParam}@id}),
    firstValue       RNSAP-PROTOCOL-IES-PAIR.&FirstValue       ({IEsSetParam}@id}),
    secondCriticality RNSAP-PROTOCOL-IES-PAIR.&secondCriticality ({IEsSetParam}@id}),
    secondValue      RNSAP-PROTOCOL-IES-PAIR.&SecondValue      ({IEsSetParam}@id)
}

-- *****
--
-- Container Lists for Protocol IE Containers
--
-- *****

ProtocolIE-ContainerList {INTEGER : lowerBound, INTEGER : upperBound, RNSAP-PROTOCOL-IES : IEsSetParam} ::=
    SEQUENCE (SIZE (lowerBound..upperBound)) OF
    ProtocolIE-Container {{IEsSetParam}}

ProtocolIE-ContainerPairList {INTEGER : lowerBound, INTEGER : upperBound, RNSAP-PROTOCOL-IES-PAIR : IEsSetParam} ::=
    SEQUENCE (SIZE (lowerBound..upperBound)) OF
    ProtocolIE-ContainerPair {{IEsSetParam}}

-- *****
--
-- Container for Protocol Extensions
--
-- *****

ProtocolExtensionContainer {RNSAP-PROTOCOL-EXTENSION : ExtensionSetParam} ::=
    SEQUENCE (SIZE (1..maxProtocolExtensions)) OF
    ProtocolExtensionField {{ExtensionSetParam}}

ProtocolExtensionField {RNSAP-PROTOCOL-EXTENSION : ExtensionSetParam} ::= SEQUENCE {
    id                RNSAP-PROTOCOL-EXTENSION.&id                ({ExtensionSetParam}),
    criticality       RNSAP-PROTOCOL-EXTENSION.&criticality       ({ExtensionSetParam}@id}),
    extensionValue    RNSAP-PROTOCOL-EXTENSION.&Extension        ({ExtensionSetParam}@id)
}

```

```
-- *****  
--  
-- Container for Private IEs  
--  
-- *****  
  
PrivateIE-Container {RNSAP-PRIVATE-IES : IEsSetParam} ::=  
  SEQUENCE (SIZE (1..maxPrivateIEs)) OF  
  PrivateIE-Field {{IEsSetParam}}  
  
PrivateIE-Field {RNSAP-PRIVATE-IES : IEsSetParam} ::= SEQUENCE {  
  id          RNSAP-PRIVATE-IES.&id          ({IEsSetParam}),  
  criticality RNSAP-PRIVATE-IES.&criticality  ({IEsSetParam}{@id}),  
  value       RNSAP-PRIVATE-IES.&Value       ({IEsSetParam}{@id})  
}  
  
END
```

9.4 Message Transfer Syntax

RNSAP shall use the ASN.1 Basic Packed Encoding Rules (BASIC-PER) Aligned Variant as transfer syntax as specified in ref. [20].

The following encoding rules apply in addition to what has been specified in X.691 [20]:

When a bitstring value is placed in a bit-field as specified in 15.6 to 15.11 in [20], the leading bit of the bitstring value shall be placed in the leading bit of the bit-field, and the trailing bit of the bitstring value shall be placed in the trailing bit of the bit-field.

NOTE - When using the "bstring" notation, the leading bit of the bitstring value is on the left, and the trailing bit of the bitstring value is on the right. The term "leading bit" is to be interpreted as equal to the term "first bit" defined in [18].

9.5 Timers

T_{Preempt}

- Specifies the maximum time that a DRNS may wait for pre-emption of resources for establishment or reconfiguration of Radio Links.

10 Handling of Unknown, Unforeseen and Erroneous Protocol Data

10.1 General

Protocol Error cases can be divided into three classes:

1. Transfer Syntax Error;
2. Abstract Syntax Error;
3. Logical Error.

Protocol errors can occur in the following functions within a receiving node.

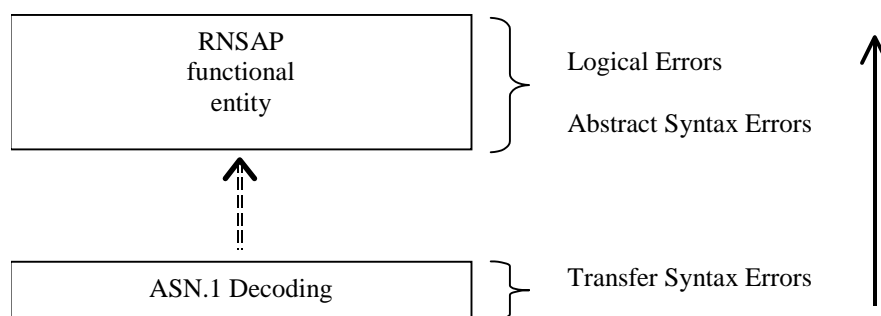

Figure 34: Protocol Errors in RNSAP

The information stated in subclauses 10.2, 10.3 and 10.4, to be included in the message used when reporting an error, is what at minimum shall be included. Other optional information elements within the message may also be included, if available. This is also valid for the case when the reporting is done with a response message. The latter is an exception to what is stated in subclause 4.1.

10.2 Transfer Syntax Error

A Transfer Syntax Error occurs when the receiver is not able to decode the received physical message. Transfer syntax errors are always detected in the process of ASN.1 decoding. If a Transfer Syntax Error occurs, the receiver should initiate Error Indication procedure with appropriate cause value for the Transfer Syntax protocol error.

Examples for Transfer Syntax Errors are:

- Violation of value ranges in ASN.1 definition of messages. e.g.: If an IE has a defined value range of 0 to 10 (ASN.1: INTEGER (0..10)), and 12 will be received, then this will be treated as a transfer syntax error;
- Violation in list element constraints. e.g.: If a list is defined as containing 1 to 10 elements, and 12 elements will be received, then this case will be handled as a transfer syntax error;
- Missing mandatory elements in ASN.1 SEQUENCE definitions (as sent by the originator of the message);
- Wrong order of elements in ASN.1 SEQUENCE definitions (as sent by the originator of the message).

10.3 Abstract Syntax Error

10.3.1 General

An Abstract Syntax Error occurs when the receiving functional RNSAP entity:

1. Receives IEs or IE groups that cannot be understood (unknown IE id);
2. Receives IEs for which the logical range is violated (e.g.: ASN.1 definition: 0 to 15, the logical range is 0 to 10 (values 11 to 15 are undefined), and 12 will be received; this case will be handled as an abstract syntax error using criticality information sent by the originator of the message);
3. Does not receive IEs or IE groups but according to the specified presence of the concerned object, the IEs or IE groups should have been present in the received message;
4. Receives IEs or IE groups that are defined to be part of that message in wrong order or with too many occurrences of the same IE or IE group;
5. receives IEs or IE groups but according to the conditional presence of the concerned object and the specified condition, the IEs or IE groups should not have been present in the received message.

Cases 1 and 2 (not comprehended IE/IE group) are handled based on received Criticality information. Case 3 (missing IE/IE group) is handled based on Criticality information and Presence information for the missing IE/IE group specified in the version of the specification used by the receiver. Case 4 (IEs or IE groups in wrong order or with too many occurrences) and Case 5 (erroneously present conditional IEs or IE groups) result in rejecting the procedure.

If an Abstract Syntax Error occurs, the receiver shall read the remaining message and shall then for each detected Abstract Syntax Error that belong to cases 1-3 act according to the Criticality Information and Presence Information for the IE/IE group due to which Abstract Syntax Error occurred in accordance with subclauses 10.3.4 and 10.3.5. The handling of cases 4 and 5 is specified in subclause 10.3.6.

10.3.2 Criticality Information

In the RNSAP messages there is criticality information set for individual IEs and/or IE groups. This criticality information instructs the receiver how to act when receiving an IE or an IE group that is not comprehended, i.e. the entire item (IE or IE group) which is not (fully or partially) comprehended shall be treated in accordance with its own criticality information as specified in subclause 10.3.4.

In addition, the criticality information is used in case of the missing IE/IE group abstract syntax error (see subclause 10.3.5).

The receiving node shall take different actions depending on the value of the Criticality Information. The three possible values of the Criticality Information for an IE/IE group are:

1. Reject IE;
2. Ignore IE and Notify Sender;
3. Ignore IE.

The following rules restrict when a receiving entity may consider an IE, an IE group or an EP not comprehended (not implemented), and when action based on criticality information is applicable:

1. IE or IE group: When one new or modified IE or IE group is implemented for one EP from a standard version, then other new or modified IEs or IE groups specified for that EP in that standard version shall be considered comprehended by a receiving entity (some may still remain unsupported).

Note that this restriction is not applicable to a sending entity for constructing messages.

2. EP: The comprehension of different EPs within a standard version or between different standard versions is not mandated. Any EP that is not supported may be considered not comprehended, even if another EP from that standard version is comprehended, and action based on criticality shall be applied.

10.3.3 Presence Information

For many IEs/IE groups which are optional according to the ASN.1 transfer syntax, RNSAP specifies separately if the presence of these IEs/IE groups is optional or mandatory with respect to RNS application by means of the presence field of the concerned object of class RNSAP-PROTOCOL-IES, RNSAP-PROTOCOL-IES-PAIR, RNSAP-PROTOCOL-EXTENSION or RNSAP-PRIVATE-IES.

The presence field of the indicated classes supports three values:

1. Optional;
2. Conditional;
3. Mandatory.

If an IE/IE group is not included in a received message and the presence of the IE/IE group is mandatory or the presence is conditional and the condition is true according to the version of the specification used by the receiver, an abstract syntax error occurs due to a missing IE/IE group.

If an IE/IE group is included in a received message and the presence of the IE/IE group is conditional and the condition is false according to the version of the specification used by the receiver, an abstract syntax error occurs due to this erroneously present conditional IE/IE group.

10.3.4 Not Comprehended IE/IE Group

10.3.4.1 Procedure ID

The receiving node shall treat the different types of received criticality information of the *Procedure ID* according to the following:

Reject IE:

- If a message is received with a *Procedure ID* marked with "*Reject IE*" which the receiving node does not comprehend, the receiving node shall reject the procedure using the Error Indication procedure.

Ignore IE and Notify Sender:

- If a message is received with a *Procedure ID* marked with "*Ignore IE and Notify Sender*" which the receiving node does not comprehend, the receiving node shall ignore the procedure and initiate the Error Indication procedure.

Ignore IE:

- If a message is received with a *Procedure ID* marked with "*Ignore IE*" which the receiving node does not comprehend, the receiving node shall ignore the procedure.

When using the Error Indication procedure to reject a procedure or to report an ignored procedure it shall include the *Procedure ID IE*, the *Triggering Message IE*, and the *Procedure Criticality IE* in the *Criticality Diagnostics IE*.

10.3.4.1A Type of Message

When the receiving node cannot decode the *Type of Message IE*, the Error Indication procedure shall be initiated with an appropriate cause value.

10.3.4.2 IEs Other Than the Procedure ID and Type of Message

The receiving node shall treat the different types of received criticality information of an IE/IE group other than the *Procedure ID* according to the following:

Reject IE:

- If a message *initiating* a procedure is received containing one or more IEs/IE groups marked with "*Reject IE*" which the receiving node does not comprehend; none of the functional requests of the message shall be executed. The receiving node shall reject the procedure and report the rejection of one or more IEs/IE groups using the message normally used to report unsuccessful outcome of the procedure. In case the information received in the initiating message was insufficient to determine a value for all IEs that are required to be present in the message used to report the unsuccessful outcome of the procedure, the receiving node shall instead terminate the procedure and initiate the Error Indication procedure.
- If a message *initiating* a procedure that does not have a message to report unsuccessful outcome is received containing one or more IEs/IE groups marked with "*Reject IE*" which the receiving node does not comprehend, the receiving node shall terminate the procedure and initiate the Error Indication procedure.
- If a *response* message is received containing one or more IEs/IE groups marked with "*Reject IE*", that the receiving node does not comprehend, the receiving node shall consider the procedure as unsuccessfully terminated and initiate local error handling.

Ignore IE and Notify Sender:

- If a message *initiating* a procedure is received containing one or more IEs/IE groups marked with "*Ignore IE and Notify Sender*" which the receiving node does not comprehend, the receiving node shall ignore the content of the not comprehended IEs/IE groups, continue with the procedure as if the not comprehended IEs/IE groups were not received (except for the reporting) using the understood IEs/IE groups, and report in the response message of the procedure that one or more IEs/IE groups have been ignored. In case the information received in the initiating message was insufficient to determine a value for all IEs that are required to be present in the response message, the receiving node shall instead terminate the procedure and initiate the Error Indication procedure.
- If a message *initiating* a procedure that does not have a message to report the outcome of the procedure is received containing one or more IEs/IE groups marked with "*Ignore IE and Notify Sender*" which the receiving node does not comprehend, the receiving node shall ignore the content of the not comprehended IEs/IE groups, continue with the procedure as if the not comprehended IEs/IE groups were not received (except for the reporting) using the understood IEs/IE groups, and initiate the Error Indication procedure to report that one or more IEs/IE groups have been ignored.
- If a *response* message is received containing one or more IEs/IE groups marked with "*Ignore IE and Notify Sender*" which the receiving node does not comprehend, the receiving node shall ignore the content of the not comprehended IEs/IE groups, continue with the procedure as if the not comprehended IEs/IE groups were not received (except for the reporting) using the understood IEs/IE groups and initiate the Error Indication procedure.

Ignore IE:

- If a message *initiating* a procedure is received containing one or more IEs/IE groups marked with "*Ignore IE*" which the receiving node does not comprehend, the receiving node shall ignore the content of the not comprehended IEs/IE groups and continue with the procedure as if the not comprehended IEs/IE groups were not received using the understood IEs/IE groups.
- If a *response* message is received containing one or more IEs/IE groups marked with "*Ignore IE*" which the receiving node does not comprehend, the receiving node shall ignore the content of the not comprehended IEs/IE

groups and continue with the procedure as if the not comprehended IEs/IE groups were not received using the understood IEs/IE groups.

When reporting not comprehended IEs/IE groups marked with "*Reject IE*" or "*Ignore IE and Notify Sender*" using a response message defined for the procedure, the *Information Element Criticality Diagnostics IE* shall be included in the *Criticality Diagnostics IE* for each reported IE/IE group. In the *Information Element Criticality Diagnostics IE* the *Repetition Number IE* shall be included and in addition, if the not comprehended IE/IE group is not at message hierarchy level 1 (top level; see annex C) also the *Message Structure IE* shall be included.

When reporting not comprehended IEs/IE groups marked with "*Reject IE*" or "*Ignore IE and Notify Sender*" using the Error Indication procedure, the *Procedure ID IE*, the *Triggering Message IE*, *Procedure Criticality IE*, the *Transaction ID IE*, and the *Information Element Criticality Diagnostics IE* shall be included in the *Criticality Diagnostics IE* for each reported IE/IE group. In the *Information Element Criticality Diagnostics IE* the *Repetition Number IE* shall be included and in addition, if the not comprehended IE/IE group is not at message hierarchy level 1 (top level; see annex C) also the *Message Structure IE* shall be included.

10.3.5 Missing IE or IE Group

The receiving node shall treat the missing IE/IE group according to the criticality information for the missing IE/IE group in the received message specified in the version of this specification used by the receiver:

Reject IE:

- If a received message *initiating* a procedure is missing one or more IEs/IE groups with specified criticality "*Reject IE*"; none of the functional requests of the message shall be executed. The receiving node shall reject the procedure and report the missing IEs/IE groups using the message normally used to report unsuccessful outcome of the procedure. In case the information received in the initiating message was insufficient to determine a value for all IEs that are required to be present in the message used to report the unsuccessful outcome of the procedure, the receiving node shall instead terminate the procedure and initiate the Error Indication procedure.
- If a received message *initiating* a procedure that does not have a message to report unsuccessful outcome is missing one or more IEs/IE groups with specified criticality "*Reject IE*", the receiving node shall terminate the procedure and initiate the Error Indication procedure.
- If a received *response* message is missing one or more IEs/IE groups with specified criticality "*Reject IE*", the receiving node shall consider the procedure as unsuccessfully terminated and initiate local error handling.

Ignore IE and Notify Sender:

- If a received message *initiating* a procedure is missing one or more IEs/IE groups with specified criticality "*Ignore IE and Notify Sender*", the receiving node shall ignore that those IEs are missing and continue with the procedure based on the other IEs/IE groups present in the message and report in the response message of the procedure that one or more IEs/IE groups were missing. In case the information received in the initiating message was insufficient to determine a value for all IEs that are required to be present in the response message, the receiving node shall instead terminate the procedure and initiate the Error Indication procedure.
- If a received message *initiating* a procedure that does not have a message to report the outcome of the procedure is missing one or more IEs/IE groups with specified criticality "*Ignore IE and Notify Sender*", the receiving node shall ignore that those IEs are missing and continue with the procedure based on the other IEs/IE groups present in the message and initiate the Error Indication procedure to report that one or more IEs/IE groups were missing.
- If a received *response* message is missing one or more IEs/IE groups with specified criticality "*Ignore IE and Notify Sender*", the receiving node shall ignore that those IEs are missing and continue with the procedure based on the other IEs/IE groups present in the message and initiate the Error Indication procedure to report that one or more IEs/IE groups were missing.

Ignore IE:

- If a received message *initiating* a procedure is missing one or more IEs/IE groups with specified criticality "*Ignore IE*", the receiving node shall ignore that those IEs are missing and continue with the procedure based on the other IEs/IE groups present in the message.

- If a received *response* message is missing one or more IEs/IE groups with specified criticality "*Ignore IE*", the receiving node shall ignore that those IEs/IE groups are missing and continue with the procedure based on the other IEs/IE groups present in the message.

When reporting missing IEs/IE groups with specified criticality "*Reject IE*" or "*Ignore IE and Notify Sender*" using a response message defined for the procedure, the *Information Element Criticality Diagnostics IE* shall be included in the *Criticality Diagnostics IE* for each reported IE/IE group. In the *Information Element Criticality Diagnostics IE* the *Repetition Number IE* shall be included and in addition, if the missing IE/IE group is not at message hierarchy level 1 (top level; see annex C) also the *Message Structure IE* shall be included.

When reporting missing IEs/IE groups with specified criticality "*Reject IE*" or "*Ignore IE and Notify Sender*" using the Error Indication procedure, the *Procedure ID IE*, the *Triggering Message IE*, *Procedure Criticality IE*, the *Transaction ID IE*, and the *Information Element Criticality Diagnostics IE* shall be included in the *Criticality Diagnostics IE* for each reported IE/IE group. In the *Information Element Criticality Diagnostics IE* the *Repetition Number IE* shall be included and in addition, if the missing IE/IE group is not at message hierarchy level 1 (top level; see annex C) also the *Message Structure IE* shall be included.

10.3.6 IEs or IE Groups Received in Wrong Order or With Too Many Occurrences or Erroneously Present

If a message with IEs or IE groups in wrong order or with too many occurrences is received or if IEs or IE groups with a conditional presence are present when the condition is not met (i.e. erroneously present), the receiving node shall behave according to the following:

- If a message *initiating* a procedure is received containing IEs or IE groups in wrong order or with too many occurrences or erroneously present, none of the functional requests of the message shall be executed. The receiving node shall reject the procedure and report the cause value "Abstract Syntax Error (Falsely Constructed Message)" using the message normally used to report unsuccessful outcome of the procedure. In case the information received in the initiating message was insufficient to determine a value for all IEs that are required to be present in the message used to report the unsuccessful outcome of the procedure, the receiving node shall instead terminate the procedure and initiate the Error Indication procedure.
- If a message *initiating* a procedure that does not have a message to report unsuccessful outcome is received containing IEs or IE groups in wrong order or with too many occurrences or erroneously present, the receiving node shall terminate the procedure and initiate the Error Indication procedure, and use cause value "Abstract Syntax Error (Falsely Constructed Message)".
- If a *response* message is received containing IEs or IE groups in wrong order or with too many occurrences or erroneously present, the receiving node shall consider the procedure as unsuccessfully terminated and initiate local error handling.

When determining the correct order only the IEs specified in the specification version used by the receiver shall be considered.

10.4 Logical Error

Logical error situations occur when a message is comprehended correctly, but the information contained within the message is not valid (i.e. semantic error), or describes a procedure which is not compatible with the state of the receiver. In these conditions, the following behaviour shall be performed (unless otherwise specified) as defined by the class of the elementary procedure, irrespective of the criticality information of the IEs/IE groups containing the erroneous values.

Class 1:

Where the logical error occurs in a request message of a class 1 procedure, and the procedure has a failure message, the failure message shall be sent with an appropriate cause value. Typical cause values are:

Protocol Causes:

1. Semantic Error;
2. Message not Compatible with Receiver State.

Where the logical error is contained in a request message of a class 1 procedure, and the procedure does not have a failure message, the procedure shall be terminated and the Error Indication procedure shall be initiated with an appropriate cause value. The *Procedure ID* IE, the *Triggering Message* IE and the *Transaction ID* IE within the *Criticality Diagnostics* IE shall then be included in order to identify the message containing the logical error.

Where the logical error exists in a response message of a class 1 procedure, the procedure shall be considered as unsuccessfully terminated and local error handling shall be initiated.

Class 2:

Where the logical error occurs in a message of a class 2 procedure, the procedure shall be terminated and the Error Indication procedure shall be initiated with an appropriate cause value. The *Procedure ID* IE, the *Triggering Message* IE and the *Transaction ID* IE within the *Criticality Diagnostics* IE shall then be included in order to identify the message containing the logical error.

10.5 Exceptions

The error handling for all the cases described hereafter shall take precedence over any other error handling described in the other subclauses of clause 10.

- If any type of error (Transfer Syntax Error, Abstract Syntax Error or Logical Error) is detected in the ERROR INDICATION message, it shall not trigger the Error Indication procedure in the receiving Node but local error handling.
- In case a response message, failure message or ERROR INDICATION message needs to be returned, but the information necessary to determine the receiver of that message is missing, the procedure shall be considered as unsuccessfully terminated and local error handling shall be initiated.
- If an error that terminates a procedure occurs, the returned cause value shall reflect the error that caused the termination of the procedure even if one or more abstract syntax errors with criticality 'ignore and notify' have earlier occurred within the same procedure.

Annex A (normative): Allocation and Pre-emption of Radio Links in the DRNS

A.1 Deriving Allocation Information for a Radio Link

A.1.1 Establishment of a New Radio Link

The Allocation Information for a Radio Link in the case of establishment of a new Radio Link shall be derived as follows:

- The latest received *Allocation/Retention Priority* IE for each transport channel shall be used.

Note: The *Allocation/Retention Priority* IE for a transport channel may have been received in

- a) the procedure that establishes the first Radio Link for the UE in the DRNS or
- b) a procedure adding or modifying the transport channel.

- If the *Priority Level* IE in the *Allocation/Retention Priority* IE for all transport channels that are intended to use the Radio Link is set to "no priority", the pre-emption capability of the Radio Link shall be set to 'shall not trigger pre-emption'.
- If the *Priority Level* IE in the *Allocation/Retention Priority* IE for one or more of the transport channels that are intended to use the Radio Link is not set to "no priority", the allocation priority and the pre-emption capability of the Radio Link shall be set according to the following:
 - The transport channels that have the *Priority Level* IE in the *Allocation/Retention Priority* IE set to "no priority" shall be excluded when setting the allocation priority and pre-emption capability of a Radio Link.
 - The allocation priority for a Radio Link shall be set to highest priority level, given by the *Priority Level* IE in the *Allocation/Retention Priority* IE, for all non excluded transport channels that are intended to use the Radio Link.
 - If all non-excluded transport channels that are intended to use a Radio Link to be established have the pre-emption capability, given by the *Pre-emption Capability* IE in the *Allocation/Retention Priority* IE, set to "shall not trigger pre-emption", the pre-emption capability of the Radio Link shall be set to "shall not trigger pre-emption".
If one or more non-excluded transport channels that are intended to use the Radio Link to be established have the value of the *Pre-emption Capability* IE in the *Allocation/Retention Priority* IE set to "may trigger pre-emption", the pre-emption capability of the Radio Link shall be set to "may trigger pre-emption".

The derived allocation priority and pre-emption capability are only valid during this allocation/retention process.

A.1.2 Modification of an Existing Radio Link

The Allocation Information for a Radio Link in the case of modification of a Radio Link (addition or modification of transport channels using the Radio Link) shall be derived as follows:

- The latest received *Allocation/Retention Priority* IE for each transport channel shall be used.

Note: The *Allocation/Retention Priority* IE for a transport channel may have been received in

- a) the procedure that establishes the first Radio Link for the UE in the DRNS,
- b) a previous procedure adding or modifying the transport channel, or
- c) the current procedure adding or modifying the transport channel.

- If the *Priority Level* IE in the *Allocation/Retention Priority* IE for all transport channels to be added or modified in the Radio Link is set to "no priority", the pre-emption capability of the Radio Link to be modified shall be set to "shall not trigger pre-emption".

- If the *Priority Level* IE in the *Allocation/Retention Priority* IE for one or more of the transport channels to be added or modified in the Radio Link is not set to "no priority", the allocation priority of and the pre-emption capability of the Radio Link to be modified shall be set according to the following:
 - The transport channels to be added or modified that have the *Priority Level* IE in the *Allocation/Retention Priority* IE set to "not used" shall be excluded when setting the allocation priority and pre-emption capability of a Radio Link to be modified.
 - The allocation priority for a Radio Link to be modified shall be set to highest priority level, given by the *Priority Level* IE in the *Allocation/Retention Priority* IE, for all the non-excluded transport channels that are to be added or modified.
 - If all non-excluded transport channels that are to be added or modified in the Radio Link have the pre-emption capability, given by the *Pre-emption Capability* IE in the *Allocation/Retention Priority* IE, set to "shall not trigger pre-emption", the pre-emption capability of the Radio Link to be modified shall be set to "shall not trigger pre-emption".
If one or more of the non-excluded transport channels to be added or modified in the Radio Link have the value of the *Pre-emption Capability* IE in the *Allocation/Retention Priority* IE set to "may trigger pre-emption", the pre-emption capability of the Radio Link to be modified shall be set to "may trigger pre-emption".

The derived allocation priority and pre-emption capability are only valid during this allocation/retention process.

A.2 Deriving Retention Information for a Radio Link

The Retention Information for an existing Radio Link shall be derived as follows:

- The latest received *Allocation/Retention Priority* IE for each transport channel shall be used.
- Note: The *Allocation/Retention Priority* IE for a transport channel may have been received in
- a) the procedure that establishes the first Radio Link for the UE in the DRNS or
 - b) a procedure adding or modifying the transport channel.
- If the *Priority Level* IE in the *Allocation/Retention Priority* IE for one or more transport channels using the Radio Link is set to "no priority", the pre-emption vulnerability of the Radio Link shall be set to "not pre-emptable".
 - If the *Priority Level* IE in the *Allocation/Retention Priority* IE for all the transport channels using the Radio Link is not set to "no priority", the retention priority of the Radio Link and the pre-emption vulnerability of the Radio Link shall be set according to the following:
 - The retention priority for a Radio Link shall be set to highest priority level, given by the *Priority Level* IE in the *Allocation/Retention Priority* IE, for all transport channels that uses the Radio Link.
 - If all transport channels that uses the Radio Link have the pre-emption vulnerability, given by the *Pre-emption Vulnerability* IE in the *Allocation/Retention Priority* IE, set to "pre-emptable", the pre-emption vulnerability of the Radio Link shall be set to "pre-emptable".
If one or more transport channels that uses the Radio Link have the value of the *Pre-emption Vulnerability* IE in the *Allocation/Retention Priority* IE set to "not pre-emptable", the pre-emption vulnerability of the Radio Link shall be set to "not pre-emptable".

The derived retention priority and pre-emption vulnerability are valid until they are changed, or until the Radio Link is deleted. When new transport channels are added to or deleted from the Radio Link or when existing transport channels are modified with regards to the *Allocation/Retention Priority* IE, the retention information shall be derived again according to above.

A.3 The Allocation/Retention Process

The DRNS shall establish or modify the resources for a Radio Link according to:

- The value of the Allocation Information (allocation priority and pre-emption capability) of the Radio to be established or modified. The Allocation Information is derived according to clause A.1.
- The value of the Retention Information (retention priority and pre-emption vulnerability) of existing Radio Links. The Retention Information derived according to clause A.2.
- The resource situation in the DRNS.

Whilst the process and the extent of the pre-emption functionality is operator dependent, the pre-emption indicators (pre-emption capability and pre-emption vulnerability) shall be treated as follows:

- If the pre-emption capability for a Radio Link to be established or modified is set to "may trigger pre-emption" and the resource situation so requires, the DRNS may trigger the pre-emption process in clause A.4 to free resources for this allocation request.
- If the pre-emption capability for a Radio Link to be established or modified is set to "shall not trigger pre-emption", then this allocation request shall not trigger the pre-emption process in clause A.4.
- If the pre-emption vulnerability for an existing Radio Link is set to "pre-emptable", then this Radio Link shall be included in the pre-emption process in clause A.4.
- If the pre-emption vulnerability for an existing Radio Link is set to "not pre-emptable", then this Radio Link shall not be included in the pre-emption process in clause A.4.

A.4 The Pre-emption Process

The pre-emption process shall only pre-empt Radio Links with lower retention priority than the allocation priority of the Radio Link to be established or modified. The Radio Links to be pre-empted shall be selected in ascending order of the retention priority.

When the pre-emption process detects that one or more Radio Links have to be pre-empted to free resources for a Radio Link(s) to be established or modified, the DRNS shall initiate the Radio Link Pre-emption procedure for all the UE Contexts having Radio Links selected for pre-emption and start the T_{Preempt} timer.

When enough resources are freed to establish or modify the Radio Link(s) according to the request, the DRNS shall stop the T_{Preempt} timer and complete the procedure that triggered the pre-emption process in accordance with the "Successful Operation" subclause of the procedure.

If the T_{Preempt} timer expires, the DRNS shall regard the procedure that triggered the pre-emption process as failed and complete the procedure in accordance with the "Unsuccessful Operation" subclause of the procedure.

Annex B (informative): Measurement Reporting

When the *Report Characteristics* IE is set to "Event A" (figure B.1), the Measurement Reporting procedure is initiated when the measured entity rises above the requested threshold and stays there for the requested hysteresis time. If no hysteresis time is given, the value zero shall be used for the hysteresis time.

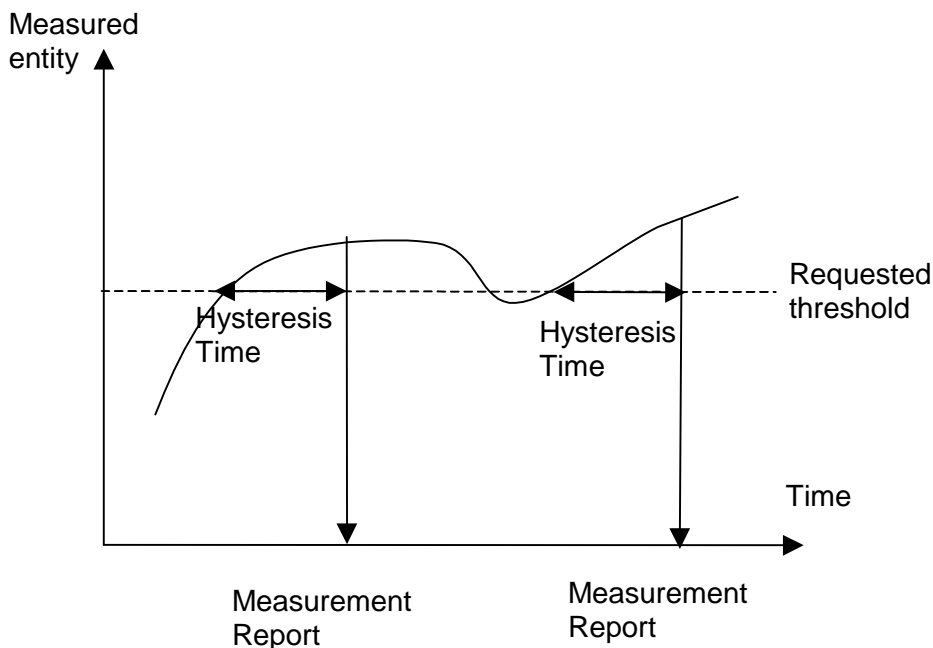

Figure B.1: Event A reporting with Hysteresis Time specified

When the *Report Characteristics* IE is set to "Event B" (figure B.2), the Measurement Reporting procedure is initiated when the measured entity falls below the requested threshold and stays there for the requested hysteresis time. If no hysteresis time is given, the value zero shall be used for the hysteresis time.

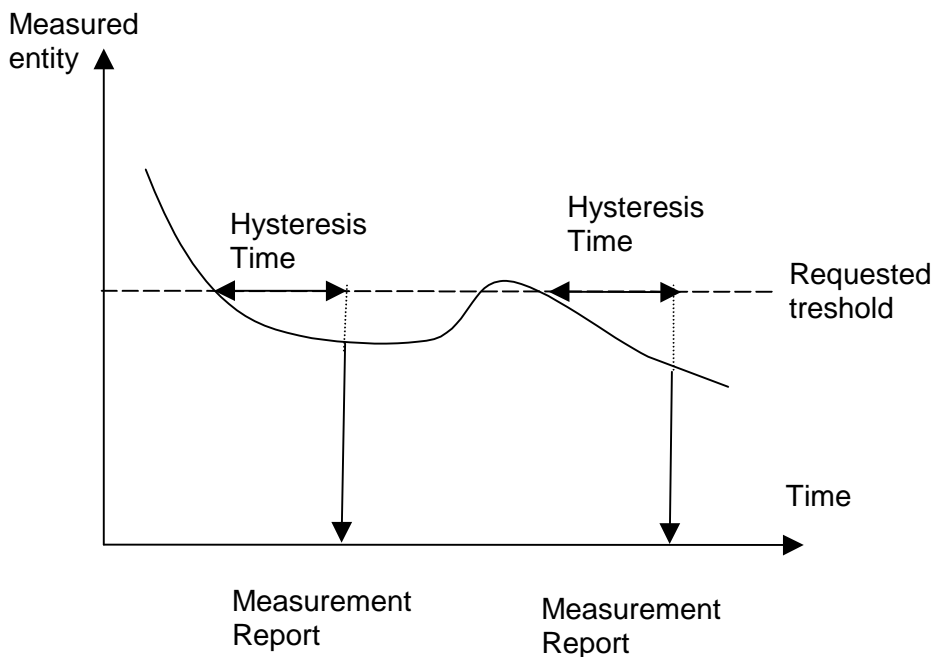

Figure B.2: Event B reporting with Hysteresis Time specified

When the *Report Characteristics* IE is set to "Event C" (figure B.3), the Measurement Reporting procedure is initiated always when the measured entity rises by an amount greater than the requested threshold within the requested time. The reporting in figure B.3 is initiated if the Rising Time T1 is less than the requested time.

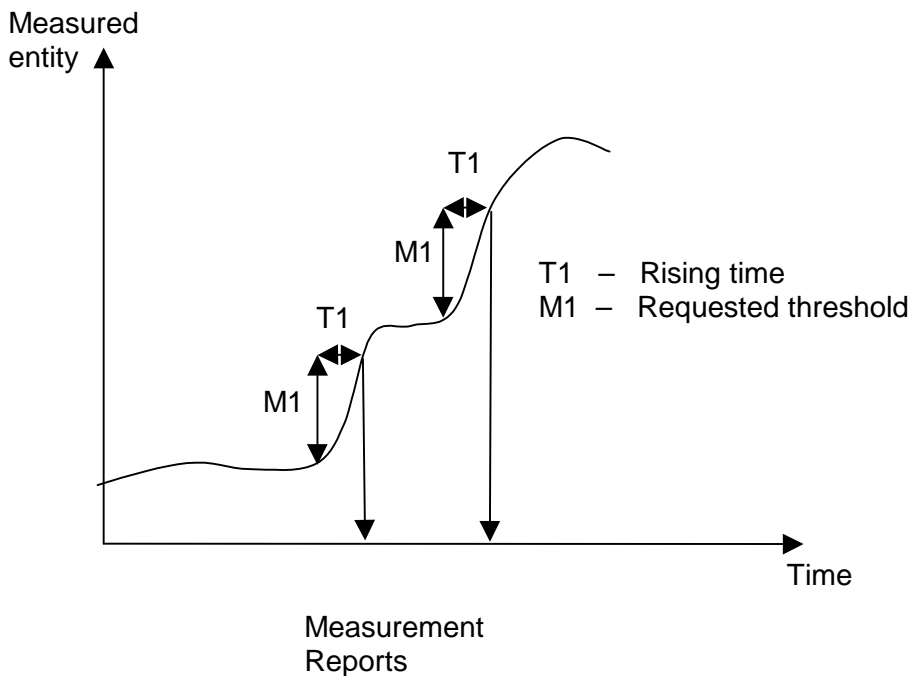

Figure B.3: Event C reporting

When the *Report Characteristics* IE is set to "Event D" (figure B.4), the Measurement Reporting procedure is initiated always when the measured entity falls by an amount greater than the requested threshold within the requested time. The reporting in figure B.4 is initiated if the Falling Time T1 is less than the requested time.

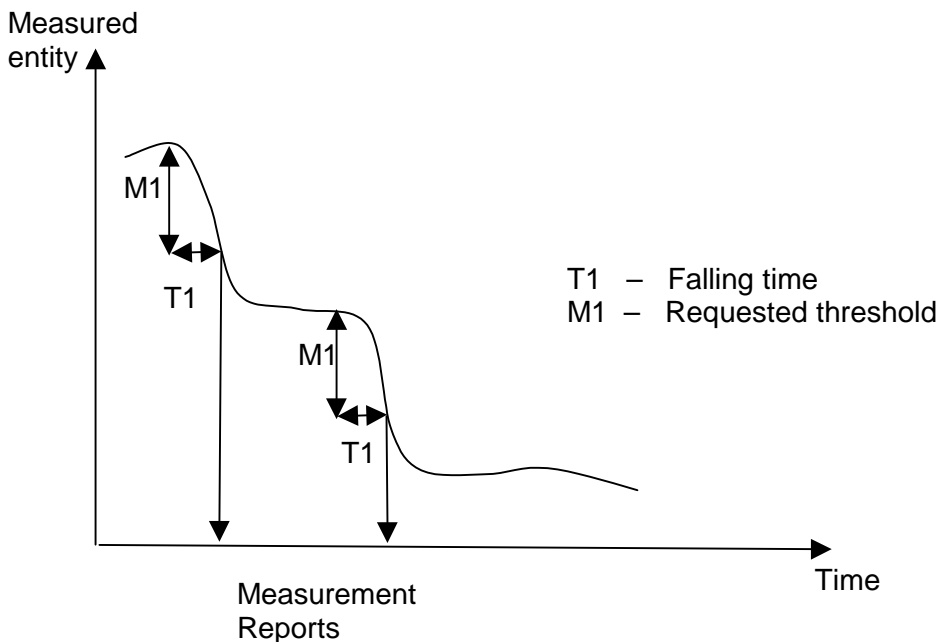

Figure B.4: Event D reporting

When the *Report Characteristics* IE is set to "Event E" (figure B.5), the Measurement Reporting procedure (Report A) is initiated always when the measured entity rises above the "Measurement Threshold 1" and stays there for the "Measurement Hysteresis Time" (T1 in figure B.5). If *Report Periodicity* IE is provided DRNS shall also initiate Measurement Reporting procedure periodically. The periodic reporting continues although the measured entity falls below the "Measurement Threshold 1" and is terminated by the Report B.

When the Report A conditions have been met and the measured entity falls below the "Measurement Threshold 2" and stays there for the "Measurement Hysteresis Time" (T1) the Measurement Reporting procedure (Report B) is initiated and the periodic reporting is terminated.

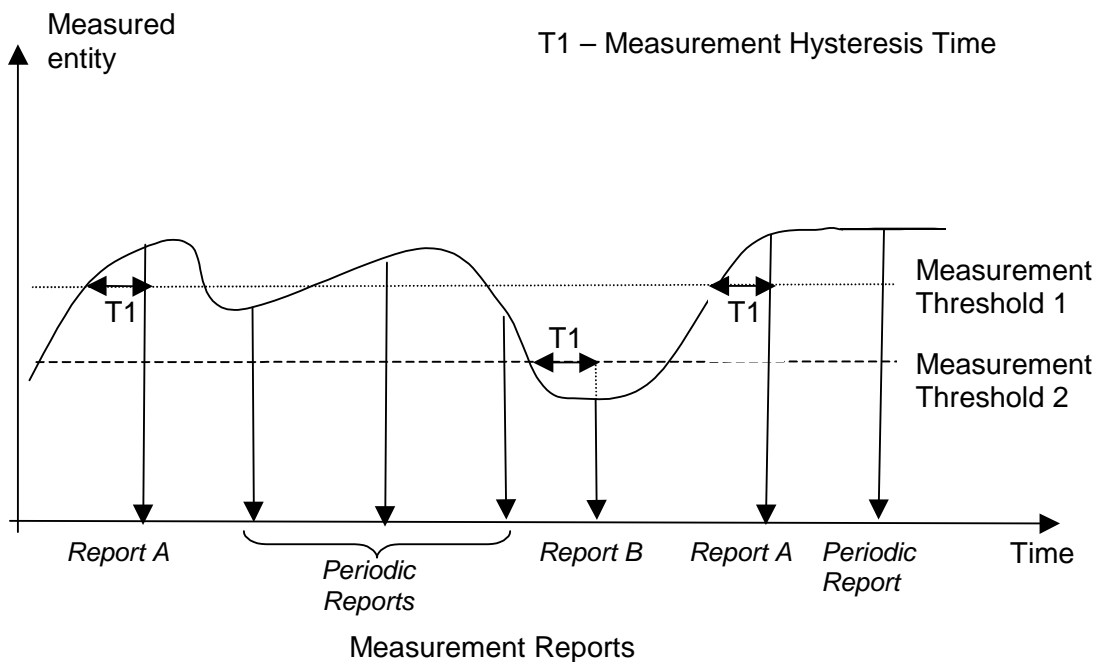

Figure B.5: Event E reporting with Hysteresis Time specified and Periodic Reporting requested

When the *Report Characteristics* IE is set to "Event F" (figure B.6), the Measurement Reporting procedure (Report A) is initiated always when the measured entity falls below the "Measurement Threshold 1" and stays there for the "Measurement Hysteresis Time" (T1 in figure B.6). If *Report Periodicity* IE is provided DRNS shall also initiate Measurement Reporting procedure periodically. The periodic reporting continues although the measured entity rises above the "Measurement Threshold 1" and is terminated by the Report B.

When the Report A conditions have been met and the measured entity rises above the "Measurement Threshold 2" and stays there for the "Measurement Hysteresis Time" (T1) the Measurement Reporting procedure (Report B) is initiated and the periodic reporting is terminated.

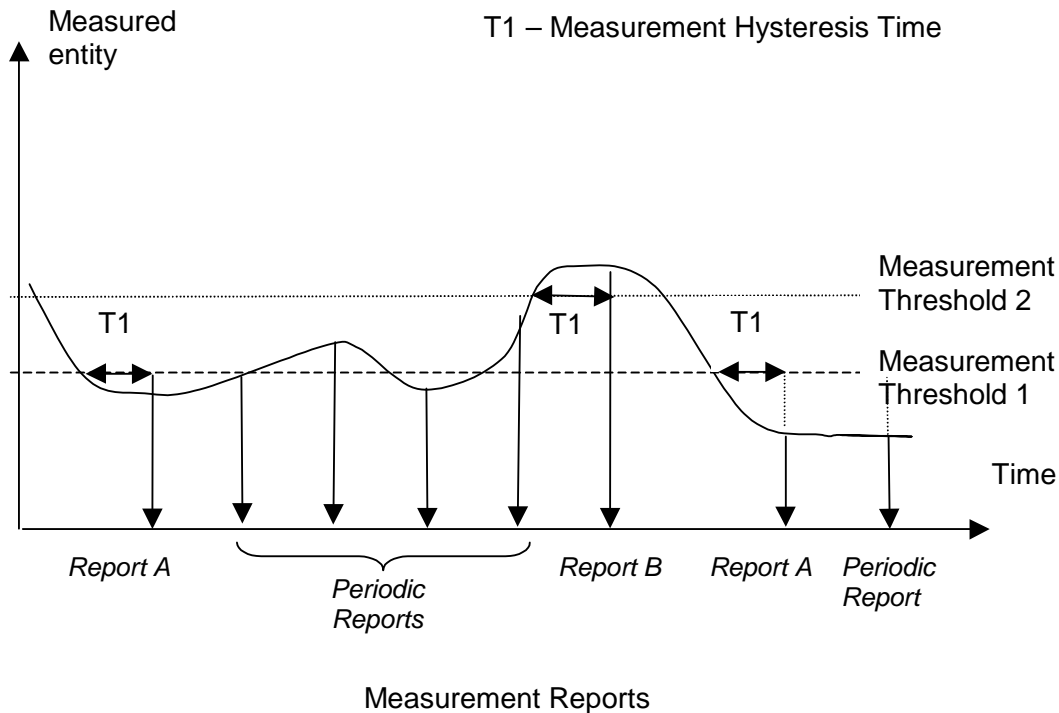

Figure B.6: Event F reporting with Hysteresis Time specified and Periodic

Annex C (informative): Guidelines for Usage of the Criticality Diagnostics IE

C.1 EXAMPLE MESSAGE Layout

Assume the following message format:

IE/Group Name	Presence	Range	IE Type and Reference	Semantics Description	Criticality	Assigned Criticality
Message Type	M				YES	reject
Transaction ID	M				-	
A	M				YES	reject
B	M				YES	reject
>E		1..<maxE>			EACH	ignore
>>F		1..<maxF>			-	
>>>G		0..3, ...			EACH	ignore
>>H		1..<maxH>			EACH	ignore
>>>G		0..3, ...			EACH	ignore and notify
>>G	M				YES	reject
>>J		1..<maxJ>			-	
>>>G		0..3, ...			EACH	reject
C	M				YES	reject
>K		1..<maxK>			EACH	ignore and notify
>>L		1..<maxL>			-	
>>>M	O				-	
D	M				YES	reject

Note 1. The IEs F, J, and L do not have assigned criticality. The IEs F, J, and L are consequently realised as the ASN.1 type SEQUENCE OF of "ordinary" ASN.1 type, e.g. INTEGER. On the other hand, the repeatable IEs with assigned criticality are realised as the ASN.1 type SEQUENCE OF of an IE object, e.g. ProtocolIE-Single-Container.

For the corresponding ASN.1 layout, see subclause C.4.

C.2 Example on a Received EXAMPLE MESSAGE

Assume further more that a received message based on the above tabular format is according to the figure below.

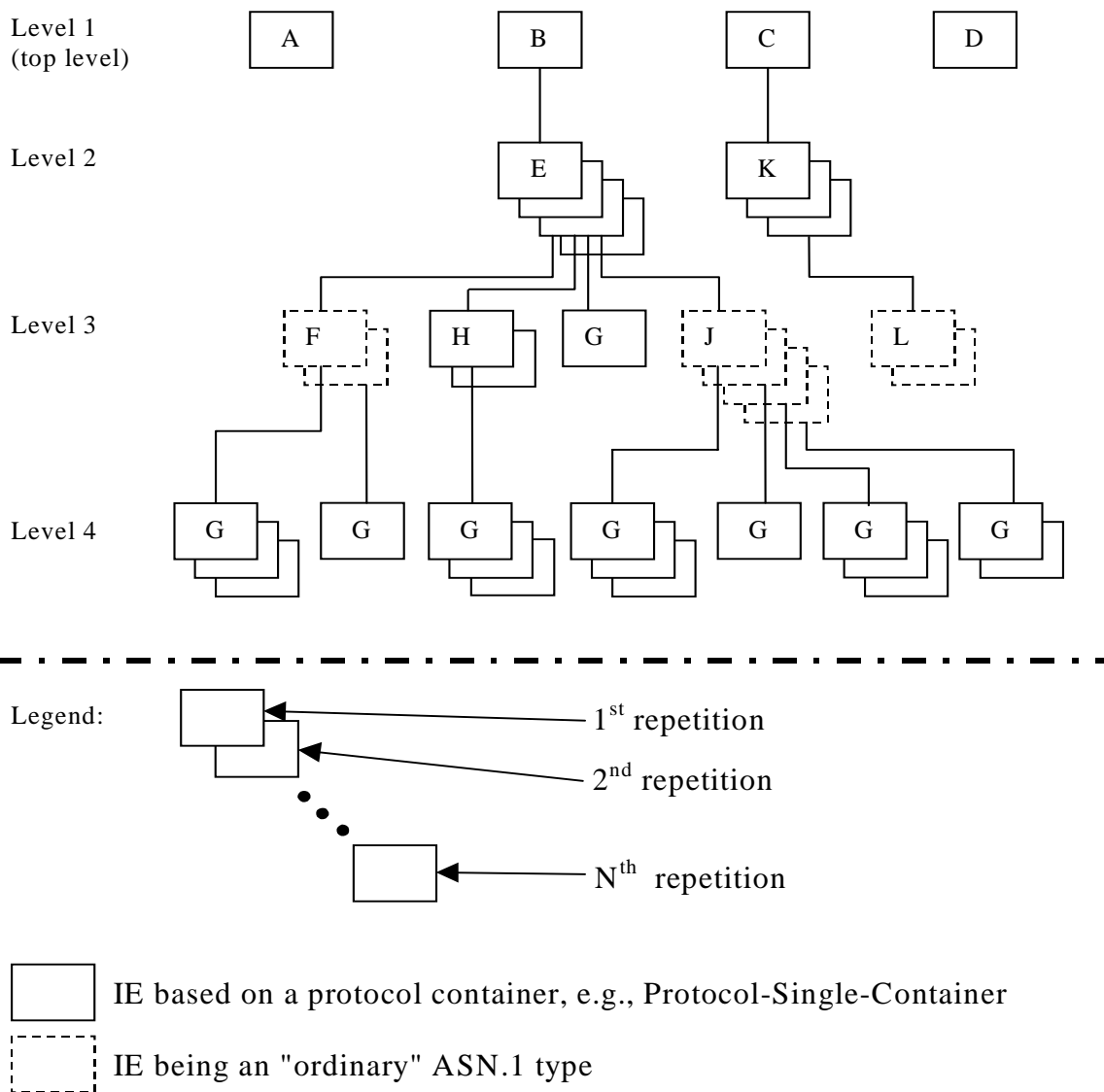

Figure C.1: Example of content of a received RNSAP message based on the EXAMPLE MESSAGE

C.3 Content of Criticality Diagnostics

C.3.1 Example 1

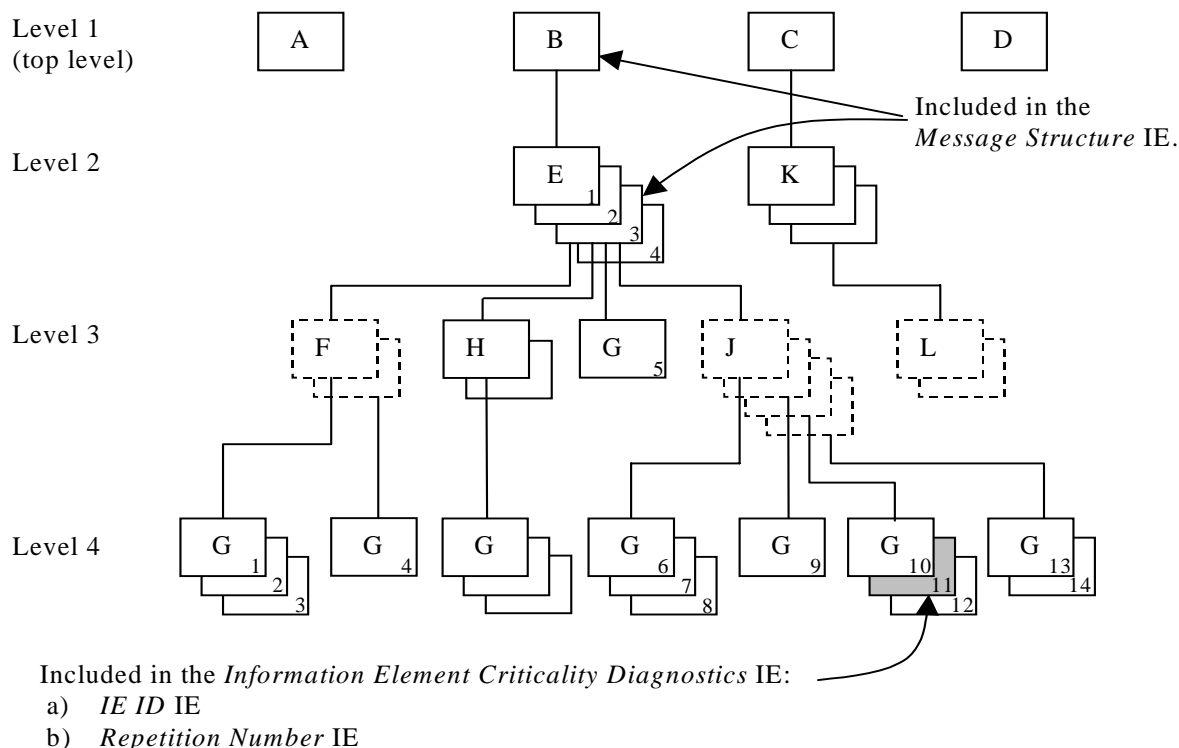

Figure C.2: Example of a received RNSAP message containing a not comprehended IE

If there is an error within the instance marked as grey in the IE G in the IE J shown in the figure C.2 above, this will be reported within the *Information Element Criticality Diagnostics* IE within the *Criticality Diagnostics* IE as follows:

IE name	Value	Comment
IE Criticality	reject	Criticality for IE on the reported level, i.e. level 4.
IE ID	id-G	IE ID from the reported level, i.e. level 4.
Repetition Number	11	Repetition number on the reported level, i.e. level 4. (Since the IE E (level 2) is the lowest level included in the <i>Message Structure</i> IE this is the eleventh occurrence of IE G within the IE E (level 2).)
Type of Error	not understood	
<i>Message Structure, first repetition</i>		
>IE ID	id-B	IE ID from level 1.
<i>Message Structure, second repetition</i>		
>IE ID	id-E	IE ID from the lowest level above the reported level, i.e. level 2.
>Repetition Number	3	Repetition number from the lowest level above the reported level, i.e. level 2.

Note 2. The IE J on level 3 cannot be included in the *Message Structure* IE since they have no criticality of their own.

Note 3. The repetition number of the reported IE indicates the number of repetitions of IE G received up to the detected erroneous repetition, counting all occurrences of the IE G below the same instance of the previous level with assigned criticality (instance 3 of IE E on level 2).

C.3.2 Example 2

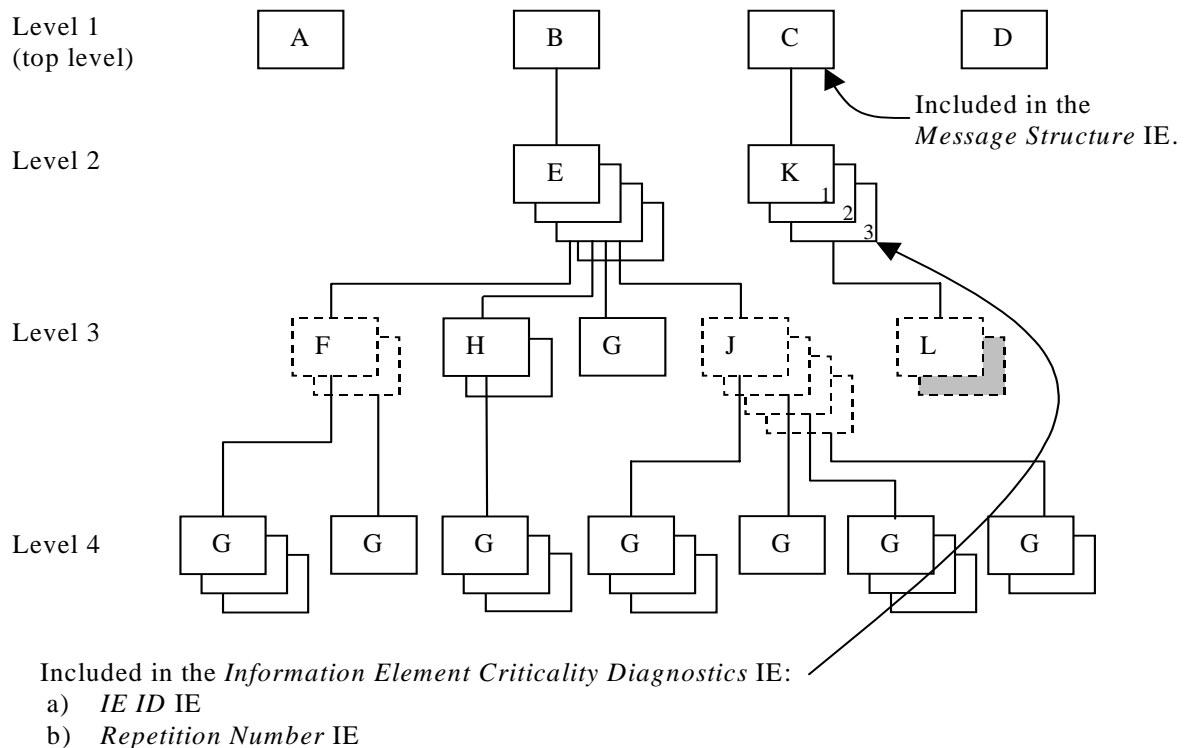

Figure C.3: Example of a received RNSAP message containing a not comprehended IE

If there is an error within the second instance (marked as grey) in the sequence (IE L in the tabular format) on level 3 below IE K in the structure shown in the figure C.3 above, this will be reported within the *Information Element Criticality Diagnostics* IE within the *Criticality Diagnostics* IE as follows:

IE name	Value	Comment
IE Criticality	ignore and notify	Criticality for IE on the reported level, i.e. level 2.
IE ID	id-K	IE ID from the reported level, i.e. level 2.
Repetition Number	3	Repetition number on the reported level, i.e. level 2.
Type of Error	not understood	
<i>Message Structure, first repetition</i>		
>IE ID	id-C	IE ID from the lowest level above the reported level, i.e. level 1.

Note 4. The IE L on level 3 cannot be reported individually included in the *Message Structure* IE since it has no criticality of its own.

C.3.3 Example 3

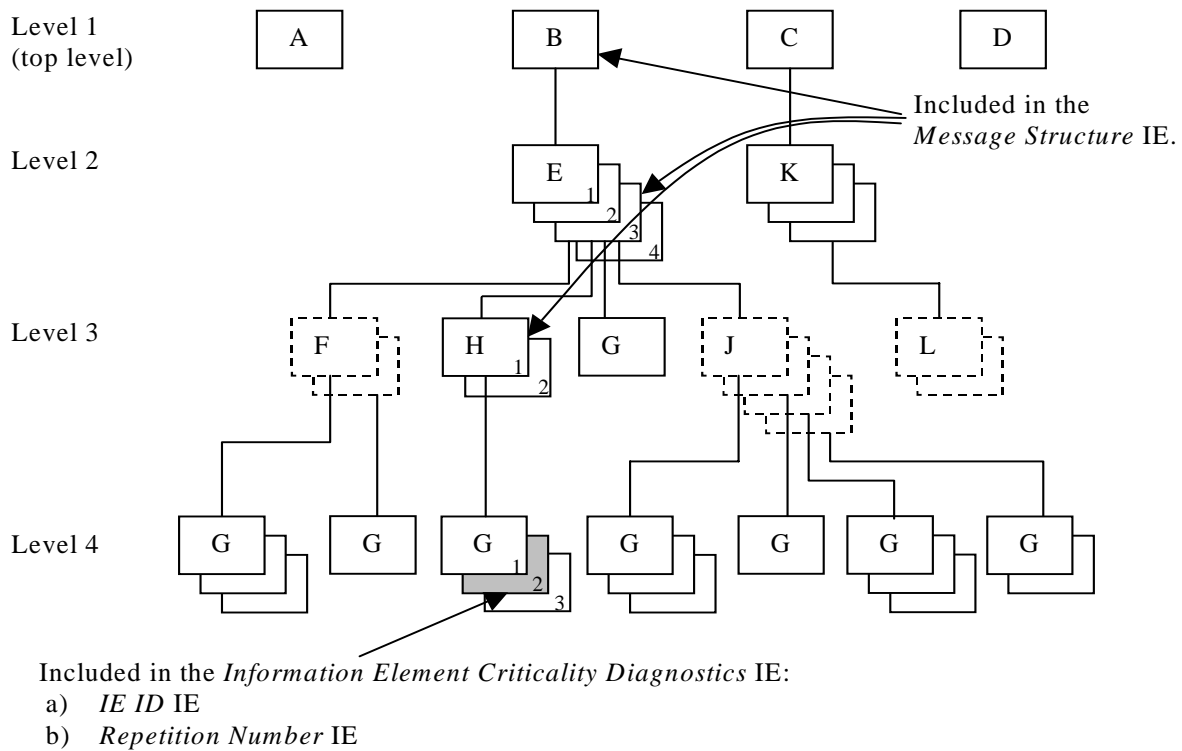

Figure C.4: Example of a received RNSAP message containing a not comprehended IE

If there is an error within the instance marked as grey in the IE G in the IE H shown in the figure C.4 above, this will be reported within the *Information Element Criticality Diagnostics* IE within the *Criticality Diagnostics* IE as follows:

IE name	Value	Comment
IE Criticality	ignore and notify	Criticality for IE on the reported level, i.e. level 4.
IE ID	id-G	IE ID from the reported level, i.e. level 4.
Repetition Number	2	Repetition number on the reported level, i.e. level 4.
Type of Error	not understood	
<i>Message Structure, first repetition</i>		
>IE ID	id-B	IE ID from level 1.
<i>Message Structure, second repetition</i>		
>IE ID	id-E	IE ID from level 2.
>Repetition Number	3	Repetition number from level 2.
<i>Message Structure, third repetition</i>		
>IE ID	id-H	IE ID from the lowest level above the reported level, i.e. level 3.
>Repetition Number	1	Repetition number from the lowest level above the reported level, i.e. level 3.

Note 5. The repetition number of level 4 indicates the number of repetitions of IE G received up to the detected erroneous repetition, counted below the same instance of the previous level with assigned criticality (instance 1 of IE H on level 3).

C.3.4 Example 4

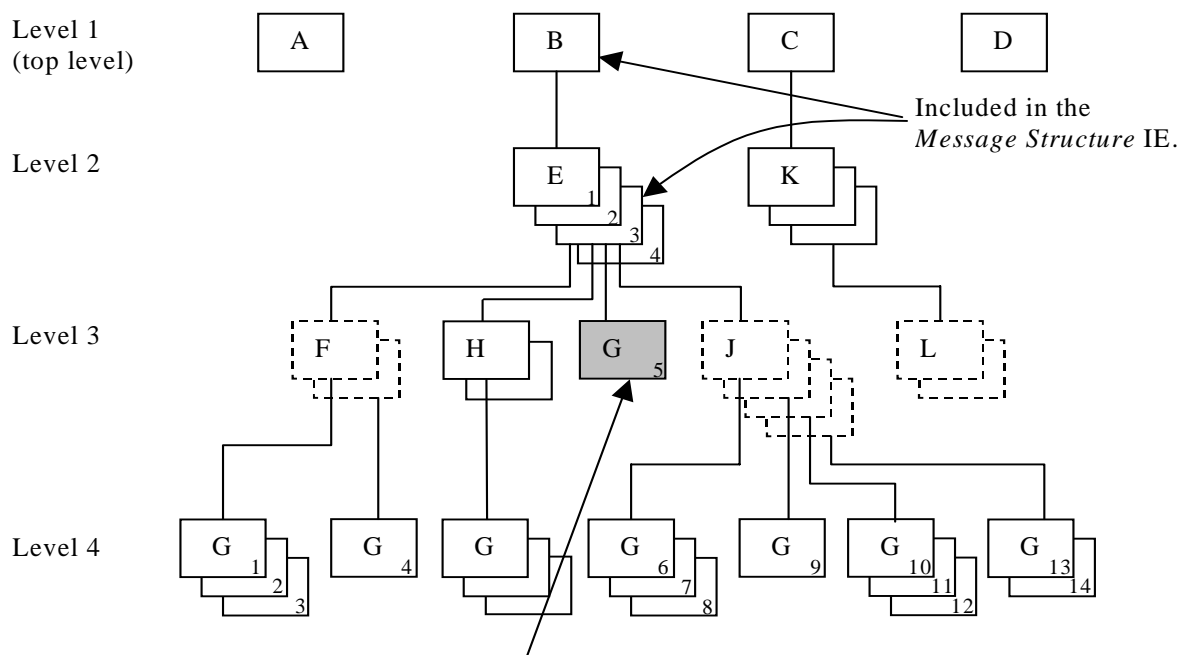

Included in the *Information Element Criticality Diagnostics IE*:

- a) *IE ID IE*
- b) *Repetition Number IE*

Figure C.5: Example of a received RNSAP message containing a not comprehended IE

If there is an error within the instance marked as grey in the IE G in the IE E shown in the figure C.5 above, this will be reported within the *Information Element Criticality Diagnostics IE* within the *Criticality Diagnostics IE* as follows:

IE name	Value	Comment
IE Criticality	Reject	Criticality for IE on the reported level, i.e. level 3.
IE ID	id-G	IE ID from the reported level, i.e. level 3.
Repetition Number	5	Repetition number on the reported level, i.e. level 3. (Since the IE E (level 2) is the lowest level included in the <i>Message Structure IE</i> this is the fifth occurrence of IE G within the IE E (level 2).
Type of Error	Not understood	
<i>Message Structure, first repetition</i>		
>IE ID	id-B	IE ID from level 1.
<i>Message Structure, second repetition</i>		
>IE ID	id-E	IE ID from the lowest level above the reported level, i.e. level 2.
>Repetition Number	3	Repetition number from the lowest level above the reported level, i.e. level 2.

Note 6. The repetition number of the reported IE indicates the number of repetitions of IE G received up to the detected erroneous repetition, counting all occurrences of the IE G below the same instance of the previous level with assigned criticality (instance 3 of IE E on level 2).

C.3.5 Example 5

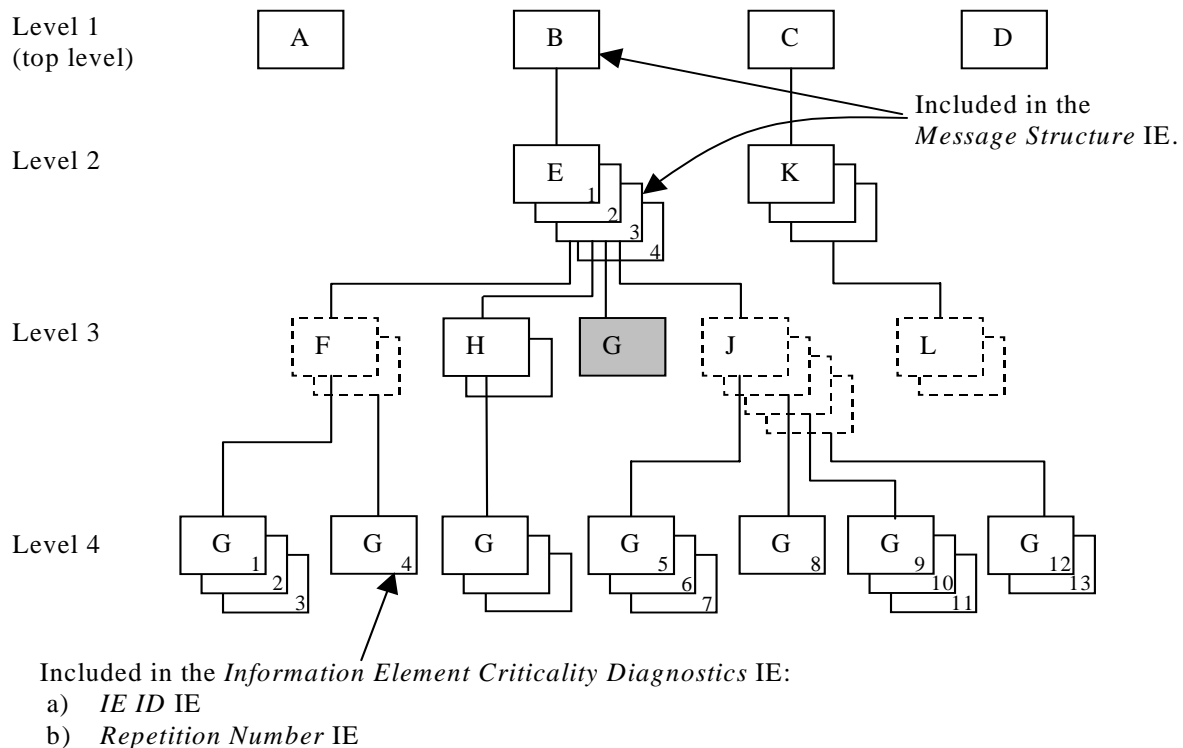

Figure C.6: Example of a received RNSAP message with a missing IE

If the instance marked as grey in the IE G in the IE E shown in the figure C.6 above, is missing this will be reported within the *Information Element Criticality Diagnostics* IE within the *Criticality Diagnostics* IE as follows:

IE name	Value	Comment
IE Criticality	reject	Criticality for IE on the reported level, i.e. level 3.
IE ID	id-G	IE ID from the reported level, i.e. level 3.
Repetition Number	4	Repetition number up to the missing IE on the reported level, i.e. level 3. (Since the IE E (level 2) is the lowest level included in the <i>Message Structure</i> IE there have been four occurrences of IE G within the IE E (level 2) up to the missing occurrence.
Type of Error	missing	
<i>Message Structure, first repetition</i>		
>IE ID	id-B	IE ID from level 1.
<i>Message Structure, second repetition</i>		
>IE ID	id-E	IE ID from the lowest level above the reported level, i.e. level 2.
>Repetition Number	3	Repetition number from the lowest level above the reported level, i.e. level 2.

Note 7. The repetition number of the reported IE indicates the number of repetitions of IE G received up to but not including the missing occurrence, counting all occurrences of the IE G below the same instance of the previous level with assigned criticality (instance 3 of IE E on level 2).

C.4 ASN.1 of EXAMPLE MESSAGE

```

ExampleMessage ::= SEQUENCE {
    ProtocolIEs          ProtocolIE-Container          {{ExampleMessage-IEs}},
    ProtocolExtensions  ProtocolExtensionContainer  {{ExampleMessage-Extensions}}  OPTIONAL,
    ...
}

ExampleMessage-IEs RNSAP-PROTOCOL-IES ::= {
    { ID id-A    CRITICALITY reject  TYPE A  PRESENCE mandatory } |
    { ID id-B    CRITICALITY reject  TYPE B  PRESENCE mandatory } |
    { ID id-C    CRITICALITY reject  TYPE C  PRESENCE mandatory } |
    { ID id-D    CRITICALITY reject  TYPE D  PRESENCE mandatory } ,
    ...
}

B ::= SEQUENCE {
    e                E-List,
    iE-Extensions   ProtocolExtensionContainer { {B-ExtIEs} }  OPTIONAL,
    ...
}

B-ExtIEs RNSAP-PROTOCOL-EXTENSION ::= {
    ...
}

E-List ::= SEQUENCE (SIZE (1..maxE)) OF ProtocolIE-Single-Container { {E-IEs} }

E-IEs RNSAP-PROTOCOL-IES ::= {
    { ID id-E    CRITICALITY ignore  TYPE E  PRESENCE mandatory }
}

E ::= SEQUENCE {
    f                F-List,
    h                H-List,
    g                G-List1,
    j                J-List,
    iE-Extensions   ProtocolExtensionContainer { {E-ExtIEs} }  OPTIONAL,
    ...
}

E-ExtIEs RNSAP-PROTOCOL-EXTENSION ::= {
    ...
}

F-List ::= SEQUENCE (SIZE (1..maxF)) OF F

F ::= SEQUENCE {
    g                G-List2 OPTIONAL,
    iE-Extensions   ProtocolExtensionContainer { {F-ExtIEs} }  OPTIONAL,
    ...
}

F-ExtIEs RNSAP-PROTOCOL-EXTENSION ::= {
    ...
}

G-List2 ::= SEQUENCE (SIZE (1..3, ...)) OF ProtocolIE-Single-Container { {G2-IEs} }

G2-IEs RNSAP-PROTOCOL-IES ::= {
    { ID id-G    CRITICALITY ignore  TYPE G  PRESENCE mandatory }
}

H-List ::= SEQUENCE (SIZE (1..maxH)) OF ProtocolIE-Single-Container { {H-IEs} }

H-IEs RNSAP-PROTOCOL-IES ::= {
    { ID id-H    CRITICALITY ignore  TYPE H  PRESENCE mandatory }
}

H ::= SEQUENCE {
    g                G-List3 OPTIONAL,
    iE-Extensions   ProtocolExtensionContainer { {H-ExtIEs} }  OPTIONAL,
    ...
}

H-ExtIEs RNSAP-PROTOCOL-EXTENSION ::= {

```

```

}
...
}
G-List3 ::= SEQUENCE (SIZE (1..3, ...)) OF ProtocolIE-Single-Container { {G3-IEs} }

G3-IEs RNSAP-PROTOCOL-IES ::= {
  { ID id-G    CRITICALITY notify  TYPE G  PRESENCE mandatory }
}

G-List1 ::= ProtocolIE-Single-Container { {G1-IEs} }

G1-IEs RNSAP-PROTOCOL-IES ::= {
  { ID id-G    CRITICALITY reject  TYPE G  PRESENCE mandatory }
}

J-List ::= SEQUENCE (SIZE (1..maxJ)) OF J

J ::= SEQUENCE {
  g                G-List4 OPTIONAL,
  iE-Extensions   ProtocolExtensionContainer { {J-ExtIEs} } OPTIONAL,
  ...
}

J-ExtIEs RNSAP-PROTOCOL-EXTENSION ::= {
  ...
}

G-List4 ::= SEQUENCE (SIZE (1..3, ...)) OF ProtocolIE-Single-Container { {G4-IEs} }

G4-IEs RNSAP-PROTOCOL-IES ::= {
  { ID id-G    CRITICALITY reject  TYPE G  PRESENCE mandatory }
}

C ::= SEQUENCE {
  k                K-List,
  iE-Extensions   ProtocolExtensionContainer { {C-ExtIEs} } OPTIONAL,
  ...
}

C-ExtIEs RNSAP-PROTOCOL-EXTENSION ::= {
  ...
}

K-List ::= SEQUENCE (SIZE (1..maxK)) OF ProtocolIE-Single-Container { {K-IEs} }

K-IEs RNSAP-PROTOCOL-IES ::= {
  { ID id-K    CRITICALITY notify  TYPE K  PRESENCE mandatory }
}

K ::= SEQUENCE {
  l                L-List,
  iE-Extensions   ProtocolExtensionContainer { {K-ExtIEs} } OPTIONAL,
  ...
}

K-ExtIEs RNSAP-PROTOCOL-EXTENSION ::= {
  ...
}

L-List ::= SEQUENCE (SIZE (1..maxL)) OF L

L ::= SEQUENCE {
  m                M OPTIONAL,
  iE-Extensions   ProtocolExtensionContainer { {L-ExtIEs} } OPTIONAL,
  ...
}

L-ExtIEs RNSAP-PROTOCOL-EXTENSION ::= {
  ...
}

ExampleMessage-Extensions RNSAP-PROTOCOL-EXTENSION ::= {
  ...
}

```

Annex D (normative): DRNS Behaviour at SRNC or RNSAP Signalling Bearer Failure

This annex describes the DRNC actions in the event of SRNC or RNSAP Signalling Bearer failure when all or some of the UE Contexts related to the SRNC need to be removed in DRNC.

D.1 Detection of SRNC or RNSAP Signalling Bearer/Connection Failure

Termination of all or some of the UE Contexts in DRNC which are related to an SRNC may be triggered due to failure of SRNC, RNSAP Signalling Bearer or the Iur signalling connection of an UE(s).

D.1.1 Termination of All UE Contexts Related to a Specific SRNC

Termination of all UE Contexts in DRNC which are related to a specific SRNC is triggered if the RNSAP Signalling Bearer failure is detected by the RNSAP according to the procedure described in the sub-clause 4.5.1.5.1 of TS 25.420. By "all" UE Contexts, it means all UEs having dedicated and/or common channel resources.

D.1.2 Termination of Specific UE Context

Termination of a specific UE Context in DRNC is triggered for an UE which has dedicated transport channel resources according to the procedure described in the sub-clause 4.5.1.5.2 of TS 25.420.

D.2 DRNC Actions at UE Context Termination

When termination of the UE Context is required, the DRNC shall remove any common and/or dedicated radio resources related to the UE Context. The DRNC shall also initiate release of the dedicated or common user plane resources that were involved in these UE Contexts. In addition, if it is possible the DRNC shall release the RRC connection.

Annex E (informative): Change History

Change history					
TSG RAN#	Version	CR	Tdoc RAN	New Version	Subject/Comment
RAN_06	-	-	RP-99755	3.0.0	Approved at TSG RAN #6 and placed under Change Control
RAN_07	3.0.0	-	RP-000100	3.1.0	Approved at TSG RAN #7
RAN_07	3.0.0	-	RP-000143	3.1.0	Approved at TSG RAN #7
RAN_07	3.0.0	-	RP-000146	3.1.0	Approved at TSG RAN #7
RAN_08	3.1.0	-	RP-000241	3.2.0	Approved at TSG RAN #8
RAN_08	3.1.0	-	RP-000242	3.2.0	Approved at TSG RAN #8
RAN_08	3.1.0	-	RP-000243	3.2.0	Approved at TSG RAN #8
RAN_08	3.1.0	-	RP-000244	3.2.0	Approved at TSG RAN #8
RAN_09	3.2.0	145-149, 151-154, 156-164, 166, 167	RP-000379	3.3.0	Approved at TSG RAN #9
RAN_09	3.2.0	168-171, 173, 174, 176, 178-180, 183-193	RP-000380	3.3.0	Approved at TSG RAN #9
RAN_09	3.2.0	194-200-	RP-000381	3.3.0	Approved at TSG RAN #9
RAN_10	3.3.0	202-219, 221-228, 230, 232-239, 241, 243-257, 259, 260, 263-265, 268-272, 274-278, 280, 281	RP-000618 RP-000619 RP-000621 RP-000696	3.4.0	Approved at TSG RAN #10
RAN_11	3.4.0	282-286, 288-293, 295-302, 304-308, 311, 313-319, 329, 332, 334-335	RP-010117 RP-010118	3.5.0	Approved at TSG RAN #11

RAN_12	3.5.0	340, 342, 344, 346, 348, 350, 352, 354, 356, 358	RP-010378	3.6.0	Approved at TSG RAN #12
RAN_12	3.5.0	360, 362, 364, 366, 368, 377, 381, 387, 394	RP-010379	3.6.0	Approved at TSG RAN #12
RAN_12	3.5.0	398, 402, 404, 406, 408, 410, 413	RP-010380	3.6.0	Approved at TSG RAN #12
RAN 13	3.6.0	370	R3-012210	3.7.0	Ambiguity in CM handling
RAN 13	3.6.0	417	R3-012240	3.7.0	Transport bearer replacement clarification
RAN 13	3.6.0	424	R3-012500	3.7.0	Correction to the Error handling of the ERROR INDICATION message
RAN 13	3.6.0	429	R3-012556	3.7.0	Corrections to the DSCH Code Mapping IE
RAN 13	3.6.0	431	R3-012668	3.7.0	Cell Reserved for operator use
RAN 13	3.6.0	436	R3-012560	3.7.0	Clarification of Abnormal Conditions/Unsuccessful Operation
RAN 13	3.6.0	439	R3-012576	3.7.0	TFCS Correction for TDD
RAN 13	3.6.0	441	R3-012328	3.7.0	Correction of a wrong implementation of CR 414
RAN 13	3.6.0	443	R3-012519	3.7.0	Error handling of the Erroneously Present Conditional Ies
RAN 13	3.6.0	445	R3-012578	3.7.0	Correction to Downlink Signaling Transfer
RAN 13	3.6.0	449	R3-012375	3.7.0	Bitstrings ordering
RAN 13	3.6.0	458	R3-012389	3.7.0	Correction of CR implementation errors
RAN 13	3.6.0	459	R3-012394	3.7.0	Mapping of TFCS to TFCl
RAN 13	3.6.0	462	R3-012405	3.7.0	TDD Channelisation code range definition
RAN 13	3.6.0	467	R3-012511	3.7.0	Rnsap criticality
RAN 13	3.6.0	469	R3-012651	3.7.0	Clarification of chapter 10
RAN 13	3.6.0	471	R3-012562	3.7.0	Clarification of use of Diversity Control Indicator
RAN 13	3.6.0	474	R3-012705	3.7.0	Clarification of coordinated DCHs
RAN 14	3.7.0	477	RP-010855	3.8.0	CR on Priority range
RAN 14	3.7.0	479	RP-010855	3.8.0	Bitstrings ordering
RAN 14	3.7.0	481	RP-010855	3.8.0	Added UTRAN modes in the Semantics Description in IEs in RNSAP messages
RAN 14	3.7.0	483	RP-010855	3.8.0	Alignment to RAN4 spec for Transmitted Code Power Measurement
RAN 14	3.7.0	490	RP-010855	3.8.0	TDD Transmit Diversity for P-CCPCH and S-CCPCH
RAN 14	3.7.0	496	RP-010855	3.8.0	Clarification for the definition of the ASN.1 constants
RAN 14	3.7.0	503	RP-010855	3.8.0	Terminology Corrections
RAN 14	3.7.0	508	RP-010855	3.8.0	Procedure Code Criticality in Error Indication
RAN 14	3.7.0	511	RP-010855	3.8.0	Clarification for the Power Adjustment Type IE in the DL POWER CONTROL REQUEST message
RAN 14	3.7.0	513	RP-010855	3.8.0	Forward Compatibility for DL Power Balancing
RAN 14	3.7.0	515	RP-010856	3.8.0	Reconfiguration clarification
RAN 14	3.7.0	517	RP-010856	3.8.0	DRNC behaviour at SRNC or RNSAP Signalling Bearer failure
RAN 14	3.7.0	519	RP-010856	3.8.0	Addition of amendment to clarify the PER encoding of bitstrings
RAN 14	3.7.0	524	RP-010856	3.8.0	Clarification on Primary CPICH Ec/No IE
RAN 14	3.7.0	526	RP-010856	3.8.0	Transport Bearer replacement clarification for the DSCH case
RAN 14	3.7.0	528	RP-010856	3.8.0	Clarification of the Transaction ID
RAN 14	3.7.0	531	RP-010856	3.8.0	Clarification of S Field Length usage
RAN 14	3.7.0	533	RP-010856	3.8.0	Correction the Clause 10 Error Handling
RAN 14	3.7.0	539	RP-010856	3.8.0	Correction to Primary CPICH handling in RL Setup procedure
RAN 15	3.8.0	541	RP-020169	3.9.0	RNSAP signalling support for flexible split
RAN 15	3.8.0	548	RP-020169	3.9.0	Setting of Initial power in a new CCTrCH in TDD
RAN 15	3.8.0	551	RP-020169	3.9.0	Removal of obsolete IMSI from ASN.1
RAN 15	3.8.0	559	RP-020169	3.9.0	Clarification to measurement unit at Higher Layer Filtering.

RAN 15	3.8.0	573	RP-020169	3.9.0	New UE identifier for MAC-c/sh multiplexing for DSCH
RAN 15	3.8.0			3.9.0	Correction to physical channels which SCTD can be applied (Iur)
RAN 15	3.8.0	580	RP-020169	3.9.0	
RAN 15	3.8.0	585	RP-020231	3.9.0	Removing of channel coding option "no coding" for FDD
RAN 16	3.9.0	590r2	RP-020406	3.10.0	Criticality Information Decoding Failure Handling
RAN 16	3.9.0	600r1	RP-020406	3.10.0	Alignment of tabular and ASN.1 coding for DL power
RAN 16	3.9.0	603r1	RP-020406	3.10.0	Correction to RL Restore Indication
RAN 16	3.9.0			3.10.0	New UE identifier for Shared Channel handling for TDD DSCH/USCH
RAN 16	3.9.0	609	RP-020406	3.10.0	
RAN 16	3.9.0	612	RP-020406	3.10.0	Clarification of Cell individual offset
RAN 16	3.9.0			3.10.0	Correction to the use of the CFN IE / SFN IE in the Measurement Initiation procedures
RAN 16	3.9.0	624	RP-020406	3.10.0	
RAN 16	3.9.0	630	RP-020406	3.10.0	TFCI 0 definition for TDD
RAN 16	3.9.0	633r1	RP-020406	3.10.0	CELL_DCH to CELL_FACH TDD correction
RAN 16	3.9.0	639r2	RP-020406	3.10.0	DSCH Information Correction
RAN 16	3.9.0	654r1	RP-020407	3.10.0	Clarification for the usage of the cause value
RAN 16	3.9.0	671	RP-020407	3.10.0	RNSAP Tabular alignment to ASN1 and other corrections
RAN 17	3.10.0	698r1	RP-020589	3.11.0	Replacing all occurrences of $P_{SIR}(k)$ by δP_{curr} in 25.423
RAN 17	3.10.0	703r2	RP-020603	3.11.0	Correction of the Error Indication
RAN 17	3.10.0	718r1	RP-020603	3.11.0	Correction to Compressed Mode in RL Addition Failure
RAN 18	3.11.0	754	RP-020744	3.12.0	Correction for the DL DPDCH transmission
RAN 18	3.11.0	761r1	RP-020743	3.12.0	DSCH-RNTI in RADIO LINK SETUP FAILURE
RAN 19	3.12.0	782r1	RP-030082	3.13.0	Corrections to Channelisation Code TFCI Mapping for TDD
RAN 19	3.12.0	788r5	RP-030183	3.13.0	Support of Cell Individual Offset in RNSAP
RAN 19	3.12.0	801	RP-030066	3.13.0	Corrections to DCH Combining in RL SETUP and RL ADDITION

History

Document history		
V3.0.0	January 2000	Publication
V3.1.0	March 2000	Publication
V3.2.0	June 2000	Publication
V3.3.0	September 2000	Publication
V3.4.0	December 2000	Publication
V3.5.0	March 2001	Publication
V3.6.0	June 2001	Publication
V3.7.0	September 2001	Publication
V3.8.0	December 2001	Publication
V3.9.0	March 2002	Publication
V3.10.0	June 2002	Publication
V3.11.0	September 2002	Publication
V3.12.0	December 2002	Publication
V3.13.0	March 2003	Publication